

ETSI TS 129 540 V19.4.0 (2026-02)



TECHNICAL SPECIFICATION

**5G;
5G System;
SMS Services;
Stage 3
(3GPP TS 29.540 version 19.4.0 Release 19)**



Reference

RTS/TSGC-0429540vj40

Keywords

5G

ETSI

650 Route des Lucioles
F-06921 Sophia Antipolis Cedex - FRANCE

Tel.: +33 4 92 94 42 00 Fax: +33 4 93 65 47 16

Siret N° 348 623 562 00017 - APE 7112B
Association à but non lucratif enregistrée à la
Sous-Préfecture de Grasse (06) N° w061004871

Important notice

The present document can be downloaded from the
[ETSI Search & Browse Standards](#) application.

The present document may be made available in electronic versions and/or in print. The content of any electronic and/or print versions of the present document shall not be modified without the prior written authorization of ETSI. In case of any existing or perceived difference in contents between such versions and/or in print, the prevailing version of an ETSI deliverable is the one made publicly available in PDF format on [ETSI deliver](#) repository.

Users should be aware that the present document may be revised or have its status changed,
this information is available in the [Milestones listing](#).

If you find errors in the present document, please send your comments to
the relevant service listed under [Committee Support Staff](#).

If you find a security vulnerability in the present document, please report it through our
[Coordinated Vulnerability Disclosure \(CVD\)](#) program.

Notice of disclaimer & limitation of liability

The information provided in the present deliverable is directed solely to professionals who have the appropriate degree of experience to understand and interpret its content in accordance with generally accepted engineering or other professional standard and applicable regulations.

No recommendation as to products and services or vendors is made or should be implied.

No representation or warranty is made that this deliverable is technically accurate or sufficient or conforms to any law and/or governmental rule and/or regulation and further, no representation or warranty is made of merchantability or fitness for any particular purpose or against infringement of intellectual property rights.

In no event shall ETSI be held liable for loss of profits or any other incidental or consequential damages.

Any software contained in this deliverable is provided "AS IS" with no warranties, express or implied, including but not limited to, the warranties of merchantability, fitness for a particular purpose and non-infringement of intellectual property rights and ETSI shall not be held liable in any event for any damages whatsoever (including, without limitation, damages for loss of profits, business interruption, loss of information, or any other pecuniary loss) arising out of or related to the use of or inability to use the software.

Copyright Notification

No part may be reproduced or utilized in any form or by any means, electronic or mechanical, including photocopying and microfilm except as authorized by written permission of ETSI.

The content of the PDF version shall not be modified without the written authorization of ETSI.

The copyright and the foregoing restriction extend to reproduction in all media.

© ETSI 2026.
All rights reserved.

Intellectual Property Rights

Essential patents

IPRs essential or potentially essential to normative deliverables may have been declared to ETSI. The declarations pertaining to these essential IPRs, if any, are publicly available for **ETSI members and non-members**, and can be found in ETSI SR 000 314: "*Intellectual Property Rights (IPRs); Essential, or potentially Essential, IPRs notified to ETSI in respect of ETSI standards*", which is available from the ETSI Secretariat. Latest updates are available on the [ETSI IPR online database](#).

Pursuant to the ETSI Directives including the ETSI IPR Policy, no investigation regarding the essentiality of IPRs, including IPR searches, has been carried out by ETSI. No guarantee can be given as to the existence of other IPRs not referenced in ETSI SR 000 314 (or the updates on the ETSI Web server) which are, or may be, or may become, essential to the present document.

Trademarks

The present document may include trademarks and/or tradenames which are asserted and/or registered by their owners. ETSI claims no ownership of these except for any which are indicated as being the property of ETSI, and conveys no right to use or reproduce any trademark and/or tradename. Mention of those trademarks in the present document does not constitute an endorsement by ETSI of products, services or organizations associated with those trademarks.

DECT™, **PLUGTESTS™**, **UMTS™** and the ETSI logo are trademarks of ETSI registered for the benefit of its Members. **3GPP™**, **LTE™** and **5G™** logo are trademarks of ETSI registered for the benefit of its Members and of the 3GPP Organizational Partners. **oneM2M™** logo is a trademark of ETSI registered for the benefit of its Members and of the oneM2M Partners. **GSM®** and the GSM logo are trademarks registered and owned by the GSM Association.

Legal Notice

This Technical Specification (TS) has been produced by ETSI 3rd Generation Partnership Project (3GPP).

The present document may refer to technical specifications or reports using their 3GPP identities. These shall be interpreted as being references to the corresponding ETSI deliverables.

The cross reference between 3GPP and ETSI identities can be found at [3GPP to ETSI numbering cross-referencing](#).

Modal verbs terminology

In the present document "**shall**", "**shall not**", "**should**", "**should not**", "**may**", "**need not**", "**will**", "**will not**", "**can**" and "**cannot**" are to be interpreted as described in clause 3.2 of the [ETSI Drafting Rules](#) (Verbal forms for the expression of provisions).

"**must**" and "**must not**" are **NOT** allowed in ETSI deliverables except when used in direct citation.

Contents

Intellectual Property Rights	2
Legal Notice	2
Modal verbs terminology.....	2
Foreword.....	5
1 Scope	7
2 References	7
3 Definitions and abbreviations.....	8
3.1 Definitions	8
3.2 Abbreviations	8
4 Overview	8
5 Services offered by the SMSF.....	9
5.1 Introduction	9
5.2 Nsmsf_SMSService Service.....	9
5.2.1 Service Description.....	9
5.2.2 Service Operations	10
5.2.2.1 Introduction.....	10
5.2.2.2 Activate	10
5.2.2.2.1 General	10
5.2.2.2.2 Registration procedure using Activate service operation	10
5.2.2.2.3 Modify UE Context in SMSF using HTTP PATCH Method	11
5.2.2.3 Deactivate.....	12
5.2.2.3.1 General	12
5.2.2.3.2 De-Registration procedure to remove SMS service authorization from SMSF.....	13
5.2.2.3.3 De-Registration procedure to remove SMS service authorization from SMSF for one of the registered Access Type.....	13
5.2.2.4 UplinkSMS.....	14
5.2.2.4.1 General	14
5.2.2.4.2 Procedures of sending SMS payload in uplink direction using UplinkSMS service operation	14
5.2.2.5 MtForwardSm	15
5.2.2.5.1 General	15
5.2.2.5.2 Procedures of sending SMS payload in downlink direction using MtForwardSm service operation.....	15
6 API Definitions	16
6.1 Nsmsf_SMSService Service API	16
6.1.1 API URI.....	16
6.1.2 Usage of HTTP.....	16
6.1.2.1 General	16
6.1.2.2 HTTP standard headers	16
6.1.2.2.1 General	16
6.1.2.2.2 Content type	16
6.1.2.2.3 ETag	17
6.1.2.2.4 If-Match.....	17
6.1.2.3 HTTP custom headers	17
6.1.2.3.1 General	17
6.1.2.4 HTTP multipart messages	17
6.1.3 Resources.....	17
6.1.3.1 Overview.....	17
6.1.3.2 Resource: UEContexts (Store)	19
6.1.3.2.1 Description	19
6.1.3.2.2 Resource Definition.....	19
6.1.3.2.3 Resource Standard Methods	20
6.1.3.3 Resource: UEContext (Document).....	20

6.1.3.3.1	Description	20
6.1.3.3.2	Resource Definition	20
6.1.3.3.3	Resource Standard Methods	20
6.1.3.3.4	Resource Custom Operations	25
6.1.3.3.4.1	Overview	25
6.1.3.3.4.2	Operation: sendsms	25
6.1.3.3.4.2.1	Description	25
6.1.3.3.4.2.2	Operation Definition	25
6.1.3.3.4.3	Operation: send-mt-sms	26
6.1.3.3.4.3.1	Description	26
6.1.3.3.4.3.2	Operation Definition	27
6.1.4	Custom Operations without associated resources	28
6.1.5	Notifications	28
6.1.6	Data Model	28
6.1.6.1	General	28
6.1.6.2	Structured data types	29
6.1.6.2.1	Introduction	29
6.1.6.2.2	Type: UeSmsContextData	30
6.1.6.2.3	Type: SmsRecordData	31
6.1.6.2.4	Void	31
6.1.6.2.5	Type: SmsRecordDeliveryData	31
6.1.6.3	Simple data types and enumerations	31
6.1.6.3.1	Introduction	31
6.1.6.3.2	Simple data types	31
6.1.6.3.3	Enumeration: SmsDeliveryStatus	32
6.1.6.4	Binary data	32
6.1.6.4.1	Introduction	32
6.1.6.4.2	SMS Payload Information	32
6.1.7	Error Handling	32
6.1.7.1	General	32
6.1.7.2	Protocol Errors	32
6.1.7.3	Application Errors	32
6.1.8	Feature negotiation	33
6.1.9	Security	33
6.1.10	HTTP redirection	33
Annex A (normative): OpenAPI specification		35
A.1	General	35
A.2	Nsmsf_SMSService API	35
Annex B (Informative): HTTP Multipart Messages		43
B.1	Example of HTTP multipart message	43
B.2	Void	43
B.3	Example HTTP multipart message with SMS binary data	43
Annex C (informative): Change history		45
History		48

Foreword

This Technical Specification has been produced by the 3rd Generation Partnership Project (3GPP).

The contents of the present document are subject to continuing work within the TSG and may change following formal TSG approval. Should the TSG modify the contents of the present document, it will be re-released by the TSG with an identifying change of release date and an increase in version number as follows:

Version x.y.z

where:

- x the first digit:
 - 1 presented to TSG for information;
 - 2 presented to TSG for approval;
 - 3 or greater indicates TSG approved document under change control.
- y the second digit is incremented for all changes of substance, i.e. technical enhancements, corrections, updates, etc.
- z the third digit is incremented when editorial only changes have been incorporated in the document.

In the present document, modal verbs have the following meanings:

- shall** indicates a mandatory requirement to do something
- shall not** indicates an interdiction (prohibition) to do something

The constructions "shall" and "shall not" are confined to the context of normative provisions, and do not appear in Technical Reports.

The constructions "must" and "must not" are not used as substitutes for "shall" and "shall not". Their use is avoided insofar as possible, and they are not used in a normative context except in a direct citation from an external, referenced, non-3GPP document, or so as to maintain continuity of style when extending or modifying the provisions of such a referenced document.

- should** indicates a recommendation to do something
- should not** indicates a recommendation not to do something
- may** indicates permission to do something
- need not** indicates permission not to do something

The construction "may not" is ambiguous and is not used in normative elements. The unambiguous constructions "might not" or "shall not" are used instead, depending upon the meaning intended.

- can** indicates that something is possible
- cannot** indicates that something is impossible

The constructions "can" and "cannot" are not substitutes for "may" and "need not".

- will** indicates that something is certain or expected to happen as a result of action taken by an agency the behaviour of which is outside the scope of the present document
- will not** indicates that something is certain or expected not to happen as a result of action taken by an agency the behaviour of which is outside the scope of the present document
- might** indicates a likelihood that something will happen as a result of action taken by some agency the behaviour of which is outside the scope of the present document

might not indicates a likelihood that something will not happen as a result of action taken by some agency the behaviour of which is outside the scope of the present document

In addition:

is (or any other verb in the indicative mood) indicates a statement of fact

is not (or any other negative verb in the indicative mood) indicates a statement of fact

The constructions "is" and "is not" do not indicate requirements.

1 Scope

The present document specifies the stage 3 protocol and data model for the Nsmsf Service Based Interface. It provides stage 3 protocol definitions and message flows, and specifies the API for each service offered by the SMSF.

The 5G System stage 2 architecture and procedures are specified in 3GPP TS 23.501 [2] and 3GPP TS 23.502 [3].

The Technical Realization of the Service Based Architecture and the Principles and Guidelines for Services Definition are specified in 3GPP TS 29.500 [4] and 3GPP TS 29.501 [5].

2 References

The following documents contain provisions which, through reference in this text, constitute provisions of the present document.

- References are either specific (identified by date of publication, edition number, version number, etc.) or non-specific.
- For a specific reference, subsequent revisions do not apply.
- For a non-specific reference, the latest version applies. In the case of a reference to a 3GPP document (including a GSM document), a non-specific reference implicitly refers to the latest version of that document *in the same Release as the present document*.

- [1] 3GPP TR 21.905: "Vocabulary for 3GPP Specifications".
- [2] 3GPP TS 23.501: "System Architecture for the 5G System; Stage 2".
- [3] 3GPP TS 23.502: "Procedures for the 5G System; Stage 2".
- [4] 3GPP TS 29.500: "5G System; Technical Realization of Service Based Architecture; Stage 3".
- [5] 3GPP TS 29.501: "5G System; Principles and Guidelines for Services Definition; Stage 3".
- [6] 3GPP TS 29.571: "5G System; Common Data Types for Service Based Interfaces; Stage 3".
- [7] IETF RFC 9113: "HTTP/2".
- [8] IETF RFC 8259: "The JavaScript Object Notation (JSON) Data Interchange Format".
- [9] IETF RFC 2387: "The MIME Multipart/Related Content-type".
- [10] IETF RFC 2045: "Multipurpose Internet Mail Extensions (MIME) Part One: Format of Internet Message Bodies".
- [11] 3GPP TS 23.040: "Technical realization of the Short Message Service (SMS)".
- [12] 3GPP TS 24.011: "Point-to-Point (PP) Short Message Service (SMS) support on mobile radio interface".
- [13] 3GPP TS 33.501: "Security architecture and procedures for 5G system".
- [14] IETF RFC 6749: "The OAuth 2.0 Authorization Framework".
- [15] 3GPP TS 29.510: "Network Function Repository Services; Stage 3".
- [16] 3GPP TR 21.900: "Technical Specification Group working methods".
- [17] IETF RFC 9457: "Problem Details for HTTP APIs".
- [18] Void.
- [19] OpenAPI: "OpenAPI Specification Version 3.0.0", <https://spec.openapis.org/oas/v3.0.0>.

- [20] IETF RFC 6902: "JavaScript Object Notation (JSON) Patch".
- [21] 3GPP TS 23.540: "5G System; Technical realization of Service Based Short Message Service Stage 2".
- [22] 3GPP TS 29.577: "5G System; IP Short Message Gateway and SMS Router For Short Message Services Stage 3".
- [23] IETF RFC 9110: "HTTP Semantics".

3 Definitions and abbreviations

3.1 Definitions

For the purposes of the present document, the terms and definitions given in 3GPP TR 21.905 [1] and the following apply. A term defined in the present document takes precedence over the definition of the same term, if any, in 3GPP TR 21.905 [1].

3.2 Abbreviations

For the purposes of the present document, the abbreviations given in 3GPP TR 21.905 [1] and the following apply. An abbreviation defined in the present document takes precedence over the definition of the same abbreviation, if any, in 3GPP TR 21.905 [1].

5GC	5G Core Network
AMF	Access Management Function
JSON	Javascript Object Notation
SMSF	SMS Function

4 Overview

Within the 5GC, the SMSF offers services to the AMF, SMS-GMSC, IP-SM-GW and SMS Router via the Nsmsf service based interface (see 3GPP TS 23.501 [2], 3GPP TS 23.502 [3] and 3GPP TS 23.540 [21]).

Figure 4.1 provides the reference model (in service based interface representation and in reference point representation), with focus on the SMSF and the scope of the present specification.

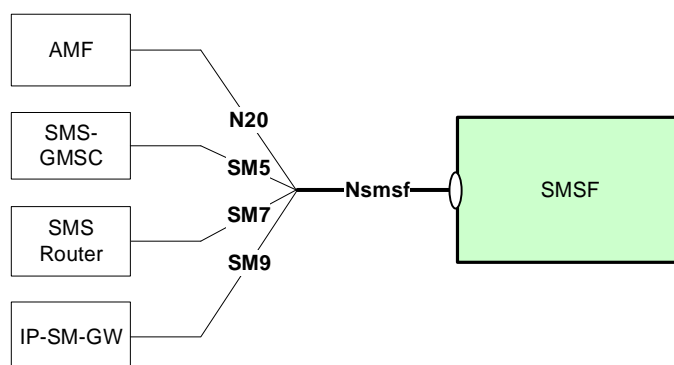

Figure 4-1: Reference model – SMSF

The functionalities supported by the SMSF are listed in clause 6.2.13 of 3GPP TS 23.501 [2].

The services and service operations provided by the Nsmf interface are listed in clause 5.2.9 of 3GPP TS 23.502 [3] and clause 6.4 of 3GPP TS 23.540 [21].

5 Services offered by the SMSF

5.1 Introduction

The SMSF supports the following services.

Table 5.1-1: NF Services provided by SMSF

Service Name	Description	Example Consumer
Nsmf_SMSService	This service allows AMF to authorize SMS and activate SMS for the served user on SMSF. This service also allows the SMS-GMSC, SMS Router and IP-SM-GW to send the SMS payload in downlink direction to the SMSF.	AMF, SMS-GMSC, SMS Router, IP-SM-GW

Table 5.1-2 summarizes the corresponding APIs defined for this specification.

Table 5.1-2: API Descriptions

Service Name	Clause	Description	OpenAPI Specification File	apiName	Annex
Nsmf_SMSService	6.1	SMSF SMSService	TS29540_Nsmf_SMSService.yaml	nsmsf-sms	A.2

5.2 Nsmf_SMSService Service

5.2.1 Service Description

The Nsmf_SMSService service provides the service capability for the NF Service Consumer (e.g. AMF) to authorize SMS and activate SMS for a service user on SMSF, for the NF Service Consumer (e.g. SMS GMSC, SMS Router and IP-SM-GW) to send the SMS payload in downlink direction to the SMSF. The following are the key functionalities of this NF service:

- Activation or deactivation of SMS service for a given service user, which results in creating/updating/deleting an UE Context for SMS in SMSF;
- Send SMS payload in uplink direction to SMSF;
- Send SMS payload in downlink direction to SMSF.

The Nsmf_SMSService service supports the following service operations.

Table 5.2.1-1: Service operations supported by the Nsmsf_SMSservice service

Service Operations	Description	Operation Semantics	Example Consumer(s)
Activate	Activate SMS service for a given service user, which results in creating or updating a UE Context for SMS in SMSF.	Request/Response	AMF
Deactivate	Deactivate SMS service for a given service user, which results in deleting or updating a UE Context for SMS in SMSF.	Request/Response	AMF
UplinkSMS	Send SMS payload in uplink direction to SMSF.	Request/Response	AMF
MtForwardSm	Send SMS payload in downlink direction to SMSF.	Request/Response	SMS-GMSC, SMS Router, IP-SM-GW

5.2.2 Service Operations

5.2.2.1 Introduction

This clause introduces the related procedures using Nsmsf_SMSservice service operations for supporting SMS service.

5.2.2.2 Activate

5.2.2.2.1 General

The Activate service operation shall be used by the NF Service Consumer (e.g. AMF) to activate SMS service for a given service user, which results in creating or updating an individual UE Context for SMS in the SMSF, in the following procedures:

- Registration Procedure for SMS over NAS (see clause 4.13.3.1 of 3GPP TS 23.502 [3]);
- Registration Update Procedure for SMS over NAS due to AMF change (see clause 4.13.3.1 of 3GPP TS 23.502 [3]);
- Registration Update Procedure for SMS over NAS to add authorization for SMS over a new additional Access Type;
- AMF initiated modification to UE Context in SMSF, e.g. modify the backup AMF information.

There shall be only one individual UE Context for SMS per service user.

5.2.2.2.2 Registration procedure using Activate service operation

The NF Service Consumer (e.g. AMF) shall activate SMS service for a given service user by using the HTTP PUT method as shown in Figure 5.2.2.2.2-1.

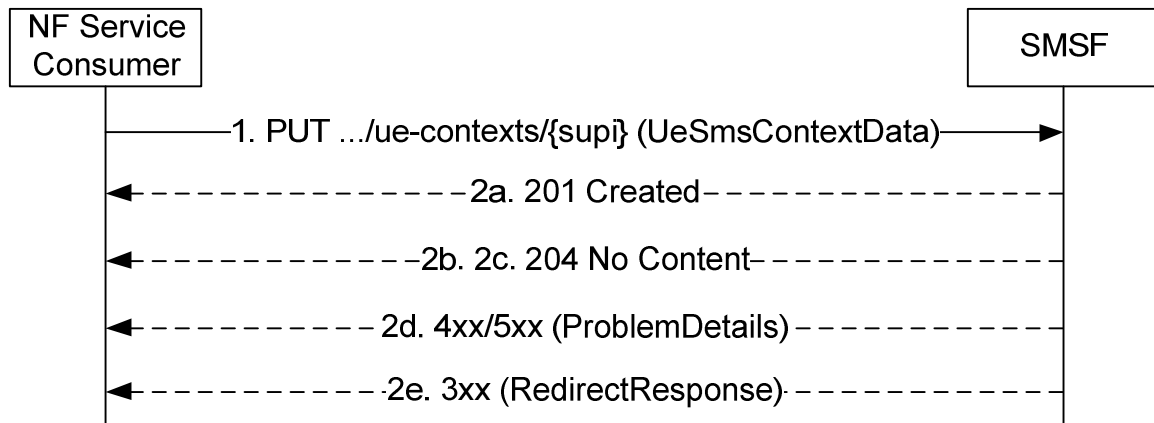

Figure 5.2.2.2-1: Activation of SMS service

1. The NF Service Consumer (e.g. AMF) shall send a PUT request to the resource representing the UE Context for SMS (i.e. .../ue-contexts/{supi}) in the SMSF to activate SMS service for a given service user. The content of the PUT request shall contain a representation of the individual UE Context resource to be created or updated.

Depending on whether the target UE Context for SMS has already been created, the SMSF performs 2a or 2b:

- 2a. If the target UE Context for SMS is not created in SMSF, the SMSF registers itself in UDM for the Access Type(s) provided, retrieves subscription data from the UDM, performs service authorization for the given UE, and create UE Context for SMS for this UE.

If successful, "201 Created" shall be returned, the content of the PUT response shall contain the representation of the created resource and the "Location" header shall contain the URI of the created resource.

- 2b. If the target UE Context for SMS has already been created, the SMSF updates the UE Context for SMS with the NF Service Consumer (e.g. AMF) provided parameters.

If successful, "204 No Content" shall be returned.

- 2c. If the target UE Context for SMS has already been created and the NF Service Consumer (e.g. AMF) provided parameters contains 2 access types (i.e. an additional Access Type), the SMSF registers itself in UDM for the new Access Type for the given UE, performs service authorization for the given UE for the new Access Type and updates the UE context for SMS for this UE with the new additional Access Type.

If successful, "204 No Content" shall be returned.

- 2d. On failure, the appropriate HTTP status code (e.g. "403 Forbidden") indicating the error shall be returned.

A ProblemDetails IE shall be included in the content of PUT response, with the "cause" attribute of ProblemDetails set to application error codes specified in table 6.1.7.3-1.

- 2e. On redirection, the appropriate HTTP status code (e.g. "307 Temporary Redirect") shall be returned.

A RedirectResponse IE may be included in the content of PUT response, as specified in table 6.1.3.3.3.1-3.

5.2.2.2.3 Modify UE Context in SMSF using HTTP PATCH Method

The NF Service Consumer (e.g. AMF) may update UE context in SMSF for a given service user by using the HTTP PATCH method as shown in Figure 5.2.2.2.3-1.

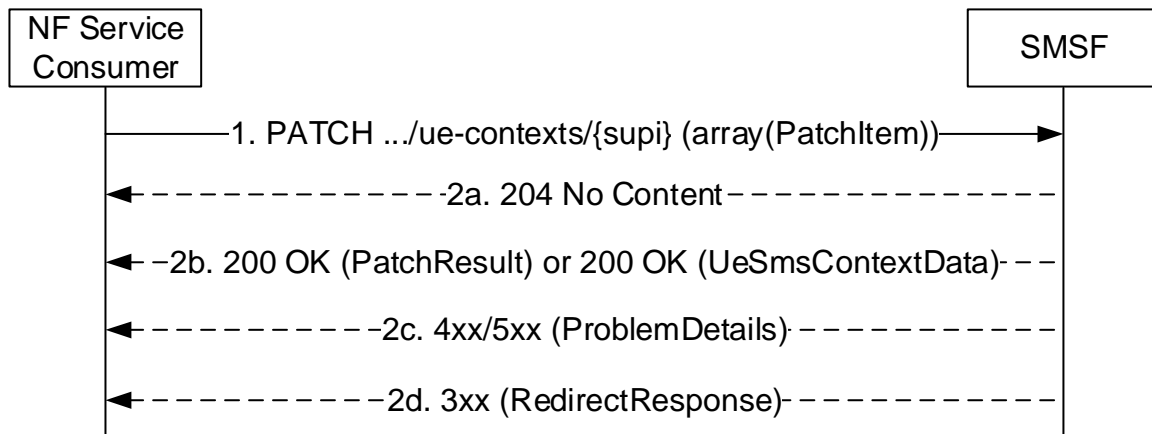

Figure 5.2.2.3-1: Modify UE Context in SMSF using HTTP PATCH Method

1. The NF Service Consumer (e.g. AMF) shall send a PATCH request to the resource representing the UE Context for SMS (i.e. .../ue-contexts/{supi}) in the SMSF to modify the UE Context in SMSF for a given service user. The request body shall contain a list of PatchItem for each the JSON pointer is set to the attribute to be modified.
- 2a. On success, the request is accepted, and all the modification instructions in the PATCH request have been implemented, the SMSF shall respond with "204 No Content".
- 2b. On partial success, the request is accepted, but some of the modification instructions in the PATCH request have been discarded:
 - the SMSF shall respond with "200 OK" including PatchResult to indicate the failed modifications, if the NF service consumer has included in the supported-feature query parameter the "PatchReport" feature; or
 - the SMSF shall respond with "200 OK" with the response body containing UeSmsContextData, if the NF service consumer does not support the "PatchReport" feature.
- 2c. On failure, the appropriate HTTP status code (e.g. "403 Forbidden") indicating the error shall be returned. A ProblemDetails IE shall be included in the content of PATCH response, with the "cause" attribute of ProblemDetails set to application error codes specified in table 6.1.7.3-1.

If the modification is not allowed, HTTP status code "403 Forbidden" should be returned including additional error information in the response body (in the "ProblemDetails" element).

If the resource does not exist, e.g. the attribute to be modified cannot be found, HTTP status code "404 Not Found" should be returned including additional error information in the response body (in the "ProblemDetails" element).
- 2d. On redirection, the appropriate HTTP status code (e.g. "307 Temporary Redirect") shall be returned. A RedirectResponse IE may be included in the content of PATCH response, as specified in table 6.1.3.3.3.1-3.

5.2.2.3 Deactivate

5.2.2.3.1 General

The Deactivate service operation shall be used by the NF Service Consumer (e.g. AMF) to deactivate SMS service for a given service user, which results in deleting or updating an individual UE Context for SMS in the SMSF, in the following procedures:

- De-Registration Procedure to remove SMS service authorization from SMSF for SMS over NAS (see clause 4.13.3.2 of 3GPP TS 23.502 [3]);
- De-Registration procedure to remove SMS service authorization from SMSF for one of the registered Access Type (see clause 4.13.3.2 of 3GPP TS 23.502 [3]);

5.2.2.3.2 De-Registration procedure to remove SMS service authorization from SMSF

The NF Service Consumer (e.g. AMF) shall deactivate SMS service for a given service user by using the HTTP DELETE method as shown in Figure 5.2.2.3.2-1.

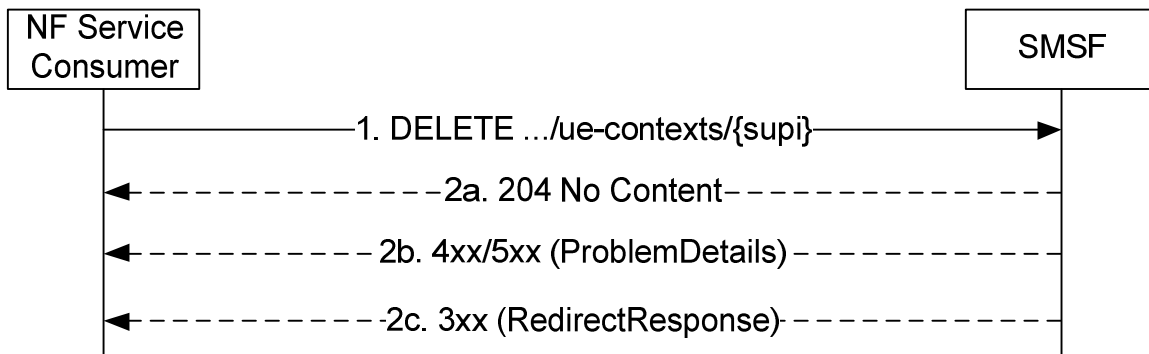

Figure 5.2.2.3.2-1: Deactivation of SMS service

1. The NF Service Consumer (e.g. AMF) shall send a DELETE request to the resource representing the UE Context for SMS (i.e. .../ue-contexts/{supi}) in the SMSF.
- 2a. The SMSF deactivates the SMS service for the service user, and deletes the UE context for SMS from the SMSF.
On success, "204 No Content" shall be returned.
- 2b. On failure, the appropriate HTTP status code (e.g. "404 Not Found") indicating the error shall be returned.
A ProblemDetails IE shall be included in the content of DELETE response, with the "cause" attribute of ProblemDetails set to application error codes specified in table 6.1.7.3-1.
- 2c. On redirection, the appropriate HTTP status code (e.g. "307 Temporary Redirect") shall be returned.
A RedirectResponse IE may be included in the content of DELETE response, as specified in table 6.1.3.3.2-3.

5.2.2.3.3 De-Registration procedure to remove SMS service authorization from SMSF for one of the registered Access Type

When the UE has SMS service activated on both of the Access Types and the NF Service Consumer (e.g. AMF) wants to deactivate SMS service for the given UE for one of the affected Access Type, the NF Service Consumer (e.g. AMF) shall use HTTP PUT method as shown in Figure 5.2.2.3.3-1.

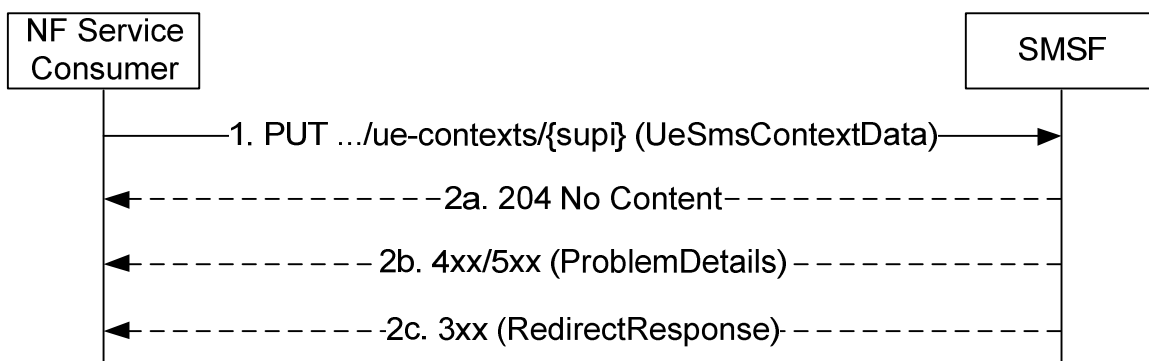

Figure 5.2.2.3.3-1: Removal of SMS service authorization over one of the access types

1. The NF Service Consumer (e.g. AMF) shall send a PUT request to the resource representing the UE Context for SMS (i.e. .../ue-contexts/{supi}) in the SMSF. The content of the PUT request shall contain a representation of the individual UE Context resource to be updated. Only one Access Type that is allowed for SMS service shall be included in the content of PUT request.

2a. Since the target UE Context for SMS was already created at the SMSF with both 3GPP and non-3GPP Access Types for the same NF Service Consumer (e.g. AMF) and the NF Service Consumer provided parameters contains only one Access Type, the SMSF deregisters itself in the UDM for the affected Access Type (i.e. the access type not included in the PUT request) for the given UE and updates the UE context for SMS by removing the affected Access Type.

On success, "204 No Content" shall be returned.

2b. On failure, the appropriate HTTP status code (e.g. "403 Forbidden") indicating the error shall be returned.

A ProblemDetails IE shall be included in the content of PUT response, with the "cause" attribute of ProblemDetails set to application error codes specified in table 6.1.7.3-1.

2c. On redirection, the appropriate HTTP status code (e.g. "307 Temporary Redirect") shall be returned.

A RedirectResponse IE may be included in the content of PUT response, as specified in table 6.1.3.3.3.1-3.

5.2.2.4 UplinkSMS

5.2.2.4.1 General

The UplinkSMS service operation shall be used by NF Service Consumer (e.g. AMF) to send SMS payload (e.g. SMS message or Ack) in the uplink direction to SMSF, in the following procedures:

- MO SMS delivery procedure (see clause 4.13.3.3-4.13.3.5 of 3GPP TS 23.502 [3]);
- MT SMS delivery procedure (see clause 4.13.3.6-4.13.3.8 of 3GPP TS 23.502 [3]);

5.2.2.4.2 Procedures of sending SMS payload in uplink direction using UplinkSMS service operation

The NF Service Consumer (e.g. AMF) shall send SMS payload in uplink direction by using the "sendsms" custom operation as shown in Figure 5.2.2.4.2-1.

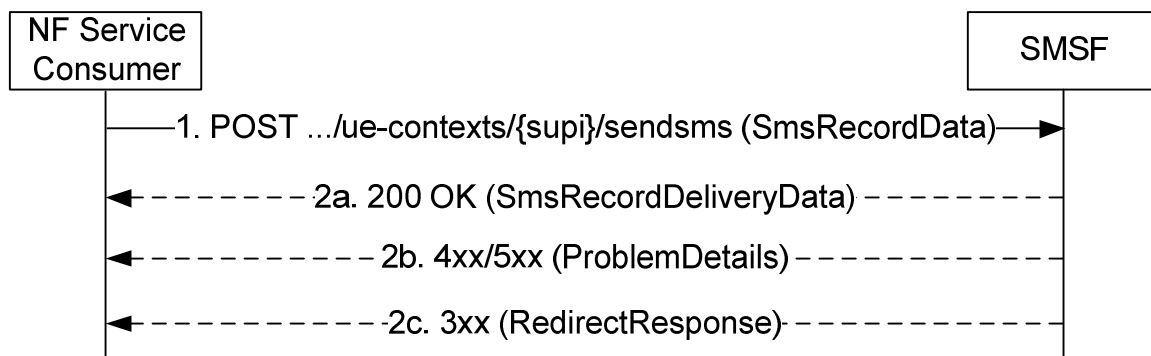

Figure 5.2.2.4.2-1: Send SMS payload in uplink direction

1. The NF Service Consumer (e.g. AMF) shall send a POST request to the resource representing the UEContext (i.e. .../ue-contexts/{supi}/sendsms) of the SMSF. The content of the POST request shall contain the SMS record to be sent.

2a. On success, "200 OK" shall be returned with "SmsRecordDeliveryData" object in the response body.

The SMSF may immediately respond to the NF service consumer, after successful inspection of the SMS payload, and set the "deliveryStatus" attribute to "SMS_DELIVERY_SMSF_ACCEPTED"; the SMSF may also attempt to forward the SMS payload to SMS-GMSC/IWMSC/IP-SM-GW/SMS Router.

If successful, "200 OK" shall be returned. If needed, the content body of the POST response shall contain the status of SMS record delivery attempts at the SMSF.

2b. On failure, the appropriate HTTP status code (e.g. "403 Forbidden") indicating the error shall be returned.

A ProblemDetails IE shall be included in the content of POST response, with the "cause" attribute of ProblemDetails set to application error codes specified in table 6.1.7.3-1.

2c. On redirection, the appropriate HTTP status code (e.g. "307 Temporary Redirect") shall be returned.

A RedirectResponse IE may be included in the content of POST response, as specified in table 6.1.3.3.4.2.2-2.

5.2.2.5 MtForwardSm

5.2.2.5.1 General

The MtForwardSm service operation shall be used by NF Service Consumer (e.g. SMS GMSC, SMS Router and IP-SM-GW) to send SMS payload (e.g. SMS message) in the downlink direction to SMSF, in the following procedures:

- Successful Mobile Terminated short message transfer as defined in 3GPP TS 23.540 [21] clause 5.1.2, clause 5.1.3 and clause 5.1.4.
- Unsuccessful Mobile Terminated short message transfer as defined in 3GPP TS 23.540 [21] clause 5.1.5, clause 5.1.6 and clause 5.1.9.

5.2.2.5.2 Procedures of sending SMS payload in downlink direction using MtForwardSm service operation

The NF Service Consumer (e.g. SMS GMSC, SMS Router and IP-SM-GW) shall send SMS payload in downlink direction by using the "send-mt-sms" custom operation as shown in Figure 5.2.2.5.2-1.

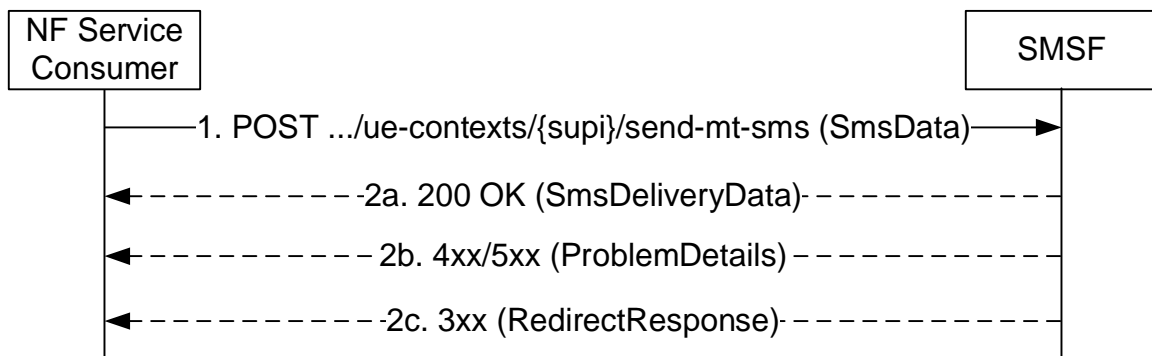

Figure 5.2.2.5.2-1: Send SMS payload in downlink direction

1. The NF Service Consumer (e.g. SMS GMSC, SMS Router and IP-SM-GW) shall send a POST request to the resource representing the UEContext (i.e. .../ue-contexts/{supi}/send-mt-sms) of the SMSF. The content of the POST request shall contain the MT SMS record to be sent.

If the Send Routing Information For SM response from the UDM contained an mpsMsgIndication with a value of set (enabled), or if a priority indication is received with the SMS from the SMS Service Center, the SMS-GMSC shall set the DSCP to a value appropriate for MPS and shall set the SBI-Message-Priority header with a value appropriate for MPS.

NOTE: The priority indication from the SMS Service Center is outside the scope of 3GPP specifications.

2a. On success, "200 OK" shall be returned with "SmsDeliveryData" object contains the MT SMS Delivery Report in the response body.

2b. On failure, the appropriate HTTP status code (e.g. "403 Forbidden") indicating the error shall be returned.

A ProblemDetails IE shall be included in the content of POST response, with the "cause" attribute of ProblemDetails set to application error codes specified in table 6.1.7.3-1.

2c. On redirection, the appropriate HTTP status code (e.g. "307 Temporary Redirect") shall be returned.

A RedirectResponse IE may be included in the content of POST response, as specified in table 6.1.3.4.3.2-2.

6 API Definitions

6.1 Nsmsf_SMSservice Service API

6.1.1 API URI

The Nsmsf_SMSservice shall use the Nsmsf_SMSservice API.

The request URI used in HTTP request from the NF service consumer towards the NF service producer shall have the structure defined in clause 4.4.1 of 3GPP TS 29.501 [5], i.e.:

{apiRoot}/<apiName>/<apiVersion>/<apiSpecificResourceUriPart>

with the following components:

- The {apiRoot} shall be set as described in 3GPP TS 29.501 [5].
- The <apiName> shall be "nsmsf-sms".
- The <apiVersion> shall be "v2".
- The <apiSpecificResourceUriPart> shall be set as described in clause 6.1.3.

6.1.2 Usage of HTTP

6.1.2.1 General

HTTP/2, as defined in IETF RFC 9113 [7], shall be used as specified in clause 5 of 3GPP TS 29.500 [4].

HTTP/2 shall be transported as specified in clause 5.3 of 3GPP TS 29.500 [4].

HTTP messages and bodies for the Nsmsf_SMSservice service shall comply with the OpenAPI [19] specification contained in Annex A.

6.1.2.2 HTTP standard headers

6.1.2.2.1 General

The usage of HTTP standard headers is specified in clause 5.2.2 of 3GPP TS 29.500 [4].

6.1.2.2.2 Content type

The following content types shall be supported:

- the JSON format (IETF RFC 8259 [8]). The use of the JSON format shall be signalled by the content type "application/json". See also clause 5.4 of 3GPP TS 29.500 [4].
- the Problem Details JSON Object (IETF RFC 9457 [17]). The use of the Problem Details JSON object in a HTTP response body shall be signalled by the content type "application/problem+json".
- the JSON Patch (IETF RFC 6902 [20]). The use of the JSON Patch format in a HTTP request body shall be signalled by the content type "application/json-patch+json".

Multipart messages shall also be supported (see clause 6.1.2.4) using the content type "multipart/related", comprising:

- one JSON body part with the "application/json" content type; and

- one binary body part with 3gpp vendor specific content subtypes.

The 3gpp vendor specific content subtypes defined in Table 6.1.2.2-1 shall be supported.

Table 6.1.2.2-1: 3GPP vendor specific content subtypes

content subtype	Description
vnd.3gpp.sms	Binary encoded content, encoding SMS payload, as specified in 3GPP TS 23.040 [11] and 3GPP TS 24.011 [12].
NOTE:	Using 3GPP vendor content subtypes allows to describe the nature of the opaque content (e.g. SMS payload) without having to rely on metadata in the JSON content.

See clause 6.1.2.4 for the binary contents supported in the binary body part of multipart messages.

6.1.2.2.3 ETag

As described in IETF RFC 9110 [23] clause 8.8.3, an "ETag" (entity-tag) header should be included in HTTP responses except for non-cacheable resources to allow an NF Service Consumer performing a conditional request with "If-Match" header. If it is included, it shall contain a server-generated strong validator, that allows further matching of this value (included in subsequent client requests) with a given resource representation stored in the server or in a cache.

6.1.2.2.4 If-Match

As described in IETF RFC 9110 [23] clause 13.1.1, an NF Service Consumer may issue conditional DELETE request towards SMSF by including an "If-Match" header in HTTP requests containing an entity tags received in previous response for the same resource.

6.1.2.3 HTTP custom headers

6.1.2.3.1 General

In this release of this specification, no custom headers specific to the Nsmsf_SMSservice service are defined. For 3GPP specific HTTP custom headers used across all service based interfaces, see clause 5.2.3 of 3GPP TS 29.500 [4].

6.1.2.4 HTTP multipart messages

HTTP multipart messages shall be supported, to transfer opaque SMS payload (e.g. SMS message, CP Ack, etc.), in the following service operations (and HTTP messages):

- UplinkSMS service operation;

HTTP multipart messages shall include one JSON body part and one binary body part comprising content of SMS payload content (see clause 6.1.6.4).

The JSON body part shall be the "root" body part of the multipart message. It shall be encoded as the first body part of the multipart message. The "Start" parameter does not need to be included.

The multipart message shall include a "type" parameter (see IETF RFC 2387 [9]) specifying the media type of the root body part, i.e. "application/json".

- NOTE: The "root" body part (or "root" object) is the first body part the application processes when receiving a multipart/related message, see IETF RFC 2387 [9]. The default root is the first body within the multipart/related message. The "Start" parameter indicates the root body part, e.g. when this is not the first body part in the message.

A binary body part shall include a Content-ID header (see IETF RFC 2045 [10]), and the JSON body part shall make a reference to the binary body part using the Content-ID header field.

Examples of multipart/related messages can be found in Annex B.

6.1.3 Resources

6.1.3.1 Overview

The figure 6.1.3.1-1 describes the resource URI structure of the Nsmsf-sms API.

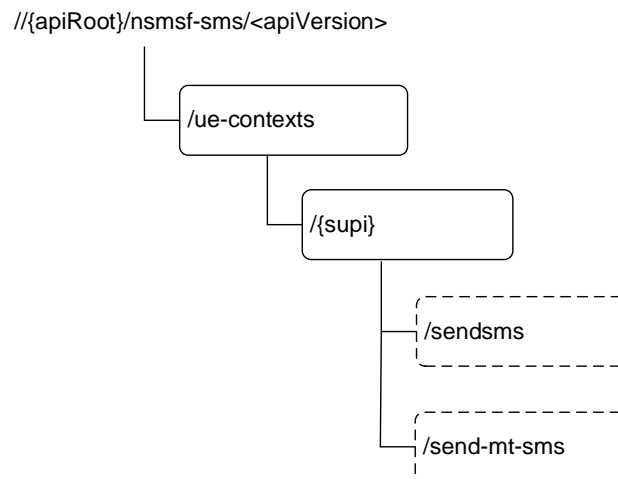

Figure 6.1.3.1-1: Resource URI structure of the nsmsf-sms API

Table 6.1.3.1-1 provides an overview of the resources and applicable HTTP methods.

Table 6.1.3.1-1: Resources and methods overview

Resource name	Resource URI	HTTP method or custom operation	Description
UEContext (Document)	/ue-contexts/{supi}	PUT	It is used for the Activate service operation, for the purpose of: - Activate SMS service for a given UE, which results in creating an individual UE Context resource in SMSF. - Update SMS service parameters for a given UE, which results in updating an existing individual UE Context resource in SMSF. - Deactivate SMS service for a given UE for one of the two registered Access Types, which results in updating an existing individual UE context resource in SMSF.
		PATCH	It is used for the Activate service operation, for the purpose of: - Partially update SMS service parameters for a given UE, which results in updating an existing individual UE Context resource in SMSF.
		DELETE	It is used for the Deactivate service operation, for the purpose of: - Deactivate SMS service for a given UE, which results in deleting an existing individual UE Context resource in SMSF.
	/ue-contexts/{supi}/sendsms	sendsms (POST)	It is used for the UplinkSMS service operation, to allow NF Service Consumer to send SMS payload in uplink direction.
	/ue-contexts/{supi}/send-mt-sms	send-mt-sms (POST)	It is used for the MtForwardSm service operation, to allow NF Service Consumer to send SMS payload in downlink direction.

6.1.3.2 Resource: UEContexts (Store)

6.1.3.2.1 Description

This resource represents the collection of UE Context for SMS in SMSF.

This resource is modelled with the Store resource archetype (see clause C.3 of 3GPP TS 29.501 [5]).

No HTTP method has been defined for this resource.

6.1.3.2.2 Resource Definition

Resource URI: {apiRoot}/nsmf-sms/<apiVersion>/ue-contexts

This resource shall support the resource URI variables defined in table 6.1.3.2.2-1.

Table 6.1.3.2.2-1: Resource URI variables for this resource

Name	Data type	Definition
apiRoot	string	See clause 6.1.1

6.1.3.2.3 Resource Standard Methods

No HTTP method has been defined for the UE Context collection resource.

6.1.3.3 Resource: UEContext (Document)

6.1.3.3.1 Description

This resource represents an individual UE Context for SMS in SMSF.

This resource is modelled with the Document resource archetype (see clause C.1 of 3GPP TS 29.501 [5]).

A PUT method to this resource can be invoked by the NF Service Consumer (e.g. AMF) to:

- activate SMS service for a given UE, which results in creating new individual UE Context for SMS in SMSF, during the Registration procedure for SMS over NAS (see 3GPP TS 23.502 [3] clause 4.13.3.1);
- update SMS service parameters for a given UE, which results in updating individual UE Context for SMS in SMSF, during the Registration Update procedure due to AMF change (see 3GPP TS 23.502 [3] clause 4.13.3.1).
- update SMS service parameters for a given UE, which results in updating individual UE Context for SMS in SMSF, to add a new Access Type for SMS over NAS.
- Deactivate SMS service for a given UE for one of the two registered Access Types, which results in updating an existing individual UE context resource in SMSF to remove the affected Access Type for SMS over NAS.

A DELETE method to this resource can be invoked by the NF Service Consumer (e.g. AMF) to:

- deactivate SMS service for a given UE, which results in deleting existing individual UE Context for SMS in SMSF, during the De-Registration procedure form SMS over NAS (see 3GPP TS 23.502 [3] clause 4.13.3.2).

6.1.3.3.2 Resource Definition

Resource URI: {apiRoot}/nsmf-sms/<apiVersion>/ue-contexts/{supi}

This resource shall support the resource URI variables defined in table 6.1.3.3.2-1.

Table 6.1.3.3.2-1: Resource URI variables for this resource

Name	Data type	Definition
apiRoot	string	See clause 6.1.1
supi	Supi	Represents the Subscription Permanent Identifier (see 3GPP TS 23.501 [2] clause 5.9.2) pattern: See pattern of type Supi in 3GPP TS 29.571 [6]

6.1.3.3.3 Resource Standard Methods

6.1.3.3.3.1 PUT

This method creates an individual resource of UE Context for SMS in the SMSF, or updates the indicated resource of UE Context for SMS in the SMSF.

This method shall support the URI query parameters specified in table 6.1.3.3.3.1-1.

Table 6.1.3.3.3.1-1: URI query parameters supported by the PUT method on this resource

Name	Data type	P	Cardinality	Description
n/a				

This method shall support the request data structures specified in table 6.1.3.3.3.1-2 and the response data structures and response codes specified in table 6.1.3.3.3.1-3.

Table 6.1.3.3.3.1-2: Data structures supported by the PUT Request Body on this resource

Data type	P	Cardinality	Description
UeSmsContextData	M	1	Representation of the UE Context for SMS to be created in the SMSF, or to be updated in the SMSF.

Table 6.1.3.3.3.1-3: Data structures supported by the PUT Response Body on this resource

Data type	P	Cardinality	Response codes	Description
UeSmsContextData	M	1	201 Created	This case represents the successful creation of an UE Context for SMS. The HTTP response shall include a "Location" HTTP header that contains the resource URI of the created resource.
n/a			204 No Content	This case represents the successful update of an UE Context for SMS.
RedirectResponse	O	0..1	307 Temporary Redirect	Temporary redirection. (NOTE 2)
RedirectResponse	O	0..1	308 Permanent Redirect	Permanent redirection. (NOTE 2)
ProblemDetails	O	0..1	403 Forbidden	When used to represent the failure of creation / update of an UE Context for SMS, the "cause" attribute of the "ProblemDetails" shall be set to one of the following application error codes: - SERVICE_NOT_ALLOWED, if SMS service is not allowed for the given service user;
ProblemDetails	O	0..1	404 Not Found	When used to represent the failure of creation / update of an UE Context for SMS, the "cause" attribute of the "ProblemDetails" shall be set to one of the following application error codes: - USER_NOT_FOUND, if the provided subscriber identifier is invalid or the service user is not found from UDM;

NOTE 1: The mandatory HTTP error status codes for the PUT method listed in Table 5.2.7.1-1 of 3GPP TS 29.500 [4] also apply.

NOTE 2: RedirectResponse may be inserted by an SCP, see clause 6.10.9.1 of 3GPP TS 29.500 [4].

Table 6.1.3.3.3.1-4: Headers supported by the 201 Response Code on this resource

Name	Data type	P	Cardinality	Description
Location	string	M	1	Contains the URI of the newly created resource, according to the structure: {apiRoot}/nsmf-sms/<apiVersion>/ue-contexts/{supi}
ETag	string	O	0..1	Entity Tag, containing a strong validator, as described in IETF RFC 9110 [23], clause 8.8.3.

Table 6.1.3.3.3.1-5: Headers supported by the 204 Response Code on this resource

Name	Data type	P	Cardinality	Description
ETag	string	O	0..1	Entity Tag, containing a strong validator, as described in IETF RFC 9110 [23], clause 8.8.3.

Table 6.1.3.3.3.1-6: Headers supported by the 307 Response Code on this resource

Name	Data type	P	Cardinality	Description
Location	string	M	1	An alternative URI of the resource located on an alternative service instance within the same SMSF or SMSF (service) set. For the case, when a request is redirected to the same target resource via a different SCP, see clause 6.10.9.1 in 3GPP TS 29.500 [4].
3gpp-Sbi-Target-Nf-Id	string	O	0..1	Identifier of the target NF (service) instance ID towards which the request is redirected

Table 6.1.3.3.3.1-7: Headers supported by the 308 Response Code on this resource

Name	Data type	P	Cardinality	Description
Location	string	M	1	An alternative URI of the resource located on an alternative service instance within the same SMSF or SMSF (service) set. For the case, when a request is redirected to the same target resource via a different SCP, see clause 6.10.9.1 in 3GPP TS 29.500 [4].
3gpp-Sbi-Target-Nf-Id	string	O	0..1	Identifier of the target NF (service) instance ID towards which the request is redirected

6.1.3.3.3.2 DELETE

This method deletes an individual resource of UE Context for SMS in the SMSF.

This method shall support the URI query parameters specified in table 6.1.3.3.3.2-1.

Table 6.1.3.3.3.2-1: URI query parameters supported by the DELETE method on this resource

Name	Data type	P	Cardinality	Description
n/a				

This method shall support the request data structures specified in table 6.1.3.3.3.2-2 and the response data structures and response codes specified in table 6.1.3.3.3.2-3.

Table 6.1.3.3.3.2-2: Data structures supported by the DELETE Request Body on this resource

Data type	P	Cardinality	Description
n/a			

Table 6.1.3.3.3.2-3: Data structures supported by the DELETE Response Body on this resource

Data type	P	Cardinality	Response codes	Description
n/a			204 No Content	This case represents a successful deletion of an UE Context for SMS.
RedirectResponse	O	0..1	307 Temporary Redirect	Temporary redirection. (NOTE 2)
RedirectResponse	O	0..1	308 Permanent Redirect	Permanent redirection. (NOTE 2)
ProblemDetails	O	0..1	404 Not Found	When used to represent an unsuccessful deletion of an UE Context for SMS, the "cause" attribute of the "ProblemDetails" may be used to include one of the following application error codes: <ul style="list-style-type: none"> - CONTEXT_NOT_FOUND, if the UE context for SMS to be operated is invalid or not found in SMSF.
NOTE 1: The mandatory HTTP error status codes for the DELETE method listed in Table 5.2.7.1-1 of 3GPP TS 29.500 [4] also apply.				
NOTE 2: RedirectResponse may be inserted by an SCP, see clause 6.10.9.1 of 3GPP TS 29.500 [4].				

Table 6.1.3.3.3.2-4: Headers supported by the DELETE method on this resource

Name	Data type	P	Cardinality	Description
If-Match	String	O	0..1	Validator for conditional requests, as described in IETF RFC 7232 [18], clause 3.1

Table 6.1.3.3.3.2-5: Headers supported by the 307 Response Code on this resource

Name	Data type	P	Cardinality	Description
Location	String	M	1	An alternative URI of the resource located on an alternative service instance within the same SMSF or SMSF (service) set. For the case, when a request is redirected to the same target resource via a different SCP, see clause 6.10.9.1 in 3GPP TS 29.500 [4].
3gpp-Sbi-Target-Nf-Id	String	O	0..1	Identifier of the target NF (service) instance ID towards which the request is redirected

Table 6.1.3.3.3.2-6: Headers supported by the 308 Response Code on this resource

Name	Data type	P	Cardinality	Description
Location	string	M	1	An alternative URI of the resource located on an alternative service instance within the same SMSF or SMSF (service) set. For the case, when a request is redirected to the same target resource via a different SCP, see clause 6.10.9.1 in 3GPP TS 29.500 [4].
3gpp-Sbi-Target-Nf-Id	string	O	0..1	Identifier of the target NF (service) instance ID towards which the request is redirected

6.1.3.3.3.3 PATCH

This method shall support the URI query parameters specified in table 6.1.3.3.3.3-1.

Table 6.1.3.3.3.3-1: URI query parameters supported by the PATCH method on this resource

Name	Data type	P	Cardinality	Description
supported-features	SupportedFeatures	O	0..1	see 3GPP TS 29.500 [4] clause 6.6

This method shall support the request data structures specified in table 6.1.3.3.3.3-2 and the response data structures and response codes specified in table 6.1.3.3.3.3-3.

Table 6.1.3.3.3.3-2: Data structures supported by the PATCH Request Body on this resource

Data type	P	Cardinality	Description
array(PatchItem)	M	1..N	Items describe the modifications to the Event Subscription

Table 6.1.3.3.3.3-3: Data structures supported by the PATCH Response Body on this resource

Data type	P	Cardinality	Response codes	Description
n/a			204 No Content	Upon success, an empty response body shall be returned.
PatchResult	C	1	200 OK	Upon partial success, if the NF service consumer has indicated "PatchReport" in the supported-feature, the execution report is returned. (NOTE 3)
UeSmsContextData	C	0..1	200 OK	Upon partial success, if the NF service consumer does not support the "PatchReport" feature, the SMSF shall return a UeSmsContextData object in the response. (NOTE 3)
RedirectResponse	O	0..1	307 Temporary Redirect	Temporary redirection. (NOTE 2)
RedirectResponse	O	0..1	308 Permanent Redirect	Permanent redirection. (NOTE 2)
ProblemDetails	O	0..1	403 Forbidden	One or more attributes are not allowed to be modified. The "cause" attribute may be used to indicate one of the following application errors: - MODIFICATION_NOT_ALLOWED, see 3GPP TS 29.500 [4] table 5.2.7.2-1.
ProblemDetails	O	0..1	404 Not Found	The "cause" attribute may be used to indicate one of the following application errors: - USER_NOT_FOUND - CONTEXT_NOT_FOUND
NOTE 1: In addition common data structures as listed in table 5.2.7.1-1 of 3GPP TS 29.500 [4] are supported.				
NOTE 2: RedirectResponse may be inserted by an SCP, see clause 6.10.9.1 of 3GPP TS 29.500 [4].				
NOTE 3: One of UeSmsContextData or PatchResult shall be returned, depending on whether the NF service consumer support "PatchReport" feature or not.				

Table 6.1.3.3.3.3-4: Headers supported by the 307 Response Code on this resource

Name	Data type	P	Cardinality	Description
Location	string	M	1	An alternative URI of the resource located on an alternative service instance within the same SMSF or SMSF (service) set. For the case, when a request is redirected to the same target resource via a different SCP, see clause 6.10.9.1 in 3GPP TS 29.500 [4].
3gpp-Sbi-Target-Nf-Id	string	O	0..1	Identifier of the target NF (service) instance ID towards which the request is redirected

Table 6.1.3.3.3-5: Headers supported by the 308 Response Code on this resource

Name	Data type	P	Cardinality	Description
Location	string	M	1	An alternative URI of the resource located on an alternative service instance within the same SMSF or SMSF (service) set. For the case, when a request is redirected to the same target resource via a different SCP, see clause 6.10.9.1 in 3GPP TS 29.500 [4].
3gpp-Sbi-Target-Nf-Id	string	O	0..1	Identifier of the target NF (service) instance ID towards which the request is redirected

6.1.3.3.4 Resource Custom Operations

6.1.3.3.4.1 Overview

Table 6.1.3.3.4.1-1: Custom operations

Operation Name	Custom operation URI	Mapped HTTP method	Description
sendsms	/ue-contexts/{supi}/sendsms	POST	Send SMS payload or CP Ack in uplink direction.
send-mt-sms	/ue-contexts/{supi}/send-mt-sms	POST	Send MT SMS payload, or the related CP Ack.

6.1.3.3.4.2 Operation: sendsms

6.1.3.3.4.2.1 Description

This custom operation is used for NF Service Consumers to send SMS record in uplink direction.

6.1.3.3.4.2.2 Operation Definition

This custom operation is used to send a SMS payload to an individual UEContext resource in the SMSF.

This operation shall support the request data structures specified in table 6.1.3.3.4.2.2-1 and the response data structure and response codes specified in table 6.1.3.3.4.2.2-2.

Table 6.1.3.3.4.2.2-1: Data structures supported by the POST Request Body on this resource

Data type	P	Cardinality	Description
SmsRecordData	M	1	Representation of the SMS Record to be created in the SMSF.

Table 6.1.3.3.4.2.2-2: Data structures supported by the POST Response Body on this resource

Data type	P	Cardinality	Response codes	Description
SmsRecordDeliveryData	M	1	200 OK	This case represents the successful of sending SMS record in uplink direction, with necessary response data.
RedirectResponse	O	0..1	307 Temporary Redirect	Temporary redirection. (NOTE 2)
RedirectResponse	O	0..1	308 Permanent Redirect	Permanent redirection. (NOTE 2)
ProblemDetails	O	0..1	400 Bad Request	This case represents an unsuccessful delivery of SMS payload. The "cause" attribute may be used to indicate one of the following application errors: <ul style="list-style-type: none"> - SMS_PAYLOAD_MISSING, if the expected SMS payload content is missing; - SMS_PAYLOAD_ERROR, if error exists in the SMS payload content.
ProblemDetails	O	0..1	403 Forbidden	This case represents an unsuccessful delivery of SMS payload. The "cause" attribute may be used to indicate one of the following application errors: <ul style="list-style-type: none"> - SERVICE_NOT_ALLOWED, if SMS service is not allowed for the given service user;
ProblemDetails	O	0..1	404 Not Found	This case represents an unsuccessful delivery of SMS payload. The "cause" attribute may be used to indicate one of the following application errors: <ul style="list-style-type: none"> - CONTEXT_NOT_FOUND, if the UE context for SMS to be operated is invalid or not found in SMSF.
NOTE 1: The mandatory HTTP error status codes for the POST method listed in Table 5.2.7.1-1 of 3GPP TS 29.500 [4] also apply.				
NOTE 2: RedirectResponse may be inserted by an SCP, see clause 6.10.9.1 of 3GPP TS 29.500 [4].				

Table 6.1.3.3.4.2.2-3: Headers supported by the 307 Response Code on this resource

Name	Data type	P	Cardinality	Description
Location	string	M	1	An alternative URI of the resource located on an alternative service instance within the same SMSF or SMSF (service) set. For the case, when a request is redirected to the same target resource via a different SCP, see clause 6.10.9.1 in 3GPP TS 29.500 [4].
3gpp-Sbi-Target-Nf-Id	string	O	0..1	Identifier of the target NF (service) instance ID towards which the request is redirected

Table 6.1.3.3.4.2.2-4: Headers supported by the 308 Response Code on this resource

Name	Data type	P	Cardinality	Description
Location	string	M	1	An alternative URI of the resource located on an alternative service instance within the same SMSF or SMSF (service) set. For the case, when a request is redirected to the same target resource via a different SCP, see clause 6.10.9.1 in 3GPP TS 29.500 [4].
3gpp-Sbi-Target-Nf-Id	string	O	0..1	Identifier of the target NF (service) instance ID towards which the request is redirected

6.1.3.3.4.3 Operation: send-mt-sms

6.1.3.3.4.3.1 Description

This custom operation is used for NF Service Consumers to send SMS record in downlink direction.

6.1.3.3.4.3.2 Operation Definition

This custom operation is used to send a SMS payload to an individual UEContext resource in the SMSF.

This operation shall support the request data structures specified in table 6.1.3.3.4.3.2-1 and the response data structure and response codes specified in table 6.1.3.3.4.3.2-2.

Table 6.1.3.3.4.3.2-1: Data structures supported by the POST Request Body on this resource

Data type	P	Cardinality	Description
SmsData	M	1	Representation of the MT SMS sent to the SMSF.

Table 6.1.3.3.4.3.2-2: Data structures supported by the POST Response Body on this resource

Data type	P	Cardinality	Response codes	Description
SmsDeliveryData	M	1	200 OK	This case represents the successful of sending SMS message in downlink direction, with necessary response data on the received delivery report.
RedirectResponse	O	0..1	307 Temporary Redirect	Temporary redirection. (NOTE 2)
RedirectResponse	O	0..1	308 Permanent Redirect	Permanent redirection. (NOTE 2)
ProblemDetails	O	0..1	400 Bad Request	This case represents an unsuccessful delivery of SMS payload. The "cause" attribute may be used to indicate one of the following application errors: <ul style="list-style-type: none"> - SMS_PAYLOAD_MISSING, if the expected SMS payload content is missing; - SMS_PAYLOAD_ERROR, if error exists in the SMS payload content.
ProblemDetails	O	0..1	403 Forbidden	This case represents an unsuccessful delivery of SMS payload. The "cause" attribute may be used to indicate one of the following application errors: <ul style="list-style-type: none"> - SERVICE_NOT_ALLOWED, if SMS service is not allowed for the given service user;
ProblemDetails	O	0..1	404 Not Found	This case represents an unsuccessful delivery of SMS payload. The "cause" attribute may be used to indicate one of the following application errors: <ul style="list-style-type: none"> - CONTEXT_NOT_FOUND, if the UE context for SMS to be operated is invalid or not found in SMSF.
NOTE 1: The mandatory HTTP error status codes for the POST method listed in Table 5.2.7.1-1 of 3GPP TS 29.500 [4] also apply.				
NOTE 2: RedirectResponse may be inserted by an SCP, see clause 6.10.9.1 of 3GPP TS 29.500 [4].				

Table 6.1.3.3.4.3.2-3: Headers supported by the 307 Response Code on this resource

Name	Data type	P	Cardinality	Description
Location	string	M	1	An alternative URI of the resource located on an alternative service instance within the same SMSF or SMSF (service) set. For the case, when a request is redirected to the same target resource via a different SCP, see clause 6.10.9.1 in 3GPP TS 29.500 [4].
3gpp-Sbi-Target-Nf-Id	string	O	0..1	Identifier of the target NF (service) instance ID towards which the request is redirected

Table 6.1.3.3.4.3.2-4: Headers supported by the 308 Response Code on this resource

Name	Data type	P	Cardinality	Description
Location	string	M	1	An alternative URI of the resource located on an alternative service instance within the same SMSF or SMSF (service) set. For the case, when a request is redirected to the same target resource via a different SCP, see clause 6.10.9.1 in 3GPP TS 29.500 [4].
3gpp-Sbi-Target-Nf-Id	string	O	0..1	Identifier of the target NF (service) instance ID towards which the request is redirected

6.1.4 Custom Operations without associated resources

In this release of this specification, no custom operations without associated resources are defined.

6.1.5 Notifications

In this release of this specification, no notification procedures are defined.

6.1.6 Data Model

6.1.6.1 General

This clause specifies the application data model supported by the API.

Table 6.1.6.1-1 specifies the data types defined for the Nsmsf service based interface protocol.

Table 6.1.6.1-1: Nsmsf specific Data Types

Data type	Clause defined	Description
UeSmsContextData	6.1.6.2.2	Information used for activating SMS service for a service user, or updating the parameters for SMS service.
SmsRecordData	6.1.6.2.3	Information within request message invoking UplinkSMS service operation, for delivering SMS payload.
SmsRecordDeliveryData	6.1.6.2.5	Information for result of invoking UplinkSMS service operation.
RecordId	6.1.6.3.2	Record ID used to identify a message carrying SMS payload.
SmsDeliveryStatus	6.1.6.3.3	Status of SMS delivery attempts.

Table 6.1.6.1-2 specifies data types re-used by the Nsmsf service based interface protocol from other specifications, including a reference to their respective specifications and when needed, a short description of their use within the Nsmsf service based interface.

Table 6.1.6.1-2: Nsmsf re-used Data Types

Data type	Reference	Comments
ProblemDetails	3GPP TS 29.571 [6]	Common Data Type used in response bodies
RedirectResponse	3GPP TS 29.571 [6]	Redirect Response
Supi	3GPP TS 29.571 [6]	Subscription Permanent Identifier
Gpsi	3GPP TS 29.571 [6]	General Public Subscription Identifier
Pei	3GPP TS 29.571 [6]	Permanent Equipment, it contains an IMEI or IMEISV.
Guami	3GPP TS 29.571 [6]	Globally Unique AMF Identifier
AccessType	3GPP TS 29.571 [6]	Access Type (3GPP or non-3GPP access)
UserLocation	3GPP TS 29.571 [6]	User location information
TimeZone	3GPP TS 29.571 [6]	User time zone information
NfInstanceId	3GPP TS 29.571 [6]	NF Instance ID
RefToBinaryData	3GPP TS 29.571 [6]	Information for indicating the binary content of SMS payload.
TraceData	3GPP TS 29.571 [6]	Trace control and configuration parameters
BackupAmfInfo	3GPP TS 29.571 [6]	Backup AMF Information
NfGroupId	3GPP TS 29.571 [6]	Network Function Group Id
RatType	3GPP TS 29.571 [6]	RAT Type
SupportedFeatures	3GPP TS 29.571 [6]	Supported Features
PatchItem	3GPP TS 29.571 [6]	Patch item
PatchResult	3GPP TS 29.571 [6]	PATCH result
SmsData	3GPP TS 29.577 [22]	Information within request message for delivering SMS.
SmsDeliveryData	3GPP TS 29.577 [22]	Information within response message invoking MtForwardSm service operation, for delivering MT SMS Delivery Report.

6.1.6.2 Structured data types

6.1.6.2.1 Introduction

This clause defines the structures to be used in resource representations.

6.1.6.2.2 Type: UeSmsContextData

Table 6.1.6.2.2-1: Definition of type UeSmsContextData

Attribute name	Data type	P	Cardinality	Description
supi	Supi	M	1	This IE shall be present, and it shall contain the subscriber permanent identify of the service user.
gpsi	Gpsi	O	0..1	When present, this IE shall contain the generic public subscriber identifier of the service user.
pei	Pei	O	0..1	When present, this IE shall contain the IMEI or IMEISV of the service user.
accessType	AccessType	M	1	This IE shall be present, and it shall contain the access type from which the service user accesses to network.
additionalAccessType	AccessType	C	0..1	This IE shall be present in activate service operations to indicate that the service user accesses the network and request SMS service from both 3GPP access and Non-3GPP access. This IE shall be absent in deactivate service operations to indicate that service user is no longer served with SMS service via two access types. In this case the accessType attribute shall indicate the remaining access type.
amfId	NfInstanceId	M	1	This IE shall be present, and it shall contain the NF instance ID of the requesting AMF.
guamis	array(Guami)	O	1..N	When present, this IE shall contain the GUAMI(s) of the AMF.
ueLocation	UserLocation	O	0..1	When present, this IE shall contain the UE location information (e.g. TAI and CGI).
ueTimeZone	TimeZone	O	0..1	When present, this IE shall contain the current time zone of the service user.
traceData	TraceData	O	0..1	Trace Data. The Null value indicates that trace is not active.
backupAmfInfo	array(BackupAmfInfo)	C	1..N	This IE shall be included if the NF service consumer is an AMF and the AMF supports the AMF management without UDSF when the UE Context for SMS to be created in the SMSF, or to be updated in the SMSF. The SMSF uses this attribute to do an NRF query in order to invoke later services in a backup AMF e.g. Namf_MT. Absence of this attribute indicates the backup AMF Info is not provided or the previous provided backup AMF Info is removed.
udmGroupId	NfGroupId	O	0..1	Identity of the UDM group serving the supi
routingIndicator	string	O	0..1	When present, it shall indicate the Routing Indicator of the UE.
hNwPubKeyld	integer	O	0..1	When present, it shall indicate the Home Network Public Key Identifier of the UE. (see NOTE).
ratType	RatType	C	0..1	When present, it shall indicate the RAT type of the UE.
additionalRatType	RatType	C	0..1	When present, it shall indicate the RAT type of the UE corresponding to additionalAccessType. This IE shall not be included if additionalAccessType IE is not present.
supportedFeatures	SupportedFeatures	C	0..1	This IE shall be present if at least one feature defined in clause 6.1.8 is supported.
NOTE: If present, this attribute shall be used together with routingIndicator. This attribute is only used by the HPLMN in roaming scenarios.				

6.1.6.2.3 Type: SmsRecordData

Table 6.1.6.2.3-1: Definition of type SmsRecordData

Attribute name	Data type	P	Cardinality	Description
smsRecordId	RecordId	M	1	This IE shall be present, and it shall contain the record id uniquely identify a message carrying SMS payload.
smsPayload	RefToBinaryData	M	1	This IE shall be present, and it shall contain the reference to the SMS Payload Information binary data (see clause 6.1.6.4)
gpsi	Gpsi	O	0..1	When present, this IE shall contain the global permanent subscriber identifier of the service user.
pei	Pei	O	0..1	When present, this IE shall contain the IMEI or IMEISV of the service user.
accessType	AccessType	O	0..1	When present, this IE shall contain the access type from which the service user accesses to network.
ueLocation	UserLocation	O	0..1	When present, this IE shall contain the UE location information (e.g. TAI and CGI).
ueTimeZone	TimeZone	O	0..1	When present, this IE shall contain the time zone of the service user.

6.1.6.2.4 Void

6.1.6.2.5 Type: SmsRecordDeliveryData

Table 6.1.6.2.5-1: Definition of type SmsRecordDeliveryData

Attribute name	Data type	P	Cardinality	Description
smsRecordId	RecordId	M	1	This IE shall be present, and it shall contain the record id uniquely identify a message carrying SMS payload.
deliveryStatus	SmsDeliveryStatus	M	1	This IE shall be present, and it shall indicate the status of SMS payload delivery attempt in the SMSF, after SMSF receiving SMS payload on Nsmsf interface.

6.1.6.3 Simple data types and enumerations

6.1.6.3.1 Introduction

This clause defines simple data types and enumerations that can be referenced from data structures defined in the previous clauses.

6.1.6.3.2 Simple data types

The simple data types defined in table 6.1.6.3.2-1 shall be supported.

Table 6.1.6.3.2-1: Simple data types

Type Name	Type Definition	Description
RecordId	string	String uniquely identifying a record in the SMSF. The format of RecordId is implementation specific, e.g. using UUID format. In an OpenAPI Specification [19] schema, the format shall be designated as "RecordId".

6.1.6.3.3 Enumeration: SmsDeliveryStatus

The enumeration SmsDeliveryStatus represents the status of SMS payload delivery attempt at the SMSF. It shall comply with the provisions defined in table 6.1.6.3.3-1.

Table 6.1.6.3.3-1: Enumeration SmsDeliveryStatus

Enumeration value	Description
SMS_DELIVERY_PENDING	The SMS payload delivery at SMSF is pending.
SMS_DELIVERY_COMPLETED	The SMS payload delivery at SMSF is completed.
SMS_DELIVERY_FAILED	The SMS payload delivery at SMSF is failed due to certain reasons.
SMS_DELIVERY_SMSF_ACCEPTED	The SMS payload is accepted by the SMSF for further delivery.

6.1.6.4 Binary data

6.1.6.4.1 Introduction

This clause defines the binary data that shall be supported in a binary body part in an HTTP multipart message (see clauses 6.1.2.2.2 and 6.1.2.4), to support delivery of binary content of SMS payload.

Table 6.1.6.4.1-1: Binary Data Types

Name	Clause defined	Content type
SMS Payload Information	6.1.6.4.2	vnd.3gpp.sms

6.1.6.4.2 SMS Payload Information

SMS Payload Information shall encode a SMS payload as specified in 3GPP TS 23.040 [11] and 3GPP TS 24.011 [12], using the vnd.3gpp.sms content-type.

SMS Payload Information may encode e.g. the following content:

- CP-DATA, CP-ACK, CP-ERROR as specified in 3GPP TS 23.040 [11] and 3GPP TS 24.011 [12];

6.1.7 Error Handling

6.1.7.1 General

HTTP error handling shall be supported as specified in clause 5.2.4 of 3GPP TS 29.500 [4].

6.1.7.2 Protocol Errors

Protocol errors handling shall be supported as specified in clause 5.2.7 of 3GPP TS 29.500 [4].

6.1.7.3 Application Errors

The common application errors defined in the Table 5.2.7.2-1 in 3GPP TS 29.500 [4] may also be used for the Nsmsf_SMSservice service, and the following application errors listed in Table 6.1.7.3-1 are specific for the Nsmsf_SMSservice service.

Table 6.1.7.3-1: Application errors

Application Error	HTTP status code	Description
USER_NOT_FOUND	404 Not Found	The provided subscriber identifier is invalid or the service user not found.
CONTEXT_NOT_FOUND	404 Not Found	The UE context for SMS to be operated is invalid or not found in SMSF.
SERVICE_NOT_ALLOWED	403 Forbidden	The requested service is not allowed for this service user.
SMS_PAYLOAD_MISSING	400 Bad Request	The expected SMS payload content is missing.
SMS_PAYLOAD_ERROR	400 Bad Request	Errors exist in the format of SMS payload.

6.1.8 Feature negotiation

The features in table 6.1.8-1 are defined for the Nsmsf_SMSservice API. They shall be negotiated using the extensibility mechanism defined in clause 6.6 of 3GPP TS 29.500 [4].

Table 6.1.8-1: Features of supportedFeatures attribute used by Nsmsf_SMSservice service

Feature Number	Feature	M/O	Description
1	ES3XX	M	Extended Support of HTTP 307/308 redirection An NF Service Consumer (e.g. AMF) that supports this feature shall support handling of HTTP 307/308 redirection for any service operation of the Nsmsf_SMSservice service. An NF Service Consumer that does not support this feature does only support HTTP redirection as specified for 3GPP Release 15.
2	PatchReport	O	If some of the modifications included in the PATCH request are not successfully implemented, the SMSF reports the result of PATCH request execution to the consumer. See clause 5.2.7.2 of 3GPP TS 29.500 [4].
Feature number: The order number of the feature within the supportedFeatures attribute (starting with 1). Feature: A short name that can be used to refer to the bit and to the feature. M/O: Defines if the implementation of the feature is mandatory ("M") or optional ("O"). Description: A clear textual description of the feature.			

6.1.9 Security

As indicated in 3GPP TS 33.501 [13] and 3GPP TS 29.500 [4], the access to the Nsmsf_SMSservice API may be authorized by means of the OAuth2 protocol (see IETF RFC 6749 [14]), based on local configuration, using the "Client Credentials" authorization grant, where the NRF (see 3GPP TS 29.510 [15]) plays the role of the authorization server.

If OAuth2 is used, an NF Service Consumer, prior to consuming services offered by the Nsmsf_SMSservice API, shall obtain a "token" from the authorization server, by invoking the Access Token Request service, as described in 3GPP TS 29.510 [15], clause 5.4.2.2.

NOTE: When multiple NRFs are deployed in a network, the NRF used as authorization server is the same NRF that the NF Service Consumer used for discovering the Nsmsf_SMSservice service.

The Nsmsf_SMSservice API defines a single scope "nsmsf-sms" for OAuth2 authorization (as specified in 3GPP TS 33.501 [13]) for the entire API, and it does not define any additional scopes at resource or operation level.

6.1.10 HTTP redirection

An HTTP request may be redirected to a different SMSF service instance, within the same SMSF or a different SMSF of an SMSF set, e.g. when an SMSF service instance is part of an SMSF (service) set or when using indirect communications (see 3GPP TS 29.500 [4]). See the ES3XX feature in clause 6.1.8.

An SCP that reselects a different SMSF producer instance will return the NF Instance ID of the new SMSF producer instance in the 3gpp-Sbi-Producer-Id header, as specified in clause 6.10.3.4 of 3GPP TS 29.500 [4].

If an SMSF within an SMSF set redirects a service request to a different SMSF of the set using a 307 Temporary Redirect or 308 Permanent Redirect status code, the identity of the new SMSF towards which the service request is redirected shall be indicated in the 3gpp-Sbi-Target-Nf-Id header of the 307 Temporary Redirect or 308 Permanent Redirect response as specified in clause 6.10.9.1 of 3GPP TS 29.500 [4].

Annex A (normative): OpenAPI specification

A.1 General

This Annex specifies the formal definition of the Nsmsf_SMSservice service. It consists of OpenAPI 3.0.0 specifications, in YAML format.

This Annex takes precedence when being discrepant to other parts of the specification with respect to the encoding of information elements and methods within the API(s).

NOTE 1: The semantics and procedures, as well as conditions, e.g. for the applicability and allowed combinations of attributes or values, not expressed in the OpenAPI definitions but defined in other parts of the specification also apply.

Informative copies of the OpenAPI specification files contained in this 3GPP Technical Specification are available on a Git-based repository that uses the GitLab software version control system (see 3GPP TS 29.501 [5] clause 5.3.1 and 3GPP TR 21.900 [16] clause 5B).

A.2 Nsmsf_SMSservice API

```
openapi: 3.0.0

info:
  version: '2.4.0'
  title: 'Nsmsf_SMSservice Service API'
  description: |
    SMSF SMSservice.
    © 2025, 3GPP Organizational Partners (ARIB, ATIS, CCSA, ETSI, TSDSI, TTA, TTC).
    All rights reserved.

externalDocs:
  description: 3GPP TS 29.540 V19.4.0; 5G System; SMS Services; Stage 3
  url: 'https://www.3gpp.org/ftp/Specs/archive/29_series/29.540/'

security:
  - oAuth2ClientCredentials:
    - nsmsf-sms
  - {}

servers:
  - url: '{apiRoot}/nsmsf-sms/v2'
    variables:
      apiRoot:
        default: https://example.com
        description: apiRoot as defined in clause 4.4 of 3GPP TS 29.501.

paths:
  /ue-contexts/{supi}:
    put:
      summary: Activate SMS Service for a given UE
      operationId: SMSserviceActivation
      tags:
        - Activation of SMS service
      parameters:
        - name: supi
          in: path
          required: true
          description: Subscriber Permanent Identifier (SUPI)
          schema:
            type: string
      requestBody:
        content:
          application/json:
            schema:
              $ref: '#/components/schemas/UeSmsContextData'
```

```

    required: true
  responses:
    '201':
      description: UE Context for SMS is created in SMSF
      content:
        application/json:
          schema:
            $ref: '#/components/schemas/UeSmsContextData'
      headers:
        Location:
          description: 'Contains the URI of the newly created resource, according to the
structure: {apiRoot}/nsmsf-sms/<apiVersion>/ue-contexts/{supi}'
          required: true
          schema:
            type: string
        ETag:
          description: Entity Tag, containing a strong validator, as described in IETF RFC 9110
          schema:
            type: string
    '204':
      description: UE Context for SMS is updated in SMSF
      headers:
        ETag:
          description: Entity Tag, containing a strong validator, as described in IETF RFC 9110
          schema:
            type: string
    '307':
      $ref: 'TS29571_CommonData.yaml#/components/responses/307'
    '308':
      $ref: 'TS29571_CommonData.yaml#/components/responses/308'
    '400':
      description: Invalid Service Request
      content:
        application/problem+json:
          schema:
            $ref: 'TS29571_CommonData.yaml#/components/schemas/ProblemDetails'
    '401':
      $ref: 'TS29571_CommonData.yaml#/components/responses/401'
    '403':
      description: Unable to create/update UE Context for SMS in SMSF
      content:
        application/problem+json:
          schema:
            $ref: 'TS29571_CommonData.yaml#/components/schemas/ProblemDetails'
    '404':
      description: Unable to found subscription for service user or UE Context for SMS in SMSF
      content:
        application/problem+json:
          schema:
            $ref: 'TS29571_CommonData.yaml#/components/schemas/ProblemDetails'
    '411':
      $ref: 'TS29571_CommonData.yaml#/components/responses/411'
    '413':
      $ref: 'TS29571_CommonData.yaml#/components/responses/413'
    '415':
      $ref: 'TS29571_CommonData.yaml#/components/responses/415'
    '429':
      $ref: 'TS29571_CommonData.yaml#/components/responses/429'
    '500':
      $ref: 'TS29571_CommonData.yaml#/components/responses/500'
    '502':
      $ref: 'TS29571_CommonData.yaml#/components/responses/502'
    '503':
      description: Service Unavailable
      content:
        application/problem+json:
          schema:
            $ref: 'TS29571_CommonData.yaml#/components/schemas/ProblemDetails'
  default:
    description: Unexpected error
    content:
      application/problem+json:
        schema:
          $ref: 'TS29571_CommonData.yaml#/components/schemas/ProblemDetails'
  patch:
    summary: Update a parameter in the UE SMS Context in SMSF
    operationId: SMSServiceParameterUpdate
    tags:

```

```

- Parameter update in the UE SMS Context in SMSF
parameters:
- name: supi
  in: path
  required: true
  description: Subscriber Permanent Identifier (SUPI)
  schema:
    type: string
- name: supported-features
  in: query
  description: Features required to be supported by the target NF
  schema:
    $ref: 'TS29571_CommonData.yaml#/components/schemas/SupportedFeatures'
requestBody:
  content:
    application/json-patch+json:
      schema:
        type: array
        items:
          $ref: 'TS29571_CommonData.yaml#/components/schemas/PatchItem'
        minItems: 1
      required: true
responses:
'200':
  description: Expected response to a valid request
  content:
    application/json:
      schema:
        oneOf:
          - $ref: 'TS29571_CommonData.yaml#/components/schemas/PatchResult'
          - $ref: '#/components/schemas/UeSmsContextData'
'204':
  description: Successful response
'307':
  $ref: 'TS29571_CommonData.yaml#/components/responses/307'
'308':
  $ref: 'TS29571_CommonData.yaml#/components/responses/308'
'400':
  $ref: 'TS29571_CommonData.yaml#/components/responses/400'
'401':
  $ref: 'TS29571_CommonData.yaml#/components/responses/401'
'403':
  $ref: 'TS29571_CommonData.yaml#/components/responses/403'
'404':
  $ref: 'TS29571_CommonData.yaml#/components/responses/404'
'411':
  $ref: 'TS29571_CommonData.yaml#/components/responses/411'
'413':
  $ref: 'TS29571_CommonData.yaml#/components/responses/413'
'415':
  $ref: 'TS29571_CommonData.yaml#/components/responses/415'
'422':
  description: Unprocessable Request
  content:
    application/problem+json:
      schema:
        $ref: 'TS29571_CommonData.yaml#/components/schemas/ProblemDetails'
'429':
  $ref: 'TS29571_CommonData.yaml#/components/responses/429'
'500':
  $ref: 'TS29571_CommonData.yaml#/components/responses/500'
'502':
  $ref: 'TS29571_CommonData.yaml#/components/responses/502'
'503':
  $ref: 'TS29571_CommonData.yaml#/components/responses/503'
default:
  description: Unexpected error
delete:
  summary: Deactivate SMS Service for a given UE
  operationId: SMSServiceDeactivation
  tags:
    - Deactivation of SMS service
parameters:
- name: supi
  in: path
  required: true
  description: Subscriber Permanent Identifier (SUPI)
  schema:

```

```

    type: string
  - name: If-Match
    in: header
    description: Validator for conditional requests, as described in IETF RFC 9110
    schema:
      type: string
responses:
  '204':
    description: UE Context for SMS is deleted from SMSF
  '307':
    $ref: 'TS29571_CommonData.yaml#/components/responses/307'
  '308':
    $ref: 'TS29571_CommonData.yaml#/components/responses/308'
  '400':
    description: Invalid Service Request
    content:
      application/problem+json:
        schema:
          $ref: 'TS29571_CommonData.yaml#/components/schemas/ProblemDetails'
  '401':
    $ref: 'TS29571_CommonData.yaml#/components/responses/401'
  '403':
    $ref: 'TS29571_CommonData.yaml#/components/responses/403'
  '404':
    description: Unable to found UE Context for SMS in SMSF
    content:
      application/problem+json:
        schema:
          $ref: 'TS29571_CommonData.yaml#/components/schemas/ProblemDetails'
  '429':
    $ref: 'TS29571_CommonData.yaml#/components/responses/429'
  '500':
    $ref: 'TS29571_CommonData.yaml#/components/responses/500'
  '502':
    $ref: 'TS29571_CommonData.yaml#/components/responses/502'
  '503':
    description: Service Unavailable
    content:
      application/problem+json:
        schema:
          $ref: 'TS29571_CommonData.yaml#/components/schemas/ProblemDetails'

/ue-contexts/{supi}/sendsms:
  post:
    summary: Send SMS payload for a given UE
    operationId: SendsSMS
    tags:
      - Send SMS payload in uplink direction
    parameters:
      - name: supi
        in: path
        required: true
        description: Subscriber Permanent Identifier (SUPI)
        schema:
          type: string
    requestBody:
      content:
        multipart/related:
          schema:
            type: object
            properties:
              jsonData:
                $ref: '#/components/schemas/SmsRecordData'
              binaryPayload:
                type: string
                format: binary
            encoding:
              jsonData:
                contentType: application/json
              binaryPayload:
                contentType: application/vnd.3gpp.sms
            headers:
              Content-Id:
                schema:
                  type: string
        required: true
    responses:
      '200':

```

```

    description: SMS payload is received by SMSF, and is being delivered out
    content:
      application/json:
        schema:
          $ref: '#/components/schemas/SmsRecordDeliveryData'
'307':
  $ref: 'TS29571_CommonData.yaml#/components/responses/307'
'308':
  $ref: 'TS29571_CommonData.yaml#/components/responses/308'
'400':
  description: Invalid Service Request
  content:
    application/problem+json:
      schema:
        $ref: 'TS29571_CommonData.yaml#/components/schemas/ProblemDetails'
'401':
  $ref: 'TS29571_CommonData.yaml#/components/responses/401'
'403':
  description: Unable to deliver SMS at SMSF
  content:
    application/problem+json:
      schema:
        $ref: 'TS29571_CommonData.yaml#/components/schemas/ProblemDetails'
'404':
  description: Unable to found UE Context for SMS in SMSF
  content:
    application/problem+json:
      schema:
        $ref: 'TS29571_CommonData.yaml#/components/schemas/ProblemDetails'
'411':
  $ref: 'TS29571_CommonData.yaml#/components/responses/411'
'413':
  $ref: 'TS29571_CommonData.yaml#/components/responses/413'
'415':
  $ref: 'TS29571_CommonData.yaml#/components/responses/415'
'429':
  $ref: 'TS29571_CommonData.yaml#/components/responses/429'
'500':
  $ref: 'TS29571_CommonData.yaml#/components/responses/500'
'502':
  $ref: 'TS29571_CommonData.yaml#/components/responses/502'
'503':
  description: Service Unavailable
  content:
    application/problem+json:
      schema:
        $ref: 'TS29571_CommonData.yaml#/components/schemas/ProblemDetails'

/ue-contexts/{supi}/send-mt-sms:
  post:
    summary: Send MT SMS payload for a given UE
    operationId: SendMtSMS
    tags:
      - Send SMS payload in downlink direction
    parameters:
      - name: supi
        in: path
        required: true
        description: Subscriber Permanent Identifier (SUPI)
        schema:
          type: string
    requestBody:
      content:
        multipart/related:
          schema:
            type: object
            properties:
              jsonData:
                $ref: 'TS29577_Nipsmgw_SMSservice.yaml#/components/schemas/SmsData'
              binaryPayload:
                type: string
                format: binary
            encoding:
              jsonData:
                contentType: application/json
              binaryPayload:
                contentType: application/vnd.3gpp.sms
            headers:

```

```

        Content-Id:
          schema:
            type: string
      required: true
    responses:
      '200':
        description: sending delivery report
        content:
          multipart/related:
            schema:
              type: object
              properties:
                jsonData:
                  $ref: 'TS29577_Nipsmgw_SMSservice.yaml#/components/schemas/SmsDeliveryData'
                binaryPayload:
                  type: string
                  format: binary
            encoding:
              jsonData:
                contentType: application/json
              binaryPayload:
                contentType: application/vnd.3gpp.sms
            headers:
              Content-Id:
                schema:
                  type: string
      '307':
        $ref: 'TS29571_CommonData.yaml#/components/responses/307'
      '308':
        $ref: 'TS29571_CommonData.yaml#/components/responses/308'
      '400':
        description: Invalid Service Request
        content:
          application/problem+json:
            schema:
              $ref: 'TS29571_CommonData.yaml#/components/schemas/ProblemDetails'
      '401':
        $ref: 'TS29571_CommonData.yaml#/components/responses/401'
      '403':
        description: Unable to deliver SMS at SMSF
        content:
          application/problem+json:
            schema:
              $ref: 'TS29571_CommonData.yaml#/components/schemas/ProblemDetails'
      '404':
        description: Unable to found UE Context for SMS in SMSF
        content:
          application/problem+json:
            schema:
              $ref: 'TS29571_CommonData.yaml#/components/schemas/ProblemDetails'
      '411':
        $ref: 'TS29571_CommonData.yaml#/components/responses/411'
      '413':
        $ref: 'TS29571_CommonData.yaml#/components/responses/413'
      '415':
        $ref: 'TS29571_CommonData.yaml#/components/responses/415'
      '429':
        $ref: 'TS29571_CommonData.yaml#/components/responses/429'
      '500':
        $ref: 'TS29571_CommonData.yaml#/components/responses/500'
      '502':
        $ref: 'TS29571_CommonData.yaml#/components/responses/502'
      '503':
        description: Service Unavailable
        content:
          application/problem+json:
            schema:
              $ref: 'TS29571_CommonData.yaml#/components/schemas/ProblemDetails'

```

components:

```

securitySchemes:
  oAuth2ClientCredentials:
    type: oauth2
    flows:
      clientCredentials:
        tokenUrl: '{nrfApiRoot}/oauth2/token'

```

```

    scopes:
      nsmsf-sms: Access to the nsmsf-sms API

schemas:

  UeSmsContextData:
    description: Represents the information used for activating the SMS service for a service
    user, or updating the parameters of the SMS service.
    type: object
    required:
      - supi
      - amfId
      - accessType
    properties:
      supi:
        $ref: 'TS29571_CommonData.yaml#/components/schemas/Supi'
      pei:
        $ref: 'TS29571_CommonData.yaml#/components/schemas/Pei'
      amfId:
        $ref: 'TS29571_CommonData.yaml#/components/schemas/NfInstanceId'
      guamis:
        type: array
        items:
          $ref: 'TS29571_CommonData.yaml#/components/schemas/Guami'
        minItems: 1
      accessType:
        $ref: 'TS29571_CommonData.yaml#/components/schemas/AccessType'
      additionalAccessType:
        $ref: 'TS29571_CommonData.yaml#/components/schemas/AccessType'
      gpsi:
        $ref: 'TS29571_CommonData.yaml#/components/schemas/Gpsi'
      ueLocation:
        $ref: 'TS29571_CommonData.yaml#/components/schemas/UserLocation'
      ueTimeZone:
        $ref: 'TS29571_CommonData.yaml#/components/schemas/TimeZone'
      traceData:
        $ref: 'TS29571_CommonData.yaml#/components/schemas/TraceData'
      backupAmfInfo:
        type: array
        items:
          $ref: 'TS29571_CommonData.yaml#/components/schemas/BackupAmfInfo'
        minItems: 1
      udmGroupId:
        $ref: 'TS29571_CommonData.yaml#/components/schemas/NfGroupId'
      routingIndicator:
        type: string
      hNwPubKeyId:
        type: integer
      ratType:
        $ref: 'TS29571_CommonData.yaml#/components/schemas/RatType'
      additionalRatType:
        $ref: 'TS29571_CommonData.yaml#/components/schemas/RatType'
      supportedFeatures:
        $ref: 'TS29571_CommonData.yaml#/components/schemas/SupportedFeatures'

  SmsRecordData:
    description: Represents the information sent within a request message of the UplinkSMS service
    operation, for delivering SMS payload.
    type: object
    required:
      - smsRecordId
      - smsPayload
    properties:
      smsRecordId:
        $ref: '#/components/schemas/RecordId'
      smsPayload:
        $ref: 'TS29571_CommonData.yaml#/components/schemas/RefToBinaryData'
      accessType:
        $ref: 'TS29571_CommonData.yaml#/components/schemas/AccessType'
      gpsi:
        $ref: 'TS29571_CommonData.yaml#/components/schemas/Gpsi'
      pei:
        $ref: 'TS29571_CommonData.yaml#/components/schemas/Pei'
      ueLocation:
        $ref: 'TS29571_CommonData.yaml#/components/schemas/UserLocation'
      ueTimeZone:
        $ref: 'TS29571_CommonData.yaml#/components/schemas/TimeZone'

```

RecordId:
description: Represents a record ID, used to identify a message carrying SMS payload.
type: string

SmsRecordDeliveryData:
description: Represents information on the result of invoking the UplinkSMS service operation.
type: object
required:
- smsRecordId
- deliveryStatus
properties:
smsRecordId:
 \$ref: '#/components/schemas/RecordId'
deliveryStatus:
 \$ref: '#/components/schemas/SmsDeliveryStatus'

SmsDeliveryStatus:
description: Represents the Status of an SMS delivery attempt.
type: string
enum:
- SMS_DELIVERY_PENDING
- SMS_DELIVERY_COMPLETED
- SMS_DELIVERY_FAILED
- SMS_DELIVERY_SMSF_ACCEPTED

Annex B (Informative): HTTP Multipart Messages

B.1 Example of HTTP multipart message

This Annex provides a (partial) example of HTTP multipart message. The example does not aim to be a complete representation of the HTTP message, e.g. additional information or headers can be included.

This Annex is informative and the normative descriptions in this specification prevail over the description in this Annex if there is any difference.

B.2 Void

B.3 Example HTTP multipart message with SMS binary data

Example HTTP multipart message with SMS binary data:

```
POST /example.com/nsmsf-sms/v1/ue-contexts/{supi}/sendsms HTTP/2
Content-Type: multipart/related; boundary=----Boundary
Content-Length: xyz

-----Boundary
Content-Type: application/json

{
  "smsRecordId": "777c3edf-129f-486e-a3f8-c48e7b515605",
  "smsPayload": {
    "contentId": "sms"
  },
  "gpsi": "msisdn-8613915900000",
  "pei": "imei-123456789012345",
  "accessType": "3GPP_ACCESS",
  "ueLocation": {
    "nrLocation": {
      "tai": {
        "plmnId": {
          "mcc": "46",
          "mnc": "000"
        },
        "tac": "A01001",
        "ncgi": {
          "plmnId": {
            "mcc": "46",
            "mnc": "000"
          },
          "nrCellId": "225BD6007"
        }
      }
    }
  },
  "ueTimeZone": "+08:00"
}

-----Boundary
Content-Type: application/vnd.3gpp.sms
Content-Id: sms

{ ... SMS Message binary data ...}

-----Boundary
```

The JSON part of the HTTP POST message includes an attribute named "smsPayload" which refers to RefToBinaryData structure. The "contentId" of RefToBinaryData is encoded as a string and used to reference the value of the Content-ID header field of the binary body part.

Annex C (informative): Change history

Change history							
Date	Meeting	TDoc	CR	Rev	Cat	Subject/Comment	New version
2017-10	CT4#80	C4-175084				Initial Draft.	0.1.0
2017-10	CT4#80	C4-175399				Implementation of C4-175281, C4-175282, C4-175284.	0.2.0
2017-12	CT4#81	C4-176441				Implementation of C4-176092, C4-176097, C4-176346, C4-176347, C4-176349, C4-176351, C4-176353.	0.3.0
2018-03	CT4#83	C4-182439				Implementation of C4-182300, C4-182301, C4-182303, C4-182416	0.4.0
2018-04	CT4#84	C4-183520				Implementation of C4-183375, C4-183376, C4-183377, C4-183378, C4-183379.	0.5.0
2018-05	CT4#85	C4-184633				Implementation of C4-184467, C4-184605, C4-184470, C4-184473, C4-184474, C4-184634.	0.6.0
2018-06	CT#80	CP-181109				Presented for information and approval	1.0.0
2018-06	CT#80					Approved in CT#80.	15.0.0
2018-09	CT#81	CP-182064	0002	1	F	Change to Common Data Type	15.1.0
2018-09	CT#81	CP-182064	0003	1	F	Correct HTTP Response Code	15.1.0
2018-09	CT#81	CP-182064	0004	1	F	Add Missing Parameters	15.1.0
2018-09	CT#81	CP-182064	0005	-	F	Clarify the Format of SMS Record ID	15.1.0
2018-09	CT#81	CP-182064	0006	-	F	Add support of 5G Trace	15.1.0
2018-09	CT#81	CP-182064	0007	2	F	Backup AMF Info	15.1.0
2018-09	CT#81	CP-182064	0008	-	F	Description of Structured data types	15.1.0
2018-09	CT#81	CP-182064	0009	1	F	API Version Update	15.1.0
2018-12	CT#82	CP-183023	0010	1	F	API Correction	15.2.0
2018-12	CT#82	CP-183023	0011	-	F	CR cardinality	15.2.0
2018-12	CT#82	CP-183023	0012	1	F	NF group Id	15.2.0
2018-12	CT#82	CP-183023	0013	-	F	APIRoot Clarification	15.2.0
2018-12	CT#82	CP-183023	0014	-	F	Location Header in HTTP 201 Response	15.2.0
2018-12	CT#82	CP-183023	0015	-	F	Open API version	15.2.0
2018-12	CT#82	CP-183188	0016	-	F	Optionality of OAuth2	15.2.0
2018-12	CT#82	CP-183189	0017	-	F	Correction of "externalDocs" for Nsmf_SMSservice Service	15.2.0
2019-03	CT#83	CP-190069	0018	2	F	SMS payload	15.3.0
2019-03	CT#83	CP-190028	0020	-	F	API version update	15.3.0
2019-06	CT#84	CP-191040	0019	2	F	Resolve Editor's Notes	15.4.0
2019-06	CT#84	CP-191040	0021	1	F	Resource URI correction	15.4.0
2019-06	CT#84	CP-191040	0022	1	F	API URI Description	15.4.0
2019-06	CT#84	CP-191040	0023	2	F	Storage of OpenAPI specification files	15.4.0
2019-06	CT#84	CP-191040	0025	1	F	API Version Correction	15.4.0
2019-06	CT#84	CP-191040	0026	1	F	Supported Content Type	15.4.0
2019-06	CT#84	CP-191040	0027	1	F	Essential Corrections on MultiPart Message	15.4.0
2019-06	CT#84	CP-191040	0029	1	F	Copyright Note in YAML file	15.4.0
2019-06	CT#84	CP-191040	0031	1	F	3GPP TS 29.540 API Version Update	15.4.0
2019-06	CT#84	CP-191057	0024	-	B	Remove useless and misleading application error	16.0.0
2019-09	CT#85	CP-192112	0033	1	F	Decouple uplinkSMS Response with SMS-C Communication	16.1.0
2019-09	CT#85	CP-192123	0034	-	F	CRLF between Header fields and Data	16.1.0
2019-09	CT#85	CP-192120	0036	-	F	29.540 Rel-16 Open API version externalDocs	16.1.0
2019-12	CT#86	CP-193044	0040	-	F	29.540 Rel-16 API version and External doc update	16.2.0
2020-03	CT#87	CP-200039	0041	2	F	Add Corresponding API descriptions in clause 5.1	16.3.0
2020-03	CT#87	CP-200039	0042	2	F	Correction - formatting consistency	16.3.0
2020-03	CT#87	CP-200033	0043	-	B	RAT Type	16.3.0
2020-03	CT#87	CP-200020	0044	2	F	Optionality of ProblemDetails	16.3.0
2020-03	CT#87	CP-200052	0045	-	F	API version and External doc update	16.3.0
2020-06	CT#88	CP-201059	0046	1	F	Supported Headers table for response code 201	16.4.0
2020-06	CT#88	CP-201059	0047	1	F	Binary Data Types Table	16.4.0
2020-06	CT#88	CP-201024	0048	1	F	Correct the Data Type Descriptions	16.4.0
2020-06	CT#88	CP-201059	0051	1	F	Data type column in Resource URI variables Table	16.4.0
2020-06	CT#88	CP-201059	0052	1	F	Add custom operation Name	16.4.0
2020-06	CT#88	CP-201024	0054	-	F	Essential Corrections	16.4.0
2020-06	CT#88	CP-201073	0055	-	F	API version and External doc update	16.4.0
2020-09	CT#89	CP-202101	0056	1	F	Storage of YAML files in 3GPP Forge	16.5.0
2020-09	CT#89	CP-202096	0057	-	F	API version and External doc update	16.5.0
2020-12	CT#90	CP-203027	0059	1	F	Correction to support multiple access type for SMS	16.6.0
2020-12	CT#90	CP-203054	0060	1	F	HTTP 3xx redirection	16.6.0
2020-12	CT#90	CP-203048	0064	1	F	Essential corrections	16.6.0
2020-12	CT#90	CP-203027	0066	2	F	Header check at deactivation of SMS service	16.6.0
2020-12	CT#90	CP-203036	0069	-	F	API version and External doc update	16.6.0
2021-03	CT#91	CP-210062	0074	-	F	Etag in 204 Response	16.7.0
2021-03	CT#91	CP-210054	0078	-	F	API version and External doc update	16.7.0
2021-03	CT#91	CP-210021	0072	1	B	Home Network Public Key identifier as additional input for SMSF service	17.0.0
2021-03	CT#91	CP-210034	0075	-	F	Editorial and reference errors	17.0.0
2021-03	CT#91	CP-210034	0076	1	F	OpenAPI Reference	17.0.0

2021-03	CT#91	CP-210029	0077	-	F	API version and External doc update	17.0.0
2021-06	CT#92	CP-211028	0080	-	F	Adding some missing description fields to data type definitions in the OpenAPI specification file of the Nsmsf_SMSservice API	17.1.0
2021-06	CT#92	CP-211177	0082	2	F	Redirect Response	17.1.0
2021-06	CT#92	CP-211050	0083	-	F	29.540 Rel-17 API version and External doc update	17.1.0
2021-09	CT#93	CP-212026	0085	1	F	SMSF dual access registration	17.2.0
2021-09	CT#93	CP-212060	0087	-	F	3xx description correction for SCP	17.2.0
2021-09	CT#93	CP-212059	0088	-	F	29.540 Rel-17 API version and External doc update	17.2.0
2021-12	CT#94	CP-213087	0090	1	F	Removal of backupAmfInfo	17.3.0
2021-12	CT#94	CP-213121	0091	-	F	29.540 Rel-17 API version and External doc update	17.3.0
2022-03	CT#95	CP-220024	0093	3	F	Introduce HTTP PATCH Method	17.4.0
2022-03	CT#95	CP-220024	0094	-	F	Simplify 307/308 Response in OpenAPI	17.4.0
2022-03	CT#95	CP-220026	0096	1	A	3xx Redirect Response	17.4.0
2022-03	CT#95	CP-220066	0097	-	F	29.540 Rel-17 API version and External doc update	17.4.0
2022-06	CT#96	CP-221027	0099	-	F	Correction of typos in description fields	17.5.0
2022-06	CT#96	CP-221054	0100	-	F	Correction on USER_NOT_FOUND error	17.5.0
2022-06	CT#96	CP-221090	0103	2	B	MtForwardSm service operation	17.5.0
2022-06	CT#96	CP-221031	0104	1	B	Removal of the NOTE on interaction between SMSF and SMS-GMSC/IW/MSC/IP-SM-GW/SMS Router	17.5.0
2022-06	CT#96	CP-221051	0105	-	B	29.540 Rel-17 API version and External doc update	17.5.0
2022-09	CT#97	CP-222026	0106	1	F	Partial success in PATCH	17.6.0
2022-09	CT#97	CP-222058	0107	-	F	29.540 Rel-17 API version and External doc update	17.6.0
2022-12	CT#98	CP-223028	0108	1	F	Missing Mandatory Status Codes in OpenAPI	18.0.0
2022-12	CT#98	CP-223033	0109	-	F	29.540 Rel-18 API version and External doc update	18.0.0
2023-03	CT#99	CP-230029	0110	-	F	Missing Mandatory Status Codes	18.1.0
2023-03	CT#99	CP-220071	0112	-	F	29.540 Rel-18 API version and External doc update	18.1.0
2023-06	CT#100	CP-231026	0111	2	F	Location header description	18.2.0
2023-12	CT#102	CP-233027	0116	-	F	ProblemDetails RFC 7807 obsoleted by 9457	18.3.0
2023-12	CT#102	CP-233029	0115	2	F	Obsoleted HTTP/2 RFCs	18.3.0
2024-06	CT#104	CP-241050	0117	-	F	Correction of feature negotiation description	18.4.0
2024-06	CT#104	CP-241052	0118	-	F	PI version and External doc update	18.4.0
2024-09	CT#105	CP-242053	0119	-	F	Incorrect implementation of CR 29.540 #0117	18.5.0
2024-09	CT#105	CP-242030	0120	1	F	The term Payload is replaced with Content due to RFC 9113	19.0.0
2025-03	CT#107	CP-250038	0121	1	F	MPS for Messaging SMSF SBI	19.1.0
2025-06	CT#108	CP-251079	0122	-	F	29.540 Rel-19 API version and External doc update	19.2.0
2025-09	CT#109	CP-252176	0123	-	F	29.540 Rel-19 API version and External doc update	19.3.0
2025-12	CT#110	CP-253167	0124	-	F	29.540 Rel-19 API version and External doc update	19.4.0

History

Version	Date	Status
V19.4.0	February 2026	Publication