

# ETSI TS 129 548 V18.2.0 (2025-01)



TECHNICAL SPECIFICATION

**5G;  
Service Enabler Architecture Layer for Verticals (SEAL);  
SEAL Data Delivery (SEALDD) Server Services;  
Stage 3  
(3GPP TS 29.548 version 18.2.0 Release 18)**



---

**Reference**

RTS/TSGC-0329548vi20

---

**Keywords**

5G

**ETSI**

---

650 Route des Lucioles  
F-06921 Sophia Antipolis Cedex - FRANCE

Tel.: +33 4 92 94 42 00 Fax: +33 4 93 65 47 16

Siret N° 348 623 562 00017 - APE 7112B  
Association à but non lucratif enregistrée à la  
Sous-Préfecture de Grasse (06) N° w061004871

---

**Important notice**

The present document can be downloaded from the  
[ETSI Search & Browse Standards application](#).

The present document may be made available in electronic versions and/or in print. The content of any electronic and/or print versions of the present document shall not be modified without the prior written authorization of ETSI. In case of any existing or perceived difference in contents between such versions and/or in print, the prevailing version of an ETSI deliverable is the one made publicly available in PDF format on [ETSI deliver repository](#).

Users should be aware that the present document may be revised or have its status changed, this information is available in the [Milestones listing](#).

If you find errors in the present document, please send your comments to the relevant service listed under [Committee Support Staff](#).

If you find a security vulnerability in the present document, please report it through our [Coordinated Vulnerability Disclosure \(CVD\)](#) program.

---

**Notice of disclaimer & limitation of liability**

The information provided in the present deliverable is directed solely to professionals who have the appropriate degree of experience to understand and interpret its content in accordance with generally accepted engineering or other professional standard and applicable regulations.

No recommendation as to products and services or vendors is made or should be implied.

No representation or warranty is made that this deliverable is technically accurate or sufficient or conforms to any law and/or governmental rule and/or regulation and further, no representation or warranty is made of merchantability or fitness for any particular purpose or against infringement of intellectual property rights.

In no event shall ETSI be held liable for loss of profits or any other incidental or consequential damages.

Any software contained in this deliverable is provided "AS IS" with no warranties, express or implied, including but not limited to, the warranties of merchantability, fitness for a particular purpose and non-infringement of intellectual property rights and ETSI shall not be held liable in any event for any damages whatsoever (including, without limitation, damages for loss of profits, business interruption, loss of information, or any other pecuniary loss) arising out of or related to the use of or inability to use the software.

---

**Copyright Notification**

No part may be reproduced or utilized in any form or by any means, electronic or mechanical, including photocopying and microfilm except as authorized by written permission of ETSI.

The content of the PDF version shall not be modified without the written authorization of ETSI.

The copyright and the foregoing restriction extend to reproduction in all media.

© ETSI 2025.  
All rights reserved.

---

## Intellectual Property Rights

### Essential patents

IPRs essential or potentially essential to normative deliverables may have been declared to ETSI. The declarations pertaining to these essential IPRs, if any, are publicly available for **ETSI members and non-members**, and can be found in ETSI SR 000 314: "*Intellectual Property Rights (IPRs); Essential, or potentially Essential, IPRs notified to ETSI in respect of ETSI standards*", which is available from the ETSI Secretariat. Latest updates are available on the [ETSI IPR online database](#).

Pursuant to the ETSI Directives including the ETSI IPR Policy, no investigation regarding the essentiality of IPRs, including IPR searches, has been carried out by ETSI. No guarantee can be given as to the existence of other IPRs not referenced in ETSI SR 000 314 (or the updates on the ETSI Web server) which are, or may be, or may become, essential to the present document.

### Trademarks

The present document may include trademarks and/or tradenames which are asserted and/or registered by their owners. ETSI claims no ownership of these except for any which are indicated as being the property of ETSI, and conveys no right to use or reproduce any trademark and/or tradename. Mention of those trademarks in the present document does not constitute an endorsement by ETSI of products, services or organizations associated with those trademarks.

**DECT™**, **PLUGTESTS™**, **UMTS™** and the ETSI logo are trademarks of ETSI registered for the benefit of its Members. **3GPP™**, **LTE™** and **5G™** logo are trademarks of ETSI registered for the benefit of its Members and of the 3GPP Organizational Partners. **oneM2M™** logo is a trademark of ETSI registered for the benefit of its Members and of the oneM2M Partners. **GSM®** and the GSM logo are trademarks registered and owned by the GSM Association.

---

## Legal Notice

This Technical Specification (TS) has been produced by ETSI 3rd Generation Partnership Project (3GPP).

The present document may refer to technical specifications or reports using their 3GPP identities. These shall be interpreted as being references to the corresponding ETSI deliverables.

The cross reference between 3GPP and ETSI identities can be found at [3GPP to ETSI numbering cross-referencing](#).

---

## Modal verbs terminology

In the present document "**shall**", "**shall not**", "**should**", "**should not**", "**may**", "**need not**", "**will**", "**will not**", "**can**" and "**cannot**" are to be interpreted as described in clause 3.2 of the [ETSI Drafting Rules](#) (Verbal forms for the expression of provisions).

"**must**" and "**must not**" are **NOT** allowed in ETSI deliverables except when used in direct citation.

# Contents

Intellectual Property Rights .....	2
Legal Notice .....	2
Modal verbs terminology.....	2
Foreword.....	10
1 Scope .....	12
2 References .....	13
3 Definitions, symbols and abbreviations .....	14
3.1 Definitions .....	14
3.2 Symbols.....	14
3.3 Abbreviations .....	14
4 Overview .....	15
5 Services offered by the SEALDD Server.....	16
5.1 Introduction .....	16
5.2 SDD_Transmission Service.....	17
5.2.1 Service Description.....	17
5.2.2 Service Operations .....	17
5.2.2.1 Introduction.....	17
5.2.2.2 SDD_Transmission_Request .....	17
5.2.2.2.1 General .....	17
5.2.2.2.2 SEALDD Transmission Request .....	17
5.2.2.3 SDD_Transmission_ConnStatusSubscribe .....	18
5.2.2.3.1 General .....	18
5.2.2.3.2 SEALDD Connection Status Subscription Creation.....	18
5.2.2.3.3 SEALDD Connection Status Subscription Update.....	19
5.2.2.3.4 SEALDD Connection Status Subscription Deletion.....	20
5.2.2.4 SDD_Transmission_ConnStatusNotify.....	20
5.2.2.4.1 General .....	20
5.2.2.4.2 SEALDD Connection Status Notification .....	20
5.3 SDD_DataStorage Service .....	22
5.3.1 Service Description.....	22
5.3.2 Service Operations.....	22
5.3.2.1 Introduction.....	22
5.3.2.2 SDD_DataStorage_Create.....	22
5.3.2.2.1 General .....	22
5.3.2.2.2 Data Storage Creation.....	23
5.3.2.2.3 Data Management and/or Status Information Notification.....	23
5.3.2.3 SDD_DataStorage_Manage .....	24
5.3.2.3.1 General .....	24
5.3.2.3.2 Data Storage Update.....	24
5.3.2.3.3 Data Storage Deletion.....	25
5.3.2.4 SDD_DataStorage_Query .....	25
5.3.2.4.1 General .....	25
5.3.2.4.2 Data Storage(s) Query .....	25
5.3.2.5 SDD_DataStorage_DelRequest .....	26
5.3.2.5.1 General .....	26
5.3.2.5.2 SEALDD Data Storage Delivery Request.....	26
5.3.2.6 SDD_DataStorage_EstablishDelConn .....	27
5.3.2.6.1 General .....	27
5.3.2.6.2 SEALDD Data Storage Delivery Connection Establishment Request.....	27
5.3.2.7 SDD_DataStorage_DelSubscribe.....	28
5.3.2.7.1 General .....	28
5.3.2.7.2 Data Storage Delivery Subscription Creation.....	28
5.3.2.7.3 Data Storage Delivery Subscription Update.....	28

5.3.2.7.4	Data Storage Delivery Subscription Deletion.....	29
5.3.2.8	SDD_DataStorage_DelNotify.....	30
5.3.2.8.1	General.....	30
5.3.2.8.2	Data Storage Delivery Notification.....	30
5.4	SDD_DDContext Service.....	31
5.4.1	Service Description.....	31
5.4.2	Service Operations.....	31
5.4.2.1	Introduction.....	31
5.4.2.2	SDD_DDContext_Push.....	31
5.4.2.2.1	General.....	31
5.4.2.2.2	DD Context Push.....	31
5.4.2.3	SDD_DDContext_Pull.....	32
5.4.2.3.1	General.....	32
5.4.2.3.2	DD Context Pull.....	32
5.5	SDD_TransmissionQualityMeasurement.....	33
5.5.1	Service Description.....	33
5.5.2	Service Operations.....	33
5.5.2.1	Introduction.....	33
5.5.2.2	SDD_TransmissionQualityMeasurement_Subscribe.....	33
5.5.2.2.1	General.....	33
5.5.2.2.2	Transmission Quality Measurement Subscription Creation.....	33
5.5.2.3	SDD_TransmissionQualityMeasurement_Update.....	34
5.5.2.3.1	General.....	34
5.5.2.3.2	Transmission Quality Measurement Subscription Update.....	34
5.5.2.4	SDD_TransmissionQualityMeasurement_Unsubscribe.....	35
5.5.2.4.1	General.....	35
5.5.2.4.2	Transmission Quality Measurement Subscription Deletion.....	35
5.5.2.5	SDD_TransmissionQualityMeasurement_Notify.....	36
5.5.2.5.1	General.....	36
5.5.2.5.2	Transmission Quality Measurement Notification.....	36
5.5.2.6	SDD_TransmissionQualityMeasurement_Query.....	36
5.5.2.6.1	General.....	36
5.5.2.6.2	Historical Transmission Quality Measurement Report(s) Retrieval.....	36
5.6	SDD_PolicyConfiguration.....	38
5.6.1	Service Description.....	38
5.6.2	Service Operations.....	38
5.6.2.1	Introduction.....	38
5.6.2.2	SDD_PolicyConfiguration_Create.....	38
5.6.2.2.1	General.....	38
5.6.2.2.2	Policy Configuration Creation.....	38
5.6.2.3	SDD_PolicyConfiguration_Update.....	39
5.6.2.3.1	General.....	39
5.6.2.3.2	Policy Configuration Update.....	39
5.6.2.4	SDD_PolicyConfiguration_Delete.....	40
5.6.2.4.1	General.....	40
5.6.2.4.2	Policy Configuration Deletion.....	40
6	API Definitions.....	41
6.1	SDD_Transmission Service API.....	41
6.1.1	Introduction.....	41
6.1.2	Usage of HTTP.....	41
6.1.3	Resources.....	41
6.1.3.1	Overview.....	41
6.1.3.2	Resource: Connection Status Subscriptions.....	42
6.1.3.2.1	Description.....	42
6.1.3.2.2	Resource Definition.....	42
6.1.3.2.3	Resource Standard Methods.....	42
6.1.3.2.4	Resource Custom Operations.....	43
6.1.3.3	Resource: Individual Connection Status Subscription.....	43
6.1.3.3.1	Description.....	43
6.1.3.3.2	Resource Definition.....	43
6.1.3.3.3	Resource Standard Methods.....	43

6.1.3.3.4	Resource Custom Operations .....	47
6.1.4	Custom Operations without associated resources .....	48
6.1.4.1	Overview .....	48
6.1.4.2	Operation: RequestTrans .....	48
6.1.4.2.1	Description .....	48
6.1.4.2.2	Operation Definition .....	48
6.1.5	Notifications .....	49
6.1.5.1	General .....	49
6.1.5.2	Connection Status Notification .....	50
6.1.5.2.1	Description .....	50
6.1.5.2.2	Target URI .....	50
6.1.5.2.3	Standard Methods .....	50
6.1.6	Data Model .....	51
6.1.6.1	General .....	51
6.1.6.2	Structured data types .....	52
6.1.6.2.1	Introduction .....	52
6.1.6.2.2	Type: TransReq .....	53
6.1.6.2.3	Type: TransResp .....	53
6.1.6.2.4	Type: ConnInfo .....	54
6.1.6.2.5	Type: QosInfo .....	54
6.1.6.2.6	Type: ValServBdw .....	54
6.1.6.2.7	Type: ValUsersBdw .....	55
6.1.6.2.8	Type: ConnStatusSubsc .....	55
6.1.6.2.9	Type: ConnStatusSubscPatch .....	55
6.1.6.2.10	Type: ConnStatusNotif .....	56
6.1.6.2.11	Type: ConnStatusReport .....	56
6.1.6.2.12	Type: ConnEstabData .....	56
6.1.6.3	Simple data types and enumerations .....	56
6.1.6.3.1	Introduction .....	56
6.1.6.3.2	Simple data types .....	56
6.1.6.3.3	Enumeration: ConnStatusEvent .....	57
6.1.6.3.4	Enumeration: TransType .....	57
6.1.6.4	Data types describing alternative data types or combinations of data types .....	57
6.1.6.5	Binary data .....	57
6.1.6.5.1	Binary Data Types .....	57
6.1.7	Error Handling .....	57
6.1.7.1	General .....	57
6.1.7.2	Protocol Errors .....	57
6.1.7.3	Application Errors .....	58
6.1.8	Feature negotiation .....	58
6.1.9	Security .....	58
6.2	SDD_DataStorage Service API .....	59
6.2.1	Introduction .....	59
6.2.2	Usage of HTTP .....	59
6.2.3	Resources .....	59
6.2.3.1	Overview .....	59
6.2.3.2	Resource: Data Storages .....	61
6.2.3.2.1	Description .....	61
6.2.3.2.2	Resource Definition .....	61
6.2.3.2.3	Resource Standard Methods .....	61
6.2.3.2.4	Resource Custom Operations .....	63
6.2.3.3	Resource: Individual Data Storage .....	63
6.2.3.3.1	Description .....	63
6.2.3.3.2	Resource Definition .....	63
6.2.3.3.3	Resource Standard Methods .....	63
6.2.3.3.4	Resource Custom Operations .....	67
6.2.3.4	Resource: Data Storage Delivery Subscriptions .....	68
6.2.3.4.1	Description .....	68
6.2.3.4.2	Resource Definition .....	68
6.2.3.4.3	Resource Standard Methods .....	68
6.2.3.4.4	Resource Custom Operations .....	69
6.2.3.5	Resource: Individual Data Storage Delivery Subscription .....	69

6.2.3.5.1	Description .....	69
6.2.3.5.2	Resource Definition .....	69
6.2.3.5.3	Resource Standard Methods .....	69
6.2.3.5.4	Resource Custom Operations .....	73
6.2.4	Custom Operations without associated resources .....	73
6.2.4.1	Overview .....	73
6.2.4.2	Operation: DataDeliveryRequest .....	74
6.2.4.2.1	Description .....	74
6.2.4.2.2	Operation Definition .....	74
6.2.4.3	Operation: EstablishDelConn .....	75
6.2.4.3.1	Description .....	75
6.2.4.3.2	Operation Definition .....	75
6.2.5	Notifications .....	76
6.2.5.1	General .....	76
6.2.5.2	Data Management and/or Status Information Notification .....	77
6.2.5.2.1	Description .....	77
6.2.5.2.2	Target URI .....	77
6.2.5.2.3	Standard Methods .....	77
6.2.5.3	Data Storage Delivery Notification .....	78
6.2.5.3.1	Description .....	78
6.2.5.3.2	Target URI .....	78
6.2.5.3.3	Standard Methods .....	78
6.2.6	Data Model .....	79
6.2.6.1	General .....	79
6.2.6.2	Structured data types .....	81
6.2.6.2.1	Introduction .....	81
6.2.6.2.2	Type: DataStorage .....	81
6.2.6.2.3	Type: ReservReqData .....	81
6.2.6.2.4	Type: ReservRespData .....	81
6.2.6.2.5	Type: DataStoragePatch .....	82
6.2.6.2.6	Type: AccessCtrlPolicy .....	82
6.2.6.2.7	Type: DataMngtSubsc .....	82
6.2.6.2.8	Type: DataMngtNotif .....	83
6.2.6.2.9	Type: DataAccessStats .....	83
6.2.6.2.10	Type: DataMngtStats .....	84
6.2.6.2.11	Type: DataDelSubsc .....	84
6.2.6.2.12	Type: DataDelSubscPatch .....	84
6.2.6.2.13	Type: DataDelNotif .....	85
6.2.6.2.14	Type: DataDelReq .....	85
6.2.6.2.15	Type: DelConnEstabReq .....	85
6.2.6.2.16	Type: DelConnEstabResp .....	86
6.2.6.3	Simple data types and enumerations .....	86
6.2.6.3.1	Introduction .....	86
6.2.6.3.2	Simple data types .....	86
6.2.6.3.3	Enumeration: EntityName .....	86
6.2.6.3.4	Enumeration: DataAccessRight .....	86
6.2.6.3.5	Enumeration: DataMngtEvent .....	87
6.2.6.4	Data types describing alternative data types or combinations of data types .....	87
6.2.6.4.1	Type: DataStorageReq .....	87
6.2.6.5	Binary data .....	87
6.2.6.5.1	Binary Data Types .....	87
6.2.7	Error Handling .....	87
6.2.7.1	General .....	87
6.2.7.2	Protocol Errors .....	87
6.2.7.3	Application Errors .....	87
6.2.8	Feature negotiation .....	88
6.2.9	Security .....	88
6.3	SDD_DDContext Service API .....	89
6.3.1	Introduction .....	89
6.3.2	Usage of HTTP .....	89
6.3.3	Resources .....	89
6.3.3.1	Overview .....	89

6.3.3.2	Resource: DD Contexts.....	90
6.3.3.2.1	Description .....	90
6.3.3.2.2	Resource Definition.....	90
6.3.3.2.3	Resource Standard Methods .....	90
6.3.3.2.4	Resource Custom Operations .....	93
6.3.4	Custom Operations without associated resources .....	93
6.3.5	Notifications .....	93
6.3.6	Data Model .....	93
6.3.6.1	General .....	93
6.3.6.2	Structured data types .....	94
6.3.6.2.1	Introduction .....	94
6.3.6.2.2	Type: DdContext .....	94
6.3.6.2.3	Type: TranspLayerContext.....	94
6.3.6.2.4	Type: DdContextPushReq .....	94
6.3.6.2.5	Type: DdContextResp .....	95
6.3.6.2.6	Type: SddUuContext.....	95
6.3.6.2.7	Type: SddSContext.....	96
6.3.6.3	Simple data types and enumerations .....	96
6.3.6.3.1	Introduction .....	96
6.3.6.3.2	Simple data types.....	96
6.3.6.4	Data types describing alternative data types or combinations of data types .....	96
6.3.6.5	Binary data .....	96
6.3.6.5.1	Binary Data Types .....	96
6.3.7	Error Handling .....	97
6.3.7.1	General .....	97
6.3.7.2	Protocol Errors .....	97
6.3.7.3	Application Errors.....	97
6.3.8	Feature negotiation .....	97
6.3.9	Security .....	97
6.4	SDD_TransmissionQualityMeasurement Service API.....	98
6.4.1	Introduction.....	98
6.4.2	Usage of HTTP .....	98
6.4.3	Resources.....	98
6.4.3.1	Overview.....	98
6.4.3.2	Resource: Transmission Quality Measurement Subscriptions .....	99
6.4.3.2.1	Description .....	99
6.4.3.2.2	Resource Definition.....	99
6.4.3.2.3	Resource Standard Methods .....	99
6.4.3.2.4	Resource Custom Operations .....	100
6.4.3.3	Resource: Individual Transmission Quality Measurement Subscription .....	100
6.4.3.3.1	Description .....	100
6.4.3.3.2	Resource Definition.....	100
6.4.3.3.3	Resource Standard Methods .....	101
6.4.3.3.4	Resource Custom Operations .....	105
6.4.3.4	Resource: Historical Transmission Quality Measurement Reports.....	105
6.4.3.4.1	Description .....	105
6.4.3.4.2	Resource Definition.....	105
6.4.3.4.3	Resource Standard Methods .....	106
6.4.3.4.4	Resource Custom Operations .....	107
6.4.4	Custom Operations without associated resources .....	107
6.4.5	Notifications .....	107
6.4.5.1	General .....	107
6.4.5.2	Transmission Quality Measurement Notification .....	108
6.4.5.2.1	Description .....	108
6.4.5.2.2	Target URI.....	108
6.4.5.2.3	Standard Methods.....	108
6.4.6	Data Model .....	109
6.4.6.1	General .....	109
6.4.6.2	Structured data types .....	110
6.4.6.2.1	Introduction .....	110
6.4.6.2.2	Type: TransQualMeasSubsc.....	111
6.4.6.2.3	Type: TransQualMeasReq.....	112



6.4.6.2.4	Type: TransQualMeasSubscPatch .....	112
6.4.6.2.5	Type: TransQualMeasNotif .....	113
6.4.6.2.6	Type: TransQualMeasReport .....	113
6.4.6.2.7	Type: TransQualMeasCriteria .....	114
6.4.6.2.8	Type: TransQualMeasData .....	115
6.4.6.2.9	Type: HistTransQualMeasReports .....	118
6.4.6.2.10	Type: TransQualMeasCriteriaSet .....	118
6.4.6.3	Simple data types and enumerations .....	118
6.4.6.3.1	Introduction .....	118
6.4.6.3.2	Simple data types.....	118
6.4.6.3.3	Enumeration: MeasurementId .....	118
6.4.6.3.4	Enumeration: RepGranularity.....	119
6.4.6.4	Data types describing alternative data types or combinations of data types .....	119
6.4.6.5	Binary data .....	119
6.4.6.5.1	Binary Data Types .....	119
6.4.7	Error Handling .....	119
6.4.7.1	General .....	119
6.4.7.2	Protocol Errors .....	119
6.4.7.3	Application Errors.....	119
6.4.8	Feature negotiation .....	120
6.4.9	Security .....	120
6.5	SDD_PolicyConfiguration Service API .....	121
6.5.1	Introduction.....	121
6.5.2	Usage of HTTP .....	121
6.5.3	Resources.....	121
6.5.3.1	Overview.....	121
6.5.3.2	Resource: Policy Configurations.....	122
6.5.3.2.1	Description .....	122
6.5.3.2.2	Resource Definition.....	122
6.5.3.2.3	Resource Standard Methods .....	122
6.5.3.2.4	Resource Custom Operations .....	123
6.5.3.3	Resource: Individual Policy Configuration.....	123
6.5.3.3.1	Description .....	123
6.5.3.3.2	Resource Definition.....	123
6.5.3.3.3	Resource Standard Methods .....	123
6.5.3.3.4	Resource Custom Operations .....	127
6.5.4	Custom Operations without associated resources .....	128
6.5.5	Notifications .....	128
6.5.6	Data Model .....	128
6.5.6.1	General .....	128
6.5.6.2	Structured data types .....	128
6.5.6.2.1	Introduction .....	128
6.5.6.2.2	Type: PolicyConfig .....	129
6.5.6.2.3	Type: PolicyConfigPatch.....	129
6.5.6.2.4	Type: SealddPolicy.....	129
6.5.6.2.5	Type: QualGuarPolicy.....	130
6.5.6.2.6	Type: QualGuarThresh.....	130
6.5.6.3	Simple data types and enumerations .....	130
6.5.6.3.1	Introduction .....	130
6.5.6.3.2	Simple data types.....	130
6.5.6.3.3	Enumeration: BdwCtrlPolicy .....	130
6.5.6.4	Data types describing alternative data types or combinations of data types .....	131
6.5.6.5	Binary data .....	131
6.5.6.5.1	Binary Data Types .....	131
6.5.7	Error Handling .....	131
6.5.7.1	General .....	131
6.5.7.2	Protocol Errors .....	131
6.5.7.3	Application Errors.....	131
6.5.8	Feature negotiation .....	131
6.5.9	Security .....	132
7	Using Common API Framework.....	133

<b>Annex A (normative):</b>	<b>OpenAPI specification</b> .....	<b>134</b>
A.1	General .....	134
A.2	SDD_Transmission API.....	135
A.3	SDD_DataStorage API.....	144
A.4	SDD_DDContext API.....	158
A.5	SDD_TransmissionQualityMeasurement API .....	162
A.6	SDD_PolicyConfiguration API.....	172
<b>Annex B (informative):</b>	<b>Withdrawn API versions</b> .....	<b>177</b>
B.1	General .....	177
B.2	SDD_Transmission API.....	177
B.3	SDD_DataStorage API.....	177
B.4	SDD_DDContext API.....	177
B.5	SDD_TransmissionQualityMeasurement API .....	177
B.6	SDD_PolicyConfiguration API.....	178
<b>Annex C (informative):</b>	<b>Change history</b> .....	<b>179</b>
History .....		180

---

# Foreword

This Technical Specification has been produced by the 3rd Generation Partnership Project (3GPP).

The contents of the present document are subject to continuing work within the TSG and may change following formal TSG approval. Should the TSG modify the contents of the present document, it will be re-released by the TSG with an identifying change of release date and an increase in version number as follows:

Version x.y.z

where:

- x the first digit:
  - 1 presented to TSG for information;
  - 2 presented to TSG for approval;
  - 3 or greater indicates TSG approved document under change control.
- y the second digit is incremented for all changes of substance, i.e. technical enhancements, corrections, updates, etc.
- z the third digit is incremented when editorial only changes have been incorporated in the document.

In the present document, modal verbs have the following meanings:

- shall** indicates a mandatory requirement to do something
- shall not** indicates an interdiction (prohibition) to do something

The constructions "shall" and "shall not" are confined to the context of normative provisions, and do not appear in Technical Reports.

The constructions "must" and "must not" are not used as substitutes for "shall" and "shall not". Their use is avoided insofar as possible, and they are not used in a normative context except in a direct citation from an external, referenced, non-3GPP document, or so as to maintain continuity of style when extending or modifying the provisions of such a referenced document.

- should** indicates a recommendation to do something
- should not** indicates a recommendation not to do something
- may** indicates permission to do something
- need not** indicates permission not to do something

The construction "may not" is ambiguous and is not used in normative elements. The unambiguous constructions "might not" or "shall not" are used instead, depending upon the meaning intended.

- can** indicates that something is possible
- cannot** indicates that something is impossible

The constructions "can" and "cannot" are not substitutes for "may" and "need not".

- will** indicates that something is certain or expected to happen as a result of action taken by an agency the behaviour of which is outside the scope of the present document
- will not** indicates that something is certain or expected not to happen as a result of action taken by an agency the behaviour of which is outside the scope of the present document
- might** indicates a likelihood that something will happen as a result of action taken by some agency the behaviour of which is outside the scope of the present document

**might not** indicates a likelihood that something will not happen as a result of action taken by some agency the behaviour of which is outside the scope of the present document

In addition:

**is** (or any other verb in the indicative mood) indicates a statement of fact

**is not** (or any other negative verb in the indicative mood) indicates a statement of fact

The constructions "is" and "is not" do not indicate requirements.

---

# 1 Scope

The present document specifies the stage 3 protocol and data model for the SEAL Data Delivery (SEALDD) Server Services, for enabling the support of SEAL Data Delivery (SEALDD) services for vertical applications. It provides stage 3 protocol definitions and message flows, and specifies the API for each service offered by the SEALDD Server.

The stage 2 application layer architecture, functional requirements, procedures and information flows necessary for enabling SEAL Data Delivery (SEALDD) are specified in 3GPP TS 23.433 [7].

The common protocol and interface aspects for API definition are specified in clause 5.2 of 3GPP TS 29.122 [2].

---

## 2 References

The following documents contain provisions which, through reference in this text, constitute provisions of the present document.

- References are either specific (identified by date of publication, edition number, version number, etc.) or non-specific.
- For a specific reference, subsequent revisions do not apply.
- For a non-specific reference, the latest version applies. In the case of a reference to a 3GPP document (including a GSM document), a non-specific reference implicitly refers to the latest version of that document *in the same Release as the present document*.

- [1] 3GPP TR 21.905: "Vocabulary for 3GPP Specifications".
- [2] 3GPP TS 29.122: "T8 reference point for Northbound Application Programming Interfaces (APIs)".
- [3] 3GPP TS 29.501: "5G System; Principles and Guidelines for Services Definition; Stage 3".
- [4] OpenAPI: "OpenAPI Specification Version 3.0.0", <https://spec.openapis.org/oas/v3.0.0>.
- [5] 3GPP TR 21.900: "Technical Specification Group working methods".
- [6] 3GPP TS 23.434: "Service Enabler Architecture Layer for Verticals (SEAL); Functional architecture and information flows".
- [7] 3GPP TS 23.433: "Service Enabler Architecture Layer for Verticals (SEAL); Data Delivery enabler for vertical applications".
- [8] 3GPP TS 23.222: "Common API Framework for 3GPP Northbound APIs; Stage 2".
- [9] 3GPP TS 29.222: "Common API Framework for 3GPP Northbound APIs; Stage 3".
- [10] 3GPP TS 33.122: "Security aspects of Common API Framework (CAPIF) for 3GPP northbound APIs".
- [11] IETF RFC 6749: "The OAuth 2.0 Authorization Framework".
- [12] IETF RFC 9113: "HTTP/2".
- [13] IETF RFC 8259: "The JavaScript Object Notation (JSON) Data Interchange Format".
- [14] IETF RFC 9457: "Problem Details for HTTP APIs".
- [15] 3GPP TS 29.549: "Service Enabler Architecture Layer for Verticals (SEAL); Application Programming Interface (API) specification; Stage 3".
- [16] 3GPP TS 29.508: "5G System; Session Management Event Exposure Service; Stage 3".
- [17] 3GPP TS 29.558: "Enabling Edge Applications; Application Programming Interface (API) specification; Stage 3".
- [18] 3GPP TS 29.571: "5G System; Common Data Types for Service Based Interfaces; Stage 3".
- [19] 3GPP TS 29.514: "5G System; Policy Authorization Service; Stage 3".
- [20] 3GPP TS 29.520: "5G System; Network Data Analytics Services; Stage 3".

---

## 3 Definitions, symbols and abbreviations

### 3.1 Definitions

For the purposes of the present document, the terms and definitions given in 3GPP TR 21.905 [1] and the following apply. A term defined in the present document takes precedence over the definition of the same term, if any, in 3GPP TR 21.905 [1].

For the purpose of the present document, the terms and definitions specified in clause 3.1 of 3GPP TS 23.433 [7] and clause 3.1 of 3GPP TS 29.549 [15] also apply, including the ones referencing other specifications.

### 3.2 Symbols

Void.

### 3.3 Abbreviations

For the purposes of the present document, the abbreviations given in 3GPP TR 21.905 [1] and the following apply. An abbreviation defined in the present document takes precedence over the definition of the same abbreviation, if any, in 3GPP TR 21.905 [1].

DD	Data Delivery
E2E	End to End
SEAL	Service Enabler Architecture Layer for Verticals
SEALDD	SEAL Data Delivery
VAL	Vertical Application Layer

## 4 Overview

The SEAL Data Delivery (SEALDD) Server forms part of the SEAL Enabler Layer defined in 3GPP TS 23.434 [6] and aims to ensure the efficient use and deployment of storage and delivery capabilities for the application content/data of vertical applications. The SEALDD Server supports for this purpose, among other functionalities defined in 3GPP TS 23.433 [7], the following functionalities:

- SEALDD application layer support functions to VAL Servers over the SEALDD-S reference point, i.e.:
  - SEALDD enabled Regular or URLLC application data transmission management;
  - SEALDD enabled data storage management;
  - SEALDD enabled data transmission quality measurement management; and
  - SEALDD policy configuration management.
- SEALDD application layer support functions to other SEALDD Servers over the SEALDD-E reference point, i.e.:
  - SEALDD enabled data storage management;
  - SEALDD Server relocation management; and
  - SEALDD enabled data transmission quality measurement management.

Figure 4-1 shows the reference model of the SEALDD Enabler Layer, with a focus on the SEALDD Server:

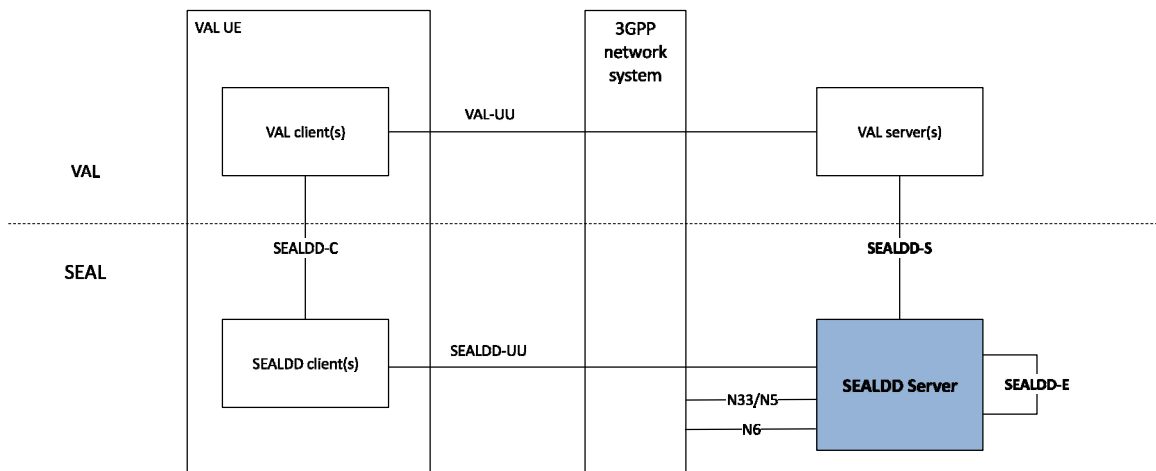

**Figure 4-1: SEALDD Enabler Layer functional model**



## 5 Services offered by the SEALDD Server

### 5.1 Introduction

The SEALDD Server provides the following services:

- SDD\_Transmission
- SDD\_DataStorage
- SDD\_DDContext
- SDD\_TransmissionQualityMeasurement
- SDD\_PolicyConfiguration

NOTE: The stage 2 Sdd\_RegularTransmission and Sdd\_URLLCTransmission APIs defined in 3GPP TS 23.433 [7] are defined via the SDD\_Transmission API.

Table 5.1-1 summarizes the corresponding APIs defined for this specification.

**Table 5.1-1: API Descriptions**

Service Name	Clause	Description	OpenAPI Specification File	API Name	Annex
SDD_Transmission	6.1	SEALDD Data Transmission Service	TS29548_SDD_Transmission.yaml	sdd-trans	A.2
SDD_DataStorage	6.2	SEALDD Data Storage Service	TS29548_SDD_DataStorage.yaml	sdd-ds	A.3
SDD_DDContext	6.3	SEALDD Context Relocation Service	TS29548_SDD_DDContext.yaml	sdd-ddc	A.4
SDD_TransmissionQuality Measurement	6.4	SEALDD Data Transmission Quality Measurement Service	TS29548_SDD_TransmissionQualityMeasurement.yaml	sdd-tqm	A.5
SDD_PolicyConfiguration	6.5	SEALDD Policy Configuration Service	TS29548_SDD_PolicyConfiguration.yaml	sdd-pc	A.6

NOTE: When 3GPP TS 29.122 [2] is referenced for the common protocol and interface aspects for API definition in the clauses under clause 5, the SEALDD Server takes the role of the SCEF and the service consumer takes the role of the SCS/AS.

## 5.2 SDD\_Transmission Service

### 5.2.1 Service Description

The SDD\_Transmission service exposed by the SEALDD Server enables a service consumer to:

- request SEALDD enabled Regular or URLLC application data transmission; and
- subscribe to / receive notifications on SEALDD connection status event(s).

### 5.2.2 Service Operations

#### 5.2.2.1 Introduction

The service operations defined for the SDD\_Transmission service are shown in table 5.2.2.1-1.

**Table 5.2.2.1-1: SDD\_Transmission Service Operations**

Service Operation Name	Description	Initiated by
SDD_Transmission_Request	This service operation enables a service consumer to request SEALDD enabled Regular or URLLC application data transmission.	e.g., VAL Server
SDD_Transmission_ConnStatusSubscribe	This service operation enables a service consumer to request the creation/update/deletion of a subscription to SEALDD connection status event(s) reporting.	e.g., VAL Server
SDD_Transmission_ConnStatusNotify	This service operation enables a service consumer to receive notifications on SEALDD connection status event(s).	SEALDD Server

#### 5.2.2.2 SDD\_Transmission\_Request

##### 5.2.2.2.1 General

This service operation is used by a service consumer to request SEALDD enabled Regular or URLLC application data transmission to the SEALDD Server.

The following procedures are supported by the "SDD\_Transmission\_Request" service operation:

- SEALDD Transmission Request.

##### 5.2.2.2.2 SEALDD Transmission Request

Figure 5.2.2.2.2-1 depicts a scenario where a service consumer sends a request to the SEALDD Server to request SEALDD enabled Regular or URLLC application data transmission (see also clauses 9.2 and 9.3 of 3GPP TS 23.433[7]).

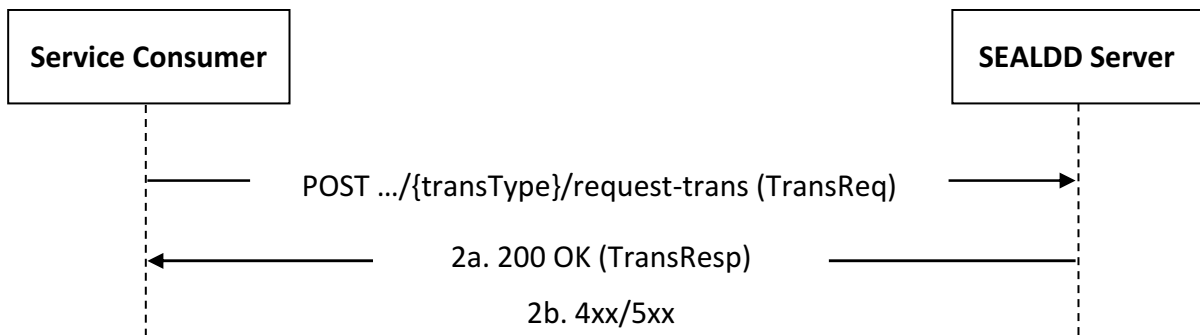

**Figure 5.2.2.2-1: Procedure for SEALDD Transmission Request**

1. In order to request SEALDD enabled Regular or URLLC application data transmission, the service consumer shall send an HTTP POST request to the SEALDD Server targeting the URI of the corresponding custom operation (i.e., "RequestTrans"), with the request body including the TransReq data structure. The "{transType}" URI variable path segment shall be set to either:
  - "regular", when Regular application data transmission is requested; or
  - "urllc", when URLLC application data transmission is requested.
- 2a. Upon success, the SEALDD Server shall respond with an HTTP "200 OK" status code to indicate that the SEALDD enabled Regular or URLLC application data transmission service request is successfully received and processed, with the response body containing SEALDD enabled Regular or URLLC application data transmission related information within the TransResp data structure.
- 2b. On failure, the appropriate HTTP status code indicating the error shall be returned and appropriate additional error information should be returned in the HTTP POST response body, as specified in clause 6.1.7.

### 5.2.2.3 SDD\_Transmission\_ConnStatusSubscribe

#### 5.2.2.3.1 General

This service operation is used by a service consumer to request the creation of a subscription to SEALDD connection status event(s) reporting.

The following procedures are supported by the "SDD\_Transmission\_ConnStatusSubscribe" service operation:

- SEALDD Connection Status Subscription Creation.
- SEALDD Connection Status Subscription Update.
- SEALDD Connection Status Subscription Deletion.

#### 5.2.2.3.2 SEALDD Connection Status Subscription Creation

Figure 5.2.2.3.2-1 depicts a scenario where a service consumer sends a request to the SEALDD Server to request the creation of a subscription to SEALDD Connection Status event(s) reporting (see also clauses 9.2 and 9.3 of 3GPP TS 23.433[7]).

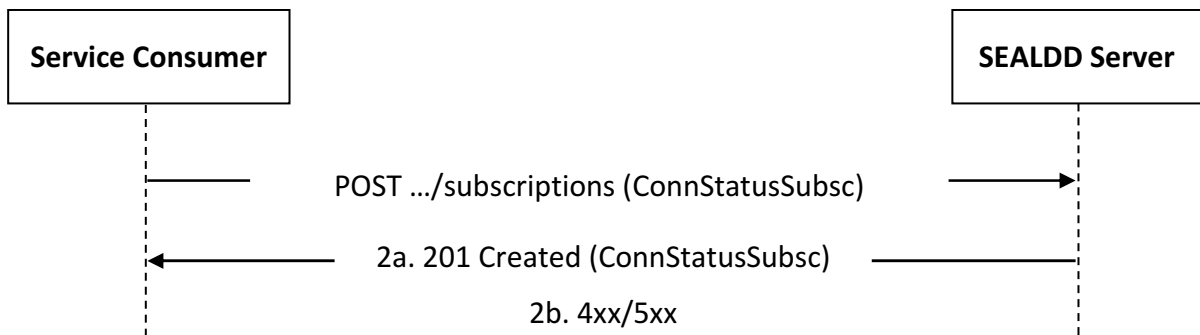
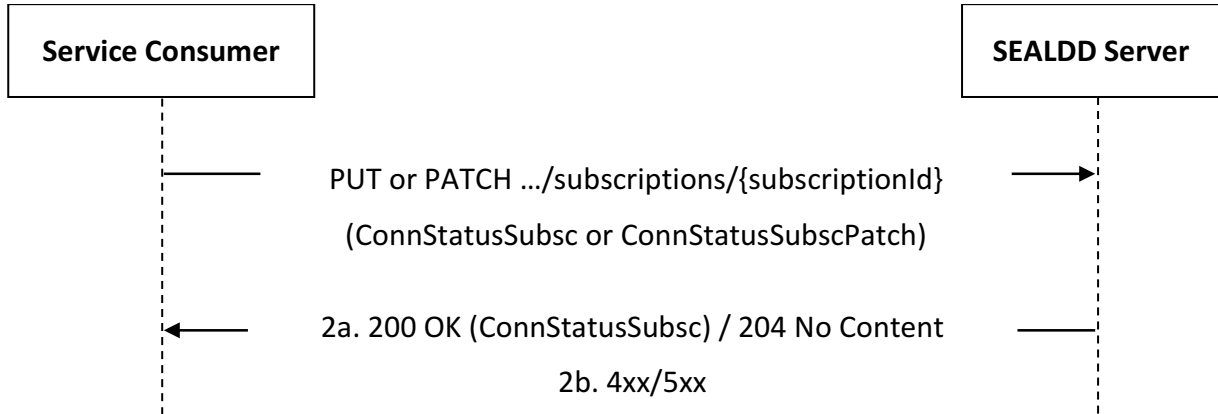

**Figure 5.2.2.3.2-1: Procedure for SEALDD Connection Status Subscription Creation**

1. In order to subscribe to SEALDD connection status event(s) reporting, the service consumer shall send an HTTP POST request message to the SEALDD Server targeting the URI of the "Connection Status Subscriptions" collection resource with the request body including the ConnStatusSubsc data structure.
- 2a. Upon success, the SEALDD Server shall respond with an HTTP "201 Created" status code with the response body including a representation of the created "Individual Connection Status Subscription" resource within the ConnStatusSubsc data structure, and an HTTP "Location" header field containing the URI of the created resource.
- 2b. On failure, the appropriate HTTP status code indicating the error shall be returned and appropriate additional error information should be returned in the HTTP POST response body, as specified in clause 6.1.7.

### 5.2.2.3.3 SEALDD Connection Status Subscription Update

Figure 5.2.2.3.3-1 depicts a scenario where a service consumer sends a request to the SEALDD Server to request the update of an existing SEALDD Connection Status Subscription (see also clauses 9.2 and 9.3 of 3GPP TS 23.433 [7]).



**Figure 5.2.2.3.3-1: Procedure for SEALDD Connection Status Subscription Update**

1. In order to update an existing SEALDD Connection Status Subscription, the service consumer shall send an HTTP PUT/PATCH request to the SEALDD Server, targeting the URI of the corresponding "Individual Connection Status Subscription" resource, with the request body including either:
  - the updated representation of the resource within the ConnStatusSubsc data structure, in case the HTTP PUT method is used; or
  - the requested modifications to the resource within the ConnStatusSubscPatch data structure, in case the HTTP PATCH method is used.

**NOTE:** An alternative service consumer (i.e. other than the one that requested the creation of the targeted resource) can initiate this request.

- 2a. Upon success, the SEALDD Server shall update the targeted "Individual Connection Status Subscription" resource accordingly and respond with either:

- an HTTP "200 OK" status code with the response body containing a representation of the updated "Individual Connection Status Subscription" resource within the ConnStatusSubsc data structure; or
- an HTTP "204 No Content" status code.

2b. On failure, the appropriate HTTP status code indicating the error shall be returned and appropriate additional error information should be returned in the HTTP PUT/PATCH response body, as specified in clause 6.1.7.

#### 5.2.2.3.4 SEALDD Connection Status Subscription Deletion

Figure 5.2.2.3.4-1 depicts a scenario where a service consumer sends a request to the SEALDD Server to request the deletion of an existing SEALDD Connection Status Subscription (see also clauses 9.2 and 9.3 of 3GPP°TS°23.433°[7]).

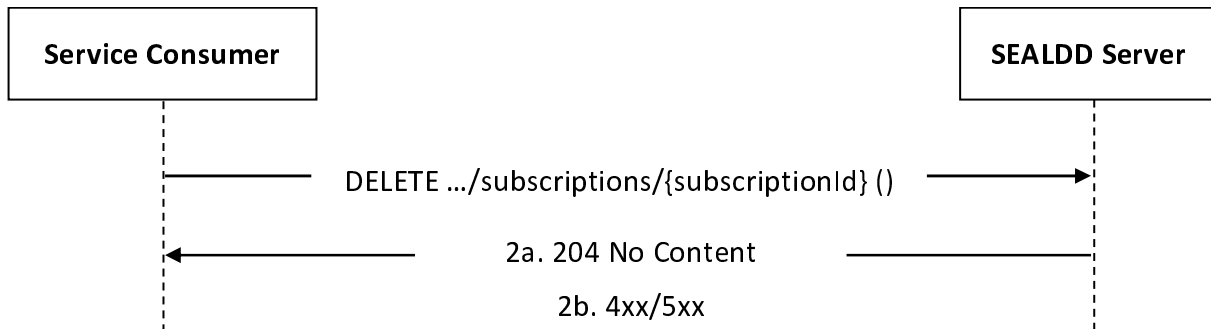

**Figure 5.2.2.3.4-1: Procedure for SEALDD Connection Status Subscription Deletion**

1. In order to request the deletion of an existing SEALDD Connection Status Subscription, the service consumer shall send an HTTP DELETE request to the SEALDD Server targeting the URI of the corresponding "Individual Connection Status Subscription" resource.

NOTE: An alternative service consumer (i.e. other than the one that requested the creation/update of the targeted resource) can initiate this request.

2a. Upon success, the SEALDD Server shall respond with an HTTP "204 No Content" status code.

2b. On failure, the appropriate HTTP status code indicating the error shall be returned and appropriate additional error information should be returned in the HTTP DELETE response body, as specified in clause 6.1.7.

#### 5.2.2.4 SDD\_Transmission\_ConnStatusNotify

##### 5.2.2.4.1 General

This service operation is used by a SEALDD Server to notify a previously subscribed service consumer on:

- SEALDD connection status event(s).

The following procedures are supported by the "SDD\_Transmission\_ConnStatusNotify" service operation:

- SEALDD Connection Status Notification.

##### 5.2.2.4.2 SEALDD Connection Status Notification

Figure 5.2.2.4.2-1 depicts a scenario where the SEALDD Server sends a request to notify a previously subscribed service consumer on SEALDD connection status event(s) (see also clauses 9.2 and 9.3 of 3GPP°TS°23.433°[7]).

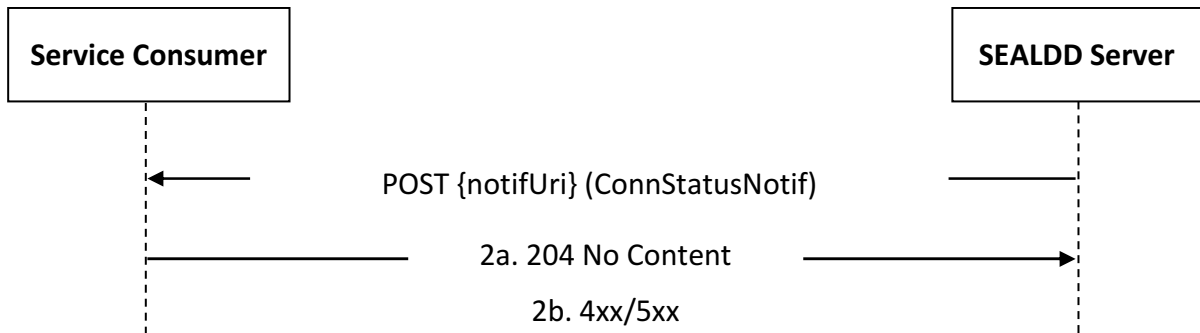

**Figure 5.2.2.4.2-1: Procedure for SEALDD Connection Status Notification**

1. In order to notify a previously subscribed service consumer on SEALDD Connection Status event(s), the SEALDD Server shall send an HTTP POST request message to the service consumer with the request URI set to "{notifUri}", where the "notifUri" variable is set to the value received from the service consumer during the creation/update of the corresponding SEALDD Connection Status Subscription using the procedures defined in clause 5.2.2.3, and the request body including the ConnStatusNotif data structure.
- 2a. Upon success, the service consumer shall respond to the SEALDD Server with an HTTP "204 No Content" status code.
- 2b. On failure, the appropriate HTTP status code indicating the error shall be returned and appropriate additional error information should be returned in the HTTP POST response body, as specified in clause 6.1.7.

## 5.3 SDD\_DataStorage Service

### 5.3.1 Service Description

The SDD\_DataStorage service exposed by the SEALDD Server enables a service consumer to:

- create/update/delete/query a SEALDD Data Storage;
- receive SEALDD Data Management and/or Status Information Notifications;
- create/update/delete a SEALDD Data Storage Delivery Subscription;
- receive SEALDD Data Storage Delivery Notifications; and
- request for one-time SEALDD Data Storage delivery.

### 5.3.2 Service Operations

#### 5.3.2.1 Introduction

The service operations defined for the SDD\_DataStorage service are shown in table 5.3.2.1-1.

**Table 5.3.2.1-1: SDD\_DataStorage Service Operations**

Service Operation Name	Description	Initiated by
SDD_DataStorage_Create	This service operation enables a service consumer to request the creation of a SEALDD Data Storage and receive notifications on SEALDD Data Management and/or Status Information event(s).	e.g., VAL Server, SEALDD Server
SDD_DataStorage_Manage	This service operation enables a service consumer to request the update/modification/deletion of an existing SEALDD Data Storage.	e.g., VAL Server
SDD_DataStorage_Query	This service operation enables a service consumer to request the retrieval of one or several existing SEALDD Data Storage(s).	e.g., VAL Server, SEALDD Server
SDD_DataStorage_DelRequest	This service operation enables a service consumer to request for one-time SEALDD Data Storage Delivery.	e.g., VAL Server
SDD_DataStorage_EstablishDelConn	This service operation enables a service consumer to request for one-time SEALDD Data Storage Delivery connection establishment.	e.g., SEALDD Server
SDD_DataStorage_DelSubscribe	This service operation enables a service consumer to request the creation/update/deletion of a SEALDD Data Storage Delivery Subscription.	e.g., VAL Server
SDD_DataStorage_DelNotify	This service operation enables a service consumer to receive SEALDD Data Storage Delivery Notifications.	SEALDD Server

#### 5.3.2.2 SDD\_DataStorage\_Create

##### 5.3.2.2.1 General

This service operation is used by a service consumer to request the creation of a SEALDD Data Storage at the SEALDD Server.

The following procedures are supported by the "SDD\_DataStorage\_Create" service operation:

- Data Storage Creation.

- Data Management and/or Status Information Notification.

### 5.3.2.2.2 Data Storage Creation

Figure 5.3.2.2.2-1 depicts a scenario where a service consumer sends a request to the SEALDD Server to request the creation of a SEALDD Data Storage (see also clause 9.5 of 3GPP TS 23.433 [7]).

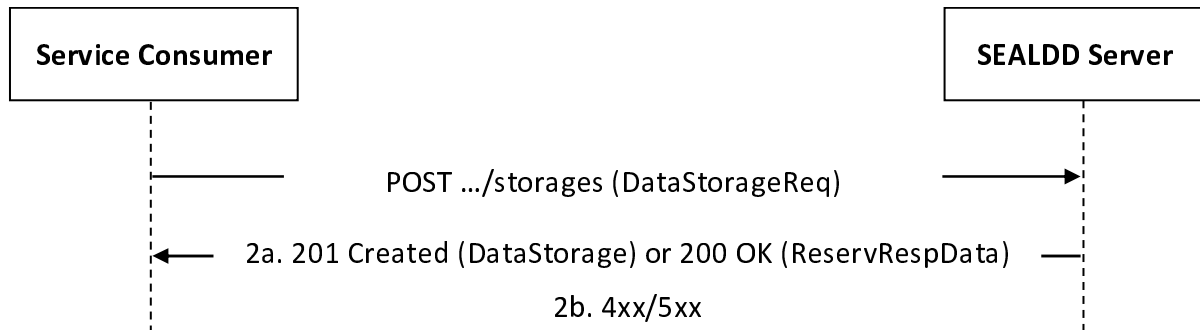
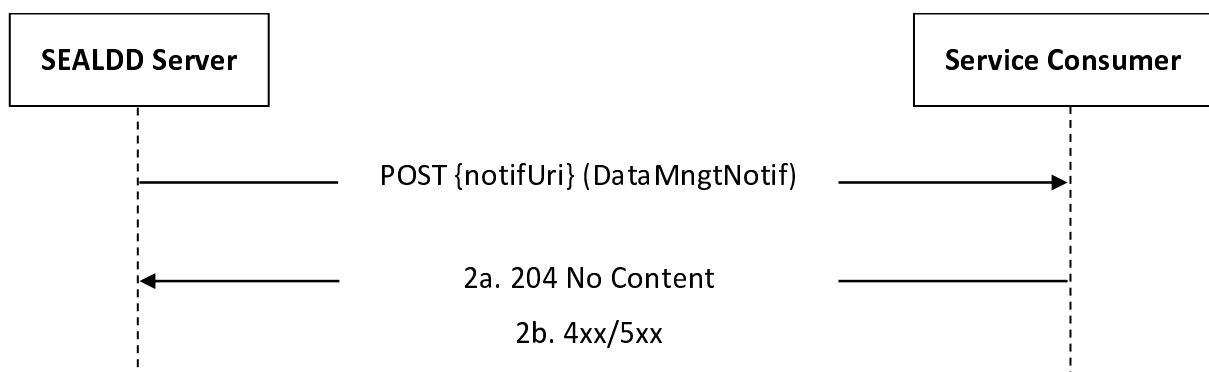

**Figure 5.3.2.2.2-1: Procedure for Data Storage Creation**

- In order to create or reserve a new SEALDD Data Storage, the service consumer shall send an HTTP POST request to the SEALDD Server targeting the URI of the "Data Storages" collection resource, with the request body including the DataStorageReq data structure that shall be set to either:
  - the DataStorage data structure for a Data Storage Creation request; or
  - the ReservReqData data structure for a Data Storage Reservation request.
- Upon success, the SEALDD Server shall respond with either:
  - an HTTP "201 Created" status code, with the response body containing a representation of the created "Individual Data Storage" resource within the DataStorage data structure, and an HTTP "Location" header field containing the URI of the created resource, for the case of Data Storage Creation; or
  - an HTTP "200 OK" status code with the response body containing the ReservRespData data structure including Data Storage reservation related information, for the case of Data Storage Reservation.
- On failure, the appropriate HTTP status code indicating the error shall be returned and appropriate additional error information should be returned in the HTTP POST response body, as specified in clause 6.2.7.

### 5.3.2.2.3 Data Management and/or Status Information Notification

Figure 5.3.2.2.3-1 depicts a scenario where the SEALDD Server sends a request to notify a previously subscribed service consumer on SEALDD Data Management and/or Status Information event(s) (see also clause 9.5 of 3GPP TS 23.433 [7]).



**Figure 5.3.2.2.3-1: Data Storage Delivery Notification**

- In order to notify a previously subscribed service consumer on SEALDD Data Management and/or Status Information event(s), the SEALDD Server shall send an HTTP POST request to the service consumer with the



request URI set to "{notifUri}", where the "notifUri" variable is set to the value received from the service consumer during the creation/update of the corresponding SEALDD Data Storage using the procedures defined in clauses 5.3.2.2.2 and 5.3.2.3.2, and the request body including the DataMngtNotif data structure.

- 2a. Upon success, the service consumer shall respond to the SEALDD Server with an HTTP "204 No Content" status code to acknowledge the reception of the notification.
- 2b. On failure, the appropriate HTTP status code indicating the error shall be returned and appropriate additional error information should be returned in the HTTP POST response body, as specified in clause 6.2.7.

### 5.3.2.3 SDD\_DataStorage\_Manage

#### 5.3.2.3.1 General

This service operation is used by a service consumer to manage (e.g., update, delete) an existing SEALDD Data Storage at the SEALDD Server.

The following procedures are supported by the "SDD\_DataStorage\_Manage" service operation:

- Data Storage Update.
- Data Storage Deletion.

#### 5.3.2.3.2 Data Storage Update

Figure 5.3.2.3.2-1 depicts a scenario where a service consumer sends a request to the SEALDD Server to request the update of an existing SEALDD Data Storage (see also clause 9.5 of 3GPP°TS°23.433°[7]).

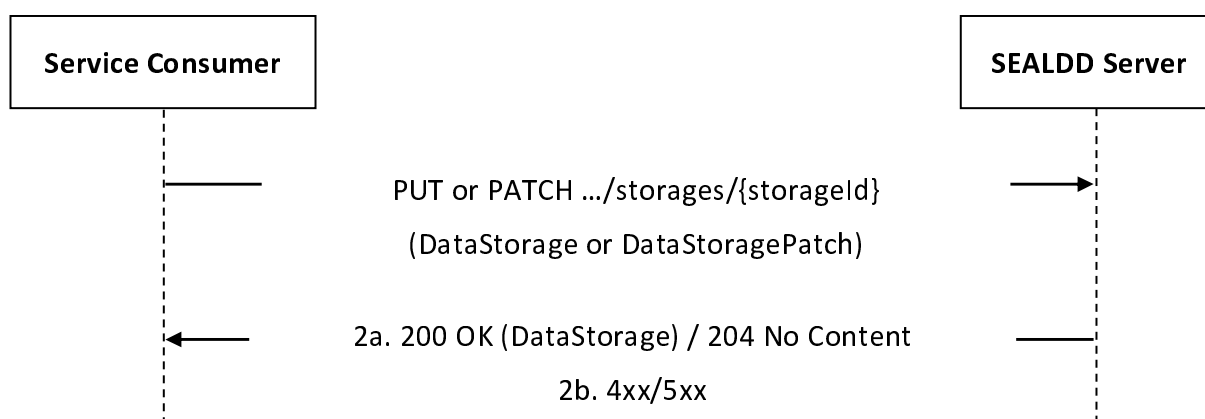

**Figure 5.3.2.3.2-1: Procedure for Data Storage Update**

1. In order to update an existing SEALDD Data Storage, the service consumer shall send an HTTP PUT/PATCH request to the SEALDD Server, targeting the URI of the corresponding "Individual Data Storage" resource, with the request body including either:

- the updated representation of the resource within the DataStorage data structure, in case the HTTP PUT method is used; or
- the requested modifications to the resource within the DataStoragePatch data structure, in case the HTTP PATCH method is used.

**NOTE:** An alternative service consumer (i.e. other than the one that requested the creation of the targeted resource) can initiate this request.

- 2a. Upon success, the SEALDD Server shall update the targeted "Individual Data Storage" resource accordingly and respond with either:

- an HTTP "200 OK" status code with the response body containing a representation of the updated "Individual Data Storage" resource within the DataStorage data structure; or

- an HTTP "204 No Content" status code.

2b. On failure, the appropriate HTTP status code indicating the error shall be returned and appropriate additional error information should be returned in the HTTP PUT/PATCH response body, as specified in clause 6.2.7.

### 5.3.2.3.3 Data Storage Deletion

Figure 5.3.2.3.3-1 depicts a scenario where a service consumer sends a request to the SEALDD Server to request the deletion of an existing SEALDD Data Storage (see also clause 9.5 of 3GPP°TS°23.433°[7]).

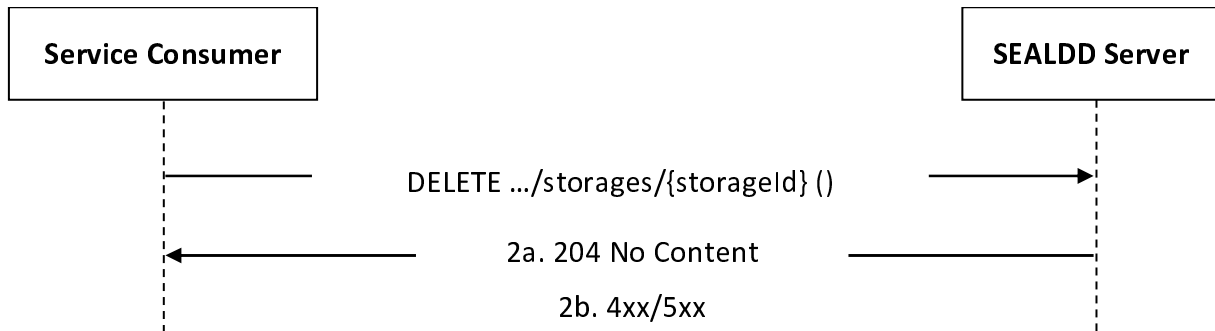

**Figure 5.3.2.3.3-1: Procedure for Data Storage Deletion**

1. In order to request the deletion of an existing SEALDD Data Storage, the service consumer shall send an HTTP DELETE request to the SEALDD Server targeting the corresponding "Individual Data Storage" resource.

NOTE: An alternative service consumer (i.e. other than the one that requested the creation of the targeted resource) can initiate this request.

2a. Upon success, the SEALDD Server shall respond with an HTTP "204 No Content" status code.

2b. On failure, the appropriate HTTP status code indicating the error shall be returned and appropriate additional error information should be returned in the HTTP DELETE response body, as specified in clause 6.2.7.

### 5.3.2.4 SDD\_DataStorage\_Query

#### 5.3.2.4.1 General

This service operation is used by a service consumer to request the retrieval of one or several existing SEALDD Data Storage(s) at the SEALDD Server.

The following procedures are supported by the "SDD\_DataStorage\_Query" service operation:

- Data Storage(s) Query.

#### 5.3.2.4.2 Data Storage(s) Query

Figure 5.3.2.2-1 depicts a scenario where a a service consumer sends a request to the SEALDD Server to request the retrieval of one or several existing SEALDD Data Storage(s) (see also clause 9.5 of 3GPP°TS°23.433°[7]).

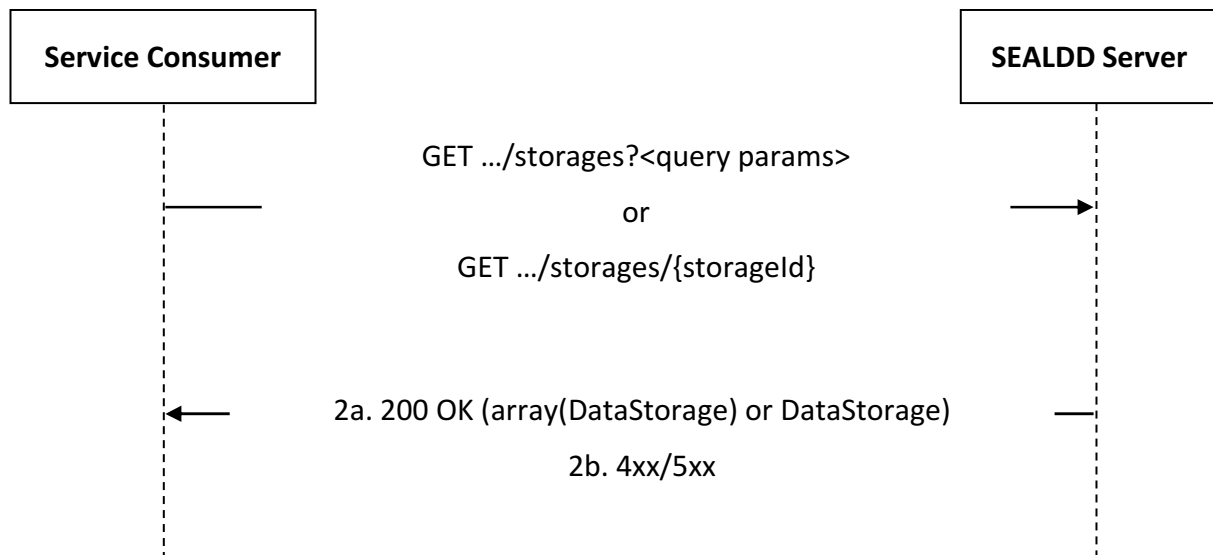

**Figure 5.3.2.4.2-1: Procedure for Data Storage(s) Query**

1. In order to request the retrieval of one or several existing SEALDD Data Storage(s), the service consumer shall send an HTTP GET request to the SEALDD Server targeting either:
  - the URI of the "Data Storages" collection resource, with query parameters to filter the targeted Data Storage(s), if one or several Data Storage(s) are to be retrieved; or
  - the URI of the targeted "Individual Data Storage" resource, if a single Data Storage is to be retrieved.
- 2a. Upon success, the SEALDD Server shall respond with an HTTP "200 OK" status code with the response body containing either:
  - the targeted "Individual Data Storage" resource(s) within one or several instance(s) of the DataStorage data structure, for the case of a response to a request to retrieve one or several Data Storage(s);
  - the targeted "Individual Data Storage" resource within the DataStorage data structure, for the case of a response to a request to retrieve a single Data Storage;
- 2b. On failure, the appropriate HTTP status code indicating the error shall be returned and appropriate additional error information should be returned in the HTTP GET response body, as specified in clause 6.2.7.

## 5.3.2.5 SDD\_DataStorage\_DelRequest

### 5.3.2.5.1 General

This service operation is used by a service consumer to request SEALDD Data Storage Delivery to the SEALDD Server.

The following procedures are supported by the "SDD\_DataStorage\_DelRequest" service operation:

- SEALDD Data Storage Delivery Request.

### 5.3.2.5.2 SEALDD Data Storage Delivery Request

Figure 5.3.2.5.2-1 depicts a scenario where a service consumer sends a request to the SEALDD Server to request SEALDD Data Storage Delivery (see also clauses 9.5 of 3GPP TS 23.433 [7]).

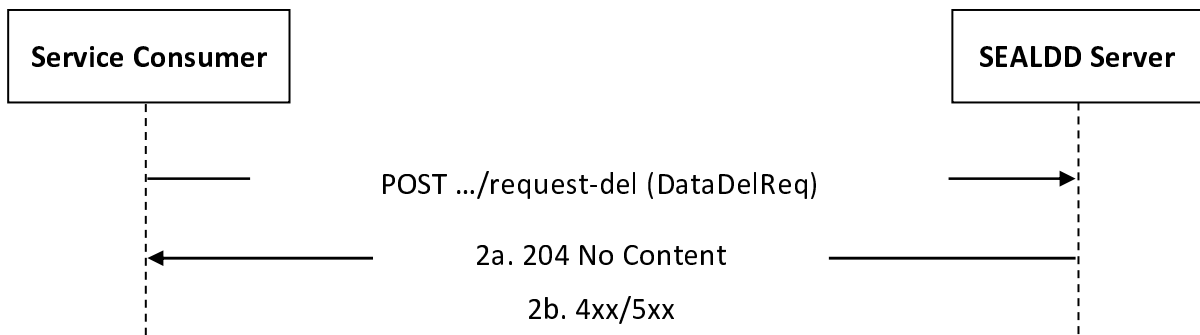

**Figure 5.3.2.5.2-1: Procedure for SEALDD Data Storage Delivery Request**

1. In order to request SEALDD Data Storage Delivery, the service consumer shall send an HTTP POST request to the SEALDD Server targeting the URI of the corresponding custom operation (i.e., "DataDeliveryRequest"), with the request body including the DataDelReq data structure.
- 2a. Upon success, the SEALDD Server shall respond with an HTTP "204 No Content" status code.
- 2b. On failure, the appropriate HTTP status code indicating the error shall be returned and appropriate additional error information should be returned in the HTTP POST response body, as specified in clause 6.2.7.

### 5.3.2.6 SDD\_DataStorage\_EstablishDelConn

#### 5.3.2.6.1 General

This service operation is used by a service consumer to request SEALDD Data Storage Delivery connection establishment to the SEALDD Server.

The following procedures are supported by the "SDD\_DataStorage\_EstablishDelConn" service operation:

- SEALDD Data Storage Delivery Connection Establishment Request.

#### 5.3.2.6.2 SEALDD Data Storage Delivery Connection Establishment Request

Figure 5.3.2.6.2-1 depicts a scenario where a service consumer sends a request to the SEALDD Server to request SEALDD Data Storage Delivery connection establishment (see also clauses 9.5 of 3GPP°TS°23.433°[7]).

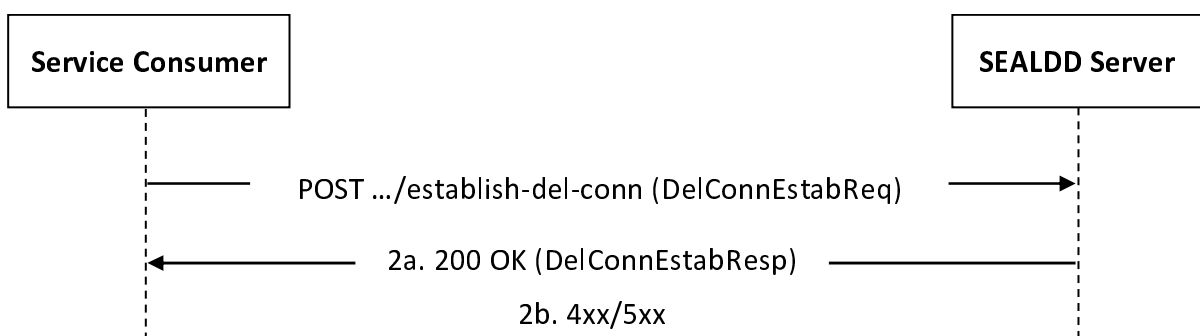

**Figure 5.3.2.6.2-1: Procedure for SEALDD Data Storage Delivery Connection Establishment Request**

1. In order to request SEALDD Data Storage Delivery connection establishment, the service consumer shall send an HTTP POST request to the SEALDD Server targeting the URI of the corresponding custom operation (i.e., "EstablishDelConn"), with the request body including the DelConnEstabReq data structure.
- 2a. Upon success, the SEALDD Server shall respond with either:
  - an HTTP "200 OK" status code to indicate that the SEALDD Data Storage Delivery connection establishment request is successfully received and processed, with the response body containing SEALDD Data Storage Delivery connection establishment related information within the DelConnEstabResp data structure; or

- an HTTP "204 No Content" status code to indicate that the SEALDD Data Storage Delivery connection establishment request is successfully received and processed.

2b. On failure, the appropriate HTTP status code indicating the error shall be returned and appropriate additional error information should be returned in the HTTP POST response body, as specified in clause 6.2.7.

### 5.3.2.7 SDD\_DataStorage\_DelSubscribe

#### 5.3.2.7.1 General

This service operation is used by a service consumer to request the creation/update/deletion of a SEALDD Data Storage Delivery Subscription at the SEALDD Server.

The following procedures are supported by the "SDD\_DataStorage\_DelSubscribe" service operation:

- Data Storage Delivery Subscription Creation.
- Data Storage Delivery Subscription Update.
- Data Storage Delivery Subscription Deletion.

#### 5.3.2.7.2 Data Storage Delivery Subscription Creation

Figure 5.3.2.7.2-1 depicts a scenario where a service consumer sends a request to the SEALDD Server to request the creation of a SEALDD Data Storage Delivery Subscription (see also clause 9.5 of 3GPP°TS°23.433°[7]).

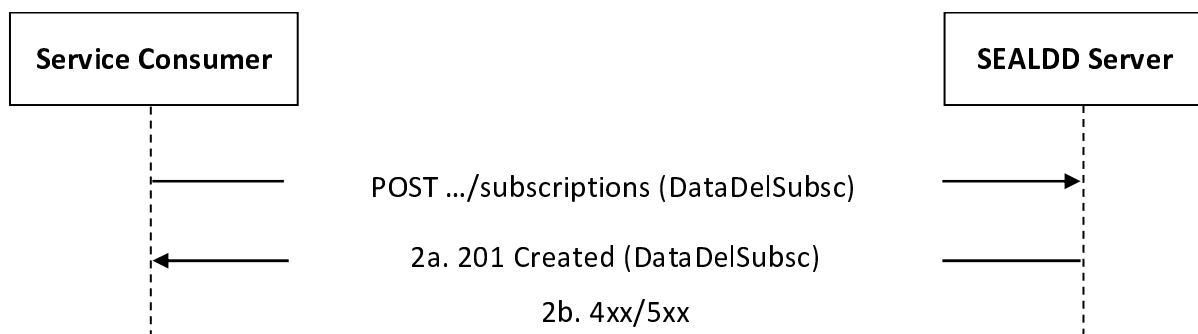
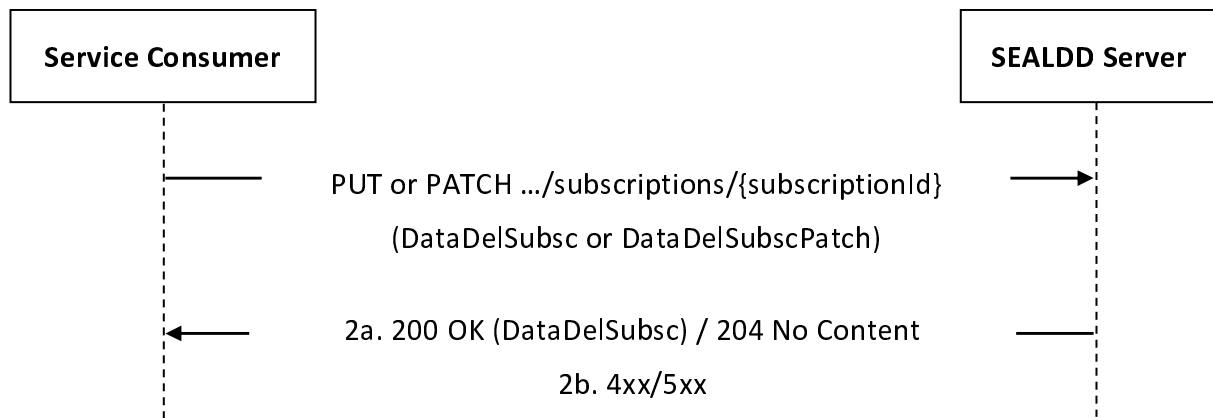

**Figure 5.3.2.7.2-1: Procedure for Data Storage Delivery Subscription Creation**

1. In order to request the creation of a new SEALDD Data Storage Delivery Subscription, the service consumer shall send an HTTP POST request to the SEALDD Server targeting the URI of the "Data Storage Delivery Subscriptions" collection resource, with the request body including the DataDelSubsc data structure.
- 2a. Upon success, the SEALDD Server shall respond with an HTTP "201 Created" status code, with the response body containing a representation of the created "Individual Data Storage Delivery Subscription" resource within the DataDelSubsc data structure, and an HTTP "Location" header field containing the URI of the created resource.
- 2b. On failure, the appropriate HTTP status code indicating the error shall be returned and appropriate additional error information should be returned in the HTTP POST response body, as specified in clause 6.2.7.

#### 5.3.2.7.3 Data Storage Delivery Subscription Update

Figure 5.3.2.7.3-1 depicts a scenario where a service consumer sends a request to the SEALDD Server to request the update of an existing SEALDD Data Storage Delivery Subscription (see also clause 9.5 of 3GPP°TS°23.433°[7]).



**Figure 5.3.2.7.3-1: Procedure for Data Storage Delivery Subscription Update**

1. In order to update an existing SEALDD Data Storage Delivery Subscription, the service consumer shall send an HTTP PUT/PATCH request to the SEALDD Server, targeting the URI of the corresponding "Individual Data Storage Delivery Subscription" resource, with the request body including either:
  - the updated representation of the resource within the DataDelSubsc data structure, in case the HTTP PUT method is used; or
  - the requested modifications to the resource within the DataDelSubscPatch data structure, in case the HTTP PATCH method is used.

NOTE: An alternative service consumer (i.e. other than the one that requested the creation of the targeted resource) can initiate this request.

- 2a. Upon success, the SEALDD Server shall update the targeted "Individual Data Storage Delivery Subscription" resource accordingly and respond with either:
  - an HTTP "200 OK" status code with the response body containing a representation of the updated "Individual Data Storage Delivery Subscription" resource within the DataDelSubsc data structure; or
  - an HTTP "204 No Content" status code.
- 2b. On failure, the appropriate HTTP status code indicating the error shall be returned and appropriate additional error information should be returned in the HTTP PUT/PATCH response body, as specified in clause 6.2.7.

#### 5.3.2.7.4 Data Storage Delivery Subscription Deletion

Figure 5.3.2.7.4-1 depicts a scenario where a service consumer sends a request to the SEALDD Server to request the deletion of an existing SEALDD Data Storage Delivery Subscription (see also clause 9.5 of 3GPP TS 23.433 [7]).

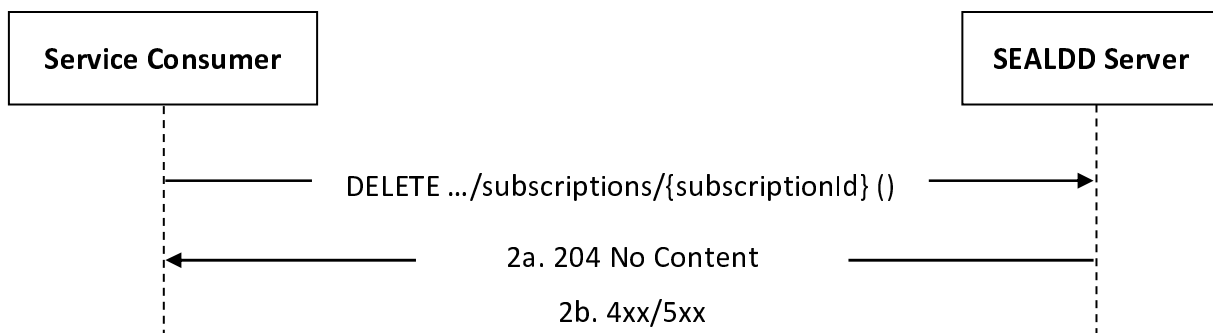

**Figure 5.3.2.7.4-1: Procedure for Data Storage Delivery Subscription Deletion**

1. In order to request the deletion of an existing SEALDD Data Storage Delivery Subscription, the service consumer shall send an HTTP DELETE request to the SEALDD Server targeting the URI of the corresponding "Individual Data Storage Delivery Subscription" resource.

NOTE: An alternative service consumer (i.e. other than the one that requested the creation/update of the targeted resource) can initiate this request.

2a. Upon success, the SEALDD Server shall respond with an HTTP "204 No Content" status code.

2b. On failure, the appropriate HTTP status code indicating the error shall be returned and appropriate additional error information should be returned in the HTTP DELETE response body, as specified in clause 6.2.7.

### 5.3.2.8 SDD\_DataStorage\_DelNotify

#### 5.3.2.8.1 General

This service operation is used by a SEALDD Server to notify a previously subscribed service consumer on:

- SEALDD Data Storage Delivery.

The following procedures are supported by the "SDD\_DataStorage\_DelNotify" service operation:

- Data Storage Delivery Notification.

#### 5.3.2.8.2 Data Storage Delivery Notification

Figure 5.3.2.8.2-1 depicts a scenario where the SEALDD Server sends a request to notify a previously subscribed service consumer on SEALDD Data Storage Delivery (see also clause 9.5 of 3GPP TS 23.433 [7]).

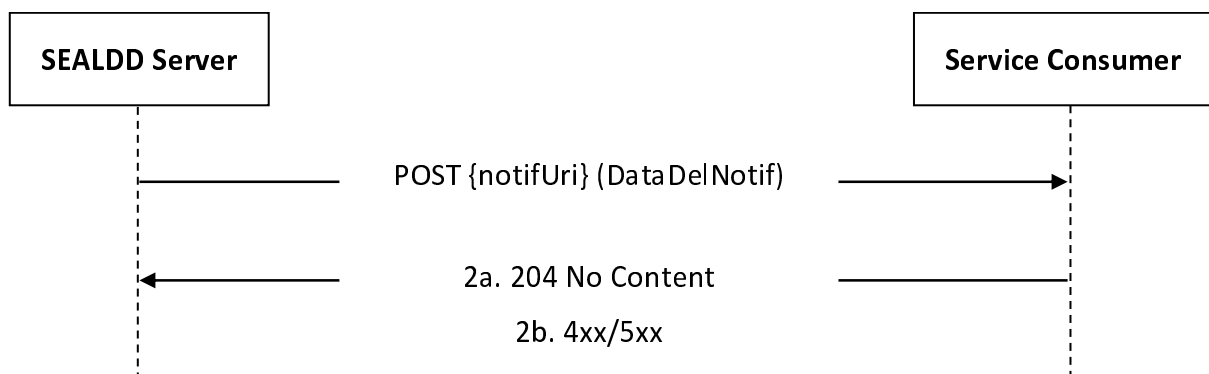

**Figure 5.3.2.8.2-1: Procedure for Data Storage Delivery Notification**

1. In order to notify a previously subscribed service consumer on SEALDD Data Storage Delivery, the SEALDD Server shall send an HTTP POST request to the service consumer with the request URI set to "{notifUri}", where the "notifUri" variable is set to the value received from the service consumer during the creation/update of the corresponding SEALDD Data Storage Delivery Subscription using the procedures defined in clause 5.3.2.7, and the request body including the DataDelNotif data structure.
- 2a. Upon success, the service consumer shall respond to the SEALDD Server with an HTTP "204 No Content" status code to acknowledge the reception of the notification.
- 2b. On failure, the appropriate HTTP status code indicating the error shall be returned and appropriate additional error information should be returned in the HTTP POST response body, as specified in clause 6.2.7.

## 5.4 SDD\_DDContext Service

### 5.4.1 Service Description

The SDD\_DDContext service exposed by the SEALDD Server enables a service consumer to:

- push the DD context to the SEALDD Server; and
- pull the DD context from the SEALDD Server.

### 5.4.2 Service Operations

#### 5.4.2.1 Introduction

The service operations defined for the SDD\_DDContext API are shown in the table 5.4.2.1-1.

**Table 5.4.2.1-1: SDD\_DDContext Service Operations**

Service operation name	Description	Initiated by
SDD_DDContext_Push	This service operation is used by a service consumer to push a DD context to the SEALDD Server.	e.g., SEALDD Server
SDD_DDContext_Pull	This service operation is used by a service consumer to pull a DD context from the SEALDD Server.	e.g., SEALDD Server

#### 5.4.2.2 SDD\_DDContext\_Push

##### 5.4.2.2.1 General

This service operation is used by a service consumer to push a DD Context to the SEALDD Server.

The following procedures are supported by the "SDD\_DDContext\_Push" service operation:

- DD Context Push.

##### 5.4.2.2.2 DD Context Push

Figure 5.4.2.2.2-1 depicts a scenario where a service consumer sends a request to the SEALDD Server to push a DD Context (see also clause 9.6 of 3GPP TS 23.433 [7]).

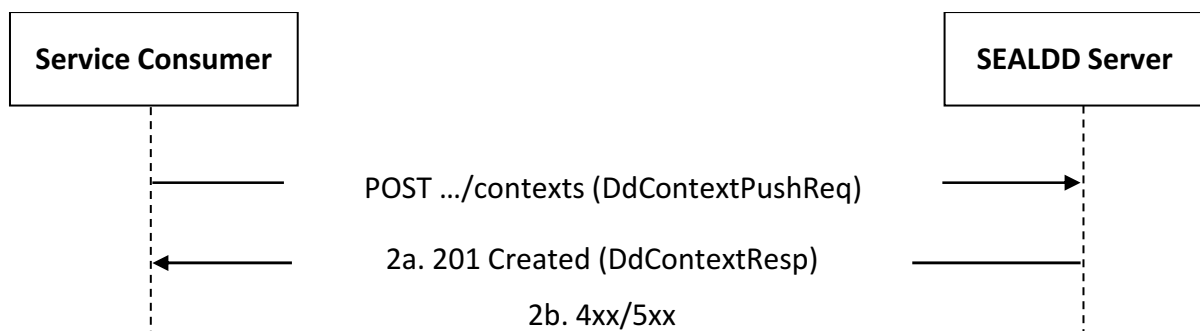

**Figure 5.4.2.2.2-1: Procedure for DD Context Push**

1. In order to push a DD context to the SEALDD Server, the service consumer shall send an HTTP POST request targeting the URI of the "DD Contexts" collection resource, with the request body including the DdContextPushReq data structure.
- 2a. Upon success, the SEALDD Server shall respond with an HTTP "200 OK" status code with the response body containing the DdContextResp data structure.



2b. On failure, the appropriate HTTP status code indicating the error shall be returned and appropriate additional error information should be returned in the HTTP POST response body, as specified in clause 6.3.7.

### 5.4.2.3 SDD\_DDContext\_Pull

#### 5.4.2.3.1 General

This service operation is used by a service consumer to pull a DD context from the SEALDD Server.

The following procedures are supported by the "SDD\_DDContext\_Pull" service operation:

- DD Context Pull.

#### 5.4.2.3.2 DD Context Pull

Figure 5.4.2.3.2-1 depicts a scenario where a service consumer sends a request to the SEALDD Server to pull a DD Context (see also clause 9.6 of 3GPP TS 23.433 [7]).

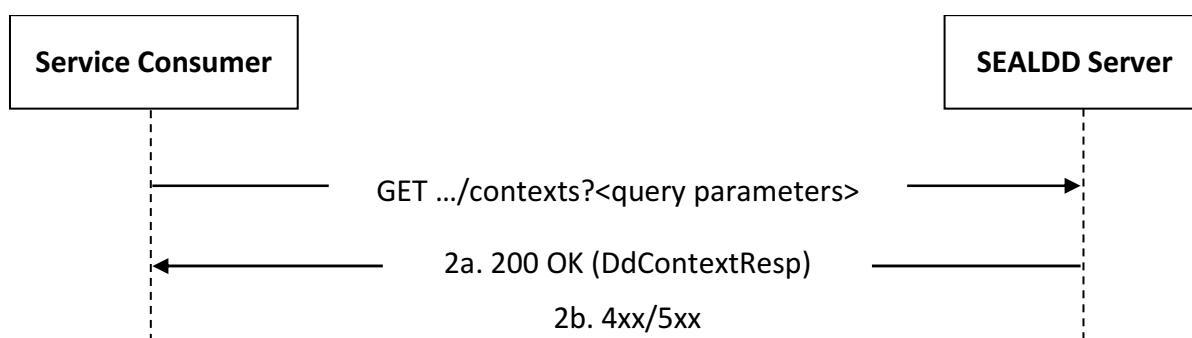

**Figure 5.4.2.3.2-1: Procedure for DD Context Pull**

1. In order to pull a DD context from the SEALDD Server, the service consumer shall send an HTTP GET request message targeting the URI of the "DD Contexts" collection resource, with query parameters to filter the targeted DD context and its content, if needed.

2a. Upon success, the SEALDD Server shall respond with an HTTP "200 OK" status code with the response body containing the DdContextResp data structure.

NOTE: The content of the "ddContext" attribute of the DdContextResp data structure in step 2a is determined by the SEALDD Server based on the service consumer's identity.

2b. On failure, the appropriate HTTP status code indicating the error shall be returned and appropriate additional error information should be returned in the HTTP GET response body, as specified in clause 6.3.7.

## 5.5 SDD\_TransmissionQualityMeasurement

### 5.5.1 Service Description

The SDD\_TransmissionQualityMeasurement service exposed by the SEALDD Server enables a service consumer to:

- create/update/delete a Transmission Quality Measurement Subscription;
- receive Transmission Quality Measurement notifications; and
- request historical Transmission Quality Measurement reports.

### 5.5.2 Service Operations

#### 5.5.2.1 Introduction

The service operations defined for the SDD\_TransmissionQualityMeasurement service are shown in table 5.5.2.1-1.

**Table 5.5.2.1-1: SDD\_TransmissionQualityMeasurement Service Operations**

Service Operation Name	Description	Initiated by
SDD_TransmissionQualityMeasurement_Subscribe	This service operation enables a service consumer to create a Transmission Quality Measurement Subscription.	e.g. VAL Server
SDD_TransmissionQualityMeasurement_Update	This service operation enables a service consumer to update an existing Transmission Quality Measurement Subscription.	e.g. VAL Server
SDD_TransmissionQualityMeasurement_Unsubscribe	This service operation enables a service consumer to delete an existing Transmission Quality Measurement Subscription.	e.g. VAL Server
SDD_TransmissionQualityMeasurement_Notify	This service operation enables a service consumer to receive Transmission Quality Measurement notifications.	SEALDD Server
SDD_TransmissionQualityMeasurement_Query	This service operation enables a service consumer to request historical Transmission Quality Measurement reports.	e.g., VAL Server, SEALDD Server, NSCE Server, ADAE Server

#### 5.5.2.2 SDD\_TransmissionQualityMeasurement\_Subscribe

##### 5.5.2.2.1 General

This service operation is used by a service consumer to request the creation of a Transmission Quality Measurement Subscription at the SEALDD Server.

The following procedures are supported by the "SDD\_TransmissionQualityMeasurement\_Subscribe" service operation:

- Transmission Quality Measurement Subscription Creation.

##### 5.5.2.2.2 Transmission Quality Measurement Subscription Creation

Figure 5.5.2.2.2-1 depicts a scenario where a service consumer sends a request to the SEALDD Server to request the creation of a Transmission Quality Measurement Subscription (see also clause 9.7 of 3GPP<sup>o</sup>TS<sup>o</sup>23.433<sup>o</sup>[7]).

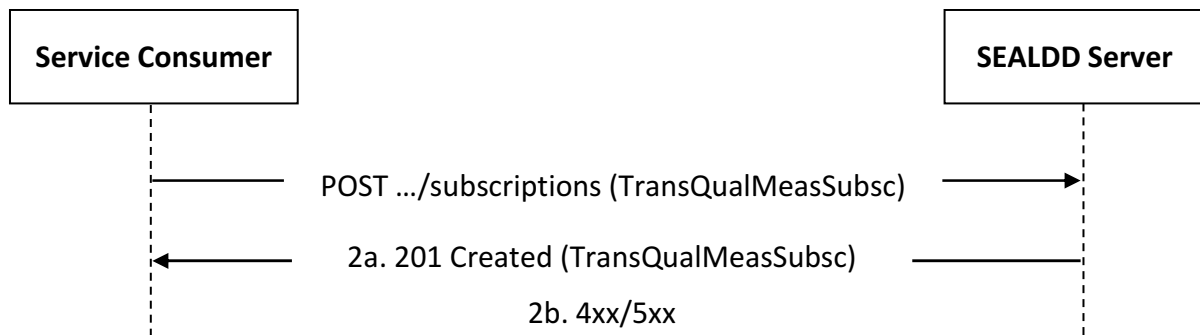

**Figure 5.5.2.2.2-1: Procedure for Transmission Quality Measurement Subscription Creation**

1. In order to subscribe to transmission quality measurement reporting, the service consumer shall send an HTTP POST request to the SEALDD Server targeting the URI of the "Transmission Quality Measurement Subscriptions" collection resource, with the request body including the TransQualMeasSubsc data structure.
- 2a. Upon success, the SEALDD Server shall respond with an HTTP "201 Created" status code with the response body containing a representation of the created "Individual Transmission Quality Measurement Subscription" resource within the TransQualMeasSubsc data structure, and an HTTP "Location" header field containing the URI of the created resource.
- 2b. On failure, the appropriate HTTP status code indicating the error shall be returned and appropriate additional error information should be returned in the HTTP POST response body, as specified in clause 6.4.7.

### 5.5.2.3 SDD\_TransmissionQualityMeasurement\_Update

#### 5.5.2.3.1 General

This service operation is used by a service consumer to request the update of a Transmission Quality Measurement Subscription at the SEALDD Server.

The following procedures are supported by the "SDD\_TransmissionQualityMeasurement\_Update" service operation:

- Transmission Quality Measurement Subscription Update.

#### 5.5.2.3.2 Transmission Quality Measurement Subscription Update

Figure 5.5.2.3.2-1 depicts a scenario where a service consumer sends a request to the SEALDD Server to request the update of an existing Transmission Quality Measurement Subscription (see also clause 9.7 of 3GPP TS 23.433 [7]).

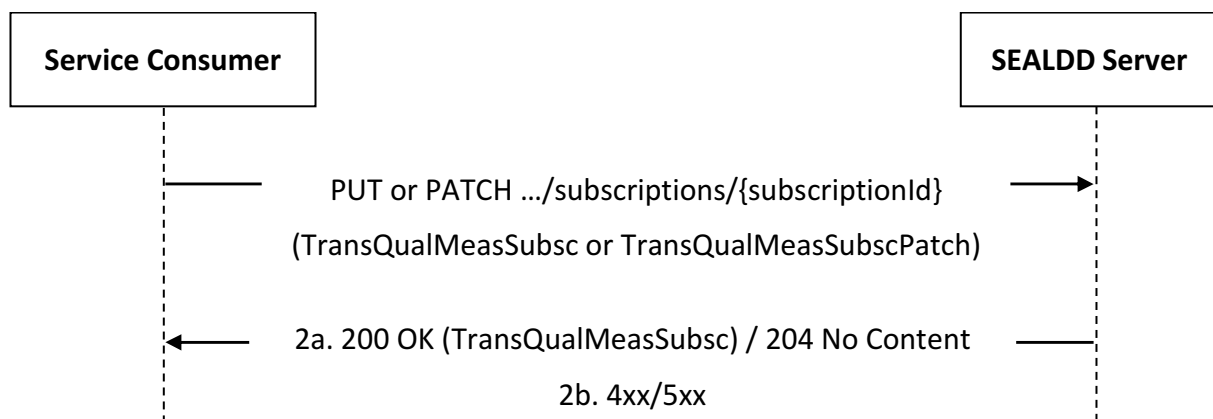

**Figure 5.5.2.3.2-1: Procedure for Transmission Quality Measurement Subscription Update**

1. In order to request the update of an existing transmission quality measurement subscription, the service consumer shall send an HTTP PUT/PATCH request to the SEALDD Server, targeting the URI of the corresponding "Individual Transmission Quality Measurement Subscription" resource, with the request body including either:

- the updated representation of the resource within the TransQualMeasSubsc data structure, in case the HTTP PUT method is used; or
- the requested modifications to the resource within the TransQualMeasSubscPatch data structure, in case the HTTP PATCH method is used.

NOTE: An alternative service consumer (i.e. other than the one that requested the creation of the targeted resource) can initiate this request.

2a. Upon success, the SEALDD Server shall update the targeted "Individual Transmission Quality Measurement Subscription" resource accordingly and respond with either:

- an HTTP "200 OK" status code with the response body containing a representation of the updated "Individual Transmission Quality Measurement Subscription" resource within the TransQualMeasSubsc data structure; or
- an HTTP "204 No Content" status code.

2b. On failure, the appropriate HTTP status code indicating the error shall be returned and appropriate additional error information should be returned in the HTTP PUT/PATCH response body, as specified in clause 6.4.7.

## 5.5.2.4 SDD\_TransmissionQualityMeasurement\_Unsubscribe

### 5.5.2.4.1 General

This service operation is used by a service consumer to request the deletion of a Transmission Quality Measurement Subscription at the SEALDD Server.

The following procedures are supported by the "SDD\_TransmissionQualityMeasurement\_Unsubscribe" service operation:

- Transmission Quality Measurement Subscription Deletion.

### 5.5.2.4.2 Transmission Quality Measurement Subscription Deletion

Figure 5.5.2.4.2-1 depicts a scenario where a service consumer sends a request to the SEALDD Server to delete an existing Transmission Quality Measurement Subscription (see also clause 9.7 of 3GPP TS 23.433 [7]).

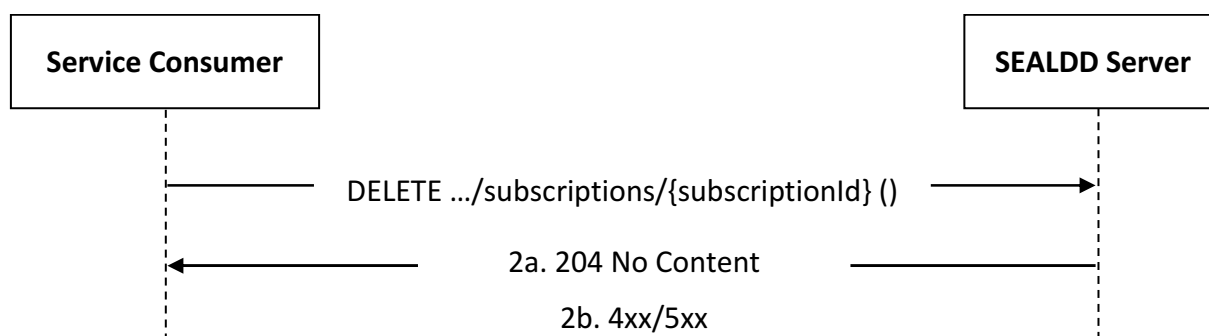

**Figure 5.5.2.4.2-1: Procedure for Transmission Quality Measurement Subscription Deletion**

1. In order to request the deletion of an existing transmission quality measurement subscription, the service consumer shall send an HTTP DELETE request to the SEALDD Server targeting the URI of the corresponding "Individual Transmission Quality Measurement Subscription" resource.

NOTE: An alternative service consumer (i.e. other than the one that requested the creation/update of the targeted resource) can initiate this request.

2a. Upon success, the SEALDD Server shall respond with an HTTP "204 No Content" status code.

2b. On failure, the appropriate HTTP status code indicating the error shall be returned and appropriate additional error information should be returned in the HTTP DELETE response body, as specified in clause 6.4.7.

## 5.5.2.5 SDD\_TransmissionQualityMeasurement\_Notify

### 5.5.2.5.1 General

This service operation is used by a SEALDD Server to notify a previously subscribed service consumer on:

- transmission Quality Measurement report(s).

The following procedures are supported by the "SDD\_TransmissionQualityMeasurement\_Notify" service operation:

- Transmission Quality Measurement Notification.

### 5.5.2.5.2 Transmission Quality Measurement Notification

Figure 5.5.2.5.2-1 depicts a scenario where the SEALDD Server sends a request to notify a previously subscribed service consumer on Transmission Quality Measurement report(s) (see also clause 9.7 of 3GPP°TS°23.433°[7]).

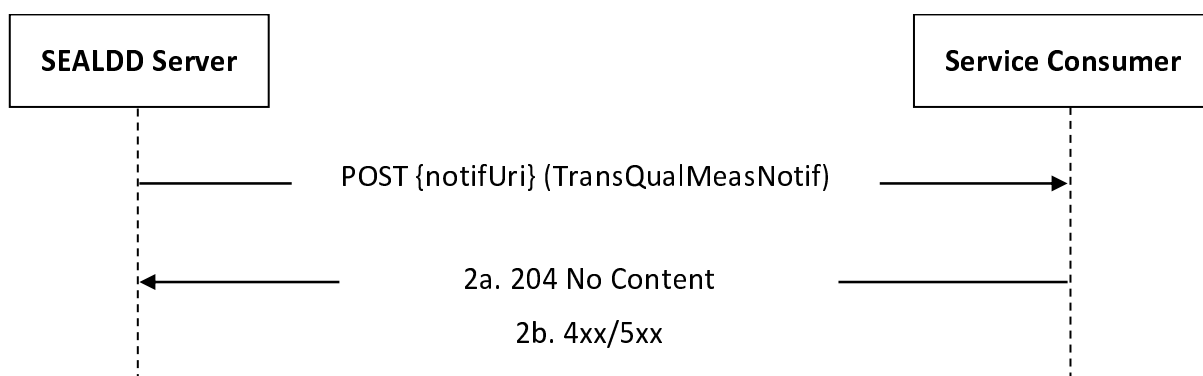

**Figure 5.5.2.5.2-1: Procedure for Transmission Quality Measurement Notification**

1. In order to notify a previously subscribed service consumer on Transmission Quality Measurement report(s), the SEALDD Server shall send an HTTP POST request to the service consumer with the request URI set to "{notifUri}", where the "notifUri" variable is set to the value received from the service consumer during the creation/update of the corresponding Transmission Quality Measurement Subscription using the procedures defined in clauses 5.5.2.2 and 5.5.2.3, and the request body including the TransQualMeasNotif data structure.
- 2a. Upon success, the service consumer shall respond to the SEALDD Server with an HTTP "204 No Content" status code to acknowledge the reception of the notification.
- 2b. On failure, the appropriate HTTP status code indicating the error shall be returned and appropriate additional error information should be returned in the HTTP POST response body, as specified in clause 6.4.7.

## 5.5.2.6 SDD\_TransmissionQualityMeasurement\_Query

### 5.5.2.6.1 General

This service operation is used by a service consumer to retrieve Historical Transmission Quality Measurement Report(s) from the SEALDD Server.

The following procedures are supported by the "SDD\_TransmissionQualityMeasurement\_Query" service operation:

- Historical Transmission Quality Measurement Report(s) Retrieval.

### 5.5.2.6.2 Historical Transmission Quality Measurement Report(s) Retrieval

Figure 5.5.2.6.2-1 depicts a scenario where a service consumer sends a request to the SEALDD Server to retrieve Historical Transmission Quality Measurement Report(s) (see also clause 9.7 of 3GPP°TS°23.433°[7]).

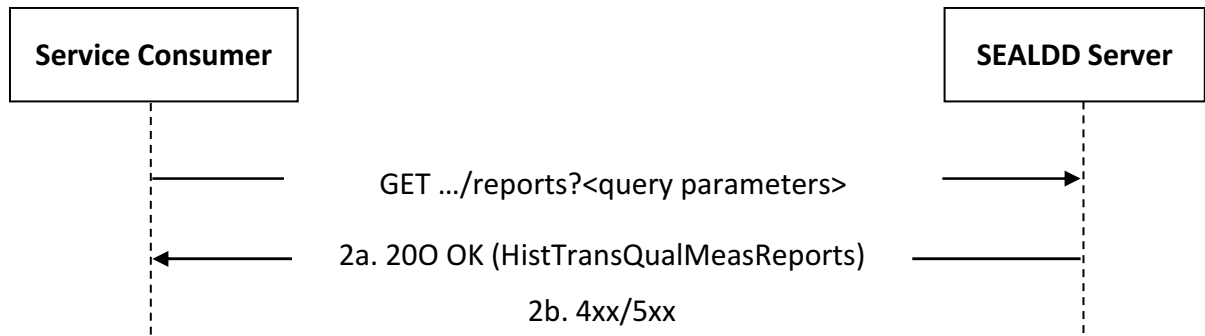

**Figure 5.5.2.6.2-1: Procedure for Historical Transmission Quality Measurement Report(s) Retrieval**

1. In order to retrieve Historical Transmission Quality Measurement Report(s), the service consumer shall send an HTTP GET request to the SEALDD Server targeting the URI of the "Historical Transmission Quality Measurement Reports" collection resource, with the request URI containing query parameter(s) to filter the responses from the SEALDD Server.
- 2a. Upon success, the SEALDD Server shall respond with an HTTP "200 OK" status code with the response body containing the requested Historical Transmission Quality Measurement Report(s) within the HistTransQualMeasReports data structure.
- 2b. On failure, the appropriate HTTP status code indicating the error shall be returned and appropriate additional error information should be returned in the HTTP GET response body, as specified in clause 6.4.7.

## 5.6 SDD\_PolicyConfiguration

### 5.6.1 Service Description

The SDD\_PolicyConfiguration service exposed by the SEALDD Server enables a service consumer to:

- create/update/delete a SEALDD Policy Configuration.

### 5.6.2 Service Operations

#### 5.6.2.1 Introduction

The service operations defined for the SDD\_PolicyConfiguration service are shown in table 5.6.2.1-1.

**Table 5.6.2.1-1: SDD\_PolicyConfiguration Service Operations**

Service Operation Name	Description	Initiated by
SDD_PolicyConfiguration_Create	This service operation enables a service consumer to request the creation of a SEALDD Policy Configuration.	e.g., VAL Server
SDD_PolicyConfiguration_Update	This service operation enables a service consumer to request the update of an existing SEALDD Policy Configuration.	e.g., VAL Server
SDD_PolicyConfiguration_Delete	This service operation enables a service consumer to request the deletion of an existing SEALDD Policy Configuration.	e.g., VAL Server

#### 5.6.2.2 SDD\_PolicyConfiguration\_Create

##### 5.6.2.2.1 General

This service operation is used by a service consumer to request the creation of a SEALDD Policy Configuration at the SEALDD Server.

The following procedures are supported by the "SDD\_PolicyConfiguration\_Create" service operation:

- Policy Configuration Creation.

##### 5.6.2.2.2 Policy Configuration Creation

Figure 5.6.2.2.2-1 depicts a scenario where a service consumer sends a request to the SEALDD Server to request the creation of a SEALDD Policy Configuration (see also clause 9.10 of 3GPP°TS°23.433°[7]).

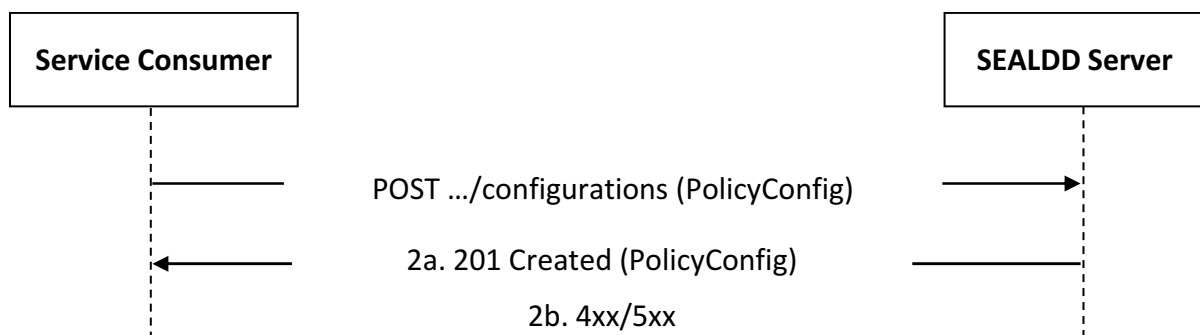

**Figure 5.6.2.2.2-1: Procedure for Policy Configuration Creation**

1. In order to create a new SEALDD Policy Configuration, the service consumer shall send an HTTP POST request to the SEALDD Server targeting the URI of the "Policy Configurations" collection resource, with the request body including the PolicyConfig data structure.
- 2a. Upon success, the SEALDD Server shall respond with an HTTP "201 Created" status code with the response body containing a representation of the created "Individual Policy Configuration" resource within the PolicyConfig data structure, and an HTTP "Location" header field containing the URI of the created resource.
- 2b. On failure, the appropriate HTTP status code indicating the error shall be returned and appropriate additional error information should be returned in the HTTP POST response body, as specified in clause 6.5.7.

### 5.6.2.3 SDD\_PolicyConfiguration\_Update

#### 5.6.2.3.1 General

This service operation is used by a service consumer to request the update of an existing SEALDD Policy Configuration at the SEALDD Server.

The following procedures are supported by the "SDD\_PolicyConfiguration\_Update" service operation:

- Policy Configuration Update.

#### 5.6.2.3.2 Policy Configuration Update

Figure 5.6.2.3.2-1 depicts a scenario where a service consumer sends a request to the SEALDD Server to request the update of an existing SEALDD Policy Configuration (see also clause 9.10 of 3GPP TS 23.433 [7]).

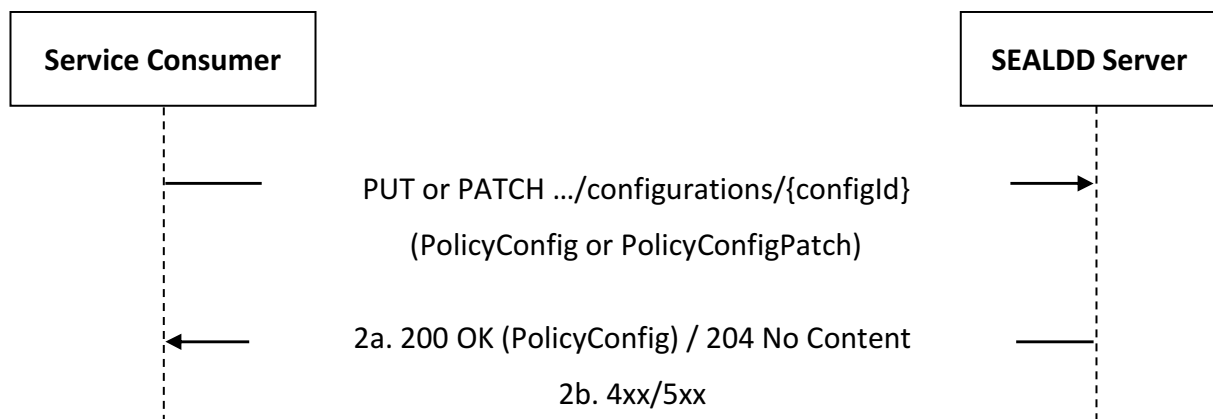

**Figure 5.6.2.3.2-1: Procedure for Policy Configuration Update**

1. In order to update an existing SEALDD Policy Configuration, the service consumer shall send an HTTP PUT/PATCH request to the SEALDD Server, targeting the URI of the corresponding "Individual Policy Configuration" resource, with the request body including either:
  - the updated representation of the resource within the PolicyConfig data structure, in case the HTTP PUT method is used; or
  - the requested modifications to the resource within the PolicyConfigPatch data structure, in case the HTTP PATCH method is used.

NOTE: An alternative service consumer (i.e. other than the one that requested the creation of the targeted resource) can initiate this request.

- 2a. Upon success, the SEALDD Server shall update the targeted "Individual Policy Configuration" resource accordingly and respond with either:

- an HTTP "200 OK" status code with the response body containing a representation of the updated "Individual Policy Configuration" resource within the PolicyConfig data structure; or



- an HTTP "204 No Content" status code.

2b. On failure, the appropriate HTTP status code indicating the error shall be returned and appropriate additional error information should be returned in the HTTP PUT/PATCH response body, as specified in clause 6.5.7.

## 5.6.2.4 SDD\_PolicyConfiguration\_Delete

### 5.6.2.4.1 General

This service operation is used by a service consumer to request the deletion of an existing SEALDD Policy Configuration at the SEALDD Server.

The following procedures are supported by the "SDD\_PolicyConfiguration\_Delete" service operation:

- Policy Configuration Deletion.

### 5.6.2.4.2 Policy Configuration Deletion

Figure 5.6.2.4.2-1 depicts a scenario where a service consumer sends a request to the SEALDD Server to request the deletion of an existing SEALDD Policy Configuration (see also clause 9.10 of 3GPP TS 23.433 [7]).

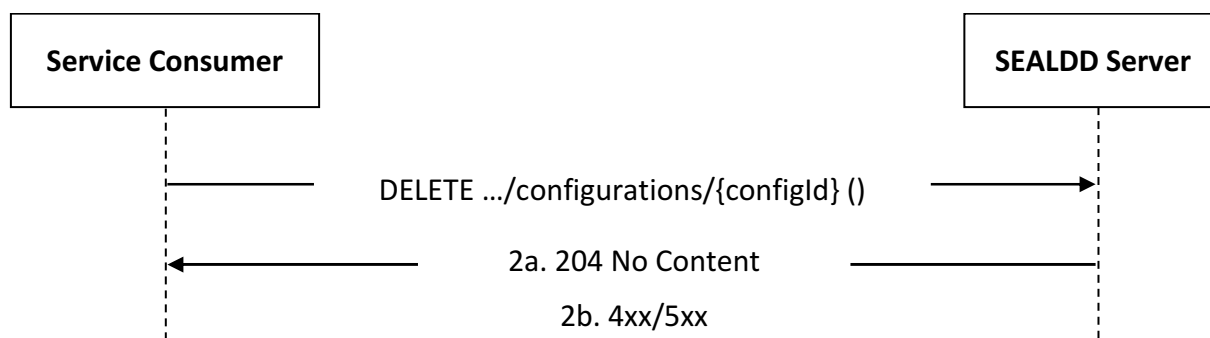

**Figure 5.6.2.4.2-1: Procedure for Policy Configuration Deletion**

1. In order to request the deletion of an existing SEALDD Policy Configuration, the service consumer shall send an HTTP DELETE request to the SEALDD Server targeting the URI of the corresponding "Individual Policy Configuration" resource.

NOTE: An alternative service consumer (i.e. other than the one that requested the creation of the targeted resource) can initiate this request.

2a. Upon success, the SEALDD Server shall respond with an HTTP "204 No Content" status code.

2b. On failure, the appropriate HTTP status code indicating the error shall be returned and appropriate additional error information should be returned in the HTTP DELETE response body, as specified in clause 6.5.7.

## 6 API Definitions

### 6.1 SDD\_Transmission Service API

#### 6.1.1 Introduction

The SDD\_Transmission service shall use the SDD\_Transmission API.

The API URI of the SDD\_Transmission API shall be:

**{apiRoot}/<apiName>/<apiVersion>**

The request URIs used in HTTP requests shall have the Resource URI structure defined in clause 6.5 of 3GPP TS 29.549 [15], i.e.:

**{apiRoot}/<apiName>/<apiVersion>/<apiSpecificSuffixes>**

with the following components:

- The {apiRoot} shall be set as described in clause 6.5 of 3GPP TS 29.549 [15].
- The <apiName> shall be "sdd-trans".
- The <apiVersion> shall be "v1".
- The <apiSpecificSuffixes> shall be set as described in clause 6.5 of 3GPP TS 29.549 [15].

NOTE: When 3GPP TS 29.122 [2] is referenced for the common protocol and interface aspects for API definition in the clauses under clause 6.1, the SEALDD Server takes the role of the SCEF and the service consumer takes the role of the SCS/AS.

#### 6.1.2 Usage of HTTP

The provisions of clause 6.3 of 3GPP TS 29.549 [15] shall apply for the SDD\_Transmission API.

#### 6.1.3 Resources

##### 6.1.3.1 Overview

This clause describes the structure for the Resource URIs and the resources and methods used for the service.

Figure 6.1.3.1-1 depicts the resource URIs structure for the SDD\_Transmission API.

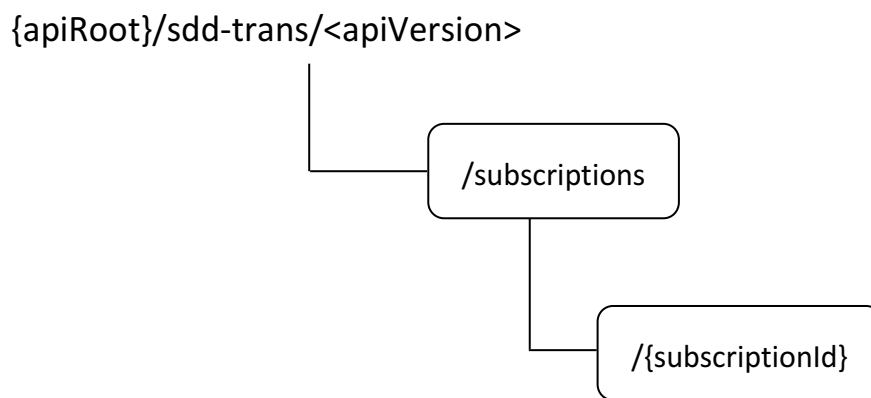

**Figure 6.1.3.1-1: Resource URI structure of the SDD\_Transmission API**

Table 6.1.3.1-1 provides an overview of the resources and applicable HTTP methods.

**Table 6.1.3.1-1: Resources and methods overview**

Resource purpose/name	Resource URI (relative path after API URI)	HTTP method or custom operation	Description (service operation)
Connection Status Subscriptions	/subscriptions	POST	Request the creation of a new Connection Status Subscription.
Individual Connection Status Subscription	/subscriptions/{subscriptionId}	GET	Retrieve an existing "Individual Connection Status Subscription" resource.
		PUT	Request the update of an existing "Individual Connection Status Subscription" resource.
		PATCH	Request the modification of an existing "Individual Connection Status Subscription" resource.
		DELETE	Request the deletion of an existing "Individual Connection Status Subscription" resource.

### 6.1.3.2 Resource: Connection Status Subscriptions

#### 6.1.3.2.1 Description

This resource represents the collection of Connection Status Subscription(s) managed by the SEALDD Server.

#### 6.1.3.2.2 Resource Definition

Resource URI: {apiRoot}/sdd-trans/<apiVersion>/subscriptions

This resource shall support the resource URI variables defined in table 6.1.3.2.2-1.

**Table 6.1.3.2.2-1: Resource URI variables for this resource**

Name	Data type	Definition
apiRoot	string	See clause 6.1.1.

#### 6.1.3.2.3 Resource Standard Methods

##### 6.1.3.2.3.1 POST

The HTTP POST method enables a service consumer to request the creation of a new Connection Status Subscription at the SEALDD Server.

This method shall support the URI query parameters specified in table 6.1.3.2.3.1-1.

**Table 6.1.3.2.3.1-1: URI query parameters supported by the POST method on this resource**

Name	Data type	P	Cardinality	Description	Applicability
n/a					

This method shall support the request data structures specified in table 6.1.3.2.3.1-2 and the response data structures and response codes specified in table 6.1.3.2.3.1-3.

**Table 6.1.3.2.3.1-2: Data structures supported by the POST Request Body on this resource**

Data type	P	Cardinality	Description
ConnStatusSubsc	M	1	Represents the parameters to request the creation of a Connection Status Subscription.

**Table 6.1.3.2.3.1-3: Data structures supported by the POST Response Body on this resource**

Data type	P	Cardinality	Response codes	Description
ConnStatusSubsc	M	1	201 Created	Successful case. The Connection Status Subscription is successfully created and a representation of the created "Individual Connection Status Subscription" resource shall be returned in the response body.  An HTTP "Location" header that contains the URI of the created resource shall also be included.
NOTE: The mandatory HTTP error status codes for the HTTP POST method listed in table 5.2.6-1 of 3GPP TS 29.122 [2] shall also apply.				

**Table 6.1.3.2.3.1-4: Headers supported by the 201 Response Code on this resource**

Name	Data type	P	Cardinality	Description
Location	string	M	1	Contains the URI of the newly created resource, according to the structure: {apiRoot}/sdd-trans/<apiVersion>/subscriptions/{subscriptionId}

#### 6.1.3.2.4 Resource Custom Operations

There are no resource custom operations defined for this resource in this release of the specification.

### 6.1.3.3 Resource: Individual Connection Status Subscription

#### 6.1.3.3.1 Description

This resource represents a Connection Status Subscription managed by the SEALDD Server.

#### 6.1.3.3.2 Resource Definition

Resource URI: {apiRoot}/sdd-trans/<apiVersion>/subscriptions/{subscriptionId}

This resource shall support the resource URI variables defined in table 6.1.3.3.2-1.

**Table 6.1.3.3.2-1: Resource URI variables for this resource**

Name	Data type	Definition
apiRoot	string	See clause 6.1.1.
subscriptionId	string	Represents the identifier of the "Individual Connection Status Subscription" resource.

#### 6.1.3.3.3 Resource Standard Methods

##### 6.1.3.3.3.1 GET

The HTTP GET method allows a service consumer to retrieve an existing "Individual Connection Status Subscription" resource at the SEALDD Server.

This method shall support the URI query parameters specified in table 6.1.3.3.3.1-1.

**Table 6.1.3.3.3.1-1: URI query parameters supported by the GET method on this resource**

Name	Data type	P	Cardinality	Description	Applicability
n/a					

This method shall support the request data structures specified in table 6.1.3.3.3.1-2 and the response data structures and response codes specified in table 6.1.3.3.3.1-3.

**Table 6.1.3.3.3.1-2: Data structures supported by the GET Request Body on this resource**

Data type	P	Cardinality	Description
n/a			

**Table 6.1.3.3.3.1-3: Data structures supported by the GET Response Body on this resource**

Data type	P	Cardinality	Response codes	Description
ConnStatusSubsc	M	1	200 OK	Successful case. The requested "Individual Connection Status Subscription" resource shall be returned.
n/a			307 Temporary Redirect	Temporary redirection. The response shall include a Location header field containing an alternative URI of the resource located in an alternative SEALDD Server. Redirection handling is described in clause 5.2.10 of 3GPP TS 29.122 [2].
n/a			308 Permanent Redirect	Permanent redirection. The response shall include a Location header field containing an alternative URI of the resource located in an alternative SEALDD Server. Redirection handling is described in clause 5.2.10 of 3GPP TS 29.122 [2].
NOTE: The mandatory HTTP error status codes for the HTTP GET method listed in table 5.2.6-1 of 3GPP TS 29.122 [2] shall also apply.				

**Table 6.1.3.3.3.1-4: Headers supported by the 307 Response Code on this resource**

Name	Data type	P	Cardinality	Description
Location	string	M	1	Contains an alternative URI of the resource located in an alternative SEALDD Server.

**Table 6.1.3.3.3.1-5: Headers supported by the 308 Response Code on this resource**

Name	Data type	P	Cardinality	Description
Location	string	M	1	Contains an alternative URI of the resource located in an alternative SEALDD Server.

#### 6.1.3.3.3.2 PUT

The HTTP PUT method allows a service consumer to request the update of an existing "Individual Connection Status Subscription" resource at the SEALDD Server.

This method shall support the URI query parameters specified in table 6.1.3.3.3.2-1.

**Table 6.1.3.3.3.2-1: URI query parameters supported by the PUT method on this resource**

Name	Data type	P	Cardinality	Description	Applicability
n/a					

This method shall support the request data structures specified in table 6.1.3.3.3.2-2 and the response data structures and response codes specified in table 6.1.3.3.3.2-3.

**Table 6.1.3.3.3.2-2: Data structures supported by the PUT Request Body on this resource**

Data type	P	Cardinality	Description
ConnStatusSubsc	M	1	Represents the updated representation of the "Individual Connection Status Subscription" resource.

**Table 6.1.3.3.3.2-3: Data structures supported by the PUT Response Body on this resource**

Data type	P	Cardinality	Response codes	Description
ConnStatusSubsc	M	1	200 OK	Successful case. The "Individual Connection Status Subscription" resource is successfully updated and a representation of the updated resource shall be returned in the response body.
n/a			204 No Content	Successful case. The "Individual Connection Status Subscription" resource is successfully updated and no content is returned in the response body.
n/a			307 Temporary Redirect	Temporary redirection. The response shall include a Location header field containing an alternative URI of the resource located in an alternative SEALDD Server. Redirection handling is described in clause 5.2.10 of 3GPP TS 29.122 [2].
n/a			308 Permanent Redirect	Permanent redirection. The response shall include a Location header field containing an alternative URI of the resource located in an alternative SEALDD Server. Redirection handling is described in clause 5.2.10 of 3GPP TS 29.122 [2].
NOTE: The mandatory HTTP error status codes for the HTTP PUT method listed in table 5.2.6-1 of 3GPP TS 29.122 [2] shall also apply.				

**Table 6.1.3.3.3.2-4: Headers supported by the 307 Response Code on this resource**

Name	Data type	P	Cardinality	Description
Location	string	M	1	Contains an alternative URI of the resource located in an alternative SEALDD Server.

**Table 6.1.3.3.3.2-5: Headers supported by the 308 Response Code on this resource**

Name	Data type	P	Cardinality	Description
Location	string	M	1	Contains an alternative URI of the resource located in an alternative SEALDD Server.

### 6.1.3.3.3.3 PATCH

The HTTP PATCH method allows a service consumer to request the modification of an existing "Individual Connection Status Subscription" resource at the SEALDD Server.

This method shall support the URI query parameters specified in table 6.1.3.3.3.3-1.

**Table 6.1.3.3.3.3-1: URI query parameters supported by the PATCH method on this resource**

Name	Data type	P	Cardinality	Description	Applicability
n/a					

This method shall support the request data structures specified in table 6.1.3.3.3.3-2 and the response data structures and response codes specified in table 6.1.3.3.3.3-3.

**Table 6.1.3.3.3.3-2: Data structures supported by the PATCH Request Body on this resource**

Data type	P	Cardinality	Description
ConnStatusSubscPatch	M	1	Represents the parameters to request the modification of the "Individual Connection Status Subscription" resource.

**Table 6.1.3.3.3.3-3: Data structures supported by the PATCH Response Body on this resource**

Data type	P	Cardinality	Response codes	Description
ConnStatusSubsc	M	1	200 OK	Successful case. The "Individual Connection Status Subscription" resource is successfully modified and a representation of the updated resource shall be returned in the response body.
n/a			204 No Content	Successful case. The "Individual Connection Status Subscription" resource is successfully modified and no content is returned in the response body.
n/a			307 Temporary Redirect	Temporary redirection. The response shall include a Location header field containing an alternative URI of the resource located in an alternative SEALDD Server. Redirection handling is described in clause 5.2.10 of 3GPP TS 29.122 [2].
n/a			308 Permanent Redirect	Permanent redirection. The response shall include a Location header field containing an alternative URI of the resource located in an alternative SEALDD Server. Redirection handling is described in clause 5.2.10 of 3GPP TS 29.122 [2].
NOTE: The mandatory HTTP error status codes for the HTTP PATCH method listed in table 5.2.6-1 of 3GPP TS 29.122 [2] shall also apply.				

**Table 6.1.3.3.3.3-4: Headers supported by the 307 Response Code on this resource**

Name	Data type	P	Cardinality	Description
Location	string	M	1	Contains an alternative URI of the resource located in an alternative SEALDD Server.

**Table 6.1.3.3.3.3-5: Headers supported by the 308 Response Code on this resource**

Name	Data type	P	Cardinality	Description
Location	string	M	1	Contains an alternative URI of the resource located in an alternative SEALDD Server.

## 6.1.3.3.4 DELETE

The HTTP DELETE method allows a service consumer to request the deletion of an existing "Individual Connection Status Subscription" resource at the SEALDD Server.

This method shall support the URI query parameters specified in table 6.1.3.3.4-1.

**Table 6.1.3.3.4-1: URI query parameters supported by the DELETE method on this resource**

Name	Data type	P	Cardinality	Description	Applicability
n/a					

This method shall support the request data structures specified in table 6.1.3.3.4-2 and the response data structures and response codes specified in table 6.1.3.3.4-3.

**Table 6.1.3.3.4-2: Data structures supported by the DELETE Request Body on this resource**

Data type	P	Cardinality	Description
n/a			

**Table 6.1.3.3.4-3: Data structures supported by the DELETE Response Body on this resource**

Data type	P	Cardinality	Response codes	Description
n/a			204 No Content	Successful case. The "Individual Connection Status Subscription" resource is successfully deleted.
n/a			307 Temporary Redirect	Temporary redirection. The response shall include a Location header field containing an alternative URI of the resource located in an alternative SEALDD Server. Redirection handling is described in clause 5.2.10 of 3GPP TS 29.122 [2].
n/a			308 Permanent Redirect	Permanent redirection. The response shall include a Location header field containing an alternative URI of the resource located in an alternative SEALDD Server. Redirection handling is described in clause 5.2.10 of 3GPP TS 29.122 [2].
NOTE: The mandatory HTTP error status codes for the HTTP DELETE method listed in table 5.2.6-1 of 3GPP TS 29.122 [2] shall also apply.				

**Table 6.1.3.3.4-4: Headers supported by the 307 Response Code on this resource**

Name	Data type	P	Cardinality	Description
Location	string	M	1	Contains an alternative URI of the resource located in an alternative SEALDD Server.

**Table 6.1.3.3.4-5: Headers supported by the 308 Response Code on this resource**

Name	Data type	P	Cardinality	Description
Location	string	M	1	Contains an alternative URI of the resource located in an alternative SEALDD Server.

## 6.1.3.3.4 Resource Custom Operations

There are no resource custom operations defined for this resource in this release of the specification.



## 6.1.4 Custom Operations without associated resources

### 6.1.4.1 Overview

The structure of the custom operation URIs of the SDD\_Transmission API is shown in Figure 6.1.4.1-1.

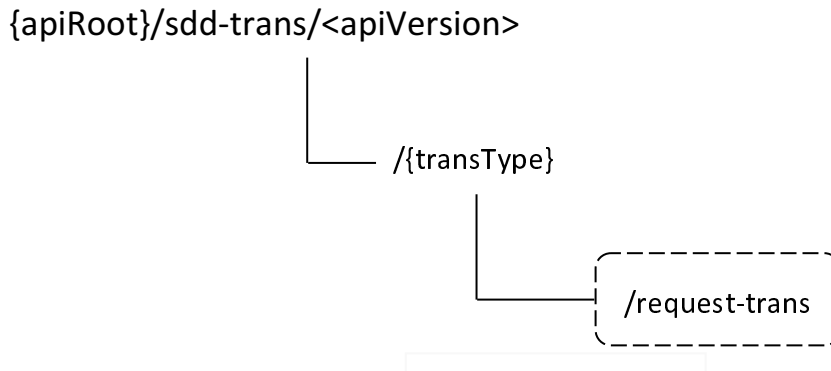

**Figure 6.1.4.1-1: Custom operation URI structure of the SDD\_Transmission API**

Table 6.1.4.1-1 provides an overview of the custom operations and applicable HTTP methods defined for the SDD\_Transmission API.

**Table 6.1.4.1-1: Custom operations without associated resources**

Custom operation name	Custom operation URI	Mapped HTTP method	Description
RequestTrans	/{transType}/request-trans	POST	Enables a service consumer to request SEALDD enabled Regular or URLLC application data transmission.

The custom operations shall support the URI variables defined in table 6.1.4.1-2.

**Table 6.1.4.1-2: URI variables for this custom operation**

Name	Data type	Definition
apiRoot	string	See clause 6.1.1.
transType	TransType	Represents the requested transmission type (i.e., "regular" for Regular application data transmission or "urllc" for URLLC application data transmission).

### 6.1.4.2 Operation: RequestTrans

#### 6.1.4.2.1 Description

The custom operation enables a service consumer to request SEALDD enabled Regular or URLLC application data transmission to the SEALDD Server.

#### 6.1.4.2.2 Operation Definition

This operation shall support the request data structures specified in table 6.1.4.2.2-1 and the response data structures and response codes specified in table 6.1.4.2.2-2.

**Table 6.1.4.2.2-1: Data structures supported by the POST Request Body on this custom operation**

Data type	P	Cardinality	Description
TransReq	M	1	Contains the parameters to request SEALDD enabled Regular or URLLC application data transmission.

**Table 6.1.4.2.2-2: Data structures supported by the POST Response Body on this custom operation**

Data type	P	Cardinality	Response codes	Description
TransResp	M	1	200 OK	Successful case. The SEALDD enabled Regular or URLLC application data transmission service request is successfully received and processed, and SEALDD enabled Regular or URLLC application data transmission related information shall be returned in the response body.
n/a			307 Temporary Redirect	Temporary redirection. The response shall include a Location header field containing an alternative target URI located in an alternative SEALDD Server. Redirection handling is described in clause 5.2.10 of 3GPP TS 29.122 [2].
n/a			308 Permanent Redirect	Permanent redirection. The response shall include a Location header field containing an alternative target URI located in an alternative SEALDD Server. Redirection handling is described in clause 5.2.10 of 3GPP TS 29.122 [2].
NOTE: The mandatory HTTP error status codes for the HTTP POST method listed in table 5.2.6-1 of 3GPP TS 29.122 [2] shall also apply.				

**Table 6.1.4.2.2-3: Headers supported by the 307 Response Code on this custom operation**

Name	Data type	P	Cardinality	Description
Location	string	M	1	Contains an alternative target URI located in an alternative SEALDD Server.

**Table 6.1.4.2.2-4: Headers supported by the 308 Response Code on this custom operation**

Name	Data type	P	Cardinality	Description
Location	string	M	1	Contains an alternative target URI located in an alternative SEALDD Server.

## 6.1.5 Notifications

### 6.1.5.1 General

Notifications shall comply to clause 6.6 of 3GPP TS 29.549 [15].

**Table 6.1.5.1-1: Notifications overview**

Notification	Callback URI	HTTP method or custom operation	Description (service operation)
Connection Status Notification	{notifUri}	POST	Enables a SEALDD Server to notify a previously subscribed service consumer on SEALDD connection status event(s).

## 6.1.5.2 Connection Status Notification

### 6.1.5.2.1 Description

The Connection Status Notification is used by the SEALDD Server to notify a previously subscribed service consumer on SEALDD connection status event(s).

### 6.1.5.2.2 Target URI

The Callback URI "{notifUri}" shall be used with the callback URI variables defined in table 6.1.5.2.2-1.

**Table 6.1.5.2.2-1: Callback URI variables**

Name	Definition
notifUri	Represents the callback URI encoded as a string formatted as URI.

### 6.1.5.2.3 Standard Methods

#### 6.1.5.2.3.1 POST

This method shall support the request data structures specified in table 6.1.5.2.3.1-1 and the response data structures and response codes specified in table 6.1.5.2.3.1-2.

**Table 6.1.5.2.3.1-1: Data structures supported by the POST Request Body**

Data type	P	Cardinality	Description
ConnStatusNotif	M	1	Represents the SEALDD Connection Status Notification.

**Table 6.1.5.2.3.1-2: Data structures supported by the POST Response Body**

Data type	P	Cardinality	Response codes	Description
n/a			204 No Content	Successful case. The Connection Status Notification is successfully received.
n/a			307 Temporary Redirect	Temporary redirection.  The response shall include a Location header field containing an alternative URI representing the end point of an alternative service consumer towards which the notification should be sent.  Redirection handling is described in clause 5.2.10 of 3GPP TS 29.122 [3].
n/a			308 Permanent Redirect	Permanent redirection.  The response shall include a Location header field containing an alternative URI representing the end point of an alternative service consumer towards which the notification should be sent.  Redirection handling is described in clause 5.2.10 of 3GPP TS 29.122 [3].
NOTE: The mandatory HTTP error status codes for the HTTP POST method listed in table 5.2.6-1 of 3GPP TS 29.122 [2] shall also apply.				

**Table 6.1.5.2.3.1-3: Headers supported by the 307 Response Code on this resource**

Name	Data type	P	Cardinality	Description
Location	string	M	1	Contains an alternative URI representing the end point of an alternative service consumer towards which the notification should be redirected.

**Table 6.1.5.2.3.1-4: Headers supported by the 308 Response Code on this resource**

Name	Data type	P	Cardinality	Description
Location	string	M	1	Contains an alternative URI representing the end point of an alternative service consumer towards which the notification should be redirected.

## 6.1.6 Data Model

### 6.1.6.1 General

This clause specifies the application data model supported by the API.

Table 6.1.6.1-1 specifies the data types defined for the SDD\_Transmission API.

**Table 6.1.6.1-1: SDD\_Transmission API specific Data Types**

Data type	Clause defined	Description	Applicability
ConnEstabData	6.1.6.2.12	Represents SEALDD connection status establishment data.	
ConnStatusEvent	6.1.6.3.3	Represents a Connection Status Event.	
ConnInfo	6.1.6.2.4	Represents SEALDD Data transmission connection information.	
ConnStatusNotif	6.1.6.2.10	Represents a Connection Status Notification.	
ConnStatusReport	6.1.6.2.11	Represents a Connection Status Event report.	
ConnStatusSubsc	6.1.6.2.8	Represents a Connection Status Subscription.	
ConnStatusSubscPatch	6.1.6.2.9	Represents the requested modifications to a Connection Status Subscription.	
QoSInfo	6.1.6.2.5	Represents SEALDD related QoS requirements.	
TransReq	6.1.6.2.2	Represents the parameters to request SEALDD enabled Regular or URLLC application data transmission service.	
TransResp	6.1.6.2.3	Represents a SEALDD enabled Regular or URLLC application data transmission service response.	
TransType	6.1.6.3.4	Represents the requested transmission type (i.e., Regular transmission or URLLC transmission).	
ValServBdw	6.1.6.2.6	Represents VAL Server related bandwidth information.	
ValUsersBdw	6.1.6.2.7	Represents VAL users related bandwidth information.	

Table 6.1.6.1-2 specifies data types re-used by the SDD\_Transmission API from other specifications, including a reference to their respective specifications, and when needed, a short description of their use within the SDD\_Transmission API.

**Table 6.1.6.1-2: SDD\_Transmission API re-used Data Types**

Data type	Reference	Comments	Applicability
AlternativeServiceRequirementsData	3GPP TS 29.514 [19]	Represents alternative QoS related service requirements.	
Bandwidth	3GPP TS 29.122 [2]	Represents a bandwidth.	
DateTime	3GPP TS 29.122 [2]	Represents a date and a time.	
DateTimeRo	3GPP TS 29.122 [2]	Represents a date and a time with the read-only property.	
DurationSec	3GPP TS 29.122 [2]	Represents a time duration in seconds.	
Ipv4Addr	3GPP TS 29.122 [2]	Represents an IPv4 address.	
Ipv6Addr	3GPP TS 29.122 [2]	Represents an IPv6 address.	
Port	3GPP TS 29.122 [2]	Represents an IP port.	
SupportedFeatures	3GPP TS 29.571 [18]	Represents the list of supported feature(s) and used to negotiate the applicability of the optional features.	
Uri	3GPP TS 29.122 [2]	Represents a URI.	
ValTargetUe	3GPP TS 29.549 [15]	Represents the identifier of the targeted VAL UE or VAL user.	

## 6.1.6.2 Structured data types

### 6.1.6.2.1 Introduction

This clause defines the structures to be used in resource representations.

## 6.1.6.2.2 Type: TransReq

Table 6.1.6.2.2-1: Definition of type TransReq

Attribute name	Data type	P	Cardinality	Description	Applicability
valServiceId	string	O	0..1	Contains the identifier of the target VAL service.	
valTargetId	ValTargetUe	O	0..1	Contains the identifier of the target VAL UE or VAL user.	
valServerConnInfo	ConnInfo	M	1	Contains the VAL Server's side SEALDD-S Data transmission connection information, i.e., address/port and/or URI via which the VAL Server desires to receive the application traffic from the SEALDD Server.	
qosInfo	QosInfo	O	0..1	Contains the requested QoS requirements for the application data transmission.	
valServerBdw	ValServBdw	O	0..1	Contains the total UL/DL bandwidth limit of the VAL Server.	
valUsersBdw	ValUsersBdw	O	0..1	Contains the UL/DL bandwidth limits for VAL users.	
suppFeat	SupportedFeatures	C	0..1	Contains the list of supported features among the ones defined in clause 6.1.8.  This attribute shall be present only when feature negotiation needs to take place.	

## 6.1.6.2.3 Type: TransResp

Table 6.1.6.2.3-1: Definition of type TransResp

Attribute name	Data type	P	Cardinality	Description	Applicability
ddServerConnInfo	ConnInfo	C	0..1	Contains the SEALDD Server's side SEALDD-S Data transmission connection information, i.e., address/port and/or URI via which the SEALDD Server desires to receive the application traffic from the VAL Server.  This attribute shall be provided, if needed.	
suppFeat	SupportedFeatures	C	0..1	Contains the list of supported features among the ones defined in clause 6.1.8.  This attribute shall be present only when feature negotiation needs to take place.	

## 6.1.6.2.4 Type: ConnInfo

Table 6.1.6.2.4-1: Definition of type ConnInfo

Attribute name	Data type	P	Cardinality	Description	Applicability
ipv4Addr	Ipv4Addr	C	0..1	Contains the IPv4 address. (NOTE)	
ipv6Addr	Ipv6Addr	C	0..1	Contains the IPv6 address. (NOTE)	
port	Port	O	0..1	Contains the port information. This attribute may be present only when either the "ipv4Addr" attribute or the "ipv6Addr" attribute is present.	
uri	Uri	C	0..1	Contains the URI. (NOTE)	
NOTE: These attributes are mutually exclusive. Either one of them shall be present.					

## 6.1.6.2.5 Type: QosInfo

Table 6.1.6.2.5-1: Definition of type QosInfo

Attribute name	Data type	P	Cardinality	Description	Applicability
qosReference	string	C	0..1	Contains a reference to a pre-defined QoS information set. (NOTE 1, NOTE 3)	
altQoSReferences	array(string)	C	1..N	Contains an ordered list of identifier(s) of pre-defined QoS information set(s). The lower the index of the array for a given entry, the higher the priority of this entry. (NOTE 1, NOTE 2)	
altQosReqs	array(AlternativeServiceRequirementsData)	C	1..N	Contains an ordered list of alternative service requirements that include individual QoS parameter set(s). The lower the index of the array for a given entry, the higher the priority of this entry. (NOTE 1, NOTE 2, NOTE 3)	
NOTE 1: At least one of these attributes shall be provided. NOTE 2: These attributes are mutually exclusive. NOTE 3: These attributes are mutually exclusive.					

## 6.1.6.2.6 Type: ValServBdw

Table 6.1.6.2.6-1: Definition of type ValServBdw

Attribute name	Data type	P	Cardinality	Description	Applicability
totalUIBdw	Bandwidth	M	1	Contains the total UL bandwidth of the VAL Server.	
totalDIBdw	Bandwidth	M	1	Contains the total DL bandwidth of the VAL Server.	

## 6.1.6.2.7 Type: ValUsersBdw

**Table 6.1.6.2.7-1: Definition of type ValUserBdw**

Attribute name	Data type	P	Cardinality	Description	Applicability
minUIBdw	Bandwidth	M	1	Contains the minimum UL bandwidth for VAL users.	
minDIBdw	Bandwidth	M	1	Contains the minimum DL bandwidth for VAL users.	
maxUIBdw	Bandwidth	M	1	Contains the maximum UL bandwidth for VAL users.	
maxDIBdw	Bandwidth	M	1	Contains the maximum DL bandwidth for VAL users.	

## 6.1.6.2.8 Type: ConnStatusSubsc

**Table 6.1.6.2.8-1: Definition of type ConnStatusSubsc**

Attribute name	Data type	P	Cardinality	Description	Applicability
events	array(ConnStatusEvent)	M	1..N	Contains the list of the subscribed event(s).	
valServiceId	string	O	0..1	Contains the identity of the target VAL service.	
valTgtUe	ValTargetUe	O	0..1	Contains the targeted VAL UE or VAL user.	
valServerConnInfo	ConnInfo	M	1	Contains the SEALDD-S data transmission connection information.	
notifUri	Uri	M	1	Contains the URI via which the Connection Status notifications shall be delivered.	
expTime	DateTimeRo	O	0..1	Contains the subscription's expiration time. This attribute may be present only in the response to a SEALDD Connection Status Subscription creation/update request.	
suppFeat	SupportedFeatures	C	0..1	Contains the list of supported features among the ones defined in clause 6.1.8. This attribute shall be present only when the feature negotiation needs to take place.	

## 6.1.6.2.9 Type: ConnStatusSubscPatch

**Table 6.1.6.2.9-1: Definition of type ConnStatusSubscPatch**

Attribute name	Data type	P	Cardinality	Description	Applicability
events	array(ConnStatusEvent)	O	1..N	Contains the updated list of the subscribed event(s).	
valServiceId	string	O	0..1	Contains the identity of the VAL service.	
valTgtUe	ValTargetUe	O	0..1	Contains the targeted VAL UE or VAL user.	
valServerConnInfo	ConnInfo	O	0..1	Contains the updated SEALDD-S data transmission connection information.	
notifUri	Uri	O	0..1	Contains the updated URI via which the Connection Status notifications shall be delivered.	



## 6.1.6.2.10 Type: ConnStatusNotif

**Table 6.1.6.2.10-1: Definition of type ConnStatusNotif**

Attribute name	Data type	P	Cardinality	Description	Applicability
subscriptionId	string	M	1	Contains the identifier of the subscription to which the Connection Status notification is related.	
reports	array(ConnStatusReport)	M	1..N	Contains the connection status event report(s).	

## 6.1.6.2.11 Type: ConnStatusReport

**Table 6.1.6.2.11-1: Definition of type ConnStatusReport**

Attribute name	Data type	P	Cardinality	Description	Applicability
event	ConnStatusEvent	M	1	Contains the reported connection status event.	
valTgtUe	ValTargetUe	M	1	Contains the VAL UE or VAL user to which the connection status event report is related.	
valServiceId	string	M	1	Contains the identity of the VAL service to which the connection status event report is related.	
connEstData	ConnEstabData	C	0..1	Contains the SEALDD connection establishment data. This attribute shall be present only if the "event" attribute is set to "ESTABLISHED".	
timestamp	DateTime	O	0..1	Contains the timestamp of this SEALDD connection status report.	

## 6.1.6.2.12 Type: ConnEstabData

**Table 6.1.6.2.12-1: Definition of type ConnEstabData**

Attribute name	Data type	P	Cardinality	Description	Applicability
ddServerConnInfo	ConnInfo	M	1	Contains the SEALDD Server's side SEALDD-S Data transmission connection information, i.e., address/port and/or URI via which the SEALDD Server sends/receives the application traffic.	
comLifetime	DurationSec	O	0..1	Contains the SEALDD communication lifetime.	

## 6.1.6.3 Simple data types and enumerations

## 6.1.6.3.1 Introduction

This clause defines simple data types and enumerations that can be referenced from data structures defined in the previous clauses.

## 6.1.6.3.2 Simple data types

The simple data types defined in table 6.1.6.3.2-1 shall be supported.

**Table 6.1.6.3.2-1: Simple data types**

Type Name	Type Definition	Description	Applicability

### 6.1.6.3.3 Enumeration: ConnStatusEvent

The enumeration ConnStatusEvent represents a Connection Status Event. It shall comply with the provisions defined in table 6.1.6.3.3-1.

**Table 6.1.6.3.3-1: Enumeration ConnStatusEvent**

Enumeration value	Description	Applicability
ESTABLISHED	Indicates that the SEALDD connection status event is that the SEALDD connection is established.	
RELEASED	Indicates that the SEALDD connection status event is that the SEALDD connection is released.	

### 6.1.6.3.4 Enumeration: TransType

The enumeration TransType represents the requested transmission type. It shall comply with the provisions defined in table 6.1.6.3.4-1.

**Table 6.1.6.3.4-1: Enumeration TransType**

Enumeration value	Description	Applicability
regular	Indicates that the requested transmission type is Regular transmission.	
urllc	Indicates that the requested transmission type is URLLC transmission.	
NOTE: The enumeration values defined in this table shall use the "lower-with-hyphen" naming convention, as defined in clause 5.2.4.1 of 3GPP TS 29.122 [2], because they are used as values of a URI path segment variable (see Table 6.1.4.1-2). Therefore, they shall not follow the "UPPER_WITH_UNDERSCORE" convention for enumerations defined in clause 5.2.9.10 of 3GPP TS 29.122 [2].		

### 6.1.6.4 Data types describing alternative data types or combinations of data types

There are no data types describing alternative data types or combinations of data types defined for this API in this release of the specification.

### 6.1.6.5 Binary data

#### 6.1.6.5.1 Binary Data Types

**Table 6.1.6.5.1-1: Binary Data Types**

Name	Clause defined	Content type

## 6.1.7 Error Handling

### 6.1.7.1 General

For the SDD\_Transmission API, error handling shall be supported as specified in clause 6.7 of 3GPP TS 29.549 [15].

In addition, the requirements in the following clauses are applicable for the SDD\_Transmission API.

### 6.1.7.2 Protocol Errors

No specific procedures for the SDD\_Transmission API are specified.

### 6.1.7.3 Application Errors

The application errors defined for the SDD\_Transmission API are listed in Table 6.1.7.3-1.

**Table 6.1.7.3-1: Application errors**

Application Error	HTTP status code	Description	Applicability

### 6.1.8 Feature negotiation

The optional features in table 6.1.8-1 are defined for the SDD\_Transmission API. They shall be negotiated using the extensibility mechanism defined in clause 6.8 of 3GPP TS 29.549 [15].

**Table 6.1.8-1: Supported Features**

Feature number	Feature Name	Description

### 6.1.9 Security

The provisions of clause 9 of 3GPP TS 29.549 [15] shall apply for the SDD\_Transmission API.

## 6.2 SDD\_DataStorage Service API

### 6.2.1 Introduction

The SDD\_DataStorage service shall use the SDD\_DataStorage API.

The API URI of the SDD\_DataStorage Service API shall be:

**{apiRoot}/<apiName>/<apiVersion>**

The request URIs used in HTTP requests shall have the Resource URI structure defined in clause 6.5 of 3GPP TS 29.549 [15], i.e.:

**{apiRoot}/<apiName>/<apiVersion>/<apiSpecificSuffixes>**

with the following components:

- The {apiRoot} shall be set as described in clause 6.5 of 3GPP TS 29.549 [15].
- The <apiName> shall be "sdd-ds".
- The <apiVersion> shall be "v1".
- The <apiSpecificSuffixes> shall be set as described in clause 6.5 of 3GPP TS 29.549 [15].

NOTE: When 3GPP TS 29.122 [2] is referenced for the common protocol and interface aspects for API definition in the clauses under clause 6.2, the SEALDD Server takes the role of the SCEF and the service consumer takes the role of the SCS/AS.

### 6.2.2 Usage of HTTP

The provisions of clause 6.3 of 3GPP TS 29.549 [15] shall apply for the SDD\_DataStorage API.

### 6.2.3 Resources

#### 6.2.3.1 Overview

This clause describes the structure for the Resource URIs and the resources and methods used for the service.

Figure 6.2.3.1-1 depicts the resource URIs structure for the SDD\_DataStorage API.

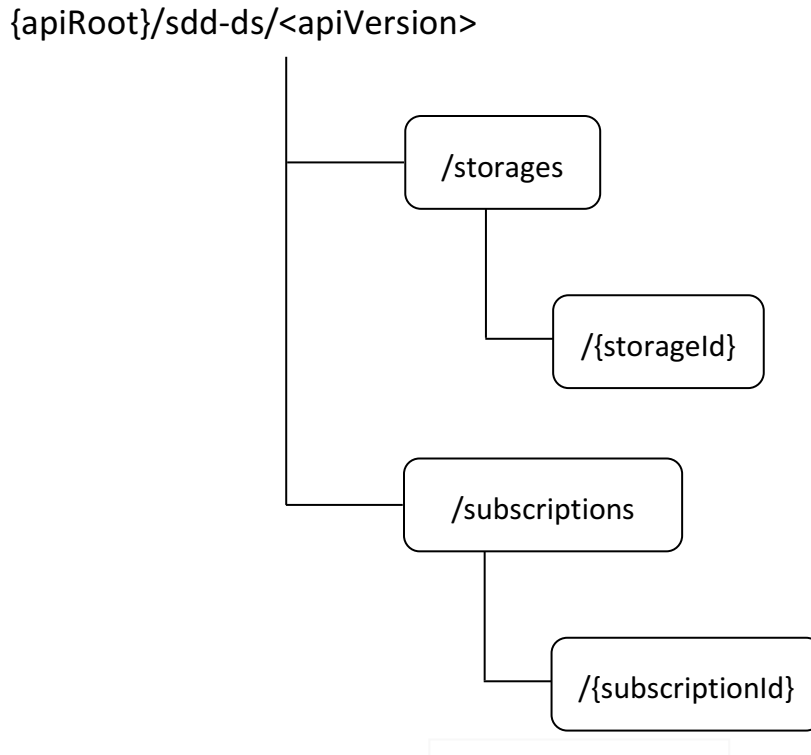

**Figure 6.2.3.1-1: Resource URIs structure of the SDD\_DataStorage API**

Table 6.2.3.1-1 provides an overview of the resources and applicable HTTP methods for the SDD\_DataStorage API.

**Table 6.2.3.1-1: Resources and methods overview**

Resource name	Resource URI	HTTP method or custom operation	Description
Data Storages	/storages	GET	Retrieve one or several existing data Storage(s).
		POST	Request the creation of a Data Storage.
Individual Data Storage	/storages/{storageId}	GET	Retrieve an existing Data Storage.
		PUT	Request the update of an existing "Individual Data Storage" resource.
		PATCH	Request the modification of an existing "Individual Data Storage" resource.
		DELETE	Request the deletion of an existing "Individual Data Storage" resource.
Data Storage Delivery Subscriptions	/subscriptions	POST	Request the creation of a Data Storage Delivery Subscription.
Individual Data Storage Delivery Subscription	/subscriptions/{subscriptionId}	GET	Retrieve an existing "Individual Data Storage Delivery Subscription" resource.
		PUT	Request the update of an existing "Individual Data Storage Delivery Subscription" resource.
		PATCH	Request the modification of an existing "Individual Data Storage Delivery Subscription" resource.
		DELETE	Request the deletion of an existing "Individual Data Storage Delivery Subscription" resource.

## 6.2.3.2 Resource: Data Storages

### 6.2.3.2.1 Description

This resource represents the collection of Data Storage(s) managed by the SEALDD Server.

### 6.2.3.2.2 Resource Definition

Resource URI: {apiRoot}/sdd-ds/<apiVersion>/storages

This resource shall support the resource URI variables defined in table 6.2.3.2.2-1.

**Table 6.2.3.2.2-1: Resource URI variables for this resource**

Name	Data type	Definition
apiRoot	string	See clause 6.2.1.

### 6.2.3.2.3 Resource Standard Methods

#### 6.2.3.2.3.1 GET

The HTTP GET method allows a service consumer to retrieve one or several existing "Individual Data Storage" resource(s) managed by the SEALDD Server.

This method shall support the URI query parameters specified in table 6.2.3.2.3.1-1.

**Table 6.2.3.2.3.1-1: URI query parameters supported by the GET method on this resource**

Name	Data type	P	Cardinality	Description	Applicability
storage-ids	array(string)	O	1..N	Contains the identifier(s) of the targeted Data Storage resource(s).	
supp-feats	SupportedFeatures	C	0..1	Contains the list of supported features among the ones defined in clause 6.2.8. This query parameter shall be present only when feature negotiation needs to take place.	

This method shall support the request data structures specified in table 6.2.3.2.3.1-2 and the response data structures and response codes specified in table 6.2.3.2.3.1-3.

**Table 6.2.3.2.3.1-2: Data structures supported by the GET Request Body on this resource**

Data type	P	Cardinality	Description
n/a			

**Table 6.2.3.2.3.1-3: Data structures supported by the GET Response Body on this resource**

Data type	P	Cardinality	Response codes	Description
array(DataStorage)	M	0..N	200 OK	Successful case. The requested "Individual Data Storage" resource(s) shall be returned. If there are no available "Individual Data Storage" resource(s) fulfilling the request, an empty array shall be returned.
n/a			307 Temporary Redirect	Temporary redirection. The response shall include a Location header field containing an alternative URI of the resource located in an alternative SEALDD Server. Redirection handling is described in clause 5.2.10 of 3GPP TS 29.122 [2].
n/a			308 Permanent Redirect	Permanent redirection. The response shall include a Location header field containing an alternative URI of the resource located in an alternative SEALDD Server. Redirection handling is described in clause 5.2.10 of 3GPP TS 29.122 [2].
NOTE: The mandatory HTTP error status codes for the HTTP GET method listed in table 5.2.6-1 of 3GPP TS 29.122 [2] shall also apply.				

**Table 6.2.3.2.3.1-4: Headers supported by the 307 Response Code on this resource**

Name	Data type	P	Cardinality	Description
Location	string	M	1	Contains an alternative URI of the resource located in an alternative SEALDD Server.

**Table 6.2.3.2.3.1-5: Headers supported by the 308 Response Code on this resource**

Name	Data type	P	Cardinality	Description
Location	string	M	1	Contains an alternative URI of the resource located in an alternative SEALDD Server.

#### 6.2.3.2.3.2 POST

The HTTP POST method allows a service consumer to request the creation of a Data Storage at the SEALDD Server.

This method shall support the URI query parameters specified in table 6.2.3.2.3.2-1.

**Table 6.2.3.2.3.2-1: URI query parameters supported by the POST method on this resource**

Name	Data type	P	Cardinality	Description	Applicability
n/a					

This method shall support the request data structures specified in table 6.2.3.2.3.2-2 and the response data structures and response codes specified in table 6.2.3.2.3.2-3.

**Table 6.2.3.2.3.2-2: Data structures supported by the POST Request Body on this resource**

Data type	P	Cardinality	Description
DataStorageReq	M	1	Represents the parameters to request the creation or reservation of a Data Storage resource.

**Table 6.2.3.2.3-3: Data structures supported by the POST Response Body on this resource**

Data type	P	Cardinality	Response codes	Description
DataStorage	M	1	201 Created	Successful case. The Data Storage is successfully created and a representation of the created "Individual Data Storage" resource shall be returned.  An HTTP "Location" header that contains the resource URI of the created resource shall also be included.
ReservRespData	M	1	200 OK	Successful case. The Data Storage resource is successfully reserved and Data Storage resource reservation related information shall be returned.
ProblemDetails	O	0..1	403 Forbidden	(NOTE 2)
NOTE 1: The mandatory HTTP error status codes for the HTTP POST method listed in table 5.2.6-1 of 3GPP TS 29.122 [2] shall also apply.				
NOTE 2: Failure causes are described in clause 6.2.7.				

**Table 6.2.3.2.3.2-4: Headers supported by the 201 Response Code on this resource**

Name	Data type	P	Cardinality	Description
Location	string	M	1	Contains the URI of the newly created resource, according to the structure: {apiRoot}/sdd-ds/<apiVersion>/storages/{storageId}

#### 6.2.3.2.4 Resource Custom Operations

There are no resource custom operations defined for this resource in this release of the specification.

### 6.2.3.3 Resource: Individual Data Storage

#### 6.2.3.3.1 Description

This resource represents an "Individual Data Storage" resource managed by the SEALDD Server.

#### 6.2.3.3.2 Resource Definition

Resource URI: {apiRoot}/sdd-ds/<apiVersion>/storages/{storageId}

This resource shall support the resource URI variables defined in table 6.2.3.3.2-1.

**Table 6.2.3.3.2-1: Resource URI variables for this resource**

Name	Data type	Definition
apiRoot	string	See clause 6.2.1.
storageId	string	Represents the identifier of the "Individual Data Storage" resource.

#### 6.2.3.3.3 Resource Standard Methods

##### 6.2.3.3.3.1 GET

The HTTP GET method allows a service consumer to retrieve an existing "Individual Data Storage" resource at the SEALDD Server.

This method shall support the URI query parameters specified in table 6.2.3.3.3.1-1.



**Table 6.2.3.3.3.1-1: URI query parameters supported by the GET method on this resource**

Name	Data type	P	Cardinality	Description	Applicability
n/a					

This method shall support the request data structures specified in table 6.2.3.3.3.1-2 and the response data structures and response codes specified in table 6.2.3.3.3.1-3.

**Table 6.2.3.3.3.1-2: Data structures supported by the GET Request Body on this resource**

Data type	P	Cardinality	Description
n/a			

**Table 6.2.3.3.3.1-3: Data structures supported by the GET Response Body on this resource**

Data type	P	Cardinality	Response codes	Description
DataStorage	M	1	200 OK	Successful case. The requested "Individual Data Storage" resource shall be returned.
n/a			307 Temporary Redirect	Temporary redirection. The response shall include a Location header field containing an alternative URI of the resource located in an alternative SEALDD Server. Redirection handling is described in clause 5.2.10 of 3GPP TS 29.122 [2].
n/a			308 Permanent Redirect	Permanent redirection. The response shall include a Location header field containing an alternative URI of the resource located in an alternative SEALDD Server. Redirection handling is described in clause 5.2.10 of 3GPP TS 29.122 [2].
NOTE: The mandatory HTTP error status codes for the HTTP GET method listed in table 5.2.6-1 of 3GPP TS 29.122 [2] shall also apply.				

**Table 6.2.3.3.3.1-4: Headers supported by the 307 Response Code on this resource**

Name	Data type	P	Cardinality	Description
Location	string	M	1	Contains an alternative URI of the resource located in an alternative SEALDD Server.

**Table 6.2.3.3.3.1-5: Headers supported by the 308 Response Code on this resource**

Name	Data type	P	Cardinality	Description
Location	string	M	1	Contains an alternative URI of the resource located in an alternative SEALDD Server.

#### 6.2.3.3.3.2 PUT

The HTTP PUT method allows a service consumer to request the update of an existing "Individual Data Storage" resource at the SEALDD Server.

This method shall support the URI query parameters specified in table 6.2.3.3.3.2-1.

**Table 6.2.3.3.3.2-1: URI query parameters supported by the PUT method on this resource**

Name	Data type	P	Cardinality	Description	Applicability
n/a					

This method shall support the request data structures specified in table 6.2.3.3.3.2-2 and the response data structures and response codes specified in table 6.2.3.3.3.2-3.

**Table 6.2.3.3.3.2-2: Data structures supported by the PUT Request Body on this resource**

Data type	P	Cardinality	Description
DataStorage	M	1	Represents the updated representation of the "Individual Data Storage" resource.

**Table 6.2.3.3.3.2-3: Data structures supported by the PUT Response Body on this resource**

Data type	P	Cardinality	Response codes	Description
DataStorage	M	1	200 OK	Successful case. The "Individual Data Storage" resource is successfully updated and a representation of the updated resource shall be returned in the response body.
n/a			204 No Content	Successful case. The "Individual Data Storage" resource is successfully updated and no content is returned in the response body.
n/a			307 Temporary Redirect	Temporary redirection. The response shall include a Location header field containing an alternative URI of the resource located in an alternative SEALDD Server. Redirection handling is described in clause 5.2.10 of 3GPP TS 29.122 [2].
n/a			308 Permanent Redirect	Permanent redirection. The response shall include a Location header field containing an alternative URI of the resource located in an alternative SEALDD Server. Redirection handling is described in clause 5.2.10 of 3GPP TS 29.122 [2].
NOTE: The mandatory HTTP error status codes for the HTTP PUT method listed in table 5.2.6-1 of 3GPP TS 29.122 [2] shall also apply.				

**Table 6.2.3.3.3.2-4: Headers supported by the 307 Response Code on this resource**

Name	Data type	P	Cardinality	Description
Location	string	M	1	Contains an alternative URI of the resource located in an alternative SEALDD Server.

**Table 6.2.3.3.3.2-5: Headers supported by the 308 Response Code on this resource**

Name	Data type	P	Cardinality	Description
Location	string	M	1	Contains an alternative URI of the resource located in an alternative SEALDD Server.

### 6.2.3.3.3.3 PATCH

The HTTP PATCH method allows a service consumer to request the modification of an existing "Individual Data Storage" resource at the SEALDD Server.

This method shall support the URI query parameters specified in table 6.2.3.3.3.3-1.

**Table 6.2.3.3.3.3-1: URI query parameters supported by the PATCH method on this resource**

Name	Data type	P	Cardinality	Description	Applicability
n/a					

This method shall support the request data structures specified in table 6.2.3.3.3.3-2 and the response data structures and response codes specified in table 6.2.3.3.3.3-3.

**Table 6.2.3.3.3.3-2: Data structures supported by the PATCH Request Body on this resource**

Data type	P	Cardinality	Description
DataStoragePatch	M	1	Represents the parameters to request the modification of the "Individual Data Storage" resource.

**Table 6.2.3.3.3.3-3: Data structures supported by the PATCH Response Body on this resource**

Data type	P	Cardinality	Response codes	Description
DataStorage	M	1	200 OK	Successful case. The "Individual Data Storage" resource is successfully modified and a representation of the updated resource shall be returned in the response body.
n/a			204 No Content	Successful case. The "Individual Data Storage" resource is successfully modified and no content is returned in the response body.
n/a			307 Temporary Redirect	Temporary redirection. The response shall include a Location header field containing an alternative URI of the resource located in an alternative SEALDD Server. Redirection handling is described in clause 5.2.10 of 3GPP TS 29.122 [2].
n/a			308 Permanent Redirect	Permanent redirection. The response shall include a Location header field containing an alternative URI of the resource located in an alternative SEALDD Server. Redirection handling is described in clause 5.2.10 of 3GPP TS 29.122 [2].
NOTE: The mandatory HTTP error status codes for the HTTP PATCH method listed in table 5.2.6-1 of 3GPP TS 29.122 [2] shall also apply.				

**Table 6.2.3.3.3.3-4: Headers supported by the 307 Response Code on this resource**

Name	Data type	P	Cardinality	Description
Location	string	M	1	Contains an alternative URI of the resource located in an alternative SEALDD Server.

**Table 6.2.3.3.3.3-5: Headers supported by the 308 Response Code on this resource**

Name	Data type	P	Cardinality	Description
Location	string	M	1	Contains an alternative URI of the resource located in an alternative SEALDD Server.

## 6.2.3.3.3.4 DELETE

The HTTP DELETE method allows a service consumer to request the deletion of an existing "Individual Data Storage" resource at the SEALDD Server.

This method shall support the URI query parameters specified in table 6.2.3.3.3.4-1.

**Table 6.2.3.3.3.4-1: URI query parameters supported by the DELETE method on this resource**

Name	Data type	P	Cardinality	Description	Applicability
n/a					

This method shall support the request data structures specified in table 6.2.3.3.3.4-2 and the response data structures and response codes specified in table 6.2.3.3.3.4-3.

**Table 6.2.3.3.3.4-2: Data structures supported by the DELETE Request Body on this resource**

Data type	P	Cardinality	Description
n/a			

**Table 6.2.3.3.3.4-3: Data structures supported by the DELETE Response Body on this resource**

Data type	P	Cardinality	Response codes	Description
n/a			204 No Content	Successful case. The "Individual Data Storage" resource is successfully deleted.
n/a			307 Temporary Redirect	Temporary redirection. The response shall include a Location header field containing an alternative URI of the resource located in an alternative SEALDD Server. Redirection handling is described in clause 5.2.10 of 3GPP TS 29.122 [2].
n/a			308 Permanent Redirect	Permanent redirection. The response shall include a Location header field containing an alternative URI of the resource located in an alternative SEALDD Server. Redirection handling is described in clause 5.2.10 of 3GPP TS 29.122 [2].
NOTE: The mandatory HTTP error status codes for the HTTP DELETE method listed in table 5.2.6-1 of 3GPP TS 29.122 [2] shall also apply.				

**Table 6.2.3.3.3.4-4: Headers supported by the 307 Response Code on this resource**

Name	Data type	P	Cardinality	Description
Location	string	M	1	Contains an alternative URI of the resource located in an alternative SEALDD Server.

**Table 6.2.3.3.3.4-5: Headers supported by the 308 Response Code on this resource**

Name	Data type	P	Cardinality	Description
Location	string	M	1	Contains an alternative URI of the resource located in an alternative SEALDD Server.

## 6.2.3.3.4 Resource Custom Operations

There are no resource custom operations defined for this resource in this release of the specification.

## 6.2.3.4 Resource: Data Storage Delivery Subscriptions

### 6.2.3.4.1 Description

This resource represents the collection of Data Storage Delivery Subscription(s) managed by the SEALDD Server.

### 6.2.3.4.2 Resource Definition

Resource URI: **{apiRoot}/sdd-ds/<apiVersion>/subscriptions**

This resource shall support the resource URI variables defined in table 6.2.3.4.2-1.

**Table 6.2.3.4.2-1: Resource URI variables for this resource**

Name	Data type	Definition
apiRoot	string	See clause 6.2.1.

### 6.2.3.4.3 Resource Standard Methods

#### 6.2.3.4.3.2 POST

The HTTP POST method allows a service consumer to request the creation of a Data Storage Delivery Subscription at the SEALDD Server.

This method shall support the URI query parameters specified in table 6.2.3.4.3.2-1.

**Table 6.2.3.4.3.2-1: URI query parameters supported by the POST method on this resource**

Name	Data type	P	Cardinality	Description	Applicability
n/a					

This method shall support the request data structures specified in table 6.2.3.4.3.2-2 and the response data structures and response codes specified in table 6.2.3.4.3.2-3.

**Table 6.2.3.4.3.2-2: Data structures supported by the POST Request Body on this resource**

Data type	P	Cardinality	Description
DataDelSubsc	M	1	Represents the parameters to request the creation of a Data Storage Delivery Subscription resource.

**Table 6.2.3.4.3.2-3: Data structures supported by the POST Response Body on this resource**

Data type	P	Cardinality	Response codes	Description
DataDelSubsc	M	1	201 Created	Successful case. The Data Storage Delivery Subscription is successfully created and a representation of the created "Individual Data Storage Delivery Subscription" resource shall be returned.  An HTTP "Location" header that contains the resource URI of the created resource shall also be included.
NOTE: The mandatory HTTP error status codes for the HTTP POST method listed in table 5.2.6-1 of 3GPP TS 29.122 [2] shall also apply.				

**Table 6.2.3.4.3.2-4: Headers supported by the 201 Response Code on this resource**

Name	Data type	P	Cardinality	Description
Location	string	M	1	Contains the URI of the newly created resource, according to the structure: {apiRoot}/sdd-ds/<apiVersion>/subscriptions/{subscriptionId}

6.2.3.4.4 Resource Custom Operations

There are no resource custom operations defined for this resource in this release of the specification.

6.2.3.5 Resource: Individual Data Storage Delivery Subscription

6.2.3.5.1 Description

This resource represents an "Individual Data Storage Delivery Subscription" resource managed by the SEALDD Server.

6.2.3.5.2 Resource Definition

Resource URI: {apiRoot}/sdd-ds/<apiVersion>/subscriptions/{subscriptionId}

This resource shall support the resource URI variables defined in table 6.2.3.5.2-1.

**Table 6.2.3.5.2-1: Resource URI variables for this resource**

Name	Data type	Definition
apiRoot	string	See clause 6.2.1.
subscriptionId	string	Represents the identifier of the "Individual Data Storage Delivery Subscription" resource.

6.2.3.5.3 Resource Standard Methods

6.2.3.5.3.1 GET

The HTTP GET method allows a service consumer to retrieve an existing "Individual Data Storage Delivery Subscription" resource at the SEALDD Server.

This method shall support the URI query parameters specified in table 6.2.3.5.3.1-1.

**Table 6.2.3.5.3.1-1: URI query parameters supported by the GET method on this resource**

Name	Data type	P	Cardinality	Description	Applicability
n/a					

This method shall support the request data structures specified in table 6.2.3.5.3.1-2 and the response data structures and response codes specified in table 6.2.3.5.3.1-3.

**Table 6.2.3.5.3.1-2: Data structures supported by the GET Request Body on this resource**

Data type	P	Cardinality	Description
n/a			

**Table 6.2.3.5.3.1-3: Data structures supported by the GET Response Body on this resource**

Data type	P	Cardinality	Response codes	Description
DataDelSubsc	M	1	200 OK	Successful case. The requested "Individual Data Storage Delivery Subscription" resource shall be returned.
n/a			307 Temporary Redirect	Temporary redirection. The response shall include a Location header field containing an alternative URI of the resource located in an alternative SEALDD Server. Redirection handling is described in clause 5.2.10 of 3GPP TS 29.122 [2].
n/a			308 Permanent Redirect	Permanent redirection. The response shall include a Location header field containing an alternative URI of the resource located in an alternative SEALDD Server. Redirection handling is described in clause 5.2.10 of 3GPP TS 29.122 [2].
NOTE: The mandatory HTTP error status codes for the HTTP GET method listed in table 5.2.6-1 of 3GPP TS 29.122 [2] shall also apply.				

**Table 6.2.3.5.3.1-4: Headers supported by the 307 Response Code on this resource**

Name	Data type	P	Cardinality	Description
Location	string	M	1	Contains an alternative URI of the resource located in an alternative SEALDD Server.

**Table 6.2.3.5.3.1-5: Headers supported by the 308 Response Code on this resource**

Name	Data type	P	Cardinality	Description
Location	string	M	1	Contains an alternative URI of the resource located in an alternative SEALDD Server.

#### 6.2.3.5.3.2 PUT

The HTTP PUT method allows a service consumer to request the update of an existing "Individual Data Storage Delivery Subscription" resource at the SEALDD Server.

This method shall support the URI query parameters specified in table 6.2.3.5.3.2-1.

**Table 6.2.3.5.3.2-1: URI query parameters supported by the PUT method on this resource**

Name	Data type	P	Cardinality	Description	Applicability
n/a					

This method shall support the request data structures specified in table 6.2.3.5.3.2-2 and the response data structures and response codes specified in table 6.2.3.5.3.2-3.

**Table 6.2.3.5.3.2-2: Data structures supported by the PUT Request Body on this resource**

Data type	P	Cardinality	Description
DataDelSubsc	M	1	Represents the updated representation of the "Individual Data Storage Delivery Subscription" resource.

**Table 6.2.3.5.3.2-3: Data structures supported by the PUT Response Body on this resource**

Data type	P	Cardinality	Response codes	Description
DataDelSubsc	M	1	200 OK	Successful case. The "Individual Data Storage Delivery Subscription" resource is successfully updated and a representation of the updated resource shall be returned in the response body.
n/a			204 No Content	Successful case. The "Individual Data Storage Delivery Subscription" resource is successfully updated and no content is returned in the response body.
n/a			307 Temporary Redirect	Temporary redirection.  The response shall include a Location header field containing an alternative URI of the resource located in an alternative SEALDD Server.  Redirection handling is described in clause 5.2.10 of 3GPP TS 29.122 [2].
n/a			308 Permanent Redirect	Permanent redirection.  The response shall include a Location header field containing an alternative URI of the resource located in an alternative SEALDD Server.  Redirection handling is described in clause 5.2.10 of 3GPP TS 29.122 [2].
NOTE: The mandatory HTTP error status codes for the HTTP PUT method listed in table 5.2.6-1 of 3GPP TS 29.122 [2] shall also apply.				

**Table 6.2.3.5.3.2-4: Headers supported by the 307 Response Code on this resource**

Name	Data type	P	Cardinality	Description
Location	string	M	1	Contains an alternative URI of the resource located in an alternative SEALDD Server.

**Table 6.2.3.5.3.2-5: Headers supported by the 308 Response Code on this resource**

Name	Data type	P	Cardinality	Description
Location	string	M	1	Contains an alternative URI of the resource located in an alternative SEALDD Server.

### 6.2.3.5.3.3 PATCH

The HTTP PATCH method allows a service consumer to request the modification of an existing "Individual Data Storage Delivery Subscription" resource at the SEALDD Server.

This method shall support the URI query parameters specified in table 6.2.3.5.3.3-1.

**Table 6.2.3.5.3.3-1: URI query parameters supported by the PATCH method on this resource**

Name	Data type	P	Cardinality	Description	Applicability
n/a					

This method shall support the request data structures specified in table 6.2.3.5.3.3-2 and the response data structures and response codes specified in table 6.2.3.5.3.3-3.



**Table 6.2.3.5.3.3-2: Data structures supported by the PATCH Request Body on this resource**

Data type	P	Cardinality	Description
DataDelSubscPatch	M	1	Represents the parameters to request the modification of the "Individual Data Storage Delivery Subscription" resource.

**Table 6.2.3.5.3.3-3: Data structures supported by the PATCH Response Body on this resource**

Data type	P	Cardinality	Response codes	Description
DataDelSubsc	M	1	200 OK	Successful case. The "Individual Data Storage Delivery Subscription" resource is successfully modified and a representation of the updated resource shall be returned in the response body.
n/a			204 No Content	Successful case. The "Individual Data Storage Delivery Subscription" resource is successfully modified and no content is returned in the response body.
n/a			307 Temporary Redirect	Temporary redirection.  The response shall include a Location header field containing an alternative URI of the resource located in an alternative SEALDD Server.  Redirection handling is described in clause 5.2.10 of 3GPP TS 29.122 [2].
n/a			308 Permanent Redirect	Permanent redirection.  The response shall include a Location header field containing an alternative URI of the resource located in an alternative SEALDD Server.  Redirection handling is described in clause 5.2.10 of 3GPP TS 29.122 [2].
NOTE: The mandatory HTTP error status codes for the HTTP PATCH method listed in table 5.2.6-1 of 3GPP TS 29.122 [2] shall also apply.				

**Table 6.2.3.5.3.3-4: Headers supported by the 307 Response Code on this resource**

Name	Data type	P	Cardinality	Description
Location	string	M	1	Contains an alternative URI of the resource located in an alternative SEALDD Server.

**Table 6.2.3.5.3.3-5: Headers supported by the 308 Response Code on this resource**

Name	Data type	P	Cardinality	Description
Location	string	M	1	Contains an alternative URI of the resource located in an alternative SEALDD Server.

#### 6.2.3.5.3.4 DELETE

The HTTP DELETE method allows a service consumer to request the deletion of an existing "Individual Data Storage Delivery Subscription" resource at the SEALDD Server.

This method shall support the URI query parameters specified in table 6.2.3.5.3.4-1.

**Table 6.2.3.5.3.4-1: URI query parameters supported by the DELETE method on this resource**

Name	Data type	P	Cardinality	Description	Applicability
n/a					

This method shall support the request data structures specified in table 6.2.3.5.3.4-2 and the response data structures and response codes specified in table 6.2.3.5.3.4-3.

**Table 6.2.3.5.3.4-2: Data structures supported by the DELETE Request Body on this resource**

Data type	P	Cardinality	Description
n/a			

**Table 6.2.3.5.3.4-3: Data structures supported by the DELETE Response Body on this resource**

Data type	P	Cardinality	Response codes	Description
n/a			204 No Content	Successful case. The "Individual Data Storage Delivery Subscription" resource is successfully deleted.
n/a			307 Temporary Redirect	Temporary redirection.  The response shall include a Location header field containing an alternative URI of the resource located in an alternative SEALDD Server.  Redirection handling is described in clause 5.2.10 of 3GPP TS 29.122 [2].
n/a			308 Permanent Redirect	Permanent redirection.  The response shall include a Location header field containing an alternative URI of the resource located in an alternative SEALDD Server.  Redirection handling is described in clause 5.2.10 of 3GPP TS 29.122 [2].
NOTE: The mandatory HTTP error status codes for the HTTP DELETE method listed in table 5.2.6-1 of 3GPP TS 29.122 [2] shall also apply.				

**Table 6.2.3.5.3.4-4: Headers supported by the 307 Response Code on this resource**

Name	Data type	P	Cardinality	Description
Location	string	M	1	Contains an alternative URI of the resource located in an alternative SEALDD Server.

**Table 6.2.3.5.3.4-5: Headers supported by the 308 Response Code on this resource**

Name	Data type	P	Cardinality	Description
Location	string	M	1	Contains an alternative URI of the resource located in an alternative SEALDD Server.

#### 6.2.3.5.4 Resource Custom Operations

There are no resource custom operations defined for this resource in this release of the specification.

### 6.2.4 Custom Operations without associated resources

#### 6.2.4.1 Overview

The structure of the custom operation URIs of the SDD\_DataStorage API is shown in Figure 6.2.4.1-1.

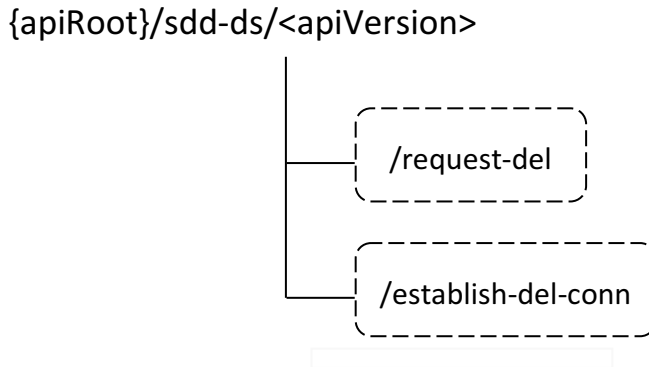

**Figure 6.2.4.1-1: Custom operation URI structure of the SDD\_DataStorage API**

Table 6.2.4.1-1 provides an overview of the custom operations and applicable HTTP methods defined for the SDD\_DataStorage API.

**Table 6.2.4.1-1: Custom operations without associated resources**

Custom operation name	Custom operation URI	Mapped HTTP method	Description
DataDeliveryRequest	/request-del	POST	Enables a service consumer to request SEALDD data storage delivery.
EstablishDelConn	/establish-del-conn	POST	Enables a service consumer to request SEALDD data storage delivery connection establishment.

The custom operations shall support the URI variables defined in table 6.2.4.1-2.

**Table 6.2.4.1-2: URI variables for this custom operation**

Name	Data type	Definition
apiRoot	string	See clause 6.2.1.

6.2.4.2 Operation: DataDeliveryRequest

6.2.4.2.1 Description

The custom operation enables a service consumer to request SEALDD Data Storage delivery to the SEALDD Server.

6.2.4.2.2 Operation Definition

This operation shall support the request data structures specified in table 6.2.4.2.2-1 and the response data structures and response codes specified in table 6.2.4.2.2-2.

**Table 6.2.4.2.2-1: Data structures supported by the POST Request Body on this custom operation**

Data type	P	Cardinality	Description
DataDelReq	M	1	Contains the parameters to request SEALDD Data Storage delivery.

**Table 6.2.4.2.2-2: Data structures supported by the POST Response Body on this custom operation**

Data type	P	Cardinality	Response codes	Description
n/a			204 No Content	Successful case. The SEALDD Data Storage delivery request is successfully received and processed.
n/a			307 Temporary Redirect	Temporary redirection. The response shall include a Location header field containing an alternative target URI located in an alternative SEALDD Server. Redirection handling is described in clause 5.2.10 of 3GPP TS 29.122 [2].
n/a			308 Permanent Redirect	Permanent redirection. The response shall include a Location header field containing an alternative target URI located in an alternative SEALDD Server. Redirection handling is described in clause 5.2.10 of 3GPP TS 29.122 [2].
NOTE: The mandatory HTTP error status codes for the HTTP POST method listed in table 5.2.6-1 of 3GPP TS 29.122 [2] shall also apply.				

**Table 6.2.4.2.2-3: Headers supported by the 307 Response Code on this custom operation**

Name	Data type	P	Cardinality	Description
Location	string	M	1	Contains an alternative target URI located in an alternative SEALDD Server.

**Table 6.2.4.2.2-4: Headers supported by the 308 Response Code on this custom operation**

Name	Data type	P	Cardinality	Description
Location	string	M	1	Contains an alternative target URI located in an alternative SEALDD Server.

### 6.2.4.3 Operation: EstablishDelConn

#### 6.2.4.3.1 Description

The custom operation enables a service consumer to request SEALDD Data Storage delivery connection establishment to the SEALDD Server.

#### 6.2.4.3.2 Operation Definition

This operation shall support the request data structures specified in table 6.2.4.3.2-1 and the response data structures and response codes specified in table 6.2.4.3.2-2.

**Table 6.2.4.3.2-1: Data structures supported by the POST Request Body on this custom operation**

Data type	P	Cardinality	Description
DelConnEstabReq	M	1	Contains the parameters to request SEALDD Data Storage delivery connection establishment.

**Table 6.2.4.3.2-2: Data structures supported by the POST Response Body on this custom operation**

Data type	P	Cardinality	Response codes	Description
DelConnEstabResp	M	1	200 OK	Successful case. The SEALDD Data Storage delivery connection establishment request is successfully received and processed, and SEALDD Data Storage delivery connection establishment related information shall be returned in the response body.
n/a			204 No Content	Successful case. The SEALDD Data Storage delivery connection establishment request is successfully received and processed.
n/a			307 Temporary Redirect	Temporary redirection.  The response shall include a Location header field containing an alternative target URI located in an alternative SEALDD Server.  Redirection handling is described in clause 5.2.10 of 3GPP TS 29.122 [2].
n/a			308 Permanent Redirect	Permanent redirection.  The response shall include a Location header field containing an alternative target URI located in an alternative SEALDD Server.  Redirection handling is described in clause 5.2.10 of 3GPP TS 29.122 [2].
NOTE: The mandatory HTTP error status codes for the HTTP POST method listed in table 5.2.6-1 of 3GPP TS 29.122 [2] shall also apply.				

**Table 6.2.4.3.2-3: Headers supported by the 307 Response Code on this custom operation**

Name	Data type	P	Cardinality	Description
Location	string	M	1	Contains an alternative target URI located in an alternative SEALDD Server.

**Table 6.2.4.3.2-4: Headers supported by the 308 Response Code on this custom operation**

Name	Data type	P	Cardinality	Description
Location	string	M	1	Contains an alternative target URI located in an alternative SEALDD Server.

## 6.2.5 Notifications

### 6.2.5.1 General

Notifications shall comply to clause 6.6 of 3GPP TS 29.549 [15].

**Table 6.2.5.1-1: Notifications overview**

Notification	Callback URI	HTTP method or custom operation	Description (service operation)
Data Management and/or Status Information Notification	{notifUri}	POST	Enables a SEALDD Server to notify a previously subscribed service consumer on SEALDD Data Management and/or Status Information event(s).
Data Storage Delivery Notification	{notifUri}	POST	Enables a SEALDD Server to notify a previously subscribed service consumer on SEALDD Data Storage Delivery.

## 6.2.5.2 Data Management and/or Status Information Notification

### 6.2.5.2.1 Description

The Data Management and/or Status Information Notification is used by the SEALDD Server to notify a previously subscribed service consumer on SEALDD Data Management and/or Status Information event(s).

### 6.2.5.2.2 Target URI

The Callback URI "{notifUri}" shall be used with the callback URI variables defined in table 6.2.5.2.2-1.

**Table 6.2.5.2.2-1: Callback URI variables**

Name	Definition
notifUri	Represents the callback URI encoded as a string formatted as a URI.

### 6.2.5.2.3 Standard Methods

#### 6.2.5.2.3.1 POST

This method shall support the request data structures specified in table 6.2.5.2.3.1-1 and the response data structures and response codes specified in table 6.2.5.2.3.1-2.

**Table 6.2.5.2.3.1-1: Data structures supported by the POST Request Body**

Data type	P	Cardinality	Description
DataMngtNotif	M	1	Represents the Data Management and/or Status Information Notification.

**Table 6.2.5.2.3.1-2: Data structures supported by the POST Response Body**

Data type	P	Cardinality	Response codes	Description
n/a			204 No Content	Successful case. The Data Management and/or Status Information Notification is successfully received.
n/a			307 Temporary Redirect	Temporary redirection.  The response shall include a Location header field containing an alternative URI representing the end point of an alternative service consumer towards which the notification should be sent.  Redirection handling is described in clause 5.2.10 of 3GPP TS 29.122 [3].
n/a			308 Permanent Redirect	Permanent redirection.  The response shall include a Location header field containing an alternative URI representing the end point of an alternative service consumer towards which the notification should be sent.  Redirection handling is described in clause 5.2.10 of 3GPP TS 29.122 [3].
NOTE: The mandatory HTTP error status codes for the HTTP POST method listed in table 5.2.6-1 of 3GPP TS 29.122 [2] shall also apply.				

**Table 6.2.5.2.3.1-3: Headers supported by the 307 Response Code on this resource**

Name	Data type	P	Cardinality	Description
Location	string	M	1	Contains an alternative URI representing the end point of an alternative service consumer towards which the notification should be redirected.

**Table 6.2.5.2.3.1-4: Headers supported by the 308 Response Code on this resource**

Name	Data type	P	Cardinality	Description
Location	string	M	1	Contains an alternative URI representing the end point of an alternative service consumer towards which the notification should be redirected.

### 6.2.5.3 Data Storage Delivery Notification

#### 6.2.5.3.1 Description

The Data Storage Delivery Notification is used by the SEALDD Server to notify a previously subscribed service consumer on SEALDD Data Storage Delivery.

#### 6.2.5.3.2 Target URI

The Callback URI "{notifUri}" shall be used with the callback URI variables defined in table 6.2.5.3.2-1.

**Table 6.2.5.3.2-1: Callback URI variables**

Name	Definition
notifUri	Represents the callback URI encoded as a string formatted as a URI.

#### 6.2.5.3.3 Standard Methods

##### 6.2.5.3.3.1 POST

This method shall support the request data structures specified in table 6.2.5.3.3.1-1 and the response data structures and response codes specified in table 6.2.5.3.3.1-2.

**Table 6.2.5.3.3.1-1: Data structures supported by the POST Request Body**

Data type	P	Cardinality	Description
DataDelNotif	M	1	Represents the Data Storage Delivery Notification.

**Table 6.2.5.3.3.1-2: Data structures supported by the POST Response Body**

Data type	P	Cardinality	Response codes	Description
n/a			204 No Content	Successful case. The Data Storage Delivery Notification is successfully received.
n/a			307 Temporary Redirect	Temporary redirection.  The response shall include a Location header field containing an alternative URI representing the end point of an alternative service consumer towards which the notification should be sent.  Redirection handling is described in clause 5.2.10 of 3GPP TS 29.122 [3].
n/a			308 Permanent Redirect	Permanent redirection.  The response shall include a Location header field containing an alternative URI representing the end point of an alternative service consumer towards which the notification should be sent.  Redirection handling is described in clause 5.2.10 of 3GPP TS 29.122 [3].
NOTE: The mandatory HTTP error status codes for the HTTP POST method listed in table 5.2.6-1 of 3GPP TS 29.122 [2] shall also apply.				

**Table 6.2.5.3.3.1-3: Headers supported by the 307 Response Code on this resource**

Name	Data type	P	Cardinality	Description
Location	string	M	1	Contains an alternative URI representing the end point of an alternative service consumer towards which the notification should be redirected.

**Table 6.2.5.3.3.1-4: Headers supported by the 308 Response Code on this resource**

Name	Data type	P	Cardinality	Description
Location	string	M	1	Contains an alternative URI representing the end point of an alternative service consumer towards which the notification should be redirected.

## 6.2.6 Data Model

### 6.2.6.1 General

This clause specifies the application data model supported by the API.

Table 6.2.6.1-1 specifies the data types defined for the SDD\_DataStorage API.



**Table 6.2.6.1-1: SDD\_DataStorage API specific Data Types**

Data type	Clause defined	Description	Applicability
AccessCtrlPolicy	6.2.6.2.6	Represents the data access control policy.	
DataAccessRight	6.2.6.3.4	Represents the data access right.	
DataAccessStats	6.2.6.2.9	Represents data access statistics.	
DataDelNotif	6.2.6.2.13	Represents a SEALDD Data Storage Delivery Notification.	
DataDelReq	6.2.6.2.14	Represents a SEALDD Data Storage Delivery request.	
DataDelSubsc	6.2.6.2.11	Represents a SEALDD Data Storage Delivery Subscription.	
DataDelSubscPatch	6.2.6.2.12	Represents the requested modification to a SEALDD Data Storage Delivery Subscription.	
DataMngtEvent	6.2.6.3.5	Represents the Data Management and/or Status Information events.	
DataMngtNotif	6.2.6.2.8	Represents a SEALDD Data Management and/or Status Information Notification.	
DataMngtStats	6.2.6.2.10	Represents data management statistics.	
DataMngtSubsc	6.2.6.2.7	Represents the stored data management and/or status information subscription related information.	
DataStorage	6.2.6.2.2	Represents a SEALDD Data Storage.	
DataStoragePatch	6.2.6.2.5	Represents the requested modification to a SEALDD Data Storage.	
DataStorageReq	6.2.6.4.1	Represents a SEALDD Data Storage creation or reservation request.	
DelConnEstabReq	6.2.6.2.15	Represents a SEALDD Data Storage Delivery connection establishment request.	
DelConnEstabResp	6.2.6.2.16	Represents the response to a SEALDD Data Storage Delivery connection establishment request.	
EntityName	6.2.6.3.3	Represents the name of a SEALDD entity.	
ReservReqData	6.2.6.2.3	Represents a Data Storage reservation request.	
ReservRespData	6.2.6.2.4	Represents a Data Storage reservation response.	

Table 6.2.6.1-2 specifies data types re-used by the SDD\_DataStorage API from other specifications, including a reference to their respective specifications, and when needed, a short description of their use within the SDD\_DataStorage API.

**Table 6.2.6.1-2: SDD\_DataStorage API re-used Data Types**

Data type	Reference	Comments	Applicability
Bytes	3GPP TS 29.122 [4]	Represents a sequence of bytes.	
ConnInfo	6.1.6.2.4	Represents SEALDD Data transmission connection information.	
DateTime	3GPP TS 29.122 [2]	Represents a date and a time.	
DateTimeRo	3GPP TS 29.122 [2]	Represents a date and a time with the read-only property.	
DurationSec	3GPP TS 29.122 [2]	Represents a time duration in seconds.	
ProblemDetails	3GPP TS 29.122 [2]	Represents error related information.	
SupportedFeatures	3GPP TS 29.571 [18]	Represents the list of supported feature(s) and used to negotiate the applicability of the optional features.	
TransportProtocol	3GPP TS 29.558 [17]	Represents the transport layer protocol.	
UInteger	3GPP TS 29.571 [18]	Represents an unsigned integer.	
Uri	3GPP TS 29.122 [2]	Represents a URI.	

## 6.2.6.2 Structured data types

### 6.2.6.2.1 Introduction

This clause defines the data structures to be used in resource representations.

### 6.2.6.2.2 Type: DataStorage

**Table 6.2.6.2.2-1: Definition of type DataStorage**

Attribute name	Data type	P	Cardinality	Description	Applicability
data	Bytes	M	1	Contains the application data to be stored.	
ctrlPolicies	array(AccessControlPolicy)	O	1..N	Contains the Storage of policy(ies) for controlling the access to the data.	
expTime	DateTime	O	0..1	Contains the expiration time of the data to be stored.	
mngtSubsc	DataMngtSubsc	O	0..1	Contains the stored data management and/or status information subscription related information.	
suppFeat	SupportedFeatures	C	0..1	Contains the list of supported features among the ones defined in clause 6.2.8. This attribute shall be present only when feature negotiation needs to take place.	

### 6.2.6.2.3 Type: ReservReqData

**Table 6.2.6.2.3-1: Definition of type ReservReqData**

Attribute name	Data type	P	Cardinality	Description	Applicability
valServiceId	string	M	1	Contains the identifier of the target VAL service.	
dataLength	UInteger	O	0..1	Contains the length of the data to be stored and for which a Data Storage resource needs to be reserved.	
suppFeat	SupportedFeatures	C	0..1	Contains the list of supported features among the ones defined in clause 6.2.8. This attribute shall be present only when feature negotiation needs to take place.	

### 6.2.6.2.4 Type: ReservRespData

**Table 6.2.6.2.4-1: Definition of type ReservRespData**

Attribute name	Data type	P	Cardinality	Description	Applicability
resourceAddr	Uri	M	1	Contains the URI of the reserved Data Storage resource.	

## 6.2.6.2.5 Type: DataStoragePatch

Table 6.2.6.2.5-1: Definition of type DataStoragePatch

Attribute name	Data type	P	Cardinality	Description	Applicability
data	Bytes	O	0..1	Contains the updated application data to be stored.	
ctrlPolicies	array(AccessCtrlPolicy)	O	1..N	Contains the updated access control policy(ies) for the stored data.	
expTime	DateTime	O	0..1	Contains the updated expiration time of the data to be stored.	
mngtSubsc	DataMngtSubsc	O	0..1	Contains the updated stored data management and/or status information subscription related information.	

## 6.2.6.2.6 Type: AccessCtrlPolicy

Table 6.2.6.2.6-1: Definition of type AccessCtrlPolicy

Attribute name	Data type	P	Cardinality	Description	Applicability
entityName	EntityName	C	0..1	Contains the allowed entity's name. (NOTE)	
entityId	string	C	0..1	Contains the allowed entity's identifier. (NOTE)	
rights	array(DataAccessRight)	M	1..N	Contains the allowed access right(s) for the entity identified by the "entityName" and/or "entityId" attribute(s).	
NOTE: At least one of these attributes shall be present.					

## 6.2.6.2.7 Type: DataMngtSubsc

Table 6.2.6.2.7-1: Definition of type DataMngtSubsc

Attribute name	Data type	P	Cardinality	Description	Applicability
events	array(DataMngtEvent)	M	1..N	Contains the list of subscribed data management and/or status information event(s).	
notifUri	Uri	M	1	Contains the URI via which Data Management and/or Status Information Notifications shall be delivered.	
repPeriodicity	DurationSec	C	0..1	Contains the reporting periodicity.  This attribute shall be present only when the subscribed event(s) within the "events" attribute is/are "DATA_ACCESS_STATISTICS" and/or "DATA_MNGT_STATISTICS".	

6.2.6.2.8 Type: DataMngtNotif

**Table 6.2.6.2.8-1: Definition of type DataMngtNotif**

Attribute name	Data type	P	Cardinality	Description	Applicability
storageld	string	M	1	Contains the identifier of the data storage to which the data management and/or status information notification is related.	
events	array(DataMngtEvent)	M	1..N	Contains the list of reported data management and/or status information event(s).	
accessStats	DataAccessStats	C	0..1	Contains the data access statistics of the stored data.  This attribute shall be present only when one of the reported event(s) within the "events" attribute is "DATA_ACCESS_STATISTICS".	
mngtStats	DataMngtStats	C	0..1	Contains the data management statistics of the stored data.  This attribute shall be present only when one of the reported event(s) within the "events" attribute is "DATA_MNGT_STATISTICS".	

6.2.6.2.9 Type: DataAccessStats

**Table 6.2.6.2.9-1: Definition of type DataAccessStats**

Attribute name	Data type	P	Cardinality	Description	Applicability
genAccessStats	UInteger	C	0..1	Represents the general data access statistics of the stored data. It contains how many times the stored data was accessed (i.e., retrieved or updated).  (NOTE)	
detAccessStats	map(Uinteger)	C	1..N	Represents the data access statistics of the stored data detailed per consumer SEALDD entity. It contains how many times the stored data was accessed (i.e., retrieved or updated) per SEALDD entity.  The key of the map shall be the name of the SEALDD entity, encoded using the EntityName data type as specified in clause 6.2.6.3.3, to which the data access statistics provided within the map value are related.  (NOTE)	

NOTE: At least one of these attributes shall be present.

## 6.2.6.2.10 Type: DataMngtStats

Table 6.2.6.2.10-1: Definition of type DataMngtStats

Attribute name	Data type	P	Cardinality	Description	Applicability
genMngtStats	UInteger	C	0..1	Represents the general data management statistics of the stored data. It contains how many times the stored data was accessed for management purposes (i.e., data update).  (NOTE)	
detMngtStats	map(Uinteger)	C	1..N	Represents the data management statistics of the stored data detailed per consumer SEALDD entity. It contains how many times the stored data was accessed for management purposes (i.e., data update) per SEALDD entity.  The key of the map shall be the name of the SEALDD entity, encoded using the EntityName data type as specified in clause 6.2.6.3.3, to which the data management statistics provided within the map value are related.  (NOTE)	
NOTE: At least one of these attributes shall be present.					

## 6.2.6.2.11 Type: DataDelSubsc

Table 6.2.6.2.11-1: Definition of type DataDelSubsc

Attribute name	Data type	P	Cardinality	Description	Applicability
notifUri	Uri	M	1	Contains the URI via which Data Storage Delivery notifications shall be delivered.	
expTime	DateTimeRo	O	0..1	Contains the subscription's expiration time.  This attribute may be present only in the response to a Data Storage Delivery Subscription creation/update request.	
suppFeat	SupportedFeatures	C	0..1	Contains the list of supported features among the ones defined in clause 6.2.8.  This attribute shall be present only when feature negotiation needs to take place.	

## 6.2.6.2.12 Type: DataDelSubscPatch

Table 6.2.6.2.12-1: Definition of type DataDelSubscPatch

Attribute name	Data type	P	Cardinality	Description	Applicability
notifUri	Uri	M	1	Contains the updated URI via which Data Storage Delivery notifications shall be delivered.	

## 6.2.6.2.13 Type: DataDelNotif

Table 6.2.6.2.13-1: Definition of type DataDelNotif

Attribute name	Data type	P	Cardinality	Description	Applicability
subscriptionId	string	M	1	Contains the identifier of the subscription to which the data storage delivery notification is related.	
data	Bytes	C	0..1	Contains the stored data. (NOTE)	
storageId	string	C	0..1	Contains the identifier of the "Individual Data Storage" resource where the data is stored. (NOTE)	
NOTE: These attributes are mutually exclusive. Either one of them shall be present.					

## 6.2.6.2.14 Type: DataDelReq

Table 6.2.6.2.14-1: Definition of type DataDelReq

Attribute name	Data type	P	Cardinality	Description	Applicability
targetId	string	M	1	Contains the identifier of the target (e.g., VAL Server).	
sealddServId	string	O	0..1	Contains the identifier of the target SEALDD Server.	
storageId	string	C	0..1	Contains the identifier of the Data Storage resource where is stored the data to be delivered. (NOTE)	
data	Bytes	C	0..1	Contains the data to be delivered. (NOTE)	
suppFeat	SupportedFeatures	C	0..1	Contains the list of supported features among the ones defined in clause 6.2.8.  This attribute shall be present only when feature negotiation needs to take place.	
NOTE: These attributes are mutually exclusive. Either one of them shall be present.					

## 6.2.6.2.15 Type: DelConnEstabReq

Table 6.2.6.2.15-1: Definition of type DelConnEstabReq

Attribute name	Data type	P	Cardinality	Description	Applicability
targetId	string	M	1	Contains the identifier of the target VAL Server.	
ddServerConnInfo	ConnInfo	O	0..1	Contains source SEALDD Server's side connection information, i.e., address/port and/or URI via which the SEALDD Server will send the data storage delivery data.	
transProtoc	array(TransportProtocol)	O	1..N	Represents the transport layer protocol(s) that are supported by the service consumer (e.g., source SEALDD Server).	
suppFeat	SupportedFeatures	C	0..1	Contains the list of supported features among the ones defined in clause 6.2.8.  This attribute shall be present only when feature negotiation needs to take place.	

6.2.6.2.16 Type: DelConnEstabResp

**Table 6.2.6.2.16-1: Definition of type DelConnEstabResp**

Attribute name	Data type	P	Cardinality	Description	Applicability
ddServerConnInfo	ConnInfo	O	0..1	Contains target SEALDD Server's side connection information, i.e., address/port and/or URI via which the SEALDD Server desires to receive the data storage delivery data.	
transProtoc	TransportProtocol	O	0..1	Represents the transport layer protocol that is retained by the SEALDD Server (e.g., target SEALDD Server).	
suppFeat	SupportedFeatures	C	0..1	Contains the list of supported features among the ones defined in clause 6.2.8.  This attribute shall be present only when feature negotiation needs to take place.	

6.2.6.3 Simple data types and enumerations

6.2.6.3.1 Introduction

This clause defines simple data types and enumerations that can be referenced from data structures defined in the previous clauses.

6.2.6.3.2 Simple data types

The simple data types defined in table 6.2.6.3.2-1 shall be supported.

**Table 6.2.6.3.2-1: Simple data types**

Type Name	Type Definition	Description	Applicability

6.2.6.3.3 Enumeration: EntityName

The enumeration EntityName represents the name of a SEALDD entity. It shall comply with the provisions defined in table 6.2.6.3.3-1.

**Table 6.2.6.3.3-1: Enumeration EntityName**

Enumeration value	Description	Applicability
SEALDD_SERVER	Indicates the SEALDD Server.	
SEALDD_CLIENT	Indicates the SEALDD Client.	
VAL_SERVER	Indicates the VAL Server.	

6.2.6.3.4 Enumeration: DataAccessRight

The enumeration DataAccessRight represents the data access rights. It shall comply with the provisions defined in table 6.2.6.3.4-1.

**Table 6.2.6.3.4-1: Enumeration DataAccessRight**

Enumeration value	Description	Applicability
RETRIEVE	Indicates that the access right is data storage retrieval.	
UPDATE	Indicates that the access right is data storage update.	
DELETE	Indicates that the access right is data storage deletion.	

### 6.2.6.3.5 Enumeration: DataMngtEvent

The enumeration DataMngtEvent represents the Data Management and/or Status Information events. It shall comply with the provisions defined in table 6.2.6.3.5-1.

**Table 6.2.6.3.5-1: Enumeration DataMngtEvent**

Enumeration value	Description	Applicability
DATA_ACCESS_STATISTICS	Indicates that the Data Management Event is data access statistics (i.e., how often the stored data is accessed).	
DATA_MNGT_STATISTICS	Indicates that the Data Management Event is data management statistics (i.e., how often the stored data is managed).	

## 6.2.6.4 Data types describing alternative data types or combinations of data types

### 6.2.6.4.1 Type: DataStorageReq

**Table 6.2.6.4.1-1: Definition of type DataStorageReq as a list of mutually exclusive alternatives**

Data type	Cardinality	Description	Applicability
DataStorage	0..1	Represents a Data Storage resource creation request containing the necessary parameters to create the Data Storage resource.	
ReservReqData	0..1	Represents a Data Storage resource reservation request containing the necessary parameters to reserve of a Data storage resource.	

## 6.2.6.5 Binary data

### 6.2.6.5.1 Binary Data Types

**Table 6.2.6.5.1-1: Binary Data Types**

Name	Clause defined	Content type

## 6.2.7 Error Handling

### 6.2.7.1 General

For the SDD\_DataStorage API, error handling shall be supported as specified in clause 6.7 of 3GPP TS 29.549 [15].

In addition, the requirements in the following clauses are applicable for the SDD\_DataStorage API.

### 6.2.7.2 Protocol Errors

No specific protocol errors for the SDD\_DataStorage API are specified.

### 6.2.7.3 Application Errors

The application errors defined for the SDD\_DataStorage API are listed in Table 6.2.7.3-1.



**Table 6.2.7.3-1: Application errors**

Application Error	HTTP status code	Description	Applicability
STORAGE_REQ_REJECTED	403 Forbidden	Indicates that the Data Storage creation or reservation request is rejected because the service consumer is not authorized.	
DATA_LENGTH_FAILURE	403 Forbidden	Indicates that the Data Storage creation or reservation request is rejected because the length of requested Data Storage is not available or not authorized.	

## 6.2.8 Feature negotiation

The optional features listed in table 6.2.8-1 are defined for the SDD\_DataStorage API. They shall be negotiated using the extensibility mechanism defined in clause 6.8 of 3GPP TS 29.549 [15].

**Table 6.2.8-1: Supported Features**

Feature number	Feature Name	Description

## 6.2.9 Security

The provisions of clause 9 of 3GPP TS 29.549 [15] shall apply for the SDD\_DataStorage API.

## 6.3 SDD\_DDContext Service API

### 6.3.1 Introduction

The SDD\_DDContext service shall use the SDD\_DDContext API.

The API URI of the SDD\_DDContext Service API shall be:

**{apiRoot}/<apiName>/<apiVersion>**

The request URIs used in HTTP requests shall have the Resource URI structure as defined in clause 6.5 of 3GPP TS 29.549 [15], i.e.:

**{apiRoot}/<apiName>/<apiVersion>/<apiSpecificSuffixes>**

with the following components:

- The {apiRoot} shall be set as described in clause 6.5 of 3GPP TS 29.549 [15].
- The <apiName> shall be "sdd-ddc".
- The <apiVersion> shall be "v1".
- The <apiSpecificSuffixes> shall be set as described in clause 6.5 of 3GPP TS 29.549 [15].

NOTE: When 3GPP TS 29.122 [2] is referenced for the common protocol and interface aspects for API definition in the clauses under clause 6.3, the SEALDD Server takes the role of the SCEF and the service consumer takes the role of the SCS/AS.

### 6.3.2 Usage of HTTP

The provisions of clause 6.3 of 3GPP TS 29.549 [15] shall apply for the SDD\_DDContext API.

### 6.3.3 Resources

#### 6.3.3.1 Overview

This clause describes the structure for the Resource URIs and the resources and methods used for the service.

Figure 6.3.3.1-1 depicts the resource URIs structure for the SDD\_DDContext API.

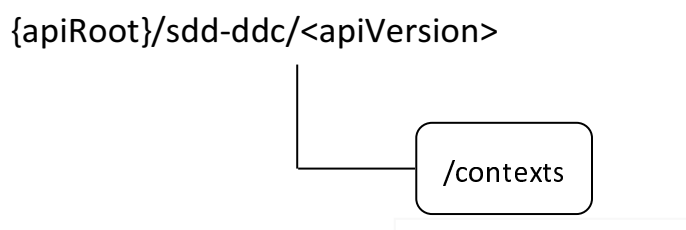

**Figure 6.3.3.1-1: Resource URI structure of the SDD\_DDContext API**

Table 6.3.3.1-1 provides an overview of the resources and applicable HTTP methods for the SDD\_DDContext API.

**Table 6.3.3.1-1: Resources and methods overview**

Resource name	Resource URI	HTTP method or custom operation	Description
DD Contexts	/contexts	POST	Push the DD context to the SEALDD Server.
		GET	Pull the DD context from the SEALDD Server.

### 6.3.3.2 Resource: DD Contexts

#### 6.3.3.2.1 Description

This resource represents the collection of DD Context(s) managed by the SEALDD Server.

#### 6.3.3.2.2 Resource Definition

Resource URI: {apiRoot}/sdd-ddc/<apiVersion>/contexts

This resource shall support the resource URI variables defined in the table 6.3.3.2.2-1.

**Table 6.3.3.2.2-1: Resource URI variables for this resource**

Name	Data Type	Definition
apiRoot	string	See clause 6.3.1.

#### 6.3.3.2.3 Resource Standard Methods

##### 6.3.3.2.3.1 POST

The HTTP POST method enables a service consumer to push a DD context to the SEALDD Server.

This method shall support the URI query parameters specified in table 6.3.3.2.3.1-1.

**Table 6.3.3.2.3.1-1: URI query parameters supported by the POST method on this resource**

Name	Data type	P	Cardinality	Description
n/a				

This method shall support the request data structures specified in table 6.3.3.2.3.1-2 and the response data structures and response codes specified in table 6.3.3.2.3.1-3.

**Table 6.3.3.2.3.1-2: Data structures supported by the POST Request Body on this resource**

Data type	P	Cardinality	Description
DdContextPushReq	M	1	Represents the DD context to be pushed to the SEALDD Server.

**Table 6.3.3.2.3.1-3: Data structures supported by the POST Response Body on this resource**

Data type	P	Cardinality	Response codes	Description
DdContextResp	M	1	200 OK	Successful case. The DD context is successfully pushed to the SEALDD Server and the related information is returned in the response body.
n/a			307 Temporary Redirect	Temporary redirection.  The response shall include a Location header field containing an alternative URI of the resource located in an alternative SEALDD Server.  Redirection handling is described in clause 5.2.10 of 3GPP TS 29.122 [2].
n/a			308 Permanent Redirect	Permanent redirection.  The response shall include a Location header field containing an alternative URI of the resource located in an alternative SEALDD Server.  Redirection handling is described in clause 5.2.10 of 3GPP TS 29.122 [2].
ProblemDetails	O	0..1	403 Forbidden	(NOTE 2)
NOTE 1: The mandatory HTTP error status codes for the HTTP POST method listed in table 5.2.6-1 of 3GPP TS 29.122 [2] shall also apply.				
NOTE 2: Failure causes are described in clause 6.3.7.				

**Table 6.3.3.2.3.1-4: Headers supported by the 307 Response Code on this resource**

Name	Data type	P	Cardinality	Description
Location	string	M	1	Contains an alternative URI of the resource located in an alternative SEALDD Server.

**Table 6.3.3.2.3.1-5: Headers supported by the 308 Response Code on this resource**

Name	Data type	P	Cardinality	Description
Location	string	M	1	Contains an alternative URI of the resource located in an alternative SEALDD Server.

#### 6.3.3.2.3.2 GET

The HTTP GET method enables a service consumer to pull a DD Context from the SEALDD Server.

This method shall support the URI query parameters specified in table 6.3.3.2.3.2-1.

**Table 6.3.3.2.3.2-1: URI query parameters supported by the GET method on this resource**

Name	Data type	P	Cardinality	Description
sealdd-pol-ind	boolean	O	0..1	Indicates whether the configured SEALDD Policy(ies) at the SEALDD Server, if any, is/are requested and shall hence be provided in addition to the DD Context. <ul style="list-style-type: none"> <li>- "true" indicates that the configured SEALDD Policy(ies) is/are requested.</li> <li>- "false" indicates that the configured SEALDD Policy(ies) is/are not requested.</li> <li>- The default value when this query parameter is omitted is "false".</li> </ul>
supp-feats	SupportedFeatures	C	0..1	Contains the list of supported features among the ones defined in clause 6.3.8.  This query parameter shall be present only when feature negotiation needs to take place.

This method shall support the request data structures specified in table 6.3.3.2.3.2-2 and the response data structures and response codes specified in table 6.3.3.2.3.2-3.

**Table 6.3.3.2.3.2-2: Data structures supported by the GET Request Body on this resource**

Data type	P	Cardinality	Description
n/a			

**Table 6.3.3.2.3.2-3: Data structures supported by the GET Response Body on this resource**

Data type	P	Cardinality	Response codes	Description
DdContextResp	M	1	200 OK	Successful case. The requested DD context is returned in the response body.
n/a			307 Temporary Redirect	Temporary redirection.  The response shall include a Location header field containing an alternative URI of the resource located in an alternative SEALDD Server.  Redirection handling is described in clause 5.2.10 of 3GPP TS 29.122 [2].
n/a			308 Permanent Redirect	Permanent redirection.  The response shall include a Location header field containing an alternative URI of the resource located in an alternative SEALDD Server.  Redirection handling is described in clause 5.2.10 of 3GPP TS 29.122 [2].
NOTE: The mandatory HTTP error status codes for the HTTP GET method listed in table 5.2.6-1 of 3GPP TS 29.122 [2] shall also apply.				

**Table 6.3.3.2.3.2-4: Headers supported by the 307 Response Code on this resource**

Name	Data type	P	Cardinality	Description
Location	string	M	1	Contains an alternative URI of the resource located in an alternative SEALDD Server.

**Table 6.3.3.2.3.2-5: Headers supported by the 308 Response Code on this resource**

Name	Data type	P	Cardinality	Description
Location	string	M	1	Contains an alternative URI of the resource located in an alternative SEALDD Server.

#### 6.3.3.2.4 Resource Custom Operations

There are no resource custom operations defined for this resource in this release of the specification.

### 6.3.4 Custom Operations without associated resources

There are no custom operations without associated resources defined for this API in this release of the specification.

### 6.3.5 Notifications

There are no notifications defined for this API in this release of the specification.

### 6.3.6 Data Model

#### 6.3.6.1 General

This clause specifies the application data model supported by the API.

Table 6.3.6.1-1 specifies the data types defined for the SDD\_DDContext API.

**Table 6.3.6.1-1: SDD\_DDContext API specific Data Types**

Data type	Section defined	Description	Applicability
DdContext	6.3.6.2.2	Represents the DD context.	
DdContextPushReq	6.3.6.2.4	Represents the DD context push request.	
DdContextResp	6.3.6.2.5	Represents the DD context push response.	
SddUuContext	6.3.6.2.6	Represents the context related to the SEALDD-Uu connection.	
SddSContext	6.3.6.2.7	Represents the context related to the SEALDD-S connection.	
TranspLayerContext	6.3.6.2.3	Represents the transport layer context.	

Table 6.3.6.1-2 specifies data types re-used by the SDD\_DDContext API from other specifications, including a reference to their respective specifications, and when needed, a short description of their use within the SDD\_DDContext API.

**Table 6.3.6.1-2: SDD\_DDContext API re-used Data Types**

Data type	Reference	Comments	Applicability
ConnInfo	6.1.6.2.4	Represents SEALDD Data transmission connection information.	
DurationSec	3GPP TS 29.122 [2]	Represents a time duration in seconds.	
ProblemDetails	3GPP TS 29.122 [2]	Represents error related information.	
QoSInfo	6.1.6.2.5	Represents SEALDD related QoS requirements.	
SupportedFeatures	3GPP TS 29.571 [18]	Represents the list of supported feature(s) and used to negotiate the applicability of the optional features.	
TransportProtocol	3GPP TS 29.558 [17]	Represents the transport layer protocol.	
ValServBdw	6.1.6.2.6	Represents VAL Server related bandwidth information.	
ValTargetUe	3GPP TS 29.549 [15]	Represents the identifier of a VAL UE or VAL user.	
ValUsersBdw	6.1.6.2.7	Represents VAL users related bandwidth information.	

## 6.3.6.2 Structured data types

### 6.3.6.2.1 Introduction

This clause defines the data structures to be used in resource representations.

### 6.3.6.2.2 Type: DdContext

**Table 6.3.6.2.2-1: Definition of type DdContext**

Attribute name	Data type	P	Cardinality	Description	Applicability
uuContext	SddUuContext	M	1	Represents the context related to the SEALDD-Uu connection.	
sContext	SddSContext	M	1	Represents the context related to the SEALDD-S connection.	
trLayerContext	TranspLayerContext	O	0..1	Represents the transport layer context. This attribute is applicable only for the SEALDD-Uu connection.	

### 6.3.6.2.3 Type: TranspLayerContext

**Table 6.3.6.2.3-1: Definition of type TranspLayerContext**

Attribute name	Data type	P	Cardinality	Description	Applicability
transProtoc	TransportProtocol	M	1	Represents the transport layer context for the SEALDD-Uu user plane communication.	

### 6.3.6.2.4 Type: DdContextPushReq

**Table 6.3.6.2.4-1: Definition of type DdContextPushReq**

Attribute name	Data type	P	Cardinality	Description	Applicability
ddContext	DdContext	M	1	Represents the DD context information.	
suppFeat	SupportedFeatures	C	0..1	Represents the list of supported features among the ones defined in clause 6.3.8. This attribute shall be present only when feature negotiation needs to take place.	

## 6.3.6.2.5 Type: DdContextResp

Table 6.3.6.2.5-1: Definition of type DdContextResp

Attribute name	Data type	P	Cardinality	Description	Applicability
ddContext	DdContext	C	0..1	Represents the DD context information.  This attribute shall be present only in the response to a DD Context Pull request.	
endPoint	ConnInfo	C	0..1	Represents the endpoint information of the SEALDD Server for the new SEALDD-Uu user plane communication.  This attribute shall be present only in a response to a DD Context Push request.	
policies	array(Policy Config)	C	0..1	Represents the set of SEALDD Policy(ies) and the related configuration information currently configured at (and being used by) the SEALDD Server.  This attribute shall be present only in a response to a DD Context Pull request.	
suppFeat	SupportedFeatures	C	0..1	Represents the list of supported features among the ones defined in clause 6.3.8.  This attribute shall be present only when feature negotiation needs to take place.	

## 6.3.6.2.6 Type: SddUuContext

Table 6.3.6.2.6-1: Definition of type SddUuContext

Attribute name	Data type	P	Cardinality	Description	Applicability
sddFlowId	string	M	1	Represents the SEALDD flow ID.	
valServiceId	string	O	0..1	Contains the identifier of the VAL service.	
valServerId	string	O	0..1	Contains the identifier of the VAL Server.	
valServEndPoint	ConnInfo	M	1	Represents the endpoint information of the selected VAL Server.	
ddClientConnInfo	ConnInfo	O	0..1	Represents the SEALDD Client-side SEALDD-Uu data transmission connection information.	
ddServConnInfo	ConnInfo	O	0..1	Represents the SEALDD Server-side SEALDD-Uu data transmission connection information.	
valTgtUe	ValTargetUe	O	0..1	Contains the identifier of the target VAL UE or VAL user.	
comLifetime	DurationSec	O	0..1	Represents the SEALDD communication lifetime.	
valUsersBdw	ValUsersBdw	O	0..1	Contains the UL/DL bandwidth limits for VAL users.	
pendingTimer	DurationSec	O	0..1	Contains the value of the pending timer representing the time duration to be respected before triggering re-connection from SEALDD Client when the bandwidth limit check fails.	



## 6.3.6.2.7 Type: SddSContext

**Table 6.3.6.2.7-1: Definition of type SddSContext**

Attribute name	Data type	P	Cardinality	Description	Applicability
valServerId	string	M	1	Contains the identifier of the VAL Server that is sending the request.	
valServiceId	string	O	0..1	Contains the identifier of the VAL service.	
valTargetId	ValTargetUe	O	0..1	Contains the identifier of the target VAL UE or VAL user.	
valServerConnInfo	ConnInfo	M	1	Contains VAL Server's side SEALDD-S data transmission connection information.	
ddServerConnInfo	ConnInfo	O	0..1	Contains SEALDD Server's side SEALDD-S data transmission connection information, i.e., address/port and/or URI via which the SEALDD Server desires to receive the application traffic from the VAL Server.	
qosInfo	QosInfo	O	0..1	Contains the requested QoS requirements for the application data transmission.	
valServerBdw	ValServBdw	O	0..1	Contains the total UL/DL bandwidth limit of the VAL Server.	
valUsersBdw	ValUsersBdw	O	0..1	Contains the UL/DL bandwidth limits for VAL users.	

## 6.3.6.3 Simple data types and enumerations

## 6.3.6.3.1 Introduction

This clause defines simple data types and enumerations that can be referenced from data structures defined in the previous clauses.

## 6.3.6.3.2 Simple data types

The simple data types defined in table 6.3.6.3.2-1 shall be supported.

**Table 6.3.6.3.2-1: Simple data types**

Type name	Description

## 6.3.6.4 Data types describing alternative data types or combinations of data types

There are no data types describing alternative data types or combinations of data types defined for this API in this release of the specification.

## 6.3.6.5 Binary data

## 6.3.6.5.1 Binary Data Types

**Table 6.3.6.5.1-1: Binary Data Types**

Name	Clause defined	Content type

## 6.3.7 Error Handling

### 6.3.7.1 General

For the SDD\_DDContext API, error handling shall be supported as specified in clause 6.7 of 3GPP TS 29.549 [15].

In addition, the requirements in the following clauses are applicable for the SDD\_DDContext API.

### 6.3.7.2 Protocol Errors

No specific protocol errors for the SDD\_DDContext API are specified.

### 6.3.7.3 Application Errors

The application errors defined for the SDD\_DDContext API are listed in table 6.3.7.3-1.

**Table 6.3.7.3-1: Application errors**

Application Error	HTTP status code	Description	Applicability
RELOCATION_REJECTED	403 Forbidden	Indicates that the DD Context push request is rejected because the DD Context relocation is rejected or not authorized by the SEALDD Server for the concerned SEALDD Client.	

## 6.3.8 Feature negotiation

The optional features listed in table 6.3.8-1 are defined for the SDD\_DDContext API. They shall be negotiated using the extensibility mechanism defined in clause 6.8 of 3GPP TS 29.549 [15].

**Table 6.3.8-1: Supported Features**

Feature number	Feature Name	Description

## 6.3.9 Security

The provisions of clause 9 of 3GPP TS 29.549 [15] shall apply for the SDD\_DDContext API.

## 6.4 SDD\_TransmissionQualityMeasurement Service API

### 6.4.1 Introduction

The SDD\_TransmissionQualityMeasurement service shall use the SDD\_TransmissionQualityMeasurement API.

The API URI of the SDD\_TransmissionQualityMeasurement Service API shall be:

**{apiRoot}/<apiName>/<apiVersion>**

The request URIs used in HTTP requests shall have the Resource URI structure defined in clause 6.5 of 3GPP TS 29.549 [15], i.e.:

**{apiRoot}/<apiName>/<apiVersion>/<apiSpecificSuffixes>**

with the following components:

- The {apiRoot} shall be set as described in clause 6.5 of 3GPP TS 29.549 [15].
- The <apiName> shall be "sdd-tqm".
- The <apiVersion> shall be "v1".
- The <apiSpecificSuffixes> shall be set as described in clause 6.5 of 3GPP TS 29.549 [15].

**NOTE:** When 3GPP TS 29.122 [2] is referenced for the common protocol and interface aspects for API definition in the clauses under clause 6.4, the SEALDD Server takes the role of the SCEF and the service consumer takes the role of the SCS/AS.

### 6.4.2 Usage of HTTP

The provisions of clause 6.3 of 3GPP TS 29.549 [15] shall apply for the SDD\_TransmissionQualityMeasurement API.

### 6.4.3 Resources

#### 6.4.3.1 Overview

This clause describes the structure for the Resource URIs and the resources and methods used for the service.

Figure 6.4.3.1-1 depicts the resource URIs structure for the SDD\_TransmissionQualityMeasurement API.

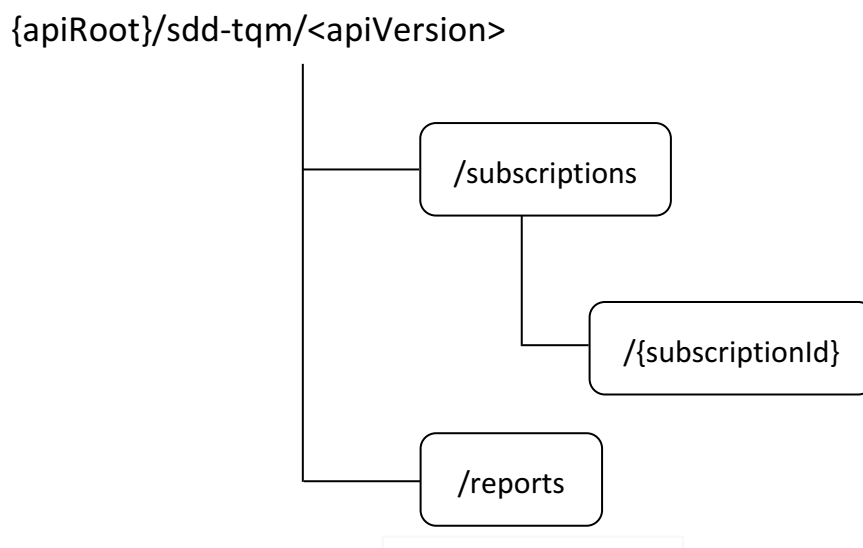

**Figure 6.4.3.1-1: Resource URIs structure of the SDD\_TransmissionQualityMeasurement API**

Table 6.4.3.1-1 provides an overview of the resources and applicable HTTP methods for the SDD\_TransmissionQualityMeasurement API.

**Table 6.4.3.1-1: Resources and methods overview**

Resource name	Resource URI	HTTP method or custom operation	Description
Transmission Quality Measurement Subscriptions	/subscriptions	POST	Request the creation of a Transmission Quality Measurement Subscription.
Individual Transmission Quality Measurement Subscription	/subscriptions/{subscriptionId}	GET	Retrieve an existing "Individual Transmission Quality Measurement Subscription" resource.
		PUT	Request the update of an existing "Individual Transmission Quality Measurement Subscription" resource.
		PATCH	Request the modification of an existing "Individual Transmission Quality Measurement Subscription" resource.
		DELETE	Request the deletion of an existing "Individual Transmission Quality Measurement Subscription" resource.
Historical Transmission Quality Measurement Reports	/reports	GET	Retrieve Historical Transmission Quality Measurement Report(s).

## 6.4.3.2 Resource: Transmission Quality Measurement Subscriptions

### 6.4.3.2.1 Description

This resource represents the collection of Transmission Quality Measurement Subscription(s) managed by the SEALDD Server.

### 6.4.3.2.2 Resource Definition

Resource URI: **{apiRoot}/sdd-tqm/<apiVersion>/subscriptions**

This resource shall support the resource URI variables defined in table 6.4.3.2.2-1.

**Table 6.4.3.2.2-1: Resource URI variables for this resource**

Name	Data type	Definition
apiRoot	string	See clause 6.4.1.

### 6.4.3.2.3 Resource Standard Methods

#### 6.4.3.2.3.1 POST

The HTTP POST method allows a service consumer to request the creation of a Transmission Quality Measurement Subscription at the SEALDD Server.

This method shall support the URI query parameters specified in table 6.4.3.2.3.1-1.

**Table 6.4.3.2.3.1-1: URI query parameters supported by the POST method on this resource**

Name	Data type	P	Cardinality	Description	Applicability
n/a					

This method shall support the request data structures specified in table 6.4.3.2.3.1-2 and the response data structures and response codes specified in table 6.4.3.2.3.1-3.

**Table 6.4.3.2.3.1-2: Data structures supported by the POST Request Body on this resource**

Data type	P	Cardinality	Description
TransQualMeasSubsc	M	1	Represents the parameters to request the creation of a Transmission Quality Measurement Subscription.

**Table 6.4.3.2.3.1-3: Data structures supported by the POST Response Body on this resource**

Data type	P	Cardinality	Response codes	Description
TransQualMeasSubsc	M	1	201 Created	Successful case. The Transmission Quality Measurement Subscription is successfully created and a representation of the created "Individual Transmission Quality Measurement Subscription" resource shall be returned in the response body.  An HTTP "Location" header that contains the URI of the created resource shall also be included.
ProblemDetails	O	0..1	403 Forbidden	(NOTE 2)
NOTE 1: The mandatory HTTP error status codes for the HTTP POST method listed in table 5.2.6-1 of 3GPP TS 29.122 [2] shall also apply.				
NOTE 2: Failure causes are described in clause 6.4.7.				

**Table 6.4.3.2.3.1-4: Headers supported by the 201 Response Code on this resource**

Name	Data type	P	Cardinality	Description
Location	string	M	1	Contains the URI of the newly created resource, according to the structure: {apiRoot}/sdd-tqm/<apiVersion>/subscriptions/{subscriptionId}

#### 6.4.3.2.4 Resource Custom Operations

There are no resource custom operations defined for this resource in this release of the specification.

### 6.4.3.3 Resource: Individual Transmission Quality Measurement Subscription

#### 6.4.3.3.1 Description

This resource represents a Transmission Quality Measurement Subscription managed by the SEALDD Server.

#### 6.4.3.3.2 Resource Definition

Resource URI: {apiRoot}/sdd-tqm/<apiVersion>/subscriptions/{subscriptionId}

This resource shall support the resource URI variables defined in table 6.4.3.3.2-1.

**Table 6.4.3.3.2-1: Resource URI variables for this resource**

Name	Data type	Definition
apiRoot	string	See clause 6.4.1.
subscriptionId	string	Represents the identifier of the "Individual Transmission Quality Measurement Subscription" resource.

### 6.4.3.3.3 Resource Standard Methods

#### 6.4.3.3.3.1 GET

The HTTP GET method allows a service consumer to retrieve an existing "Individual Transmission Quality Measurement Subscription" resource at the SEALDD Server.

This method shall support the URI query parameters specified in table 6.4.3.3.3.1-1.

**Table 6.4.3.3.3.1-1: URI query parameters supported by the GET method on this resource**

Name	Data type	P	Cardinality	Description	Applicability
n/a					

This method shall support the request data structures specified in table 6.4.3.3.3.1-2 and the response data structures and response codes specified in table 6.4.3.3.3.1-3.

**Table 6.4.3.3.3.1-2: Data structures supported by the GET Request Body on this resource**

Data type	P	Cardinality	Description
n/a			

**Table 6.4.3.3.3.1-3: Data structures supported by the GET Response Body on this resource**

Data type	P	Cardinality	Response codes	Description
TransQualMeasSubsc	M	1	200 OK	Successful case. The requested "Individual Transmission Quality Measurement Subscription" resource shall be returned.
n/a			307 Temporary Redirect	Temporary redirection. The response shall include a Location header field containing an alternative URI of the resource located in an alternative SEALDD Server. Redirection handling is described in clause 5.2.10 of 3GPP TS 29.122 [2].
n/a			308 Permanent Redirect	Permanent redirection. The response shall include a Location header field containing an alternative URI of the resource located in an alternative SEALDD Server. Redirection handling is described in clause 5.2.10 of 3GPP TS 29.122 [2].
NOTE: The mandatory HTTP error status codes for the HTTP GET method listed in table 5.2.6-1 of 3GPP TS 29.122 [2] shall also apply.				

**Table 6.4.3.3.3.1-4: Headers supported by the 307 Response Code on this resource**

Name	Data type	P	Cardinality	Description
Location	string	M	1	Contains an alternative URI of the resource located in an alternative SEALDD Server.

**Table 6.4.3.3.1-5: Headers supported by the 308 Response Code on this resource**

Name	Data type	P	Cardinality	Description
Location	string	M	1	Contains an alternative URI of the resource located in an alternative SEALDD Server.

## 6.4.3.3.3.2 PUT

The HTTP PUT method allows a service consumer to request the update of an existing "Individual Transmission Quality Measurement Subscription" resource at the SEALDD Server.

This method shall support the URI query parameters specified in table 6.4.3.3.2-1.

**Table 6.4.3.3.2-1: URI query parameters supported by the PUT method on this resource**

Name	Data type	P	Cardinality	Description	Applicability
n/a					

This method shall support the request data structures specified in table 6.4.3.3.2-2 and the response data structures and response codes specified in table 6.4.3.3.2-3.

**Table 6.4.3.3.2-2: Data structures supported by the PUT Request Body on this resource**

Data type	P	Cardinality	Description
TransQualMeasSubsc	M	1	Represents the updated representation of the "Individual Transmission Quality Measurement Subscription" resource.

**Table 6.4.3.3.2-3: Data structures supported by the PUT Response Body on this resource**

Data type	P	Cardinality	Response codes	Description
TransQualMeasSubsc	M	1	200 OK	Successful case. The "Individual Transmission Quality Measurement Subscription" resource is successfully updated and a representation of the updated resource shall be returned in the response body.
n/a			204 No Content	Successful case. The "Individual Transmission Quality Measurement Subscription" resource is successfully updated and no content is returned in the response body.
n/a			307 Temporary Redirect	Temporary redirection. The response shall include a Location header field containing an alternative URI of the resource located in an alternative SEALDD Server. Redirection handling is described in clause 5.2.10 of 3GPP TS 29.122 [2].
n/a			308 Permanent Redirect	Permanent redirection. The response shall include a Location header field containing an alternative URI of the resource located in an alternative SEALDD Server. Redirection handling is described in clause 5.2.10 of 3GPP TS 29.122 [2].
ProblemDetails	O	0..1	403 Forbidden	(NOTE 2)
NOTE 1: The mandatory HTTP error status codes for the HTTP PUT method listed in table 5.2.6-1 of 3GPP TS 29.122 [2] shall also apply.				
NOTE 2: Failure causes are described in clause 6.4.7.				

**Table 6.4.3.3.3.2-4: Headers supported by the 307 Response Code on this resource**

Name	Data type	P	Cardinality	Description
Location	string	M	1	Contains an alternative URI of the resource located in an alternative SEALDD Server.

**Table 6.4.3.3.3.2-5: Headers supported by the 308 Response Code on this resource**

Name	Data type	P	Cardinality	Description
Location	string	M	1	Contains an alternative URI of the resource located in an alternative SEALDD Server.

#### 6.4.3.3.3.3 PATCH

The HTTP PATCH method allows a service consumer to request the modification of an existing "Individual Transmission Quality Measurement Subscription" resource at the SEALDD Server.

This method shall support the URI query parameters specified in table 6.4.3.3.3.3-1.

**Table 6.4.3.3.3.3-1: URI query parameters supported by the PATCH method on this resource**

Name	Data type	P	Cardinality	Description	Applicability
n/a					

This method shall support the request data structures specified in table 6.4.3.3.3.3-2 and the response data structures and response codes specified in table 6.4.3.3.3.3-3.

**Table 6.4.3.3.3.3-2: Data structures supported by the PATCH Request Body on this resource**

Data type	P	Cardinality	Description
TransQualMeasSubscPatch	M	1	Represents the parameters to request the modification of the "Individual Transmission Quality Measurement Subscription" resource.



**Table 6.4.3.3.3-3: Data structures supported by the PATCH Response Body on this resource**

Data type	P	Cardinality	Response codes	Description
TransQualMeasSubsc	M	1	200 OK	Successful case. The "Individual Transmission Quality Measurement Subscription" resource is successfully modified and a representation of the updated resource shall be returned in the response body.
n/a			204 No Content	Successful case. The "Individual Transmission Quality Measurement Subscription" resource is successfully modified and no content is returned in the response body.
n/a			307 Temporary Redirect	Temporary redirection.  The response shall include a Location header field containing an alternative URI of the resource located in an alternative SEALDD Server.  Redirection handling is described in clause 5.2.10 of 3GPP TS 29.122 [2].
n/a			308 Permanent Redirect	Permanent redirection.  The response shall include a Location header field containing an alternative URI of the resource located in an alternative SEALDD Server.  Redirection handling is described in clause 5.2.10 of 3GPP TS 29.122 [2].
ProblemDetails	O	0..1	403 Forbidden	(NOTE 2)
NOTE 1: The mandatory HTTP error status codes for the HTTP PATCH method listed in table 5.2.6-1 of 3GPP TS 29.122 [2] shall also apply.				
NOTE 2: Failure causes are described in clause 6.4.7.				

**Table 6.4.3.3.3-4: Headers supported by the 307 Response Code on this resource**

Name	Data type	P	Cardinality	Description
Location	string	M	1	Contains an alternative URI of the resource located in an alternative SEALDD Server.

**Table 6.4.3.3.3-5: Headers supported by the 308 Response Code on this resource**

Name	Data type	P	Cardinality	Description
Location	string	M	1	Contains an alternative URI of the resource located in an alternative SEALDD Server.

#### 6.4.3.3.3.4 DELETE

The HTTP DELETE method allows a service consumer to request the deletion of an existing "Individual Transmission Quality Measurement Subscription" resource at the SEALDD Server.

This method shall support the URI query parameters specified in table 6.4.3.3.3.4-1.

**Table 6.4.3.3.3.4-1: URI query parameters supported by the DELETE method on this resource**

Name	Data type	P	Cardinality	Description	Applicability
n/a					

This method shall support the request data structures specified in table 6.4.3.3.3.4-2 and the response data structures and response codes specified in table 6.4.3.3.3.4-3.

**Table 6.4.3.3.3.4-2: Data structures supported by the DELETE Request Body on this resource**

Data type	P	Cardinality	Description
n/a			

**Table 6.4.3.3.3.4-3: Data structures supported by the DELETE Response Body on this resource**

Data type	P	Cardinality	Response codes	Description
n/a			204 No Content	Successful case. The "Individual Transmission Quality Measurement Subscription" resource is successfully deleted.
n/a			307 Temporary Redirect	Temporary redirection. The response shall include a Location header field containing an alternative URI of the resource located in an alternative SEALDD Server. Redirection handling is described in clause 5.2.10 of 3GPP TS 29.122 [2].
n/a			308 Permanent Redirect	Permanent redirection. The response shall include a Location header field containing an alternative URI of the resource located in an alternative SEALDD Server. Redirection handling is described in clause 5.2.10 of 3GPP TS 29.122 [2].
NOTE: The mandatory HTTP error status codes for the HTTP DELETE method listed in table 5.2.6-1 of 3GPP TS 29.122 [2] shall also apply.				

**Table 6.4.3.3.3.4-4: Headers supported by the 307 Response Code on this resource**

Name	Data type	P	Cardinality	Description
Location	string	M	1	Contains an alternative URI of the resource located in an alternative SEALDD Server.

**Table 6.4.3.3.3.4-5: Headers supported by the 308 Response Code on this resource**

Name	Data type	P	Cardinality	Description
Location	string	M	1	Contains an alternative URI of the resource located in an alternative SEALDD Server.

#### 6.4.3.3.4 Resource Custom Operations

There are no resource custom operations defined for this resource in this release of the specification.

#### 6.4.3.4 Resource: Historical Transmission Quality Measurement Reports

##### 6.4.3.4.1 Description

This resource represents the collection of Historical Transmission Quality Measurement Report(s) managed by the SEALDD Server.

##### 6.4.3.4.2 Resource Definition

Resource URI: `{apiRoot}/sdd-tqm/<apiVersion>/reports`

This resource shall support the resource URI variables defined in table 6.4.3.4.2-1.

**Table 6.4.3.4.2-1: Resource URI variables for this resource**

Name	Data type	Definition
apiRoot	string	See clause 6.4.1.

### 6.4.3.4.3 Resource Standard Methods

#### 6.4.3.4.3.1 GET

The HTTP GET method allows a service consumer to retrieve Historical Transmission Quality Measurement Report(s) from the SEALDD Server.

This method shall support the URI query parameters specified in table 6.4.3.4.3.1-1.

**Table 6.4.3.4.3.1-1: URI query parameters supported by the GET method on this resource**

Name	Data type	P	Cardinality	Description	Applicability
app-traffic-ids	array(string)	M	1..N	Contains the identifier(s) of the targeted application traffic (e.g., VAL Service ID, VAL Server ID).	
val-group-id	string	O	0..1	Contains the identity of the VAL group to which the request is related. (NOTE)	
val-ue-ids-list	array(string)	O	1..N	Contains the list of the identifier(s) of the VAL UE(s) to which the request is related. (NOTE)	
val-user-ids-list	array(string)	O	1..N	Contains the list of the identifier(s) of the VAL user(s) to which the request is related. (NOTE)	
all-val-ues	boolean	O	0..1	Indicates that the request is related to all VAL UE/user(s) of the application traffic identified by the application traffic identifier(s) provided within the "appTrafficIds" attribute.  - "true" indicates that the request is related to all VAL UE/user(s). - "false" indicates that the request is not related to all VAL UE/user(s). - The default value when this query parameter is omitted is "false".  (NOTE)	
supp-feat	SupportedFeatures	O	0..1	Contains the list of supported features among the ones defined in clause 6.4.8.  This query parameter shall be present only when feature negotiation needs to take place.	
NOTE: The "val-group-id" query parameter, the "val-ue-ids-list" query parameter and/or the "val-user-ids-list" query parameter, and when set to "true", the "all-val-ues" query parameter, are mutually exclusive. Either one of them may be present.					

This method shall support the request data structures specified in table 6.4.3.4.3.1-2 and the response data structures and response codes specified in table 6.4.3.4.3.1-3.

**Table 6.4.3.4.3.1-2: Data structures supported by the GET Request Body on this resource**

Data type	P	Cardinality	Description
n/a			

**Table 6.4.3.4.3.1-3: Data structures supported by the GET Response Body on this resource**

Data type	P	Cardinality	Response codes	Description
HistTransQualMeasReports	M	1	200 OK	Successful case. The requested Historical Transmission Quality Measurement Report(s), if any, shall be returned.
n/a			307 Temporary Redirect	Temporary redirection. The response shall include a Location header field containing an alternative URI of the resource located in an alternative SEALDD Server. Redirection handling is described in clause 5.2.10 of 3GPP TS 29.122 [2].
n/a			308 Permanent Redirect	Permanent redirection. The response shall include a Location header field containing an alternative URI of the resource located in an alternative SEALDD Server. Redirection handling is described in clause 5.2.10 of 3GPP TS 29.122 [2].
NOTE: The mandatory HTTP error status codes for the HTTP GET method listed in table 5.2.6-1 of 3GPP TS 29.122 [2] shall also apply.				

**Table 6.4.3.4.3.1-4: Headers supported by the 307 Response Code on this resource**

Name	Data type	P	Cardinality	Description
Location	string	M	1	Contains an alternative URI of the resource located in an alternative SEALDD Server.

**Table 6.4.3.4.3.1-5: Headers supported by the 308 Response Code on this resource**

Name	Data type	P	Cardinality	Description
Location	string	M	1	Contains an alternative URI of the resource located in an alternative SEALDD Server.

#### 6.4.3.4.4 Resource Custom Operations

There are no resource custom operations defined for this resource in this release of the specification.

#### 6.4.4 Custom Operations without associated resources

There are no custom operations without associated resources defined for this API in this release of the specification.

#### 6.4.5 Notifications

##### 6.4.5.1 General

Notifications shall comply to clause 6.6 of 3GPP TS 29.549 [15].

**Table 6.4.5.1-1: Notifications overview**

Notification	Callback URI	HTTP method or custom operation	Description (service operation)
Transmission Quality Measurement Notification	{notifUri}	POST	Enables a SEALDD Server to notify a previously subscribed service consumer on Transmission Quality Measurement report(s).

## 6.4.5.2 Transmission Quality Measurement Notification

### 6.4.5.2.1 Description

The Transmission Quality Measurement Notification is used by a SEALDD Server to notify a previously subscribed service consumer on Transmission Quality Measurement report(s).

### 6.4.5.2.2 Target URI

The Callback URI "{**notifUri**}" shall be used with the callback URI variables defined in table 6.4.5.2.2-1.

**Table 6.4.5.2.2-1: Callback URI variables**

Name	Data type	Definition
notifUri	Uri	Represents the callback URI encoded as a string formatted as a URI.

### 6.4.5.2.3 Standard Methods

#### 6.4.5.2.3.1 POST

This method shall support the request data structures specified in table 6.4.5.2.3.1-1 and the response data structures and response codes specified in table 6.4.5.2.3.1-2.

**Table 6.4.5.2.3.1-1: Data structures supported by the POST Request Body**

Data type	P	Cardinality	Description
TransQualMeasNotif	M	1	Represents the Transmission Quality Measurement Notification.

**Table 6.4.5.2.3.1-2: Data structures supported by the POST Response Body**

Data type	P	Cardinality	Response codes	Description
n/a			204 No Content	Successful case. The Transmission Quality Measurement Notification is successfully received and acknowledged.
n/a			307 Temporary Redirect	Temporary redirection. The response shall include a Location header field containing an alternative URI representing the end point of an alternative service consumer towards which the notification should be sent. Redirection handling is described in clause 5.2.10 of 3GPP TS 29.122 [2].
n/a			308 Permanent Redirect	Permanent redirection. The response shall include a Location header field containing an alternative URI representing the end point of an alternative service consumer towards which the notification should be sent. Redirection handling is described in clause 5.2.10 of 3GPP TS 29.122 [2].
NOTE: The mandatory HTTP error status codes for the HTTP POST method listed in table 5.2.6-1 of 3GPP TS 29.122 [2] shall also apply.				

**Table 6.4.5.2.3.1-3: Headers supported by the 307 Response Code on this resource**

Name	Data type	P	Cardinality	Description
Location	string	M	1	Contains an alternative URI representing the end point of an alternative service consumer towards which the notification should be redirected.

**Table 6.4.5.2.3.1-4: Headers supported by the 308 Response Code on this resource**

Name	Data type	P	Cardinality	Description
Location	string	M	1	Contains an alternative URI representing the end point of an alternative service consumer towards which the notification should be redirected.

## 6.4.6 Data Model

### 6.4.6.1 General

This clause specifies the application data model supported by the API.

Table 6.4.6.1-1 specifies the data types defined for the SDD\_TransmissionQualityMeasurement API.

**Table 6.4.6.1-1: SDD\_TransmissionQualityMeasurement API specific Data Types**

Data type	Clause defined	Description	Applicability
HistTransQualMeasReports	6.4.6.2.9	Represents the Historical Transmission Quality Measurement Report(s).	
MeasurementId	6.4.6.3.3	Represents the transmission quality measurement type.	
RepGranularity	6.4.6.3.4	Represents the reporting granularity.	
TransQualMeasCriteria	6.4.6.2.7	Represents the transmission quality measurement reporting criteria.	
TransQualMeasCriteriaSet	6.4.6.2.10	Represents a set of transmission quality measurement reporting criteria.	
TransQualMeasData	6.4.6.2.8	Represents the transmission quality measurement data.	
TransQualMeasNotif	6.4.6.2.5	Represents a Transmission Quality Measurement Notification.	
TransQualMeasReport	6.4.6.2.6	Represents a Transmission Quality Measurement report.	
TransQualMeasReq	6.4.6.2.3	Represents the Transmission Quality Measurement reporting requirements.	
TransQualMeasSubsc	6.4.6.2.2	Represents a Transmission Quality Measurement Subscription.	
TransQualMeasSubscPatch	6.4.6.2.4	Represents the requested modifications to a Transmission Quality Measurement Subscription.	

Table 6.4.6.1-2 specifies data types re-used by the SDD\_TransmissionQualityMeasurement API from other specifications, including a reference to their respective specifications, and when needed, a short description of their use within the SDD\_TransmissionQualityMeasurement API.

**Table 6.4.6.1-2: SDD\_TransmissionQualityMeasurement API re-used Data Types**

Data type	Reference	Comments	Applicability
BitRate	3GPP TS 29.571 [18]	Represents a bit rate.	
DateTime	3GPP TS 29.122 [2]	Represents a date and a time.	
DateTimeRo	3GPP TS 29.122 [2]	Represents a date and a time with the read-only property.	
DurationSec	3GPP TS 29.122 [2]	Represents a time duration in seconds.	
MatchingDirection	3GPP TS 29.520 [20]	Represents the threshold matching direction.	
NotificationMethod	3GPP TS 29.508 [16]	Represents the reporting type.	
PacketLossRate	3GPP TS 29.571 [18]	Represents the packet loss rate.	
ProblemDetails	3GPP TS 29.122 [2]	Represents error related information.	
SupportedFeatures	3GPP TS 29.571 [18]	Represents the list of supported feature(s) and used to negotiate the applicability of the optional features.	
TimeWindow	3GPP TS 29.122 [2]	Represents a time window.	
UInt32	3GPP TS 29.571 [18]	Represents an unsigned 32-bit integer.	
UInteger	3GPP TS 29.571 [18]	Represents an unsigned integer.	
Uri	3GPP TS 29.122 [2]	Represents a URI.	
ValidityConditions	3GPP TS 29.549 [15]	Represents temporal and/or spatial validity conditions.	

## 6.4.6.2 Structured data types

### 6.4.6.2.1 Introduction

This clause defines the data structures to be used in resource representations.

## 6.4.6.2.2 Type: TransQualMeasSubsc

Table 6.4.6.2.2-1: Definition of type TransQualMeasSubsc

Attribute name	Data type	P	Cardinality	Description	Applicability
appTrafficIds	array(string)	M	1..N	Contains the identifier(s) of the targeted application traffic (e.g., VAL Service ID, VAL Server ID).	
notifUri	Uri	M	1	Contains the URI via which Transmission Quality Measurement notifications shall be delivered.	
valGroupId	string	C	0..1	Contains the identity of the VAL group to which the subscription is related.  (NOTE)	
valUeIdsList	array(string)	C	1..N	Contains the list of the identifier(s) of the VAL UE(s) to which the subscription is related.  (NOTE)	
valUserIdsList	array(string)	C	1..N	Contains the list of the identifier(s) of the VAL user(s) to which the subscription is related.  (NOTE)	
allValUesInd	boolean	C	0..1	Indicates that the subscription is related to all VAL UE/user(s) of the application traffic identified by the application traffic identifier(s) provided within the "appTrafficIds" attribute.  - "true" indicates that the subscription is related to all VAL UE/user(s). - "false" indicates that the subscription is not related to all VAL UE/user(s). - The default value when this attribute is omitted is "false".  (NOTE)	
measConds	array(ValidityConditions)	O	1..N	Contains the set of temporal and/or spatial measurement condition(s) of the subscription.	
reqs	map(TransQualMeasReq)	M	1..N	Contains the transmission quality measurement reporting requirements of the subscription.  The key of the map shall be any unique string encoded value.	
subsExpTime	DateTimeRo	O	0..1	Indicates the time at which the subscription shall expire.  This attribute may be present only in Transmission Quality Measurement subscription creation/update responses.  If this attribute is absent, this means that the subscription shall not expire, until explicitly deleted by the service consumer.	
suppFeat	SupportedFeatures	C	0..1	Contains the list of supported features among the ones defined in clause 6.4.8.  This attribute shall be present only when feature negotiation needs to take place.	
NOTE: The "valGroupId" attribute, the "valUeIdsList" attribute and/or the "valUserIdsList" attribute, and when set to "true", the "allValUesInd" attribute, are mutually exclusive. Either one of them shall be present.					



## 6.4.6.2.3 Type: TransQualMeasReq

Table 6.4.6.2.3-1: Definition of type TransQualMeasReq

Attribute name	Data type	P	Cardinality	Description	Applicability
measId	array(MeasurementId)	M	1..N	Contains the requested transmission quality measurement(s).	
repType	NotificationMethod	O	0..1	Contains the requested reporting type (e.g. periodic reporting). The default value is "PERIODIC" (i.e., periodic reporting), if this attribute is not present.	
repPeriodicity	DurationSec	O	0..1	Contains the reporting periodicity. This attribute shall be present only if the "repType" attribute is not present, or present and set to the value "PERIODIC".	
repGranularity	RepGranularity	O	0..1	Contains the reporting granularity, i.e., whether the requested transmission quality measurement reporting is per individual VAL UE/user, VAL group or all VAL UE/user(s) granularity.	
measWindow	TimeWindow	O	0..1	Contains the measurement window for the requested transmission quality measurements.	
measExpTime	DateTime	O	0..1	Contains the measurement expiration time.	
repCriteriaSets	map(TransQualMeasCriteriaSet)	O	1..N	Contains one or several set(s) of transmission quality measurement reporting criteria. The key of the map shall be any unique string encoded value. Only the criteria related to the subscribed measurement(s) within the "measId" attribute shall be present within this attribute.  (NOTE)	
NOTE: This attribute shall not contain two map entries having the same value for the "criteria" attribute of the TransQualMeasCriteriaSet data type (i.e., a transmission quality measurement reporting criteria shall not be provided twice).					

## 6.4.6.2.4 Type: TransQualMeasSubscPatch

Table 6.4.6.2.4-1: Definition of type TransQualMeasSubscPatch

Attribute name	Data type	P	Cardinality	Description	Applicability
measConds	array(ValidityConditions)	O	1..N	Contains the updated set of temporal and/or spatial measurement condition(s) of the subscription.	
reqs	map(TransQualMeasReq)	O	1..N	Contains the updated transmission quality measurement reporting requirements of the subscription. The key of the map shall be any unique string encoded value and shall be set to the same value as the one provided during the creation of the corresponding transmission quality measurement subscription.	
notifUri	Uri	O	0..1	Contains the updated URI via which the notifications shall be delivered.	

## 6.4.6.2.5 Type: TransQualMeasNotif

**Table 6.4.6.2.5-1: Definition of type TransQualMeasNotif**

Attribute name	Data type	P	Cardinality	Description	Applicability
subscriptionId	string	M	1	Contains the identifier of the subscription to which the transmission quality measurement notification is related.	
reports	array(TransQualMeasReport)	M	1..N	Contains the transmission quality measurement report(s).	

## 6.4.6.2.6 Type: TransQualMeasReport

**Table 6.4.6.2.6-1: Definition of type TransQualMeasReport**

Attribute name	Data type	P	Cardinality	Description	Applicability
measId	array(MeasurementId)	M	1..N	Contains the reported transmission quality measurement(s).	
valUeIds	array(string)	C	1..N	Contains the list of the identifier(s) of the VAL UE(s) to which the transmission quality measurement(s) report is related. (NOTE)	
valUserIds	array(string)	C	1..N	Contains the list of the identifier(s) of the VAL user(s) to which the transmission quality measurement(s) report is related. (NOTE)	
measData	TransQualMeasData	O	0..1	Contains the reported transmission quality measurement(s) data.	
timestamp	DateTime	O	0..1	Contains the timestamp of this transmission quality measurement(s) report.	
NOTE: These attributes are mutually exclusive. Either one of them shall be present, unless the corresponding request targets a single VAL UE/user, in which case these attributes may not be present.					

## 6.4.6.2.7 Type: TransQualMeasCriteria

Table 6.4.6.2.7-1: Definition of type TransQualMeasCriteria

Attribute name	Data type	P	Cardinality	Description	Applicability
minLatency	UInteger	C	0..1	Contains the requested minimum latency (expressed in milliseconds) for transmission quality measurement reporting. (NOTE)	
avgLatency	UInteger	C	0..1	Contains the requested average latency (expressed in milliseconds) for transmission quality measurement reporting. (NOTE)	
maxLatency	UInteger	C	0..1	Contains the requested maximum latency (expressed in milliseconds) for transmission quality measurement reporting. (NOTE)	
minBitRate	BitRate	C	0..1	Contains the requested minimum bit rate for transmission quality measurement reporting. (NOTE)	
avgBitRate	BitRate	C	0..1	Contains the requested average bit rate for transmission quality measurement reporting. (NOTE)	
maxBitRate	BitRate	C	0..1	Contains the requested maximum bit rate for transmission quality measurement reporting. (NOTE)	
minPackLossRate	PacketLossRate	C	0..1	Contains the requested minimum packet loss rate for transmission quality measurement reporting. (NOTE)	
avgPackLossRate	PacketLossRate	C	0..1	Contains the requested average packet loss rate for transmission quality measurement reporting. (NOTE)	
maxPackLossRate	PacketLossRate	C	0..1	Contains the requested maximum packet loss rate for transmission quality measurement reporting. (NOTE)	
minJitter	Uint32	C	0..1	Contains the requested minimum jitter (expressed in nanoseconds) for transmission quality measurement reporting. (NOTE)	
avgJitter	Uint32	C	0..1	Contains the requested average jitter (expressed in nanoseconds) for transmission quality measurement reporting. (NOTE)	
maxJitter	Uint32	C	0..1	Contains the requested maximum jitter (expressed in nanoseconds) for transmission quality measurement reporting. (NOTE)	
NOTE: These attributes are mutually exclusive. Either one of them shall be present.					

6.4.6.2.8 Type: TransQualMeasData

**Table 6.4.6.2.8-1: Definition of type TransQualMeasData**

Attribute name	Data type	P	Cardinality	Description	Applicability
minLatency	UInteger	O	0..1	Contains the measured minimum latency (expressed in milliseconds).  (NOTE)	
maxLatency	UInteger	O	0..1	Contains the measured maximum latency (expressed in milliseconds).  (NOTE)	
avgLatency	UInteger	O	0..1	Contains the measured average latency (expressed in milliseconds).  (NOTE)	
stdDevLatency	UInteger	O	0..1	Contains the standard deviation (expressed in milliseconds) for the measured latency.  This attribute may be present only if the "minLatency", "maxLatency" and/or "avgLatency" attribute(s) is/are present.	
kPercLatency	UInteger	O	0..1	Contains the kPercentile (expressed in milliseconds) for the measured latency.  This attribute may be present only if the "minLatency", "maxLatency" and/or "avgLatency" attribute(s) is/are present.	
kValLatency	UInteger	C	0..1	Contains the value of the reported percentile ("k" parameter value) within the "kPercLatency" attribute.  This attribute shall be present only if the "kPercLatency" attribute is present.	
minBitRate	BitRate	O	0..1	Contains the measured minimum bit rate.  (NOTE)	
maxBitRate	BitRate	O	0..1	Contains the measured maximum bit rate.  (NOTE)	
avgBitRate	BitRate	O	0..1	Contains the measured average bit rate.  (NOTE)	
stdDevBitRate	BitRate	O	0..1	Contains the standard deviation for the measured bit rate.  This attribute may be present only if the "minBitRate", "maxBitRate" and/or "avgBitRate" attribute(s) is/are present.	
kPercBitRate	BitRate	O	0..1	Contains the kPercentile for the measured bit rate.  This attribute may be present only if the "minBitRate", "maxBitRate" and/or "avgBitRate" attribute(s) is/are present.	
kValBitRate	UInteger	C	0..1	Contains the value of the reported percentile ("k" parameter value) within the "kPercBitRate" attribute.  This attribute shall be present only if the "kPercBitRate" attribute is present.	
minPackLossRate	PacketLossRate	O	0..1	Contains the measured minimum packet loss rate.  (NOTE)	
maxPackLossRate	PacketLossRate	O	0..1	Contains the measured maximum packet loss rate.  (NOTE)	

avgPackLossRate	PacketLossRate	O	0..1	Contains the measured average packet loss rate. (NOTE)
stdDevPackLossRate	PacketLossRate	O	0..1	Contains the standard deviation for the measured packet loss rate. This attribute may be present only if the "minPackLossRate", "maxPackLossRate" and/or "avgPackLossRate" attribute(s) is/are present.
kPercPackLossRate	PacketLossRate	O	0..1	Contains the kPercentile for the measured packet loss rate. This attribute may be present only if the "minPackLossRate", "maxPackLossRate" and/or "avgPackLossRate" attribute(s) is/are present.
kValPackLossRate	UInteger	C	0..1	Contains the value of the reported percentile ("k" parameter value) within the "kPercPackLossRate" attribute. This attribute shall be present only if the "kPercPackLossRate" attribute is present.
minJitter	UInt32	O	0..1	Contains the measured minimum jitter (expressed in nanoseconds). (NOTE)
maxJitter	UInt32	O	0..1	Contains the measured maximum jitter (expressed in nanoseconds). (NOTE)
avgJitter	UInt32	O	0..1	Contains the measured average jitter (expressed in nanoseconds). (NOTE)
stdDevJitter	UInt32	O	0..1	Contains the standard deviation (expressed in nanoseconds) for the measured Jitter. This attribute may be present only if the "minJitter", "maxJitter" and/or "avgJitter" attribute(s) is/are present.
kPercJitter	UInt32	O	0..1	Contains the kPercentile (expressed in nanoseconds) for the measured Jitter. This attribute may be present only if the "minJitter", "maxJitter" and/or "avgJitter" attribute(s) is/are present.
kValJitter	UInteger	C	0..1	Contains the value of the reported percentile ("k" parameter value) within the "kPercJitter" attribute. This attribute shall be present only if the "kPercJitter" attribute is present.
measPeriod	DurationSec	O	0..1	Contains the measurement period of the reported measurements.
timestamp	DateTime	O	0..1	Contains the timestamp of the reported measurements.
NOTE: At least one of these attributes shall be present.				

6.4.6.2.9 Type: HistTransQualMeasReports

**Table 6.4.6.2.9-1: Definition of type HistTransQualMeasReports**

Attribute name	Data type	P	Cardinality	Description	Applicability
reports	array(TransQualMeasReport)	M	0..N	Contains the Historical Transmission Quality Measurement Report(s). If there are no Historical Transmission Quality Measurement Report(s) fulfilling the request, this attribute shall contain an empty array.	
suppFeat	SupportedFeatures	C	0..1	Contains the list of supported features among the ones defined in clause 6.4.8. This attribute shall be present only when feature negotiation needs to take place.	

6.4.6.2.10 Type: TransQualMeasCriteriaSet

**Table 6.4.6.2.10-1: Definition of type TransQualMeasCriteriaSet**

Attribute name	Data type	P	Cardinality	Description	Applicability
criteria	TransQualMeasCriteria	M	1	Represents the transmission quality measurement reporting criteria.	
direction	MatchingDirection	M	1	Indicates the matching direction for the transmission quality measurement reporting criteria provided within the "criteria" attribute.	

6.4.6.3 Simple data types and enumerations

6.4.6.3.1 Introduction

This clause defines simple data types and enumerations that can be referenced from data structures defined in the previous clauses.

6.4.6.3.2 Simple data types

The simple data types defined in table 6.4.6.3.2-1 shall be supported.

**Table 6.4.6.3.2-1: Simple data types**

Type Name	Type Definition	Description	Applicability

6.4.6.3.3 Enumeration: MeasurementId

The enumeration MeasurementId represents the transmission quality measurement type. It shall comply with the provisions defined in table 6.4.6.3.3-1.

**Table 6.4.6.3.3-1: Enumeration MeasurementId**

Enumeration value	Description	Applicability
LATENCY	Indicates that the requested/reported measurement is the latency.	
BITRATE	Indicates that the requested/reported measurement is the bit rate.	
PACKET_LOSS_RATE	Indicates that the requested/reported measurement is the packet loss rate.	
JITTER	Indicates that the requested/reported measurement is the jitter.	

6.4.6.3.4 Enumeration: RepGranularity

The enumeration RepGranularity represents the reporting granularity. It shall comply with the provisions defined in table 6.4.6.3.4-1.

**Table 6.4.6.3.4-1: Enumeration RepGranularity**

Enumeration value	Description	Applicability
INDIVIDUAL_VAL_UE	Indicates that the granularity is individual VAL UE/user.	
VAL_GROUP	Indicates that the granularity is VAL Group.	
ALL_VAL_UES	Indicates that the granularity is all VAL UE/user(s).	

6.4.6.4 Data types describing alternative data types or combinations of data types

There are no data types describing alternative data types or combinations of data types defined for this API in this release of the specification.

6.4.6.5 Binary data

6.4.6.5.1 Binary Data Types

**Table 6.4.6.5.1-1: Binary Data Types**

Name	Clause defined	Content type

6.4.7 Error Handling

6.4.7.1 General

For the SDD\_TransmissionQualityMeasurement API, error handling shall be supported as specified in clause 6.7 of 3GPP TS 29.549 [15].

In addition, the requirements in the following clauses are applicable for the SDD\_TransmissionQualityMeasurement API.

6.4.7.2 Protocol Errors

No specific protocol errors for the SDD\_TransmissionQualityMeasurement API are specified.

6.4.7.3 Application Errors

The application errors defined for the SDD\_TransmissionQualityMeasurement API are listed in Table 6.4.7.3-1.

**Table 6.4.7.3-1: Application errors**

Application Error	HTTP status code	Description	Applicability
NO_TRANS_CONN	403 Forbidden	Indicates that the Transmission Quality Measurement Subscription creation/update request is rejected because there are no existing Regular/URLLC transmission connections corresponding to the parameters provided in the request.	



## 6.4.8 Feature negotiation

The optional features listed in table 6.4.8-1 are defined for the SDD\_TransmissionQualityMeasurement API. They shall be negotiated using the extensibility mechanism defined in clause 6.8 of 3GPP TS 29.549 [15].

**Table 6.4.8-1: Supported Features**

Feature number	Feature Name	Description

## 6.4.9 Security

The provisions of clause 9 of 3GPP TS 29.549 [15] shall apply for the SDD\_TransmissionQualityMeasurement API.

## 6.5 SDD\_PolicyConfiguration Service API

### 6.5.1 Introduction

The SDD\_PolicyConfiguration service shall use the SDD\_PolicyConfiguration API.

The API URI of the SDD\_PolicyConfiguration Service API shall be:

**{apiRoot}/<apiName>/<apiVersion>**

The request URIs used in HTTP requests shall have the Resource URI structure defined in clause 6.5 of 3GPP TS 29.549 [15], i.e.:

**{apiRoot}/<apiName>/<apiVersion>/<apiSpecificSuffixes>**

with the following components:

- The {apiRoot} shall be set as described in clause 6.5 of 3GPP TS 29.549 [15].
- The <apiName> shall be "sdd-pc".
- The <apiVersion> shall be "v1".
- The <apiSpecificSuffixes> shall be set as described in clause 6.5 of 3GPP TS 29.549 [15].

**NOTE:** When 3GPP TS 29.122 [2] is referenced for the common protocol and interface aspects for API definition in the clauses under clause 6.5, the SEALDD Server takes the role of the SCEF and the service consumer takes the role of the SCS/AS.

### 6.5.2 Usage of HTTP

The provisions of clause 6.3 of 3GPP TS 29.549 [15] shall apply for the SDD\_PolicyConfiguration API.

### 6.5.3 Resources

#### 6.5.3.1 Overview

This clause describes the structure for the Resource URIs and the resources and methods used for the service.

Figure 6.5.3.1-1 depicts the resource URIs structure for the SDD\_PolicyConfiguration API.

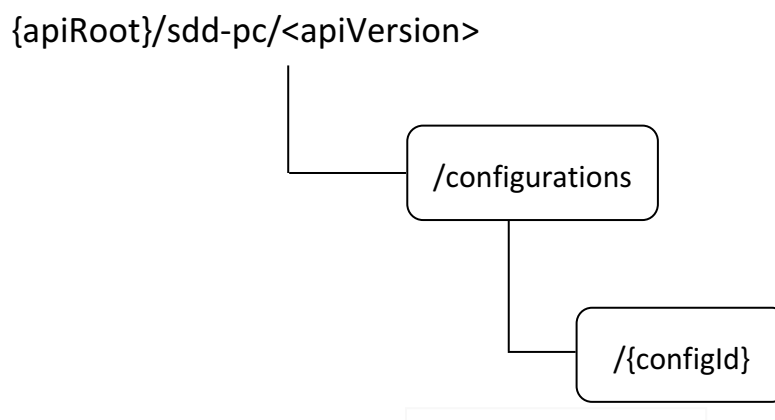

**Figure 6.5.3.1-1: Resource URIs structure of the SDD\_PolicyConfiguration API**

Table 6.5.3.1-1 provides an overview of the resources and applicable HTTP methods for the SDD\_PolicyConfiguration API.

**Table 6.5.3.1-1: Resources and methods overview**

Resource name	Resource URI	HTTP method or custom operation	Description
Policy Configurations	/configurations	POST	Request the creation of a Policy Configuration.
Individual Policy Configuration	/configurations/{configId}	GET	Retrieve an existing "Individual Policy Configuration" resource.
		PUT	Request the update of an existing "Individual Policy Configuration" resource.
		PATCH	Request the modification of an existing "Individual Policy Configuration" resource.
		DELETE	Request the deletion of an existing "Individual Policy Configuration" resource.

### 6.5.3.2 Resource: Policy Configurations

#### 6.5.3.2.1 Description

This resource represents the collection of SEALDD Policy Configuration(s) managed by the SEALDD Server.

#### 6.5.3.2.2 Resource Definition

Resource URI: **{apiRoot}/sdd-pc/<apiVersion>/configurations**

This resource shall support the resource URI variables defined in table 6.5.3.2.2-1.

**Table 6.5.3.2.2-1: Resource URI variables for this resource**

Name	Data type	Definition
apiRoot	string	See clause 6.5.1.

#### 6.5.3.2.3 Resource Standard Methods

##### 6.5.3.2.3.1 POST

The HTTP POST method allows a service consumer to request the creation of a Policy Configuration at the SEALDD Server.

This method shall support the URI query parameters specified in table 6.5.3.2.3.1-1.

**Table 6.5.3.2.3.1-1: URI query parameters supported by the POST method on this resource**

Name	Data type	P	Cardinality	Description	Applicability
n/a					

This method shall support the request data structures specified in table 6.5.3.2.3.1-2 and the response data structures and response codes specified in table 6.5.3.2.3.1-3.

**Table 6.5.3.2.3.1-2: Data structures supported by the POST Request Body on this resource**

Data type	P	Cardinality	Description
PolicyConfig	M	1	Represents the parameters to request the creation of a Policy Configuration.

**Table 6.5.3.2.3.1-3: Data structures supported by the POST Response Body on this resource**

Data type	P	Cardinality	Response codes	Description
PolicyConfig	M	1	201 Created	Successful case. The Policy Configuration is successfully created and a representation of the created "Individual Policy Configuration" resource shall be returned.  An HTTP "Location" header that contains the URI of the created resource shall also be included.
NOTE: The mandatory HTTP error status codes for the HTTP POST method listed in table 5.2.6-1 of 3GPP TS 29.122 [2] shall also apply.				

**Table 6.5.3.2.3.1-4: Headers supported by the 201 Response Code on this resource**

Name	Data type	P	Cardinality	Description
Location	string	M	1	Contains the URI of the newly created resource, according to the structure: {apiRoot}/sdd-pc/<apiVersion>/configurations/{configId}

#### 6.5.3.2.4 Resource Custom Operations

There are no resource custom operations defined for this resource in this release of the specification.

### 6.5.3.3 Resource: Individual Policy Configuration

#### 6.5.3.3.1 Description

This resource represents an "Individual SEALDD Policy Configuration" resource managed by the SEALDD Server.

#### 6.5.3.3.2 Resource Definition

Resource URI: {apiRoot}/sdd-pc/<apiVersion>/configurations/{configId}

This resource shall support the resource URI variables defined in table 6.5.3.3.2-1.

**Table 6.5.3.3.2-1: Resource URI variables for this resource**

Name	Data type	Definition
apiRoot	string	See clause 6.5.1.
configId	string	Represents the identifier of the "Individual Policy Configuration" resource.

#### 6.5.3.3.3 Resource Standard Methods

##### 6.5.3.3.3.1 GET

The HTTP GET method allows a service consumer to retrieve an existing "Individual Policy Configuration" resource at the SEALDD Server.

This method shall support the URI query parameters specified in table 6.5.3.3.3.1-1.

**Table 6.5.3.3.3.1-1: URI query parameters supported by the GET method on this resource**

Name	Data type	P	Cardinality	Description	Applicability
n/a					

This method shall support the request data structures specified in table 6.5.3.3.3.1-2 and the response data structures and response codes specified in table 6.5.3.3.3.1-3.

**Table 6.5.3.3.3.1-2: Data structures supported by the GET Request Body on this resource**

Data type	P	Cardinality	Description
n/a			

**Table 6.5.3.3.3.1-3: Data structures supported by the GET Response Body on this resource**

Data type	P	Cardinality	Response codes	Description
PolicyConfig	M	1	200 OK	Successful case. The requested "Individual Policy Configuration" resource shall be returned.
n/a			307 Temporary Redirect	Temporary redirection. The response shall include a Location header field containing an alternative URI of the resource located in an alternative SEALDD Server. Redirection handling is described in clause 5.2.10 of 3GPP TS 29.122 [2].
n/a			308 Permanent Redirect	Permanent redirection. The response shall include a Location header field containing an alternative URI of the resource located in an alternative SEALDD Server. Redirection handling is described in clause 5.2.10 of 3GPP TS 29.122 [2].
NOTE: The mandatory HTTP error status codes for the HTTP GET method listed in table 5.2.6-1 of 3GPP TS 29.122 [2] shall also apply.				

**Table 6.5.3.3.3.1-4: Headers supported by the 307 Response Code on this resource**

Name	Data type	P	Cardinality	Description
Location	string	M	1	Contains an alternative URI of the resource located in an alternative SEALDD Server.

**Table 6.5.3.3.3.1-5: Headers supported by the 308 Response Code on this resource**

Name	Data type	P	Cardinality	Description
Location	string	M	1	Contains an alternative URI of the resource located in an alternative SEALDD Server.

#### 6.5.3.3.3.2 PUT

The HTTP PUT method allows a service consumer to request the update of an existing "Individual Policy Configuration" resource at the SEALDD Server.

This method shall support the URI query parameters specified in table 6.5.3.3.3.2-1.

**Table 6.5.3.3.2-1: URI query parameters supported by the PUT method on this resource**

Name	Data type	P	Cardinality	Description	Applicability
n/a					

This method shall support the request data structures specified in table 6.5.3.3.2-2 and the response data structures and response codes specified in table 6.5.3.3.2-3.

**Table 6.5.3.3.2-2: Data structures supported by the PUT Request Body on this resource**

Data type	P	Cardinality	Description
PolicyConfig	M	1	Represents the updated representation of the "Individual Policy Configuration" resource.

**Table 6.5.3.3.2-3: Data structures supported by the PUT Response Body on this resource**

Data type	P	Cardinality	Response codes	Description
PolicyConfig	M	1	200 OK	Successful case. The "Individual Policy Configuration" resource is successfully updated and a representation of the updated resource shall be returned in the response body.
n/a			204 No Content	Successful case. The "Individual Policy Configuration" resource is successfully updated and no content is returned in the response body.
n/a			307 Temporary Redirect	Temporary redirection. The response shall include a Location header field containing an alternative URI of the resource located in an alternative SEALDD Server. Redirection handling is described in clause 5.2.10 of 3GPP TS 29.122 [2].
n/a			308 Permanent Redirect	Permanent redirection. The response shall include a Location header field containing an alternative URI of the resource located in an alternative SEALDD Server. Redirection handling is described in clause 5.2.10 of 3GPP TS 29.122 [2].
NOTE: The mandatory HTTP error status codes for the HTTP PUT method listed in table 5.2.6-1 of 3GPP TS 29.122 [2] shall also apply.				

**Table 6.5.3.3.2-4: Headers supported by the 307 Response Code on this resource**

Name	Data type	P	Cardinality	Description
Location	string	M	1	Contains an alternative URI of the resource located in an alternative SEALDD Server.

**Table 6.5.3.3.2-5: Headers supported by the 308 Response Code on this resource**

Name	Data type	P	Cardinality	Description
Location	string	M	1	Contains an alternative URI of the resource located in an alternative SEALDD Server.

### 6.5.3.3.3 PATCH

The HTTP PATCH method allows a service consumer to request the modification of an existing "Individual Policy Configuration" resource at the SEALDD Server.

This method shall support the URI query parameters specified in table 6.5.3.3.3.3-1.

**Table 6.5.3.3.3.3-1: URI query parameters supported by the PATCH method on this resource**

Name	Data type	P	Cardinality	Description	Applicability
n/a					

This method shall support the request data structures specified in table 6.5.3.3.3.3-2 and the response data structures and response codes specified in table 6.5.3.3.3.3-3.

**Table 6.5.3.3.3.3-2: Data structures supported by the PATCH Request Body on this resource**

Data type	P	Cardinality	Description
PolicyConfigPatch	M	1	Represents the parameters to request the modification of the "Individual Policy Configuration" resource.

**Table 6.5.3.3.3.3-3: Data structures supported by the PATCH Response Body on this resource**

Data type	P	Cardinality	Response codes	Description
PolicyConfig	M	1	200 OK	Successful case. The "Individual Policy Configuration" resource is successfully modified and a representation of the updated resource shall be returned in the response body.
n/a			204 No Content	Successful case. The "Individual Policy Configuration" resource is successfully modified and no content is returned in the response body.
n/a			307 Temporary Redirect	Temporary redirection. The response shall include a Location header field containing an alternative URI of the resource located in an alternative SEALDD Server. Redirection handling is described in clause 5.2.10 of 3GPP TS 29.122 [2].
n/a			308 Permanent Redirect	Permanent redirection. The response shall include a Location header field containing an alternative URI of the resource located in an alternative SEALDD Server. Redirection handling is described in clause 5.2.10 of 3GPP TS 29.122 [2].
NOTE: The mandatory HTTP error status codes for the HTTP PATCH method listed in table 5.2.6-1 of 3GPP TS 29.122 [2] shall also apply.				

**Table 6.5.3.3.3.3-4: Headers supported by the 307 Response Code on this resource**

Name	Data type	P	Cardinality	Description
Location	string	M	1	Contains an alternative URI of the resource located in an alternative SEALDD Server.

**Table 6.5.3.3.3.3-5: Headers supported by the 308 Response Code on this resource**

Name	Data type	P	Cardinality	Description
Location	string	M	1	Contains an alternative URI of the resource located in an alternative SEALDD Server.

## 6.5.3.3.3.4 DELETE

The HTTP DELETE method allows a service consumer to request the deletion of an existing "Individual Policy Configuration" resource at the SEALDD Server.

This method shall support the URI query parameters specified in table 6.5.3.3.3.4-1.

**Table 6.5.3.3.3.4-1: URI query parameters supported by the DELETE method on this resource**

Name	Data type	P	Cardinality	Description	Applicability
n/a					

This method shall support the request data structures specified in table 6.5.3.3.3.4-2 and the response data structures and response codes specified in table 6.5.3.3.3.4-3.

**Table 6.5.3.3.3.4-2: Data structures supported by the DELETE Request Body on this resource**

Data type	P	Cardinality	Description
n/a			

**Table 6.5.3.3.3.4-3: Data structures supported by the DELETE Response Body on this resource**

Data type	P	Cardinality	Response codes	Description
n/a			204 No Content	Successful case. The "Individual Policy Configuration" resource is successfully deleted.
n/a			307 Temporary Redirect	Temporary redirection. The response shall include a Location header field containing an alternative URI of the resource located in an alternative SEALDD Server. Redirection handling is described in clause 5.2.10 of 3GPP TS 29.122 [2].
n/a			308 Permanent Redirect	Permanent redirection. The response shall include a Location header field containing an alternative URI of the resource located in an alternative SEALDD Server. Redirection handling is described in clause 5.2.10 of 3GPP TS 29.122 [2].
NOTE: The mandatory HTTP error status codes for the HTTP DELETE method listed in table 5.2.6-1 of 3GPP TS 29.122 [2] shall also apply.				

**Table 6.5.3.3.3.4-4: Headers supported by the 307 Response Code on this resource**

Name	Data type	P	Cardinality	Description
Location	string	M	1	Contains an alternative URI of the resource located in an alternative SEALDD Server.

**Table 6.5.3.3.3.4-5: Headers supported by the 308 Response Code on this resource**

Name	Data type	P	Cardinality	Description
Location	string	M	1	Contains an alternative URI of the resource located in an alternative SEALDD Server.

## 6.5.3.3.4 Resource Custom Operations

There are no resource custom operations defined for this resource in this release of the specification.



## 6.5.4 Custom Operations without associated resources

There are no custom operations without associated resources defined for this API in this release of the specification.

## 6.5.5 Notifications

There are no notifications defined for this API in this release of the specification.

## 6.5.6 Data Model

### 6.5.6.1 General

This clause specifies the application data model supported by the API.

Table 6.5.6.1-1 specifies the data types defined for the SDD\_PolicyConfiguration API.

**Table 6.5.6.1-1: SDD\_PolicyConfiguration API specific Data Types**

Data type	Clause defined	Description	Applicability
BdwCtrlPolicy	6.5.6.3.3	Represents the bandwidth control policy.	
QualGuarPolicy	6.5.6.2.5	Represents the quality guarantee policy.	
QualGuarThresh	6.5.6.2.6	Represents the quality guarantee related thresholds.	
PolicyConfig	6.5.6.2.2	Represents a SEALDD Policy Configuration.	
PolicyConfigPatch	6.5.6.2.3	Represents the parameters to request the modification of a SEALDD Policy Configuration.	
SealddPolicy	6.5.6.2.4	Represents a SEALDD Policy.	

Table 6.5.6.1-2 specifies data types re-used by the SDD\_PolicyConfiguration API from other specifications, including a reference to their respective specifications, and when needed, a short description of their use within the SDD\_PolicyConfiguration API.

**Table 6.5.6.1-2: SDD\_PolicyConfiguration API re-used Data Types**

Data type	Reference	Comments	Applicability
DateTimeRo	3GPP TS 29.122 [2]	Represents a date and a time with the "read-only" property.	
MeasurementId	Clause 6.4.6.3.3	Represents the transmission quality measurement type.	
TransQualMeasCriteria	Clause 6.4.6.2.7	Represents the transmission quality measurement reporting criteria.	
Uri	3GPP TS 29.122 [2]	Represents a URI.	
SupportedFeatures	3GPP TS 29.571 [18]	Represents the list of supported feature(s) and used to negotiate the applicability of the optional features.	
ValTargetUe	3GPP TS 29.549 [15]	Represents the identifier of the targeted VAL UE or VAL user.	

### 6.5.6.2 Structured data types

#### 6.5.6.2.1 Introduction

This clause defines the data structures to be used in resource representations.

## 6.5.6.2.2 Type: PolicyConfig

Table 6.5.6.2.2-1: Definition of type PolicyConfig

Attribute name	Data type	P	Cardinality	Description	Applicability
appTrafficIds	array(string)	M	1..N	Contains the identifier(s) of the targeted application traffic. This can be in the form of e.g., VAL Service ID, VAL Server ID.	
valTargetId	ValTargetUe	O	0..1	Contains the identifier of the VAL UE or VAL user to which the SEALDD policy configuration is related.	
sealddPol	SealddPolicy	M	1	Represents the SEALDD policy that is to be configured.	
expTime	DateTimeRo	O	0..1	Contains the expiration time of the policy configuration.  This attribute may be present only in Policy Configuration creation/update responses.  If this attribute is absent, this means that the Policy Configuration shall not expire, until explicitly deleted by the service consumer.	
suppFeat	SupportedFeatures	C	0..1	Contains the list of supported feature(s) among the ones defined in clause 6.5.8.  This attribute shall be present only when feature negotiation needs to take place.	

## 6.5.6.2.3 Type: PolicyConfigPatch

Table 6.5.6.2.3-1: Definition of type PolicyConfigPatch

Attribute name	Data type	P	Cardinality	Description	Applicability
sealddPol	SealddPolicy	O	0..1	Represents the updated SEALDD policy to be configured.	

## 6.5.6.2.4 Type: SealddPolicy

Table 6.5.6.2.4-1: Definition of type SealddPolicy

Attribute name	Data type	P	Cardinality	Description	Applicability
qualGuarPol	QualGuarPolicy	O	0..1	Contains the quality guarantee policy.  (NOTE)	
bdwCtrlSets	array(BdwCtrlPolicy)	O	1..N	Contains the bandwidth control policy.  This attribute shall not contain at the same time both the "REALLOCATE_DL" and "NOT_REALLOCATE_DL" actions nor both the "REALLOCATE_UL" and "NOT_REALLOCATE_UL" actions.  (NOTE)	
NOTE: At least one of these attributes shall be present.					

6.5.6.2.5 Type: QualGuarPolicy

**Table 6.5.6.2.5-1: Definition of type QualGuarPolicy**

Attribute name	Data type	P	Cardinality	Description	Applicability
thresholds	QualGuarThresh	M	1	Contains the quality guarantee/optimization threshold(s), i.e., the measurement threshold(s) to be used by the SEALDD enabler layer as criteria for triggering quality guarantee or quality optimization action(s) (e.g., establish a redundant transmission path, re-establish the transmission path, switch to backup transmission path, switch back to a single transmission path, etc.).	

6.5.6.2.6 Type: QualGuarThresh

**Table 6.5.6.2.6-1: Definition of type QualGuarThresh**

Attribute name	Data type	P	Cardinality	Description	Applicability
measId	array(MeasurementId)	M	1..N	Contains the considered transmission quality measurement(s).	
measThresh	TransQualMeasCriteria	M	1	Contains the transmission quality measurement threshold criteria. Only the criteria related to the considered measurements provided within the "measId" attribute shall be present within this attribute.	

6.5.6.3 Simple data types and enumerations

6.5.6.3.1 Introduction

This clause defines simple data types and enumerations that can be referenced from data structures defined in the previous clauses.

6.5.6.3.2 Simple data types

The simple data types defined in table 6.5.6.3.2-1 shall be supported.

**Table 6.5.6.3.2-1: Simple data types**

Type Name	Type Definition	Description	Applicability

6.5.6.3.3 Enumeration: BdwCtrlPolicy

The enumeration BdwCtrlPolicy represents the the bandwidth control policy. It shall comply with the provisions defined in table 6.5.6.3.3-1.

**Table 6.5.6.3-1: Enumeration BdwCtrlPolicy**

Enumeration value	Description	Applicability
REALLOCATE_DL	Indicates that the bandwidth control action is to reallocate the bandwidth limit between different VAL users for DL traffic.	
REALLOCATE_UL	Indicates that the bandwidth control action is to reallocate the bandwidth limit between different VAL users for UL traffic.	
NOT_REALLOCATE_DL	Indicates that the bandwidth control action is to not reallocate the bandwidth limit between different VAL users for DL traffic.	
NOT_REALLOCATE_UL	Indicates that the bandwidth control action is to not reallocate the bandwidth limit between different VAL users for UL traffic.	

**6.5.6.4 Data types describing alternative data types or combinations of data types**

There are no data types describing alternative data types or combinations of data types defined for this API in this release of the specification.

**6.5.6.5 Binary data**

**6.5.6.5.1 Binary Data Types**

**Table 6.5.6.5.1-1: Binary Data Types**

Name	Clause defined	Content type

**6.5.7 Error Handling**

**6.5.7.1 General**

For the SDD\_PolicyConfiguration API, error handling shall be supported as specified in clause 6.7 of 3GPP TS 29.549 [15].

In addition, the requirements in the following clauses are applicable for the SDD\_PolicyConfiguration API.

**6.5.7.2 Protocol Errors**

No specific protocol errors for the SDD\_PolicyConfiguration API are specified.

**6.5.7.3 Application Errors**

The application errors defined for the SDD\_PolicyConfiguration API are listed in Table 6.5.7.3-1.

**Table 6.5.7.3-1: Application errors**

Application Error	HTTP status code	Description	Applicability

**6.5.8 Feature negotiation**

The optional features listed in table 6.5.8-1 are defined for the SDD\_PolicyConfiguration API. They shall be negotiated using the extensibility mechanism defined in clause 6.8 of 3GPP TS 29.549 [15].

**Table 6.5.8-1: Supported Features**

Feature number	Feature Name	Description

## 6.5.9 Security

The provisions of clause 9 of 3GPP TS 29.549 [15] shall apply for the SDD\_PolicyConfiguration API.

---

## 7 Using Common API Framework

The provisions of clause 8 of 3GPP TS 29.549 [15] shall apply for the SEALDD Server APIs defined in this specification.

---

# Annex A (normative): OpenAPI specification

## A.1 General

This Annex specifies the formal definition of the API(s) defined in the present specification. It consists of OpenAPI specifications in YAML format.

This Annex takes precedence when being discrepant to other parts of the specification with respect to the encoding of information elements and methods within the API(s).

NOTE 1: The semantics and procedures, as well as conditions, e.g. for the applicability and allowed combinations of attributes or values, not expressed in the OpenAPI definitions but defined in other parts of the specification also apply.

Informative copies of the OpenAPI specification files contained in this 3GPP Technical Specification are available on a Git-based repository that uses the GitLab software version control system (see clause 5.3.1 of 3GPP TS 29.501 [3] and clause 5B of 3GPP TR 21.900 [5]).

## A.2 SDD\_Transmission API

openapi: 3.0.0

info:

```
title: SEALDD Server Data Transmission Service
version: 1.0.0
description: |
  SEALDD Server Data Transmission Service.
  © 2024, 3GPP Organizational Partners (ARIB, ATIS, CCSA, ETSI, TSDSI, TTA, TTC).
  All rights reserved.
```

externalDocs:

```
description: >
  3GPP TS 29.548 V18.1.0; Service Enabler Architecture Layer for Verticals (SEAL);
  SEAL Data Delivery (SEALDD) Server Services; Stage 3.
url: https://www.3gpp.org/ftp/Specs/archive/29_series/29.548/
```

servers:

```
- url: '{apiRoot}/sdd-trans/v1'
  variables:
    apiRoot:
      default: https://example.com
      description: apiRoot as defined in clause 6.5 of 3GPP TS 29.549
```

security:

```
- {}
- oAuth2ClientCredentials: []
```

paths:

```
/{transType}/request-trans:
  parameters:
    - name: transType
      in: path
      description: >
        Represents the requested transmission type.
      required: true
      schema:
        $ref: '#/components/schemas/TransType'
```

post:

```
summary: Request SEALDD enabled Regular or URLLC Data Transmission.
operationId: RequestTrans
```

tags:

```
- Request SEALDD Data Transmission
```

requestBody:

```
required: true
content:
  application/json:
    schema:
      $ref: '#/components/schemas/TransReq'
```

responses:

```
'200':
  description: >
    OK. The SEALDD enabled Regular or URLLC application data transmission service request
    was successfully received and processed.
  content:
    application/json:
      schema:
        $ref: '#/components/schemas/TransResp'
'307':
  $ref: 'TS29122_CommonData.yaml#/components/responses/307'
'308':
  $ref: 'TS29122_CommonData.yaml#/components/responses/308'
'400':
  $ref: 'TS29122_CommonData.yaml#/components/responses/400'
'401':
  $ref: 'TS29122_CommonData.yaml#/components/responses/401'
'403':
  $ref: 'TS29122_CommonData.yaml#/components/responses/403'
'404':
  $ref: 'TS29122_CommonData.yaml#/components/responses/404'
'411':
  $ref: 'TS29122_CommonData.yaml#/components/responses/411'
'413':
  $ref: 'TS29122_CommonData.yaml#/components/responses/413'
'415':
```



```

    $ref: 'TS29122_CommonData.yaml#/components/responses/415'
  '429':
    $ref: 'TS29122_CommonData.yaml#/components/responses/429'
  '500':
    $ref: 'TS29122_CommonData.yaml#/components/responses/500'
  '503':
    $ref: 'TS29122_CommonData.yaml#/components/responses/503'
  default:
    $ref: 'TS29122_CommonData.yaml#/components/responses/default'

/subscriptions:
  post:
    summary: Request the Creation of a new Connection Status Subscription.
    operationId: CreateConnStatusSubsc
    tags:
      - Connection Status Subscriptions (Collection)
    requestBody:
      required: true
      content:
        application/json:
          schema:
            $ref: '#/components/schemas/ConnStatusSubsc'
    responses:
      '201':
        description: >
          Successful case. The requested Connection Status Subscription resource is successfully
          created and a representation of the created "Individual Connection Status Subscription"
          resource is returned in the response body.
        content:
          application/json:
            schema:
              $ref: '#/components/schemas/ConnStatusSubsc'
        headers:
          Location:
            description: >
              Contains the URI of the newly created Individual Connection Status Subscription
              resource.
            required: true
            schema:
              type: string
      '400':
        $ref: 'TS29122_CommonData.yaml#/components/responses/400'
      '401':
        $ref: 'TS29122_CommonData.yaml#/components/responses/401'
      '403':
        $ref: 'TS29122_CommonData.yaml#/components/responses/403'
      '404':
        $ref: 'TS29122_CommonData.yaml#/components/responses/404'
      '411':
        $ref: 'TS29122_CommonData.yaml#/components/responses/411'
      '413':
        $ref: 'TS29122_CommonData.yaml#/components/responses/413'
      '415':
        $ref: 'TS29122_CommonData.yaml#/components/responses/415'
      '429':
        $ref: 'TS29122_CommonData.yaml#/components/responses/429'
      '500':
        $ref: 'TS29122_CommonData.yaml#/components/responses/500'
      '503':
        $ref: 'TS29122_CommonData.yaml#/components/responses/503'
      default:
        $ref: 'TS29122_CommonData.yaml#/components/responses/default'
    callbacks:
      ConnStatusNotif:
        '{$request.body#/notifUri}':
          post:
            summary: Notify a previously subscribed service consumer on SEALDD connection status
            event(s).
            requestBody:
              required: true
              content:
                application/json:
                  schema:
                    $ref: '#/components/schemas/ConnStatusNotif'
            responses:
              '204':
                description: >
                  Successful case. The Connection Status Notification is successfully received.

```

```

    '307':
      $ref: 'TS29122_CommonData.yaml#/components/responses/307'
    '308':
      $ref: 'TS29122_CommonData.yaml#/components/responses/308'
    '400':
      $ref: 'TS29122_CommonData.yaml#/components/responses/400'
    '401':
      $ref: 'TS29122_CommonData.yaml#/components/responses/401'
    '403':
      $ref: 'TS29122_CommonData.yaml#/components/responses/403'
    '404':
      $ref: 'TS29122_CommonData.yaml#/components/responses/404'
    '411':
      $ref: 'TS29122_CommonData.yaml#/components/responses/411'
    '413':
      $ref: 'TS29122_CommonData.yaml#/components/responses/413'
    '415':
      $ref: 'TS29122_CommonData.yaml#/components/responses/415'
    '429':
      $ref: 'TS29122_CommonData.yaml#/components/responses/429'
    '500':
      $ref: 'TS29122_CommonData.yaml#/components/responses/500'
    '503':
      $ref: 'TS29122_CommonData.yaml#/components/responses/503'
    default:
      $ref: 'TS29122_CommonData.yaml#/components/responses/default'

/subscriptions/{subscriptionId}:
  parameters:
    - name: subscriptionId
      in: path
      description: >
        Represents the identifier of the Individual Connection Status Subscription resource.
      required: true
      schema:
        type: string

  get:
    summary: Retrieve an existing Individual Connection Status Subscription resource.
    operationId: GetIndConnStatusSubsc
    tags:
      - Individual Connection Status Subscription (Document)
    responses:
      '200':
        description: >
          OK. The requested Individual Connection Status Subscription resource shall be returned.
        content:
          application/json:
            schema:
              $ref: '#/components/schemas/ConnStatusSubsc'
      '307':
        $ref: 'TS29122_CommonData.yaml#/components/responses/307'
      '308':
        $ref: 'TS29122_CommonData.yaml#/components/responses/308'
      '400':
        $ref: 'TS29122_CommonData.yaml#/components/responses/400'
      '401':
        $ref: 'TS29122_CommonData.yaml#/components/responses/401'
      '403':
        $ref: 'TS29122_CommonData.yaml#/components/responses/403'
      '404':
        $ref: 'TS29122_CommonData.yaml#/components/responses/404'
      '406':
        $ref: 'TS29122_CommonData.yaml#/components/responses/406'
      '429':
        $ref: 'TS29122_CommonData.yaml#/components/responses/429'
      '500':
        $ref: 'TS29122_CommonData.yaml#/components/responses/500'
      '503':
        $ref: 'TS29122_CommonData.yaml#/components/responses/503'
      default:
        $ref: 'TS29122_CommonData.yaml#/components/responses/default'

  put:
    summary: Request the update of an existing Individual Connection Status Subscription resource.
    operationId: UpdateIndConnStatusSubsc
    tags:
      - Individual Connection Status Subscription (Document)

```

```

requestBody:
  required: true
  content:
    application/json:
      schema:
        $ref: '#/components/schemas/ConnStatusSubsc'
responses:
  '200':
    description: >
      OK. The Individual Connection Status Subscription resource is successfully updated and
      a representation of the updated resource shall be returned in the response body.
    content:
      application/json:
        schema:
          $ref: '#/components/schemas/ConnStatusSubsc'
  '204':
    description: >
      No Content. The Individual Connection Status Subscription resource is successfully
      updated and no content is returned in the response body.
  '307':
    $ref: 'TS29122_CommonData.yaml#/components/responses/307'
  '308':
    $ref: 'TS29122_CommonData.yaml#/components/responses/308'
  '400':
    $ref: 'TS29122_CommonData.yaml#/components/responses/400'
  '401':
    $ref: 'TS29122_CommonData.yaml#/components/responses/401'
  '403':
    $ref: 'TS29122_CommonData.yaml#/components/responses/403'
  '404':
    $ref: 'TS29122_CommonData.yaml#/components/responses/404'
  '411':
    $ref: 'TS29122_CommonData.yaml#/components/responses/411'
  '413':
    $ref: 'TS29122_CommonData.yaml#/components/responses/413'
  '415':
    $ref: 'TS29122_CommonData.yaml#/components/responses/415'
  '429':
    $ref: 'TS29122_CommonData.yaml#/components/responses/429'
  '500':
    $ref: 'TS29122_CommonData.yaml#/components/responses/500'
  '503':
    $ref: 'TS29122_CommonData.yaml#/components/responses/503'
  default:
    $ref: 'TS29122_CommonData.yaml#/components/responses/default'

patch:
  summary: Request the modification of an existing Individual Connection Status Subscription
  resource.
  operationId: ModifyIndConnStatusSubsc
  tags:
    - Individual Connection Status Subscription (Document)
  requestBody:
    required: true
    content:
      application/merge-patch+json:
        schema:
          $ref: '#/components/schemas/ConnStatusSubscPatch'
  responses:
    '200':
      description: >
        OK. The Individual Connection Status Subscription resource is successfully modified
        and a representation of the updated resource shall be returned in the response body.
      content:
        application/json:
          schema:
            $ref: '#/components/schemas/ConnStatusSubsc'
    '204':
      description: >
        No Content. The Individual Connection Status Subscription resource is successfully
        modified and no content is returned in the response body.
    '307':
      $ref: 'TS29122_CommonData.yaml#/components/responses/307'
    '308':
      $ref: 'TS29122_CommonData.yaml#/components/responses/308'
    '400':
      $ref: 'TS29122_CommonData.yaml#/components/responses/400'
    '401':

```

```

    $ref: 'TS29122_CommonData.yaml#/components/responses/401'
  '403':
    $ref: 'TS29122_CommonData.yaml#/components/responses/403'
  '404':
    $ref: 'TS29122_CommonData.yaml#/components/responses/404'
  '411':
    $ref: 'TS29122_CommonData.yaml#/components/responses/411'
  '413':
    $ref: 'TS29122_CommonData.yaml#/components/responses/413'
  '415':
    $ref: 'TS29122_CommonData.yaml#/components/responses/415'
  '429':
    $ref: 'TS29122_CommonData.yaml#/components/responses/429'
  '500':
    $ref: 'TS29122_CommonData.yaml#/components/responses/500'
  '503':
    $ref: 'TS29122_CommonData.yaml#/components/responses/503'
  default:
    $ref: 'TS29122_CommonData.yaml#/components/responses/default'

```

delete:

```

  summary: Request the deletion of an existing Individual Connection Status Subscription
  resource.
  operationId: DeleteIndConnStatusSubsc
  tags:
  - Individual Connection Status Subscription (Document)
  responses:
    '204':
      description: >
        No Content. The Individual Connection Status Subscription resource is successfully
        deleted.
    '307':
      $ref: 'TS29122_CommonData.yaml#/components/responses/307'
    '308':
      $ref: 'TS29122_CommonData.yaml#/components/responses/308'
    '400':
      $ref: 'TS29122_CommonData.yaml#/components/responses/400'
    '401':
      $ref: 'TS29122_CommonData.yaml#/components/responses/401'
    '403':
      $ref: 'TS29122_CommonData.yaml#/components/responses/403'
    '404':
      $ref: 'TS29122_CommonData.yaml#/components/responses/404'
    '429':
      $ref: 'TS29122_CommonData.yaml#/components/responses/429'
    '500':
      $ref: 'TS29122_CommonData.yaml#/components/responses/500'
    '503':
      $ref: 'TS29122_CommonData.yaml#/components/responses/503'
  default:
    $ref: 'TS29122_CommonData.yaml#/components/responses/default'

```

components:

```

  securitySchemes:
    oAuth2ClientCredentials:
      type: oauth2
      flows:
        clientCredentials:
          tokenUrl: '{tokenUrl}'
          scopes: {}

```

schemas:

```

#
# STRUCTURED DATA TYPES
#

```

TransReq:

```

  description: >
    Represents the parameters to request the SEALDD enabled Regular or URLLC application data
    transmission service.
  type: object
  properties:
    valServiceId:
      type: string
    valTargetId:
      $ref: 'TS29549_SS_UserProfileRetrieval.yaml#/components/schemas/ValTargetUe'

```

```

    valServerConnInfo:
      $ref: '#/components/schemas/ConnInfo'
    qosInfo:
      $ref: '#/components/schemas/QosInfo'
    valServerBdw:
      $ref: '#/components/schemas/ValServBdw'
    valUsersBdw:
      $ref: '#/components/schemas/ValUsersBdw'
    suppFeat:
      $ref: 'TS29571_CommonData.yaml#/components/schemas/SupportedFeatures'
  required:
    - valServerConnInfo

TransResp:
  description: >
    Represents a SEALDD enabled Regular or URLLC application data transmission service response.
  type: object
  properties:
    ddServerConnInfo:
      $ref: '#/components/schemas/ConnInfo'
    suppFeat:
      $ref: 'TS29571_CommonData.yaml#/components/schemas/SupportedFeatures'

ConnInfo:
  description: >
    Represents SEALDD Data transmission connection information.
  type: object
  properties:
    ipv4Addr:
      $ref: 'TS29571_CommonData.yaml#/components/schemas/Ipv4Addr'
    ipv6Addr:
      $ref: 'TS29571_CommonData.yaml#/components/schemas/Ipv6Addr'
    port:
      $ref: 'TS29122_CommonData.yaml#/components/schemas/Port'
    uri:
      $ref: 'TS29122_CommonData.yaml#/components/schemas/Uri'
  oneOf:
    - required: [ipv4Addr]
    - required: [ipv6Addr]
    - required: [uri]

QosInfo:
  description: >
    Represents SEALDD related QoS requirements.
  type: object
  properties:
    qosReference:
      type: string
    altQoSReferences:
      type: array
      items:
        type: string
    minItems: 1
    altQosReqs:
      type: array
      items:
        $ref:
'TS29514_Npcf_PolicyAuthorization.yaml#/components/schemas/AlternativeServiceRequirementsData'
    minItems: 1
  anyOf:
    - required: [qosReference]
    - required: [altQoSReferences]
    - required: [altQosReqs]
    - not:
      required: [altQoSReferences, altQosReqs]
    - not:
      required: [qosReference, altQosReqs]

ValServBdw:
  description: >
    Represents VAL Server related bandwidth information.
  type: object
  properties:
    totalUlBdw:
      $ref: 'TS29122_CommonData.yaml#/components/schemas/Bandwidth'
    totalDlBdw:
      $ref: 'TS29122_CommonData.yaml#/components/schemas/Bandwidth'
  required:

```

```

    - totalUlBdw
    - totalDlBdw

ValUsersBdw:
  description: >
    Represents VAL users related bandwidth information.
  type: object
  properties:
    minUlBdw:
      $ref: 'TS29122_CommonData.yaml#/components/schemas/Bandwidth'
    minDlBdw:
      $ref: 'TS29122_CommonData.yaml#/components/schemas/Bandwidth'
    maxUlBdw:
      $ref: 'TS29122_CommonData.yaml#/components/schemas/Bandwidth'
    maxDlBdw:
      $ref: 'TS29122_CommonData.yaml#/components/schemas/Bandwidth'
  required:
    - minUlBdw
    - minDlBdw
    - maxUlBdw
    - maxDlBdw

ConnStatusSubsc:
  description: >
    Represents a Connection Status Subscription.
  type: object
  properties:
    events:
      type: array
      items:
        $ref: '#/components/schemas/ConnStatusEvent'
      minItems: 1
      description: >
        Represents the subscribed event(s).
    valServiceId:
      type: string
    valTgtUe:
      $ref: 'TS29549_SS_UserProfileRetrieval.yaml#/components/schemas/ValTargetUe'
    valServerConnInfo:
      $ref: '#/components/schemas/ConnInfo'
    notifUri:
      $ref: 'TS29122_CommonData.yaml#/components/schemas/Uri'
    expTime:
      $ref: 'TS29122_CommonData.yaml#/components/schemas/DateTimeRo'
    suppFeat:
      $ref: 'TS29571_CommonData.yaml#/components/schemas/SupportedFeatures'
  required:
    - events
    - valServerConnInfo
    - notifUri

ConnStatusSubscPatch:
  description: >
    Represents the requested modifications to a Connection Status Subscription.
  type: object
  properties:
    events:
      type: array
      items:
        $ref: '#/components/schemas/ConnStatusEvent'
      minItems: 1
    valServiceId:
      type: string
    valTgtUe:
      $ref: 'TS29549_SS_UserProfileRetrieval.yaml#/components/schemas/ValTargetUe'
    valServerConnInfo:
      $ref: '#/components/schemas/ConnInfo'
    notifUri:
      $ref: 'TS29122_CommonData.yaml#/components/schemas/Uri'

ConnStatusNotif:
  description: >
    Represents a Connection Status Notification.
  type: object
  properties:
    subscriptionId:
      type: string
    reports:

```

```

    type: array
    items:
      $ref: '#/components/schemas/ConnStatusReport'
    minItems: 1
  required:
    - subscriptionId
    - reports

ConnStatusReport:
  description: >
    Represents a Connection Status Event report.
  type: object
  properties:
    event:
      $ref: '#/components/schemas/ConnStatusEvent'
    valTgtUe:
      $ref: 'TS29549_SS_UserProfileRetrieval.yaml#/components/schemas/ValTargetUe'
    valServiceId:
      type: string
    connEstData:
      $ref: '#/components/schemas/ConnEstabData'
    timestamp:
      $ref: 'TS29122_CommonData.yaml#/components/schemas/DateTime'
  required:
    - event
    - valTgtUe
    - valServiceId

ConnEstabData:
  description: >
    Represents SEALDD connection status establishment data.
  type: object
  properties:
    ddServerConnInfo:
      $ref: '#/components/schemas/ConnInfo'
    comLifetime:
      $ref: 'TS29122_CommonData.yaml#/components/schemas/DurationSec'
  required:
    - ddServerConnInfo

# SIMPLE DATA TYPES
#

#
# ENUMERATIONS
#

ConnStatusEvent:
  anyOf:
    - type: string
      enum:
        - ESTABLISHED
        - RELEASED
    - type: string
      description: >
        This string provides forward-compatibility with future extensions to the enumeration
        and is not used to encode content defined in the present version of this API.
  description: |
    Represents Connection Status Events.
    Possible values are:
    - ESTABLISHED: Indicates that the SEALDD connection status event is that the SEALDD
      connection is established.
    - RELEASED: Indicates that the SEALDD connection status event is that the SEALDD connection
      is released.

TransType:
  anyOf:
    - type: string
      enum:
        - regular
        - urlc
    - type: string
      description: >
        This string provides forward-compatibility with future extensions to the enumeration
        and is not used to encode content defined in the present version of this API.
  description: |
    Represents the requested transmission type.

```

Possible values are:

- regular: Indicates that the requested transmission type is Regular transmission.
- urllc: Indicates that the requested transmission type is URLLC transmission.

# Data types describing alternative data types or combinations of data types:  
#



## A.3 SDD\_DataStorage API

openapi: 3.0.0

info:

```
title: SEALDD Server Data Storage Service
version: 1.0.0
description: |
  SEALDD Server Data Storage Service.
  © 2024, 3GPP Organizational Partners (ARIB, ATIS, CCSA, ETSI, TSDSI, TTA, TTC).
  All rights reserved.
```

externalDocs:

```
description: >
  3GPP TS 29.548 V18.1.0; Service Enabler Architecture Layer for Verticals (SEAL);
  SEAL Data Delivery (SEALDD) Server Services; Stage 3.
url: https://www.3gpp.org/ftp/Specs/archive/29_series/29.548/
```

servers:

```
- url: '{apiRoot}/sdd-ds/v1'
  variables:
    apiRoot:
      default: https://example.com
      description: apiRoot as defined in clause 6.5 of 3GPP TS 29.549
```

security:

```
- {}
- oAuth2ClientCredentials: []
```

paths:

```
/storages:
  get:
    summary: Retrieve one or several existing Individual Data Storage resource(s).
    operationId: GetDataStorages
    tags:
      - Data Storages (Collection)
    parameters:
      - name: storage-ids
        in: query
        description: Contains the identifier(s) of the targeted Data Storage resource(s).
        required: false
        schema:
          type: array
          items:
            type: string
            minItems: 1
      - name: supp-feats
        in: query
        description: Contains the list of supported features.
        required: false
        schema:
          $ref: 'TS29571_CommonData.yaml#/components/schemas/SupportedFeatures'
    responses:
      '200':
        description: >
          OK. The requested Individual Data Storage resource shall be returned.
        content:
          application/json:
            schema:
              type: array
              items:
                $ref: '#/components/schemas/DataStorage'
              minItems: 0
      '307':
        $ref: 'TS29122_CommonData.yaml#/components/responses/307'
      '308':
        $ref: 'TS29122_CommonData.yaml#/components/responses/308'
      '400':
        $ref: 'TS29122_CommonData.yaml#/components/responses/400'
      '401':
        $ref: 'TS29122_CommonData.yaml#/components/responses/401'
      '403':
        $ref: 'TS29122_CommonData.yaml#/components/responses/403'
      '404':
        $ref: 'TS29122_CommonData.yaml#/components/responses/404'
      '406':
        $ref: 'TS29122_CommonData.yaml#/components/responses/406'
```

```

'429':
  $ref: 'TS29122_CommonData.yaml#/components/responses/429'
'500':
  $ref: 'TS29122_CommonData.yaml#/components/responses/500'
'503':
  $ref: 'TS29122_CommonData.yaml#/components/responses/503'
default:
  $ref: 'TS29122_CommonData.yaml#/components/responses/default'

post:
  summary: Request the creation of a Data Storage.
  operationId: CreateDataStorage
  tags:
    - Data Storages (Collection)
  requestBody:
    required: true
    content:
      application/json:
        schema:
          $ref: '#/components/schemas/DataStorageReq'
  responses:
    '201':
      description: >
        Created. The Data Storage is successfully created and a representation of the created
        Individual Data Storage resource shall be returned.
      content:
        application/json:
          schema:
            $ref: '#/components/schemas/DataStorage'
      headers:
        Location:
          description: >
            Contains the URI of the created Individual Data Storage resource.
          required: true
          schema:
            type: string
    '200':
      description: >
        OK. The Data Storage resource is successfully reserved and Data Storage resource
        reservation related information shall be returned.
      content:
        application/json:
          schema:
            $ref: '#/components/schemas/ReservRespData'
    '400':
      $ref: 'TS29122_CommonData.yaml#/components/responses/400'
    '401':
      $ref: 'TS29122_CommonData.yaml#/components/responses/401'
    '403':
      $ref: 'TS29122_CommonData.yaml#/components/responses/403'
    '404':
      $ref: 'TS29122_CommonData.yaml#/components/responses/404'
    '411':
      $ref: 'TS29122_CommonData.yaml#/components/responses/411'
    '413':
      $ref: 'TS29122_CommonData.yaml#/components/responses/413'
    '415':
      $ref: 'TS29122_CommonData.yaml#/components/responses/415'
    '429':
      $ref: 'TS29122_CommonData.yaml#/components/responses/429'
    '500':
      $ref: 'TS29122_CommonData.yaml#/components/responses/500'
    '503':
      $ref: 'TS29122_CommonData.yaml#/components/responses/503'
    default:
      $ref: 'TS29122_CommonData.yaml#/components/responses/default'
  callbacks:
    DataMngtNotif:
      '{$request.body#/notifUri}':
        post:
          requestBody:
            required: true
            content:
              application/json:
                schema:
                  $ref: '#/components/schemas/DataMngtNotif'
          responses:
            '204':

```

```

    description: >
      No Content. The Data Management and or Status Information Notification is
      successfully received and acknowledged.
  '307':
    $ref: 'TS29122_CommonData.yaml#/components/responses/307'
  '308':
    $ref: 'TS29122_CommonData.yaml#/components/responses/308'
  '400':
    $ref: 'TS29122_CommonData.yaml#/components/responses/400'
  '401':
    $ref: 'TS29122_CommonData.yaml#/components/responses/401'
  '403':
    $ref: 'TS29122_CommonData.yaml#/components/responses/403'
  '404':
    $ref: 'TS29122_CommonData.yaml#/components/responses/404'
  '411':
    $ref: 'TS29122_CommonData.yaml#/components/responses/411'
  '413':
    $ref: 'TS29122_CommonData.yaml#/components/responses/413'
  '415':
    $ref: 'TS29122_CommonData.yaml#/components/responses/415'
  '429':
    $ref: 'TS29122_CommonData.yaml#/components/responses/429'
  '500':
    $ref: 'TS29122_CommonData.yaml#/components/responses/500'
  '503':
    $ref: 'TS29122_CommonData.yaml#/components/responses/503'
  default:
    $ref: 'TS29122_CommonData.yaml#/components/responses/default'

/storages/{storageId}:
  parameters:
    - name: storageId
      in: path
      description: >
        Represents the identifier of the Individual Data Storage resource.
      required: true
      schema:
        type: string

  get:
    summary: Retrieve an existing Individual Data Storage resource.
    operationId: GetIndDataStorage
    tags:
      - Individual Data Storage (Document)
    responses:
      '200':
        description: >
          OK. The requested Individual Data Storage resource shall be returned.
        content:
          application/json:
            schema:
              $ref: '#/components/schemas/DataStorage'
      '307':
        $ref: 'TS29122_CommonData.yaml#/components/responses/307'
      '308':
        $ref: 'TS29122_CommonData.yaml#/components/responses/308'
      '400':
        $ref: 'TS29122_CommonData.yaml#/components/responses/400'
      '401':
        $ref: 'TS29122_CommonData.yaml#/components/responses/401'
      '403':
        $ref: 'TS29122_CommonData.yaml#/components/responses/403'
      '404':
        $ref: 'TS29122_CommonData.yaml#/components/responses/404'
      '406':
        $ref: 'TS29122_CommonData.yaml#/components/responses/406'
      '429':
        $ref: 'TS29122_CommonData.yaml#/components/responses/429'
      '500':
        $ref: 'TS29122_CommonData.yaml#/components/responses/500'
      '503':
        $ref: 'TS29122_CommonData.yaml#/components/responses/503'
      default:
        $ref: 'TS29122_CommonData.yaml#/components/responses/default'

  put:
    summary: Request the update of an existing Individual Data Storage resource.

```

```

operationId: UpdateIndDataStorage
tags:
  - Individual Data Storage (Document)
requestBody:
  required: true
  content:
    application/json:
      schema:
        $ref: '#/components/schemas/DataStorage'
responses:
  '200':
    description: >
      OK. The Individual Data Storage resource is successfully updated and a representation
      of the updated resource shall be returned in the response body.
    content:
      application/json:
        schema:
          $ref: '#/components/schemas/DataStorage'
  '204':
    description: >
      No Content. The Individual Data Storage resource is successfully updated and no content
      is returned in the response body.
  '307':
    $ref: 'TS29122_CommonData.yaml#/components/responses/307'
  '308':
    $ref: 'TS29122_CommonData.yaml#/components/responses/308'
  '400':
    $ref: 'TS29122_CommonData.yaml#/components/responses/400'
  '401':
    $ref: 'TS29122_CommonData.yaml#/components/responses/401'
  '403':
    $ref: 'TS29122_CommonData.yaml#/components/responses/403'
  '404':
    $ref: 'TS29122_CommonData.yaml#/components/responses/404'
  '411':
    $ref: 'TS29122_CommonData.yaml#/components/responses/411'
  '413':
    $ref: 'TS29122_CommonData.yaml#/components/responses/413'
  '415':
    $ref: 'TS29122_CommonData.yaml#/components/responses/415'
  '429':
    $ref: 'TS29122_CommonData.yaml#/components/responses/429'
  '500':
    $ref: 'TS29122_CommonData.yaml#/components/responses/500'
  '503':
    $ref: 'TS29122_CommonData.yaml#/components/responses/503'
  default:
    $ref: 'TS29122_CommonData.yaml#/components/responses/default'

patch:
summary: Request the modification of an existing Individual Data Storage resource.
operationId: ModifyIndDataStorage
tags:
  - Individual Data Storage (Document)
requestBody:
  required: true
  content:
    application/merge-patch+json:
      schema:
        $ref: '#/components/schemas/DataStoragePatch'
responses:
  '200':
    description: >
      OK. The Individual Data Storage resource is successfully modified and a representation
      of the updated resource shall be returned in the response body.
    content:
      application/json:
        schema:
          $ref: '#/components/schemas/DataStorage'
  '204':
    description: >
      No Content. The Individual Data Storage resource is successfully modified and no content
      is returned in the response body.
  '307':
    $ref: 'TS29122_CommonData.yaml#/components/responses/307'
  '308':
    $ref: 'TS29122_CommonData.yaml#/components/responses/308'
  '400':

```

```

    $ref: 'TS29122_CommonData.yaml#/components/responses/400'
  '401':
    $ref: 'TS29122_CommonData.yaml#/components/responses/401'
  '403':
    $ref: 'TS29122_CommonData.yaml#/components/responses/403'
  '404':
    $ref: 'TS29122_CommonData.yaml#/components/responses/404'
  '411':
    $ref: 'TS29122_CommonData.yaml#/components/responses/411'
  '413':
    $ref: 'TS29122_CommonData.yaml#/components/responses/413'
  '415':
    $ref: 'TS29122_CommonData.yaml#/components/responses/415'
  '429':
    $ref: 'TS29122_CommonData.yaml#/components/responses/429'
  '500':
    $ref: 'TS29122_CommonData.yaml#/components/responses/500'
  '503':
    $ref: 'TS29122_CommonData.yaml#/components/responses/503'
  default:
    $ref: 'TS29122_CommonData.yaml#/components/responses/default'

```

## delete:

```

summary: Request the deletion of an existing Individual Data Storage resource.
operationId: DeleteIndDataStorage
tags:
  - Individual Data Storage (Document)
responses:
  '204':
    description: >
      No Content. The Individual Data Storage resource is successfully deleted.
  '307':
    $ref: 'TS29122_CommonData.yaml#/components/responses/307'
  '308':
    $ref: 'TS29122_CommonData.yaml#/components/responses/308'
  '400':
    $ref: 'TS29122_CommonData.yaml#/components/responses/400'
  '401':
    $ref: 'TS29122_CommonData.yaml#/components/responses/401'
  '403':
    $ref: 'TS29122_CommonData.yaml#/components/responses/403'
  '404':
    $ref: 'TS29122_CommonData.yaml#/components/responses/404'
  '429':
    $ref: 'TS29122_CommonData.yaml#/components/responses/429'
  '500':
    $ref: 'TS29122_CommonData.yaml#/components/responses/500'
  '503':
    $ref: 'TS29122_CommonData.yaml#/components/responses/503'
  default:
    $ref: 'TS29122_CommonData.yaml#/components/responses/default'

```

## /subscriptions:

```

post:
  summary: Request the creation of a Data Storage Delivery Subscription.
  operationId: CreateDataDelSubsc
  tags:
    - Data Storage Delivery Subscriptions (Collection)
  requestBody:
    required: true
    content:
      application/json:
        schema:
          $ref: '#/components/schemas/DataDelSubsc'
  responses:
    '201':
      description: >
        Created. The Data Storage Delivery Subscription is successfully created and a
        representation of the created Individual Data Storage Delivery Subscription resource
        shall be returned.
      content:
        application/json:
          schema:
            $ref: '#/components/schemas/DataDelSubsc'
      headers:
        Location:
          description: >
            Contains the URI of the created Individual Data Storage Delivery Subscription

```

```

    resource.
    required: true
    schema:
      type: string
'400':
  $ref: 'TS29122_CommonData.yaml#/components/responses/400'
'401':
  $ref: 'TS29122_CommonData.yaml#/components/responses/401'
'403':
  $ref: 'TS29122_CommonData.yaml#/components/responses/403'
'404':
  $ref: 'TS29122_CommonData.yaml#/components/responses/404'
'411':
  $ref: 'TS29122_CommonData.yaml#/components/responses/411'
'413':
  $ref: 'TS29122_CommonData.yaml#/components/responses/413'
'415':
  $ref: 'TS29122_CommonData.yaml#/components/responses/415'
'429':
  $ref: 'TS29122_CommonData.yaml#/components/responses/429'
'500':
  $ref: 'TS29122_CommonData.yaml#/components/responses/500'
'503':
  $ref: 'TS29122_CommonData.yaml#/components/responses/503'
default:
  $ref: 'TS29122_CommonData.yaml#/components/responses/default'
callbacks:
  DataDelNotif:
    '{$request.body#/notifUri}':
      post:
        requestBody:
          required: true
          content:
            application/json:
              schema:
                $ref: '#/components/schemas/DataDelNotif'
        responses:
          '204':
            description: >
              No Content. The Data Storage Delivery Notification is successfully received
              and acknowledged.
          '307':
            $ref: 'TS29122_CommonData.yaml#/components/responses/307'
          '308':
            $ref: 'TS29122_CommonData.yaml#/components/responses/308'
          '400':
            $ref: 'TS29122_CommonData.yaml#/components/responses/400'
          '401':
            $ref: 'TS29122_CommonData.yaml#/components/responses/401'
          '403':
            $ref: 'TS29122_CommonData.yaml#/components/responses/403'
          '404':
            $ref: 'TS29122_CommonData.yaml#/components/responses/404'
          '411':
            $ref: 'TS29122_CommonData.yaml#/components/responses/411'
          '413':
            $ref: 'TS29122_CommonData.yaml#/components/responses/413'
          '415':
            $ref: 'TS29122_CommonData.yaml#/components/responses/415'
          '429':
            $ref: 'TS29122_CommonData.yaml#/components/responses/429'
          '500':
            $ref: 'TS29122_CommonData.yaml#/components/responses/500'
          '503':
            $ref: 'TS29122_CommonData.yaml#/components/responses/503'
          default:
            $ref: 'TS29122_CommonData.yaml#/components/responses/default'

/subscriptions/{subscriptionId}:
  parameters:
    - name: subscriptionId
      in: path
      description: >
        Represents the identifier of the Individual Data Storage Delivery Subscription resource.
      resource.
      required: true
      schema:
        type: string

```

```
get:
  summary: Retrieve an existing Individual Data Storage Delivery Subscription resource.
  operationId: GetIndDataDelSubsc
  tags:
    - Individual Data Storage Delivery Subscription (Document)
  responses:
    '200':
      description: >
        OK. The requested Individual Data Storage Delivery Subscription resource shall be
        returned.
      content:
        application/json:
          schema:
            $ref: '#/components/schemas/DataDelSubsc'
    '307':
      $ref: 'TS29122_CommonData.yaml#/components/responses/307'
    '308':
      $ref: 'TS29122_CommonData.yaml#/components/responses/308'
    '400':
      $ref: 'TS29122_CommonData.yaml#/components/responses/400'
    '401':
      $ref: 'TS29122_CommonData.yaml#/components/responses/401'
    '403':
      $ref: 'TS29122_CommonData.yaml#/components/responses/403'
    '404':
      $ref: 'TS29122_CommonData.yaml#/components/responses/404'
    '406':
      $ref: 'TS29122_CommonData.yaml#/components/responses/406'
    '429':
      $ref: 'TS29122_CommonData.yaml#/components/responses/429'
    '500':
      $ref: 'TS29122_CommonData.yaml#/components/responses/500'
    '503':
      $ref: 'TS29122_CommonData.yaml#/components/responses/503'
  default:
    $ref: 'TS29122_CommonData.yaml#/components/responses/default'

put:
  summary: Request the update of an existing Individual Data Storage Delivery Subscription
  resource.
  operationId: UpdateIndDataDelSubsc
  tags:
    - Individual Data Storage Delivery Subscription (Document)
  requestBody:
    required: true
    content:
      application/json:
        schema:
          $ref: '#/components/schemas/DataDelSubsc'
  responses:
    '200':
      description: >
        OK. The Individual Data Storage Delivery Subscription resource is successfully
        updated and a representation of the updated resource shall be returned in the
        response body.
      content:
        application/json:
          schema:
            $ref: '#/components/schemas/DataDelSubsc'
    '204':
      description: >
        No Content. The Individual Data Storage Delivery Subscription resource is successfully
        updated and no content is returned in the response body.
    '307':
      $ref: 'TS29122_CommonData.yaml#/components/responses/307'
    '308':
      $ref: 'TS29122_CommonData.yaml#/components/responses/308'
    '400':
      $ref: 'TS29122_CommonData.yaml#/components/responses/400'
    '401':
      $ref: 'TS29122_CommonData.yaml#/components/responses/401'
    '403':
      $ref: 'TS29122_CommonData.yaml#/components/responses/403'
    '404':
      $ref: 'TS29122_CommonData.yaml#/components/responses/404'
    '411':
      $ref: 'TS29122_CommonData.yaml#/components/responses/411'
```

```

'413':
  $ref: 'TS29122_CommonData.yaml#/components/responses/413'
'415':
  $ref: 'TS29122_CommonData.yaml#/components/responses/415'
'429':
  $ref: 'TS29122_CommonData.yaml#/components/responses/429'
'500':
  $ref: 'TS29122_CommonData.yaml#/components/responses/500'
'503':
  $ref: 'TS29122_CommonData.yaml#/components/responses/503'
default:
  $ref: 'TS29122_CommonData.yaml#/components/responses/default'

patch:
  summary: Request the modification of an existing Individual Data Storage Delivery Subscription
resource.
  operationId: ModifyIndDataDelSubsc
  tags:
    - Individual Data Storage Delivery Subscription (Document)
  requestBody:
    required: true
    content:
      application/merge-patch+json:
        schema:
          $ref: '#/components/schemas/DataDelSubscPatch'
  responses:
    '200':
      description: >
        OK. The Individual Data Storage Delivery Subscription resource is successfully modified
        and a representation of the updated resource shall be returned in the response body.
      content:
        application/json:
          schema:
            $ref: '#/components/schemas/DataDelSubsc'
    '204':
      description: >
        No Content. The Individual Data Storage Delivery Subscription resource is successfully
        modified and no content is returned in the response body.
    '307':
      $ref: 'TS29122_CommonData.yaml#/components/responses/307'
    '308':
      $ref: 'TS29122_CommonData.yaml#/components/responses/308'
    '400':
      $ref: 'TS29122_CommonData.yaml#/components/responses/400'
    '401':
      $ref: 'TS29122_CommonData.yaml#/components/responses/401'
    '403':
      $ref: 'TS29122_CommonData.yaml#/components/responses/403'
    '404':
      $ref: 'TS29122_CommonData.yaml#/components/responses/404'
    '411':
      $ref: 'TS29122_CommonData.yaml#/components/responses/411'
    '413':
      $ref: 'TS29122_CommonData.yaml#/components/responses/413'
    '415':
      $ref: 'TS29122_CommonData.yaml#/components/responses/415'
    '429':
      $ref: 'TS29122_CommonData.yaml#/components/responses/429'
    '500':
      $ref: 'TS29122_CommonData.yaml#/components/responses/500'
    '503':
      $ref: 'TS29122_CommonData.yaml#/components/responses/503'
    default:
      $ref: 'TS29122_CommonData.yaml#/components/responses/default'

delete:
  summary: Request the deletion of an existing Individual Data Storage Delivery Subscription
resource.
  operationId: DeleteIndDataDelSubsc
  tags:
    - Individual Data Storage Delivery Subscription (Document)
  responses:
    '204':
      description: >
        No Content. The Individual Data Storage Delivery Subscription resource is successfully
        deleted.
    '307':
      $ref: 'TS29122_CommonData.yaml#/components/responses/307'

```



```

'308':
  $ref: 'TS29122_CommonData.yaml#/components/responses/308'
'400':
  $ref: 'TS29122_CommonData.yaml#/components/responses/400'
'401':
  $ref: 'TS29122_CommonData.yaml#/components/responses/401'
'403':
  $ref: 'TS29122_CommonData.yaml#/components/responses/403'
'404':
  $ref: 'TS29122_CommonData.yaml#/components/responses/404'
'429':
  $ref: 'TS29122_CommonData.yaml#/components/responses/429'
'500':
  $ref: 'TS29122_CommonData.yaml#/components/responses/500'
'503':
  $ref: 'TS29122_CommonData.yaml#/components/responses/503'
default:
  $ref: 'TS29122_CommonData.yaml#/components/responses/default'

```

/request-del:

```

post:
  summary: Enables a service consumer to request SEALDD data storage delivery.
  operationId: DataDeliveryRequest
  tags:
    - SEALDD Data Storage Delivery Request
  requestBody:
    required: true
    content:
      application/json:
        schema:
          $ref: '#/components/schemas/DataDelReq'
  responses:
    '204':
      description: >
        No Content. The SEALDD Data Storage delivery request is successfully received and
        processed.
    '307':
      $ref: 'TS29122_CommonData.yaml#/components/responses/307'
    '308':
      $ref: 'TS29122_CommonData.yaml#/components/responses/308'
    '400':
      $ref: 'TS29122_CommonData.yaml#/components/responses/400'
    '401':
      $ref: 'TS29122_CommonData.yaml#/components/responses/401'
    '403':
      $ref: 'TS29122_CommonData.yaml#/components/responses/403'
    '404':
      $ref: 'TS29122_CommonData.yaml#/components/responses/404'
    '411':
      $ref: 'TS29122_CommonData.yaml#/components/responses/411'
    '413':
      $ref: 'TS29122_CommonData.yaml#/components/responses/413'
    '415':
      $ref: 'TS29122_CommonData.yaml#/components/responses/415'
    '429':
      $ref: 'TS29122_CommonData.yaml#/components/responses/429'
    '500':
      $ref: 'TS29122_CommonData.yaml#/components/responses/500'
    '503':
      $ref: 'TS29122_CommonData.yaml#/components/responses/503'
    default:
      $ref: 'TS29122_CommonData.yaml#/components/responses/default'

```

/establish-del-conn:

```

post:
  summary: Enables a service consumer to request SEALDD data storage delivery connection
  establishment.
  operationId: EstablishDelConn
  tags:
    - SEALDD Data Storage Delivery Connection Establishment Request
  requestBody:
    required: true
    content:
      application/json:
        schema:
          $ref: '#/components/schemas/DelConnEstabReq'
  responses:
    '200':

```

```

description: >
  OK. The SEALDD Data Storage delivery connection establishment request is successfully
  received and processed, and SEALDD Data Storage delivery connection establishment
  related information shall be returned in the response body.
content:
  application/json:
    schema:
      $ref: '#/components/schemas/DelConnEstabResp'
'204':
  description: >
    No Content. The SEALDD Data Storage delivery connection establishment request is
    successfully received and processed.
'307':
  $ref: 'TS29122_CommonData.yaml#/components/responses/307'
'308':
  $ref: 'TS29122_CommonData.yaml#/components/responses/308'
'400':
  $ref: 'TS29122_CommonData.yaml#/components/responses/400'
'401':
  $ref: 'TS29122_CommonData.yaml#/components/responses/401'
'403':
  $ref: 'TS29122_CommonData.yaml#/components/responses/403'
'404':
  $ref: 'TS29122_CommonData.yaml#/components/responses/404'
'411':
  $ref: 'TS29122_CommonData.yaml#/components/responses/411'
'413':
  $ref: 'TS29122_CommonData.yaml#/components/responses/413'
'415':
  $ref: 'TS29122_CommonData.yaml#/components/responses/415'
'429':
  $ref: 'TS29122_CommonData.yaml#/components/responses/429'
'500':
  $ref: 'TS29122_CommonData.yaml#/components/responses/500'
'503':
  $ref: 'TS29122_CommonData.yaml#/components/responses/503'
default:
  $ref: 'TS29122_CommonData.yaml#/components/responses/default'

```

```

components:
  securitySchemes:
    oAuth2ClientCredentials:
      type: oauth2
      flows:
        clientCredentials:
          tokenUrl: '{tokenUrl}'
          scopes: {}

```

```
schemas:
```

```

#
# STRUCTURED DATA TYPES
#

```

```

DataStorage:
  description: >
    Represents a SEALDD Data Storage.
  type: object
  properties:
    data:
      $ref: 'TS29122_CommonData.yaml#/components/schemas/Bytes'
    ctrlPolicies:
      type: array
      items:
        $ref: '#/components/schemas/AccessCtrlPolicy'
      minItems: 1
    expTime:
      $ref: 'TS29122_CommonData.yaml#/components/schemas/DateTime'
    mngtSubsc:
      $ref: '#/components/schemas/DataMngtSubsc'
    suppFeat:
      $ref: 'TS29571_CommonData.yaml#/components/schemas/SupportedFeatures'
  required:
    - data

ReservReqData:
  description: >

```

```

    Represents a Data Storage reservation request.
  type: object
  properties:
    valServiceId:
      type: string
    dataLength:
      $ref: 'TS29571_CommonData.yaml#/components/schemas/UInteger'
    suppFeat:
      $ref: 'TS29571_CommonData.yaml#/components/schemas/SupportedFeatures'
  required:
    - valServiceId

ReservRespData:
  description: >
    Represents a Data Storage reservation response.
  type: object
  properties:
    resourceAddr:
      $ref: 'TS29122_CommonData.yaml#/components/schemas/Uri'
  required:
    - resourceAddr

DataStoragePatch:
  description: >
    Represents the requested modifications to a SEALDD Data Storage.
  type: object
  properties:
    data:
      $ref: 'TS29122_CommonData.yaml#/components/schemas/Bytes'
    ctrlPolicies:
      type: array
      items:
        $ref: '#/components/schemas/AccessCtrlPolicy'
      minItems: 1
    expTime:
      $ref: 'TS29122_CommonData.yaml#/components/schemas/DateTime'
    mngtSubsc:
      $ref: '#/components/schemas/DataMngtSubsc'

AccessCtrlPolicy:
  description: >
    Represents the data access control policy.
  type: object
  properties:
    entityName:
      $ref: '#/components/schemas/EntityName'
    entityId:
      type: string
    rights:
      type: array
      items:
        $ref: '#/components/schemas/DataAccessRight'
      minItems: 1
  required:
    - rights
  anyOf:
    - required: [entityName]
    - required: [entityId]

DataMngtSubsc:
  description: >
    Represents the stored data management and/or status information subscription related
    information.
  type: object
  properties:
    events:
      type: array
      items:
        $ref: '#/components/schemas/DataMngtEvent'
      minItems: 1
    notifUri:
      $ref: 'TS29122_CommonData.yaml#/components/schemas/Uri'
    repPeriodicity:
      $ref: 'TS29122_CommonData.yaml#/components/schemas/DurationSec'
  required:
    - events
    - notifUri

```

```

DataMngtNotif:
  description: >
    Represents a SEALDD Data Management and/or Status Information Notification.
  type: object
  properties:
    storageId:
      type: string
    events:
      type: array
      items:
        $ref: '#/components/schemas/DataMngtEvent'
      minItems: 1
    accessStats:
      $ref: '#/components/schemas/DataAccessStats'
    mngtStats:
      $ref: '#/components/schemas/DataMngtStats'
  required:
    - storageId
    - events
  anyOf:
    - required: [accessStats]
    - required: [mngtStats]

DataAccessStats:
  description: >
    Represents data access statistics.
  type: object
  properties:
    genAccessStats:
      $ref: 'TS29571_CommonData.yaml#/components/schemas/UInteger'
    detAccessStats:
      type: object
      additionalProperties:
        $ref: 'TS29571_CommonData.yaml#/components/schemas/UInteger'
      minProperties: 1
    description: >
      Represents the data access statistics of the stored data detailed per consumer SEALDD
      entity. It contains how many times the stored data was accessed (i.e., retrieved or
      updated) per SEALDD entity.
      The key of the map shall be the name of the SEALDD entity, encoded using the EntityName
      data type as specified in clause 6.2.6.3.3, to which the data access statistics provided
      within the map value are related.
  anyOf:
    - required: [genAccessStats]
    - required: [detAccessStats]

DataMngtStats:
  description: >
    Represents data management statistics.
  type: object
  properties:
    genMngtStats:
      $ref: 'TS29571_CommonData.yaml#/components/schemas/UInteger'
    detMngtStats:
      type: object
      additionalProperties:
        $ref: 'TS29571_CommonData.yaml#/components/schemas/UInteger'
      minProperties: 1
    description: >
      Represents the data management statistics of the stored data detailed per consumer
      SEALDD entity. It contains how many times the stored data was accessed for management
      purposes (i.e., data update) per SEALDD entity.
      The key of the map shall be the name of the SEALDD entity, encoded using the EntityName
      data type as specified in clause 6.2.6.3.3, to which the data management statistics
      provided within the map value are related.
  anyOf:
    - required: [genMngtStats]
    - required: [detMngtStats]

DataDelSubsc:
  description: >
    Represents a SEALDD Data Storage Delivery Subscription.
  type: object
  properties:
    notifUri:
      $ref: 'TS29122_CommonData.yaml#/components/schemas/Uri'
    expTime:

```

```
    $ref: 'TS29122_CommonData.yaml#/components/schemas/DateTimeRo'
  suppFeat:
    $ref: 'TS29571_CommonData.yaml#/components/schemas/SupportedFeatures'
  required:
    - notifUri

DataDelSubscPatch:
  description: >
    Represents the requested modification to a SEALDD Data Storage Delivery Subscription.
  type: object
  properties:
    notifUri:
      $ref: 'TS29122_CommonData.yaml#/components/schemas/Uri'

DataDelNotif:
  description: >
    Represents a SEALDD Data Storage Delivery Notification.
  type: object
  properties:
    subscriptionId:
      type: string
    data:
      $ref: 'TS29122_CommonData.yaml#/components/schemas/Bytes'
    storageId:
      type: string
  required:
    - subscriptionId
  oneOf:
    - required: [data]
    - required: [storageId]

DataDelReq:
  description: >
    Represents a SEALDD Data Storage Delivery request.
  type: object
  properties:
    targetId:
      type: string
    sealddServId:
      type: string
    storageId:
      type: string
    data:
      $ref: 'TS29122_CommonData.yaml#/components/schemas/Bytes'
    suppFeat:
      $ref: 'TS29571_CommonData.yaml#/components/schemas/SupportedFeatures'
  required:
    - targetId
  oneOf:
    - required: [data]
    - required: [storageId]

DelConnEstabReq:
  description: >
    Represents a SEALDD Data Storage Delivery connection establishment request.
  type: object
  properties:
    targetId:
      type: string
    ddServerConnInfo:
      $ref: 'TS29548_SDD_Transmission.yaml#/components/schemas/ConnInfo'
    transProtoc:
      type: array
      items:
        $ref: 'TS29558_Eees_EASRegistration.yaml#/components/schemas/TransportProtocol'
      minItems: 1
    suppFeat:
      $ref: 'TS29571_CommonData.yaml#/components/schemas/SupportedFeatures'
  required:
    - targetId

DelConnEstabResp:
  description: >
    Represents the response to a SEALDD Data Storage Delivery connection establishment request.
  type: object
  properties:
    ddServerConnInfo:
      $ref: 'TS29548_SDD_Transmission.yaml#/components/schemas/ConnInfo'
```

```
transProtoc:
  $ref: 'TS29558_Eees_EASRegistration.yaml#/components/schemas/TransportProtocol'
suppFeat:
  $ref: 'TS29571_CommonData.yaml#/components/schemas/SupportedFeatures'

# SIMPLE DATA TYPES
#

#
# ENUMERATIONS
#

EntityName:
  anyOf:
    - type: string
      enum:
        - SEALDD_SERVER
        - SEALDD_CLIENT
        - VAL_SERVER
    - type: string
      description: >
        This string provides forward-compatibility with future extensions to the enumeration
        and is not used to encode content defined in the present version of this API.
  description: |
    Represents the name of a SEALDD entity.
    Possible values are:
    - SEALDD_SERVER: Indicates the SEALDD Server.
    - SEALDD_CLIENT: Indicates the SEALDD Client.
    - VAL_SERVER: Indicates the VAL Server.

DataAccessRight:
  anyOf:
    - type: string
      enum:
        - RETRIEVE
        - UPDATE
        - DELETE
    - type: string
      description: >
        This string provides forward-compatibility with future extensions to the enumeration
        and is not used to encode content defined in the present version of this API.
  description: |
    Represents the data access rights.
    Possible values are:
    - RETRIEVE: Indicates that the access right is data storage retrieval.
    - UPDATE: Indicates that the access right is data storage update.
    - DELETE: Indicates that the access right is data storage deletion.

DataMngtEvent:
  anyOf:
    - type: string
      enum:
        - DATA_ACCESS_STATISTICS
        - DATA_MNGT_STATISTICS
    - type: string
      description: >
        This string provides forward-compatibility with future extensions to the enumeration
        and is not used to encode content defined in the present version of this API.
  description: |
    Represents the Data Management and (or) Status Information events.
    Possible values are:
    - DATA_ACCESS_STATISTICS: Indicates that the Data Management Event is data access statistics
      (i.e., how often the stored data is accessed).
    - DATA_MNGT_STATISTICS: Indicates that the Data Management Event is data management
      statistics (i.e., how often the stored data is managed).

# Data types describing alternative data types or combinations of data types:
#

DataStorageReq:
  description: Represents a SEALDD Data Storage creation or reservation request.
  oneOf:
    - $ref: '#/components/schemas/DataStorage'
    - $ref: '#/components/schemas/ReservReqData'
```

## A.4 SDD\_DDContext API

openapi: 3.0.0

info:

```

title: SEALDD Server Data Delivery Context Relocation
version: 1.0.0
description: |
  SEALDD Server Data Delivery Context Relocation.
  © 2024, 3GPP Organizational Partners (ARIB, ATIS, CCSA, ETSI, TSDSI, TTA, TTC).
  All rights reserved.

```

externalDocs:

```

description: >
  3GPP TS 29.548 V18.1.0 Service Enabler Architecture Layer for Verticals (SEAL);
  SEAL Data Delivery (SEALDD) Server Services; Stage 3.
url: https://www.3gpp.org/ftp/Specs/archive/29_series/29.548/

```

security:

```

- {}
- oAuth2ClientCredentials: []

```

servers:

```

- url: '{apiRoot}/sdd-ddc/v1'
  variables:
    apiRoot:
      default: https://example.com
      description: apiRoot as defined in clause 6.5 of 3GPP TS 29.549

```

paths:

```

/contextes:
  get:
    summary: Pull the DD context from the SEALDD Server.
    operationId: PullDdContext
    tags:
      - DD Contexts (Collection)
    parameters:
      - name: sealdd-pol-ind
        in: query
        required: false
        schema:
          type: boolean
          default: false
          description: >
            Indicates whether the configured SEALDD Policy(ies), if any, is/are requested and
            shall hence be provided in addition to the DD Context.
            true indicates that the configured SEALDD Policy(ies) is/are requested.
            false indicates that the configured SEALDD Policy(ies) is/are not requested.
            The default value when this query parameter is omitted is false.
      - name: supp-feats
        in: query
        description: Contains the list of supported features.
        required: false
        schema:
          $ref: 'TS29571_CommonData.yaml#/components/schemas/SupportedFeatures'
    responses:
      '200':
        description: Successful case. The requested DD context is returned.
        content:
          application/json:
            schema:
              $ref: '#/components/schemas/DdContextResp'
      '400':
        $ref: 'TS29122_CommonData.yaml#/components/responses/400'
      '401':
        $ref: 'TS29122_CommonData.yaml#/components/responses/401'
      '403':
        $ref: 'TS29122_CommonData.yaml#/components/responses/403'
      '404':
        $ref: 'TS29122_CommonData.yaml#/components/responses/404'
      '406':
        $ref: 'TS29122_CommonData.yaml#/components/responses/406'
      '429':
        $ref: 'TS29122_CommonData.yaml#/components/responses/429'
      '500':
        $ref: 'TS29122_CommonData.yaml#/components/responses/500'
      '503':

```

```

    $ref: 'TS29122_CommonData.yaml#/components/responses/503'
  default:
    $ref: 'TS29122_CommonData.yaml#/components/responses/default'

post:
  summary: Push the DD context to the SEALDD Server.
  tags:
    - DD Contexts (Collection)
  requestBody:
    description: >
      Represents the DD context to be pushed to the
      SEALDD Server.
    required: true
    content:
      application/json:
        schema:
          $ref: '#/components/schemas/DdContextPushReq'
  responses:
    '201':
      description: >
        Created. Successful case. The DD context is successfully pushed to the SEALDD Server and
        the related information is returned in the response body.
      content:
        application/json:
          schema:
            $ref: '#/components/schemas/DdContextResp'
    '307':
      $ref: 'TS29122_CommonData.yaml#/components/responses/307'
    '308':
      $ref: 'TS29122_CommonData.yaml#/components/responses/308'
    '400':
      $ref: 'TS29122_CommonData.yaml#/components/responses/400'
    '401':
      $ref: 'TS29122_CommonData.yaml#/components/responses/401'
    '403':
      $ref: 'TS29122_CommonData.yaml#/components/responses/403'
    '404':
      $ref: 'TS29122_CommonData.yaml#/components/responses/404'
    '411':
      $ref: 'TS29122_CommonData.yaml#/components/responses/411'
    '413':
      $ref: 'TS29122_CommonData.yaml#/components/responses/413'
    '415':
      $ref: 'TS29122_CommonData.yaml#/components/responses/415'
    '429':
      $ref: 'TS29122_CommonData.yaml#/components/responses/429'
    '500':
      $ref: 'TS29122_CommonData.yaml#/components/responses/500'
    '503':
      $ref: 'TS29122_CommonData.yaml#/components/responses/503'
  default:
    $ref: 'TS29122_CommonData.yaml#/components/responses/default'

components:
  securitySchemes:
    oAuth2ClientCredentials:
      type: oauth2
      flows:
        clientCredentials:
          tokenUrl: '{tokenUrl}'
          scopes: {}

  schemas:

#
# STRUCTURED DATA TYPES
#

DdContext:
  description: Represents the DD context.
  type: object
  properties:
    uuContext:
      $ref: '#/components/schemas/SddUuContext'
    sContext:
      $ref: '#/components/schemas/SddSContext'
    trLayerContext:
      $ref: '#/components/schemas/TranspLayerContext'

```



```

required:
- uuContext
- sContext

TranspLayerContext:
description: Represents the transport layer context.
type: object
properties:
  transProtoc:
    $ref: 'TS29558_Eees_EASRegistration.yaml#/components/schemas/TransportProtocol'
required:
- transProtoc

DdContextPushReq:
description: Represents the DD context push request.
type: object
properties:
  ddContext:
    $ref: '#/components/schemas/DdContext'
  suppFeat:
    $ref: 'TS29571_CommonData.yaml#/components/schemas/SupportedFeatures'
required:
- ddContext

DdContextResp:
description: Represents the DD context push response.
type: object
properties:
  ddContext:
    $ref: '#/components/schemas/DdContext'
  endPoint:
    $ref: 'TS29548_SDD_Transmission.yaml#/components/schemas/ConnInfo'
  policies:
    type: array
    items:
      $ref: 'TS29548_SDD_PolicyConfiguration.yaml#/components/schemas/PolicyConfig'
    minItems: 1
  suppFeat:
    $ref: 'TS29571_CommonData.yaml#/components/schemas/SupportedFeatures'

SddUuContext:
description: Represents the context related to the SEALDD-Uu connection.
type: object
properties:
  sddFlowId:
    type: string
    description: Represents the SEALDD flow ID.
  valServiceId:
    type: string
    description: Contains the identifier of the VAL service.
  valServerId:
    type: string
    description: Contains the identifier of the VAL Server.
  valServEndPoint:
    $ref: 'TS29548_SDD_Transmission.yaml#/components/schemas/ConnInfo'
  ddClientConnInfo:
    $ref: 'TS29548_SDD_Transmission.yaml#/components/schemas/ConnInfo'
  ddServConnInfo:
    $ref: 'TS29548_SDD_Transmission.yaml#/components/schemas/ConnInfo'
  valTgtUe:
    $ref: 'TS29549_SS_UserProfileRetrieval.yaml#/components/schemas/ValTargetUe'
  comLifetime:
    $ref: 'TS29122_CommonData.yaml#/components/schemas/DurationSec'
  valUsersBdw:
    $ref: 'TS29548_SDD_Transmission.yaml#/components/schemas/ValUsersBdw'
  pendingTimer:
    $ref: 'TS29122_CommonData.yaml#/components/schemas/DurationSec'
required:
- sddFlowId
- valServEndPoint

SddSContext:
description: Represents the context related to the SEALDD-S connection.
type: object
properties:
  valServerId:
    type: string
    description: Contains the identifier of the VAL Server.

```

```
valServiceId:
  type: string
  description: Contains the identifier of the VAL service.
valTargetId:
  $ref: 'TS29549_SS_UserProfileRetrieval.yaml#/components/schemas/ValTargetUe'
valServerConnInfo:
  $ref: 'TS29548_SDD_Transmission.yaml#/components/schemas/ConnInfo'
ddServerConnInfo:
  $ref: 'TS29548_SDD_Transmission.yaml#/components/schemas/ConnInfo'
qosInfo:
  $ref: 'TS29548_SDD_Transmission.yaml#/components/schemas/QosInfo'
valServerBdw:
  $ref: 'TS29548_SDD_Transmission.yaml#/components/schemas/ValServBdw'
valUsersBdw:
  $ref: 'TS29548_SDD_Transmission.yaml#/components/schemas/ValUsersBdw'
required:
- valServerId
- valServerConnInfo
```

```
# SIMPLE DATA TYPES
#
```

```
#
# ENUMERATIONS
#
```

```
# Data types describing alternative data types or combinations of data types:
#
```

## A.5 SDD\_TransmissionQualityMeasurement API

openapi: 3.0.0

info:

```
title: SEALDD Server Data Transmission Quality Measurement Service
version: 1.0.0
description: |
  SEALDD Server Data Transmission Quality Measurement Service.
  © 2024, 3GPP Organizational Partners (ARIB, ATIS, CCSA, ETSI, TSDSI, TTA, TTC).
  All rights reserved.
```

externalDocs:

```
description: >
  3GPP TS 29.548 V18.1.0; Service Enabler Architecture Layer for Verticals (SEAL);
  SEAL Data Delivery (SEALDD) Server Services; Stage 3.
url: https://www.3gpp.org/ftp/Specs/archive/29_series/29.548/
```

servers:

```
- url: '{apiRoot}/sdd-tqm/v1'
  variables:
    apiRoot:
      default: https://example.com
      description: apiRoot as defined in clause 6.5 of 3GPP TS 29.549
```

security:

```
- {}
- oAuth2ClientCredentials: []
```

paths:

```
/subscriptions:
  post:
    summary: Request the creation of a Transmission Quality Measurement Subscription.
    operationId: CreateTransQualMeasSubsc
    tags:
      - Transmission Quality Measurement Subscriptions (Collection)
    requestBody:
      required: true
      content:
        application/json:
          schema:
            $ref: '#/components/schemas/TransQualMeasSubsc'
    responses:
      '201':
        description: >
          Created. The Transmission Quality Measurement Subscription is successfully created
          and a representation of the created Individual Transmission Quality Measurement
          Subscription resource shall be returned.
        content:
          application/json:
            schema:
              $ref: '#/components/schemas/TransQualMeasSubsc'
        headers:
          Location:
            description: >
              Contains the URI of the created Individual Transmission Quality Measurement
              Subscription resource.
            required: true
            schema:
              type: string
      '400':
        $ref: 'TS29122_CommonData.yaml#/components/responses/400'
      '401':
        $ref: 'TS29122_CommonData.yaml#/components/responses/401'
      '403':
        $ref: 'TS29122_CommonData.yaml#/components/responses/403'
      '404':
        $ref: 'TS29122_CommonData.yaml#/components/responses/404'
      '411':
        $ref: 'TS29122_CommonData.yaml#/components/responses/411'
      '413':
        $ref: 'TS29122_CommonData.yaml#/components/responses/413'
      '415':
        $ref: 'TS29122_CommonData.yaml#/components/responses/415'
      '429':
        $ref: 'TS29122_CommonData.yaml#/components/responses/429'
      '500':
```

```

    $ref: 'TS29122_CommonData.yaml#/components/responses/500'
  '503':
    $ref: 'TS29122_CommonData.yaml#/components/responses/503'
  default:
    $ref: 'TS29122_CommonData.yaml#/components/responses/default'
callbacks:
  TransQualMeasNotif:
    '{$request.body#/notifUri}':
      post:
        requestBody:
          required: true
          content:
            application/json:
              schema:
                $ref: '#/components/schemas/TransQualMeasNotif'
        responses:
          '204':
            description: >
              No Content. The Transmission Quality Measurement notification is successfully
              received and acknowledged.
          '307':
            $ref: 'TS29122_CommonData.yaml#/components/responses/307'
          '308':
            $ref: 'TS29122_CommonData.yaml#/components/responses/308'
          '400':
            $ref: 'TS29122_CommonData.yaml#/components/responses/400'
          '401':
            $ref: 'TS29122_CommonData.yaml#/components/responses/401'
          '403':
            $ref: 'TS29122_CommonData.yaml#/components/responses/403'
          '404':
            $ref: 'TS29122_CommonData.yaml#/components/responses/404'
          '411':
            $ref: 'TS29122_CommonData.yaml#/components/responses/411'
          '413':
            $ref: 'TS29122_CommonData.yaml#/components/responses/413'
          '415':
            $ref: 'TS29122_CommonData.yaml#/components/responses/415'
          '429':
            $ref: 'TS29122_CommonData.yaml#/components/responses/429'
          '500':
            $ref: 'TS29122_CommonData.yaml#/components/responses/500'
          '503':
            $ref: 'TS29122_CommonData.yaml#/components/responses/503'
          default:
            $ref: 'TS29122_CommonData.yaml#/components/responses/default'

/subscriptions/{subscriptionId}:
  parameters:
    - name: subscriptionId
      in: path
      description: >
        Represents the identifier of the Individual Transmission Quality Measurement Subscription
        resource.
      required: true
      schema:
        type: string

  get:
    summary: Retrieve an existing Individual Transmission Quality Measurement Subscription
    resource.
    operationId: GetIndTransQualMeasSubsc
    tags:
      - Individual Transmission Quality Measurement Subscription (Document)
    responses:
      '200':
        description: >
          OK. The requested Individual Transmission Quality Measurement Subscription resource
          shall be returned.
        content:
          application/json:
            schema:
              $ref: '#/components/schemas/TransQualMeasSubsc'
      '307':
        $ref: 'TS29122_CommonData.yaml#/components/responses/307'
      '308':
        $ref: 'TS29122_CommonData.yaml#/components/responses/308'
      '400':

```

```

    $ref: 'TS29122_CommonData.yaml#/components/responses/400'
  '401':
    $ref: 'TS29122_CommonData.yaml#/components/responses/401'
  '403':
    $ref: 'TS29122_CommonData.yaml#/components/responses/403'
  '404':
    $ref: 'TS29122_CommonData.yaml#/components/responses/404'
  '406':
    $ref: 'TS29122_CommonData.yaml#/components/responses/406'
  '429':
    $ref: 'TS29122_CommonData.yaml#/components/responses/429'
  '500':
    $ref: 'TS29122_CommonData.yaml#/components/responses/500'
  '503':
    $ref: 'TS29122_CommonData.yaml#/components/responses/503'
  default:
    $ref: 'TS29122_CommonData.yaml#/components/responses/default'

```

put:

```

summary: Request the update of an existing Individual Transmission Quality Measurement
Subscription resource.
operationId: UpdateIndTransQualMeasSubsc
tags:
  - Individual Transmission Quality Measurement Subscription (Document)
requestBody:
  required: true
  content:
    application/json:
      schema:
        $ref: '#/components/schemas/TransQualMeasSubsc'
responses:
  '200':
    description: >
      OK. The Individual Transmission Quality Measurement Subscription resource is
      successfully updated and a representation of the updated resource shall be returned in
      the response body.
    content:
      application/json:
        schema:
          $ref: '#/components/schemas/TransQualMeasSubsc'
  '204':
    description: >
      No Content. The Individual Transmission Quality Measurement Subscription resource is
      successfully updated and no content is returned in the response body.
  '307':
    $ref: 'TS29122_CommonData.yaml#/components/responses/307'
  '308':
    $ref: 'TS29122_CommonData.yaml#/components/responses/308'
  '400':
    $ref: 'TS29122_CommonData.yaml#/components/responses/400'
  '401':
    $ref: 'TS29122_CommonData.yaml#/components/responses/401'
  '403':
    $ref: 'TS29122_CommonData.yaml#/components/responses/403'
  '404':
    $ref: 'TS29122_CommonData.yaml#/components/responses/404'
  '411':
    $ref: 'TS29122_CommonData.yaml#/components/responses/411'
  '413':
    $ref: 'TS29122_CommonData.yaml#/components/responses/413'
  '415':
    $ref: 'TS29122_CommonData.yaml#/components/responses/415'
  '429':
    $ref: 'TS29122_CommonData.yaml#/components/responses/429'
  '500':
    $ref: 'TS29122_CommonData.yaml#/components/responses/500'
  '503':
    $ref: 'TS29122_CommonData.yaml#/components/responses/503'
  default:
    $ref: 'TS29122_CommonData.yaml#/components/responses/default'

```

patch:

```

summary: Request the modification of an existing Individual Transmission Quality Measurement
Subscription resource.
operationId: ModifyIndTransQualMeasSubsc
tags:
  - Individual Transmission Quality Measurement Subscription (Document)
requestBody:

```

```

    required: true
    content:
      application/merge-patch+json:
        schema:
          $ref: '#/components/schemas/TransQualMeasSubscPatch'
  responses:
    '200':
      description: >
        OK. The Individual Transmission Quality Measurement Subscription resource is
        successfully modified and a representation of the updated resource shall be returned in
        the response body.
      content:
        application/json:
          schema:
            $ref: '#/components/schemas/TransQualMeasSubsc'
    '204':
      description: >
        No Content. The Individual Transmission Quality Measurement Subscription resource is
        successfully modified and no content is returned in the response body.
    '307':
      $ref: 'TS29122_CommonData.yaml#/components/responses/307'
    '308':
      $ref: 'TS29122_CommonData.yaml#/components/responses/308'
    '400':
      $ref: 'TS29122_CommonData.yaml#/components/responses/400'
    '401':
      $ref: 'TS29122_CommonData.yaml#/components/responses/401'
    '403':
      $ref: 'TS29122_CommonData.yaml#/components/responses/403'
    '404':
      $ref: 'TS29122_CommonData.yaml#/components/responses/404'
    '411':
      $ref: 'TS29122_CommonData.yaml#/components/responses/411'
    '413':
      $ref: 'TS29122_CommonData.yaml#/components/responses/413'
    '415':
      $ref: 'TS29122_CommonData.yaml#/components/responses/415'
    '429':
      $ref: 'TS29122_CommonData.yaml#/components/responses/429'
    '500':
      $ref: 'TS29122_CommonData.yaml#/components/responses/500'
    '503':
      $ref: 'TS29122_CommonData.yaml#/components/responses/503'
    default:
      $ref: 'TS29122_CommonData.yaml#/components/responses/default'

  delete:
    summary: Request the deletion of an existing Individual Transmission Quality Measurement
    Subscription resource.
    operationId: DeleteIndTransQualMeasSubsc
    tags:
      - Individual Transmission Quality Measurement Subscription (Document)
    responses:
      '204':
        description: >
          No Content. The Individual Transmission Quality Measurement Subscription resource is
          successfully deleted.
      '307':
        $ref: 'TS29122_CommonData.yaml#/components/responses/307'
      '308':
        $ref: 'TS29122_CommonData.yaml#/components/responses/308'
      '400':
        $ref: 'TS29122_CommonData.yaml#/components/responses/400'
      '401':
        $ref: 'TS29122_CommonData.yaml#/components/responses/401'
      '403':
        $ref: 'TS29122_CommonData.yaml#/components/responses/403'
      '404':
        $ref: 'TS29122_CommonData.yaml#/components/responses/404'
      '429':
        $ref: 'TS29122_CommonData.yaml#/components/responses/429'
      '500':
        $ref: 'TS29122_CommonData.yaml#/components/responses/500'
      '503':
        $ref: 'TS29122_CommonData.yaml#/components/responses/503'
      default:
        $ref: 'TS29122_CommonData.yaml#/components/responses/default'

```

```

/reports:
  get:
    summary: Retrieve Historical Transmission Quality Measurement Report(s).
    operationId: GetHistTransQualMeasReports
    tags:
      - Historical Transmission Quality Measurement Reports (Collection)
    parameters:
      - name: app-traffic-ids
        in: query
        required: true
        schema:
          type: array
          items:
            type: string
            minItems: 1
      - name: val-group-id
        in: query
        required: false
        schema:
          type: string
      - name: val-ue-ids-list
        in: query
        required: false
        schema:
          type: array
          items:
            type: string
            minItems: 1
      - name: val-user-ids-list
        in: query
        required: false
        schema:
          type: array
          items:
            type: string
            minItems: 1
      - name: all-val-ues
        in: query
        required: false
        schema:
          type: boolean
          default: false
          description: >
            Indicates that the request is related to all VAL UE(s) of the application traffic
            identified by the application traffic identifier(s) provided within the
            appTrafficIds attribute.
            true indicates that the request is related to all VAL UE(s).
            false" indicates that the request is not related to all VAL UE(s).
            The default value when this query parameter is omitted is false.
      - name: supp-feat
        in: query
        required: false
        schema:
          $ref: 'TS29571_CommonData.yaml#/components/schemas/SupportedFeatures'
    responses:
      '200':
        description: >
          OK. The requested Historical Transmission Quality Measurement Report(s) , if any, shall
          be returned.
        content:
          application/json:
            schema:
              $ref: '#/components/schemas/HistTransQualMeasReports'
      '307':
        $ref: 'TS29122_CommonData.yaml#/components/responses/307'
      '308':
        $ref: 'TS29122_CommonData.yaml#/components/responses/308'
      '400':
        $ref: 'TS29122_CommonData.yaml#/components/responses/400'
      '401':
        $ref: 'TS29122_CommonData.yaml#/components/responses/401'
      '403':
        $ref: 'TS29122_CommonData.yaml#/components/responses/403'
      '404':
        $ref: 'TS29122_CommonData.yaml#/components/responses/404'
      '406':
        $ref: 'TS29122_CommonData.yaml#/components/responses/406'
      '429':

```

```

    $ref: 'TS29122_CommonData.yaml#/components/responses/429'
  '500':
    $ref: 'TS29122_CommonData.yaml#/components/responses/500'
  '503':
    $ref: 'TS29122_CommonData.yaml#/components/responses/503'
  default:
    $ref: 'TS29122_CommonData.yaml#/components/responses/default'

```

components:

```

  securitySchemes:
    oAuth2ClientCredentials:
      type: oauth2
      flows:
        clientCredentials:
          tokenUrl: '{tokenUrl}'
          scopes: {}

```

schemas:

```

#
# STRUCTURED DATA TYPES
#

```

```

TransQualMeasSubsc:
  description: >
    Represents a Transmission Quality Measurement Subscription.
  type: object
  properties:
    appTrafficIds:
      type: array
      items:
        type: string
    minItems: 1
    valGroupId:
      type: string
    valUeIdsList:
      type: array
      items:
        type: string
    minItems: 1
    valUserIdsList:
      type: array
      items:
        type: string
    minItems: 1
    allValUesInd:
      type: boolean
      default: false
    measConds:
      type: array
      items:
        $ref: 'TS29549_SS_Events.yaml#/components/schemas/ValidityConditions'
    minItems: 1
    reqs:
      type: object
      additionalProperties:
        $ref: '#/components/schemas/TransQualMeasReq'
      minProperties: 1
      nullable: true
      description: >
        Represents the transmission quality measurement reporting requirements of the
        subscription.
        The key of the map shall be any unique string encoded value.
    subsExpTime:
      $ref: 'TS29122_CommonData.yaml#/components/schemas/DateTimeRo'
    notifUri:
      $ref: 'TS29122_CommonData.yaml#/components/schemas/Uri'
    suppFeat:
      $ref: 'TS29571_CommonData.yaml#/components/schemas/SupportedFeatures'
  required:
    - appTrafficIds
    - reqs
    - notifUri
  oneOf:
    - required: [valGroupId]
    - required: [valUeIdsList]
    - required: [valUserIdsList]
    - required: [allValUesInd]

```



```

TransQualMeasReq:
  description: >
    Represents Transmission Quality Measurement requirements.
  type: object
  properties:
    measId:
      type: array
      items:
        $ref: '#/components/schemas/MeasurementId'
      minItems: 1
    repType:
      $ref: 'TS29508_Nsmf_EventExposure.yaml#/components/schemas/NotificationMethod'
    repPeriodicity:
      $ref: 'TS29122_CommonData.yaml#/components/schemas/DurationSec'
    repGranularity:
      $ref: '#/components/schemas/RepGranularity'
    measWindow:
      $ref: 'TS29122_CommonData.yaml#/components/schemas/TimeWindow'
    measExpTime:
      $ref: 'TS29122_CommonData.yaml#/components/schemas/DateTime'
    repCriteriaSets:
      type: object
      additionalProperties:
        $ref: '#/components/schemas/TransQualMeasCriteriaSet'
      minProperties: 1
      description: >
        Contains one or several set(s) of transmission quality measurement reporting
        criteria.
        The key of the map shall be any unique string encoded value.
        Only the criteria related to the subscribed measurement(s) within the measId attribute
        shall be present within this attribute.
    required:
      - measId

TransQualMeasSubscPatch:
  description: >
    Represents the requested modifications to a Transmission Quality Measurement Subscription.
  type: object
  properties:
    measConds:
      type: array
      items:
        $ref: 'TS29549_SS_Events.yaml#/components/schemas/ValidityConditions'
      minItems: 1
    reqs:
      type: object
      additionalProperties:
        $ref: '#/components/schemas/TransQualMeasReq'
      minProperties: 1
      nullable: true
      description: >
        Represents the transmission quality measurement reporting requirements of the
        subscription.
        The key of the map shall be any unique string encoded value and shall be set to the same
        value as the one provided during the creation of the transmission quality measurement
        subscription.
    notifUri:
      $ref: 'TS29122_CommonData.yaml#/components/schemas/Uri'

TransQualMeasNotif:
  description: >
    Represents a Transmission Quality Measurement Notification.
  type: object
  properties:
    subscriptionId:
      type: string
    reports:
      type: array
      items:
        $ref: '#/components/schemas/TransQualMeasReport'
      minItems: 1
    required:
      - subscriptionId
      - reports

TransQualMeasReport:
  description: >

```

```

    Represents a Transmission Quality Measurement report.
  type: object
  properties:
    measId:
      type: array
      items:
        $ref: '#/components/schemas/MeasurementId'
      minItems: 1
    valUeIds:
      type: array
      items:
        type: string
      minItems: 1
    valUserIds:
      type: array
      items:
        type: string
      minItems: 1
    measData:
      $ref: '#/components/schemas/TransQualMeasData'
    timestamp:
      $ref: 'TS29122_CommonData.yaml#/components/schemas/DateTime'
  required:
    - measId
  not:
    required: [valUeIds, valUserIds]

TransQualMeasCriteria:
  description: >
    Represents the Transmission Quality Measurement reporting criteria.
  type: object
  properties:
    minLatency:
      $ref: 'TS29571_CommonData.yaml#/components/schemas/UInteger'
    avgLatency:
      $ref: 'TS29571_CommonData.yaml#/components/schemas/UInteger'
    maxLatency:
      $ref: 'TS29571_CommonData.yaml#/components/schemas/UInteger'
    minBitRate:
      $ref: 'TS29571_CommonData.yaml#/components/schemas/BitRate'
    avgBitRate:
      $ref: 'TS29571_CommonData.yaml#/components/schemas/BitRate'
    maxBitRate:
      $ref: 'TS29571_CommonData.yaml#/components/schemas/BitRate'
    minPackLossRate:
      $ref: 'TS29571_CommonData.yaml#/components/schemas/PacketLossRate'
    avgPackLossRate:
      $ref: 'TS29571_CommonData.yaml#/components/schemas/PacketLossRate'
    maxPackLossRate:
      $ref: 'TS29571_CommonData.yaml#/components/schemas/PacketLossRate'
    minJitter:
      $ref: 'TS29571_CommonData.yaml#/components/schemas/Uint32'
    avgJitter:
      $ref: 'TS29571_CommonData.yaml#/components/schemas/Uint32'
    maxJitter:
      $ref: 'TS29571_CommonData.yaml#/components/schemas/Uint32'
  oneOf:
    - required: [minLatency]
    - required: [avgLatency]
    - required: [maxLatency]
    - required: [minBitRate]
    - required: [avgBitRate]
    - required: [maxBitRate]
    - required: [minPackLossRate]
    - required: [avgPackLossRate]
    - required: [maxPackLossRate]
    - required: [minJitter]
    - required: [avgJitter]
    - required: [maxJitter]

TransQualMeasData:
  description: >
    Represents the Transmission Quality Measurement data.
  type: object
  properties:
    minLatency:
      $ref: 'TS29571_CommonData.yaml#/components/schemas/UInteger'
    maxLatency:

```

```

    $ref: 'TS29571_CommonData.yaml#/components/schemas/UInteger'
  avgLatency:
    $ref: 'TS29571_CommonData.yaml#/components/schemas/UInteger'
  stdDevLatency:
    $ref: 'TS29571_CommonData.yaml#/components/schemas/UInteger'
  kPercLatency:
    $ref: 'TS29571_CommonData.yaml#/components/schemas/UInteger'
  kValLatency:
    $ref: 'TS29571_CommonData.yaml#/components/schemas/UInteger'
  minBitRate:
    $ref: 'TS29571_CommonData.yaml#/components/schemas/BitRate'
  maxBitRate:
    $ref: 'TS29571_CommonData.yaml#/components/schemas/BitRate'
  avgBitRate:
    $ref: 'TS29571_CommonData.yaml#/components/schemas/BitRate'
  stdDevBitRate:
    $ref: 'TS29571_CommonData.yaml#/components/schemas/BitRate'
  kPercBitRate:
    $ref: 'TS29571_CommonData.yaml#/components/schemas/BitRate'
  kValBitRate:
    $ref: 'TS29571_CommonData.yaml#/components/schemas/UInteger'
  minPackLossRate:
    $ref: 'TS29571_CommonData.yaml#/components/schemas/PacketLossRate'
  maxPackLossRate:
    $ref: 'TS29571_CommonData.yaml#/components/schemas/PacketLossRate'
  avgPackLossRate:
    $ref: 'TS29571_CommonData.yaml#/components/schemas/PacketLossRate'
  stdDevPackLossRate:
    $ref: 'TS29571_CommonData.yaml#/components/schemas/PacketLossRate'
  kPercPackLossRate:
    $ref: 'TS29571_CommonData.yaml#/components/schemas/PacketLossRate'
  kValPackLossRate:
    $ref: 'TS29571_CommonData.yaml#/components/schemas/UInteger'
  minJitter:
    $ref: 'TS29571_CommonData.yaml#/components/schemas/Uint32'
  maxJitter:
    $ref: 'TS29571_CommonData.yaml#/components/schemas/Uint32'
  avgJitter:
    $ref: 'TS29571_CommonData.yaml#/components/schemas/Uint32'
  stdDevJitter:
    $ref: 'TS29571_CommonData.yaml#/components/schemas/Uint32'
  kPercJitter:
    $ref: 'TS29571_CommonData.yaml#/components/schemas/Uint32'
  kValJitter:
    $ref: 'TS29571_CommonData.yaml#/components/schemas/UInteger'
  measPeriod:
    $ref: 'TS29122_CommonData.yaml#/components/schemas/DurationSec'
  timestamp:
    $ref: 'TS29122_CommonData.yaml#/components/schemas/DateTime'
  anyOf:
    - required: [minLatency]
    - required: [maxLatency]
    - required: [avgLatency]
    - required: [minBitRate]
    - required: [maxBitRate]
    - required: [avgBitRate]
    - required: [minPackLossRate]
    - required: [maxPackLossRate]
    - required: [avgPackLossRate]
    - required: [minJitter]
    - required: [maxJitter]
    - required: [avgJitter]

HistTransQualMeasReports:
  description: >
    Represents Historical Transmission Quality Measurement Report(s).
  type: object
  properties:
    reports:
      type: array
      items:
        $ref: '#/components/schemas/TransQualMeasReport'
      minItems: 0
      description: >
        Contains the Historical Transmission Quality Measurement Report(s).
        If there are no Historical Transmission Quality Measurement Report(s) fulfilling the
        request, this attribute shall contain an empty array.
  suppFeat:

```

```
    $ref: 'TS29571_CommonData.yaml#/components/schemas/SupportedFeatures'
  required:
    - reports

TransQualMeasCriteriaSet:
  description: >
    Represents a set of transmission quality measurement reporting criteria.
  type: object
  properties:
    criteria:
      $ref: '#/components/schemas/TransQualMeasCriteria'
    direction:
      $ref: 'TS29520_Nnwdaf_EventsSubscription.yaml#/components/schemas/MatchingDirection'
  required:
    - criteria
    - direction

# SIMPLE DATA TYPES
#

#
# ENUMERATIONS
#

MeasurementId:
  anyOf:
    - type: string
      enum:
        - LATENCY
        - BITRATE
        - PACKET_LOSS_RATE
        - JITTER
    - type: string
      description: >
        This string provides forward-compatibility with future extensions to the enumeration
        and is not used to encode content defined in the present version of this API.
  description: |
    Represents the transmission quality measurement type.
    Possible values are:
    - LATENCY: Indicates that the requested/reported measurement is the latency.
    - BITRATE: Indicates that the requested/reported measurement is the bit rate.
    - PACKET_LOSS_RATE: Indicates that the requested/reported measurement is the packet loss
      rate.
    - JITTER: Indicates that the requested/reported measurement is the jitter.

RepGranularity:
  anyOf:
    - type: string
      enum:
        - INDIVIDUAL_VAL_UE
        - VAL_GROUP
        - ALL_VAL_UES
    - type: string
      description: >
        This string provides forward-compatibility with future extensions to the enumeration
        and is not used to encode content defined in the present version of this API.
  description: |
    Represents the reporting granularity.
    Possible values are:
    - INDIVIDUAL_VAL_UE: Indicates that the granularity is individual VAL UE/user.
    - VAL_GROUP: Indicates that the granularity is VAL Group.
    - ALL_VAL_UES: Indicates that the granularity is all VAL UE/user(s).

# Data types describing alternative data types or combinations of data types:
#
```

## A.6 SDD\_PolicyConfiguration API

openapi: 3.0.0

info:

```
title: SEALDD Server Policy Configuration Service
version: 1.0.0
description: |
  SEALDD Server Policy Configuration Service.
  © 2024, 3GPP Organizational Partners (ARIB, ATIS, CCSA, ETSI, TSDSI, TTA, TTC).
  All rights reserved.
```

externalDocs:

```
description: >
  3GPP TS 29.548 V18.1.0; Service Enabler Architecture Layer for Verticals (SEAL);
  SEAL Data Delivery (SEALDD) Server Services; Stage 3.
url: https://www.3gpp.org/ftp/Specs/archive/29_series/29.548/
```

servers:

```
- url: '{apiRoot}/sdd-pc/v1'
  variables:
    apiRoot:
      default: https://example.com
      description: apiRoot as defined in clause 6.5 of 3GPP TS 29.549
```

security:

```
- {}
- oAuth2ClientCredentials: []
```

paths:

```
/configurations:
  post:
    summary: Request the creation of a Policy Configuration.
    operationId: CreatePolicyConfig
    tags:
      - Policy Configurations (Collection)
    requestBody:
      required: true
      content:
        application/json:
          schema:
            $ref: '#/components/schemas/PolicyConfig'
    responses:
      '201':
        description: >
          Created. The Policy Configuration is successfully created and a representation of
          the created Individual Policy Configuration resource shall be returned.
        content:
          application/json:
            schema:
              $ref: '#/components/schemas/PolicyConfig'
        headers:
          Location:
            description: >
              Contains the URI of the created Individual Policy Configuration resource.
            required: true
            schema:
              type: string
      '400':
        $ref: 'TS29122_CommonData.yaml#/components/responses/400'
      '401':
        $ref: 'TS29122_CommonData.yaml#/components/responses/401'
      '403':
        $ref: 'TS29122_CommonData.yaml#/components/responses/403'
      '404':
        $ref: 'TS29122_CommonData.yaml#/components/responses/404'
      '411':
        $ref: 'TS29122_CommonData.yaml#/components/responses/411'
      '413':
        $ref: 'TS29122_CommonData.yaml#/components/responses/413'
      '415':
        $ref: 'TS29122_CommonData.yaml#/components/responses/415'
      '429':
        $ref: 'TS29122_CommonData.yaml#/components/responses/429'
      '500':
        $ref: 'TS29122_CommonData.yaml#/components/responses/500'
      '503':
```

```
    $ref: 'TS29122_CommonData.yaml#/components/responses/503'
  default:
    $ref: 'TS29122_CommonData.yaml#/components/responses/default'

/configurations/{configId}:
  parameters:
    - name: configId
      in: path
      description: >
        Represents the identifier of the Individual Policy Configuration resource.
      required: true
      schema:
        type: string

  get:
    summary: Retrieve an existing Individual Policy Configuration resource.
    operationId: GetIndPolicyConfig
    tags:
      - Individual Policy Configuration (Document)
    responses:
      '200':
        description: >
          OK. The requested Individual Policy Configuration resource shall be returned.
        content:
          application/json:
            schema:
              $ref: '#/components/schemas/PolicyConfig'
      '307':
        $ref: 'TS29122_CommonData.yaml#/components/responses/307'
      '308':
        $ref: 'TS29122_CommonData.yaml#/components/responses/308'
      '400':
        $ref: 'TS29122_CommonData.yaml#/components/responses/400'
      '401':
        $ref: 'TS29122_CommonData.yaml#/components/responses/401'
      '403':
        $ref: 'TS29122_CommonData.yaml#/components/responses/403'
      '404':
        $ref: 'TS29122_CommonData.yaml#/components/responses/404'
      '406':
        $ref: 'TS29122_CommonData.yaml#/components/responses/406'
      '429':
        $ref: 'TS29122_CommonData.yaml#/components/responses/429'
      '500':
        $ref: 'TS29122_CommonData.yaml#/components/responses/500'
      '503':
        $ref: 'TS29122_CommonData.yaml#/components/responses/503'
      default:
        $ref: 'TS29122_CommonData.yaml#/components/responses/default'

  put:
    summary: Request the update of an existing Individual Policy Configuration resource.
    operationId: UpdateIndPolicyConfig
    tags:
      - Individual Policy Configuration (Document)
    requestBody:
      required: true
      content:
        application/json:
          schema:
            $ref: '#/components/schemas/PolicyConfig'
    responses:
      '200':
        description: >
          OK. The Individual Policy Configuration resource is successfully updated and a
          representation of the updated resource shall be returned in the response body.
        content:
          application/json:
            schema:
              $ref: '#/components/schemas/PolicyConfig'
      '204':
        description: >
          No Content. The Individual Policy Configuration resource is successfully updated
          and no content is returned in the response body.
      '307':
        $ref: 'TS29122_CommonData.yaml#/components/responses/307'
      '308':
        $ref: 'TS29122_CommonData.yaml#/components/responses/308'
```

```

'400':
  $ref: 'TS29122_CommonData.yaml#/components/responses/400'
'401':
  $ref: 'TS29122_CommonData.yaml#/components/responses/401'
'403':
  $ref: 'TS29122_CommonData.yaml#/components/responses/403'
'404':
  $ref: 'TS29122_CommonData.yaml#/components/responses/404'
'411':
  $ref: 'TS29122_CommonData.yaml#/components/responses/411'
'413':
  $ref: 'TS29122_CommonData.yaml#/components/responses/413'
'415':
  $ref: 'TS29122_CommonData.yaml#/components/responses/415'
'429':
  $ref: 'TS29122_CommonData.yaml#/components/responses/429'
'500':
  $ref: 'TS29122_CommonData.yaml#/components/responses/500'
'503':
  $ref: 'TS29122_CommonData.yaml#/components/responses/503'
default:
  $ref: 'TS29122_CommonData.yaml#/components/responses/default'

patch:
  summary: Request the modification of an existing Individual Policy Configuration resource.
  operationId: ModifyIndPolicyConfig
  tags:
    - Individual Policy Configuration (Document)
  requestBody:
    required: true
    content:
      application/merge-patch+json:
        schema:
          $ref: '#/components/schemas/PolicyConfigPatch'
  responses:
    '200':
      description: >
        OK. The Individual Policy Configuration resource is successfully modified and a
        representation of the updated resource shall be returned in the response body.
      content:
        application/json:
          schema:
            $ref: '#/components/schemas/PolicyConfig'
    '204':
      description: >
        No Content. The Individual Policy Configuration resource is successfully modified and
        no content is returned in the response body.
    '307':
      $ref: 'TS29122_CommonData.yaml#/components/responses/307'
    '308':
      $ref: 'TS29122_CommonData.yaml#/components/responses/308'
    '400':
      $ref: 'TS29122_CommonData.yaml#/components/responses/400'
    '401':
      $ref: 'TS29122_CommonData.yaml#/components/responses/401'
    '403':
      $ref: 'TS29122_CommonData.yaml#/components/responses/403'
    '404':
      $ref: 'TS29122_CommonData.yaml#/components/responses/404'
    '411':
      $ref: 'TS29122_CommonData.yaml#/components/responses/411'
    '413':
      $ref: 'TS29122_CommonData.yaml#/components/responses/413'
    '415':
      $ref: 'TS29122_CommonData.yaml#/components/responses/415'
    '429':
      $ref: 'TS29122_CommonData.yaml#/components/responses/429'
    '500':
      $ref: 'TS29122_CommonData.yaml#/components/responses/500'
    '503':
      $ref: 'TS29122_CommonData.yaml#/components/responses/503'
    default:
      $ref: 'TS29122_CommonData.yaml#/components/responses/default'

delete:
  summary: Request the deletion of an existing Individual Policy Configuration resource.
  operationId: DeleteIndPolicyConfig
  tags:

```

```

- Individual Policy Configuration (Document)
responses:
  '204':
    description: >
      No Content. The Individual Policy Configuration resource is successfully deleted.
  '307':
    $ref: 'TS29122_CommonData.yaml#/components/responses/307'
  '308':
    $ref: 'TS29122_CommonData.yaml#/components/responses/308'
  '400':
    $ref: 'TS29122_CommonData.yaml#/components/responses/400'
  '401':
    $ref: 'TS29122_CommonData.yaml#/components/responses/401'
  '403':
    $ref: 'TS29122_CommonData.yaml#/components/responses/403'
  '404':
    $ref: 'TS29122_CommonData.yaml#/components/responses/404'
  '429':
    $ref: 'TS29122_CommonData.yaml#/components/responses/429'
  '500':
    $ref: 'TS29122_CommonData.yaml#/components/responses/500'
  '503':
    $ref: 'TS29122_CommonData.yaml#/components/responses/503'
default:
  $ref: 'TS29122_CommonData.yaml#/components/responses/default'

components:
  securitySchemes:
    oAuth2ClientCredentials:
      type: oauth2
      flows:
        clientCredentials:
          tokenUrl: '{tokenUrl}'
          scopes: {}

  schemas:

#
# STRUCTURED DATA TYPES
#

PolicyConfig:
  description: >
    Represents a SEALDD Policy Configuration.
  type: object
  properties:
    appTrafficIds:
      type: array
      items:
        type: string
      minItems: 1
    valTargetId:
      $ref: 'TS29549_SS_UserProfileRetrieval.yaml#/components/schemas/ValTargetUe'
    sealddPol:
      $ref: '#/components/schemas/SealddPolicy'
    expTime:
      $ref: 'TS29122_CommonData.yaml#/components/schemas/DateTimeRo'
    suppFeat:
      $ref: 'TS29571_CommonData.yaml#/components/schemas/SupportedFeatures'
  required:
    - appTrafficIds
    - sealddPol

PolicyConfigPatch:
  description: >
    Represents the requested modifications to a SEALDD Policy Configuration.
  type: object
  properties:
    sealddPol:
      $ref: '#/components/schemas/SealddPolicy'

SealddPolicy:
  description: >
    Represents a SEALDD Policy.
  type: object
  properties:
    qualGuarPol:

```



```

    $ref: '#/components/schemas/QualGuarPolicy'
  bdwCtrlSets:
    type: array
    items:
      $ref: '#/components/schemas/BdwCtrlPolicy'
    minItems: 1
  anyOf:
    - required: [qualGuarPol]
    - required: [bdwCtrlSets]

QualGuarPolicy:
  description: >
    Represents the quality guarantee policy.
  type: object
  properties:
    thresholds:
      $ref: '#/components/schemas/QualGuarThresh'
  required:
    - thresholds

QualGuarThresh:
  description: >
    Represents the quality guarantee related thresholds.
  type: object
  properties:
    measId:
      type: array
      items:
        $ref:
          'TS29548_SDD_TransmissionQualityMeasurement.yaml#/components/schemas/MeasurementId'
      minItems: 1
    measThesh:
      $ref:
        'TS29548_SDD_TransmissionQualityMeasurement.yaml#/components/schemas/TransQualMeasCriteria'
  required:
    - measId
    - measThesh

# SIMPLE DATA TYPES
#

#
# ENUMERATIONS
#

BdwCtrlPolicy:
  anyOf:
    - type: string
      enum:
        - REALLOCATE_DL
        - REALLOCATE_UL
        - NOT_REALLOCATE_DL
        - NOT_REALLOCATE_UL
    - type: string
      description: >
        This string provides forward-compatibility with future extensions to the enumeration
        and is not used to encode content defined in the present version of this API.
      description: |
        Represents the bandwidth control policy.
        Possible values are:
        - REALLOCATE_DL: Indicates that the bandwidth control action is to reallocate the
          bandwidth limit between different VAL users for DL traffic.
        - REALLOCATE_UL: Indicates that the bandwidth control action is to reallocate the
          bandwidth limit between different VAL users for UL traffic.
        - NOT_REALLOCATE_DL: Indicates that the bandwidth control action is to not reallocate
          the bandwidth limit between different VAL users for DL traffic.
        - NOT_REALLOCATE_UL: Indicates that the bandwidth control action is to not reallocate
          the bandwidth limit between different VAL users for UL traffic.

# Data types describing alternative data types or combinations of data types:
#

```

---

## Annex B (informative): Withdrawn API versions

### B.1 General

This Annex lists withdrawn API versions of the APIs defined in the present specification. 3GPP TS 29.501 [3] clause 4.3.1.6 describes the withdrawal of API versions.

---

### B.2 SDD\_Transmission API

The API versions listed in table B.2-1 are withdrawn for the SDD\_Transmission API.

**Table B.2-1: Withdrawn API versions of the SDD\_Transmission service**

API version number	Remarks

---

### B.3 SDD\_DataStorage API

The API versions listed in table B.3-1 are withdrawn for the SDD\_DataStorage API.

**Table B.3-1: Withdrawn API versions of the SDD\_DataStorage service**

API version number	Remarks

---

### B.4 SDD\_DDContext API

The API versions listed in table B.4-1 are withdrawn for the SDD\_DDContext API.

**Table B.4-1: Withdrawn API versions of the SDD\_DDContext service**

API version number	Remarks

---

### B.5 SDD\_TransmissionQualityMeasurement API

The API versions listed in table B.5-1 are withdrawn for the SDD\_TransmissionQualityMeasurement API.

**Table B.5-1: Withdrawn API versions of the SDD\_TransmissionQualityMeasurement service**

API version number	Remarks

---

## B.6 SDD\_PolicyConfiguration API

The API versions listed in table B.6-1 are withdrawn for the SDD\_PolicyConfiguration API.

**Table B.6-1: Withdrawn API versions of the SDD\_PolicyConfiguration service**

API version number	Remarks

## Annex C (informative): Change history

Change history							
Date	Meeting	TDoc	CR	Rev	Cat	Subject/Comment	New version
2023-03	CT3#126	C3-230474	-	-	-	The skeleton for the new SEADD Server Services TS	0.0.0
2023-04	CT3#127-e	C3-231509	-	-	-	Inclusion of C3-231212, C3-231568, C3-231214 and C3-231569.	0.1.0
2023-06	CT3#128	C3-232590	-	-	-	Inclusion of C3-232513, C3-232524, C3-232525, C3-232526 and C3-232527.	0.2.0
2023-09	CT3#129	C3-233737	-	-	-	Inclusion of C3-233655, C3-233656, C3-233657, C3-233658, C3-233659, C3-233660, C3-233715, C3-233716, C3-233717, C3-233718 and C3-233719.	0.3.0
2023-10	CT3#130	C3-234660	-	-	-	Inclusion of C3-234127, C3-234128, C3-234129, C3-234499, C3-234500, C3-234666 and C3-234670.	0.4.0
2023-11	CT3#131	C3-235463	-	-	-	Inclusion of C3-235082, C3-235085, C3-235086, C3-235087, C3-235553, C3-235554 and C3-235625.	0.5.0
2023-12	CT#102	CP-233289				Presentation to TSG CT for information.	1.0.0
2024-03	CT3#133	C3-241654	-	-	-	Inclusion of C3-241313, C3-241531, C3-241619, C3-241676 and C3-241691.	1.1.0
2024-03	CT#103	CP-240214				Presentation to TSG CT for approval.	2.0.0
2024-03	CT#103	CP-240214				Approved by TSG CT.	18.0.0
2024-06	CT#104	CP-241108	0001	1	F	Corrections to SDD_DataStorage API	18.1.0
2024-06	CT#104	CP-241108	0002		F	Corrections to SDD_DDContext API	18.1.0
2024-06	CT#104	CP-241108	0003	1	F	Corrections to SDD_PolicyConfiguration API	18.1.0
2024-06	CT#104	CP-241108	0004	1	F	Corrections to SDD_TransmissionQualityMeasurement API	18.1.0
2024-06	CT#104	CP-241108	0005	1	B	The support of a timestamp indication in notification reports	18.1.0
2024-06	CT#104	CP-241108	0006		F	Various corrections to references	18.1.0
2024-06	CT#104	CP-241083	0007		F	Correct the reference to HTTP error status codes.	18.1.0
2024-06	CT#104	CP-241108	0008	2	F	Corrections to SDD_DataStorage data model and open API	18.1.0
2024-06	CT#104	CP-241108	0009	1	F	Essential corrections to the Historical Transmission Quality Measurement Report(s) retrieval procedure	18.1.0
2024-06	CT#104	CP-241108	0010	1	F	Various essential corrections to the SDD_TransmissionQualityMeasurement API	18.1.0
2024-06	CT#104	CP-241108	0011	1	F	Various essential corrections to the SEALDD APIs	18.1.0
2024-06	CT#104	CP-241086	0012	-	F	Update of info and externalDocs fields	18.1.0
2024-12	CT#106	CP-243131	0027		F	Correcting the content of the Connection Status Notification request body	18.2.0

---

# History

<b>Document history</b>		
V18.0.0	May 2024	Publication
V18.1.0	July 2024	Publication
V18.2.0	January 2025	Publication