

ETSI TS 136 104 V16.16.0 (2024-05)



**LTE;
Evolved Universal Terrestrial Radio Access (E-UTRA);
Base Station (BS) radio transmission and reception
(3GPP TS 36.104 version 16.16.0 Release 16)**



Reference

RTS/TSGR-0436104vgg0

Keywords

LTE

ETSI

650 Route des Lucioles
F-06921 Sophia Antipolis Cedex - FRANCE

Tel.: +33 4 92 94 42 00 Fax: +33 4 93 65 47 16

Siret N° 348 623 562 00017 - APE 7112B
Association à but non lucratif enregistrée à la
Sous-Préfecture de Grasse (06) N° w061004871

Important notice

The present document can be downloaded from:

<https://www.etsi.org/standards-search>

The present document may be made available in electronic versions and/or in print. The content of any electronic and/or print versions of the present document shall not be modified without the prior written authorization of ETSI. In case of any existing or perceived difference in contents between such versions and/or in print, the prevailing version of an ETSI deliverable is the one made publicly available in PDF format at www.etsi.org/deliver.

Users of the present document should be aware that the document may be subject to revision or change of status.

Information on the current status of this and other ETSI documents is available at

<https://portal.etsi.org/TB/ETSIDeliverableStatus.aspx>

If you find errors in the present document, please send your comment to one of the following services:

<https://portal.etsi.org/People/CommitteeSupportStaff.aspx>

If you find a security vulnerability in the present document, please report it through our
Coordinated Vulnerability Disclosure Program:

<https://www.etsi.org/standards/coordinated-vulnerability-disclosure>

Notice of disclaimer & limitation of liability

The information provided in the present deliverable is directed solely to professionals who have the appropriate degree of experience to understand and interpret its content in accordance with generally accepted engineering or other professional standard and applicable regulations.

No recommendation as to products and services or vendors is made or should be implied.

No representation or warranty is made that this deliverable is technically accurate or sufficient or conforms to any law and/or governmental rule and/or regulation and further, no representation or warranty is made of merchantability or fitness for any particular purpose or against infringement of intellectual property rights.

In no event shall ETSI be held liable for loss of profits or any other incidental or consequential damages.

Any software contained in this deliverable is provided "AS IS" with no warranties, express or implied, including but not limited to, the warranties of merchantability, fitness for a particular purpose and non-infringement of intellectual property rights and ETSI shall not be held liable in any event for any damages whatsoever (including, without limitation, damages for loss of profits, business interruption, loss of information, or any other pecuniary loss) arising out of or related to the use of or inability to use the software.

Copyright Notification

No part may be reproduced or utilized in any form or by any means, electronic or mechanical, including photocopying and microfilm except as authorized by written permission of ETSI.

The content of the PDF version shall not be modified without the written authorization of ETSI.

The copyright and the foregoing restriction extend to reproduction in all media.

© ETSI 2024.
All rights reserved.

Intellectual Property Rights

Essential patents

IPRs essential or potentially essential to normative deliverables may have been declared to ETSI. The declarations pertaining to these essential IPRs, if any, are publicly available for **ETSI members and non-members**, and can be found in ETSI SR 000 314: "*Intellectual Property Rights (IPRs); Essential, or potentially Essential, IPRs notified to ETSI in respect of ETSI standards*", which is available from the ETSI Secretariat. Latest updates are available on the ETSI Web server (<https://ipr.etsi.org/>).

Pursuant to the ETSI Directives including the ETSI IPR Policy, no investigation regarding the essentiality of IPRs, including IPR searches, has been carried out by ETSI. No guarantee can be given as to the existence of other IPRs not referenced in ETSI SR 000 314 (or the updates on the ETSI Web server) which are, or may be, or may become, essential to the present document.

Trademarks

The present document may include trademarks and/or tradenames which are asserted and/or registered by their owners. ETSI claims no ownership of these except for any which are indicated as being the property of ETSI, and conveys no right to use or reproduce any trademark and/or tradename. Mention of those trademarks in the present document does not constitute an endorsement by ETSI of products, services or organizations associated with those trademarks.

DECT™, **PLUGTESTS™**, **UMTS™** and the ETSI logo are trademarks of ETSI registered for the benefit of its Members. **3GPP™** and **LTE™** are trademarks of ETSI registered for the benefit of its Members and of the 3GPP Organizational Partners. **oneM2M™** logo is a trademark of ETSI registered for the benefit of its Members and of the oneM2M Partners. **GSM®** and the GSM logo are trademarks registered and owned by the GSM Association.

Legal Notice

This Technical Specification (TS) has been produced by ETSI 3rd Generation Partnership Project (3GPP).

The present document may refer to technical specifications or reports using their 3GPP identities. These shall be interpreted as being references to the corresponding ETSI deliverables.

The cross reference between 3GPP and ETSI identities can be found under <https://webapp.etsi.org/key/queryform.asp>.

Modal verbs terminology

In the present document "**shall**", "**shall not**", "**should**", "**should not**", "**may**", "**need not**", "**will**", "**will not**", "**can**" and "**cannot**" are to be interpreted as described in clause 3.2 of the [ETSI Drafting Rules](#) (Verbal forms for the expression of provisions).

"**must**" and "**must not**" are **NOT** allowed in ETSI deliverables except when used in direct citation.

Contents

Intellectual Property Rights	2
Legal Notice	2
Modal verbs terminology.....	2
Foreword.....	8
1 Scope	10
2 References	10
3 Definitions, symbols and abbreviations	11
3.1 Definitions	11
3.2 Symbols.....	14
3.3 Abbreviations	15
4 General	17
4.1 Relationship between minimum requirements and test requirements	17
4.2 Base station classes	17
4.3 Regional requirements.....	17
4.4 Applicability of requirements.....	18
4.5 Requirements for BS capable of multi-band operation	19
5 Operating bands and channel arrangement.....	20
5.1 General	20
5.2 Void.....	20
5.3 Void.....	20
5.4 Void.....	20
5.5 Operating bands.....	20
5.6 Channel bandwidth.....	24
5.7 Channel arrangement.....	28
5.7.1 Channel spacing.....	28
5.7.1A CA Channel spacing	28
5.7.2 Channel raster	29
5.7.3 Carrier frequency and EARFCN.....	29
5.7.4 EARFCN sets for Type B multi-carrier downlink transmissions and conversion to Type 2 channel access for multi-carrier uplink transmissions on multiple Scells configured in Band 46	32
5.8 Requirements for contiguous and non-contiguous spectrum.....	33
6 Transmitter characteristics	33
6.1 General	33
6.2 Base station output power	34
6.2.1 Minimum requirement	35
6.2.2 Additional requirement (regional)	35
6.2.3 Home BS output power for adjacent UTRA channel protection.....	35
6.2.4 Home BS output power for adjacent E-UTRA channel protection.....	36
6.2.5 Home BS Output Power for co-channel E-UTRA protection.....	37
6.3 Output power dynamics.....	38
6.3.1 RE Power control dynamic range	38
6.3.1.1 Minimum requirements	38
6.3.2 Total power dynamic range	39
6.3.2.1 Minimum requirements.....	39
6.3.3 NB-IoT RB power dynamic range for in-band or guard band operation	39
6.3.3.1 Minimum Requirement	40
6.4 Transmit ON/OFF power	40
6.4.1 Transmitter OFF power	40
6.4.1.1 Minimum Requirement	40
6.4.2 Transmitter transient period.....	40
6.4.2.1 Minimum requirements.....	41
6.5 Transmitted signal quality	41

6.5.1	Frequency error.....	41
6.5.1.1	Minimum requirement	41
6.5.2	Error Vector Magnitude.....	42
6.5.3	Time alignment error	42
6.5.3.1	Minimum Requirement	42
6.5.4	DL RS power	43
6.5.4.1	Minimum requirements	43
6.6	Unwanted emissions.....	43
6.6.1	Occupied bandwidth	43
6.6.1.1	Minimum requirement	44
6.6.2	Adjacent Channel Leakage power Ratio (ACLR)	44
6.6.2.1	Minimum requirement	44
6.6.2.2	Cumulative ACLR requirement in non-contiguous spectrum.....	47
6.6.3	Operating band unwanted emissions	48
6.6.3.1	Minimum requirements for Wide Area BS (Category A).....	50
6.6.3.2	Minimum requirements for Wide Area BS (Category B).....	53
6.6.3.2.1	Category B requirements (Option 1).....	53
6.6.3.2.2	Category B (Option 2).....	57
6.6.3.2A	Minimum requirements for Local Area BS (Category A and B).....	59
6.6.3.2B	Minimum requirements for Home BS (Category A and B).....	60
6.6.3.2C	Minimum requirements for Medium Range BS (Category A and B).....	61
6.6.3.2D	Minimum requirements for Local Area and Medium Range BS in Band 46 (Category A and B).....	64
6.6.3.2E	Minimum requirements for standalone NB-IoT Wide Area BS.....	65
6.6.3.2F	Minimum requirements for standalone NB-IoT Local Area BS	65
6.6.3.2G	Minimum requirements for standalone NB-IoT Home BS (Category A and B).....	66
6.6.3.2H	Minimum requirements for standalone NB-IoT Medium Range BS	68
6.6.3.3	Additional requirements.....	69
6.6.4	Transmitter spurious emissions.....	74
6.6.4.1	Mandatory Requirements	75
6.6.4.1.1	Spurious emissions (Category A).....	75
6.6.4.1.2	Spurious emissions (Category B).....	75
6.6.4.2	Protection of the BS receiver of own or different BS	75
6.6.4.2.1	Minimum Requirement	76
6.6.4.3	Additional spurious emissions requirements.....	76
6.6.4.3.1	Minimum Requirement	76
6.6.4.4	Co-location with other base stations	91
6.6.4.4.1	Minimum Requirement	91
6.7	Transmitter intermodulation.....	104
6.7.1	Minimum requirement	104
6.7.2	Additional requirement for Band 41	105
7	Receiver characteristics	106
7.1	General	106
7.2	Reference sensitivity level.....	106
7.2.1	Minimum requirement	106
7.3	Dynamic range	111
7.3.1	Minimum requirement	112
7.4	In-channel selectivity	118
7.4.1	Minimum requirement	118
7.5	Adjacent Channel Selectivity (ACS) and narrow-band blocking.....	125
7.5.1	Minimum requirement	125
7.6	Blocking	136
7.6.1	General blocking requirement.....	136
7.6.1.1	Minimum requirement	136
7.6.2	Co-location with other base stations	152
7.6.2.1	Minimum requirement	152
7.6.3	Additional requirement (regional)	164
7.7	Receiver spurious emissions.....	164
7.7.1	Minimum requirement	164
7.8	Receiver intermodulation	165
7.8.1	Minimum requirement	165

8	Performance requirement	180
8.1	General	180
8.2	Performance requirements for PUSCH	180
8.2.1	Requirements in multipath fading propagation conditions	180
8.2.1.1	Minimum requirements	181
8.2.2	Requirements for UL timing adjustment	200
8.2.2.1	Minimum requirements	201
8.2.3	Requirements for high speed train	201
8.2.3.1	Minimum requirements	202
8.2.4	Requirements for HARQ-ACK multiplexed on PUSCH	205
8.2.4.1	Minimum requirement	205
8.2.5	Requirements for PUSCH with TTI bundling and enhanced HARQ pattern	206
8.2.5.1	Minimum requirements	207
8.2.6	Enhanced performance requirement type A in multipath fading propagation conditions with synchronous interference	207
8.2.6.1	Minimum requirements	208
8.2.6A	Enhanced performance requirement type A in multipath fading propagation conditions with asynchronous interference	209
8.2.6A.1	Minimum requirements	210
8.2.7	Requirements for PUSCH supporting coverage enhancement	212
8.2.8	Requirements for PUSCH of Frame structure type 3	213
8.2.9	Enhanced performance requirement type B in multipath fading propagation conditions	214
8.2.9.1	Minimum requirements	216
8.2.10	Requirements for PUSCH supporting subPRB transmission	218
8.3	Performance requirements for PUCCH	220
8.3.1	DTX to ACK performance	220
8.3.1.1	Minimum requirement	220
8.3.2	ACK missed detection requirements for single user PUCCH format 1a	220
8.3.2.1	Minimum requirements	221
8.3.3	CQI performance requirements for PUCCH format 2	221
8.3.3.1	Minimum requirements	221
8.3.4	ACK missed detection requirements for multi user PUCCH format 1a	222
8.3.4.1	Minimum requirement	222
8.3.5	ACK missed detection requirements for PUCCH format 1b with Channel Selection	222
8.3.5.1	Minimum requirements	223
8.3.6	ACK missed detection requirements for PUCCH format 3	223
8.3.6.1	Minimum requirements	223
8.3.7	NACK to ACK requirements for PUCCH format 3	224
8.3.7.1	Minimum requirement	224
8.3.8	CQI performance requirements for PUCCH format 2 with DTX detection	224
8.3.8.1	Minimum requirements	225
8.3.9	PUCCH performance requirements for coverage enhancement	225
8.3.9.1	DTX to ACK performance	225
8.3.9.1.1	Minimum requirement	225
8.3.9.2	ACK missed detection requirements for single user PUCCH format 1a	225
8.3.9.2.1	Minimum requirements	226
8.3.9.3	CQI performance requirements for PUCCH format 2	226
8.3.9.3.1	Minimum requirements	226
8.3.10	ACK missed detection requirements for PUCCH format 4	226
8.3.10.1	Minimum requirements	227
8.3.11	ACK missed detection requirements for PUCCH format 5	227
8.3.11.1	Minimum requirements	227
8.4	Performance requirements for PRACH	228
8.4.1	PRACH False alarm probability	228
8.4.1.1	Minimum requirement	228
8.4.2	PRACH detection requirements	228
8.4.2.1	Minimum requirements	228
8.5	Performance requirements for Narrowband IoT	230
8.5.1	Requirements for NPUSCH format 1	230
8.5.1.1	Requirements	230
8.5.1.1.1	Minimum requirements	231
8.5.2	Performance requirements for NPUSCH format 2	232

8.5.2.1	DTX to ACK performance	232
8.5.2.1.1	Minimum requirement	232
8.5.2.2	ACK missed detection requirements	232
8.5.2.2.1	Minimum requirements	232
8.5.3	Performance requirements for NPRACH	233
8.5.3.1	NPRACH False alarm probability	233
8.5.3.1.1	Minimum requirement	233
8.5.3.2	NPRACH detection requirements	233
8.5.3.2.1	Minimum requirements	234
8.6	Performance requirements for subslot-PUSCH	234
8.6.1	Requirements	234
8.6.1.1	Minimum requirements	234
8.7	Performance requirements for SPUCCH	235
8.7.1	ACK missed detection requirements for single user SPUCCH format 1a	235
8.7.1.1	Minimum requirements	235
8.7.2	ACK missed detection requirements for SPUCCH format 4	236
8.7.2.1	Minimum requirements	236
9	Void	237
Annex A (normative): Reference measurement channels		238
A.1	Fixed Reference Channels for reference sensitivity and in-channel selectivity (QPSK, R=1/3)	239
A.2	Fixed Reference Channels for dynamic range (16QAM, R=2/3)	240
A.3	Fixed Reference Channels for performance requirements (QPSK 1/3)	240
A.4	Fixed Reference Channels for performance requirements (16QAM 3/4)	241
A.5	Fixed Reference Channels for performance requirements (64QAM 5/6)	241
A.6	PRACH Test preambles	241
A.7	Fixed Reference Channels for UL timing adjustment (Scenario 1)	242
A.8	Fixed Reference Channels for UL timing adjustment (Scenario 2)	243
A.9	Multi user PUCCH test	243
A.10	PUCCH transmission on two antenna ports test	243
A.11	Fixed Reference Channel for PUSCH with TTI bundling and enhanced HARQ pattern	244
A.12	Fixed Reference Channels for performance requirements (QPSK 0.36)	244
A.13	Fixed Reference Channels for performance requirements (16QAM 1/2)	245
A.14	Fixed Reference Channels for NB-IOT reference sensitivity ($\pi/2$ BPSK, R=1/3)	245
A.15	Fixed Reference Channels for NB-IoT dynamic range ($\pi/4$ QPSK, R=2/3)	245
A.16	Fixed Reference Channels for NB-IoT NPUSCH format 1	246
A.16.1	One PRB	246
A.17	Fixed Reference Channels for performance requirements (256QAM 5/6)	247
A.18	Fixed Reference Channels for PUSCH transmission in UpPTS (16QAM 0.65)	247
A.19	Fixed Reference Channels for PUSCH transmission in UpPTS (256QAM 0.69)	248
A.20	Fixed Reference Channels for PUSCH of Frame structure type 3	248
A.21	Fixed Reference Channels for performance requirements (QPSK 3/5)	249
A.22	Fixed Reference Channels for performance requirements (64QAM 1/2)	250
A.23	Fixed Reference Channels for SubPRB allocation reference sensitivity ($\pi/2$ BPSK, R=1/3)	250
A.24	Fixed Reference Channel for subslot-PUSCH	251
A.25	Fixed Reference Channels for PUSCH with SubPRB transmission	251

Annex B (normative):	Propagation conditions.....	252
B.1	Static propagation condition.....	252
B.2	Multi-path fading propagation conditions.....	252
B.3	High speed train condition	253
B.4	Moving propagation conditions.....	257
B.5	Multi-Antenna channel models	258
B.5.1	Definition of MIMO Correlation Matrices.....	258
B.5.2	MIMO Correlation Matrices at High, Medium and Low Level	259
B.5A	Multi-Antenna channel models using cross polarized antennas.....	261
B.5A.1	Definition of MIMO Correlation Matrices using cross polarized antennas.....	262
B.5A.2	Spatial Correlation Matrices at UE and eNB sides.....	262
B.5A.2.1	Spatial Correlation Matrices at UE side.....	262
B.5A.2.2	Spatial Correlation Matrices at eNB side.....	263
B.5A.3	MIMO Correlation Matrices using cross polarized antennas	263
B.6	Interference model for enhanced performance requirements type A and type B	263
B.6.1	Dominant interferer proportion	263
B.6.2	Interference model for synchronous scenario.....	264
B.6.3	Interference model for asynchronous scenario	264
Annex C (normative):	Characteristics of the interfering signals.....	265
Annex D (normative):	Environmental requirements for the BS equipment	266
Annex E (normative):	Error Vector Magnitude	267
E.1	Reference point for measurement.....	267
E.2	Basic unit of measurement	267
E.3	Modified signal under test.....	268
E.4	Estimation of frequency offset	268
E.5	Estimation of time offset	268
E.5.1	Window length	269
E.6	Estimation of TX chain amplitude and frequency response parameters	271
E.7	Averaged EVM	272
Annex F (Informative):	Unwanted emission requirements for multi-carrier BS.....	274
F.1	General	274
F.2	Multi-carrier BS of different E-UTRA channel bandwidths.....	274
F.3	Multi-carrier BS of E-UTRA and UTRA.....	274
Annex G (Informative):	Regional requirement for protection of DTT	275
G.1	Regional requirement for protection of DTT	275
G.2	Regional requirement for Public Safety LTE BS in Korea	275
Annex H (Informative):	Calculation of EIRP based on manufacturer declarations and site specific conditions	278
H.1	Calculation of EIRP based on manufacturer declarations and site specific conditions.....	278
Annex I (Informative):	Change history	279
History		294

Foreword

This Technical Specification has been produced by the 3rd Generation Partnership Project (3GPP).

The contents of the present document are subject to continuing work within the TSG and may change following formal TSG approval. Should the TSG modify the contents of the present document, it will be re-released by the TSG with an identifying change of release date and an increase in version number as follows:

Version x.y.z

where:

- x the first digit:
 - 1 presented to TSG for information;
 - 2 presented to TSG for approval;
 - 3 or greater indicates TSG approved document under change control.
- y the second digit is incremented for all changes of substance, i.e. technical enhancements, corrections, updates, etc.
- z the third digit is incremented when editorial only changes have been incorporated in the document.

In the present document, modal verbs have the following meanings:

- shall** indicates a mandatory requirement to do something
- shall not** indicates an interdiction (prohibition) to do something

The constructions "shall" and "shall not" are confined to the context of normative provisions, and do not appear in Technical Reports.

The constructions "must" and "must not" are not used as substitutes for "shall" and "shall not". Their use is avoided insofar as possible, and they are not used in a normative context except in a direct citation from an external, referenced, non-3GPP document, or so as to maintain continuity of style when extending or modifying the provisions of such a referenced document.

- should** indicates a recommendation to do something
- should not** indicates a recommendation not to do something
- may** indicates permission to do something
- need not** indicates permission not to do something

The construction "may not" is ambiguous and is not used in normative elements. The unambiguous constructions "might not" or "shall not" are used instead, depending upon the meaning intended.

- can** indicates that something is possible
- cannot** indicates that something is impossible

The constructions "can" and "cannot" are not substitutes for "may" and "need not".

- will** indicates that something is certain or expected to happen as a result of action taken by an agency the behaviour of which is outside the scope of the present document
- will not** indicates that something is certain or expected not to happen as a result of action taken by an agency the behaviour of which is outside the scope of the present document
- might** indicates a likelihood that something will happen as a result of action taken by some agency the behaviour of which is outside the scope of the present document

might not indicates a likelihood that something will not happen as a result of action taken by some agency the behaviour of which is outside the scope of the present document

In addition:

is (or any other verb in the indicative mood) indicates a statement of fact

is not (or any other negative verb in the indicative mood) indicates a statement of fact

The constructions "is" and "is not" do not indicate requirements.

1 Scope

The present document establishes the minimum RF characteristics and minimum performance requirements of E-UTRA, E-UTRA with NB-IoT or NB-IoT Base Station (BS).

2 References

The following documents contain provisions which, through reference in this text, constitute provisions of the present document.

- References are either specific (identified by date of publication, edition number, version number, etc.) or non-specific.
- For a specific reference, subsequent revisions do not apply.
- For a non-specific reference, the latest version applies. In the case of a reference to a 3GPP document (including a GSM document), a non-specific reference implicitly refers to the latest version of that document *in the same Release as the present document*.

- [1] 3GPP TR 21.905: "Vocabulary for 3GPP Specifications".
- [2] ITU-R Recommendation SM.329: "Unwanted emissions in the spurious domain".
- [3] ITU-R Recommendation M.1545: "Measurement uncertainty as it applies to test limits for the terrestrial component of International Mobile Telecommunications-2000".
- [4] 3GPP TS 36.141: "Evolved Universal Terrestrial Radio Access (E-UTRA); Base Station (BS) conformance testing".
- [5] ITU-R recommendation SM.328: "Spectra and bandwidth of emissions".
- [6] 3GPP TS 25.104: "Base Station (BS) radio transmission and reception (FDD)".
- [7] 3GPP TS 25.105: "Base Station (BS) radio transmission and reception (TDD)".
- [8] 3GPP TR 25.942: "RF system scenarios".
- [9] 3GPP TR 36.942: "E-UTRA RF system scenarios".
- [10] 3GPP TS 36.211: "Evolved Universal Terrestrial Radio Access (E-UTRA); Physical Channels and Modulation".
- [11] 3GPP TS 36.213: "Evolved Universal Terrestrial Radio Access (E-UTRA); Physical layer procedures".
- [12] ECC/DEC/(09)03 "Harmonised conditions for MFCN in the band 790-862 MHz", 30 Oct. 2009
- [13] IEC 60721-3-3 (2002): "Classification of environmental conditions - Part 3: Classification of groups of environmental parameters and their severities - Section 3: Stationary use at weather protected locations".
- [14] IEC 60721-3-4 (1995): "Classification of environmental conditions - Part 3: Classification of groups of environmental parameters and their severities - Section 4: Stationary use at non-weather protected locations".
- [15] 3GPP TS 37.104: "E-UTRA, UTRA and GSM/EDGE; Multi-Standard Radio (MSR) Base Station (BS) radio transmission and reception".
- [16] CEPT ECC Decision (13)03, "The harmonised use of the frequency band 1452-1492 MHz for Mobile/Fixed Communications Networks Supplemental Downlink (MFCN SDL)".
- [17] 3GPP TS 36.211: "Evolved Universal Terrestrial Radio Access (E-UTRA); Physical channels and modulation".

- [18] 3GPP TS 36.213: "Evolved Universal Terrestrial Radio Access (E-UTRA); Physical layer procedures".
- [19] CEPT ECC Decision (17)06, "The harmonised use of the frequency bands 1427-1452 MHz and 1492-1518 MHz for Mobile/Fixed Communications Networks Supplemental Downlink (MFCN SDL)".
- [20] 3GPP TS 37.213: "Physical layer procedures for shared spectrum channel access".

3 Definitions, symbols and abbreviations

3.1 Definitions

For the purposes of the present document, the terms and definitions given in TR 21.905 [1] and the following apply. A term defined in the present document takes precedence over the definition of the same term, if any, in TR 21.905 [1].

Aggregated Channel Bandwidth: RF bandwidth in which a base station transmits and/or receives multiple contiguously aggregated carriers.

NOTE: The Aggregated Channel Bandwidth is measured in MHz.

Base station receive period: time during which the base station is receiving data subframes or UpPTS.

Base Station RF Bandwidth: RF bandwidth in which a base station transmits and/or receives single or multiple carrier(s) within a supported operating band.

NOTE: In single E-UTRA carrier operation, the Base Station RF Bandwidth is equal to the channel bandwidth.

Base Station RF Bandwidth edge: frequency of one of the edges of the Base Station RF Bandwidth.

Carrier: modulated waveform conveying the E-UTRA or UTRA physical channels

Carrier aggregation: aggregation of two or more component carriers in order to support wider transmission bandwidths

Carrier aggregation band: a set of one or more operating bands across which multiple carriers are aggregated with a specific set of technical requirements.

NOTE: Carrier aggregation band(s) for an E-UTRA BS is declared by the manufacturer according to the designations in Tables 5.5-2 to 5.5-4.

Channel bandwidth: RF bandwidth supporting a single E-UTRA RF carrier with the transmission bandwidth configured in the uplink or downlink of a cell.

NOTE: The channel bandwidth is measured in MHz and is used as a reference for transmitter and receiver RF requirements.

Channel edge: lowest or highest frequency of the E-UTRA carrier, separated by the channel bandwidth.

Contiguous carriers: set of two or more carriers configured in a spectrum block where there are no RF requirements based on co-existence for un-coordinated operation within the spectrum block.

Contiguous spectrum: spectrum consisting of a contiguous block of spectrum with no sub-block gap(s).

DL RS power: resource element power of Downlink Reference Symbol.

DL NRS power: resource element power of Downlink Narrowband Reference Signal.

Downlink operating band: part of the operating band designated for downlink.

Enhanced performance requirements type A: This defines performance requirements assuming baseline receiver as demodulation reference signal based linear minimum mean square error interference rejection combining.

Enhanced performance requirements type B: This defines performance requirements assuming baseline receiver as code word level interference cancellation for intra-cell inter-user interference plus demodulation reference signal based linear minimum mean square error interference rejection combining for inter-cell interference.

Highest carrier: carrier with the highest carrier centre frequency transmitted/received in a specified operating band.

Inter RF Bandwidth gap: frequency gap between two consecutive Base Station RF Bandwidths that are placed within two supported operating bands.

Inter-band carrier aggregation: carrier aggregation of component carriers in different operating bands.

NOTE: Carriers aggregated in each band can be contiguous or non-contiguous.

Inter-band gap: The frequency gap between two supported consecutive operating bands.

Intra-band contiguous carrier aggregation: contiguous carriers aggregated in the same operating band.

Intra-band non-contiguous carrier aggregation: non-contiguous carriers aggregated in the same operating band.

Lower sub-block edge: frequency at the lower edge of one sub-block.

NOTE: It is used as a frequency reference point for both transmitter and receiver requirements.

Lowest carrier: carrier with the lowest carrier centre frequency transmitted/received in a specified operating band.

Maximum output power: mean power level per carrier of the base station measured at the antenna connector in a specified reference condition.

Maximum throughput: maximum achievable throughput for a reference measurement channel.

Mean power: power measured in the channel bandwidth of the carrier.

NOTE: The period of measurement shall be at least one subframe (1ms), unless otherwise stated.

Measurement bandwidth: RF bandwidth in which an emission level is specified.

Multi-band base station: base station characterized by the ability of its transmitter and/or receiver to process two or more carriers in common active RF components simultaneously, where at least one carrier is configured at a different operating band (which is not a sub-band or superseding-band of another supported operating band) than the other carrier(s).

Multi-band transmitter: transmitter characterized by the ability to process two or more carriers in common active RF components simultaneously, where at least one carrier is configured at a different operating band (which is not a sub-band or superseding-band of another supported operating band) than the other carrier(s).

Multi-band receiver: receiver characterized by the ability to process two or more carriers in common active RF components simultaneously, where at least one carrier is configured at a different operating band (which is not a sub-band or superseding-band of another supported operating band) than the other carrier(s).

Multi-carrier transmission configuration: set of one or more contiguous or non-contiguous carriers that a BS is able to transmit simultaneously according to the manufacturer's specification.

NB-IoT In-band operation: NB-IoT is operating in-band when it utilizes the resource block(s) within a normal E-UTRA carrier

NB-IoT guard band operation: NB-IoT is operating in guard band when it utilizes the unused resource block(s) within a E-UTRA carrier's guard-band.

NB-IoT standalone operation: NB-IoT is operating standalone when it utilizes its own spectrum, for example the spectrum currently being used by GERAN systems as a replacement of one or more GSM carriers, as well as scattered spectrum for potential IoT deployment.

Non-contiguous spectrum: spectrum consisting of two or more sub-blocks separated by sub-block gap(s).

Occupied bandwidth: width of a frequency band such that, below the lower and above the upper frequency limits, the mean powers emitted are each equal to a specified percentage $\beta/2$ of the total mean power of a given emission.

Operating band: frequency range in which E-UTRA operates (paired or unpaired), that is defined with a specific set of technical requirements.

NOTE: The operating band(s) for an E-UTRA BS is declared by the manufacturer according to the designations in table 5.5-1.

Output power: mean power of one carrier of the base station, delivered to a load with resistance equal to the nominal load impedance of the transmitter.

Radio Bandwidth: frequency difference between the upper edge of the highest used carrier and the lower edge of the lowest used carrier.

Rated output power: mean power level per carrier that the manufacturer has declared to be available at the antenna connector during the transmitter ON period.

RE power control dynamic range: difference between the power of a RE and the average RE power for a BS at maximum output power for a specified reference condition.

RRC filtered mean power: mean power of an UTRA carrier as measured through a root raised cosine filter with roll-off factor α and a bandwidth equal to the chip rate of the radio access mode.

NOTE 1: The RRC filtered mean power of a perfectly modulated UTRA signal is 0.246 dB lower than the mean power of the same signal.

sTTI: A transmission time interval (TTI) of either one slot or one subslot as defined in [10] on either uplink or downlink.

Sub-band: A sub-band of an operating band contains a part of the uplink and downlink frequency range of the operating band.

Sub-block: one contiguous allocated block of spectrum for transmission and reception by the same base station.

NOTE: There may be multiple instances of sub-blocks within a Base Station RF Bandwidth.

Sub-block bandwidth: bandwidth of one sub-block.

Sub-block gap: frequency gap between two consecutive sub-blocks within a Base Station RF Bandwidth, where the RF requirements in the gap are based on co-existence for un-coordinated operation.

Superseding-band: A superseding-band of an operating band includes the whole of the uplink and downlink frequency range of the operating band.

Synchronized operation: operation of TDD in two different systems, where no simultaneous uplink and downlink occur.

Throughput: number of payload bits successfully received per second for a reference measurement channel in a specified reference condition.

Total power dynamic range: difference between the maximum and the minimum transmit power of an OFDM symbol for a specified reference condition.

Transmission bandwidth: RF Bandwidth of an instantaneous transmission from a UE or BS, measured in resource block units.

Transmission bandwidth configuration: highest transmission bandwidth allowed for uplink or downlink in a given channel bandwidth, measured in resource block units.

Transmitter ON period: time period during which the BS transmitter is transmitting data and/or reference symbols, i.e. data subframes or DwPTS.

Transmitter OFF period: time period during which the BS transmitter is not allowed to transmit.

Transmitter transient period: time period during which the transmitter is changing from the OFF period to the ON period or vice versa.

Unsynchronized operation: operation of TDD in two different systems, where the conditions for synchronized operation are not met.

Uplink operating band: part of the operating band designated for uplink.

Upper sub-block edge: frequency at the upper edge of one sub-block.

NOTE: It is used as a frequency reference point for both transmitter and receiver requirements.

3.2 Symbols

For the purposes of the present document, the following symbols apply:

α	Roll-off factor
β	Percentage of the mean transmitted power emitted outside the occupied bandwidth on the assigned channel
BW	Bandwidth
BW_{Channel}	Channel bandwidth
$BW_{\text{Channel,CA}}$	Aggregated Channel Bandwidth, expressed in MHz. $BW_{\text{Channel,CA}} = F_{\text{edge,high}} - F_{\text{edge,low}}$.
$BW_{\text{Channel,block}}$	Sub-block bandwidth, expressed in MHz. $BW_{\text{Channel,block}} = F_{\text{edge,block,high}} - F_{\text{edge,block,low}}$.
BW_{Config}	Transmission bandwidth configuration, expressed in MHz, where $BW_{\text{Config}} = N_{\text{RB}} \times 180$ kHz in the uplink and $BW_{\text{Config}} = 15$ kHz + $N_{\text{RB}} \times 180$ kHz in the downlink.
CA_X	Intra-band contiguous CA of component carriers in one sub-block within band X where X is the applicable E-UTRA operating band
CA_X-X	Intra-band non-contiguous CA of component carriers in two sub-blocks within band X where X is the applicable E-UTRA operating band
CA_X-Y	Inter-band CA of component carrier(s) in one sub-block within band X and component carrier(s) in one sub-block within Band Y where X and Y are the applicable E-UTRA operating bands
CA_X-X-Y	CA of component carriers in two sub-blocks within Band X and component carrier(s) in one sub-block within Band Y where X and Y are the applicable E-UTRA operating bands
f	Frequency
Δf	Separation between the channel edge frequency and the nominal -3dB point of the measuring filter closest to the carrier frequency
Δf_{max}	The largest value of Δf used for defining the requirement
F_{C}	Carrier centre frequency
$F_{\text{C,block,high}}$	Centre frequency of the highest transmitted/received carrier in a sub-block.
$F_{\text{C,block,low}}$	Centre frequency of the lowest transmitted/received carrier in a sub-block.
$F_{\text{C,low}}$	The carrier centre frequency of the lowest carrier, expressed in MHz.
$F_{\text{C,high}}$	The carrier centre frequency of the highest carrier, expressed in MHz.
$F_{\text{edge,low}}$	The lower edge of Aggregated Channel Bandwidth, expressed in MHz. $F_{\text{edge,low}} = F_{\text{C,low}} - F_{\text{offset}}$.
$F_{\text{edge,high}}$	The upper edge of Aggregated Channel Bandwidth, expressed in MHz. $F_{\text{edge,high}} = F_{\text{C,high}} + F_{\text{offset}}$.
$F_{\text{edge,block,low}}$	The lower sub-block edge, where $F_{\text{edge,block,low}} = F_{\text{C,block,low}} - F_{\text{offset}}$.
$F_{\text{edge,block,high}}$	The upper sub-block edge, where $F_{\text{edge,block,high}} = F_{\text{C,block,high}} + F_{\text{offset}}$.
F_{offset}	Frequency offset from $F_{\text{C,high}}$ to the upper Base Station RF Bandwidth edge, or from $F_{\text{C,block,high}}$ to the upper sub-block edge, or $F_{\text{C,low}}$ to the lower Base Station RF Bandwidth edge, or from $F_{\text{C,block,low}}$ to the lower sub-block edge.
F_{filter}	Filter centre frequency
f_{offset}	Separation between the channel edge frequency and the centre of the measuring filter
$f_{\text{offset,max}}$	The maximum value of f_{offset} used for defining the requirement
$F_{\text{DL,low}}$	The lowest frequency of the downlink operating band
$F_{\text{DL,high}}$	The highest frequency of the downlink operating band
$F_{\text{UL,low}}$	The lowest frequency of the uplink operating band
$F_{\text{UL,high}}$	The highest frequency of the uplink operating band
G_{ant}	Net antenna gain
M_{DL}	Offset of NB-IoT Downlink channel number to Downlink EARFCN
M_{UL}	Offset of NB-IoT Uplink channel number to Uplink EARFCN
N_{ant}	Number of transmitter antennas
N_{DL}	Downlink EARFCN
$N_{\text{Offs-DL}}$	Offset used for calculating downlink EARFCN

$N_{\text{Offis-UL}}$	Offset used for calculating uplink EARFCN
N_{CS}	Number of Cyclic shifts for preamble generation in PRACH
N_{RB}	Transmission bandwidth configuration, expressed in units of resource blocks
N_{UL}	Uplink EARFCN
$P_{10\text{MHz}}$	Maximum output Power within 10 MHz
$P_{\text{EIRP,N}}$	EIRP level for channel N
$P_{\text{EIRP,N,MAX}}$	Maximum EIRP level for channel N
$P_{\text{EM,N}}$	Declared emission level for channel N
$P_{\text{EM,B32,B75,B76,ind}}$	Declared emission level in Band 32, Band 75 and Band 76, ind=a, b, c
$P_{\text{EM,B32,ind}}$	Declared emission level in Band 32, ind=d, e
$P_{\text{EM,B50,B74,B75,ind}}$	Declared emission level for Band 50, Band 74 and Band 75, ind=a,b
$P_{\text{max,c}}$	Maximum carrier output power
P_{out}	Output power (per carrier)
$P_{\text{rated,c}}$	Rated output power (per carrier)
P_{REFSENS}	Reference Sensitivity power level
T_{A}	Timing advance command, as defined in [11]
T_{s}	Basic time unit, as defined in [10]
W_{gap}	Sub-block gap or Inter RF Bandwidth gap size

3.3 Abbreviations

For the purposes of the present document, the abbreviations given in TR 21.905 [1] and the following apply. An abbreviation defined in the present document takes precedence over the definition of the same abbreviation, if any, in TR 21.905 [1].

ACLR	Adjacent Channel Leakage Ratio
ACK	Acknowledgement (in HARQ protocols)
ACS	Adjacent Channel Selectivity
AWGN	Additive White Gaussian Noise
BS	Base Station
CA	Carrier Aggregation
CACLR	Cumulative ACLR
CP	Cyclic prefix
CRC	Cyclic Redundancy Check
CW	Continuous Wave
DC	Direct Current
DFT	Discrete Fourier Transformation
DIP	Dominant Interferer Proportion
DTT	Digital Terrestrial Television
DTX	Discontinuous Transmission
DwPTS	Downlink part of the special subframe (for TDD operation)
EARFCN	E-UTRA Absolute Radio Frequency Channel Number
EIRP	Effective Isotropic Radiated Power
EPA	Extended Pedestrian A model
ETU	Extended Typical Urban model
E-UTRA	Evolved UTRA
EVA	Extended Vehicular A model
EVM	Error Vector Magnitude
FDD	Frequency Division Duplex
FFT	Fast Fourier Transformation
FRC	Fixed Reference Channel
GP	Guard Period (for TDD operation)
GSM	Global System for Mobile communications
HARQ	Hybrid Automatic Repeat Request
ICS	In-Channel Selectivity
ITU-R	Radiocommunication Sector of the ITU
LA	Local Area
LNA	Low Noise Amplifier
MCS	Modulation and Coding Scheme
MFCN	Mobile/Fixed Communications Network

MR	Medium Range
NB-IoT	Narrowband – Internet of Things
NPDSCH	Narrowband Physical Downlink Shared Channel
NPUSCH	Narrowband Physical Uplink Shared Channel
NRS	Narrowband Reference Signal
OFDM	Orthogonal Frequency Division Multiplex
OOB	Out-of-band
PA	Power Amplifier
PBCH	Physical Broadcast Channel
PDCCH	Physical Downlink Control Channel
PDSCH	Physical Downlink Shared Channel
PUSCH	Physical Uplink Shared Channel
PUCCH	Physical Uplink Control Channel
PRACH	Physical Random Access Channel
QAM	Quadrature Amplitude Modulation
QPSK	Quadrature Phase-Shift Keying
RAT	Radio Access Technology
RB	Resource Block
RE	Resource Element
RF	Radio Frequency
RMS	Root Mean Square (value)
RS	Reference Symbol
RX	Receiver
RRC	Root Raised Cosine
SINR	Signal-to-Interference-and-Noise Ratio
SNR	Signal-to-Noise Ratio
sPDCCH	shortened Physical Downlink Control Channel
sPDSCH	shortened Physical Downlink Shared Channel
TA	Timing Advance
TDD	Time Division Duplex
TX	Transmitter
UE	User Equipment
WA	Wide Area

4 General

4.1 Relationship between minimum requirements and test requirements

The Minimum Requirements given in this specification make no allowance for measurement uncertainty. The test specification TS 36.141 [4] Annex G defines Test Tolerances. These Test Tolerances are individually calculated for each test. The Test Tolerances are used to relax the Minimum Requirements in this specification to create Test Requirements.

The measurement results returned by the Test System are compared - without any modification - against the Test Requirements as defined by the shared risk principle.

The Shared Risk principle is defined in ITU-R M.1545 [3].

4.2 Base station classes

The requirements in this specification apply to Wide Area Base Stations, Medium Range Base Stations, Local Area Base Stations and Home Base Stations unless otherwise stated.

Wide Area Base Stations are characterised by requirements derived from Macro Cell scenarios with a BS to UE minimum coupling loss equal to 70 dB. The Wide Area Base Station class has the same requirements as the base station for General Purpose application in Release 8.

Medium Range Base Stations are characterised by requirements derived from Micro Cell scenarios with a BS to UE minimum coupling loss equal to 53 dB.

Local Area Base Stations are characterised by requirements derived from Pico Cell scenarios with a BS to UE minimum coupling loss equal to 45 dB.

Home Base Stations are characterised by requirements derived from Femto Cell scenarios.

4.3 Regional requirements

Some requirements in the present document may only apply in certain regions either as optional requirements or set by local and regional regulation as mandatory requirements. It is normally not stated in the 3GPP specifications under what exact circumstances that the requirements apply, since this is defined by local or regional regulation.

Table 4.3-1 lists all requirements that may be applied differently in different regions.

Table 4.3-1: List of regional requirements

Clause number	Requirement	Comments
5.5	Operating bands	Some bands may be applied regionally.
5.6	Channel bandwidth	Some channel bandwidths may be applied regionally.
5.7	Channel arrangement	The requirement is applied according to what operating bands in clause 5.5 that are supported by the BS.
6.2	Base station maximum output power	In certain regions, the minimum requirement for normal conditions may apply also for some conditions outside the range of conditions defined as normal.
6.2.2	Additional requirement (regional)	For Band 34 and Band 41 operation in certain regions, the rated output power declared by the manufacturer shall be less than or equal to the values specified in Table 6.2.2-1 and 6.2.2-2, respectively. In addition for Band 46 operation, the BS may have to comply with the applicable BS power limits established regionally, when deployed in regions where those limits apply and under the conditions declared by the manufacturer.
6.6.1.1	Occupied bandwidth	For Band 46 operation in certain regions, the occupied bandwidth for each 20MHz channel bandwidth E-UTRA carrier shall be less than or equal to 19MHz or 19.7MHz.
6.6.3.1	Operating band unwanted emissions (Category A)	This requirement is mandatory for regions where Category A limits for spurious emissions, as defined in ITU-R Recommendation SM.329 [2] apply.
6.6.3.2	Operating band unwanted emissions (Category B)	This requirement is mandatory for regions where Category B limits for spurious emissions, as defined in ITU-R Recommendation SM.329 [2], apply.
6.6.3.3	Additional requirements	These requirements may apply in certain regions as additional Operating band unwanted emission limits. In addition for Band 46 operation, the BS may have to comply with the applicable operating band unwanted emission limits established regionally, when deployed in regions where those limits apply and under the conditions declared by the manufacturer.
6.6.4.1.1	Spurious emissions (Category A)	This requirement is mandatory for regions where Category A limits for spurious emissions, as defined in ITU-R Recommendation SM.329 [2] apply.
6.6.4.1.2	Spurious emissions (Category B)	This requirement is mandatory for regions where Category B limits for spurious emissions, as defined in ITU-R Recommendation SM.329 [2], apply.
6.6.4.3	Additional spurious emission requirements	These requirements may be applied for the protection of system operating in frequency ranges other than the E-UTRA BS operating band. In addition for Band 46 operation, the BS may have to comply with the applicable spurious emission limits established regionally, when deployed in regions where those limits apply and under the conditions declared by the manufacturer.
6.6.4.4	Co-location with other base stations	These requirements may be applied for the protection of other BS receivers when a BS operating in another frequency band is co-located with an E-UTRA BS.
6.7.2	Additional requirements	These requirements may apply in certain regions.
7.6.2	Co-location with other base stations	These requirements may be applied for the protection of the BS receiver when a BS operating in another frequency band is co-located with an E-UTRA BS.

4.4 Applicability of requirements

For BS that is E-UTRA (single-RAT), E-UTRA with NB-IoT (in band and/or guard band) or standalone NB-IoT capable only, MBMS (including 15 kHz, 7.5 kHz, 1.25 kHz, 2.5 kHz and 0.37 kHz subcarrier spacing), the requirements in the present document are applicable and additional conformance to TS 37.104 [15] is optional. For a BS additionally conforming to TS 37.104 [15], conformance to some of the RF requirements in the present document can be demonstrated through the corresponding requirements in TS 37.104 [15] as listed in Table 4.4-1.

Table 4.4-1: Alternative RF minimum requirements for a BS additionally conforming to TS 37.104 [15]

RF requirement	Clause in the present document	Alternative clause in TS 37.104 [15]
Base station output power	6.2.1	6.2.1
	6.2.2	6.2.2
Transmit ON/OFF power	6.4	6.4
Unwanted emissions		
Transmitter spurious emissions	6.6.4	6.6.1 (except for 6.6.1.1.3)
Operating band unwanted emissions	6.6.3.1, 6.6.3.2 (NOTE 1)	6.6.2 (except for 6.6.2.3 and 6.6.2.4)
Transmitter intermodulation	6.7	6.7.1
Narrowband blocking	7.5.1	7.4.2
Blocking	7.6.1.1	7.4.1
Out-of-band blocking	7.6.1.1	7.5.1
Co-location with other base stations	7.6.2.1	7.5.2
Receiver spurious emissions	7.7.1	7.6.1
Intermodulation	7.8.1	7.7.1
Narrowband intermodulation	7.8.1	7.7.2
NOTE 1: This does not apply when the lowest or highest carrier frequency is configured as 1.4 or 3 MHz carrier in bands of Band Category 1 or 3 according to clause 4.5 in TS 37.104 [15].		

4.5 Requirements for BS capable of multi-band operation

For BS capable of multi-band operation, the RF requirements in clause 6 and 7 apply for each supported operating band unless otherwise stated. For some requirements it is explicitly stated that specific additions or exclusions to the requirement apply for BS capable of multi-band operation.

For BS capable of multi-band operation, various structures in terms of combinations of different transmitter and receiver implementations (multi-band or single band) with mapping of transceivers to one or more antenna port(s) in different ways are possible. In the case where multiple bands are mapped on an antenna connector, the exclusions or provisions for multi-band capable BS are applicable to this antenna connector. In the case where a single band is mapped on an antenna connector, the following applies:

- Single-band ACLR, operating band unwanted emissions, transmitter spurious emissions, transmitter intermodulation and receiver spurious emissions requirements apply to this antenna connector that is mapped to single-band. In case there are carrier(s) transmitted simultaneously in another supported *operating band* in common active RF components, when the RF signals of these antenna connectors cover the same geographical area, the frequency range of the Base Station RF bandwidth in the other supported band to this antenna connector should be excluded from the unwanted emission requirements.
- If the BS is configured for single-band operation, single-band requirements shall apply to this antenna connector configured for single-band operation and no exclusions or provisions for multi-band capable BS are applicable. Single-band requirements are tested separately at the antenna connector configured for single-band operation, with all other antenna connectors terminated.

For a band supported by a Base Station where the transmitted carriers are not processed in active RF components together with carriers in any other band, single-band transmitter requirements shall apply. For a band supported by a Base Station where the received carriers are not processed in active RF components together with carriers in any other band, single-band receiver requirements shall apply.

For a BS capable of multi-band operation supporting bands for TDD, the RF requirements in the present specification assume synchronized operation, where no simultaneous uplink and downlink occur between the supported operating bands.

The RF requirements in the present specification are FFS for multi-band operation supporting bands for both FDD and TDD.

5 Operating bands and channel arrangement

5.1 General

The channel arrangements presented in this clause are based on the operating bands and channel bandwidths defined in the present release of specifications.

NOTE: Other operating bands and channel bandwidths may be considered in future releases.

5.2 Void

5.3 Void

5.4 Void

5.5 Operating bands

E-UTRA is designed to operate in the operating bands defined in Table 5.5-1. Unless stated otherwise, requirements specified for the TDD duplex mode apply for downlink and uplink operations in Frame Structure Type 2 [4].

NB-IoT is designed to operate in the E-UTRA operating bands 1, 2, 3, 4, 5, 7, 8, 11, 12, 13, 14, 17, 18, 19, 20, 21, 25, 26, 28, 31, 41 (in certain regions), 42, 43, 65, 66, 70, 71, 72, 73, 74, 85, 87, 88 which are defined in Table 5.5-1.

Table 5.5-1 E-UTRA frequency bands

E-UTRA Operating Band	Uplink (UL) operating band BS receive UE transmit		Downlink (DL) operating band BS transmit UE receive		Duplex Mode
	F _{UL_low}	F _{UL_high}	F _{DL_low}	F _{DL_high}	
1	1920 MHz	1980 MHz	2110 MHz	2170 MHz	FDD
2	1850 MHz	1910 MHz	1930 MHz	1990 MHz	FDD
3	1710 MHz	1785 MHz	1805 MHz	1880 MHz	FDD
4	1710 MHz	1755 MHz	2110 MHz	2155 MHz	FDD
5	824 MHz	849 MHz	869 MHz	894 MHz	FDD
6 (NOTE 1)	830 MHz	840 MHz	875 MHz	885 MHz	FDD
7	2500 MHz	2570 MHz	2620 MHz	2690 MHz	FDD
8	880 MHz	915 MHz	925 MHz	960 MHz	FDD
9	1749.9 MHz	1784.9 MHz	1844.9 MHz	1879.9 MHz	FDD
10	1710 MHz	1770 MHz	2110 MHz	2170 MHz	FDD
11	1427.9 MHz	1447.9 MHz	1475.9 MHz	1495.9 MHz	FDD
12	699 MHz	716 MHz	729 MHz	746 MHz	FDD
13	777 MHz	787 MHz	746 MHz	756 MHz	FDD
14	788 MHz	798 MHz	758 MHz	768 MHz	FDD
15	Reserved		Reserved		FDD
16	Reserved		Reserved		FDD
17	704 MHz	716 MHz	734 MHz	746 MHz	FDD
18	815 MHz	830 MHz	860 MHz	875 MHz	FDD
19	830 MHz	845 MHz	875 MHz	890 MHz	FDD
20	832 MHz	862 MHz	791 MHz	821 MHz	FDD
21	1447.9 MHz	1462.9 MHz	1495.9 MHz	1510.9 MHz	FDD
22	3410 MHz	3490 MHz	3510 MHz	3590 MHz	FDD
23 ¹	2000 MHz	2020 MHz	2180 MHz	2200 MHz	FDD
24 ⁹	1626.5 MHz	1660.5 MHz	1525 MHz	1559 MHz	FDD
25	1850 MHz	1915 MHz	1930 MHz	1995 MHz	FDD
26	814 MHz	849 MHz	859 MHz	894 MHz	FDD
27	807 MHz	824 MHz	852 MHz	869 MHz	FDD
28	703 MHz	748 MHz	758 MHz	803 MHz	FDD
29	N/A		717 MHz	728 MHz	FDD (NOTE 2)
30	2305 MHz	2315 MHz	2350 MHz	2360 MHz	FDD
31	452.5 MHz	457.5 MHz	462.5 MHz	467.5 MHz	FDD
32	N/A		1452 MHz	1496 MHz	FDD (NOTE 2)
33	1900 MHz	1920 MHz	1900 MHz	1920 MHz	TDD
34	2010 MHz	2025 MHz	2010 MHz	2025 MHz	TDD
35	1850 MHz	1910 MHz	1850 MHz	1910 MHz	TDD
36	1930 MHz	1990 MHz	1930 MHz	1990 MHz	TDD
37	1910 MHz	1930 MHz	1910 MHz	1930 MHz	TDD
38	2570 MHz	2620 MHz	2570 MHz	2620 MHz	TDD
39	1880 MHz	1920 MHz	1880 MHz	1920 MHz	TDD
40	2300 MHz	2400 MHz	2300 MHz	2400 MHz	TDD
41	2496 MHz	2690 MHz	2496 MHz	2690 MHz	TDD
42	3400 MHz	3600 MHz	3400 MHz	3600 MHz	TDD
43	3600 MHz	3800 MHz	3600 MHz	3800 MHz	TDD
44	703 MHz	803 MHz	703 MHz	803 MHz	TDD
45	1447 MHz	1467 MHz	1447 MHz	1467 MHz	TDD
46	5150 MHz	5925 MHz	5150 MHz	5925 MHz	TDD (NOTE 3, NOTE 4)
47	5855 MHz	5925 MHz	5855 MHz	5925 MHz	TDD
48	3550 MHz	3700 MHz	3550 MHz	3700 MHz	TDD
49	3550 MHz	3700 MHz	3550 MHz	3700 MHz	TDD (NOTE 8)
50	1432 MHz	1517 MHz	1432 MHz	1517 MHz	TDD
51	1427 MHz	1432 MHz	1427 MHz	1432 MHz	TDD

52	3300 MHz - 3400 MHz	3300 MHz - 3400 MHz	TDD
53	2483.5 MHz - 2495 MHz	2483.5 MHz - 2495 MHz	TDD
65	1920 MHz - 2010 MHz	2110 MHz - 2200 MHz	FDD
66	1710 MHz - 1780 MHz	2110 MHz - 2200 MHz	FDD (NOTE 5)
67	N/A	738 MHz - 758 MHz	FDD (NOTE 2)
68	698 MHz - 728 MHz	753 MHz - 783 MHz	FDD
69	N/A	2570 MHz - 2620 MHz	FDD (NOTE 2)
70	1695 MHz - 1710 MHz	1995 MHz - 2020 MHz	FDD ⁶
71	663 MHz - 698 MHz	617 MHz - 652 MHz	FDD
72	451 MHz - 456 MHz	461 MHz - 466 MHz	FDD
73	450 MHz - 455 MHz	460 MHz - 465 MHz	FDD
74	1427 MHz - 1470 MHz	1475 MHz - 1518 MHz	FDD
75	N/A	1432 MHz - 1517 MHz	FDD (NOTE 2)
76	N/A	1427 MHz - 1432 MHz	FDD (NOTE 2)
85	698 MHz - 716 MHz	728 MHz - 746 MHz	FDD
87	410 MHz - 415 MHz	420 MHz - 425 MHz	FDD
88	412 MHz - 417 MHz	422 MHz - 427 MHz	FDD
NOTE 1: Band 6, 23 are not applicable.			
NOTE 2: Restricted to E-UTRA operation when carrier aggregation is configured. The downlink operating band is paired with the uplink operating band (external) of the carrier aggregation configuration that is supporting the configured Pcell.			
NOTE 3: This band is an unlicensed band restricted to licensed-assisted operation using Frame Structure Type 3.			
NOTE 4: Band 46 is divided into four sub-bands as in Table 5.5-1A.			
NOTE 5: The range 2180 - 2200 MHz of the DL operating band is restricted to E-UTRA operation when carrier aggregation is configured.			
NOTE 6: The range 2010-2020 MHz of the DL operating band is restricted to E-UTRA operation when carrier aggregation is configured and TX-RX separation is 300 MHz. The range 2005-2020 MHz of the DL operating band is restricted to E-UTRA operation when carrier aggregation is configured and TX-RX separation is 295 MHz.			
NOTE 7: Void			
NOTE 8: This band is restricted to licensed-assisted operation using Frame Structure Type 3.			
NOTE 9: DL operation is restricted to 1526-1536 MHz frequency range. UL operation is restricted to 1627.5 - 1637.5 MHz and 1646.5 - 1656.5 MHz per FCC Order DA 20-48.			

Table 5.5-1A Sub-bands for Band 46

E-UTRA Operating Band	Uplink (UL) operating band BS receive UE transmit	Downlink (DL) operating band BS transmit UE receive
	F _{UL_low} - F _{UL_high}	F _{DL_low} - F _{DL_high}
46a	5150 MHz - 5250 MHz	5150 MHz - 5250 MHz
46b	5250 MHz - 5350 MHz	5250 MHz - 5350 MHz
46c	5470 MHz - 5725 MHz	5470 MHz - 5725 MHz
46d	5725 MHz - 5925 MHz	5725 MHz - 5925 MHz

Table 5.5-2: Void

Table 5.5-3: Void

Table 5.5-3A: Void

Table 5.5-3B: Void

Table 5.5-3C: Void

Table 5.5-4: Void

Table 5.5-5: Void

Table 5.5-6: Void

5.6 Channel bandwidth

For E-UTRA, requirements in present document are specified for the channel bandwidths listed in Table 5.6-1.

Table 5.6-1 Transmission bandwidth configuration N_{RB} in E-UTRA channel bandwidths

Channel bandwidth $BW_{Channel}$ [MHz]	1.4	3	5	10	15	20
Transmission bandwidth configuration N_{RB}	6	15	25	50	75	100

For E-UTRA, figure 5.6-1 shows the relation between the channel bandwidth ($BW_{Channel}$) and the transmission bandwidth configuration (N_{RB}). The channel edges are defined as the lowest and highest frequencies of the carrier separated by the channel bandwidth, i.e. at $F_C \pm BW_{Channel} / 2$.

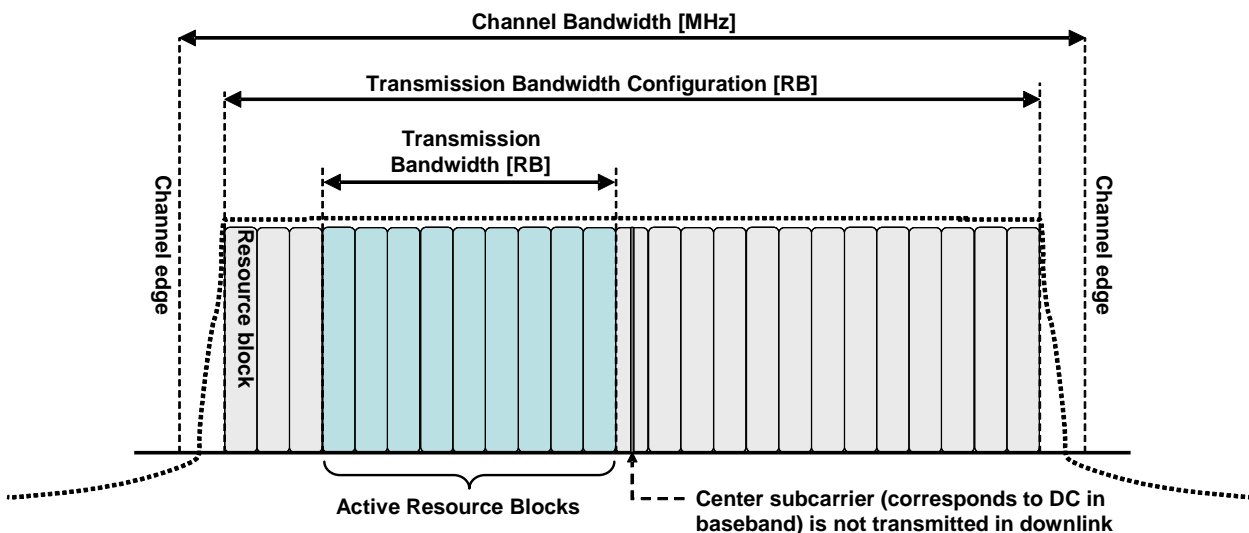

Figure 5.6-1 Definition of Channel Bandwidth and Transmission Bandwidth Configuration for one E-UTRA carrier

Figure 5.6-2 illustrates the Aggregated Channel Bandwidth for intra-band carrier aggregation.

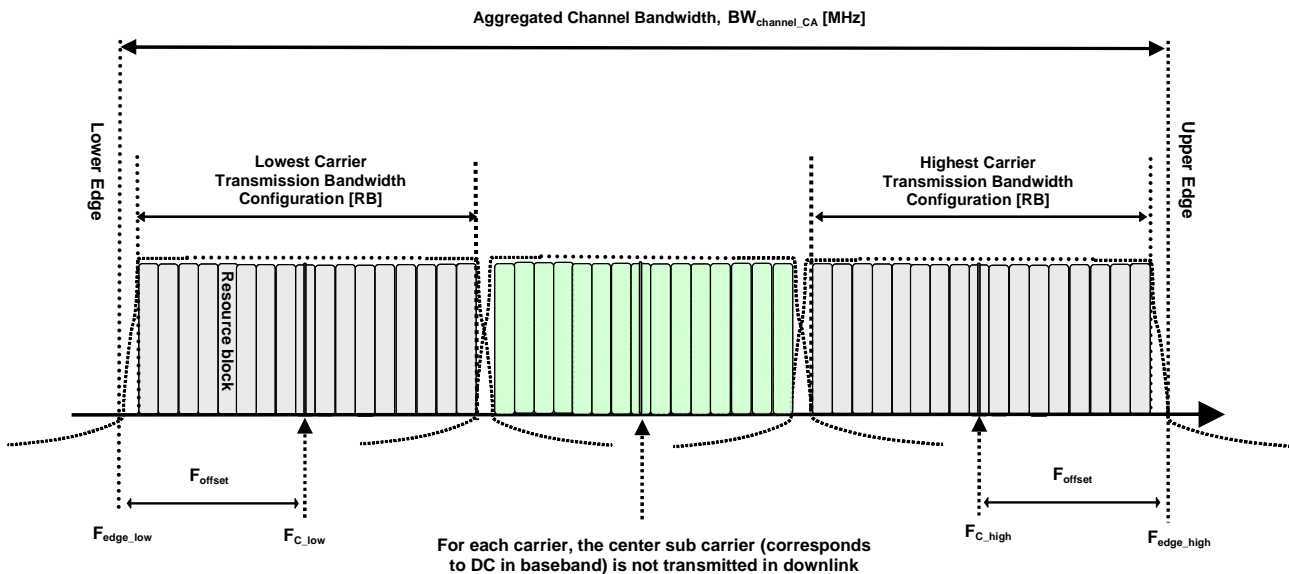

Figure 5.6-2 Definition of Aggregated Channel Bandwidth for intra-band carrier aggregation

The lower edge of the Aggregated Channel Bandwidth ($BW_{Channel_CA}$) is defined as $F_{edge_low} = F_{C_low} - F_{offset}$. The upper edge of the Aggregated Channel Bandwidth is defined as $F_{edge_high} = F_{C_high} + F_{offset}$. The Aggregated Channel Bandwidth, $BW_{Channel_CA}$, is defined as follows:

$$BW_{Channel_CA} = F_{edge_high} - F_{edge_low} \text{ [MHz]}$$

Figure 5.6-3 illustrates the sub-block bandwidth for a BS operating in non-contiguous spectrum

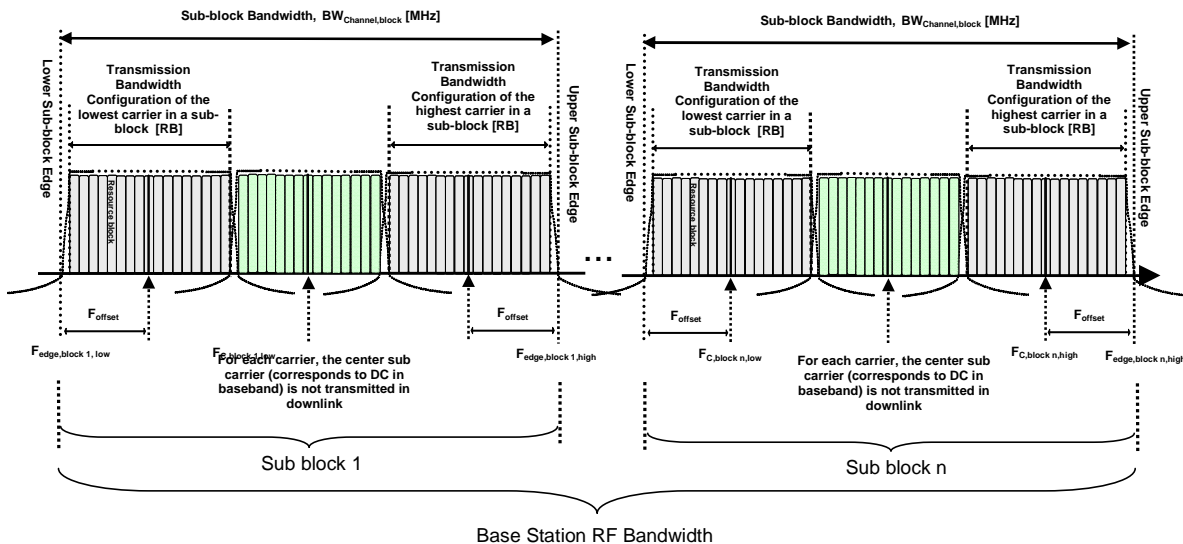

Figure 5.6-3 Definition of sub-block bandwidth for intra-band non-contiguous spectrum

The lower sub-block edge of the sub-block bandwidth ($BW_{Channel_block}$) is defined as $F_{edge_block,low} = F_{C_block,low} - F_{offset}$. The upper sub-block edge of the sub-block bandwidth is defined as $F_{edge_block,high} = F_{C_block,high} + F_{offset}$. The sub-block bandwidth, $BW_{Channel_block}$, is defined as follows:

$$BW_{Channel_block} = F_{edge_block,high} - F_{edge_block,low} \text{ [MHz]}$$

F_{offset} is defined in Table 5.6-2 below where $BW_{Channel}$ is defined in Table 5.6-1.

Table 5.6-2: Definition of F_{offset}

Channel Bandwidth of the Lowest or Highest Carrier: BW_{Channel} [MHz]	F_{offset} [MHz]
5, 10, 15, 20	$BW_{\text{Channel}}/2$

NOTE 1: F_{offset} is calculated separately for each Base Station RF Bandwidth edge / sub-block edge.

NOTE 2: The values of $BW_{\text{Channel_CA}}/BW_{\text{Channel_block}}$ for UE and BS are the same if the channel bandwidths of lowest and the highest component carriers are identical.

For NB-IoT, requirements in present document are specified for the channel bandwidths listed in Table 5.6-3.

Table 5.6-3: Transmission bandwidth configuration N_{RB} , $N_{\text{tone 15kHz}}$ and $N_{\text{tone 3.75kHz}}$ in NB-IoT channel bandwidth

NB-IoT	Standalone	In-band	Guard Band
Channel bandwidth BW_{Channel} [kHz]	200	E-UTRA channel bandwidth in Table 5.6-1 for $BW_{\text{Channel}} > 1.4\text{MHz}$	E-UTRA channel bandwidth in Table 5.6-1 for $BW_{\text{Channel}} > 3\text{MHz}$
Transmission bandwidth configuration N_{RB}	1	1	1
Transmission bandwidth configuration $N_{\text{tone 15kHz}}$	12	12	12
Transmission bandwidth configuration $N_{\text{tone 3.75kHz}}$	48	48	48

For NB-IoT standalone operation, figure 5.6-4 shows the relation between the channel bandwidth (BW_{Channel}) and the transmission bandwidth configuration (N_{RB} , $N_{\text{tone 15kHz}}$ and $N_{\text{tone 3.75kHz}}$) for NB-IoT standalone operation. The channel edges are defined as the lowest and highest frequencies of the carrier separated by the channel bandwidth, i.e. at $F_{\text{C}} \pm BW_{\text{Channel}}/2$.

For NB-IoT standalone operation, NB-IoT requirements for receiver and transmitter shall apply with a frequency offset F_{offset} as defined in Table 5.6-3A.

Table 5.6-3A: F_{offset} for NB-IoT standalone operation

Lowest or Highest Carrier	F_{offset}
Standalone NB-IoT	200 kHz

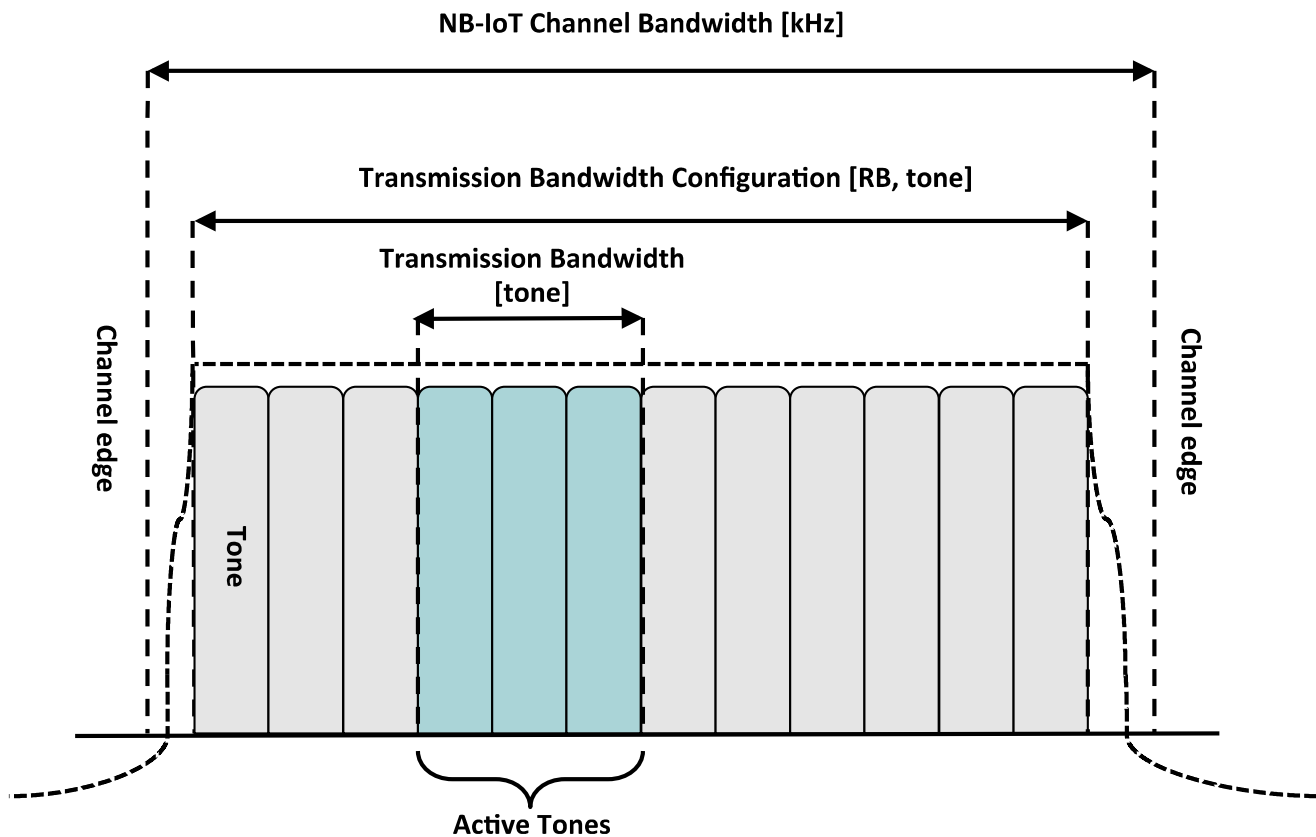

Figure 5.6-4 Definition of Channel Bandwidth and Transmission Bandwidth Configuration for NB-IoT standalone operation

For NB-IoT in-band operation, figure 5.6-5 shows the relation between the channel bandwidth (BW_{Channel}) and the transmission bandwidth configuration (N_{RB} , $N_{\text{tone 15kHz}}$ and $N_{\text{tone 3.75kHz}}$). The channel edges are defined as the lowest and highest frequencies of the carrier separated by the channel bandwidth, i.e. at $F_c \pm BW_{\text{Channel}}/2$.

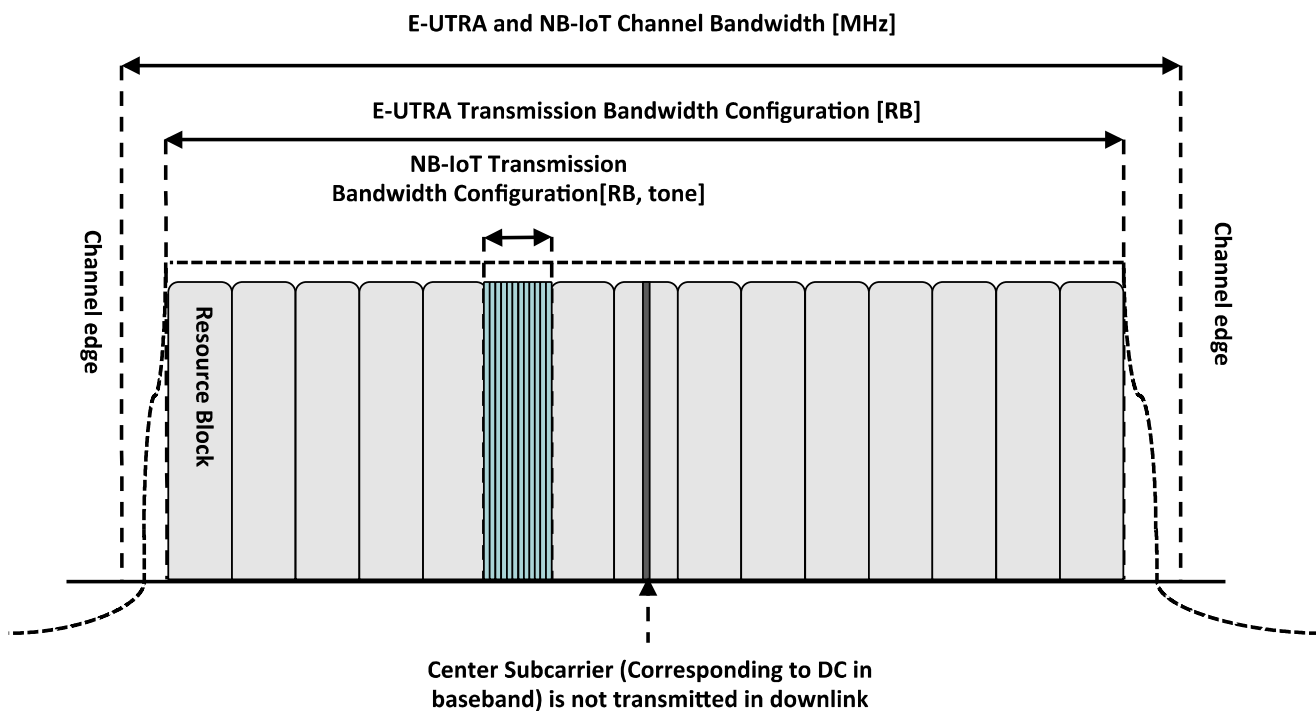

Figure 5.6-5 Definition of Channel Bandwidth and Transmission Bandwidth Configuration for NB-IoT in-band operation

For NB-IoT guard band operation, figure 5.6-6 shows the relation between the channel bandwidth (BW_{Channel}) and the transmission bandwidth configuration (N_{RB} , $N_{\text{tone 15kHz}}$ and $N_{\text{tone 3.75kHz}}$). The channel edges are defined as the lowest and highest frequencies of the carrier separated by the channel bandwidth, i.e. at $F_C \pm BW_{\text{Channel}}/2$.

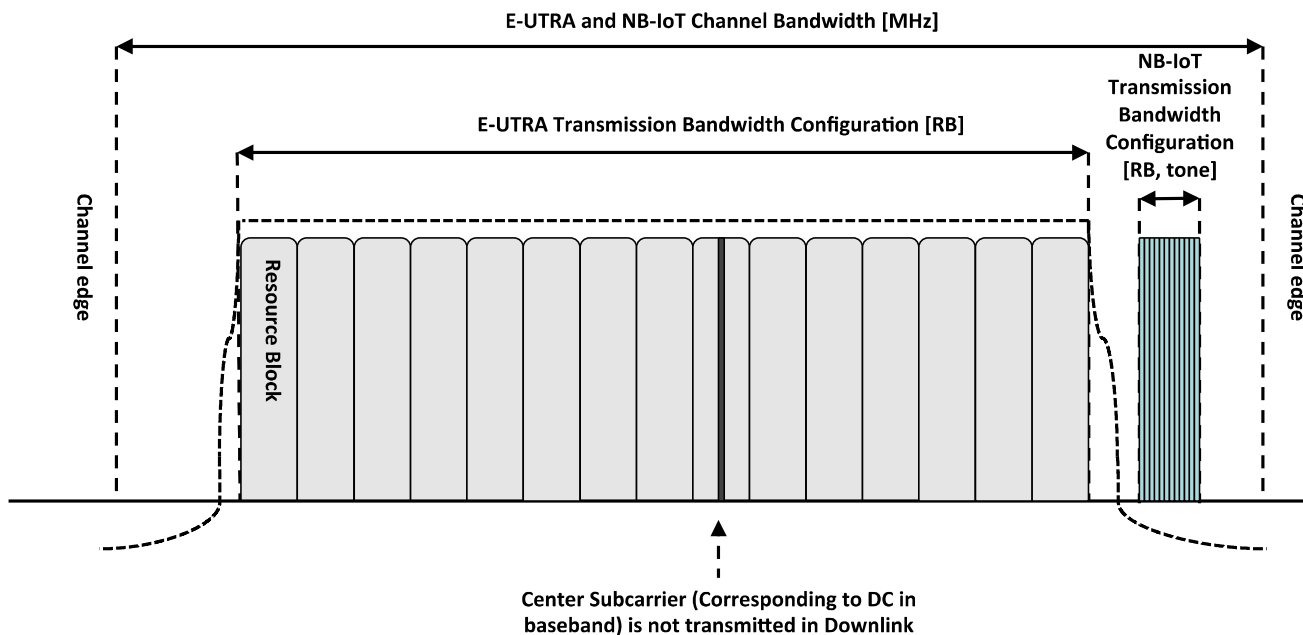

Figure 5.6-6 Definition of Channel Bandwidth and Transmission Bandwidth Configuration for NB-IoT guard band operation

5.7 Channel arrangement

5.7.1 Channel spacing

The spacing between carriers will depend on the deployment scenario, the size of the frequency block available and the channel bandwidths. The nominal channel spacing between two adjacent E-UTRA carriers is defined as following:

$$\text{Nominal Channel spacing} = (BW_{\text{Channel}(1)} + BW_{\text{Channel}(2)})/2$$

where $BW_{\text{Channel}(1)}$ and $BW_{\text{Channel}(2)}$ are the channel bandwidths of the two respective E-UTRA carriers. The channel spacing can be adjusted to optimize performance in a particular deployment scenario.

For 20MHz carriers in Band 46, the requirements apply for both 19.8 MHz and 20.1 MHz nominal carrier spacing.

5.7.1A CA Channel spacing

For intra-band contiguously aggregated carriers the channel spacing between adjacent component carriers shall be multiple of 300 kHz.

The nominal channel spacing between two adjacent aggregated E-UTRA carriers is defined as follows:

$$\text{Nominal channel spacing} = \left\lceil \frac{BW_{\text{Channel}(1)} + BW_{\text{Channel}(2)} - 0.1|BW_{\text{Channel}(1)} - BW_{\text{Channel}(2)}|}{0.6} \right\rceil 0.3$$

where $BW_{\text{Channel}(1)}$ and $BW_{\text{Channel}(2)}$ are the channel bandwidths of the two respective E-UTRA component carriers according to Table 5.6-1 with values in MHz. The channel spacing for intra-band contiguous carrier aggregation can be adjusted to any multiple of 300 kHz less than the nominal channel spacing to optimize performance in a particular deployment scenario.

For intra-band contiguous carrier aggregation with two or more component carriers in Band 46, the requirements apply for both 19.8 MHz and 20.1 MHz nominal carrier spacing between two 20 MHz component carriers, and for 15.0 MHz nominal carrier spacing between 10 MHz and 20 MHz component carriers.

5.7.2 Channel raster

The channel raster is 100 kHz for all bands, which means that the carrier centre frequency must be an integer multiple of 100 kHz.

5.7.3 Carrier frequency and EARFCN

The carrier frequency in the uplink and downlink is designated by the E-UTRA Absolute Radio Frequency Channel Number (EARFCN) in the range 0 - 262143. The relation between EARFCN and the carrier frequency in MHz for the downlink is given by the following equation, where F_{DL_low} and $N_{Offs-DL}$ are given in table 5.7.3-1 and N_{DL} is the downlink EARFCN.

$$F_{DL} = F_{DL_low} + 0.1(N_{DL} - N_{Offs-DL})$$

The relation between EARFCN and the carrier frequency in MHz for the uplink is given by the following equation where F_{UL_low} and $N_{Offs-UL}$ are given in table 5.7.3-1 and N_{UL} is the uplink EARFCN.

$$F_{UL} = F_{UL_low} + 0.1(N_{UL} - N_{Offs-UL})$$

The carrier frequency of NB-IoT in the downlink is designated by the E-UTRA Absolute Radio Frequency Channel Number (EARFCN) in the range 0 – 262143 and the Offset of NB-IoT Channel Number to EARFCN in the range $\{-10,-9,-8,-7,-6,-5,-4,-3,-2,-1,-0.5,0,1,2,3,4,5,6,7,8,9\}$ for FDD and in the range $\{-10,-9,-8.5,-8,-7,-6,-5,-4.5,-4,-3,-2,-1,-0.5,0,1,2,3,3.5,4,5,6,7,7.5,8,9\}$ for TDD. The relation between EARFCN, Offset of NB-IoT Channel Number to EARFCN and the carrier frequency in MHz for the downlink is given by the following equation, where F_{DL} is the downlink carrier frequency of NB-IoT, F_{DL_low} and $N_{Offs-DL}$ are given in table 5.7.3-1, N_{DL} is the downlink EARFCN, M_{DL} is the Offset of NB-IoT Channel Number to downlink EARFCN.

$$F_{DL} = F_{DL_low} + 0.1(N_{DL} - N_{Offs-DL}) + 0.0025*(2M_{DL}+1)$$

The carrier frequency of NB-IoT in the uplink is designated by the E-UTRA Absolute Radio Frequency Channel Number (EARFCN) in the range 0 – 262143, and the Offset of NB-IoT Channel Number to EARFCN in the range $\{-10,-9,-8,-7,-6,-5,-4,-3,-2,-1,0,1,2,3,4,5,6,7,8,9\}$ for FDD and in the range $\{-11,-10,-9.5,-9,-8.5,-8,-7.5,-7,-6.5,-6,-5.5,-5,-4.5,-4,-3.5,-3,-2.5,-2,-1.5,-1,-0.5,0,0.5,1,1.5,2,2.5,3,3.5,4,4.5,5,5.5,6,6.5,7,7.5,8,8.5,9,9.5,10,11\}$ for TDD. The relation between EARFCN, Offset of NB-IoT Channel Number to EARFCN and the carrier frequency in MHz for the uplink is given by the following equation, where F_{UL} is the uplink carrier frequency of NB-IoT, F_{UL_low} and $N_{Offs-UL}$ are given in table 5.7.3-1, N_{UL} is the uplink EARFCN, M_{UL} is the Offset of NB-IoT Channel Number to uplink EARFCN.

$$F_{UL} = F_{UL_low} + 0.1(N_{UL} - N_{Offs-UL}) + 0.0025*(2M_{UL})$$

NOTE 1: For NB-IoT, N_{DL} or N_{UL} is different than the value of EARFCN that corresponds to E-UTRA downlink or uplink carrier frequency for in-band and guard band operation.

NOTE 2: For FDD $M_{DL} = -0.5$ is not applicable for in-band and guard band operation. For TDD $M_{DL} \{-0.5,+3.5,-4.5,+7.5,-8.5\}$ is not applicable for in-band and guard band operation.

NOTE 3: For the carrier including NPSS/NSSS for in-band and guard band operation, M_{DL} is selected from $\{-2,-1,0,1\}$.

NOTE 4: For the carrier including NPSS/NSSS for stand-alone operation, $M_{DL} = -0.5$.

Table 5.7.3-1: E-UTRA channel numbers

E-UTRA Operating Band	Downlink			Uplink		
	F _{DL_low} [MHz]	N _{Offs-DL}	Range of N _{DL}	F _{UL_low} [MHz]	N _{Offs-UL}	Range of N _{UL}
1	2110	0	0 – 599	1920	18000	18000 – 18599
2	1930	600	600 – 1199	1850	18600	18600 – 19199
3	1805	1200	1200 – 1949	1710	19200	19200 – 19949
4	2110	1950	1950 – 2399	1710	19950	19950 – 20399
5	869	2400	2400 – 2649	824	20400	20400 – 20649
6	875	2650	2650 – 2749	830	20650	20650 – 20749
7	2620	2750	2750 – 3449	2500	20750	20750 – 21449
8	925	3450	3450 – 3799	880	21450	21450 – 21799
9	1844.9	3800	3800 – 4149	1749.9	21800	21800 – 22149
10	2110	4150	4150 – 4749	1710	22150	22150 – 22749
11	1475.9	4750	4750 – 4949	1427.9	22750	22750 – 22949
12	729	5010	5010 – 5179	699	23010	23010 – 23179
13	746	5180	5180 – 5279	777	23180	23180 – 23279
14	758	5280	5280 – 5379	788	23280	23280 – 23379
...						
17	734	5730	5730 – 5849	704	23730	23730 – 23849
18	860	5850	5850 – 5999	815	23850	23850 – 23999
19	875	6000	6000 – 6149	830	24000	24000 – 24149
20	791	6150	6150 - 6449	832	24150	24150 - 24449
21	1495.9	6450	6450 – 6599	1447.9	24450	24450 – 24599
22	3510	6600	6600 - 7399	3410	24600	24600 - 25399
23	2180	7500	7500 – 7699	2000	25500	25500 – 25699
24	1525	7700	7700 – 8039	1626.5	25700	25700 – 26039
25	1930	8040	8040 - 8689	1850	26040	26040 - 26689
26	859	8690	8690 – 9039	814	26690	26690 - 27039
27	852	9040	9040 – 9209	807	27040	27040 – 27209
28	758	9210	9210 – 9659	703	27210	27210 – 27659
29 (NOTE 2)	717	9660	9660 – 9769	N/A		
30	2350	9770	9770 – 9869	2305	27660	27660 – 27759
31	462.5	9870	9870 – 9919	452.5	27760	27760 – 27809
32 (NOTE 2)	1452	9920	9920 – 10359	N/A		
33	1900	36000	36000 – 36199	1900	36000	36000 – 36199
34	2010	36200	36200 – 36349	2010	36200	36200 – 36349
35	1850	36350	36350 – 36949	1850	36350	36350 – 36949
36	1930	36950	36950 – 37549	1930	36950	36950 – 37549
37	1910	37550	37550 – 37749	1910	37550	37550 – 37749
38	2570	37750	37750 – 38249	2570	37750	37750 – 38249
39	1880	38250	38250 – 38649	1880	38250	38250 – 38649
40	2300	38650	38650 – 39649	2300	38650	38650 – 39649
41	2496	39650	39650 – 41589	2496	39650	39650 – 41589
42	3400	41590	41590 - 43589	3400	41590	41590 - 43589
43	3600	43590	43590 – 45589	3600	43590	43590 – 45589
44	703	45590	45590 – 46589	703	45590	45590 – 46589
45	1447	46590	46590 – 46789	1447	46590	46590 – 46789
46 (NOTE 3)	5150	46790	46790 – 54539	5150	46790	46790 – 54539
47	5855	54540	54540 – 55239	5855	54540	54540 – 55239
48	3550	55240	55240 – 56739	3550	55240	55240 – 56739
49	3550	56740	56740 – 58239	3550	56740	56740 – 58239
50	1432	58240	58240 - 59089	1432	58240	58240 - 59089
51	1427	59090	59090 - 59139	1427	59090	59090 - 59139
52	3300	59140	59140 - 60139	3300	59140	59140 - 60139
53	2483.5	60140	60140 - 60254	2483.5	60140	60140 - 60254
65	2110	65536	65536 – 66435	1920	131072	131072 – 131971
66 (NOTE 4)	2110	66436	66436 – 67335	1710	131972	131972 – 132671
67 (NOTE 2)	738	67336	67336 - 67535	N/A		
68	753	67536	67536 - 67835	698	132672	132672 - 132971

69 (NOTE 2)	2570	67836	67836 - 68335	N/A		
70 (NOTE 5)	1995	68336	68336 - 68585	1695	132972	132972 - 133121
71	617	68586	68586 - 68935	663	133122	133122-133471
72	461	68936	68936 - 68985	451	133472	133472-133521
73	460	68986	68986 - 69035	450	133522	133522-133571
74	1475	69036	69036 - 69465	1427	133572	133572 - 134001
75 (NOTE 2)	1432	69466	69466 - 70315	N/A		
76 (NOTE 2)	1427	70316	70316 - 70365	N/A		
85	728	70366	70366 - 70545	698	134002	134002 - 134181
87	420	70546	70546 - 70595	410	134182	134182 - 134231
88	422	70596	70596 - 70645	412	134232	134232 - 134281
<p>NOTE 1: The channel numbers that designate carrier frequencies so close to the operating band edges that the carrier extends beyond the operating band edge shall not be used. This implies that the first 7, 15, 25, 50, 75 and 100 channel numbers at the lower operating band edge and the last 6, 14, 24, 49, 74 and 99 channel numbers at the upper operating band edge shall not be used for channel bandwidths of 1.4, 3, 5, 10, 15 and 20 MHz respectively.</p> <p>NOTE 2: Restricted to E-UTRA operation when carrier aggregation is configured.</p> <p>NOTE 3: The following NDL and NUL are allowed for operation in Band 46 assuming 20MHz channel bandwidth: NDL = NUL = {n-2, n-1, n, n+1, n+2 n = 46890 (5160 MHz), 47090 (5180 MHz), 47290 (5200 MHz), 47490 (5220 MHz), 47690 (5240 MHz), 47890 (5260 MHz), 48090 (5280 MHz), 48290 (5300 MHz), 48490 (5320 MHz), 48690 (5340 MHz), 50090 (5480 MHz), 50290 (5500 MHz), 50490 (5520 MHz), 50690 (5540 MHz), 50890 (5560 MHz), 51090 (5580 MHz), 51290 (5600 MHz), 51490 (5620 MHz), 51690 (5640 MHz), 51890 (5660 MHz), 52090 (5680 MHz), 52290 (5700 MHz), 52490 (5720 MHz), 52740 (5745 MHz), 52940 (5765 MHz), 53140 (5785 MHz), 53340 (5805 MHz), 53540 (5825 MHz), 53740 (5845 MHz), 53940 (5865 MHz), 54140 (5885 MHz), 54340 (5905 MHz)}. And the following N_{DL} and N_{UL} are allowed for operation in Band 46 assuming 10MHz channel bandwidth: N_{DL} = N_{UL} = {n-2, n-1, n, n+1, n+2 n = 52590 (5730 MHz), 53590 (5830 MHz)}. 10 MHz channel bandwidth shall only apply in certain regions where the absence of non 3GPP technologies can be guaranteed on a long term basis in this version of specification.</p> <p>NOTE 4: Downlink frequency range 2180 – 2200 MHz is restricted to E-UTRA operation when carrier aggregation is configured.</p> <p>NOTE 5: The range 2010-2020 MHz of the DL operating band is restricted to E-UTRA operation when carrier aggregation is configured and TX-RX separation is 300 MHz. The range 2005-2020 MHz of the DL operating band is restricted to E-UTRA operation when carrier aggregation is configured and TX-RX separation is 295 MHz.</p>						

5.7.4 EARFCN sets for Type B multi-carrier downlink transmissions and conversion to Type 2 channel access for multi-carrier uplink transmissions on multiple Scells configured in Band 46

If the maximum frequency separation between the center frequencies of any two of the carriers on which LAA transmissions are performed is > 62 MHz, then on a configured set of carriers with carrier frequencies that are a subset of any of the following sets of EARFCN, downlink transmissions in accordance with Type B multi-carrier access procedure as defined in 4.1.6.2 of TS 37.213 [20] are allowed:

- for sets of two Scells: n-2, n-1, n, n+1, n+2 | n = {47090, 47290}, {47490, 47690}, {47890, 48090}, {48290, 48490}, {50290, 50490}, {50690, 50890}, {51090, 51290}, {51490, 51690}, {51890, 52090}, {52290, 52490}; {52740, 52940}; {53140, 53340}
- for sets of four Scells: n-2, n-1, n, n+1, n+2 | n = {47090, 47290, 47490, 47690}, {47890, 48090, 48290, 48490}, {50290, 50490, 50690, 50890}, {51090, 51290, 51490, 51690}, {51890, 52090, 52290, 52490}, {52740, 52940, 53140, 53340}
- for sets of eight Scells: n-2, n-1, n, n+1, n+2 | n = {47090, 47290, 47490, 47690, 47890, 48090, 48290, 48490}, {50290, 50490, 50690, 50890, 51090, 51290, 51490, 51690}

Additionally, if the maximum frequency separation between the center frequencies of any two of the carriers on which LAA transmissions are performed is ≤ 62 MHz, then the Type B multi-carrier access procedure as defined in 4.1.6.2 of TS 37.213 [20] is allowed without any of the above EARFCN restrictions.

If the maximum frequency separation between the center frequencies of any two of the carriers on which LAA transmissions are performed is > 62 MHz and transmissions are permitted by national regulations, then Type B multi-carrier access procedure is also allowed only within a configured set of carriers that does not include any carrier frequencies that are included in any of the sets of EARFCN above, as defined in Note 3 in Table 5.7.3-1. EARFCN values that are not included in any of the sets of EARFCN above are as follows: $n-2, n-1, n, n+1, n+2 \mid n = \{46890, 48690, 50090, 53540\}$

For any LAA transmissions, single carrier access procedure as defined in clause 4.1.1 and 4.1.2 of TS 37.213 [20] or Type A multi-carrier access procedure as defined in clause 4.1.6.1 of TS 37.213 [20] are also allowed.

On a configured set of carriers with carrier frequencies that are a subset of any of the following sets of EARFCN, if the eNB schedules a UE to transmit in a subframe on the configured set of carriers, and if the UL grants scheduling PUSCH transmissions on any of the said set of carriers indicate Type 1 channel access procedure, and if the same '*PUSCH starting position*' is indicated for all carriers, transmissions in accordance with the conditions for Type 2 channel access specified in clause 15.2.1 of [11] are allowed:

- for sets of two Scells: $n-2, n-1, n, n+1, n+2 \mid n = \{47090, 47290\}, \{47490, 47690\}, \{47890, 48090\}, \{48290, 48490\}, \{50290, 50490\}, \{50690, 50890\}, \{51090, 51290\}, \{51490, 51690\}, \{51890, 52090\}, \{52290, 52490\}; \{52740, 52940\}; \{53140, 53340\}$
- for sets of four Scells: $n-2, n-1, n, n+1, n+2 \mid n = \{47090, 47290, 47490, 47690\}, \{47890, 48090, 48290, 48490\}, \{50290, 50490, 50690, 50890\}, \{51090, 51290, 51490, 51690\}, \{51890, 52090, 52290, 52490\}, \{52740, 52940, 53140, 53340\}$
- for sets of eight Scells: $n-2, n-1, n, n+1, n+2 \mid n = \{47090, 47290, 47490, 47690, 47890, 48090, 48290, 48490\}, \{50290, 50490, 50690, 50890, 51090, 51290, 51490, 51690\}$

Type 2 channel access is also allowed within a configured set of carriers that does not include any carrier frequencies that are included in any of the sets of EARFCN above, as defined in Note 3 in Table 5.7.3-1. EARFCN values that are not included in any of the sets of EARFCN above are as follows: $n-2, n-1, n, n+1, n+2 \mid n = \{46890, 48690, 50090, 53540\}$

5.8 Requirements for contiguous and non-contiguous spectrum

A spectrum allocation where the BS operates can either be contiguous or non-contiguous. Unless otherwise stated, the requirements in the present specification apply for BS configured for both contiguous spectrum operation and non-contiguous spectrum operation.

For BS operation in non-contiguous spectrum, some requirements apply also inside the sub-block gaps. For each such requirement, it is stated how the limits apply relative to the sub-block edges.

6 Transmitter characteristics

6.1 General

Unless otherwise stated, the requirements in clause 6 are expressed for a single transmitter antenna connector. In case of multi-carrier transmission with one or multiple transmitter antenna connectors, transmit diversity or MIMO transmission, the requirements apply for each transmitter antenna connector.

Unless otherwise stated, the transmitter characteristics are specified at the BS antenna connector (test port A) with a full complement of transceivers for the configuration in normal operating conditions. If any external apparatus such as a TX amplifier, a filter or the combination of such devices is used, requirements apply at the far end antenna connector (port B).

Unless otherwise stated the requirements in clause 6 applies at all times, i.e. during the Transmitter ON period, the Transmitter OFF period and the Transmitter transient period.

Unless otherwise stated the requirements for NB-IoT in clause 6 applies for all operation modes (In-band operation, Guard-band operation and Stand-alone operation).

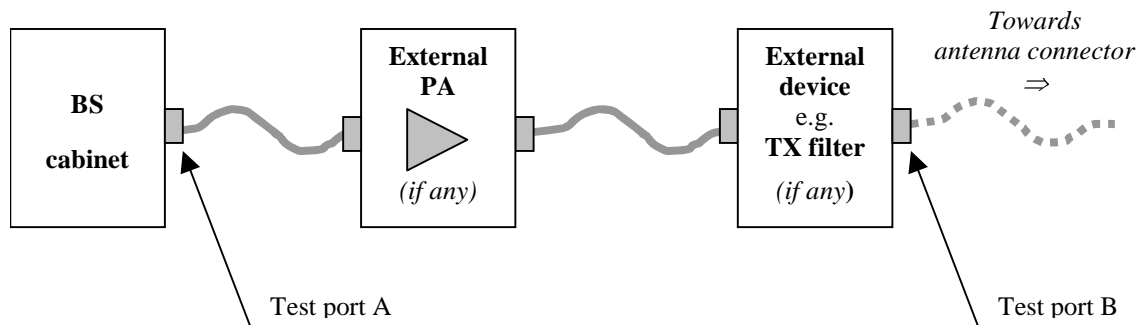

Figure 6.1-1: Transmitter test ports

6.2 Base station output power

Output power, P_{out} , of the base station is the mean power of one carrier delivered to a load with resistance equal to the nominal load impedance of the transmitter.

Rated total output power of the base station is the mean power for BS operating in single carrier, multi-carrier, or carrier aggregation configurations that the manufacturer has declared to be available at the antenna connector during the transmitter ON period.

Maximum output power ($P_{max,c}$) of the base station is the mean power level per carrier measured at the antenna connector during the transmitter ON period in a specified reference condition.

Rated output power, $P_{rated,c}$, of the base station is the mean power level per carrier for BS operating in single carrier, multi-carrier, or carrier aggregation configurations that the manufacturer has declared to be available at the antenna connector during the transmitter ON period.

NOTE: Different $P_{rated,c}$ may be declared for different configurations.

NOTE: For NB-IoT in-band and guard band operation, the LTE carrier and NB-IoT carrier shall be seen as a single carrier occupied LTE channel bandwidth, the output power over this carrier is shared between LTE and NB-IoT. This note is applied for P_{out} , Rated total output power, $P_{max,c}$ and $P_{rated,c}$.

The rated output power, $P_{rated,c}$, of the BS shall be as specified in Table 6.2-1.

Table 6.2-1: Base Station rated output power

BS class	$P_{rated,c}$
Wide Area BS	- (note)
Medium Range BS	$\leq + 38$ dBm
Local Area BS	$\leq + 24$ dBm
Home BS	$\leq + 20$ dBm (for one transmit antenna port) $\leq + 17$ dBm (for two transmit antenna ports) $\leq + 14$ dBm (for four transmit antenna ports) $< + 11$ dBm (for eight transmit antenna ports)
NOTE:	There is no upper limit for the rated output power of the Wide Area Base Station.

In addition for Band 46 operation, the BS may have to comply with the applicable BS power limits established regionally, when deployed in regions where those limits apply and under the conditions declared by the manufacturer. The regional requirements may be in the form of conducted power, power spectral density, EIRP and other types of limits. In case of regulatory limits based on EIRP, assessment of the EIRP level is described in Annex H.

In addition for Band 49 operation in US, the BS EIRP power limit established by FCC for Category A CBSDs (Citizens Broadband Radio Service Devices) applies. Assessment of the EIRP level is described in Annex H.

In addition for Band 85 NB-IoT standalone operation, the BS rated output power limit of 43 dBm applies over the NB-IoT carriers in the range 728-729 MHz of the DL operating band. The BS output power limit of 43 dBm shall be considered as shared among all NB-IoT carriers in the 728-729 MHz frequency range or as the maximum value per NB-IoT carrier in the case where only one NB-IoT carrier is deployed in 728-729 MHz frequency range.

6.2.1 Minimum requirement

In normal conditions, the base station maximum output power, $P_{\max,c}$, shall remain within +2 dB and -2 dB of the rated output power, $P_{\text{rated},c}$, declared by the manufacturer.

In extreme conditions, the base station maximum output power, $P_{\max,c}$, shall remain within +2.5 dB and -2.5 dB of the rated output power, $P_{\text{rated},c}$, declared by the manufacturer.

In certain regions, the minimum requirement for normal conditions may apply also for some conditions outside the range of conditions defined as normal.

6.2.2 Additional requirement (regional)

For Band 34 operation in Japan, the rated output power, $P_{\text{rated},c}$, declared by the manufacturer shall be less than or equal to the values specified in Table 6.2.2-1.

Table 6.2.2-1: Regional requirements for Band 34 for rated output power declared by the manufacturer.

Channel bandwidth BW_{Channel} [MHz]	1.4	3	5	10	15	20
Maximum output power $P_{\max,c}$ [W]	N/A	N/A	20	40	60	N/A

For Band 41 operation in Japan, the rated output power, $P_{\text{rated},c}$, per BS declared by the manufacturer shall be less than or equal to the values specified in Table 6.2.2-2.

Table 6.2.2-2: Regional requirements for Band 41 for rated output power declared by the manufacturer.

Channel bandwidth BW_{Channel} [MHz]	1.4	3	5	10	15	20
Maximum output power $P_{\max,c}$ [W]	N/A	N/A	N/A	20	N/A	40

6.2.3 Home BS output power for adjacent UTRA channel protection

The E-UTRA or E-UTRA with NB-IoT or NB-IoT Home BS shall be capable of adjusting the transmitter output power to minimize the interference level on the adjacent channels licensed to other operators in the same geographical area while optimize the Home BS coverage. These requirements are only applicable to Home BS. The requirements in this clause are applicable for AWGN radio propagation conditions.

The output power, P_{out} , of the E-UTRA or E-UTRA with NB-IoT or NB-IoT Home BS shall be as specified in Table 6.2.3-1 under the following input conditions:

- CPICH \hat{E}_c , measured in dBm, is the code power of the Primary CPICH on one of the adjacent channels present at the Home BS antenna connector for the CPICH received on the adjacent channels. If Tx diversity is applied on the Primary CPICH, CPICH \hat{E}_c shall be the sum in [W] of the code powers of the Primary CPICH transmitted from each antenna.

- I_{oh} , measured in dBm, is the total received power density, including signals and interference but excluding the own Home BS signal, present at the Home BS antenna connector on the Home BS operating channel.

In case that both adjacent channels are licensed to other operators, the most stringent limit shall apply for P_{out} . In the case when one of the adjacent channels is licensed to an E-UTRA operator while the other adjacent channel is licensed to an UTRA operator, the more stringent limit of this clause and clause 6.2.4 shall apply for P_{out} . In case the Home BS's operating channel and both adjacent channels are licensed to the same operator, the requirements of this clause do not apply.

The input conditions defined for the requirements in this clause are specified at the antenna connector of the Home BS. For Home BS receivers with diversity, the requirements apply to each antenna connector separately, with the other one(s) terminated or disabled. The requirements are otherwise unchanged. For Home BS(s) without measurement capability, a reference antenna with a gain of 0 dBi is assumed for converting these power levels into field strength requirements.

Table 6.2.3-1: Home BS output power for adjacent operator UTRA channel protection

Input Conditions	Output power, P_{out}
$I_{oh} > CPICH \hat{E}_c + 43$ dB And $CPICH \hat{E}_c \geq -105$ dBm	≤ 10 dBm
$I_{oh} \leq CPICH \hat{E}_c + 43$ dB and $CPICH \hat{E}_c \geq -105$ dBm	$\leq \max(8 \text{ dBm}, \min(20 \text{ dBm}, CPICH \hat{E}_c + 100 \text{ dB}))$

Note 1: The Home BS transmitter output power specified in Table 6.2.3-1 assumes a Home BS reference antenna gain of 0 dBi, an target outage zone of 47dB around the Home BS for an UE on the adjacent channel, with an allowance of 2 dB for measurement errors, an ACIR of 33 dB, an adjacent channel UE CPICH \hat{E}_c/I_o target of -18 dB and the same CPICH \hat{E}_c value at the adjacent channel UE as for the Home BS.

Note 2: For $CPICH \hat{E}_c < -105$ dBm, the requirements in clauses 6.2.1 and 6.2.2 apply.

Note 3: The output power P_{out} is the sum transmit power across all the antennas of the Home BS, with each transmit power measured at the respective antenna connectors.

6.2.4 Home BS output power for adjacent E-UTRA channel protection

The E-UTRA or E-UTRA with NB-IoT or NB-IoT Home BS shall be capable of adjusting the transmitter output power to minimize the interference level on the adjacent channels licensed to other operators in the same geographical area while optimize the Home BS coverage. These requirements are only applicable to Home BS. The requirements in this clause are applicable for AWGN radio propagation conditions.

The output power, P_{out} , of the E-UTRA or E-UTRA with NB-IoT or NB-IoT Home BS shall be as specified in Table 6.2. 4-1 under the following input conditions:

- $CRS \hat{E}_s$, measured in dBm, is the Reference Signal Received Power per resource element on one of the adjacent channels present at the Home BS antenna connector for the Reference Signal received on the adjacent channels. For $CRS \hat{E}_s$ determination, the cell-specific reference signal R0 according TS 36.211 [3] shall be used. If the Home BS can reliably detect that multiple TX antennas are used for transmission on the adjacent channel, it may use the average in [W] of the $CRS \hat{E}_s$ on all detected antennas.
- I_{oh} , measured in dBm, is the total received power density, including signals and interference but excluding the own Home BS signal, present at the Home BS antenna connector on the Home BS operating channel.

In case that both adjacent channels are licensed to other operators, the most stringent limit shall apply for P_{out} . In the case when one of the adjacent channels is licensed to an E-UTRA operator while the other adjacent channel is licensed to an UTRA operator, the more stringent limit of this clause and clause 6.2.3 shall apply for P_{out} . In case the E-UTRA or E-UTRA with NB-IoT or NB-IoT Home BS's operating channel and both adjacent channels are licensed to the same operator, the requirements of this clause do not apply.

The input conditions defined for the requirements in this clause are specified at the antenna connector of the Home BS. For E-UTRA or E-UTRA with NB-IoT or NB-IoT Home BS receivers with diversity, the requirements apply to each antenna connector separately, with the other one(s) terminated or disabled. The requirements are otherwise unchanged.

For Home BS(s) without measurement capability, a reference antenna with a gain of 0 dBi is assumed for converting these power levels into field strength requirements.

Table 6.2. 4-1: Home BS output power for adjacent operator E-UTRA channel protection

Input Conditions	Output power, P _{out}
$I_{oh} > \text{CRS } \hat{E}_s +$ $10 \cdot \log_{10}(N_{RB}^{DL} \cdot N_{sc}^{RB})$ $+ 30 \text{ dB}$ and $\text{CRS } \hat{E}_s \geq -127 \text{ dBm}$	$\leq 10 \text{ dBm}$
$I_{oh} \leq \text{CRS } \hat{E}_s +$ $10 \cdot \log_{10}(N_{RB}^{DL} \cdot N_{sc}^{RB})$ $+ 30 \text{ dB}$ and $\text{CRS } \hat{E}_s \geq -127 \text{ dBm}$	$\leq \max(8 \text{ dBm}, \min(20 \text{ dBm}, \text{CRS } \hat{E}_s +$ $10 \cdot \log_{10}(N_{RB}^{DL} \cdot N_{sc}^{RB})$ $+ 85 \text{ dB}))$

Note 1: The E-UTRA or E-UTRA with NB-IoT or NB-IoT Home BS transmitter output power specified in Table 6.2. 4-1 assumes a Home BS reference antenna gain of 0 dBi, an target outage zone of 47dB around the Home BS for an UE on the adjacent channel, with an allowance of 2 dB for measurement errors, an ACIR of 30 dB, an adjacent channel UE \hat{E}_s /Iot target of -6 dB and the same CRS \hat{E}_s value at the adjacent channel UE as for the Home BS.

Note 2: For $\text{CRS } \hat{E}_s < -127 \text{ dBm}$, the requirements in clauses 6.2.1 and 6.2.2 apply.

Note 3: The output power P_{out} is the sum transmit power across all the antennas of the Home BS, with each transmit power measured at the respective antenna connectors.

Note 4: N_{RB}^{DL} is the number of downlink resource blocks in the own E-UTRA or E-UTRA with NB-IoT or NB-IoT Home BS channel.

Note 5: N_{sc}^{RB} is the number of subcarriers in a resource block, $N_{sc}^{RB} = 12$.

6.2.5 Home BS Output Power for co-channel E-UTRA protection

To minimize the co-channel DL interference to non-CSG macro UEs operating in close proximity while optimizing the CSG Home BS coverage, E-UTRA or E-UTRA with NB-IoT or NB-IoT Home BS may adjust its output power according to the requirements set out in this clause. These requirements are only applicable to E-UTRA or E-UTRA with NB-IoT or NB-IoT Home BS. The requirements in this clause are applicable for AWGN radio propagation conditions.

For E-UTRA or E-UTRA with NB-IoT or NB-IoT Home BS that supports the requirements in this clause, the output power, P_{out}, of the Home BS shall be as specified in Table 6.2.5-1 under the following input conditions:

- $\text{CRS } \hat{E}_s$, measured in dBm, is the Reference Signal Received Power per resource element present at the Home BS antenna connector received from the co-channel Wide Area BS. For $\text{CRS } \hat{E}_s$ determination, the cell-specific reference signal R0 according TS 36.211 [10] shall be used. If the Home BS can reliably detect that multiple TX antenna ports are used for transmission by the co-channel Wide Area Base Station, it may use the average in [W] of the $\text{CRS } \hat{E}_s$ on all detected TX antenna ports, including R0.
- I_{oh} , measured in dBm, is the total received DL power, including all interference but excluding the own Home BS signal, present at the Home BS antenna connector on the Home BS operating channel.
- I_{ob} , measured in dBm, is the uplink received interference power, including thermal noise, within one physical resource block's bandwidth of N_{sc}^{RB} resource elements as defined in TS 36.214, present at the Home BS antenna connector on the Home BS operating channel.

The input conditions defined for the requirements in this clause are specified at the antenna connector of the Home BS. For E-UTRA or E-UTRA with NB-IoT or NB-IoT Home BS receivers with diversity, the requirements apply to each antenna connector separately, with the other one(s) terminated or disabled. The requirements are otherwise unchanged.

For E-UTRA or E-UTRA with NB-IoT or NB-IoT Home BS(s) without measurement capability, a reference antenna with a gain of 0 dBi is assumed for converting these power levels into field strength requirements.

Table 6.2.5-1: Home BS output power for co-channel E-UTRA channel protection

Input Conditions	Output power, P _{out}
$l_{oh} (DL) > CRS \hat{E}_s + 10\log_{10}(N_{RB}^{DL} N_{sc}^{RB}) + 30 \text{ dB}$ and Option 1: $CRS \hat{E}_s \geq -127 \text{ dBm}$ or Option 2: $CRS \hat{E}_s \geq -127 \text{ dBm}$ and $l_{ob} > -103 \text{ dBm}$	$\leq 10 \text{ dBm}$
$l_{oh} (DL) \leq CRS \hat{E}_s + 10\log_{10}(N_{RB}^{DL} N_{sc}^{RB}) + 30 \text{ dB}$ and Option 1: $CRS \hat{E}_s \geq -127 \text{ dBm}$ or Option 2: $CRS \hat{E}_s \geq -127 \text{ dBm}$ and $l_{ob} > -103 \text{ dBm}$	$\leq \max(P_{min}, \min(P_{max,c} CRS \hat{E}_s + 10\log_{10}(N_{RB}^{DL} N_{sc}^{RB}) + X))$ $30 \text{ dB} \leq X \leq 70 \text{ dB}$ $P_{min} = -10 \text{ dBm}$

Note 1: Only the option supported by the E-UTRA or E-UTRA with NB-IoT or NB-IoT Home BS shall be tested.

Note 2: For $CRS \hat{E}_s < -127 \text{ dBm}$, or $l_{ob} \leq -103 \text{ dBm}$ when Option 2 is supported, the requirements in clauses 6.2.1 and 6.2.2 apply.

Note 3: The output power, P_{out}, is the sum of transmits power across all the antennas of the Home BS, with each transmit power measured at the respective antenna connectors.

Note 4: N_{RB}^{DL} is the number of downlink resource blocks in the own E-UTRA or E-UTRA with NB-IoT or NB-IoT Home BS channel.

Note 5: N_{sc}^{RB} is the number of subcarriers in a resource block, $N_{sc}^{RB} = 12$.

Note 6: X is a network configurable parameter.

Note 7: P_{min} can be lower dependent on the E-UTRA or E-UTRA with NB-IoT or NB-IoT Home BS total dynamic range.

Note 8: Other input conditions and output power to be applied for network scenarios other than co-channel E-UTRA macro channel protection shall not be precluded.

6.3 Output power dynamics

The requirements in clause 6.3 apply during the transmitter ON period. Transmit signal quality (as specified in clause 6.5) shall be maintained for the output power dynamics requirements of this Clause.

Power control is used to limit the interference level.

6.3.1 RE Power control dynamic range

The RE power control dynamic range is the difference between the power of an RE and the average RE power for a BS at maximum output power for a specified reference condition.

6.3.1.1 Minimum requirements

RE power control dynamic range:

Table 6.3.1.1-1 E-UTRA BS RE power control dynamic range

Modulation scheme used on the RE	RE power control dynamic range (dB)	
	(down)	(up)
QPSK (PDCCH)	-6	+4
QPSK (PDSCH)	-6	+3
QPSK (sPDCCH)	-6	+4
QPSK (sPDSCH)	-6	+3
16QAM (PDSCH)	-3	+3
16QAM (sPDSCH)	-3	+3
16QAM (sPDSCH)	-3	+3
64QAM (PDSCH)	0	0
64QAM (sPDSCH)	0	0
256QAM (PDSCH)	0	0
1024QAM (PDSCH)	0	0

NOTE 1: The output power per carrier shall always be less or equal to the maximum output power of the base station.

6.3.2 Total power dynamic range

The total power dynamic range is the difference between the maximum and the minimum transmit power of an OFDM symbol for a specified reference condition.

NOTE 1: The upper limit of the dynamic range is the OFDM symbol power for a BS at maximum output power. The lower limit of the dynamic range is the OFDM symbol power for a BS when one resource block is transmitted. The OFDM symbol shall carry PDSCH or sPDSCH and not contain RS, PBCH or synchronisation signals.

NOTE 2: The requirement does not apply to Band 46.

6.3.2.1 Minimum requirements

The downlink (DL) total power dynamic range for each E-UTRA carrier shall be larger than or equal to the level in Table 6.3.2.1-1.

Table 6.3.2.1-1 E-UTRA BS total power dynamic range

E-UTRA channel bandwidth (MHz)	Total power dynamic range (dB)
1.4	7.7
3	11.7
5	13.9
10	16.9
15	18.7
20	20

6.3.3 NB-IoT RB power dynamic range for in-band or guard band operation

The NB-IoT RB power dynamic range (or NB-IoT power boosting) for guard band operation is the difference between the power of NB-IoT RB (which occupies 180kHz in guard band of an E-UTRA carrier) and the average power over all RBs (from both NB-IoT and the E-UTRA carrier containing the NB-IoT RB).

The NB-IoT RB power dynamic range (or NB-IoT power boosting) for in-band operation is the difference between the average power of NB-IoT REs (which occupy certain REs in a RB of an E-UTRA carrier) and the average power over all REs (from both NB-IoT and the E-UTRA carrier containing the NB-IoT REs).

6.3.3.1 Minimum Requirement

NB-IoT power dynamic range shall be larger than or equal to +6dB, except for guard band operation with E-UTRA 5 MHz channel bandwidth signal where BS manufacturer shall declare the NB-IoT dynamic range power it could support. (in this version of the specification).

The +6 dB power dynamic range is only required for one NB-IoT RB for both in-band and guard band operation modes.

For guard band operation, this NB-IoT RB should be placed adjacent to the E-UTRA RB edge as close as possible (i.e., away from edge of channel bandwidth).

6.4 Transmit ON/OFF power

The requirements in clause 6.4 are only applied for E-UTRA, E-UTRA with NB-IoT and NB-IoT TDD BS.

6.4.1 Transmitter OFF power

Transmitter OFF power is defined as the mean power measured over 70 us filtered with a square filter of bandwidth equal to the transmission bandwidth configuration of the BS (BW_{Config}) centred on the assigned channel frequency during the transmitter OFF period.

For BS supporting intra-band contiguous CA, the transmitter OFF power is defined as the mean power measured over 70 us filtered with a square filter of bandwidth equal to the Aggregated Channel Bandwidth $BW_{\text{Channel_CA}}$ centred on $(F_{\text{edge_high}}+F_{\text{edge_low}})/2$ during the transmitter OFF period.

6.4.1.1 Minimum Requirement

The transmitter OFF power spectral density shall be less than -85dBm/MHz.

For BS capable of multi-band operation, the requirement is only applicable during the transmitter OFF period in all supported operating bands.

6.4.2 Transmitter transient period

The transmitter transient period is the time period during which the transmitter is changing from the OFF period to the ON period or vice versa. The transmitter transient period is illustrated in Figure 6.4.2-1.

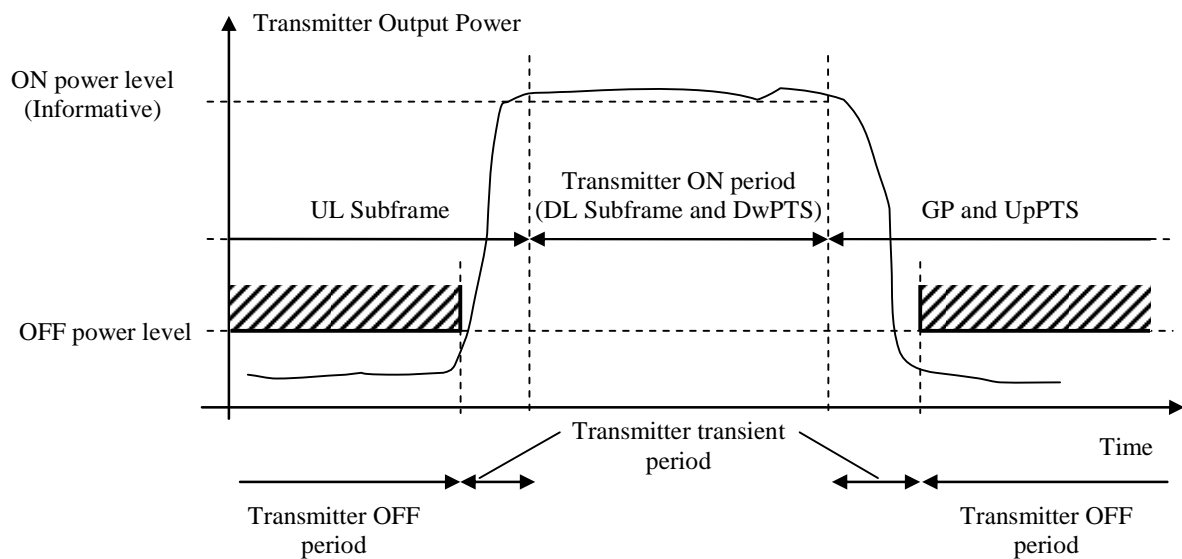

Figure 6.4.2-1 Illustration of the relations of transmitter ON period, transmitter OFF period and transmitter transient period.

6.4.2.1 Minimum requirements

The transmitter transient period shall be shorter than the values listed in Table 6.4.2.1-1.

Table 6.4.2.1-1 Minimum requirements for the transmitter transient period

Transition	Transient period length [us]
OFF to ON	17
ON to OFF	17

6.5 Transmitted signal quality

The requirements in clause 6.5 apply to the transmitter ON period.

6.5.1 Frequency error

Frequency error is the measure of the difference between the actual BS transmit frequency and the assigned frequency. The same source shall be used for RF frequency and data clock generation.

6.5.1.1 Minimum requirement

For E-UTRA, the modulated carrier frequency of each E-UTRA carrier configured by the BS shall be accurate to within the accuracy range given in Table 6.5.1-1 observed over a period of one subframe (1ms).

For NB-IoT, the modulated carrier frequency of each NB-IoT carrier configured by the BS shall be accurate to within the accuracy range given in Table 6.5.1-1 observed over a period of one subframe (1ms).

Table 6.5.1-1: Frequency error minimum requirement

BS class	Accuracy
Wide Area BS	± 0.05 ppm
Medium Range BS	± 0.1 ppm
Local Area BS	± 0.1 ppm
Home BS	± 0.25 ppm

6.5.2 Error Vector Magnitude

The Error Vector Magnitude is a measure of the difference between the ideal symbols and the measured symbols after the equalization. This difference is called the error vector. The equaliser parameters are estimated as defined in Annex E. The EVM result is defined as the square root of the ratio of the mean error vector power to the mean reference power expressed in percent.

For E-UTRA, for all bandwidths, the EVM measurement shall be performed for each E-UTRA carrier over all allocated resource blocks and downlink subframes within 10ms measurement periods for subframe TTI, and over all allocated resource blocks and downlink sTTIs within 10ms measurement periods for sTTI. The boundaries of the EVM measurement periods need not be aligned with radio frame boundaries. The EVM value is then calculated as the mean square root of the measured values. The EVM of each E-UTRA carrier for different modulation schemes on PDSCH or sPDSCH shall be better than the limits in table 6.5.2-1:

Table 6.5.2-1: EVM requirements for E-UTRA carrier

Modulation scheme for PDSCH or sPDSCH	Required EVM [%]
QPSK	17.5 %
16QAM	12.5 %
64QAM	8 %
256QAM	3.5 %
1024QAM	2.5 %

For NB-IoT, for all bandwidths, the EVM measurement shall be performed for each NB-IoT carrier over all allocated resource and downlink subframes within 10ms measurement periods. The boundaries of the EVM measurement periods need not be aligned with radio frame boundaries. The EVM value is then calculated as the mean square root of the measured values. The EVM of each NB-IoT carrier on NB-PDSCH shall be better than the limits in Table 6.5.2-2:

Table 6.5.2-2: EVM requirements for NB-IoT carrier

Modulation scheme for NB-PDSCH	Required EVM [%]
QPSK	17.5 %

6.5.3 Time alignment error

This requirement applies to frame timing in TX diversity, MIMO transmission, carrier aggregation and their combinations.

Frames of the LTE signals present at the BS transmitter antenna port(s) are not perfectly aligned in time. In relation to each other, the RF signals present at the BS transmitter antenna port(s) experience certain timing differences.

For a specific set of signals/transmitter configuration/transmission mode, time alignment error (TAE) is defined as the largest timing difference between any two signals.

6.5.3.1 Minimum Requirement

For E-UTRA:

- For MIMO or TX diversity transmissions, at each carrier frequency, TAE shall not exceed 65 ns.
- For intra-band contiguous carrier aggregation, with or without MIMO or TX diversity, TAE shall not exceed 130 ns.
- For intra-band non-contiguous carrier aggregation, with or without MIMO or TX diversity, TAE shall not exceed 260 ns.
- For inter-band carrier aggregation, with or without MIMO or TX diversity, TAE shall not exceed 260ns.

For NB-IoT:

- For TX diversity transmissions, at each carrier frequency, TAE shall not exceed 65 ns.

6.5.4 DL RS power

For E-UTRA, DL RS power is the resource element power of the Downlink Reference Symbol.

The absolute DL RS power is indicated on the DL-SCH. The absolute accuracy is defined as the maximum deviation between the DL RS power indicated on the DL-SCH and the DL RS power of each E-UTRA carrier at the BS antenna connector.

For NB-IoT, DL NRS power is the resource element power of the Downlink Narrow-band Reference Signal.

The absolute DL NRS power is indicated on the DL-SCH. The absolute accuracy is defined as the maximum deviation between the DL NRS power indicated on the DL-SCH and the DL NRS power of each NB-IoT carrier at the BS antenna connector.

6.5.4.1 Minimum requirements

For E-UTRA, DL RS power of each E-UTRA carrier shall be within ± 2.1 dB of the DL RS power indicated on the DL-SCH.

For NB-IoT, DL NRS power of each NB-IoT carrier shall be within ± 2.1 dB of the DL NRS power indicated on the DL-SCH.

6.6 Unwanted emissions

Unwanted emissions consist of out-of-band emissions and spurious emissions [2]. Out of band emissions are unwanted emissions immediately outside the channel bandwidth resulting from the modulation process and non-linearity in the transmitter but excluding spurious emissions. Spurious emissions are emissions which are caused by unwanted transmitter effects such as harmonics emission, parasitic emission, intermodulation products and frequency conversion products, but exclude out of band emissions.

The out-of-band emissions requirement for the BS transmitter is specified both in terms of Adjacent Channel Leakage power Ratio (ACLR) and Operating band unwanted emissions. The Operating band unwanted emissions define all unwanted emissions in each supported downlink operating band plus the frequency ranges 10 MHz above and 10 MHz below each band. Unwanted emissions outside of this frequency range are limited by a spurious emissions requirement.

For a BS supporting multi-carrier or intra-band contiguous CA, the unwanted emissions requirements apply to channel bandwidths of the outermost carrier larger than or equal to 5 MHz.

There is in addition a requirement for occupied bandwidth.

6.6.1 Occupied bandwidth

The occupied bandwidth is the width of a frequency band such that, below the lower and above the upper frequency limits, the mean powers emitted are each equal to a specified percentage $\beta/2$ of the total mean transmitted power. See also ITU-R Recommendation SM.328 [5].

The value of $\beta/2$ shall be taken as 0.5%.

The requirement applies during the transmitter ON period.

6.6.1.1 Minimum requirement

For E-UTRA, the occupied bandwidth for each E-UTRA carrier shall be less than the channel bandwidth as defined in Table 5.6-1. For intra-band contiguous CA, the occupied bandwidth shall be less than or equal to the Aggregated Channel Bandwidth as defined in clause 5.6. For Band 46 operation in Japan, the occupied bandwidth for each 20MHz channel bandwidth E-UTRA carrier assigned within 5150-5350 MHz and 5470-5725 MHz shall be less than or equal to 19 MHz and 19.7MHz respectively.

For NB-IoT in-band operation, the occupied bandwidth for each E-UTRA carrier with NB-IoT shall be less than the channel bandwidth as defined in Table 5.6-1.

For NB-IoT guard band operation, the occupied bandwidth for each E-UTRA carrier with NB-IoT shall be less than the channel bandwidth as defined in Table 5.6-1 for channel bandwidth larger than or equal to 5 MHz.

For NB-IoT standalone operation, the occupied bandwidth for each NB-IoT carrier shall be less than the channel bandwidth as defined in Table 5.6-3.

6.6.2 Adjacent Channel Leakage power Ratio (ACLR)

Adjacent Channel Leakage power Ratio (ACLR) is the ratio of the filtered mean power centred on the assigned channel frequency to the filtered mean power centred on an adjacent channel frequency.

The requirements shall apply outside the Base Station RF Bandwidth or Radio Bandwidth whatever the type of transmitter considered (single carrier or multi-carrier) and for all transmission modes foreseen by the manufacturer's specification.

For a E-UTRA or E-UTRA with NB-IoT (in-band and/or guard band) BS operating in non-contiguous spectrum, the ACLR also applies for the first adjacent channel inside any sub-block gap with a gap size $W_{\text{gap}} \geq 15\text{MHz}$ or $W_{\text{gap}} \geq 60\text{MHz}$ for Band 46. The ACLR requirement for the second adjacent channel applies inside any sub-block gap with a gap size $W_{\text{gap}} \geq 20\text{MHz}$ or $W_{\text{gap}} \geq 80\text{MHz}$ for Band 46. The CACLR requirement in clause 6.6.2.2 applies in sub block gaps for the frequency ranges defined in Table 6.6.2.2-1/2/2a.

For a E-UTRA or E-UTRA with NB-IoT (in-band and/or guard band) BS operating in multiple bands, where multiple bands are mapped onto the same antenna connector, the ACLR also applies for the first adjacent channel inside any Inter RF Bandwidth gap with a gap size $W_{\text{gap}} \geq 15\text{MHz}$. The ACLR requirement for the second adjacent channel applies inside any Inter RF Bandwidth gap with a gap size $W_{\text{gap}} \geq 20\text{MHz}$. The CACLR requirement in clause 6.6.2.2 applies in Inter RF Bandwidth gaps for the frequency ranges defined in Table 6.6.2.2-1/2.

The requirement applies during the transmitter ON period.

6.6.2.1 Minimum requirement

The ACLR is defined with a square filter of bandwidth equal to the transmission bandwidth configuration of the transmitted signal (BW_{Config}) centred on the assigned channel frequency and a filter centred on the adjacent channel frequency according to the tables below.

For Category A Wide Area BS, either the ACLR limits in the tables below or the absolute limit of -13dBm/MHz shall apply, whichever is less stringent.

For Category B Wide Area BS, either the ACLR limits in the tables below or the absolute limit of -15dBm/MHz shall apply, whichever is less stringent.

For Medium Range BS, either the ACLR limits in the tables below or the absolute limit of -25 dBm/MHz shall apply, whichever is less stringent.

For Local Area BS, either the ACLR limits in the tables below or the absolute limit of -32dBm/MHz shall apply, whichever is less stringent.

For Home BS, either the ACLR limits in the tables below or the absolute limit of -50dBm/MHz shall apply, whichever is less stringent.

The ACLR requirements in Tables 6.6.2.1-1 to 6.6.2.1-4 (except Table 6.6.2.1-2b) apply to BS that supports E-UTRA or E-UTRA with NB-IoT (in-band and/or guard band), in any operating band except for Band 46. The ACLR requirements for Band 46 are in Table 6.6.2.1-2a and 6.6.2.1-5. The ACLR requirements in Table 6.6.2.1-2b and 6.6.2.1-6 apply to BS that supports standalone NB-IoT.

For operation in paired spectrum, the ACLR shall be higher than the value specified in Table 6.6.2.1-1.

Table 6.6.2.1-1: Base Station ACLR in paired spectrum

Channel bandwidth of E-UTRA lowest/highest carrier transmitted BW_{Channel} [MHz]	BS adjacent channel centre frequency offset below the lowest or above the highest carrier centre frequency transmitted	Assumed adjacent channel carrier (informative)	Filter on the adjacent channel frequency and corresponding filter bandwidth	ACLR limit
1.4, 3.0, 5, 10, 15, 20	BW_{Channel}	E-UTRA of same BW	Square (BW_{Config})	45 dB
	$2 \times BW_{\text{Channel}}$	E-UTRA of same BW	Square (BW_{Config})	45 dB
	$BW_{\text{Channel}}/2 + 2.5$ MHz	3.84 Mcps UTRA	RRC (3.84 Mcps)	45 dB
	$BW_{\text{Channel}}/2 + 7.5$ MHz	3.84 Mcps UTRA	RRC (3.84 Mcps)	45 dB
NOTE 1: BW_{Channel} and BW_{Config} are the channel bandwidth and transmission bandwidth configuration of the E-UTRA lowest/highest carrier transmitted on the assigned channel frequency.				
NOTE 2: The RRC filter shall be equivalent to the transmit pulse shape filter defined in TS 25.104 [6], with a chip rate as defined in this table.				

For operation in unpaired spectrum, the ACLR shall be higher than the value specified in Table 6.6.2.1-2.

Table 6.6.2.1-2: Base Station ACLR in unpaired spectrum with synchronized operation

Channel bandwidth of E-UTRA lowest/highest carrier transmitted BW_{Channel} [MHz]	BS adjacent channel centre frequency offset below the lowest or above the highest carrier centre frequency transmitted	Assumed adjacent channel carrier (informative)	Filter on the adjacent channel frequency and corresponding filter bandwidth	ACLR limit
1.4, 3	BW_{Channel}	E-UTRA of same BW	Square (BW_{Config})	45 dB
	$2 \times BW_{\text{Channel}}$	E-UTRA of same BW	Square (BW_{Config})	45 dB
	$BW_{\text{Channel}}/2 + 0.8$ MHz	1.28 Mcps UTRA	RRC (1.28 Mcps)	45 dB
	$BW_{\text{Channel}}/2 + 2.4$ MHz	1.28 Mcps UTRA	RRC (1.28 Mcps)	45 dB
5, 10, 15, 20	BW_{Channel}	E-UTRA of same BW	Square (BW_{Config})	45 dB
	$2 \times BW_{\text{Channel}}$	E-UTRA of same BW	Square (BW_{Config})	45 dB
	$BW_{\text{Channel}}/2 + 0.8$ MHz	1.28 Mcps UTRA	RRC (1.28 Mcps)	45 dB
	$BW_{\text{Channel}}/2 + 2.4$ MHz	1.28 Mcps UTRA	RRC (1.28 Mcps)	45 dB
	$BW_{\text{Channel}}/2 + 2.5$ MHz	3.84 Mcps UTRA	RRC (3.84 Mcps)	45 dB
	$BW_{\text{Channel}}/2 + 7.5$ MHz	3.84 Mcps UTRA	RRC (3.84 Mcps)	45 dB
	$BW_{\text{Channel}}/2 + 5$ MHz	7.68 Mcps UTRA	RRC (7.68 Mcps)	45 dB
	$BW_{\text{Channel}}/2 + 15$ MHz	7.68 Mcps UTRA	RRC (7.68 Mcps)	45 dB
NOTE 1: BW_{Channel} and BW_{Config} are the channel bandwidth and transmission bandwidth configuration of the E-UTRA lowest/highest carrier transmitted on the assigned channel frequency.				
NOTE 2: The RRC filter shall be equivalent to the transmit pulse shape filter defined in TS 25.105 [7], with a chip rate as defined in this table.				

For operation in Band 46, the ACLR shall be higher than the value specified in Table 6.6.2.1-2a.

Table 6.6.2.1-2a: Base Station ACLR in Band 46

Channel bandwidth of E-UTRA lowest/highest carrier transmitted BW_{Channel} [MHz]	BS adjacent channel centre frequency offset below the lowest or above the highest carrier centre frequency transmitted	Assumed adjacent channel carrier (informative)	Filter on the adjacent channel frequency and corresponding filter bandwidth	ACLR limit
10, 20	BW_{Channel}	E-UTRA of same BW	Square (BW_{Config})	35 dB
	$2 \times BW_{\text{Channel}}$	E-UTRA of same BW	Square (BW_{Config})	40 dB
NOTE 1: BW_{Channel} and BW_{Config} are the channel bandwidth and transmission bandwidth configuration of the E-UTRA lowest/highest carrier transmitted on the assigned channel frequency.				

For standalone NB-IoT operation in paired spectrum, the ACLR shall be higher than the value specified in Table 6.6.2.1-2b.

Table 6.6.2.1-2b: Base Station ACLR for standalone NB-IoT operation in paired spectrum

Channel bandwidth of NB-IoT lowest/highest carrier transmitted BW_{Channel} [kHz]	BS adjacent channel centre frequency offset below the lowest or above the highest carrier centre frequency transmitted	Assumed adjacent channel carrier (informative)	Filter on the adjacent channel frequency and corresponding filter bandwidth	ACLR limit
200	300 kHz	Standalone NB-IoT	Square (180 kHz)	40 dB
	500 kHz	Standalone NB-IoT	Square (180 kHz)	50 dB

For operation in non-contiguous paired spectrum or multiple bands, the ACLR shall be higher than the value specified in Table 6.6.2.1-3.

Table 6.6.2.1-3: Base Station ACLR in non-contiguous paired spectrum or multiple bands

Sub-block or Inter RF Bandwidth gap size (W_{gap}) where the limit applies	BS adjacent channel centre frequency offset below or above the sub-block edge or the Base Station RF Bandwidth edge (inside the gap)	Assumed adjacent channel carrier (informative)	Filter on the adjacent channel frequency and corresponding filter bandwidth	ACLR limit
$W_{\text{gap}} \geq 15$ MHz	2.5 MHz	3.84 Mcps UTRA	RRC (3.84 Mcps)	45 dB
$W_{\text{gap}} \geq 20$ MHz	7.5 MHz	3.84 Mcps UTRA	RRC (3.84 Mcps)	45 dB
NOTE: The RRC filter shall be equivalent to the transmit pulse shape filter defined in TS 25.104 [6], with a chip rate as defined in this table.				

For operation in non-contiguous unpaired spectrum or multiple bands, the ACLR shall be higher than the value specified in Table 6.6.2.1-4.

Table 6.6.2.1-4: Base Station ACLR in non-contiguous unpaired spectrum or multiple bands

Sub-block or Inter RF Bandwidth gap size (W_{gap}) where the limit applies	BS adjacent channel centre frequency offset below or above the sub-block edge or the Base Station RF Bandwidth edge (inside the gap)	Assumed adjacent channel carrier (informative)	Filter on the adjacent channel frequency and corresponding filter bandwidth	ACLR limit
$W_{\text{gap}} \geq 15$ MHz	2.5 MHz	5MHz E-UTRA carrier	Square (BW_{Config})	45 dB
$W_{\text{gap}} \geq 20$ MHz	7.5 MHz	5MHz E-UTRA carrier	Square (BW_{Config})	45 dB

For operation in non-contiguous spectrum in Band 46, the ACLR shall be higher than the value specified in Table 6.6.2.1-5.

Table 6.6.2.1-5: Base Station ACLR in non-contiguous spectrum in Band 46

Sub-block gap size (W_{gap}) where the limit applies	BS adjacent channel centre frequency offset below or above the sub-block edge (inside the gap)	Assumed adjacent channel carrier (informative)	Filter on the adjacent channel frequency and corresponding filter bandwidth	ACLR limit
$W_{\text{gap}} \geq 60$ MHz	10 MHz	20MHz E-UTRA carrier	Square (BW_{Config})	35 dB
$W_{\text{gap}} \geq 80$ MHz	30 MHz	20MHz E-UTRA carrier	Square (BW_{Config})	40 dB

6.6.2.2 Cumulative ACLR requirement in non-contiguous spectrum

The following requirement applies for the sub-block or Inter RF Bandwidth gap sizes listed in Table 6.6.2.2-1/2/2a,

- Inside a sub-block gap within an operating band for a BS operating in non-contiguous spectrum.
- Inside an Inter RF Bandwidth gap for a BS operating in multiple bands, where multiple bands are mapped on the same antenna connector.

The Cumulative Adjacent Channel Leakage power Ratio (CACLR) in a sub-block gap or the Inter RF Bandwidth gap is the ratio of:

- a) the sum of the filtered mean power centred on the assigned channel frequencies for the two carriers adjacent to each side of the sub-block gap or the Inter RF Bandwidth gap, and
- b) the filtered mean power centred on a frequency channel adjacent to one of the respective sub-block edges or Base Station RF Bandwidth edges.

The assumed filter for the adjacent channel frequency is defined in Table 6.6.2.2-1/2/2a and the filters on the assigned channels are defined in Table 6.6.2.2-3.

For Wide Area Category A BS, either the CACLR limits in Table 6.6.2.2-1/2 or the absolute limit of -13dBm/MHz shall apply, whichever is less stringent.

For Wide Area Category B BS, either the CACLR limits in Table 6.6.2.2-1/2 or the absolute limit of -15dBm/MHz shall apply, whichever is less stringent.

For Medium Range BS, either the CACLR limits in Table 6.6.2.2-1/2/2a or the absolute limit of -25 dBm/MHz shall apply, whichever is less stringent.

For Local Area BS, either the CACLR limits in Table 6.6.2.2-1/2/2a or the absolute limit of -32 dBm/MHz shall apply, whichever is less stringent.

The ACLR requirements in Tables 6.6.2.2-1 and 6.6.2.2-2 apply to BS that supports E-UTRA, in any operating band except for Band 46. The ACLR requirements for Band 46 are in Table 6.6.2.2-2a.

For operation in non-contiguous spectrum or multiple bands, the CACLR for E-UTRA carriers located on either side of the sub-block gap or the Inter RF Bandwidth gap shall be higher than the value specified in Table 6.6.2.2-1/2.

Table 6.6.2.2-1: Base Station ACLR in non-contiguous paired spectrum or multiple bands

Sub-block or Inter RF Bandwidth gap size (W_{gap}) where the limit applies	BS adjacent channel centre frequency offset below or above the sub-block edge or the Base Station RF Bandwidth edge (inside the gap)	Assumed adjacent channel carrier (informative)	Filter on the adjacent channel frequency and corresponding filter bandwidth	CACLR limit
$5 \text{ MHz} \leq W_{\text{gap}} < 15 \text{ MHz}$	2.5 MHz	3.84 Mcps UTRA	RRC (3.84 Mcps)	45 dB
$10 \text{ MHz} < W_{\text{gap}} < 20 \text{ MHz}$	7.5 MHz	3.84 Mcps UTRA	RRC (3.84 Mcps)	45 dB
NOTE: The RRC filter shall be equivalent to the transmit pulse shape filter defined in TS 25.104 [6], with a chip rate as defined in this table.				

Table 6.6.2.2-2: Base Station ACLR in non-contiguous unpaired spectrum or multiple bands

Sub-block or Inter RF Bandwidth gap size (W_{gap}) where the limit applies	BS adjacent channel centre frequency offset below or above the sub-block edge or the Base Station RF Bandwidth edge (inside the gap)	Assumed adjacent channel carrier (informative)	Filter on the adjacent channel frequency and corresponding filter bandwidth	CACLR limit
$5 \text{ MHz} \leq W_{\text{gap}} < 15 \text{ MHz}$	2.5 MHz	5MHz E-UTRA carrier	Square (BW_{Config})	45 dB
$10 \text{ MHz} < W_{\text{gap}} < 20 \text{ MHz}$	7.5 MHz	5MHz E-UTRA carrier	Square (BW_{Config})	45 dB

For operation in non-contiguous spectrum in Band 46, the CACLR for E-UTRA carriers located on either side of the sub-block gap shall be higher than the value specified in Table 6.6.2.2-2a.

Table 6.6.2.2-2a: Base Station ACLR in non-contiguous spectrum in Band 46

Sub-block gap size (W_{gap}) where the limit applies	BS adjacent channel centre frequency offset below or above the sub-block edge (inside the gap)	Assumed adjacent channel carrier (informative)	Filter on the adjacent channel frequency and corresponding filter bandwidth	CACLR limit
$20 \text{ MHz} \leq W_{\text{gap}} < 60 \text{ MHz}$	10 MHz	20MHz E-UTRA carrier	Square (BW_{Config})	35 dB
$40 \text{ MHz} < W_{\text{gap}} < 80 \text{ MHz}$	30 MHz	20MHz E-UTRA carrier	Square (BW_{Config})	35 dB

Table 6.6.2.2-3: Filter parameters for the assigned channel

RAT of the carrier adjacent to the sub-block or Inter RF Bandwidth gap	Filter on the assigned channel frequency and corresponding filter bandwidth
E-UTRA	E-UTRA of same bandwidth

6.6.3 Operating band unwanted emissions

Unless otherwise stated, the Operating band unwanted emission limits are defined from 10 MHz below the lowest frequency of each supported downlink operating band up to 10 MHz above the highest frequency of each supported downlink operating band.

The requirements shall apply whatever the type of transmitter considered (single carrier or multi-carrier) and for all transmission modes foreseen by the manufacturer's specification. In addition, for a BS operating in non-contiguous

spectrum, the requirements apply inside any sub-block gap. In addition, for a BS operating in multiple bands, the requirements apply inside any Inter RF Bandwidth gap.

For BS capable of multi-band operation where multiple bands are mapped on separate antenna connectors, the single-band requirements apply and the cumulative evaluation of the emission limit in the Inter RF Bandwidth gap are not applicable.

For a BS supporting E-UTRA with NB-IoT guard band operation, the Operating band unwanted emissions requirements apply to E-UTRA carrier with channel bandwidth larger than or equal to 5 MHz.

The unwanted emission limits in the part of the downlink operating band that falls in the spurious domain are consistent with ITU-R Recommendation SM.329 [2].

Emissions shall not exceed the maximum levels specified in the tables below, where:

- Δf is the separation between the Base Station RF Bandwidth edge frequency and the nominal -3dB point of the measuring filter closest to the carrier frequency.
- f_{offset} is the separation between the Base Station RF Bandwidth edge frequency and the centre of the measuring filter.
- $f_{\text{offset}_{\text{max}}}$ is the offset to the frequency 10 MHz outside the downlink operating band.
- Δf_{max} is equal to $f_{\text{offset}_{\text{max}}}$ minus half of the bandwidth of the measuring filter.

For E-UTRA or E-UTRA with NB-IoT (in-band and/or guard band) BS operating in multiple bands, inside any Inter RF Bandwidth gaps with $W_{\text{gap}} < 20$ MHz, emissions shall not exceed the cumulative sum of the minimum requirements specified at the Base Station RF Bandwidth edges on each side of the Inter RF Bandwidth gap. The minimum requirement for Base Station RF Bandwidth edge is specified in Tables 6.6.3.1-1 to 6.6.3.3-3 below, where in this case:

- Δf is the separation between the Base Station RF Bandwidth edge frequency and the nominal -3 dB point of the measuring filter closest to the Base Station RF Bandwidth edge.
- f_{offset} is the separation between the Base Station RF Bandwidth edge frequency and the centre of the measuring filter.
- $f_{\text{offset}_{\text{max}}}$ is equal to the Inter RF Bandwidth gap minus half of the bandwidth of the measuring filter.
- Δf_{max} is equal to $f_{\text{offset}_{\text{max}}}$ minus half of the bandwidth of the measuring filter.

For BS capable of multi-band operation where multiple bands are mapped on the same antenna connector, the operating band unwanted emission limits apply also in a supported operating band without any carrier transmitted, in the case where there are carrier(s) transmitted in other supported operating band(s). In this case where there is no carrier transmitted in an operating band, the operating band unwanted emission limit, as defined in the tables of the present clause for the largest frequency offset (Δf_{max}), of a band where there is no carrier transmitted shall apply from 10 MHz below the lowest frequency, up to 10 MHz above the highest frequency of the supported downlink operating band without any carrier transmitted. And no cumulative limit is applied in the inter-band gap between a supported downlink operating band with carrier(s) transmitted and a supported downlink operating band without any carrier transmitted.

For a multicarrier E-UTRA BS or BS configured for intra-band contiguous or non-contiguous carrier aggregation the definitions above apply to the lower edge of the carrier transmitted at the lowest carrier frequency and the upper edge of the carrier transmitted at the highest carrier frequency within a specified frequency band.

In addition inside any sub-block gap for a BS operating in non-contiguous spectrum, emissions shall not exceed the cumulative sum of the minimum requirements specified for the adjacent sub blocks on each side of the sub block gap. The minimum requirement for each sub block is specified in Tables 6.6.3.1-1 to 6.6.3.3-3 below, where in this case:

- Δf is the separation between the sub block edge frequency and the nominal -3 dB point of the measuring filter closest to the sub block edge.
- f_{offset} is the separation between the sub block edge frequency and the centre of the measuring filter.
- $f_{\text{offset}_{\text{max}}}$ is equal to the sub block gap bandwidth minus half of the bandwidth of the measuring filter.
- Δf_{max} is equal to $f_{\text{offset}_{\text{max}}}$ minus half of the bandwidth of the measuring filter.

For Wide Area BS, the requirements of either clause 6.6.3.1 (Category A limits) or clause 6.6.3.2 (Category B limits) shall apply.

For Local Area BS, the requirements of clause 6.6.3.2A shall apply (Category A and B).

For Home BS, the requirements of clause 6.6.3.2B shall apply (Category A and B).

For Medium Range BS, the requirements in clause 6.6.3.2C shall apply (Category A and B).

The application of either Category A or Category B limits shall be the same as for Transmitter spurious emissions (Mandatory Requirements) in clause 6.6.4.1.

The requirements of clauses 6.6.3.1 and 6.6.3.2 apply to Wide Area BS that supports E-UTRA or E-UTRA with NB-IoT (in-band and/or guard band). The requirements for Wide Area BS that supports NB-IoT standalone are in clause 6.6.3.2E.

The requirements of clauses 6.6.3.2A apply to Local Area BS that supports E-UTRA or E-UTRA with NB-IoT (in-band and/or guard band). The requirements for Local Area BS that supports NB-IoT standalone are in clause 6.6.3.2F.

The requirements of clauses 6.6.3.2B apply to Home BS that supports E-UTRA or E-UTRA with NB-IoT (in-band and/or guard band). The requirements for Home BS that supports NB-IoT standalone are in clause 6.6.3.2G.

The requirements of clauses 6.6.3.2C apply to Medium Range BS that supports E-UTRA or E-UTRA with NB-IoT (in-band and/or guard band). The requirements for Medium Range BS that supports NB-IoT standalone are in clause 6.6.3.2H.

6.6.3.1 Minimum requirements for Wide Area BS (Category A)

For E-UTRA BS operating in Bands 5, 6, 8, 12, 13, 14, 17, 18, 19, 26, 27, 28, 29, 31, 44, 68, 71, 72, 73, 85, 87, 88 emissions shall not exceed the maximum levels specified in Tables 6.6.3.1-1 to 6.6.3.1-3.

Table 6.6.3.1-1: Wide Area BS operating band unwanted emission limits for 1.4 MHz channel bandwidth (E-UTRA bands <1GHz) for Category A

Frequency offset of measurement filter -3dB point, Δf	Frequency offset of measurement filter centre frequency, f_{offset}	Minimum requirement (Note 1, 2)	Measurement bandwidth (Note 8)
$0 \text{ MHz} \leq \Delta f < 1.4 \text{ MHz}$	$0.05 \text{ MHz} \leq f_{\text{offset}} < 1.45 \text{ MHz}$	$-1 \text{ dBm} - \frac{10}{1.4} \cdot \left(\frac{f_{\text{offset}}}{\text{MHz}} - 0.05 \right) \text{ dB}$	100 kHz
$1.4 \text{ MHz} \leq \Delta f < 2.8 \text{ MHz}$	$1.45 \text{ MHz} \leq f_{\text{offset}} < 2.85 \text{ MHz}$	-11 dBm	100 kHz
$2.8 \text{ MHz} \leq \Delta f \leq \Delta f_{\text{max}}$	$2.85 \text{ MHz} \leq f_{\text{offset}} < f_{\text{offset}_{\text{max}}}$	-13 dBm	100 kHz
<p>NOTE 1: For a BS supporting non-contiguous spectrum operation within any operating band, the minimum requirement within sub-block gaps is calculated as a cumulative sum of contributions from adjacent sub blocks on each side of the sub block gap. Exception is $\Delta f \geq 10 \text{ MHz}$ from both adjacent sub blocks on each side of the sub-block gap, where the minimum requirement within sub-block gaps shall be -13dBm/100kHz.</p> <p>NOTE 2: For BS supporting multi-band operation with Inter RF Bandwidth gap < 20MHz the minimum requirement within the Inter RF Bandwidth gaps is calculated as a cumulative sum of contributions from adjacent sub-blocks or RF Bandwidth on each side of the Inter RF Bandwidth gap.</p>			

Table 6.6.3.1-2: Wide Area BS operating band unwanted emission limits for 3 MHz channel bandwidth (E-UTRA bands <1GHz) for Category A

Frequency offset of measurement filter -3dB point, Δf	Frequency offset of measurement filter centre frequency, f_{offset}	Minimum requirement (Note 1, 2)	Measurement bandwidth (Note 8)
$0 \text{ MHz} \leq \Delta f < 3 \text{ MHz}$	$0.05 \text{ MHz} \leq f_{\text{offset}} < 3.05 \text{ MHz}$	$-5 \text{ dBm} - \frac{10}{3} \cdot \left(\frac{f_{\text{offset}}}{\text{MHz}} - 0.05 \right) \text{ dB}$	100 kHz
$3 \text{ MHz} \leq \Delta f < 6 \text{ MHz}$	$3.05 \text{ MHz} \leq f_{\text{offset}} < 6.05 \text{ MHz}$	-15 dBm	100 kHz
$6 \text{ MHz} \leq \Delta f \leq \Delta f_{\text{max}}$	$6.05 \text{ MHz} \leq f_{\text{offset}} < f_{\text{offset}_{\text{max}}}$	-13 dBm	100 kHz
<p>NOTE 1: For a BS supporting non-contiguous spectrum operation within any operating band, the minimum requirement within sub-block gaps is calculated as a cumulative sum of contributions from adjacent sub blocks on each side of the sub block gap. Exception is $\Delta f \geq 10 \text{ MHz}$ from both adjacent sub blocks on each side of the sub-block gap, where the minimum requirement within sub-block gaps shall be -13dBm/100kHz.</p> <p>NOTE 2: For BS supporting multi-band operation with Inter RF Bandwidth gap < 20MHz the minimum requirement within the Inter RF Bandwidth gaps is calculated as a cumulative sum of contributions from adjacent sub-blocks or RF Bandwidth on each side of the Inter RF Bandwidth gap.</p>			

Table 6.6.3.1-3: Wide Area BS operating band unwanted emission limits for 5, 10, 15 and 20 MHz channel bandwidth (E-UTRA bands <1GHz) for Category A

Frequency offset of measurement filter -3dB point, Δf	Frequency offset of measurement filter centre frequency, f_{offset}	Minimum requirement (Note 1, 2)	Measurement bandwidth (Note 8)
$0 \text{ MHz} \leq \Delta f < 5 \text{ MHz}$	$0.05 \text{ MHz} \leq f_{\text{offset}} < 5.05 \text{ MHz}$	$-7 \text{ dBm} - \frac{7}{5} \cdot \left(\frac{f_{\text{offset}}}{\text{MHz}} - 0.05 \right) \text{ dB}$	100 kHz
$5 \text{ MHz} \leq \Delta f < \min(10 \text{ MHz}, \Delta f_{\text{max}})$	$5.05 \text{ MHz} \leq f_{\text{offset}} < \min(10.05 \text{ MHz}, f_{\text{offset}_{\text{max}}})$	-14 dBm	100 kHz
$10 \text{ MHz} \leq \Delta f \leq \Delta f_{\text{max}}$	$10.05 \text{ MHz} \leq f_{\text{offset}} < f_{\text{offset}_{\text{max}}}$	-13 dBm (Note 10)	100 kHz
<p>NOTE 1: For a BS supporting non-contiguous spectrum operation within any operating band, the minimum requirement within sub-block gaps is calculated as a cumulative sum of contributions from adjacent sub blocks on each side of the sub block gap. Exception is $\Delta f \geq 10 \text{ MHz}$ from both adjacent sub blocks on each side of the sub-block gap, where the minimum requirement within sub-block gaps shall be -13dBm/100kHz.</p> <p>NOTE 2: For BS supporting multi-band operation with Inter RF Bandwidth gap < 20MHz the minimum requirement within the Inter RF Bandwidth gaps is calculated as a cumulative sum of contributions from adjacent sub-blocks or RF Bandwidth on each side of the Inter RF Bandwidth gap.</p>			

For E-UTRA BS operating in Bands 1, 2, 3, 4, 7, 9, 10, 11, 21, 22, 23, 24, 25, 30, 32, 33, 34, 35, 36, 37, 38, 39, 40, 41, 42, 43, 45, 48, 50, 52, 65, 66, 69, 70, 74, 75 emissions shall not exceed the maximum levels specified in Tables 6.6.3.1-4 to 6.6.3.1-6:

Table 6.6.3.1-4: Wide Area BS operating band unwanted emission limits for 1.4 MHz channel bandwidth (E-UTRA bands >1GHz) for Category A

Frequency offset of measurement filter -3dB point, Δf	Frequency offset of measurement filter centre frequency, f_{offset}	Minimum requirement (Note 1, 2)	Measurement bandwidth (Note 8)
$0 \text{ MHz} \leq \Delta f < 1.4 \text{ MHz}$	$0.05 \text{ MHz} \leq f_{\text{offset}} < 1.45 \text{ MHz}$	$-1 \text{ dBm} - \frac{10}{1.4} \cdot \left(\frac{f_{\text{offset}}}{\text{MHz}} - 0.05 \right) \text{ dB}$	100 kHz
$1.4 \text{ MHz} \leq \Delta f < 2.8 \text{ MHz}$	$1.45 \text{ MHz} \leq f_{\text{offset}} < 2.85 \text{ MHz}$	-11 dBm	100 kHz
$2.8 \text{ MHz} \leq \Delta f \leq \Delta f_{\text{max}}$	$3.3 \text{ MHz} \leq f_{\text{offset}} < f_{\text{offset}_{\text{max}}}$	-13 dBm	1MHz
<p>NOTE 1: For a BS supporting non-contiguous spectrum operation within any operating band, the minimum requirement within sub-block gaps is calculated as a cumulative sum of contributions from adjacent sub blocks on each side of the sub block gap, where the contribution from the far-end sub-block shall be scaled according to the measurement bandwidth of the near-end sub-block. Exception is $\Delta f \geq 10\text{MHz}$ from both adjacent sub blocks on each side of the sub-block gap, where the minimum requirement within sub-block gaps shall be -13dBm/1MHz.</p> <p>NOTE 2: For BS supporting multi-band operation with Inter RF Bandwidth gap < 20MHz the minimum requirement within the Inter RF Bandwidth gaps is calculated as a cumulative sum of contributions from adjacent sub-blocks or RF Bandwidth on each side of the Inter RF Bandwidth gap, where the contribution from the far-end sub-block or RF Bandwidth shall be scaled according to the measurement bandwidth of the near-end sub-block or RF Bandwidth.</p>			

Table 6.6.3.1-5: Wide Area BS operating band unwanted emission limits for 3 MHz channel bandwidth (E-UTRA bands >1GHz) for Category A

Frequency offset of measurement filter -3dB point, Δf	Frequency offset of measurement filter centre frequency, f_{offset}	Minimum requirement (Note 1, 2)	Measurement bandwidth (Note 8)
$0 \text{ MHz} \leq \Delta f < 3 \text{ MHz}$	$0.05 \text{ MHz} \leq f_{\text{offset}} < 3.05 \text{ MHz}$	$-5 \text{ dBm} - \frac{10}{3} \cdot \left(\frac{f_{\text{offset}}}{\text{MHz}} - 0.05 \right) \text{ dB}$	100 kHz
$3 \text{ MHz} \leq \Delta f < 6 \text{ MHz}$	$3.05 \text{ MHz} \leq f_{\text{offset}} < 6.05 \text{ MHz}$	-15 dBm	100 kHz
$6 \text{ MHz} \leq \Delta f \leq \Delta f_{\text{max}}$	$6.5 \text{ MHz} \leq f_{\text{offset}} < f_{\text{offset}_{\text{max}}}$	-13 dBm	1MHz
<p>NOTE 1: For a BS supporting non-contiguous spectrum operation within any operating band, the minimum requirement within sub-block gaps is calculated as a cumulative sum of contributions from adjacent sub blocks on each side of the sub block gap, where the contribution from the far-end sub-block shall be scaled according to the measurement bandwidth of the near-end sub-block. Exception is $\Delta f \geq 10\text{MHz}$ from both adjacent sub blocks on each side of the sub-block gap, where the minimum requirement within sub-block gaps shall be -13dBm/1MHz.</p> <p>NOTE 2: For BS supporting multi-band operation with Inter RF Bandwidth gap < 20MHz the minimum requirement within the Inter RF Bandwidth gaps is calculated as a cumulative sum of contributions from adjacent sub-blocks or RF Bandwidth on each side of the Inter RF Bandwidth gap, where the contribution from the far-end sub-block or RF Bandwidth shall be scaled according to the measurement bandwidth of the near-end sub-block or RF Bandwidth.</p>			

Table 6.6.3.1-6: Wide Area BS operating band unwanted emission limits for 5, 10, 15 and 20 MHz channel bandwidth (E-UTRA bands >1GHz) for Category A

Frequency offset of measurement filter -3dB point, Δf	Frequency offset of measurement filter centre frequency, f_{offset}	Minimum requirement (Note 1, 2)	Measurement bandwidth (Note 8)
$0 \text{ MHz} \leq \Delta f < 5 \text{ MHz}$	$0.05 \text{ MHz} \leq f_{\text{offset}} < 5.05 \text{ MHz}$	$-7 \text{ dBm} - \frac{7}{5} \cdot \left(\frac{f_{\text{offset}}}{\text{MHz}} - 0.05 \right) \text{ dB}$	100 kHz
$5 \text{ MHz} \leq \Delta f < \min(10 \text{ MHz}, \Delta f_{\text{max}})$	$5.05 \text{ MHz} \leq f_{\text{offset}} < \min(10.05 \text{ MHz}, f_{\text{offset}_{\text{max}}})$	-14 dBm	100 kHz
$10 \text{ MHz} \leq \Delta f \leq \Delta f_{\text{max}}$	$10.5 \text{ MHz} \leq f_{\text{offset}} < f_{\text{offset}_{\text{max}}}$	-13 dBm (Note 10)	1MHz
<p>NOTE 1: For a BS supporting non-contiguous spectrum operation within any operating band, the minimum requirement within sub-block gaps is calculated as a cumulative sum of contributions from adjacent sub blocks on each side of the sub block gap, where the contribution from the far-end sub-block shall be scaled according to the measurement bandwidth of the near-end sub-block. Exception is $\Delta f \geq 10\text{MHz}$ from both adjacent sub blocks on each side of the sub-block gap, where the minimum requirement within sub-block gaps shall be -13dBm/1MHz.</p> <p>NOTE 2: For BS supporting multi-band operation with Inter RF Bandwidth gap < 20MHz the minimum requirement within the Inter RF Bandwidth gaps is calculated as a cumulative sum of contributions from adjacent sub-blocks or RF Bandwidth on each side of the Inter RF Bandwidth gap, where the contribution from the far-end sub-block or RF Bandwidth shall be scaled according to the measurement bandwidth of the near-end sub-block or RF Bandwidth.</p>			

6.6.3.2 Minimum requirements for Wide Area BS (Category B)

For Category B Operating band unwanted emissions, there are two options for the limits that may be applied regionally. Either the limits in clause 6.6.3.2.1 or clause 6.6.3.2.2 shall be applied.

6.6.3.2.1 Category B requirements (Option 1)

For E-UTRA BS operating in Bands 5, 8, 12, 13, 14, 17, 20, 26, 27, 28, 29, 31, 44, 68, 67, 71, 72, 73, 85, 87, 88 emissions shall not exceed the maximum levels specified in Tables 6.6.3.2.1-1 to 6.6.3.2.1-3:

Table 6.6.3.2.1-1: Wide Area BS operating band unwanted emission limits for 1.4 MHz channel bandwidth (E-UTRA bands <1GHz) for Category B

Frequency offset of measurement filter -3dB point, Δf	Frequency offset of measurement filter centre frequency, f_{offset}	Minimum requirement (Note 1, 2)	Measurement bandwidth (Note 8)
$0 \text{ MHz} \leq \Delta f < 1.4 \text{ MHz}$	$0.05 \text{ MHz} \leq f_{\text{offset}} < 1.45 \text{ MHz}$	$-1 \text{ dBm} - \frac{10}{1.4} \cdot \left(\frac{f_{\text{offset}}}{\text{MHz}} - 0.05 \right) \text{ dB}$	100 kHz
$1.4 \text{ MHz} \leq \Delta f < 2.8 \text{ MHz}$	$1.45 \text{ MHz} \leq f_{\text{offset}} < 2.85 \text{ MHz}$	-11 dBm	100 kHz
$2.8 \text{ MHz} \leq \Delta f \leq \Delta f_{\text{max}}$	$2.85 \text{ MHz} \leq f_{\text{offset}} < f_{\text{offset}_{\text{max}}}$	-16 dBm	100 kHz
<p>NOTE 1: For a BS supporting non-contiguous spectrum operation within any operating band, the minimum requirement within sub-block gaps is calculated as a cumulative sum of contributions from adjacent sub blocks on each side of the sub block gap. Exception is $\Delta f \geq 10\text{MHz}$ from both adjacent sub blocks on each side of the sub-block gap, where the minimum requirement within sub-block gaps shall be -16dBm/100kHz.</p> <p>NOTE 2: For BS supporting multi-band operation with Inter RF Bandwidth gap < 20MHz the minimum requirement within the Inter RF Bandwidth gaps is calculated as a cumulative sum of contributions from adjacent sub-blocks or RF Bandwidth on each side of the Inter RF Bandwidth gap.</p>			

Table 6.6.3.2.1-2: Wide Area BS operating band unwanted emission limits for 3 MHz channel bandwidth (E-UTRA bands <1GHz) for Category B

Frequency offset of measurement filter -3dB point, Δf	Frequency offset of measurement filter centre frequency, f_{offset}	Minimum requirement (Note 1, 2)	Measurement bandwidth (Note 8)
$0 \text{ MHz} \leq \Delta f < 3 \text{ MHz}$	$0.05 \text{ MHz} \leq f_{\text{offset}} < 3.05 \text{ MHz}$	$-5 \text{ dBm} - \frac{10}{3} \cdot \left(\frac{f_{\text{offset}}}{\text{MHz}} - 0.05 \right) \text{ dB}$	100 kHz
$3 \text{ MHz} \leq \Delta f < 6 \text{ MHz}$	$3.05 \text{ MHz} \leq f_{\text{offset}} < 6.05 \text{ MHz}$	-15 dBm	100 kHz
$6 \text{ MHz} \leq \Delta f \leq \Delta f_{\text{max}}$	$6.05 \text{ MHz} \leq f_{\text{offset}} < f_{\text{offset}_{\text{max}}}$	-16 dBm	100 kHz
<p>NOTE 1: For a BS supporting non-contiguous spectrum operation within any operating band, the minimum requirement within sub-block gaps is calculated as a cumulative sum of contributions from adjacent sub blocks on each side of the sub block gap. Exception is $\Delta f \geq 10 \text{ MHz}$ from both adjacent sub blocks on each side of the sub-block gap, where the minimum requirement within sub-block gaps shall be -16dBm/100kHz.</p> <p>NOTE 2: For BS supporting multi-band operation with Inter RF Bandwidth gap < 20MHz the minimum requirement within the Inter RF Bandwidth gaps is calculated as a cumulative sum of contributions from adjacent sub-blocks or RF Bandwidth on each side of the Inter RF Bandwidth gap.</p>			

Table 6.6.3.2.1-3: Wide Area BS operating band unwanted emission limits for 5, 10, 15 and 20 MHz channel bandwidth (E-UTRA bands <1GHz) for Category B

Frequency offset of measurement filter -3dB point, Δf	Frequency offset of measurement filter centre frequency, f_{offset}	Minimum requirement (Note 1, 2)	Measurement bandwidth (Note 8)
$0 \text{ MHz} \leq \Delta f < 5 \text{ MHz}$	$0.05 \text{ MHz} \leq f_{\text{offset}} < 5.05 \text{ MHz}$	$-7 \text{ dBm} - \frac{7}{5} \cdot \left(\frac{f_{\text{offset}}}{\text{MHz}} - 0.05 \right) \text{ dB}$	100 kHz
$5 \text{ MHz} \leq \Delta f < \min(10 \text{ MHz}, \Delta f_{\text{max}})$	$5.05 \text{ MHz} \leq f_{\text{offset}} < \min(10.05 \text{ MHz}, f_{\text{offset}_{\text{max}}})$	-14 dBm	100 kHz
$10 \text{ MHz} \leq \Delta f \leq \Delta f_{\text{max}}$	$10.05 \text{ MHz} \leq f_{\text{offset}} < f_{\text{offset}_{\text{max}}}$	-16 dBm (Note 10)	100 kHz
<p>NOTE 1: For a BS supporting non-contiguous spectrum operation within any operating band, the minimum requirement within sub-block gaps is calculated as a cumulative sum of contributions from adjacent sub blocks on each side of the sub block gap. Exception is $\Delta f \geq 10 \text{ MHz}$ from both adjacent sub blocks on each side of the sub-block gap, where the minimum requirement within sub-block gaps shall be -16dBm/100kHz.</p> <p>NOTE 2: For BS supporting multi-band operation with Inter RF Bandwidth gap < 20MHz the minimum requirement within the Inter RF Bandwidth gaps is calculated as a cumulative sum of contributions from adjacent sub-blocks or RF Bandwidth on each side of the Inter RF Bandwidth gap.</p>			

For E-UTRA BS operating in Bands 1, 2, 3, 4, 7, 10, 22, 25, 30, 33, 34, 35, 36, 37, 38, 39, 40, 41, 42, 43, 45, 48, 50, 52, 65, 66, 69, 70, 75 emissions shall not exceed the maximum levels specified in Tables 6.6.3.2.1-4 to 6.6.3.2.1-6:

Table 6.6.3.2.1-4: Wide Area BS operating band unwanted emission limits for 1.4 MHz channel bandwidth (E-UTRA bands >1GHz) for Category B

Frequency offset of measurement filter -3dB point, Δf	Frequency offset of measurement filter centre frequency, f_{offset}	Minimum requirement (Note 1, 2)	Measurement bandwidth (Note 8)
$0 \text{ MHz} \leq \Delta f < 1.4 \text{ MHz}$	$0.05 \text{ MHz} \leq f_{\text{offset}} < 1.45 \text{ MHz}$	$-1 \text{ dBm} - \frac{10}{1.4} \cdot \left(\frac{f_{\text{offset}}}{\text{MHz}} - 0.05 \right) \text{ dB}$	100 kHz
$1.4 \text{ MHz} \leq \Delta f < 2.8 \text{ MHz}$	$1.45 \text{ MHz} \leq f_{\text{offset}} < 2.85 \text{ MHz}$	-11 dBm	100 kHz
$2.8 \text{ MHz} \leq \Delta f \leq \Delta f_{\text{max}}$	$3.3 \text{ MHz} \leq f_{\text{offset}} < f_{\text{offset}_{\text{max}}}$	-15 dBm	1MHz
<p>NOTE 1: For a BS supporting non-contiguous spectrum operation within any operating band, the minimum requirement within sub-block gaps is calculated as a cumulative sum of contributions from adjacent sub blocks on each side of the sub block gap, where the contribution from the far-end sub-block shall be scaled according to the measurement bandwidth of the near-end sub-block. Exception is $\Delta f \geq 10\text{MHz}$ from both adjacent sub blocks on each side of the sub-block gap, where the minimum requirement within sub-block gaps shall be -15dBm/1MHz.</p> <p>NOTE 2: For BS supporting multi-band operation with Inter RF Bandwidth gap < 20MHz the minimum requirement within the Inter RF Bandwidth gaps is calculated as a cumulative sum of contributions from adjacent sub-blocks or RF Bandwidth on each side of the Inter RF Bandwidth gap, where the contribution from the far-end sub-block or RF Bandwidth shall be scaled according to the measurement bandwidth of the near-end sub-block or RF Bandwidth.</p>			

Table 6.6.3.2.1-5: Wide Area BS operating band unwanted emission limits for 3 MHz channel bandwidth (E-UTRA bands >1GHz) for Category B

Frequency offset of measurement filter -3dB point, Δf	Frequency offset of measurement filter centre frequency, f_{offset}	Minimum requirement (Note 1, 2)	Measurement bandwidth (Note 8)
$0 \text{ MHz} \leq \Delta f < 3 \text{ MHz}$	$0.05 \text{ MHz} \leq f_{\text{offset}} < 3.05 \text{ MHz}$	$-5 \text{ dBm} - \frac{10}{3} \cdot \left(\frac{f_{\text{offset}}}{\text{MHz}} - 0.05 \right) \text{ dB}$	100 kHz
$3 \text{ MHz} \leq \Delta f < 6 \text{ MHz}$	$3.05 \text{ MHz} \leq f_{\text{offset}} < 6.05 \text{ MHz}$	-15 dBm	100 kHz
$6 \text{ MHz} \leq \Delta f \leq \Delta f_{\text{max}}$	$6.5 \text{ MHz} \leq f_{\text{offset}} < f_{\text{offset}_{\text{max}}}$	-15 dBm	1MHz
<p>NOTE 1: For a BS supporting non-contiguous spectrum operation within any operating band, the minimum requirement within sub-block gaps is calculated as a cumulative sum of contributions from adjacent sub blocks on each side of the sub block gap, where the contribution from the far-end sub-block shall be scaled according to the measurement bandwidth of the near-end sub-block. Exception is $\Delta f \geq 10\text{MHz}$ from both adjacent sub blocks on each side of the sub-block gap, where the minimum requirement within sub-block gaps shall be -15dBm/1MHz.</p> <p>NOTE 2: For BS supporting multi-band operation with Inter RF Bandwidth gap < 20MHz the minimum requirement within the Inter RF Bandwidth gaps is calculated as a cumulative sum of contributions from adjacent sub-blocks or RF Bandwidth on each side of the Inter RF Bandwidth gap, where the contribution from the far-end sub-block or RF Bandwidth shall be scaled according to the measurement bandwidth of the near-end sub-block or RF Bandwidth.</p>			

Table 6.6.3.2.1-6: Wide Area BS operating band unwanted emission limits for 5, 10, 15 and 20 MHz channel bandwidth (E-UTRA bands >1GHz) for Category B

Frequency offset of measurement filter -3dB point, Δf	Frequency offset of measurement filter centre frequency, f_{offset}	Minimum requirement (Note 1, 2)	Measurement bandwidth (Note 8)
$0 \text{ MHz} \leq \Delta f < 5 \text{ MHz}$	$0.05 \text{ MHz} \leq f_{\text{offset}} < 5.05 \text{ MHz}$	$-7 \text{ dBm} - \frac{7}{5} \cdot \left(\frac{f_{\text{offset}}}{\text{MHz}} - 0.05 \right) \text{ dB}$	100 kHz
$5 \text{ MHz} \leq \Delta f < \min(10 \text{ MHz}, \Delta f_{\text{max}})$	$5.05 \text{ MHz} \leq f_{\text{offset}} < \min(10.05 \text{ MHz}, f_{\text{offset}_{\text{max}}})$	-14 dBm	100 kHz
$10 \text{ MHz} \leq \Delta f \leq \Delta f_{\text{max}}$	$10.5 \text{ MHz} \leq f_{\text{offset}} < f_{\text{offset}_{\text{max}}}$	-15 dBm (Note 10)	1MHz
<p>NOTE 1: For a BS supporting non-contiguous spectrum operation within any operating band, the minimum requirement within sub-block gaps is calculated as a cumulative sum of contributions from adjacent sub blocks on each side of the sub block gap, where the contribution from the far-end sub-block shall be scaled according to the measurement bandwidth of the near-end sub-block. Exception is $\Delta f \geq 10\text{MHz}$ from both adjacent sub blocks on each side of the sub-block gap, where the minimum requirement within sub-block gaps shall be -15dBm/1MHz.</p> <p>NOTE 2: For BS supporting multi-band operation with Inter RF Bandwidth gap < 20MHz the minimum requirement within the Inter RF Bandwidth gaps is calculated as a cumulative sum of contributions from adjacent sub-blocks or RF Bandwidth on each side of the Inter RF Bandwidth gap, where the contribution from the far-end sub-block or RF Bandwidth shall be scaled according to the measurement bandwidth of the near-end sub-block or RF Bandwidth.</p>			

6.6.3.2.2 Category B (Option 2)

The limits in this clause are intended for Europe and may be applied regionally for BS operating in band 1, 3, 7, 8, 32, 33, 34, 38, 65 or 69.

For a BS operating in band 1, 3, 7, 8, 32, 33, 34, 38, 65 or 69 emissions shall not exceed the maximum levels specified in Table 6.6.3.2.2-1 below for 5, 10, 15 and 20 MHz channel bandwidth:

Table 6.6.3.2.2-1: Regional Wide Area BS operating band unwanted emission limits in band 1, 3, 7, 8, 32, 33, 34, 38, 65 or 69 for 5, 10, 15 and 20 MHz channel bandwidth for Category B

Frequency offset of measurement filter -3dB point, Δf	Frequency offset of measurement filter centre frequency, f_{offset}	Minimum requirement (Note 1, 2)	Measurement bandwidth (Note 8)
$0 \text{ MHz} \leq \Delta f < 0.2 \text{ MHz}$	$0.015 \text{ MHz} \leq f_{\text{offset}} < 0.215 \text{ MHz}$	-14 dBm	30 kHz
$0.2 \text{ MHz} \leq \Delta f < 1 \text{ MHz}$	$0.215 \text{ MHz} \leq f_{\text{offset}} < 1.015 \text{ MHz}$	$-14 \text{ dBm} - 15 \cdot \left(\frac{f_{\text{offset}}}{\text{MHz}} - 0.215 \right) \text{ dB}$ (Note 3)	30 kHz
(Note 9)	$1.015 \text{ MHz} \leq f_{\text{offset}} < 1.5 \text{ MHz}$	-26 dBm (Note 3)	30 kHz
$1 \text{ MHz} \leq \Delta f \leq \min(10 \text{ MHz}, \Delta f_{\text{max}})$	$1.5 \text{ MHz} \leq f_{\text{offset}} < \min(10.5 \text{ MHz}, f_{\text{offset}_{\text{max}}})$	-13 dBm (Note 3)	1 MHz
$10 \text{ MHz} \leq \Delta f \leq \Delta f_{\text{max}}$	$10.5 \text{ MHz} \leq f_{\text{offset}} < f_{\text{offset}_{\text{max}}}$	-15 dBm (Note 3) (Note 10)	1 MHz
<p>NOTE 1: For a BS supporting non-contiguous spectrum operation within any operating band, the minimum requirement within sub-block gaps is calculated as a cumulative sum of contributions from adjacent sub blocks on each side of the sub block gap, where the contribution from the far-end sub-block shall be scaled according to the measurement bandwidth of the near-end sub-block. Exception is $\Delta f \geq 10 \text{ MHz}$ from both adjacent sub blocks on each side of the sub-block gap, where the minimum requirement within sub-block gaps shall be -15dBm/1MHz. For BS supporting multi-band operation, either this limit or -16dBm/100kHz (f_{offset} adjusted according to the measurement bandwidth), whichever is less stringent, shall apply at $\Delta f \geq 10 \text{ MHz}$ for operating bands <1GHz.</p> <p>NOTE 2: For BS supporting multi-band operation with Inter RF Bandwidth gap < 20MHz the minimum requirement within the Inter RF Bandwidth gaps is calculated as a cumulative sum of contributions from adjacent sub-blocks or RF Bandwidth on each side of the Inter RF Bandwidth gap, where the contribution from the far-end sub-block or RF Bandwidth shall be scaled according to the measurement bandwidth of the near-end sub-block or RF Bandwidth.</p> <p>NOTE 3: For BS supporting multi-band operation, either this limit or -16dBm/100kHz (f_{offset} adjusted according to the measurement bandwidth), whichever is less stringent, shall apply for operating bands <1GHz.</p>			

For a BS operating in band 3, 8 or 65, emissions shall not exceed the maximum levels specified in Table 6.6.3.2.2-2 below for 3 MHz channel bandwidth:

Table 6.6.3.2.2-2: Regional Wide Area BS operating band unwanted emission limits in band 3, 8 or 65 for 3 MHz channel bandwidth for Category B

Frequency offset of measurement filter -3dB point, Δf	Frequency offset of measurement filter centre frequency, f_{offset}	Minimum requirement (Note 1, 2)	Measurement bandwidth (Note 8)
$0 \text{ MHz} \leq \Delta f < 0.05 \text{ MHz}$	$0.015 \text{ MHz} \leq f_{\text{offset}} < 0.065 \text{ MHz}$	$5\text{dBm} - 60 \cdot \left(\frac{f_{\text{offset}}}{\text{MHz}} - 0.015 \right) \text{dB}$	30 kHz
$0.05 \text{ MHz} \leq \Delta f < 0.15 \text{ MHz}$	$0.065 \text{ MHz} \leq f_{\text{offset}} < 0.165 \text{ MHz}$	$2\text{dBm} - 160 \cdot \left(\frac{f_{\text{offset}}}{\text{MHz}} - 0.065 \right) \text{dB}$	30 kHz
$0.15 \text{ MHz} \leq \Delta f < 0.2 \text{ MHz}$	$0.165\text{MHz} \leq f_{\text{offset}} < 0.215\text{MHz}$	-14 dBm	30 kHz
$0.2 \text{ MHz} \leq \Delta f < 1 \text{ MHz}$	$0.215\text{MHz} \leq f_{\text{offset}} < 1.015\text{MHz}$	$-14\text{dBm} - 15 \cdot \left(\frac{f_{\text{offset}}}{\text{MHz}} - 0.215 \right)$ (Note 3)	30 kHz
(Note 9)	$1.015\text{MHz} \leq f_{\text{offset}} < 1.5 \text{ MHz}$	-26 dBm (Note 3)	30 kHz
$1 \text{ MHz} \leq \Delta f \leq 6 \text{ MHz}$	$1.5 \text{ MHz} \leq f_{\text{offset}} < 6.5 \text{ MHz}$	-13 dBm (Note 3)	1 MHz
$6 \text{ MHz} \leq \Delta f \leq \Delta f_{\text{max}}$	$6.5 \text{ MHz} \leq f_{\text{offset}} < f_{\text{offset}_{\text{max}}}$	-15 dBm (Note 3)	1 MHz
<p>NOTE 1: For a BS supporting non-contiguous spectrum operation within any operating band, the minimum requirement within sub-block gaps is calculated as a cumulative sum of contributions from adjacent sub blocks on each side of the sub block gap, where the contribution from the far-end sub-block shall be scaled according to the measurement bandwidth of the near-end sub-block. Exception is $\Delta f \geq 10\text{MHz}$ from both adjacent sub blocks on each side of the sub-block gap, where the minimum requirement within sub-block gaps shall be -15dBm/1MHz. For BS supporting multi-band operation, either this limit or -16dBm/100kHz (f_{offset} adjusted according to the measurement bandwidth), whichever is less stringent, shall apply at $\Delta f \geq 10\text{MHz}$ for operating bands <1GHz.</p> <p>NOTE 2: For BS supporting multi-band operation with Inter RF Bandwidth gap < 20MHz the minimum requirement within the Inter RF Bandwidth gaps is calculated as a cumulative sum of contributions from adjacent sub-blocks or RF Bandwidth on each side of the Inter RF Bandwidth gap, where the contribution from the far-end sub-block or RF Bandwidth shall be scaled according to the measurement bandwidth of the near-end sub-block or RF Bandwidth.</p> <p>NOTE 3: For BS supporting multi-band operation, either this limit or -16dBm/100kHz (f_{offset} adjusted according to the measurement bandwidth), whichever is less stringent, shall apply for operating bands <1GHz.</p>			

For a BS operating in band 3, 8 or 65, emissions shall not exceed the maximum levels specified in Table 6.6.3.2.2-3 below for 1.4 MHz channel bandwidth:

Table 6.6.3.2.2-3: Regional Wide Area BS operating band unwanted emission limits in band 3, 8 or 65 for 1.4 MHz channel bandwidth for Category B

Frequency offset of measurement filter -3dB point, Δf	Frequency offset of measurement filter centre frequency, f_{offset}	Minimum requirement (Note 1, 2)	Measurement bandwidth (Note 8)
$0 \text{ MHz} \leq \Delta f < 0.05 \text{ MHz}$	$0.015 \text{ MHz} \leq f_{\text{offset}} < 0.065 \text{ MHz}$	$5\text{dBm} - 60 \cdot \left(\frac{f_{\text{offset}}}{\text{MHz}} - 0.015 \right) \text{dB}$	30 kHz
$0.05 \text{ MHz} \leq \Delta f < 0.15 \text{ MHz}$	$0.065 \text{ MHz} \leq f_{\text{offset}} < 0.165 \text{ MHz}$	$2\text{dBm} - 160 \cdot \left(\frac{f_{\text{offset}}}{\text{MHz}} - 0.065 \right) \text{dB}$	30 kHz
$0.15 \text{ MHz} \leq \Delta f < 0.2 \text{ MHz}$	$0.165\text{MHz} \leq f_{\text{offset}} < 0.215\text{MHz}$	-14 dBm	30 kHz
$0.2 \text{ MHz} \leq \Delta f < 1 \text{ MHz}$	$0.215\text{MHz} \leq f_{\text{offset}} < 1.015\text{MHz}$	$-14\text{dBm} - 15 \cdot \left(\frac{f_{\text{offset}}}{\text{MHz}} - 0.215 \right) \text{dB}$ (Note 3)	30 kHz
(Note 9)	$1.015\text{MHz} \leq f_{\text{offset}} < 1.5 \text{ MHz}$	-26 dBm (Note 3)	30 kHz
$1 \text{ MHz} \leq \Delta f \leq 2.8 \text{ MHz}$	$1.5 \text{ MHz} \leq f_{\text{offset}} < 3.3 \text{ MHz}$	-13 dBm (Note 3)	1 MHz
$2.8 \text{ MHz} \leq \Delta f \leq \Delta f_{\text{max}}$	$3.3 \text{ MHz} \leq f_{\text{offset}} < f_{\text{offset}_{\text{max}}}$	-15 dBm (Note 3)	1 MHz
<p>NOTE 1: For a BS supporting non-contiguous spectrum operation within any operating band, the minimum requirement within sub-block gaps is calculated as a cumulative sum of contributions from adjacent sub blocks on each side of the sub block gap, where the contribution from the far-end sub-block shall be scaled according to the measurement bandwidth of the near-end sub-block. Exception is $\Delta f \geq 10\text{MHz}$ from both adjacent sub blocks on each side of the sub-block gap, where the minimum requirement within sub-block gaps shall be -15dBm/1MHz. For BS supporting multi-band operation, either this limit or -16dBm/100kHz (f_{offset} adjusted according to the measurement bandwidth), whichever is less stringent, shall apply at $\Delta f \geq 10\text{MHz}$ for operating bands <1GHz.</p> <p>NOTE 2: For BS supporting multi-band operation with Inter RF Bandwidth gap < 20MHz the minimum requirement within the Inter RF Bandwidth gaps is calculated as a cumulative sum of contributions from adjacent sub-blocks or RF Bandwidth on each side of the Inter RF Bandwidth gap, where the contribution from the far-end sub-block or RF Bandwidth shall be scaled according to the measurement bandwidth of the near-end sub-block or RF Bandwidth.</p> <p>NOTE 3: For BS supporting multi-band operation, either this limit or -16dBm/100kHz (f_{offset} adjusted according to the measurement bandwidth), whichever is less stringent, shall apply for operating bands <1GHz.</p>			

6.6.3.2A Minimum requirements for Local Area BS (Category A and B)

For Local Area BS, emissions shall not exceed the maximum levels specified in Tables 6.6.3.2A-1 to 6.6.3.2A-3.

Table 6.6.3.2A-1: Local Area BS operating band unwanted emission limits for 1.4 MHz channel bandwidth

Frequency offset of measurement filter -3dB point, Δf	Frequency offset of measurement filter centre frequency, f_{offset}	Minimum requirement (Note 1, 2)	Measurement bandwidth (Note 8)
$0 \text{ MHz} \leq \Delta f < 1.4 \text{ MHz}$	$0.05 \text{ MHz} \leq f_{\text{offset}} < 1.45 \text{ MHz}$	$-21\text{dBm} - \frac{10}{1.4} \left(\frac{f_{\text{offset}}}{\text{MHz}} - 0.05 \right) \text{dB}$	100 kHz
$1.4 \text{ MHz} \leq \Delta f < 2.8 \text{ MHz}$	$1.45 \text{ MHz} \leq f_{\text{offset}} < 2.85 \text{ MHz}$	-31 dBm	100 kHz
$2.8 \text{ MHz} \leq \Delta f \leq \Delta f_{\text{max}}$	$2.85 \text{ MHz} \leq f_{\text{offset}} < f_{\text{offset}_{\text{max}}}$	-31 dBm	100 kHz
<p>NOTE 1: For a BS supporting non-contiguous spectrum operation within any operating band the minimum requirement within sub-block gaps is calculated as a cumulative sum of contributions from adjacent sub blocks on each side of the sub block gap. Exception is $\Delta f \geq 10\text{MHz}$ from both adjacent sub blocks on each side of the sub-block gap, where the minimum requirement within sub-block gaps shall be -31dBm/100kHz.</p> <p>NOTE 2: For BS supporting multi-band operation with Inter RF Bandwidth gap < 20MHz the minimum requirement within the Inter RF Bandwidth gaps is calculated as a cumulative sum of contributions from adjacent sub-blocks or RF Bandwidth on each side of the Inter RF Bandwidth gap.</p>			

Table 6.6.3.2A-2: Local Area BS operating band unwanted emission limits for 3 MHz channel bandwidth

Frequency offset of measurement filter -3dB point, Δf	Frequency offset of measurement filter centre frequency, f_{offset}	Minimum requirement (Note 1, 2)	Measurement bandwidth (Note 8)
$0 \text{ MHz} \leq \Delta f < 3 \text{ MHz}$	$0.05 \text{ MHz} \leq f_{\text{offset}} < 3.05 \text{ MHz}$	$-25\text{dBm} - \frac{10}{3} \left(\frac{f_{\text{offset}}}{\text{MHz}} - 0.05 \right) \text{dB}$	100 kHz
$3 \text{ MHz} \leq \Delta f < 6 \text{ MHz}$	$3.05 \text{ MHz} \leq f_{\text{offset}} < 6.05 \text{ MHz}$	-35 dBm	100 kHz
$6 \text{ MHz} \leq \Delta f \leq \Delta f_{\text{max}}$	$6.05 \text{ MHz} \leq f_{\text{offset}} < f_{\text{offset}_{\text{max}}}$	-35 dBm	100 kHz

NOTE 1: For a BS supporting non-contiguous spectrum operation within any operating band the minimum requirement within sub-block gaps is calculated as a cumulative sum of contributions from adjacent sub blocks on each side of the sub block gap. Exception is $\Delta f \geq 10\text{MHz}$ from both adjacent sub blocks on each side of the sub-block gap, where the minimum requirement within sub-block gaps shall be -35dBm/100kHz.

NOTE 2: For BS supporting multi-band operation with Inter RF Bandwidth gap < 20MHz the minimum requirement within the Inter RF Bandwidth gaps is calculated as a cumulative sum of contributions from adjacent sub-blocks or RF Bandwidth on each side of the Inter RF Bandwidth gap.

Table 6.6.3.2A-3: Local Area BS operating band unwanted emission limits for 5, 10, 15 and 20 MHz channel bandwidth

Frequency offset of measurement filter -3dB point, Δf	Frequency offset of measurement filter centre frequency, f_{offset}	Minimum requirement (Note 1, 2))	Measurement bandwidth (Note 8)
$0 \text{ MHz} \leq \Delta f < 5 \text{ MHz}$	$0.05 \text{ MHz} \leq f_{\text{offset}} < 5.05 \text{ MHz}$	$-30\text{dBm} - \frac{7}{5} \left(\frac{f_{\text{offset}}}{\text{MHz}} - 0.05 \right) \text{dB}$	100 kHz
$5 \text{ MHz} \leq \Delta f < \min(10 \text{ MHz}, \Delta f_{\text{max}})$	$5.05 \text{ MHz} \leq f_{\text{offset}} < \min(10.05 \text{ MHz}, f_{\text{offset}_{\text{max}}})$	-37 dBm	100 kHz
$10 \text{ MHz} \leq \Delta f \leq \Delta f_{\text{max}}$	$10.05 \text{ MHz} \leq f_{\text{offset}} < f_{\text{offset}_{\text{max}}}$	-37 dBm (Note 10)	100 kHz

NOTE 1: For a BS supporting non-contiguous spectrum operation within any operating band the minimum requirement within sub-block gaps is calculated as a cumulative sum of contributions from adjacent sub blocks on each side of the sub block gap. Exception is $\Delta f \geq 10\text{MHz}$ from both adjacent sub blocks on each side of the sub-block gap, where the minimum requirement within sub-block gaps shall be -37dBm/100kHz.

NOTE 2: For BS supporting multi-band operation with Inter RF Bandwidth gap < 20MHz the minimum requirement within the Inter RF Bandwidth gaps is calculated as a cumulative sum of contributions from adjacent sub-blocks or RF Bandwidth on each side of the Inter RF Bandwidth gap.

6.6.3.2B Minimum requirements for Home BS (Category A and B)

For Home BS, emissions shall not exceed the maximum levels specified in Tables 6.6.3.2B-1 to 6.6.3.2B-3.

Table 6.6.3.2B-1: Home BS operating band unwanted emission limits for 1.4 MHz channel bandwidth

Frequency offset of measurement filter -3dB point, Δf	Frequency offset of measurement filter centre frequency, f_{offset}	Minimum requirement	Measurement bandwidth (Note 8)
$0 \text{ MHz} \leq \Delta f < 1.4 \text{ MHz}$	$0.05 \text{ MHz} \leq f_{\text{offset}} < 1.45 \text{ MHz}$	$-30\text{dBm} - \frac{6}{1.4} \left(\frac{f_{\text{offset}}}{\text{MHz}} - 0.05 \right) \text{dB}$	100 kHz
$1.4 \text{ MHz} \leq \Delta f < 2.8 \text{ MHz}$	$1.45 \text{ MHz} \leq f_{\text{offset}} < 2.85 \text{ MHz}$	-36 dBm	100 kHz
$2.8 \text{ MHz} \leq \Delta f \leq \Delta f_{\text{max}}$	$3.3 \text{ MHz} \leq f_{\text{offset}} < f_{\text{offset}_{\text{max}}}$	$\begin{cases} P - 52\text{dB}, & 2\text{dBm} \leq P \leq 20\text{dBm} \\ -50\text{dBm}, & P < 2\text{dBm} \end{cases}$ (Note 11)	1MHz

Table 6.6.3.2B-2: Home BS operating band unwanted emission limits for 3 MHz channel bandwidth

Frequency offset of measurement filter -3dB point, Δf	Frequency offset of measurement filter centre frequency, f_{offset}	Minimum requirement	Measurement bandwidth (Note 8)
$0 \text{ MHz} \leq \Delta f < 3 \text{ MHz}$	$0.05 \text{ MHz} \leq f_{\text{offset}} < 3.05 \text{ MHz}$	$-34 \text{ dBm} - 2 \left(\frac{f_{\text{offset}}}{\text{MHz}} - 0.05 \right) \text{ dB}$	100 kHz
$3 \text{ MHz} \leq \Delta f < 6 \text{ MHz}$	$3.05 \text{ MHz} \leq f_{\text{offset}} < 6.05 \text{ MHz}$	-40 dBm	100 kHz
$6 \text{ MHz} \leq \Delta f \leq \Delta f_{\text{max}}$	$6.5 \text{ MHz} \leq f_{\text{offset}} < f_{\text{offset}_{\text{max}}}$	$\begin{cases} P - 52 \text{ dB}, 2 \text{ dBm} \leq P \leq 20 \text{ dBm} \\ -50 \text{ dBm}, P < 2 \text{ dBm} \end{cases}$ (Note 11)	1 MHz

Table 6.6.3.2B-3: Home BS operating band unwanted emission limits for 5, 10, 15 and 20 MHz channel bandwidth

Frequency offset of measurement filter -3dB point, Δf	Frequency offset of measurement filter centre frequency, f_{offset}	Minimum requirement	Measurement bandwidth (Note 8)
$0 \text{ MHz} \leq \Delta f < 5 \text{ MHz}$	$0.05 \text{ MHz} \leq f_{\text{offset}} < 5.05 \text{ MHz}$	$-36 \text{ dBm} - \frac{6}{5} \left(\frac{f_{\text{offset}}}{\text{MHz}} - 0.05 \right) \text{ dB}$	100 kHz
$5 \text{ MHz} \leq \Delta f < \min(10 \text{ MHz}, \Delta f_{\text{max}})$	$5.05 \text{ MHz} \leq f_{\text{offset}} < \min(10.05 \text{ MHz}, f_{\text{offset}_{\text{max}}})$	-42 dBm	100 kHz
$10 \text{ MHz} \leq \Delta f \leq \Delta f_{\text{max}}$	$10.5 \text{ MHz} \leq f_{\text{offset}} < f_{\text{offset}_{\text{max}}}$	$\begin{cases} P - 52 \text{ dB}, 2 \text{ dBm} \leq P \leq 20 \text{ dBm} \\ -50 \text{ dBm}, P < 2 \text{ dBm} \end{cases}$ (Note 10, Note 11)	1 MHz

6.6.3.2C Minimum requirements for Medium Range BS (Category A and B)

For Medium Range BS, emissions shall not exceed the maximum levels specified in Tables 6.6.3.2C-1 to 6.6.3.2C-6.

Table 6.6.3.2C-1: Medium Range BS operating band unwanted emission limits for 1.4 MHz channel bandwidth, $31 < P_{\text{rated,c}} \leq 38 \text{ dBm}$

Frequency offset of measurement filter -3dB point, Δf	Frequency offset of measurement filter centre frequency, f_{offset}	Minimum requirement (Note 1, 2)	Measurement bandwidth (Note 8)
$0 \text{ MHz} \leq \Delta f < 1.4 \text{ MHz}$	$0.05 \text{ MHz} \leq f_{\text{offset}} < 1.45 \text{ MHz}$	$P_{\text{rated,c}} - 45 \text{ dB} - \frac{10}{1.4} \left(\frac{f_{\text{offset}}}{\text{MHz}} - 0.05 \right) \text{ dB}$	100 kHz
$1.4 \text{ MHz} \leq \Delta f < 2.8 \text{ MHz}$	$1.45 \text{ MHz} \leq f_{\text{offset}} < 2.85 \text{ MHz}$	$P_{\text{rated,c}} - 55 \text{ dB}$	100 kHz
$2.8 \text{ MHz} \leq \Delta f \leq \Delta f_{\text{max}}$	$2.85 \text{ MHz} \leq f_{\text{offset}} < f_{\text{offset}_{\text{max}}}$	-25 dBm	100 kHz
NOTE 1: For a BS supporting non-contiguous spectrum operation within any operating band the minimum requirement within sub-block gaps is calculated as a cumulative sum of contributions from adjacent sub blocks on each side of the sub block gap. Exception is $\Delta f \geq 10 \text{ MHz}$ from both adjacent sub blocks on each side of the sub-block gap, where the minimum requirement within sub-block gaps shall be -25dBm/100kHz. NOTE 2: For BS supporting multi-band operation with Inter RF Bandwidth gap < 20MHz the minimum requirement within the Inter RF Bandwidth gaps is calculated as a cumulative sum of contributions from adjacent sub-blocks or RF Bandwidth on each side of the Inter RF Bandwidth gap.			

Table 6.6.3.2C-2: Medium Range BS operating band unwanted emission limits for 1.4 MHz channel bandwidth, $P_{\text{rated,c}} \leq 31$ dBm

Frequency offset of measurement filter -3dB point, Δf	Frequency offset of measurement filter centre frequency, f_{offset}	Minimum requirement (Note 1, 2)	Measurement bandwidth (Note 8)
$0 \text{ MHz} \leq \Delta f < 1.4 \text{ MHz}$	$0.05 \text{ MHz} \leq f_{\text{offset}} < 1.45 \text{ MHz}$	$-14\text{dBm} - \frac{10}{1.4} \left(\frac{f_{\text{offset}}}{\text{MHz}} - 0.05 \right) \text{dB}$	100 kHz
$1.4 \text{ MHz} \leq \Delta f < 2.8 \text{ MHz}$	$1.45 \text{ MHz} \leq f_{\text{offset}} < 2.85 \text{ MHz}$	-24 dBm	100 kHz
$2.8 \text{ MHz} \leq \Delta f \leq \Delta f_{\text{max}}$	$2.85 \text{ MHz} \leq f_{\text{offset}} < f_{\text{offset}_{\text{max}}}$	-25dBm	100 kHz

NOTE 1: For a BS supporting non-contiguous spectrum operation within any operating band the minimum requirement within sub-block gaps is calculated as a cumulative sum of contributions from adjacent sub blocks on each side of the sub block gap. Exception is $\Delta f \geq 10\text{MHz}$ from both adjacent sub blocks on each side of the sub-block gap, where the minimum requirement within sub-block gaps shall be -25dBm/100kHz.

NOTE 2: For BS supporting multi-band operation with Inter RF Bandwidth gap < 20MHz the minimum requirement within the Inter RF Bandwidth gaps is calculated as a cumulative sum of contributions from adjacent sub-blocks or RF Bandwidth on each side of the Inter RF Bandwidth gap.

Table 6.6.3.2C-3: Medium Range BS operating band unwanted emission limits for 3 MHz channel bandwidth, $31 < P_{\text{rated,c}} \leq 38$ dBm

Frequency offset of measurement filter -3dB point, Δf	Frequency offset of measurement filter centre frequency, f_{offset}	Minimum requirement (Note 1, 2)	Measurement bandwidth (Note 8)
$0 \text{ MHz} \leq \Delta f < 3 \text{ MHz}$	$0.05 \text{ MHz} \leq f_{\text{offset}} < 3.05 \text{ MHz}$	$P_{\text{rated,c}} - 49\text{dB} - \frac{10}{3} \left(\frac{f_{\text{offset}}}{\text{MHz}} - 0.05 \right) \text{dB}$	100 kHz
$3 \text{ MHz} \leq \Delta f < 6 \text{ MHz}$	$3.05 \text{ MHz} \leq f_{\text{offset}} < 6.05 \text{ MHz}$	$P_{\text{rated,c}} - 59\text{dB}$	100 kHz
$6 \text{ MHz} \leq \Delta f \leq \Delta f_{\text{max}}$	$6.05 \text{ MHz} \leq f_{\text{offset}} < f_{\text{offset}_{\text{max}}}$	$\text{Min}(P_{\text{rated,c}} - 59\text{dB}, -25\text{dBm})$	100 kHz

NOTE 1: For a BS supporting non-contiguous spectrum operation within any operating band the minimum requirement within sub-block gaps is calculated as a cumulative sum of contributions from adjacent sub blocks on each side of the sub block gap. Exception is $\Delta f \geq 10\text{MHz}$ from both adjacent sub blocks on each side of the sub-block gap, where the minimum requirement within sub-block gaps shall be $\text{Min}(P_{\text{rated,c}} - 59\text{dB}, -25\text{dBm})/100\text{kHz}$.

NOTE 2: For BS supporting multi-band operation with Inter RF Bandwidth gap < 20MHz the minimum requirement within the Inter RF Bandwidth gaps is calculated as a cumulative sum of contributions from adjacent sub-blocks or RF Bandwidth on each side of the Inter RF Bandwidth gap.

Table 6.6.3.2C-4: Medium Range BS operating band unwanted emission limits for 3 MHz channel bandwidth, $P_{\text{rated,c}} \leq 31$ dBm

Frequency offset of measurement filter -3dB point, Δf	Frequency offset of measurement filter centre frequency, f_{offset}	Minimum requirement (Note 1, 2)	Measurement bandwidth (Note 8)
$0 \text{ MHz} \leq \Delta f < 3 \text{ MHz}$	$0.05 \text{ MHz} \leq f_{\text{offset}} < 3.05 \text{ MHz}$	$-18\text{dBm} - \frac{10}{3} \left(\frac{f_{\text{offset}}}{\text{MHz}} - 0.05 \right) \text{dB}$	100 kHz
$3 \text{ MHz} \leq \Delta f < 6 \text{ MHz}$	$3.05 \text{ MHz} \leq f_{\text{offset}} < 6.05 \text{ MHz}$	-28 dBm	100 kHz
$6 \text{ MHz} \leq \Delta f \leq \Delta f_{\text{max}}$	$6.05 \text{ MHz} \leq f_{\text{offset}} < f_{\text{offset}_{\text{max}}}$	-28 dBm	100 kHz

NOTE 1: For a BS supporting non-contiguous spectrum operation within any operating band the minimum requirement within sub-block gaps is calculated as a cumulative sum of contributions from adjacent sub blocks on each side of the sub block gap. Exception is $\Delta f \geq 10\text{MHz}$ from both adjacent sub blocks on each side of the sub-block gap, where the minimum requirement within sub-block gaps shall be -28dBm/100kHz.

NOTE 2: For BS supporting multi-band operation with Inter RF Bandwidth gap < 20MHz the minimum requirement within the Inter RF Bandwidth gaps is calculated as a cumulative sum of contributions from adjacent sub-blocks or RF Bandwidth on each side of the Inter RF Bandwidth gap.

Table 6.6.3.2C-5: Medium Range BS operating band unwanted emission limits for 5, 10, 15 and 20 MHz channel bandwidth, $31 < P_{\text{rated,c}} \leq 38$ dBm

Frequency offset of measurement filter -3dB point, Δf	Frequency offset of measurement filter centre frequency, f_{offset}	Minimum requirement (Note 1, 2)	Measurement bandwidth (Note 8)
$0 \text{ MHz} \leq \Delta f < 5 \text{ MHz}$	$0.05 \text{ MHz} \leq f_{\text{offset}} < 5.05 \text{ MHz}$	$P_{\text{rated,c}} - 53 \text{ dB} - \frac{7}{5} \left(\frac{f_{\text{offset}}}{\text{MHz}} - 0.05 \right) \text{ dB}$	100 kHz
$5 \text{ MHz} \leq \Delta f < \min(10 \text{ MHz}, \Delta f_{\text{max}})$	$5.05 \text{ MHz} \leq f_{\text{offset}} < \min(10.05 \text{ MHz}, f_{\text{offset}_{\text{max}}})$	$P_{\text{rated,c}} - 60 \text{ dB}$	100 kHz
$10 \text{ MHz} \leq \Delta f \leq \Delta f_{\text{max}}$	$10.05 \text{ MHz} \leq f_{\text{offset}} < f_{\text{offset}_{\text{max}}}$	$\text{Min}(P_{\text{rated,c}} - 60 \text{ dB}, -25 \text{ dBm})$ (Note 9)	100 kHz
<p>NOTE 1: For a BS supporting non-contiguous spectrum operation within any operating band the minimum requirement within sub-block gaps is calculated as a cumulative sum of contributions from adjacent sub blocks on each side of the sub block gap. Exception is $\Delta f \geq 10 \text{ MHz}$ from both adjacent sub blocks on each side of the sub-block gap, where the minimum requirement within sub-block gaps shall be $\text{Min}(P_{\text{rated,c}} - 60 \text{ dB}, -25 \text{ dBm})/100 \text{ kHz}$.</p> <p>NOTE 2: For BS supporting multi-band operation with Inter RF Bandwidth gap $< 20 \text{ MHz}$ the minimum requirement within the Inter RF Bandwidth gaps is calculated as a cumulative sum of contributions from adjacent sub-blocks or RF Bandwidth on each side of the Inter RF Bandwidth gap.</p>			

Table 6.6.3.2C-6: Medium Range BS operating band unwanted emission limits for 5, 10, 15 and 20 MHz channel bandwidth, $P_{\text{rated,c}} \leq 31$ dBm

Frequency offset of measurement filter -3dB point, Δf	Frequency offset of measurement filter centre frequency, f_{offset}	Minimum requirement (Note 1, 2)	Measurement bandwidth (Note 8)
$0 \text{ MHz} \leq \Delta f < 5 \text{ MHz}$	$0.05 \text{ MHz} \leq f_{\text{offset}} < 5.05 \text{ MHz}$	$-22 \text{ dBm} - \frac{7}{5} \left(\frac{f_{\text{offset}}}{\text{MHz}} - 0.05 \right) \text{ dB}$	100 kHz
$5 \text{ MHz} \leq \Delta f < \min(10 \text{ MHz}, \Delta f_{\text{max}})$	$5.05 \text{ MHz} \leq f_{\text{offset}} < \min(10.05 \text{ MHz}, f_{\text{offset}_{\text{max}}})$	-29 dBm	100 kHz
$10 \text{ MHz} \leq \Delta f \leq \Delta f_{\text{max}}$	$10.05 \text{ MHz} \leq f_{\text{offset}} < f_{\text{offset}_{\text{max}}}$	-29 dBm (Note 9)	100 kHz
<p>NOTE 1: For a BS supporting non-contiguous spectrum operation within any operating band the minimum requirement within sub-block gaps is calculated as a cumulative sum of contributions from adjacent sub blocks on each side of the sub block gap. Exception is $\Delta f \geq 10 \text{ MHz}$ from both adjacent sub blocks on each side of the sub-block gap, where the minimum requirement within sub-block gaps shall be $-29 \text{ dBm}/100 \text{ kHz}$.</p> <p>NOTE 2: For BS supporting multi-band operation with Inter RF Bandwidth gap $< 20 \text{ MHz}$ the minimum requirement within the Inter RF Bandwidth gaps is calculated as a cumulative sum of contributions from adjacent sub-blocks or RF Bandwidth on each side of the Inter RF Bandwidth gap.</p>			

6.6.3.2D Minimum requirements for Local Area and Medium Range BS in Band 46 (Category A and B)

For Local Area and Medium Range BS operating in Band 46, emissions shall not exceed the maximum levels specified in Tables 6.6.3.2D-1 and Tables 6.6.3.2D-2.

Table 6.6.3.2D-1: Local Area and Medium Range BS operating band unwanted emission limits in Band 46 for 20MHz channel bandwidth

Frequency offset of measurement filter -3dB point, Δf	Frequency offset of measurement filter centre frequency, f_{offset}	Minimum requirement (Note 1)	Measurement bandwidth (Note 8)
$0 \text{ MHz} \leq \Delta f < 1 \text{ MHz}$	$0.05 \text{ MHz} \leq f_{\text{offset}} < 1.05 \text{ MHz}$	$P_{\text{rated,c}} - 32.6\text{dB} - 10 \left(\frac{f_{\text{offset}} - 0.05}{\text{MHz}} \right) \text{dB}$	100 kHz
$1 \text{ MHz} \leq \Delta f < \min(10 \text{ MHz}, \Delta f_{\text{max}})$	$1.05 \text{ MHz} \leq f_{\text{offset}} < \min(10.05 \text{ MHz}, f_{\text{offset}_{\text{max}}})$	$P_{\text{rated,c}} - 42.6\text{dB} - \frac{8}{9} \left(\frac{f_{\text{offset}} - 1.05}{\text{MHz}} \right) \text{dB}$	100 kHz
$10 \text{ MHz} \leq \Delta f < \min(20 \text{ MHz}, \Delta f_{\text{max}})$	$10.05 \text{ MHz} \leq f_{\text{offset}} < \min(20.05 \text{ MHz}, f_{\text{offset}_{\text{max}}})$	$P_{\text{rated,c}} - 50.6\text{dB} - \frac{12}{10} \left(\frac{f_{\text{offset}} - 10.05}{\text{MHz}} \right) \text{dB}$	100 kHz
$20 \text{ MHz} \leq \Delta f < \min(170 \text{ MHz}, \Delta f_{\text{max}})$	$20.05 \text{ MHz} \leq f_{\text{offset}} < \min(170.05 \text{ MHz}, f_{\text{offset}_{\text{max}}})$	$\text{Max}(P_{\text{rated,c}} - 62.6\text{dB}, -40\text{dBm})$	100 kHz
$170 \text{ MHz} \leq \Delta f < \min(206 \text{ MHz}, \Delta f_{\text{max}})$	$170.05 \text{ MHz} \leq f_{\text{offset}} < \min(206.05 \text{ MHz}, f_{\text{offset}_{\text{max}}})$	$\text{Max}(P_{\text{rated,c}} - 64.6\text{dB}, -40\text{dBm})$	100 kHz
$206 \text{ MHz} \leq \Delta f \leq \Delta f_{\text{max}}$	$206.05 \text{ MHz} \leq f_{\text{offset}} < f_{\text{offset}_{\text{max}}}$	$\text{Max}(P_{\text{rated,c}} - 69.6\text{dB}, -40\text{dBm})$	100 kHz
NOTE 1: For a BS supporting non-contiguous spectrum operation within any operating band, the minimum requirement within sub-block gaps is calculated as a cumulative sum of contributions from adjacent sub blocks on each side of the sub block gap. Exception is $\Delta f \geq 20 \text{ MHz}$ from both adjacent sub blocks on each side of the sub-block gap, where the minimum requirement within sub-block gaps shall be $\text{Max}(P_{\text{rated,c}} - 62.6\text{dB}, -40 \text{ dBm})/100\text{kHz}$.			

Table 6.6.3.2D-2: Local Area and Medium Range BS operating band unwanted emission limits in Band 46 for 10MHz channel bandwidth

Frequency offset of measurement filter -3dB point, Δf	Frequency offset of measurement filter centre frequency, f_{offset}	Minimum requirement (Note 1)	Measurement bandwidth (Note 8)
$0 \text{ MHz} \leq \Delta f < 0.5 \text{ MHz}$	$0.05 \text{ MHz} \leq f_{\text{offset}} < 0.55 \text{ MHz}$	$P_{\text{rated,c}} - 29.5\text{dB} - 20 \left(\frac{f_{\text{offset}} - 0.05}{\text{MHz}} \right) \text{dB}$	100 kHz
$0.5 \text{ MHz} \leq \Delta f < 5 \text{ MHz}$	$0.55 \text{ MHz} \leq f_{\text{offset}} < \min(5.05 \text{ MHz}, f_{\text{offset}_{\text{max}}})$	$P_{\text{rated,c}} - 39.5\text{dB} - \frac{16}{9} \left(\frac{f_{\text{offset}} - 0.55}{\text{MHz}} \right) \text{dB}$	100 kHz
$5 \text{ MHz} \leq \Delta f < \min(10 \text{ MHz}, \Delta f_{\text{max}})$	$5.05 \text{ MHz} \leq f_{\text{offset}} < \min(10.05 \text{ MHz}, f_{\text{offset}_{\text{max}}})$	$P_{\text{rated,c}} - 47.5\text{dB} - \frac{12}{5} \left(\frac{f_{\text{offset}} - 5.05}{\text{MHz}} \right) \text{dB}$	100 kHz
$10 \text{ MHz} \leq \Delta f < \min(85 \text{ MHz}, \Delta f_{\text{max}})$	$10.05 \text{ MHz} \leq f_{\text{offset}} < \min(85.05 \text{ MHz}, f_{\text{offset}_{\text{max}}})$	$\text{Max}(P_{\text{rated,c}} - 59.5\text{dB}, -40\text{dBm})$	100 kHz
$85 \text{ MHz} \leq \Delta f < \min(103 \text{ MHz}, \Delta f_{\text{max}})$	$85.05 \text{ MHz} \leq f_{\text{offset}} < \min(103.05 \text{ MHz}, f_{\text{offset}_{\text{max}}})$	$\text{Max}(P_{\text{rated,c}} - 61.5\text{dB}, -40\text{dBm})$	100 kHz
$103 \text{ MHz} \leq \Delta f \leq \Delta f_{\text{max}}$	$103.05 \text{ MHz} \leq f_{\text{offset}} < f_{\text{offset}_{\text{max}}}$	$\text{Max}(P_{\text{rated,c}} - 66.5\text{dB}, -40\text{dBm})$	100 kHz
NOTE 1: For a BS supporting non-contiguous spectrum operation within any operating band, the minimum requirement within sub-block gaps is calculated as a cumulative sum of contributions from adjacent sub blocks on each side of the sub block gap. Exception is $\Delta f \geq 10 \text{ MHz}$ from both adjacent sub blocks on each side of the sub-block gap, where the minimum requirement within sub-block gaps shall be $\text{Max}(P_{\text{rated,c}} - 59.5\text{dB}, -40 \text{ dBm})/100\text{kHz}$.			

6.6.3.2E Minimum requirements for standalone NB-IoT Wide Area BS

For standalone NB-IoT BS, emissions shall not exceed the maximum levels specified in Tables 6.6.3.2E-1.

Table 6.6.3.2E-1: Standalone NB-IoT BS operating band unwanted emission limits

Frequency offset of measurement filter -3dB point, Δf	Frequency offset of measurement filter centre frequency, f_{offset}	Minimum requirement (Note 1, 2, 3, 4, 5)	Measurement bandwidth (Note 8)
$0 \text{ MHz} \leq \Delta f < 0.05 \text{ MHz}$	$0.015 \text{ MHz} \leq f_{\text{offset}} < 0.065 \text{ MHz}$	$Max(5dBm - 60 \cdot \left(\frac{f_{\text{offset}}}{\text{MHz}} - 0.015\right) dB + XdB, -14dBm)$	30 kHz
$0.05 \text{ MHz} \leq \Delta f < 0.15 \text{ MHz}$	$0.065 \text{ MHz} \leq f_{\text{offset}} < 0.165 \text{ MHz}$	$Max(2dBm - 160 \cdot \left(\frac{f_{\text{offset}}}{\text{MHz}} - 0.065\right) dB + XdB, -14dBm)$	30 kHz
$0.15 \text{ MHz} \leq \Delta f < 0.2 \text{ MHz}$	$0.165 \text{ MHz} \leq f_{\text{offset}} < 0.215 \text{ MHz}$	-14 dBm	30 kHz
$0.2 \text{ MHz} \leq \Delta f < 1 \text{ MHz}$	$0.215 \text{ MHz} \leq f_{\text{offset}} < 1.015 \text{ MHz}$	$-14dBm - 15 \cdot \left(\frac{f_{\text{offset}}}{\text{MHz}} - 0.215\right) dB$	30 kHz
(Note 9)	$1.015 \text{ MHz} \leq f_{\text{offset}} < 1.5 \text{ MHz}$	-26 dBm	30 kHz
$1 \text{ MHz} \leq \Delta f \leq \min(\Delta f_{\text{max}}, 10 \text{ MHz})$	$1.5 \text{ MHz} \leq f_{\text{offset}} < \min(f_{\text{offset}_{\text{max}}}, 10.5 \text{ MHz})$	-13 dBm	1 MHz
$10 \text{ MHz} \leq \Delta f \leq \Delta f_{\text{max}}$	$10.5 \text{ MHz} \leq f_{\text{offset}} < f_{\text{offset}_{\text{max}}}$	-15 dBm (Note 10)	1 MHz
<p>NOTE 1: The limits in this table only apply for operation with a NB-IoT carrier adjacent to the Base Station RF Bandwidth edge.</p> <p>NOTE 2: For a BS supporting non-contiguous spectrum operation within any operating band the minimum requirement within sub-block gaps is calculated as a cumulative sum of contributions from adjacent sub blocks on each side of the sub block gap, where the contribution from the far-end sub-block shall be scaled according to the measurement bandwidth of the near-end sub-block.</p> <p>NOTE 3: For a BS supporting multi-band operation with Inter RF Bandwidth gap < 20MHz the minimum requirement within the Inter RF Bandwidth gaps is calculated as a cumulative sum of contributions from adjacent sub-blocks or RF Bandwidth on each side of the Inter RF Bandwidth gap, where the contribution from the far-end sub-block or RF Bandwidth shall be scaled according to the measurement bandwidth of the near-end sub-block or RF Bandwidth.</p> <p>NOTE 4: In case the carrier adjacent to the RF bandwidth edge is a NB-IoT carrier, the value of X = PNB-IoTcarrier – 43, where PNB-IoTcarrier is the power level of the NB-IoT carrier adjacent to the RF bandwidth edge. In other cases, X = 0.</p> <p>NOTE 5: For BS that only support E-UTRA and NB-IoT multi-carrier operation, the requirements in this table do not apply to an E-UTRA BS from Release 8, which is upgraded to support E-UTRA and NB-IoT multi-carrier operation, where the upgrade does not affect existing RF parts of the radio unit related to the requirements in this table. In this case, the requirements in clauses 6.6.3.1 and 6.6.3.2 shall apply.</p>			

6.6.3.2F Minimum requirements for standalone NB-IoT Local Area BS

For standalone NB-IoT local area BS, emissions shall not exceed the maximum levels specified in Tables 6.6.3.2H-1.

Table 6.6.3.2F-1: Standalone NB-IoT local area BS operating band unwanted emission limits

Frequency offset of measurement filter -3dB point, Δf	Frequency offset of measurement filter centre frequency, f_{offset}	Minimum requirement (Note 1, 2, 3, 4)	Measurement bandwidth (Note 8)
$0 \text{ MHz} \leq \Delta f < 0.05 \text{ MHz}$ (Note 1)	$0.015 \text{ MHz} \leq f_{\text{offset}} < 0.065 \text{ MHz}$	$\text{Max}\{-14\text{dBm} - 60 \cdot \left(\frac{f_{\text{offset}}}{\text{MHz}} - 0.015\right) \text{dB} + X\text{dB} - 35\text{dBm}\}$	30 kHz
$0.05 \text{ MHz} \leq \Delta f < 0.16 \text{ MHz}$	$0.065 \text{ MHz} \leq f_{\text{offset}} < 0.175 \text{ MHz}$	$\text{Max}\{-17\text{dBm} - 160 \cdot \left(\frac{f_{\text{offset}}}{\text{MHz}} - 0.065\right) \text{dB} + X\text{dB} - 35\text{dBm}\}$	30 kHz
$0.15 \text{ MHz} \leq \Delta f < 5 \text{ MHz}$ (Note 1)	$0.05 \text{ MHz} \leq f_{\text{offset}} < 5.05 \text{ MHz}$	$-30\text{dBm} - \frac{7}{5} \left(\frac{f_{\text{offset}}}{\text{MHz}} - 0.05\right) \text{dB}$	100 kHz
$5 \text{ MHz} \leq \Delta f < \min(10 \text{ MHz}, \Delta f_{\text{max}})$	$5.05 \text{ MHz} \leq f_{\text{offset}} < \min(10.05 \text{ MHz}, f_{\text{offset}_{\text{max}}})$	-37 dBm	100 kHz
$10 \text{ MHz} \leq \Delta f \leq \Delta f_{\text{max}}$	$10.05 \text{ MHz} \leq f_{\text{offset}} < f_{\text{offset}_{\text{max}}}$	-37 dBm (Note 10)	100 kHz
<p>NOTE 1: The limits in this table only apply for operation with a NB-IoT carrier adjacent to the Base Station RF Bandwidth edge.</p> <p>NOTE 2: For BS supporting non-contiguous spectrum operation within any operating band the minimum requirement within sub-block gaps is calculated as a cumulative sum of contributions from adjacent sub blocks on each side of the sub block gap, where the contribution from the far-end sub-block shall be scaled according to the measurement bandwidth of the near-end sub-block.</p> <p>NOTE 3: For BS supporting multi-band operation with Inter RF Bandwidth gap < 20MHz the minimum requirement within the Inter RF Bandwidth gaps is calculated as a cumulative sum of contributions from adjacent sub-blocks or RF Bandwidth on each side of the Inter RF Bandwidth gap, where the contribution from the far-end sub-block or RF Bandwidth shall be scaled according to the measurement bandwidth of the near-end sub-block or RF Bandwidth.</p> <p>NOTE 4: In case the carrier adjacent to the RF bandwidth edge is a NB-IoT carrier, the value of $X = P_{\text{NB-IoTcarrier}} - 24$, where $P_{\text{NB-IoTcarrier}}$ is the power level of the NB-IoT carrier adjacent to the RF bandwidth edge. In other cases, $X = 0$.</p>			

6.6.3.2G Minimum requirements for standalone NB-IoT Home BS (Category A and B)

For standalone NB-IoT Home BS, emissions shall not exceed the maximum levels specified in Table 6.6.3.2G-1.

Table 6.6.3.2G-1: Standalone NB-IoT Home BS operating band unwanted emission limits (E-UTRA bands ≤3GHz)

Frequency offset of measurement filter -3dB point, Δf	Frequency offset of measurement filter centre frequency, f_{offset}	Minimum requirement (Note 1, 2)	Measurement bandwidth (Note 8)
$0 \text{ MHz} \leq \Delta f < 0.05 \text{ MHz}$	$0.015 \text{ MHz} \leq f_{\text{offset}} < 0.065 \text{ MHz}$	$\text{Max}(-18\text{dBm} - 60 \cdot \left(\frac{f_{\text{offset}}}{\text{MHz}} - 0.015\right) \text{dB} + X\text{dB}, -39\text{dBm})$	30 kHz
$0.05 \text{ MHz} \leq \Delta f < 0.16 \text{ MHz}$	$0.065 \text{ MHz} \leq f_{\text{offset}} < 0.175 \text{ MHz}$	$\text{Max}(-21\text{dBm} - 160 \cdot \left(\frac{f_{\text{offset}}}{\text{MHz}} - 0.065\right) \text{dB} + X\text{dB}, -39\text{dBm})$	30 kHz
$0.16 \text{ MHz} \leq \Delta f < 5 \text{ MHz}$ (Note 8)	$0.175 \text{ MHz} \leq f_{\text{offset}} < 5.05 \text{ MHz}$	$-34\text{dBm} - \frac{7}{5} \left(\frac{f_{\text{offset}}}{\text{MHz}} - 0.05\right) \text{dB}$	100 kHz
$5 \text{ MHz} \leq \Delta f < \min(10 \text{ MHz}, \Delta f_{\text{max}})$	$5.05 \text{ MHz} \leq f_{\text{offset}} < \min(10.05 \text{ MHz}, f_{\text{offset}_{\text{max}}})$	-41 dBm	100 kHz
$10 \text{ MHz} \leq \Delta f \leq \Delta f_{\text{max}}$	$10.05 \text{ MHz} \leq f_{\text{offset}} < f_{\text{offset}_{\text{max}}}$	-41 dBm (Note 10)	100 kHz
NOTE 1: The limits in this table only apply for operation with a standalone NB-IoT carrier adjacent to the Base Station RF Bandwidth edge.			
NOTE 2: In case the carrier adjacent to the RF bandwidth edge is a standalone NB-IoT carrier, the value of $X = \text{PNB-IoTcarrier} - 20$, where PNB-IoTcarrier is the power level of the standalone NB-IoT carrier adjacent to the RF bandwidth edge. In other cases, $X = 0$.			

6.6.3.2H Minimum requirements for standalone NB-IoT Medium Range BS

For standalone NB-IoT medium range BS (maximum output power $31 < P_{\text{rated,c}} \leq 38$ dBm), emissions shall not exceed the maximum levels specified in Tables 6.6.3.2H-1.

Table 6.6.3.2H-1: Standalone NB-IoT medium range BS operating band unwanted emission limits, BS maximum output power $31 < P_{\text{rated,c}} \leq 38$ dBm

Frequency offset of measurement filter -3dB point, Δf	Frequency offset of measurement filter centre frequency, f_{offset}	Minimum requirement (Note 1, 2, 3)	Measurement bandwidth (Note 8)
$0 \text{ MHz} \leq \Delta f < 0.05 \text{ MHz}$ (Note 1)	$0.015 \text{ MHz} \leq f_{\text{offset}} < 0.065 \text{ MHz}$	$P_{\text{rated,c}} - 38\text{dB} - 60 \left(\frac{f_{\text{offset}}}{\text{MHz}} - 0.015 \right) \text{dB}$	30 kHz
$0.05 \text{ MHz} \leq \Delta f < 0.15 \text{ MHz}$	$0.065 \text{ MHz} \leq f_{\text{offset}} < 0.165 \text{ MHz}$	$P_{\text{rated,c}} - 41\text{dB} - 160 \left(\frac{f_{\text{offset}}}{\text{MHz}} - 0.065 \right) \text{dB}$	30 kHz
$0.15 \text{ MHz} \leq \Delta f < 0.6 \text{ MHz}$ (Note 1)	$0.015\text{MHz} \leq f_{\text{offset}} < 0.615\text{MHz}$	$P_{\text{rated,c}} - 58\text{dB} - \frac{5}{3} \left(\frac{f_{\text{offset}}}{\text{MHz}} - 0.015 \right) \text{dB}$	30 kHz
$0.6 \text{ MHz} \leq \Delta f < 1 \text{ MHz}$	$0.615\text{MHz} \leq f_{\text{offset}} < 1.015\text{MHz}$	$P_{\text{rated,c}} - 53\text{dB} - 15 \left(\frac{f_{\text{offset}}}{\text{MHz}} - 0.215 \right) \text{dB}$	30 kHz
(Note 6)	$1.015\text{MHz} \leq f_{\text{offset}} < 1.5 \text{ MHz}$	$P_{\text{rated,c}} - 65 \text{ dB}$	30 kHz
$1 \text{ MHz} \leq \Delta f \leq 2.8 \text{ MHz}$	$1.5 \text{ MHz} \leq f_{\text{offset}} < 3.3 \text{ MHz}$	$P_{\text{rated,c}} - 52 \text{ dB}$	1 MHz
$2.8 \text{ MHz} \leq \Delta f \leq 5 \text{ MHz}$	$3.3 \text{ MHz} \leq f_{\text{offset}} < 5.5 \text{ MHz}$	$\min(P_{\text{rated,c}} - 52 \text{ dB}, -15\text{dBm})$	1 MHz
$5 \text{ MHz} \leq \Delta f \leq \Delta f_{\text{max}}$	$5.5 \text{ MHz} \leq f_{\text{offset}} < f_{\text{offset}_{\text{max}}}$	$P_{\text{rated,c}} - 56 \text{ dB}$	1 MHz
<p>NOTE 1: The limits in this table only apply for operation with a standalone NB-IoT carrier adjacent to the Base Station RF Bandwidth edge.</p> <p>NOTE 2: For BS supporting non-contiguous spectrum operation within any operating band the minimum requirement within sub-block gaps is calculated as a cumulative sum of contributions from adjacent sub blocks on each side of the sub block gap, where the contribution from the far-end sub-block shall be scaled according to the measurement bandwidth of the near-end sub-block.</p> <p>NOTE 3: For BS supporting multi-band operation with Inter RF Bandwidth gap $< 20\text{MHz}$ the minimum requirement within the Inter RF Bandwidth gaps is calculated as a cumulative sum of contributions from adjacent sub-blocks or RF Bandwidth on each side of the Inter RF Bandwidth gap, where the contribution from the far-end sub-block or RF Bandwidth shall be scaled according to the measurement bandwidth of the near-end sub-block or RF Bandwidth.</p>			

For standalone NB-IoT medium range BS (maximum output power $P_{\text{rated,c}} \leq 31$ dBm), emissions shall not exceed the maximum levels specified in Tables 6.6.3.2H-2.

Table 6.6.3.2H-2: Standalone NB-IoT medium range BS operating band unwanted emission limits, BS maximum output power $P_{\text{rated,c}} \leq 31$ dBm

Frequency offset of measurement filter -3dB point, Δf	Frequency offset of measurement filter centre frequency, f_{offset}	Minimum requirement (Note 1, 2, 3, 4)	Measurement bandwidth (Note 8)
$0 \text{ MHz} \leq \Delta f < 0.05 \text{ MHz}$ (Note 1)	$0.015 \text{ MHz} \leq f_{\text{offset}} < 0.065 \text{ MHz}$	$\text{Max}(-7\text{dBm} - 60 \cdot \left(\frac{f_{\text{offset}}}{\text{MHz}} - 0.015\right) \text{dB} + X\text{dB} - 27\text{dBm})$	30 kHz
$0.05 \text{ MHz} \leq \Delta f < 0.15 \text{ MHz}$	$0.065 \text{ MHz} \leq f_{\text{offset}} < 0.165 \text{ MHz}$	$\text{Max}(-10\text{dBm} - 160 \cdot \left(\frac{f_{\text{offset}}}{\text{MHz}} - 0.065\right) \text{dB} + X\text{dB} - 27\text{dBm})$	30 kHz
$0.15 \text{ MHz} \leq \Delta f < 0.6 \text{ MHz}$ (Note 1)	$0.015\text{MHz} \leq f_{\text{offset}} < 0.615\text{MHz}$	$-27\text{dBm} - \frac{5}{3} \cdot \left(\frac{f_{\text{offset}}}{\text{MHz}} - 0.015\right) \text{dB}$	30 kHz
$0.6 \text{ MHz} \leq \Delta f < 1 \text{ MHz}$	$0.615\text{MHz} \leq f_{\text{offset}} < 1.015\text{MHz}$	$-22\text{dBm} - 15 \cdot \left(\frac{f_{\text{offset}}}{\text{MHz}} - 0.215\right) \text{dB}$	30 kHz
(Note 6)	$1.015\text{MHz} \leq f_{\text{offset}} < 1.5 \text{ MHz}$	-34 dBm	30 kHz
$1 \text{ MHz} \leq \Delta f \leq 5 \text{ MHz}$	$1.5 \text{ MHz} \leq f_{\text{offset}} < 5.5 \text{ MHz}$	-21 dBm	1 MHz
$5 \text{ MHz} \leq \Delta f \leq \Delta f_{\text{max}}$	$5.5 \text{ MHz} \leq f_{\text{offset}} < f_{\text{offset}_{\text{max}}}$	-25 dBm	1 MHz
<p>NOTE 1: The limits in this table only apply for operation with a NB-IoT carrier adjacent to the Base Station RF Bandwidth edge.</p> <p>NOTE 2: For BS supporting non-contiguous spectrum operation within any operating band the minimum requirement within sub-block gaps is calculated as a cumulative sum of contributions from adjacent sub blocks on each side of the sub block gap, where the contribution from the far-end sub-block shall be scaled according to the measurement bandwidth of the near-end sub-block.</p> <p>NOTE 3: For BS supporting multi-band operation with Inter RF Bandwidth gap < 20MHz the minimum requirement within the Inter RF Bandwidth gaps is calculated as a cumulative sum of contributions from adjacent sub-blocks or RF Bandwidth on each side of the Inter RF Bandwidth gap, where the contribution from the far-end sub-block or RF Bandwidth shall be scaled according to the measurement bandwidth of the near-end sub-block or RF Bandwidth.</p> <p>NOTE 4: In case the carrier adjacent to the RF bandwidth edge is a NB-IoT carrier, the value of $X = P_{\text{NB-IoTcarrier}} - 31$, where $P_{\text{NB-IoTcarrier}}$ is the power level of the NB-IoT carrier adjacent to the RF bandwidth edge. In other cases, $X = 0$.</p>			

6.6.3.3 Additional requirements

These requirements may be applied for the protection of other systems operating inside or near each supported E-UTRA, E-UTRA with NB-IoT and NB-IoT BS downlink operating band. The limits may apply as an optional protection of such systems that are deployed in the same geographical area as the E-UTRA, E-UTRA with NB-IoT and NB-IoT BS, or they may be set by local or regional regulation as a mandatory requirement for an E-UTRA operating band. It is in some cases not stated in the present document whether a requirement is mandatory or under what exact

circumstances that a limit applies, since this is set by local or regional regulation. An overview of regional requirements in the present document is given in clause 4.3.

In certain regions the following requirement may apply. For E-UTRA, E-UTRA with NB-IoT and NB-IoT BS operating in Bands 5, 26, 27 or 28, emissions shall not exceed the maximum levels specified in Tables 6.6.3.3-1.

Table 6.6.3.3-1: Additional operating band unwanted emission limits for E-UTRA bands <1GHz

Channel bandwidth	Frequency offset of measurement filter -3dB point, Δf	Frequency offset of measurement filter centre frequency, f_{offset}	Minimum requirement	Measurement bandwidth (Note 8)
200 kHz	$0 \text{ MHz} \leq \Delta f < 1 \text{ MHz}$	$0.005 \text{ MHz} \leq f_{\text{offset}} < 0.995 \text{ MHz}$	-6 dBm	10 kHz
1.4 MHz	$0 \text{ MHz} \leq \Delta f < 1 \text{ MHz}$	$0.005 \text{ MHz} \leq f_{\text{offset}} < 0.995 \text{ MHz}$	-14 dBm	10 kHz
3 MHz	$0 \text{ MHz} \leq \Delta f < 1 \text{ MHz}$	$0.015 \text{ MHz} \leq f_{\text{offset}} < 0.985 \text{ MHz}$	-13 dBm	30 kHz
5 MHz	$0 \text{ MHz} \leq \Delta f < 1 \text{ MHz}$	$0.015 \text{ MHz} \leq f_{\text{offset}} < 0.985 \text{ MHz}$	-15 dBm	30 kHz
10 MHz	$0 \text{ MHz} \leq \Delta f < 1 \text{ MHz}$	$0.05 \text{ MHz} \leq f_{\text{offset}} < 0.95 \text{ MHz}$	-13 dBm	100 kHz
15 MHz	$0 \text{ MHz} \leq \Delta f < 1 \text{ MHz}$	$0.05 \text{ MHz} \leq f_{\text{offset}} < 0.95 \text{ MHz}$	-13 dBm	100 kHz
20 MHz	$0 \text{ MHz} \leq \Delta f < 1 \text{ MHz}$	$0.05 \text{ MHz} \leq f_{\text{offset}} < 0.95 \text{ MHz}$	-13 dBm	100 kHz
All	$1 \text{ MHz} \leq \Delta f < \Delta f_{\text{max}}$	$1.05 \text{ MHz} \leq f_{\text{offset}} < f_{\text{offset}_{\text{max}}}$	-13 dBm	100 kHz

In certain regions the following requirement may apply. For E-UTRA, E-UTRA with NB-IoT and NB-IoT BS operating in Bands 2, 4, 10, 23, 25, 30, 35, 36, 41, 66, 70, emissions shall not exceed the maximum levels specified in Table 6.6.3.3-2.

Table 6.6.3.3-2: Additional operating band unwanted emission limits for E-UTRA bands >1GHz

Channel bandwidth	Frequency offset of measurement filter -3dB point, Δf	Frequency offset of measurement filter centre frequency, f_{offset}	Minimum requirement	Measurement bandwidth (Note 8)
200 kHz	$0 \text{ MHz} \leq \Delta f < 1 \text{ MHz}$	$0.005 \text{ MHz} \leq f_{\text{offset}} < 0.995 \text{ MHz}$	-6 dBm	10 kHz
1.4 MHz	$0 \text{ MHz} \leq \Delta f < 1 \text{ MHz}$	$0.005 \text{ MHz} \leq f_{\text{offset}} < 0.995 \text{ MHz}$	-14 dBm	10 kHz
3 MHz	$0 \text{ MHz} \leq \Delta f < 1 \text{ MHz}$	$0.015 \text{ MHz} \leq f_{\text{offset}} < 0.985 \text{ MHz}$	-13 dBm	30 kHz
5 MHz	$0 \text{ MHz} \leq \Delta f < 1 \text{ MHz}$	$0.015 \text{ MHz} \leq f_{\text{offset}} < 0.985 \text{ MHz}$	-15 dBm	30 kHz
10 MHz	$0 \text{ MHz} \leq \Delta f < 1 \text{ MHz}$	$0.05 \text{ MHz} \leq f_{\text{offset}} < 0.95 \text{ MHz}$	-13 dBm	100 kHz
15 MHz	$0 \text{ MHz} \leq \Delta f < 1 \text{ MHz}$	$0.05 \text{ MHz} \leq f_{\text{offset}} < 0.95 \text{ MHz}$	-15 dBm	100 kHz
20 MHz	$0 \text{ MHz} \leq \Delta f < 1 \text{ MHz}$	$0.05 \text{ MHz} \leq f_{\text{offset}} < 0.95 \text{ MHz}$	-16 dBm	100 kHz
All	$1 \text{ MHz} \leq \Delta f < \Delta f_{\text{max}}$	$1.5 \text{ MHz} \leq f_{\text{offset}} < f_{\text{offset}_{\text{max}}}$	-13 dBm	1 MHz

In certain regions the following requirement may apply. For E-UTRA, E-UTRA with NB-IoT and NB-IoT BS operating in Bands 12, 13, 14, 17, 29, 71, 85 emissions shall not exceed the maximum levels specified in Table 6.6.3.3-3.

Table 6.6.3.3-3: Additional operating band unwanted emission limits for E-UTRA (bands 12, 13, 14, 17, 29, 71 and 85)

Channel bandwidth	Frequency offset of measurement filter -3dB point, Δf	Frequency offset of measurement filter centre frequency, f_{offset}	Minimum requirement	Measurement bandwidth (Note 8)
All	$0 \text{ MHz} \leq \Delta f < 100 \text{ kHz}$	$0.015 \text{ MHz} \leq f_{\text{offset}} < 0.085 \text{ MHz}$	-13 dBm	30 kHz
All	$100 \text{ kHz} \leq \Delta f < \Delta f_{\text{max}}$	$150 \text{ kHz} \leq f_{\text{offset}} < f_{\text{offset}_{\text{max}}}$	-13 dBm	100 kHz

In certain regions, the following requirements may apply to an E-UTRA, E-UTRA with NB-IoT and NB-IoT TDD BS operating in the same geographic area and in the same operating band as another E-UTRA TDD system without synchronisation. For this case the emissions shall not exceed -52 dBm/MHz in each supported downlink operating band except in:

- The frequency range from 10 MHz below the lower channel edge to the frequency 10 MHz above the upper channel edge of each supported band.

In certain regions the following requirement may apply for protection of DTT. For E-UTRA BS operating in Band 20, the level of emissions in the band 470-790 MHz, measured in an 8MHz filter bandwidth on centre frequencies F_{filter}

according to Table 6.6.3.3-4, shall not exceed the maximum emission level $P_{EM,N}$ declared by the manufacturer. This requirement applies in the frequency range 470-790 MHz even though part of the range falls in the spurious domain.

Table 6.6.3.3-4: Declared emissions levels for protection of DTT

Filter centre frequency, F_{filter}	Measurement bandwidth	Declared emission level [dBm]
$F_{\text{filter}} = 8 \cdot N + 306$ (MHz); $21 \leq N \leq 60$	8 MHz	$P_{EM,N}$

Note: The regional requirement is defined in terms of EIRP (effective isotropic radiated power), which is dependent on both the BS emissions at the antenna connector and the deployment (including antenna gain and feeder loss). The requirement defined above provides the characteristics of the base station needed to verify compliance with the regional requirement. Compliance with the regional requirement can be determined using the method outlined in Annex G.

Table 6.6.3.3-5: Void

In regions where FCC regulation applies, requirements for protection of GPS according to FCC Order DA 20-48 applies for operation in Band 24. The following normative requirement covers the base station, to be used together with other information about the site installation to verify compliance with the requirement in FCC Order DA 20-48. The requirement applies to BS operating in Band 24 to ensure that appropriate interference protection is provided to the 1541 – 1650 MHz band. This requirement applies to the frequency range 1541-1650 MHz, even though part of this range falls within the spurious domain.

The level of emissions in the 1541 – 1650 MHz band, measured in measurement bandwidth according to Table 6.6.3.3-6 shall not exceed the maximum emission levels $P_{EM,B24,a}$, $P_{EM,B24,b}$, $P_{EM,B24,c}$, $P_{EM,B24,d}$, $P_{EM,B24,e}$ and $P_{EM,B24,f}$ declared by the manufacturer.

Table 6.6.3.3-6: Declared emissions levels for protection of the 1541-1650 MHz band

Operating Band	Frequency range	Declared emission level (dBW) (Measurement bandwidth = 1 MHz)	Declared emission level (dBW) of discrete emissions of less than 700 Hz bandwidth (Measurement bandwidth = 1 kHz)	Declared emission level (dBW) of discrete emissions of less than 2 kHz bandwidth (Measurement bandwidth = 1 kHz)
24	1541 - 1559 MHz	$P_{EM,B24,a}$		$P_{EM,B24,f}$
	1559 - 1610 MHz	$P_{EM,B24,b}$	$P_{EM,B24,d}$	
	1610 - 1650 MHz	$P_{EM,B24,c}$	$P_{EM,B24,e}$	

Note: The regional requirements in FCC Order DA 20-48 are defined in terms of EIRP (effective isotropic radiated power), which is dependent on both the BS emissions at the antenna connector and the deployment (including antenna gain and feeder loss). The EIRP level is calculated using: $P_{EIRP} = P_E + G_{\text{ant}}$ where P_E denotes the BS unwanted emission level at the antenna connector, G_{ant} equals the BS antenna gain minus feeder loss. The requirement defined above provides the characteristics of the base station needed to verify compliance with the regional requirement.

Table 6.6.3.3-7: Void

In certain regions, the following requirements may apply to E-UTRA BS operating in Band 32 within 1452-1492 MHz, in Band 75 within 1432-1517 MHz and in Band 76 within 1427-1432 MHz. The level of operating band unwanted emissions, measured on centre frequencies f_{offset} with filter bandwidth, according to Table 6.6.3.3-8, shall neither exceed the maximum emission level $P_{EM,B32,B75,B76,a}$, $P_{EM,B32,B75,B76,b}$ nor $P_{EM,B32,B75,B76,c}$ declared by the manufacturer.

For Band 32, this requirement applies in the frequency range 1452-1492 MHz when non-Mobile/Fixed Communications Network (MFCN) services are deployed in adjacent frequency ranges, while it applies also within 1427-1452 MHz and/or 1492-1517 MHz when MFCN services are deployed in such frequency ranges, even though part of the ranges falls in the spurious domain. For Band 75, this requirement applies in the frequency range 1427-1517 MHz. For Band 76, this requirement applies in the frequency range 1432-1517 MHz even though part of the range falls in the spurious domain.

Table 6.6.3.3-8: Declared operating band 32, 75 and 76 unwanted emission within 1427-1517 MHz

Frequency offset of measurement filter centre frequency, f_{offset}	Declared emission level [dBm]	Measurement bandwidth
2.5 MHz	$P_{EM,B32,B75,B76,a}$	5 MHz
7.5 MHz	$P_{EM,B32,B75,B76,b}$	5 MHz
$12.5 \text{ MHz} \leq f_{\text{offset}} \leq f_{\text{offset}_{\text{max}}}$	$P_{EM,B32,B75,B76,c}$	5 MHz
NOTE: For Band 32, when non-MFCN services are deployed in the adjacent bands, $f_{\text{offset}_{\text{max}}}$ denotes the frequency difference between the lower channel edge and 1454.5 MHz, and the frequency difference between the upper channel edge and 1489.5 MHz for the set channel position. For Band 32, when MFCN services are deployed in the adjacent frequencies, Band 75 and Band 76, $f_{\text{offset}_{\text{max}}}$ denotes the frequency difference between the lower channel edge and 1429.5 MHz, and the frequency difference between the upper channel edge and 1514.5 MHz for the set channel position.		

NOTE: The regional requirement, included in [19], is defined in terms of EIRP per antenna, which is dependent on both the BS emissions at the antenna connector and the deployment (including antenna gain and feeder loss). The requirement defined above provides the characteristics of the base station needed to verify compliance with the regional requirement. The assessment of the EIRP level is described in Annex H.

In certain regions, the following requirement may apply to E-UTRA BS operating in Band 32 within 1452-1492 MHz for the protection of non-MFCN services in spectrum adjacent to the frequency range 1452-1492 MHz. The level of emissions, measured on centre frequencies F_{filter} with filter bandwidth according to Table 6.6.3.3-9, shall neither exceed the maximum emission level $P_{EM,B32,d}$ nor $P_{EM,B32,e}$ declared by the manufacturer. This requirement applies in the frequency range 1429-1518MHz even though part of the range falls in the spurious domain.

Table 6.6.3.3-9: Operating band 32 declared emission outside 1452-1492 MHz

Filter centre frequency, F_{filter}	Declared emission level [dBm]	Measurement bandwidth
$1429.5 \text{ MHz} \leq F_{\text{filter}} \leq 1448.5 \text{ MHz}$	$P_{EM,B32,d}$	1 MHz
$F_{\text{filter}} = 1450.5 \text{ MHz}$	$P_{EM,B32,e}$	3 MHz
$F_{\text{filter}} = 1493.5 \text{ MHz}$	$P_{EM,B32,e}$	3 MHz
$1495.5 \text{ MHz} \leq F_{\text{filter}} \leq 1517.5 \text{ MHz}$	$P_{EM,B32,d}$	1 MHz

NOTE: The regional requirement, included in [16], is defined in terms of EIRP, which is dependent on both the BS emissions at the antenna connector and the deployment (including antenna gain and feeder loss). The requirement defined above provides the characteristics of the base station needed to verify compliance with the regional requirement. The assessment of the EIRP level is described in Annex H.

In certain regions, the following requirement may apply to BS operating in Band 50 and Band 75 within 1492-1517 MHz and in Band 74 within 1492-1518 MHz. The level of emissions, measured on centre frequencies F_{filter} with filter bandwidth according to Table 6.6.3.3-9A, shall neither exceed the maximum emission level $P_{EM,B50,B74,B75,a}$ nor $P_{EM,B50,B74,B75,b}$ declared by the manufacturer.

Table 6.6.3.3-9A: Operating band 50, 74 and 75 declared emission above 1518 MHz

Filter centre frequency, F_{filter}	Declared emission level [dBm]	Measurement bandwidth
$1518.5 \text{ MHz} \leq F_{\text{filter}} \leq 1519.5 \text{ MHz}$	$P_{EM,B50,B74,B75,a}$	1 MHz
$1520.5 \text{ MHz} \leq F_{\text{filter}} \leq 1558.5 \text{ MHz}$	$P_{EM,B50,B74,B75,b}$	1 MHz

NOTE: The regional requirement, included in [19], is defined in terms of EIRP, which is dependent on both the BS emissions at the antenna connector and the deployment (including antenna gain and feeder loss). The requirement defined above provides the characteristics of the base station needed to verify compliance with the regional requirement. The assessment of the EIRP level is described in Annex H.

In certain regions, the following requirement may apply to E-UTRA BS operating in Band 50 and Band 75 within 1432-1452 MHz, and in Band 51 and Band 76. Emissions shall not exceed the maximum levels specified in Table 6.6.3.3-9B.

Table 6.6.3.3-9B: Additional operating band unwanted emission limits for BS operating in Band 50 and 75 within 1432-1452 MHz, and in Band 51 and 76

Filter centre frequency, F_{filter}	Maximum Level [dBm]	Measurement Bandwidth
$F_{\text{filter}} = 1413.5$ MHz	-42	27 MHz

In addition for Band 46 operation, the BS may have to comply with the applicable operating band unwanted emission limits established regionally, when deployed in regions where those limits apply and under the conditions declared by the manufacturer. The regional requirements may be in the form of conducted power, power spectral density, EIRP and other types of limits. In case of regulatory limits based on EIRP, assessment of the EIRP level is described in Annex H.

In certain regions the following requirement may apply to E-UTRA BS operating in Band 45. Emissions shall not exceed the maximum levels specified in Table 6.6.3.3-10.

Table 6.6.3.3-10: Emissions limits for protection of adjacent band services

Operating Band	Filter centre frequency, F_{filter}	Maximum Level [dBm]	Measurement Bandwidth
45	$F_{\text{filter}} = 1467.5$	-20	1 MHz
	$F_{\text{filter}} = 1468.5$	-23	1 MHz
	$F_{\text{filter}} = 1469.5$	-26	1 MHz
	$F_{\text{filter}} = 1470.5$	-33	1 MHz
	$F_{\text{filter}} = 1471.5$	-40	1 MHz
	$1472.5 \text{ MHz} \leq F_{\text{filter}} \leq 1491.5 \text{ MHz}$	-47	1 MHz

The following requirement may apply to E-UTRA BS operating in Band 48 and Band 49 in certain regions. Emissions shall not exceed the maximum levels specified in Table 6.6.3.3-11.

Table 6.6.3.3-11: Additional operating band unwanted emission limits for Band 48 and Band 49

Channel bandwidth	Frequency offset of measurement filter -3dB point, Δf	Frequency offset of measurement filter centre frequency, f_{offset}	Minimum requirement	Measurement bandwidth (Note 8)
All	$0 \text{ MHz} \leq \Delta f < 10 \text{ MHz}$	$0.5 \text{ MHz} \leq f_{\text{offset}} < 9.5 \text{ MHz}$	-13 dBm	1 MHz

The following requirement may apply to E-UTRA BS operating in Band 53 in certain regions. Emissions shall not exceed the maximum levels specified in Table 6.6.3.3-12.

Table 6.6.3.3-12: Additional operating band unwanted emission limits for Band 53

Channel bandwidth [MHz]	Frequency range [MHz]	Frequency offset of measurement filter -3dB point, Δf	Frequency offset of measurement filter centre frequency, f_{offset}	Minimum requirement	Measurement bandwidth (Note 8)
1.4, 3, 5	2400 - 2477.5	$6 \text{ MHz} \leq \Delta f < 83.5 \text{ MHz}$	$6.5 \text{ MHz} \leq f_{\text{offset}} < 83 \text{ MHz}$	-25 dBm	1 MHz
10	2400 - 2473.5	$10 \text{ MHz} \leq \Delta f < 83.5 \text{ MHz}$	$10.5 \text{ MHz} \leq f_{\text{offset}} < 83 \text{ MHz}$	-25 dBm	1 MHz
1.4, 3, 5	2477.5 - 2478.5	$5 \text{ MHz} \leq \Delta f < 6 \text{ MHz}$	5.5 MHz	-13 dBm	1 MHz
10	2473.5 - 2478.5	$5 \text{ MHz} \leq \Delta f < 10 \text{ MHz}$	$5.5 \text{ MHz} \leq f_{\text{offset}} < 9.5 \text{ MHz}$	-13 dBm	1 MHz
All	2478.5 - 2483.5	$0 \text{ MHz} \leq \Delta f < 5 \text{ MHz}$	$0.5 \text{ MHz} \leq f_{\text{offset}} < 4.5 \text{ MHz}$	-10 dBm	1 MHz
1.4, 3, 5	2495 - 2501	$0 \text{ MHz} \leq \Delta f < 6 \text{ MHz}$	$0.5 \text{ MHz} \leq f_{\text{offset}} < 5.5 \text{ MHz}$	-13 dBm	1 MHz
10	2495 - 2505	$0 \text{ MHz} \leq \Delta f < 10 \text{ MHz}$	$0.5 \text{ MHz} \leq f_{\text{offset}} < 9.5 \text{ MHz}$	-13 dBm	1 MHz
1.4, 3, 5	2501 - 2690	$6 \text{ MHz} \leq \Delta f < 195 \text{ MHz}$	$6.5 \text{ MHz} \leq f_{\text{offset}} < 194.5 \text{ MHz}$	-25 dBm	1 MHz
10	2505 - 2690	$10 \text{ MHz} \leq \Delta f < 195 \text{ MHz}$	$10.5 \text{ MHz} \leq f_{\text{offset}} < 194.5 \text{ MHz}$	-25 dBm	1 MHz

The following notes are common to all clauses in 6.6.3:

NOTE 6: Local or regional regulations may specify another excluded frequency range, which may include frequencies where synchronised E-UTRA TDD systems operate.

NOTE 7: E-UTRA TDD base stations that are synchronized can transmit without these additional co-existence requirements.

NOTE 8: As a general rule for the requirements in clause 6.6.3, the resolution bandwidth of the measuring equipment should be equal to the measurement bandwidth. However, to improve measurement accuracy, sensitivity and efficiency, the resolution bandwidth may be smaller than the measurement bandwidth. When the resolution bandwidth is smaller than the measurement bandwidth, the result should be integrated over the measurement bandwidth in order to obtain the equivalent noise bandwidth of the measurement bandwidth.

NOTE 9: This frequency range ensures that the range of values of f_{offset} is continuous.

NOTE 10: The requirement is not applicable when $\Delta f_{\text{max}} < 10$ MHz.

NOTE 11: For Home BS, the parameter P is defined as the aggregated maximum output power of all transmit antenna connectors of Home BS.

6.6.4 Transmitter spurious emissions

The transmitter spurious emission limits apply from 9 kHz to 12.75 GHz, excluding the frequency range from 10 MHz below the lowest frequency of the downlink operating band up to 10 MHz above the highest frequency of the downlink operating band. For BS capable of multi-band operation where multiple bands are mapped on the same antenna connector, this exclusion applies for each supported operating band. For BS capable of multi-band operation where multiple bands are mapped on separate antenna connectors, the single-band requirements apply and the multi-band exclusions and provisions are not applicable. Exceptions are the requirements in Table 6.6.4.3.1-2, Table 6.6.4.3.1-3, and specifically stated exceptions in Table 6.6.4.3.1-1 that apply also closer than 10 MHz from the downlink operating band and Table 6.6.4.3.1-1a that applies inside the downlink operating band. For some operating bands the upper frequency limit is higher than 12.75 GHz.

The requirements shall apply to BS that supports E-UTRA or E-UTRA with NB-IoT in-band/guard band operation or NB-IoT standalone operation.

The requirements shall apply whatever the type of transmitter considered (single carrier or multi-carrier). It applies for all transmission modes foreseen by the manufacturer's specification. Unless otherwise stated, all requirements are measured as mean power (RMS).

6.6.4.1 Mandatory Requirements

The requirements of either clause 6.6.4.1.1 (Category A limits) or clause 6.6.4.1.2 (Category B limits) shall apply. The application of either Category A or Category B limits shall be the same as for Operating band unwanted emissions in clause 6.6.3.

6.6.4.1.1 Spurious emissions (Category A)

6.6.4.1.1.1 Minimum Requirement

The power of any spurious emission shall not exceed the limits in Table 6.6.4.1.1.1-1

Table 6.6.4.1.1.1-1: BS Spurious emission limits, Category A

Frequency range	Maximum level	Measurement Bandwidth	Note
9kHz - 150kHz	-13 dBm	1 kHz	Note 1
150kHz - 30MHz		10 kHz	Note 1
30MHz - 1GHz		100 kHz	Note 1
1GHz - 12.75 GHz		1 MHz	Note 2
12.75 GHz - 5 th harmonic of the upper frequency edge of the DL operating band in GHz		1 MHz	Note 2, Note 3
12.75 GHz - 26 GHz		1 MHz	Note 2, Note 4
NOTE 1: Bandwidth as in ITU-R SM.329 [2] , s4.1 NOTE 2: Bandwidth as in ITU-R SM.329 [2] , s4.1. Upper frequency as in ITU-R SM.329 [2] , s2.5 table 1 NOTE 3: Applies only for Bands 22, 42, 43, 48 and 49. NOTE 4: Applies only for Band 46.			

6.6.4.1.2 Spurious emissions (Category B)

6.6.4.1.2.1 Minimum Requirement

The power of any spurious emission shall not exceed the limits in Table 6.6.4.1.2.1-1

Table 6.6.4.1.2.1-1: BS Spurious emissions limits, Category B

Frequency range	Maximum Level	Measurement Bandwidth	Note
9 kHz ↔ 150 kHz	-36 dBm	1 kHz	Note 1
150 kHz ↔ 30 MHz	-36 dBm	10 kHz	Note 1
30 MHz ↔ 1 GHz	-36 dBm	100 kHz	Note 1
1 GHz ↔ 12.75 GHz	-30 dBm	1 MHz	Note 2
12.75 GHz ↔ 5 th harmonic of the upper frequency edge of the DL operating band in GHz	-30 dBm	1 MHz	Note 2, Note 3
12.75 GHz ↔ 26 GHz	-30 dBm	1 MHz	Note 2, Note 4
NOTE 1: Bandwidth as in ITU-R SM.329 [2] , s4.1 NOTE 2: Bandwidth as in ITU-R SM.329 [2] , s4.1. Upper frequency as in ITU-R SM.329 [2] , s2.5 table 1 NOTE 3: Applies only for Bands 22, 42, 43, 48 and 49. NOTE 4: Applies only for Band 46.			

6.6.4.2 Protection of the BS receiver of own or different BS

This requirement shall be applied for E-UTRA FDD operation in order to prevent the receivers of the BSs being desensitised by emissions from a BS transmitter. It is measured at the transmit antenna port for any type of BS which has common or separate Tx/Rx antenna ports.

6.6.4.2.1 Minimum Requirement

The power of any spurious emission shall not exceed the limits in Table 6.6.4.2-1.

Table 6.6.4.2-1: BS Spurious emissions limits for protection of the BS receiver

	Frequency range	Maximum Level	Measurement Bandwidth	Note
Wide Area BS	$F_{UL_low} - F_{UL_high}$	-96 dBm	100 kHz	
Medium Range BS	$F_{UL_low} - F_{UL_high}$	-91 dBm	100 kHz	
Local Area BS	$F_{UL_low} - F_{UL_high}$	-88 dBm	100 kHz	
Home BS	$F_{UL_low} - F_{UL_high}$	-88 dBm	100 kHz	
Note 1: For E-UTRA Band 28 BS operating in regions where Band 28 is only partially allocated for E-UTRA operations, this requirement only applies in the UL frequency range of the partial allocation.				

6.6.4.3 Additional spurious emissions requirements

These requirements may be applied for the protection of system operating in frequency ranges other than the E-UTRA BS downlink operating band. The limits may apply as an optional protection of such systems that are deployed in the same geographical area as the E-UTRA BS, or they may be set by local or regional regulation as a mandatory requirement for an E-UTRA operating band. It is in some cases not stated in the present document whether a requirement is mandatory or under what exact circumstances that a limit applies, since this is set by local or regional regulation. An overview of regional requirements in the present document is given in clause 4.3.

Some requirements may apply for the protection of specific equipment (UE, MS and/or BS) or equipment operating in specific systems (GSM, CDMA, UTRA, E-UTRA, NR, etc.) as listed below.

6.6.4.3.1 Minimum Requirement

The power of any spurious emission shall not exceed the limits of Table 6.6.4.3.1-1 for a BS where requirements for co-existence with the system listed in the first column apply. For BS capable of multi-band operation, the exclusions and conditions in the Note column of Table 6.6.4.3.1-1 apply for each supported operating band. For BS capable of multi-

band operation where multiple bands are mapped on separate antenna connectors, the exclusions and conditions in the Note column of Table 6.6.4.3.1-1 apply for the operating band supported at that antenna connector.

Table 6.6.4.3.1-1: BS Spurious emissions limits for E-UTRA BS for co-existence with systems operating in other frequency bands

System type for E-UTRA to co-exist with	Frequency range for co-existence requirement	Maximum Level	Measurement Bandwidth	Note
GSM900	921 - 960 MHz	-57 dBm	100 kHz	This requirement does not apply to E-UTRA BS operating in band 8
	876 - 915 MHz	-61 dBm	100 kHz	For the frequency range 880-915 MHz, this requirement does not apply to E-UTRA BS operating in band 8, since it is already covered by the requirement in clause 6.6.4.2.
DCS1800	1805 - 1880 MHz	-47 dBm	100 kHz	This requirement does not apply to E-UTRA BS operating in band 3.
	1710 - 1785 MHz	-61 dBm	100 kHz	This requirement does not apply to E-UTRA BS operating in band 3, since it is already covered by the requirement in clause 6.6.4.2.
PCS1900	1930 - 1990 MHz	-47 dBm	100 kHz	This requirement does not apply to E-UTRA BS operating in band 2, band 25, band 36 or band 70.
	1850 - 1910 MHz	-61 dBm	100 kHz	This requirement does not apply to E-UTRA BS operating in band 2 or 25, since it is already covered by the requirement in clause 6.6.4.2. This requirement does not apply to E-UTRA BS operating in band 35.
GSM850 or CDMA850	869 - 894 MHz	-57 dBm	100 kHz	This requirement does not apply to E-UTRA BS operating in band 5 or 26. This requirement applies to E-UTRA BS operating in Band 27 for the frequency range 879-894 MHz.
	824 - 849 MHz	-61 dBm	100 kHz	This requirement does not apply to E-UTRA BS operating in band 5 or 26, since it is already covered by the requirement in clause 6.6.4.2. For E-UTRA BS operating in Band 27, it applies 3 MHz below the Band 27 downlink operating band.
UTRA FDD Band I or E-UTRA Band 1 or NR Band n1	2110 - 2170 MHz	-52 dBm	1 MHz	This requirement does not apply to E-UTRA BS operating in band 1 or 65
	1920 - 1980 MHz	-49 dBm	1 MHz	This requirement does not apply to E-UTRA BS operating in band 1 or 65, since it is already covered by the requirement in clause 6.6.4.2.
UTRA FDD Band II or E-UTRA Band 2 or NR Band n2	1930 - 1990 MHz	-52 dBm	1 MHz	This requirement does not apply to E-UTRA BS operating in band 2, 25 or 70.
	1850 - 1910 MHz	-49 dBm	1 MHz	This requirement does not apply to E-UTRA BS operating in band 2 or 25, since it is already covered by the requirement in clause 6.6.4.2
UTRA FDD Band III or E-UTRA Band 3 or NR Band n3	1805 - 1880 MHz	-52 dBm	1 MHz	This requirement does not apply to E-UTRA BS operating in band 3 or 9.
	1710 - 1785 MHz	-49 dBm	1 MHz	This requirement does not apply to E-UTRA BS operating in band 3, since it is already covered by the requirement in clause 6.6.4.2. For E-UTRA BS operating in band 9, it applies for 1710 MHz to 1749.9 MHz and 1784.9 MHz to 1785 MHz, while the rest is covered in clause 6.6.4.2.
UTRA FDD Band IV or E-UTRA Band 4	2110 - 2155 MHz	-52 dBm	1 MHz	This requirement does not apply to E-UTRA BS operating in band 4, 10 or 66
	1710 - 1755 MHz	-49 dBm	1 MHz	This requirement does not apply to E-UTRA BS operating in band 4, 10 or 66, since it is already covered by the requirement in clause 6.6.4.2.
UTRA FDD Band V or E-UTRA Band 5 or NR Band n5	869 - 894 MHz	-52 dBm	1 MHz	This requirement does not apply to E-UTRA BS operating in band 5 or 26. This requirement applies to E-UTRA BS operating in Band 27 for the frequency range 879-894 MHz.
	824 - 849 MHz	-49 dBm	1 MHz	This requirement does not apply to E-UTRA BS operating in band 5 or 26, since it is already covered by the requirement in clause 6.6.4.2. For E-UTRA BS operating in Band 27, it applies 3 MHz below the Band 27 downlink operating band.
UTRA FDD Band VI, XIX or E-UTRA Band 6, 18, 19 or NR Band n18	860 - 890 MHz	-52 dBm	1 MHz	This requirement does not apply to E-UTRA BS operating in band 6, 18, 19.
	815 - 830 MHz	-49 dBm	1 MHz	This requirement does not apply to E-UTRA BS operating in band 18, since it is already covered by the requirement in clause 6.6.4.2.

	830 - 845 MHz	-49 dBm	1 MHz	This requirement does not apply to E-UTRA BS operating in band 6, 19, since it is already covered by the requirement in clause 6.6.4.2.
UTRA FDD Band VII or E-UTRA Band 7 or NR Band n7	2620 - 2690 MHz	-52 dBm	1 MHz	This requirement does not apply to E-UTRA BS operating in band 7.
	2500 - 2570 MHz	-49 dBm	1 MHz	This requirement does not apply to E-UTRA BS operating in band 7, since it is already covered by the requirement in clause 6.6.4.2.
UTRA FDD Band VIII or E-UTRA Band 8 or NR Band n8	925 - 960 MHz	-52 dBm	1 MHz	This requirement does not apply to E-UTRA BS operating in band 8.
	880 - 915 MHz	-49 dBm	1 MHz	This requirement does not apply to E-UTRA BS operating in band 8, since it is already covered by the requirement in clause 6.6.4.2.
UTRA FDD Band IX or E-UTRA Band 9	1844.9 - 1879.9 MHz	-52 dBm	1 MHz	This requirement does not apply to E-UTRA BS operating in band 3 or 9.
	1749.9 - 1784.9 MHz	-49 dBm	1 MHz	This requirement does not apply to E-UTRA BS operating in band 3 or 9, since it is already covered by the requirement in clause 6.6.4.2.
UTRA FDD Band X or E-UTRA Band 10	2110 - 2170 MHz	-52 dBm	1 MHz	This requirement does not apply to E-UTRA BS operating in band 4, 10 or 66
	1710 - 1770 MHz	-49 dBm	1 MHz	This requirement does not apply to E-UTRA BS operating in band 10 or 66, since it is already covered by the requirement in clause 6.6.4.2. For E-UTRA BS operating in Band 4, it applies for 1755 MHz to 1770 MHz, while the rest is covered in clause 6.6.4.2.
UTRA FDD Band XI or XXI or E-UTRA Band 11 or 21	1475.9 - 1510.9 MHz	-52 dBm	1 MHz	This requirement does not apply to E-UTRA BS operating in band 11, 21, 32, 50, 74 or 75.
	1427.9 - 1447.9 MHz	-49 dBm	1 MHz	This requirement does not apply to E-UTRA BS operating in band 11 or 74, since it is already covered by the requirement in clause 6.6.4.2. This requirement does not apply to BS operating in band 32, 50, 51, 75 or 76.
	1447.9 - 1462.9 MHz	-49 dBm	1 MHz	This requirement does not apply to E-UTRA BS operating in band 21 or 74, since it is already covered by the requirement in clause 6.6.4.2. This requirement does not apply to BS operating in band 32, 50 or 75.
UTRA FDD Band XII or E-UTRA Band 12 or NR Band n12	729 - 746 MHz	-52 dBm	1 MHz	This requirement does not apply to E-UTRA BS operating in band 12 or 85.
	699 - 716 MHz	-49 dBm	1 MHz	This requirement does not apply to E-UTRA BS operating in band 12 or 85, since it is already covered by the requirement in clause 6.6.4.2. For E-UTRA BS operating in Band 29, it applies 1 MHz below the Band 29 downlink operating band (Note 6).
UTRA FDD Band XIII or E-UTRA Band 13	746 - 756 MHz	-52 dBm	1 MHz	This requirement does not apply to E-UTRA BS operating in band 13.
	777 - 787 MHz	-49 dBm	1 MHz	This requirement does not apply to E-UTRA BS operating in band 13, since it is already covered by the requirement in clause 6.6.4.2.
UTRA FDD Band XIV or E-UTRA Band 14 or NR Band n14	758 - 768 MHz	-52 dBm	1 MHz	This requirement does not apply to E-UTRA BS operating in band 14.
	788 - 798 MHz	-49 dBm	1 MHz	This requirement does not apply to E-UTRA BS operating in band 14, since it is already covered by the requirement in clause 6.6.4.2.
E-UTRA Band 17	734 - 746 MHz	-52 dBm	1 MHz	This requirement does not apply to E-UTRA BS operating in band 17.
	704 - 716 MHz	-49 dBm	1 MHz	This requirement does not apply to E-UTRA BS operating in band 17, since it is already covered by the requirement in clause 6.6.4.2. For E-UTRA BS operating in Band 29, it applies 1 MHz below the Band 29 downlink operating band (Note 6).
UTRA FDD Band XX or E-UTRA Band 20 or NR Band n20	791 - 821 MHz	-52 dBm	1 MHz	This requirement does not apply to E-UTRA BS operating in band 20 or 28.
	832 - 862 MHz	-49 dBm	1 MHz	This requirement does not apply to E-UTRA BS operating in band 20, since it is already covered by the requirement in clause 6.6.4.2.
	3510 – 3590 MHz	-52 dBm	1 MHz	This requirement does not apply to E-UTRA BS operating in band 22, 42, 48 or 49.

UTRA FDD Band XXII or E-UTRA Band 22	3410 – 3490 MHz	-49 dBm	1 MHz	This requirement does not apply to E-UTRA BS operating in band 22, since it is already covered by the requirement in clause 6.6.4.2. This requirement does not apply to E-UTRA BS operating in Band 42
E-UTRA Band 24	1525 – 1559 MHz	-52 dBm	1 MHz	This requirement does not apply to E-UTRA BS operating in band 24.
	1626.5 – 1660.5 MHz	-49 dBm	1 MHz	This requirement does not apply to E-UTRA BS operating in band 24, since it is already covered by the requirement in clause 6.6.4.2.
UTRA FDD Band XXV or E-UTRA Band 25 or NR Band n25	1930 – 1995 MHz	-52 dBm	1 MHz	This requirement does not apply to E-UTRA BS operating in band 2, 25 or 70.
	1850 – 1915 MHz	-49 dBm	1 MHz	This requirement does not apply to E-UTRA BS operating in band 25, since it is already covered by the requirement in clause 6.6.4.2. For E-UTRA BS operating in Band 2, it applies for 1910 MHz to 1915 MHz, while the rest is covered in clause 6.6.4.2
TRA FDD Band XXVI or E-UTRA Band 26 or NR Band n26	859 – 894 MHz	-52 dBm	1 MHz	This requirement does not apply to E-UTRA BS operating in band 5 or 26. This requirement applies to E-UTRA BS operating in Band 27 for the frequency range 879-894 MHz.
	814 – 849 MHz	-49 dBm	1 MHz	This requirement does not apply to E-UTRA BS operating in band 26, since it is already covered by the requirement in clause 6.6.4.2. For E-UTRA BS operating in Band 5, it applies for 814 MHz to 824 MHz, while the rest is covered in clause 6.6.4.2. For E-UTRA BS operating in Band 27, it applies 3 MHz below the Band 27 downlink operating band.
E-UTRA Band 27	852 – 869 MHz	-52 dBm	1 MHz	This requirement does not apply to E-UTRA BS operating in Band 5, 26 or 27.
	807 – 824 MHz	-49 dBm	1 MHz	This requirement does not apply to E-UTRA BS operating in Band 27, since it is already covered by the requirement in clause 6.6.4.2. For E-UTRA BS operating in Band 26, it applies for 807 MHz to 814 MHz, while the rest is covered in clause 6.6.4.2. This requirement also applies to E-UTRA BS operating in Band 28, starting 4 MHz above the Band 28 downlink operating band (Note 5).
E-UTRA Band 28 or NR Band n28	758 - 803 MHz	-52 dBm	1 MHz	This requirement does not apply to E-UTRA BS operating in band 20, 28, 44, 67 or 68.
	703 - 748 MHz	-49 dBm	1 MHz	This requirement does not apply to E-UTRA BS operating in band 28, since it is already covered by the requirement in clause 6.6.4.2. This requirement does not apply to E-UTRA BS operating in Band 44. For E-UTRA BS operating in Band 67, it applies for 703 MHz to 736 MHz. For E-UTRA BS operating in Band 68, it applies for 728MHz to 733MHz.
E-UTRA Band 29 or NR Band n29	717 – 728 MHz	-52 dBm	1 MHz	This requirement does not apply to E-UTRA BS operating in Band 29 or 85.
E-UTRA Band 30 or NR Band n30	2350 – 2360 MHz	-52 dBm	1 MHz	This requirement does not apply to E-UTRA BS operating in band 30 or 40.
	2305 – 2315 MHz	-49 dBm	1 MHz	This requirement does not apply to E-UTRA BS operating in band 30, since it is already covered by the requirement in clause 6.6.4.2. This requirement does not apply to E-UTRA BS operating in Band 40.
E-UTRA Band 31	462.5 -467.5 MHz	-52 dBm	1 MHz	This requirement does not apply to E-UTRA BS operating in band 31, 72 or 73.
	452.5 -457.5 MHz	-49 dBm	1 MHz	This requirement does not apply to E-UTRA BS operating in band 31, since it is already covered by the requirement in clause 6.6.4.2. This requirement does not apply to E-UTRA BS operating in band 72 or 73.
UTRA FDD band XXXII or E-UTRA band 32	1452 – 1496 MHz	-52 dBm	1 MHz	This requirement does not apply to E-UTRA BS operating in band 11, 21, 32, 50, 74 or 75.
UTRA TDD Band a) or E-UTRA Band 33	1900 - 1920 MHz	-52 dBm	1 MHz	This requirement does not apply to E-UTRA BS operating in Band 33.

UTRA TDD Band a) or E-UTRA Band 34 or NR Band n34	2010 - 2025 MHz	-52 dBm	1 MHz	This requirement does not apply to E-UTRA BS operating in Band 34.
UTRA TDD Band b) or E-UTRA Band 35	1850 - 1910 MHz	-52 dBm	1 MHz	This requirement does not apply to E-UTRA BS operating in Band 35.
UTRA TDD Band b) or E-UTRA Band 36	1930 - 1990 MHz	-52 dBm	1 MHz	This requirement does not apply to E-UTRA BS operating in Band 2 and 36.
UTRA TDD Band c) or E-UTRA Band 37	1910 - 1930 MHz	-52 dBm	1 MHz	This is not applicable to E-UTRA BS operating in Band 37. This unpaired band is defined in ITU-R M.1036, but is pending any future deployment.
UTRA TDD Band d) or E-UTRA Band 38 or NR Band n38	2570 - 2620 MHz	-52 dBm	1 MHz	This requirement does not apply to E-UTRA BS operating in Band 38 or 69.
UTRA TDD Band f) or E-UTRA Band 39 or NR Band n39	1880 - 1920MHz	-52 dBm	1 MHz	This is not applicable to E-UTRA BS operating in Band 39.
UTRA TDD Band e) or E-UTRA Band 40 or NR Band n40	2300 - 2400MHz	-52 dBm	1 MHz	This is not applicable to E-UTRA BS operating in Band 30 or 40.
E-UTRA Band 41 or NR Band n41	2496 - 2690 MHz	-52 dBm	1 MHz	This is not applicable to E-UTRA BS operating in Band 41 or 53.
E-UTRA Band 42	3400 - 3600 MHz	-52 dBm	1 MHz	This is not applicable to E-UTRA BS operating in Band 22, 42, 43, 48, 49 or 52.
E-UTRA Band 43	3600 - 3800 MHz	-52 dBm	1 MHz	This is not applicable to E-UTRA BS operating in Band 42, 43, 48 or 49.
E-UTRA Band 44	703 - 803 MHz	-52 dBm	1 MHz	This is not applicable to E-UTRA BS operating in Band 28 or 44.
E-UTRA Band 45	1447 - 1467 MHz	-52 dBm	1 MHz	This is not applicable to E-UTRA BS operating in Band 45.
E-UTRA Band 46 or NR Band n46	5150 - 5925 MHz	-52 dBm	1 MHz	This is not applicable to E-UTRA BS operating in Band 46.
E-UTRA Band 47	5855 - 5925 MHz	-52 dBm	1 MHz	
E-UTRA Band 48 or NR Band n48	3550 - 3700 MHz	-52 dBm	1 MHz	This is not applicable to E-UTRA BS operating in Band 22, 42, 43, 48 or 49.
E-UTRA Band 49	3550 - 3700 MHz	-52 dBm	1 MHz	This is not applicable to E-UTRA BS operating in Band 22, 42, 43, 48 or 49.
E-UTRA Band 50	1432 - 1517 MHz	-52 dBm	1 MHz	This requirement does not apply to E-UTRA BS operating in Band 11, 21, 32, 45, 50, 51, 74, 75 or 76.
E-UTRA Band 51 or NR Band n51	1427 - 1432 MHz	-52 dBm	1 MHz	This requirement does not apply to E-UTRA BS operating in Band 50, 51, 75 or 76.
E-UTRA Band 52	3300 - 3400 MHz	-52 dBm	1 MHz	This is not applicable to E-UTRA BS operating in Band 42 or 52.
E-UTRA Band 53 or NR Band n53	2483.5 - 2495 MHz	-52 dBm	1 MHz	This is not applicable to E-UTRA BS operating in Band 41 or 53.
	2110 - 2200 MHz	-52 dBm	1 MHz	This requirement does not apply to E-UTRA BS operating in band 1 or 65,

E-UTRA Band 65 or NR Band n65	1920 - 2010 MHz	-49 dBm	1 MHz	This requirement does not apply to E-UTRA BS operating in band 65, since it is already covered by the requirement in clause 6.6.4.2. For E-UTRA BS operating in Band 1, it applies for 1980 MHz to 2010 MHz, while the rest is covered in clause 6.6.4.2.
E-UTRA Band 66 or NR Band n66	2110 - 2200 MHz	-52 dBm	1 MHz	This requirement does not apply to E-UTRA BS operating in band 4, 10, 23 or 66.
	1710 - 1780 MHz	-49 dBm	1 MHz	This requirement does not apply to E-UTRA BS operating in band 66, since it is already covered by the requirement in clause 6.6.4.2. For E-UTRA BS operating in Band 4, it applies for 1755 MHz to 1780 MHz, while the rest is covered in clause 6.6.4.2. For E-UTRA BS operating in Band 10, it applies for 1770 MHz to 1780 MHz, while the rest is covered in clause 6.6.4.2.
E-UTRA Band 67	738 – 758 MHz	-52 dBm	1 MHz	This requirement does not apply to E-UTRA BS operating in Band 28 or 67.
E-UTRA Band 68	753 -783 MHz	-52 dBm	1 MHz	This requirement does not apply to E-UTRA BS operating in band 28, or 68.
	698-728 MHz	-49 dBm	1 MHz	This requirement does not apply to E-UTRA BS operating in band 68, since it is already covered by the requirement in clause 6.6.4.2. For E-UTRA BS operating in Band 28, it applies between 698 MHz and 703 MHz, while the rest is covered in clause 6.6.4.2.
E-UTRA Band 69	2570 - 2620 MHz	-52 dBm	1 MHz	This requirement does not apply to E-UTRA BS operating in Band 38 or 69.
E-UTRA Band 70 or NR Band n70	1995 - 2020 MHz	-52 dBm	1 MHz	This requirement does not apply to E-UTRA BS operating in band 2, 25 or 70
	1695 – 1710 MHz	-49 dBm	1 MHz	This requirement does not apply to E-UTRA BS operating in band 70, since it is already covered by the requirement in clause 6.6.4.2
E-UTRA Band 71 or NR Band n71	617 - 652 MHz	-52 dBm	1 MHz	This requirement does not apply to E-UTRA BS operating in band 71
	663 – 698 MHz	-49 dBm	1 MHz	This requirement does not apply to E-UTRA BS operating in band 71, since it is already covered by the requirement in clause 6.6.4.2
E-UTRA Band 72	461 - 466 MHz	-52 dBm	1 MHz	This requirement does not apply to E-UTRA BS operating in band 31, 72 or 73.
	451 - 456 MHz	-49 dBm	1 MHz	This requirement does not apply to E-UTRA BS operating in band 72, since it is already covered by the requirement in clause 6.6.4.2. This requirement does not apply to E-UTRA BS operating in band 73.
E-UTRA Band 73	460 - 465 MHz	-52 dBm	1 MHz	This requirement does not apply to E-UTRA BS operating in band 31, 72 or 73.
	450 - 455 MHz	-49 dBm	1 MHz	This requirement does not apply to E-UTRA BS operating in band 73, since it is already covered by the requirement in clause 6.6.4.2.
E-UTRA Band 74	1475 – 1518 MHz	-52 dBm	1 MHz	This requirement does not apply to E-UTRA BS operating in band 11, 21, 32, 50, 74 or 75.
	1427 – 1470 MHz	-49 dBm	1MHz	This requirement does not apply to E-UTRA BS operating in Band 74, since it is already covered by the requirement in clause 6.6.4.2. This requirement does not apply to BS operating in band 32, 45, 50, 51, 75 or 76.
E-UTRA Band 75 or NR Band n75	1432 - 1517 MHz	-52 dBm	1 MHz	This requirement does not apply to E-UTRA BS operating in Band 11, 21, 32, 45, 50, 51, 74, 75 or 76.
E-UTRA Band 76 or NR Band n76	1427 - 1432 MHz	-52 dBm	1 MHz	This requirement does not apply to E-UTRA BS operating in Band 50, 51, 75 or 76.
NR Band n77	3.3 – 4.2 GHz	-52 dBm	1 MHz	This is not applicable to E-UTRA BS operating in Band 22, 42, 43, 48, 49 or 52.
NR Band n78	3.3 – 3.8 GHz	-52 dBm	1 MHz	This is not applicable to E-UTRA BS operating in Band 22, 42, 43, 48, 49 or 52.
NR Band n79	4.4 – 5.0 GHz	-52 dBm	1 MHz	

NR Band n80	1710 – 1785 MHz	-49 dBm	1 MHz	This requirement does not apply to E-UTRA BS operating in band 3, since it is already covered by the requirement in clause 6.6.4.2. For E-UTRA BS operating in band 9, it applies for 1710 MHz to 1749.9 MHz and 1784.9 MHz to 1785 MHz, while the rest is covered in clause 6.6.4.2.
NR Band n81	880 – 915 MHz	-49 dBm	1 MHz	This requirement does not apply to E-UTRA BS operating in band 8, since it is already covered by the requirement in clause 6.6.4.2.
NR Band n82	832 – 862 MHz	-49 dBm	1 MHz	This requirement does not apply to E-UTRA BS operating in band 20, since it is already covered by the requirement in clause 6.6.4.2.
NR Band n83	703 – 748 MHz	-49 dBm	1 MHz	This requirement does not apply to E-UTRA BS operating in band 28, since it is already covered by the requirement in clause 6.6.4.2. This requirement does not apply to E-UTRA BS operating in Band 44. For E-UTRA BS operating in Band 67, it applies for 703 MHz to 736 MHz. For E-UTRA BS operating in Band 68, it applies for 728MHz to 733MHz.
NR Band n84	1920 – 1980 MHz	-49 dBm	1 MHz	This requirement does not apply to E-UTRA BS operating in band 1 or 65, since it is already covered by the requirement in clause 6.6.4.2.
E-UTRA Band 85	728 - 746 MHz	-52 dBm	1 MHz	This requirement does not apply to E-UTRA BS operating in band 12, 29 or 85.
	698 - 716 MHz	-49 dBm	1 MHz	This requirement does not apply to E-UTRA BS operating in band 85, since it is already covered by the requirement in clause 6.6.4.2. For E-UTRA BS operating in Band 29, it applies 1 MHz below the Band 29 downlink operating band (Note 6).
NR Band n86	1710 - 1780 MHz	-49 dBm	1 MHz	This requirement does not apply to E-UTRA BS operating in band 66, since it is already covered by the requirement in clause 6.6.4.2. For E-UTRA BS operating in Band 4, it applies for 1755 MHz to 1780 MHz, while the rest is covered in clause 6.6.4.2. For E-UTRA BS operating in Band 10, it applies for 1770 MHz to 1780 MHz, while the rest is covered in clause 6.6.4.2.
E-UTRA Band 87	420 - 425 MHz	-52 dBm	1 MHz	This requirement does not apply to E-UTRA BS operating in band 87 or 88.
	410 – 415 MHz	-49 dBm	1 MHz	This requirement does not apply to E-UTRA BS operating in band 87, since it is already covered by the requirement in clause 6.6.4.2
E-UTRA Band 88	422 - 427 MHz	-52 dBm	1 MHz	This requirement does not apply to E-UTRA BS operating in band 87 or 88.
	412 - 417 MHz	-49 dBm	1 MHz	This requirement does not apply to E-UTRA BS operating in band 88, since it is already covered by the requirement in clause 6.6.4.2. This requirement does not apply to E-UTRA BS operating in band 87.
NR Band n89	824 - 849 MHz	-49 dBm	1 MHz	This requirement does not apply to E-UTRA BS operating in band 5 or 26, since it is already covered by the requirement in clause 6.6.4.2. For E-UTRA BS operating in Band 27, it applies 3 MHz below the Band 27 downlink operating band.
NR Band n91	1427 – 1432 MHz	-52 dBm	1 MHz	This requirement does not apply to E-UTRA BS operating in Band 50, 51, 75 or 76.
	832 – 862 MHz	-49 dBm	1 MHz	This requirement does not apply to E-UTRA BS operating in band 20, since it is already covered by the requirement in clause 6.6.4.2.
NR Band n92	1432 – 1517 MHz	-52 dBm	1 MHz	This requirement does not apply to E-UTRA BS operating in Band 11, 21, 32, 45, 50, 51, 74, 75 or 76.
	832 – 862 MHz	-49 dBm	1 MHz	This requirement does not apply to E-UTRA BS operating in band 20, since it is already covered by the requirement in clause 6.6.4.2.
NR Band n93	1427 – 1432 MHz	-52 dBm	1 MHz	This requirement does not apply to E-UTRA BS operating in Band 50, 51, 75 or 76.
	880 – 915 MHz	-49 dBm	1 MHz	This requirement does not apply to E-UTRA BS operating in band 8, since it is already covered by the requirement in clause 6.6.4.2.

NR Band n94	1432 – 1517 MHz	-52 dBm	1 MHz	This requirement does not apply to E-UTRA BS operating in Band 11, 21, 32, 45, 50, 51, 74, 75 or 76.
	880 – 915 MHz	-49 dBm	1 MHz	This requirement does not apply to E-UTRA BS operating in band 8, since it is already covered by the requirement in clause 6.6.4.2.
NR Band n95	2010 - 2025 MHz	-52 dBm	1 MHz	
NR Band n96	5925 - 7125 MHz	-52 dBm	1 MHz	This is not applicable to E-UTRA BS operating in Band 46.
NOTE 4: Void				

Additional co-existence requirements in Table 6.6.4.3.1-1a may apply for some regions.

Table 6.6.4.3.1-1a: BS Spurious emissions limits for E-UTRA BS for co-existence with systems operating in Band 46

System type for E-UTRA to co-exist with	Frequency range for co-existence requirement	Maximum Level	Measurement Bandwidth	Note
E-UTRA Band 46a	5150 - 5250 MHz	-40 dBm	1 MHz	This is only applicable to E-UTRA BS operating in Band 46c or 46d.
E-UTRA Band 46b	5250 - 5350 MHz	-40 dBm	1 MHz	This is only applicable to E-UTRA BS operating in Band 46c or 46d.
E-UTRA Band 46c	5470 - 5725 MHz	-40 dBm	1 MHz	This is only applicable to E-UTRA BS operating in Band 46a or 46b.
E-UTRA Band 46d	5725 - 5925 MHz	-40 dBm	1 MHz	This is only applicable to E-UTRA BS operating in Band 46a or 46b.
NOTE 1: This requirement may apply to E-UTRA BS operating in certain regions.				

NOTE 1: As defined in the scope for spurious emissions in this clause, except for the cases where the noted requirements apply to a BS operating in Band 25, Band 27, Band 28 or Band 29, the co-existence requirements in Table 6.6.4.3.1-1 do not apply for the 10 MHz frequency range immediately outside the downlink operating band (see Table 5.5-1). Emission limits for this excluded frequency range may be covered by local or regional requirements.

NOTE 2: Table 6.6.4.3.1-1 assumes that two operating bands, where the frequency ranges in Table 5.5-1 would be overlapping, are not deployed in the same geographical area. For such a case of operation with overlapping frequency arrangements in the same geographical area, special co-existence requirements may apply that are not covered by the 3GPP specifications.

NOTE 3: TDD base stations deployed in the same geographical area, that are synchronized and use the same or adjacent operating bands can transmit without additional co-existence requirements. For unsynchronized base stations (except in Band 46), special co-existence requirements may apply that are not covered by the 3GPP specifications.

NOTE 5: For E-UTRA Band 28 BS, specific solutions may be required to fulfil the spurious emissions limits for E-UTRA BS for co-existence with E-UTRA Band 27 UL operating band.

NOTE 6: For E-UTRA Band 29 BS, specific solutions may be required to fulfil the spurious emissions limits for E-UTRA BS for co-existence with UTRA Band XII or E-UTRA Band 12 UL operating band, E-UTRA Band 17 UL operating band or E-UTRA Band 85 UL operating band.

The power of any spurious emission shall not exceed the limits of Table 6.6.4.3.1-1A for a Home BS where requirements for co-existence with a Home BS type listed in the first column apply.

Table 6.6.4.3.1-1A: Home BS Spurious emissions limits for co-existence with Home BS operating in other frequency bands

Type of coexistence BS	Frequency range for co-location requirement	Maximum Level	Measurement Bandwidth	Note
UTRA FDD Band I or E-UTRA Band 1	1920 - 1980 MHz	-71 dBm	100 kHz	This requirement does not apply to Home BS operating in band 1 or 65, since it is already covered by the requirement in clause 6.6.4.2.
UTRA FDD Band II or E-UTRA Band 2	1850 - 1910 MHz	-71 dBm	100 kHz	This requirement does not apply to Home BS operating in band 2 or 25, since it is already covered by the requirement in clause 6.6.4.2.
UTRA FDD Band III or E-UTRA Band 3	1710 - 1785 MHz	-71 dBm	100 kHz	This requirement does not apply to Home BS operating in band 3, since it is already covered by the requirement in clause 6.6.4.2. For Home BS operating in band 9, it applies for 1710 MHz to 1749.9 MHz and 1784.9 MHz to 1785 MHz, while the rest is covered in clause 6.6.4.2.
UTRA FDD Band IV or E-UTRA Band 4	1710 - 1755 MHz	-71 dBm	100 kHz	This requirement does not apply to Home BS operating in band 4, 10 or 66, since it is already covered by the requirement in clause 6.6.4.2.
UTRA FDD Band V or E-UTRA Band 5	824 - 849 MHz	-71 dBm	100 kHz	This requirement does not apply to Home BS operating in band 5 or 26, since it is already covered by the requirement in clause 6.6.4.2. For E-UTRA BS operating in Band 27, it applies 3 MHz below the Band 27 downlink operating band.
UTRA FDD Band VI, XIX or E-UTRA Band 6, 18, 19	815 - 830 MHz	-71 dBm	100 kHz	This requirement does not apply to Home BS operating in band 18, since it is already covered by the requirement in clause 6.6.4.2.
	830 - 845 MHz	-71 dBm	100 kHz	This requirement does not apply to Home BS operating in band 6, 19, since it is already covered by the requirement in clause 6.6.4.2.
UTRA FDD Band VII or E-UTRA Band 7	2500 - 2570 MHz	-71 dBm	100 kHz	This requirement does not apply to Home BS operating in band 7, since it is already covered by the requirement in clause 6.6.4.2.
UTRA FDD Band VIII or E-UTRA Band 8	880 - 915 MHz	-71 dBm	100 kHz	This requirement does not apply to Home BS operating in band 8, since it is already covered by the requirement in clause 6.6.4.2.
UTRA FDD Band IX or E-UTRA Band 9	1749.9 - 1784.9 MHz	-71 dBm	100 kHz	This requirement does not apply to Home BS operating in band 3 or 9, since it is already covered by the requirement in clause 6.6.4.2.
UTRA FDD Band X or E-UTRA Band 10	1710 - 1770 MHz	-71 dBm	100 kHz	This requirement does not apply to Home BS operating in band 10 or 66, since it is already covered by the requirement in clause 6.6.4.2. For Home BS operating in Band 4, it applies for 1755 MHz to 1770 MHz, while the rest is covered in clause 6.6.4.2.
UTRA FDD Band XI, XXI or E-UTRA Band 11, 21	1427.9 - 1447.9 MHz	-71 dBm	100 kHz	This requirement does not apply to Home BS operating in band 11 or 74, since it is already covered by the requirement in clause 6.6.4.2. This requirement does not apply to Home BS operating in band 32, 50, 51, 75 or 76.

	1447.9 - 1462.9 MHz	-71 dBm	100 kHz	This requirement does not apply to Home BS operating in band 21 or 74, since it is already covered by the requirement in clause 6.6.4.2. This requirement does not apply to Home BS operating in band 32, 50 or 75.
UTRA FDD Band XII or E-UTRA Band 12	699 - 716 MHz	-71 dBm	100 kHz	This requirement does not apply to Home BS operating in band 12 or 85, since it is already covered by the requirement in clause 6.6.4.2. For Home BS operating in Band 29, it applies 1 MHz below the Band 29 downlink operating band (Note 5)
UTRA FDD Band XIII or E-UTRA Band 13	777 - 787 MHz	-71 dBm	100 kHz	This requirement does not apply to Home BS operating in band 13, since it is already covered by the requirement in clause 6.6.4.2.
UTRA FDD Band XIV or E-UTRA Band 14	788 - 798 MHz	-71 dBm	100 kHz	This requirement does not apply to Home BS operating in band 14, since it is already covered by the requirement in clause 6.6.4.2.
E-UTRA Band 17	704 - 716 MHz	-71 dBm	100 kHz	This requirement does not apply to Home BS operating in band 17, since it is already covered by the requirement in clause 6.6.4.2. For Home BS operating in Band 29, it applies 1 MHz below the Band 29 downlink operating band (Note 5)
UTRA FDD Band XX or E-UTRA Band 20	832 - 862 MHz	-71 dBm	100 kHz	This requirement does not apply to Home BS operating in band 20, since it is already covered by the requirement in clause 6.6.4.2.
UTRA FDD Band XXII or E-UTRA Band 22	3410 - 3490 MHz	-71 dBm	100 kHz	This requirement does not apply to Home BS operating in band 22, since it is already covered by the requirement in clause 6.6.4.2. This requirement does not apply to Home BS operating in Band 42
E-UTRA Band 24	1626.5 – 1660.5 MHz	-71 dBm	100 kHz	This requirement does not apply to Home BS operating in band 24, since it is already covered by the requirement in clause 6.6.4.2.
UTRA FDD Band XXV or E-UTRA Band 25	1850 - 1915 MHz	-71 dBm	100 kHz	This requirement does not apply to Home BS operating in band 25, since it is already covered by the requirement in clause 6.6.4.2
UTRA FDD Band XXVI or E-UTRA Band 26	814 - 849 MHz	-71 dBm	100 kHz	This requirement does not apply to Home BS operating in band 26, since it is already covered by the requirement in clause 6.6.4.2. For Home BS operating in Band 5, it applies for 814 MHz to 824 MHz, while the rest is covered in clause 6.6.4.2. For E-UTRA BS operating in Band 27, it applies 3 MHz below the Band 27 downlink operating band.

E-UTRA Band 27	807 - 824 MHz	-71 dBm	100 kHz	This requirement does not apply to E-UTRA BS operating in Band 27, since it is already covered by the requirement in clause 6.6.4.2. For E-UTRA BS operating in Band 26, it applies for 807 MHz to 814 MHz, while the rest is covered in clause 6.6.4.2. This requirement also applies to E-UTRA BS operating in Band 28, starting 4 MHz above the Band 28 downlink operating band (Note 4).
E-UTRA Band 28	703 – 748 MHz	-71 dBm	100 kHz	This requirement does not apply to Home BS operating in band 28, since it is already covered by the requirement in clause 6.6.4.2. This requirement does not apply to Home BS operating in Band 44. For E-UTRA BS operating in Band 67, it applies for 703 MHz to 736 MHz. For E-UTRA BS operating in Band 68, it applies for 728MHz to 733MHz.
E-UTRA Band 30	2305 – 2315 MHz	-71 dBm	100 kHz	This requirement does not apply to Home BS operating in band 30, since it is already covered by the requirement in clause 6.6.4.2. This requirement does not apply to Home BS operating in Band 40.
UTRA TDD Band a) or E-UTRA Band 33	1900 - 1920 MHz	-71 dBm	100 kHz	This requirement does not apply to Home BS operating in Band 33
UTRA TDD Band a) or E-UTRA Band 34	2010 - 2025 MHz	-71 dBm	100 kHz	This requirement does not apply to Home BS operating in Band 34
UTRA TDD Band b) or E-UTRA Band 35	1850 – 1910 MHz	-71 dBm	100 kHz	This requirement does not apply to Home BS operating in Band 35
UTRA TDD Band b) or E-UTRA Band 36	1930 - 1990 MHz	-71 dBm	100 kHz	This requirement does not apply to Home BS operating in Band 2 and 36
UTRA TDD Band c) or E-UTRA Band 37	1910 - 1930 MHz	-71 dBm	100 kHz	This is not applicable to Home BS operating in Band 37. This unpaired band is defined in ITU-R M.1036, but is pending any future deployment.
UTRA TDD Band d) or E-UTRA Band 38	2570 - 2620 MHz	-71 dBm	100 kHz	This requirement does not apply to Home BS operating in Band 38.
UTRA TDD Band f) or E-UTRA Band 39	1880 - 1920MHz	-71 dBm	100 kHz	This is not applicable to Home BS operating in Band 39
UTRA TDD Band e) or E-UTRA Band 40	2300 - 2400MHz	-71 dBm	100 kHz	This is not applicable to Home BS operating in Band 30 or 40
E-UTRA Band 41	2496 – 2690 MHz	-71 dBm	100 kHz	This is not applicable to Home BS operating in Band 41
E-UTRA Band 42	3400 - 3600 MHz	-71 dBm	100 kHz	This is not applicable to Home BS operating in Band 22, 42, 43, 48 or 52.
E-UTRA Band 43	3600 - 3800 MHz	-71 dBm	100 kHz	This is not applicable to Home BS operating in Band 42, 43 or 48.
E-UTRA Band 44	703 - 803 MHz	-71 dBm	100 kHz	This is not applicable to Home BS operating in Band 28 or 44
E-UTRA Band 48	3550 - 3700 MHz	-71 dBm	100 kHz	This is not applicable to Home BS operating in Band 22, 42, 43 or 48.
E-UTRA Band 50	1432 - 1517 MHz	-71 dBm	100 kHz	This requirement does not apply to Home BS operating in Band 11, 21, 32, 50, 51, 74, 75 or 76.
E-UTRA Band 51	1427 - 1432 MHz	-71 dBm	100 kHz	This requirement does not apply to Home BS operating in Band 50, 51, 75 or 76.
E-UTRA Band 52	3300 - 3400 MHz	-71 dBm	100 kHz	This is not applicable to Home BS operating in Band 42 or 52.

E-UTRA Band 65	1920 - 2010 MHz	-71 dBm	100 kHz	This requirement does not apply to Home BS operating in band 65, since it is already covered by the requirement in clause 6.6.4.2. For Home BS operating in Band 1, it applies for 1980 MHz to 2010 MHz, while the rest is covered in clause 6.6.4.2.
E-UTRA Band 66	1710 - 1780 MHz	-71 dBm	100 kHz	This requirement does not apply to Home BS operating in band 66, since it is already covered by the requirement in clause 6.6.4.2. For Home BS operating in Band 4, it applies for 1755 MHz to 1780 MHz, while the rest is covered in clause 6.6.4.2. For Home BS operating in Band 10, it applies for 1770 MHz to 1780 MHz, while the rest is covered in clause 6.6.4.2.
E-UTRA Band 68	698-728 MHz	-71 dBm	100 kHz	This requirement does not apply to Home BS operating in band 68, since it is already covered by the requirement in clause 6.6.4.2. For Home BS operating in Band 28, it applies between 698 MHz and 703 MHz, while the rest is covered in clause 6.6.4.2.
E-UTRA Band 70	1695 - 1710 MHz	-71 dBm	100 kHz	This requirement does not apply to Home BS operating in band 70, since it is already covered by the requirement in clause 6.6.4.2.
E-UTRA Band 71	663 – 698 MHz	-71 dBm	100 kHz	This requirement does not apply to Home BS operating in band 71, since it is already covered by the requirement in clause 6.6.4.2.
E-UTRA Band 74	1427 – 1470 MHz	-71 dBm	100 kHz	This requirement does not apply to Home BS operating in Band 74, since it is already covered by the requirement in clause 6.6.4.2. This requirement does not apply to BS operating in band 32, 50, 51, 75 or 76.
E-UTRA Band 85	698 - 716 MHz	-71 dBm	100 kHz	This requirement does not apply to Home BS operating in band 85, since it is already covered by the requirement in clause 6.6.4.2. For Home BS operating in Band 29, it applies 1 MHz below the Band 29 downlink operating band (Note 5).

NOTE 1: As defined in the scope for spurious emissions in this clause, except for the cases where the noted requirements apply to a BS operating in Band 27, Band 28 or Band 29, the coexistence requirements in Table 6.6.4.3.1-1A do not apply for the 10 MHz frequency range immediately outside the Home BS transmit frequency range of a downlink operating band (see Table 5.5-1). Emission limits for this excluded frequency range may be covered by local or regional requirements.

NOTE 2: Table 6.6.4.3.1-1A assumes that two operating bands, where the frequency ranges in Table 5.5-1 would be overlapping, are not deployed in the same geographical area. For such a case of operation with overlapping frequency arrangements in the same geographical area, special co-existence requirements may apply that are not covered by the 3GPP specifications.

NOTE 3: TDD base stations deployed in the same geographical area, that are synchronized and use the same or adjacent operating bands can transmit without additional co-existence requirements. For unsynchronized base stations, special co-existence requirements may apply that are not covered by the 3GPP specifications.

NOTE 4: For E-UTRA Band 28 BS, specific solutions may be required to fulfil the spurious emissions limits for E-UTRA BS for co-existence with E-UTRA Band 27 UL operating band.

NOTE 5: For E-UTRA Band 29 BS, specific solutions may be required to fulfil the spurious emissions limits for E-UTRA BS for co-existence with UTRA Band XII or E-UTRA Band 12 UL operating band, E-UTRA Band 17 UL operating band or E-UTRA Band 85 UL operating band.

The following requirement may be applied for the protection of PHS. This requirement is also applicable at specified frequencies falling between 10 MHz below the lowest BS transmitter frequency of the downlink operating band and 10 MHz above the highest BS transmitter frequency of the downlink operating band.

The power of any spurious emission shall not exceed:

Table 6.6.4.3.1-2: E-UTRA BS Spurious emissions limits for BS for co-existence with PHS

Frequency range	Maximum Level	Measurement Bandwidth	Note
1884.5 - 1915.7 MHz	-41 dBm	300 kHz	Applicable when co-existence with PHS system operating in 1884.5-1915.7MHz

The following requirement shall be applied to BS operating in Bands 13 and 14 to ensure that appropriate interference protection is provided to 700 MHz public safety operations. This requirement is also applicable at the frequency range from 10 MHz below the lowest frequency of the BS downlink operating band up to 10 MHz above the highest frequency of the BS downlink operating band.

The power of any spurious emission shall not exceed:

Table 6.6.4.3.1-3: BS Spurious emissions limits for protection of 700 MHz public safety operations

Operating Band	Frequency range	Maximum Level	Measurement Bandwidth	Note
13	763 - 775 MHz	-46 dBm	6.25 kHz	
13	793 - 805 MHz	-46 dBm	6.25 kHz	
14	769 - 775 MHz	-46 dBm	6.25 kHz	
14	799 - 805 MHz	-46 dBm	6.25 kHz	

Table 6.6.4.3.1-4: Void

The following requirement shall be applied to BS operating in Band 26 to ensure that appropriate interference protection is provided to 800 MHz public safety operations. This requirement is also applicable at the frequency range from 10 MHz below the lowest frequency of the BS downlink operating band up to 10 MHz above the highest frequency of the BS downlink operating band.

The power of any spurious emission shall not exceed:

Table 6.6.4.3.1-5: BS Spurious emissions limits for protection of 800 MHz public safety operations

Operating Band	Frequency range	Maximum Level	Measurement Bandwidth	Note
26	851 - 859 MHz	-13 dBm	100 kHz	Applicable for offsets > 37.5kHz from the channel edge

The following requirement may apply to E-UTRA BS operating in Band 41 in certain regions. This requirement is also applicable at the frequency range from 10 MHz below the lowest frequency of the BS downlink operating band up to 10 MHz above the highest frequency of the BS downlink operating band.

The power of any spurious emission shall not exceed:

Table 6.6.4.3.1-6: Additional E-UTRA BS Spurious emissions limits for Band 41

Frequency range	Maximum Level	Measurement Bandwidth	Note
2505 MHz – 2535 MHz	-42 dBm	1 MHz	
NOTE: This requirement applies for 10 or 20 MHz E-UTRA carriers allocated within 2545-2645 MHz.			

The following requirement may apply to E-UTRA BS operating in Band 30 in certain regions. This requirement is also applicable at the frequency range from 10 MHz below the lowest frequency of the BS downlink operating band up to 10 MHz above the highest frequency of the BS downlink operating band.

The power of any spurious emission shall not exceed:

Table 6.6.4.3.1-7: Additional E-UTRA BS Spurious emissions limits for Band 30

Frequency range	Maximum Level	Measurement Bandwidth	Note
2200MHz – 2345MHz	-45dBm	1 MHz	
2362.5MHz – 2365MHz	-25dBm	1 MHz	
2365MHz – 2367.5MHz	-40dBm	1 MHz	
2367.5MHz – 2370MHz	-42dBm	1 MHz	
2370MHz – 2395MHz	-45dBm	1 MHz	

In addition for Band 46 operation, the BS may have to comply with the applicable spurious emission limits established regionally, when deployed in regions where those limits apply and under the conditions declared by the manufacturer. The regional requirements may be in the form of conducted power, power spectral density, EIRP and other types of limits. In case of regulatory limits based on EIRP, assessment of the EIRP level is described in Annex H.

The following requirement may apply to E-UTRA BS operating in Band 48 and Band 49 in certain regions. The power of any spurious emission shall not exceed:

Table 6.6.4.3.1-8: Additional E-UTRA BS Spurious emissions limits for Band 48 and Band 49

Frequency range	Maximum Level	Measurement Bandwidth	Note
3530MHz – 3720MHz	-25dBm	1 MHz	Applicable 10MHz from the assigned channel edge
3100MHz – 3530MHz 3720MHz – 4200MHz	-40dBm	1 MHz	

6.6.4.4 Co-location with other base stations

These requirements may be applied for the protection of other BS receivers when GSM900, DCS1800, PCS1900, GSM850, CDMA850, UTRA FDD, UTRA TDD, E-UTRA and/or NR BS are co-located with an E-UTRA BS.

The requirements assume a 30 dB coupling loss between transmitter and receiver and are based on co-location with base stations of the same class.

6.6.4.4.1 Minimum Requirement

The power of any spurious emission shall not exceed the limits of Table 6.6.4.4.1-1 for a Wide Area BS where requirements for co-location with a BS type listed in the first column apply. For BS capable of multi-band operation, the exclusions and conditions in the Note column of Table 6.6.4.4.1-1 apply for each supported operating band. For BS

capable of multi-band operation where multiple bands are mapped on separate antenna connectors, the exclusions and conditions in the Note column of Table 6.6.4.4.1-1 apply for the operating band supported at that antenna connector.

Table 6.6.4.4.1-1: BS Spurious emissions limits for Wide Area BS co-located with another BS

Type of co-located BS	Frequency range for co-location requirement	Maximum Level	Measurement Bandwidth	Note
Macro GSM900	876-915 MHz	-98 dBm	100 kHz	
Macro DCS1800	1710 - 1785 MHz	-98 dBm	100 kHz	
Macro PCS1900	1850 - 1910 MHz	-98 dBm	100 kHz	
Macro GSM850 or CDMA850	824 - 849 MHz	-98 dBm	100 kHz	
WA UTRA FDD Band I or E-UTRA Band 1 or NR Band n1	1920 - 1980 MHz	-96 dBm	100 kHz	
WA UTRA FDD Band II or E-UTRA Band 2 or NR Band n2	1850 - 1910 MHz	-96 dBm	100 kHz	
WA UTRA FDD Band III or E-UTRA Band 3 or NR Band n3	1710 - 1785 MHz	-96 dBm	100 kHz	
WA UTRA FDD Band IV or E-UTRA Band 4	1710 - 1755 MHz	-96 dBm	100 kHz	
WA UTRA FDD Band V or E-UTRA Band 5 or NR Band n5	824 - 849 MHz	-96 dBm	100 kHz	
WA UTRA FDD Band VI, XIX or E-UTRA Band 6, 19	830 - 845 MHz	-96 dBm	100 kHz	
WA UTRA FDD Band VII or E-UTRA Band 7 or NR Band n7	2500 - 2570 MHz	-96 dBm	100 kHz	
WA UTRA FDD Band VIII or E-UTRA Band 8 or NR Band n8	880 - 915 MHz	-96 dBm	100 kHz	
WA UTRA FDD Band IX or E-UTRA Band 9	1749.9 - 1784.9 MHz	-96 dBm	100 kHz	
WA UTRA FDD Band X or E-UTRA Band 10	1710 - 1770 MHz	-96 dBm	100 kHz	
WA UTRA FDD Band XI or E-UTRA Band 11	1427.9 – 1447.9 MHz	-96 dBm	100 kHz	This is not applicable to E-UTRA BS operating in Band 50 or 75
WA UTRA FDD Band XII or E-UTRA Band 12 or NR Band n12	699 - 716 MHz	-96 dBm	100 kHz	
WA UTRA FDD Band XIII or E-UTRA Band 13	777 - 787 MHz	-96 dBm	100 kHz	
WA UTRA FDD Band XIV or E-UTRA Band 14 or NR Band n14	788 - 798 MHz	-96 dBm	100 kHz	
WA E-UTRA Band 17	704 - 716 MHz	-96 dBm	100 kHz	
WA E-UTRA Band 18 or NR Band n18	815 - 830 MHz	-96 dBm	100 kHz	
WA UTRA FDD Band XX or E-UTRA Band 20 or NR Band n20	832 - 862 MHz	-96 dBm	100 kHz	
WA UTRA FDD Band XXI or E-UTRA Band 21	1447.9 – 1462.9 MHz	-96 dBm	100 kHz	This is not applicable to E-UTRA BS operating in Band 32, 50 or 75
WA UTRA FDD Band XXII or E-UTRA Band 22	3410 – 3490 MHz	-96 dBm	100 kHz	This is not applicable to E-UTRA BS operating in Band 42
WA E-UTRA Band 24	1626.5 – 1660.5 MHz	-96 dBm	100 kHz	

WA UTRA FDD Band XXV or E-UTRA Band 25 or NR Band n25	1850 – 1915 MHz	-96 dBm	100 kHz	
WA UTRA FDD Band XXVI or E-UTRA Band 26 or NR Band n26	814 – 849 MHz	-96 dBm	100 kHz	
WA E-UTRA Band 27	807 - 824 MHz	-96 dBm	100 kHz	
WA E-UTRA Band 28 or NR Band n28	703 – 748 MHz	-96 dBm	100 kHz	This is not applicable to E-UTRA BS operating in Band 44
WA E-UTRA Band 30 or NR Band n30	2305 – 2315 MHz	-96 dBm	100 kHz	This is not applicable to E-UTRA BS operating in Band 40
WA E-UTRA Band 31	452.5 -457.5 MHz	-96 dBm	100 kHz	
WA UTRA TDD Band a) or E-UTRA Band 33	1900 - 1920 MHz	-96 dBm	100 kHz	This is not applicable to E-UTRA BS operating in Band 33
WA UTRA TDD Band a) or E-UTRA Band 34 or NR Band n34	2010 - 2025 MHz	-96 dBm	100 kHz	This is not applicable to E-UTRA BS operating in Band 34
WA UTRA TDD Band b) or E-UTRA Band 35	1850 – 1910 MHz	-96 dBm	100 kHz	This is not applicable to E-UTRA BS operating in Band 35
WA UTRA TDD Band b) or E-UTRA Band 36	1930 - 1990 MHz	-96 dBm	100 kHz	This is not applicable to E-UTRA BS operating in Band 2 and 36
WA UTRA TDD Band c) or E-UTRA Band 37	1910 - 1930 MHz	-96 dBm	100 kHz	This is not applicable to E-UTRA BS operating in Band 37. This unpaired band is defined in ITU-R M.1036, but is pending any future deployment.
WA UTRA TDD Band d) or E-UTRA Band 38 or NR Band n38	2570 – 2620 MHz	-96 dBm	100 kHz	This is not applicable to E-UTRA BS operating in Band 38.
WA UTRA TDD Band f) or E-UTRA Band 39 or NR Band n39	1880 – 1920MHz	-96 dBm	100 kHz	This is not applicable to E-UTRA BS operating in Band 33 and 39
WA UTRA TDD Band e) or E-UTRA Band 40 or NR Band n40	2300 – 2400MHz	-96 dBm	100 kHz	This is not applicable to E-UTRA BS operating in Band 30 or 40
WA E-UTRA Band 41 or NR Band n41	2496 – 2690 MHz	-96 dBm	100 kHz	This is not applicable to E-UTRA BS operating in Band 41
WA E-UTRA Band 42	3400 – 3600 MHz	-96 dBm	100 kHz	This is not applicable to E-UTRA BS operating in Band 22, 42, 43, 48 or 52
WA E-UTRA Band 43	3600 – 3800 MHz	-96 dBm	100 kHz	This is not applicable to E-UTRA BS operating in Band 42, 43 or 48

WA E-UTRA Band 44	703 – 803 MHz	-96 dBm	100 kHz	This is not applicable to E-UTRA BS operating in Band 28 or 44
WA E-UTRA Band 45	1447 – 1467 MHz	-96 dBm	100 kHz	This is not applicable to E-UTRA BS operating in Band 45
WA E-UTRA Band 48 or NR Band n48	3550 – 3700 MHz	-96 dBm	100 kHz	This is not applicable to E-UTRA BS operating in Band 42, 43 or 48
WA E-UTRA Band 50	1432 – 1517 MHz	-96 dBm	100 kHz	This is not applicable to E-UTRA BS operating in Band 11, 21, 32, 74 or 75
WA E-UTRA Band 52	3300 – 3400 MHz	-96 dBm	100 kHz	This is not applicable to E-UTRA BS operating in Band 42 or 52
WA E-UTRA Band 65 or NR Band n65	1920 - 2010 MHz	-96 dBm	100 kHz	
WA E-UTRA Band 66 or NR Band n66	1710 - 1780 MHz	-96 dBm	100 kHz	
WA E-UTRA Band 68	698 - 728 MHz	-96 dBm	100 kHz	
WA E-UTRA Band 70 or NR Band n70	1695 - 1710 MHz	-96 dBm	100 kHz	
WA E-UTRA Band 71 or NR Band n71	663 - 698 MHz	-96 dBm	100 kHz	
WA E-UTRA Band 72	451 - 456 MHz	-96 dBm	100 kHz	
WA E-UTRA Band 73	450 - 455 MHz	-96 dBm	100 kHz	
WA E-UTRA Band 74	1427 – 1470 MHz	-96 dBm	100 kHz	This is not applicable to E-UTRA BS operating in Band 50
WA NR Band n77	3.3 – 4.2 GHz	-96 dBm	100 kHz	This is not applicable to E-UTRA BS operating in Band 22, 42, 43, 48 or 52
WA NR Band n78	3.3 – 3.8 GHz	-96 dBm	100 kHz	This is not applicable to E-UTRA BS operating in Band 22, 42, 43, 48 or 52
WA NR Band n79	4.4 – 5.0 GHz	-96 dBm	100 kHz	
WA NR Band n80	1710 – 1785 MHz	-96 dBm	100 kHz	
WA NR Band n81	880 – 915 MHz	-96 dBm	100 kHz	
WA NR Band n82	832 – 862 MHz	-96 dBm	100 kHz	
WA NR Band n83	703 – 748 MHz	-96 dBm	100 kHz	
WA NR Band n84	1920 – 1980 MHz	-96 dBm	100 kHz	
WA E-UTRA Band 85	698 - 716 MHz	-96 dBm	100 kHz	
WA NR Band n86	1710 – 1780 MHz	-96 dBm	100 kHz	
WA E-UTRA Band 87	410 - 415 MHz	-96 dBm	100 kHz	
WA E-UTRA Band 88	412 - 417 MHz	-96 dBm	100 kHz	
WA NR Band n89	824 – 849 MHz	-96 dBm	100 kHz	
WA NR Band n92	832 – 862 MHz	-96 dBm	100 kHz	
WA NR Band n94	880 – 915 MHz	-96 dBm	100 kHz	
WA NR Band n95	2010 - 2025 MHz	-96 dBm	100 kHz	

The power of any spurious emission shall not exceed the limits of Table 6.6.4.4.1-2 for a Local Area BS where requirements for co-location with a BS type listed in the first column apply. For BS capable of multi-band operation, the exclusions and conditions in the Note column of Table 6.6.4.4.1-2 apply for each supported operating band. For BS

capable of multi-band operation where multiple bands are mapped on separate antenna connectors, the exclusions and conditions in the Note column of Table 6.6.4.4.1-2 apply for the operating band supported at that antenna connector.

Table 6.6.4.4.1-2: BS Spurious emissions limits for Local Area BS co-located with another BS

Type of co-located BS	Frequency range for co-location requirement	Maximum Level	Measurement Bandwidth	Note
Pico GSM900	876-915 MHz	-70 dBm	100 kHz	
Pico DCS1800	1710 - 1785 MHz	-80 dBm	100 kHz	
Pico PCS1900	1850 - 1910 MHz	-80 dBm	100 kHz	
Pico GSM850	824 - 849 MHz	-70 dBm	100 kHz	
LA UTRA FDD Band I or E-UTRA Band 1 or NR Band n1	1920 - 1980 MHz	-88 dBm	100 kHz	
LA UTRA FDD Band II or E-UTRA Band 2 or NR Band n2	1850 - 1910 MHz	-88 dBm	100 kHz	
LA UTRA FDD Band III or E-UTRA Band 3 or NR Band n3	1710 - 1785 MHz	-88 dBm	100 kHz	
LA UTRA FDD Band IV or E-UTRA Band 4	1710 - 1755 MHz	-88 dBm	100 kHz	
LA UTRA FDD Band V or E-UTRA Band 5 or NR Band n5	824 - 849 MHz	-88 dBm	100 kHz	
LA UTRA FDD Band VI, XIX or E-UTRA Band 6, 19	830 - 845 MHz	-88 dBm	100 kHz	
LA UTRA FDD Band VII or E-UTRA Band 7 or NR Band n7	2500 - 2570 MHz	-88 dBm	100 kHz	
LA UTRA FDD Band VIII or E-UTRA Band 8 or NR Band n8	880 - 915 MHz	-88 dBm	100 kHz	
LA UTRA FDD Band IX or E-UTRA Band 9	1749.9 - 1784.9 MHz	-88 dBm	100 kHz	
LA UTRA FDD Band X or E-UTRA Band 10	1710 - 1770 MHz	-88 dBm	100 kHz	
LA UTRA FDD Band XI or E-UTRA Band 11	1427.9 - 1447.9 MHz	-88 dBm	100 kHz	This is not applicable to E-UTRA BS operating in Band 50, 51, 75 or 76
LA UTRA FDD Band XII or E-UTRA Band 12 or NR Band n12	699 - 716 MHz	-88 dBm	100 kHz	
LA UTRA FDD Band XIII or E-UTRA Band 13	777 - 787 MHz	-88 dBm	100 kHz	
LA UTRA FDD Band XIV or E-UTRA Band 14 or NR Band n14	788 - 798 MHz	-88 dBm	100 kHz	
LA E-UTRA Band 17	704 - 716 MHz	-88 dBm	100 kHz	
LA E-UTRA Band 18 or NR Band n18	815 - 830 MHz	-88 dBm	100 kHz	
LA UTRA FDD Band XX or E-UTRA Band 20 or NR Band n20	832 - 862 MHz	-88 dBm	100 kHz	
LA UTRA FDD Band XXI or E-UTRA Band 21	1447.9 - 1462.9 MHz	-88 dBm	100 kHz	This is not applicable to E-UTRA BS operating in Band 32, 50 or 75
LA UTRA FDD Band XXII or E-UTRA Band 22	3410 – 3490 MHz	-88 dBm	100 kHz	This is not applicable to E-UTRA BS operating in Band 42
LA E-UTRA Band 24	1626.5 – 1660.5 MHz	-88 dBm	100 kHz	
LA UTRA FDD Band XXV or E-UTRA Band 25 or NR Band n25	1850 – 1915 MHz	-88 dBm	100 kHz	

LA UTRA FDD Band XXVI or E-UTRA Band 26 or NR Band n26	814 – 849 MHz	-88 dBm	100 kHz	
LA E-UTRA Band 27	807 - 824 MHz	-88 dBm	100 kHz	
LA E-UTRA Band 28 or NR Band n28	703 – 748 MHz	-88 dBm	100 kHz	This is not applicable to E-UTRA BS operating in Band 44
LA E-UTRA Band 30 or NR Band n30	2305 – 2315 MHz	-88 dBm	100 kHz	This is not applicable to E-UTRA BS operating in Band 40
LA E-UTRA Band 31	452.5 – 457.5 MHz	-88 dBm	100 kHz	
LA UTRA TDD Band a) or E-UTRA Band 33	1900 - 1920 MHz	-88 dBm	100 kHz	This is not applicable to E-UTRA BS operating in Band 33
LA UTRA TDD Band a) or E-UTRA Band 34 or NR Band n34	2010 - 2025 MHz	-88 dBm	100 kHz	This is not applicable to E-UTRA BS operating in Band 34
LA UTRA TDD Band b) or E-UTRA Band 35	1850 – 1910 MHz	-88 dBm	100 kHz	This is not applicable to E-UTRA BS operating in Band 35
LA UTRA TDD Band b) or E-UTRA Band 36	1930 - 1990 MHz	-88 dBm	100 kHz	This is not applicable to E-UTRA BS operating in Band 2 and 36
LA UTRA TDD Band c) or E-UTRA Band 37	1910 - 1930 MHz	-88 dBm	100 kHz	This is not applicable to E-UTRA BS operating in Band 37. This unpaired band is defined in ITU-R M.1036, but is pending any future deployment.
LA UTRA TDD Band d) or E-UTRA Band 38 or NR Band n38	2570 – 2620 MHz	-88 dBm	100 kHz	This is not applicable to E-UTRA BS operating in Band 38.
LA LUTRA TDD Band f) or E-UTRA Band 39 or NR Band n39	1880 – 1920MHz	-88 dBm	100 kHz	This is not applicable to E-UTRA BS operating in Band 33 and 39
LA UTRA TDD Band e) or E-UTRA Band 40 or NR Band n40	2300 – 2400MHz	-88 dBm	100 kHz	This is not applicable to E-UTRA BS operating in Band 30 or 40
LA E-UTRA Band 41 or NR Band n41	2496 – 2690 MHz	-88 dBm	100 kHz	This is not applicable to E-UTRA BS operating in Band 41 or 53
LA E-UTRA Band 42	3400 – 3600 MHz	-88 dBm	100 kHz	This is not applicable to E-UTRA BS operating in Band 22, 42, 43, 48, 49 or 52
LA E-UTRA Band 43	3600 – 3800 MHz	-88 dBm	100 kHz	This is not applicable to E-UTRA BS operating in Band 42, 43, 48 or 49

LA E-UTRA Band 44	703 – 803 MHz	-88 dBm	100 kHz	This is not applicable to E-UTRA BS operating in Band 28 or 44
LA E-UTRA Band 45	1447 – 1467 MHz	-88 dBm	100 kHz	This is not applicable to E-UTRA BS operating in Band 45
LA E-UTRA Band 46 or NR Band n46	5150 – 5925 MHz	-88 dBm	100 kHz	This is not applicable to E-UTRA BS operating in Band 46
LA E-UTRA Band 48 or NR Band n48	3550 – 3700 MHz	-88 dBm	100 kHz	This is not applicable to E-UTRA BS operating in Band 42, 43, 48 or 49
LA E-UTRA Band 49	3550 – 3700 MHz	-88 dBm	100 kHz	This is not applicable to E-UTRA BS operating in Band 42, 43, 48 or 49
LA E-UTRA Band 50	1432 – 1517 MHz	-88 dBm	100 kHz	This is not applicable to E-UTRA BS operating in Band 11, 21, 32, 51, 74, 75 or 76
LA E-UTRA Band 51 or NR Band n51	1427 – 1432 MHz	-88 dBm	100 kHz	This is not applicable to E-UTRA BS operating in Band 50, 75 or 76
LA E-UTRA Band 52	3300 – 3400 MHz	-88 dBm	100 kHz	This is not applicable to E-UTRA BS operating in Band 42 or 52
LA E-UTRA Band 53 or NR Band n53	2483.5 – 2495 MHz	-88 dBm	100 kHz	This is not applicable to E-UTRA BS operating in Band 41 or 53
LA E-UTRA Band 65 or NR Band n65	1920 - 2010 MHz	-88 dBm	100 kHz	
LA E-UTRA Band 66 or NR Band n66	1710 - 1780 MHz	-88 dBm	100 kHz	
LA E-UTRA Band 68	698 - 728 MHz	-88 dBm	100 kHz	
LA E-UTRA Band 70 or NR Band n70	1695 - 1710 MHz	-88 dBm	100 kHz	
LA E-UTRA Band 71 or NR Band n71	663 - 698 MHz	-88 dBm	100 kHz	
LA E-UTRA Band 72	451 - 456 MHz	-88 dBm	100 kHz	
LA E-UTRA Band 73	450 - 455 MHz	-88 dBm	100 kHz	
LA E-UTRA Band 74	1427 – 1470 MHz	-88 dBm	100 kHz	This is not applicable to E-UTRA BS operating in Band 50 or 51
LA NR Band n77	3.3 – 4.2 GHz	-88 dBm	100 kHz	This is not applicable to E-UTRA BS operating in Band 22, 42, 43, 48, 49 or 52
LA NR Band n78	3.3 – 3.8 GHz	-88 dBm	100 kHz	This is not applicable to E-UTRA BS operating in Band 22, 42, 43, 48, 49 or 52
LA NR Band n79	4.4 – 5.0 GHz	-88 dBm	100 kHz	
LA NR Band n80	1710 – 1785 MHz	-88 dBm	100 kHz	
LA NR Band n81	880 – 915 MHz	-88 dBm	100 kHz	

LA NR Band n82	832 – 862 MHz	-88 dBm	100 kHz	
LA NR Band n83	703 – 748 MHz	-88 dBm	100 kHz	
LA NR Band n84	1920 – 1980 MHz	-88 dBm	100 kHz	
LA E-UTRA Band 85	698 - 716 MHz	-88 dBm	100 kHz	
LA NR Band n86	1710 – 1780 MHz	-88 dBm	100 kHz	
LA E-UTRA Band 87	410 - 415 MHz	-88 dBm	100 kHz	
LA E-UTRA Band 88	412 - 417 MHz	-88 dBm	100 kHz	
LA NR Band n89	824 – 849 MHz	-88 dBm	100 kHz	
LA NR Band n91	832 – 862 MHz	-88 dBm	100 kHz	
LA NR Band n92	832 – 862 MHz	-88 dBm	100 kHz	
LA NR Band n93	880 – 915 MHz	-88 dBm	100 kHz	
LA NR Band n94	880 – 915 MHz	-88 dBm	100 kHz	
LA NR Band n95	2010 - 2025 MHz	-88 dBm	100 kHz	
LA NR Band n96	5925 - 7125 MHz	-87 dBm	100 kHz	This is not applicable to E-UTRA BS operating in Band 46

The power of any spurious emission shall not exceed the limits of Table 6.6.4.4.1-3 for a Medium Range BS where requirements for co-location with a BS type listed in the first column apply. For BS capable of multi-band operation, the exclusions and conditions in the Note column of Table 6.6.4.4.1-3 apply for each supported operating band. For BS capable of multi-band operation where multiple bands are mapped on separate antenna connectors, the exclusions and conditions in the Note column of Table 6.6.4.4.1-3 apply for the operating band supported at that antenna connector.

Table 6.6.4.4.1-3: BS Spurious emissions limits for Medium range BS co-located with another BS

Type of co-located BS	Frequency range for co-location requirement	Maximum Level	Measurement Bandwidth	Note
Micro/MR GSM900	876-915 MHz	-91 dBm	100 kHz	
Micro/MR DCS1800	1710 - 1785 MHz	-91 dBm	100 kHz	
Micro/MR PCS1900	1850 - 1910 MHz	-91 dBm	100 kHz	
Micro/MR GSM850	824 - 849 MHz	-91 dBm	100 kHz	
MR UTRA FDD Band I or E-UTRA Band 1 or NR Band n1	1920 - 1980 MHz	-91 dBm	100 kHz	
MR UTRA FDD Band II or E-UTRA Band 2 or NR Band n2	1850 - 1910 MHz	-91 dBm	100 kHz	
MR UTRA FDD Band III or E-UTRA Band 3 or NR Band n3	1710 - 1785 MHz	-91 dBm	100 kHz	
MR UTRA FDD Band IV or E-UTRA Band 4	1710 - 1755 MHz	-91 dBm	100 kHz	
MR UTRA FDD Band V or E-UTRA Band 5 or NR Band n5	824 - 849 MHz	-91 dBm	100 kHz	
MR UTRA FDD Band VI, XIX or E-UTRA Band 6, 19	830 - 850 MHz	-91 dBm	100 kHz	
MR UTRA FDD Band VII or E-UTRA Band 7 or NR Band n7	2500 - 2570 MHz	-91 dBm	100 kHz	
MR UTRA FDD Band VIII or E-UTRA Band 8 or NR Band n8	880 - 915 MHz	-91 dBm	100 kHz	
MR UTRA FDD Band IX or E-UTRA Band 9	1749.9 - 1784.9 MHz	-91 dBm	100 kHz	
MR UTRA FDD Band X or E-UTRA Band 10	1710 - 1770 MHz	-91 dBm	100 kHz	
MR UTRA FDD Band XI or E-UTRA Band 11	1427.9 - 1447.9 MHz	-91 dBm	100 kHz	This is not applicable to E-UTRA BS operating in Band 50 or 75

MR UTRA FDD Band XII or E-UTRA Band 12 or NR Band n12	699 - 716 MHz	-91 dBm	100 kHz	
MR UTRA FDD Band XIII or E-UTRA Band 13	777 - 787 MHz	-91 dBm	100 kHz	
MR UTRA FDD Band XIV or E-UTRA Band 14 or NR Band n14	788 - 798 MHz	-91 dBm	100 kHz	
MR E-UTRA Band 17	704 - 716 MHz	-91 dBm	100 kHz	
MR E-UTRA Band 18 or NR Band n18	815 - 830 MHz	-91 dBm	100 kHz	
MR UTRA FDD Band XX or E-UTRA Band 20 or NR Band n20	832 - 862 MHz	-91 dBm	100 kHz	
MR UTRA FDD Band XXI or E-UTRA Band 21	1447.9 - 1462.9 MHz	-91 dBm	100 kHz	This is not applicable to E-UTRA BS operating in Band 32, 50 or 75
MR UTRA FDD Band XXII or E-UTRA Band 22	3410 – 3490 MHz	-91 dBm	100 kHz	This is not applicable to E-UTRA BS operating in Band 42
MR E-UTRA Band 24	1626.5 – 1660.5 MHz	-91 dBm	100 kHz	
MR UTRA FDD Band XXV or E-UTRA Band 25 or NR Band n25	1850 – 1915 MHz	-91 dBm	100 kHz	
MR UTRA FDD Band XXVI or E-UTRA Band 26 or NR Band n26	814 – 849 MHz	-91 dBm	100 kHz	
MR E-UTRA Band 27	807 - 824 MHz	-91 dBm	100 kHz	
MR E-UTRA Band 28 or NR Band n28	703 – 748 MHz	-91 dBm	100 kHz	This is not applicable to E-UTRA BS operating in Band 44
MR E-UTRA Band 30 or NR Band n30	2305 – 2315 MHz	-91 dBm	100 kHz	This is not applicable to E-UTRA BS operating in Band 40
MR E-UTRA Band 31	452.5 – 457.5 MHz	-91 dBm	100 kHz	
MR E-UTRA Band 33	1900 - 1920 MHz	-91 dBm	100 kHz	This is not applicable to E-UTRA BS operating in Band 33
MR E-UTRA Band 34 or NR Band n34	2010 - 2025 MHz	-91 dBm	100 kHz	This is not applicable to E-UTRA BS operating in Band 34
MR E-UTRA Band 35	1850 – 1910 MHz	-91 dBm	100 kHz	This is not applicable to E-UTRA BS operating in Band 35
MR E-UTRA Band 36	1930 - 1990 MHz	-91 dBm	100 kHz	This is not applicable to E-UTRA BS operating in Band 2 and 36
MR E-UTRA Band 37	1910 - 1930 MHz	-91 dBm	100 kHz	This is not applicable to E-UTRA BS operating in Band 37. This unpaired band is defined in ITU-R M.1036, but is pending any future deployment.

MR E-UTRA Band 38 or NR Band n38	2570 – 2620 MHz	-91 dBm	100 kHz	This is not applicable to E-UTRA BS operating in Band 38.
MR E-UTRA Band 39 or NR Band n39	1880 – 1920MHz	-91 dBm	100 kHz	This is not applicable to E-UTRA BS operating in Band 33 and 39
MR E-UTRA Band 40 or NR Band n40	2300 – 2400MHz	-91 dBm	100 kHz	This is not applicable to E-UTRA BS operating in Band 30 or 40
MR E-UTRA Band 41 or NR Band n41	2496 – 2690 MHz	-91 dBm	100 kHz	This is not applicable to E-UTRA BS operating in Band 41 or 53
MR E-UTRA Band 42	3400 – 3600 MHz	-91 dBm	100 kHz	This is not applicable to E-UTRA BS operating in Band 22, 42, 43, 48 or 52
MR E-UTRA Band 43	3600 – 3800 MHz	-91 dBm	100 kHz	This is not applicable to E-UTRA BS operating in Band 42, 43 or 48
MR E-UTRA Band 44	703 – 803 MHz	-91 dBm	100 kHz	This is not applicable to E-UTRA BS operating in Band 28 or 44
MR E-UTRA Band 45	1447 – 1467 MHz	-91 dBm	100 kHz	This is not applicable to E-UTRA BS operating in Band 45
MR E-UTRA Band 46 or NR Band n46	5150 – 5925 MHz	-91 dBm	100 kHz	This is not applicable to E-UTRA BS operating in Band 46
MR E-UTRA Band 48 or NR Band n48	3550 – 3700 MHz	-91 dBm	100 kHz	This is not applicable to E-UTRA BS operating in Band 42, 43 or 48
MR E-UTRA Band 50	1432 – 1517 MHz	-91 dBm	100 kHz	This is not applicable to E-UTRA BS operating in Band 11, 21, 32, 74 or 75
MR E-UTRA Band 52	3300 – 3400 MHz	-91 dBm	100 kHz	This is not applicable to E-UTRA BS operating in Band 42 or 52
MR E-UTRA Band 53 or NR Band n53	2483.5 – 2495 MHz	-91 dBm	100 kHz	This is not applicable to E-UTRA BS operating in Band 41 or 53

MR E-UTRA Band 65 or NR Band n65	1920 - 2010 MHz	-91 dBm	100 kHz	
MR E-UTRA Band 66 or NR Band n66	1710 - 1780 MHz	-91 dBm	100 kHz	
MR E-UTRA Band 68	698 - 728 MHz	-91 dBm	100 kHz	
MR E-UTRA Band 70 or NR Band n70	1695 - 1710 MHz	-91 dBm	100 kHz	
MR E-UTRA Band 71 or NR Band n71	663 - 698 MHz	-91 dBm	100 kHz	
MR E-UTRA Band 72	451 - 456 MHz	-91 dBm	100 kHz	
MR E-UTRA Band 73	450 - 455 MHz	-91 dBm	100 kHz	
MR E-UTRA Band 74	1427 – 1470 MHz	-91 dBm	100 kHz	This is not applicable to E-UTRA BS operating in Band 50
MR NR Band n77	3.3 – 4.2 GHz	-91 dBm	100 kHz	This is not applicable to E-UTRA BS operating in Band 22, 42, 43, 48 or 52
MR NR Band n78	3.3 – 3.8 GHz	-91 dBm	100 kHz	This is not applicable to E-UTRA BS operating in Band 22, 42, 43, 48 or 52
MR NR Band n79	4.4 – 5.0 GHz	-91 dBm	100 kHz	
MR NR Band n80	1710 – 1785 MHz	-91 dBm	100 kHz	
MR NR Band n81	880 – 915 MHz	-91 dBm	100 kHz	
MR NR Band n82	832 – 862 MHz	-91 dBm	100 kHz	
MR NR Band n83	703 – 748 MHz	-91 dBm	100 kHz	
MR NR Band n84	1920 – 1980 MHz	-91 dBm	100 kHz	
MR E-UTRA Band 85	698 - 716 MHz	-91 dBm	100 kHz	
MR NR Band n86	1710 – 1780 MHz	-91 dBm	100 kHz	
MR E-UTRA Band 87	410 - 415 MHz	-91 dBm	100 kHz	
MR E-UTRA Band 88	412 - 417 MHz	-91 dBm	100 kHz	
MR NR Band n89	824 – 849 MHz	-91 dBm	100 kHz	
MR NR Band n92	832 – 862 MHz	-91 dBm	100 kHz	
MR NR Band n94	880 – 915 MHz	-91 dBm	100 kHz	
MR NR Band n95	2010 - 2025 MHz	-91 dBm	100 kHz	
MR NR Band n96	5925 - 7125 MHz	-90 dBm	100 kHz	This is not applicable to E-UTRA BS operating in Band 46

NOTE 1: As defined in the scope for spurious emissions in this clause, the co-location requirements in Table 6.6.4.4.1-1 to Table 6.6.4.4.1-3 do not apply for the 10 MHz frequency range immediately outside the BS transmit frequency range of a downlink operating band (see Table 5.5-1). The current state-of-the-art technology does not allow a single generic solution for co-location with other system on adjacent frequencies for 30dB BS-BS minimum coupling loss. However, there are certain site-engineering solutions that can be used. These techniques are addressed in TR 25.942 [8].

NOTE 2: Table 6.6.4.4.1-1 to Table 6.6.4.4.1-3 assume that two operating bands, where the corresponding BS transmit and receive frequency ranges in Table 5.5-1 would be overlapping, are not deployed in the same geographical area. For such a case of operation with overlapping frequency arrangements in the same geographical area, special co-location requirements may apply that are not covered by the 3GPP specifications.

NOTE 3: Co-located TDD base stations that are synchronized and using the same or adjacent operating band can transmit without special co-locations requirements. For unsynchronized base stations (except in Band 46), special co-location requirements may apply that are not covered by the 3GPP specifications.

6.7 Transmitter intermodulation

The transmit intermodulation requirement is a measure of the capability of the transmitter to inhibit the generation of signals in its non linear elements caused by presence of the wanted signal and an interfering signal reaching the transmitter via the antenna. The requirement applies during the transmitter ON period and the transmitter transient period.

For BS capable of multi-band operation where multiple bands are mapped on separate antenna connectors, the single-band requirements apply regardless of the interfering signals position relative to the Inter RF Bandwidth gap.

6.7.1 Minimum requirement

The transmitter intermodulation level is the power of the intermodulation products when an E-UTRA signal of channel bandwidth 5 MHz as an interfering signal is injected into the antenna connector.

The transmitter intermodulation level shall not exceed the unwanted emission limits in clauses 6.6.2, 6.6.3 and 6.6.4 in the presence of an E-UTRA interfering signal according to Table 6.7.1-1, Table 6.7.1-2 and Table 6.7.1-3.

The requirement is applicable outside the Base Station RF Bandwidth or Radio Bandwidth. The interfering signal offset is defined relative to the Base Station RF Bandwidth edges or Radio Bandwidth edges.

For a BS operating in non-contiguous spectrum, the requirement is also applicable inside a sub-block gap for interfering signal offsets where the interfering signal falls completely within the sub-block gap. The interfering signal offset is defined relative to the sub-block edges.

For a BS capable of multi-band operation, the requirement applies relative to the Base Station RF Bandwidth edges of each supported operating band. In case the Inter RF Bandwidth gap is less than 15 MHz, the requirement in the gap applies only for interfering signal offsets where the interfering signal falls completely within the Inter RF Bandwidth gap.

For E-UTRA, the wanted signal and interfering signal centre frequency offset shall be as in Table 6.7.1-1.

Table 6.7.1-1 Interfering and wanted signals for the Transmitter intermodulation requirement for E-UTRA

Parameter	Value
Wanted signal	E-UTRA single carrier, or multi-carrier, or multiple intra-band contiguously or non-contiguously aggregated carriers
Interfering signal type	E-UTRA signal of channel bandwidth 5 MHz
Interfering signal level	Rated total output power in the operating band – 30 dB
Interfering signal centre frequency offset from the lower/upper edge of the wanted signal or edge of sub-block inside a sub-block gap	± 2.5 MHz ± 7.5 MHz ± 12.5 MHz
NOTE1:	Interfering signal positions that are partially or completely outside of any downlink operating band of the base station are excluded from the requirement, unless the interfering signal positions fall within the frequency range of adjacent downlink operating bands in the same geographical area. In case that none of the interfering signal positions fall completely within the frequency range of the downlink operating band, TS 36.141 [4] provides further guidance regarding appropriate test requirements.
NOTE2:	In certain regions, NOTE1 is not applied in Band 1, 3, 8, 9, 11, 18, 19, 21, 28, 32 operating within 1475.9-1495.9MHz, 34, 74.

For NB-IoT in-band and guard band operation, the wanted signal and interfering signal centre frequency offset shall be as in Table 6.7.1-2.

Table 6.7.1-2 Interfering and wanted signals for the Transmitter intermodulation requirement for NB-IoT in-band and guard band operations

Parameter	Value
Wanted signal	E-UTRA single carrier, or multi-carrier, or multiple intra-band contiguously or non-contiguously aggregated carriers with NB-IoT in-band and/or guard band operation
Interfering signal type	E-UTRA signal of channel bandwidth 5 MHz
Interfering signal level	Rated total output power in the operating band – 30 dB
Interfering signal centre frequency offset from the lower/upper edge of the wanted signal or edge of sub-block inside a sub-block gap	± 2.5 MHz ± 7.5 MHz ± 12.5 MHz
NOTE1:	Interfering signal positions that are partially or completely outside of any downlink operating band of the base station are excluded from the requirement, unless the interfering signal positions fall within the frequency range of adjacent downlink operating bands in the same geographical area. In case that none of the interfering signal positions fall completely within the frequency range of the downlink operating band, TS 36.141 [4] provides further guidance regarding appropriate test requirements.
NOTE2:	In certain regions, NOTE1 is not applied in Band 1, 3, 8, 9, 11, 18, 19, 21, 28, 32 operating within 1475.9-1495.9MHz, 34, 74.

For NB-IoT standalone operation, the wanted signal and interfering signal centre frequency offset shall be as in Table 6.7.1-3.

Table 6.7.1-3 Interfering and wanted signals for the Transmitter intermodulation requirement for standalone NB-IoT

Parameter	Value
Wanted signal	Standalone NB-IoT carrier
Interfering signal type	E-UTRA signal of channel bandwidth 5 MHz
Interfering signal level	Rated total output power in the operating band – 30 dB
Interfering signal centre frequency offset from the lower/upper edge of the wanted signal or edge of sub-block inside a sub-block gap	± 2.5 MHz ± 7.5 MHz ± 12.5 MHz
NOTE1:	Interfering signal positions that are partially or completely outside of any downlink operating band of the base station are excluded from the requirement, unless the interfering signal positions fall within the frequency range of adjacent downlink operating bands in the same geographical area. In case that none of the interfering signal positions fall completely within the frequency range of the downlink operating band, TS 36.141 [4] provides further guidance regarding appropriate test requirements.
NOTE2:	In certain regions, NOTE1 is not applied in Band 1, 3, 8, 9, 11, 18, 19, 21, 28, 32 operating within 1475.9-1495.9MHz, 34, 74.

6.7.2 Additional requirement for Band 41

In certain regions the following requirement may apply. For E-UTRA BS operating in Band 41, the transmitter intermodulation level shall not exceed the maximum levels specified in Table 6.6.2.1-2 with a square filter in the first adjacent channel, and Table 6.6.4.3.1-6 in the presence of an interfering signal according to Table 6.7.2-1.

Table 6.7.2-1 Interfering and wanted signals for the additional transmitter intermodulation requirement for Band 41

Parameter	Value
Wanted signal	E-UTRA single carrier (NOTE)
Interfering signal type	E-UTRA signal of the same channel bandwidth as the wanted signal
Interfering signal level	Rated total output power in the operating band – 30 dB
Interfering signal centre frequency offset from the lower/upper carrier centre frequency of the wanted signal	± BW_{Channel} ± $2 \times BW_{\text{Channel}}$
NOTE:	This requirement applies for 10 or 20 MHz E-UTRA carriers allocated within 2545-2645 MHz.

7 Receiver characteristics

7.1 General

The requirements in clause 7 are expressed for a single receiver antenna connector. For receivers with antenna diversity, the requirements apply for each receiver antenna connector.

Unless otherwise stated, the receiver characteristics are specified at the BS antenna connector (test port A) with a full complement of transceivers for the configuration in normal operating conditions. For FDD operation the requirements in clause 7 shall be met with the transmitter(s) on. If any external apparatus such as a RX amplifier, a filter or the combination of such devices is used, requirements apply at the far end antenna connector (port B).

NOTE: In normal operating conditions the BS in FDD operation is configured to transmit and receive at the same time. The transmitter may be off for some of the tests as specified in 36.141 [4].

Unless otherwise stated the requirements in clause 7 apply during the base station receive period.

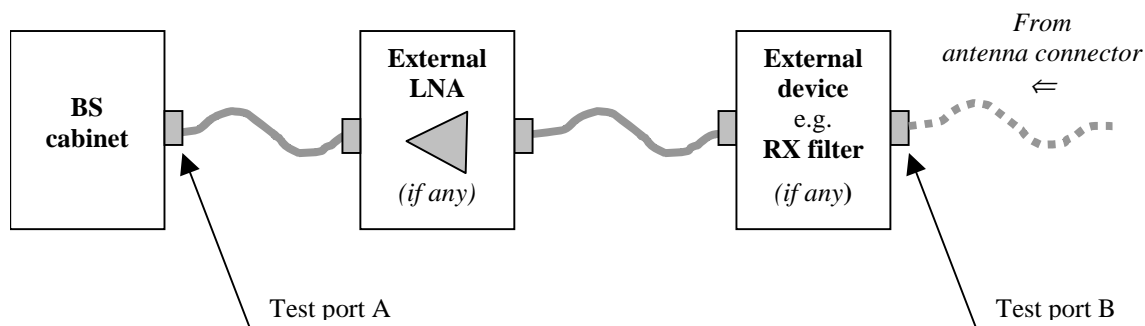

Figure 7.1: Receiver test ports

The throughput requirements defined for the receiver characteristics in this clause do not assume HARQ retransmissions.

When the BS is configured to receive multiple carriers, all the throughput requirements are applicable for each received carrier. For ACS, blocking and intermodulation characteristics, the negative offsets of the interfering signal apply relative to the lower Base Station RF Bandwidth edge and positive offsets of the interfering signal apply relative to the upper Base Station RF Bandwidth edge.

NOTE: Requirements may only be supported for certain frequency ranges within the operating band(s). These frequency ranges could be different for NB-IoT comparing to E-UTRA.

NOTE: For E-UTRA BS with NB-IoT (in band and/or guard band) or standalone NB-IoT BS, requirements are defined for 15 kHz sub-carrier spacing and 3.75 kHz sub-carrier spacing. A NB-IoT Base Station supports 15 kHz sub-carrier spacing, 3.75 kHz sub-carrier spacing, or both.

7.2 Reference sensitivity level

The reference sensitivity power level P_{REFSENS} is the minimum mean power received at the antenna connector at which a throughput requirement shall be met for a specified reference measurement channel.

7.2.1 Minimum requirement

For E-UTRA, the throughput shall be $\geq 95\%$ of the maximum throughput of the reference measurement channel as specified in Annex A with parameters specified in Table 7.2.1-1 for Wide Area BS, in Table 7.2.1-2 for Local Area BS, in Table 7.2.1-3 for Home BS and in Table 7.2.1-4 for Medium Range BS.

Table 7.2.1-1: E-UTRA Wide Area BS reference sensitivity levels

E-UTRA channel bandwidth [MHz]	Reference measurement channel	Reference sensitivity power level, P_{REFSENS} [dBm]
1.4	FRC A1-1 in Annex A.1	-106.8
3	FRC A1-2 in Annex A.1	-103.0
3	FRC A1-6 in Annex A.1 for E-UTRA with NB-IoT in-band operation (Note 3)	-103.0 (Note 2)
5	FRC A1-3 in Annex A.1	-101.5
5	FRC A1-7 in Annex A.1 for E-UTRA with NB-IoT in-band operation	-101.5 (Note 2)
10	FRC A1-3 in Annex A.1 (Note 1)	-101.5
10	FRC A1-7 in Annex A.1 for E-UTRA with NB-IoT in-band operation (Note 4)	-101.5 (Note 2)
15	FRC A1-3 in Annex A.1 (Note 1)	-101.5
15	FRC A1-7 in Annex A.1 for E-UTRA with NB-IoT in-band operation (Note 4)	-101.5 (Note 2)
20	FRC A1-3 in Annex A.1 (Note 1)	-101.5
20	FRC A1-7 in Annex A.1 for E-UTRA with NB-IoT in-band operation (Note 4)	-101.5 (Note 2)
Note 1:	P_{REFSENS} is the power level of a single instance of the reference measurement channel. This requirement shall be met for each consecutive application of a single instance of FRC A1-3 mapped to disjoint frequency ranges with a width of 25 resource blocks each.	
Note 2:	The requirements apply to BS that supports E-UTRA with NB-IoT in-band operation.	
Note 3:	P_{REFSENS} is the power level of a single instance of the reference measurement channel. This requirement shall be met for a single instance of FRC A1-6 mapped to the 12 E-UTRA resource blocks adjacent to the NB-IoT PRB.	
Note 4:	P_{REFSENS} is the power level of a single instance of the reference measurement channel. This requirement shall be met for a single instance of FRC A1-7 mapped to the 24 E-UTRA resource blocks adjacent to the NB-IoT PRB, and for each consecutive application of a single instance of FRC A1-3 mapped to disjoint frequency ranges with a width of 25 resource blocks each.	

Table 7.2.1-2: E-UTRA Local Area BS reference sensitivity levels

E-UTRA channel bandwidth [MHz]	Reference measurement channel	Reference sensitivity power level, $P_{REFSENS}$ [dBm]
1.4	FRC A1-1 in Annex A.1	-98.8
3	FRC A1-2 in Annex A.1	-95.0
3	FRC A1-6 in Annex A.1 for E-UTRA with NB-IoT in-band operation (Note 4)	-95.0 (Note 3)
5	FRC A1-3 in Annex A.1	-93.5
5	FRC A1-7 in Annex A.1 for E-UTRA with NB-IoT in-band operation	-93.5 (Note 3)
10	FRC A1-3 in Annex A.1 (Note 1) FRC A1-8 in Annex A.1 (Note 2)	-93.5 -96.2
10	FRC A1-7 in Annex A.1 for E-UTRA with NB-IoT in-band operation (Note 5)	-93.5 (Note 3)
15	FRC A1-3 in Annex A.1 (Note 1)	-93.5
15	FRC A1-7 in Annex A.1 for E-UTRA with NB-IoT in-band operation (Note 5)	-93.5 (Note 3)
20	FRC A1-3 in Annex A.1 (Note 1) FRC A1-9 in Annex A.1 (Note 2)	-93.5 -96.2
20	FRC A1-7 in Annex A.1 for E-UTRA with NB-IoT in-band operation (Note 5)	-93.5 (Note 3)
Note 1:	$P_{REFSENS}$ is the power level of a single instance of the reference measurement channel. This requirement shall be met for each consecutive application of a single instance of FRC A1-3 mapped to disjoint frequency ranges with a width of 25 resource blocks each. This reference measurement channel is not applied for Band 46 and Band 49.	
Note 2:	$P_{REFSENS}$ is the power level of a single instance of the reference measurement channel. This requirement shall be met for each single interlace of FRC A1-8 and A1-9. This reference measurement channel is only applied for Band 46 and Band 49.	
Note 3:	The requirements apply to BS that supports E-UTRA with NB-IoT in-band operation.	
Note 4:	$P_{REFSENS}$ is the power level of a single instance of the reference measurement channel. This requirement shall be met for a single instance of FRC A1-6 mapped to the 12 E-UTRA resource blocks adjacent to the NB-IoT PRB.	
Note 5:	$P_{REFSENS}$ is the power level of a single instance of the reference measurement channel. This requirement shall be met for a single instance of FRC A1-7 mapped to the 24 E-UTRA resource blocks adjacent to the NB-IoT PRB, and for each consecutive application of a single instance of FRC A1-3 mapped to disjoint frequency ranges with a width of 25 resource blocks each.	

Table 7.2.1-3: E-UTRA Home BS reference sensitivity levels

E-UTRA channel bandwidth [MHz]	Reference measurement channel	Reference sensitivity power level, P_{REFSENS} [dBm]
1.4	FRC A1-1 in Annex A.1	-98.8
3	FRC A1-2 in Annex A.1	-95.0
3	FRC A1-6 in Annex A.1 1 for E-UTRA with NB-IoT in-band operation (Note 3)	-95.0 (Note 2)
5	FRC A1-3 in Annex A.1	-93.5
5	FRC A1-7 in Annex A.1 for E-UTRA with NB-IoT in-band operation	-93.5 (Note 2)
10	FRC A1-3 in Annex A.1 (Note)	-93.5
10	FRC A1-7 in Annex A.1 for E-UTRA with NB-IoT in-band operation (Note 4)	-93.5 (Note 2)
15	FRC A1-3 in Annex A.1 (Note)	-93.5
15	FRC A1-7 in Annex A.1 for E-UTRA with NB-IoT in-band operation (Note 4)	-93.5 (Note 2)
20	FRC A1-3 in Annex A.1 (Note)	-93.5
20	FRC A1-7 in Annex A.1 for E-UTRA with NB-IoT in-band operation (Note 4)	-93.5 (Note 2)
Note 1:	P_{REFSENS} is the power level of a single instance of the reference measurement channel. This requirement shall be met for each consecutive application of a single instance of FRC A1-3 mapped to disjoint frequency ranges with a width of 25 resource blocks each	
Note 2:	The requirements apply to BS that supports E-UTRA with NB-IoT in-band operation.	
Note 3:	P_{REFSENS} is the power level of a single instance of the reference measurement channel. This requirement shall be met for a single instance of FRC A1-6 mapped to the 12 E-UTRA resource blocks adjacent to the NB-IoT PRB.	
Note 4:	P_{REFSENS} is the power level of a single instance of the reference measurement channel. This requirement shall be met for a single instance of FRC A1-7 mapped to the 24 E-UTRA resource blocks adjacent to the NB-IoT PRB, and for each consecutive application of a single instance of FRC A1-3 mapped to disjoint frequency ranges with a width of 25 resource blocks each.	

Table 7.2.1-4: E-UTRA Medium Range BS reference sensitivity levels

E-UTRA channel bandwidth [MHz]	Reference measurement channel	Reference sensitivity power level, PREFSENS [dBm]
1.4	FRC A1-1 in Annex A.1	-101.8
3	FRC A1-2 in Annex A.1	-98.0
3	FRC A1-6 in Annex A.1 1 for E-UTRA with NB-IoT in-band operation (Note 4)	-98.0 (Note 3)
5	FRC A1-3 in Annex A.1	-96.5
5	FRC A1-7 in Annex A.1 for E-UTRA with NB-IoT in-band operation	-96.5 (Note 3)
10	FRC A1-3 in Annex A.1 (Note 1) FRC A1-8 in Annex A.1 (Note 2)	-96.5 -99.2
10	FRC A1-7 in Annex A.1 for E-UTRA with NB-IoT in-band operation (Note 5)	-96.5 (Note 3)
15	FRC A1-3 in Annex A.1 (Note 1)	-96.5
15	FRC A1-7 in Annex A.1 for E-UTRA with NB-IoT in-band operation (Note 5)	-96.5 (Note 3)
20	FRC A1-3 in Annex A.1 (Note 1) FRC A1-9 in Annex A.1 (Note 2)	-96.5 -99.2
20	FRC A1-7 in Annex A.1 for E-UTRA with NB-IoT in-band operation (Note 5)	-96.5 (Note 3)
Note 1:	PREFSENS is the power level of a single instance of the reference measurement channel. This requirement shall be met for each consecutive application of a single instance of FRC A1-3 mapped to disjoint frequency ranges with a width of 25 resource blocks each. This reference measurement channel is not applied for Band 46.	
Note 2:	PREFSENS is the power level of a single instance of the reference measurement channel. This requirement shall be met for each single interlace of FRC A1-8 and A1-9. This reference measurement channel is only applied for Band 46.	
Note 3:	The requirements apply to BS that supports E-UTRA with NB-IoT in-band operation.	
Note 4:	PREFSENS is the power level of a single instance of the reference measurement channel. This requirement shall be met for a single instance of FRC A1-6 mapped to the 12 E-UTRA resource blocks adjacent to the NB-IoT PRB.	
Note 5:	PREFSENS is the power level of a single instance of the reference measurement channel. This requirement shall be met for a single instance of FRC A1-7 mapped to the 24 E-UTRA resource blocks adjacent to the NB-IoT PRB, and for each consecutive application of a single instance of FRC A1-3 mapped to disjoint frequency ranges with a width of 25 resource blocks each.	

For NB-IoT standalone BS or E-UTRA BS with NB-IoT (in-band and/or guard band), NB-IoT throughput shall be \geq 95% of the maximum throughput of the reference measurement channel as specified in Annex A with parameters specified in Table 7.2.1-5 for Wide Area BS, in Table 7.2.1-5a for Local Area BS, in Table 7.2.1-5b for Home BS and in Table 7.2.1-5c for Medium Range BS.

Table 7.2.1-5: NB-IoT Wide Area BS reference sensitivity levels

NB-IoT channel bandwidth [kHz]	NB-IoT Sub-carrier spacing [kHz]	Reference measurement channel	Reference sensitivity power level, PREFSENS [dBm]
200	15	FRC A14-1 in Annex A.14	-127.3
200	3.75	FRC A14-2 in Annex A.14	-133.3

Table 7.2.1-5a: NB-IoT Local Area BS reference sensitivity levels

NB-IoT channel bandwidth [kHz]	NB-IoT Sub-carrier spacing [kHz]	Reference measurement channel	Reference sensitivity power level, PREFSENS [dBm]
200	15	FRC A14-1 in Annex A.14	-119.3
200	3.75	FRC A14-2 in Annex A.14	-125.3

Table 7.2.1-5b: NB-IoT Home BS reference sensitivity levels

NB-IoT channel bandwidth [kHz]	NB-IoT Sub-carrier spacing [kHz]	Reference measurement channel	Reference sensitivity power level, PREFSENS [dBm]
200	15	FRC A14-1 in Annex A.14	-119.3
200	3.75	FRC A14-2 in Annex A.14	-125.3

Table 7.2.1-5c: NB-IoT Medium Range BS reference sensitivity levels

NB-IoT channel bandwidth [kHz]	NB-IoT Sub-carrier spacing [kHz]	Reference measurement channel	Reference sensitivity power level, PREFSENS [dBm]
200	15	FRC A14-1 in Annex A.14	-122.3
200	3.75	FRC A14-2 in Annex A.14	-128.3

Table 7.2.1-6: Void

For E-UTRA BS with subPRB allocation, subPRB allocation throughput shall be $\geq 95\%$ of the maximum throughput of the reference measurement channel as specified in Annex A with parameters specified in Table 7.2.1-7 for Wide Area BS, in Table 7.2.1-7a for Local Area BS, in Table 7.2.1-7b for Home BS and in Table 7.2.1-7c for Medium Range BS.

Table 7.2.1-7: SubPRB allocation for Wide Area BS reference sensitivity levels

SubPRB transmission bandwidth [kHz]	subPRB Sub-carrier spacing [kHz]	Reference measurement channel	Reference sensitivity power level, PREFSENS [dBm]
30	15	FRC A23-1 in Annex A.	-124.7

Table 7.2.1-7a: subPRB allocation for Local Area BS reference sensitivity levels

SubPRB transmission bandwidth [kHz]	subPRB Sub-carrier spacing [kHz]	Reference measurement channel	Reference sensitivity power level, PREFSENS [dBm]
30	15	FRC A23-1 in Annex A.	-116.7

Table 7.2.1-7b: subPRB allocation for Home BS reference sensitivity levels

SubPRB transmission bandwidth [kHz]	subPRB Sub-carrier spacing [kHz]	Reference measurement channel	Reference sensitivity power level, PREFSENS [dBm]
30	15	FRC A23-1 in Annex A.	-116.7

Table 7.2.1-7c: subPRB allocation for Medium Range BS reference sensitivity levels

SubPRB transmission bandwidth [kHz]	subPRB Sub-carrier spacing [kHz]	Reference measurement channel	Reference sensitivity power level, PREFSENS [dBm]
30	15	FRC A23-1 in Annex A.	-119.7

7.3 Dynamic range

The dynamic range is specified as a measure of the capability of the receiver to receive a wanted signal in the presence of an interfering signal inside the received channel bandwidth. In this condition a throughput requirement shall be met for a specified reference measurement channel. The interfering signal for the dynamic range requirement is an AWGN signal.

7.3.1 Minimum requirement

For E-UTRA, the throughput shall be $\geq 95\%$ of the maximum throughput of the reference measurement channel as specified in Annex A with parameters specified in Table 7.3.1-1 for Wide Area BS, in Table 7.3.1-2 for Local Area BS, in Table 7.3.1-3 for Home BS and in Table 7.3.1-4 for Medium Range BS.

Table 7.3.1-1: Wide Area BS dynamic range for E-UTRA carrier

E-UTRA channel bandwidth [MHz]	Reference measurement channel	Wanted signal mean power [dBm]	Interfering signal mean power [dBm] / BW_{Config}	Type of interfering signal
1.4	FRC A2-1 in Annex A.2	-76.3	-88.7	AWGN
3	FRC A2-2 in Annex A.2	-72.4	-84.7	AWGN
5	FRC A2-3 in Annex A.2	-70.2	-82.5	AWGN
10	FRC A2-3 in Annex A.2*	-70.2	-79.5	AWGN
15	FRC A2-3 in Annex A.2*	-70.2	-77.7	AWGN
20	FRC A2-3 in Annex A.2*	-70.2	-76.4	AWGN
Note*:	The wanted signal mean power is the power level of a single instance of the reference measurement channel. This requirement shall be met for each consecutive application of a single instance of FRC A2-3 mapped to disjoint frequency ranges with a width of 25 resource blocks each.			

Table 7.3.1-2: Local Area BS dynamic range for E-UTRA carrier

E-UTRA channel bandwidth [MHz]	Reference measurement channel	Wanted signal mean power [dBm]	Interfering signal mean power [dBm] / BW_{Config}	Type of interfering signal
1.4	FRC A2-1 in Annex A.2	-68.3	-80.7	AWGN
3	FRC A2-2 in Annex A.2	-64.4	-76.7	AWGN
5	FRC A2-3 in Annex A.2	-62.2	-74.5	AWGN
10	FRC A2-3 in Annex A.2 (Note 1) FRC A2-4 in Annex A.2 (Note 2)	-62.2 -65.3	-71.5	AWGN
15	FRC A2-3 in Annex A.2 (Note 1)	-62.2	-69.7	AWGN
20	FRC A2-3 in Annex A.2 (Note 1) FRC A2-5 in Annex A.2 (Note 2)	-62.2 -65.3	-68.4	AWGN
Note 1:	The wanted signal mean power is the power level of a single instance of the reference measurement channel. This requirement shall be met for each consecutive application of a single instance of FRC A2-3 mapped to disjoint frequency ranges with a width of 25 resource blocks each. This reference measurement channel is not applied for Band 46 and Band 49.			
Note 2:	The wanted signal mean power is the power level of a single instance of the reference measurement channel. This requirement shall be met for each single interlace of FRC A2-4 and A2-5. This reference measurement channel is only applied for Band 46 and Band 49.			

Table 7.3.1-3: Home BS dynamic range for E-UTRA carrier

E-UTRA channel bandwidth [MHz]	Reference measurement channel	Wanted signal mean power [dBm]	Interfering signal mean power [dBm] / BW_{Config}	Type of interfering signal
1.4	FRC A2-1 in Annex A.2	-31.8	-44.2	AWGN
3	FRC A2-2 in Annex A.2	-27.9	-40.2	AWGN
5	FRC A2-3 in Annex A.2	-25.7	-38	AWGN
10	FRC A2-3 in Annex A.2*	-25.7	-35	AWGN
15	FRC A2-3 in Annex A.2*	-25.7	-33.2	AWGN
20	FRC A2-3 in Annex A.2*	-25.7	-31.9	AWGN
Note*:	The wanted signal mean power is the power level of a single instance of the reference measurement channel. This requirement shall be met for each consecutive application of a single instance of FRC A2-3 mapped to disjoint frequency ranges with a width of 25 resource blocks each.			

Table 7.3.1-4: Medium Range BS dynamic range for E-UTRA carrier

E-UTRA channel bandwidth [MHz]	Reference measurement channel	Wanted signal mean power [dBm]	Interfering signal mean power [dBm] / BWConfig	Type of interfering signal
1.4	FRC A2-1 in Annex A.2	-71.3	-83.7	AWGN
3	FRC A2-2 in Annex A.2	-67.4	-79.7	AWGN
5	FRC A2-3 in Annex A.2	-65.2	-77.5	AWGN
10	FRC A2-3 in Annex A.2 (Note 1) FRC A2-4 in Annex A.2 (Note 2)	-65.2 -68.3	-74.5	AWGN
15	FRC A2-3 in Annex A.2 (Note 1)	-65.2	-72.7	AWGN
20	FRC A2-3 in Annex A.2 (Note 1) FRC A2-5 in Annex A.2 (Note 2)	-65.2 -68.3	-71.4	AWGN
<p>Note 1: The wanted signal mean power is the power level of a single instance of the reference measurement channel. This requirement shall be met for each consecutive application of a single instance of FRC A2-3 mapped to disjoint frequency ranges with a width of 25 resource blocks each. This reference measurement channel is not applied for Band 46.</p> <p>Note 2: The wanted signal mean power is the power level of a single instance of the reference measurement channel. This requirement shall be met for each single interlace of FRC A2-4 and A2-5. This reference measurement channel is only applied for Band 46.</p>				

For NB-IoT standalone operation, the throughput shall be $\geq 95\%$ of the maximum throughput of the reference measurement channel as specified in Annex A with parameters specified in Table 7.3.1-5 for Wide Area BS.

Table 7.3.1-5: Wide Area BS dynamic range for NB-IoT standalone operation

NB-IoT channel bandwidth [kHz]	Reference measurement channel	Wanted signal mean power [dBm]	Interfering signal mean power [dBm] / BW _{Channel}	Type of interfering signal
200	FRC A15-1 in Annex A.15	-99.7	-96	AWGN
200	FRC A15-2 in Annex A.15	-105.6	-96	AWGN

For NB-IoT in-band or guard band operation, the throughput shall be $\geq 95\%$ of the maximum throughput of the reference measurement channel as specified in Annex A with parameters specified in Table 7.3.1-6 for Wide Area BS.

Table 7.3.1-6: Wide Area BS dynamic range for NB-IoT in-band or guard band operation

NB-IoT channel bandwidth [MHz]	Reference measurement channel	Wanted signal mean power [dBm]	Interfering signal mean power [dBm] / BW_{Channel}	Type of interfering signal
3*	FRC A15-1 in Annex A.15	-99.7	-84.2	AWGN
	FRC A15-2 in Annex A.15	-105.6		
5	FRC A15-1 in Annex A.15	-99.7	-82.0	AWGN
	FRC A15-2 in Annex A.15	-105.6		
10	FRC A15-1 in Annex A.15	-99.7	-79.0	AWGN
	FRC A15-2 in Annex A.15	-105.6		
15	FRC A15-1 in Annex A.15	-99.7	-77.2	AWGN
	FRC A15-2 in Annex A.15	-105.6		
20	FRC A15-1 in Annex A.15	-99.7	-76.0	AWGN
	FRC A15-2 in Annex A.15	-105.6		
Note*: 3 MHz channel bandwidth is not applicable to guard band operation.				

For NB-IoT standalone operation, the throughput shall be $\geq 95\%$ of the maximum throughput of the reference measurement channel as specified in Annex A with parameters specified in Table 7.3.1-7 for Local Area BS

Table 7.3.1-7: Local Area BS dynamic range for NB-IoT standalone operation

NB-IoT channel bandwidth [kHz]	Reference measurement channel	Wanted signal mean power [dBm]	Interfering signal mean power [dBm] / BW_{Channel}	Type of interfering signal
200	FRC A15-1 in Annex A.15	-91.7	-88	AWGN
200	FRC A15-2 in Annex A.15	-97.6	-88	AWGN

For NB-IoT in-band or guard band operation, the throughput shall be $\geq 95\%$ of the maximum throughput of the reference measurement channel as specified in Annex A with parameters specified in Table 7.3.1-8 for Local Area BS.

Table 7.3.1-8: Local Area BS dynamic range for NB-IoT in-band or guard band operation

NB-IoT channel bandwidth [MHz]	Reference measurement channel	Wanted signal mean power [dBm]	Interfering signal mean power [dBm] / BW_{Channel}	Type of interfering signal
3 (Note 1)	FRC A15-1 in Annex A.15	-91.7	-76.2	AWGN
	FRC A15-2 in Annex A.15	-97.6		
5	FRC A15-1 in Annex A.15	-91.7	-74.0	AWGN
	FRC A15-2 in Annex A.15	-97.6		
10	FRC A15-1 in Annex A.15	-91.7	-71.0	AWGN
	FRC A15-2 in Annex A.15	-97.6		
15	FRC A15-1 in Annex A.15	-91.7	-69.2	AWGN
	FRC A15-2 in Annex A.15	-97.6		
20	FRC A15-1 in Annex A.15	-91.7	-68.0	AWGN
	FRC A15-2 in Annex A.15	-97.6		
Note 1: 3 MHz channel bandwidth is not applicable to guard band operation.				

For NB-IoT standalone operation, the throughput shall be $\geq 95\%$ of the maximum throughput of the reference measurement channel as specified in Annex A with parameters specified in Table 7.3.1-9 for Home BS

Table 7.3.1-9: Home BS dynamic range for NB-IoT standalone operation

NB-IoT channel bandwidth [kHz]	Reference measurement channel	Wanted signal mean power [dBm]	Interfering signal mean power [dBm] / BW_{Channel}	Type of interfering signal
200	FRC A15-1 in Annex A.15	-55.2	-51.5	AWGN
200	FRC A15-2 in Annex A.15	-61.1	-51.5	AWGN

For NB-IoT in-band or guard band operation, the throughput shall be $\geq 95\%$ of the maximum throughput of the reference measurement channel as specified in Annex A with parameters specified in Table 7.3.1-10 for Home BS.

Table 7.3.1-10: Home BS dynamic range for NB-IoT in-band or guard band operation

NB-IoT channel bandwidth [MHz]	Reference measurement channel	Wanted signal mean power [dBm]	Interfering signal mean power [dBm] / BW_{Channel}	Type of interfering signal
3 (Note 1)	FRC A15-1 in Annex A.15	-55.2	-39.7	AWGN
	FRC A15-2 in Annex A.15	-61.1		
5	FRC A15-1 in Annex A.15	-55.2	-37.5	AWGN
	FRC A15-2 in Annex A.15	-61.1		
10	FRC A15-1 in Annex A.15	-55.2	-34.5	AWGN
	FRC A15-2 in Annex A.15	-61.1		
15	FRC A15-1 in Annex A.15	-55.2	-32.7	AWGN
	FRC A15-2 in Annex A.15	-61.1		
20	FRC A15-1 in Annex A.15	-55.2	-31.5	AWGN
	FRC A15-2 in Annex A.15	-61.1		

Note 1: 3 MHz channel bandwidth is not applicable to guard band operation.

For NB-IoT standalone operation, the throughput shall be $\geq 95\%$ of the maximum throughput of the reference measurement channel as specified in Annex A with parameters specified in Table 7.3.1-11 for Medium Range BS

Table 7.3.1-11: Medium Range BS dynamic range for NB-IoT standalone operation

NB-IoT channel bandwidth [kHz]	Reference measurement channel	Wanted signal mean power [dBm]	Interfering signal mean power [dBm] / BW_{Channel}	Type of interfering signal
200	FRC A15-1 in Annex A.15	-94.7	-91	AWGN
200	FRC A15-2 in Annex A.15	-100.6	-91	AWGN

For NB-IoT in-band or guard band operation, the throughput shall be $\geq 95\%$ of the maximum throughput of the reference measurement channel as specified in Annex A with parameters specified in Table 7.3.1-12 for Medium Range BS.

Table 7.3.1-12: Medium Range BS dynamic range for NB-IoT in-band or guard band operation

NB-IoT channel bandwidth [MHz]	Reference measurement channel	Wanted signal mean power [dBm]	Interfering signal mean power [dBm] / BW_{Channel}	Type of interfering signal
3 (Note 1)	FRC A15-1 in Annex A.15	-94.7	-79.2	AWGN
	FRC A15-2 in Annex A.15	-100.6		
5	FRC A15-1 in Annex A.15	-94.7	-77.0	AWGN
	FRC A15-2 in Annex A.15	-100.6		
10	FRC A15-1 in Annex A.15	-94.7	-74.0	AWGN
	FRC A15-2 in Annex A.15	-100.6		
15	FRC A15-1 in Annex A.15	-94.7	-72.2	AWGN
	FRC A15-2 in Annex A.15	-100.6		
20	FRC A15-1 in Annex A.15	-94.7	-71.0	AWGN
	FRC A15-2 in Annex A.15	-100.6		

Note 1: 3 MHz channel bandwidth is not applicable to guard band operation.

7.4 In-channel selectivity

In-channel selectivity (ICS) is a measure of the receiver ability to receive a wanted signal at its assigned resource block locations in the presence of an interfering signal received at a larger power spectral density. In this condition a throughput requirement shall be met for a specified reference measurement channel. The interfering signal shall be an E-UTRA signal as specified in Annex C and shall be time aligned with the wanted signal.

7.4.1 Minimum requirement

For E-UTRA, the throughput shall be $\geq 95\%$ of the maximum throughput of the reference measurement channel as specified in Annex A with parameters specified in Table 7.4.1-1 for Wide Area BS, in Table 7.4.1-2 for Local Area BS, in Table 7.4.1-3 for Home BS and in Table 7.4.1-4 for Medium Range BS.

Table 7.4.1-1 Wide Area BS in-channel selectivity for E-UTRA

E-UTRA channel bandwidth (MHz)	Reference measurement channel	Wanted signal mean power [dBm]	Interfering signal mean power [dBm]	Type of interfering signal
1.4	A1-4 in Annex A.1	-106.9	-87	1.4 MHz E-UTRA signal, 3 RBs
3	A1-5 in Annex A.1	-102.1	-84	3 MHz E-UTRA signal, 6 RBs
5	A1-2 in Annex A.1	-100.0	-81	5 MHz E-UTRA signal, 10 RBs
10	A1-3 in Annex A.1	-98.5	-77	10 MHz E-UTRA signal, 25 RBs
15	A1-3 in Annex A.1 (Note)	-98.5	-77	15 MHz E-UTRA signal, 25 RBs (Note)
20	A1-3 in Annex A.1 (Note)	-98.5	-77	20 MHz E-UTRA signal, 25 RBs (Note)

Note: Wanted and interfering signal are placed adjacently around F_c .

Table 7.4.1-2 Local Area BS in-channel selectivity for E-UTRA

E-UTRA channel bandwidth (MHz)	Reference measurement channel	Wanted signal mean power [dBm]	Interfering signal mean power [dBm]	Type of interfering signal
1.4	A1-4 in Annex A.1	-98.9	-79	1.4 MHz E-UTRA signal, 3 RBs
3	A1-5 in Annex A.1	-94.1	-76	3 MHz E-UTRA signal, 6 RBs
5	A1-2 in Annex A.1	-92.0	-73	5 MHz E-UTRA signal, 10 RBs
10	A1-3 in Annex A.1 (Note 3)	-90.5	-69	10 MHz E-UTRA signal, 25 RBs (Note 3)
	A1-8 in Annex A.1 (Note 2)	-93.2	-71.8	10 MHz E-UTRA interlace signal, 10 RBs (Note 2)
15	A1-3 in Annex A.1 (Note 1)	-90.5	-69	15 MHz E-UTRA signal, 25 RBs (Note 1)
20	A1-3 in Annex A.1 (Note 1)	-90.5	-69	20 MHz E-UTRA signal, 25 RBs (Note 1)
	A1-9 in Annex A.1 (Note 2)	-93.2	-71.8	20 MHz E-UTRA interlace signal, 10 RBs (Note 2)
<p>Note 1: Wanted and interfering signal are placed adjacently around F_c, this reference measurement channel and interfering signal are not applied for Band 46 and Band 49.</p> <p>Note 2: Wanted and interfering signal interlaces are mirrored around F_c, this reference measurement channel and interfering signal are only applied for Band 46 and Band 49.</p> <p>Note 3: This reference measurement channel and interfering signal are not applied for Band 46 and Band 49.</p>				

Table 7.4.1-3 Home BS in-channel selectivity for E-UTRA

E-UTRA channel bandwidth (MHz)	Reference measurement channel	Wanted signal mean power [dBm]	Interfering signal mean power [dBm]	Type of interfering signal
1.4	A1-4 in Annex A.1	-98.9	-79	1.4 MHz E-UTRA signal, 3 RBs
3	A1-5 in Annex A.1	-94.1	-76	3 MHz E-UTRA signal, 6 RBs
5	A1-2 in Annex A.1	-92.0	-73	5 MHz E-UTRA signal, 10 RBs
10	A1-3 in Annex A.1	-90.5	-69	10 MHz E-UTRA signal, 25 RBs
15	A1-3 in Annex A.1 (Note)	-90.5	-69	15 MHz E-UTRA signal, 25 RBs (Note)
20	A1-3 in Annex A.1 (Note)	-90.5	-69	20 MHz E-UTRA signal, 25 RBs (Note)
<p>Note: Wanted and interfering signal are placed adjacently around F_c</p>				

Table 7.4.1-4 Medium Range BS in-channel selectivity for E-UTRA

E-UTRA channel bandwidth (MHz)	Reference measurement channel	Wanted signal mean power [dBm]	Interfering signal mean power [dBm]	Type of interfering signal
1.4	A1-4 in Annex A.1	-101.9	-82	1.4 MHz E-UTRA signal, 3 RBs
3	A1-5 in Annex A.1	-97.1	-79	3 MHz E-UTRA signal, 6 RBs
5	A1-2 in Annex A.1	-95.0	-76	5 MHz E-UTRA signal, 10 RBs
10	A1-3 in Annex A.1 (Note 3)	-93.5	-72	10 MHz E-UTRA signal, 25 RBs (Note 3)
	A1-8 in Annex A.1 (Note 2)	-96.2	-74.8	10 MHz E-UTRA interlace signal, 10 RBs (Note 2)
15	A1-3 in Annex A.1 (Note 1)	-93.5	-72	15 MHz E-UTRA signal, 25 RBs (Note 1)
20	A1-3 in Annex A.1 (Note 1)	-93.5	-72	20 MHz E-UTRA signal, 25 RBs (Note 1)
	A1-9 in Annex A.1 (Note 2)	-96.2	-74.8	20 MHz E-UTRA interlace signal, 10 RBs (Note 2)
<p>Note 1: Wanted and interfering signal are placed adjacently around F_c, this reference measurement channel and interfering signal are not applied for Band 46.</p> <p>Note 2: Wanted and interfering signal interlaces are mirrored around F_c, this reference measurement channel and interfering signal are only applied for Band 46.</p> <p>Note 3: This reference measurement channel and interfering signal are not applied for Band 46.</p>				

For NB-IoT in-band operation, the throughput shall be $\geq 95\%$ of the maximum throughput of the reference measurement channel as specified in Annex A with parameters specified in Table 7.4.1-5 and Table 7.4.1-6 for Wide Area BS.

Table 7.4.1-5 Wide Area BS in-channel selectivity for NB-IoT in-band operation with 15kHz channel spacing

E-UTRA channel bandwidth (MHz)	Reference measurement channel	Wanted signal mean power [dBm]	Interfering signal mean power [dBm]	Type of interfering signal
3	FRC A14-1 in Annex A.14	-124.3	-84	3 MHz E-UTRA signal, 6 RBs (Note 2)
5	FRC A14-1 in Annex A.14	-124.3	-81	5 MHz E-UTRA signal, 10 RBs (Note 1)
10	FRC A14-1 in Annex A.14	-124.3	-77	10 MHz E-UTRA signal, 25 RBs (Note 1)
15	FRC A14-1 in Annex A.14	-124.3	-77	15 MHz E-UTRA signal, 25 RBs (Note 1)
20	FRC A14-1 in Annex A.14	-124.3	-77	20 MHz E-UTRA signal, 25 RBs (Note 1)
<p>Note 1: Interfering signal is placed in one side of the F_c, while the NB-IoT PRB is placed on the other side. Both interfering signal and NB-IoT PRB are placed at the middle of the available PRB locations. The wanted NB-IoT tone is placed at the centre of this NB-IoT PRB.</p> <p>Note 2: Interfering signal is placed from the edge of BW_{Config}, while the NB-IoT PRB is placed at the middle of the remaining PRB locations. The wanted NB-IoT tone is placed at the centre of this NB-IoT PRB.</p>				

Table 7.4.1-6 Wide Area BS in-channel selectivity for NB-IoT in-band operation with 3.75kHz channel spacing

E-UTRA channel bandwidth (MHz)	Reference measurement channel	Wanted signal mean power [dBm]	Interfering signal mean power [dBm]	Type of interfering signal
3	FRC A14-2 in Annex A.14	-133.2+[3]	-84	3 MHz E-UTRA signal, 6 RBs (Note 2)
5	FRC A14-2 in Annex A.14	-133.2+[3]	-81	5 MHz E-UTRA signal, 10 RBs (Note 1)
10	FRC A14-2 in Annex A.14	-133.2+[3]	-77	10 MHz E-UTRA signal, 25 RBs (Note 1)
15	FRC A14-2 in Annex A.14	-133.2+[3]	-77	15 MHz E-UTRA signal, 25 RBs (Note 1)
20	FRC A14-2 in Annex A.14	-133.2+[3]	-77	20 MHz E-UTRA signal, 25 RBs (Note 1)
<p>Note 1: Interfering signal is placed in one side of the F_c, while the NB-IoT PRB is placed on the other side. Both interfering signal and NB-IoT PRB are placed at the middle of the available PRB locations. The wanted NB-IoT tone is placed at the centre of this NB-IoT PRB.</p> <p>Note 2: Interfering signal is placed from the edge of BW_{Config}, while the NB-IoT PRB is placed at the middle of the remaining PRB locations. The wanted NB-IoT tone is placed at the centre of this NB-IoT PRB.</p>				

For NB-IoT in-band operation, the throughput shall be $\geq 95\%$ of the maximum throughput of the reference measurement channel as specified in Annex A with parameters specified in Table 7.4.1-7 and Table 7.4.1-8 for Local Area BS.

Table 7.4.1-7 Local Area BS in-channel selectivity for NB-IoT in-band operation with 15kHz channel spacing

E-UTRA channel bandwidth (MHz)	Reference measurement channel	Wanted signal mean power [dBm]	Interfering signal mean power [dBm]	Type of interfering signal
3	FRC A14-1 in Annex A.14	-116.3	-76	3 MHz E-UTRA signal, 6 RBs (Note 2)
5	FRC A14-1 in Annex A.14	-116.3	-73	5 MHz E-UTRA signal, 10 RBs (Note 1)
10	FRC A14-1 in Annex A.14	-116.3	-69	10 MHz E-UTRA signal, 25 RBs (Note 1)
15	FRC A14-1 in Annex A.14	-116.3	-69	15 MHz E-UTRA signal, 25 RBs (Note 1)
20	FRC A14-1 in Annex A.14	-116.3	-69	20 MHz E-UTRA signal, 25 RBs (Note 1)
Note 1: Interfering signal is placed in one side of the F_c , while the NB-IoT PRB is placed on the other side. Both interfering signal and NB-IoT PRB are placed at the middle of the available PRB locations. The wanted NB-IoT tone is placed at the centre of this NB-IoT PRB. Note 2: Interfering signal is placed from the edge of BW_{Config} , while the NB-IoT PRB is placed at the middle of the remaining PRB locations. The wanted NB-IoT tone is placed at the centre of this NB-IoT PRB.				

Table 7.4.1-8 Local Area BS in-channel selectivity for NB-IoT in-band operation with 3.75kHz channel spacing

E-UTRA channel bandwidth (MHz)	Reference measurement channel	Wanted signal mean power [dBm]	Interfering signal mean power [dBm]	Type of interfering signal
3	FRC A14-2 in Annex A.14	-122.2	-76	3 MHz E-UTRA signal, 6 RBs (Note 2)
5	FRC A14-2 in Annex A.14	-122.2	-73	5 MHz E-UTRA signal, 10 RBs (Note 1)
10	FRC A14-2 in Annex A.14	-122.2	-69	10 MHz E-UTRA signal, 25 RBs (Note 1)
15	FRC A14-2 in Annex A.14	-122.2	-69	15 MHz E-UTRA signal, 25 RBs (Note 1)
20	FRC A14-2 in Annex A.14	-122.2	-69	20 MHz E-UTRA signal, 25 RBs (Note 1)
Note 1: Interfering signal is placed in one side of the F_c , while the NB-IoT PRB is placed on the other side. Both interfering signal and NB-IoT PRB are placed at the middle of the available PRB locations. The wanted NB-IoT tone is placed at the centre of this NB-IoT PRB. Note 2: Interfering signal is placed from the edge of BW_{Config} , while the NB-IoT PRB is placed at the middle of the remaining PRB locations. The wanted NB-IoT tone is placed at the centre of this NB-IoT PRB.				

For NB-IoT in-band operation, the throughput shall be $\geq 95\%$ of the maximum throughput of the reference measurement channel as specified in Annex A with parameters specified in Table 7.4.1-9 and Table 7.4.1-10 for Home BS.

Table 7.4.1-9 Home BS in-channel selectivity for NB-IoT in-band operation with 15kHz channel spacing

E-UTRA channel bandwidth (MHz)	Reference measurement channel	Wanted signal mean power [dBm]	Interfering signal mean power [dBm]	Type of interfering signal
3	FRC A14-1 in Annex A.14	-116.3	-76	3 MHz E-UTRA signal, 6 RBs (Note 2)
5	FRC A14-1 in Annex A.14	-116.3	-73	5 MHz E-UTRA signal, 10 RBs (Note 1)
10	FRC A14-1 in Annex A.14	-116.3	-69	10 MHz E-UTRA signal, 25 RBs (Note 1)
15	FRC A14-1 in Annex A.14	-116.3	-69	15 MHz E-UTRA signal, 25 RBs (Note 1)
20	FRC A14-1 in Annex A.14	-116.3	-69	20 MHz E-UTRA signal, 25 RBs (Note 1)
<p>Note 1: Interfering signal is placed in one side of the F_c, while the NB-IoT PRB is placed on the other side. Both interfering signal and NB-IoT PRB are placed at the middle of the available PRB locations. The wanted NB-IoT tone is placed at the centre of this NB-IoT PRB.</p> <p>Note 2: Interfering signal is placed from the edge of BW_{Config}, while the NB-IoT PRB is placed at the middle of the remaining PRB locations. The wanted NB-IoT tone is placed at the centre of this NB-IoT PRB.</p>				

Table 7.4.1-10 Home BS in-channel selectivity for NB-IoT in-band operation with 3.75kHz channel spacing

E-UTRA channel bandwidth (MHz)	Reference measurement channel	Wanted signal mean power [dBm]	Interfering signal mean power [dBm]	Type of interfering signal
3	FRC A14-2 in Annex A.14	-122.2	-76	3 MHz E-UTRA signal, 6 RBs (Note 2)
5	FRC A14-2 in Annex A.14	-122.2	-73	5 MHz E-UTRA signal, 10 RBs (Note 1)
10	FRC A14-2 in Annex A.14	-122.2	-69	10 MHz E-UTRA signal, 25 RBs (Note 1)
15	FRC A14-2 in Annex A.14	-122.2	-69	15 MHz E-UTRA signal, 25 RBs (Note 1)
20	FRC A14-2 in Annex A.14	-122.2	-69	20 MHz E-UTRA signal, 25 RBs (Note 1)
<p>Note 1: Interfering signal is placed in one side of the F_c, while the NB-IoT PRB is placed on the other side. Both interfering signal and NB-IoT PRB are placed at the middle of the available PRB locations. The wanted NB-IoT tone is placed at the centre of this NB-IoT PRB.</p> <p>Note 2: Interfering signal is placed from the edge of BW_{Config}, while the NB-IoT PRB is placed at the middle of the remaining PRB locations. The wanted NB-IoT tone is placed at the centre of this NB-IoT PRB.</p>				

For NB-IoT in-band operation, the throughput shall be $\geq 95\%$ of the maximum throughput of the reference measurement channel as specified in Annex A with parameters specified in Table 7.4.1-11 and Table 7.4.1-12 for Medium Range BS.

Table 7.4.1-11 Medium Range BS in-channel selectivity for NB-IoT in-band operation with 15kHz channel spacing

E-UTRA channel bandwidth (MHz)	Reference measurement channel	Wanted signal mean power [dBm]	Interfering signal mean power [dBm]	Type of interfering signal
3	FRC A14-1 in Annex A.14	-119.3	-79	3 MHz E-UTRA signal, 6 RBs (Note 2)
5	FRC A14-1 in Annex A.14	-119.3	-76	5 MHz E-UTRA signal, 10 RBs (Note 1)
10	FRC A14-1 in Annex A.14	-119.3	-72	10 MHz E-UTRA signal, 25 RBs (Note 1)
15	FRC A14-1 in Annex A.14	-119.3	-72	15 MHz E-UTRA signal, 25 RBs (Note 1)
20	FRC A14-1 in Annex A.14	-119.3	-72	20 MHz E-UTRA signal, 25 RBs (Note 1)
<p>Note 1: Interfering signal is placed in one side of the F_c, while the NB-IoT PRB is placed on the other side. Both interfering signal and NB-IoT PRB are placed at the middle of the available PRB locations. The wanted NB-IoT tone is placed at the centre of this NB-IoT PRB.</p> <p>Note 2: Interfering signal is placed from the edge of BW_{Config}, while the NB-IoT PRB is placed at the middle of the remaining PRB locations. The wanted NB-IoT tone is placed at the centre of this NB-IoT PRB.</p>				

Table 7.4.1-12 Medium Range BS in-channel selectivity for NB-IoT in-band operation with 3.75kHz channel spacing

E-UTRA channel bandwidth (MHz)	Reference measurement channel	Wanted signal mean power [dBm]	Interfering signal mean power [dBm]	Type of interfering signal
3	FRC A14-2 in Annex A.14	-125.2	-79	3 MHz E-UTRA signal, 6 RBs (Note 2)
5	FRC A14-2 in Annex A.14	-125.2	-76	5 MHz E-UTRA signal, 10 RBs (Note 1)
10	FRC A14-2 in Annex A.14	-125.2	-72	10 MHz E-UTRA signal, 25 RBs (Note 1)
15	FRC A14-2 in Annex A.14	-125.2	-72	15 MHz E-UTRA signal, 25 RBs (Note 1)
20	FRC A14-2 in Annex A.14	-125.2	-72	20 MHz E-UTRA signal, 25 RBs (Note 1)
<p>Note 1: Interfering signal is placed in one side of the F_c, while the NB-IoT PRB is placed on the other side. Both interfering signal and NB-IoT PRB are placed at the middle of the available PRB locations. The wanted NB-IoT tone is placed at the centre of this NB-IoT PRB.</p> <p>Note 2: Interfering signal is placed from the edge of BW_{Config}, while the NB-IoT PRB is placed at the middle of the remaining PRB locations. The wanted NB-IoT tone is placed at the centre of this NB-IoT PRB.</p>				

7.5 Adjacent Channel Selectivity (ACS) and narrow-band blocking

Adjacent channel selectivity (ACS) is a measure of the receiver ability to receive a wanted signal at its assigned channel frequency in the presence of an adjacent channel signal with a specified centre frequency offset of the interfering signal to the band edge of a victim system. For E-UTRA or E-UTRA with NB-IoT (in-band and/or guard band operation) BS, the interfering signal shall be an E-UTRA signal as specified in Annex C. For NB-IoT standalone BS, the interfering signal shall be a NB-IoT signal as specified in Annex C.

7.5.1 Minimum requirement

The throughput shall be $\geq 95\%$ of the maximum throughput of the reference measurement channel.

For E-UTRA Wide Area BS, the wanted and the interfering signal coupled to the BS antenna input are specified in Tables 7.5.1-1 and 7.5.1-2 for narrowband blocking and in Table 7.5.1-3 for ACS. The reference measurement channel for the wanted signal is identified in Table 7.2.1-1 for each channel bandwidth and further specified in Annex A.

For E-UTRA Medium Range BS, the wanted and the interfering signal coupled to the BS antenna input are specified in Tables 7.5.1-1 and 7.5.1-2 for narrowband blocking and in Table 7.5.1-6 for ACS. Narrowband blocking requirements are not applied for Band 46. The reference measurement channel for the wanted signal is identified in Table 7.2.1-4 for each channel bandwidth and further specified in Annex A.

For E-UTRA Local Area BS, the wanted and the interfering signal coupled to the BS antenna input are specified in Tables 7.5.1-1 and 7.5.1-2 for narrowband blocking and in Table 7.5.1-4 for ACS. Narrowband blocking requirements are not applied for Band 46. The reference measurement channel for the wanted signal is identified in Table 7.2.1-2 for each channel bandwidth and further specified in Annex A.

For E-UTRA Home BS, the wanted and the interfering signal coupled to the BS antenna input are specified in Tables 7.5.1-1 and 7.5.1-2 for narrowband blocking and in Table 7.5.1-5 for ACS. The reference measurement channel for the wanted signal is identified in Table 7.2.1-3 for each channel bandwidth and further specified in Annex A.

For NB-IoT in-band operation Wide Area BS, the wanted signal and the interfering signal coupled to the BS antenna input are specified in Tables 7.5.1-1a and 7.5.1-2 for narrowband blocking and in Table 7.5.1-3a for ACS. The reference measurement channel for the NB-IoT wanted signal is identified in Table 7.2.1-5 for each sub-carrier spacing and further specified in Annex A.

For NB-IoT guard band operation Wide Area BS, the wanted signal and the interfering signal coupled to the BS antenna input are specified in Tables 7.5.1-1b and 7.5.1-2 for narrowband blocking and in Table 7.5.1-3b for ACS. The reference measurement channel for the NB-IoT wanted signal is identified in Table 7.2.1-5 for each sub-carrier spacing and further specified in Annex A.

For NB-IoT standalone operation Wide Area BS, the wanted signal and the interfering signal coupled to the BS antenna input are specified in Tables 7.5.1-1c and 7.5.1-2a for narrowband blocking and in Table 7.5.1-3c for ACS. The reference measurement channel for the NB-IoT wanted signal is identified in Table 7.2.1-5 for each sub-carrier spacing and further specified in Annex A.

For NB-IoT in-band operation Local Area BS, the wanted signal and the interfering signal coupled to the BS antenna input are specified in Tables 7.5.1-1a and 7.5.1-2 for narrowband blocking and in Table 7.5.1-4a for ACS. The reference measurement channel for the NB-IoT wanted signal is identified in Table 7.2.1-5a for each sub-carrier spacing and further specified in Annex A.

For NB-IoT guard band operation Local Area BS, the wanted signal and the interfering signal coupled to the BS antenna input are specified in Tables 7.5.1-1b and 7.5.1-2 for narrowband blocking and in Table 7.5.1-4b for ACS. The reference measurement channel for the NB-IoT wanted signal is identified in Table 7.2.1-5a for each sub-carrier spacing and further specified in Annex A.

For NB-IoT standalone operation Local Area BS, the wanted signal and the interfering signal coupled to the BS antenna input are specified in Tables 7.5.1-1c and 7.5.1-2a for narrowband blocking and in Table 7.5.1-4c for ACS. The reference measurement channel for the NB-IoT wanted signal is identified in Table 7.2.1-5a for each sub-carrier spacing and further specified in Annex A.

For NB-IoT in-band operation Medium Range BS, the wanted signal and the interfering signal coupled to the BS antenna input are specified in Tables 7.5.1-1a and 7.5.1-2 for narrowband blocking and in Table 7.5.1-5a for ACS. The

reference measurement channel for the NB-IoT wanted signal is identified in Table 7.2.1-5b for each sub-carrier spacing and further specified in Annex A.

For NB-IoT guard band operation Medium Range BS, the wanted signal and the interfering signal coupled to the BS antenna input are specified in Tables 7.5.1-1b and 7.5.1-2 for narrowband blocking and in Table 7.5.1-5b for ACS. The reference measurement channel for the NB-IoT wanted signal is identified in Table 7.2.1-5c for each sub-carrier spacing and further specified in Annex A.

For NB-IoT standalone operation Medium Range BS, the wanted signal and the interfering signal coupled to the BS antenna input are specified in Tables 7.5.1-1c and 7.5.1-2a for narrowband blocking and in Table 7.5.1-5c for ACS. The reference measurement channel for the NB-IoT wanted signal is identified in Table 7.2.1-5c for each sub-carrier spacing and further specified in Annex A.

For NB-IoT in-band operation Home BS, the wanted signal and the interfering signal coupled to the BS antenna input are specified in Tables 7.5.1-1a and 7.5.1-2 for narrowband blocking and in Table 7.5.1-5a for ACS. The reference measurement channel for the NB-IoT wanted signal is identified in Table 7.2.1-5c for each sub-carrier spacing and further specified in Annex A.

For NB-IoT guard band operation Home BS, the wanted signal and the interfering signal coupled to the BS antenna input are specified in Tables 7.5.1-1b and 7.5.1-2 for narrowband blocking and in Table 7.5.1-5b for ACS. The reference measurement channel for the NB-IoT wanted signal is identified in Table 7.2.1-5b for each sub-carrier spacing and further specified in Annex A.

For NB-IoT standalone operation Home BS, the wanted signal and the interfering signal coupled to the BS antenna input are specified in Tables 7.5.1-1c and 7.5.1-2a for narrowband blocking and in Table 7.5.1-5c for ACS. The reference measurement channel for the NB-IoT wanted signal is identified in Table 7.2.1-5b for each sub-carrier spacing and further specified in Annex A.

The ACS and narrowband blocking requirement is applicable outside the Base Station RF Bandwidth or Radio Bandwidth. The interfering signal offset is defined relative to the Base station RF Bandwidth edges or Radio Bandwidth edges.

For a E-UTRA BS operating in non-contiguous spectrum within any operating band, the ACS requirement applies in addition inside any sub-block gap, in case the sub-block gap size is at least as wide as the E-UTRA interfering signal in Table 7.5.1-3, 7.5.1-4 and 7.5.1-6. The interfering signal offset is defined relative to the sub-block edges inside the sub-block gap.

For a E-UTRA BS capable of multi-band operation, the ACS requirement applies in addition inside any Inter RF Bandwidth gap, in case the Inter RF Bandwidth gap size is at least as wide as the E-UTRA interfering signal in Tables 7.5.1-3, 7.5.1-4 and 7.5.1-6. The interfering signal offset is defined relative to the Base Station RF Bandwidth edges inside the Inter RF Bandwidth gap.

For a E-UTRA BS operating in non-contiguous spectrum within any operating band, the narrowband blocking requirement applies in addition inside any sub-block gap, in case the sub-block gap size is at least as wide as the channel bandwidth of the E-UTRA interfering signal in Table 7.5.1-2. The interfering signal offset is defined relative to the sub-block edges inside the sub-block gap.

For a E-UTRA BS capable of multi-band operation, the narrowband blocking requirement applies in addition inside any Inter RF Bandwidth gap, in case the Inter RF Bandwidth gap size is at least as wide as the E-UTRA interfering signal in Table 7.5.1-2. The interfering signal offset is defined relative to the Base Station RF Bandwidth edges inside the Inter RF Bandwidth gap.

Table 7.5.1-1: Narrowband blocking requirement for E-UTRA BS

	Wanted signal mean power [dBm]	Interfering signal mean power [dBm]	Type of interfering signal
Wide Area BS	$P_{\text{REFSENS}} + 6\text{dB}$ (Note 1)	-49	See Table 7.5.1-2
Medium Range BS	$P_{\text{REFSENS}} + 6\text{dB}$ (Note 4)	-44	See Table 7.5.1-2
Local Area BS	$P_{\text{REFSENS}} + 6\text{dB}$ (Note 2)	-41	See Table 7.5.1-2
Home BS	$P_{\text{REFSENS}} + 14\text{dB}$ (Note 3)	-33	See Table 7.5.1-2
Note 1:	P_{REFSENS} depends on the channel bandwidth as specified in Table 7.2.1-1.		
Note 2:	P_{REFSENS} depends on the channel bandwidth as specified in Table 7.2.1-2.		
Note 3:	P_{REFSENS} depends on the channel bandwidth as specified in Table 7.2.1-3.		
Note 4:	P_{REFSENS} depends on the channel bandwidth as specified in Table 7.2.1-4.		

Table 7.5.1-1a: Narrowband blocking requirement for NB-IoT in-band operation BS

	E-UTRA channel BW of the lowest/highest carrier received [MHz]	NB-IoT Wanted signal mean power [dBm]	Interfering signal mean power [dBm]	Type of interfering signal
Wide Area BS	3	$P_{\text{REFSENS}} + 11$ dB (Note 1)	-49	See Table 7.5.1-2
	5	$P_{\text{REFSENS}} + 8$ dB (Note 1)	-49	See Table 7.5.1-2
	10	$P_{\text{REFSENS}} + 6$ dB (Note 1)	-49	See Table 7.5.1-2
	15	$P_{\text{REFSENS}} + 6$ dB (Note 1)	-49	See Table 7.5.1-2
	20	$P_{\text{REFSENS}} + 6$ dB (Note 1)	-49	See Table 7.5.1-2
Local Area BS	3	$P_{\text{REFSENS}} + 11$ dB (Note 2)	-41	See Table 7.5.1-2
	5	$P_{\text{REFSENS}} + 8$ dB (Note 2)	-41	See Table 7.5.1-2
	10	$P_{\text{REFSENS}} + 6$ dB (Note 2)	-41	See Table 7.5.1-2
	15	$P_{\text{REFSENS}} + 6$ dB (Note 2)	-41	See Table 7.5.1-2
	20	$P_{\text{REFSENS}} + 6$ dB (Note 2)	-41	See Table 7.5.1-2
Medium Range BS	3	$P_{\text{REFSENS}} + 11$ dB (Note 3)	-44	See Table 7.5.1-2
	5	$P_{\text{REFSENS}} + 8$ dB (Note 3)	-44	See Table 7.5.1-2
	10	$P_{\text{REFSENS}} + 6$ dB (Note 3)	-44	See Table 7.5.1-2
	15	$P_{\text{REFSENS}} + 6$ dB (Note 3)	-44	See Table 7.5.1-2
	20	$P_{\text{REFSENS}} + 6$ dB (Note 3)	-44	See Table 7.5.1-2
Home BS	3	$P_{\text{REFSENS}} + 19$ dB (Note 4)	-33	See Table 7.5.1-2
	5	$P_{\text{REFSENS}} + 16$ dB (Note 4)	-33	See Table 7.5.1-2
	10	$P_{\text{REFSENS}} + 14$ dB (Note 4)	-33	See Table 7.5.1-2
	15	$P_{\text{REFSENS}} + 14$ dB (Note 4)	-33	See Table 7.5.1-2
	20	$P_{\text{REFSENS}} + 14$ dB (Note 4)	-33	See Table 7.5.1-2
Note 1: P_{REFSENS} depends on the sub-carrier spacing as specified in Table 7.2.1-5. Note 2: P_{REFSENS} depends on the sub-carrier spacing as specified in Table 7.2.1-5a. Note 3: P_{REFSENS} depends on the sub-carrier spacing as specified in Table 7.2.1-5c. Note 4: P_{REFSENS} depends on the sub-carrier spacing as specified in Table 7.2.1-5b.				

Table 7.5.1-1b: Narrowband blocking requirement for NB-IoT guard band operation BS

	E-UTRA channel BW of the lowest/highest carrier received [MHz]	NB-IoT Wanted signal mean power [dBm]	Interfering signal mean power [dBm]	Type of interfering signal
Wide Area BS	5	$P_{\text{REFSENS}} + 11$ dB (Note 1)	-49	See Table 7.5.1-2
	10	$P_{\text{REFSENS}} + 6$ dB (Note 1)	-49	See Table 7.5.1-2
	15	$P_{\text{REFSENS}} + 6$ dB (Note 1)	-49	See Table 7.5.1-2
	20	$P_{\text{REFSENS}} + 6$ dB (Note 1)	-49	See Table 7.5.1-2
Local Area BS	5	$P_{\text{REFSENS}} + 11$ dB (Note 2)	-41	See Table 7.5.1-2
	10	$P_{\text{REFSENS}} + 6$ dB (Note 2)	-41	See Table 7.5.1-2
	15	$P_{\text{REFSENS}} + 6$ dB (Note 2)	-41	See Table 7.5.1-2
	20	$P_{\text{REFSENS}} + 6$ dB (Note 2)	-41	See Table 7.5.1-2
Medium Range BS	5	$P_{\text{REFSENS}} + 11$ dB (Note 3)	-44	See Table 7.5.1-2
	10	$P_{\text{REFSENS}} + 6$ dB (Note 3)	-44	See Table 7.5.1-2
	15	$P_{\text{REFSENS}} + 6$ dB (Note 3)	-44	See Table 7.5.1-2
	20	$P_{\text{REFSENS}} + 6$ dB (Note 3)	-44	See Table 7.5.1-2
Home BS	3	$P_{\text{REFSENS}} + 19$ dB (Note 4)	-33	See Table 7.5.1-2
	5	$P_{\text{REFSENS}} + 16$ dB (Note 4)	-33	See Table 7.5.1-2
	10	$P_{\text{REFSENS}} + 14$ dB (Note 4)	-33	See Table 7.5.1-2
	15	$P_{\text{REFSENS}} + 14$ dB (Note 4)	-33	See Table 7.5.1-2
	20	$P_{\text{REFSENS}} + 14$ dB (Note 4)	-33	See Table 7.5.1-2
Note:	The mentioned desens values consider only one NB-IoT PRB in the guard band, which is placed adjacent to the E-UTRA PRB edge as close as possible (i.e., away from edge of channel bandwidth).			
Note 1:	P_{REFSENS} depends on the sub-carrier spacing as specified in Table 7.2.1-5.			
Note 2:	P_{REFSENS} depends on the sub-carrier spacing as specified in Table 7.2.1-5a.			
Note 3:	P_{REFSENS} depends on the sub-carrier spacing as specified in Table 7.2.1-5c.			
Note 4:	P_{REFSENS} depends on the sub-carrier spacing as specified in Table 7.2.1-5b.			

Table 7.5.1-1c: Narrowband blocking requirement for NB-IoT standalone

	NB-IoT channel bandwidth of the lowest/highest carrier received [kHz]	Wanted signal mean power [dBm]	Interfering signal mean power [dBm]	Type of interfering signal
Wide Area BS	200	$P_{\text{REFSENS}} + 12$ dB (Note 1)	-49	See Table 7.5.1-2a
Local Area BS	200	$P_{\text{REFSENS}} + 12$ dB (Note 2)	-41	See Table 7.5.1-2a
Medium Range BS	200	$P_{\text{REFSENS}} + 12$ dB (Note 3)	-44	See Table 7.5.1-2a
Home BS	200	$P_{\text{REFSENS}} + 20$ dB (Note 4)	-33	See Table 7.5.1-2a
Note 1:	P_{REFSENS} depends on the sub-carrier spacing as specified in Table 7.2.1-5.			
Note 2:	P_{REFSENS} depends on the sub-carrier spacing as specified in Table 7.2.1-5a.			
Note 3:	P_{REFSENS} depends on the sub-carrier spacing as specified in Table 7.2.1-5c.			
Note 4:	P_{REFSENS} depends on the sub-carrier spacing as specified in Table 7.2.1-5b.			

Table 7.5.1-2: Interfering signal for Narrowband blocking requirement for E-UTRA BS

E-UTRA channel BW of the lowest/highest carrier received [MHz]	Interfering RB centre frequency offset to the lower/upper Base Station RF Bandwidth edge or sub-block edge inside a sub-block gap [kHz]	Type of interfering signal
1.4	$\pm(252.5+m*180)$, $m=0, 1, 2, 3, 4, 5$	1.4 MHz E-UTRA signal, 1 RB*
3	$\pm(247.5+m*180)$, $m=0, 1, 2, 3, 4, 7, 10, 13$	3 MHz E-UTRA signal, 1 RB*
5	$\pm(342.5+m*180)$, $m=0, 1, 2, 3, 4, 9, 14, 19, 24$	5 MHz E-UTRA signal, 1 RB*
10	$\pm(347.5+m*180)$, $m=0, 1, 2, 3, 4, 9, 14, 19, 24$	5 MHz E-UTRA signal, 1 RB*
15	$\pm(352.5+m*180)$, $m=0, 1, 2, 3, 4, 9, 14, 19, 24$	5 MHz E-UTRA signal, 1 RB*
20	$\pm(342.5+m*180)$, $m=0, 1, 2, 3, 4, 9, 14, 19, 24$	5 MHz E-UTRA signal, 1 RB*
Note*:	Interfering signal consisting of one resource block is positioned at the stated offset, the channel bandwidth of the interfering signal is located adjacently to the lower/upper Base Station RF Bandwidth edge.	

Table 7.5.1-2a: Interfering signal for Narrowband blocking requirement for NB-IoT standalone operation BS

NB-IoT channel bandwidth of the lowest/highest carrier received [kHz]	Interfering RB centre frequency offset to the lower/upper Base Station RF Bandwidth edge or sub-block edge inside a sub-block gap [kHz]	Type of interfering signal
200	$\pm(240 + m*180)$, $m=0, 1, 2, 3, 4, 9, 14$	3 MHz E-UTRA signal, 1 RB*

Note*: Interfering signal consisting of one resource block is positioned at the stated offset, the channel bandwidth of the interfering signal is located adjacently to the lower/upper Base Station RF Bandwidth edge.

Table 7.5.1-3: Adjacent channel selectivity for E-UTRA Wide Area BS

E-UTRA channel bandwidth of the lowest/highest carrier received [MHz]	Wanted signal mean power [dBm]	Interfering signal mean power [dBm]	Interfering signal centre frequency offset from the lower/upper Base Station RF Bandwidth edge or sub-block edge inside a sub-block gap [MHz]	Type of interfering signal
1.4	$P_{\text{REFSENS}} + 11\text{dB}$ (Note)	-52	± 0.7025	1.4MHz E-UTRA signal
3	$P_{\text{REFSENS}} + 8\text{dB}$ (Note)	-52	± 1.5075	3MHz E-UTRA signal
5	$P_{\text{REFSENS}} + 6\text{dB}$ (Note)	-52	± 2.5025	5MHz E-UTRA signal
10	$P_{\text{REFSENS}} + 6\text{dB}$ (Note)	-52	± 2.5075	5MHz E-UTRA signal
15	$P_{\text{REFSENS}} + 6\text{dB}$ (Note)	-52	± 2.5125	5MHz E-UTRA signal
20	$P_{\text{REFSENS}} + 6\text{dB}$ (Note)	-52	± 2.5025	5MHz E-UTRA signal

Note: P_{REFSENS} depends on the channel bandwidth as specified in Table 7.2.1-1.

Table 7.5.1-3a: Adjacent channel selectivity for NB-IoT in-band operation Wide Area BS

E-UTRA channel bandwidth of the lowest/highest carrier received [MHz]	NB-IoT wanted signal mean power [dBm]	Interfering signal mean power [dBm]	Interfering signal centre frequency offset from the lower/upper Base Station RF Bandwidth edge or sub-block edge inside a sub-block gap [MHz]	Type of interfering signal
3	$P_{\text{REFSENS}} + 8\text{dB}$ (Note)	-52	± 1.5075	3MHz E-UTRA signal
5	$P_{\text{REFSENS}} + 6\text{dB}$ (Note)	-52	± 2.5025	5MHz E-UTRA signal
10	$P_{\text{REFSENS}} + 6\text{dB}$ (Note)	-52	± 2.5075	5MHz E-UTRA signal
15	$P_{\text{REFSENS}} + 6\text{dB}$ (Note)	-52	± 2.5125	5MHz E-UTRA signal
20	$P_{\text{REFSENS}} + 6\text{dB}$ (Note)	-52	± 2.5025	5MHz E-UTRA signal

Note: P_{REFSENS} depends on the sub-carrier spacing as specified in Table 7.2.1-5.

Table 7.5.1-3b: Adjacent channel selectivity NB-IoT guard band operation Wide Area BS

E-UTRA channel bandwidth of the lowest/highest carrier received [MHz]	NB-IoT wanted signal mean power [dBm]	Interfering signal mean power [dBm]	Interfering signal centre frequency offset from the lower/upper Base Station RF Bandwidth edge or sub-block edge inside a sub-block gap [MHz]	Type of interfering signal
5	$P_{\text{REFSENS}} + 10$ dB (Note)	-52	± 2.5025	5MHz E-UTRA signal
10	$P_{\text{REFSENS}} + 8$ dB (Note)	-52	± 2.5075	5MHz E-UTRA signal
15	$P_{\text{REFSENS}} + 6$ dB (Note)	-52	± 2.5125	5MHz E-UTRA signal
20	$P_{\text{REFSENS}} + 6$ dB (Note)	-52	± 2.5025	5MHz E-UTRA signal

Note: P_{REFSENS} depends on the sub-carrier spacing as specified in Table 7.2.1-5.

Table 7.5.1-3c: Adjacent channel selectivity for NB-IoT standalone Wide Area BS

NB-IoT channel bandwidth of the lowest/highest carrier received [kHz]	Wanted signal mean power [dBm]	Interfering signal mean power [dBm]	Interfering signal centre frequency offset to the lower/upper Base Station RF Bandwidth edge or sub-block edge inside a sub-block gap [kHz]	Type of interfering signal
200	$P_{\text{REFSENS}} + 19.5$ dB (Note)	-52	± 100	180 kHz NB-IoT signal

Note: P_{REFSENS} depends on the sub-carrier spacing as specified in Table 7.2.1-5.

Table 7.5.1-4: Adjacent channel selectivity for E-UTRA Local Area BS

E-UTRA channel bandwidth of the lowest/highest carrier received [MHz]	Wanted signal mean power [dBm]	Interfering signal mean power [dBm]	Interfering signal centre frequency offset from the lower/upper Base Station RF Bandwidth edge or sub-block edge inside a sub-block gap [MHz]	Type of interfering signal
1.4	$P_{\text{REFSENS}} + 11$ dB (Note 1)	-44	± 0.7025	1.4MHz E-UTRA signal
3	$P_{\text{REFSENS}} + 8$ dB (Note 1)	-44	± 1.5075	3MHz E-UTRA signal
5	$P_{\text{REFSENS}} + 6$ dB (Note 1)	-44	± 2.5025	5MHz E-UTRA signal
10	$P_{\text{REFSENS}} + 6$ dB (Note 1)	-44	± 2.5075 ± 10.0175	5MHz E-UTRA signal (Note 2) 20 MHz E-UTRA signal (Note 3)
15	$P_{\text{REFSENS}} + 6$ dB (Note 1)	-44	± 2.5125	5MHz E-UTRA signal
20	$P_{\text{REFSENS}} + 6$ dB (Note 1)	-44	± 2.5025 ± 10.0175	5MHz E-UTRA signal (Note 2) 20 MHz E-UTRA signal (Note 3)

Note 1: P_{REFSENS} depends on the channel bandwidth as specified in Table 7.2.1-2.
Note 2: This type of interfering signal is not applied for Band 46.
Note 3: This type of interfering signal is only applied for Band 46.

Table 7.5.1-4a: Adjacent channel selectivity for NB-IoT in-band operation Local Area BS

E-UTRA channel bandwidth of the lowest/highest carrier received [MHz]	NB-IoT wanted signal mean power [dBm]	Interfering signal mean power [dBm]	Interfering signal centre frequency offset from the lower/upper Base Station RF Bandwidth edge or sub-block edge inside a sub-block gap [MHz]	Type of interfering signal
3	$P_{\text{REFSENS}} + 8\text{dB}$ (Note)	-44	± 1.5075	3MHz E-UTRA signal
5	$P_{\text{REFSENS}} + 6\text{dB}$ (Note)	-44	± 2.5025	5MHz E-UTRA signal
10	$P_{\text{REFSENS}} + 6\text{dB}$ (Note)	-44	± 2.5075	5MHz E-UTRA signal
15	$P_{\text{REFSENS}} + 6\text{dB}$ (Note)	-44	± 2.5125	5MHz E-UTRA signal
20	$P_{\text{REFSENS}} + 6\text{dB}$ (Note)	-44	± 2.5025	5MHz E-UTRA signal

Note: P_{REFSENS} depends on the sub-carrier spacing as specified in Table 7.2.1-5a.

Table 7.5.1-4b: Adjacent channel selectivity NB-IoT guard band operation Local Area BS

E-UTRA channel bandwidth of the lowest/highest carrier received [MHz]	NB-IoT wanted signal mean power [dBm]	Interfering signal mean power [dBm]	Interfering signal centre frequency offset from the lower/upper Base Station RF Bandwidth edge or sub-block edge inside a sub-block gap [MHz]	Type of interfering signal
5	$P_{\text{REFSENS}} + 10\text{dB}$ (Note)	-44	± 2.5025	5MHz E-UTRA signal
10	$P_{\text{REFSENS}} + 8\text{dB}$ (Note)	-44	± 2.5075	5MHz E-UTRA signal
15	$P_{\text{REFSENS}} + 6\text{dB}$ (Note)	-44	± 2.5125	5MHz E-UTRA signal
20	$P_{\text{REFSENS}} + 6\text{dB}$ (Note)	-44	± 2.5025	5MHz E-UTRA signal

Note: P_{REFSENS} depends on the sub-carrier spacing as specified in Table 7.2.1-5a.

Table 7.5.1-4c: Adjacent channel selectivity for NB-IoT standalone Local Area BS

NB-IoT channel bandwidth of the lowest/highest carrier received [kHz]	Wanted signal mean power [dBm]	Interfering signal mean power [dBm]	Interfering signal centre frequency offset to the lower/upper Base Station RF Bandwidth edge or sub-block edge inside a sub-block gap [kHz]	Type of interfering signal
200	$P_{\text{REFSENS}} + 19.5\text{dB}$ (Note)	-44	± 100	180 kHz NB-IoT signal

Note: P_{REFSENS} depends on the sub-carrier spacing as specified in Table 7.2.1-5a.

Table 7.5.1-5: Adjacent channel selectivity for E-UTRA Home BS

E-UTRA channel bandwidth [MHz]	Wanted signal mean power [dBm]	Interfering signal mean power [dBm]	Interfering signal centre frequency offset from the channel edge of the wanted signal [MHz]	Type of interfering signal
1.4	$P_{\text{REFSENS}} + 27\text{dB}$ (Note)	-28	0.7025	1.4MHz E-UTRA signal
3	$P_{\text{REFSENS}} + 24\text{dB}$ (Note)	-28	1.5075	3MHz E-UTRA signal
5	$P_{\text{REFSENS}} + 22\text{dB}$ (Note)	-28	2.5025	5MHz E-UTRA signal
10	$P_{\text{REFSENS}} + 22\text{dB}$ (Note)	-28	2.5075	5MHz E-UTRA signal
15	$P_{\text{REFSENS}} + 22\text{dB}$ (Note)	-28	2.5125	5MHz E-UTRA signal
20	$P_{\text{REFSENS}} + 22\text{dB}$ (Note)	-28	2.5025	5MHz E-UTRA signal

Note: P_{REFSENS} depends on the channel bandwidth as specified in Table 7.2.1-3.

Table 7.5.1-5a: Adjacent channel selectivity for NB-IoT in-band operation Home BS

E-UTRA channel bandwidth of the lowest/highest carrier received [MHz]	NB-IoT wanted signal mean power [dBm]	Interfering signal mean power [dBm]	Interfering signal centre frequency offset from the lower/upper Base Station RF Bandwidth edge or sub-block edge inside a sub-block gap [MHz]	Type of interfering signal
3	$P_{\text{REFSENS}} + 24\text{dB}$ (Note)	-28	± 1.5075	3MHz E-UTRA signal
5	$P_{\text{REFSENS}} + 22\text{dB}$ (Note)	-28	± 2.5025	5MHz E-UTRA signal
10	$P_{\text{REFSENS}} + 22\text{dB}$ (Note)	-28	± 2.5075	5MHz E-UTRA signal
15	$P_{\text{REFSENS}} + 22\text{dB}$ (Note)	-28	± 2.5125	5MHz E-UTRA signal
20	$P_{\text{REFSENS}} + 22\text{dB}$ (Note)	-28	± 2.5025	5MHz E-UTRA signal

Note: P_{REFSENS} depends on the sub-carrier spacing as specified in Table 7.2.1-5b.

Table 7.5.1-5b: Adjacent channel selectivity NB-IoT guard band operation Home BS

E-UTRA channel bandwidth of the lowest/highest carrier received [MHz]	NB-IoT wanted signal mean power [dBm]	Interfering signal mean power [dBm]	Interfering signal centre frequency offset from the lower/upper Base Station RF Bandwidth edge or sub-block edge inside a sub-block gap [MHz]	Type of interfering signal
5	$P_{\text{REFSENS}} + 26\text{dB}$ (Note)	-28	± 2.5025	5MHz E-UTRA signal
10	$P_{\text{REFSENS}} + 24\text{dB}$ (Note)	-28	± 2.5075	5MHz E-UTRA signal
15	$P_{\text{REFSENS}} + 22\text{dB}$ (Note)	-28	± 2.5125	5MHz E-UTRA signal
20	$P_{\text{REFSENS}} + 22\text{dB}$ (Note)	-28	± 2.5025	5MHz E-UTRA signal

Note: P_{REFSENS} depends on the sub-carrier spacing as specified in Table 7.2.1-5b.

Table 7.5.1-5c: Adjacent channel selectivity for NB-IoT standalone Home BS

NB-IoT channel bandwidth of the lowest/highest carrier received [kHz]	Wanted signal mean power [dBm]	Interfering signal mean power [dBm]	Interfering signal centre frequency offset to the lower/upper Base Station RF Bandwidth edge or sub-block edge inside a sub-block gap [kHz]	Type of interfering signal
200	$P_{\text{REFSENS}} + 35.5\text{dB}$ (Note)	-28	± 100	180 kHz NB-IoT signal

Note: P_{REFSENS} depends on the sub-carrier spacing as specified in Table 7.2.1-5b.

Table 7.5.1-6: Adjacent channel selectivity for E-UTRA Medium Range BS

E-UTRA channel bandwidth of the lowest/highest carrier received [MHz]	Wanted signal mean power [dBm]	Interfering signal mean power [dBm]	Interfering signal centre frequency offset to the lower/upper Base Station RF Bandwidth edge or sub-block edge inside a sub-block gap [MHz]	Type of interfering signal
1.4	$P_{\text{REFSENS}} + 11\text{dB}$ (Note 1)	-47	± 0.7025	1.4MHz E-UTRA signal
3	$P_{\text{REFSENS}} + 8\text{dB}$ (Note 1)	-47	± 1.5075	3MHz E-UTRA signal
5	$P_{\text{REFSENS}} + 6\text{dB}$ (Note 1)	-47	± 2.5025	5MHz E-UTRA signal
10	$P_{\text{REFSENS}} + 6\text{dB}$ (Note 1)	-47	± 2.5075 ± 10.0175	5MHz E-UTRA signal (Note 2) 20 MHz E-UTRA signal (Note 3)
15	$P_{\text{REFSENS}} + 6\text{dB}$ (Note 1)	-47	± 2.5125	5MHz E-UTRA signal
20	$P_{\text{REFSENS}} + 6\text{dB}$ (Note 1)	-47	± 2.5025 ± 10.0175	5MHz E-UTRA signal (Note 2) 20 MHz E-UTRA signal (Note 3)

Note 1: P_{REFSENS} depends on the channel bandwidth as specified in Table 7.2.1-4.
Note 2: This type of interfering signal is not applied for Band 46.
Note 3: This type of interfering signal is only applied for Band 46.

Table 7.5.1-6a: Adjacent channel selectivity for NB-IoT in-band operation Medium Range BS

E-UTRA channel bandwidth of the lowest/highest carrier received [MHz]	NB-IoT wanted signal mean power [dBm]	Interfering signal mean power [dBm]	Interfering signal centre frequency offset from the lower/upper Base Station RF Bandwidth edge or sub-block edge inside a sub-block gap [MHz]	Type of interfering signal
3	$P_{\text{REFSENS}} + 8\text{dB}$ (Note)	-47	± 1.5075	3MHz E-UTRA signal
5	$P_{\text{REFSENS}} + 6\text{dB}$ (Note)	-47	± 2.5025	5MHz E-UTRA signal
10	$P_{\text{REFSENS}} + 6\text{dB}$ (Note)	-47	± 2.5075	5MHz E-UTRA signal
15	$P_{\text{REFSENS}} + 6\text{dB}$ (Note)	-47	± 2.5125	5MHz E-UTRA signal
20	$P_{\text{REFSENS}} + 6\text{dB}$ (Note)	-47	± 2.5025	5MHz E-UTRA signal

Note: P_{REFSENS} depends on the sub-carrier spacing as specified in Table 7.2.1-5c.

Table 7.5.1-6b: Adjacent channel selectivity NB-IoT guard band operation Medium Range BS

E-UTRA channel bandwidth of the lowest/highest carrier received [MHz]	NB-IoT wanted signal mean power [dBm]	Interfering signal mean power [dBm]	Interfering signal centre frequency offset from the lower/upper Base Station RF Bandwidth edge or sub-block edge inside a sub-block gap [MHz]	Type of interfering signal
5	$P_{\text{REFSENS}} + 10$ dB (Note)	-47	± 2.5025	5MHz E-UTRA signal
10	$P_{\text{REFSENS}} + 8$ dB (Note)	-47	± 2.5075	5MHz E-UTRA signal
15	$P_{\text{REFSENS}} + 6$ dB (Note)	-47	± 2.5125	5MHz E-UTRA signal
20	$P_{\text{REFSENS}} + 6$ dB (Note)	-47	± 2.5025	5MHz E-UTRA signal

Note: P_{REFSENS} depends on the sub-carrier spacing as specified in Table 7.2.1-5c.

Table 7.5.1-6c: Adjacent channel selectivity for NB-IoT standalone Medium Range BS

NB-IoT channel bandwidth of the lowest/highest carrier received [kHz]	Wanted signal mean power [dBm]	Interfering signal mean power [dBm]	Interfering signal centre frequency offset to the lower/upper Base Station RF Bandwidth edge or sub-block edge inside a sub-block gap [kHz]	Type of interfering signal
200	$P_{\text{REFSENS}} + 19.5$ dB (Note)	-47	± 100	180 kHz NB-IoT signal

Note: P_{REFSENS} depends on the sub-carrier spacing as specified in Table 7.2.1-5c.

7.6 Blocking

7.6.1 General blocking requirement

The blocking characteristics is a measure of the receiver ability to receive a wanted signal at its assigned channel in the presence of an unwanted interferer, which are either a 1.4MHz, 3MHz or 5MHz E-UTRA signal for in-band blocking or a CW signal for out-of-band blocking. The interfering signal shall be an E-UTRA signal as specified in Annex C.

7.6.1.1 Minimum requirement

For E-UTRA, the throughput shall be $\geq 95\%$ of the maximum throughput of the reference measurement channel, with a wanted and an interfering signal coupled to BS antenna input using the parameters in Tables 7.6.1.1-1, 7.6.1.1-1a, 7.6.1.1-1b, 7.6.1.1-1c and 7.6.1.1-2. The reference measurement channel for the wanted signal is identified in Table 7.2.1-1, 7.2.1-2, 7.2.1-3 and 7.2.1-4 for each channel bandwidth and further specified in Annex A.

The blocking requirement is applicable outside the Base Station RF Bandwidth or Radio Bandwidth. The interfering signal offset is defined relative to the Base Station RF Bandwidth edges or Radio Bandwidth edges.

For a BS operating in non-contiguous spectrum within any operating band, the blocking requirement applies in addition inside any sub-block gap, in case the sub-block gap size is at least as wide as twice the interfering signal minimum

offset in Table 7.6.1.1-2. The interfering signal offset is defined relative to the sub-block edges inside the sub-block gap.

For a BS capable of multi-band operation, the requirement in the in-band blocking frequency ranges applies for each supported operating band. The requirement applies in addition inside any Inter RF Bandwidth gap, in case the Inter RF Bandwidth gap size is at least as wide as twice the interfering signal minimum offset in Table 7.6.1.1-2.

For a BS capable of multi-band operation, the requirement in the out-of-band blocking frequency ranges apply for each operating band, with the exception that the in-band blocking frequency ranges of all supported operating bands according to Tables 7.6.1.1-1, 7.6.1.1-1a and 7.6.1.1-1c shall be excluded from the out-of-band blocking requirement.

Table 7.6.1.1-1: Blocking performance requirement for Wide Area BS for E-UTRA

Operating Band	Centre Frequency of Interfering Signal [MHz]	Interfering Signal mean power [dBm]	Wanted Signal mean power [dBm]	Interfering signal centre frequency minimum frequency offset from the lower/upper Base Station RF Bandwidth edge or sub-block edge inside a sub-block gap [MHz]	Type of Interfering Signal
1-7, 9-11, 13, 14, 18, 19, 21-23, 24, 27, 30, 33-45, 48, 50, 52, 65, 66, 68, 70	(F _{UL_low} -20) to (F _{UL_high} +20)	-43	P _{PREFSENS} +6dB (Note 1)	See table 7.6.1.1-2	See table 7.6.1.1-2
	1 to (F _{UL_low} -20) (F _{UL_high} +20) to 12750	-15	P _{PREFSENS} +6dB (Note 1)	—	CW carrier
8, 26, 28	(F _{UL_low} -20) to (F _{UL_high} +10)	-43	P _{PREFSENS} +6dB (Note 1)	See table 7.6.1.1-2	See table 7.6.1.1-2
	1 to (F _{UL_low} -20) (F _{UL_high} +10) to 12750	-15	P _{PREFSENS} +6dB (Note 1)	—	CW carrier
12	(F _{UL_low} -20) to (F _{UL_high} +13)	-43	P _{PREFSENS} +6dB (Note 1)	See table 7.6.1.1-2	See table 7.6.1.1-2
	1 to (F _{UL_low} -20) (F _{UL_high} +13) to 12750	-15	P _{PREFSENS} +6dB (Note 1)	—	CW carrier
17	(F _{UL_low} -20) to (F _{UL_high} +18)	-43	P _{PREFSENS} +6dB (Note 1)	See table 7.6.1.1-2	See table 7.6.1.1-2
	1 to (F _{UL_low} -20) (F _{UL_high} +18) to 12750	-15	P _{PREFSENS} +6dB (Note 1)	—	CW carrier
20, 71	(F _{UL_low} -11) to (F _{UL_high} +20)	-43	P _{PREFSENS} +6dB (Note 1)	See table 7.6.1.1-2	See table 7.6.1.1-2
	1 to (F _{UL_low} -11) (F _{UL_high} +20) to 12750	-15	P _{PREFSENS} +6dB (Note 1)	—	CW carrier
25	(F _{UL_low} -20) to (F _{UL_high} +15)	-43	P _{PREFSENS} +6dB (Note 1)	See table 7.6.1.1-2	See table 7.6.1.1-2
	1 to (F _{UL_low} -20) (F _{UL_high} +15) to 12750	-15	P _{PREFSENS} +6dB (Note 1)	—	CW carrier
31, 72, 73, 74, 87, 88	(F _{UL_low} -20) to (F _{UL_high} +5)	-43	P _{PREFSENS} +6dB (Note 1)	See table 7.6.1.1-2	See table 7.6.1.1-2
	1 to (F _{UL_low} -20) (F _{UL_high} +5) to 12750	-15	P _{PREFSENS} +6dB (Note 1)	—	CW carrier
85	(F _{UL_low} -20) to (F _{UL_high} +12)	-43	P _{PREFSENS} +6dB (Note 1)	See table 7.6.1.1-2	See table 7.6.1.1-2
	1 to (F _{UL_low} -20) (F _{UL_high} +12) to 12750	-15	P _{PREFSENS} +6dB (Note 1)	—	CW carrier
Note 1:	P _{PREFSENS} depends on the channel bandwidth as specified in Table 7.2.1-1.				
Note 2:	For a BS capable of multiband operation, in case of interfering signal that is not in the in-band blocking frequency range of the operating band where the wanted signal is present, and not in the in-band blocking frequency range of an adjacent or overlapping operating band, the wanted signal mean power is equal to P _{PREFSENS} + 1.4 dB.				

NOTE: Table 7.6.1.1-1 assumes that two operating bands, where the downlink operating band (see Table 5.5-1) of one band would be within the in-band blocking region of the other band, are not deployed in the same geographical area.

Table 7.6.1.1-1a: Blocking performance requirement for Local Area BS for E-UTRA

Operating Band	Centre Frequency of Interfering Signal [MHz]	Interfering Signal mean power [dBm]	Wanted Signal mean power [dBm]	Interfering signal centre frequency minimum frequency offset from the lower/upper Base Station RF Bandwidth edge or sub-block edge inside a sub-block gap [MHz]	Type of Interfering Signal
1-7, 9-11, 13-14, 18,19, 21-23, 24, 27, 30, 33-45, 48-53, 65, 66, 68, 70	(F _{UL_low} -20) to (F _{UL_high} +20)	-35	P _{REFSENS} +6dB (Note 1)	See table 7.6.1.1-2	See table 7.6.1.1-2
	1 to (F _{UL_low} -20) (F _{UL_high} +20) to 12750	-15	P _{REFSENS} +6dB (Note 1)	—	CW carrier
8, 26, 28	(F _{UL_low} -20) to (F _{UL_high} +10)	-35	P _{REFSENS} +6dB (Note 1)	See table 7.6.1.1-2	See table 7.6.1.1-2
	1 to (F _{UL_low} -20) (F _{UL_high} +10) to 12750	-15	P _{REFSENS} +6dB (Note 1)	—	CW carrier
12	(F _{UL_low} -20) to (F _{UL_high} +13)	-35	P _{REFSENS} +6dB (Note 1)	See table 7.6.1.1-2	See table 7.6.1.1-2
	1 to (F _{UL_low} -20) (F _{UL_high} +13) to 12750	-15	P _{REFSENS} +6dB (Note 1)	—	CW carrier
17	(F _{UL_low} -20) to (F _{UL_high} +18)	-35	P _{REFSENS} +6dB (Note 1)	See table 7.6.1. 1-2	See table 7.6.1.1-2
	1 to (F _{UL_low} -20) (F _{UL_high} +18) to 12750	-15	P _{REFSENS} +6dB (Note 1)	—	CW carrier
20, 71	(F _{UL_low} -11) to (F _{UL_high} +20)	-35	P _{REFSENS} +6dB (Note 1)	See table 7.6.1. 1-2	See table 7.6.1.1-2
	1 to (F _{UL_low} -11) (F _{UL_high} +20) to 12750	-15	P _{REFSENS} +6dB (Note 1)	—	CW carrier
25	(F _{UL_low} -20) to (F _{UL_high} +15)	-35	P _{REFSENS} +6dB (Note 1)	See table 7.6.1. 1-2	See table 7.6.1.1-2
	1 to (F _{UL_low} -20) (F _{UL_high} +15) to 12750	-15	P _{REFSENS} +6dB (Note 1)	—	CW carrier
31, 72, 73, 74, 87, 88	(F _{UL_low} -20) to (F _{UL_high} +5)	-35	P _{REFSENS} +6dB (Note 1)	See table 7.6.1.1-2	See table 7.6.1.1-2
	1 to (F _{UL_low} -20) (F _{UL_high} +5) to 12750	-15	P _{REFSENS} +6dB (Note 1)	—	CW carrier
46	(F _{UL_low} -20) to (F _{UL_high} +20)	-35	P _{REFSENS} +6dB (Note 1)	See table 7.6.1.1-2	See table 7.6.1.1-2
	(F _{UL_low} -500) to (F _{UL_low} -20) (F _{UL_high} +20) to (F _{UL_high} +500)	-35	P _{REFSENS} +6dB (Note 1)	—	CW carrier
	1 to (F _{UL_low} -500) (F _{UL_high} +500) to 12750	-15	P _{REFSENS} +6dB (Note 1)	—	CW carrier
85	(F _{UL_low} -20) to (F _{UL_high} +12)	-35	P _{REFSENS} +6dB (Note 1)	See table 7.6.1. 1-2	See table 7.6.1.1-2
	1 to (F _{UL_low} -20) (F _{UL_high} +12) to 12750	-15	P _{REFSENS} +6dB (Note 1)	—	CW carrier
Note 1:	P _{REFSENS} depends on the channel bandwidth as specified in Table 7.2.1-2				
Note 2:	For a BS capable of multiband operation, in case of interfering signal that is not in the in-band blocking frequency range of the operating band where the wanted signal is present, and not in the in-band blocking frequency range of an adjacent or overlapping operating band, the wanted signal mean power is equal to P _{REFSENS} + 1.4 dB..				

NOTE: Table 7.6.1.1-1a assumes that two operating bands, where the downlink operating band (see Table 5.5-1) of one band would be within the in-band blocking region of the other band, are not deployed in the same geographical area.

Table 7.6.1.1-1b: Blocking performance requirement for Home BS for E-UTRA

Operating Band	Centre Frequency of Interfering Signal [MHz]	Interfering Signal mean power [dBm]	Wanted Signal mean power [dBm]	Interfering signal centre frequency minimum frequency offset from the channel edge of the wanted signal [MHz]	Type of Interfering Signal
1-7, 9-11, 13, 14, 18, 19, 21-23, 24, 27, 30, 33-44, 48, 50-52, 65, 66, 68, 70	(F _{UL_low} -20) to (F _{UL_high} +20)	-27	P _{REFSENS} +14dB (Note 1)	See table 7.6.1.1-2	See table 7.6.1.1-2
	1 to (F _{UL_low} -20) (F _{UL_high} +20) to 12750	-15	P _{REFSENS} +14dB (Note 1)	—	CW carrier
8, 26, 28	(F _{UL_low} -20) to (F _{UL_high} +10)	-27	P _{REFSENS} +14dB (Note 1)	See table 7.6.1.1-2	See table 7.6.1.1-2
	1 to (F _{UL_low} -20) (F _{UL_high} +10) to 12750	-15	P _{REFSENS} +14dB (Note 1)	—	CW carrier
12	(F _{UL_low} -20) to (F _{UL_high} +13)	-27	P _{REFSENS} +14dB (Note 1)	See table 7.6.1.1-2	See table 7.6.1.1-2
	1 to (F _{UL_low} -20) (F _{UL_high} +13) to 12750	-15	P _{REFSENS} +14dB (Note 1)	—	CW carrier
17	(F _{UL_low} -20) to (F _{UL_high} +18)	-27	P _{REFSENS} +14dB (Note 1)	See table 7.6.1.1-2	See table 7.6.1.1-2
	1 to (F _{UL_low} -20) (F _{UL_high} +18) to 12750	-15	P _{REFSENS} +14dB (Note 1)	—	CW carrier
20, 71	(F _{UL_low} -11) to (F _{UL_high} +20)	-27	P _{REFSENS} +14dB (Note 1)	See table 7.6.1.1-2	See table 7.6.1.1-2
	1 to (F _{UL_low} -11) (F _{UL_high} +20) to 12750	-15	P _{REFSENS} +14dB (Note 1)	—	CW carrier
25	(F _{UL_low} -20) to (F _{UL_high} +15)	-27	P _{REFSENS} +14dB (Note 1)	See table 7.6.1.1-2	See table 7.6.1.1-2
	1 to (F _{UL_low} -20) (F _{UL_high} +15) to 12750	-15	P _{REFSENS} +14dB (Note 1)	—	CW carrier
74	(F _{UL_low} -20) to (F _{UL_high} +5)	-27	P _{REFSENS} +14dB (Note 1)	See table 7.6.1.1-2	See table 7.6.1.1-2
	1 to (F _{UL_low} -20) (F _{UL_high} +5) to 12750	-15	P _{REFSENS} +14dB (Note 1)	—	CW carrier
85	(F _{UL_low} -20) to (F _{UL_high} +12)	-27	P _{REFSENS} +14dB (Note 1)	See table 7.6.1.1-2	See table 7.6.1.1-2
	1 to (F _{UL_low} -20) (F _{UL_high} +12) to 12750	-15	P _{REFSENS} +14dB (Note 1)	—	CW carrier
Note 1: P _{REFSENS} depends on the channel bandwidth as specified in Table 7.2.1-3.					

NOTE: Table 7.6.1.1-1b assumes that two operating bands, where the downlink operating band (see Table 5.5-1) of one band would be within the in-band blocking region of the other band, are not deployed in the same geographical area.

Table 7.6.1.1-1c: Blocking performance requirement for Medium Range BS for E-UTRA

Operating Band	Centre Frequency of Interfering Signal [MHz]	Interfering Signal mean power [dBm]	Wanted Signal mean power [dBm]	Interfering signal centre frequency minimum frequency offset to the lower/higher Base Station RF Bandwidth edge or sub-block edge inside a sub-block gap [MHz]	Type of Interfering Signal
1-7, 9-11, 13, 14, 18,19, 21-23, 24, 27, 30, 33-45, 48, 50, 52-53, 65, 66, 68, 70	(F _{UL_low} -20) to (F _{UL_high} +20)	-38	P _{PREFSENS} +6dB (Note 1)	See table 7.6.1.1-2	See table 7.6.1.1-2
	1 to (F _{UL_low} -20) (F _{UL_high} +20) to 12750	-15	P _{PREFSENS} +6dB (Note 1)	—	CW carrier
8, 26, 28	(F _{UL_low} -20) to (F _{UL_high} +10)	-38	P _{PREFSENS} +6dB (Note 1)	See table 7.6.1.1-2	See table 7.6.1.1-2
	1 to (F _{UL_low} -20) (F _{UL_high} +10) to 12750	-15	P _{PREFSENS} +6dB (Note 1)	—	CW carrier
12	(F _{UL_low} -20) to (F _{UL_high} +13)	-38	P _{PREFSENS} +6dB (Note 1)	See table 7.6.1.1-2	See table 7.6.1.1-2
	1 to (F _{UL_low} -20) (F _{UL_high} +13) to 12750	-15	P _{PREFSENS} +6dB (Note 1)	—	CW carrier
17	(F _{UL_low} -20) to (F _{UL_high} +18)	-38	P _{PREFSENS} +6dB (Note 1)	See table 7.6.1.1-2	See table 7.6.1.1-2
	1 to (F _{UL_low} -20) (F _{UL_high} +18) to 12750	-15	P _{PREFSENS} +6dB (Note 1)	—	CW carrier
20, 71	(F _{UL_low} -11) to (F _{UL_high} +20)	-38	P _{PREFSENS} +6dB (Note 1)	See table 7.6.1.1-2	See table 7.6.1.1-2
	1 to (F _{UL_low} -11) (F _{UL_high} +20) to 12750	-15	P _{PREFSENS} +6dB (Note 1)	—	CW carrier
25	(F _{UL_low} -20) to (F _{UL_high} +15)	-38	P _{PREFSENS} +6dB (Note 1)	See table 7.6.1.1-2	See table 7.6.1.1-2
	1 to (F _{UL_low} -20) (F _{UL_high} +15) to 12750	-15	P _{PREFSENS} +6dB (Note 1)	—	CW carrier
31, 72, 73, 74, 87, 88	(F _{UL_low} -20) to (F _{UL_high} +5)	-38	P _{PREFSENS} +6dB (Note 1)	See table 7.6.1.1-2	See table 7.6.1.1-2
	1 to (F _{UL_low} -20) (F _{UL_high} +5) to 12750	-15	P _{PREFSENS} +6dB (Note 1)	—	CW carrier
46	(F _{UL_low} -20) to (F _{UL_high} +20)	-38	P _{PREFSENS} +6dB (Note 1)	See table 7.6.1.1-2	See table 7.6.1.1-2
	(F _{UL_low} -500) to (F _{UL_low} -20) (F _{UL_high} +20) to (F _{UL_high} +500)	-35	P _{PREFSENS} +6dB (Note 1)	—	CW carrier
	1 to (F _{UL_low} -500) (F _{UL_high} +500) to 12750	-15	P _{PREFSENS} +6dB (Note 1)	—	CW carrier
85	(F _{UL_low} -20) to (F _{UL_high} +12)	-38	P _{PREFSENS} +6dB (Note 1)	See table 7.6.1.1-2	See table 7.6.1.1-2
	1 to (F _{UL_low} -20) (F _{UL_high} +12) to 12750	-15	P _{PREFSENS} +6dB (Note 1)	—	CW carrier
Note 1:	P _{PREFSENS} depends on the channel bandwidth as specified in Table 7.2.1-4.				
Note 2:	For a BS capable of multiband operation, in case of interfering signal that is not in the in-band blocking frequency range of the operating band where the wanted signal is present, and not in the in-band blocking frequency range of an adjacent or overlapping operating band, the wanted signal mean power is equal to P _{PREFSENS} + 1.4 dB.				

NOTE: Table 7.6.1.1-1c assumes that two operating bands, where the downlink operating band (see Table 5.5-1) of one band would be within the in-band blocking region of the other band, are not deployed in the same geographical area.

Table 7.6.1.1-2: Interfering signals for blocking performance requirement

E-UTRA channel BW of the lowest/highest carrier received [MHz]	Interfering signal centre frequency minimum offset to the lower/upper Base Station RF Bandwidth edge or sub-block edge inside a sub-block gap [MHz]	Type of interfering signal
1.4	±2.1	1.4 MHz E-UTRA signal
3	±4.5	3 MHz E-UTRA signal
5	±7.5	5 MHz E-UTRA signal
10	±7.5	5 MHz E-UTRA signal
15	±7.5	5 MHz E-UTRA signal
20	±7.5	5 MHz E-UTRA signal (Note 1)
20	±30	20 MHz E-UTRA signal (Note 2)
Note 1: This type of interfering signal is not applied for Band 46.		
Note 2: This type of interfering signal is only applied for Band 46.		

For NB-IoT standalone operation, the throughput shall be $\geq 95\%$ of the maximum throughput of the reference measurement channel, with a wanted and an interfering signal coupled to BS antenna input using the parameters in

Tables 7.6.1.1-3, 7.6.1.1-3a, 7.6.1.1-3b, 7.6.1.1-3c and 7.6.1.1-4. The reference measurement channel for the wanted signal is identified in Table 7.2.1-5, 7.2.1-5a, 7.2.1-5b and 7.2.1-5c and further specified in Annex A.

The blocking requirement is applicable outside the Base Station RF Bandwidth or Radio Bandwidth. The interfering signal offset is defined relative to the Base Station RF Bandwidth edges or Radio Bandwidth edges.

Table 7.6.1.1-3: Blocking performance requirement for Wide Area BS for NB-IoT standalone operation

Operating Band	Centre Frequency of Interfering Signal [MHz]	Interfering Signal mean power [dBm]	Wanted Signal mean power [dBm]	Interfering signal centre frequency minimum frequency offset from the lower/upper Base Station RF Bandwidth edge or sub-block edge inside a sub-block gap [MHz]	Type of Interfering Signal
1-5, 7, 11, 13-14, 18, 19, 21, 42, 43, 65, 66, 70	(F _{UL_low} -20) to (F _{UL_high} +20)	-43	P _{REFSENS} +6dB (Note 1)	See table 7.6.1.1-4	See table 7.6.1.1-4
	1 to (F _{UL_low} -20) (F _{UL_high} +20) to 12750	-15 (Note 2)	P _{REFSENS} +6dB (Note 1)	—	CW carrier
8, 26, 28	(F _{UL_low} -20) to (F _{UL_high} +10)	-43	P _{REFSENS} +6dB (Note 1)	See table 7.6.1.1-4	See table 7.6.1.1-4
	1 to (F _{UL_low} -20) (F _{UL_high} +10) to 12750	-15 (Note 2)	P _{REFSENS} +6dB (Note 1)	—	CW carrier
12	(F _{UL_low} -20) to (F _{UL_high} +13)	-43	P _{REFSENS} +6dB (Note 1)	See table 7.6.1.1-4	See table 7.6.1.1-4
	1 to (F _{UL_low} -20) (F _{UL_high} +13) to 12750	-15 (Note 2)	P _{REFSENS} +6dB (Note 1)	—	CW carrier
17	(F _{UL_low} -20) to (F _{UL_high} +18)	-43	P _{REFSENS} +6dB (Note 1)	See table 7.6.1.1-4	See table 7.6.1.1-4
	1 to (F _{UL_low} -20) (F _{UL_high} +18) to 12750	-15 (Note 2)	P _{REFSENS} +6dB (Note 1)	—	CW carrier
20, 71	(F _{UL_low} -11) to (F _{UL_high} +20)	-43	P _{REFSENS} +6dB (Note 1)	See table 7.6.1.1-4	See table 7.6.1.1-4
	1 to (F _{UL_low} -11) (F _{UL_high} +20) to 12750	-15 (Note 2)	P _{REFSENS} +6dB (Note 1)	—	CW carrier
25	(F _{UL_low} -20) to (F _{UL_high} +15)	-43	P _{REFSENS} +6dB (Note 1)	See table 7.6.1.1-4	See table 7.6.1.1-4
	1 to (F _{UL_low} -20) (F _{UL_high} +15) to 12750	-15 (Note 2)	P _{REFSENS} +6dB (Note 1)	—	CW carrier
31, 72, 73, 74, 87, 88	(F _{UL_low} -20) to (F _{UL_high} +5)	-43	P _{REFSENS} +6dB (Note 1)	See table 7.6.1.1-4	See table 7.6.1.1-4
	1 to (F _{UL_low} -20) (F _{UL_high} +5) to 12750	-15 (Note 2)	P _{REFSENS} +6dB (Note 1)	—	CW carrier
85	(F _{UL_low} -20) to (F _{UL_high} +12)	-43	P _{REFSENS} +6dB (Note 1)	See table 7.6.1.1-4	See table 7.6.1.1-4
	1 to (F _{UL_low} -20) (F _{UL_high} +12) to 12750	-15 (Note 2)	P _{REFSENS} +6dB (Note 1)	—	CW carrier
Note 1: P _{REFSENS} is specified in Table 7.2.1-5.					
Note 2: Up to 24 exceptions are allowed for spurious response frequencies in each wanted signal frequency when measured using a 1MHz step size. For these exceptions the above throughput requirement shall be met when the blocking signal is set to a level of -40 dBm for 15 kHz subcarrier spacing and -46 dBm for 3.75 kHz subcarrier spacing. In addition, each group of exceptions shall not exceed three contiguous measurements using a 1MHz step size.					

Table 7.6.1.1-3a: Blocking performance requirement for Local Area BS for NB-IoT standalone operation

Operating Band	Centre Frequency of Interfering Signal [MHz]	Interfering Signal mean power [dBm]	Wanted Signal mean power [dBm]	Interfering signal centre frequency minimum frequency offset from the lower/upper Base Station RF Bandwidth edge or sub-block edge inside a sub-block gap [MHz]	Type of Interfering Signal
1-5, 7, 11, 13-14, 18, 19, 21, 42, 43, 65, 66, 70	(F _{UL_low} -20) to (F _{UL_high} +20)	-35	P _{PREFSENS} +6dB (Note 1)	See table 7.6.1.1-4	See table 7.6.1.1-4
	1 to (F _{UL_low} -20) (F _{UL_high} +20) to 12750	-15 (Note 2)	P _{PREFSENS} +6dB (Note 1)	—	CW carrier
8, 26, 28	(F _{UL_low} -20) to (F _{UL_high} +10)	-35	P _{PREFSENS} +6dB (Note 1)	See table 7.6.1.1-4	See table 7.6.1.1-4
	1 to (F _{UL_low} -20) (F _{UL_high} +10) to 12750	-15 (Note 2)	P _{PREFSENS} +6dB (Note 1)	—	CW carrier
12	(F _{UL_low} -20) to (F _{UL_high} +13)	-35	P _{PREFSENS} +6dB (Note 1)	See table 7.6.1.1-4	See table 7.6.1.1-4
	1 to (F _{UL_low} -20) (F _{UL_high} +13) to 12750	-15 (Note 2)	P _{PREFSENS} +6dB (Note 1)	—	CW carrier
17	(F _{UL_low} -20) to (F _{UL_high} +18)	-35	P _{PREFSENS} +6dB (Note 1)	See table 7.6.1.1-4	See table 7.6.1.1-4
	1 to (F _{UL_low} -20) (F _{UL_high} +18) to 12750	-15 (Note 2)	P _{PREFSENS} +6dB (Note 1)	—	CW carrier
20, 71	(F _{UL_low} -11) to (F _{UL_high} +20)	-35	P _{PREFSENS} +6dB (Note 1)	See table 7.6.1.1-4	See table 7.6.1.1-4
	1 to (F _{UL_low} -11) (F _{UL_high} +20) to 12750	-15 (Note 2)	P _{PREFSENS} +6dB (Note 1)	—	CW carrier
25	(F _{UL_low} -20) to (F _{UL_high} +15)	-35	P _{PREFSENS} +6dB (Note 2)	See table 7.6.1.1-4	See table 7.6.1.1-4
	1 to (F _{UL_low} -20) (F _{UL_high} +15) to 12750	-15 (Note 2)	P _{PREFSENS} +6dB (Note 2)	—	CW carrier
31, 72, 74, 87, 88	(F _{UL_low} -20) to (F _{UL_high} +5)	-35	P _{PREFSENS} +6dB (Note 2)	See table 7.6.1.1-4	See table 7.6.1.1-4
	1 to (F _{UL_low} -20) (F _{UL_high} +5) to 12750	-15 (Note 2)	P _{PREFSENS} +6dB (Note 2)	—	CW carrier
85	(F _{UL_low} -20) to (F _{UL_high} +12)	-35	P _{PREFSENS} +6dB (Note 2)	See table 7.6.1.1-4	See table 7.6.1.1-4
	1 to (F _{UL_low} -20) (F _{UL_high} +12) to 12750	-15 (Note 2)	P _{PREFSENS} +6dB (Note 2)	—	CW carrier
<p>Note 1: P_{PREFSENS} is specified in Table 7.2.1-5a.</p> <p>Note 2: Up to 24 exceptions are allowed for spurious response frequencies in each wanted signal frequency when measured using a 1MHz step size. For these exceptions the above throughput requirement shall be met when the blocking signal is set to a level of -40 dBm for 15 kHz subcarrier spacing and -46 dBm for 3.75 kHz subcarrier spacing. In addition, each group of exceptions shall not exceed three contiguous measurements using a 1MHz step size.</p>					

Table 7.6.1.1-3b: Blocking performance requirement for Home BS for NB-IoT standalone operation

Operating Band	Centre Frequency of Interfering Signal [MHz]	Interfering Signal mean power [dBm]	Wanted Signal mean power [dBm]	Interfering signal centre frequency minimum frequency offset from the lower/upper Base Station RF Bandwidth edge or sub-block edge inside a sub-block gap [MHz]	Type of Interfering Signal
1-5, 7,11, 13-14,18,19, 21, 42, 43, 65, 66, 70	(F _{UL_low} -20) to (F _{UL_high} +20)	-27	P _{REFSENS} +14dB (Note 1)	See table 7.6.1.1-4	See table 7.6.1.1-4
	1 to (F _{UL_low} -20) (F _{UL_high} +20) to 12750	-15 (Note 2)	P _{REFSENS} +14dB (Note 1)	—	CW carrier
8, 26, 28	(F _{UL_low} -20) to (F _{UL_high} +10)	-27	P _{REFSENS} +14dB (Note 1)	See table 7.6.1.1-4	See table 7.6.1.1-4
	1 to (F _{UL_low} -20) (F _{UL_high} +10) to 12750	-15 (Note 2)	P _{REFSENS} +14dB (Note 1)	—	CW carrier
12	(F _{UL_low} -20) to (F _{UL_high} +13)	-27	P _{REFSENS} +14dB (Note 1)	See table 7.6.1.1-4	See table 7.6.1.1-4
	1 to (F _{UL_low} -20) (F _{UL_high} +13) to 12750	-15 (Note 2)	P _{REFSENS} +14dB (Note 1)	—	CW carrier
17	(F _{UL_low} -20) to (F _{UL_high} +18)	-27	P _{REFSENS} +14dB (Note 1)	See table 7.6.1.1-4	See table 7.6.1.1-4
	1 to (F _{UL_low} -20) (F _{UL_high} +18) to 12750	-15 (Note 2)	P _{REFSENS} +14dB (Note 1)	—	CW carrier
20, 71	(F _{UL_low} -11) to (F _{UL_high} +20)	-27	P _{REFSENS} +14dB (Note 1)	See table 7.6.1.1-4	See table 7.6.1.1-4
	1 to (F _{UL_low} -11) (F _{UL_high} +20) to 12750	-15 (Note 2)	P _{REFSENS} +14dB (Note 1)	—	CW carrier
25	(F _{UL_low} -20) to (F _{UL_high} +15)	-27	P _{REFSENS} +14dB (Note 1)	See table 7.6.1.1-4	See table 7.6.1.1-4
	1 to (F _{UL_low} -20) (F _{UL_high} +15) to 12750	-15 (Note 2)	P _{REFSENS} +14dB (Note 1)	—	CW carrier
74	(F _{UL_low} -20) to (F _{UL_high} +5)	-27	P _{REFSENS} +14dB (Note 1)	See table 7.6.1.1-4	See table 7.6.1.1-4
	1 to (F _{UL_low} -20) (F _{UL_high} +5) to 12750	-15 (Note 2)	P _{REFSENS} +14dB (Note 1)	—	CW carrier
85	(F _{UL_low} -20) to (F _{UL_high} +12)	-27	P _{REFSENS} +14dB (Note 1)	See table 7.6.1.1-4	See table 7.6.1.1-4
	1 to (F _{UL_low} -20) (F _{UL_high} +12) to 12750	-15 (Note 2)	P _{REFSENS} +14dB (Note 1)	—	CW carrier
<p>Note 1: P_{REFSENS} is specified in Table 7.2.1-5b.</p> <p>Note 2: Up to 24 exceptions are allowed for spurious response frequencies in each wanted signal frequency when measured using a 1MHz step size. For these exceptions the above throughput requirement shall be met when the blocking signal is set to a level of -40 dBm for 15 kHz subcarrier spacing and -46 dBm for 3.75 kHz subcarrier spacing. In addition, each group of exceptions shall not exceed three contiguous measurements using a 1MHz step size.</p>					

Table 7.6.1.1-3c: Blocking performance requirement for Medium Range BS for NB-IoT standalone operation

Operating Band	Centre Frequency of Interfering Signal [MHz]	Interfering Signal mean power [dBm]	Wanted Signal mean power [dBm]	Interfering signal centre frequency minimum frequency offset from the lower/upper Base Station RF Bandwidth edge or sub-block edge inside a sub-block gap [MHz]	Type of Interfering Signal
1-5, 7, 11, 13-14, 18, 19, 21, 42, 43, 65, 66, 70	(F _{UL_low} -20) to (F _{UL_high} +20)	-38	P _{PREFSENS} +6dB (Note 1)	See table 7.6.1.1-4	See table 7.6.1.1-4
	1 to (F _{UL_low} -20) (F _{UL_high} +20) to 12750	-15 (Note 2)	P _{PREFSENS} +6dB (Note 1)	—	CW carrier
8, 26, 28	(F _{UL_low} -20) to (F _{UL_high} +10)	-38	P _{PREFSENS} +6dB (Note 1)	See table 7.6.1.1-4	See table 7.6.1.1-4
	1 to (F _{UL_low} -20) (F _{UL_high} +10) to 12750	-15 (Note 2)	P _{PREFSENS} +6dB (Note 1)	—	CW carrier
12	(F _{UL_low} -20) to (F _{UL_high} +13)	-38	P _{PREFSENS} +6dB (Note 1)	See table 7.6.1.1-4	See table 7.6.1.1-4
	1 to (F _{UL_low} -20) (F _{UL_high} +13) to 12750	-15 (Note 2)	P _{PREFSENS} +6dB (Note 1)	—	CW carrier
17	(F _{UL_low} -20) to (F _{UL_high} +18)	-38	P _{PREFSENS} +6dB (Note 1)	See table 7.6.1.1-4	See table 7.6.1.1-4
	1 to (F _{UL_low} -20) (F _{UL_high} +18) to 12750	-15 (Note 2)	P _{PREFSENS} +6dB (Note 1)	—	CW carrier
20, 71	(F _{UL_low} -11) to (F _{UL_high} +20)	-38	P _{PREFSENS} +6dB (Note 1)	See table 7.6.1.1-4	See table 7.6.1.1-4
	1 to (F _{UL_low} -11) (F _{UL_high} +20) to 12750	-15 (Note 2)	P _{PREFSENS} +6dB (Note 1)	—	CW carrier
25	(F _{UL_low} -20) to (F _{UL_high} +15)	-38	P _{PREFSENS} +6dB (Note 1)	See table 7.6.1.1-4	See table 7.6.1.1-4
	1 to (F _{UL_low} -20) (F _{UL_high} +15) to 12750	-15 (Note 2)	P _{PREFSENS} +6dB (Note 1)	—	CW carrier
31, 72, 74, 87, 88	(F _{UL_low} -20) to (F _{UL_high} +5)	-38	P _{PREFSENS} +6dB (Note 1)	See table 7.6.1.1-4	See table 7.6.1.1-4
	1 to (F _{UL_low} -20) (F _{UL_high} +5) to 12750	-15 (Note 2)	P _{PREFSENS} +6dB (Note 1)	—	CW carrier
85	(F _{UL_low} -20) to (F _{UL_high} +12)	-38	P _{PREFSENS} +6dB (Note 1)	See table 7.6.1.1-4	See table 7.6.1.1-4
	1 to (F _{UL_low} -20) (F _{UL_high} +12) to 12750	-15 (Note 2)	P _{PREFSENS} +6dB (Note 1)	—	CW carrier
Note 1:	P _{PREFSENS} is specified in Table 7.2.1-5c.				
Note 2:	Up to 24 exceptions are allowed for spurious response frequencies in each wanted signal frequency when measured using a 1MHz step size. For these exceptions the above throughput requirement shall be met when the blocking signal is set to a level of -40 dBm for 15 kHz subcarrier spacing and -46 dBm for 3.75 kHz subcarrier spacing. In addition, each group of exceptions shall not exceed three contiguous measurements using a 1MHz step size.				

NOTE: Tables 7.6.1.1-3, 7.6.1.1-3a, 7.6.1.1-3b and 7.6.1.1-3c assumes that two operating bands, where the downlink operating band (see Table 5.5-1) of one band would be within the in-band blocking region of the other band, are not deployed in the same geographical area.

Table 7.6.1.1-4: Interfering signals for blocking performance requirement for NB-IoT standalone operation

NB-IoT channel BW of the lowest/highest carrier received [MHz]	Interfering signal centre frequency minimum offset to the lower/upper Base Station RF Bandwidth edge or sub-block edge inside a sub-block gap [MHz]	Type of interfering signal
0.2	± 7.5	5MHz E-UTRA signal

For E-UTRA with NB-IoT in-band/guard band operation, the throughput shall be $\geq 95\%$ of the maximum throughput of the reference measurement channel, with a wanted and an interfering signal coupled to BS antenna input using the parameters in Tables 7.6.1.1-5, 7.6.1.1-5a, 7.6.1.1-5b, 7.6.1.1-5c and 7.6.1.1-6. The reference measurement channel for

the wanted signal is identified in Table 7.2.1-1, 7.2.1-2, 7.2.1-3 and 7.2.1-4 for each channel bandwidth for E-UTRA, Table 7.2.1-5, 7.2.1-5a, 7.2.1-5b and 7.2.1-5c for NB-IoT and further specified in Annex A.

The blocking requirement is applicable outside the Base Station RF Bandwidth or Radio Bandwidth. The interfering signal offset is defined relative to the Base Station RF Bandwidth edges or Radio Bandwidth edges.

Table 7.6.1.1-5: Blocking performance requirement for Wide Area BS for E-UTRA with NB-IoT in-band/guard band operation

Operating Band	Centre Frequency of Interfering Signal [MHz]	Interfering Signal mean power [dBm]	Wanted Signal mean power [dBm]	Interfering signal centre frequency minimum frequency offset from the lower/upper Base Station RF Bandwidth edge or sub-block edge inside a sub-block gap [MHz]	Type of Interfering Signal
1-5, 7,11, 13-14,18,19, 21, 42, 43, 65, 66, 70	(F _{UL_low} -20) to (F _{UL_high} +20)	-43	P _{PREFSENS} +6dB (Note 1)	See table 7.6.1.1-6	See table 7.6.1.1-6
	1 to (F _{UL_low} -20) (F _{UL_high} +20) to 12750	-15 (Note 3)	P _{PREFSENS} +6dB (Note 1)	—	CW carrier
8, 26, 28	(F _{UL_low} -20) to (F _{UL_high} +10)	-43	P _{PREFSENS} +6dB (Note 1)	See table 7.6.1.1-6	See table 7.6.1.1-6
	1 to (F _{UL_low} -20) (F _{UL_high} +10) to 12750	-15 (Note 3)	P _{PREFSENS} +6dB (Note 1)	—	CW carrier
12	(F _{UL_low} -20) to (F _{UL_high} +13)	-43	P _{PREFSENS} +6dB (Note 1)	See table 7.6.1.1-6	See table 7.6.1.1-6
	1 to (F _{UL_low} -20) (F _{UL_high} +13) to 12750	-15 (Note 3)	P _{PREFSENS} +6dB (Note 1)	—	CW carrier
17	(F _{UL_low} -20) to (F _{UL_high} +18)	-43	P _{PREFSENS} +6dB (Note 1)	See table 7.6.1.1-6	See table 7.6.1.1-6
	1 to (F _{UL_low} -20) (F _{UL_high} +18) to 12750	-15 (Note 3)	P _{PREFSENS} +6dB (Note 1)	—	CW carrier
20, 71	(F _{UL_low} -11) to (F _{UL_high} +20)	-43	P _{PREFSENS} +6dB (Note 1)	See table 7.6.1.1-6	See table 7.6.1.1-6
	1 to (F _{UL_low} -11) (F _{UL_high} +20) to 12750	-15 (Note 3)	P _{PREFSENS} +6dB (Note 1)	—	CW carrier
25	(F _{UL_low} -20) to (F _{UL_high} +15)	-43	P _{PREFSENS} +6dB (Note 1)	See table 7.6.1.1-6	See table 7.6.1.1-6
	1 to (F _{UL_low} -20) (F _{UL_high} +15) to 12750	-15 (Note 3)	P _{PREFSENS} +6dB (Note 1)	—	CW carrier
31, 72, 73, 74, 87, 88	(F _{UL_low} -20) to (F _{UL_high} +5)	-43	P _{PREFSENS} +6dB (Note 1)	See table 7.6.1.1-6	See table 7.6.1.1-6
	1 to (F _{UL_low} -20) (F _{UL_high} +5) to 12750	-15 (Note 3)	P _{PREFSENS} +6dB (Note 1)	—	CW carrier
85	(F _{UL_low} -20) to (F _{UL_high} +12)	-43	P _{PREFSENS} +6dB (Note 1)	See table 7.6.1.1-6	See table 7.6.1.1-6
	1 to (F _{UL_low} -20) (F _{UL_high} +12) to 12750	-15 (Note 3)	P _{PREFSENS} +6dB (Note 1)	—	CW carrier
Note 1:	P _{PREFSENS} depends on the channel bandwidth as specified in Table 7.2.1-1 for E-UTRA and is specified in Table 7.2.1-5 for NB-IoT.				
Note 2:	For a BS capable of multiband operation, in case of interfering signal that is not in the in-band blocking frequency range of the operating band where the wanted signal is present, and not in the in-band blocking frequency range of an adjacent or overlapping operating band, the wanted signal mean power is equal to P _{PREFSENS} + 1.4 dB.				
Note 3:	For NB-IoT, up to 24 exceptions are allowed for spurious response frequencies in each wanted signal frequency when measured using a 1MHz step size. For these exceptions the above throughput requirement shall be met when the blocking signal is set to a level of -40 dBm for 15 kHz subcarrier spacing and -46 dBm for 3.75 kHz subcarrier spacing. In addition, each group of exceptions shall not exceed three contiguous measurements using a 1MHz step size.				

Table 7.6.1.1-5a: Blocking performance requirement for Local Area BS for E-UTRA with NB-IoT in-band/guard band operation

Operating Band	Centre Frequency of Interfering Signal [MHz]	Interfering Signal mean power [dBm]	Wanted Signal mean power [dBm]	Interfering signal centre frequency minimum frequency offset from the lower/upper Base Station RF Bandwidth edge or sub-block edge inside a sub-block gap [MHz]	Type of Interfering Signal
1-5, 7, 11, 13-14, 18, 19, 21, 42, 43, 65, 66, 70	(F _{UL_low} -20) to (F _{UL_high} +20)	-35	P _{REFSENS} +6dB (Note 1)	See table 7.6.1.1-6	See table 7.6.1.1-6
	1 to (F _{UL_low} -20) (F _{UL_high} +20) to 12750	-15 (Note 3)	P _{REFSENS} +6dB (Note 1)	—	CW carrier
8, 26, 28	(F _{UL_low} -20) to (F _{UL_high} +10)	-35	P _{REFSENS} +6dB (Note 1)	See table 7.6.1.1-6	See table 7.6.1.1-6
	1 to (F _{UL_low} -20) (F _{UL_high} +10) to 12750	-15 (Note 3)	P _{REFSENS} +6dB (Note 1)	—	CW carrier
12	(F _{UL_low} -20) to (F _{UL_high} +13)	-35	P _{REFSENS} +6dB (Note 1)	See table 7.6.1.1-6	See table 7.6.1.1-6
	1 to (F _{UL_low} -20) (F _{UL_high} +13) to 12750	-15 (Note 3)	P _{REFSENS} +6dB (Note 1)	—	CW carrier
17	(F _{UL_low} -20) to (F _{UL_high} +18)	-35	P _{REFSENS} +6dB (Note 1)	See table 7.6.1.1-6	See table 7.6.1.1-6
	1 to (F _{UL_low} -20) (F _{UL_high} +18) to 12750	-15 (Note 3)	P _{REFSENS} +6dB (Note 1)	—	CW carrier
20, 71	(F _{UL_low} -11) to (F _{UL_high} +20)	-35	P _{REFSENS} +6dB (Note 1)	See table 7.6.1.1-6	See table 7.6.1.1-6
	1 to (F _{UL_low} -11) (F _{UL_high} +20) to 12750	-15 (Note 3)	P _{REFSENS} +6dB (Note 1)	—	CW carrier
25	(F _{UL_low} -20) to (F _{UL_high} +15)	-35	P _{REFSENS} +6dB (Note 1)	See table 7.6.1.1-6	See table 7.6.1.1-6
	1 to (F _{UL_low} -20) (F _{UL_high} +15) to 12750	-15 (Note 3)	P _{REFSENS} +6dB (Note 1)	—	CW carrier
31, 72, 74, 87, 88	(F _{UL_low} -20) to (F _{UL_high} +5)	-35	P _{REFSENS} +6dB (Note 1)	See table 7.6.1.1-6	See table 7.6.1.1-6
	1 to (F _{UL_low} -20) (F _{UL_high} +5) to 12750	-15 (Note 3)	P _{REFSENS} +6dB (Note 1)	—	CW carrier
85	(F _{UL_low} -20) to (F _{UL_high} +12)	-35	P _{REFSENS} +6dB (Note 1)	See table 7.6.1.1-6	See table 7.6.1.1-6
	1 to (F _{UL_low} -20) (F _{UL_high} +12) to 12750	-15 (Note 3)	P _{REFSENS} +6dB (Note 1)	—	CW carrier
<p>Note 1: P_{REFSENS} depends on the channel bandwidth as specified in Table 7.2.1-1 for E-UTRA and is specified in Table 7.2.1-5a for NB-IoT.</p> <p>Note 2: For a BS capable of multiband operation, in case of interfering signal that is not in the in-band blocking frequency range of the operating band where the wanted signal is present, and not in the in-band blocking frequency range of an adjacent or overlapping operating band, the wanted signal mean power is equal to P_{REFSENS} + 1.4 dB.</p> <p>Note 3: For NB-IoT, up to 24 exceptions are allowed for spurious response frequencies in each wanted signal frequency when measured using a 1MHz step size. For these exceptions the above throughput requirement shall be met when the blocking signal is set to a level of -40 dBm for 15 kHz subcarrier spacing and -46 dBm for 3.75 kHz subcarrier spacing. In addition, each group of exceptions shall not exceed three contiguous measurements using a 1MHz step size.</p>					

Table 7.6.1.1-5b: Blocking performance requirement for Home BS for E-UTRA with NB-IoT in-band/guard band operation

Operating Band	Centre Frequency of Interfering Signal [MHz]	Interfering Signal mean power [dBm]	Wanted Signal mean power [dBm]	Interfering signal centre frequency minimum frequency offset from the lower/upper Base Station RF Bandwidth edge or sub-block edge inside a sub-block gap [MHz]	Type of Interfering Signal
1-5, 7, 11, 13-14, 18, 19, 21, 42, 43, 65, 66, 70	(F _{UL_low} -20) to (F _{UL_high} +20)	-27	P _{REFSENS} +14dB (Note 1)	See table 7.6.1.1-6	See table 7.6.1.1-6
	1 to (F _{UL_low} -20) (F _{UL_high} +20) to 12750	-15 (Note 3)	P _{REFSENS} +14dB (Note 1)	—	CW carrier
8, 26, 28	(F _{UL_low} -20) to (F _{UL_high} +10)	-27	P _{REFSENS} +14dB (Note 1)	See table 7.6.1.1-6	See table 7.6.1.1-6
	1 to (F _{UL_low} -20) (F _{UL_high} +10) to 12750	-15 (Note 3)	P _{REFSENS} +14dB (Note 1)	—	CW carrier
12	(F _{UL_low} -20) to (F _{UL_high} +13)	-27	P _{REFSENS} +14dB (Note 1)	See table 7.6.1.1-6	See table 7.6.1.1-6
	1 to (F _{UL_low} -20) (F _{UL_high} +13) to 12750	-15 (Note 3)	P _{REFSENS} +14dB (Note 1)	—	CW carrier
17	(F _{UL_low} -20) to (F _{UL_high} +18)	-27	P _{REFSENS} +14dB (Note 1)	See table 7.6.1.1-6	See table 7.6.1.1-6
	1 to (F _{UL_low} -20) (F _{UL_high} +18) to 12750	-15 (Note 3)	P _{REFSENS} +14dB (Note 1)	—	CW carrier
20, 71	(F _{UL_low} -11) to (F _{UL_high} +20)	-27	P _{REFSENS} +14dB (Note 1)	See table 7.6.1.1-6	See table 7.6.1.1-6
	1 to (F _{UL_low} -11) (F _{UL_high} +20) to 12750	-15 (Note 3)	P _{REFSENS} +14dB (Note 1)	—	CW carrier
25	(F _{UL_low} -20) to (F _{UL_high} +15)	-27	P _{REFSENS} +14dB (Note 1)	See table 7.6.1.1-6	See table 7.6.1.1-6
	1 to (F _{UL_low} -20) (F _{UL_high} +15) to 12750	-15 (Note 3)	P _{REFSENS} +14dB (Note 1)	—	CW carrier
74	(F _{UL_low} -20) to (F _{UL_high} +5)	-27	P _{REFSENS} +14dB (Note 1)	See table 7.6.1.1-6	See table 7.6.1.1-6
	1 to (F _{UL_low} -20) (F _{UL_high} +5) to 12750	-15 (Note 3)	P _{REFSENS} +14dB (Note 1)	—	CW carrier
85	(F _{UL_low} -20) to (F _{UL_high} +12)	-27	P _{REFSENS} +14dB (Note 1)	See table 7.6.1.1-6	See table 7.6.1.1-6
	1 to (F _{UL_low} -20) (F _{UL_high} +12) to 12750	-15 (Note 3)	P _{REFSENS} +14dB (Note 1)	—	CW carrier
<p>Note 1: P_{REFSENS} depends on the channel bandwidth as specified in Table 7.2.1-1 for E-UTRA and is specified in Table 7.2.1-5b for NB-IoT.</p> <p>Note 2: (Void)</p> <p>Note 3: For NB-IoT, up to 24 exceptions are allowed for spurious response frequencies in each wanted signal frequency when measured using a 1MHz step size. For these exceptions the above throughput requirement shall be met when the blocking signal is set to a level of -40 dBm for 15 kHz subcarrier spacing and -46 dBm for 3.75 kHz subcarrier spacing. In addition, each group of exceptions shall not exceed three contiguous measurements using a 1MHz step size.</p>					

Table 7.6.1.1-5c: Blocking performance requirement for Medium Range BS for E-UTRA with NB-IoT in-band/guard band operation

Operating Band	Centre Frequency of Interfering Signal [MHz]	Interfering Signal mean power [dBm]	Wanted Signal mean power [dBm]	Interfering signal centre frequency minimum frequency offset from the lower/upper Base Station RF Bandwidth edge or sub-block edge inside a sub-block gap [MHz]	Type of Interfering Signal
1-5, 7, 11, 13-14, 18, 19, 21, 42, 43, 65, 66, 70	(F _{UL_low} -20) to (F _{UL_high} +20)	-38	P _{REFSENS} +6dB (Note 1)	See table 7.6.1.1-6	See table 7.6.1.1-6
	1 to (F _{UL_low} -20) (F _{UL_high} +20) to 12750	-15 (Note 3)	P _{REFSENS} +6dB (Note 1)	—	CW carrier
8, 26, 28	(F _{UL_low} -20) to (F _{UL_high} +10)	-38	P _{REFSENS} +6dB (Note 1)	See table 7.6.1.1-6	See table 7.6.1.1-6
	1 to (F _{UL_low} -20) (F _{UL_high} +10) to 12750	-15 (Note 3)	P _{REFSENS} +6dB (Note 1)	—	CW carrier
12	(F _{UL_low} -20) to (F _{UL_high} +13)	-38	P _{REFSENS} +6dB (Note 1)	See table 7.6.1.1-6	See table 7.6.1.1-6
	1 to (F _{UL_low} -20) (F _{UL_high} +13) to 12750	-15 (Note 3)	P _{REFSENS} +6dB (Note 1)	—	CW carrier
17	(F _{UL_low} -20) to (F _{UL_high} +18)	-38	P _{REFSENS} +6dB (Note 1)	See table 7.6.1.1-6	See table 7.6.1.1-6
	1 to (F _{UL_low} -20) (F _{UL_high} +18) to 12750	-15 (Note 3)	P _{REFSENS} +6dB (Note 1)	—	CW carrier
20, 71	(F _{UL_low} -11) to (F _{UL_high} +20)	-38	P _{REFSENS} +6dB (Note 1)	See table 7.6.1.1-6	See table 7.6.1.1-6
	1 to (F _{UL_low} -11) (F _{UL_high} +20) to 12750	-15 (Note 3)	P _{REFSENS} +6dB (Note 1)	—	CW carrier
25	(F _{UL_low} -20) to (F _{UL_high} +15)	-38	P _{REFSENS} +6dB (Note 1)	See table 7.6.1.1-6	See table 7.6.1.1-6
	1 to (F _{UL_low} -20) (F _{UL_high} +15) to 12750	-15 (Note 3)	P _{REFSENS} +6dB (Note 1)	—	CW carrier
31, 72, 74, 87, 88	(F _{UL_low} -20) to (F _{UL_high} +5)	-38	P _{REFSENS} +6dB (Note 1)	See table 7.6.1.1-6	See table 7.6.1.1-6
	1 to (F _{UL_low} -20) (F _{UL_high} +5) to 12750	-15 (Note 3)	P _{REFSENS} +6dB (Note 1)	—	CW carrier
85	(F _{UL_low} -20) to (F _{UL_high} +12)	-38	P _{REFSENS} +6dB (Note 1)	See table 7.6.1.1-6	See table 7.6.1.1-6
	1 to (F _{UL_low} -20) (F _{UL_high} +12) to 12750	-15 (Note 3)	P _{REFSENS} +6dB (Note 1)	—	CW carrier
<p>Note 1: P_{REFSENS} depends on the channel bandwidth as specified in Table 7.2.1-1 for E-UTRA and is specified in Table 7.2.1-5c for NB-IoT.</p> <p>Note 2: For a BS capable of multiband operation, in case of interfering signal that is not in the in-band blocking frequency range of the operating band where the wanted signal is present, and not in the in-band blocking frequency range of an adjacent or overlapping operating band, the wanted signal mean power is equal to P_{REFSENS} + 1.4 dB.</p> <p>Note 3: For NB-IoT, up to 24 exceptions are allowed for spurious response frequencies in each wanted signal frequency when measured using a 1MHz step size. For these exceptions the above throughput requirement shall be met when the blocking signal is set to a level of -40 dBm for 15 kHz subcarrier spacing and -46 dBm for 3.75 kHz subcarrier spacing. In addition, each group of exceptions shall not exceed three contiguous measurements using a 1MHz step size.</p>					

NOTE: Tables 7.6.1.1-5, 7.6.1.1-5a and 7.6.1.1-5b assume that two operating bands, where the downlink operating band (see Table 5.5-1) of one band would be within the in-band blocking region of the other band, are not deployed in the same geographical area.

Table 7.6.1.1-6: Interfering signals for blocking performance requirement for E-UTRA with NB-IoT in-band/guard band operation

E-UTRA channel BW of the lowest/highest carrier received [MHz]	Interfering signal centre frequency minimum offset to the lower/upper Base Station RF Bandwidth edge or sub-block edge inside a sub-block gap [MHz]	Type of interfering signal
3(Note)	±4.5	3MHz E-UTRA signal
5	±7.5	5MHz E-UTRA signal
10	±7.5	5MHz E-UTRA signal
15	±7.5	5MHz E-UTRA signal
20	±7.5	5MHz E-UTRA signal
Note: 3 MHz channel bandwidth is not applicable to guard band operation.		

7.6.2 Co-location with other base stations

This additional blocking requirement may be applied for the protection of E-UTRA and NB-IoT BS receivers when GSM, CDMA, UTRA, E-UTRA, NR or NB-IoT BS operating in a different frequency band are co-located with an E-UTRA or NB-IoT BS. The requirement is applicable to all channel bandwidths supported by the E-UTRA BS and E-UTRA with NB-IoT in-band/guard band operation.

The requirements in this clause assume a 30 dB coupling loss between interfering transmitter and E-UTRA or NB-IoT BS receiver and are based on co-location with base stations of the same class.

7.6.2.1 Minimum requirement

The throughput shall be $\geq 95\%$ of the maximum throughput of the reference measurement channel, with a wanted and an interfering signal coupled to BS antenna input using the parameters in Table 7.6.2.1-1 for Wide Area BS, in Table 7.6.2.1-2 for Local Area BS and in Table 7.6.2.1-3 for Medium Range BS. The reference measurement channel for the

wanted signal is identified in Tables 7.2.1-1, 7.2.1-2 and 7.2.1-4 for each channel bandwidth for E-UTRA, Table 7.2.1-5 for NB-IoT and further specified in Annex A.

Table 7.6.2.1-1: Blocking performance requirement for E-UTRA and NB-IoT Wide Area BS when co-located with BS in other frequency bands.

Co-located BS type	Centre Frequency of Interfering Signal (MHz)	Interfering Signal mean power (dBm)	Wanted Signal mean power (dBm)	Type of Interfering Signal
Macro GSM850 or CDMA850	869 – 894	+16**	$P_{\text{REFSENS}} + 6\text{dB}^*$	CW carrier
Macro GSM900	921 – 960	+16**	$P_{\text{REFSENS}} + 6\text{dB}^*$	CW carrier
Macro DCS1800	1805 – 1880	+16**	$P_{\text{REFSENS}} + 6\text{dB}^*$	CW carrier
Macro PCS1900	1930 – 1990	+16**	$P_{\text{REFSENS}} + 6\text{dB}^*$	CW carrier
WA UTRA FDD Band I or E-UTRA Band 1 or NR band n1	2110 – 2170	+16**	$P_{\text{REFSENS}} + 6\text{dB}^*$	CW carrier
WA UTRA FDD Band II or E-UTRA Band 2 or NR band n2	1930 – 1990	+16**	$P_{\text{REFSENS}} + 6\text{dB}^*$	CW carrier
WA UTRA FDD Band III or E-UTRA Band 3 or NR band n3	1805 – 1880	+16**	$P_{\text{REFSENS}} + 6\text{dB}^*$	CW carrier
WA UTRA FDD Band IV or E-UTRA Band 4	2110 – 2155	+16**	$P_{\text{REFSENS}} + 6\text{dB}^*$	CW carrier
WA UTRA FDD Band V or E-UTRA Band 5 or NR band n5	869 – 894	+16**	$P_{\text{REFSENS}} + 6\text{dB}^*$	CW carrier
WA UTRA FDD Band VI or E-UTRA Band 6	875 – 885	+16**	$P_{\text{REFSENS}} + 6\text{dB}^*$	CW carrier
WA UTRA FDD Band VII or E-UTRA Band 7 or NR band n7	2620 – 2690	+16**	$P_{\text{REFSENS}} + 6\text{dB}^*$	CW carrier
WA UTRA FDD Band VIII or E-UTRA Band 8 or NR band n8	925 – 960	+16**	$P_{\text{REFSENS}} + 6\text{dB}^*$	CW carrier
WA UTRA FDD Band IX or E-UTRA Band 9	1844.9 – 1879.9	+16**	$P_{\text{REFSENS}} + 6\text{dB}^*$	CW carrier
WA UTRA FDD Band X or E-UTRA Band 10	2110 – 2170	+16**	$P_{\text{REFSENS}} + 6\text{dB}^*$	CW carrier
WA UTRA FDD Band XI or E-UTRA Band 11	1475.9 – 1495.9	+16**	$P_{\text{REFSENS}} + 6\text{dB}^*$	CW carrier
WA UTRA FDD Band XII or E-UTRA Band 12 or NR band n12	729 - 746	+16**	$P_{\text{REFSENS}} + 6\text{dB}^*$	CW carrier
WA UTRA FDD Band XIII or E-UTRA Band 13	746 - 756	+16**	$P_{\text{REFSENS}} + 6\text{dB}^*$	CW carrier
WA UTRA FDD Band XIV or E-UTRA Band 14 or NR Band n14	758 - 768	+16**	$P_{\text{REFSENS}} + 6\text{dB}^*$	CW carrier
WA E-UTRA Band 17	734 - 746	+16**	$P_{\text{REFSENS}} + 6\text{dB}^*$	CW carrier
WA E-UTRA Band 18	860 - 875	+16**	$P_{\text{REFSENS}} + 6\text{dB}^*$	CW carrier
WA UTRA FDD Band XIX or E-UTRA Band 19	875 - 890	+16**	$P_{\text{REFSENS}} + 6\text{dB}^*$	CW carrier
WA UTRA FDD Band XX or E-UTRA Band 20 or NR band n20	791 - 821	+16**	$P_{\text{REFSENS}} + 6\text{dB}^*$	CW carrier
WA UTRA FDD Band XXI or E-UTRA Band 21	1495.9 – 1510.9	+16**	$P_{\text{REFSENS}} + 6\text{dB}^*$	CW carrier
WA UTRA FDD Band XXII or E-UTRA Band 22	3510 – 3590	+16**	$P_{\text{REFSENS}} + 6\text{dB}^*$	CW carrier
WA E-UTRA Band 24	1525 – 1559	+16**	$P_{\text{REFSENS}} + 6\text{dB}^*$	CW carrier
WA UTRA FDD Band XXV or E-UTRA Band 25 or NR band n25	1930 – 1995	+16**	$P_{\text{REFSENS}} + 6\text{dB}^*$	CW carrier
WA UTRA FDD Band XXVI or E-UTRA Band 26 or NR Band n26	859 – 894	+16**	$P_{\text{REFSENS}} + 6\text{dB}^*$	CW carrier
WA E-UTRA Band 27	852 - 869	+16**	$P_{\text{REFSENS}} + 6\text{dB}^*$	CW carrier
WA E-UTRA Band 28 or NR band n28	758 – 803	+16**	$P_{\text{REFSENS}} + 6\text{dB}^*$	CW carrier

WA E-UTRA Band 29 or NR Band n29	717-728	+16**	P _{REFSENS} + 6dB*	CW carrier
WA E-UTRA Band 30 or NR Band n30	2350 – 2360	+16**	P _{REFSENS} + 6dB*	CW carrier
WA E-UTRA Band 31	462.5-467.5	+16**	P _{REFSENS} + 6dB*	CW carrier
WA UTRA FDD Band XXXII or E-UTRA Band 32	1452-1496 (NOTE 3)	+16**	P _{REFSENS} + 6dB*	CW carrier
WA UTRA TDD Band a) or E-UTRA Band 33	1900-1920	+16**	P _{REFSENS} + 6dB*	CW carrier
WA UTRA TDD Band a) or E-UTRA Band 34 or NR band n34	2010-2025	+16**	P _{REFSENS} + 6dB*	CW carrier
WA UTRA TDD Band b) or E-UTRA Band 35	1850-1910	+16**	P _{REFSENS} + 6dB*	CW carrier
WA UTRA TDD Band b) or E-UTRA Band 36	1930-1990	+16**	P _{REFSENS} + 6dB*	CW carrier
WA UTRA TDD Band c) or E-UTRA Band 37	1910-1930	+16**	P _{REFSENS} + 6dB*	CW carrier
WA UTRA TDD Band d) or E-UTRA Band 38 or NR band n38	2570-2620	+16**	P _{REFSENS} + 6dB*	CW carrier
WA UTRA TDD Band f) or E-UTRA Band 39 or NR band n39	1880-1920	+16**	P _{REFSENS} + 6dB*	CW carrier
WA UTRA TDD Band e) or E-UTRA Band 40 or NR band n40	2300-2400	+16**	P _{REFSENS} + 6dB*	CW carrier
WA E-UTRA Band 41 or NR band n41	2496 - 2690	+16**	P _{REFSENS} + 6dB*	CW carrier
WA E-UTRA Band 42	3400-3600	+16**	P _{REFSENS} + 6dB*	CW carrier
WA E-UTRA Band 43	3600-3800	+16**	P _{REFSENS} + 6dB*	CW carrier
WA E-UTRA Band 44	703-803	+16**	P _{REFSENS} + 6dB*	CW carrier
WA E-UTRA Band 45	1447-1467	+16**	P _{REFSENS} + 6dB*	CW carrier
WA E-UTRA Band 48 or NR Band n48	3550-3700	+16**	P _{REFSENS} + 6dB*	CW carrier
WA E-UTRA Band 50 or NR band n50	1432 – 1517	+16**	P _{REFSENS} + 6dB*	CW carrier
WA E-UTRA Band 52	3300-3400	+16**	P _{REFSENS} + 6dB*	CW carrier
WA E-UTRA Band 65 or NR Band n65	2110 – 2200	+16**	P _{REFSENS} + 6dB*	CW carrier
WA E-UTRA Band 66 or NR band n66	2110 – 2200	+16**	P _{REFSENS} + 6dB*	CW carrier
WA E-UTRA Band 67	738-758	+16**	P _{REFSENS} + 6dB*	CW carrier
WA E-UTRA Band 68	753-783	+16**	P _{REFSENS} + 6dB*	CW carrier
WA E-UTRA Band 69	2570-2620	+16**	P _{REFSENS} + 6dB*	CW carrier
WA E-UTRA Band 70 or NR band n70	1995 – 2020	+16**	P _{REFSENS} + 6dB*	CW carrier
WA E-UTRA Band 71 or NR band n71	617 – 652	+16**	P _{REFSENS} + 6dB*	CW carrier
WA E-UTRA Band 72	461 – 466	+16**	P _{REFSENS} + 6dB*	CW carrier
WA E-UTRA Band 73	460 – 465	+16**	P _{REFSENS} + 6dB*	CW carrier
WA E-UTRA Band 74 or NR band n74	1475 - 1518	+16**	P _{REFSENS} + 6dB*	CW carrier
WA E-UTRA Band 75	1432 – 1517	+16**	P _{REFSENS} + 6dB*	CW carrier
WA NR band n77	3300-4200	+16**	P _{REFSENS} + 6dB*	CW carrier
WA NR band n78	3300-3800	+16**	P _{REFSENS} + 6dB*	CW carrier
WA NR band n79	4400-5000	+16**	P _{REFSENS} + 6dB*	CW carrier
WA E-UTRA Band 85	728 - 746	+16**	P _{REFSENS} + 6dB*	CW carrier
WA E-UTRA Band 87	420 – 425	+16**	P _{REFSENS} + 6dB*	CW carrier
WA E-UTRA Band 88	422 – 427	+16**	P _{REFSENS} + 6dB*	CW carrier
WA NR band n92	1432 – 1517	+16**	P _{REFSENS} + 6dB*	CW carrier
WA NR band n94	1432 – 1517	+16**	P _{REFSENS} + 6dB*	CW carrier

Note*:	P_{REFSENS} depends on the channel bandwidth as specified in Table 7.2.1-1 for E-UTRA and is specified in Table 7.2.1-5 for NB-IoT.
Note**:	For NB-IoT, up to 24 exceptions are allowed for spurious response frequencies in each wanted signal frequency when measured using a 1MHz step size. For these exceptions the above throughput requirement shall be met when the blocking signal is set to a level of -40 dBm for 15 kHz subcarrier spacing and -46 dBm for 3.75 kHz subcarrier spacing. In addition, each group of exceptions shall not exceed three contiguous measurements using a 1MHz step size.
NOTE 1:	Except for a BS operating in Band 13, these requirements do not apply when the interfering signal falls within any of the supported uplink operating band or in the 10 MHz immediately outside any of the supported uplink operating band. For a BS operating in band 13 the requirements do not apply when the interfering signal falls within the frequency range 768-797 MHz.
NOTE 2:	Some combinations of bands may not be possible to co-site based on the requirements above. The current state-of-the-art technology does not allow a single generic solution for co-location of UTRA TDD or E-UTRA TDD with E-UTRA FDD on adjacent frequencies for 30dB BS-BS minimum coupling loss. However, there are certain site-engineering solutions that can be used. These techniques are addressed in TR 25.942 [8].
NOTE 3:	For a BS operating in band 11, 21 or 74, the requirement for co-location with Band 32 applies for interfering signal within the frequency range 1475.9-1495.9 MHz.
NOTE 4:	Co-located TDD base stations that are synchronized and using the same or adjacent operating band can receive without special co-location requirements. For unsynchronized base stations, special co-location requirements may apply that are not covered by the 3GPP specifications.

Table 7.6.2.1-2: Blocking performance requirement for E-UTRA and NB-IoT Local Area BS when co-located with BS in other frequency bands.

Co-located BS type	Centre Frequency of Interfering Signal (MHz)	Interfering Signal mean power (dBm)	Wanted Signal mean power (dBm)	Type of Interfering Signal
Pico GSM850	869 – 894	-7**	$P_{\text{REFSENS}} + 6\text{dB}^*$	CW carrier
Pico GSM900	921 – 960	-7**	$P_{\text{REFSENS}} + 6\text{dB}^*$	CW carrier
Pico DCS1800	1805 – 1880	-4**	$P_{\text{REFSENS}} + 6\text{dB}^*$	CW carrier
Pico PCS1900	1930 – 1990	-4**	$P_{\text{REFSENS}} + 6\text{dB}^*$	CW carrier
LA UTRA FDD Band I or E-UTRA Band 1 or NR band n1	2110 – 2170	-6**	$P_{\text{REFSENS}} + 6\text{dB}^*$	CW carrier
LA UTRA FDD Band II or E-UTRA Band 2 or NR band n2	1930 – 1990	-6**	$P_{\text{REFSENS}} + 6\text{dB}^*$	CW carrier
LA UTRA FDD Band III or E-UTRA Band 3 or NR band n3	1805 – 1880	-6**	$P_{\text{REFSENS}} + 6\text{dB}^*$	CW carrier
LA UTRA FDD Band IV or E-UTRA Band 4	2110 – 2155	-6**	$P_{\text{REFSENS}} + 6\text{dB}^*$	CW carrier
LA UTRA FDD Band V or E-UTRA Band 5 or NR band n5	869 – 894	-6**	$P_{\text{REFSENS}} + 6\text{dB}^*$	CW carrier
LA UTRA FDD Band VI or E-UTRA Band 6	875 – 885	-6**	$P_{\text{REFSENS}} + 6\text{dB}^*$	CW carrier
LA UTRA FDD Band VII or E-UTRA Band 7 or NR band n7	2620 – 2690	-6**	$P_{\text{REFSENS}} + 6\text{dB}^*$	CW carrier
LA UTRA FDD Band VIII or E-UTRA Band 8 or NR band n8	925 – 960	-6**	$P_{\text{REFSENS}} + 6\text{dB}^*$	CW carrier
LA UTRA FDD Band IX or E-UTRA Band 9	1844.9 – 1879.9	-6**	$P_{\text{REFSENS}} + 6\text{dB}^*$	CW carrier
LA UTRA FDD Band X or E-UTRA Band 10	2110 – 2170	-6**	$P_{\text{REFSENS}} + 6\text{dB}^*$	CW carrier
LA UTRA FDD Band XI or E-UTRA Band 11	1475.9 - 1495.9	-6**	$P_{\text{REFSENS}} + 6\text{dB}^*$	CW carrier
LA UTRA FDD Band XII or E-UTRA Band 12 or NR band n12	729 - 746	-6**	$P_{\text{REFSENS}} + 6\text{dB}^*$	CW carrier
LA UTRA FDD Band XIII or E-UTRA Band 13	746 - 756	-6**	$P_{\text{REFSENS}} + 6\text{dB}^*$	CW carrier
LA UTRA FDD Band XIV or E-UTRA Band 14 or NR Band n14	758 - 768	-6**	$P_{\text{REFSENS}} + 6\text{dB}^*$	CW carrier
LA E-UTRA Band 17	734 - 746	-6**	$P_{\text{REFSENS}} + 6\text{dB}^*$	CW carrier
LA E-UTRA Band 18	860 - 875	-6**	$P_{\text{REFSENS}} + 6\text{dB}^*$	CW carrier
LA UTRA FDD Band XIX or E-UTRA Band 19	875 - 890	-6**	$P_{\text{REFSENS}} + 6\text{dB}^*$	CW carrier
LA UTRA FDD Band XX or E-UTRA Band 20 or NR band n20	791 - 821	-6**	$P_{\text{REFSENS}} + 6\text{dB}^*$	CW carrier
LA UTRA FDD Band XXI or E-UTRA Band 21	1495.9 – 1510.9	-6**	$P_{\text{REFSENS}} + 6\text{dB}^*$	CW carrier
LA UTRA FDD Band XXII or E-UTRA Band 22	3510 – 3590	-6**	$P_{\text{REFSENS}} + 6\text{dB}^*$	CW carrier
LA E-UTRA Band 24	1525 – 1559	-6**	$P_{\text{REFSENS}} + 6\text{dB}^*$	CW carrier
LA UTRA FDD Band XXV or E-UTRA Band 25 or NR band n25	1930 – 1995	-6**	$P_{\text{REFSENS}} + 6\text{dB}^*$	CW carrier
LA UTRA FDD Band XXVI or E-UTRA Band 26 or NR Band n26	859 – 894	-6**	$P_{\text{REFSENS}} + 6\text{dB}^*$	CW carrier
LA E-UTRA Band 27	852 - 869	-6**	$P_{\text{REFSENS}} + 6\text{dB}^*$	CW carrier
LA E-UTRA Band 28 or NR band n28	758 – 803	-6**	$P_{\text{REFSENS}} + 6\text{dB}^*$	CW carrier
LA E-UTRA Band 29 or NR Band n29	717 - 728	-6**	$P_{\text{REFSENS}} + 6\text{dB}^*$	CW carrier

LA E-UTRA Band 30 or NR Band n30	2350 – 2360	-6**	$P_{\text{REFSENS}} + 6\text{dB}^*$	CW carrier
LA E-UTRA Band 31	462.5 - 467.5	-6**	$P_{\text{REFSENS}} + 6\text{dB}^*$	CW carrier
LA UTRA FDD Band XXXII or E-UTRA Band 32	1452 - 1496 (NOTE 3)	-6**	$P_{\text{REFSENS}} + 6\text{dB}^*$	CW carrier
LA UTRA TDD Band a) or E-UTRA Band 33	1900 - 1920	-6**	$P_{\text{REFSENS}} + 6\text{dB}^*$	CW carrier
LA UTRA TDD Band a) or E-UTRA Band 34 or NR band n34	2010 - 2025	-6**	$P_{\text{REFSENS}} + 6\text{dB}^*$	CW carrier
LA UTRA TDD Band b) or E-UTRA Band 35	1850 - 1910	-6**	$P_{\text{REFSENS}} + 6\text{dB}^*$	CW carrier
LA UTRA TDD Band b) or E-UTRA Band 36	1930 - 1990	-6**	$P_{\text{REFSENS}} + 6\text{dB}^*$	CW carrier
LA UTRA TDD Band c) or E-UTRA Band 37	1910 - 1930	-6**	$P_{\text{REFSENS}} + 6\text{dB}^*$	CW carrier
LA UTRA TDD Band d) or E-UTRA Band 38 or NR band n38	2570 - 2620	-6**	$P_{\text{REFSENS}} + 6\text{dB}^*$	CW carrier
LA UTRA TDD Band f) or E-UTRA Band 39 or NR band n39	1880 - 1920	-6**	$P_{\text{REFSENS}} + 6\text{dB}^*$	CW carrier
LA E-UTRA UTRA TDD Band e) or Band 40 or NR band n40	2300 - 2400	-6**	$P_{\text{REFSENS}} + 6\text{dB}^*$	CW carrier
LA E-UTRA Band 41 or NR band n41	2496 - 2690	-6**	$P_{\text{REFSENS}} + 6\text{dB}^*$	CW carrier
LA E-UTRA Band 42	3400 - 3600	-6**	$P_{\text{REFSENS}} + 6\text{dB}^*$	CW carrier
LA E-UTRA Band 43	3600 - 3800	-6**	$P_{\text{REFSENS}} + 6\text{dB}^*$	CW carrier
LA E-UTRA Band 44	703 - 803	-6**	$P_{\text{REFSENS}} + 6\text{dB}^*$	CW carrier
LA E-UTRA Band 45	1447 - 1467	-6**	$P_{\text{REFSENS}} + 6\text{dB}^*$	CW carrier
LA E-UTRA Band 46 or NR Band n46	5150 - 5925	-6	$P_{\text{REFSENS}} + 6\text{dB}^*$	CW carrier
LA E-UTRA Band 48 or NR Band n48	3550 - 3700	-6**	$P_{\text{REFSENS}} + 6\text{dB}^*$	CW carrier
LA E-UTRA Band 49	3550 - 3700	-6**	$P_{\text{REFSENS}} + 6\text{dB}^*$	CW carrier
LA E-UTRA Band 50 or NR band n50	1432 – 1517	-6**	$P_{\text{REFSENS}} + 6\text{dB}^*$	CW carrier
LA E-UTRA Band 51 or NR band n51	1427 – 1432	-6**	$P_{\text{REFSENS}} + 6\text{dB}^*$	CW carrier
LA E-UTRA Band 52	3300 - 3400	-6**	$P_{\text{REFSENS}} + 6\text{dB}^*$	CW carrier
LA E-UTRA Band 53 or NR Band n53	2483.5 - 2495	-6**	$P_{\text{REFSENS}} + 6\text{dB}^*$	CW carrier
LA E-UTRA Band 65 or NR Band n65	2110 – 2200	-6**	$P_{\text{REFSENS}} + 6\text{dB}^*$	CW carrier
LA E-UTRA Band 66 or NR band n66	2110 – 2200	-6**	$P_{\text{REFSENS}} + 6\text{dB}^*$	CW carrier
LA E-UTRA Band 67	738 - 758	-6**	$P_{\text{REFSENS}} + 6\text{dB}^*$	CW carrier
LA E-UTRA Band 68	753 - 783	-6**	$P_{\text{REFSENS}} + 6\text{dB}^*$	CW carrier
LA E-UTRA Band 69	2570 - 2620	-6**	$P_{\text{REFSENS}} + 6\text{dB}^*$	CW carrier
LA E-UTRA Band 70 or NR band n70	1995 – 2020	-6**	$P_{\text{REFSENS}} + 6\text{dB}^*$	CW carrier
LA E-UTRA Band 71 or NR band n71	617 – 652	-6**	$P_{\text{REFSENS}} + 6\text{dB}^*$	CW carrier
LA E-UTRA Band 72	461 – 466	-6**	$P_{\text{REFSENS}} + 6\text{dB}^*$	CW carrier
LA E-UTRA Band 73	460 – 465	-6**	$P_{\text{REFSENS}} + 6\text{dB}^*$	CW carrier
LA E-UTRA Band 74 or NR band n74	1475 - 1518	-6**	$P_{\text{REFSENS}} + 6\text{dB}^*$	CW carrier
LA E-UTRA Band 75 or NR band n75	1432 – 1517	-6**	$P_{\text{REFSENS}} + 6\text{dB}^*$	CW carrier
LA E-UTRA Band 76 or NR band n76	1427 – 1432	-6**	$P_{\text{REFSENS}} + 6\text{dB}^*$	CW carrier
LA NR band n77	3300 - 4200	-6**	$P_{\text{REFSENS}} + 6\text{dB}^*$	CW carrier
LA NR band n78	3300 - 3800	-6**	$P_{\text{REFSENS}} + 6\text{dB}^*$	CW carrier
LA NR band n79	4400 - 5000	-6**	$P_{\text{REFSENS}} + 6\text{dB}^*$	CW carrier
LA E-UTRA Band 85	728 - 746	-6**	$P_{\text{REFSENS}} + 6\text{dB}^*$	CW carrier
LA E-UTRA Band 87	420 – 425	-6**	$P_{\text{REFSENS}} + 6\text{dB}^*$	CW carrier

LA E-UTRA Band 88	422 – 427	-6**	$P_{\text{REFSENS}} + 6\text{dB}^*$	CW carrier
LA NR band n91	1427 – 1432	-6**	$P_{\text{REFSENS}} + 6\text{dB}^*$	CW carrier
LA NR band n92	1432 – 1517	-6**	$P_{\text{REFSENS}} + 6\text{dB}^*$	CW carrier
LA NR band n93	1427 – 1432	-6**	$P_{\text{REFSENS}} + 6\text{dB}^*$	CW carrier
LA NR band n94	1432 – 1517	-6**	$P_{\text{REFSENS}} + 6\text{dB}^*$	CW carrier
LA NR band n96	5925 – 7125	-6	$P_{\text{REFSENS}} + 6\text{dB}^*$	CW carrier
Note*:	P_{REFSENS} depends on the channel bandwidth as specified in Table 7.2.1-2.			
Note**:	For NB-IoT, up to 24 exceptions are allowed for spurious response frequencies in each wanted signal frequency when measured using a 1MHz step size. For these exceptions the above throughput requirement shall be met when the blocking signal is set to a level of -40 dBm for 15 kHz subcarrier spacing and -46 dBm for 3.75 kHz subcarrier spacing. In addition, each group of exceptions shall not exceed three contiguous measurements using a 1MHz step size.			
NOTE 1:	Except for a BS operating in Band 13, these requirements do not apply when the interfering signal falls within any of the supported uplink operating band or in the 10 MHz immediately outside any of the supported uplink operating band. For a BS operating in band 13 the requirements do not apply when the interfering signal falls within the frequency range 768-797 MHz.			
NOTE 2:	Some combinations of bands may not be possible to co-site based on the requirements above. The current state-of-the-art technology does not allow a single generic solution for co-location of UTRA TDD or E-UTRA TDD with E-UTRA FDD on adjacent frequencies for 30dB BS-BS minimum coupling loss. However, there are certain site-engineering solutions that can be used. These techniques are addressed in TR 25.942 [8].			
NOTE 3:	For a BS operating in band 11, 21 or 74, the requirement for co-location with Band 32 applies for interfering signal within the frequency range 1475.9-1495.9 MHz.			
NOTE 4:	Co-located TDD base stations that are synchronized and using the same or adjacent operating band can receive without special co-location requirements. For unsynchronized base stations (except in Band 46), special co-location requirements may apply that are not covered by the 3GPP specifications.			

Table 7.6.2.1-3: Blocking performance requirement for E-UTRA and NB-IoT Medium Range BS when co-located with BS in other frequency bands.

Co-located BS type	Centre Frequency of Interfering Signal (MHz)	Interfering Signal mean power (dBm)	Wanted Signal mean power (dBm)	Type of Interfering Signal
Micro/MR GSM850	869 – 894	+8**	$P_{\text{REFSENS}} + 6\text{dB}^*$	CW carrier
Micro/MR GSM900	921 – 960	+8**	$P_{\text{REFSENS}} + 6\text{dB}^*$	CW carrier
Micro/MR DCS1800	1805 – 1880	+8**	$P_{\text{REFSENS}} + 6\text{dB}^*$	CW carrier
Micro/MR PCS1900	1930 – 1990	+8**	$P_{\text{REFSENS}} + 6\text{dB}^*$	CW carrier
MR UTRA FDD Band I or E-UTRA Band 1 or NR band n1	2110 – 2170	+8**	$P_{\text{REFSENS}} + 6\text{dB}^*$	CW carrier
MR UTRA FDD Band II or E-UTRA Band 2 or NR band n2	1930 – 1990	+8**	$P_{\text{REFSENS}} + 6\text{dB}^*$	CW carrier
MR UTRA FDD Band III or E-UTRA Band 3 or NR band n3	1805 – 1880	+8**	$P_{\text{REFSENS}} + 6\text{dB}^*$	CW carrier
MR UTRA FDD Band IV or E-UTRA Band 4	2110 – 2155	+8**	$P_{\text{REFSENS}} + 6\text{dB}^*$	CW carrier
MR UTRA FDD Band V or E-UTRA Band 5 or NR band n5	869 – 894	+8**	$P_{\text{REFSENS}} + 6\text{dB}^*$	CW carrier
MR UTRA FDD Band VI or E-UTRA Band 6	875 – 885	+8**	$P_{\text{REFSENS}} + 6\text{dB}^*$	CW carrier
MR UTRA FDD Band VII or E-UTRA Band 7 or NR band n7	2620 – 2690	+8**	$P_{\text{REFSENS}} + 6\text{dB}^*$	CW carrier
MR UTRA FDD Band VIII or E-UTRA Band 8 or NR band n8	925 – 960	+8**	$P_{\text{REFSENS}} + 6\text{dB}^*$	CW carrier
MR UTRA FDD Band IX or E-UTRA Band 9	1844.9 – 1879.9	+8**	$P_{\text{REFSENS}} + 6\text{dB}^*$	CW carrier
MR UTRA FDD Band X or E-UTRA Band 10	2110 – 2170	+8**	$P_{\text{REFSENS}} + 6\text{dB}^*$	CW carrier
MR UTRA FDD Band XI or E-UTRA Band 11	1475.9 – 1495.9	+8**	$P_{\text{REFSENS}} + 6\text{dB}^*$	CW carrier
MR UTRA FDD Band XII or E-UTRA Band 12 or NR band n12	729 – 746	+8**	$P_{\text{REFSENS}} + 6\text{dB}^*$	CW carrier
MR UTRA FDD Band XIII or E-UTRA Band 13	746 – 756	+8**	$P_{\text{REFSENS}} + 6\text{dB}^*$	CW carrier
MR UTRA FDD Band XIV or E-UTRA Band 14 or NR Band n14	758 – 768	+8**	$P_{\text{REFSENS}} + 6\text{dB}^*$	CW carrier
MR E-UTRA Band 17	734 – 746	+8**	$P_{\text{REFSENS}} + 6\text{dB}^*$	CW carrier
MR E-UTRA Band 18	860 – 875	+8**	$P_{\text{REFSENS}} + 6\text{dB}^*$	CW carrier
MR UTRA FDD Band XIX or E-UTRA Band 19	875 – 890	+8**	$P_{\text{REFSENS}} + 6\text{dB}^*$	CW carrier
MR UTRA FDD Band XX or E-UTRA Band 20 or NR band n20	791 – 821	+8**	$P_{\text{REFSENS}} + 6\text{dB}^*$	CW carrier
MR UTRA FDD Band XXI or E-UTRA Band 21	1495.9 – 1510.9	+8**	$P_{\text{REFSENS}} + 6\text{dB}^*$	CW carrier
MR UTRA FDD Band XXII or E-UTRA Band 22	3510 – 3590	+8**	$P_{\text{REFSENS}} + 6\text{dB}^*$	CW carrier
MR E-UTRA Band 24	1525 – 1559	+8**	$P_{\text{REFSENS}} + 6\text{dB}^*$	CW carrier
MR UTRA FDD Band XXV or E-UTRA Band 25 or NR band n25	1930 – 1995	+8**	$P_{\text{REFSENS}} + 6\text{dB}^*$	CW carrier
MR UTRA FDD Band XXVI or E-UTRA Band 26 or NR Band n26	859 – 894	+8**	$P_{\text{REFSENS}} + 6\text{dB}^*$	CW carrier
MR E-UTRA Band 27	852 – 869	+8**	$P_{\text{REFSENS}} + 6\text{dB}^*$	CW carrier
MR E-UTRA Band 28 or NR band n28	758 – 803	+8**	$P_{\text{REFSENS}} + 6\text{dB}^*$	CW carrier
MR E-UTRA Band 29 or NR Band n29	717 – 728	+8**	$P_{\text{REFSENS}} + 6\text{dB}^*$	CW carrier

MR E-UTRA Band 30 or NR Band n30	2350 – 2360	+8**	P _{REFSENS} + 6dB*	CW carrier
MR E-UTRA Band 31	462.5 – 467.5	+8**	P _{REFSENS} + 6dB*	CW carrier
MR UTRA FDD Band XXXII or E-UTRA Band 32	1452-1496 (NOTE 3)	+8**	P _{REFSENS} + 6dB*	CW carrier
MR E-UTRA Band 33	1900 – 1920	+8**	P _{REFSENS} + 6dB*	CW carrier
MR E-UTRA Band 34 or NR band n34	2010 – 2025	+8**	P _{REFSENS} + 6dB*	CW carrier
MR E-UTRA Band 35	1850 – 1910	+8**	P _{REFSENS} + 6dB*	CW carrier
MR E-UTRA Band 36	1930 – 1990	+8**	P _{REFSENS} + 6dB*	CW carrier
MR E-UTRA Band 37	1910 – 1930	+8**	P _{REFSENS} + 6dB*	CW carrier
MR E-UTRA Band 38 or NR band n38	2570 – 2620	+8**	P _{REFSENS} + 6dB*	CW carrier
MR E-UTRA Band 39 or NR band n39	1880 – 1920	+8**	P _{REFSENS} + 6dB*	CW carrier
MR E-UTRA Band 40 or NR band n40	2300 – 2400	+8**	P _{REFSENS} + 6dB*	CW carrier
MR E-UTRA Band 41 or NR band n41	2496 – 2690	+8**	P _{REFSENS} + 6dB*	CW carrier
MR E-UTRA Band 42	3400 – 3600	+8**	P _{REFSENS} + 6dB*	CW carrier
MR E-UTRA Band 43	3600 – 3800	+8**	P _{REFSENS} + 6dB*	CW carrier
MR E-UTRA Band 44	703 – 803	+8**	P _{REFSENS} + 6dB*	CW carrier
MR E-UTRA Band 45	1447 – 1467	+8**	P _{REFSENS} + 6dB*	CW carrier
MR E-UTRA Band 46 or NR Band n46	5150 – 5925	+8**	P _{REFSENS} + 6dB*	CW carrier
MR E-UTRA Band 48 or NR Band n48	3550-3700	+8**	P _{REFSENS} + 6dB*	CW carrier
MR E-UTRA Band 50 or NR band n50	1432 – 1517	+8**	P _{REFSENS} + 6dB*	CW carrier
MR E-UTRA Band 52	3300 – 3400	+8**	P _{REFSENS} + 6dB*	CW carrier
MR E-UTRA Band 53 or NR Band n53	2483.5 - 2495	+8**	P _{REFSENS} + 6dB*	CW carrier
MR E-UTRA Band 65 or NR Band n65	2110 – 2200	+8**	P _{REFSENS} + 6dB*	CW carrier
MR E-UTRA Band 66 or NR band n66	2110 – 2200	+8**	P _{REFSENS} + 6dB*	CW carrier
MR E-UTRA Band 67	738-758	+8**	P _{REFSENS} + 6dB*	CW carrier
MR E-UTRA Band 68	753-783	+8**	P _{REFSENS} + 6dB*	CW carrier
MR E-UTRA Band 69	2570-2620	+8**	P _{REFSENS} + 6dB*	CW carrier
MR E-UTRA Band 70 or NR band n70	1995 – 2020	+8**	P _{REFSENS} + 6dB*	CW carrier
MR E-UTRA Band 71 or NR band n71	617 – 652	+8**	P _{REFSENS} + 6dB*	CW carrier
MR E-UTRA Band 72	461 – 466	+8**	P _{REFSENS} + 6dB*	CW carrier
MR E-UTRA Band 73	460 – 465	+8**	P _{REFSENS} + 6dB*	CW carrier
MR E-UTRA Band 74 or NR band n74	1475 - 1518	+8**	P _{REFSENS} + 6dB*	CW carrier
MR E-UTRA Band 75 or NR band n75	1432 – 1517	+8**	P _{REFSENS} + 6dB*	CW carrier
MR NR band n77	3300-4200	+8**	P _{REFSENS} + 6dB*	CW carrier
MR NR band n78	3300-3800	+8**	P _{REFSENS} + 6dB*	CW carrier
MR NR band n79	4400-5000	+8**	P _{REFSENS} + 6dB*	CW carrier
MR E-UTRA Band 85	728 - 746	+8**	P _{REFSENS} + 6dB*	CW carrier
MR E-UTRA Band 87	420 – 425	+8**	P _{REFSENS} + 6dB*	CW carrier
MR E-UTRA Band 88	422 – 427	+8**	P _{REFSENS} + 6dB*	CW carrier
MR NR band n92	1432 – 1517	+8**	P _{REFSENS} + 6dB*	CW carrier
MR NR band n94	1432 – 1517	+8**	P _{REFSENS} + 6dB*	CW carrier
MR NR band n96	5925 – 7125	+8	P _{REFSENS} + 6dB*	CW carrier
Note*:	P _{REFSENS} depends on the channel bandwidth as specified in Table 7.2.1-4.			
Note**:	For NB-IoT, up to 24 exceptions are allowed for spurious response frequencies in each wanted signal frequency when measured using a 1MHz step size. For these exceptions the above throughput requirement shall be met when the blocking signal is set to a level of -40 dBm for 15 kHz subcarrier spacing and -46 dBm for 3.75 kHz subcarrier spacing. In addition, each group of exceptions shall not exceed three contiguous measurements using a 1MHz step size.			

<p>NOTE 1: Except for a BS operating in Band 13, these requirements do not apply when the interfering signal falls within any of the supported uplink operating band or in the 10 MHz immediately outside any of the supported uplink operating band. For a BS operating in band 13 the requirements do not apply when the interfering signal falls within the frequency range 768-797 MHz.</p> <p>NOTE 2: Some combinations of bands may not be possible to co-site based on the requirements above. The current state-of-the-art technology does not allow a single generic solution for co-location of UTRA TDD or E-UTRA TDD with E-UTRA FDD on adjacent frequencies for 30dB BS-BS minimum coupling loss. However, there are certain site-engineering solutions that can be used. These techniques are addressed in TR 25.942 [8].</p> <p>NOTE 3: For a BS operating in band 11, 21 or 74, the requirement for co-location with Band 32 applies for interfering signal within the frequency range 1475.9-1495.9 MHz.</p> <p>NOTE 4: Co-located TDD base stations that are synchronized and using the same or adjacent operating band can receive without special co-location requirements. For unsynchronized base stations (except in Band 46), special co-location requirements may apply that are not covered by the 3GPP specifications.</p>

7.6.3 Additional requirement (regional)

For the Public Safety LTE BS in Korea from 718 to 728 MHz in band 28, the wanted and the interfering signal coupled to the BS antenna input are specified in Tables G-2.2, G-2.3, G-2.4 and G-2.5 for the blocking requirements. The reference measurement channel for the wanted signal is A.1-3 for 10 MHz channel bandwidth and further specified in Annex A.

7.7 Receiver spurious emissions

The spurious emissions power is the power of emissions generated or amplified in a receiver that appear at the BS receiver antenna connector. The requirements apply to all BS with separate RX and TX antenna ports. In this case for FDD BS the test shall be performed when both TX and RX are on, with the TX port terminated.

For TDD BS with common RX and TX antenna port the requirement applies during the Transmitter OFF period. For FDD BS with common RX and TX antenna port the transmitter spurious emission as specified in clause 6.6.4 is valid.

For BS capable of multi-band operation where multiple bands are mapped on separate antenna connectors, the single-band requirements apply and the excluded frequency range is only applicable for the operating band supported on each antenna connector.

The requirements shall apply to BS that supports E-UTRA or E-UTRA with NB-IoT in-band/guard band operation or NB-IoT standalone operation.

7.7.1 Minimum requirement

The power of any spurious emission shall not exceed the levels in Table 7.7.1-1:

Table 7.7.1-1: General spurious emission minimum requirement

Frequency range	Maximum level	Measurement Bandwidth	Note
30MHz - 1 GHz	-57 dBm	100 kHz	
1 GHz – 12.75 GHz	-47 dBm	1 MHz	
12.75 GHz - 5 th harmonic of the upper frequency edge of the UL operating band in GHz	-47 dBm	1 MHz	Applies only for Bands 22, 42, 43, 48 or 49.
12.75 GHz - 26 GHz	-47 dBm	1 MHz	Applies only for Band 46
NOTE: The frequency range between $2.5 * BW_{\text{Channel}}$ below the first carrier frequency and $2.5 * BW_{\text{Channel}}$ above the last carrier frequency transmitted by the BS, where BW_{Channel} is the channel bandwidth according to Table 5.6-1, may be excluded from the requirement. However, frequencies that are more than 10 MHz below the lowest frequency of any of the BS supported downlink operating band or more than 10 MHz above the highest frequency of any of the BS supported downlink operating band shall not be excluded from the requirement. For BS capable of multiband operation, the exclusion applies for all supported operating bands. For BS capable of multi-band operation where multiple bands are mapped on separate antenna connectors, the single-band requirements apply and the excluded frequency range is only applicable for the operating band supported on each antenna connector.			

In addition to the requirements in Table 7.7.1-1, the power of any spurious emission shall not exceed the levels specified for Protection of the E-UTRA FDD BS receiver of own or different BS in clause 6.6.4.2 and for Co-existence with other systems in the same geographical area in clause 6.6.4.3. In addition, the co-existence requirements for co-located base stations specified in clause 6.6.4.4 may also be applied.

7.8 Receiver intermodulation

Third and higher order mixing of the two interfering RF signals can produce an interfering signal in the band of the desired channel. Intermodulation response rejection is a measure of the capability of the receiver to receive a wanted signal on its assigned channel frequency in the presence of two interfering signals which have a specific frequency relationship to the wanted signal. Interfering signals shall be a CW signal and an E-UTRA signal as specified in Annex C.

7.8.1 Minimum requirement

For E-UTRA, the throughput shall be $\geq 95\%$ of the maximum throughput of the reference measurement channel, with a wanted signal at the assigned channel frequency and two interfering signals coupled to the BS antenna input, with the conditions specified in Tables 7.8.1-1 and 7.8.1-2 for intermodulation performance and in Tables 7.8.1-3, 7.8.1-4, 7.8.1-5 and 7.8.1-6 for narrowband intermodulation performance. Narrowband intermodulation requirements are not applied for Band 46. The reference measurement channel for the wanted signal is identified in Table 7.2.1-1, Table 7.2.1-2, Table 7.2.1-3 and Table 7.2.1-4 for each channel bandwidth and further specified in Annex A.

For NB-IoT in-band operation, the throughput shall be $\geq 95\%$ of the maximum throughput of the reference measurement channel, with a wanted signal at the assigned channel frequency and two interfering signals coupled to the BS antenna input, with the conditions specified in Tables 7.8.1-1a and 7.8.1-2 for intermodulation performance and in Tables 7.8.1-3a, 7.8.1-4a, 7.8.1-5a and 7.8.1-6a for narrowband intermodulation performance. The reference measurement channel for the wanted signal is identified in Tables 7.2.1-5, 7.2.1-5a, 7.2.1-5b and 7.2.1-5c and further specified in Annex A.

For NB-IoT guard band operation, the throughput shall be $\geq 95\%$ of the maximum throughput of the reference measurement channel, with a wanted signal at the assigned channel frequency and two interfering signals coupled to the BS antenna input, with the conditions specified in Tables 7.8.1-1b and 7.8.1-2 for intermodulation performance and in Tables 7.8.1-3b, 7.8.1-4b, 7.8.1-5b and 7.8.1-6b for narrowband intermodulation performance. The reference measurement channel for the wanted signal is identified in Tables 7.2.1-5, 7.2.1-5a, 7.2.1-5b and 7.2.1-5c and further specified in Annex A.

For NB-IoT standalone operation, the throughput shall be $\geq 95\%$ of the maximum throughput of the reference measurement channel, with a wanted signal at the assigned channel frequency and two interfering signals coupled to the BS antenna input, with the conditions specified in Tables 7.8.1-1c and 7.8.1-2a for intermodulation performance and in

Tables 7.8.1-3c, 7.8.1-4c, 7.8.1-5c and 7.8.1-6c for narrowband intermodulation performance. The reference measurement channel for the wanted signal is identified in Tables 7.2.1-5, 7.2.1-5a and 7.2.1-5c and further specified in Annex A.

The receiver intermodulation requirement is applicable outside the Base Station RF Bandwidth or Radio Bandwidth edges. The interfering signal offset is defined relative to the Base Station RF Bandwidth edges or Radio Bandwidth edges.

For a BS operating in non-contiguous spectrum within any operating band, the narrowband intermodulation requirement applies in addition inside any sub-block gap in case the sub-block gap is at least as wide as the channel bandwidth of the E-UTRA interfering signal in Table 7.8.1-3. The interfering signal offset is defined relative to the sub-block edges inside the sub-block gap.

For a BS capable of multi-band operation, the intermodulation requirement applies in addition inside any Inter RF Bandwidth gap, in case the gap size is at least twice as wide as the E-UTRA interfering signal centre frequency offset from the Base Station RF Bandwidth edge.

For a BS capable of multi-band operation, the narrowband intermodulation requirement applies in addition inside any Inter RF Bandwidth gap in case the gap size is at least as wide as the E-UTRA interfering signal in Tables 7.8.1-3, 7.8.1-4 and 7.8.1-6. The interfering signal offset is defined relative to the Base Station RF Bandwidth edges inside the Inter RF Bandwidth gap.

Table 7.8.1-1: Intermodulation performance requirement for E-UTRA

BS type	Wanted signal mean power [dBm]	Interfering signal mean power [dBm]	Type of interfering signal
Wide Area BS	$P_{\text{REFSENS}} + 6\text{dB}^*$	-52	See Table 7.8.1-2
Medium Range BS	$P_{\text{REFSENS}} + 6\text{dB}^{**}$	-47	
Local Area BS	$P_{\text{REFSENS}} + 6\text{dB}^{***}$	-44	
Home BS	$P_{\text{REFSENS}} + 14\text{dB}^{****}$	-36	
Note*:	P_{REFSENS} depends on the channel bandwidth as specified in Table 7.2.1-1.		
Note**:	P_{REFSENS} depends on the channel bandwidth as specified in Table 7.2.1-4.		
Note***:	P_{REFSENS} depends on the channel bandwidth as specified in Table 7.2.1-2.		
Note****:	P_{REFSENS} depends on the channel bandwidth as specified in Table 7.2.1-3.		

Table 7.8.1-1a: Intermodulation performance requirement for E-UTRA with NB-IoT in-band operation BS

BS type	Wanted signal mean power [dBm]	Interfering signal mean power [dBm]	Type of interfering signal
Wide Area BS	$P_{\text{REFSENS}} + 6\text{dB}^*$	-52	See Table 7.8.1-2
Medium Range BS	$P_{\text{REFSENS}} + 6\text{dB}^{**}$	-47	
Local Area BS	$P_{\text{REFSENS}} + 6\text{dB}^{***}$	-44	
Home BS	$P_{\text{REFSENS}} + 14\text{dB}^{****}$	-36	
Note*:	P_{REFSENS} depends on the sub-carrier spacing as specified in Table 7.2.1-5.		
Note**:	P_{REFSENS} depends on the sub-carrier spacing as specified in Table 7.2.1-5c.		
Note***:	P_{REFSENS} depends on the sub-carrier spacing as specified in Table 7.2.1-5a.		
Note****:	P_{REFSENS} depends on the sub-carrier spacing as specified in Table 7.2.1-5b.		

Table 7.8.1-1b: Intermodulation performance requirement for E-UTRA with NB-IoT guard band operation BS

BS type	Wanted signal mean power [dBm]	Interfering signal mean power [dBm]	Type of interfering signal
Wide Area BS	$P_{\text{REFSENS}} + 6\text{dB}^*$	-52	See Table 7.8.1-2
Medium Area BS	$P_{\text{REFSENS}} + 6\text{dB}^{**}$	-47	
Local Area BS	$P_{\text{REFSENS}} + 6\text{dB}^{***}$	-44	
Home BS	$P_{\text{REFSENS}} + 14\text{dB}^{****}$	-36	
Note*:	P_{REFSENS} depends on the sub-carrier spacing as specified in Table 7.2.1-5.		
Note**:	P_{REFSENS} depends on the sub-carrier spacing as specified in Table 7.2.1-5c.		
Note***:	P_{REFSENS} depends on the sub-carrier spacing as specified in Table 7.2.1-5a.		
Note****:	P_{REFSENS} depends on the sub-carrier spacing as specified in Table 7.2.1-5b.		

Table 7.8.1-1c: Intermodulation performance requirement for NB-IoT standalone

	NB-IoT channel bandwidth of the lowest/highest carrier received [kHz]	Wanted signal mean power [dBm]	Interfering signal mean power [dBm]	Type of interfering signal
Wide Area BS	200	$P_{\text{REFSENS}} + 6 \text{ dB}^*$	-52	See Table 7.8.1-2a
Medium Area BS	200	$P_{\text{REFSENS}} + 6 \text{ dB}^{**}$	-47	
Local Area BS	200	$P_{\text{REFSENS}} + 6 \text{ dB}^{***}$	-44	
Home BS	200	$P_{\text{REFSENS}} + 14 \text{ dB}^{****}$	-36	
Note*: P_{REFSENS} depends on the sub-carrier spacing as specified in Table 7.2.1-5. Note**: P_{REFSENS} depends on the sub-carrier spacing as specified in Table 7.2.1-5c. Note***: P_{REFSENS} depends on the sub-carrier spacing as specified in Table 7.2.1-5a. Note****: P_{REFSENS} depends on the sub-carrier spacing as specified in Table 7.2.1-5b.				

Table 7.8.1-2: Interfering signal for Intermodulation performance requirement for E-UTRA or E-UTRA with NB-IoT in-band/guard band operation BS

E-UTRA channel bandwidth of the lowest/highest carrier received [MHz]	Interfering signal centre frequency offset from the lower/upper Base Station RF Bandwidth edge [MHz]	Type of interfering signal
3	± 4.5	CW
	± 10.5	3 MHz E-UTRA signal (Note 3)
5	± 7.5	CW
	± 17.5	5 MHz E-UTRA signal
10	± 7.375	CW
	± 17.5	5 MHz E-UTRA signal
15	± 7.25	CW
	± 17.5	5 MHz E-UTRA signal
20	± 7.125	CW
	± 17.5	5 MHz E-UTRA signal (Note 1)
20	± 7.125	CW
	± 24	20 MHz E-UTRA signal (Note 2)
Note 1: This type of interfering signal is not applied for Band 46. Note 2: This type of interfering signal is only applied for Band 46. Note 3: 3 MHz channel bandwidth is not applicable to guard band operation.		

Table 7.8.1-2a: Interfering signal for Intermodulation performance requirement for NB-IoT standalone operation BS

Channel bandwidth of the lowest/highest carrier received [MHz]	Interfering signal centre frequency offset from the lower/upper Base Station RF Bandwidth edge [MHz]	Type of interfering signal
0.2	± 7.575	CW
	± 17.5	5 MHz E-UTRA signal

Table 7.8.1-3: Narrowband intermodulation performance requirement for Wide Area BS for E-UTRA

E-UTRA channel bandwidth of the lowest/highest carrier received [MHz]	Wanted signal mean power [dBm]	Interfering signal mean power [dBm]	Interfering RB centre frequency offset from the lower/upper Base Station RF Bandwidth edge or sub-block edge inside a sub-block gap [kHz]	Type of interfering signal
1.4	$P_{\text{REFSENS}} + 6\text{dB}^*$	-52	± 270	CW
		-52	± 790	1.4 MHz E-UTRA signal, 1 RB**
3	$P_{\text{REFSENS}} + 6\text{dB}^*$	-52	± 270	CW
		-52	± 780	3.0 MHz E-UTRA signal, 1 RB**
5	$P_{\text{REFSENS}} + 6\text{dB}^*$	-52	± 360	CW
		-52	± 1060	5 MHz E-UTRA signal, 1 RB**
10	$P_{\text{REFSENS}} + 6\text{dB}^*$ (***)	-52	± 325	CW
		-52	± 1240	5 MHz E-UTRA signal, 1 RB**
15	$P_{\text{REFSENS}} + 6\text{dB}^*$ (***)	-52	± 380	CW
		-52	± 1600	5MHz E-UTRA signal, 1 RB**
20	$P_{\text{REFSENS}} + 6\text{dB}^*$ (***)	-52	± 345	CW
		-52	± 1780	5MHz E-UTRA signal, 1 RB**
Note*:	P_{REFSENS} is related to the channel bandwidth as specified in Table 7.2.1-1.			
Note**:	Interfering signal consisting of one resource block positioned at the stated offset, the channel bandwidth of the interfering signal is located adjacently to the lower/upper Base Station RF Bandwidth edge.			
Note***:	This requirement shall apply only for a FRC A1-3 mapped to the frequency range at the channel edge adjacent to the interfering signals			

Table 7.8.1-3a: Narrowband intermodulation performance requirement for Wide Area BS for E-UTRA with NB-IoT in-band operation BS

E-UTRA channel bandwidth of the lowest/highest carrier received [MHz]	Wanted signal mean power [dBm]	Interfering signal mean power [dBm]	Interfering RB centre frequency offset from the lower/upper Base Station RF Bandwidth edge or sub-block edge inside a sub-block gap [kHz]	Type of interfering signal
3	$P_{\text{REFSENS}} + 6\text{dB}^*$	-52	± 270	CW
		-52	± 780	3.0 MHz E-UTRA signal, 1 RB**
5	$P_{\text{REFSENS}} + 6\text{dB}^*$	-52	$\pm 360^{\text{****}}$	CW
		-52	± 1060	5 MHz E-UTRA signal, 1 RB**
10	$P_{\text{REFSENS}} + 6\text{dB}^*$ (***)	-52	$\pm 325^{\text{****}}$	CW
		-52	± 1240	5 MHz E-UTRA signal, 1 RB**
15	$P_{\text{REFSENS}} + 6\text{dB}^*$ (***)	-52	$\pm 380^{\text{****}}$	CW
		-52	± 1600	5MHz E-UTRA signal, 1 RB**
20	$P_{\text{REFSENS}} + 6\text{dB}^*$ (***)	-52	$\pm 345^{\text{****}}$	CW
		-52	± 1780	5MHz E-UTRA signal, 1 RB**
<p>Note*: P_{REFSENS} depends on the sub-carrier spacing as specified in Table 7.2.1-5.</p> <p>Note**: Interfering signal consisting of one resource block positioned at the stated offset, the channel bandwidth of the interfering signal is located adjacently to the lower/upper Base Station RF Bandwidth edge.</p> <p>Note***: This requirement shall apply only for a FRC A1-3 mapped to the frequency range at the channel edge adjacent to the interfering signals.</p> <p>Note****: The frequency offset shall be adjusted to accommodate the IMD product to fall in the NB-IoT RB for NB-IoT in-band operation.</p> <p>Note*****: If a BS RF receiver fails the test of the requirement, the test shall be performed with the CW interfering signal frequency shifted away from the wanted signal by 180 kHz and the E-UTRA interfering signal frequency shifted away from the wanted signal by 360 kHz. If the BS RF receiver still fails the test after the frequency shift, then the BS RF receiver shall be deemed to fail the requirement.</p>				

Table 7.8.1-3b: Narrowband intermodulation performance requirement for Wide Area BS for E-UTRA with NB-IoT guard band operation BS

E-UTRA channel bandwidth of the lowest/highest carrier received [MHz]	Wanted signal mean power [dBm]	Interfering signal mean power [dBm]	Interfering RB centre frequency offset from the lower/upper Base Station RF Bandwidth edge or sub-block edge inside a sub-block gap [kHz]	Type of interfering signal
5	$P_{\text{REFSENS}} + 6\text{dB}^*$	-52	$\pm 360^{****}$	CW
		-52	± 1060	5 MHz E-UTRA signal, 1 RB**
10	$P_{\text{REFSENS}} + 6\text{dB}^*$ (***)	-52	$\pm 325^{****}$	CW
		-52	± 1240	5 MHz E-UTRA signal, 1 RB**
15	$P_{\text{REFSENS}} + 6\text{dB}^*$ (***)	-52	$\pm 380^{****}$	CW
		-52	± 1600	5MHz E-UTRA signal, 1 RB**
20	$P_{\text{REFSENS}} + 6\text{dB}^*$ (***)	-52	$\pm 345^{****}$	CW
		-52	± 1780	5MHz E-UTRA signal, 1 RB**

Note*: P_{REFSENS} depends on the sub-carrier spacing as specified in Table 7.2.1-5.
 Note**: Interfering signal consisting of one resource block positioned at the stated offset, the channel bandwidth of the interfering signal is located adjacently to the lower/upper Base Station RF Bandwidth edge.
 Note***: This requirement shall apply only for a FRC A1-3 mapped to the frequency range at the channel edge adjacent to the interfering signals.
 Note****: The frequency offset shall be adjusted to accommodate the IMD product to fall in the NB-IoT RB for NB-IoT guard band operation.
 Note*****: If a BS RF receiver fails the test of the requirement, the test shall be performed with the CW interfering signal frequency shifted away from the wanted signal by 180 kHz and the E-UTRA interfering signal frequency shifted away from the wanted signal by 360 kHz. If the BS RF receiver still fails the test after the frequency shift, then the BS RF receiver shall be deemed to fail the requirement.

Table 7.8.1-3c: Narrowband intermodulation performance requirement for Wide Area BS for NB-IoT standalone

Channel bandwidth of the lowest/highest carrier received [MHz]	Wanted signal mean power [dBm]	Interfering signal mean power [dBm]	Interfering RB centre frequency offset from the lower/upper Base Station RF Bandwidth edge or sub-block edge inside a sub-block gap [kHz]	Type of interfering signal
0.2	$P_{\text{REFSENS}} + 6\text{dB}^*$	-52	± 340	CW
		-52	± 880	5MHz E-UTRA signal, 1 RB**

Note*: P_{REFSENS} depends on the sub-carrier spacing as specified in Table 7.2.1-5.
 Note**: Interfering signal consisting of one resource block positioned at the stated offset, the channel bandwidth of the interfering signal is located adjacently to the lower/upper Base Station RF Bandwidth edge.
 Note***: If a BS RF receiver fails the test of the requirement, the test shall be performed with the CW interfering signal frequency shifted away from the wanted signal by 180 kHz and the E-UTRA interfering signal frequency shifted away from the wanted signal by 360 kHz. If the BS RF receiver still fails the test after the frequency shift, then the BS RF receiver shall be deemed to fail the requirement.

Table 7.8.1-4: Narrowband intermodulation performance requirement for Local Area BS for E-UTRA

E-UTRA channel bandwidth of the lowest/highest carrier received [MHz]	Wanted signal mean power [dBm]	Interfering signal mean power [dBm]	Interfering RB centre frequency offset from the lower/upper Base Station RF Bandwidth edge or sub-block edge inside a sub-block [kHz]	Type of interfering signal
1.4	$P_{\text{REFSENS}} + 6\text{dB}^*$	-44	± 270	CW
		-44	± 790	1.4 MHz E-UTRA signal, 1 RB**
3	$P_{\text{REFSENS}} + 6\text{dB}^*$	-44	± 270	CW
		-44	± 780	3.0 MHz E-UTRA signal, 1 RB**
5	$P_{\text{REFSENS}} + 6\text{dB}^*$	-44	± 360	CW
		-44	± 1060	5 MHz E-UTRA signal, 1 RB**
10	$P_{\text{REFSENS}} + 6\text{dB}^*$ (***)	-44	± 325	CW
		-44	± 1240	5 MHz E-UTRA signal, 1 RB**
15	$P_{\text{REFSENS}} + 6\text{dB}^*$ (***)	-44	± 380	CW
		-44	± 1600	5MHz E-UTRA signal, 1 RB**
20	$P_{\text{REFSENS}} + 6\text{dB}^*$ (***)	-44	± 345	CW
		-44	± 1780	5MHz E-UTRA signal, 1 RB**
<p>Note*: P_{REFSENS} is related to the channel bandwidth as specified in Table 7.2.1-2.</p> <p>Note**: Interfering signal consisting of one resource block positioned at the stated offset, the channel bandwidth of the interfering signal is located adjacently to the lower/upper Base Station RF Bandwidth edge.</p> <p>Note***: This requirement shall apply only for a FRC A1-3 mapped to the frequency range at the channel edge adjacent to the interfering signals.</p>				

Table 7.8.1-4a: Narrowband intermodulation performance requirement for Local Area BS for E-UTRA with NB-IoT in-band operation BS

E-UTRA channel bandwidth of the lowest/highest carrier received [MHz]	Wanted signal mean power [dBm]	Interfering signal mean power [dBm]	Interfering RB centre frequency offset from the lower/upper Base Station RF Bandwidth edge or sub-block edge inside a sub-block gap [kHz]	Type of interfering signal
3	$P_{\text{REFSENS}} + 6\text{dB}^*$	-44	± 270	CW
		-44	± 780	3.0 MHz E-UTRA signal, 1 RB**
5	$P_{\text{REFSENS}} + 6\text{dB}^*$	-44	$\pm 360^{\text{****}}$	CW
		-44	± 1060	5 MHz E-UTRA signal, 1 RB**
10	$P_{\text{REFSENS}} + 6\text{dB}^*$ (***)	-44	$\pm 325^{\text{****}}$	CW
		-44	± 1240	5 MHz E-UTRA signal, 1 RB**
15	$P_{\text{REFSENS}} + 6\text{dB}^*$ (***)	-44	$\pm 380^{\text{****}}$	CW
		-44	± 1600	5MHz E-UTRA signal, 1 RB**
20	$P_{\text{REFSENS}} + 6\text{dB}^*$ (***)	-44	$\pm 345^{\text{****}}$	CW
		-44	± 1780	5MHz E-UTRA signal, 1 RB**
<p>Note*: P_{REFSENS} depends on the sub-carrier spacing as specified in Table 7.2.1-5a.</p> <p>Note**: Interfering signal consisting of one resource block positioned at the stated offset, the channel bandwidth of the interfering signal is located adjacently to the lower/upper Base Station RF Bandwidth edge.</p> <p>Note***: This requirement shall apply only for a FRC A1-3 mapped to the frequency range at the channel edge adjacent to the interfering signals.</p> <p>Note****: The frequency offset shall be adjusted to accommodate the IMD product to fall in the NB-IoT RB for NB-IoT in-band operation.</p> <p>Note*****: If a BS RF receiver fails the test of the requirement, the test shall be performed with the CW interfering signal frequency shifted away from the wanted signal by 180 kHz and the E-UTRA interfering signal frequency shifted away from the wanted signal by 360 kHz. If the BS RF receiver still fails the test after the frequency shift, then the BS RF receiver shall be deemed to fail the requirement.</p>				

Table 7.8.1-4b: Narrowband intermodulation performance requirement for Local Area BS for E-UTRA with NB-IoT guard band operation BS

E-UTRA channel bandwidth of the lowest/highest carrier received [MHz]	Wanted signal mean power [dBm]	Interfering signal mean power [dBm]	Interfering RB centre frequency offset from the lower/upper Base Station RF Bandwidth edge or sub-block edge inside a sub-block gap [kHz]	Type of interfering signal
5	$P_{\text{REFSENS}} + 6\text{dB}^*$	-44	$\pm 360^{****}$	CW
		-44	± 1060	5 MHz E-UTRA signal, 1 RB**
10	$P_{\text{REFSENS}} + 6\text{dB}^*$ (***)	-44	$\pm 325^{****}$	CW
		-44	± 1240	5 MHz E-UTRA signal, 1 RB**
15	$P_{\text{REFSENS}} + 6\text{dB}^*$ (***)	-44	$\pm 380^{****}$	CW
		-44	± 1600	5MHz E-UTRA signal, 1 RB**
20	$P_{\text{REFSENS}} + 6\text{dB}^*$ (***)	-44	$\pm 345^{****}$	CW
		-44	± 1780	5MHz E-UTRA signal, 1 RB**
<p>Note*: P_{REFSENS} depends on the sub-carrier spacing as specified in Table 7.2.1-5a.</p> <p>Note**: Interfering signal consisting of one resource block positioned at the stated offset, the channel bandwidth of the interfering signal is located adjacently to the lower/upper Base Station RF Bandwidth edge.</p> <p>Note***: This requirement shall apply only for a FRC A1-3 mapped to the frequency range at the channel edge adjacent to the interfering signals.</p> <p>Note****: The frequency offset shall be adjusted to accommodate the IMD product to fall in the NB-IoT RB for NB-IoT guard band operation.</p> <p>Note*****: If a BS RF receiver fails the test of the requirement, the test shall be performed with the CW interfering signal frequency shifted away from the wanted signal by 180 kHz and the E-UTRA interfering signal frequency shifted away from the wanted signal by 360 kHz. If the BS RF receiver still fails the test after the frequency shift, then the BS RF receiver shall be deemed to fail the requirement.</p>				

Table 7.8.1-4c: Narrowband intermodulation performance requirement for Local Area BS for NB-IoT standalone

Channel bandwidth of the lowest/highest carrier received [MHz]	Wanted signal mean power [dBm]	Interfering signal mean power [dBm]	Interfering RB centre frequency offset from the lower/upper Base Station RF Bandwidth edge or sub-block edge inside a sub-block gap [kHz]	Type of interfering signal
0.2	$P_{\text{REFSENS}} + 6\text{dB}^*$	-44	± 340	CW
		-44	± 880	5MHz E-UTRA signal, 1 RB**
<p>Note*: P_{REFSENS} depends on the sub-carrier spacing as specified in Table 7.2.1-5a.</p> <p>Note**: Interfering signal consisting of one resource block positioned at the stated offset, the channel bandwidth of the interfering signal is located adjacently to the lower/upper Base Station RF Bandwidth edge.</p> <p>Note***: If a BS RF receiver fails the test of the requirement, the test shall be performed with the CW interfering signal frequency shifted away from the wanted signal by 180 kHz and the E-UTRA interfering signal frequency shifted away from the wanted signal by 360 kHz. If the BS RF receiver still fails the test after the frequency shift, then the BS RF receiver shall be deemed to fail the requirement.</p>				

Table 7.8.1-5: Narrowband intermodulation performance requirement for Home BS for E-UTRA

E-UTRA channel bandwidth [MHz]	Wanted signal mean power [dBm]	Interfering signal mean power [dBm]	Interfering RB centre frequency offset from the channel edge of the wanted signal [kHz]	Type of interfering signal
1.4	$P_{\text{REFSENS}} + 14\text{dB}^*$	-36	270	CW
		-36	790	1.4 MHz E-UTRA signal, 1 RB**
3	$P_{\text{REFSENS}} + 14\text{dB}^*$	-36	270	CW
		-36	780	3.0 MHz E-UTRA signal, 1 RB**
5	$P_{\text{REFSENS}} + 14\text{dB}^*$	-36	360	CW
		-36	1060	5 MHz E-UTRA signal, 1 RB**
10	$P_{\text{REFSENS}} + 14\text{dB}^*$ (***)	-36	325	CW
		-36	1240	5 MHz E-UTRA signal, 1 RB**
15	$P_{\text{REFSENS}} + 14\text{dB}^*$ (***)	-36	380	CW
		-36	1600	5MHz E-UTRA signal, 1 RB**
20	$P_{\text{REFSENS}} + 14\text{dB}^*$ (***)	-36	345	CW
		-36	1780	5MHz E-UTRA signal, 1 RB**
<p>Note*: P_{REFSENS} is related to the channel bandwidth as specified in Table 7.2.1-3.</p> <p>Note**: Interfering signal consisting of one resource block positioned at the stated offset, the channel bandwidth of the interfering signal is located adjacently to the channel edge of the wanted signal.</p> <p>Note***: This requirement shall apply only for a FRC A1-3 mapped to the frequency range at the channel edge adjacent to the interfering signals.</p>				

Table 7.8.1-5a: Narrowband intermodulation performance requirement for Home BS for E-UTRA with NB-IoT in-band operation BS

E-UTRA channel bandwidth of the lowest/highest carrier received [MHz]	Wanted signal mean power [dBm]	Interfering signal mean power [dBm]	Interfering RB centre frequency offset from the lower/upper Base Station RF Bandwidth edge or sub-block edge inside a sub-block gap [kHz]	Type of interfering signal
3	$P_{\text{REFSENS}} + 14\text{dB}^*$	-36	± 270	CW
		-36	± 780	3.0 MHz E-UTRA signal, 1 RB**
5	$P_{\text{REFSENS}} + 14\text{dB}^*$	-36	$\pm 360^{\text{****}}$	CW
		-36	± 1060	5 MHz E-UTRA signal, 1 RB**
10	$P_{\text{REFSENS}} + 14\text{dB}^*$ (***)	-36	$\pm 325^{\text{****}}$	CW
		-36	± 1240	5 MHz E-UTRA signal, 1 RB**
15	$P_{\text{REFSENS}} + 14\text{dB}^*$ (***)	-36	$\pm 380^{\text{****}}$	CW
		-36	± 1600	5MHz E-UTRA signal, 1 RB**
20	$P_{\text{REFSENS}} + 14\text{dB}^*$ (***)	-36	$\pm 345^{\text{****}}$	CW
		-36	± 1780	5MHz E-UTRA signal, 1 RB**
<p>Note*: P_{REFSENS} depends on the sub-carrier spacing as specified in Table 7.2.1-5c.</p> <p>Note**: Interfering signal consisting of one resource block positioned at the stated offset, the channel bandwidth of the interfering signal is located adjacently to the lower/upper Base Station RF Bandwidth edge.</p> <p>Note***: This requirement shall apply only for a FRC A1-3 mapped to the frequency range at the channel edge adjacent to the interfering signals.</p> <p>Note****: The frequency offset shall be adjusted to accommodate the IMD product to fall in the NB-IoT RB for NB-IoT in-band operation.</p> <p>Note*****: If a BS RF receiver fails the test of the requirement, the test shall be performed with the CW interfering signal frequency shifted away from the wanted signal by 180 kHz and the E-UTRA interfering signal frequency shifted away from the wanted signal by 360 kHz. If the BS RF receiver still fails the test after the frequency shift, then the BS RF receiver shall be deemed to fail the requirement.</p>				

Table 7.8.1-5b: Narrowband intermodulation performance requirement for Home BS for E-UTRA with NB-IoT guard band operation BS

E-UTRA channel bandwidth of the lowest/highest carrier received [MHz]	Wanted signal mean power [dBm]	Interfering signal mean power [dBm]	Interfering RB centre frequency offset from the lower/upper Base Station RF Bandwidth edge or sub-block edge inside a sub-block gap [kHz]	Type of interfering signal
5	$P_{\text{REFSENS}} + 14\text{dB}^*$	-36	$\pm 360^{****}$	CW
		-36	± 1060	5 MHz E-UTRA signal, 1 RB**
10	$P_{\text{REFSENS}} + 14\text{dB}^*$ (***)	-36	$\pm 325^{****}$	CW
		-36	± 1240	5 MHz E-UTRA signal, 1 RB**
15	$P_{\text{REFSENS}} + 14\text{dB}^*$ (***)	-36	$\pm 380^{****}$	CW
		-36	± 1600	5MHz E-UTRA signal, 1 RB**
20	$P_{\text{REFSENS}} + 14\text{dB}^*$ (***)	-36	$\pm 345^{****}$	CW
		-36	± 1780	5MHz E-UTRA signal, 1 RB**
<p>Note*: P_{REFSENS} depends on the sub-carrier spacing as specified in Table 7.2.1-5c. Note**: Interfering signal consisting of one resource block positioned at the stated offset, the channel bandwidth of the interfering signal is located adjacently to the lower/upper Base Station RF Bandwidth edge. Note***: This requirement shall apply only for a FRC A1-3 mapped to the frequency range at the channel edge adjacent to the interfering signals. Note****: The frequency offset shall be adjusted to accommodate the IMD product to fall in the NB-IoT RB for NB-IoT guard band operation. Note*****: If a BS RF receiver fails the test of the requirement, the test shall be performed with the CW interfering signal frequency shifted away from the wanted signal by 180 kHz and the E-UTRA interfering signal frequency shifted away from the wanted signal by 360 kHz. If the BS RF receiver still fails the test after the frequency shift, then the BS RF receiver shall be deemed to fail the requirement.</p>				

Table 7.8.1-5c: Narrowband intermodulation performance requirement for Home BS for NB-IoT standalone

Channel bandwidth of the lowest/highest carrier received [MHz]	Wanted signal mean power [dBm]	Interfering signal mean power [dBm]	Interfering RB centre frequency offset from the lower/upper Base Station RF Bandwidth edge or sub-block edge inside a sub-block gap [kHz]	Type of interfering signal
0.2	$P_{\text{REFSENS}} + 14\text{dB}^*$	-36	± 340	CW
		-36	± 880	5MHz E-UTRA signal, 1 RB**
<p>Note*: P_{REFSENS} depends on the sub-carrier spacing as specified in Table 7.2.1-5c. Note**: Interfering signal consisting of one resource block positioned at the stated offset, the channel bandwidth of the interfering signal is located adjacently to the lower/upper Base Station RF Bandwidth edge. Note***: If a BS RF receiver fails the test of the requirement, the test shall be performed with the CW interfering signal frequency shifted away from the wanted signal by 180 kHz and the E-UTRA interfering signal frequency shifted away from the wanted signal by 360 kHz. If the BS RF receiver still fails the test after the frequency shift, then the BS RF receiver shall be deemed to fail the requirement.</p>				

Table 7.8.1-6: Narrowband intermodulation performance requirement for Medium Range BS for E-UTRA

E-UTRA channel bandwidth of the lowest/highest carrier received [MHz]	Wanted signal mean power [dBm]	Interfering signal mean power [dBm]	Interfering RB centre frequency offset to the lower/higher Base Station RF Bandwidth edge or sub-block edge inside a sub-block gap [kHz]	Type of interfering signal
1.4	$P_{\text{REFSENS}} + 6\text{dB}^*$	-47	± 270	CW
		-47	± 790	1.4 MHz E-UTRA signal, 1 RB**
3	$P_{\text{REFSENS}} + 6\text{dB}^*$	-47	± 270	CW
		-47	± 780	3.0 MHz E-UTRA signal, 1 RB**
5	$P_{\text{REFSENS}} + 6\text{dB}^*$	-47	± 360	CW
		-47	± 1060	5 MHz E-UTRA signal, 1 RB**
10	$P_{\text{REFSENS}} + 6\text{dB}^*$ (***)	-47	± 325	CW
		-47	± 1240	5 MHz E-UTRA signal, 1 RB**
15	$P_{\text{REFSENS}} + 6\text{dB}^*$ (***)	-47	± 380	CW
		-47	± 1600	5MHz E-UTRA signal, 1 RB**
20	$P_{\text{REFSENS}} + 6\text{dB}^*$ (***)	-47	± 345	CW
		-47	± 1780	5MHz E-UTRA signal, 1 RB**
<p>Note*: P_{REFSENS} is related to the channel bandwidth as specified in Table 7.2.1-4.</p> <p>Note**: Interfering signal consisting of one resource block positioned at the stated offset, the channel bandwidth of the interfering signal is located adjacently to the lower/upper Base Station RF Bandwidth edge.</p> <p>Note***: This requirement shall apply only for a FRC A1-3 mapped to the frequency range at the channel edge adjacent to the interfering signals.</p>				

Table 7.8.1-6a: Narrowband intermodulation performance requirement for Medium Range BS for E-UTRA with NB-IoT in-band operation BS

E-UTRA channel bandwidth of the lowest/highest carrier received [MHz]	Wanted signal mean power [dBm]	Interfering signal mean power [dBm]	Interfering RB centre frequency offset from the lower/upper Base Station RF Bandwidth edge or sub-block edge inside a sub-block gap [kHz]	Type of interfering signal
3	$P_{\text{REFSENS}} + 6\text{dB}^*$	-47	± 270	CW
		-47	± 780	3.0 MHz E-UTRA signal, 1 RB**
5	$P_{\text{REFSENS}} + 6\text{dB}^*$	-47	$\pm 360^{\text{****}}$	CW
		-47	± 1060	5 MHz E-UTRA signal, 1 RB**
10	$P_{\text{REFSENS}} + 6\text{dB}^*$ (***)	-47	$\pm 325^{\text{****}}$	CW
		-47	± 1240	5 MHz E-UTRA signal, 1 RB**
15	$P_{\text{REFSENS}} + 6\text{dB}^*$ (***)	-47	$\pm 380^{\text{****}}$	CW
		-47	± 1600	5MHz E-UTRA signal, 1 RB**
20	$P_{\text{REFSENS}} + 6\text{dB}^*$ (***)	-47	$\pm 345^{\text{****}}$	CW
		-47	± 1780	5MHz E-UTRA signal, 1 RB**
<p>Note*: P_{REFSENS} depends on the sub-carrier spacing as specified in Table 7.2.1-5c.</p> <p>Note**: Interfering signal consisting of one resource block positioned at the stated offset, the channel bandwidth of the interfering signal is located adjacently to the lower/upper Base Station RF Bandwidth edge.</p> <p>Note***: This requirement shall apply only for a FRC A1-3 mapped to the frequency range at the channel edge adjacent to the interfering signals.</p> <p>Note****: The frequency offset shall be adjusted to accommodate the IMD product to fall in the NB-IoT RB for NB-IoT in-band operation.</p> <p>Note*****: If a BS RF receiver fails the test of the requirement, the test shall be performed with the CW interfering signal frequency shifted away from the wanted signal by 180 kHz and the E-UTRA interfering signal frequency shifted away from the wanted signal by 360 kHz. If the BS RF receiver still fails the test after the frequency shift, then the BS RF receiver shall be deemed to fail the requirement.</p>				

Table 7.8.1-6b: Narrowband intermodulation performance requirement for Medium Range BS for E-UTRA with NB-IoT guard band operation BS

E-UTRA channel bandwidth of the lowest/highest carrier received [MHz]	Wanted signal mean power [dBm]	Interfering signal mean power [dBm]	Interfering RB centre frequency offset from the lower/upper Base Station RF Bandwidth edge or sub-block edge inside a sub-block gap [kHz]	Type of interfering signal
5	$P_{\text{REFSENS}} + 6\text{dB}^*$	-47	$\pm 360^{****}$	CW
		-47	± 1060	5 MHz E-UTRA signal, 1 RB**
10	$P_{\text{REFSENS}} + 6\text{dB}^*$ (***)	-47	$\pm 325^{****}$	CW
		-47	± 1240	5 MHz E-UTRA signal, 1 RB**
15	$P_{\text{REFSENS}} + 6\text{dB}^*$ (***)	-47	$\pm 380^{****}$	CW
		-47	± 1600	5MHz E-UTRA signal, 1 RB**
20	$P_{\text{REFSENS}} + 6\text{dB}^*$ (***)	-47	$\pm 345^{****}$	CW
		-47	± 1780	5MHz E-UTRA signal, 1 RB**
<p>Note*: P_{REFSENS} depends on the sub-carrier spacing as specified in Table 7.2.1-5c. Note**: Interfering signal consisting of one resource block positioned at the stated offset, the channel bandwidth of the interfering signal is located adjacently to the lower/upper Base Station RF Bandwidth edge. Note***: This requirement shall apply only for a FRC A1-3 mapped to the frequency range at the channel edge adjacent to the interfering signals. Note****: The frequency offset shall be adjusted to accommodate the IMD product to fall in the NB-IoT RB for NB-IoT guard band operation. Note*****: If a BS RF receiver fails the test of the requirement, the test shall be performed with the CW interfering signal frequency shifted away from the wanted signal by 180 kHz and the E-UTRA interfering signal frequency shifted away from the wanted signal by 360 kHz. If the BS RF receiver still fails the test after the frequency shift, then the BS RF receiver shall be deemed to fail the requirement.</p>				

Table 7.8.1-6c: Narrowband intermodulation performance requirement for Medium Range BS for NB-IoT standalone

Channel bandwidth of the lowest/highest carrier received [MHz]	Wanted signal mean power [dBm]	Interfering signal mean power [dBm]	Interfering RB centre frequency offset from the lower/upper Base Station RF Bandwidth edge or sub-block edge inside a sub-block gap [kHz]	Type of interfering signal
0.2	$P_{\text{REFSENS}} + 6\text{dB}^*$	-47	± 340	CW
		-47	± 880	5MHz E-UTRA signal, 1 RB**
<p>Note*: P_{REFSENS} depends on the sub-carrier spacing as specified in Table 7.2.1-5c. Note**: Interfering signal consisting of one resource block positioned at the stated offset, the channel bandwidth of the interfering signal is located adjacently to the lower/upper Base Station RF Bandwidth edge. Note***: If a BS RF receiver fails the test of the requirement, the test shall be performed with the CW interfering signal frequency shifted away from the wanted signal by 180 kHz and the E-UTRA interfering signal frequency shifted away from the wanted signal by 360 kHz. If the BS RF receiver still fails the test after the frequency shift, then the BS RF receiver shall be deemed to fail the requirement.</p>				

8 Performance requirement

8.1 General

Performance requirements for the BS are specified for the fixed reference channels defined in Annex A and the propagation conditions in Annex B. The requirements only apply to those FRCs that are supported by the base station.

Unless stated otherwise, performance requirements apply for a single carrier only. Performance requirements for a BS supporting carrier aggregation are defined in terms of single carrier requirements. For FDD operation the requirements in clause 8 shall be met with the transmitter(s) on.

NOTE: In normal operating conditions the BS in FDD operation is configured to transmit and receive at the same time. The transmitter may be off for some of the tests as specified in 36.141 [4].

The SNR used in this clause is specified based on a single carrier and defined as:

$$\text{SNR} = S / N$$

Where:

S is the total signal energy in the subframe on a single antenna port.

N is the noise energy in a bandwidth corresponding to the transmission bandwidth over the duration of a subframe.

For enhanced performance requirements type A and type B, the SINR used in this clause is specified based on a single carrier and defined as:

$$\text{SINR} = S / N'$$

Where:

S is the total signal energy of one intra-cell UE in the subframe on a single antenna port.

N' is the summation of the received energy of the strongest inter-cell interferers explicitly defined in a test procedure plus the white noise energy N , in a bandwidth corresponding to the transmission bandwidth over the duration of a subframe on a single antenna port. The respective energy of each inter-cell interferer relative to N' is defined by its associated DIP value.

8.2 Performance requirements for PUSCH

8.2.1 Requirements in multipath fading propagation conditions

The performance requirement of PUSCH is determined by a minimum required throughput for a given SNR. The required throughput is expressed as a fraction of maximum throughput for the FRCs listed in Annex A. The performance requirements assume HARQ retransmissions. For 2Tx test the HARQ retransmissions for two codewords are independent. The requirements defined based on FRC in Annex A.17 apply to the BS supporting PUSCH with 256QAM. The requirements defined based on FRC in Annex A.18 apply to the BS supporting PUSCH transmission in UpPTS. The requirements defined based on FRC in Annex A.19 apply to the BS supporting both PUSCH transmission in UpPTS and PUSCH with 256QAM. For PUSCH transmission in UpPTS, the special subframe configuration is 10 as specified in 36.211 [10] Table 4.2-1, and during the test only special subframe is scheduled.

Table 8.2.1-1 Test parameters for testing PUSCH

Parameter	Value
Maximum number of HARQ transmissions	4
RV sequence	0, 2, 3, 1, 0, 2, 3, 1
Uplink-downlink allocation for TDD	Configuration 1 (2:2)

8.2.1.1 Minimum requirements

The throughput shall be equal to or larger than the fraction of maximum throughput stated in the tables 8.2.1.1-1 to 8.2.1.1-6 at the given SNR for 1Tx and in tables 8.2.1.1-7 to 8.2.1.1-12 for 2Tx two layer spatial multiplexing transmission.

Table 8.2.1.1-1 Minimum requirements for PUSCH, 1.4 MHz Channel Bandwidth, 1Tx

Number of TX antennas	Number of RX antennas	Cyclic prefix	Propagation conditions and correlation matrix (Annex B)	FRC (Annex A)	Fraction of maximum throughput	SNR [dB]		
1	2	Normal	EPA 5Hz Low	A3-2	30%	-4.1		
					70%	0.1		
				A4-3	70%	10.6		
					A5-2	70%	17.7	
				A17-1	70%	21.4		
				A18-1	70%	7.4		
			A19-1	70%	18.1			
			EVA 5Hz Low	A3-1	30%	-2.7		
					70%	1.8		
				A4-1	30%	4.4		
					70%	11.3		
				A5-1	70%	18.6		
				EVA 70Hz Low	A3-2	30%	-3.9	
			70%			0.7		
			A4-3		30%	4.0		
					70%	11.9		
			ETU 70Hz* Low	A3-1	30%	-2.4		
					70%	2.4		
			ETU 300Hz* Low	A3-1	30%	-2.2		
					70%	2.9		
			Extended	ETU 70Hz* Low	A4-2	30%	4.8	
						70%	13.5	
			4	Normal	EPA 5Hz Low	A3-2	30%	-6.6
							70%	-3.1
	A4-3	70%				7.1		
		A5-2				70%	14.4	
	A17-1	70%				18.2		
	A18-1	70%				4.1		
	A19-1	70%			14.7			
	EVA 5Hz Low	A3-1			30%	-5.0		
					70%	-1.3		
		A4-1			30%	1.3		
					70%	7.8		
		A5-1			70%	15.4		
		EVA 70Hz Low			A3-2	30%	-6.3	
	70%					-2.7		
	A4-3				30%	0.8		
					70%	8.3		
	ETU 70Hz* Low	A3-1			30%	-4.8		
					70%	-1.0		
	ETU 300Hz* Low	A3-1			30%	-4.6		
					70%	-0.6		
	ETU 600Hz** Low	A13-1			30%	-0.9		
					70%	6.1		
	Extended	ETU 70Hz* Low			A4-2	30%	1.6	
						70%	9.9	
	8	Normal	EPA 5Hz Low	A3-2	30%	-9.4		
					70%	-6.4		
A4-3				70%	4.0			
				A5-2	70%	10.9		
A17-1				70%	15.1			
A18-1				70%	1.1			
A19-1			70%	11.6				
EVA 5Hz Low			A3-1	30%	-7.2			
				70%	-3.8			
			A4-1	30%	-1.7			
				70%	4.6			
			A5-1	70%	11.7			
			EVA 70Hz Low	A3-2	30%	-9.0		
70%					-5.8			

				A4-3	30%	-2.5
					70%	4.8
			ETU 70Hz* Low	A3-1	30%	-6.8
					70%	-3.6
			ETU 300Hz* Low	A3-1	30%	-6.7
					70%	-3.3
		Extended	ETU 70Hz* Low	A4-2	30%	-1.1
					70%	6.4
Note*: Not applicable for Local Area BS and Home BS.						
Note**: Not applicable for Local Area BS and Home BS, and only applicable for BS supporting ETU600.						

Table 8.2.1.1-2 Minimum requirements for PUSCH, 3 MHz Channel Bandwidth, 1Tx

Number of TX antennas	Number of RX antennas	Cyclic prefix	Propagation conditions and correlation matrix (Annex B)	FRC (Annex A)	Fraction of maximum throughput	SNR [dB]		
1	2	Normal	EPA 5Hz Low	A3-3	30%	-4.1		
					70%	0.1		
				A4-4	70%	10.9		
					A5-3	70%	18.1	
				A17-2	70%	22.0		
				A18-2	70%	7.4		
			A19-2	70%	17.9			
			EVA 5Hz Low	A3-1	30%	-2.8		
					70%	1.8		
				A4-1	30%	4.3		
					70%	11.5		
				A5-1	70%	18.8		
				EVA 70Hz Low	A3-3	30%	-4.0	
			70%			0.6		
			A4-4	30%	4.7			
				70%	12.5			
			ETU 70Hz* Low	A3-1	30%	-2.5		
					70%	2.4		
			ETU 300Hz* Low	A3-1	30%	-2.2		
					70%	2.9		
			Extended	ETU 70Hz* Low	A4-2	30%	4.7	
						70%	13.5	
			4	Normal	EPA 5Hz Low	A3-3	30%	-6.8
							70%	-3.4
	A4-4	70%				7.7		
		A5-3				70%	14.4	
	A17-2	70%				18.7		
	A18-2	70%				4.0		
	A19-2	70%			14.0			
	EVA 5Hz Low	A3-1			30%	-5.0		
					70%	-1.3		
		A4-1			30%	1.2		
					70%	7.8		
		A5-1			70%	15.4		
		EVA 70Hz Low			A3-3	30%	-6.5	
	70%					-2.9		
	A4-4	30%			1.6			
		70%			8.7			
	ETU 70Hz* Low	A3-1			30%	-4.8		
					70%	-0.9		
	ETU 300Hz* Low	A3-1			30%	-4.6		
					70%	-0.6		
	ETU 600Hz** Low	A13-2			30%	-1.1		
					70%	5.8		
	Extended	ETU 70Hz* Low			A4-2	30%	1.5	
						70%	9.9	
	8	Normal	EPA 5Hz Low	A3-3	30%	-9.6		
					70%	-6.6		
A4-4				70%	4.1			
				A5-3	70%	11.1		
A17-2				70%	15.6			
A18-2				70%	1.3			
A19-2			70%	11.0				
EVA 5Hz Low			A3-1	30%	-7.1			
				70%	-4.0			
			A4-1	30%	-1.6			
				70%	4.4			
			A5-1	70%	11.7			
			EVA 70Hz Low	A3-3	30%	-9.3		
70%					-5.9			

				A4-4	30%	-2.8
					70%	4.8
			ETU 70Hz* Low	A3-1	30%	-7.0
					70%	-3.7
			ETU 300Hz* Low	A3-1	30%	-6.8
					70%	-3.3
		Extended	ETU 70Hz* Low	A4-2	30%	-1.2
					70%	6.5
Note*: Not applicable for Local Area BS and Home BS.						
Note**: Not applicable for Local Area BS and Home BS, and only applicable for BS supporting ETU600.						

Table 8.2.1.1-3 Minimum requirements for PUSCH, 5 MHz Channel Bandwidth, 1Tx

Number of TX antennas	Number of RX antennas	Cyclic prefix	Propagation conditions a and correlation matrix (Annex B)	FRC (Annex A)	Fraction of maximum throughput	SNR [dB]
1	2	Normal	EPA 5Hz Low	A3-4	30%	-4.7
					70%	-0.7
				A4-5	70%	10.4
					A5-4	70%
				A17-3	70%	21.9
				A18-3	70%	8.3
			A19-3	70%	19.4	
			EVA 5Hz Low	A3-1	30%	-2.7
					70%	1.8
				A4-1	30%	4.3
					70%	11.5
				A5-1	70%	18.6
				EVA 70Hz Low	A3-4	30%
			70%			-0.1
			A4-5	30%	4.3	
				70%	12.3	
			ETU 70Hz* Low	A3-1	30%	-2.5
					70%	2.4
	ETU 300Hz* Low	A3-1	30%	-2.2		
			70%	2.9		
	Extended	ETU 70Hz* Low	A4-2	30%	4.8	
				70%	13.5	
	4	Normal	EPA 5Hz Low	A3-4	30%	-7.1
					70%	-3.8
				A4-5	70%	7.6
					A5-4	70%
				A17-3	70%	18.5
				A18-3	70%	5.1
			A19-3	70%	15.8	
			EVA 5Hz Low	A3-1	30%	-5.1
					70%	-1.4
				A4-1	30%	1.2
					70%	7.9
				A5-1	70%	15.5
				EVA 70Hz Low	A3-4	30%
			70%			-3.3
			A4-5	30%	1.2	
				70%	8.3	
			ETU 70Hz* Low	A3-1	30%	-4.8
					70%	-0.9
			ETU 300Hz* Low	A3-1	30%	-4.6
					70%	-0.6
ETU 600Hz** Low			A13-3	30%	-0.9	
				70%	6.1	
Extended			ETU 70Hz* Low	A4-2	30%	1.6
					70%	9.9
8	Normal	EPA 5Hz Low	A3-4	30%	-10.1	
				70%	-7.2	
			A4-5	70%	4.0	
				A5-4	70%	11.3
			A17-3	70%	15.3	
			A18-3	70%	2.0	
		A19-3	70%	12.5		
		EVA 5Hz Low	A3-1	30%	-7.1	
				70%	-3.9	
			A4-1	30%	-1.9	
				70%	4.4	
			A5-1	70%	11.7	
			EVA 70Hz Low	A3-4	30%	-9.9
		70%			-6.7	

				A4-5	30%	-2.5
					70%	4.6
			ETU 70Hz* Low	A3-1	30%	-6.9
					70%	-3.4
			ETU 300Hz* Low	A3-1	30%	-6.9
					70%	-3.3
		Extended	ETU 70Hz* Low	A4-2	30%	-1.2
					70%	6.4
Note*: Not applicable for Local Area BS and Home BS.						
Note**: Not applicable for Local Area BS and Home BS, and only applicable for BS supporting ETU600.						

Table 8.2.1.1-4 Minimum requirements for PUSCH, 10 MHz Channel Bandwidth, 1Tx

Number of TX antennas	Number of RX antennas	Cyclic prefix	Propagation conditions and correlation matrix (Annex B)	FRC (Annex A)	Fraction of maximum throughput	SNR [dB]		
1	2	Normal	EPA 5Hz Low	A3-5	30%	-4.2		
					70%	-0.4		
				A4-6	70%	10.8		
					A5-5	70%	18.3	
				A17-4	70%	22.6		
				A18-4	70%	8.5		
			A19-4	70%	19.5			
			EVA 5Hz Low	A3-1	30%	-2.7		
					70%	1.9		
				A4-1	30%	4.3		
			70%		11.4			
			A5-1	70%	18.8			
			EVA 70Hz Low	A3-5	30%	-4.1		
					70%	0.1		
				A4-6	30%	4.5		
			70%		12.6			
			ETU 70Hz* Low	A3-1	30%	-2.5		
					70%	2.4		
			ETU 300Hz* Low	A3-1	30%	-2.2		
					70%	2.9		
			Extended	ETU 70Hz* Low	A4-2	30%	4.8	
						70%	13.6	
			4	Normal	EPA 5Hz Low	A3-5	30%	-6.8
							70%	-3.5
	A4-6	70%				7.5		
		A5-5				70%	14.7	
	A17-4	70%				19.2		
	A18-4	70%				5.3		
	A19-4	70%			15.8			
	EVA 5Hz Low	A3-1			30%	-5.0		
					70%	-1.2		
		A4-1			30%	1.2		
	70%				7.9			
	A5-1	70%			15.5			
	EVA 70Hz Low	A3-5			30%	-6.7		
					70%	-2.9		
		A4-6			30%	0.7		
	70%				8.0			
	ETU 70Hz* Low	A3-1			30%	-4.8		
					70%	-0.9		
	ETU 300Hz* Low	A3-1			30%	-4.6		
					70%	-0.6		
	ETU 600Hz** Low	A13-4			30%	-1.0		
					70%	6.2		
	Extended	ETU 70Hz* Low			A4-2	30%	1.7	
						70%	10.3	
	8	Normal	EPA 5Hz Low	A3-5	30%	-9.8		
					70%	-6.7		
A4-6				70%	4.2			
				A5-5	70%	11.5		
A17-4				70%	15.9			
A18-4				70%	2.1			
A19-4			70%	12.5				
EVA 5Hz Low			A3-1	30%	-6.9			
				70%	-3.8			
			A4-1	30%	-1.7			
70%				4.5				
A5-1			70%	11.9				
EVA 70Hz Low			A3-5	30%	-9.7			
				70%	-6.2			

				A4-6	30%	-2.6
					70%	4.7
			ETU 70Hz* Low	A3-1	30%	-6.8
					70%	-3.6
			ETU 300Hz* Low	A3-1	30%	-6.8
					70%	-3.3
		Extended	ETU 70Hz* Low	A4-2	30%	-1.1
					70%	6.5
Note*: Not applicable for Local Area BS and Home BS.						
Note**: Not applicable for Local Area BS and Home BS, and only applicable for BS supporting ETU600.						

Table 8.2.1.1-5 Minimum requirements for PUSCH, 15 MHz Channel Bandwidth, 1Tx

Number of TX antennas	Number of RX antennas	Cyclic prefix	Propagation conditions and correlation matrix (Annex B)	FRC (Annex A)	Fraction of maximum throughput	SNR [dB]
1	2	Normal	EPA 5Hz Low	A3-6	30%	-4.5
					70%	-0.8
				A4-7	70%	11.3
					A5-6	70%
				A17-5	70%	22.8
				A18-5	70%	9.4
			A19-5	70%	21.4	
			EVA 5Hz Low	A3-1	30%	-2.8
					70%	1.8
				A4-1	30%	4.2
			70%		11.4	
			A5-1	70%	18.7	
			EVA 70Hz Low	A3-6	30%	-4.5
					70%	-0.3
			A4-7	30%	4.2	
				70%	12.9	
			ETU 70Hz* Low	A3-1	30%	-2.5
					70%	2.4
			ETU 300Hz* Low	A3-1	30%	-2.2
					70%	2.9
			Extended	ETU 70Hz* Low	A4-2	30%
	70%	13.6				
	4	Normal	EPA 5Hz Low	A3-6	30%	-7.2
					70%	-3.8
				A4-7	70%	7.6
					A5-6	70%
				A17-5	70%	18.9
				A18-5	70%	5.9
			A19-5	70%	17.1	
			EVA 5Hz Low	A3-1	30%	-5.0
					70%	-1.2
				A4-1	30%	1.2
			70%		7.9	
			A5-1	70%	15.7	
			EVA 70Hz Low	A3-6	30%	-7.0
					70%	-3.3
			A4-7	30%	0.7	
				70%	8.5	
			ETU 70Hz* Low	A3-1	30%	-4.8
					70%	-1.0
			ETU 300Hz* Low	A3-1	30%	-4.6
					70%	-0.6
ETU 600Hz** Low			A13-5	30%	-0.9	
	70%	6.4				
Extended	ETU 70Hz* Low	A4-2	30%	1.6		
		70%	10.1			
8	Normal	EPA 5Hz Low	A3-6	30%	-10.4	
				70%	-7.3	
			A4-7	70%	4.4	
				A5-6	70%	11.8
			A17-5	70%	15.5	
			A18-5	70%	2.8	
		A19-5	70%	13.8		
		EVA 5Hz Low	A3-1	30%	-7.1	
				70%	-4.0	
			A4-1	30%	-1.7	
		70%		4.4		
		A5-1	70%	11.7		
		EVA 70Hz Low	A3-6	30%	-10.1	
				70%	-6.8	

				A4-7	30%	-2.5
					70%	5.0
			ETU 70Hz* Low	A3-1	30%	-7.0
					70%	-3.6
			ETU 300Hz* Low	A3-1	30%	-6.9
					70%	-3.3
		Extended	ETU 70Hz* Low	A4-2	30%	-1.1
					70%	6.7
Note*: Not applicable for Local Area BS and Home BS.						
Note**: Not applicable for Local Area BS and Home BS, and only applicable for BS supporting ETU600.						

Table 8.2.1.1-6 Minimum requirements for PUSCH, 20 MHz Channel Bandwidth, 1Tx

Number of TX antennas	Number of RX antennas	Cyclic prefix	Propagation conditions and correlation matrix (Annex B)	FRC (Annex A)	Fraction of maximum throughput	SNR [dB]
1	2	Normal	EPA 5Hz Low	A3-7	30%	-4.2
					70%	-0.4
				A4-8	70%	11.5
					70%	19.7
				A17-6	70%	23.7
					70%	9.3
			A18-6	70%	21.0	
				70%	-2.7	
			EVA 5Hz Low	A3-1	70%	1.8
					30%	4.3
				A4-1	70%	11.5
			EVA 70Hz Low	A3-7	30%	18.7
					70%	-4.1
				A4-8	30%	0.2
			ETU 70Hz* Low	A3-7	70%	4.2
					70%	13.0
				A3-1	30%	-2.4
			ETU 300Hz* Low	A3-1	70%	2.4
					30%	-2.1
			ETU 70Hz* Low	A3-1	70%	2.9
					30%	4.7
	ETU 70Hz* Low	A4-2	70%	13.6		
			30%	-6.8		
	4	Normal	EPA 5Hz Low	A3-7	70%	-3.5
					30%	7.5
				A4-8	70%	15.9
					70%	19.8
				A17-6	70%	5.7
					70%	16.6
			A18-6	70%	-5.1	
				70%	-1.3	
			EVA 5Hz Low	A3-1	30%	1.2
					70%	7.9
				A4-1	30%	15.6
			EVA 70Hz Low	A3-7	70%	-6.7
					70%	-2.9
				A4-8	30%	0.7
			ETU 70Hz* Low	A3-7	70%	8.6
					30%	-4.4
				A3-1	70%	-0.9
			ETU 300Hz* Low	A3-1	30%	-4.6
					70%	-0.7
ETU 600Hz** Low			A3-1	30%	-0.9	
				70%	6.4	
ETU 70Hz* Low	A4-2	30%	1.6			
		70%	10.0			
8	Normal	EPA 5Hz Low	A3-7	30%	-9.7	
				70%	-6.7	
			A4-8	70%	4.3	
				70%	12.5	
			A17-6	70%	16.3	
				70%	2.6	
		A18-6	70%	13.2		
			70%	-7.0		
		EVA 5Hz Low	A3-1	70%	-3.9	
				30%	-1.7	
			A4-1	30%	4.6	
		EVA 70Hz Low	A3-7	70%	12.0	
				30%	-9.7	
			A4-8	70%	-6.1	

				A4-8	30%	-2.2
					70%	4.9
			ETU 70Hz* Low	A3-1	30%	-6.9
					70%	-3.5
			ETU 300Hz* Low	A3-1	30%	-6.8
					70%	-3.3
		Extended	ETU 70Hz* Low	A4-2	30%	-1.2
					70%	6.5
Note*: Not applicable for Local Area BS and Home BS.						
Note**: Not applicable for Local Area BS and Home BS, and only applicable for BS supporting ETU600.						

Table 8.2.1.1-7 Minimum requirements for PUSCH, 1.4 MHz Channel Bandwidth, 2Tx

Number of TX antennas	Number of RX antennas	Cyclic prefix	Propagation conditions and correlation matrix (Annex B)	FRC (Annex A)	Fraction of maximum throughput	SNR [dB]
2	2	Normal	EPA 5Hz Low	A3-2	70%	4.6
				A4-3	70%	17.70
	4	Normal	EPA 5Hz Low	A3-2	70%	-0.1
				A4-3	70%	11.9
	8	Normal	EPA 5Hz Low	A3-2	70%	-3.0
				A4-3	70%	7.5

Table 8.2.1.1-8 Minimum requirements for PUSCH, 3 MHz Channel Bandwidth, 2Tx

Number of TX antennas	Number of RX antennas	Cyclic prefix	Propagation conditions and correlation matrix (Annex B)	FRC (Annex A)	Fraction of maximum throughput	SNR [dB]
2	2	Normal	EPA 5Hz Low	A3-3	70%	4.4
				A4-4	70%	17.6
	4	Normal	EPA 5Hz Low	A3-3	70%	0.3
				A4-4	70%	11.8
	8	Normal	EPA 5Hz Low	A3-3	70%	-3.1
				A4-4	70%	7.6

Table 8.2.1.1-9 Minimum requirements for PUSCH, 5 MHz Channel Bandwidth, 2Tx

Number of TX antennas	Number of RX antennas	Cyclic prefix	Propagation conditions and correlation matrix (Annex B)	FRC (Annex A)	Fraction of maximum throughput	SNR [dB]
2	2	Normal	EPA 5Hz Low	A3-4	70%	3.7
				A4-5	70%	18.2
	4	Normal	EPA 5Hz Low	A3-4	70%	-0.5
				A4-5	70%	11.9
	8	Normal	EPA 5Hz Low	A3-4	70%	-3.9
				A4-5	70%	7.6

Table 8.2.1.1-10 Minimum requirements for PUSCH, 10 MHz Channel Bandwidth, 2Tx

Number of TX antennas	Number of RX antennas	Cyclic prefix	Propagation conditions and correlation matrix (Annex B)	FRC (Annex A)	Fraction of maximum throughput	SNR [dB]
2	2	Normal	EPA 5Hz Low	A3-5	70%	4.2
				A4-6	70%	18.6
	4	Normal	EPA 5Hz Low	A3-5	70%	0.2
				A4-6	70%	12.0
	8	Normal	EPA 5Hz Low	A3-5	70%	-3.3
				A4-6	70%	7.9

Table 8.2.1.1-11 Minimum requirements for PUSCH, 15 MHz Channel Bandwidth, 2Tx

Number of TX antennas	Number of RX antennas	Cyclic prefix	Propagation conditions and correlation matrix (Annex B)	FRC (Annex A)	Fraction of maximum throughput	SNR [dB]
2	2	Normal	EPA 5Hz Low	A3-6	70%	3.7
				A4-7	70%	19.4
	4	Normal	EPA 5Hz Low	A3-6	70%	-0.2
				A4-7	70%	12.7
	8	Normal	EPA 5Hz Low	A3-6	70%	-3.8
				A4-7	70%	8.3

Table 8.2.1.1-12 Minimum requirements for PUSCH, 20 MHz Channel Bandwidth, 2Tx

Number of TX antennas	Number of RX antennas	Cyclic prefix	Propagation conditions and correlation matrix (Annex B)	FRC (Annex A)	Fraction of maximum throughput	SNR [dB]
2	2	Normal	EPA 5Hz Low	A3-7	70%	4.4
				A4-8	70%	19.7
	4	Normal	EPA 5Hz Low	A3-7	70%	0.5
				A4-8	70%	12.7
	8	Normal	EPA 5Hz Low	A3-7	70%	-3.4
				A4-8	70%	8.3

8.2.2 Requirements for UL timing adjustment

The performance requirement of UL timing adjustment is determined by a minimum required throughput for the moving UE at given SNR. The performance requirements assume HARQ retransmissions. The performance requirements for UL timing adjustment scenario 2 defined in Annex B.4 are optional.

In the tests for UL timing adjustment, two signals are configured, one being transmitted by a moving UE and the other being transmitted by a stationary UE. The transmission of SRS from UE is optional. FRC parameters in Table A.7-1 and Table A.8-1 are applied for both UEs. The received power for both UEs is the same. The resource blocks allocated for both UEs are consecutive. In Scenario 2, Doppler shift is not taken into account.

This requirement shall not be applied to Local Area BS and Home BS.

Table 8.2.2-1 Test parameters for testing UL timing adjustment

Parameter	Value
Maximum number of HARQ transmissions	4
RV sequence	0, 2, 3, 1, 0, 2, 3, 1
Uplink-downlink allocation for TDD	Configuration 1 (2:2)
Subframes in which PUSCH is transmitted	For FDD: subframe #0, #2, #4, #6, and #8 in radio frames For TDD: subframe #2, #3, #7 and #8 in radio frames
Subframes in which sounding RS is transmitted (Note 1)	For FDD: subframe #1 in radio frames For TDD: UpPTS in subframe #1 in radio frames
Note 1. The transmission of SRS is optional.	

8.2.2.1 Minimum requirements

The throughput shall be $\geq 70\%$ of the maximum throughput of the reference measurement channel as specified in Annex A for the moving UE at the SNR given in table 8.2.2.1-1.

Table 8.2.2.1-1 Minimum requirements for UL timing adjustment

Number of TX antennas	Number of RX antennas	Cyclic prefix	Channel Bandwidth [MHz]	Moving propagation conditions and correlation matrix (Annex B)	FRC (Annex A)	SNR [dB]
1	2	Normal	1.4	Scenario 1 Low	A7-1	13.1
				Scenario 2 Low	A8-1	-1.9
			3	Scenario 1 Low	A7-2	13.4
				Scenario 2 Low	A8-2	-1.5
			5	Scenario 1 Low	A7-3	13.2
				Scenario 2 Low	A8-3	-1.6
			10	Scenario 1 Low	A7-4	13.8
				Scenario 2 Low	A8-4	-1.8
			15	Scenario 1 Low	A7-5	14.0
				Scenario 2 Low	A8-5	-1.8
			20	Scenario 1 Low	A7-6	13.9
				Scenario 2 Low	A8-6	-1.8

8.2.3 Requirements for high speed train

The performance requirement of PUSCH for high speed train is determined by a minimum required throughput for a given SNR. The required throughput is expressed as a fraction of maximum throughput for the FRCs listed in Annex A. The performance requirements assume HARQ retransmissions. The performance requirements for high speed train are optional.

This requirement shall not be applied to Local Area BS and Home BS.

Table 8.2.3-1 Test parameters for high speed train

Parameter	Value
Maximum number of HARQ transmissions	4
RV sequence	0, 2, 3, 1, 0, 2, 3, 1
Uplink-downlink allocation for TDD	Configuration 1 (2:2)
Subframes in which PUSCH is transmitted	For FDD: subframe #0 and #8 in radio frames for which SFN mod 4 = 0 subframe #6 in radio frames for which SFN mod 4 = 1 subframe #4 in radio frames for which SFN mod 4 = 2 subframe #2 in radio frames for which SFN mod 4 = 3 For TDD: subframe #2 in each radio frame
Subframes in which PUCCH is transmitted (Note 1, Note 2)	For FDD: subframe #5 in radio frames For TDD: subframe #3 in each radio frame
Note 1:	The configuration of PUCCH (format 2) is optional.
Note 2:	The SNR values per antenna shall be set to -4.5 dB and -1.5 dB for Scenario 1 and 3, respectively.

8.2.3.1 Minimum requirements

The throughput shall be equal to or larger than the fraction of maximum throughput stated in table 8.2.3.1-1 at the given SNR.

Table 8.2.3.1-1 Minimum requirements of PUSCH for high speed train

Channel Bandwidth [MHz]	Cyclic prefix	FRC (Annex A)	Number of TX antennas	Number of RX antennas	Propagation conditions and correlation matrix (Annex B)	Fraction of maximum throughput	SNR [dB]
1.4	Normal	A3-2	1	1	HST Scenario 3	30%	-1.5
						70%	1.9
					HST Scenario 3-LTE500a ^(NOTE 1)	30%	-1.5
						70%	1.9
					HST Scenario 3-LTE500b ^(NOTE 2)	30%	-1.5
						70%	1.9
				2	HST Scenario 1 Low	30%	-3.9
						70%	-0.6
					HST Scenario 1-LTE500a Low ^(NOTE 1)	30%	-3.9
						70%	-0.6
HST Scenario 1-LTE500b Low ^(NOTE 2)	30%	-3.9					
	70%	-0.6					
3	Normal	A3-3	1	1	HST Scenario 3	30%	-2.1
						70%	1.6
					HST Scenario 3-LTE500a ^(NOTE 1)	30%	-2.1
						70%	1.8
					HST Scenario 3-LTE500b ^(NOTE 2)	30%	-2.1
						70%	1.7
				2	HST Scenario 1 Low	30%	-4.5
						70%	-1.0
					HST Scenario 1-LTE500a Low ^(NOTE 1)	30%	-4.5
						70%	-1.0
HST Scenario 1-LTE500b Low ^(NOTE 2)	30%	-4.5					
	70%	-1.0					
5	Normal	A3-4	1	1	HST Scenario 3	30%	-2.6
						70%	1.3
					HST Scenario 3-LTE500a ^(NOTE 1)	30%	-2.6
						70%	1.3
					HST Scenario 3-LTE500b ^(NOTE 2)	30%	-2.6
						70%	1.3
				2	HST Scenario 1 Low	30%	-5.1
						70%	-1.4
					HST Scenario 1-LTE500a Low ^(NOTE 1)	30%	-5.1
						70%	-1.4
HST Scenario 1-LTE500b Low ^(NOTE 2)	30%	-5.1					
	70%	-1.4					
10	Normal	A3-5	1	1	HST Scenario 3	30%	-2.7
						70%	1.2
					HST Scenario 3-LTE500a ^(NOTE 1)	30%	-2.7
						70%	1.7
					HST Scenario 3-LTE500b ^(NOTE 2)	30%	-2.7
						70%	1.7
				2	HST Scenario 1 Low	30%	-5.4
						70%	-1.5
					HST Scenario 1-LTE500a Low ^(NOTE 1)	30%	-5.4
						70%	-1.5
HST Scenario 1-LTE500b Low ^(NOTE 2)	30%	-5.4					
	70%	-1.2					
15	Normal	A3-6	1	1	HST Scenario 3	30%	-2.7
						70%	1.2
					HST Scenario 3-LTE500a ^(NOTE 1)	30%	-2.7
						70%	1.2
					HST Scenario 3-LTE500b ^(NOTE 2)	30%	-2.7
						70%	1.2
				2	HST Scenario 1 Low	30%	-5.2
						70%	-1.4
					HST Scenario 1-LTE500a Low ^(NOTE 1)	30%	-5.2
						70%	-1.4
HST Scenario 1-LTE500b Low ^(NOTE 2)	30%	-5.2					
	70%	-1.4					
20	Normal	A3-7	1	1	HST Scenario 3	30%	-2.7

						70%	1.2
					HST Scenario 3-LTE500a ^(NOTE 1)	30%	-2.7
						70%	1.5
					HST Scenario 3-LTE500b ^(NOTE 2)	30%	-2.7
						70%	1.8
			2		HST Scenario 1 Low	30%	-5.3
							70%
					HST Scenario 1-LTE500a Low ^(NOTE 1)	30%	-5.3
							70%
					HST Scenario 1-LTE500b Low ^(NOTE 2)	30%	-5.3
							70%
NOTE 1: Not applicable if the BS manufacturer declares supported maximum Doppler frequency is 1750 Hz							
NOTE 2: Not applicable if the BS manufacturer declares supported maximum Doppler frequency is 1944 Hz							

8.2.4 Requirements for HARQ-ACK multiplexed on PUSCH

Two performance requirements are defined for HARQ-ACK multiplexed on PUSCH: ACK false detection and ACK missed detection requirements.

The ACK false detection probability for PUSCH is the probability that ACK is detected when data only is sent on symbols where HARQ-ACK information can be allocated (i.e. by puncturing data).

The ACK missed detection probability for HARQ-ACK multiplexed on PUSCH is the conditional probability of not detecting an ACK when it was sent on PUSCH resources.

In the tests for ACK missed detection on PUSCH, data is punctured by the control information (i.e. ACK/NACK) in both slots within subframe on symbols as specified in 36.212.

In both tests none of CQI, RI nor SRS is transmitted. Tests are to be performed for one bit HARQ-ACK information ($O = 1$).

8.2.4.1 Minimum requirement

The ACK false detection probability as well as the ACK missed detection probability for HARQ-ACK multiplexed on PUSCH shall not exceed 1% at PUSCH power settings presented in table 8.2.4.1-1.

Table 8.2.4.1-1 Minimum requirements for HARQ-ACK multiplexed on PUSCH

Number of TX antennas	Number of RX antennas	Cyclic Prefix	Propagation conditions and correlation matrix (Annex B)	Channel Bandwidth [MHz]	FRC (Annex A)	$I_{offset}^{HARQ-ACK}$	SNR [dB]	
1	2	Normal	EVA 5* Low	1.4	A.3-1	8	6.8	
					A.4-3	5	13.6	
				3	A.3-1	8	6.8	
					A.4-4	5	13.1	
				5	A.3-1	8	6.9	
					A.4-5	5	12.4	
				10	A.3-1	8	6.8	
					A.4-6	5	12.4	
				15	A.3-1	8	6.8	
					A.4-7	5	12.0	
				20	A.3-1	8	6.8	
					A.4-8	5	11.9	
				ETU70** Low	1.4	A.3-1	8	6.6
						A.4-3	5	13.8
			3		A.3-1	8	6.6	
					A.4-4	5	12.9	
			5		A.3-1	8	6.5	
					A.4-5	5	12.5	
			10	A.3-1	8	6.6		
				A.4-6	5	12.3		
15	A.3-1	8	6.7					
	A.4-7	5	12.1					
20	A.3-1	8	6.5					
	A.4-8	5	12					
Note*: Not applicable for Wide Area BS and Medium Range BS.								
Note**: Not applicable for Local Area BS and Home BS.								

8.2.5 Requirements for PUSCH with TTI bundling and enhanced HARQ pattern

The performance requirement of PUSCH configured with TTI bundling and enhanced HARQ pattern, as specified in 36.213 [11] clause 8 and 8.0, is determined by residual block error probability (BLER) after HARQ retransmission. The performance is measured by the required SNR at residual BLER of 2% for the FRCs listed in Annex A.11. The residual BLER is defined as follows:

$$BLER_{residual} = \frac{A}{B}$$

where:

- A is the number of incorrectly decoded transport blocks after HARQ retransmission.
- B is the number of transmitted transport blocks (retransmitted transport blocks are not counted repetitively).

The requirement is applicable for FDD. TTI bundling and enhanced HARQ pattern are enabled in the tests.

Table 8.2.5-1: Test parameters for PUSCH with TTI bundling and enhanced HARQ pattern

Parameter	Value
Number of TTIs for a TTI bundle	4
RV sequence for 4 TTIs within a TTI bundle	0, 2, 3, 1
HARQ round trip time	12 ms
Maximum number of HARQ transmissions for a TTI bundle	5

8.2.5.1 Minimum requirements

The residual BLER shall not exceed 2% at the given SNR in Table 8.2.5.1-1.

Table 8.2.5.1-1: Minimum requirements for PUSCH with TTI bundling and enhanced HARQ pattern

Number of TX antennas	Number of RX antennas	Cyclic Prefix	Propagation conditions and correlation matrix (Annex B)	Channel Bandwidth / SNR [dB]					
				1.4 MHz	3 MHz	5 MHz	10 MHz	15 MHz	20 MHz
1	2	Normal	EVA 5 Low	-4.7	-4.7	-4.7	-4.7	-4.6	-4.6
			ETU 300* Low	-7.9	-7.9	-8.0	-7.9	-8.0	-7.9
	4		EVA 5 Low	-8.4	-8.3	-8.3	-8.3	-8.4	-8.4
			ETU 300* Low	-10.3	-10.3	-10.3	-10.4	-10.3	-10.3
	8		EVA 5 Low	-11.4	-11.3	-11.4	-11.4	-11.3	-11.4
			ETU 300* Low	-12.5	-12.4	-12.5	-12.4	-12.4	-12.5
Note*: Not applicable for Local Area BS and Home BS.									

8.2.6 Enhanced performance requirement type A in multipath fading propagation conditions with synchronous interference

The enhanced performance requirement type A of PUSCH is determined by a minimum required throughput for a given SINR. The required throughput is expressed as a fraction of maximum throughput for the FRCs listed in Annex A. The performance requirements assume HARQ retransmissions.

The purpose is to verify the demodulation performance when the wanted PUSCH signal in the serving cell is interfered by PUSCH of one or two dominant interferer(s) applying the interference model defined in clause B.6.2.

The requirements apply to the BS supporting the enhanced performance requirements type A.

The requirements apply to the BS receiving the synchronous interference i.e., the interference is time-synchronous with the tested signal.

Table 8.2.6-1: Test parameters for enhanced performance requirement type A

Parameter	Unit	Tested signal	Interferer 1 (Note 1)	Interferer 2 (Note 1)
Maximum number of HARQ transmissions		4	N/A	N/A
RV sequence		0, 2, 3, 1, 0, 2, 3, 1	N/A	N/A
DIP (Note 2)	Set 1	dB	N/A	-1.11
	Set 2	dB	N/A	-0.43
Cell Id		0	1	2
Interference model		N/A	As specified in clause B.6.2	As specified in clause B.6.2
Cyclic Prefix		Normal		
Uplink-downlink allocation for TDD		Configuration 1 (2:2)		
Demodulation reference signal for PUSCH		$\Delta_{ss} = 0, n_{DMRS}^{(1)} = 0, n_{DMRS,0}^{(2)} = 0$ Group hopping and sequence hopping are disabled.		
Note 1:	One explicit interferer, i.e., interferer 1, is modelled for tests with 2 RX antennas. Two explicit interferers are modelled for tests with 4 or 8 RX antennas.			
Note 2:	The respective received energy of each interferer relative to N is defined by its associated DIP value as specified in clause B.6.1. DIP set 1 and set 2 are derived respectively in homogeneous and heterogeneous network scenarios.			
Note 3:	All cells are time-synchronous.			

8.2.6.1 Minimum requirements

The throughput shall be equal to or larger than the fraction of maximum throughput stated in the tables 8.2.6.1-1 to 8.2.6.1-6 at the given SINR.

Table 8.2.6.1-1: Enhanced performance requirement type A for PUSCH, 1.4 MHz Channel Bandwidth

Number of TX antennas (Note 1)	Number of RX antennas (Note 1)	Propagation conditions and correlation matrix (Annex B) (Note 2)			DIP set	FRC (Annex A)	Fraction of maximum throughput	SINR [dB] (Note 3)
		Tested signal	Interferer 1	Interferer 2				
1	2	EPA 5 Low	ETU 5 Low	N/A	Set 2	A12-1	70%	-4.8
		EVA 70 Low	ETU 70 Low	N/A	Set 1*	A12-1	70%	-2.0
	4	EPA 5 Low	ETU 5 Low	ETU 5 Low	Set 2	A13-1	70%	-4.1
		EVA 70 Low	ETU 70 Low	ETU 70 Low	Set 1*	A13-1	70%	-0.1
	8	EPA 5 Low	ETU 5 Low	ETU 5 Low	Set 2	A4-3	70%	-4.7
		EVA 70 Low	ETU 70 Low	ETU 70 Low	Set 1*	A4-3	70%	0.0
Note*: Not applicable for Local Area BS and Home BS.								
Note 1: Antenna configuration applies for each of the tested signal, interferer 1 and interferer 2.								
Note 2: The propagation conditions for the tested signal, interferer 1 and interferer 2 are statistically independent.								
Note 3: SINR corresponds to S/N of the tested signal as defined in clause 8.1.								

Table 8.2.6.1-2: Enhanced performance requirement type A for PUSCH, 3 MHz Channel Bandwidth

Number of TX antennas (Note 1)	Number of RX antennas (Note 1)	Propagation conditions and correlation matrix (Annex B) (Note 2)			DIP set	FRC (Annex A)	Fraction of maximum throughput	SINR [dB] (Note 3)
		Tested signal	Interferer 1	Interferer 2				
1	2	EPA 5 Low	ETU 5 Low	N/A	Set 2	A12-2	70%	-5.0
		EVA 70 Low	ETU 70 Low	N/A	Set 1*	A12-2	70%	-2.3
	4	EPA 5 Low	ETU 5 Low	ETU 5 Low	Set 2	A13-2	70%	-4.4
		EVA 70 Low	ETU 70 Low	ETU 70 Low	Set 1*	A13-2	70%	-0.1
	8	EPA 5 Low	ETU 5 Low	ETU 5 Low	Set 2	A4-4	70%	-4.6
		EVA 70 Low	ETU 70 Low	ETU 70 Low	Set 1*	A4-4	70%	-0.1
Note*: Not applicable for Local Area BS and Home BS.								
Note 1: Antenna configuration applies for each of the tested signal, interferer 1 and interferer 2.								
Note 2: The propagation conditions for the tested signal, interferer 1 and interferer 2 are statistically independent.								
Note 3: SINR corresponds to S/N of the tested signal as defined in clause 8.1.								

Table 8.2.6.1-3: Enhanced performance requirement type A for PUSCH, 5 MHz Channel Bandwidth

Number of TX antennas (Note 1)	Number of RX antennas (Note 1)	Propagation conditions and correlation matrix (Annex B) (Note 2)			DIP set	FRC (Annex A)	Fraction of maximum throughput	SINR [dB] (Note 3)
		Tested signal	Interferer 1	Interferer 2				
1	2	EPA 5 Low	ETU 5 Low	N/A	Set 2	A12-3	70%	-5.1
		EVA 70 Low	ETU 70 Low	N/A	Set 1*	A12-3	70%	-2.5
	4	EPA 5 Low	ETU 5 Low	ETU 5 Low	Set 2	A13-3	70%	-4.1
		EVA 70 Low	ETU 70 Low	ETU 70 Low	Set 1*	A13-3	70%	0.1
	8	EPA 5 Low	ETU 5 Low	ETU 5 Low	Set 2	A4-5	70%	-4.7
		EVA 70 Low	ETU 70 Low	ETU 70 Low	Set 1*	A4-5	70%	-0.5
Note*: Not applicable for Local Area BS and Home BS.								
Note 1: Antenna configuration applies for each of the tested signal, interferer 1 and interferer 2.								
Note 2: The propagation conditions for the tested signal, interferer 1 and interferer 2 are statistically independent.								
Note 3: SINR corresponds to S/N of the tested signal as defined in clause 8.1.								

Table 8.2.6.1-4: Enhanced performance requirement type A for PUSCH, 10 MHz Channel Bandwidth

Number of TX antennas (Note 1)	Number of RX antennas (Note 1)	Propagation conditions and correlation matrix (Annex B) (Note 2)			DIP set	FRC (Annex A)	Fraction of maximum throughput	SINR [dB] (Note 3)
		Tested signal	Interferer 1	Interferer 2				
1	2	EPA 5 Low	ETU 5 Low	N/A	Set 2	A12-4	70%	-5.4
		EVA 70 Low	ETU 70 Low	N/A	Set 1*	A12-4	70%	-2.7
	4	EPA 5 Low	ETU 5 Low	ETU 5 Low	Set 2	A13-4	70%	-4.2
		EVA 70 Low	ETU 70 Low	ETU 70 Low	Set 1*	A13-4	70%	-0.1
	8	EPA 5 Low	ETU 5 Low	ETU 5 Low	Set 2	A4-6	70%	-4.5
		EVA 70 Low	ETU 70 Low	ETU 70 Low	Set 1*	A4-6	70%	-0.2
Note*: Not applicable for Local Area BS and Home BS.								
Note 1: Antenna configuration applies for each of the tested signal, interferer 1 and interferer 2.								
Note 2: The propagation conditions for the tested signal, interferer 1 and interferer 2 are statistically independent.								
Note 3: SINR corresponds to S/N' of the tested signal as defined in clause 8.1.								

Table 8.2.6.1-5: Enhanced performance requirement type A for PUSCH, 15 MHz Channel Bandwidth

Number of TX antennas (Note 1)	Number of RX antennas (Note 1)	Propagation conditions and correlation matrix (Annex B) (Note 2)			DIP set	FRC (Annex A)	Fraction of maximum throughput	SINR [dB] (Note 3)
		Tested signal	Interferer 1	Interferer 2				
1	2	EPA 5 Low	ETU 5 Low	N/A	Set 2	A12-5	70%	-5.5
		EVA 70 Low	ETU 70 Low	N/A	Set 1*	A12-5	70%	-2.7
	4	EPA 5 Low	ETU 5 Low	ETU 5 Low	Set 2	A13-5	70%	-4.0
		EVA 70 Low	ETU 70 Low	ETU 70 Low	Set 1*	A13-5	70%	0.0
	8	EPA 5 Low	ETU 5 Low	ETU 5 Low	Set 2	A4-7	70%	-4.5
		EVA 70 Low	ETU 70 Low	ETU 70 Low	Set 1*	A4-7	70%	-0.3
Note*: Not applicable for Local Area BS and Home BS.								
Note 1: Antenna configuration applies for each of the tested signal, interferer 1 and interferer 2.								
Note 2: The propagation conditions for the tested signal, interferer 1 and interferer 2 are statistically independent.								
Note 3: SINR corresponds to S/N' of the tested signal as defined in clause 8.1.								

Table 8.2.6.1-6: Enhanced performance requirement type A for PUSCH, 20 MHz Channel Bandwidth

Number of TX antennas (Note 1)	Number of RX antennas (Note 1)	Propagation conditions and correlation matrix (Annex B) (Note 2)			DIP set	FRC (Annex A)	Fraction of maximum throughput	SINR [dB] (Note 3)
		Tested signal	Interferer 1	Interferer 2				
1	2	EPA 5 Low	ETU 5 Low	N/A	Set 2	A12-6	70%	-5.7
		EVA 70 Low	ETU 70 Low	N/A	Set 1*	A12-6	70%	-3.0
	4	EPA 5 Low	ETU 5 Low	ETU 5 Low	Set 2	A13-6	70%	-4.5
		EVA 70 Low	ETU 70 Low	ETU 70 Low	Set 1*	A13-6	70%	-0.4
	8	EPA 5 Low	ETU 5 Low	ETU 5 Low	Set 2	A4-8	70%	-4.6
		EVA 70 Low	ETU 70 Low	ETU 70 Low	Set 1*	A4-8	70%	-0.1
Note*: Not applicable for Local Area BS and Home BS.								
Note 1: Antenna configuration applies for each of the tested signal, interferer 1 and interferer 2.								
Note 2: The propagation conditions for the tested signal, interferer 1 and interferer 2 are statistically independent.								
Note 3: SINR corresponds to S/N' of the tested signal as defined in clause 8.1.								

8.2.6A Enhanced performance requirement type A in multipath fading propagation conditions with asynchronous interference

The enhanced performance requirement type A of PUSCH is determined by a minimum required throughput for a given SINR. The required throughput is expressed as a fraction of maximum throughput for the FRCs listed in Annex A. The performance requirements assume HARQ retransmissions.

The purpose is to verify the demodulation performance when the wanted PUSCH signal in the serving cell is interfered by PUSCH of two interferers from the same interfering cell, applying the interference model defined in clause B.6.3.

The requirements apply to the BS supporting the enhanced performance requirements type A.

The requirements apply to the BS receiving the asynchronous interference i.e., the interference is time-asynchronous with the tested signal.

Table 8.2.6A-1: Test parameters for enhanced performance requirement type A

Parameter	Unit	Tested signal	Interferer 1-1 (Note 1)	Interferer 1-2 (Note 1)
Maximum number of HARQ transmissions		4	N/A	N/A
RV sequence		0, 2, 3, 1, 0, 2, 3, 1	N/A	N/A
DIP (Note 2)	dB	N/A	-0.43	-0.43
Cell Id		0	1	1
Interference model		N/A	As specified in clause B.6.3	As specified in clause B.6.3
Cyclic Prefix		Normal		
Demodulation reference signal for PUSCH		$\Delta_{ss} = 0, n_{DMRS}^{(1)} = 0, n_{DMRS,0}^{(2)} = 0$ Group hopping and sequence hopping are disabled.		
Note 1:	Interferer 1-1 and interferer 1-2 are connected to the same cell and configured to transmit respectively in the even subframes and odd subframes.			
Note 2:	The respective received energy of each interferer relative to N is defined by its associated DIP value as specified in clause B.6.1.			
Note 3:	The transmissions of both interferer 1-1 and interferer 1-2 are delayed with respect to the tested signal by 0.33 ms.			

8.2.6A.1 Minimum requirements

The throughput shall be equal to or larger than the fraction of maximum throughput stated in the tables 8.2.6A.1-1 to 8.2.6A.1-6 at the given SINR.

Table 8.2.6A.1-1 Enhanced performance requirement type A for PUSCH, 1.4 MHz Channel Bandwidth

Number of TX antennas (Note 1)	Number of RX antennas (Note 1)	Propagation conditions and correlation matrix (Annex B) (Note 2)			FRC (Annex A)	Fraction of maximum throughput	SINR [dB] (Note 3)
		Tested signal	Interferer 1-1	Interferer 1-2			
1	2	EPA 5 Low	ETU 5 Low	ETU 5 Low	A12-1	70%	-2.3
	4	EPA 5 Low	ETU 5 Low	ETU 5 Low	A13-1	70%	-1.4
	8	EPA 5 Low	ETU 5 Low	ETU 5 Low	A4-3	70%	-2.2
Note 1:	Antenna configuration applies for each of the tested signal, interferer 1-1 and interferer 1-2.						
Note 2:	The propagation conditions for the tested signal, interferer 1-1 and interferer 1-2 are statistically independent.						
Note 3:	SINR corresponds to S/N of the tested signal as defined in clause 8.1.						

Table 8.2.6A.1-2 Enhanced performance requirement type A for PUSCH, 3 MHz Channel Bandwidth

Number of TX antennas (Note 1)	Number of RX antennas (Note 1)	Propagation conditions and correlation matrix (Annex B) (Note 2)			FRC (Annex A)	Fraction of maximum throughput	SINR [dB] (Note 3)
		Tested signal	Interferer 1-1	Interferer 1-2			
1	2	EPA 5 Low	ETU 5 Low	ETU 5 Low	A12-2	70%	-2.5
	4	EPA 5 Low	ETU 5 Low	ETU 5 Low	A13-2	70%	-1.6
	8	EPA 5 Low	ETU 5 Low	ETU 5 Low	A4-4	70%	-2.2
Note 1:	Antenna configuration applies for each of the tested signal, interferer 1-1 and interferer 1-2.						
Note 2:	The propagation conditions for the tested signal, interferer 1-1 and interferer 1-2 are statistically independent.						
Note 3:	SINR corresponds to S/N of the tested signal as defined in clause 8.1.						

Table 8.2.6A.1-3 Enhanced performance requirement type A for PUSCH, 5 MHz Channel Bandwidth

Number of TX antennas (Note 1)	Number of RX antennas (Note 1)	Propagation conditions and correlation matrix (Annex B) (Note 2)			FRC (Annex A)	Fraction of maximum throughput	SINR [dB] (Note 3)
		Tested signal	Interferer 1-1	Interferer 1-2			
1	2	EPA 5 Low	ETU 5 Low	ETU 5 Low	A12-3	70%	-2.6
	4	EPA 5 Low	ETU 5 Low	ETU 5 Low	A13-3	70%	-1.3
	8	EPA 5 Low	ETU 5 Low	ETU 5 Low	A4-5	70%	-2.1
Note 1: Antenna configuration applies for each of the tested signal, interferer 1-1 and interferer 1-2. Note 2: The propagation conditions for the tested signal, interferer 1-1 and interferer 1-2 are statistically independent. Note 3: SINR corresponds to S/N of the tested signal as defined in clause 8.1.							

Table 8.2.6A.1-4: Enhanced performance requirement type A for PUSCH, 10 MHz Channel Bandwidth

Number of TX antennas (Note 1)	Number of RX antennas (Note 1)	Propagation conditions and correlation matrix (Annex B) (Note 2)			FRC (Annex A)	Fraction of maximum throughput	SINR [dB] (Note 3)
		Tested signal	Interferer 1-1	Interferer 1-2			
1	2	EPA 5 Low	ETU 5 Low	ETU 5 Low	A12-4	70%	-2.8
	4	EPA 5 Low	ETU 5 Low	ETU 5 Low	A13-4	70%	-1.3
	8	EPA 5 Low	ETU 5 Low	ETU 5 Low	A4-6	70%	-1.9
Note 1: Antenna configuration applies for each of the tested signal, interferer 1-1 and interferer 1-2. Note 2: The propagation conditions for the tested signal, interferer 1-1 and interferer 1-2 are statistically independent. Note 3: SINR corresponds to S/N of the tested signal as defined in clause 8.1.							

Table 8.2.6A.1-5: Enhanced performance requirement type A for PUSCH, 15 MHz Channel Bandwidth

Number of TX antennas (Note 1)	Number of RX antennas (Note 1)	Propagation conditions and correlation matrix (Annex B) (Note 2)			FRC (Annex A)	Fraction of maximum throughput	SINR [dB] (Note 3)
		Tested signal	Interferer 1-1	Interferer 1-2			
1	2	EPA 5 Low	ETU 5 Low	ETU 5 Low	A12-5	70%	-2.7
	4	EPA 5 Low	ETU 5 Low	ETU 5 Low	A13-5	70%	-1.1
	8	EPA 5 Low	ETU 5 Low	ETU 5 Low	A4-7	70%	-1.4
Note 1: Antenna configuration applies for each of the tested signal, interferer 1-1 and interferer 1-2. Note 2: The propagation conditions for the tested signal, interferer 1-1 and interferer 1-2 are statistically independent. Note 3: SINR corresponds to S/N of the tested signal as defined in clause 8.1.							

Table 8.2.6A.1-6: Enhanced performance requirement type A for PUSCH, 20 MHz Channel Bandwidth

Number of TX antennas (Note 1)	Number of RX antennas (Note 1)	Propagation conditions and correlation matrix (Annex B) (Note 2)			FRC (Annex A)	Fraction of maximum throughput	SINR [dB] (Note 3)
		Tested signal	Interferer 1-1	Interferer 1-2			
1	2	EPA 5 Low	ETU 5 Low	ETU 5 Low	A12-6	70%	-2.9
	4	EPA 5 Low	ETU 5 Low	ETU 5 Low	A13-6	70%	-1.1
	8	EPA 5 Low	ETU 5 Low	ETU 5 Low	A4-8	70%	-1.3
Note 1: Antenna configuration applies for each of the tested signal, interferer 1-1 and interferer 1-2. Note 2: The propagation conditions for the tested signal, interferer 1-1 and interferer 1-2 are statistically independent. Note 3: SINR corresponds to S/N of the tested signal as defined in clause 8.1.							

8.2.7 Requirements for PUSCH supporting coverage enhancement

For the parameters specified in Table 8.2.7-1 the throughput shall be equal to or larger than the fraction of maximum throughput stated in the tables 8.2.7-2 to 8.2.7-11 at the given SNR.

Table 8.2.7-1 Test Parameters for PUSCH

Parameter	unit	Mode A	Mode B
Maximum number of HARQ transmissions		4	2
RV sequences		0, 2, 3, 1, 0, 2, 3, 1	FDD: 0, 0, 0, 0, 2, 2, 2, 2, 3, 3, 3, 3, 1, 1, 1, 1 TDD: 0, 0, 0, 0, 0, 2, 2, 2, 2, 2, 3, 3, 3, 3, 3, 1, 1, 1, 1, 1, 1
Number of PUSCH repetitions		8	256
Frequency hopping		ON	ON
Frequency hopping interval	subframes	4: FDD 5: TDD	4: FDD 5: TDD
Note 1: Guard period shall be created according to TS36.211, 5.2.5 [12]			

Table 8.2.7-2 Minimum requirements for PUSCH, 3 MHz Channel Bandwidth for Mode A, 1Tx

Number of TX antennas	Number of RX antennas	CE Mode	Propagation conditions and correlation matrix (Annex B)	FRC (Annex A)	Fraction of maximum throughput	SNR [dB]
1	2	Mode A	EPA 5Hz Low	A3-2	70%	-6.2
1	2	Mode A	ETU 200Hz Low	A3-2	70%	-7.1

Table 8.2.7-3 Minimum requirements for PUSCH, 5 MHz Channel Bandwidth for Mode A, 1Tx

Number of TX antennas	Number of RX antennas	CE Mode	Propagation conditions and correlation matrix (Annex B)	FRC (Annex A)	Fraction of maximum throughput	SNR [dB]
1	2	Mode A	EPA 5Hz Low	A3-2	70%	-6.6
1	2	Mode A	ETU 200Hz Low	A3-2	70%	-7.1

Table 8.2.7-4 Minimum requirements for PUSCH, 10 MHz Channel Bandwidth for Mode A, 1Tx

Number of TX antennas	Number of RX antennas	CE Mode	Propagation conditions and correlation matrix (Annex B)	FRC (Annex A)	Fraction of maximum throughput	SNR [dB]
1	2	Mode A	EPA 5Hz Low	A3-2	70%	-6.9
1	2	Mode A	ETU 200Hz Low	A3-2	70%	-7.1

Table 8.2.7-5 Minimum requirements for PUSCH, 15 MHz Channel Bandwidth for Mode A, 1Tx

Number of TX antennas	Number of RX antennas	CE Mode	Propagation conditions and correlation matrix (Annex B)	FRC (Annex A)	Fraction of maximum throughput	SNR [dB]
1	2	Mode A	EPA 5Hz Low	A3-2	70%	-6.9
1	2	Mode A	ETU 200Hz Low	A3-2	70%	-7.1

Table 8.2.7-6 Minimum requirements for PUSCH, 20 MHz Channel Bandwidth for Mode A, 1Tx

Number of TX antennas	Number of RX antennas	CE Mode	Propagation conditions and correlation matrix (Annex B)	FRC (Annex A)	Fraction of maximum throughput	SNR [dB]
1	2	Mode A	EPA 5Hz Low	A3-2	70%	-7.0
1	2	Mode A	ETU 200Hz Low	A3-2	70%	-7.1

Table 8.2.7-7 Minimum requirements for PUSCH, 3 MHz Channel Bandwidth for Mode B, 1Tx

Number of TX antennas	Number of RX antennas	CE Mode	Propagation conditions and correlation matrix (Annex B)	FRC (Annex A)	Fraction of maximum throughput	SNR [dB]
1	2	Mode B	ETU 1Hz Low	A3-1	70%	-15.0

Table 8.2.7-8 Minimum requirements for PUSCH, 5 MHz Channel Bandwidth for Mode B, 1Tx

Number of TX antennas	Number of RX antennas	CE Mode	Propagation conditions and correlation matrix (Annex B)	FRC (Annex A)	Fraction of maximum throughput	SNR [dB]
1	2	Mode B	ETU 1Hz Low	A3-1	70%	-15.2

Table 8.2.7-9 Minimum requirements for PUSCH, 10 MHz Channel Bandwidth for Mode B, 1Tx

Number of TX antennas	Number of RX antennas	CE Mode	Propagation conditions and correlation matrix (Annex B)	FRC (Annex A)	Fraction of maximum throughput	SNR [dB]
1	2	Mode B	ETU 1Hz Low	A3-1	70%	-15.3

Table 8.2.7-10 Minimum requirements for PUSCH, 15 MHz Channel Bandwidth for Mode B, 1Tx

Number of TX antennas	Number of RX antennas	CE Mode	Propagation conditions and correlation matrix (Annex B)	FRC (Annex A)	Fraction of maximum throughput	SNR [dB]
1	2	Mode B	ETU 1Hz Low	A3-1	70%	-15.1

Table 8.2.7-11 Minimum requirements for PUSCH, 20 MHz Channel Bandwidth for Mode B, 1Tx

Number of TX antennas	Number of RX antennas	CE Mode	Propagation conditions and correlation matrix (Annex B)	FRC (Annex A)	Fraction of maximum throughput	SNR [dB]
1	2	Mode B	ETU 1Hz Low	A3-1	70%	-15.2

8.2.8 Requirements for PUSCH of Frame structure type 3

For the parameters specified in Table 8.2.8-1 the throughput shall be equal to or larger than the fraction of maximum throughput stated in the tables 8.2.8-2 at the given SNR when the PUSCH is transmitted with Frame structure type 3.

Table 8.2.8-1: Test Parameters for PUSCH with frame structure type 3

Parameter	Unit	Value (NOTE 1)
Maximum number of HARQ transmissions		4
RV sequences		[0, 2, 0, 2]
PUSCH starting position (NOTE 2)		'01'
PUSCH ending symbol (NOTE 3)		'0'
NOTE 1: PUSCH scheduling pattern is defined as the bitmap {1111000000} with the periodicity of 10ms. Value 1 in the bitmap indicates there is PUSCH data transmission on the corresponding subframes; Value 0 indicates that there is no PUSCH data transmission on the corresponding subframes. NOTE 2: The PUSCH starting position is applicable to only the first PUSCH transmission subframe indicated in the bitmap. For other transmission subframes indicated in the bitmap, PUSCH starting position is at symbol 0. NOTE 3: The PUSCH ending symbol value indicates the configuration of the last symbol of the last PUSCH transmission subframe indicated in the bitmap.		

Table 8.2.8-2: Minimum requirements for PUSCH, 20 MHz Channel Bandwidth, 1Tx

Number of TX antennas	Number of RX antennas	Cyclic prefix	Propagation conditions and correlation matrix (Annex B)	FRC (Annex A)	Fraction of nominal maximum throughput (NOTE 1)	SNR [dB]
1	2	Normal	EPA 5Hz Low	A20-1	70%	-0.2
				A20-2	70%	12.1
	4	Normal	EPA 5Hz Low	A20-1	70%	-3.2
				A20-2	70%	8.3
NOTE1: Fraction of nominal maximum throughput is calculated based on the actual transmitted PUSCH						

8.2.9 Enhanced performance requirement type B in multipath fading propagation conditions

The purpose is to verify the demodulation performance when there are multiple co-scheduled intra-cell UEs in the serving cell and one inter-cell interfering UE in the neighboring cell. The PUSCH of all the intra-cell UEs are wanted signal for the BS.

The enhanced performance requirement type B of PUSCH is determined by a minimum required throughput for a given SINR. The required throughput is expressed as a fraction of maximum sum throughput of all the intra-cell UEs for the FRCs listed in Annex A. The performance requirements assume HARQ retransmissions.

The requirements apply to the BS supporting the enhanced performance requirements type B.

Table 8.2.9-1: Test parameters for enhanced performance requirement type B, 2 RX antennas

Parameter		Unit	Wanted intra-cell UEs (Note 1)		Inter-cell interfering UE
			UE1	UE2	
Cyclic Prefix			Normal		
Uplink-downlink allocation for TDD			Configuration 1 (2:2)		
Maximum number of HARQ transmissions			4		N/A
RV sequence			0, 2, 3, 1, 0, 2, 3, 1		N/A
Cell Id			0		1
Inter-cell interference model			N/A		As specified in clause B.6.2
DIP (Note 2)	Set 1	dB	N/A		-5.45
	Set 2	dB	N/A		-0.43
Relative power of intra-cell UEs (Note 3)	Set 1	dB	0	0	N/A
	Set 2	dB	0	3	N/A
Time offset		us	-1	1	0
Frequency offset		Hz	-200	200	0
Demodulation reference signal for PUSCH	$n_{\text{DMRS}}^{(1)}$		0	6	0
	$\Delta_{\text{ss}}, n_{\text{DMRS},0}^{(2)}$		$\Delta_{\text{ss}} = 0, n_{\text{DMRS},0}^{(2)} = 0$ Group hopping and sequence hopping are disabled.		
<p>Note 1: Two intra-cell UEs, i.e., UE1 and UE2, are configured for tests with 2 RX antennas.</p> <p>Note 2: The respective received energy of each inter-cell interferer relative to N is defined by its associated DIP value as specified in clause B.6.1. DIP set 1 and set 2 are derived respectively in homogeneous and heterogeneous network scenarios.</p> <p>Note 3: For set 1, equal average received signal energy is configured for the intra-cell UEs, while short-term variation remains. For set 2, the average received signal energy of UE2 is 3 dB higher than that of UE1.</p>					

Table 8.2.9-2: Test parameters for enhanced performance requirement type B, 4 RX antennas

Parameter		Unit	Wanted intra-cell UEs (Note 1)				Inter-cell interfering UE
			UE1	UE2	UE3	UE4	
Cyclic Prefix			Normal				
Uplink-downlink allocation for TDD			Configuration 1 (2:2)				
Maximum number of HARQ transmissions			4				N/A
RV sequence			0, 2, 3, 1, 0, 2, 3, 1				N/A
Cell Id			0				1
Inter-cell interference model			N/A				As specified in clause B.6.2
DIP (Note 2)	Set 1	dB	N/A				-5.45
	Set 2	dB	N/A				-0.43
Relative power of intra-cell UEs (Note 3)	Set 1	dB	0	0	0	0	N/A
	Set 2	dB	0	3	0	3	N/A
Time offset		us	-1	-0.5	0.5	1	0
Frequency offset		Hz	-200	-100	100	200	0
Demodulation reference signal for PUSCH	$n_{\text{DMRS}}^{(1)}$		0	3	6	9	0
	$\Delta_{\text{ss}}, n_{\text{DMRS},0}^{(2)}$		$\Delta_{\text{ss}} = 0, n_{\text{DMRS},0}^{(2)} = 0$				Group hopping and sequence hopping are disabled.
<p>Note 1: Four intra-cell UEs, i.e., UE1, UE2, UE3 and UE4, are configured for tests with 4 RX antennas.</p> <p>Note 2: The respective received energy of each inter-cell interferer relative to N is defined by its associated DIP value as specified in clause B.6.1. DIP set 1 and set 2 are derived respectively in homogeneous and heterogeneous network scenarios.</p> <p>Note 3: For set 1, equal average received signal energy is configured for the intra-cell UEs, while short-term variation remains. For set 2, the average received signal energy of UE1 and UE3 is the same, the average received signal energy of UE2 and UE4 is the same, and the average received signal energy of UE2 is 3 dB higher than that of UE1.</p>							

8.2.9.1 Minimum requirements

The throughput shall be equal to or larger than the fraction of maximum throughput stated in the tables 8.2.9.1-1 to 8.2.9.1-6 at the given SINR.

Table 8.2.9.1-1: Enhanced performance requirement type B for PUSCH, 1.4 MHz Channel Bandwidth

Number of TX antennas (Note 1)	Number of RX antennas (Note 1)	Propagation conditions and correlation matrix (Annex B) (Note 2)		DIP set	Relative power of intra-cell UEs	FRC (Annex A)		Fraction of maximum sum throughput of all the intra-cell UEs	UE1's SINR [dB] (Note 3)
		Wanted intra-cell UEs	Inter-cell interfering UE			UE1, UE3	UE2, UE4		
1	2	EPA 5 Low	ETU 5 Low	Set 2	Set 1	A22-1	A22-1	80%	15.4
		EVA 70 Low	ETU 70 Low	Set 1*	Set 2	A13-1	A13-1	80%	11.3
	4	EVA 70 Low	ETU 70 Low	Set 1*	Set 1	A13-1	A13-1	80%	10.3
		EPA 5 Low	ETU 5 Low	Set 2	Set 2	A21-1	A13-1	80%	0.6
<p>Note*: Not applicable for Local Area BS and Home BS.</p> <p>Note 1: Antenna configuration applies for each of the intra-cell and inter-cell UEs.</p> <p>Note 2: The propagation conditions for the intra-cell and inter-cell UEs are statistically independent.</p> <p>Note 3: SINR corresponds to S/N of UE1 as defined in clause 8.1.</p>									

Table 8.2.9.1-2: Enhanced performance requirement type B for PUSCH, 3 MHz Channel Bandwidth

Number of TX antennas (Note 1)	Number of RX antennas (Note 1)	Propagation conditions and correlation matrix (Annex B) (Note 2)		DIP set	Relative power of intra-cell UEs	FRC (Annex A)		Fraction of maximum sum throughput of all the intra-cell UEs	UE1's SINR [dB] (Note 3)
		Wanted intra-cell UEs	Inter-cell interfering UE			UE1, UE3	UE2, UE4		
1	2	EPA 5 Low	ETU 5 Low	Set 2	Set 1	A22-- 2	A22-- 2	80%	15.5
		EVA 70 Low	ETU 70 Low	Set 1*	Set 2	A13-2	A13-2	80%	10.7
	4	EVA 70 Low	ETU 70 Low	Set 1*	Set 1	A13-2	A13-2	80%	9.9
		EPA 5 Low	ETU 5 Low	Set 2	Set 2	A21-- 2	A13-2	80%	0.1
Note*: Not applicable for Local Area BS and Home BS.									
Note 1: Antenna configuration applies for each of the intra-cell and inter-cell UEs.									
Note 2: The propagation conditions for the intra-cell and inter-cell UEs are statistically independent.									
Note 3: SINR corresponds to S/N' of UE1 as defined in clause 8.1.									

Table 8.2.9.1-3: Enhanced performance requirement type B for PUSCH, 5 MHz Channel Bandwidth

Number of TX antennas (Note 1)	Number of RX antennas (Note 1)	Propagation conditions and correlation matrix (Annex B) (Note 2)		DIP set	Relative power of intra-cell UEs	FRC (Annex A)		Fraction of maximum sum throughput of all the intra-cell UEs	UE1's SINR [dB] (Note 3)
		Wanted intra-cell UEs	Inter-cell interfering UE			UE1, UE3	UE2, UE4		
1	2	EPA 5 Low	ETU 5 Low	Set 2	Set 1	A22-- 3	A22-- 3	80%	16.1
		EVA 70 Low	ETU 70 Low	Set 1*	Set 2	A13-3	A13-3	80%	11.0
	4	EVA 70 Low	ETU 70 Low	Set 1*	Set 1	A13-3	A13-3	80%	10.4
		EPA 5 Low	ETU 5 Low	Set 2	Set 2	A21-- 3	A13-3	80%	0.4
Note*: Not applicable for Local Area BS and Home BS.									
Note 1: Antenna configuration applies for each of the intra-cell and inter-cell UEs.									
Note 2: The propagation conditions for the intra-cell and inter-cell UEs are statistically independent.									
Note 3: SINR corresponds to S/N' of UE1 as defined in clause 8.1.									

Table 8.2.9.1-4: Enhanced performance requirement type B for PUSCH, 10 MHz Channel Bandwidth

Number of TX antennas (Note 1)	Number of RX antennas (Note 1)	Propagation conditions and correlation matrix (Annex B) (Note 2)		DIP set	Relative power of intra-cell UEs	FRC (Annex A)		Fraction of maximum sum throughput of all the intra-cell UEs	UE1's SINR [dB] (Note 3)
		Wanted intra-cell UEs	Inter-cell interfering UE			UE1, UE3	UE2, UE4		
1	2	EPA 5 Low	ETU 5 Low	Set 2	Set 1	A22-- 4	A22-- 4	80%	16.2
		EVA 70 Low	ETU 70 Low	Set 1*	Set 2	A13-4	A13-4	80%	10.5
	4	EVA 70 Low	ETU 70 Low	Set 1*	Set 1	A13-4	A13-4	80%	10.0
		EPA 5 Low	ETU 5 Low	Set 2	Set 2	A21-- 4	A13-4	80%	0.2
Note*: Not applicable for Local Area BS and Home BS.									
Note 1: Antenna configuration applies for each of the intra-cell and inter-cell UEs.									
Note 2: The propagation conditions for the intra-cell and inter-cell UEs are statistically independent.									
Note 3: SINR corresponds to S/N' of UE1 as defined in clause 8.1.									

Table 8.2.9.1-5: Enhanced performance requirement type B for PUSCH, 15 MHz Channel Bandwidth

Number of TX antennas (Note 1)	Number of RX antennas (Note 1)	Propagation conditions and correlation matrix (Annex B) (Note 2)		DIP set	Relative power of intra-cell UEs	FRC (Annex A)		Fraction of maximum sum throughput of all the intra-cell UEs	UE1's SINR [dB] (Note 3)
		Wanted intra-cell UEs	Inter-cell interfering UE			UE1, UE3	UE2, UE4		
1	2	EPA 5 Low	ETU 5 Low	Set 2	Set 1	A22--4	A22--4	80%	16.2
		EVA 70 Low	ETU 70 Low	Set 1*	Set 2	A13-5	A13-5	80%	10.6
	4	EVA 70 Low	ETU 70 Low	Set 1*	Set 1	A13-5	A13-5	80%	10.3
		EPA 5 Low	ETU 5 Low	Set 2	Set 2	A21--5	A13-5	80%	0.5
Note*: Not applicable for Local Area BS and Home BS.									
Note 1: Antenna configuration applies for each of the intra-cell and inter-cell UEs.									
Note 2: The propagation conditions for the intra-cell and inter-cell UEs are statistically independent.									
Note 3: SINR corresponds to S/N of UE1 as defined in clause 8.1.									

Table 8.2.9.1-6: Enhanced performance requirement type B for PUSCH, 20 MHz Channel Bandwidth

Number of TX antennas (Note 1)	Number of RX antennas (Note 1)	Propagation conditions and correlation matrix (Annex B) (Note 2)		DIP set	Relative power of intra-cell UEs	FRC (Annex A)		Fraction of maximum sum throughput of all the intra-cell UEs	UE1's SINR [dB] (Note 3)
		Wanted intra-cell UEs	Inter-cell interfering UE			UE1, UE3	UE2, UE4		
1	2	EPA 5 Low	ETU 5 Low	Set 2	Set 1	A22--4	A22--4	80%	16.3
		EVA 70 Low	ETU 70 Low	Set 1*	Set 2	A13-6	A13-6	80%	10.6
	4	EVA 70 Low	ETU 70 Low	Set 1*	Set 1	A13-6	A13-6	80%	10.3
		EPA 5 Low	ETU 5 Low	Set 2	Set 2	A21--6	A13-6	80%	0.6
Note*: Not applicable for Local Area BS and Home BS.									
Note 1: Antenna configuration applies for each of the intra-cell and inter-cell UEs.									
Note 2: The propagation conditions for the intra-cell and inter-cell UEs are statistically independent.									
Note 3: SINR corresponds to S/N of UE1 as defined in clause 8.1.									

8.2.10 Requirements for PUSCH supporting subPRB transmission

For the parameters specified in Table 8.2.10-1 the throughput shall be equal to or larger than the fraction of maximum throughput stated in the tables 8.2.10-2 to 8.2.10-11 at the given SNR.

The requirements apply to the BS supporting the PUSCH with subPRB transmission.

Table 8.2.10-1: Test Parameters for PUSCH

Parameter	unit	Mode A	Mode B
Maximum number of HARQ transmissions		4	2
RV sequences (Note 2)		0, 2, 3, 1, 0, 2, 3, 1	0, 2, 3, 1, 0, 2, 3, 1
Number of PUSCH repetitions		1	16
Frequency hopping		ON	ON
Frequency hopping interval	subframes	4: FDD 5: TDD	4: FDD 5: TDD
Note 1: Guard period shall be created according to TS36.211, 5.2.5 [12]			
Note 2: RV changes per repetition every (RU size x number of RUs) transmission subframes.			

Table 8.2.10-2: Minimum requirements for PUSCH, 3 MHz Channel Bandwidth for Mode A, 1Tx

Number of TX antennas	Number of RX antennas	CE Mode	Propagation conditions and correlation matrix (Annex B)	FRC (Annex A)	Fraction of maximum throughput	SNR [dB]
1	2	Mode A	EPA 5Hz Low	A25-1	70%	-0.6

Table 8.2.10-3: Minimum requirements for PUSCH, 5 MHz Channel Bandwidth for Mode A, 1Tx

Number of TX antennas	Number of RX antennas	CE Mode	Propagation conditions and correlation matrix (Annex B)	FRC (Annex A)	Fraction of maximum throughput	SNR [dB]
1	2	Mode A	EPA 5Hz Low	A25-1	70%	-0.8

Table 8.2.10-4: Minimum requirements for PUSCH, 10 MHz Channel Bandwidth for Mode A, 1Tx

Number of TX antennas	Number of RX antennas	CE Mode	Propagation conditions and correlation matrix (Annex B)	FRC (Annex A)	Fraction of maximum throughput	SNR [dB]
1	2	Mode A	EPA 5Hz Low	A25-1	70%	-0.8

Table 8.2.10-5: Minimum requirements for PUSCH, 15 MHz Channel Bandwidth for Mode A, 1Tx

Number of TX antennas	Number of RX antennas	CE Mode	Propagation conditions and correlation matrix (Annex B)	FRC (Annex A)	Fraction of maximum throughput	SNR [dB]
1	2	Mode A	EPA 5Hz Low	A25-1	70%	-1.0

Table 8.2.10-6: Minimum requirements for PUSCH, 20 MHz Channel Bandwidth for Mode A, 1Tx

Number of TX antennas	Number of RX antennas	CE Mode	Propagation conditions and correlation matrix (Annex B)	FRC (Annex A)	Fraction of maximum throughput	SNR [dB]
1	2	Mode A	EPA 5Hz Low	A25-1	70%	-1.0

Table 8.2.10-7: Minimum requirements for PUSCH, 3 MHz Channel Bandwidth for Mode B, 1Tx

Number of TX antennas	Number of RX antennas	CE Mode	Propagation conditions and correlation matrix (Annex B)	FRC (Annex A)	Fraction of maximum throughput	SNR [dB]
1	2	Mode B	EPA 5Hz Low	A25-2	70%	-9.3

Table 8.2.10-8: Minimum requirements for PUSCH, 5 MHz Channel Bandwidth for Mode B, 1Tx

Number of TX antennas	Number of RX antennas	CE Mode	Propagation conditions and correlation matrix (Annex B)	FRC (Annex A)	Fraction of maximum throughput	SNR [dB]
1	2	Mode B	EPA 5Hz Low	A25-2	70%	-9.5

Table 8.2.10-9: Minimum requirements for PUSCH, 10 MHz Channel Bandwidth for Mode B, 1Tx

Number of TX antennas	Number of RX antennas	CE Mode	Propagation conditions and correlation matrix (Annex B)	FRC (Annex A)	Fraction of maximum throughput	SNR [dB]
1	2	Mode B	EPA 5Hz Low	A25-2	70%	-9.5

Table 8.2.10-10: Minimum requirements for PUSCH, 15 MHz Channel Bandwidth for Mode B, 1Tx

Number of TX antennas	Number of RX antennas	CE Mode	Propagation conditions and correlation matrix (Annex B)	FRC (Annex A)	Fraction of maximum throughput	SNR [dB]
1	2	Mode B	EPA 5Hz Low	A25-2	70%	-9.5

Table 8.2.10-11: Minimum requirements for PUSCH, 20 MHz Channel Bandwidth for Mode B, 1Tx

Number of TX antennas	Number of RX antennas	CE Mode	Propagation conditions and correlation matrix (Annex B)	FRC (Annex A)	Fraction of maximum throughput	SNR [dB]
1	2	Mode B	EPA 5Hz Low	A25-2	70%	-9.5

8.3 Performance requirements for PUCCH

8.3.1 DTX to ACK performance

The DTX to ACK requirement is valid for any number of receive antennas, for all frame structures and for any channel bandwidth.

The DTX to ACK probability for multi user PUCCH case denotes the probability that ACK is detected when nothing is sent on the wanted signal and the interfering signals are present.

8.3.1.1 Minimum requirement

The DTX to ACK probability, i.e. the probability that ACK is detected when nothing was sent, shall not exceed 1%, where the performance measure definition is as follows:

$$\text{Prob}(\text{PUCCH DTX} \rightarrow \text{ACK bits}) = \frac{\#(\text{false ACK bits})}{\#(\text{PUCCH DTX}) \times \#(\text{ACK/NAK bits})} \leq 10^{-2}$$

where:

- #(false ACK bits) denotes the number of detected ACK bits.
- #(ACK/NAK bits) denotes the number of encoded bits per sub-frame
- #(PUCCH DTX) denotes the number of DTX occasions

8.3.2 ACK missed detection requirements for single user PUCCH format 1a

The ACK missed detection probability is the probability of not detecting an ACK when an ACK was sent.

ACK/NAK repetitions are disabled for PUCCH transmission.

Test parameters for PUCCH transmission on two antenna ports are presented in Annex A.10.

8.3.2.1 Minimum requirements

The ACK missed detection probability shall not exceed 1% at the SNR given in table 8.3.2.1-1 for 1Tx and in table 8.3.2.1-2 for 2Tx case.

Table 8.3.2.1-1 Minimum requirements for single user PUCCH format 1a, 1Tx

Number of TX antennas	Number of RX antennas	Cyclic Prefix	Propagation conditions and correlation matrix (Annex B)	Channel Bandwidth / SNR [dB]					
				1.4 MHz	3 MHz	5 MHz	10 MHz	15 MHz	20 MHz
1	2	Normal	EPA 5 Low	-2.5	-3.9	-4.8	-5.4	-5.3	-5.1
			EVA 5 Low	-4.5	-5.1	-5.1	-5.0	-5.1	-5.1
			EVA 70 Low	-4.9	-5.2	-5.2	-5.1	-5.2	-5.1
			ETU 300* Low	-5.0	-5.1	-4.9	-5.0	-5.2	-5.2
	4	Normal	EPA 5 Low	-7.9	-8.4	-8.7	-8.9	-8.9	-9.0
			EVA 5 Low	-8.8	-9.1	-9.1	-8.8	-8.9	-8.9
			EVA 70 Low	-8.9	-9.0	-9.0	-8.8	-9.0	-8.8
			ETU 300* Low	-8.7	-8.9	-8.7	-8.7	-8.9	-8.8
	8	Normal	ETU 70* Low	-7.9	-8.1	-7.9	-8.1	-8.0	-8.0
			EPA 5 Low	-11.2	-11.5	-12.2	-12.3	-12.3	-12.3
			EVA 5 Low	-12.0	-12.0	-12.1	-12.1	-12.3	-12.2
			EVA 70 Low	-12.0	-12.1	-12.2	-12.1	-12.3	-12.1
		Extended	ETU 70* Low	-7.9	-8.1	-7.9	-8.1	-8.0	-8.0
			EPA 5 Low	-11.6	-11.6	-11.6	-11.8	-11.6	-11.8
Note*: Not applicable for Local Area BS and Home BS.									

Table 8.3.2.1-2 Minimum requirements for single user PUCCH format 1a, 2Tx

Number of TX antennas	Number of RX antennas	Cyclic Prefix	Propagation conditions and correlation matrix (Annex B)	Channel Bandwidth / SNR [dB]					
				1.4 MHz	3 MHz	5 MHz	10 MHz	15 MHz	20 MHz
2	2	Normal	EPA 5 Low	-4.6	-4.9	-6.4	-6.5	-6.5	-6.7
			EVA 70 Low	-5.8	-5.9	-6.4	-5.9	-6.4	-6.4
	4	Normal	EPA 5 Low	-8.5	-8.5	-9.3	-9.5	-9.5	-9.5
			EVA 70 Low	-9.0	-9.2	-9.3	-9.3	-9.4	-9.5
2	8	Normal	EPA 5 Low	-11.4	-11.5	-11.9	-12.0	-11.9	-12.0
			EVA 70 Low	-11.7	-11.8	-11.8	-11.8	-11.8	-11.8

8.3.3 CQI performance requirements for PUCCH format 2

The CQI block error probability (BLER) is defined as the conditional probability of incorrectly decoding the CQI information when the CQI information is sent. All CQI information shall be decoded (no exclusion due to DTX).

The CQI information bit payload per sub-frame is equal to 4 bits.

Test parameters for PUCCH transmission on two antenna ports are presented in Annex A.10.

8.3.3.1 Minimum requirements

The CQI block error probability shall not exceed 1% at the SNR given in table 8.3.3.1-1 for 1Tx and in table 8.3.3.1-2 for 2Tx case.

Table 8.3.3.1-1 Minimum requirements for PUCCH format 2, 1Tx

Number of TX antennas	Number of RX antennas	Cyclic Prefix	Propagation conditions and correlation matrix (Annex B)	Channel Bandwidth / SNR [dB]					
				1.4 MHz	3 MHz	5 MHz	10 MHz	15 MHz	20 MHz
1	2	Normal	EVA 5* Low	-3.7	-4.1	-4.4	-4.0	-4.2	-4.2
			ETU 70** Low	-3.9	-4.4	-4.2	-4.4	-4.4	-4.4
Note*:			Not applicable for Wide Area BS and Medium Range BS.						
Note**:			Not applicable for Local Area BS and Home BS.						

Table 8.3.3.1-2 Minimum requirements for PUCCH format 2, 2Tx

Number of TX antennas	Number of RX antennas	Cyclic Prefix	Propagation conditions and correlation matrix (Annex B)	Channel Bandwidth / SNR [dB]					
				1.4 MHz	3 MHz	5 MHz	10 MHz	15 MHz	20 MHz
2	2	Normal	EVA 5 Low	-5.7	-5.6	-5.9	-5.8	-5.9	-5.9

8.3.4 ACK missed detection requirements for multi user PUCCH format 1a

The ACK missed detection probability is the conditional probability of not detecting an ACK on the wanted signal in the presence of the wanted signal and the interfering signals.

Test parameters for multi user PUCCH case are presented in Annex A.9.

ACK/NACK repetitions are disabled for PUCCH transmission.

8.3.4.1 Minimum requirement

The ACK missed detection probability for multi user PUCCH case shall not exceed 1% at the SNR given in table 8.3.4.1-1.

Table 8.3.4.1-1 Minimum requirements for multi user PUCCH case

Number of TX antennas	Number of RX antennas	Cyclic Prefix	Propagation conditions and correlation matrix (Annex B)	Channel Bandwidth / SNR [dB]					
				1.4 MHz	3 MHz	5 MHz	10 MHz	15 MHz	20 MHz
1	2	Normal	ETU 70* Low	-4.1	-4.4	-4.4	-4.6	-4.6	-4.4
Note*:			Not applicable for Local Area BS and Home BS.						

8.3.5 ACK missed detection requirements for PUCCH format 1b with Channel Selection

The ACK missed detection probability is the probability of not detecting an ACK bit when an ACK bit was sent on particular channel, with each missed ACK bit counted as one error.

The number of encoded ACK bits per sub-frame is equal to 4 bits (AAAA),

ACK/NACK repetitions are disabled for PUCCH transmission.

This requirement is applicable for FDD and TDD.

8.3.5.1 Minimum requirements

The ACK missed detection probability shall not exceed 1% at the SNR given in table 8.3.5.1-1.

Table 8.3.5.1-1 Minimum requirements for PUCCH format 1b with Channel Selection

Number of Tx antennas	Number of RX antennas	Cyclic Prefix	Propagation Conditions and correlation matrix (Annex B)	Channel Bandwidth / SNR [dB]					
				1.4MHz	3MHz	5MHz	10 MHz	15MHz	20MHz
1	2	Normal	EPA 5 Low	-	-	-	-4.5	-4.6	-4.6
			EVA70 Low	-	-	-	-4.3	-4.5	-4.5
	4	Normal	EPA 5 Low	-	-	-	-8.4	-8.5	-8.6
			EVA70 Low	-	-	-	-8.3	-8.5	-8.5
	8	Normal	EPA 5 Low	-	-	-	-11.7	-11.8	-11.8
			EVA70 Low	-	-	-	-11.5	-11.7	-11.6

8.3.6 ACK missed detection requirements for PUCCH format 3

The ACK missed detection probability is the probability of not detecting an ACK bit when an ACK bit was sent on the particular bit position, with each missed ACK bit being accounted as one error.

The number of encoded ACK/NACK bits per sub-frame is defined for two cases as presented below:

- 4AN bits: applicable for FDD and TDD
- 16AN bits : applicable for TDD

ACK/NACK repetitions are disabled for PUCCH transmission. Random codeword selection is assumed.

8.3.6.1 Minimum requirements

The ACK missed detection probability shall not exceed 1% at the SNR given in table 8.3.6.1-1 and table 8.3.6.1-2, for 4 and 16 AN bits per sub-frame, respectively.

Table 8.3.6.1-1 Minimum requirements for PUCCH format 3, 4AN bits

Number of Tx antennas	Number of RX antennas	Cyclic Prefix	Propagation Conditions and correlation matrix (Annex B)	Channel Bandwidth / SNR [dB]					
				1.4MHz	3MHz	5MHz	10 MHz	15MHz	20MHz
1	2	Normal	EPA 5 Low	-	-	-	-3.7	-3.8	-3.8
			EVA70 Low	-	-	-	-3.5	-3.6	-3.7
	4	Normal	EPA 5 Low	-	-	-	-7.3	-7.4	-7.5
			EVA70 Low	-	-	-	-7.2	-7.3	-7.3
	8	Normal	EPA 5 Low	-	-	-	-11.1	-10.9	-11.1
			EVA70 Low	-	-	-	-10.9	-11.0	-11.0

Table 8.3.6.1-2 Minimum requirements for PUCCH format 3, 16AN bits

Number of Tx antennas	Number of RX antennas	Cyclic Prefix	Propagation Conditions and correlation matrix (Annex B)	Channel Bandwidth / SNR [dB]					
				1.4MHz	3MHz	5MHz	10 MHz	15MHz	20MHz
1	2	Normal	EPA 5 Low	-	-	-	-1.3	-1.2	-1.2
			EVA70 Low	-	-	-	-0.8	-0.9	-0.9
	4	Normal	EPA 5 Low	-	-	-	-5.3	-5.3	-5.4
			EVA70 Low	-	-	-	-5.0	-5.1	-5.1
	8	Normal	EPA 5 Low	-	-	-	-8.8	-8.8	-8.9
			EVA70 Low	-	-	-	-8.7	-8.8	-8.7

8.3.7 NACK to ACK requirements for PUCCH format 3

The NACK to ACK detection probability is the probability that an ACK bit is falsely detected when an NACK bit was sent on the particular bit position, where the NACK to ACK detection probability is defined as follows:

$$\text{Prob}(\text{PUCCH NACK} \rightarrow \text{ACK bits}) = \frac{\#(\text{NACK bits decoded as ACK bits})}{\#(\text{Total NACK bits})},$$

where:

- $\#(\text{Total NACK bits})$ denotes the total number of NACK bits transmitted
- $\#(\text{NACK bits decoded as ACK bits})$ denotes the number of NACK bits decoded as ACK bits at the receiver, i.e. the number of received ACK bits
- NACK bits in the definition do not contain the NACK bits which are mapped from DTX, i.e. NACK bits received when DTX is sent should not be considered.

ACK/NACK repetitions are disabled for PUCCH transmission. Random codeword selection is assumed.

Note: NACK to ACK requirement only applies to the PUCCH format3 16AN bits cases.

8.3.7.1 Minimum requirement

The NACK to ACK probability shall not exceed 0,1% at the SNR given in table 8.3.7.1-1 for 16 AN bits.

Table 8.3.7.1-1 Minimum requirements for PUCCH format 3, 16AN bits

Number of Tx antennas	Number of RX antennas	Cyclic Prefix	Propagation Conditions and correlation matrix (Annex B)	Channel Bandwidth / SNR [dB]					
				1.4MHz	3MHz	5MHz	10 MHz	15MHz	20MHz
1	2	Normal	EPA 5 Low	-	-	-	1.4	1.6	1.5
			EVA70 Low	-	-	-	2.1	1.9	1.9
	4	Normal	EPA 5 Low	-	-	-	-3.1	-3.3	-3.5
			EVA70 Low	-	-	-	-2.9	-3.1	-3.2
	8	Normal	EPA 5 Low	-	-	-	-7.3	-7.3	-7.3
			EVA70 Low	-	-	-	-7.0	-7.1	-7.2

8.3.8 CQI performance requirements for PUCCH format 2 with DTX detection

The requirements in this clause apply to a BS supporting PUCCH format 2 with DTX. It is optional for a BS to support PUCCH format 2 with DTX.

A BS may meet the PUCCH format 2 requirements specified in Clause 8.3.8.1 instead of requirements specified in Clause 8.3.3.1.

The CQI block error probability (BLER) is defined as the sum of the:

- conditional probability of incorrectly decoding the CQI information when the CQI information is sent and
- conditional probability of detecting UE transmission as DTX, when the CQI information is sent.

The CQI false alarm probability is defined as the conditional probability of false detecting the CQI information transmitted from UE when no CQI information is sent.

The CQI information bit payload per sub-frame is equal to 4 bits.

Test parameters for PUCCH transmission on two antenna ports are presented in Annex A.10.

8.3.8.1 Minimum requirements

The CQI false alarm probability and the CQI block error probability shall not exceed 10% and 1%, respectively, at the SNR given in table 8.3.8.1-1.

Table 8.3.8.1-1 Minimum requirements for PUCCH format 2 with DTX detection

Number of TX antennas	Number of RX antennas	Cyclic Prefix	Propagation conditions and correlation matrix (Annex B)	Channel Bandwidth / SNR [dB]					
				1.4 MHz	3 MHz	5 MHz	10 MHz	15 MHz	20 MHz
1	2	Normal	EVA 5* Low	-3.7	-4.0	-4.4	-4.0	-4.2	-4.2
			ETU 70** Low	-3.7	-4.0	-3.7	-4.1	-3.9	-4.1
2	2	Normal	EVA 5 Low	-5.3	-5.2	-5.5	-5.4	-5.3	-5.5
Note*:			Not applicable for Wide Area BS and Medium Range BS.						
Note**:			Not applicable for Local Area BS and Home BS.						

8.3.9 PUCCH performance requirements for coverage enhancement

8.3.9.1 DTX to ACK performance

The DTX to ACK requirement is valid for any number of receive antennas, for all frame structures and for any channel bandwidth.

8.3.9.1.1 Minimum requirement

The DTX to ACK probability, i.e. the probability that ACK is detected when nothing is sent per PUCCH transmission, shall not exceed 1% per PUCCH transmission. A PUCCH transmission may take multiple subframes due to PUCCH transmission repetition. The performance measure is defined as follows:

$$\text{Prob}(\text{PUCCH DTX} \rightarrow \text{ACK bits}) = \frac{\#(\text{false ACK bits})}{\#(\text{PUCCH DTX}) \times \#(\text{ACK/NAK bits})} \leq 10^{-2}$$

where:

- #(false ACK bits) denotes the number of detected ACK bits per PUCCH transmission.
- #(ACK/NAK bits) denotes the number of encoded bits per PUCCH transmission.
- #(PUCCH DTX) denotes the number of DTX occasions per PUCCH transmission.

8.3.9.2 ACK missed detection requirements for single user PUCCH format 1a

The ACK missed detection probability is the probability of not detecting an ACK when an ACK is sent.

8.3.9.2.1 Minimum requirements

The ACK missed detection probability shall not exceed 1% at the SNR given in table 8.3.9.2.1-1 for 1Tx.

Table 8.3.9.2.1-1 Minimum requirements for single user PUCCH format 1a, 1Tx

Number of TX antennas	Number of RX antennas	Cyclic Prefix	Propagation conditions and correlation matrix (Annex B)	Repetitions	Channel Bandwidth / SNR [dB]				
					3 MHz	5 MHz	10 MHz	15 MHz	20 MHz
1	2	normal	EPA5 Low	4	-5.2	-5.5	-5.5	-5.6	-5.5
				8	-9.2	-11.0	-10.9	-11.1	-11.3
				32	-13.7	-14.8	-15.1	-15.1	-15.1
Note 1: Frequency Hopping Intervals: 4 (FDD); 10 (TDD).									
Note 2: Guard period shall be created according to TS36.211, 5.2.5 [12]									

8.3.9.3 CQI performance requirements for PUCCH format 2

The CQI block error probability (BLER) is defined as the conditional probability of incorrectly decoding the CQI information when the CQI information is sent per PUCCH transmission. A PUCCH transmission may take multiple subframes due to PUCCH transmission repetition. All CQI information shall be decoded (no exclusion due to DTX).

The CQI information bit payload per PUCCH transmission is equal to 4 bits.

8.3.9.3.1 Minimum requirements

The CQI block error probability shall not exceed 1% at the SNR given in table 8.3.9.3.1-1 for 1Tx.

Table 8.3.9.3.1-1 Minimum requirements for PUCCH format 2, 1Tx

Number of TX antennas	Number of RX antennas	Cyclic Prefix	Propagation conditions and correlation matrix (Annex B)	Repetitions	Channel Bandwidth / SNR [dB]				
					3 MHz	5 MHz	10 MHz	15 MHz	20 MHz
1	2	normal	EVA5 Low	4	-4.1	-5.0	-5.1	-4.9	-4.7
				8	-9.8	-10.3	-10.0	-10.1	-10.0
				32	-13.7	-14.1	-13.8	-14.0	-13.9
Note 1: Frequency Hopping Intervals: 4 (FDD); 10 (TDD)									
Note 2: Guard period shall be created according to TS36.211, 5.2.5 [12]									

8.3.10 ACK missed detection requirements for PUCCH format 4

The ACK missed detection probability is the probability of not detecting an ACK bit when an ACK bit was sent on the particular bit position, with each missed ACK bit being accounted as one error.

The number of encoded ACK/NACK bits per sub-frame is defined for two cases as presented below:

- 24AN bits with 1PRB allocated
- 64AN bits with 2PRB allocated

The requirements are applicable for FDD only, TDD only and TDD-FDD CA.

The requirements are applicable for both PUCCH on PCell and PUCCH on SCell.

ACK/NACK repetitions are disabled for PUCCH transmission. DAI based codebook size determination is disabled. Random codeword selection is assumed.

8.3.10.1 Minimum requirements

The ACK missed detection probability shall not exceed 1% at the SNR given in table 8.3.10.1-1 and table 8.3.10.1-2 for 24 AN bits with 1 PRB allocated and 64 AN bits with 2 PRB allocated per sub-frame, respectively.

Table 8.3.10.1-1 Minimum requirements for PUCCH format 4, 24AN bits with 1 PRB allocated

Number of TX antennas	Number of RX antennas	Cyclic Prefix	Propagation conditions and correlation matrix (Annex B)	Channel Bandwidth / SNR [dB]					
				1.4 MHz	3 MHz	5 MHz	10 MHz	15 MHz	20 MHz
1	2	Normal	EPA 5 Low	-	-	-	1.2	1.1	1.0
			EVA 70 Low	-	-	-	1.4	1.2	1.2
	4	Normal	EPA 5 Low	-	-	-	-3.0	-2.8	-2.9
			EVA 70 Low	-	-	-	-2.6	-3.0	-3.0
	8	Normal	EPA 5 Low	-	-	-	-6.1	-6.1	-6.1
			EVA 70 Low	-	-	-	-6.0	-6.0	-6.1

Table 8.3.10.1-2 Minimum requirements for PUCCH format 4, 64AN bits with 2 PRB allocated

Number of TX antennas	Number of RX antennas	Cyclic Prefix	Propagation conditions and correlation matrix (Annex B)	Channel Bandwidth / SNR [dB]					
				1.4 MHz	3 MHz	5 MHz	10 MHz	15 MHz	20 MHz
1	2	Normal	EPA 5 Low	-	-	-	1.7	1.5	1.5
			EVA 70 Low	-	-	-	2.1	2.0	1.9
	4	Normal	EPA 5 Low	-	-	-	-3.0	-2.9	-2.9
			EVA 70 Low	-	-	-	-2.5	-2.7	-2.7
	8	Normal	EPA 5 Low	-	-	-	-6.3	-6.3	-6.4
			EVA 70 Low	-	-	-	-6.0	-6.2	-6.2

8.3.11 ACK missed detection requirements for PUCCH format 5

The ACK missed detection probability is the probability of not detecting an ACK bit when an ACK bit was sent on the particular bit position, with each missed ACK bit being accounted as one error.

The number of encoded ACK/NACK bits per sub-frame is equal to 24 bits.

The requirement is applicable for FDD only, TDD only and TDD-FDD CA. The requirement is applicable for both PUCCH on PCell and PUCCH on SCell.

ACK/NACK repetitions are disabled for PUCCH transmission. DAI based codebook size determination is disabled. Random codeword selection is assumed.

8.3.11.1 Minimum requirements

The ACK missed detection probability shall not exceed 1% at the SNR given in table 8.3.11.1-1.

Table 8.3.11.1-1 Minimum requirements for PUCCH format 5

Number of Tx antennas	Number of RX antennas	Cyclic Prefix	Propagation Conditions and correlation matrix (Annex B)	Channel Bandwidth / SNR [dB]					
				1.4MHz	3MHz	5MHz	10 MHz	15MHz	20MHz
1	2	Normal	EPA 5 Low	-	-	-	1.6	1.3	1.3
			EVA70 Low	-	-	-	1.6	1.5	1.5
	4	Normal	EPA 5 Low	-	-	-	-2.9	-2.8	-2.8
			EVA70 Low	-	-	-	-2.5	-2.8	-2.7
	8	Normal	EPA 5 Low	-	-	-	-6.0	-5.9	-6.0
			EVA70 Low	-	-	-	-5.8	-5.9	-6.0

8.4 Performance requirements for PRACH

8.4.1 PRACH False alarm probability

The false alarm requirement is valid for any number of receive antennas, for all frame structures and for any channel bandwidth.

The false alarm probability is the conditional total probability of erroneous detection of the preamble (i.e. erroneous detection from any detector) when input is only noise.

8.4.1.1 Minimum requirement

The false alarm probability shall be less than or equal to 0.1%.

8.4.2 PRACH detection requirements

The probability of detection is the conditional probability of correct detection of the preamble when the signal is present. There are several error cases – detecting different preamble than the one that was sent, not detecting a preamble at all or correct preamble detection but with the wrong timing estimation. For AWGN, a timing estimation error occurs if the estimation error of the timing of the strongest path is larger than 1.04us. For ETU70 and EPA1, a timing estimation error occurs if the estimation error of the timing of the strongest path is larger than 2.08us. The strongest path for the timing estimation error refers to the strongest path (i.e. average of the delay of all paths having the same highest gain = 310ns for ETU) in the power delay profile.

The test preambles for normal mode are listed in table A.6-1 and the test preambles for high speed mode restricted set type A are listed in A.6-2. The test preambles for coverage enhancement are listed in table A.6-3. The test preambles for high speed mode restricted set type B are listed in A.6-4.

8.4.2.1 Minimum requirements

The probability of detection shall be equal to or exceed 99% for the SNR levels listed in Tables 8.4.2.1-1 to 8.4.2.1-5.

The requirements for Burst format 4 are optional and only valid for base stations supporting TDD. The requirements for high speed mode restricted set type A (table 8.4.2.1-2) and high speed mode restricted set type B (table 8.4.2.1-5) are only valid for the base stations supporting high speed mode restricted set A and restricted set type B respectively.

The requirements for coverage enhancement (Tables 8.4.2.1-3 and 8.4.2.1-4) are only valid for the base stations supporting coverage enhancement.

Table 8.4.2.1-1 PRACH missed detection requirements for Normal Mode

Number of TX antennas	Number of RX antennas	Propagation conditions and correlation matrix (Annex B)	Frequency offset	SNR [dB]				
				Burst format 0	Burst format 1	Burst format 2	Burst format 3	Burst format 4
1	2	AWGN	0	-14.2	-14.2	-16.4	-16.5	-7.2
		ETU 70 Low*	270 Hz	-8.0	-7.8	-10.0	-10.1	-0.1
	4	AWGN	0	-16.9	-16.7	-19.0	-18.8	-9.8
		ETU 70 Low*	270 Hz	-12.1	-11.7	-14.1	-13.9	-5.1
	8	AWGN	0	-19.8	-19.4	-21.5	-21.3	-11.8
		ETU 70 Low*	270 Hz	-16.3	-15.9	-17.8	-17.5	-8.6

Note*: Not applicable for Local Area BS and Home BS.

The requirements in Table 8.4.2.1-2 shall not be applied to Local Area BS and Home BS.

Table 8.4.2.1-2 PRACH missed detection requirements for High speed Mode restricted set type A

Number of TX antennas	Number of RX antennas	Propagation conditions and correlation matrix (Annex B)	Frequency offset	SNR [dB]			
				Burst format 0	Burst format 1	Burst format 2	Burst format 3
1	2	AWGN	0	-14.1	-14.2	-16.3	-16.6
		ETU 70 Low	270 Hz	-7.4	-7.3	-9.3	-9.5
		AWGN	625 Hz	-12.4	-12.3	-14.4	-14.4
		AWGN	1340 Hz	-13.4	-13.5	-15.5	-15.7
	4	AWGN	0	-16.9	-16.6	-18.9	-18.8
		ETU 70 Low	270 Hz	-11.8	-11.4	-13.7	-13.7
		AWGN	625 Hz	-14.9	-14.6	-16.8	-16.8
		AWGN	1340 Hz	-15.9	-15.5	-17.8	-17.8
	8	AWGN	0	-19.3	-19.1	-20.9	-21.0
		ETU 70 Low	270 Hz	-15.6	-15.1	-17.0	-17.0
		AWGN	625 Hz	-17.7	-17.4	-19.3	-19.4
		AWGN	1340 Hz	-18.7	-18.4	-20.5	-20.5

Table 8.4.2.1-3 PRACH missed detection requirements for coverage enhancement (PRACH frequency hopping OFF)

Number of TX antennas	Number of RX antennas	Propagation conditions and correlation matrix (Annex B)	Frequency offset	Number of Repetitions	SNR [dB]			
					Burst format 0	Burst format 1	Burst format 2	Burst format 3
1	2	AWGN	0	4	-	-	-21.3	-21.1
				8	-21.7	-21.3	-	-
				16	-	-	-25.1	-25.0
				32	-25.6	-25.3	-	-
		EPA1 Low	270 Hz	4	-	-	-12.1	-11.7
				8	-13.0	-12.3	-	-
				16	-	-	-17.2	-17.2
				32	-19.0	-18.6	-	-

Note 1: Under fading channels, the PRACH detection performance may be significantly different with different PRACH Configuration Indexes. The requirements in this table are defined based on the simulation results with PRACH Configuration Indexes (3, 19, 35, 51) for Format 0, Format 1, Format 2, and Format 3 respectively.

Table 8.4.2.1-4 PRACH missed detection requirements for coverage enhancement (PRACH frequency hopping ON)

Number of TX antennas	Number of RX antennas	Propagation conditions and correlation matrix (Annex B)	Frequency offset	Number of Repetitions	SNR [dB]			
					Burst format 0	Burst format 1	Burst format 2	Burst format 3
1	2	EPA1 Low	270 Hz	4	-	-	-15.5	-15.3
				8	-16.2	-15.8	-	-
				16	-	-	-20.1	-20.2
				32	-21.3	-21.1	-	-
<p>Note 1: Under fading channels, the PRACH detection performance may be significantly different with different PRACH Configuration Indexes. The requirements in this table are defined based on the simulation results with PRACH Configuration Indexes (3, 19, 35, 51) for Format 0, Format 1, Format 2, and Format 3 respectively.</p> <p>Note 2: The requirements in this table are defined under the assumption that UE RF tuning during PRACH frequency hopping has no impact on the symbols in PRACH subframes and thus all symbols in PRACH subframes are available for the transmission of PRACH preambles.</p> <p>Note 3: The requirements in this table are defined under the assumption that the PRACH frequency offset (prach-FreqOffset-r13) is 0 and frequency hopping offset is $N_{RB}^{UL} - 6$, where N_{RB}^{UL} is defined in TS36.211 [12].</p> <p>Note 4: The requirements in this table apply for channel bandwidth of 5MHz, 10MHz, 15MHz or 20MHz. For channel bandwidth of 3MHz, the requirements in Table 8.4.2.1-3 apply.</p>								

Table 8.4.2.1-5 PRACH missed detection requirements for High speed Mode restricted set type B

Number of TX antennas	Number of RX antennas	Propagation conditions and correlation matrix (Annex B)	Frequency offset	SNR [dB]			
				Burst format 0	Burst format 1	Burst format 2	Burst format 3
1	2	AWGN	0	-14.5	-14.1	-16.7	-16.8
		AWGN	625	-12.0	-11.7	-13.9	-13.9
		ETU 70 Low	270 Hz	-7.3	-6.9	-9.1	-9.2
		AWGN	1875 Hz	-11.8	-11.4	-13.8	-14.0
		AWGN	1944 Hz	-11.7	-11.4	-13.8	-14.0
	4	AWGN	0	-17.1	-16.6	-19.1	-19.1
		AWGN	625	-14.4	-14.1	-16.1	-16.2
		ETU 70 Low	270 Hz	-11.8	-11.3	-13.5	-13.4
		AWGN	1875 Hz	-14.2	-13.8	-15.9	-16.3
		AWGN	1944 Hz	-14.2	-13.8	-15.9	-16.3
	8	AWGN	0	-19.6	-19.1	-21.2	-21.2
		AWGN	625	-16.4	-16.3	-18.1	-18.2
		ETU 70 Low	270 Hz	-15.3	-15.1	-17.1	-17.5
		AWGN	1875 Hz	-16.3	-16.0	-18.0	-18.4
		AWGN	1944 Hz	-16.3	-16.0	-18.0	-18.4

8.5 Performance requirements for Narrowband IoT

8.5.1 Requirements for NPUSCH format 1

8.5.1.1 Requirements

The performance requirement of NPUSCH format 1 is determined by a minimum required throughput for a given SNR. The required throughput is expressed as a fraction of maximum throughput for the FRCs listed in Annex A16. The performance requirements assume HARQ retransmissions.

An NB-IoT Base Station supports 15 kHz subcarrier spacing requirements, or 3.75 kHz subcarrier spacing requirements, or both.

For 15kHz subcarrier spacing single-subcarrier/multi-subcarrier, the demodulation requirements apply for the supported number of subcarriers.

Table 8.5.1.1-1: Test parameters

Parameter	Value
Maximum number of HARQ transmissions	4
RV sequence	RV0, RV2

8.5.1.1.1 Minimum requirements

The throughput shall be equal to or larger than the fraction of maximum throughput stated in table 8.5.1.1.1-1 for the single-subcarrier of 3.75KHz subcarrier spacing, in table 8.5.1.1.1-2 for 15KHz subcarrier spacing at the given SNR for 1Tx, and in table 8.5.1.1.1-3 for multi-subcarrier of 15KHz subcarrier spacing at the given SNR for 1Tx.

Table 8.5.1.1.1-1: Minimum requirements for NPUSCH format 1, 200KHz Channel Bandwidth, 3.75KHz subcarrier spacing, 1Tx

Number of TX antennas	Number of RX antennas	Subcarrier spacing	Number of allocated subcarriers	Propagation conditions and correlation matrix (Annex B)	FRC (Annex A)	Repetition number	Fraction of maximum throughput	SNR [dB]
1	2	3.75KHz	1	ETU 1Hz Low	A16-1	1	70%	-1.9
						16	70%	-9.2
						64	70%	-12.2

Table 8.5.1.1.1-2: Minimum requirements for NPUSCH format 1, 200KHz Channel Bandwidth, 15KHz subcarrier spacing, single subcarrier, 1Tx

Number of TX antennas	Number of RX antennas	Subcarrier spacing	Number of allocated subcarriers	Propagation conditions and correlation matrix (Annex B)	FRC (Annex A)	Repetition number	Fraction of maximum throughput	SNR [dB]
1	2	15KHz	1	ETU 1Hz Low	A16-2	1	70%	-2.1
						16	70%	-8.8
						64	70%	-12.6

Table 8.5.1.1.1-3: Minimum requirements for NPUSCH format 1, 200KHz Channel Bandwidth, 15KHz subcarrier spacing, multiple subcarriers, 1Tx

Number of TX antennas	Number of RX antennas	Subcarrier spacing	Number of allocated subcarriers	Propagation conditions and correlation matrix (Annex B)	FRC (Annex A)	Repetition number	Fraction of maximum throughput	SNR [dB]
1	2	15KHz	3	ETU 1Hz Low	A16-3	2	70%	-3.0
						16	70%	-8.1
						64	70%	-11.4
			6	ETU 1Hz Low	A16-4	2	70%	-0.6
						16	70%	-6.8
						64	70%	-10.5
			12	ETU 1Hz Low	A16-5	2	70%	-0.7
						16	70%	-6.4
						64	70%	-10.1

Table 8.5.1.1.1-4: Minimum requirements for NPUSCH format 1 with two HARQ processes and multiple TBs with interleaved transmission

Number of TX antennas	Number of RX antennas	Subcarrier spacing	Number of allocated subcarriers	Propagation conditions and correlation matrix (Annex B)	FRC (Annex A)	Repetition number	Fraction of maximum throughput	SNR [dB]
1	2	15KHz	12	ETU 1Hz Low	A16-6	64	70%	-13.9

8.5.2 Performance requirements for NPUSCH format 2

8.5.2.1 DTX to ACK performance

The DTX to ACK probability for NPUSCH format 2 case denotes the probability that ACK is detected when nothing is sent on the wanted signal and only the noise is present per NPUSCH format 2 transmission.

An NB-IoT Base Station supports 15 KHz sub-carrier spacing requirements, or 3.75 KHz sub-carrier spacing requirements, or both.

8.5.2.1.1 Minimum requirement

The DTX to ACK probability, i.e. the probability that ACK is detected when nothing was sent, shall not exceed 1% per NPUSCH format 2 transmission. Where the performance measure definition is as follows:

$$\text{Prob}(\text{NPUSCH format 2 DTX} \rightarrow \text{ACK bits}) = \frac{\#(\text{false ACK bits})}{\#(\text{NPUSCH format 2 DTX}) \times \#(\text{ACK/NAK bits})} \leq 10^{-2}$$

where:

- #(false ACK bits) denotes the number of detected ACK bits.
- #(ACK/NAK bits) denotes the number of HARQ-ACK information bit per NPUSCH format 2 transmission.
- #(NPUSCH format 2 DTX) denotes the number of DTX occasions.

8.5.2.2 ACK missed detection requirements

The ACK missed detection probability is the probability of not detecting an ACK when an ACK was sent per NPUSCH format 2 transmission.

8.5.2.2.1 Minimum requirements

The ACK missed detection probability shall not exceed 1% at the SNR given in table 8.5.2.2.1-1 and table 8.5.2.2.1-2 for 1Tx case.

Table 8.5.2.2.1-1: Minimum requirements for NPUSCH format 2, 200KHz Channel Bandwidth, 3.75KHz subcarrier spacing, 1Tx

Number of TX antennas	Number of RX antennas	Propagation conditions and correlation matrix (Annex B)	Number of allocated subcarriers	Subcarrier spacing	Repetition number	SNR [dB]
1	2	EPA 5 Low	1	3.75KHz	1	7.0
					16	-5.3
					64	-10.9

Table 8.5.2.2.1-2: Minimum requirements for NPUSCH format 2, 200KHz Channel Bandwidth, 15KHz subcarrier spacing, 1Tx

Number of TX antennas	Number of RX antennas	Propagation conditions and correlation matrix (Annex B)	Number of allocated subcarriers	Subcarrier spacing	Repetition number	SNR [dB]
1	2	EPA 5 Low	1	15KHz	1	6.3
					16	-3.9
					64	-9.5

8.5.3 Performance requirements for NPRACH

8.5.3.1 NPRACH False alarm probability

The false alarm requirement is valid for any number of receive antennas, for all repetition numbers and for any number of subcarriers.

The false alarm probability is the conditional total probability of erroneous detection of the preamble (i.e. erroneous detection from any detector) when input is only noise.

8.5.3.1.1 Minimum requirement

The false alarm probability shall be less than or equal to 0.1%.

8.5.3.2 NPRACH detection requirements

The probability of detection is the conditional probability of correct detection of the preamble when the signal is present. There are several error cases – detecting different preamble than the one that was sent, not detecting a preamble at all or correct preamble detection but with the wrong timing estimation. A timing estimation error occurs if the estimation error of the timing of the strongest path is larger than 3.646 μ s. The strongest path for the timing estimation error refers to the strongest path in the power delay profile.

The requirements for TDD are optional and only valid for base stations supporting TDD.

Table 8.5.3.2-1: Test preambles for NPRACH

Parameter	Value
Narrowband physical layer cell identity	0
Initial subcarrier index	0
Uplink-downlink configuration for TDD	1
Special subframe configuration for TDD	7

8.5.3.2.1 Minimum requirements

The probability of detection shall be equal to or exceed 99% for the SNR levels listed in table 8.5.3.2.1-1.

Table 8.5.3.2.1-1: NPRACH missed detection requirements for FDD

Number of TX antennas	Number of RX antennas	Repetition number	Propagation conditions and correlation matrix (Annex B)	Frequency offset	SNR[dB]		
					Preamble format 0	Preamble format 1	Preamble format 2
1	2	8	AWGN	0	-2.1	-2.1	-1.0
			EPA1 Low	200 Hz	6.1	6.1	9.0
		32	AWGN	0	-6.8	-6.8	-5.1
			EPA1 Low	200 Hz	0.5	0.5	2.2

Table 8.5.3.2.1-2: NPRACH missed detection requirements for TDD

Number of TX antennas	Number of RX antennas	Repetition number	Propagation conditions and correlation matrix (Annex B)	Frequency offset	SNR[dB]			
					Preamble format 0	Preamble format 1	Preamble format 0-a	Preamble format 1-a
1	2	8	AWGN	0	5.6	2.5	4.0	1.0
			EPA1 Low	200 Hz	14.7	10.1	13.7	9.0
		32	AWGN	0	0.9	-2.2	-0.7	-3.6
			EPA1 Low	200 Hz	9.8	4.3	10.0	2.5

8.6 Performance requirements for subslot-PUSCH

8.6.1 Requirements

The performance requirement of subslot-PUSCH is determined by a minimum required throughput for a given SNR. The required throughput is expressed as a fraction of maximum throughput for the FRCs listed in Annex A. The performance requirements assume HARQ retransmissions. The requirements defined based on FRC in Annex A.23 apply to the BS supporting subslot-PUSCH.

Table 8.6.1-1: Test parameters for testing subslot-PUSCH

Parameter	Value
Maximum number of HARQ transmissions	4
RV sequence	0, 2, 3, 1, 0, 2, 3, 1
Number of HARQ processes	16

8.6.1.1 Minimum requirements

The throughput shall be equal to or larger than the fraction of maximum throughput stated in the Tables 8.6.1.1-1 to 8.6.1.1-4 at the given SNR for 1Tx.

Table 8.6.1.1-1: Minimum requirements for PUSCH, 5 MHz Channel Bandwidth, 1Tx

Number of TX antennas	Number of RX antennas	Cyclic prefix	Propagation conditions and correlation matrix (Annex B)	FRC (Annex A)	Fraction of maximum throughput	SNR [dB]
1	2	Normal	EPA 5Hz Low	A24-1	70%	12.2
	4	Normal	EPA 5Hz Low	A24-1	70%	8.9

Table 8.6.1.1-2: Minimum requirements for PUSCH, 10 MHz Channel Bandwidth, 1Tx

Number of TX antennas	Number of RX antennas	Cyclic prefix	Propagation conditions and correlation matrix (Annex B)	FRC (Annex A)	Fraction of maximum throughput	SNR [dB]
1	2	Normal	EPA 5Hz Low	A24-2	70%	12.2
	4	Normal	EPA 5Hz Low	A24-2	70%	8.9

Table 8.6.1.1-3: Minimum requirements for PUSCH, 15 MHz Channel Bandwidth, 1Tx

Number of TX antennas	Number of RX antennas	Cyclic prefix	Propagation conditions and correlation matrix (Annex B)	FRC (Annex A)	Fraction of maximum throughput	SNR [dB]
1	2	Normal	EPA 5Hz Low	A24-3	70%	12.2
	4	Normal	EPA 5Hz Low	A24-3	70%	8.8

Table 8.6.1.1-4: Minimum requirements for PUSCH, 20 MHz Channel Bandwidth, 1Tx

Number of TX antennas	Number of RX antennas	Cyclic prefix	Propagation conditions and correlation matrix (Annex B)	FRC (Annex A)	Fraction of maximum throughput	SNR [dB]
1	2	Normal	EPA 5Hz Low	A24-4	70%	12.4
	4	Normal	EPA 5Hz Low	A24-4	70%	9.1

8.7 Performance requirements for SPUCCH

8.7.1 ACK missed detection requirements for single user SPUCCH format 1a

The ACK missed detection probability is the probability of not detecting an ACK when an ACK was sent.

8.7.1.1 Minimum requirements

The ACK missed detection probability shall not exceed 1% at the SNR given in Table 8.7.1.1-1.

Table 8.7.1.1-1: Minimum requirements for single user SPUCCH format 1a, 1Tx

Number of TX antennas	Number of RX antennas	Cyclic Prefix	Propagation conditions and correlation matrix (Annex B)	Channel Bandwidth / SNR [dB]			
				5 MHz	10 MHz	15 MHz	20 MHz
1	2	Normal	EPA 5 Low	3.7	3.6	3.8	3.8
	4	Normal	EPA 5 Low	-0.1	-0.2	-0.1	-0.1

8.7.2 ACK missed detection requirements for SPUCCH format 4

The ACK missed detection probability is the probability of not detecting an ACK bit when an ACK bit was sent on the particular bit position, with each missed ACK bit being accounted as one error.

The number of encoded ACK/NACK bits per subslot is 3. The transmitted subslots include both subslot with $N_{\text{subslot}}^{\text{SPUCCH}} = 2$ and subslot with $N_{\text{subslot}}^{\text{SPUCCH}} = 3$.

8.7.2.1 Minimum requirements

The ACK missed detection probability shall not exceed 1% at the SNR given in table 8.7.2.1-1 for 3 AN bits per subslot.

Table 8.7.2.1-1: Minimum requirements for SPUCCH format 4, 3AN bits

Number of Tx antennas	Number of RX antennas	Cyclic Prefix	Propagation Conditions and correlation matrix (Annex B)	Channel Bandwidth / SNR [dB]			
				5MHz	10 MHz	15MHz	20MHz
1	2	Normal	EPA 5 Low	6.2	6.3	6.2	6.2
	4	Normal	EPA 5 Low	0.5	0.5	0.7	0.8

9 Void

Annex A (normative): Reference measurement channels

The parameters for the reference measurement channels are specified in clause A.1 for E-UTRA reference sensitivity and in-channel selectivity and in clause A.2 for dynamic range.

A schematic overview of the encoding process for the E-UTRA reference measurement channels is provided in Figure A-1.

E-UTRA receiver requirements in the present document are defined with a throughput stated relative to the Maximum throughput of the FRC. The Maximum throughput for an FRC equals the Payload size * the Number of uplink subframes per second. For FDD, 1000 uplink sub-frames per second are used.

The parameters for the reference measurement channels are specified in clause A.12 for NB-IoT reference sensitivity and in clause A.13 for dynamic range.

A schematic overview of the encoding process for the NB-IoT reference measurement channels is provided in Figure A-2.

NB-IoT receiver requirements in the present document are defined with a throughput stated relative to the Maximum throughput of the FRC. The Maximum throughput for an FRC equals the Payload size / (Number of Resource Unit * time to send one Resource Unit).

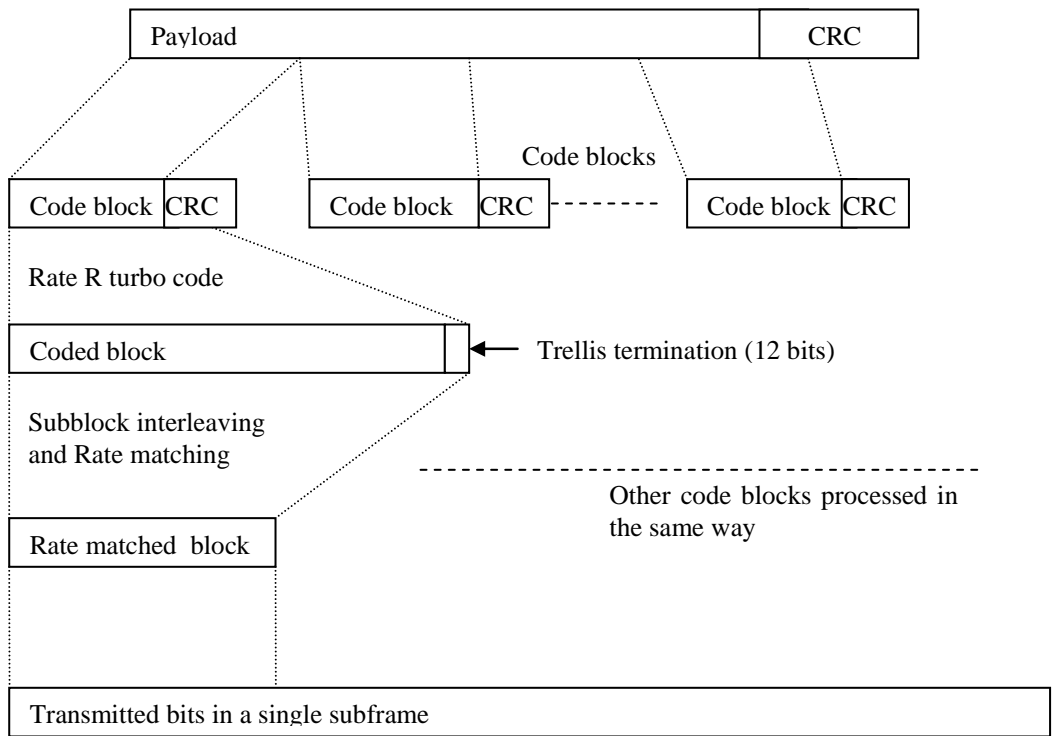

Figure A-1. Schematic overview of the encoding process

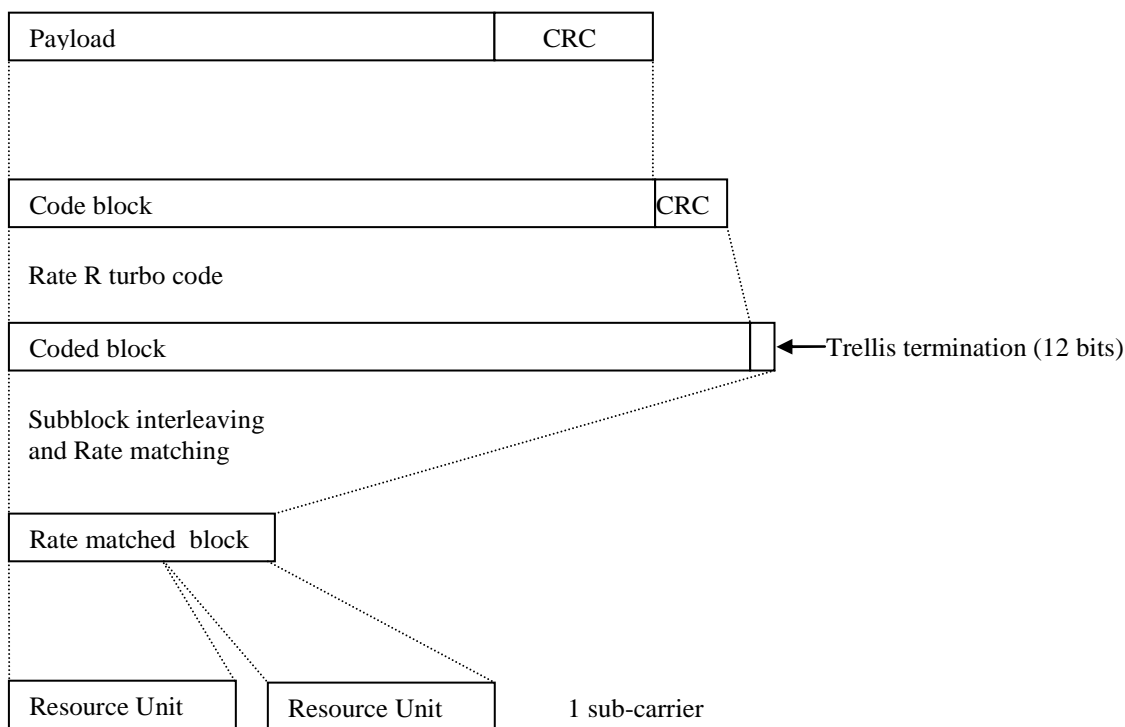

Figure A-2. Schematic overview of the encoding process for NB-IoT

A.1 Fixed Reference Channels for reference sensitivity and in-channel selectivity (QPSK, R=1/3)

The parameters for the reference measurement channels are specified in Table A.1-1 for reference sensitivity and in-channel selectivity.

Table A.1-1 FRC parameters for reference sensitivity and in-channel selectivity

Reference channel	A1-1	A1-2	A1-3	A1-4	A1-5	A1-6	A1-7	A1-8	A1-9
Allocated resource blocks	6	15	25	3	9	12	24	10 ¹	10 ²
DFT-OFDM Symbols per subframe	12	12	12	12	12	12	12	12	12
Modulation	QPSK	QPSK	QPSK	QPSK	QPSK	QPSK	QPSK	QPSK	QPSK
Code rate	1/3	1/3	1/3	1/3	1/3	1/3	1/3	1/3	1/3
Payload size (bits)	600	1544	2216	256	936	1224	2088	1032	1032
Transport block CRC (bits)	24	24	24	24	24	24	24	24	24
Code block CRC size (bits)	0	0	0	0	0	0	0	0	0
Number of code blocks - C	1	1	1	1	1	1	1	1	1
Coded block size including 12bits trellis termination (bits)	1884	4716	6732	852	2892	3756	6348	3180	3180
Total number of bits per sub-frame	1728	4320	7200	864	2592	3456	6912	2880	2880
Total symbols per sub-frame	864	2160	3600	432	1296	1728	3456	1440	1440
NOTE 1: For reference channel A1-8, the allocated RB's are uniformly spaced over the channel bandwidth at RB index N, N+5, N+10, ..., N+45 where N = {0, 1, 2, 3, 4}.									
NOTE 2: For reference channel A1-9, the allocated RB's are uniformly spaced over the channel bandwidth at RB index N, N+10, N+20, ..., N+90 where N = {0, 1, 2, ... 9}.									

A.2 Fixed Reference Channels for dynamic range (16QAM, R=2/3)

The parameters for the reference measurement channels are specified in Table A.2-1 for dynamic range.

Table A.2-1 FRC parameters for dynamic range

Reference channel	A2-1	A2-2	A2-3	A2-4	A2-5
Allocated resource blocks	6	15	25	10 ¹	10 ²
DFT-OFDM Symbols per subframe	12	12	12	12	12
Modulation	16QAM	16QAM	16QAM	16QAM	16QAM
Code rate	2/3	2/3	2/3	2/3	2/3
Payload size (bits)	2344	5992	9912	4008	4008
Transport block CRC (bits)	24	24	24	24	24
Code block CRC size (bits)	0	0	24	0	0
Number of code blocks - C	1	1	2	1	1
Coded block size including 12bits trellis termination (bits)	7116	18060	14988	12108	12108
Total number of bits per sub-frame	3456	8640	14400	5760	5760
Total symbols per sub-frame	864	2160	3600	1440	1440
NOTE 1: For reference channel A2-4, the allocated RB's are uniformly spaced over the channel bandwidth at RB index N, N+5, N+10, ..., N+45 where N = {0, 1, 2, 3, 4}.					
NOTE 2: For reference channel A2-5, the allocated RB's are uniformly spaced over the channel bandwidth at RB index N, N+10, N+20, ..., N+90 where N = {0, 1, 2, ... 9}.					

A.3 Fixed Reference Channels for performance requirements (QPSK 1/3)

Table A.3-1 FRC parameters for performance requirements (QPSK 1/3)

Reference channel	A3-1	A3-2	A3-3	A3-4	A3-5	A3-6	A3-7
Allocated resource blocks	1	6	15	25	50	75	100
DFT-OFDM Symbols per subframe	12	12	12	12	12	12	12
Modulation	QPSK	QPSK	QPSK	QPSK	QPSK	QPSK	QPSK
Code rate	1/3	1/3	1/3	1/3	1/3	1/3	1/3
Payload size (bits)	104	600	1544	2216	5160	6712	10296
Transport block CRC (bits)	24	24	24	24	24	24	24
Code block CRC size (bits)	0	0	0	0	0	24	24
Number of code blocks - C	1	1	1	1	1	2	2
Coded block size including 12bits trellis termination (bits)	396	1884	4716	6732	15564	10188	15564
Total number of bits per sub-frame	288	1728	4320	7200	14400	21600	28800
Total symbols per sub-frame	144	864	2160	3600	7200	10800	14400

A.4 Fixed Reference Channels for performance requirements (16QAM 3/4)

Table A.4-1 FRC parameters for performance requirements (16QAM 3/4)

Reference channel	A4-1	A4-2	A4-3	A4-4	A4-5	A4-6	A4-7	A4-8
Allocated resource blocks	1	1	6	15	25	50	75	100
DFT-OFDM Symbols per subframe	12	10	12	12	12	12	12	12
Modulation	16QAM	16QAM	16QAM	16QAM	16QAM	16QAM	16QAM	16QAM
Code rate	3/4	3/4	3/4	3/4	3/4	3/4	3/4	3/4
Payload size (bits)	408	376	2600	6456	10680	21384	32856	43816
Transport block CRC (bits)	24	24	24	24	24	24	24	24
Code block CRC size (bits)	0	0	0	24	24	24	24	24
Number of code blocks - C	1	1	1	2	2	4	6	8
Coded block size including 12bits trellis termination (bits)	1308	1212	7884	9804	16140	16140	16524	16524
Total number of bits per sub-frame	576	480	3456	8640	14400	28800	43200	57600
Total symbols per sub-frame	144	120	864	2160	3600	7200	10800	14400

A.5 Fixed Reference Channels for performance requirements (64QAM 5/6)

Table A.5-1 FRC parameters for performance requirements (64QAM 5/6)

Reference channel	A5-1	A5-2	A5-3	A5-4	A5-5	A5-6	A5-7
Allocated resource blocks	1	6	15	25	50	75	100
DFT-OFDM Symbols per subframe	12	12	12	12	12	12	12
Modulation	64QAM	64QAM	64QAM	64QAM	64QAM	64QAM	64QAM
Code rate	5/6	5/6	5/6	5/6	5/6	5/6	5/6
Payload size (bits)	712	4392	11064	18336	36696	55056	75376
Transport block CRC (bits)	24	24	24	24	24	24	24
Code block CRC size (bits)	0	0	24	24	24	24	24
Number of code blocks - C	1	1	2	3	6	9	13
Coded block size including 12bits trellis termination (bits)	2220	13260	16716	18444	18444	18444	17484
Total number of bits per sub-frame	864	5184	12960	21600	43200	64800	86400
Total symbols per sub-frame	144	864	2160	3600	7200	10800	14400

A.6 PRACH Test preambles

Table A.6-1 Test preambles for Normal Mode

Burst format	Ncs	Logical sequence index	v
0	13	22	32
1	167	22	2
2	167	22	0
3	0	22	0
4	10	0	0

Table A.6-2 Test preambles for High speed Mode restricted set type A

Burst format	Ncs	Logical sequence index	v
0	15	384	0
1	202	384	0
2	202	384	0
3	237	384	0

Table A.6-3 Test preambles for coverage enhancement

Burst format	Ncs	Logical sequence index	v
0	13	22	32
1	167	22	2
2	167	22	0
3	0	22	0

Table A.6-4 Test preambles for High speed Mode restricted set type B

Burst format	Ncs	Logical sequence index	v
0	15	30	30
1	100	168	20
2	118	204	10
3	137	264	0

A.7 Fixed Reference Channels for UL timing adjustment (Scenario 1)

Table A.7-1 FRC parameters for UL timing adjustment (Scenario 1)

Reference channel	A7-1	A7-2	A7-3	A7-4	A7-5	A7-6
Allocated resource blocks	3	6	12	25	25	25
DFT-OFDM Symbols per subframe	12	12	12	12	12	12
Modulation	16QAM	16QAM	16QAM	16QAM	16QAM	16QAM
Code rate	3/4	3/4	3/4	3/4	3/4	3/4
Payload size (bits)	1288	2600	5160	10680	10680	10680
Transport block CRC (bits)	24	24	24	24	24	24
Code block CRC size (bits)	0	0	0	24	24	24
Number of code blocks - C	1	1	1	2	2	2
Coded block size including 12bits trellis termination (bits)	3948	7884	15564	16140	16140	16140
Total number of bits per sub-frame	1728	3456	6912	14400	14400	14400
Total symbols per sub-frame	432	864	1728	3600	3600	3600
SRS bandwidth configuration (See TS 36.211, 5.5.3) (Note 1)	7	5	3	2	5	2
SRS-Bandwidth b (See TS 36.211, 5.5.3) (Note 1, 2)	0	0	0	0	0	1
NOTE 1. The transmission of SRS is optional						
NOTE 2. PUSCH resource blocks shall be included in SRS resource blocks						

A.8 Fixed Reference Channels for UL timing adjustment (Scenario 2)

Table A.8-1 FRC parameters for UL timing adjustment (Scenario 2)

Reference channel	A8-1	A8-2	A8-3	A8-4	A8-5	A8-6
Allocated resource blocks	3	6	12	25	25	25
DFT-OFDM Symbols per subframe	12	12	12	12	12	12
Modulation	QPSK	QPSK	QPSK	QPSK	QPSK	QPSK
Code rate	1/3	1/3	1/3	1/3	1/3	1/3
Payload size (bits)	256	600	1224	2216	2216	2216
Transport block CRC (bits)	24	24	24	24	24	24
Code block CRC size (bits)	0	0	0	0	0	0
Number of code blocks - C	1	1	1	1	1	1
Coded block size including 12bits trellis termination (bits)	852	1884	3756	6732	6732	6732
Total number of bits per sub-frame	864	1728	3456	7200	7200	7200
Total symbols per sub-frame	432	864	1728	3600	3600	3600
SRS bandwidth configuration (See TS 36.211, 5.5.3) (Note 1)	7	5	3	2	5	2
SRS-Bandwidth b (See TS 36.211, 5.5.3) (Note 1, 2)	0	0	0	0	0	1
NOTE 1. The transmission of SRS is optional						
NOTE 2. PUSCH resource blocks shall be included in SRS resource blocks						

A.9 Multi user PUCCH test

Table A.9-1 Test parameters for multi user PUCCH case

	Resource index for PUCCH formats 1/1a/1b $n_{\text{PUCCH}}^{(1)}$	Relative power [dB]	Relative timing [ns]
Tested signal	2	-	-
Interferer 1	1	0	0
Interferer 2	7	-3	
Interferer 3	14	3	
NOTE1: The following parameters shall be used $N_{\text{ID}}^{\text{cell}} = 150$, $N_{\text{cs}}^{(1)} = 0$ and $\Delta_{\text{shift}}^{\text{PUCCH}} = 2$.			
NOTE2: All above listed signals are transmitted on the same PUCCH resource block, with different PUCCH resource indices as presented above.			

A.10 PUCCH transmission on two antenna ports test

Table A.10-1 Test parameters for PUCCH transmission on two antenna ports case

PUCCH format	Resource indices for two antenna ports
Format 1a	$n_{\text{PUCCH}}^{(1,p=p_0)} = 1$, $n_{\text{PUCCH}}^{(1,p=p_1)} = 2$
Format 2	$n_{\text{PUCCH}}^{(2,p=p_0)} = 1$, $n_{\text{PUCCH}}^{(2,p=p_1)} = 2$
NOTE1: The following parameters shall be used $N_{\text{ID}}^{\text{cell}} = 150$, $N_{\text{cs}}^{(1)} = 0$. For PUCCH format 1a, $\Delta_{\text{shift}}^{\text{PUCCH}} = 2$ is assumed.	
NOTE2: The signals transmitted on two antenna ports are in the same PUCCH resource block with different resource indices as presented above.	

A.11 Fixed Reference Channel for PUSCH with TTI bundling and enhanced HARQ pattern

Table A.11-1 FRC parameters for PUSCH with TTI bundling and enhanced HARQ pattern

Reference channel	A11-1
Allocated resource blocks	3
DFT-OFDM Symbols per subframe	12
Modulation	QPSK
Code rate	11/27*
Payload size (bits)	328
Transport block CRC (bits)	24
Code block CRC size (bits)	0
Number of code blocks - C	1
Coded block size including 12bits trellis termination (bits)	1068
Total number of bits per sub-frame	864
Total symbols per sub-frame	432
Note *: code rate per TTI	

A.12 Fixed Reference Channels for performance requirements (QPSK 0.36)

Table A.12-1 FRC parameters for performance requirements (QPSK 0.36)

Reference channel	A12-1	A12-2	A12-3	A12-4	A12-5	A12-6
Allocated resource blocks	6	15	25	50	75	100
DFT-OFDM Symbols per subframe	12	12	12	12	12	12
Modulation	QPSK	QPSK	QPSK	QPSK	QPSK	QPSK
Code rate	0.36	0.36	0.36	0.36	0.36	0.36
MCS index	6	6	6	6	6	6
Payload size (bits)	600	1544	2600	5160	7736	10296
Transport block CRC (bits)	24	24	24	24	24	24
Code block CRC size (bits)	0	0	0	0	24	24
Number of code blocks - C	1	1	1	1	2	2
Coded block size including 12bits trellis termination (bits)	1884	4716	7884	15564	11724	15564
Total number of bits per sub-frame	1728	4320	7200	14400	21600	28800
Total symbols per sub-frame	864	2160	3600	7200	10800	14400
NOTE 1: FRC A12-1, A12-2, A12-4, A12-6 are identical to A3-2, A3-3, A3-5, A3-7 respectively.						

A.13 Fixed Reference Channels for performance requirements (16QAM 1/2)

Table A.13-1 FRC parameters for performance requirements (16QAM 1/2)

Reference channel	A13-1	A13-2	A13-3	A13-4	A13-5	A13-6
Allocated resource blocks	6	15	25	50	75	100
DFT-OFDM Symbols per subframe	12	12	12	12	12	12
Modulation	16QAM	16QAM	16QAM	16QAM	16QAM	16QAM
Code rate	0.51	0.50	0.50	0.49	0.50	0.49
MCS index	15	15	15	15	15	15
Payload size (bits)	1736	4264	7224	14112	21384	28336
Transport block CRC (bits)	24	24	24	24	24	24
Code block CRC size (bits)	0	0	24	24	24	24
Number of code blocks - C	1	1	2	3	4	5
Coded block size including 12bits trellis termination (bits)	5292	12876	10956	14220	16140	17100
Total number of bits per sub-frame	3456	8640	14400	28800	43200	57600
Total symbols per sub-frame	864	2160	3600	7200	10800	14400

A.14 Fixed Reference Channels for NB-IOT reference sensitivity ($\pi/2$ BPSK, R=1/3)

The parameters for the reference measurement channels are specified in Table A.14-1 for reference sensitivity.

Table A.14-1 FRC parameters for reference sensitivity and in-channel selectivity

Reference channel	A14-1	A14-2
Sub-carrier spacing (kHz)	15	3.75
Number of tone	1	1
Diversity	No	No
Modulation	$\pi/2$ BPSK	$\pi/2$ BPSK
Frequency offset	0	0
Channel estimation length (ms) ^{Note 1}	4	16
Number of NPUSCH repetition	1	1
IMCS / TBS	0 / 0	0 / 0
Payload size (bits)	32	32
Allocated resource unit	2	2
Code rate (target)	1/3	1/3
Code rate (effective)	0.29	0.29
Transport block CRC (bits)	24	24
Code block CRC size (bits)	0	0
Number of code blocks - C	1	1
Total number of bits per resource unit	96	96
Total symbols per resource unit	96	96
Tx time (ms)	16	64
Note 1: Channel estimation lengths are included in the table for information only.		

A.15 Fixed Reference Channels for NB-IoT dynamic range ($\pi/4$ QPSK, R=2/3)

The parameters for the reference measurement channels are specified in Table A.15-1 for NB-IoT dynamic range.

Table A.15-1 FRC parameters for NB-IoT dynamic range

Reference channel	A15-1	A15-2
Sub carrier spacing (kHz)	15	3.75
Number of tone	1	1
Modulation	$\pi/4$ QPSK	$\pi/4$ QPSK
Diversity	No	No
Frequency offset	0	0
IMCS / ITBS	7 / 7	7 / 7
Payload size (bits)	104	104
Allocated resource units	1	1
Transport block CRC (bits)	24	24
Coding rate (target)	2/3	2/3
Coding Rate	0.67	0.67
Code block CRC size (bits)	0	0
Number of code blocks – C	1	1
Total symbols per resource unit	96	96
Total number of bits per resource unit	192	192
Tx time (ms)	8	32
Frequency offset	0	0
Channel estimation length (ms) ^{Note 1}	4	16
Note 1: Channel estimation lengths are included in the table for information only.		

A.16 Fixed Reference Channels for NB-IoT NPUSCH format 1

A.16.1 One PRB

Table A.16.1-1: FRC parameters for NB-IoT NPUSCH format 1

Reference channel	A16-1	A16-2	A16-3	A16-4	A16-5	A16-6
Subcarrier spacing (kHz)	3.75	15	15	15	15	15
Number of allocated subcarriers	1	1	3	6	12	12
Diversity	No	No	No	No	No	No
Modulation	BPSK	BPSK	QPSK	QPSK	QPSK	QPSK
ITBS / IRU	0 / 1	0 / 1	3 / 0	7 / 0	9 / 0	5 / 4
Payload size (bits)	32	32	40	104	136	424
Allocated resource unit	2	2	1	1	1	5
Code rate (target)	1/3	1/3	1/3	1/3	2/3	1/3
Code rate (effective)	0.29	0.29	0.22	0.44	0.56	0.34
Transport block CRC (bits)	24	24	24	24	24	24
Code block CRC size (bits)	0	0	0	0	0	0
Number of code blocks - C	1	1	1	1	1	1
Total number of bits per resource unit	96	96	288	288	288	1440
Total symbols per resource unit	96	96	144	144	144	720
Channel estimation length (ms) ^{Note 1}	16	4	4	4	2 (when repetition = 2) 4 (when repetition > 2)	4
Note 1: Channel estimation lengths are included in the table for information only.						

A.17 Fixed Reference Channels for performance requirements (256QAM 5/6)

Table A.17-1 FRC parameters for performance requirements (256QAM 5/6)

Reference channel	A17-1	A17-2	A17-3	A17-4	A17-5	A17-6
Allocated resource blocks	6	15	25	50	75	100
DFT-OFDM Symbols per subframe	12	12	12	12	12	12
Modulation	256QAM	256QAM	256QAM	256QAM	256QAM	256QAM
Code rate	5/6	5/6	5/6	5/6	5/6	5/6
Payload size (bits)	5544	14112	22920	46888	68808	93800
Transport block CRC (bits)	24	24	24	24	24	24
Code block CRC size (bits)	0	24	24	24	24	24
Number of code blocks - C	1	3	4	8	12	16
Coded block size including 12bits trellis termination (bits)	16716	14220	17292	17676	17292	17676
Total number of bits per sub-frame	6912	17280	28800	57600	86400	115200
Total symbols per sub-frame	864	2160	3600	7200	10800	14400

A.18 Fixed Reference Channels for PUSCH transmission in UpPTS (16QAM 0.65)

Table A.18-1: FRC parameters for PUSCH transmission in UpPTS (16QAM 0.65)

Reference channel	A18-1	A18-2	A18-3	A18-4	A18-5	A18-6
Allocated resource blocks	6	15	25	50	75	100
DFT-OFDM Symbols in UpPTS	5	5	5	5	5	5
Modulation	16QAM	16QAM	16QAM	16QAM	16QAM	16QAM
Code rate	0.65	0.65	0.65	0.65	0.65	0.65
Payload size (bits) (Note 1)	840	2152	3880	7736	12216	15840
Transport block CRC (bits)	24	24	24	24	24	24
Code block CRC size (bits)	0	0	24	24	24	24
Number of code blocks - C	1	1	1	2	2	3
Coded block size including 12bits trellis termination (bits)	2604	6540	17724	11724	18516	15948
Total number of bits in UpPTS	1440	3600	6000	12000	18000	24000
Total symbols in UpPTS	360	900	1500	3000	4500	6000
Note 1:	for special subframe configuration with more than 3 UpPTS SC-FDMA data symbols, the UE shall determine the TBS using $\max\lfloor N_{PRB} \times 0.375 \rfloor, 1\rfloor$.					

A.19 Fixed Reference Channels for PUSCH transmission in UpPTS (256QAM 0.69)

Table A.19-1: FRC parameters for PUSCH transmission in UpPTS (256QAM 0.69)

Reference channel	A19-1	A19-2	A19-3	A19-4	A19-5	A19-6
Allocated resource blocks	6	15	25	50	75	100
DFT-OFDM Symbols in UpPTS	5	5	5	5	5	5
Modulation	256QAM	256QAM	256QAM	256QAM	256QAM	256QAM
Code rate	0.69	0.69	0.69	0.69	0.69	0.69
Payload size (bits)	1864	4584	8248	16416	26416	34008
Transport block CRC (bits)	24	24	24	24	24	24
Code block CRC size (bits)	0	0	24	24	24	24
Number of code blocks - C	1	1	2	3	5	6
Coded block size including 12bits trellis termination (bits)	5767	13836	12492	16524	15948	17100
Total number of bits in UpPTS	2880	7200	12000	24000	36000	48000
Total symbols in UpPTS	360	900	1500	3000	4500	6000
Note 1:	for special subframe configuration with more than 3 UpPTS SC-FDMA data symbols, the UE shall determine the TBS using $\max\lfloor N_{PRB} \times 0.375 \rfloor, 1\rfloor$.					

A.20 Fixed Reference Channels for PUSCH of Frame structure type 3

Table A.20-1: FRC parameters for performance requirements (QPSK 1/3)

Reference channel	A20-1
Uplink resource allocation type	3
Allocated resource blocks	50
DFT-OFDM Symbols per subframe	11
Modulation	QPSK
Code rate	1/3
Payload size (bits)	4392
Transport block CRC (bits)	24
Code block CRC size (bits)	0
Number of code blocks - C	1
Coded block size including 12bits trellis termination (bits)	13260
Total number of bits per sub-frame with the PUSCH starting position at 25 μ s in symbol 0	13200
Total number of bits per sub-frame with the PUSCH starting position at symbol 0	14400
Total symbols per sub-frame with the PUSCH starting position at 25 μ s in symbol 0	6600
Total symbols per sub-frame with the PUSCH starting position at symbol 0	7200
NOTE1:	The PUSCH ending symbol for all scheduled subframes is the last symbol.

Table A.20-2 FRC parameters for performance requirements (16QAM 3/4)

Reference channel	A20-2
Uplink resource allocation type	3
Allocated resource blocks	50
DFT-OFDM Symbols per subframe	11
Modulation	16QAM
Code rate	$\frac{3}{4}$
Payload size (bits)	19848
Transport block CRC (bits)	24
Code block CRC size (bits)	24
Number of code blocks – C	4
Coded block size including 12bits trellis termination (bits)	14988
Total number of bits per the sub-frame with the PUSCH starting position at 25 μ s in symbol 0	26400
Total number of bits per the sub-frame with the PUSCH starting position at symbol 0	28800
Total symbols per the sub-frame with the PUSCH starting position at 25 μ s in symbol 0	6600
Total symbols per the sub-frame with the PUSCH starting position at symbol 0	7200
NOTE1: The PUSCH ending symbol for all scheduled subframes is the last symbol.	

A.21 Fixed Reference Channels for performance requirements (QPSK 3/5)

Table A.21-1 FRC parameters for performance requirements (QPSK 3/5)

Reference channel	A21-1	A21-2	A21-3	A21-4	A21-5	A21-6
Allocated resource blocks	6	15	25	50	75	100
DFT-OFDM Symbols per subframe	12	12	12	12	12	12
Modulation	QPSK	QPSK	QPSK	QPSK	QPSK	QPSK
Code rate	0.61	0.62	0.61	0.61	0.60	0.61
MCS index	10	10	10	10	10	10
Payload size (bits)	1032	2664	4392	8760	12960	17568
Transport block CRC (bits)	24	24	24	24	24	24
Code block CRC size (bits)	0	0	0	24	24	24
Number of code blocks - C	1	1	1	2	3	3
Coded block size including 12bits trellis termination (bits)	3180	8076	13260	13260	13068	17676
Total number of bits per sub-frame	1728	4320	7200	14400	21600	28800
Total symbols per sub-frame	864	2160	3600	7200	10800	14400

A.22 Fixed Reference Channels for performance requirements (64QAM 1/2)

Table A.22-1 FRC parameters for performance requirements (64QAM 1/2)

Reference channel	A22-1	A22-2	A22-3	A22-4
Allocated resource blocks	6	15	25	50
DFT-OFDM Symbols per subframe	12	12	12	12
Modulation	64QAM	64QAM	64QAM	64QAM
Code rate	0.51	0.50	0.50	0.50
MCS index	21	21	21	21
Payload size (bits)	2600	6456	10680	21384
Transport block CRC (bits)	24	24	24	24
Code block CRC size (bits)	0	24	24	24
Number of code blocks - C	1	2	2	4
Coded block size including 12bits trellis termination (bits)	7884	9804	16140	16140
Total number of bits per sub-frame	5184	12960	21600	43200
Total symbols per sub-frame	864	2160	3600	7200

A.23 Fixed Reference Channels for SubPRB allocation reference sensitivity ($\pi/2$ BPSK, R=1/3)

The parameters for the reference measurement channels are specified in Table A.23-1 for reference sensitivity.

Table A.23-1 FRC parameters for reference sensitivity and in-channel selectivity

Reference channel	A23-1
Diversity	No
Allocated resource blocks	1
Number of subcarriers	2 out of 3
DFT-OFDM Symbols per subframe	12
Modulation	$\pi/2$ BPSK
Code rate	1/3
MCS index	0
Payload size (bits)	32
Transport block CRC (bits)	24
Code block CRC size (bits)	0
Number of code blocks - C	1
Total number of bits per resource unit	96*2
Total symbols per resource unit	96*2
Frequency offset	0
Number of RUs	1
Tx time (ms)	8

A.24 Fixed Reference Channel for subslot-PUSCH

Table A.24-1: FRC parameters for performance requirements (16QAM 3/4)

Reference channel	A24-1		A24-2		A24-3		A24-4	
Allocated resource blocks	24		48		72		100	
DFT-OFDM Symbols per subframe	1	2	1	2	1	2	1	2
Modulation	16QAM		16QAM		16QAM		16QAM	
Code rate	3/4		3/4		3/4		3/4	
Payload size (bits)	872	1736	1736	3496	2536	5160	3624	7224
Transport block CRC (bits)	24	24	24	24	24	24	24	24
Code block CRC size (bits)	24	24	24	24	24	24	24	24
Number of code blocks - C	1	1	1	1	1	1	1	2
Coded block size including 12bits trellis termination (bits)	2700	5292	5292	10572	7692	15564	10956	10956
Total number of bits per sub-frame	1152	2304	2304	4608	3456	6912	4800	9600
Total symbols per sub-frame	288	576	576	1152	864	1728	1200	2400

A.25 Fixed Reference Channels for PUSCH with SubPRB transmission

Table A.25-1: FRC parameters for performance requirements (subPRB transmission)

Reference channel	A25-1	A25-2
Diversity	No	No
Allocated resource blocks	1	1
Number of subcarriers	2 out of 3	2 out of 3
DFT-OFDM Symbols per subframe	12	12
Modulation	$\pi/2$ BPSK	$\pi/2$ BPSK
Code rate	1/3	1/3
MCS index	0	0
Payload size (bits)	32	88
Transport block CRC (bits)	24	24
Code block CRC size (bits)	0	0
Number of code blocks - C	1	1
Total number of bits per resource unit	96*2	96*2
Total symbols per resource unit	96*2	96*2
Frequency offset	0	0
Number of RUs	1	2
Tx time (ms)	8	16

Annex B (normative): Propagation conditions

B.1 Static propagation condition

The propagation for the static performance measurement is an Additive White Gaussian Noise (AWGN) environment. No fading or multi-paths exist for this propagation model.

B.2 Multi-path fading propagation conditions

Tables B.2-1 – B.2-3 show multi-path delay profiles that are used for the performance measurements in multi-path fading environment. All taps have classical Doppler spectrum, defined as:

$$(CLASS) \quad S(f) \propto 1/(1 - (f/f_D)^2)^{0.5} \quad \text{for } f \in -f_D, f_D.$$

Table B.2-1 Extended Pedestrian A model (EPA)

Excess tap delay [ns]	Relative power [dB]
0	0.0
30	-1.0
70	-2.0
90	-3.0
110	-8.0
190	-17.2
410	-20.8

Table B.2-2 Extended Vehicular A model (EVA)

Excess tap delay [ns]	Relative power [dB]
0	0.0
30	-1.5
150	-1.4
310	-3.6
370	-0.6
710	-9.1
1090	-7.0
1730	-12.0
2510	-16.9

Table B.2-3 Extended Typical Urban model (ETU)

Excess tap delay [ns]	Relative power [dB]
0	-1.0
50	-1.0
120	-1.0
200	0.0
230	0.0
500	0.0
1600	-3.0
2300	-5.0
5000	-7.0

A multipath fading propagation condition is defined by a combination of a multi-path delay profile and a maximum Doppler frequency f_d which is either 5, 70 or 300 Hz. In addition, 200 Hz Doppler frequency is specified for UL timing adjustment performance requirement.

For carrier aggregation requirements, the fading of the signals for each carrier shall be independent.

B.3 High speed train condition

High speed train conditions are as follows:

Scenario 1 / Scenario 1-LTE500a / Scenario 1-LTE500b: Open space

Scenario 3 / Scenario 3-LTE500a / Scenario 3-LTE500b: Tunnel for multi-antennas

The high speed train conditions for the test of the baseband performance are two non-fading propagation channels in both scenarios. For BS with Rx diversity defined in scenario 1 / Scenario 1-LTE500a / Scenario 1-LTE500b, the Doppler shift variation is the same between antennas.

Doppler shift for both scenarios is given by:

$$f_s(t) = f_d \cos \theta(t) \quad (\text{B.3.1})$$

where $f_s(t)$ is the Doppler shift and f_d is the maximum Doppler frequency. The cosine of angle $\theta(t)$ is given by:

$$\cos \theta(t) = \frac{D_s/2 - vt}{\sqrt{D_{\min}^2 + (D_s/2 - vt)^2}}, \quad 0 \leq t \leq D_s/v \quad (\text{B.3.2})$$

$$\cos \theta(t) = \frac{-1.5D_s + vt}{\sqrt{D_{\min}^2 + (-1.5D_s + vt)^2}}, \quad D_s/v < t \leq 2D_s/v \quad (\text{B.3.3})$$

$$\cos \theta(t) = \cos \theta(t \bmod (2D_s/v)), \quad t > 2D_s/v \quad (\text{B.3.4})$$

where $D_s/2$ is the initial distance of the train from BS, and D_{\min} is BS-Railway track distance, both in meters; v is the velocity of the train in m/s, t is time in seconds.

Doppler shift and cosine angle is given by equation B.3.1 and B.3.2-B.3.4 respectively, where the required input parameters listed in table B.3-1 and B.3-2, and the resulting Doppler shift shown in Figure B.3-1, B.3-2, B.3-3, B.3-4, B.3-5 and B.3-6 are applied for all frequency bands.

Table B.3-1: Parameters for high speed train conditions for UE velocity up to 350 km/h

Parameter	Value	
	Scenario 1	Scenario 3
D_s	1000 m	300 m
D_{\min}	50 m	2 m
v	350 km/h	300 km/h
f_d	1340 Hz	1150 Hz

Table B.3-2: Parameters for high speed train conditions for UE velocity up to 500 km/h

Parameter	Value			
	Scenario 1-LTE500a	Scenario 3-LTE500a	Scenario 1-LTE500b	Scenario 3-LTE500b
D_s	1000 m	300 m	1000 m	300 m
D_{min}	50 m	2 m	50 m	2 m
v	500 km/h	500 km/h	500 km/h	500 km/h
f_d	1944 Hz	1944 Hz	1750 Hz	1750 Hz

NOTE 1: Parameters for HST conditions in table B.3-1 including f_d and Doppler shift trajectories presented on figures B.3-1 and B.3-2 were derived from Band1 and are applied for performance verification in all frequency bands.

NOTE 2: Parameters for scenario 1-LTE500a and scenario 3-LTE500a in table B.3-2 including f_d and Doppler shift trajectories presented on figures B.3-3 and B.3-4 were derived from Band1 and are applied for performance verification in all frequency bands.

NOTE 3: Parameters for scenario 1-LTE500b and scenario 3-LTE500b in table B.3-2 including f_d and Doppler shift trajectories presented on figures B.3-5 and B.3-6 were derived from Band3 and are applied for performance verification in all frequency bands.

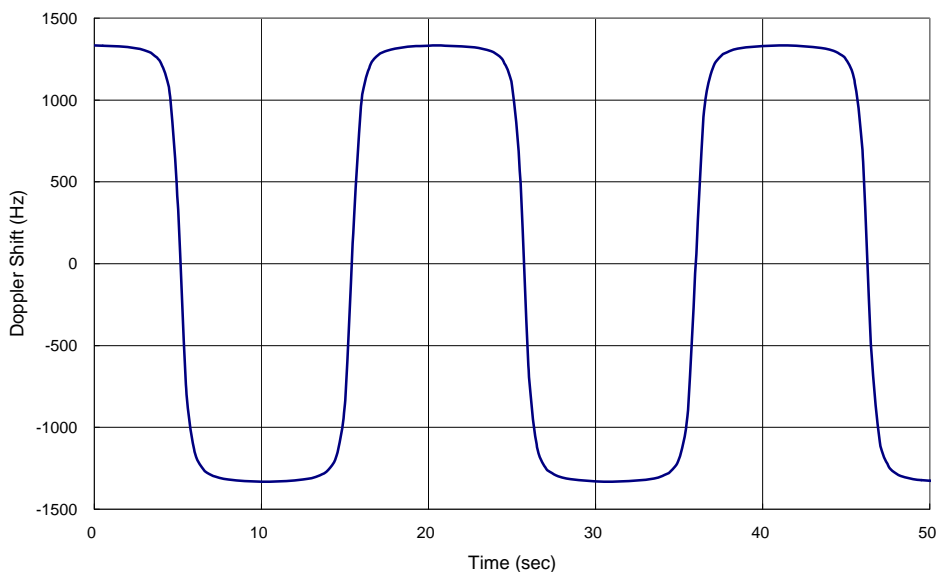

Figure B.3-1: Doppler shift trajectory for scenario 1

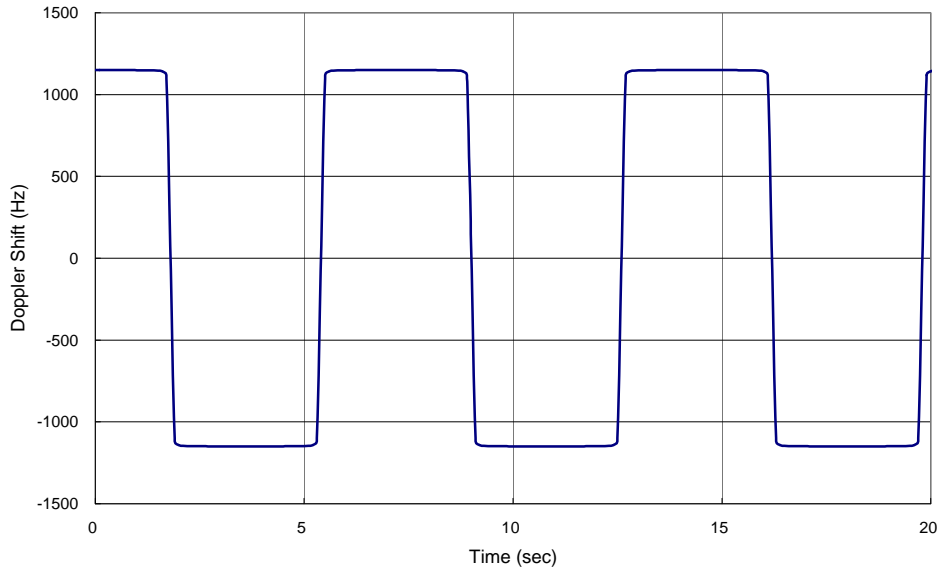

Figure B.3-2: Doppler shift trajectory for scenario 3

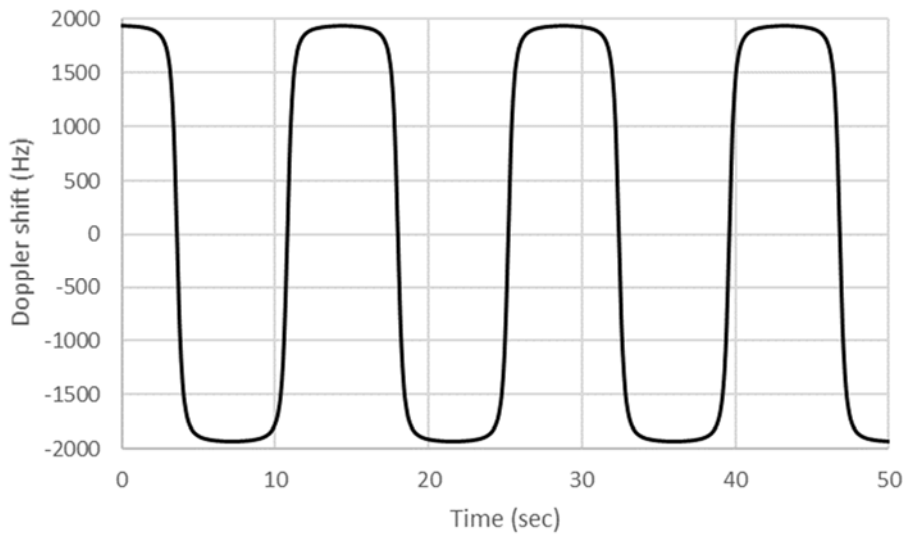

Figure B.3-3: Doppler shift trajectory for scenario 1-LTE500a

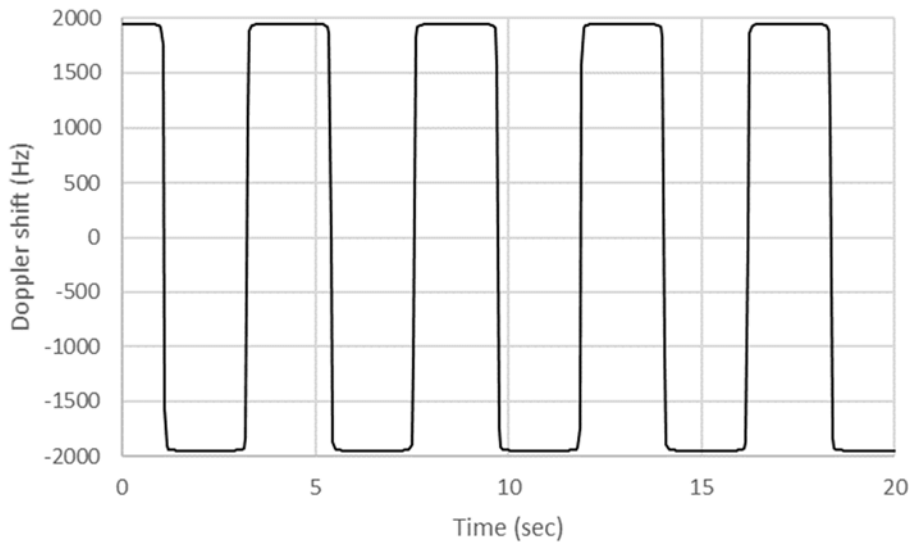

Figure B.3-4: Doppler shift trajectory for scenario 3-LTE500a

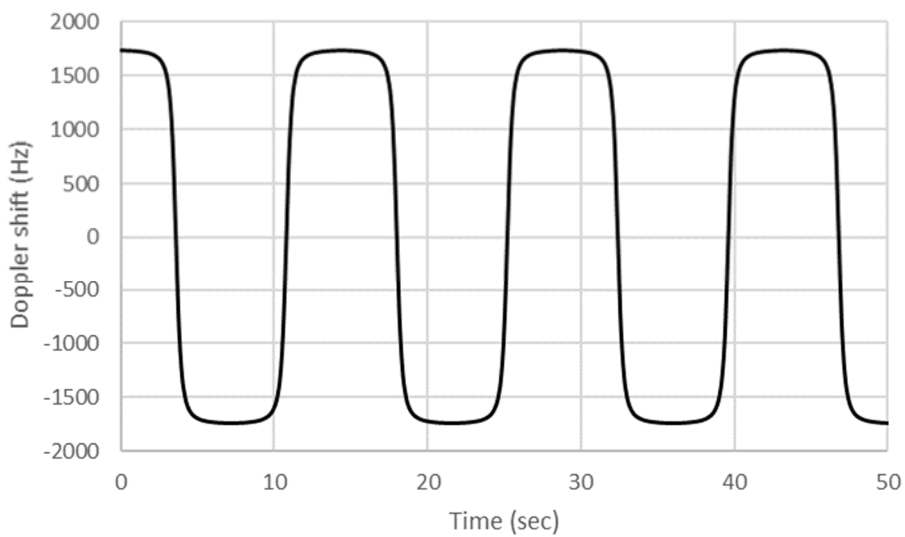

Figure B.3-5: Doppler shift trajectory for scenario 1-LTE500b

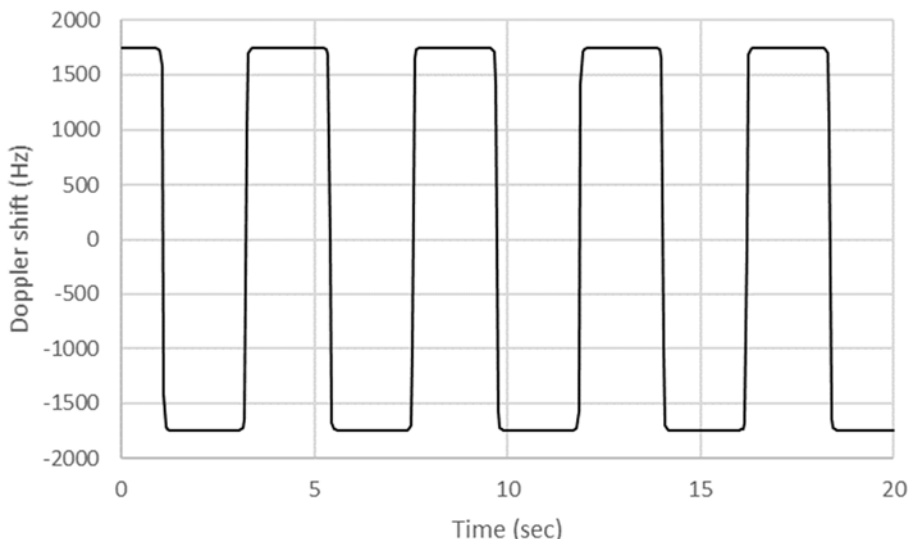

Figure B.3-6: Doppler shift trajectory for scenario 3-LTE500b

B.4 Moving propagation conditions

Figure B.4-1 illustrates the moving propagation conditions for the test of the UL timing adjustment performance. The time difference between the reference timing and the first tap is according Equation (B.4-1). The timing difference between moving UE and stationary UE is equal to $\Delta\tau - (T_A - 31) \times 16T_s$. The relative timing among all taps is fixed. The parameters for the moving propagation conditions are shown in Table B.4-1.

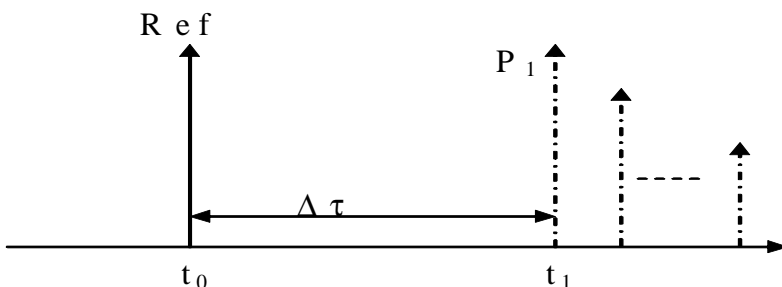

Figure B.4-1: Moving propagation conditions

$$\Delta\tau = \frac{A}{2} \cdot \sin(\Delta\omega \cdot t) \tag{B.4-1}$$

Table B.4-1: Parameters for UL timing adjustment

Parameter	Scenario 1	Scenario 2
Channel model	Stationary UE: AWGN Moving UE: ETU200	AWGN
UE speed	120 km/h	350 km/h
CP length	Normal	Normal
A	10 μ s	10 μ s
$\Delta\omega$	0.04 s ⁻¹	0.13 s ⁻¹

NOTE 1: Multipath fading propagation conditions for Scenario 1 were derived for Band 1 with additional rounding applied to the Doppler frequency calculated for the specified UE speed.

NOTE 2: In Scenario 2, Doppler shift is not taken into account.

B.5 Multi-Antenna channel models

The MIMO channel correlation matrices defined in B.5 apply for the antenna configuration using uniform linear arrays at both UE and eNodeB.

B.5.1 Definition of MIMO Correlation Matrices

Table B.5.1-1 defines the correlation matrix for the eNodeB:

Table B.5.1-1 eNodeB correlation matrix

	One antenna	Two antennas	Four antennas
eNode B Correlation	$R_{eNB} = 1$	$R_{eNB} = \begin{pmatrix} 1 & \alpha \\ \alpha^* & 1 \end{pmatrix}$	$R_{eNB} = \begin{pmatrix} 1 & \alpha^{1/9} & \alpha^{4/9} & \alpha \\ \alpha^{1/9*} & 1 & \alpha^{1/9} & \alpha^{4/9} \\ \alpha^{4/9*} & \alpha^{1/9*} & 1 & \alpha^{1/9} \\ \alpha^* & \alpha^{4/9*} & \alpha^{1/9*} & 1 \end{pmatrix}$

Table B.5.1-2 defines the correlation matrix for the UE:

Table B.5.1-2 UE correlation matrix

	One antenna	Two antennas	Four antennas
UE Correlation	$R_{UE} = 1$	$R_{UE} = \begin{pmatrix} 1 & \beta \\ \beta^* & 1 \end{pmatrix}$	$R_{UE} = \begin{pmatrix} 1 & \beta^{1/9} & \beta^{4/9} & \beta \\ \beta^{1/9*} & 1 & \beta^{1/9} & \beta^{4/9} \\ \beta^{4/9*} & \beta^{1/9*} & 1 & \beta^{1/9} \\ \beta^* & \beta^{4/9*} & \beta^{1/9*} & 1 \end{pmatrix}$

Table B.5.1-3 defines the channel spatial correlation matrix R_{spat} . The parameters α and β in Table B.5.1-3 defines the spatial correlation between the antennas at the eNodeB and UE respectively.

Table B.5.1-3: R_{spat} correlation matrices

1x2 case	$R_{spat} = R_{eNB} = \begin{pmatrix} 1 & \alpha \\ \alpha^* & 1 \end{pmatrix}$
2x2 case	$R_{spat} = R_{UE} \otimes R_{eNB} = \begin{bmatrix} 1 & \beta \\ \beta^* & 1 \end{bmatrix} \otimes \begin{bmatrix} 1 & \alpha \\ \alpha^* & 1 \end{bmatrix} = \begin{bmatrix} 1 & \alpha & \beta & \beta\alpha \\ \alpha^* & 1 & \beta\alpha^* & \beta \\ \beta^* & \beta^*\alpha & 1 & \alpha \\ \beta^*\alpha^* & \beta^* & \alpha^* & 1 \end{bmatrix}$
2x4 case	$R_{spat} = R_{UE} \otimes R_{eNB} = \begin{bmatrix} 1 & \beta \\ \beta^* & 1 \end{bmatrix} \otimes \begin{bmatrix} 1 & \alpha^{1/9} & \alpha^{4/9} & \alpha \\ \alpha^{1/9*} & 1 & \alpha^{1/9} & \alpha^{4/9} \\ \alpha^{4/9*} & \alpha^{1/9*} & 1 & \alpha^{1/9} \\ \alpha^* & \alpha^{4/9*} & \alpha^{1/9*} & 1 \end{bmatrix}$
4x4 case	$R_{spat} = R_{UE} \otimes R_{eNB} = \begin{pmatrix} 1 & \beta^{1/9} & \beta^{4/9} & \beta \\ \beta^{1/9*} & 1 & \beta^{1/9} & \beta^{4/9} \\ \beta^{4/9*} & \beta^{1/9*} & 1 & \beta^{1/9} \\ \beta^* & \beta^{4/9*} & \beta^{1/9*} & 1 \end{pmatrix} \otimes \begin{bmatrix} 1 & \alpha^{1/9} & \alpha^{4/9} & \alpha \\ \alpha^{1/9*} & 1 & \alpha^{1/9} & \alpha^{4/9} \\ \alpha^{4/9*} & \alpha^{1/9*} & 1 & \alpha^{1/9} \\ \alpha^* & \alpha^{4/9*} & \alpha^{1/9*} & 1 \end{bmatrix}$

For cases with more antennas at either eNodeB or UE or both, the channel spatial correlation matrix can still be expressed as the Kronecker product of R_{UE} and R_{eNB} according to $R_{spat} = R_{UE} \otimes R_{eNB}$.

B.5.2 MIMO Correlation Matrices at High, Medium and Low Level

The α and β for different correlation types are given in Table B.5.2-1.

Table B.5.2-1 Correlation for High Medium and Low Level

Low correlation		Medium Correlation		High Correlation	
α	β	α	β	α	β
0	0	0.9	0.3	0.9	0.9

The correlation matrices for high, medium and low correlation are defined in Table B.5.2-2, B.5.2-3 and B.5.2-4 as below.

The values in Table B.5.2-2 have been adjusted for the 2x4 and 4x4 high correlation cases to insure the correlation matrix is positive semi-definite after round-off to 4 digit precision. This is done using the equation:

$$\mathbf{R}_{high} = [\mathbf{R}_{spatial} + a\mathbf{I}_n] / (1 + a)$$

Where the value "a" is a scaling factor such that the smallest value is used to obtain a positive semi-definite result. For the 2x4 high correlation case, a=0.00010. For the 4x4 high correlation case, a=0.00012.

The same method is used to adjust the 4x4 medium correlation matrix in Table B.5.2-3 to insure the correlation matrix is positive semi-definite after round-off to 4 digit precision with a =0.00012.

Table B.5.2-2: MIMO correlation matrices for high correlation

1x2 case	$R_{high} = \begin{pmatrix} 1 & 0.9 \\ 0.9 & 1 \end{pmatrix}$
2x2 case	$R_{high} = \begin{pmatrix} 1 & 0.9 & 0.9 & 0.81 \\ 0.9 & 1 & 0.81 & 0.9 \\ 0.9 & 0.81 & 1 & 0.9 \\ 0.81 & 0.9 & 0.9 & 1 \end{pmatrix}$
2x4 case	$R_{high} = \begin{bmatrix} 1.0000 & 0.9883 & 0.9542 & 0.8999 & 0.8999 & 0.8894 & 0.8587 & 0.8099 \\ 0.9883 & 1.0000 & 0.9883 & 0.9542 & 0.8894 & 0.8999 & 0.8894 & 0.8587 \\ 0.9542 & 0.9883 & 1.0000 & 0.9883 & 0.8587 & 0.8894 & 0.8999 & 0.8894 \\ 0.8999 & 0.9542 & 0.9883 & 1.0000 & 0.8099 & 0.8587 & 0.8894 & 0.8999 \\ 0.8999 & 0.8894 & 0.8587 & 0.8099 & 1.0000 & 0.9883 & 0.9542 & 0.8999 \\ 0.8894 & 0.8999 & 0.8894 & 0.8587 & 0.8587 & 0.9883 & 1.0000 & 0.9542 \\ 0.8587 & 0.8894 & 0.8999 & 0.8894 & 0.9542 & 0.9883 & 1.0000 & 0.9883 \\ 0.8099 & 0.8587 & 0.8894 & 0.8999 & 0.8999 & 0.9542 & 0.9883 & 1.0000 \end{bmatrix}$
4x4 case	$R_{high} = \begin{bmatrix} 1.0000 & 0.9882 & 0.9541 & 0.8999 & 0.9882 & 0.9767 & 0.9430 & 0.8894 & 0.9541 & 0.9430 & 0.9105 & 0.8587 & 0.8999 & 0.8894 & 0.8587 & 0.8099 \\ 0.9882 & 1.0000 & 0.9882 & 0.9541 & 0.9767 & 0.9882 & 0.9767 & 0.9430 & 0.9430 & 0.9541 & 0.9430 & 0.9105 & 0.8894 & 0.8999 & 0.8894 & 0.8587 \\ 0.9541 & 0.9882 & 1.0000 & 0.9882 & 0.9430 & 0.9767 & 0.9882 & 0.9767 & 0.9105 & 0.9430 & 0.9541 & 0.9430 & 0.8587 & 0.8894 & 0.8999 & 0.8894 \\ 0.8999 & 0.9541 & 0.9882 & 1.0000 & 0.8894 & 0.9430 & 0.9767 & 0.9882 & 0.8587 & 0.9105 & 0.9430 & 0.9541 & 0.8099 & 0.8587 & 0.8894 & 0.8999 \\ 0.9882 & 0.9767 & 0.9430 & 0.8894 & 1.0000 & 0.9882 & 0.9541 & 0.8999 & 0.9882 & 0.9767 & 0.9430 & 0.8894 & 0.9541 & 0.9430 & 0.9105 & 0.8587 \\ 0.9767 & 0.9882 & 0.9767 & 0.9430 & 0.9882 & 1.0000 & 0.9882 & 0.9541 & 0.9767 & 0.9882 & 0.9767 & 0.9430 & 0.9430 & 0.9541 & 0.9430 & 0.9105 \\ 0.9430 & 0.9767 & 0.9882 & 0.9767 & 0.9541 & 0.9882 & 1.0000 & 0.9882 & 0.9430 & 0.9767 & 0.9882 & 0.9767 & 0.9105 & 0.9430 & 0.9541 & 0.9430 \\ 0.8894 & 0.9430 & 0.9767 & 0.9882 & 0.8999 & 0.9541 & 0.9882 & 1.0000 & 0.8894 & 0.9430 & 0.9767 & 0.9882 & 0.8587 & 0.9105 & 0.9430 & 0.9541 \\ 0.9541 & 0.9430 & 0.9105 & 0.8587 & 0.9882 & 0.9767 & 0.9430 & 0.8894 & 1.0000 & 0.9882 & 0.9541 & 0.8999 & 0.9882 & 0.9767 & 0.9430 & 0.8894 \\ 0.9430 & 0.9541 & 0.9430 & 0.9105 & 0.9767 & 0.9882 & 0.9767 & 0.9430 & 0.9882 & 1.0000 & 0.9882 & 0.9541 & 0.9767 & 0.9882 & 0.9767 & 0.9430 \\ 0.9105 & 0.9430 & 0.9541 & 0.9430 & 0.9430 & 0.9767 & 0.9882 & 0.9767 & 0.9541 & 0.9882 & 1.0000 & 0.9882 & 0.9430 & 0.9767 & 0.9882 & 0.9767 \\ 0.8587 & 0.9105 & 0.9430 & 0.9541 & 0.8894 & 0.9430 & 0.9767 & 0.9882 & 0.8999 & 0.9541 & 0.9882 & 1.0000 & 0.8894 & 0.9430 & 0.9767 & 0.9882 \\ 0.8999 & 0.8894 & 0.8587 & 0.8099 & 0.9541 & 0.9430 & 0.9105 & 0.8587 & 0.9882 & 0.9767 & 0.9430 & 0.8894 & 1.0000 & 0.9882 & 0.9541 & 0.8999 \\ 0.8894 & 0.8999 & 0.8894 & 0.8587 & 0.9430 & 0.9541 & 0.9430 & 0.9105 & 0.9767 & 0.9882 & 0.9767 & 0.9430 & 0.9882 & 1.0000 & 0.9882 & 0.9541 \\ 0.8587 & 0.8894 & 0.8999 & 0.8894 & 0.9105 & 0.9430 & 0.9541 & 0.9430 & 0.9430 & 0.9767 & 0.9882 & 0.9767 & 0.9541 & 0.9882 & 1.0000 & 0.9882 \\ 0.8099 & 0.8587 & 0.8894 & 0.8999 & 0.8587 & 0.9105 & 0.9430 & 0.9541 & 0.8894 & 0.9430 & 0.9767 & 0.9882 & 0.8999 & 0.9541 & 0.9882 & 1.0000 \end{bmatrix}$

Table B.5.2-3: MIMO correlation matrices for medium correlation

1x2 case	[N/A]
2x2 case	$[R_{medium} = \begin{pmatrix} 1.0000 & 0.9000 & 0.3000 & 0.2700 \\ 0.9000 & 1.0000 & 0.2700 & 0.3000 \\ 0.3000 & 0.2700 & 1.0000 & 0.9000 \\ 0.2700 & 0.3000 & 0.9000 & 1.0000 \end{pmatrix}]$
2x4 case	$[R_{medium} = \begin{pmatrix} 1.0000 & 0.9884 & 0.9543 & 0.9000 & 0.3000 & 0.2965 & 0.2863 & 0.2700 \\ 0.9884 & 1.0000 & 0.9884 & 0.9543 & 0.2965 & 0.3000 & 0.2965 & 0.2863 \\ 0.9543 & 0.9884 & 1.0000 & 0.9884 & 0.2863 & 0.2965 & 0.3000 & 0.2965 \\ 0.9000 & 0.9543 & 0.9884 & 1.0000 & 0.2700 & 0.2863 & 0.2965 & 0.3000 \\ 0.3000 & 0.2965 & 0.2863 & 0.2700 & 1.0000 & 0.9884 & 0.9543 & 0.9000 \\ 0.2965 & 0.3000 & 0.2965 & 0.2863 & 0.9884 & 1.0000 & 0.9884 & 0.9543 \\ 0.2863 & 0.2965 & 0.3000 & 0.2965 & 0.9543 & 0.9884 & 1.0000 & 0.9884 \\ 0.2700 & 0.2863 & 0.2965 & 0.3000 & 0.9000 & 0.9543 & 0.9884 & 1.0000 \end{pmatrix}]$
4x4 case	$[R_{medium} = \begin{pmatrix} 1.0000 & 0.9882 & 0.9541 & 0.8999 & 0.8747 & 0.8645 & 0.8347 & 0.7872 & 0.5855 & 0.5787 & 0.5588 & 0.5270 & 0.3000 & 0.2965 & 0.2862 & 0.2700 \\ 0.9882 & 1.0000 & 0.9882 & 0.9541 & 0.8645 & 0.8747 & 0.8645 & 0.8347 & 0.5787 & 0.5855 & 0.5787 & 0.5588 & 0.2965 & 0.3000 & 0.2965 & 0.2862 \\ 0.9541 & 0.9882 & 1.0000 & 0.9882 & 0.8347 & 0.8645 & 0.8747 & 0.8645 & 0.5588 & 0.5787 & 0.5855 & 0.5787 & 0.2862 & 0.2965 & 0.3000 & 0.2965 \\ 0.8999 & 0.9541 & 0.9882 & 1.0000 & 0.7872 & 0.8347 & 0.8645 & 0.8747 & 0.5270 & 0.5588 & 0.5787 & 0.5855 & 0.2700 & 0.2862 & 0.2965 & 0.3000 \\ 0.8747 & 0.8645 & 0.8347 & 0.7872 & 1.0000 & 0.9882 & 0.9541 & 0.8999 & 0.8747 & 0.8645 & 0.8347 & 0.7872 & 0.5855 & 0.5787 & 0.5588 & 0.5270 \\ 0.8645 & 0.8747 & 0.8645 & 0.8347 & 0.9882 & 1.0000 & 0.9882 & 0.9541 & 0.8645 & 0.8747 & 0.8645 & 0.8347 & 0.5787 & 0.5855 & 0.5787 & 0.5588 \\ 0.8347 & 0.8645 & 0.8747 & 0.8645 & 0.9541 & 0.9882 & 1.0000 & 0.9882 & 0.8347 & 0.8645 & 0.8747 & 0.8645 & 0.5588 & 0.5787 & 0.5855 & 0.5787 \\ 0.7872 & 0.8347 & 0.8645 & 0.8747 & 0.8999 & 0.9541 & 0.9882 & 1.0000 & 0.7872 & 0.8347 & 0.8645 & 0.8747 & 0.5270 & 0.5588 & 0.5787 & 0.5855 \\ 0.5855 & 0.5787 & 0.5588 & 0.5270 & 0.8747 & 0.8645 & 0.8347 & 0.7872 & 1.0000 & 0.9882 & 0.9541 & 0.8999 & 0.8747 & 0.8645 & 0.8347 & 0.7872 \\ 0.5787 & 0.5855 & 0.5787 & 0.5588 & 0.8645 & 0.8747 & 0.8645 & 0.8347 & 0.9882 & 1.0000 & 0.9882 & 0.9541 & 0.8645 & 0.8747 & 0.8645 & 0.8347 \\ 0.5588 & 0.5787 & 0.5855 & 0.5787 & 0.8347 & 0.8645 & 0.8747 & 0.8645 & 0.9541 & 0.9882 & 1.0000 & 0.9882 & 0.8347 & 0.8645 & 0.8747 & 0.8645 \\ 0.5270 & 0.5588 & 0.5787 & 0.5855 & 0.7872 & 0.8347 & 0.8645 & 0.8747 & 0.8999 & 0.9541 & 0.9882 & 1.0000 & 0.7872 & 0.8347 & 0.8645 & 0.8747 \\ 0.3000 & 0.2965 & 0.2862 & 0.2700 & 0.5855 & 0.5787 & 0.5588 & 0.5270 & 0.8747 & 0.8645 & 0.8347 & 0.7872 & 1.0000 & 0.9882 & 0.9541 & 0.8999 \\ 0.2965 & 0.3000 & 0.2965 & 0.2862 & 0.5787 & 0.5855 & 0.5787 & 0.5588 & 0.8645 & 0.8747 & 0.8645 & 0.8347 & 0.9882 & 1.0000 & 0.9882 & 0.9541 \\ 0.2862 & 0.2965 & 0.3000 & 0.2965 & 0.5588 & 0.5787 & 0.5855 & 0.5787 & 0.8347 & 0.8645 & 0.8747 & 0.8645 & 0.9541 & 0.9882 & 1.0000 & 0.9882 \\ 0.2700 & 0.2862 & 0.2965 & 0.3000 & 0.5270 & 0.5588 & 0.5787 & 0.5855 & 0.7872 & 0.8347 & 0.8645 & 0.8747 & 0.8999 & 0.9541 & 0.9882 & 1.0000 \end{pmatrix}]$

Table B.5.2-4: MIMO correlation matrices for low correlation

1x2 case	$R_{low} = \mathbf{I}_2$
1x4 case	$R_{low} = \mathbf{I}_4$
2x2 case	$R_{low} = \mathbf{I}_4$
2x4 case	$R_{low} = \mathbf{I}_8$
4x4 case	$R_{low} = \mathbf{I}_{16}$

In Table B.5.2-4, \mathbf{I}_d is a $d \times d$ identity matrix.

NOTE: For completeness, the 1x2 cases were defined for high, medium and low correlation but for Rel-8 onwards for 1Tx, performance requirements exist only for low correlation.

B.5A Multi-Antenna channel models using cross polarized antennas

The MIMO channel correlation matrices defined in B.5A apply to two cases as presented below:

- One TX antenna and multiple RX antennas case, with cross polarized antennas used at eNodeB

- Multiple TX antennas and multiple RX antennas case, with cross polarized antennas used at both UE and eNodeB

The cross-polarized antenna elements with ± 45 degrees polarization slant angles are deployed at eNB. For one TX antenna case, antenna element with $+90$ degree polarization slant angle is deployed at UE. For multiple TX antennas case, cross-polarized antenna elements with $\pm 90/0$ degrees polarization slant angles are deployed at UE.

For the cross-polarized antennas, the N antennas are labelled such that antennas for one polarization are listed from 1 to $N/2$ and antennas for the other polarization are listed from $N/2+1$ to N , where N is the number of TX or RX antennas.

B.5A.1 Definition of MIMO Correlation Matrices using cross polarized antennas

For the channel spatial correlation matrix, the following is used:

$$R_{Spat} = P_{UL} (R_{UE} \otimes \Gamma_{UL} \otimes R_{eNB}) P_{UL}^T$$

Where

- R_{UE} is the spatial correlation matrix at the UE with same polarization,
- R_{eNB} is the spatial correlation matrix at the eNB with same polarization,
- Γ_{UL} is a polarization correlation matrix,
- P_{UL} is a permutation matrix, and
- $(\bullet)^T$ denotes transpose.

Table B.5A.1-1 defines the polarization correlation matrix.

Table B.5A.1-1 Polarization correlation matrix

	One TX antenna	Multiple TX antennas
Polarization correlation matrix	$\Gamma_{UL} = \begin{bmatrix} 1 & -\gamma \\ -\gamma & 1 \end{bmatrix}$	$\Gamma_{UL} = \begin{bmatrix} 1 & -\gamma & 0 & 0 \\ -\gamma & 1 & 0 & 0 \\ 0 & 0 & 1 & \gamma \\ 0 & 0 & \gamma & 1 \end{bmatrix}$

The matrix P_{UL} is defined as

$$P_{UL}(a,b) = \begin{cases} 1 & \text{for } a = (j-1)Nr + i \text{ and } b = 2(j-1)Nr + i, & i = 1, \dots, Nr, j = 1, \dots, \lceil Nt/2 \rceil \\ 1 & \text{for } a = (j-1)Nr + i \text{ and } b = 2(j - Nt/2)Nr - Nr + i, & i = 1, \dots, Nr, j = \lceil Nt/2 \rceil + 1, \dots, Nt \\ 0 & \text{otherwise} \end{cases}$$

where Nt and Nr is the number of TX and RX antennas respectively, and $\lceil \bullet \rceil$ is the ceiling operator.

The matrix P_{UL} is used to map the spatial correlation coefficients in accordance with the antenna element labelling system described in B.5A.

B.5A.2 Spatial Correlation Matrices at UE and eNB sides

B.5A.2.1 Spatial Correlation Matrices at UE side

For 1-antenna transmitter, $R_{UE} = 1$.

For 2-antenna transmitter using one pair of cross-polarized antenna elements, $R_{UE} = 1$.

For 4-antenna transmitter using two pairs of cross-polarized antenna elements, $R_{UE} = \begin{pmatrix} 1 & \beta \\ \beta^* & 1 \end{pmatrix}$.

B.5A.2.2 Spatial Correlation Matrices at eNB side

For 2-antenna receiver using one pair of cross-polarized antenna elements, $R_{eNB} = 1$.

For 4-antenna receiver using two pairs of cross-polarized antenna elements, $R_{eNB} = \begin{pmatrix} 1 & \alpha \\ \alpha^* & 1 \end{pmatrix}$.

For 8-antenna receiver using four pairs of cross-polarized antenna elements, $R_{eNB} = \begin{pmatrix} 1 & \alpha^{1/9} & \alpha^{4/9} & \alpha \\ \alpha^{1/9*} & 1 & \alpha^{1/9} & \alpha^{4/9} \\ \alpha^{4/9*} & \alpha^{1/9*} & 1 & \alpha^{1/9} \\ \alpha^* & \alpha^{4/9*} & \alpha^{1/9*} & 1 \end{pmatrix}$.

B.5A.3 MIMO Correlation Matrices using cross polarized antennas

The values for parameters α , β and γ for low spatial correlation are given in Table B.5A.3-1.

Table B.5A.3-1 Values for parameters α , β and γ

Low spatial correlation		
α	β	γ
0	0	0
Note 1: Value of α applies when more than one pair of cross-polarized antenna elements at eNB side.		
Note 2: Value of β applies when more than one pair of cross-polarized antenna elements at UE side.		

The correlation matrices for low spatial correlation are defined in Table B.5A.3-2 as below.

Table B.5A.3-2 MIMO correlation matrices for low spatial correlation

1x8 case	$R_{low} = \mathbf{I}_8$
2x8 case	$R_{low} = \mathbf{I}_{16}$

In Table B.5A.3-2, \mathbf{I}_d is a $d \times d$ identity matrix.

B.6 Interference model for enhanced performance requirements type A and type B

This clause provides a description for the modelling of inter-cell interfering UE transmissions for enhanced performance requirements type A and type B, including: definition of dominant interferer proportion, interference model for synchronous scenario and interference model for asynchronous scenario.

B.6.1 Dominant interferer proportion

Each inter-cell interferer involved in enhanced performance requirements type A and type B is characterized by its associated dominant interferer proportion (DIP) value:

$$DIP_i = \frac{\hat{I}_{or(i)}}{N'} \quad (i = 1, \dots, M)$$

where $\hat{I}_{or(i)}$ is the received energy from the i -th strongest inter-cell interferer involved in the requirement scenario and

$N' = \sum_{j=1}^M \hat{I}_{or(j)} + N$ where N is the energy of the white noise source consistent with the definition provided in

clause 8.1 and M is the total number of simultaneously transmitted inter-cell interferers involved in a given requirement scenario.

B.6.2 Interference model for synchronous scenario

This clause provides interference modelling for each explicitly modelled inter-cell interferer in the requirement scenario where the inter-cell interferer(s) are time-synchronous with the tested signal.

In each subframe, each interferer shall transmit 16QAM randomly modulated data over the entire PUSCH region and the same resource blocks as the tested signal. Demodulation reference signal, configured according to Table 8.2.6-1 for enhanced performance requirements type A, and Table 8.2.9-1 to Table 8.2.9-2 for enhanced performance requirements type B, is transmitted associated with the transmission of PUSCH.

B.6.3 Interference model for asynchronous scenario

This clause provides interference modelling for each explicitly modelled inter-cell interferer in the requirement scenario where the inter-cell interferer(s) are time-asynchronous with the tested signal.

Two interfering UEs from the same interfering cell, named interferer 1-1 and interferer 1-2, are modelled. Interferer 1-1 and interferer 1-2 shall transmit 16QAM randomly modulated data over the entire PUSCH region and the same resource blocks as the tested signal, respectively in the even subframes and odd subframes, as illustrated in Figure B.6.3-1. Demodulation reference signal, configured according to Table 8.2.6A-1, is transmitted associated with the transmission of PUSCH. The transmissions of both interferer 1-1 and interferer 1-2 are delayed with respect to the tested signal by 0.33 ms.

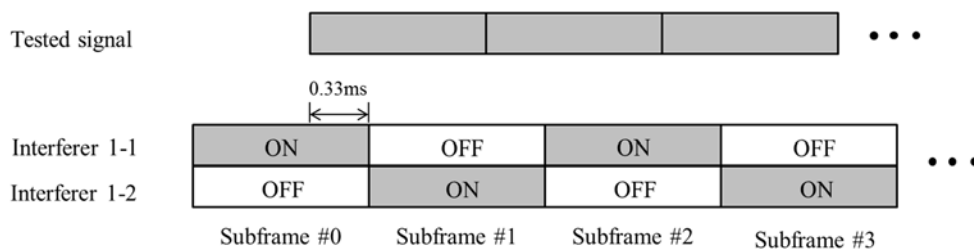

Figure B.6.3-1: Configuration of asynchronous interferers

Annex C (normative): Characteristics of the interfering signals

For E-UTRA or E-UTRA with NB-IoT (in-band and/or guard band operation) BS, the interfering signal shall be a PUSCH containing data and reference symbols. Normal cyclic prefix is used. The data content shall be uncorrelated to the wanted signal and modulated according to clause 5 of TS36.211. Mapping of PUSCH modulation to receiver requirement are specified in table C-1.1.

Table C-1: Modulation of the interfering signal

Receiver requirement	Modulation
In-channel selectivity	16QAM
Adjacent channel selectivity and narrow-band blocking	QPSK
Blocking	QPSK
Receiver intermodulation	QPSK

For NB-IoT standalone BS, the interfering signal shall be a NPUSCH containing data and reference symbols. Normal cyclic prefix is used. The data content shall be uncorrelated to the wanted signal and modulated according to clause 10.1 of TS36.211. Mapping of NPUSCH modulation to receiver requirement are specified in table C-2.

Table C-2: Modulation of the interfering signal – NB-IoT

Receiver requirement	Modulation
Adjacent channel selectivity and narrow-band blocking	$\pi/4$ QPSK
Blocking	$\pi/4$ QPSK
Receiver intermodulation	$\pi/4$ QPSK

Annex D (normative): Environmental requirements for the BS equipment

The BS equipment shall fulfil all the requirements in the full range of environmental conditions for the relevant environmental class from the relevant IEC specifications listed below

60 721-3-3 "Stationary use at weather protected locations" [13]

60 721-3-4 "Stationary use at non weather protected locations" [14]

Normally it should be sufficient for all tests to be conducted using normal test conditions except where otherwise stated. For guidance on the use of test conditions to be used in order to show compliance refer to TS 36.141.

Annex E (normative): Error Vector Magnitude

E.1 Reference point for measurement

The EVM shall be measured at the point after the FFT and a zero-forcing (ZF) equalizer in the receiver, as depicted in Figure E.1-1 below.

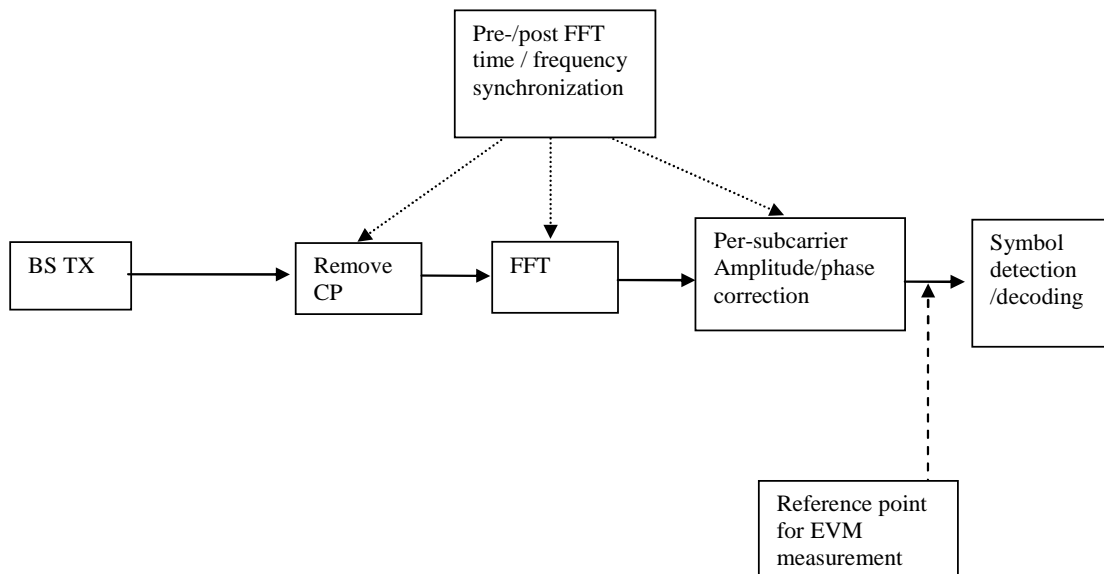

Figure E.1-1: Reference point for EVM measurement

E.2 Basic unit of measurement

For 15 kHz, 7.5 kHz, 1.25 kHz, 2.5 kHz subcarrier spacing, the basic unit of EVM measurement is defined over one subframe (1ms) for subframe TTI and over one sTTI when supporting sTTI feature in the time domain and N_{BW}^{RB} subcarriers (180kHz) in the frequency domain:

For 0.37 kHz subcarrier spacing, the basic unit of EVM measurement is defined over one slot (3ms) in the time domain and N_{BW}^{RB} subcarriers (180kHz) in the frequency domain:

$$EVM = \sqrt{\frac{\sum_{t \in T} \sum_{f \in F(t)} |Z'(t, f) - I(t, f)|^2}{\sum_{t \in T} \sum_{f \in F(t)} |I(t, f)|^2}}$$

where

T is the set of symbols with the considered modulation scheme being active within the subframe or within the sTTI,

$F(t)$ is the set of subcarriers within the N_{BW}^{RB} subcarriers with the considered modulation scheme being active in symbol t ,

$I(t, f)$ is the ideal signal reconstructed by the measurement equipment in accordance with relevant Tx models,

$Z'(t, f)$ is the modified signal under test defined in E.3.

Note: Although the basic unit of measurement is one subframe or one sTTI, the equalizer is calculated over 10 subframe measurement periods to reduce the impact of noise in the reference symbols. The boundaries of the 10 subframe measurement periods need not be aligned with radio frame boundaries.

E.3 Modified signal under test

Implicit in the definition of EVM is an assumption that the receiver is able to compensate a number of transmitter impairments. The signal under test is equalised and decoded according to:

$$Z'(t, f) = \frac{FFT\{z(v - \Delta\tilde{t}) \cdot e^{-j2\pi\Delta\tilde{f}v}\} e^{j2\pi f\Delta\tilde{t}}}{\tilde{a}(f) \cdot e^{j\tilde{\varphi}(f)}}$$

where

$z(v)$ is the time domain samples of the signal under test.

$\Delta\tilde{t}$ is the sample timing difference between the FFT processing window in relation to nominal timing of the ideal signal. Note that two timing offsets are determined, the corresponding EVM is measured and the maximum used as described in E.7.

$\Delta\tilde{f}$ is the RF frequency offset.

$\tilde{\varphi}(f)$ is the phase response of the TX chain.

$\tilde{a}(f)$ is the amplitude response of the TX chain.

E.4 Estimation of frequency offset

The observation period for determining the frequency offset $\Delta\tilde{f}$ shall be 1 ms.

For 0.37 kHz, the observation period for determining the frequency offset $\Delta\tilde{f}$ shall be 6 ms. For 2.5 kHz, the observation period for determining the frequency offset $\Delta\tilde{f}$ shall be 1 ms.

E.5 Estimation of time offset

The observation period for determining the sample timing difference $\Delta\tilde{t}$ shall be 1 ms.

For 0.37 kHz, the observation period for determining the sample timing difference $\Delta\tilde{t}$ shall be 6 ms.

For 2.5 kHz, the observation period for determining the sample timing difference $\Delta\tilde{t}$ shall be 1 ms.

In the following $\Delta\tilde{t}$ represents the middle sample of the EVM window of length w (defined in E.5.1) or the last sample of the first window half if w is even.

$\Delta\tilde{t}$ is estimated so that the EVM window of length w is centred on the measured cyclic prefix of the considered OFDM symbol. To minimize the estimation error the timing shall be based on the primary synchronization signal and reference signals. To limit time distortion of any transmit filter the reference signals in the 1 outer RBs are not taken into account in the timing estimation

Two values for $\Delta\tilde{t}$ are determined:

$$\Delta\tilde{t}_l = \Delta\tilde{c} + \alpha - \left\lfloor \frac{W}{2} \right\rfloor \text{ and}$$

$$\Delta\tilde{t}_h = \Delta\tilde{c} + \left\lfloor \frac{W}{2} \right\rfloor \text{ where } \alpha = 0 \text{ if } W \text{ is odd and } \alpha = 1 \text{ if } W \text{ is even.}$$

When the cyclic prefix length varies from symbol to symbol (e.g. time multiplexed MBMS and unicast) then T shall be further restricted to the subset of symbols with the considered modulation scheme being active and with the considered cyclic prefix length type.

E.5.1 Window length

Table E.5.1-1 and Table E.5.1-1a below specify EVM window length (W) for normal CP, the cyclic prefix length N_{cp} is 160 for symbols 0 and 144 for symbols 1-6.

Table E.5.1-2, Table E.5.1-2a, Table E.5.1-2b, Table E.5.1-2c and Table E.5.1-2d specify the EVM window length (W) for extended CP for 15 kHz, 7.5 kHz, 1.25 kHz, 2.5 kHz and 0.37 kHz sub-carrier spacing, the cyclic prefix length N_{cp} is 512, 1024, 6144, 3072 and 9208 respectively.

Table E.5.1-1: EVM window length for normal CP for E-UTRA

Channel Bandwidth MHz	FFT size		Cyclic prefix length for symbols 0 in FFT samples	Cyclic prefix length for symbols 1-6 in FFT samples	EVM window length W	Ratio of W to total CP for symbols 1-6 (Note 1) [%]
1.4	128		10	9	5	55.6
3	256		20	18	12	66.7
5	512		40	36	32	88.9
10	1024		80	72	66	91.7
15	1536		120	108	102	94.4
20	2048		160	144	136	94.4

Note 1: These percentages are informative and apply to symbols 1 through 6. Symbol 0 has a longer CP and therefore a lower percentage.

Table E.5.1-1a: EVM window length for normal CP for NB-IoT

FFT size	Cyclic prefix length for symbols 0 in FFT samples	Cyclic prefix length for symbols 1-6 in FFT samples	EVM window length W	Ratio of W to total CP for symbols 1-6 (Note 1) [%]
128	10	9	3	33.3

Note 1: These percentages are informative and apply to symbols 1 through 6. Symbol 0 has a longer CP and therefore a lower percentage.

Table E.5.1-2 EVM window length for extended CP for 15 kHz sub-carrier spacing

Channel Bandwidth [MHz]	FFT size	Cyclic prefix in FFT samples	EVM window length W	Ratio of W to total CP (Note 1) [%]
1.4	128	32	28	87.5
3	256	64	58	90.6
5	512	128	124	96.9
10	1024	256	250	97.7
15	1536	384	378	98.4
20	2048	512	504	98.4

Note 1: These percentages are informative.

Table E.5.1-2a EVM window length for extended CP for 7.5 kHz sub-carrier spacing

Channel Bandwidth [MHz]	FFT size	Cyclic prefix in FFT samples	EVM window length W	Ratio of W to total CP (Note 1) [%]
1.4	256	64	56	87.5
3	512	128	116	90.6
5	1024	256	248	96.9
10	2048	512	500	97.7
15	3072	768	756	98.4
20	4096	1024	1008	98.4

Note 1: These percentages are informative.

Table E.5.1-2b EVM window length for extended CP for 1.25 kHz sub-carrier spacing

Channel Bandwidth [MHz]	FFT size	Cyclic prefix in FFT samples	EVM window length W	Ratio of W to total CP (Note 1) [%]
1.4	1536	384	336	87.5
3	3072	768	696	90.6
5	6144	1536	1488	96.9
10	12288	3072	3000	97.7
15	18432	4608	4536	98.4
20	24576	6144	6048	98.4

Note 1: These percentages are informative.

Table E.5.1-2c EVM window length for extended CP for 2.5 kHz sub-carrier spacing

Channel Bandwidth [MHz]	FFT size	Cyclic prefix in FFT samples	EVM window length W	Ratio of W to total CP (Note 1) [%]
1.4	768	192	168	87.5
3	1536	384	348	90.6
5	3072	768	746	96.9
10	6144	1536	1500	97.7
15	9216	2304	2268	98.4
20	12288	3072	3024	98.4

Note 1: These percentages are informative.

Table E.5.1-2d EVM window length for extended CP for 0.37 kHz sub-carrier spacing

Channel Bandwidth [MHz]	FFT size	Cyclic prefix in FFT samples	EVM window length W	Ratio of W to total CP (Note 1) [%]
1.4	5184	576	504	87.5
3	10368	1152	1044	90.6
5	20736	2302	2230	96.9
10	41472	4604	4498	97.7
15	62208	6906	6796	98.4
20	82944	9208	9060	98.4
Note 1: These percentages are informative.				

E.6 Estimation of TX chain amplitude and frequency response parameters

The equalizer coefficients $\tilde{a}(f)$ and $\tilde{\varphi}(f)$ are determined as follows:

1. Calculate the complex ratios (amplitude and phase) of the post-FFT acquired signal $Z'(t, f)$ and the post-FFT Ideal signal $I_2(t, f)$, for each reference symbol, over 10 subframes. This process creates a set of complex ratios:

$$a(t, f) \cdot e^{j\varphi(t, f)} = \frac{Z'(t, f)}{I_2(t, f)}$$

Where the post-FFT Ideal signal $I_2(t, f)$ is constructed by the measuring equipment according to the relevant TX specifications, using the following parameters: restricted content: i.e. nominal Reference Symbols and the Primary Synchronisation Channel, (all other modulation symbols are set to 0 V), nominal carrier frequency, nominal amplitude and phase for each applicable subcarrier, nominal timing.

2. Perform time averaging at each reference signal subcarrier of the complex ratios, the time-averaging length is 10 subframes. Prior to the averaging of the phases $\varphi(t_i, f)$ an unwrap operation must be performed according to the following definition: The unwrap operation corrects the radian phase angles of $\varphi(t_i, f)$ by adding multiples of 2π when absolute phase jumps between consecutive time instances t_i are greater than or equal to the jump tolerance of π radians. This process creates an average amplitude and phase for each reference signal subcarrier (i.e. every third subcarrier with the exception of the reference subcarrier spacing across the DC subcarrier).

$$a(f) = \frac{\sum_{i=1}^N a(t_i, f)}{N}$$

$$\varphi(f) = \frac{\sum_{i=1}^N \varphi(t_i, f)}{N}$$

Where N is the number of reference symbol time-domain locations t_i from $Z'(f, t)$ for each reference signal subcarrier f .

3. The equalizer coefficients for amplitude and phase $\hat{a}(f)$ and $\hat{\varphi}(f)$ at the reference signal subcarriers are obtained by computing the moving average in the frequency domain of the time-averaged reference signal subcarriers, i.e. every third subcarrier. The moving average window size is 19. For reference subcarriers at or near the edge of the channel the window size is reduced accordingly as per figure E.6-1.

4. Perform linear interpolation from the equalizer coefficients $\hat{a}(f)$ and $\hat{\phi}(f)$ to compute coefficients $\tilde{a}(f)$, $\tilde{\phi}(f)$ for each subcarrier.

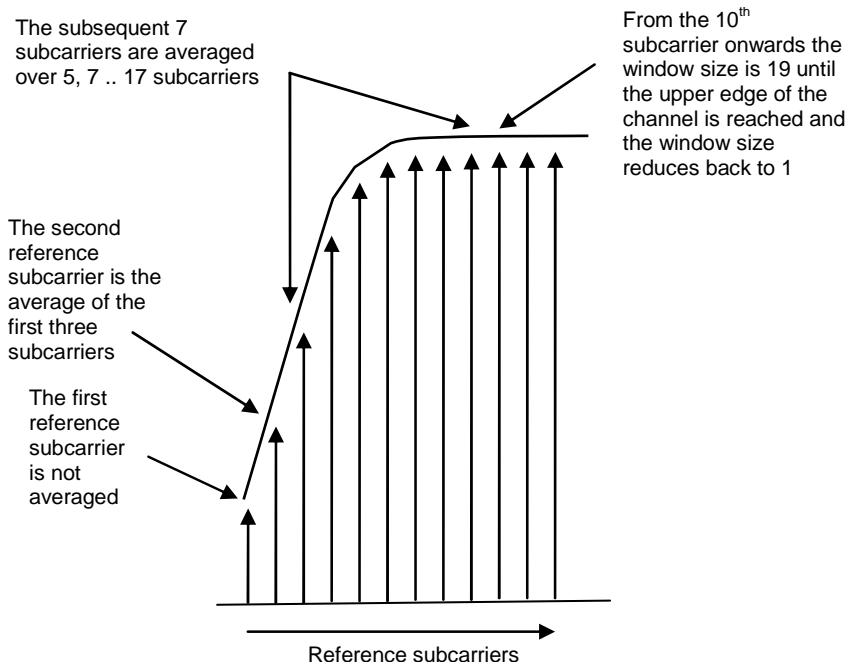

Figure E.6-1: Reference subcarrier smoothing in the frequency domain

E.7 Averaged EVM

EVM is averaged over all allocated downlink resource blocks with the considered modulation scheme in the frequency domain, and a minimum of 10 downlink subframes:

For FDD the averaging in the time domain equals the 10 subframe duration of the 10 subframes measurement period from the equalizer estimation step.

For TDD the averaging in the time domain can be calculated from subframes of different frames and should have a minimum of 10 subframes averaging length. TDD special fields (DwPTS and GP) are not included in the averaging.

$$\overline{EVM}_{frame} = \sqrt{\frac{1}{\sum_{i=1}^{N_{dl}} N_i} \sum_{i=1}^{N_{dl}} \sum_{j=1}^{N_i} EVM_{i,j}^2}$$

Where N_i is the number of resource blocks with the considered modulation scheme in subframe or sTTI i and N_{dl} is the number of allocated downlink subframes or sTTI in one frame.

The EVM requirements shall be tested against the maximum of the RMS average at the window W extremities of the EVM measurements:

Thus \overline{EVM}_{frame} is calculated using $\Delta\tilde{f} = \Delta\tilde{f}_l$ in the expressions above and $\overline{EVM}_{frame,h}$ is calculated using $\Delta\tilde{f} = \Delta\tilde{f}_h$ in the \overline{EVM}_{frame} calculation.

Thus we get:

$$EVM_{frame} = \max(\overline{EVM}_{frame,1}, \overline{EVM}_{frame,h})$$

The averaged EVM with the minimum averaging length of at least 10 subframes is then achieved by further averaging of the EVM_{frame} results

$$\overline{EVM} = \sqrt{\frac{1}{N_{frame}} \sum_{k=1}^{N_{frame}} EVM_{frame,k}^2}, N_{frame} = \left\lceil \frac{10}{N_{dl}} \right\rceil$$

Annex F (Informative): Unwanted emission requirements for multi-carrier BS

F.1 General

In clause 6.6, unwanted emission requirements for single carrier or multi-carrier BS are specified. This multi-carrier BS corresponds to a multi-carrier BS for E-UTRA, or a BS supporting intra-band contiguous CA. The following two pragmatic scenarios are considered in this annex:

- multi-carrier BS of different E-UTRA channel bandwidths, covering all scenarios except the channel bandwidth of the outermost carrier less than 5 MHz
- multi-carrier BS of E-UTRA and UTRA, covering all scenarios except the channel bandwidth of the outermost carrier less than 5 MHz.

All scenarios for channel bandwidths of the outermost carrier less than 5 MHz are for further study. The guidelines below assumes that the power spectral density of the multiple carriers is the same. All other combinations of multiple carriers are ffs.

Note 1: Further information and analysis for these scenarios can be found in TR 36.942 [9].

F.2 Multi-carrier BS of different E-UTRA channel bandwidths

For a multi-carrier E-UTRA BS transmitting a group of carriers of different channel bandwidths, the channel bandwidth of the outermost carriers (≥ 5 MHz) should be considered for ACLR and Operating band unwanted emission requirements. That is, the corresponding requirements for the channel bandwidth of each of the outermost carriers should be applied at the respective side of the group of transmitted carriers.

F.3 Multi-carrier BS of E-UTRA and UTRA

For a multi-carrier BS transmitting a group of carriers of E-UTRA and UTRA, the RAT being used on the outermost carriers (≥ 5 MHz) should be considered for ACLR and Operating band unwanted emission requirements. That is, the corresponding requirements for the RAT being used on each of the outermost carriers should be applied at the respective side of the group of transmitted carriers.

Annex G (Informative): Regional requirement for protection of DTT

G.1 Regional requirement for protection of DTT

The European Communications Committee (ECC) has adopted the "ECC Decision on harmonised conditions for Mobile/Fixed Communications Networks operating in the band 790-862 MHz" [12] applicable for BS operating in band 20. The decision defines a requirement for "Out-of-block BEM baseline requirements for 'mobile/fixed communications network' (MFCN) base stations within the spectrum allocated to the broadcasting (DTT) service", where three different cases A, B, and C for protecting broadcasting DTT are defined. These cases can be applied on a per-channel and/or per-region basis, i.e. for the same channel different cases can be applied in different geographic areas (e.g. area related to DTT coverage) and different cases can be applied to different channels in the same geographic area.

For band 20, compliance with the regulatory requirements in Europe referenced above can be assessed based on the manufacturer's declaration of $P_{EM,N}$ specified in clause 6.6.3.3, together with the deployment characteristics. Maximum output Power in 10 MHz (P_{10MHz}) is also declared by the manufacturer. The parameters G_{ant} and N_{ant} are deployment specific parameters related to the deployment of the BS, where G_{ant} is the antenna gain and N_{ant} is the number of antennas.

For each channel (N) the EIRP level is calculated using: $P_{EIRP,N} = P_{EM,N} + G_{ant} + 10 \cdot \log(N_{ant})$. The regulatory requirement in [12] limits the EIRP level to the Maximum level in Table G-1 for the protection case(s) defined in the regulation.

Table G-1: EIRP limits for protection of broadcasting (DTT) service

Case	Measurement filter centre frequency	Condition on BS maximum aggregate EIRP / 10 MHz, P_{EIRP_10MHz} (Note)	Maximum Level $P_{EIRP,N,MAX}$	Measurement Bandwidth
A: for DTT frequencies where broadcasting is protected	$N \cdot 8 + 306$ MHz, $21 \leq N \leq 60$	$P_{EIRP_10MHz} \geq 59$ dBm	0 dBm	8 MHz
	$N \cdot 8 + 306$ MHz, $21 \leq N \leq 60$	$36 \leq P_{EIRP_10MHz} < 59$ dBm	$P_{EIRP_10MHz} - 59$ dBm	8 MHz
	$N \cdot 8 + 306$ MHz, $21 \leq N \leq 60$	$P_{EIRP_10MHz} < 36$ dBm	-23 dBm	8 MHz
B: for DTT frequencies where broadcasting is subject to an intermediate level of protection	$N \cdot 8 + 306$ MHz, $21 \leq N \leq 60$	$P_{EIRP_10MHz} \geq 59$ dBm	10 dBm	8 MHz
	$N \cdot 8 + 306$ MHz, $21 \leq N \leq 60$	$36 \leq P_{EIRP_10MHz} < 59$ dBm	$P_{EIRP_10MHz} - 49$ dBm	8 MHz
	$N \cdot 8 + 306$ MHz, $21 \leq N \leq 60$	$P_{EIRP_10MHz} < 36$ dBm	-13 dBm	8 MHz
C: for DTT frequencies where broadcasting is not protected	$N \cdot 8 + 306$ MHz, $21 \leq N \leq 60$	N.A.	22 dBm	8 MHz
NOTE: P_{EIRP_10MHz} (dBm) is defined by the expression $P_{EIRP_10MHz} = P_{10MHz} + G_{ant} + 10 \cdot \log_{10}(N_{ant})$				

G.2 Regional requirement for Public Safety LTE BS in Korea

Public Safety LTE (PS-LTE) service, commercial mobile service and Broadcasting are closely allocated for Band 28 in Korea. By making more strong blocking requirements, it provides more flexible site selection to locate for the PS-LTE BS and also it protects the uplink performance degradation. RRA (National Radio Research Agency) Announce 2015-

30, "Article 17 of Technical Requirements of the Other Service Radio Equipment for Simple radio station, Space station and Earth station (Radio Equipment for Integrated Public Network)".

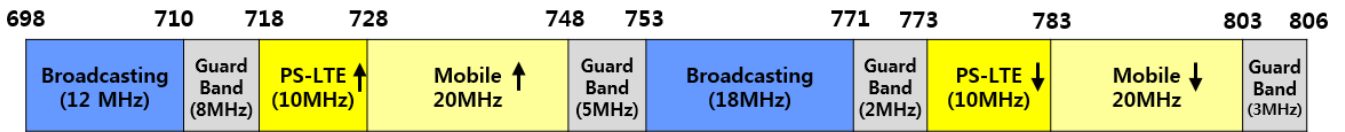

Figure G.2-1 Frequency Allocation in Korea

Table G-2.1: PS-LTE frequency band in Korea

PS- LTE Operating Band	Downlink	Uplink
	[MHz]	[MHz]
28	773 - 783	718 - 728

Table G-2.2: Blocking requirement for Wide Area BS, PS-LTE in Korea

E-UTRA channel bandwidth [MHz]	Wanted signal mean power [dBm]	Interfering signal mean power [dBm]	Interfering signal centre frequency [MHz]	Type of interfering signal
10	$P_{\text{REFSENS}} + 6\text{dB}^*$	-21	701.5, 707.5	5MHz E-UTRA signal
Note*: P_{REFSENS} depends on the channel bandwidth as specified in TS 36.104 [2] clause 7.2.1. Note**: Refer to TS 36.141, E-UTRA Test Mode 1.1 (E-TM1.1) The interfering signal shall be applied to the receiver antenna respectively.				

Table G-2.3: Blocking requirement for Local Area BS, PS-LTE in Korea

E-UTRA channel bandwidth [MHz]	Wanted signal mean power [dBm]	Interfering signal mean power [dBm]	Interfering signal centre frequency [MHz]	Type of interfering signal
10	$P_{\text{REFSENS}} + 6\text{dB}^*$	-13	701.5, 707.5	5MHz E-UTRA signal
Note*: P_{REFSENS} depends on the channel bandwidth as specified in TS 36.104 [2] clause 7.2.1. Note**: Refer to TS 36.141, E-UTRA Test Mode 1.1 (E-TM1.1) The interfering signal shall be applied to the receiver antenna respectively.				

Table G-2.4: Blocking requirement for Home BS, PS-LTE in Korea

E-UTRA channel bandwidth [MHz]	Wanted signal mean power [dBm]	Interfering signal mean power [dBm]	Interfering signal centre frequency [MHz]	Type of interfering signal
10	$P_{\text{REFSENS}} + 22\text{dB}^*$	+3	701.5, 707.5	5MHz E-UTRA signal
Note*: P_{REFSENS} depends on the channel bandwidth as specified in TS 36.104 [2] clause 7.2.1. Note**: Refer to TS 36.141, E-UTRA Test Mode 1.1 (E-TM1.1) The interfering signal shall be applied to the receiver antenna respectively.				

Table G-2.5: Blocking requirement for E-UTRA Medium Range BS, PS-LTE in Korea

E-UTRA channel bandwidth [MHz]	Wanted signal mean power [dBm]	Interfering signal mean power [dBm]	Interfering signal centre	Type of interfering signal
10	$P_{\text{REFSENS}} + 1\text{dB}^*$	-21	701.5, 707.5	5MHz E-UTRA signal
Note*: P_{REFSENS} depends on the channel bandwidth as specified in Table 7.2.1-4. Note**: Refer to TS 36.141, E-UTRA Test Mode 1.1 (E-TM1.1) The interfering signal shall be applied to the receiver antenna respectively.				

Annex H (Informative): Calculation of EIRP based on manufacturer declarations and site specific conditions

H.1 Calculation of EIRP based on manufacturer declarations and site specific conditions

Some regional requirements are defined per effective isotropic radiated power (EIRP), which is a combination of the transmitted power (or in some cases spectral density) and the effective antenna gain which is a site specific condition. Such requirements may be applied per antenna, per cell, or per base station. It shall be noted that the definition of BS or cell may differ between regulations. Where the regulator prescribes a method for EIRP calculation, that method supersedes the proposed assessment in this annex.

The 3GPP specifications mandate manufacturer declarations of the (conducted) output power or power spectral density per connector for the base station under the reference conditions stated as a way to accommodate the referred regional requirements without putting requirements on the local site conditions.

For the case when the base station manufacturer maximum output power or unwanted emission declarations apply per antenna connector, the maximum EIRP can be estimated using the following formulas:

$$\text{EIRP per antenna: } P_{\text{EIRP}} = P_{\text{Tx}} + G_{\text{Ant}}$$

$$\text{EIRP per cell or per BS: } P_{\text{EIRPcell}} = 10 * \log \left(\sum 10^{P_{\text{EIRPn}}/10} \right)$$

In case the EIRP requirement is set per polarisation, the summation shall be made per polarisation.

" P_{EIRP} " is the resulting effective isotropic radiated power (or radiated power spectral density) resulting from the power (or power spectral density) declared by the manufacturer in dBm (or dBm/measurement BW).

" P_{Tx} " is the conducted power or power spectral density declared by the manufacturer in dBm (or dBm/measurement BW)

" G_{Ant} " is the effective antenna gain, calculated as the antenna gain (dBi) minus the loss of the site infrastructure connecting the BS antenna connector with the antenna (dB) for the applied frequency. The antenna nominal gain is only applicable within a certain frequency range.

"n" is the index number of the co-located antennas illuminating the same cell. P_{EIRPn} is the P_{EIRP} of the n:th antenna.

"Cell" is in this annex used in the sense that it is the limited geographical area covered by the carrier transmitted from one site.

Annex I (Informative): Change history

Change history							
Date	Meeting	TDoc	CR	Rev	Ca t	Subject/Comment	New version
2007-08	RAN4#44	R4-071465				TS skeleton created from 3GPP TS template.	0.0.1
2007-10	RAN4#44bis	R4-071709				Agreed TP in RAN4#44: R4-071466 , "TP Common definitions for TS 36.104"	0.0.2
2007-10	RAN4#44bis	R4-071782				Agreed TP in RAN4#44bis: R4-071681 , "TP 36.104: General (6.1)". R4-071740 , "E-UTRA FDD BS general receiver requirements".	0.1.0
2007-11	RAN4#45	R4-072157				Agreed TP in RAN4#45: R4-071854 , "E-UTRA FDD BS Reference sensitivity level" R4-071858 , "E-UTRA FDD BS Receiver intermodulation" R4-071859 , "E-UTRA FDD BS Fixed Reference Channels" R4-071860 , "E-UTRA FDD BS In-channel selectivity" R4-071964 , "TS 36.104: TP for Unwanted emissions (6.6)" R4-071968 , "TS 36.104: TP for Tx Intermodulation (6.7)" R4-071969 , "TS 36.104: TP for Rx spurious emissions (7.6)" R4-072123 , "TS 36.104: TP for General (4)" R4-072124 , "TS 36.104: TP for Operating band unwanted emissions (6.6.3)" R4-072126 , "E-UTRA FDD BS Dynamic range" R4-072127 , "E-UTRA FDD BS Adjacent channel selectivity and narrow band blocking" R4-072128 , "TS 36.104: TP for Propagation conditions for BS (Annex B)" R4-072130 , "E-UTRA FDD BS Blocking" R4-072155 , "TS 36.104: TP for Occupied bandwidth (6.6.1)" R4-072162 , "TP to 36.104 on performance requirements" R4-072177 , "TS 36.104: TP for Frequency bands and channel arrangement (5)" R4-072185 , "TS 36.104: TP for ACLR (6.6.2)" R4-072205 , "TS 36.104: TP for Transmitter spurious emissions (6.6.4)"	0.2.0
2007-11	RAN#38	RP-070975				Presentation to TSG	1.0.0
2007-11						Approved version at TSG RAN #38	8.0.0
2008-03	RAN#39	RP-080123	3	2		Combined updates of E-UTRA BS RF requirements	8.1.0
2008-05	RAN#40	RP-080325	4			Updates of E-UTRA BS requirements	8.2.0
2008-09	RAN#41	RP-080640	7	2		LTE BS ON-OFF Mask	8.3.0
2008-09	RAN#41	RP-080640	8			Removal of brackets for LTE BS RF requirements	8.3.0
2008-09	RAN#41	RP-080640	14	1		Unwanted emission requirements for multi-carrier BS	8.3.0
2008-09	RAN#41	RP-080640	15	2		Clarification of emission requirements for co-existence	8.3.0
2008-09	RAN#41	RP-080640	17	1		eNB performance requirements for UL timing adjustment	8.3.0
2008-09	RAN#41	RP-080640	18			eNodeB performance requirements for PUCCH format 2	8.3.0
2008-09	RAN#41	RP-080640	21			eNB performance requirements for high speed train	8.3.0
2008-09	RAN#41	RP-080640	23			Additional band 17	8.3.0
2008-09	RAN#41	RP-080641	5	2		Updates of Fixed Reference Channels	8.3.0
2008-09	RAN#41	RP-080641	9			Removal of brackets and notes related to test requirements	8.3.0
2008-09	RAN#41	RP-080641	10			High Speed Train scenarios modification	8.3.0
2008-09	RAN#41	RP-080641	12			Several modifications for TS36.104	8.3.0
2008-09	RAN#41	RP-080641	13			Removal of notes on frequency offset	8.3.0
2008-09	RAN#41	RP-080641	16	1		LTE Abbreviations update	8.3.0
2008-09	RAN#41	RP-080641	19	1		eNodeB performance requirements for PUSCH and RF requirements	8.3.0
2008-09	RAN#41	RP-080641	20			Clarification on High Speed train model in 36.104	8.3.0
2008-09	RAN#41	RP-080641	22	1		Clarification of ACLR for multi-carrier E-UTRA BS	8.3.0
2008-12	RAN #42	RP-080914	37	1		Editorial updates of TS 36.104	8.4.0
2008-12	RAN #42	RP-080915	30			Correction to the figure with the transmission bandwidth configuration	8.4.0
2008-12	RAN #42	RP-080916	77			Modification to EARFCN	8.4.0
2008-12	RAN #42	RP-080917	38	1		Alignment of clause 5 between E-UTRA specs	8.4.0
2008-12	RAN #42	RP-080918	26			Correction of output power dynamics requirement	8.4.0
2008-12	RAN #42	RP-080918	27			LTE BS ON-OFF Mask	8.4.0
2008-12	RAN #42	RP-080918	28			Correction to RE power control dynamic range	8.4.0
2008-12	RAN #42	RP-080919	29	1		BS RF requirements for Band 17	8.4.0

2008-12	RAN #42	RP-080920	41		Update of total dynamic range limits	8.4.0
2008-12	RAN #42	RP-080921	39	1	Update of TDD-FDD coexistence requirements	8.4.0
2008-12	RAN #42	RP-080922	33	1	eNB performance requirements for Multi User PUCCH	8.4.0
2008-12	RAN #42	RP-080922	42		PRACH demodulation requirements update	8.4.0
2008-12	RAN #42	RP-080922	25	1	Updates of Fized Reference Channels and requirements for UL timing adjustment and PUCCH format 2	8.4.0
2008-12	RAN #42	RP-080922	44		eNB performance requirements for HARQ-ACK multiplexed on PUSCH	8.4.0
2008-12	RAN #42	RP-080923	43		General updates to Clause 8 and appendix A	8.4.0
2008-12	RAN #42	RP-080925	24		LTE TDD Update for Annex E of 36.104	8.4.0
2008-12	RAN #42	RP-080927	32	1	Clarification of eNB HST propagation conditions	8.4.0
2008-12	RAN #42	RP-080927	31		Corrections of eNB performance requirements for high speed train	8.4.0
2009-03	RAN #43	RP-090173	53	1	Clarification of EARFCN	8.5.0
2009-03	RAN #43	RP-090175	60	1	Regional requirement on maximum rated power for Band 34	8.5.0
2009-03	RAN #43	RP-090176	45		Correction to additional requirements for operating band unwanted emissions	8.5.0
2009-03	RAN #43	RP-090176	48		Clarification of PHS band including the future plan	8.5.0
2009-03	RAN #43	RP-090176	49		Unsynchronized TDD coexistence requirements	8.5.0
2009-03	RAN #43	RP-090176	54		eNB transmitter transient period	8.5.0
2009-03	RAN #43	RP-090176	56	1	eNB ACS frequency offset	8.5.0
2009-03	RAN #43	RP-090176	57		Correction to unwanted emission limit for 3MHz(E-UTRA bands < 1GHz) for Category A	8.5.0
2009-03	RAN #43	RP-090177	46		Modifications on UL timing adjustment test case	8.5.0
2009-03	RAN #43	RP-090177	47	1	Modifications on PUSCH high speed train test case	8.5.0
2009-03	RAN #43	RP-090177	50		Clarification on PUCCH ACK/NAK repetitions for BS performance tests	8.5.0
2009-03	RAN #43	RP-090177	52		PUSCH ACK/NAK simulation assumptions finalization for simulations with implementation margins	8.5.0
2009-03	RAN #43	RP-090177	59		HARQ-ACK multiplexed on PUSCH performance requirement results	8.5.0
2009-05	RAN #44	RP-090544	63		Clarification of requirements for multicarrier BS. (Technically Endorsed CR in R4-50bis - R4-091375)	8.6.0
2009-05	RAN #44	RP-090545	62		CR ACS frequency offset. (Technically Endorsed CR in R4-50bis - R4-091329)	8.6.0
2009-05	RAN #44	RP-090545	67		Correction to DL RS power	8.6.0
2009-05	RAN #44	RP-090545	69		Correction to Receiver Dynamic Range minimum requirements	8.6.0
2009-05	RAN #44	RP-090545	64		UL timing adjustment performance requirement clarifications. (Technically Endorsed CR in R4-50bis - R4-091437)	8.6.0
2009-05	RAN #44	RP-090559	61		Introduction of Extended LTE800 requirements. (Technically Endorsed CR in R4-50bis - R4-091060)	9.0.0
2009-09	RAN #45	RP-090953	71		Clarification of the UL timing adjustment performance determination	9.1.0
2009-09	RAN #45	RP-090953	73		Corrections to E-UTRA Rx requirements	9.1.0
2009-09	RAN #45	RP-090953	78		Clarifications on testing UL timing adjustment requirements	9.1.0
2009-09	RAN #45	RP-090953	90		Correction on Table A.3-1 FRC parameters for performance requirements (QPSK 1/3) of Annex 3	9.1.0
2009-09	RAN #45	RP-090954	86	2	LTE operating band unwanted emissions revision	9.1.0
2009-09	RAN #45	RP-090826	74		Correction of spurious emission requirements for LTE800	9.1.0
2009-12	RP-46	RP-091286	093		Introduction of Extended LTE1500 requirements for TS36.104 (Technically endorsed at RAN 4 52bis in R4-093633)	9.2.0
2009-12	RP-46	RP-091265	095		Correction to ICS requirement (Technically endorsed at RAN 4 52bis in R4-093639)	9.2.0
2009-12	RP-46	RP-091265	097		CR eNB FDD EVM (Technically endorsed at RAN 4 52bis in R4-093713)	9.2.0
2009-12	RP-46	RP-091265	099		Correction on terminology for noise bandwidth (Technically endorsed at RAN 4 52bis in R4-093740)	9.2.0
2009-12	RP-46	RP-091266	101		LTE operating band unwanted emissions correction (Technically endorsed at RAN 4 52bis in R4-093801)	9.2.0
2009-12	RP-46	RP-091266	103		Multi-path fading propagation conditions reference correction (Technically endorsed at RAN 4 52bis in R4-093927)	9.2.0
2009-12	RP-46	RP-091266	105		Clarification on Spurious emissions limits for BS co-existed with another BS (Technically endorsed at RAN 4 52bis in R4-094011)	9.2.0
2009-12	RP-46	RP-091266	106		Correction to the transmitter intermodulation (Technically endorsed at RAN 4 52bis in R4-094084)	9.2.0
2009-12	RP-46	RP-091270	109	1	Clarification on PRACH False alarm probability	9.2.0

2009-12	RP-46	RP-091295	110	1	E-UTRA BS classification	9.2.0
2009-12	RP-46	RP-091295	111	1	Home eNode B maximum output power	9.2.0
2009-12	RP-46	RP-091295	112	1	Home eNode B in-channel selectivity requirement	9.2.0
2009-12	RP-46	RP-091295	113	1	Home eNode B receiver intermodulation requirement	9.2.0
2009-12	RP-46	RP-091293	114	2	Demodulation requirements of Pico NodeB	9.2.0
2009-12	RP-46	RP-091269	116		UL Timing Adjustment test clarifications	9.2.0
2009-12	RP-46	RP-091265	118		Corrections on frequency range of unwanted emissions requirements	9.2.0
2009-12	RP-46	RP-091276	122		Testing in case of Rx diversity, Tx diversity and MIMO	9.2.0
2009-12	RP-46	RP-091265	124		Table reference correction	9.2.0
2009-12	RP-46	RP-091295	125	1	Home eNode B ACLR requirement	9.2.0
2009-12	RP-46	RP-091295	126	1	Home eNode B ACS and narrow band blocking requirement	9.2.0
2009-12	RP-46	RP-091295	127	1	Home eNode B Blocking requirement	9.2.0
2009-12	RP-46	RP-091294	128	1	Home eNode B dynamic range requirement	9.2.0
2009-12	RP-46	RP-091294	129	1	Home eNode B frequency error requirement	9.2.0
2009-12	RP-46	RP-091294	130	2	Home eNode B performance requirement	9.2.0
2009-12	RP-46	RP-091294	131	1	Home eNode B operating band unwanted emissions requirement	9.2.0
2009-12	RP-46	RP-091294	132	1	Home eNode B reference sensitivity level requirement	9.2.0
2009-12	RP-46	RP-091294	133	2	Home eNode B spurious emission requirement	9.2.0
2009-12	RP-46	RP-091284	135	1	Inclusion of Band 20 BS RF parameters	9.2.0
2009-12	RP-46	RP-091265	139		Corrections on blocking performance requirement for Band 17	9.2.0
2009-12	RP-46	RP-091294	140		CR-Protection of Adjacent Channels Owned by Other Operators	9.2.0
2009-12	RP-46	RP-091293	141		Introduction of LTE Pico NodeB class	9.2.0
2010-03	RP-47	RP-100252	155		Correction of the frequency range for unwanted emissions limits (cat-B/option 2/BW 3MHz)	9.3.0
2010-03	RP-47	RP-100252	152		Correction of Band 4 and 10 co-existence requirement	9.3.0
2010-03	RP-47	RP-100262	160		Adding missing references	9.3.0
2010-03	RP-47	RP-100275	145	1	Corrections of operating band unwanted emissions for Local Area BS	9.3.0
2010-03	RP-47	RP-100275	146	1	Editorial correction in TS36.104 for Pico NodeB	9.3.0
2010-03	RP-47	RP-100263	153		Correction of DTT protection requirement	9.3.0
2010-03	RP-47	RP-100266	144		Corrections of operating band unwanted emissions for Home BS	9.3.0
2010-03	RP-47	RP-100266	156		Corrections on Home BS operating band unwanted emission limits	9.3.0
2010-03	RP-47	RP-100266	147		Corrections of additional spurious emissions and blocking requirements for HeNB	9.3.0
2010-03	RP-47	RP-100266	150		Corrections on Home BS Output Power for Adjacent Channel Protection	9.3.0
2010-03	RP-47	RP-100274	157		Requirements for HARQ-ACK multiplexed on PUSCH for E-UTRA LA and Home BS	9.3.0
2010-03	RP-47	RP-100274	158		CQI missed detection requirements for PUCCH format 2 for E-UTRA LA and Home BS	9.3.0
2010-03	RP-47	RP-100274	149	1	Corrections to the receiver intermodulation requirements	9.3.0
2010-06	RP-48	RP-100621	164		Clarification on narrowband blocking requirements	9.4.0
2010-06	RP-48	RP-100621	162		Spurious emissions limits and blocking requirements for coexistence with CDMA850	9.4.0
2010-06	RP-48	RP-100621	167	1	Correction to the FRC for PUSCH 1.4M requirements	9.4.0
2010-06	RP-48	RP-100625	172		Clarification of applicability of requirements for multi-carrier BS	9.4.0
2010-06	RP-48	RP-100631	168		Co-existence with services in adjacent frequency bands	9.4.0
2010-09	RP-49	RP-100920	178		UL Timing Adjustment: Stationary UE propagation channel clarification	9.5.0
2010-09	RP-49	RP-100927	173		CR LTE_TDD_2600_US spectrum band definition additions to TS 36.104	10.0.0
2010-12	RP-50	RP-101327	194		Band 12 channel arrangement correction on 36.104	10.1.0
2010-12	RP-50	RP-101328	190		PUCCH format 2 performance requirements definition clarification	10.1.0
2010-12	RP-50	RP-101328	203		Correction on multi user PUCCH test	10.1.0
2010-12	RP-50	RP-101342	183		Equaliser coefficient derivation for EVM	10.1.0
2010-12	RP-50	RP-101342	186		Corrections on table reference for Local Area BS co-located with another BS	10.1.0
2010-12	RP-50	RP-101342	200		Correction of applicability of requirements	10.1.0
2010-12	RP-50	RP-101356	181	3	CR UMTS/LTE-3500 TDD spectrum band definition additions for BS to TS 36.104	10.1.0
2010-12	RP-50	RP-101358	191		Base Station Rated Output Power with up to 8 Transmit Antennas	10.1.0
2010-12	RP-50	RP-101359	204		Introduction of Carrier Aggregation for LTE in TS 36.104	10.1.0
2011-04	RP-51	RP-110360	179	4	Introduction of L-Band in TS 36.104	10.2.0

2011-04	RP-51	RP-110357	210	2		Band 42 and 43 co-existence for UMTS/LTE 3500 (TDD) for TS 36.104	10.2.0
2011-04	RP-51	RP-110344	212	-		Operating band unwanted emissions for Band 1, 33 and 34 (TS 36.104)	10.2.0
2011-06	RP-52	RP-110794	218			Modifications to Band 3 to allow LTE Band 3 operation in Japan (Rel-10 TS36.104 CR)	10.3.0
2011-06	RP-52	RP-110812	219			Add 2GHz S-Band (Band 23) in 36.104	10.3.0
2011-06	RP-52	RP-110802	224			Co-existence/co-location between Band 42 and 43 in TS 36.104	10.3.0
2011-06	RP-52	RP-110796	225			Harmonization of co-existence between Home BS and WA BS in 36.104	10.3.0
2011-06	RP-52	RP-110807	221	1		LTE CA alignment of definitions in TS 36.104	10.3.0
2011-06	RP-52	RP-110807	220	1		Corrections on LTE Carrier Aggregation requirements	10.3.0
2011-06	RP-52	RP-110804	214	1		Expanded 1900 MHz addition to 36.104	10.3.0
2011-06	RP-52	RP-110795	233	1		Fixing the misalignment of Band 24 GPS Coexistence specifications between 36.104 and 37.104	10.3.0
2011-06	RP-52	RP-110811	223	2		Requirements for HeNB Autonomous Power Setting for Macro-eNB Scenario	10.3.0
2011-09	RP-53	RP-111252	249			Band 3/III operation in Japan	10.4.0
2011-09	RP-53	RP-111255	246	1		Band 42 and 43 for LTE 3500 (TDD) correction to TS 36.104	10.4.0
2011-09	RP-53	RP-111255	247	1		Add Band 22/XXII for LTE/UMTS 3500 (FDD) to TS 36.104	10.4.0
2011-09	RP-53	RP-111259	234	1		Introduction of correlation matrices for UL MIMO	10.4.0
2011-09	RP-53	RP-111260	236	2		Performance requirements for UL-MIMO	10.4.0
2011-09	RP-53	RP-111262	240	1		CR to TS 36.104 Minimum requirements of Operating Band Unwanted Emissions	10.4.0
2011-09	RP-53	RP-111262	244			Co-existence and co-location corrections in 36.104	10.4.0
2011-09	RP-53	RP-111264	245			Band 25/XXV co-existence fix in TS 36.104	10.4.0
2011-09	RP-53	RP-111266	226	2		TS36.104 CR: on PUSCH performance	10.4.0

2011-12	RP-54	RP-111684	254		Correction for uplink demodulation performance	10.5.0
2011-12	RP-54	RP-111734	255		Clarification of general blocking requirements for co-existence in TS 36.104	10.5.0
2011-12	RP-54	RP-111686	256		Requirements for HeNB Power Setting for HeNB-eNB Scenario	10.5.0
2011-12	RP-54	RP-111691	260		CA PUCCH performance requirements for 36.104	10.5.0
2011-12	RP-54	RP-111687	261	2	TX ON or OFF CR 36.104	10.5.0
2011-12	RP-54	RP-111733	262		Correction of frequency range for spurious emission requirements	10.5.0
2012-03	RP-55	RP-120296	265		TS36.104 CR: Add the Tx antenna number for CA PUCCH requirements	10.6.0
2012-03	RP-55	RP-120304	267	1	Definition of synchronized operation	10.6.0
2012-03	RP-55	RP-120295	268	1	Finalizing Home BS Output Power parameter for co-channel E-UTRA protection in 36.104	10.6.0
2012-03	RP-55	RP-120298	272	1	Addition of Band 23 HeNB specifications in 36.104	10.6.0
2012-03	RP-55	RP-120303	273		Editorial corrections in BS output power requirements	10.6.0
2012-03	RP-55	RP-120309	263	2	Introduction of intra-band non-contiguous operation for E-UTRA	11.0.0
2012-03	RP-55	RP-120310	264		TS36.104 change for B41 CA	11.0.0
2012-03	RP-55	RP-120305	274		Introduction of Band 26/XXVI to TS 36.104	11.0.0
2012-06	RP-56	RP-120773	296		Introduction of CA band combination Band4 + Band13 to TS 36.104	11.1.0
2012-06	RP-56	RP-120773	298		Introduction of CA band combination Band4 + Band17 to TS 36.104	11.1.0
2012-06	RP-56	RP-120791	299	2	Introduction of e850_LB (Band 27) to TS 36.104	11.1.0
2012-06	RP-56	RP-120773	280		Introduction of CA band combination Band1 + Band19 to TS 36.104	11.1.0
2012-06	RP-56	RP-120782	294		Time alignment error headline	11.1.0
2012-06	RP-56	RP-120764	305		Correction of PHS protection requirements for TS 36.104	11.1.0
2012-06	RP-56	RP-120788	279	1	Corrections related to intra-band non-contiguous operation for E-UTRA	11.1.0
2012-06	RP-56	RP-120788	285		Introduction of time alignment error requirement for intra-band non-contiguous carrier aggregation	11.1.0
2012-06	RP-56	RP-120793	286		Introduction of APAC700(FDD) into TS 36.104	11.1.0
2012-06	RP-56	RP-120793	292		Introduction of Band 44	11.1.0
2012-09	RP-57	RP-121328	306		Introduction of CA band combination Band2 + Band17 to TS 36.104	11.2.0
2012-09	RP-57	RP-121321	307		Correction to intra-band non-contiguous carrier aggregation bands acronym	11.2.0
2012-09	RP-57	RP-121335	308		Introduction of CA band combination Band1 + Band21 to TS 36.104	11.2.0
2012-09	RP-57	RP-121327	309		Introduction of CA_B7_B20 in 36.104	11.2.0
2012-09	RP-57	RP-121301	312		Introduction of Japanese regulatory requirements for LTE band 8, 36.104 R11	11.2.0
2012-09	RP-57	RP-121340	313	2	Performant requirements of PUCCH format 2 with DTX detection for 36.104	11.2.0
2012-09	RP-57	RP-121334	314	1	Add requirements for inter-band CA of B_1-18 in TS36.104	11.2.0
2012-09	RP-57	RP-121338	315	1	TS 36.104 CR for CA_7	11.2.0
2012-09	RP-57	RP-121340	316	2	Reusing band 41 requirements for the Japan 2.5G TDD band	11.2.0
2012-09	RP-57	RP-121329	317		Introduction of CA band combination Band3 + Band5 to TS 36.104	11.2.0
2012-09	RP-57	RP-121321	318	1	Intra-band non-contiguous CA BS receiver requirement	11.2.0
2012-09	RP-57	RP-121300	324		Modifications of frequency ranges on spurious emission requirements for Band 6, 18, 19	11.2.0
2012-09	RP-57	RP-121331	325		Introduction of CA band combination Band3 + Band20 to TS 36.104	11.2.0
2012-09	RP-57	RP-121333	327		Introduction of CA band combination Band8 + Band20 to TS 36.104	11.2.0
2012-09	RP-57	RP-121324	328		Introduction of CA_B3_B7 in 36.104	11.2.0
2012-12	RP-58	RP-121884	0330		Introduction of CA band combination Band3 + Band8 to TS 36.104	11.3.0
2012-12	RP-58	RP-121861	0331		Introduction of CA band combination Band4 + Band5 to TS 36.104	11.3.0
2012-12	RP-58	RP-121896	0332		Introduction of CA band combination Band5 + Band17 to TS 36.104	11.3.0
2012-12	RP-58	RP-121906	0333		Introduction of medium range BS class to TS 36.104 (clause 1-5)	11.3.0
2012-12	RP-58	RP-121861	0335		Correction of performance requirements of PUCCH format2 with DTX	11.3.0

2012-12	RP-58	RP-121855	0338			Modification of output power requirement for LA E-UTRA BS	11.3.0
2012-12	RP-58	RP-121861	0340			Correction on BS demodulation performance	11.3.0
2012-12	RP-58	RP-121867	0343			Clean up of specification R11	11.3.0
2012-12	RP-58	RP-121911	0344	1		Modification on E-UTRA BS transmitter requirements	11.3.0
2012-12	RP-58	RP-121899	0348	1		Implementing NC CA in LTE LA	11.3.0
2012-12	RP-58	RP-121894	0349			Introduction of CA_B5_B12 in 36.104	11.3.0
2012-12	RP-58	RP-121899	0351			Correction to intra-band non-contiguous carrier aggregation bands acronym	11.3.0
2012-12	RP-58	RP-121906	0352	2		Transmitter characteristics (Clause 6) due to introduction of Medium Range BS	11.3.0
2012-12	RP-58	RP-121906	0353	1		E-UTRA MR BS receiver requirements	11.3.0
2012-12	RP-58	RP-121899	0354	1		Further corrections for NC CA in LTE LA BS	11.3.0
2012-12	RP-58	RP-121887	0355			Introduction of inter-band CA_4-12 into TS 36.104	11.3.0
2012-12	RP-58	RP-121882	0356			Introduction of inter-band CA_11-18 into TS 36.104	11.3.0
2012-12	RP-58	RP-121907	0357			Introduction of new BS classes to E-UTRA core specification (performance part)	11.3.0
2012-12	RP-58	RP-121863	0362			Removal of brackets around medium correlation in table	11.3.0
2012-12	RP-58	RP-121892	0363			Introduction of inter-band CA_4-7 into TS 36.104	11.3.0
2012-12	RP-58	RP-121901	0364			Introduction of Band 29	11.3.0
2012-12	RP-58					Editorial Corrections	11.3.1
2013-03	RP-59	RP-130307	0290	1		TS 36.104 CR for CA_38	11.4.0
2013-03	RP-59	RP-130365	0336	3		CR 36.104: Performant requirements of PUCCH format 2 with DTX detection	11.4.0
2013-03	RP-59	RP-130266	368			Correction of BS performance requirements	11.4.0
2013-03	RP-59	RP-130273	371	1		Supplement some note information for MR BS in TS 36.104	11.4.0
2013-03	RP-59	RP-130273	372	1		Correction of UEM requirements in TS 36.104	11.4.0
2013-03	RP-59	RP-130273	373			Correction to LTE BS classes core requirements	11.4.0
2013-03	RP-59	RP-130284	375	1		Alignment of terminology for intra-band non-contiguous CA requirement	11.4.0
2013-03	RP-59	RP-130287	376			Band 41 requirements for operation in Japan	11.4.0
2013-03	RP-59	RP-130287	377			CR 36.104: Performance requirements of PUCCH format 2 with DTX detection and removal of brackets.	11.4.0
2013-06	RP-60	RP-130769	0378			Correct the interfering signal offsets for ACS requirement for Medium range BS	11.5.0
2013-06	RP-60	RP-130765	0380	1		Editorial correction for the UL-MIMO channel model	11.5.0
2013-06	RP-60	RP-130766	0387			CR on TAE for inter-band CA	11.5.0
2013-06	RP-60	RP-130766	0388	1		Editorial correction of inter band CA table to TS 36.104	11.5.0
2013-06	RP-60	RP-130770	0389			Addition of Bands for intra-band non-contiguous CA for 36.104	11.5.0
2013-06	RP-60	RP-130761	0390			Modification on co-location spurious emission requirement for Medium Range BS	11.5.0
2013-06	RP-60	RP-130769	0391	1		Modification on co-location blocking requirement for E-UTRA Medium Range BS	11.5.0
2013-06	RP-60	RP-130769	0394	1		Introduction of multi-band BS to TS 36.104	11.5.0
2013-06	RP-60	RP-130770	0396	1		Editorial: Figure 5.6-3 Definition of Sub-block Bandwidth for intra-band non-contiguous spectrum.	11.5.0
2013-06	RP-60	RP-130765	0400			CR for UL-MIMO performance requirements	11.5.0
2013-06	RP-60	RP-130771	0366	1		Introduction of CA 1+8 into TS36.104(Rel-12)	12.0.0
2013-06	RP-60	RP-130781	0374	1		Introduction of LTE Advanced inter-band Carrier Aggregation of Band 3 and Band 28 to TS 36.104	12.0.0
2013-06	RP-60	RP-130785	0381			Introduction of LTE Advanced inter-band Carrier Aggregation of Band 23 and Band 29 to TS 36.104	12.0.0
2013-06	RP-60	RP-130779	0383			Introduction of LTE Advanced inter-band carrier aggregation of Band 3 and Band 26 into TS36.104 (Rel-12)	12.0.0
2013-06	RP-60	RP-130777	0384			Introduction of CA band combination Band3 + Band19 to TS 36.104	12.0.0
2013-06	RP-60	RP-130783	0385			Introduction of CA band combination Band19 + Band21 to TS 36.104	12.0.0
2013-06	RP-60	RP-130773	0392			Introduction of inter-band CA combination for Band 2 and Band 4	12.0.0
2013-06	RP-60	RP-130787	0393			Introduction of intra-band non-contiguous CA combination for Band 4	12.0.0
2013-06	RP-60	RP-130791	0395	1		Introduction of US WCS Band (Band 30) to TS 36.104	12.0.0
2013-06	RP-60	RP-130790	0397			Introduction of LTE 450 in Brazil into TS 36.104	12.0.0
2013-06	RP-60	RP-130775	0399	1		Introduction of LTE Advanced Inter-Band Carrier Aggregation of Band 2 and Band 13 to TS36.104	12.0.0
09-2013	RP-61	RP-131300	0401			36.104 CR for LTE_CA_C_B3	12.1.0

09-2013	RP-61	RP-131283	0403			Correction of rated output power of MR BS for E-UTRA (R12)	12.1.0
09-2013	RP-61	RP-131289	0405			Clarification on single-band operation of multi-band BS	12.1.0
09-2013	RP-61	RP-131296	0408			Add requirements for CA_1-26 into TS36.104	12.1.0
09-2013	RP-61	RP-131298	0409			Introduction of inter-band CA Band 2+5	12.1.0
09-2013	RP-61	RP-131285	0413			Non-contiguous intraband CA minimum channel spacing.	12.1.0
12-2013	RP-62	RP-131959	0414			Introduction of intra-band contiguous CA for Band 27	12.2.0
12-2013	RP-62	RP-131965	0415			Introduction of LTE-Advanced intra-band non-contiguous Carrier Aggregation (CA) in Band 23 to TS 36.104	12.2.0
12-2013	RP-62	RP-131946	0416			Introduction of CA band combination Band2 + Band12 to TS 36.104	12.2.0
12-2013	RP-62	RP-131954	0417			Introduction of CA band combination Band12 + Band25 to TS 36.104	12.2.0
12-2013	RP-62	RP-131945	0419	1		PUCCH format 1a performance requirements for 2Tx 8Rx	12.2.0
12-2013	RP-62	RP-131930	0422			Clarification for CA CLR in TS36.104	12.2.0
12-2013	RP-62	RP-131931	0426			Intraband non-contiguous CA minimum channel spacing	12.2.0
12-2013	RP-62	RP-131945	0427	2		PUSCH performance requirements for 2Tx 8Rx	12.2.0
12-2013	RP-62	RP-131945	0428	1		PUSCH performance requirements for 1Tx 8Rx	12.2.0
12-2013	RP-62	RP-131945	0429	1		Single user PUCCH format 1a performance requirements for 8 Rx	12.2.0
12-2013	RP-62	RP-131945	0430	-		Introduction of UL 8Rx channel correlation matrices	12.2.0
12-2013	RP-62	RP-131945	0431	2		Performance requirements for 8Rx PUCCH format 1b, PUCCH format 3 and PRACH	12.2.0
12-2013	RP-62	RP-131957	0432	-		Introduction of LTE-Advanced intra-band contiguous Carrier Aggregation (CA) in Band 23 to TS 36.104	12.2.0
12-2013	RP-62	RP-131961	0433	-		Introduction of Intra-band non-contiguous CA in band 3 to TS 36.104	12.2.0
12-2013	RP-62	RP-131934	0435	-		CR for clarification for receiver requirement on MB-MSR BS	12.2.0
12-2013	RP-62	RP-131930	0438	-		Corrections to requirements for multi-band operation	12.2.0
12-2013	RP-62	RP-131950	0441	-		Introduction of CA band combination Band5 + Band25 to TS 36.104	12.2.0
12-2013	RP-62	RP-131948	0442	-		Introduction of CA band combination B5 + B7 to TS 36.104	12.2.0
12-2013	RP-62	RP-131952	0444	-		Introduction of CA band combination B7 + B28 to TS 36.104	12.2.0
12-2013	RP-62	RP-131931	0446	-		Consideration on CA OBW requirement	12.2.0
12-2013	RP-62	RP-131963	0450	-		Introduction of Intra-band non-contiguous CA in band 7 to TS 36.104	12.2.0
12-2013	RP-62	RP-131967	0452	-		Band 41 deployment in Japan	12.2.0
03-2014	RP-63	RP-140388	451	1		TS36.104 changes for B39 CA	12.3.0
03-2014	RP-63	RP-140387	436	1		Introduction of CA band combination Band 39+Band 41 into BS specification	12.3.0
03-2014	RP-63	RP-140386	453			Introduction of CA band combination Band 3 and Band 27 to TS 36.104	12.3.0
03-2014	RP-63	RP-140375	463			Correction of abbreviations for negative acknowledgement	12.3.0
06-2014	RP-64	RP-140913	504			Clarification on definitions and ACLR requirement in TS36.104	12.4.0
06-2014	RP-64	RP-140913	465			CR for clarification for receiver requirement on MB-MSR BS	12.4.0
06-2014	RP-64	RP-140926	512	1		Introduction of operating band 32 and CA band 20+32 in TS36.104	12.4.0
06-2014	RP-64	RP-140930	509			Introduction of LTE-Advanced CA of Band 8 and Band 40 into TS 36.104	12.4.0
06-2014	RP-64	RP-140931	501			Introduction of CA 1+11 to 36.104 (Rel-12)	12.4.0
06-2014	RP-64	RP-140933	477	1		Introduction of band B4+B27 CA to TS36.104	12.4.0
06-2014	RP-64	RP-140938	483			Introduction of intra-band non-contiguous Carrier Aggregation in Band 2 to TS 36.104	12.4.0
06-2014	RP-64	RP-140940	527			Introduction of LTE_CA_NC_B42 into 36.104	12.4.0
06-2014	RP-64	RP-140942	535			Introduction of CA band combination Band 1 and Band 20 to TS 36.104	12.4.0
06-2014	RP-64	RP-140942	469			Introduction of CA band combination Band 1 and Band 20 to TS 36.104	12.4.0
06-2014	RP-64	RP-140944	478			Introduction of intra-band non-contiguous Carrier Aggregation in Band 41 for 3DL to TS 36.104	12.4.0
06-2014	RP-64	RP-140946	537			Introduction of intra-band CA_Band 42C to TS 36.104	12.4.0
09-2014	RP-65	RP-141538	537	1		Introduction of intra-band CA_Band 42C to TS 36.104	12.5.0

09-2014	RP-65	RP-141556	557	-		Introduction of 3 Band Carrier Aggregation (3DL/1UL) of Band 1, Band 3 and Band 8 to TS 36.104	12.5.0
09-2014	RP-65	RP-141532	559	-		Clarification of high speed train conditions in 36.104	12.5.0
09-2014	RP-65	RP-141551	560	-		Introduction of CA 8+11 to 36.104 (Rel-12)	12.5.0
09-2014	RP-65	RP-141548	562	-		Introduction of CA band combination Band1 + Band3 to TS 36.104	12.5.0
09-2014	RP-65	RP-141201	563	1		Introduction of CA band combination Band1 + Band3 + Band19 to TS 36.104	12.5.0
09-2014	RP-65	RP-141557	564	-		Introduction of CA band combination Band19 + Band42 to TS 36.104	12.5.0
09-2014	RP-65	RP-141559	565	-		Introduction of CA band combination Band1 + Band42 to TS 36.104	12.5.0
09-2014	RP-65	RP-141446	567	1		Introduction of CA band combination B1+B7 and B1+B5+B7 to TS 36.104 Rel-12	12.5.0
09-2014	RP-65	RP-141706	569	1		Introduction of 3 Band Carrier Aggregation of Band 1, Band 3 and Band 5 to TS 36.104	12.5.0
09-2014	RP-65	RP-141108	571	1		Introduction of inter-band CA_18-28 into TS36.104	12.5.0
09-2014	RP-65	RP-141558	577	-		Introduction of CA band combination Band 1, Band 3 and Band 20 to TS 36.104	12.5.0
09-2014	RP-65	RP-141528	589	-		Correction on UEM related to multi-band operation in TS36.104	12.5.0
09-2014	RP-65	RP-141554	591	1		Introduction of CA combinations	12.5.0
09-2014	RP-65	RP-141562	592	-		Update of definitions to support supplemental DL in TS36.104	12.5.0
09-2014	RP-65	RP-141463	595	-		Introduction of CA band combination Band 1, Band 7 and Band 20 to TS 36.104	12.5.0
12-2014	RP-66	RP-142175	599	1		FRC for PUSCH with TTI bundling and enhanced HARQ pattern	12.6.0
12-2014	RP-66	RP-142154	593	2		Introduction of annex H and references in TS36.104	12.6.0
12-2014	RP-66	RP-142182	614			Introduction of inter-band CA_1-28 into TS36.104	12.6.0
12-2014	RP-66	RP-142149	618			Correction on transmitter intermodulation requirement	12.6.0
12-2014	RP-66	RP-142189	624			CR for TR 36.104: LTE_CA_B5_B13	12.6.0
12-2014	RP-66	RP-142175	615	1		Performance requirements for PUSCH with TTI bundling and enhanced HARQ pattern	12.6.0
12-2014	RP-66	RP-142179	619	1		CR on RF requirements for 256QAM	12.6.0
12-2014	RP-66	RP-142190	609	2		Introduction of 3DL CA combinations	12.6.0
03-2015	RP-67	RP-150382	627			Co-location between Band 42 and Band 43 in TS 36.104	12.7.0
03-2015	RP-67	RP-150391	629			Introduction of CA_3A-42A and CA_3A-42C into 36.104	12.7.0
03-2015	RP-67	RP-150388	636			MB and TDD+FDD	12.7.0
07-2015	RP-68	RP-150955	647			Clarification of parameter P for emission requirements	12.8.0
07-2015	RP-68	RP-150955	658			Some corrections related to single carrier requirements	12.8.0
07-2015	RP-68	RP-150968	630	4		Introduction of 2DL CA combinations	13.0.0
07-2015	RP-68	RP-150972	631	4		Introduction of 3DL CA combinations	13.0.0
07-2015	RP-68	RP-150974	651	1		Introduction of 4DL CA combinations	13.0.0
07-2015	RP-68	RP-150669	664			Introduction of CA_3A-40A to TS 36.104	13.0.0
09-2015	RP-69	RP-151476	667			BS Spec improvements: TS 36.104 Corrections	13.1.0
09-2015	RP-69	RP-151506	678			CR on core requirements for support of 256QAM in wide area BS	13.1.0
09-2015	RP-69	RP-151499	680			Introduction of 3DL CA combinations	13.1.0
09-2015	RP-69	RP-151501	681			Introduction of 4DL CA combinations	13.1.0
09-2015	RP-69	RP-151204	682			Introduction of CA_7A-40A and CA_7A-40C to TS 36.104	13.1.0
12-2015	RP-70	RP-152168	0686	-		Introduction of intra-band CA_8B to TS 36.104	13.2.0
12-2015	RP-70	RP-152171	0700	-		Introduction of E-UTRA band 65 to TS36.104	13.2.0
12-2015	RP-70	RP-152132	0703	-		Clarification on the transmitter intermodulation requirement in TS36.104	13.2.0
12-2015	RP-70	RP-152157	0705	1		Introduction of Band 67 and CA_20-67 to 36.104	13.2.0
12-2015	RP-70	RP-152167	0708	-		Introduction of CA_5B to TS 36.104	13.2.0
12-2015	RP-70	RP-152169	0709	-		Introduction of intra-band NC CA_5A-5A to TS 36.104	13.2.0
12-2015	RP-70	RP-152173	0711	-		Introduction of 1447-1467MHz Band into 36.104	13.2.0
12-2015	RP-70	RP-152132	0714	-		Correction on UEM requirement for MB-MSR	13.2.0
12-2015	RP-70	RP-152148	0715	2		Introduction of LAA in TS 36.104	13.2.0
12-2015	RP-70	RP-152132	0718	-		BS Spec improvements: TS 36.104 Corrections	13.2.0
12-2015	RP-70	RP-152132	0721	-		Corrections on definition of f_offsetmax for BS operating in multiple bands or non-contiguous spectrum	13.2.0
12-2015	RP-70	RP-152172	0729	-		Introduction of Band 66 to 36.104	13.2.0
12-2015	RP-70	RP-152156	0731	-		Introduction of 2DL CA combinations	13.2.0
12-2015	RP-70	RP-152161	0732	-		Introduction of 3DL CA combinations	13.2.0
12-2015	RP-70	RP-152162	0733	-		Introduction of 4DL CA combinations	13.2.0
03/2016	RP-71	RP-160480	0753		B	Introduction of 3DL CA combinations	13.3.0

03/2016	RP-71	RP-160481	0754		B	Introduction of 4DL CA combinations	13.3.0
03/2016	RP-71	RP-160482	0752		B	Introduction of 5DL CA combinations	13.3.0
03/2016	RP-71	RP-160483	0737	2	B	Introduction of Band 68 into 36.104	13.3.0
03/2016	RP-71	RP-160488	0747		A	Band 20 and Band 28 BS co-existence	13.3.0
03/2016	RP-71	RP-160489	0739		A	Corrections to BS spurious emissions requirements for band 22 and 42 in TS36.104 (Rel-13)	13.3.0
03/2016	RP-71	RP-160490	0748		F	Correction of BS RF requirements in TS 36.104	13.3.0
06/2016	RP-72	RP-161131	0760		B	36.104 CR for BS MMSE-IRC receiver - Definitions	13.4.0
06/2016	RP-72	RP-161131	0761	1	B	36.104 CR for BS MMSE-IRC receiver - Demodulation tests in synchronous interference scenario	13.4.0
06/2016	RP-72	RP-161131	0762	1	B	36.104 CR for BS MMSE-IRC receiver - Demodulation tests in asynchronous interference scenario	13.4.0
06/2016	RP-72	RP-161131	0763	1	B	36.104 CR for BS MMSE-IRC receiver - FRC definitions	13.4.0
06/2016	RP-72	RP-161131	0764		B	36.104 CR for BS MMSE-IRC receiver - Interference model for synchronous and asynchronous scenarios	13.4.0
06/2016	RP-72	RP-161128	0765	3	B	CR: Cat-M1 PRACH Performance Requirements	13.4.0
06/2016	RP-72	RP-161128	0766	2	B	CR: Cat-M1 PUCCH Performance Requirements	13.4.0
06/2016	RP-72	RP-161142	0773	1	F	Correction on co-existence and co-location emission requirement for LAA	13.4.0
06/2016	RP-72	RP-161142	0780		F	Band 46 sub-bands indication	13.4.0
06/2016	RP-72	RP-161142	0781		F	Band 46 channel access procedures requirements	13.4.0
06/2016	RP-72	RP-116131	0783		B	Performance requirements for BS MMSE-IRC receiver in asynchronous interference scenario	13.4.0
2016/06	RP-72	RP-161129	0784	1	B	CR: Performance requirements for PUCCH format 4 (Rel-13)	13.5.0
2016/06	RP-72	RP-161128	0785	1	B	CR for eMTC PUSCH performance requirements	13.5.0
06/2016	RP-72	RP-161129	0788	1	B	CR for PUCCH format 5 performance requirements for 36.104	13.4.0
06/2016	RP-72	RP-161142	0789	1	F	Correction related to band 65	13.4.0
06/2016	RP-72	RP-161140	0795	1	F	Corrections on definition of multi-band definition and blocking	13.4.0
06/2016	RP-72	RP-116142	0799		F	Correction to BS spurious emissions for co-location with Band 46	13.4.0
06/2016	RP-72	RP-161126	0800		B	CR to TS36.104 for NB-IoT feature introduction	13.4.0
06/2016	RP-72	RP-161125	782	-	B	Introduction of Band 70 to 36.104	14.0.0
06/2016	RP-72	RP-161119	790	-	B	Introduction of additional band combinations for 4DL inter-band CA	14.0.0
06/2016	RP-72	RP-161117	792	-	B	Introduction of completed R14 2DL band combinations to TS 36.104	14.0.0
06/2016	RP-72	RP-161118	794	1	B	Introduction of completed R14 3DL band combination to TS 36.104	14.0.0
06/2016	RP-72	RP-161124	798	-	B	Introduction of Band 69 and CA_3-69 to 36.104	14.0.0
09/2016	RP-73	RP-161623	802		B	Introduction of completed R14 3DL band combination to TS 36.104	14.1.0
09/2016	RP-73	RP-161637	804		A	Corrections on NB-IoT BS unwanted emissions requirements	14.1.0
09/2016	RP-73	RP-161622	805		B	Introduction of completed R14 2DL band combinations to TS 36.104	14.1.0
09/2016	RP-73	RP-161636	807		A	correction CR for 36.104(Rel-14) NB-IoT In-channel selectivity	14.1.0
09/2016	RP-73	RP-161786	809		A	36.104 CR on bracket removal for BS IRC receiver	14.1.0
09/2016	RP-73	RP-161782	811		A	CR for eMTC PUCCH performance requirements (Rel-14)	14.1.0
09/2016	RP-73	RP-161782	813		A	CR for eMTC PUSCH performance requirements(Rel-14)	14.1.0
09/2016	RP-73	RP-161780	815		A	CR: Demodulation requirements for NPUSCH format 1 (Rel-14)	14.1.0
09/2016	RP-73	RP-161780	817		A	CR: Demodulation requirements for NPUSCH format 2 (Rel-14)	14.1.0
09/2016	RP-73	RP-161782	820		A	CR: Add Test tolerances for eMTC BS demodulation performance requirements	14.1.0
09/2016	RP-73	RP-161640	824		A	Corrections to operating band unwanted emissions in TS36.104 (Rel-14)	14.1.0
09/2016	RP-73	RP-161624	825		B	Introduction of additional band combinations for 4DL inter-band CA	14.1.0
09/2016	RP-73	RP-161629	835		F	Corrections of CA operating band tables	14.1.0
09/2016	RP-73	RP-161636	840		A	CR to section 7.8 Receiver intermodulation	14.1.0
09/2016	RP-73	RP-161637	841		A	CR to section 7.8 Receiver intermodulation	14.1.0
09/2016	RP-73	RP-161636	845		A	Clarification on EARFCN	14.1.0
09/2016	RP-73	RP-161637	847		A	Correction on ACS for standalone NB-IoT BS in TS 36.104	14.1.0

09/2016	RP-73	RP-161636	849		A	Correction on FRC for EUTRA with in-band NB-IoT in TS 36.104	14.1.0
09/2016	RP-73	RP-161625	850		B	Introduction of 5DL CA combinations	14.1.0
09/2016	RP-73	RP-161786	852		A	Maintenance for BS MMSE-IRC receiver requirements(Rel-13)	14.1.0
09/2016	RP-73	RP-161618	818	1	B	CR on ETU600 PUSCH test for 36.104	14.1.0
09/2016	RP-73	RP-161617	828	1	B	Introduction of V2V bands	14.1.0
09/2016	RP-73	RP-161635	822	1	A	Introduction of Korea regulatory requirements for PS-LTE BS, band 28, 36.104	14.1.0
09/2016	RP-73	RP-161638	857		A	LAA BS unwanted emission mask requirements in 36.104	14.1.0
12/2016	RP-74	RP-162384	0862		A	CR for Rel-14 eMTC PRACH performance requirements	14.2.0
12/2016	RP-74	RP-162388	0863	1	F	Maintenance for PUSCH ETU600 requirements	14.2.0
12/2016	RP-74	RP-162428	0864		A	Update of the Total Power Dynamic Range requirement for Band 46	14.2.0
12/2016	RP-74	RP-162407	0879	1	B	Addition of new operating bands for NB-IoT	14.2.0
12/2016	RP-74	RP-162434	0881		A	Interfering signal bandwidth for NB-IoT BS receiver dynamic range requirements	14.2.0
12/2016	RP-74	RP-162434	0882		A	Spurious responses for NB-IoT BS receiver blocking requirements	14.2.0
12/2016	RP-74	RP-162457	0883		B	Introduction of additional band combinations for 4DL inter-band CA	14.2.0
12/2016	RP-74	RP-162398	0884		B	Introduction of additional band combinations for Intra-band CA	14.2.0
12/2016	RP-74	RP-162379	0888		A	CR: Correction of Fixed Reference Channels for NPUSCH format 1 (Rel-14, 36.104)	14.2.0
12/2016	RP-74	RP-162379	0891		A	CR: Demodulation requirements for NPRACH (Rel-14)	14.2.0
12/2016	RP-74	RP-162379	0893		A	CR: Updates to demodulation requirements for NPUSCH format 1 (Rel-14)	14.2.0
12/2016	RP-74	RP-162456	0895	1	A	CR: Updates to demodulation requirements for NPUSCH format 2 (Rel-14)	14.2.0
12/2016	RP-74	RP-162382	0897		A	CR on cleaning up Rel-14 eMTC PUSCH performance requirements	14.2.0
12/2016	RP-74	RP-162399	0898		B	Introduction of completed R14 2DL band combinations to TS 36.104	14.2.0
12/2016	RP-74	RP-162433	0900		A	Correction to interfering signal for Narrowband blocking requirement for NB-IOT (Rel-14)	14.2.0
12/2016	RP-74	RP-162400	0901		B	Introduction of completed R14 3DL band combinations to TS 36.104	14.2.0
12/2016	RP-74	RP-162387	0902	1	F	Sets of EARFCN for multiple Scell operation in Band 46	14.2.0
12/2016	RP-74	RP-162433	0904		A	Correction of Fixed Reference Channels for NB-IOT reference sensitivity and dynamic range	14.2.0
12/2016	RP-74	RP-162395	0905	1	B	Necessary changes to the core requirements for Multi-Band Base Station testing with three or more bands	14.2.0
12/2016	RP-74	RP-162402	0906		B	Introduction of 5DL CA combinations	14.2.0
12/2016	RP-74	RP-162405	0907		B	Introduction of Band 48	14.2.0
12/2016	RP-74	RP-162413	0914	1	A	Correction to dynamic range requirement	14.2.0
03/2017	RP-75	RP-170568	0915		B	Introduction of additional band combinations for 4DL inter-band CA	14.3.0
03/2017	RP-75	RP-170565	0916	2	B	Introduction of additional band combinations for Intra-band CA	14.3.0
03/2017	RP-75	RP-170567	0917		F	Correction of completed 2DL and 3DL CAs	14.3.0
03/2017	RP-75	RP-170569	0918		B	Introduction of 5DL CA combinations	14.3.0
03/2017	RP-75	RP-170593	0922		A	CR to 36.104 for correction of performance requirements for BS MMSE-IRC receiver	14.3.0
03/2017	RP-75	RP-170573	0924	1	A	CR to 36.104: Addition of 1.4 and 3 MHz channel bandwidths for Band 65	14.3.0
03/2017	RP-75	RP-170600	0926		A	CR:Cleanup for NB-IoT BS demod performance requirements(R14)	14.3.0
03/2017	RP-75	RP-170596	0928		A	CR for PRACH requirements (Rel-14)	14.3.0
03/2017	RP-75	RP-170553	0931	1	B	CR on eLAA BS for TS 36.104	14.3.0
03/2017	RP-75	RP-170598	0933		A	Correction on FRC for NB-IoT in TS 36.104	14.3.0
03/2017	RP-75	RP-170567	0934		B	Introduction of completed R14 3DL band combinations to TS 36.104	14.3.0
03/2017	RP-75	RP-170595	0936		A	Correction CR on PUSCH and PUCCH supporting Cat-M1 considering guard period in 36.104	14.3.0
03/2017	RP-75	RP-170598	0938		A	Corrections on NB-IoT narrowband intermodulation performance requirement	14.3.0
03/2017	RP-75	RP-170577	0939		F	B70 Carrier Frequency and EARFCN Correction	14.3.0
03/2017	RP-75	RP-170566	0941		B	Introduction of completed R14 2DL band combinations to TS 36.104	14.3.0
06/2017	RP-76	RP-171282	0322	1	F	CR on BS for protection of V2X UE in TS 36.104	14.4.0

06/2017	RP-76	RP-171279	0944	1	B	Intorduction of new bands for NB-IoT in 36.104	14.4.0
06/2017	RP-76	RP-171301	0973		A	Updates to performance requirements for NPUSCH format 2	14.4.0
06/2017	RP-76	RP-171310	0975		A	clean up eMTC PUCCH requirements(Rel-14)	14.4.0
06/2017	RP-76	RP-171257	0976	3	B	CR for new PRACH performance requirements	14.4.0
06/2017	RP-76	RP-171261	4667	1	B	CR to 36.104: Introduction of FeMBMS numerologies	14.4.0
06/2017	RP-76	RP-171276	4668	1	B	Introduction of 5DL CA combinations to 36.104	14.4.0
06/2017	RP-76	RP-171272	4671	1	B	Introduction of additional band combinations for Intra-band CA	14.4.0
06/2017	RP-76	RP-171275	4672	2	B	Introduction of Rel-14 4DL/1UL combinations in 36.104	14.4.0
06/2017	RP-76	RP-171273	4673		B	Introduction of completed R14 2DL band combinations to TS 36.104	14.4.0
06/2017	RP-76	RP-171274	4674		B	Introduction of completed R14 3DL band combinations to TS 36.104	14.4.0
06/2017	RP-76	RP-171260	4676	1	B	Introduction of BS performance requirements for 256QAM in 36.104	14.4.0
06/2017	RP-76	RP-171299	4678		F	Channel Raster For Multiple Standalone NB-IoT Carriers (TS 36.104)	14.4.0
06/2017	RP-76	RP-171299	4680		A	Narrowband blocking requirement for NB-IoT guard band operation (TS 36.104)	14.4.0
06/2017	RP-76	RP-171300	4682		A	Intermodulation performance requirement for NB-IoT operation (TS 36.104)	14.4.0
06/2017	RP-76	RP-171299	4684		A	Note on BS in-channel selectivity for NB-IoT	14.4.0
06/2017	RP-76	RP-171300	4686		A	Clarification on 1.4 MHz for in-band operation	14.4.0
09/2017	RP-77	RP-171972	4691		A	NB-IoT PRB position in Refsens for >5 MHz E-UTRA in-band operation (TS 36.104)	14.5.0
09/2017	RP-77	RP-171971	4698		A	CR on eMTC BS PRACH requirements R14	14.5.0
09/2017	RP-77	RP-171934	4703		B	Removal of brackets of performace requirements for 256QAM.	14.5.0
09/2017	RP-77	RP-171934	4705		B	Introduction of performance requirements for PUSCH transmission in UpPTS	14.5.0
09/2017	RP-77	RP-171968	4709		A	CR to 36.104: Correction to LA BS spurious emissions limits table	14.5.0
09/2017	RP-77	RP-171933	4712	1	B	Introduce test case for eLAA PUSCH	14.5.0
09/2017	RP-77	RP-171972	4713		F	Correction on NB-IoT BS standalone UEM	14.5.0
09/2017	RP-77	RP-171942	4715		F	Maintance CR for HST PRACH enhancement requirements	14.5.0
09/2017	RP-77	RP-171945	4692	1	B	36.104 CR for BS IC receiver - Definitions	15.0.0
09/2017	RP-77	RP-171945	4693	1	B	36.104 CR for BS IC receiver - Demodulation tests	15.0.0
09/2017	RP-77	RP-171945	4694		B	36.104 CR for BS IC receiver - FRC definitions	15.0.0
09/2017	RP-77	RP-171955	4695	1	B	Introduction of Rel-15 LTE Intra-band combinations in 36.104	15.0.0
09/2017	RP-77	RP-171958	4696		B	Introduction of Rel-15 LTE 4DL/1UL combinations in 36.104	15.0.0
09/2017	RP-77	RP-171948	4699	2	B	Introduction of the FDD L-band (Band 74) into TS 36.104	15.0.0
09/2017	RP-77	RP-171959	4700	1	B	Introduction of 5DL CA combinations	15.0.0
09/2017	RP-77	RP-171952	4701		B	CR to 36.104: Introduction of Band 71	15.0.0
09/2017	RP-77	RP-171946	4702		B	CR to 36.104: Introduction of Band 72	15.0.0
09/2017	RP-77	RP-171957	4704		B	Introduction of completed R15 3DL band combinations to TS 36.104	15.0.0
09/2017	RP-77	RP-171950	4707	1	B	CR to 36.104: Introduction of B75 and B76	15.0.0
09/2017	RP-77	RP-171956	4711	3	B	Introduction of completed combination to 36.104	15.0.0
09/2017	RP-77	RP-171949	4714	2	B	Introduction of TDD L-band into TS 36.104	15.0.0
09/2017	RP-77	RP-172048	4717		B	CR to 36.104: Support of NB-IoT for Bands 4, 14 and 71	15.0.0
12/2017	RP-78	RP-172600	4720		F	36.104 CR on bracket removal for BS IC receiver	15.1.0
12/2017	RP-78	RP-172609	4723		A	Correction on NB-IoT RB power dynamic range	15.1.0
12/2017	RP-78	RP-172613	4727		A	CR to 36.104: BS Spurious emissions limits for protection of the BS receiver for B28 in Europe	15.1.0
12/2017	RP-78	RP-172593	4731		B	CR to 36.104: Introduction of Band 73	15.1.0
12/2017	RP-78	RP-172596	4733		B	CR for 36104	15.1.0
12/2017	RP-78	RP-172595	4734		B	Introduction of additional band combinations for Intra-band CA	15.1.0
12/2017	RP-78	RP-172704	4735		B	Introduction of Rel-15 LTE 4DL/1UL combinations in 36.104	15.1.0
12/2017	RP-78	RP-172586	4737		A	Correction of channel spacing for band 46 intraband CA band combinations with 10 MHz bandwidth	15.1.0
12/2017	RP-78	RP-172584	4739		A	CR to 36.104: Corrections to co-location tables for B48	15.1.0
12/2017	RP-78	RP-172594	4740	1	B	CR to 36.104: Introduction of Band 49	15.1.0
12/2017	RP-78	RP-172588	4741	2	B	Addition of NB-IoT small cells support	15.1.0
12/2017	RP-78	RP-172611	4746		A	Removal of BS repetition sensitivity	15.1.0

12/2017	RP-78	RP-172597	4747		B	Introduction of completed R15 3DL band combinations to TS 36.104	15.1.0
12/2017	RP-78	RP-172586	4750		A	Introduce burst model for eLAA PUSCH demodulation	15.1.0
12/2017	RP-78	RP-172598	4751		B	Introduction of 5DL CA combinations to 36.104	15.1.0
12/2017	RP-78	RP-172587	4752		B	Introduction on sTTI for TS 36.104	15.1.0
12/2017	RP-78	RP-172550	4753		B	Introduction of missing 3DL fallbacks to 4DL combinations	15.1.0
2018-03	RAN#79	RP-180265	4754	1	B	CR on BS RF requirements for DL 1024QAM in TS 36.104	15.2.0
2018-03	RAN#79	RP-180272	4755		B	Introduction of completed R15 3DL/1UL band combinations to TS 36.104	15.2.0
2018-03	RAN#79	RP-180273	4757		B	Introduction of Rel-15 LTE 4DL/1UL combinations in 36.104	15.2.0
2018-03	RAN#79	RP-180274	4758		B	Introduction of 5DL CA combinations to 36.104	15.2.0
2018-03	RAN#79	RP-180281	4759	1	B	CR to 36.104: Introduction of new additional unwanted emission limit for L-Band	15.2.0
2018-03	RAN#79	RP-180279	4760		B	CR to 36.104: Introduction of Band 85 (B12-extended)	15.2.0
2018-03	RAN#79	RP-180266	4761		F	Removing Section 9 from 36.104	15.2.0
2018-03	RAN#79	RP-180293	4764		A	CR on clarifications of NB-IoT RB power dynamic range for in-band or guard band operation (TS 36.104)	15.2.0
2018-03	RAN#79	RP-180267	4765		F	CR on corrections of tables for NB-IoT small cell support (TS 36.104)	15.2.0
2018-03	RAN#79	RP-180271	4766		B	CR for 36.104	15.2.0
2018-03	RAN#79	RP-180278	4767		B	Introduction of TDD 3.3-3.4GHz band (band 52)	15.2.0
2018-06	RAN#80	RP-181112	4770		A	Clarification on Base Station RF Bandwidth for stand-alone NB-IoT operation (36.104)	15.3.0
2018-06	RAN#80	RP-181091	4772		B	Introduction of Rel-15 LTE 4DL/1UL combinations in 36.104 (This CR was superseded by CR#4786)	15.3.0
2018-06	RAN#80	RP-181089	4776		B	CR to add new 2DL1UL CA combos to 36.104	15.3.0
2018-06	RAN#80	RP-181090	4777		B	Introduction of Rel-15 LTE 3DL/1UL combinations in 36.104 (This CR was superseded by CR#4788)	15.3.0
2018-06	RAN#80	RP-181089	4780	1	B	CR for 36.104 to update 2DL1UL basket items	15.3.0
2018-06	RAN#80	RP-181102	4781		F	Correction on FRC indices for enhanced performance requirement type B	15.3.0
2018-06	RAN#80	RP-181084	4782		B	NB-IoT: Adding TDD support in TS 36.104	15.3.0
2018-06	RAN#80	RP-181100	4783		F	CR to TS 36.104: Correct Pmax,c to Prated,c for UEM requirements	15.3.0
2018-06	RAN#80	RP-181088	4785		B	Introduction of Rel-15 LTE Intra-band combinations in 36.104	15.3.0
2018-06	RAN#80	RP-181091	4786		B	Introduction of Rel-15 LTE 4DL/1UL combinations in 36.104	15.3.0
2018-06	RAN#80	RP-181090	4788		B	Introduction of completed R15 3DL/1UL band combinations to TS 36.104	15.3.0
2018-06	RAN#80	RP-181092	4789		B	Introduction of 5DL CA combinations to 36.104	15.3.0
2018-09	RAN#81	RP-181900	4790		F	CR to TS 36.104: Corrections on NB-IoT operating band unwanted emission and blocking requirements (6.6.3.3, 7.6.1.1)	15.4.0
2018-09	RAN#81	RP-181897	4792	1	F	CR on protecting NR bands in 36.104	15.4.0
2018-09	RAN#81	RP-181899	4793	1	B	CR_BS REFSENSE for SubPRB_36_104	15.4.0
2018-09	RAN#81	RP-181898	4799	1	B	Performance requirements for SPUCCH	15.4.0
2018-09	RAN#81	RP-181898	4800	1	B	Performance requirements for subslot-PUSCH	15.4.0
2018-12	RAN#82	RP-182362	4801	1	B	Addition of NR bands to E-UTRA co-location blocking requirements	15.5.0
2018-12	RAN#82	RP-182364	4803		F	Introduction of PUSCH demodulation requirements for sTTI	15.5.0
2018-12	RAN#82	RP-182364	4804	4	F	Introduction of SPUCCH demodulation requirements	15.5.0
2018-12	RAN#82	RP-182365	4805	2	B	Introduction of BS demodulation requirements for eFeMTC (TS36.104)	15.5.0
2018-12	RAN#82	RP-182360	4815		F	CR on protecting NR band n86 in 36.104	15.5.0
2018-12	RAN#82	RP-182386	4816	1	B	CR to TS 36.104: Implementation of UL PRB to DL PRB center offset for TDD NB-IoT	15.5.0
2018-12	RAN#82	RP-182377	4806		B	CR adding_B65 for NB1/NB2	16.0.0
2018-12	RAN#82	RP-182375	4810		F	Removal of CA bands list for E-UTRA	16.0.0
2018-12	RAN#82	RP-182376	4811	1	B	CR to 36.104: Introduction of Band 53	16.0.0
2019-03	RAN#83	RP-190414	4829		A	CR for TS 36.104 Rel-16: Clarification on LAA and eLAA channel access	16.1.0
2019-03	RAN#83	RP-190420	4833		A	CR to 36.104: frequency offset between anchor and non-anchor carrier for TDD NB-IoT standalone operation	16.1.0
2019-03	RAN#83	RP-190406	4835		A	CR: Addition of demodulation performance requirements for new NPRACH formats in 36.104(Rel-16)	16.1.0

2019-03	RAN#83	RP-190401	4839		A	CR to TS 36.104: Corrections on transmitter co-existence and co-location requirements	16.1.0
2019-03	RAN#83	RP-190410	4847		A	CR to TS 36.104: correction of missing Band 20 duplex mode, Rel-16	16.1.0
2019-06	RAN#84	RP-191264	4853	1	A	Correction of PUSCH demodulation requirements for eFeMTC (36.104)	16.2.0
2019-06	RAN#84	RP-191248	4857		B	CR to 36.104: Introduction of co-existence requirements with Band n48	16.2.0
2019-06	RAN#84	RP-191256	4858	1	B	CR to 36.104: Introduction of Band 87 and 88	16.2.0
2019-06	RAN#84	RP-191266	4860		A	CR to 36.104: Corrections to blocking performance requirements for Home BS	16.2.0
2019-06	RAN#84	RP-191267	4863		A	CR to 36.104: category B option 2 unwanted emissions for 2500-2690 MHz band	16.2.0
2019-06	RAN#84	RP-191242	4864		B	CR to TS 36.104: Introduction of band n14	16.2.0
2019-06	RAN#84	RP-191250	4866	1	B	n65 introduction to 36.104	16.2.0
2019-06	RAN#84	RP-191265	4868		A	CR 36.104 Corrections to demodulation performance for NPRACH FDD preamble format 2	16.2.0
2019-06	RAN#84	RP-191246	4872		B	CR to TS 36.104: Introduction of band n30	16.2.0
2019-09	RAN#85	RP-192041	4873	1	B	CR to 36.104 on LTE HST PUSCH conditions	16.3.0
2019-09	RAN#85	RP-192055	4876		A	Clean up of PUSCH demodulation requirements for eFeMTC (36.104)	16.3.0
2019-09	RAN#85	RP-192034	4877		B	n29 introduction to 36.104	16.3.0
2019-09	RAN#85	RP-192043	4879	1	B	CR of adding LTE B42/B43 for UE category NB1/NB2 in R16	16.3.0
2019-09	RAN#85	RP-192043	4880	1	B	CR of adding LTE B7 for UE category NB1/NB2 in R16	16.3.0
2019-09	RAN#85	RP-192029	4881		F	CR on Protection of SUL band n89 to TS 36.104	16.3.0
2019-12	RAN#86	RP-193013	4882		B	Introduction of 2010-2025MHz SUL band into Rel-16 TS 36.104	16.4.0
2019-12	RAN#86	RP-193026	4883	1	B	CR to TS 36.104: Introduction of PUSCH performance requirements for enhanced HST scenario	16.4.0
2019-12	RAN#86	RP-193026	4884	1	B	CR to TS 36.104: Introduction of PRACH performance requirements for enhanced HST scenario	16.4.0
2019-12	RAN#86	RP-192842	4888		B	CR to 36.104 on variable duplex FDD bands	16.4.0
2020-03	RAN#87-e	RP-200381	4889		B	Introduction of n26	16.5.0
2020-03	RAN#87-e	RP-200382	4890		B	Introduction of n53	16.5.0
2020-03	RAN#87-e	RP-200412	4891		F	CR to TS 36.104 Updates of PUSCH performance requirements for enhanced HST scenario	16.5.0
2020-03	RAN#87-e	RP-200412	4892		F	CR to TS 36.104 Updates of PRACH performance requirements for enhanced HST scenario	16.5.0
2020-06	RAN#88	RP-200964	4895		F	CR to TS 36.104 Finalization on PUSCH performance requirements for enhanced HST scenario	16.6.0
2020-06	RAN#88	RP-200964	4896		F	CR to TS 36.104 Finalization on PRACH performance requirements for enhanced HST scenario	16.6.0
2020-06	RAN#88	RP-200988	4898		A	CR: Updates to FeNB-IoT NPRACH TDD performance requirements in TS 36.104 (Rel-16)	16.6.0
2020-06	RAN#88	RP-200988	4902		A	CR to 36.104 on Removal of FFSSs, brackets and TBD (Rel-16)	16.6.0
2020-09	RAN#89	RP-201509	4907	1	B	CR to 36.104: Introduction of LTE based 5G terrestrial broadcast numerologies	16.7.0
2020-09	RAN#89	RP-201509	4909	1	B	CR: Introduce NPUSCH format 1 performance requirements for multi-TB interleaved transmission.	16.7.0
2020-09	RAN#89	RP-201916	4911		B	CR to 36.104: Introduction of NR-U co-existence requirements	16.7.0
2020-12	RAN#90	RP-202474	4915		B	CR: Addition of NPUSCH format1 performance requirements for multi-TB interleaved transmission in TS 36.104	16.8.0
2020-12	RAN#90	RP-202414	4917	1	B	CR to 36.104: Introduction of n96 medium range requirements	16.8.0
2020-12	RAN#90	RP-202510	4919		A	CR to 36.104 on Removal of additional limit for Band 1	16.8.0
2021-03	RAN#91	RP-210121	4923		A	CR to TS 36.104: Additions of regional requirements for band 41 in Japan, Rel-16	16.9.0
2021-03	RAN#91	RP-210084	4925	1	F	CR to TS 36.104: corrections of NR-U BS RF requirements	16.9.0
2021-03	RAN#91	RP-210111	4934		A	CR to 36.104: Correction to Band 24 requirements (Rel-16)	16.9.0
2021-06	RAN#92	RP-211090	4939		A	CR to 36.104: In-band blocking for multi-band Base Stations	16.10.0
2021-09	RAN#93	RP-211922	4943		A	Big CR for TS 36.104 Maintenance (Rel-16, CAT A)	16.11.0
2021-12	RAN#94	RP-212853	4947		F	Big CR for TS 36.104 Maintenance (Rel-16, CAT F)	16.12.0
2022-03	RAN#95	RP-220331	4954	1	A	Big CR for TS 36.104 Maintenance (Rel-16, CAT A)	16.13.0
2023-06	RAN#100	RP-231352	4974	1	F	CR for TS 36104 Operating band unwanted emissions for Single RAT multi-band BS	16.14.0

2023-12	RAN#102	RP-233339	4980		F	[NR_n18-Core] CR to TS 36.104 on correction of transmitter spurious emissions for protection of Band n18	16.15.0
2024-03	RAN#103	RP-240556	4991	1	F	(MB_MSR_RF) CR to 36.104: clarification on requirements for BS capable of multi-band operation	16.16.0

History

Document history		
V16.6.0	July 2020	Publication
V16.7.0	November 2020	Publication
V16.8.0	January 2021	Publication
V16.9.0	April 2021	Publication
V16.10.0	September 2021	Publication
V16.11.0	October 2021	Publication
V16.12.0	March 2022	Publication
V16.13.0	April 2022	Publication
V16.14.0	July 2023	Publication
V16.15.0	January 2024	Publication
V16.16.0	May 2024	Publication