

ETSI TS 136 133 V13.24.0 (2024-10)



**LTE;
Evolved Universal Terrestrial Radio Access (E-UTRA);
Requirements for support of radio resource management
(3GPP TS 36.133 version 13.24.0 Release 13)**



Reference

RTS/TSGR-0436133vdo0

Keywords

LTE

ETSI

650 Route des Lucioles
F-06921 Sophia Antipolis Cedex - FRANCE

Tel.: +33 4 92 94 42 00 Fax: +33 4 93 65 47 16

Siret N° 348 623 562 00017 - APE 7112B
Association à but non lucratif enregistrée à la
Sous-Préfecture de Grasse (06) N° w061004871

Important notice

The present document can be downloaded from the
[ETSI Search & Browse Standards](#) application.

The present document may be made available in electronic versions and/or in print. The content of any electronic and/or print versions of the present document shall not be modified without the prior written authorization of ETSI. In case of any existing or perceived difference in contents between such versions and/or in print, the prevailing version of an ETSI deliverable is the one made publicly available in PDF format on [ETSI deliver](#).

Users should be aware that the present document may be revised or have its status changed,
this information is available in the [Milestones listing](#).

If you find errors in the present document, please send your comments to
the relevant service listed under [Committee Support Staff](#).

If you find a security vulnerability in the present document, please report it through our
[Coordinated Vulnerability Disclosure \(CVD\)](#) program.

Notice of disclaimer & limitation of liability

The information provided in the present deliverable is directed solely to professionals who have the appropriate degree of experience to understand and interpret its content in accordance with generally accepted engineering or other professional standard and applicable regulations.

No recommendation as to products and services or vendors is made or should be implied.

No representation or warranty is made that this deliverable is technically accurate or sufficient or conforms to any law and/or governmental rule and/or regulation and further, no representation or warranty is made of merchantability or fitness for any particular purpose or against infringement of intellectual property rights.

In no event shall ETSI be held liable for loss of profits or any other incidental or consequential damages.

Any software contained in this deliverable is provided "AS IS" with no warranties, express or implied, including but not limited to, the warranties of merchantability, fitness for a particular purpose and non-infringement of intellectual property rights and ETSI shall not be held liable in any event for any damages whatsoever (including, without limitation, damages for loss of profits, business interruption, loss of information, or any other pecuniary loss) arising out of or related to the use of or inability to use the software.

Copyright Notification

No part may be reproduced or utilized in any form or by any means, electronic or mechanical, including photocopying and microfilm except as authorized by written permission of ETSI.

The content of the PDF version shall not be modified without the written authorization of ETSI.

The copyright and the foregoing restriction extend to reproduction in all media.

© ETSI 2024.
All rights reserved.

Intellectual Property Rights

Essential patents

IPRs essential or potentially essential to normative deliverables may have been declared to ETSI. The declarations pertaining to these essential IPRs, if any, are publicly available for **ETSI members and non-members**, and can be found in ETSI SR 000 314: "*Intellectual Property Rights (IPRs); Essential, or potentially Essential, IPRs notified to ETSI in respect of ETSI standards*", which is available from the ETSI Secretariat. Latest updates are available on the ETSI Web server (<https://ipr.etsi.org/>).

Pursuant to the ETSI Directives including the ETSI IPR Policy, no investigation regarding the essentiality of IPRs, including IPR searches, has been carried out by ETSI. No guarantee can be given as to the existence of other IPRs not referenced in ETSI SR 000 314 (or the updates on the ETSI Web server) which are, or may be, or may become, essential to the present document.

Trademarks

The present document may include trademarks and/or tradenames which are asserted and/or registered by their owners. ETSI claims no ownership of these except for any which are indicated as being the property of ETSI, and conveys no right to use or reproduce any trademark and/or tradename. Mention of those trademarks in the present document does not constitute an endorsement by ETSI of products, services or organizations associated with those trademarks.

DECT™, **PLUGTESTS™**, **UMTS™** and the ETSI logo are trademarks of ETSI registered for the benefit of its Members. **3GPP™** and **LTE™** are trademarks of ETSI registered for the benefit of its Members and of the 3GPP Organizational Partners. **oneM2M™** logo is a trademark of ETSI registered for the benefit of its Members and of the oneM2M Partners. **GSM®** and the GSM logo are trademarks registered and owned by the GSM Association.

Legal Notice

This Technical Specification (TS) has been produced by the ETSI 3rd Generation Partnership Project (3GPP).

The present document may refer to technical specifications or reports using their 3GPP identities. These shall be interpreted as being references to the corresponding ETSI deliverables.

The cross reference between 3GPP and ETSI identities can be found under <https://webapp.etsi.org/key/queryform.asp>.

Modal verbs terminology

In the present document "**shall**", "**shall not**", "**should**", "**should not**", "**may**", "**need not**", "**will**", "**will not**", "**can**" and "**cannot**" are to be interpreted as described in clause 3.2 of the [ETSI Drafting Rules](#) (Verbal forms for the expression of provisions).

"**must**" and "**must not**" are **NOT** allowed in ETSI deliverables except when used in direct citation.

Contents

| | |
|---|----|
| Intellectual Property Rights | 2 |
| Legal Notice | 2 |
| Modal verbs terminology..... | 2 |
| Foreword..... | 65 |
| 1 Scope | 66 |
| 2 References | 66 |
| 3 Definitions, symbols and abbreviations | 67 |
| 3.1 Definitions | 67 |
| 3.2 Symbols..... | 69 |
| 3.3 Abbreviations | 70 |
| 3.4 Test tolerances..... | 72 |
| 3.5 Additional notation..... | 72 |
| 3.5.1 Groups of bands..... | 72 |
| 3.6 General | 74 |
| 3.6.1 Applicability of requirements in this specification version | 74 |
| 4 E-UTRAN RRC_IDLE state mobility..... | 77 |
| 4.1 Cell Selection | 77 |
| 4.2 Cell Re-selection | 77 |
| 4.2.1 Introduction..... | 77 |
| 4.2.2 Requirements | 78 |
| 4.2.2.1 Measurement and evaluation of serving cell..... | 79 |
| 4.2.2.2 Void..... | 80 |
| 4.2.2.3 Measurements of intra-frequency E-UTRAN cells | 80 |
| 4.2.2.4 Measurements of inter-frequency E-UTRAN cells | 81 |
| 4.2.2.5 Measurements of inter-RAT cells | 83 |
| 4.2.2.5.1 Measurements of UTRAN FDD cells..... | 83 |
| 4.2.2.5.2 Measurements of UTRAN TDD cells | 85 |
| 4.2.2.5.3 Measurements of GSM cells..... | 86 |
| 4.2.2.5.4 Measurements of HRPD cells..... | 87 |
| 4.2.2.5.5 Measurements of cdma2000 1X..... | 88 |
| 4.2.2.6 Evaluation of cell re-selection criteria..... | 89 |
| 4.2.2.7 Maximum interruption in paging reception..... | 90 |
| 4.2.2.8 void | 90 |
| 4.2.2.9 UE measurement capability | 90 |
| 4.2.2.9a UE measurement capability (Increased UE carrier monitoring) | 91 |
| 4.2.2.10 Reselection to CSG cells | 91 |
| 4.2.2.10.1 Reselection from a non CSG to an inter-frequency CSG cell..... | 91 |
| 4.2.2.10.2 Reselection from a non CSG to an inter-RAT UTRAN FDD CSG cell..... | 92 |
| 4.2.2.11 Void | 93 |
| 4.3 Minimization of Drive Tests (MDT)..... | 93 |
| 4.3.1 Introduction..... | 93 |
| 4.3.2 Measurements | 93 |
| 4.3.2.1 Requirements | 93 |
| 4.3.3 Relative Time Stamp Accuracy | 94 |
| 4.3.3.1 Requirements | 94 |
| 4.3.4 Relative Time Stamp Accuracy for RRC Connection Establishment Failure Log Reporting | 94 |
| 4.3.4.1 Requirements | 94 |
| 4.3.5 Relative Time Stamp Accuracy for Radio Link Failure and Handover Failure Log Reporting..... | 94 |
| 4.3.5.1 Requirements for <i>timeSinceFailure</i> | 94 |
| 4.4 MBSFN Measurements | 94 |
| 4.4.1 Introduction..... | 94 |
| 4.4.2 MBSFN RSRP measurements | 95 |
| 4.4.3 MBSFN RSRQ measurements..... | 95 |
| 4.4.4 MCH BLER measurements | 95 |

| | | |
|-----------|--|-----|
| 4.5 | Proximity-based Services | 95 |
| 4.5.1 | Introduction..... | 95 |
| 4.5.2 | Requirements | 95 |
| 4.5.2.1 | Interruptions with ProSe Direct Discovery | 95 |
| 4.5.2.2 | Interruptions with ProSe Direct Communication | 96 |
| 4.5.2.3 | Initiation/Cease of SLSS transmissions with ProSe Direct Discovery..... | 96 |
| 4.5.2.4 | Initiation/Cease of SLSS transmissions with ProSe Direct Communication | 96 |
| 4.6 | Cell Selection and Re-selection Requirements for UE category NB1 | 97 |
| 4.6.1 | Cell Selection..... | 97 |
| 4.6.2 | Cell Re-selection..... | 97 |
| 4.6.2.1 | Measurement and evaluation of serving NB-IoT cell for UE category NB1 in normal coverage..... | 97 |
| 4.6.2.2 | Measurements of intra-frequency NB-IoT cells for UE category NB1 in normal coverage | 98 |
| 4.6.2.3 | Measurement and evaluation of serving NB-IoT cell for UE category NB1 in enhanced coverage | 99 |
| 4.6.2.4 | Measurements of intra-frequency NB-IoT cells for UE category NB1 in enhanced coverage | 100 |
| 4.6.2.5 | Measurements of inter-frequency NB cells for UE category NB1 in normal coverage | 101 |
| 4.6.2.6 | Measurements of inter-frequency NB-IoT cells for UE category NB1 in enhanced coverage | 103 |
| 4.6.2.7 | Maximum interruption in paging reception in normal coverage | 104 |
| 4.6.2.7A | Maximum interruption in paging reception in enhanced coverage | 104 |
| 4.6.2.8 | UE measurement capability | 104 |
| 4.7 | Cell Selection and Re-selection Requirements for UE category M1 | 104 |
| 4.7.1 | Cell Selection..... | 104 |
| 4.7.2 | Cell Re-selection..... | 104 |
| 4.7.2.1 | Cell Re-selection requirements for UE category M1 in normal coverage..... | 105 |
| 4.7.2.1.1 | Measurement and evaluation of serving cell for UE category M1 in normal coverage..... | 105 |
| 4.7.2.1.2 | Measurements of intra-frequency cells for UE category M1 in normal coverage | 105 |
| 4.7.2.2 | Cell Re-selection requirements for UE category M1 in enhanced coverage | 106 |
| 4.7.2.2.1 | Measurement and evaluation of serving cell for UE category M1 in enhanced coverage..... | 106 |
| 4.7.2.2.2 | Measurements of intra-frequency cells for UE category M1 in enhanced coverage | 107 |
| 5 | E-UTRAN RRC_CONNECTED state mobility | 109 |
| 5.1 | E-UTRAN Handover..... | 109 |
| 5.1.1 | Introduction..... | 109 |
| 5.1.2 | Requirements | 109 |
| 5.1.2.1 | E-UTRAN FDD – FDD | 109 |
| 5.1.2.1.1 | Handover delay..... | 109 |
| 5.1.2.1.2 | Interruption time | 110 |
| 5.2.2.2 | E-UTRAN FDD – TDD | 110 |
| 5.2.2.2.1 | (Void) | 110 |
| 5.2.2.2.2 | (Void) | 110 |
| 5.2.2.3 | E-UTRAN TDD – FDD | 110 |
| 5.2.2.3.1 | (Void) | 110 |
| 5.2.2.3.2 | (Void) | 110 |
| 5.2.2.4 | E-UTRAN TDD – TDD..... | 110 |
| 5.2.2.4.1 | Handover delay | 110 |
| 5.2.2.4.2 | Interruption time | 111 |
| 5.2.2.5 | E-UTRAN HD–FDD | 111 |
| 5.2.2.5.1 | Handover delay..... | 111 |
| 5.2.2.5.2 | Interruption time | 111 |
| 5.3 | Handover to other RATs | 112 |
| 5.3.1 | E-UTRAN - UTRAN FDD Handover | 112 |
| 5.3.1.1 | Introduction..... | 112 |
| 5.3.1.1.1 | Handover delay..... | 112 |
| 5.3.1.1.2 | Interruption time | 112 |
| 5.3.2 | E-UTRAN - UTRAN TDD Handover | 113 |
| 5.3.2.1 | Introduction..... | 113 |
| 5.3.2.2 | Requirements | 113 |
| 5.3.2.2.1 | Handover delay..... | 113 |
| 5.3.2.2.2 | Interruption time | 113 |
| 5.3.3 | E-UTRAN - GSM Handover | 114 |
| 5.3.3.1 | Introduction..... | 114 |
| 5.3.3.2 | Requirements | 114 |
| 5.3.3.2.1 | Handover delay..... | 114 |

| | | |
|-----------|---|-----|
| 5.3.3.2.2 | Interruption time | 114 |
| 5.4 | Handover to Non-3GPP RATs | 115 |
| 5.4.1 | E-UTRAN – HRPD Handover..... | 115 |
| 5.4.1.1 | Introduction | 115 |
| 5.4.1.1.1 | Handover delay..... | 115 |
| 5.4.1.1.2 | Interruption time..... | 115 |
| 5.4.2 | E-UTRAN – cdma2000 1X Handover..... | 115 |
| 5.4.2.1 | Introduction | 115 |
| 5.4.2.1.1 | Handover delay..... | 116 |
| 5.4.2.1.2 | Interruption time..... | 116 |
| 5.5 | E-UTRAN Handover for Cat-M1 UEs..... | 116 |
| 5.5.1 | Introduction..... | 116 |
| 5.5.2 | Requirements in CEModeA..... | 116 |
| 5.5.2.1 | E-UTRAN FDD – FDD for Cat-M1 FDD UEs | 116 |
| 5.5.2.1.1 | Handover delay..... | 116 |
| 5.5.2.1.2 | Interruption time..... | 117 |
| 5.5.2.2 | E-UTRAN FDD – FDD for Cat-M1 HD – FDD UEs..... | 117 |
| 5.5.2.3 | E-UTRAN TDD – TDD for Cat-M1 TDD UEs..... | 117 |
| 5.5.2.3.1 | Void..... | 117 |
| 5.5.2.3.2 | Void..... | 117 |
| 5.5.3 | Requirements in CEModeB | 117 |
| 5.5.3.1 | E-UTRAN FDD – FDD for Cat-M1 FDD UEs | 117 |
| 5.5.3.1.1 | Handover delay..... | 117 |
| 5.5.3.1.2 | Interruption time..... | 118 |
| 5.5.3.2 | E-UTRAN FDD – FDD for Cat-M1 HD – FDD UEs..... | 118 |
| 5.5.3.3 | E-UTRAN TDD – TDD for Cat-M1 TDD UEs..... | 118 |
| 5.6 | Void..... | 118 |
| 6 | RRC Connection Mobility Control | 118 |
| 6.1 | RRC Re-establishment | 118 |
| 6.1.1 | Introduction..... | 119 |
| 6.1.2 | Requirements | 119 |
| 6.1.2.1 | UE Re-establishment delay requirement..... | 119 |
| 6.2 | Random Access | 119 |
| 6.2.1 | Introduction..... | 119 |
| 6.2.2 | Requirements | 120 |
| 6.2.2.1 | Contention based random access..... | 120 |
| 6.2.2.1.1 | Correct behaviour when receiving Random Access Response reception | 120 |
| 6.2.2.1.2 | Correct behaviour when not receiving Random Access Response reception | 120 |
| 6.2.2.1.3 | Correct behaviour when receiving a NACK on msg3 | 120 |
| 6.2.2.1.4 | Void..... | 120 |
| 6.2.2.1.5 | Correct behaviour when receiving a message over Temporary C-RNTI..... | 120 |
| 6.2.2.1.6 | Correct behaviour when contention Resolution timer expires..... | 120 |
| 6.2.2.2 | Non-Contention based random access | 120 |
| 6.2.2.2.1 | Correct behaviour when receiving Random Access Response..... | 120 |
| 6.2.2.2.2 | Correct behaviour when not receiving Random Access Response..... | 121 |
| 6.2.3 | Requirements for Cat-M1 UEs | 121 |
| 6.3 | RRC Connection Release with Redirection..... | 121 |
| 6.3.1 | Introduction..... | 121 |
| 6.3.2 | Requirements | 121 |
| 6.3.2.1 | RRC connection release with redirection to UTRAN FDD | 121 |
| 6.3.2.2 | RRC connection release with redirection to GERAN | 122 |
| 6.3.2.3 | RRC connection release with redirection to UTRAN TDD | 122 |
| 6.4 | CSG Proximity Indication for E-UTRAN and UTRAN..... | 123 |
| 6.4.1 | Introduction..... | 123 |
| 6.4.2 | Requirements | 123 |
| 6.5 | RRC Re-establishment for NB-IoT UEs | 123 |
| 6.5.1 | Introduction..... | 123 |
| 6.5.2 | Requirements | 123 |
| 6.5.2.1 | UE Re-establishment delay requirement in normal coverage | 123 |
| 6.5.2.2 | UE Re-establishment delay requirement in enhanced coverage..... | 124 |
| 6.6 | Random Access for UE category NB1 | 124 |

| | | |
|---------|--|-----|
| 6.6.1 | Introduction..... | 124 |
| 6.6.2 | Requirements | 124 |
| 6.6.2.1 | Correct behaviour when receiving Random Access Response reception..... | 125 |
| 6.6.2.2 | Correct behaviour when not receiving Random Access Response reception..... | 125 |
| 6.6.2.3 | Correct behaviour when receiving a NACK on msg3..... | 125 |
| 6.6.2.4 | Correct behaviour when receiving a message over Temporary C-RNTI | 125 |
| 6.6.2.5 | Correct behaviour when contention Resolution timer expires | 125 |
| 6.6.3 | Requirements for NPRACH configuration..... | 125 |
| 6.7 | RRC Re-establishment for Cat-M1 UEs | 125 |
| 6.7.1 | Introduction..... | 125 |
| 6.7.2 | Requirements | 125 |
| 6.7.2.1 | UE Re-establishment delay requirement for CEModeA | 126 |
| 6.7.2.2 | UE Re-establishment delay requirement for CEModeB | 126 |
| 6.8 | RRC Connection Release with Redirection for Cat-M1 UEs..... | 127 |
| 6.8.1 | Introduction..... | 127 |
| 6.8.2 | Requirements | 127 |
| 6.8.2.1 | RRC connection release with redirection to E-UTRAN with CE Mode A | 127 |
| 6.9 | RRC Connection Redirection to Non-anchor Carrier in NB-IoT | 128 |
| 6.9.1 | Introduction..... | 128 |
| 6.9.2 | Requirements | 128 |
| 7 | Timing and signalling characteristics..... | 128 |
| 7.1 | UE transmit timing | 128 |
| 7.1.1 | Introduction..... | 128 |
| 7.1.2 | Requirements | 129 |
| 7.2 | UE timer accuracy | 130 |
| 7.2.1 | Introduction..... | 130 |
| 7.2.2 | Requirements | 130 |
| 7.3 | Timing Advance | 130 |
| 7.3.1 | Introduction..... | 130 |
| 7.3.2 | Requirements | 130 |
| 7.3.2.1 | Timing Advance adjustment delay..... | 130 |
| 7.3.2.2 | Timing Advance adjustment accuracy | 130 |
| 7.4 | Cell phase synchronization accuracy (TDD)..... | 131 |
| 7.4.1 | Definition..... | 131 |
| 7.4.2 | Minimum requirements..... | 131 |
| 7.5 | Synchronization Requirements for E-UTRAN to 1xRTT and HRPD Handovers..... | 131 |
| 7.5.1 | Introduction..... | 131 |
| 7.5.2 | eNodeB Synchronization Requirements | 132 |
| 7.5.2.1 | Synchronized E-UTRAN | 132 |
| 7.5.2.2 | Non-Synchronized E-UTRAN | 132 |
| 7.6 | Radio Link Monitoring..... | 132 |
| 7.6.1 | Introduction..... | 132 |
| 7.6.2 | Requirements | 133 |
| 7.6.2.1 | Minimum requirement when no DRX is used..... | 133 |
| 7.6.2.2 | Minimum requirement when DRX is used..... | 134 |
| 7.6.2.3 | Minimum requirement at transitions | 135 |
| 7.6.2.4 | Minimum requirement during SI Acquisition with autonomous gaps | 135 |
| 7.6.2.5 | Minimum requirement under IDC Interference | 135 |
| 7.7 | SCell Activation and Deactivation Delay for E-UTRA Carrier Aggregation | 136 |
| 7.7.1 | Introduction..... | 136 |
| 7.7.2 | SCell Activation Delay Requirement for Deactivated SCell | 136 |
| 7.7.3 | SCell Deactivation Delay Requirement for Activated SCell | 137 |
| 7.7.4 | SCell Activation Delay Requirement for Deactivated SCell with Multiple Downlnk SCells..... | 137 |
| 7.7.5 | SCell Deactivation Delay Requirement for Activated SCell with Multiple Downlink SCells | 138 |
| 7.7.6 | SCell Activation Delay Requirement for Deactivated PUCCH SCell | 138 |
| 7.7.7 | SCell Activation Delay Requirement for Deactivated PUCCH SCell with Multiple SCells | 139 |
| 7.7.8 | SCell Deactivation Delay Requirement for Activated PUCCH SCell | 139 |
| 7.7.9 | SCell Deactivation Delay Requirement for Activated PUCCH SCell with Multiple SCells | 139 |
| 7.7.10 | SCell Activation Delay Requirement for Deactivated SCell under Frame Structure 3..... | 140 |
| 7.7.11 | SCell Deactivation Delay Requirement for Activated SCell under Frame Structure 3..... | 141 |

| | | |
|----------|--|-----|
| 7.7.12 | SCell Activation Delay Requirement for Deactivated SCell with Multiple Downlink SCells under Frame Structure 3 | 141 |
| 7.7.13 | SCell Deactivation Delay Requirement for Activated SCell with Multiple Downlink SCells under Frame Structure 3 | 142 |
| 7.8 | Interruptions with Carrier Aggregation | 142 |
| 7.8.1 | Introduction..... | 142 |
| 7.8.2 | Requirements | 142 |
| 7.8.2.1 | Interruptions at SCell addition/release for intra-band CA..... | 142 |
| 7.8.2.2 | Interruptions at SCell addition/release for inter-band CA..... | 142 |
| 7.8.2.3 | Interruptions at SCell activation/deactivation for intra-band CA..... | 143 |
| 7.8.2.4 | Interruptions at SCell activation/deactivation for inter-band CA..... | 143 |
| 7.8.2.5 | Interruptions during measurements on SCC for intra-band CA | 143 |
| 7.8.2.6 | Interruptions during measurements on SCC for inter-band CA | 143 |
| 7.8.2.7 | Interruptions at SCell addition/release with multiple downlink SCells..... | 143 |
| 7.8.2.8 | Interruptions at SCell activation/deactivation with multiple downlink SCells..... | 143 |
| 7.8.2.9 | Interruptions during measurements on SCC with multiple downlink SCells..... | 144 |
| 7.8.2.10 | Interruptions at overlapping addition/release/activation/deactivation of SCells | 145 |
| 7.8.2.11 | Interruptions during RSSI measurements on one SCC under Frame Structure 3..... | 145 |
| 7.8.2.12 | Interruptions during RSSI measurements on multiple SCCs under Frame Structure 3..... | 145 |
| 7.9 | Maximum Transmission Timing Difference in Carrier Aggregation | 146 |
| 7.9.1 | Introduction..... | 146 |
| 7.9.2 | Minimum Requirements for Interband Carrier Aggregation | 146 |
| 7.9.3 | Minimum Requirements for Intra-band non-contiguous Carrier Aggregation..... | 146 |
| 7.9.4 | Minimum Requirements for Inter-Band Carrier Aggregation under Frame Structure 3..... | 147 |
| 7.10 | Interruptions with RSTD Measurements with Carrier Aggregation..... | 147 |
| 7.10.1 | Introduction..... | 147 |
| 7.10.2 | Requirements | 147 |
| 7.10.2.1 | Interruptions during RSTD measurements on SCC for intra-band CA with one downlink SCell | 147 |
| 7.10.2.2 | Interruptions during RSTD measurements on SCC for inter-band CA with one downlink SCell | 147 |
| 7.10.2.3 | Interruptions during RSTD measurements on SCC with multiple downlink SCells..... | 147 |
| 7.10.2.4 | Interruptions at overlapping RSTD and inter-frequency measurements | 148 |
| 7.11 | Radio Link Monitoring for UE Category 0 | 148 |
| 7.11.1 | Introduction..... | 148 |
| 7.11.2 | Requirements for FD-FDD and TDD | 149 |
| 7.11.2.1 | Minimum requirement when no DRX is used..... | 149 |
| 7.11.2.2 | Minimum requirement when DRX is used..... | 150 |
| 7.11.2.3 | Minimum requirement at transitions | 150 |
| 7.11.3 | Requirements for HD-FDD | 151 |
| 7.11.3.1 | Minimum requirement when no DRX is used..... | 151 |
| 7.11.3.2 | Minimum requirement when DRX is used..... | 151 |
| 7.11.3.3 | Minimum requirement at transitions | 152 |
| 7.12 | Interruptions with Dual Connectivity | 152 |
| 7.12.1 | Introduction..... | 152 |
| 7.12.2 | Requirements | 152 |
| 7.12.2.1 | Interruptions at PSCell addition/release | 152 |
| 7.12.2.2 | Interruptions at transitions between active and non-active during DRX..... | 152 |
| 7.12.2.3 | Interruptions at transitions from non-DRX to DRX..... | 153 |
| 7.12.2.4 | Interruptions at SCell addition/release | 153 |
| 7.12.2.5 | Interruptions at SCell activation/deactivation | 153 |
| 7.12.2.6 | Interruptions during measurements on SCC | 153 |
| 7.13 | Cell phase synchronization accuracy (Synchronized mode of dual connectivity)..... | 154 |
| 7.13.1 | Definition..... | 154 |
| 7.13.2 | Minimum requirements..... | 154 |
| 7.14 | PSCell Addition and Release Delay for E-UTRA Dual Connectivity..... | 155 |
| 7.14.1 | Introduction..... | 155 |
| 7.14.2 | PSCell Addition Delay Requirement | 155 |
| 7.14.3 | PSCell Release Delay Requirement..... | 155 |
| 7.15 | Maximum Receive Timing Difference in Dual Connectivity | 155 |
| 7.15.1 | Introduction..... | 155 |
| 7.15.2 | Minimum Requirements for Inter-band Dual Connectivity | 156 |
| 7.16 | Proximity-based Services | 156 |
| 7.16.1 | Introduction..... | 156 |

| | | |
|------------|--|-----|
| 7.16.2 | Requirements | 156 |
| 7.16.2.1 | ProSe UE transmission timing | 156 |
| 7.16.2.1.1 | Serving cell or PCell as timing reference | 156 |
| 7.16.2.1.2 | SCell or non-serving cell as timing reference..... | 157 |
| 7.16.3 | Interruptions with ProSe | 157 |
| 7.16.3.1 | Interruptions at ProSe Direct Discovery configuration | 157 |
| 7.16.3.2 | Interruptions at ProSe Direct Communication configuration..... | 157 |
| 7.16.3.3 | Interruptions during ProSe Direct Discovery | 157 |
| 7.16.3.4 | Interruptions during ProSe Direct Discovery with discovery gaps | 158 |
| 7.16.3.5 | Interruptions during ProSe Direct Communication..... | 158 |
| 7.16.4 | Cell reselection for ProSe Direct Discovery on non-serving frequency | 158 |
| 7.16.4.1 | Measurement and evaluation of selected cell..... | 159 |
| 7.16.4.2 | Measurement of intra-frequency E-UTRAN cells | 159 |
| 7.16.5 | Selection / Reselection of ProSe relay UE..... | 159 |
| 7.16.6 | ProSe operation under deactivated SCell..... | 160 |
| 7.17 | Maximum Transmission Timing Difference in Dual Connectivity | 160 |
| 7.17.1 | Introduction..... | 160 |
| 7.17.2 | Minimum Requirements for maximum transmission timing difference Inter-band Dual Connectivity ... | 160 |
| 7.18.1 | Introduction..... | 160 |
| 7.18.2 | SCell Activation Delay Requirement for Deactivated SCell | 161 |
| 7.18.3 | SCell Deactivation Delay Requirement for Activated SCell | 161 |
| 7.19 | Radio Link Monitoring for UE Category M1 | 161 |
| 7.19.1 | Introduction..... | 161 |
| 7.19.2 | Requirements for FD-FDD and TDD CE mode A..... | 161 |
| 7.19.2.1 | Minimum requirement when no DRX is used..... | 161 |
| 7.19.2.2 | Minimum requirement when DRX is used..... | 162 |
| 7.19.2.3 | Minimum requirement at transitions | 163 |
| 7.19.3 | Requirements for HD-FDD with CE mode A..... | 163 |
| 7.19.3.1 | Minimum requirement when no DRX is used..... | 163 |
| 7.19.3.2 | Minimum requirement when DRX is used..... | 163 |
| 7.19.3.3 | Minimum requirement at transitions | 164 |
| 7.19.4 | Requirements for FD-FDD and TDD with CE mode B..... | 164 |
| 7.19.4.1 | Minimum requirement when no DRX is used..... | 165 |
| 7.19.4.2 | Minimum requirement when DRX is used..... | 165 |
| 7.19.4.3 | Minimum requirement at transitions | 166 |
| 7.19.5 | Requirements for HD-FDD with CE mode B | 166 |
| 7.19.5.1 | Minimum requirement when no DRX is used..... | 166 |
| 7.19.5.2 | Minimum requirement when DRX is used..... | 166 |
| 7.19.5.3 | Minimum requirement at transitions | 167 |
| 7.20 | UE transmit timing for NB-IoT | 167 |
| 7.20.1 | Introduction..... | 167 |
| 7.20.2 | Requirements | 167 |
| 7.21 | UE timer accuracy for NB-IoT | 168 |
| 7.21.1 | Introduction..... | 168 |
| 7.21.2 | Requirements | 168 |
| 7.22 | Timing Advance for NB-IoT..... | 169 |
| 7.22.1 | Introduction..... | 169 |
| 7.22.2 | Requirements | 169 |
| 7.22.2.1 | Timing Advance adjustment delay..... | 169 |
| 7.22.2.2 | Timing Advance adjustment accuracy | 169 |
| 7.23 | Radio Link Monitoring for Category NB1 UE..... | 169 |
| 7.23.1 | Introduction..... | 169 |
| 7.23.2 | Requirements for HD-FDD Category NB1 UE | 169 |
| 7.23.2.1 | Minimum requirement when no DRX is used..... | 170 |
| 7.23.2.2 | Minimum requirement when DRX is used..... | 170 |
| 7.23.2.3 | Minimum requirement at transitions | 171 |
| 7.24 | UE transmit timing for Category M1 | 171 |
| 7.24.1 | Introduction..... | 171 |
| 7.24.2 | Requirements | 171 |
| 7.25 | Timing Advance for Category M1 | 172 |
| 7.25.1 | Introduction..... | 172 |
| 7.25.2 | Requirements | 172 |

| | | |
|--------------|---|-----|
| 7.26 | UE timer accuracy for category M1 | 172 |
| 7.26.1 | Introduction..... | 172 |
| 7.26.2 | Requirements | 172 |
| 8 | UE Measurements Procedures in RRC_CONNECTED State | 172 |
| 8.1 | General Measurement Requirements..... | 172 |
| 8.1.1 | Introduction..... | 172 |
| 8.1.2 | Requirements | 173 |
| 8.1.2.1 | UE measurement capability | 173 |
| 8.1.2.1.1 | Monitoring of multiple layers using gaps | 175 |
| 8.1.2.1.1a | Monitoring of multiple layers using gaps (Increased UE carrier monitoring)..... | 176 |
| 8.1.2.2 | E-UTRAN intra frequency measurements | 177 |
| 8.1.2.2.1 | E-UTRAN FDD intra frequency measurements..... | 177 |
| 8.1.2.2.2 | E-UTRAN TDD intra frequency measurements | 181 |
| 8.1.2.2.3 | E-UTRAN FDD intra frequency measurements with autonomous gaps | 184 |
| 8.1.2.2.4 | E-UTRAN TDD intra frequency measurements with autonomous gaps..... | 185 |
| 8.1.2.3 | E-UTRAN inter frequency measurements | 186 |
| 8.1.2.3.1 | E-UTRAN FDD – FDD inter frequency measurements..... | 186 |
| 8.1.2.3.2 | E-UTRAN TDD – TDD inter frequency measurements | 190 |
| 8.1.2.3.3 | E-UTRAN TDD – FDD inter frequency measurements..... | 193 |
| 8.1.2.3.4 | E-UTRAN FDD – TDD inter frequency measurements..... | 194 |
| 8.1.2.3.5 | E-UTRAN FDD-FDD inter frequency measurements with autonomous gaps..... | 194 |
| 8.1.2.3.6 | E-UTRAN TDD-FDD inter frequency measurements using autonomous gaps..... | 195 |
| 8.1.2.3.7 | E-UTRAN TDD-TDD inter frequency measurements with autonomous gaps | 196 |
| 8.1.2.3.8 | E-UTRAN FDD-TDD inter frequency measurements using autonomous gaps | 197 |
| 8.1.2.4 | Inter RAT measurements | 198 |
| 8.1.2.4.1 | E-UTRAN FDD – UTRAN FDD measurements | 198 |
| 8.1.2.4.2 | E-UTRAN TDD – UTRAN FDD measurements | 202 |
| 8.1.2.4.3 | E-UTRAN TDD – UTRAN TDD measurements..... | 202 |
| 8.1.2.4.4 | E-UTRAN FDD – UTRAN TDD measurements | 206 |
| 8.1.2.4.5 | E-UTRAN FDD – GSM measurements | 206 |
| 8.1.2.4.6 | E-UTRAN TDD – GSM measurements | 212 |
| 8.1.2.4.7 | E-UTRAN FDD – UTRAN FDD measurements for SON..... | 212 |
| 8.1.2.4.8 | E-UTRAN TDD – UTRAN FDD measurements for SON..... | 214 |
| 8.1.2.4.9 | E-UTRAN FDD – cdma2000 1xRTT measurements | 214 |
| 8.1.2.4.9.1A | E-UTRAN FDD – cdma2000 1xRTT measurements when no DRX is used | 214 |
| 8.1.2.4.10 | E-UTRAN TDD – cdma2000 1xRTT measurements..... | 214 |
| 8.1.2.4.11 | E-UTRAN FDD – HRPD measurements | 214 |
| 8.1.2.4.12 | E-UTRAN TDD – HRPD measurements | 214 |
| 8.1.2.4.13 | E-UTRAN TDD – UTRAN TDD measurements for SON | 215 |
| 8.1.2.4.14 | E-UTRAN FDD – UTRAN TDD measurements for SON..... | 216 |
| 8.1.2.4.15 | E-UTRAN FDD – cdma2000 1xRTT measurements for SON ANR..... | 216 |
| 8.1.2.4.16 | E-UTRAN TDD – cdma2000 1xRTT measurements for SON ANR..... | 217 |
| 8.1.2.4.17 | E-UTRAN FDD-UTRAN FDD measurements with autonomous gaps | 217 |
| 8.1.2.4.18 | E-UTRAN TDD-UTRAN FDD measurements with autonomous gaps | 218 |
| 8.1.2.4.19 | E-UTRAN FDD – WLAN measurements | 218 |
| 8.1.2.4.20 | E-UTRAN TDD – WLAN measurements..... | 220 |
| 8.1.2.5 | E-UTRAN OTDOA Intra-Frequency RSTD Measurements | 220 |
| 8.1.2.5.1 | E-UTRAN FDD Intra-Frequency OTDOA Measurements..... | 220 |
| 8.1.2.5.2 | E-UTRAN TDD Intra-Frequency OTDOA Measurements..... | 221 |
| 8.1.2.6 | E-UTRAN Inter-Frequency OTDOA Measurements..... | 223 |
| 8.1.2.6.1 | E-UTRAN FDD-FDD Inter-Frequency OTDOA Measurements..... | 223 |
| 8.1.2.6.2 | E-UTRAN TDD-FDD Inter-Frequency OTDOA Measurements | 225 |
| 8.1.2.6.3 | E-UTRAN TDD-TDD Inter-Frequency OTDOA Measurements | 226 |
| 8.1.2.6.4 | E-UTRAN FDD-TDD Inter-Frequency OTDOA Measurements | 228 |
| 8.1.2.7 | E-UTRAN E-CID Measurements | 230 |
| 8.1.2.7.1 | E-UTRAN FDD UE Rx-Tx Time Difference Measurements | 230 |
| 8.1.2.7.2 | E-UTRAN TDD UE Rx-Tx Time Difference Measurements | 231 |
| 8.1.2.7.3 | E-UTRAN FDD Intra-frequency E-CID RSRP and RSRQ Measurements | 232 |
| 8.1.2.7.4 | E-UTRAN TDD Intra-frequency E-CID RSRP and RSRQ Measurements | 233 |
| 8.1.2.8 | E-UTRAN intra-frequency measurements under time domain measurement resource restriction | 233 |
| 8.1.2.8.1 | E-UTRAN FDD intra-frequency measurements | 233 |

| | | |
|-----------|--|-----|
| 8.1.2.8.2 | E-UTRAN TDD intra-frequency measurements | 236 |
| 8.1.2.8.3 | E-UTRAN FDD intra-frequency measurements with CRS assistance information | 239 |
| 8.1.2.8.4 | E-UTRAN TDD intra-frequency measurements with CRS assistance information | 243 |
| 8.1.2.9 | E-UTRAN E-CID Measurements when Time Domain Measurement Resource Restriction Pattern is Configured..... | 246 |
| 8.1.2.9.1 | E-UTRAN FDD UE Rx-Tx Time Difference Measurements | 246 |
| 8.1.2.9.2 | E-UTRAN TDD UE Rx-Tx Time Difference Measurements | 247 |
| 8.1.2.9.3 | E-UTRAN FDD UE Rx-Tx Time Difference Measurements with CRS Assistance Information | 247 |
| 8.1.2.9.4 | E-UTRAN TDD UE Rx-Tx Time Difference Measurements with CRS Assistance Information | 247 |
| 8.2 | Capabilities for Support of Event Triggering and Reporting Criteria | 248 |
| 8.2.1 | Introduction..... | 248 |
| 8.2.2 | Requirements | 248 |
| 8.3 | Measurements for E-UTRA carrier aggregation | 250 |
| 8.3.1 | Introduction..... | 250 |
| 8.3.2 | Measurements of the primary component carrier | 250 |
| 8.3.3 | Measurements of a secondary component carrier | 251 |
| 8.3.3.1 | Measurements of a secondary component carrier with active SCell | 251 |
| 8.3.3.2 | Measurements of a secondary component carrier with deactivated SCell | 251 |
| 8.3.3.2.1 | E-UTRAN secondary component carrier measurements when no common DRX is used | 251 |
| 8.3.3.2.2 | E-UTRAN secondary component carrier measurements when common DRX is used | 252 |
| 8.4 | OTDOA RSTD Measurements for E-UTRAN carrier aggregation | 254 |
| 8.4.1 | Introduction..... | 254 |
| 8.4.2 | Measurements on the primary component carrier..... | 254 |
| 8.4.3 | Measurements on a secondary component carrier | 255 |
| 8.4.4 | Measurements on both primary component carrier and a secondary component carrier | 255 |
| 8.4.5 | Measurements on different secondary component carriers..... | 256 |
| 8.5 | Measurements for UE category 0 | 257 |
| 8.5.1 | Introduction..... | 257 |
| 8.5.2 | Requirements | 257 |
| 8.5.2.1 | E-UTRAN intra frequency measurements | 257 |
| 8.5.2.1.1 | E-UTRAN FDD intra frequency measurements..... | 258 |
| 8.5.2.1.2 | E-UTRAN intra frequency measurements for HD-FDD | 261 |
| 8.5.2.1.3 | E-UTRAN TDD intra frequency measurements | 263 |
| 8.5.2.1.4 | E-UTRAN FDD intra frequency measurements with autonomous gaps for UE category 0 | 266 |
| 8.5.2.1.5 | E-UTRAN intra frequency measurements with autonomous gaps for HD-FDD UE category 0 | 267 |
| 8.5.2.1.6 | E-UTRAN TDD intra frequency measurements with autonomous gaps for UE category 0 | 267 |
| 8.6 | Discovery signal measurements | 268 |
| 8.6.1 | Introduction..... | 268 |
| 8.6.2 | Requirements for CRS based discovery signal measurements | 269 |
| 8.6.2.1 | E-UTRAN intra frequency measurements | 269 |
| 8.6.2.1.1 | E-UTRAN FDD intra frequency measurements..... | 269 |
| 8.6.2.1.2 | E-UTRAN TDD intra frequency measurements | 271 |
| 8.6.2.2 | E-UTRAN inter frequency measurements | 274 |
| 8.6.2.2.1 | E-UTRAN FDD – FDD inter-frequency measurements | 274 |
| 8.6.2.2.2 | E-UTRAN TDD – TDD inter frequency measurements | 277 |
| 8.6.2.2.3 | E-UTRAN TDD – FDD inter frequency measurements..... | 279 |
| 8.6.2.2.4 | E-UTRAN FDD – TDD inter frequency measurements..... | 279 |
| 8.6.3 | Requirements for CSI-RS based discovery signal measurements..... | 280 |
| 8.6.3.1 | E-UTRAN intra frequency measurements | 280 |
| 8.6.3.1.1 | E-UTRAN FDD intra frequency measurements..... | 280 |
| 8.6.3.1.2 | E-UTRAN TDD intra frequency measurements | 282 |
| 8.6.3.2 | E-UTRAN inter frequency measurements | 285 |
| 8.6.3.2.1 | E-UTRAN FDD – FDD inter frequency measurements..... | 285 |
| 8.6.3.2.2 | E-UTRAN TDD – TDD inter frequency measurements | 288 |
| 8.6.3.2.3 | E-UTRAN TDD – FDD inter frequency measurements..... | 290 |
| 8.6.3.2.4 | E-UTRAN FDD – TDD inter frequency measurements..... | 290 |
| 8.7 | Discovery signal measurements for E-UTRA carrier aggregation | 291 |
| 8.7.1 | Introduction..... | 291 |
| 8.7.2 | Requirements for CRS based discovery signal measurements for E-UTRA carrier aggregation | 291 |
| 8.7.2.1 | Measurements of the primary component carrier..... | 291 |

| | | |
|----------------|--|-----|
| 8.7.2.2 | Measurements of a secondary component carrier | 291 |
| 8.7.2.3 | Measurements of a secondary component carrier with active SCell | 291 |
| 8.7.2.4 | Measurements of a secondary component carrier with deactivated SCell | 291 |
| 8.7.2.4.1 | E-UTRAN secondary component carrier measurements when no common DRX is used | 291 |
| 8.7.2.4.2 | E-UTRAN secondary component carrier measurements when common DRX is used | 293 |
| 8.7.3 | Requirements for CSI-RS based discovery signal measurements for E-UTRA carrier aggregation | 294 |
| 8.7.3.1 | Measurements of the primary component carrier | 294 |
| 8.7.3.2 | Measurements of a secondary component carrier | 294 |
| 8.7.3.3 | Measurements of a secondary component carrier with active SCell | 294 |
| 8.7.3.4 | Measurements of a secondary component carrier with deactivated SCell | 294 |
| 8.7.3.4.1 | E-UTRAN secondary component carrier measurements when no common DRX is used | 294 |
| 8.7.3.4.2 | E-UTRAN secondary component carrier measurements when common DRX is used | 296 |
| 8.8 | Measurements for E-UTRA dual connectivity | 297 |
| 8.8.1 | Introduction | 297 |
| 8.8.2 | Intra-frequency measurements requirements on PCell | 297 |
| 8.8.3 | Intra-frequency measurements requirements on PSCell | 297 |
| 8.8.4 | Inter-frequency and inter-RAT measurement requirements | 298 |
| 8.8.5 | Intra-frequency measurements with autonomous gaps | 298 |
| 8.8.5.1 | Identification of a new CGI of E-UTRA cell with autonomous gaps | 298 |
| 8.8.5.2 | ECGI reporting delay | 299 |
| 8.8.6 | Inter-frequency measurements with autonomous gaps | 299 |
| 8.8.6.1 | Identification of a new CGI of E-UTRA cell with autonomous gaps | 299 |
| 8.8.6.2 | ECGI reporting delay | 300 |
| 8.8.7 | SSTD Measurements | 300 |
| 8.8.7.1 | Introduction | 300 |
| 8.8.7.2 | SSTD Measurement requirements | 300 |
| 8.8.7.3 | SSTD Measurement Reporting Delay | 301 |
| 8.8.8 | Intra-frequency measurements requirements on SCell | 301 |
| 8.9 | MBSFN Measurements | 301 |
| 8.9.1 | Introduction | 301 |
| 8.9.2 | MBSFN RSRP Measurements | 301 |
| 8.9.3 | MBSFN RSRQ Measurements | 302 |
| 8.9.4 | MCH BLER Measurements | 302 |
| 8.10 | Proximity-based Services | 302 |
| 8.10.1 | Introduction | 302 |
| 8.10.2 | Requirements | 302 |
| 8.10.2.1 | Initiation/Cease of SLSS transmissions with ProSe Direct Discovery | 302 |
| 8.10.2.2 | Initiation/Cease of SLSS transmissions with ProSe Direct Communication | 303 |
| 8.11 | Discovery Signal Measurements under Operation with Frame Structure 3 | 303 |
| 8.11.1 | Introduction | 303 |
| 8.11.2 | CRS based discovery signal measurements | 304 |
| 8.11.2.1 | E-UTRAN intra-frequency measurements | 304 |
| 8.11.2.1.1 | Requirements | 304 |
| 8.11.2.1.1.1 | Requirements when no DRX is used | 304 |
| 8.11.2.1.1.1.1 | Measurement Reporting Requirements | 305 |
| 8.11.2.1.1.2 | Requirements when DRX is used | 306 |
| 8.11.2.1.1.2.1 | Measurement Reporting Requirements | 307 |
| 8.11.2.2 | E-UTRAN inter-frequency measurements | 308 |
| 8.11.2.2.1 | E-UTRAN FDD-FS3 inter-frequency measurements | 308 |
| 8.11.2.2.2 | E-UTRAN TDD – FS3 inter-frequency measurements | 312 |
| 8.11.3 | CSI-RS based discovery signal measurements | 312 |
| 8.11.3.1 | E-UTRAN intra-frequency measurements | 312 |
| 8.11.3.1.1 | Requirements | 313 |
| 8.11.3.1.1.1 | Requirements when no DRX is used | 313 |
| 8.11.3.1.1.1.1 | Measurement Reporting Requirements | 314 |
| 8.11.3.1.1.2 | Requirements when DRX is used | 314 |
| 8.11.3.1.1.2.1 | Measurement Reporting Requirements | 315 |
| 8.11.3.2 | E-UTRAN inter-frequency measurements | 316 |
| 8.11.3.2.1 | E-UTRAN FDD – FS3 inter-frequency measurements | 316 |
| 8.11.3.2.2 | E-UTRAN TDD – FS3 inter-frequency measurements | 320 |
| 8.11.4 | RSSI measurements | 320 |
| 8.11.4.1 | E-UTRAN intra-frequency measurements | 320 |

| | | |
|------------|---|-----|
| 8.11.4.2 | E-UTRAN inter-frequency measurements | 320 |
| 8.11.5 | Channel occupancy measurements | 321 |
| 8.11.5.1 | E-UTRAN intra-frequency channel occupancy measurements..... | 321 |
| 8.11.5.2 | E-UTRAN inter-frequency channel occupancy measurements..... | 321 |
| 8.12 | Discovery Signal Measurements for E-UTRA Carrier Aggregation under Operation with Frame Structure 3 | 321 |
| 8.12.1 | Introduction..... | 321 |
| 8.12.2 | CRS based discovery signal measurements for E-UTRA carrier aggregation..... | 321 |
| 8.12.2.1 | Introduction..... | 321 |
| 8.12.2.2 | Measurements of a secondary component carrier | 322 |
| 8.12.2.3 | Measurements of a secondary component carrier with active SCell..... | 322 |
| 8.12.2.4 | Measurements of a secondary component carrier with deactivated SCell | 322 |
| 8.12.2.4.1 | E-UTRAN secondary component carrier measurements when no common DRX is used | 322 |
| 8.12.2.4.2 | E-UTRAN secondary component carrier measurements when common DRX is used | 324 |
| 8.12.3 | Requirements for CSI-RS based discovery signal measurements for E-UTRA carrier aggregation | 326 |
| 8.12.3.1 | Introduction..... | 326 |
| 8.12.3.2 | Measurements of a secondary component carrier | 326 |
| 8.12.3.3 | Measurements of a secondary component carrier with active SCell..... | 326 |
| 8.12.3.4 | Measurements of a secondary component carrier with deactivated SCell | 326 |
| 8.12.3.4.1 | E-UTRAN secondary component carrier measurements when no common DRX is used | 326 |
| 8.12.3.4.2 | E-UTRAN secondary component carrier measurements when common DRX is used..... | 328 |
| 8.13 | Measurements for UE Category M1..... | 330 |
| 8.13.1 | Introduction..... | 330 |
| 8.13.2 | Requirements for UE category M1 with CE mode A | 330 |
| 8.13.2.1 | E-UTRAN intra frequency measurements by UE category M1 with CE mode A | 330 |
| 8.13.2.1.1 | E-UTRAN FDD intra frequency measurements..... | 330 |
| 8.13.2.1.2 | E-UTRAN intra frequency measurements for HD-FDD | 333 |
| 8.13.2.1.3 | E-UTRAN TDD intra frequency measurements | 336 |
| 8.13.2.2 | E-UTRAN E-CID Measurements Requirements for UE category M1 with CE mode A | 339 |
| 8.13.2.2.1 | E-UTRAN FDD Intra-frequency E-CID RSRP Measurements | 339 |
| 8.13.2.2.2 | E-UTRAN HD-FDD Intra-frequency E-CID RSRP Measurements | 339 |
| 8.13.2.2.3 | E-UTRAN TDD Intra-frequency E-CID RSRP Measurements | 340 |
| 8.13.3 | Requirements for UE category M1 with CE mode B | 340 |
| 8.13.3.1 | E-UTRAN intra frequency measurements by UE category M1 with CE mode B | 340 |
| 8.13.3.1.1 | E-UTRAN FDD intra frequency measurements..... | 340 |
| 8.13.3.1.2 | E-UTRAN intra frequency measurements for HD-FDD | 344 |
| 8.13.3.1.3 | E-UTRAN TDD intra frequency measurements | 346 |
| 8.13.3.1.4 | E-UTRAN FDD intra frequency measurements with autonomous gaps for UE category M1 with CE mode B | 349 |
| 8.13.3.1.5 | E-UTRAN intra frequency measurements with autonomous gaps for HD-FDD UE category M1 with CE mode B | 350 |
| 8.13.3.1.6 | E-UTRAN TDD intra frequency measurements with autonomous gaps for UE category M1 with CE mode B | 350 |
| 8.13.3.2 | E-UTRAN E-CID Measurements Requirements for UE category M1 with CE mode B..... | 351 |
| 8.13.3.2.1 | E-UTRAN FDD Intra-frequency E-CID RSRP Measurements | 351 |
| 8.13.3.2.2 | E-UTRAN HD-FDD Intra-frequency E-CID RSRP Measurements | 352 |
| 8.13.3.2.3 | E-UTRAN TDD Intra-frequency E-CID RSRP Measurements | 352 |
| 8.14 | Measurements for UE category NB1..... | 353 |
| 8.14.1 | Introduction..... | 353 |
| 8.14.2 | NB-IoT intra frequency measurements under normal coverage | 353 |
| 8.14.2.1 | NB-IoT intra frequency measurements when no DRX is used | 353 |
| 8.14.2.2 | NB-IoT intra frequency measurements when DRX is used | 353 |
| 8.14.3 | NB-IoT intra frequency measurements under enhanced coverage | 353 |
| 8.14.3.1 | NB-IoT intra frequency measurements when no DRX is used | 353 |
| 8.14.3.2 | NB-IoT intra frequency measurements when DRX is used | 354 |
| 9 | Measurements performance requirements for UE..... | 354 |
| 9.1 | E-UTRAN measurements..... | 354 |
| 9.1.1 | Introduction..... | 354 |
| 9.1.2 | Intra-frequency RSRP Accuracy Requirements..... | 354 |
| 9.1.2.1 | Absolute RSRP Accuracy | 354 |
| 9.1.2.2 | Relative Accuracy of RSRP | 355 |

| | | |
|----------|--|-----|
| 9.1.2.3 | Absolute RSRP Accuracy under Time Domain Measurement Resource Restriction | 356 |
| 9.1.2.4 | Relative Accuracy of RSRP under Time Domain Measurement Resource Restriction | 357 |
| 9.1.2.5 | Absolute RSRP Accuracy under Time Domain Measurement Resource Restriction with CRS assistance information..... | 357 |
| 9.1.2.6 | Relative Accuracy of RSRP under Time Domain Measurement Resource Restriction with CRS assistance information..... | 358 |
| 9.1.2A | Intra-frequency RSRP Accuracy Requirements in High Doppler Conditions | 359 |
| 9.1.2A.1 | Absolute RSRP Accuracy in high Doppler conditions..... | 359 |
| 9.1.2A.2 | Relative Accuracy of RSRP in high Doppler conditions | 360 |
| 9.1.3 | Inter-frequency RSRP Accuracy Requirements..... | 361 |
| 9.1.3.1 | Absolute RSRP Accuracy | 361 |
| 9.1.3.2 | Relative Accuracy of RSRP | 361 |
| 9.1.3A | Inter-frequency RSRP Accuracy Requirements in High Doppler Conditions | 362 |
| 9.1.3A.1 | Absolute RSRP Accuracy in high Doppler conditions..... | 362 |
| 9.1.3A.2 | Relative Accuracy of RSRP in high Doppler conditions | 363 |
| 9.1.4 | RSRP Measurement Report Mapping..... | 363 |
| 9.1.5 | Intra-frequency RSRQ Accuracy Requirements..... | 364 |
| 9.1.5.1 | Absolute RSRQ Accuracy..... | 364 |
| 9.1.5.2 | Absolute RSRQ Accuracy under Time Domain Measurement Resource Restriction..... | 364 |
| 9.1.5.3 | Absolute RSRQ Accuracy under Time Domain Measurement Resource Restriction with CRS assistance information..... | 365 |
| 9.1.5.4 | Absolute WB-RSRQ Accuracy..... | 366 |
| 9.1.5A | Intra-frequency RSRQ Accuracy Requirements in High Doppler Conditions | 367 |
| 9.1.5A.1 | Absolute RSRQ Accuracy in high Doppler conditions | 367 |
| 9.1.6 | Inter-frequency RSRQ Accuracy Requirements..... | 368 |
| 9.1.6.1 | Absolute RSRQ Accuracy..... | 368 |
| 9.1.6.2 | Relative Accuracy of RSRQ | 368 |
| 9.1.6.3 | Absolute WB-RSRQ Accuracy..... | 369 |
| 9.1.6.4 | Relative WB-RSRQ Accuracy | 370 |
| 9.1.6A | Inter-frequency RSRQ Accuracy Requirements in High Doppler Conditions | 370 |
| 9.1.6A.1 | Absolute RSRQ Accuracy in high Doppler conditions | 370 |
| 9.1.6A.2 | Relative Accuracy of RSRQ in high Doppler conditions..... | 371 |
| 9.1.7 | RSRQ Measurement Report Mapping..... | 372 |
| 9.1.8 | Power Headroom | 372 |
| 9.1.8.1 | Period..... | 372 |
| 9.1.8.2 | Reporting Delay | 373 |
| 9.1.8.3 | Void..... | 373 |
| 9.1.8.4 | Report Mapping | 373 |
| 9.1.9 | UE Rx – Tx time difference..... | 373 |
| 9.1.9.1 | Measurement Requirement | 373 |
| 9.1.9.2 | Measurement Report mapping | 374 |
| 9.1.9.3 | Measurement Requirement under Time Domain Measurement Resource Restriction | 375 |
| 9.1.9.4 | Measurement Requirement when Time Domain Measurement Resource Restriction Pattern is Configured with CRS Assistance Information | 376 |
| 9.1.10 | Reference Signal Time Difference (RSTD)..... | 377 |
| 9.1.10.1 | Intra-Frequency Accuracy Requirement | 377 |
| 9.1.10.2 | Inter-Frequency Accuracy Requirement | 378 |
| 9.1.10.3 | RSTD Measurement Report Mapping..... | 379 |
| 9.1.11 | Carrier aggregation measurement accuracy..... | 379 |
| 9.1.11.1 | Primary component carrier accuracy requirement | 380 |
| 9.1.11.2 | Secondary component carrier accuracy requirement..... | 380 |
| 9.1.11.3 | Primary and secondary component carrier relative accuracy requirement..... | 380 |
| 9.1.11.4 | Secondary component carrier relative accuracy requirement..... | 380 |
| 9.1.12 | Reference Signal Time Difference (RSTD) Measurement Accuracy Requirements for Carrier Aggregation | 380 |
| 9.1.13 | Measurement accuracy for UE category 0..... | 381 |
| 9.1.13.1 | Intra-frequency Absolute RSRP Accuracy for UE category 0 | 381 |
| 9.1.13.2 | Intra-frequency Relative Accuracy of RSRP for UE category 0..... | 381 |
| 9.1.13.3 | Intra-frequency Absolute RSRQ Accuracy for UE category 0 | 382 |
| 9.1.14 | Accuracy requirements for Discovery Signal Measurements | 383 |
| 9.1.14.1 | Introduction..... | 383 |
| 9.1.14.2 | RSRP measurements in discovery signal occasions..... | 383 |

| | | |
|--------------|---|-----|
| 9.1.14.3 | CSI-RSRP measurements in discovery signal occasions | 383 |
| 9.1.14.3.1 | Intra-frequency CSI-RSRP measurements | 383 |
| 9.1.14.3.1.1 | Absolute CSI-RSRP measurement requirements | 383 |
| 9.1.14.3.1.2 | Relative CSI-RSRP measurement requirements | 384 |
| 9.1.14.3.2 | Inter-frequency CSI-RSRP measurements | 384 |
| 9.1.14.3.2.1 | Absolute CSI-RSRP measurement requirements | 384 |
| 9.1.14.3.2.2 | Relative CSI-RSRP measurement requirements | 385 |
| 9.1.14.3.3 | CSI-RSRP measurement report mapping | 386 |
| 9.1.14.4 | RSRQ measurements in discovery signal occasions | 386 |
| 9.1.15 | Discovery signal measurements accuracy for E-UTRAN carrier aggregation | 386 |
| 9.1.15.1 | Requirements for CRS based discovery signal measurements accuracy for E-UTRAN carrier aggregation | 386 |
| 9.1.15.1.1 | Primary component carrier accuracy requirement | 386 |
| 9.1.15.1.2 | Secondary component carrier accuracy requirement | 387 |
| 9.1.15.1.3 | Primary and secondary component carrier relative accuracy requirement | 387 |
| 9.1.15.1.4 | Secondary component carrier relative accuracy requirement | 387 |
| 9.1.15.2 | Requirements for CSI-RS based discovery signal measurements accuracy for E-UTRAN carrier aggregation | 387 |
| 9.1.15.2.1 | Primary component carrier accuracy requirement | 387 |
| 9.1.15.2.2 | Secondary component carrier accuracy requirement | 387 |
| 9.1.15.2.3 | Primary and secondary component carrier relative accuracy requirement | 387 |
| 9.1.15.2.4 | Secondary component carrier relative accuracy requirement | 387 |
| 9.1.16 | Accuracy requirements for RSRQ measurement on all OFDM symbols | 387 |
| 9.1.17 | RS-SINR Measurements | 388 |
| 9.1.17.1 | Measurement Report Mapping | 388 |
| 9.1.17.2 | Intra-frequency RS-SINR Measurement Accuracy Requirements | 388 |
| 9.1.17.2.1 | Absolute RS-SINR Measurement Accuracy Requirements | 388 |
| 9.1.17.3 | Inter-frequency RS-SINR Measurement Accuracy Requirements | 389 |
| 9.1.17.3.1 | Absolute RS-SINR Measurement Accuracy Requirements | 389 |
| 9.1.17.3.2 | Relative RS-SINR Measurement Accuracy Requirements | 390 |
| 9.1.18 | Accuracy Requirements for Measurements under Operation with Frame Structure 3 | 390 |
| 9.1.18.1 | Introduction | 390 |
| 9.1.18.2 | RSRP measurements | 390 |
| 9.1.18.2.1 | RSRP measurement report mapping | 390 |
| 9.1.18.2.2 | Inter-frequency absolute RSRP measurement accuracy requirements | 391 |
| 9.1.18.2.3 | Inter-frequency relative RSRP measurement accuracy requirements | 391 |
| 9.1.18.2.4 | Intra-frequency absolute RSRP measurement accuracy requirements | 392 |
| 9.1.18.2.5 | Intra-frequency relative RSRP measurement accuracy requirements | 392 |
| 9.1.18.3 | RSRQ measurements | 393 |
| 9.1.18.3.1 | RSRQ measurement report mapping | 393 |
| 9.1.18.3.2 | Inter-frequency absolute RSRQ measurement accuracy requirements | 393 |
| 9.1.18.3.3 | Inter-frequency relative RSRQ measurement accuracy requirements | 393 |
| 9.1.18.3.4 | Intra-frequency absolute RSRQ measurement accuracy requirements | 394 |
| 9.1.18.4 | CSI-RSRP measurements | 394 |
| 9.1.18.4.1 | CSI-RSRP measurement report mapping | 394 |
| 9.1.18.4.2 | Inter-frequency absolute CSI-RSRP measurement accuracy requirements | 394 |
| 9.1.18.4.3 | Inter-frequency relative CSI-RSRP measurement accuracy requirements | 395 |
| 9.1.18.4.4 | Intra-frequency absolute CSI-RSRP measurement accuracy requirements | 395 |
| 9.1.18.4.5 | Intra-frequency relative CSI-RSRP measurement accuracy requirements | 396 |
| 9.1.18.5 | RSSI measurements | 396 |
| 9.1.18.5.1 | RSSI measurement report mapping | 396 |
| 9.1.18.5.2 | Intra-frequency absolute RSSI measurement accuracy requirements | 397 |
| 9.1.18.5.3 | Inter-frequency absolute RSSI measurement accuracy requirements | 397 |
| 9.1.18.6 | Channel occupancy measurements | 397 |
| 9.1.18.6.1 | Intra-frequency channel occupancy measurement accuracy requirements | 397 |
| 9.1.18.6.2 | Inter-frequency channel occupancy measurement accuracy requirements | 398 |
| 9.1.19 | Accuracy Requirements for Carrier Aggregation for Measurements under Operation with Frame Structure 3 | 398 |
| 9.1.19.1 | Introduction | 398 |
| 9.1.19.2 | Accuracy requirements for measurements on SCC | 398 |
| 9.1.19.3 | Relative accuracy requirements for measurements on different SCCs | 399 |
| 9.1.19.4 | Relative accuracy requirements for measurements on SCC and PCC | 399 |

| | | |
|----------|--|-----|
| 9.1.20 | SFN and Subframe Time Difference (SSTD) | 399 |
| 9.1.20.1 | SSTD Accuracy Requirement | 399 |
| 9.1.20.2 | SSTD Measurement Report Mapping | 400 |
| 9.1.21 | Measurement accuracy for UE category M1 | 400 |
| 9.1.21.1 | Intra-frequency Absolute RSRP Accuracy for UE category M1 with CE mode A..... | 400 |
| 9.1.21.2 | Intra-frequency Relative Accuracy of RSRP for UE category M1 with CE mode A..... | 401 |
| 9.1.21.3 | Intra-frequency Absolute RSRP Accuracy for UE category M1 with CE mode B..... | 402 |
| 9.1.21.4 | Intra-frequency Relative Accuracy of RSRP for UE category M1 with CE mode B..... | 403 |
| 9.1.21.5 | RSRP Measurement Report Mapping | 404 |
| 9.1.22 | Measurement accuracy for UE Category NB1..... | 405 |
| 9.1.22.1 | Intra-frequency Absolute NRSRP Accuracy for UE Category NB1 | 405 |
| 9.1.22.2 | Void..... | 405 |
| 9.1.22.3 | Intra-frequency Absolute NRSRQ Accuracy for UE Category NB1 | 405 |
| 9.1.22.4 | Void..... | 406 |
| 9.1.22.5 | Inter-frequency Absolute NRSRP Accuracy for UE Category NB1 | 406 |
| 9.1.22.6 | Void..... | 406 |
| 9.1.22.7 | Inter-frequency Absolute NRSRQ Accuracy for UE Category NB1 | 406 |
| 9.1.22.8 | Void..... | 407 |
| 9.1.23 | Power Headroom for UE Category NB1 | 407 |
| 9.1.23.1 | Period | 407 |
| 9.1.23.2 | Reporting Delay | 407 |
| 9.1.23.3 | Report Mapping for UE Category NB1 | 407 |
| 9.2 | UTRAN FDD Measurements | 408 |
| 9.2.1 | UTRAN FDD CPICH RSCP | 408 |
| 9.2.2 | Void | 409 |
| 9.2.3 | UTRAN FDD CPICH Ec/No..... | 409 |
| 9.3 | UTRAN TDD Measurements..... | 409 |
| 9.3.1 | UTRAN TDD P-CCPCH RSCP | 409 |
| 9.3.2 | Void | 409 |
| 9.3.3 | Void | 410 |
| 9.4 | GSM Measurements | 410 |
| 9.4.1 | GSM carrier RSSI..... | 410 |
| 9.5 | CDMA2000 1x RTT Measurements | 410 |
| 9.5.1 | CDMA2000 1x RTT Pilot Strength..... | 410 |
| 9.6 | $P_{\text{CMAX,c}}$ | 410 |
| 9.6.1 | Report Mapping | 411 |
| 9.6.2 | Estimation Period..... | 411 |
| 9.6.3 | Reporting Delay..... | 411 |
| 9.7 | IEEE802.11 Measurements | 411 |
| 9.7.1 | WLAN RSSI..... | 411 |
| 9.7.2 | WLAN RSSI Measurement Report Mapping | 411 |
| 9.8 | MBSFN Measurements | 412 |
| 9.8.1 | Introduction..... | 412 |
| 9.8.2 | MBSFN RSRP | 412 |
| 9.8.2.1 | Absolute MBSFN RSRP measurement accuracy requirements | 412 |
| 9.8.2.2 | MBSFN RSRP measurement report mapping..... | 412 |
| 9.8.3 | MBSFN RSRQ | 413 |
| 9.8.3.1 | Absolute MBSFN RSRQ measurement accuracy requirements | 413 |
| 9.8.3.2 | MBSFN RSRQ measurement report mapping | 413 |
| 9.8.4 | MCH BLER..... | 414 |
| 9.8.4.1 | Measurement report mapping for MCH BLER..... | 414 |
| 9.8.4.2 | Measurement report mapping for MCH Block Number | 415 |
| 9.9 | ProSe Measurements | 415 |
| 9.9.1 | Introduction..... | 415 |
| 9.9.2 | Intra-Frequency S-RSRP Measurement Accuracy Requirements..... | 416 |
| 9.9.2.1 | Absolute S-RSRP Accuracy..... | 416 |
| 9.9.2.2 | Relative Accuracy of S-RSRP..... | 416 |
| 9.9.3 | Intra-Frequency SD-RSRP Measurement Accuracy Requirements..... | 417 |
| 9.9.3.1 | Absolute SD-RSRP Accuracy..... | 417 |
| 9.9.3.2 | Relative Accuracy of SD-RSRP..... | 418 |
| 10 | Measurements Performance Requirements for E-UTRAN..... | 419 |

| | | |
|---|---|------------|
| 10.1 | Received Interference Power..... | 419 |
| 10.1.1 | Absolute accuracy requirement..... | 419 |
| 10.1.2 | Relative accuracy requirement..... | 419 |
| 10.1.3 | Received Interference Power measurement report mapping..... | 419 |
| 10.2 | Angle of Arrival (AOA)..... | 419 |
| 10.2.1 | Range/mapping..... | 419 |
| 10.3 | Timing Advance (T _{ADV})..... | 420 |
| 10.3.1 | Report mapping..... | 420 |
| 11 | ProSe Requirements in Any Cell Selection state..... | 420 |
| 11.1 | Introduction..... | 420 |
| 11.2 | UE Transmit Timing for ProSe in Any Cell Selection State..... | 421 |
| 11.2.1 | Introduction..... | 421 |
| 11.2.2 | ProSe UE transmission timing..... | 421 |
| 11.3 | Initiation/Cease of SLSS Transmissions..... | 421 |
| 11.3.1 | Introduction..... | 421 |
| 11.3.2 | Requirements..... | 421 |
| 11.4 | Measurements for ProSe in Any Cell Selection State..... | 421 |
| 11.4.1 | Introduction..... | 421 |
| 11.4.2 | Requirements..... | 422 |
| 11.4.2.1 | E-UTRA FDD..... | 422 |
| 11.4.2.2 | E-UTRA TDD..... | 422 |
| 11.5 | Selection / Reselection of ProSe Synchronization Reference..... | 423 |
| 11.5.1 | Introduction..... | 423 |
| 11.5.2 | Selection/Reselection to intra-frequency SyncRef UE..... | 423 |
| 11.5.2.1 | Introduction..... | 423 |
| 11.5.2.2 | Requirements..... | 423 |
| 11.6 | Void..... | 423 |
| 11.7 | Selection / Reselection of ProSe relay UE..... | 423 |
| 11.7.1 | Introduction..... | 423 |
| 11.7.2 | Selection / Reselection of intra-frequency ProSe relay UE..... | 423 |
| Annex A (normative): Test Cases..... | | 425 |
| A.1 | Purpose of annex..... | 425 |
| A.2 | Requirement classification for statistical testing..... | 425 |
| A.2.1 | Types of requirements in TS 36.133..... | 425 |
| A.2.1.1 | Time and delay requirements on UE higher layer actions..... | 425 |
| A.2.1.2 | Measurements of power levels, relative powers and time..... | 426 |
| A.2.1.3 | Implementation requirements..... | 426 |
| A.2.1.4 | Physical layer timing requirements..... | 426 |
| A.3 | RRM test configurations..... | 426 |
| A.3.1 | Reference Measurement Channels..... | 426 |
| A.3.1.1 | PDSCH..... | 426 |
| A.3.1.1.1 | FDD..... | 426 |
| A.3.1.1.2 | TDD..... | 427 |
| A.3.1.1.3 | FDD for UE category 0..... | 428 |
| A.3.1.1.4 | HD-FDD for UE category 0..... | 429 |
| A.3.1.1.5 | TDD for UE category 0..... | 430 |
| A.3.1.1.6 | Frame Structure 3..... | 430 |
| A.3.1.2 | PCFICH/PDCCH/PHICH..... | 431 |
| A.3.1.2.1 | FDD..... | 431 |
| A.3.1.2.2 | TDD..... | 431 |
| A.3.1.2.3 | HD-FDD for UE category 0..... | 432 |
| A.3.1.2.4 | FS 3..... | 432 |
| A.3.1.3 | MPDCCH Reference Channels for Cat-M1 UEs..... | 433 |
| A.3.1.3.1 | FDD in CEModeA..... | 433 |
| A.3.1.3.2 | HD-FDD in CEModeA..... | 433 |
| A.3.1.3.3 | TDD in CEModeA..... | 433 |
| A.3.1.3.4 | FDD in CEModeB..... | 434 |
| A.3.1.3.5 | HD-FDD in CEModeB..... | 434 |

| | | |
|------------|---|-----|
| A.3.1.3.6 | TDD in CEModeB | 435 |
| A.3.1.4 | PDSCH Reference Channel for Cat-M1 UEs | 435 |
| A.3.1.4.1 | FDD in CEModeA | 435 |
| A.3.1.4.2 | HD-FDD in CEModeA | 436 |
| A.3.1.4.3 | TDD in CEModeA | 436 |
| A.3.1.4.4 | FDD in CEModeB | 437 |
| A.3.1.4.5 | HD-FDD in CEModeB | 438 |
| A.3.1.4.6 | TDD in CEModeB | 438 |
| A.3.1.5 | NPDSCH Reference Channel for UE category NB1 | 439 |
| A.3.1.5.1 | HD-FDD in-band operation | 439 |
| A.3.1.5.2 | Void..... | 439 |
| A.3.1.5.3 | HD-FDD standalone operation..... | 439 |
| A.3.1.5.4 | Void..... | 440 |
| A.3.1.5.5 | HD-FDD guard band operation..... | 440 |
| A.3.1.5.6 | Void..... | 440 |
| A.3.1.6 | NPDCCH Reference Channel for UE category NB1..... | 440 |
| A.3.1.6.1 | HD-FDD in-band operation | 440 |
| A.3.1.6.2 | Void..... | 441 |
| A.3.1.6.3 | HD-FDD standalone operation..... | 441 |
| A.3.1.6.4 | Void..... | 441 |
| A.3.1.6.5 | HD-FDD guard band operation..... | 441 |
| A.3.1.6.6 | Void..... | 442 |
| A.3.2 | OFDMA Channel Noise Generator (OCNG) | 442 |
| A.3.2.1 | OCNG Patterns for FDD..... | 442 |
| A.3.2.1.1 | OCNG FDD pattern 1: outer resource blocks allocation in 10 MHz | 442 |
| A.3.2.1.2 | OCNG FDD pattern 2: full bandwidth allocation in 10 MHz | 443 |
| A.3.2.1.3 | OCNG FDD pattern 3: outer resource blocks allocation in 1.4 MHz | 443 |
| A.3.2.1.4 | OCNG FDD pattern 4: full bandwidth allocation in 1.4 MHz | 444 |
| A.3.2.1.5 | OCNG FDD pattern 5: outer resource blocks allocation in 10 MHz (without MBSFN) | 444 |
| A.3.2.1.6 | OCNG FDD pattern 6: full bandwidth allocation in 10 MHz (without MBSFN)..... | 445 |
| A.3.2.1.7 | OCNG FDD pattern 7: full bandwidth allocation in 1.4 MHz (without MBSFN)..... | 445 |
| A.3.2.1.8 | OCNG FDD pattern 8: outer resource blocks allocation in 10 MHz for MBSFN ABS..... | 446 |
| A.3.2.1.9 | OCNG FDD pattern 9: full bandwidth allocation in 10 MHz for MBSFN ABS | 446 |
| A.3.2.1.10 | OCNG FDD pattern 10: outer resource blocks allocation in 10 MHz with user data in every subframe (without MBSFN)..... | 447 |
| A.3.2.1.11 | OCNG FDD pattern 11: outer resource blocks allocation in 20 MHz | 447 |
| A.3.2.1.12 | OCNG FDD pattern 12: full bandwidth allocation in 20 MHz | 448 |
| A.3.2.1.13 | OCNG FDD pattern 13: outer resource blocks allocation in 20 MHz (without MBSFN) | 448 |
| A.3.2.1.14 | OCNG FDD pattern 14: full bandwidth allocation in 20 MHz (without MBSFN)..... | 449 |
| A.3.2.1.15 | OCNG FDD pattern 15: outer resource blocks allocation in 5 MHz | 449 |
| A.3.2.1.16 | OCNG FDD pattern 16: full bandwidth allocation in 5 MHz | 450 |
| A.3.2.1.17 | OCNG FDD pattern 17: outer resource blocks allocation in 20 MHz with user data in every subframe (without MBSFN)..... | 450 |
| A.3.2.1.18 | OCNG FDD pattern 18: outer resource blocks allocation in 5 MHz (without MBSFN) | 451 |
| A.3.2.1.19 | OCNG FDD pattern 19: full bandwidth allocation in 5 MHz (without MBSFN)..... | 451 |
| A.3.2.1.20 | OCNG FDD pattern 20: outer resource blocks allocation in 5 MHz with user data in every subframe (without MBSFN)..... | 452 |
| A.3.2.1.21 | OCNG FDD pattern 21: Generic resource blocks allocation (without MBSFN) | 452 |
| A.3.2.1.22 | OCNG FDD pattern 22: Generic resource blocks allocation in 5MHz (without MBSFN)..... | 453 |
| A.3.2.2 | OCNG Patterns for TDD | 453 |
| A.3.2.2.1 | OCNG TDD pattern 1: outer resource blocks allocation in 10 MHz | 454 |
| A.3.2.2.2 | OCNG TDD pattern 2: full bandwidth allocation in 10 MHz | 454 |
| A.3.2.2.3 | OCNG TDD pattern 3: outer resource blocks allocation in 1.4 MHz | 455 |
| A.3.2.2.4 | OCNG TDD pattern 4: full bandwidth allocation in 1.4 MHz..... | 455 |
| A.3.2.2.5 | OCNG TDD pattern 5: outer resource blocks allocation in 10 MHz for MBSFN ABS | 456 |
| A.3.2.2.6 | OCNG TDD pattern 6: full bandwidth allocation in 10 MHz for MBSFN ABS | 457 |
| A.3.2.2.7 | OCNG TDD pattern 7: outer resource blocks allocation in 20 MHz | 457 |
| A.3.2.2.8 | OCNG TDD pattern 8: full bandwidth allocation in 20 MHz..... | 458 |
| A.3.2.2.9 | OCNG TDD pattern 9: outer resource blocks allocation in 5 MHz | 458 |
| A.3.2.2.10 | OCNG TDD pattern 10: full bandwidth allocation in 5 MHz | 459 |
| A.3.2.2.11 | OCNG TDD pattern 11: Generic resource blocks allocation (without MBSFN)..... | 460 |
| A.3.2.3 | OCNG Patterns for Narrowband IoT | 460 |

| | | |
|-------------|--|-----|
| A.3.2.3.1 | Narrowband IoT OCNF FDD pattern 1: In-band NB-IoT in 10 MHz EUTRAN cell..... | 462 |
| A.3.2.3.2 | Narrowband IoT OCNF FDD pattern 2: guard band NB-IoT in 10 MHz EUTRAN cell | 463 |
| A.3.2.3.3 | Narrowband IoT OCNF FDD pattern 3: standalone NB-IoT | 463 |
| A.3.3 | Reference DRX Configurations | 464 |
| A.3.4 | ABS Transmission Configurations..... | 464 |
| A.3.4.1 | Non-MBSFN ABS Transmission Configurations..... | 464 |
| A.3.4.1.1 | Non-MBSFN ABS Transmission, 1x2 antenna with PBCH | 464 |
| A.3.4.1.2 | Non-MBSFN ABS Transmission, 2x2 antenna without PBCH | 464 |
| A.3.4.2 | MBSFN ABS Transmission Configurations..... | 465 |
| A.3.4.2.1 | MBSFN ABS Transmission, 1x2 antenna..... | 465 |
| A.3.4.2.2 | MBSFN ABS Transmission, 2x2 antenna..... | 466 |
| A.3.5 | Impact of Reference Sensitivity Degradation with Carrier Aggregation on Test Cases..... | 466 |
| A.3.5.1 | Impact of Reference Sensitivity Degradation due to Insertion Loss..... | 466 |
| A.3.6 | Carrier Aggregation Test Cases with Different Channel Bandwidth Combinations | 467 |
| A.3.6.1 | Introduction..... | 467 |
| A.3.7 | Test Cases with Different Channel Bandwidths..... | 467 |
| A.3.7.1 | Introduction..... | 467 |
| A.3.7.2 | Principle of testing | 467 |
| A.3.8 | Antenna Configuration | 467 |
| A.3.8.1 | Antenna connection for 4 Rx capable UEs | 467 |
| A.3.8.1.1 | Introduction | 467 |
| A.3.8.1.2 | Principle of testing..... | 467 |
| A.3.8.1.2.1 | Single carrier tests | 467 |
| A.3.8.1.2.2 | Carrier aggregation and Dual connectivity tests..... | 468 |
| A.3.8.1.2.3 | Antenna connection for bands where 2RX is supported..... | 469 |
| A.3.8.1.2.4 | Antenna connection for bands where 4RX is supported..... | 469 |
| A.3.9 | Carrier Aggregation Test Cases with Different Duplex Modes..... | 469 |
| A.3.9.1 | Introduction..... | 469 |
| A.3.9.2 | Principle of testing | 469 |
| A.3.10 | Carrier Aggregation Test Cases with Different CA Configurations..... | 469 |
| A.3.10.1 | Introduction..... | 469 |
| A.3.10.2 | Principle of testing | 470 |
| A.3.11 | Test Cases for Synchronous and Asynchronous Dual Connectivity | 470 |
| A.3.11.1 | Introduction..... | 470 |
| A.3.11.2 | Principle of Testing..... | 470 |
| A.3.12 | Proximity-based Services | 470 |
| A.3.12.1 | Introduction..... | 470 |
| A.3.12.2 | Reference DRX configurations for ProSe tests..... | 470 |
| A.3.12.3 | Test Cases with Different Channel Bandwidths | 470 |
| A.3.12.3.1 | Introduction..... | 470 |
| A.3.12.3.2 | Principle of testing | 471 |
| A.3.12.4 | Reference resource pool configurations for ProSe Direct Discovery | 471 |
| A.3.12.5 | Reference resource pool configurations for ProSe Direct Communication | 475 |
| A.3.12.6 | Reference Measurement Channels for ProSe Direct Discovery | 476 |
| A.3.12.6.1 | FDD..... | 476 |
| A.3.12.7 | Reference measurement channels for ProSe Direct Communication | 477 |
| A.3.12.7.1 | FDD..... | 477 |
| A.3.12.8 | ProSe Receive Traffic Generator | 478 |
| A.3.12.8.1 | ProSe Direct Communication Receive Traffic Generator for FDD | 478 |
| A.3.12.8.2 | ProSe Direct Discovery Receive Traffic Generator for FDD..... | 478 |
| A.3.13 | Time Offset between Cells | 478 |
| A.3.13.1 | Introduction..... | 478 |
| A.3.13.2 | Definition..... | 478 |
| A.3.14 | Carrier Aggregation under operation with Frame Structure 3 Test Cases with Different Duplex Modes..... | 479 |
| A.3.14.1 | Introduction..... | 479 |
| A.3.14.2 | Principle of testing..... | 479 |
| A.3.15 | Dual connectivity test cases with different combination of duplex mode | 479 |
| A.3.15.1 | Introduction..... | 479 |
| A.3.15.2 | Principle of testing | 479 |
| A.3.16 | Reference PRACH Configurations..... | 479 |
| A.3.17 | Listen before talk model..... | 480 |
| A.3.17.1 | Introduction..... | 480 |

| | | |
|------------|--|-----|
| A.3.17.2 | Definition..... | 480 |
| A.3.18 | Reference NPRACH Configurations..... | 480 |
| A.3.19 | Dual connectivity test cases with different bandwidth combinations..... | 481 |
| A.3.19.1 | Introduction..... | 481 |
| A.3.19.2 | Principle of testing..... | 481 |
| A.3.20 | Category M1 UE Test Cases..... | 481 |
| A.3.20.1 | Introduction..... | 481 |
| A.3.20.2 | Principle of Cat-M1 UE Testing..... | 482 |
| A.4 | E-UTRAN RRC_IDLE state..... | 482 |
| A.4.2 | Cell Re-Selection..... | 482 |
| A.4.2.1 | E-UTRAN FDD – FDD Intra frequency case..... | 482 |
| A.4.2.1.1 | Test Purpose and Environment..... | 482 |
| A.4.2.1.2 | Test Requirements..... | 484 |
| A.4.2.2 | E-UTRAN TDD – TDD Intra frequency case..... | 485 |
| A.4.2.2.1 | Test Purpose and Environment..... | 485 |
| A.4.2.2.2 | Test Requirements..... | 486 |
| A.4.2.3 | E-UTRAN FDD – FDD Inter frequency case..... | 487 |
| A.4.2.3.1 | Test Purpose and Environment..... | 487 |
| A.4.2.3.2 | Test Requirements..... | 488 |
| A.4.2.4 | E-UTRAN FDD – TDD Inter frequency case..... | 489 |
| A.4.2.4.1 | Test Purpose and Environment..... | 489 |
| A.4.2.4.2 | Test Requirements..... | 490 |
| A.4.2.5 | E-UTRAN TDD – FDD Inter frequency case..... | 491 |
| A.4.2.5.1 | Test Purpose and Environment..... | 491 |
| A.4.2.5.2 | Test Requirements..... | 492 |
| A.4.2.6 | E-UTRAN TDD – TDD: Inter frequency case..... | 493 |
| A.4.2.6.1 | Test Purpose and Environment..... | 493 |
| A.4.2.6.2 | Test Requirements..... | 494 |
| A.4.2.7 | E-UTRAN FDD – FDD Inter frequency case in the existence of non-allowed CSG cell..... | 494 |
| A.4.2.7.1 | Test Purpose and Environment..... | 494 |
| A.4.2.7.2 | Test Requirements..... | 496 |
| A.4.2.8 | E-UTRAN TDD – TDD Inter frequency case in the existence of non-allowed CSG cell..... | 496 |
| A.4.2.8.1 | Test Purpose and Environment..... | 496 |
| A.4.2.8.2 | Test Requirements..... | 498 |
| A.4.2.9 | E-UTRAN FDD – FDD Intra frequency case for 5MHz bandwidth..... | 498 |
| A.4.2.9.1 | Test Purpose and Environment..... | 498 |
| A.4.2.9.2 | Test Requirements..... | 498 |
| A.4.2.10 | E-UTRAN FDD – FDD reselection using an increased number of carriers..... | 499 |
| A.4.2.10.1 | Test Purpose and Environment..... | 499 |
| A.4.2.10.2 | Test Requirements..... | 502 |
| A.4.2.11 | E-UTRAN TDD – TDD reselection using an increased number of carriers..... | 502 |
| A.4.2.11.1 | Test Purpose and Environment..... | 502 |
| A.4.2.11.2 | Test Requirements..... | 506 |
| A.4.2.12 | E-UTRAN FDD – FDD Intra frequency case for Cat-M1 UE in normal coverage..... | 506 |
| A.4.2.12.1 | Test Purpose and Environment..... | 506 |
| A.4.2.12.2 | Test Requirements..... | 508 |
| A.4.2.13 | E-UTRAN HD – FDD Intra frequency case for Cat-M1 UE in normal coverage..... | 509 |
| A.4.2.13.1 | Test Purpose and Environment..... | 509 |
| A.4.2.13.2 | Test Requirements..... | 510 |
| A.4.2.14 | E-UTRAN TDD – TDD Intra frequency case for Cat-M1 UE in normal coverage..... | 511 |
| A.4.2.14.1 | Test Purpose and Environment..... | 511 |
| A.4.2.14.2 | Test Requirements..... | 512 |
| A.4.2.15 | E-UTRAN FDD – FDD Intra frequency case for Cat-M1 UE in enhanced coverage..... | 513 |
| A.4.2.15.1 | Test Purpose and Environment..... | 513 |
| A.4.2.15.2 | Test Requirements..... | 514 |
| A.4.2.16 | E-UTRAN HD – FDD Intra frequency case for Cat-M1 UE in enhanced coverage..... | 515 |
| A.4.2.16.1 | Test Purpose and Environment..... | 515 |
| A.4.2.16.2 | Test Requirements..... | 516 |
| A.4.2.17 | E-UTRAN TDD – TDD Intra frequency case for Cat-M1 UE in enhanced coverage..... | 517 |
| A.4.2.17.1 | Test Purpose and Environment..... | 517 |
| A.4.2.17.2 | Test Requirements..... | 518 |

| | | |
|-------------|---|-----|
| A.4.2.18 | HD – FDD Intra frequency case for UE Category NB1 In-Band mode in normal coverage | 519 |
| A.4.2.18.1 | Test Purpose and Environment | 519 |
| A.4.2.18.2 | Test Requirements..... | 521 |
| A.4.2.19 | HD – FDD Intra frequency case for UE Category NB1 In-Band mode in enhanced coverage..... | 521 |
| A.4.2.19.1 | Test Purpose and Environment | 521 |
| A.4.2.19.2 | Test Requirements..... | 523 |
| A.4.2.20 | Void..... | 524 |
| A.4.2.21 | Void..... | 524 |
| A.4.2.22 | Void..... | 524 |
| A.4.2.23 | Void..... | 524 |
| A.4.2.24 | HD – FDD Inter frequency case for UE Category NB1 In-Band mode in enhanced coverage | 524 |
| A.4.2.24.1 | Test Purpose and Environment | 524 |
| A.4.2.24.2 | Test Requirements..... | 526 |
| A.4.3 | E-UTRAN to UTRAN Cell Re-Selection | 526 |
| A.4.3.1 | E-UTRAN FDD – UTRAN FDD: | 526 |
| A.4.3.1.1 | EUTRA FDD-UTRA FDD cell reselection: UTRA FDD is of higher priority..... | 526 |
| A.4.3.1.1.1 | Test Purpose and Environment..... | 526 |
| A.4.3.1.1.2 | Test Requirements | 528 |
| A.4.3.1.2 | EUTRA FDD-UTRA FDD cell reselection: UTRA FDD is of lower priority..... | 528 |
| A.4.3.1.2.1 | Test Purpose and Environment..... | 528 |
| A.4.3.1.2.2 | Test Requirements | 530 |
| A.4.3.1.3 | EUTRA FDD-UTRA FDD cell reselection in fading propagation conditions: UTRA FDD is of lower priority..... | 531 |
| A.4.3.1.3.1 | Test Purpose and Environment..... | 531 |
| A.4.3.1.3.2 | Test Requirements | 532 |
| A.4.3.1.4 | EUTRA FDD-UTRA FDD cell reselection: UTRA FDD is of lower priority for 5MHz bandwidth..... | 533 |
| A.4.3.1.4.1 | Test Purpose and Environment..... | 533 |
| A.4.3.1.4.2 | Test Requirements | 533 |
| A.4.3.1.5 | Idle mode FDD to UTRA FDD interRAT reselection | 533 |
| A.4.3.1.5.1 | Test Purpose and Environment..... | 533 |
| A.4.3.1.5.2 | Test Requirements | 536 |
| A.4.3.2 | E-UTRAN FDD – UTRAN TDD: | 536 |
| A.4.3.2.1 | Test Purpose and Environment | 536 |
| A.4.3.2.1.1 | Void..... | 536 |
| A.4.3.2.1.2 | 1.28Mcps TDD option..... | 536 |
| A.4.3.2.1.3 | Void..... | 538 |
| A.4.3.2.2 | Test Requirements..... | 538 |
| A.4.3.2.2.1 | 1.28Mcps TDD option..... | 538 |
| A.4.3.2A | E-UTRA FDD to UTRA TDD cell re-selection for IncMon | 539 |
| A.4.3.2A.1 | Test Purpose and Environment | 539 |
| A.4.3.2A.2 | Test Requirements..... | 541 |
| A.4.3.3 | E-UTRAN TDD – UTRAN FDD: | 542 |
| A.4.3.3.1 | Test Purpose and Environment | 542 |
| A.4.3.3.2 | Test Requirements..... | 544 |
| A.4.3.3A | Idle mode TDD to UTRA FDD interRAT reselection..... | 544 |
| A.4.3.3A.1 | Test Purpose and Environment | 544 |
| A.4.3.3A.2 | Test Requirements..... | 547 |
| A.4.3.4 | E-UTRAN TDD – UTRAN TDD:..... | 548 |
| A.4.3.4.1 | E-UTRA to UTRA TDD cell re-selection: UTRA is of higher priority..... | 548 |
| A.4.3.4.1.1 | Test Purpose and Environment..... | 548 |
| A.4.3.4.1.2 | Test Requirements | 550 |
| A.4.3.4.2 | E-UTRA to UTRA TDD cell re-selection: UTRA is of lower priority..... | 550 |
| A.4.3.4.2.1 | Test Purpose and Environment..... | 550 |
| A.4.3.4.2.2 | Test Requirements | 552 |
| A.4.3.4.3 | EUTRA TDD-UTRA TDD cell reselection in fading propagation conditions: UTRA TDD is of lower priority..... | 552 |
| A.4.3.4.3.1 | Test Purpose and Environment..... | 552 |
| A.4.3.4.3.2 | Test Requirements | 554 |
| A.4.3.4.4 | E-UTRA TDD to UTRA TDD cell re-selection for IncMon | 555 |
| A.4.3.4.4.1 | Test Purpose and Environment..... | 555 |
| A.4.3.4.4.2 | Test Requirements | 557 |

| | | |
|-------------|--|-----|
| A.4.4 | E-UTRAN to GSM Cell Re-Selection..... | 558 |
| A.4.4.1 | E-UTRAN FDD – GSM: | 558 |
| A.4.4.1.1 | Test Purpose and Environment | 558 |
| A.4.4.1.2 | Test Requirements..... | 559 |
| A.4.4.2 | E-UTRAN TDD – GSM: | 560 |
| A.4.4.2.1 | Test Purpose and Environment | 560 |
| A.4.4.2.2 | Test Requirements..... | 561 |
| A.4.5 | E-UTRAN to HRPD Cell Re-Selection..... | 562 |
| A.4.5.1 | E-UTRAN FDD – HRPD | 562 |
| A.4.5.1.1 | E-UTRAN FDD – HRPD Cell Reselection: HRPD is of Lower Priority | 562 |
| A.4.5.1.1.1 | Test Purpose and Environment..... | 562 |
| A.4.5.1.1.2 | Test Requirements..... | 564 |
| A.4.5.2 | E-UTRAN TDD – HRPD | 564 |
| A.4.5.2.1 | E-UTRAN TDD – HRPD Cell Reselection: HRPD is of Lower Priority | 564 |
| A.4.5.2.1.1 | Test Purpose and Environment..... | 564 |
| A.4.5.2.1.2 | Test Requirements..... | 567 |
| A.4.6 | E-UTRAN to cdma2000 1X Cell Re-Selection | 567 |
| A.4.6.1 | E-UTRAN FDD – cdma2000 1X..... | 567 |
| A.4.6.1.1 | E-UTRAN FDD – cdma2000 1X Cell Reselection: cdma2000 1X is of Lower Priority | 567 |
| A.4.6.1.1.1 | Test Purpose and Environment | 567 |
| A.4.6.1.1.2 | Test Requirements..... | 570 |
| A.4.6.2 | E-UTRAN TDD – cdma2000 1X | 570 |
| A.4.6.2.1 | E-UTRAN TDD –cdma2000 1X Cell Reselection: cdma2000 1X is of Lower Priority..... | 570 |
| A.4.6.2.1.1 | Test Purpose and Environment..... | 570 |
| A.4.6.2.1.2 | Test Requirements | 573 |
| A.5 | E-UTRAN RRC CONNECTED Mode Mobility | 573 |
| A.5.1 | E-UTRAN Handover..... | 573 |
| A.5.1.1 | E-UTRAN FDD - FDD Intra frequency handover | 573 |
| A.5.1.1.1 | Test Purpose and Environment | 573 |
| A.5.1.1.2 | Test Requirements | 575 |
| A.5.1.2 | E-UTRAN TDD - TDD Intra frequency handover | 575 |
| A.5.1.2.1 | Test Purpose and Environment | 575 |
| A.5.1.2.2 | Test Requirements..... | 577 |
| A.5.1.3 | E-UTRAN FDD – FDD Inter frequency handover..... | 577 |
| A.5.1.3.1 | Test Purpose and Environment | 577 |
| A.5.1.3.2 | Test Requirements..... | 579 |
| A.5.1.4 | E-UTRAN TDD – TDD Inter frequency handover | 579 |
| A.5.1.4.1 | Test Purpose and Environment | 579 |
| A.5.1.4.2 | Test Requirements..... | 581 |
| A.5.1.5 | E-UTRAN FDD – FDD Inter frequency handover: unknown target cell | 581 |
| A.5.1.5.1 | Test Purpose and Environment | 581 |
| A.5.1.5.2 | Test Requirements..... | 583 |
| A.5.1.6 | E-UTRAN TDD – TDD Inter frequency handover; unknown Target Cell..... | 583 |
| A.5.1.6.1 | Test Purpose and Environment | 583 |
| A.5.1.6.2 | Test Requirements..... | 585 |
| A.5.1.7 | E-UTRAN FDD – TDD Inter frequency handover..... | 585 |
| A.5.1.7.1 | Test Purpose and Environment | 585 |
| A.5.1.7.2 | Test Requirements..... | 588 |
| A.5.1.8 | E-UTRAN TDD – FDD Inter frequency handover..... | 588 |
| A.5.1.8.1 | Test Purpose and Environment | 588 |
| A.5.1.8.2 | Test Requirements..... | 590 |
| A.5.1.9 | E-UTRAN FDD - FDD Intra frequency handover for 5MHz bandwidth..... | 590 |
| A.5.1.9.1 | Test Purpose and Environment | 590 |
| A.5.1.9.2 | Test Requirements..... | 591 |
| A.5.1.10 | E-UTRAN FDD - FDD Intra frequency handover for UE category 0..... | 591 |
| A.5.1.10.1 | Test Purpose and Environment | 591 |
| A.5.1.10.2 | Test Requirements..... | 592 |
| A.5.1.11 | E-UTRAN HD - FDD Intra frequency handover for UE category 0 | 592 |
| A.5.1.11.1 | Test Purpose and Environment | 592 |
| A.5.1.11.2 | Test Requirements..... | 593 |
| A.5.1.12 | E-UTRAN TDD - TDD Intra frequency handover for UE category 0 | 594 |

| | | |
|-------------|---|-----|
| A.5.1.12.1 | Test Purpose and Environment | 594 |
| A.5.1.12.2 | Test Requirements..... | 595 |
| A.5.1.13 | E-UTRAN FDD-FDD Intra frequency handover for Cat-M1 UEs in CEModeA | 595 |
| A.5.1.13.1 | Test Purpose and Environment | 595 |
| A.5.1.13.2 | Test Requirements..... | 597 |
| A.5.1.14 | E-UTRAN HD-FDD Intra frequency handover for Cat-M1 UEs in CEModeA..... | 597 |
| A.5.1.14.1 | Test Purpose and Environment | 597 |
| A.5.1.14.2 | Test Requirements..... | 599 |
| A.5.1.15 | E-UTRAN TDD Intra frequency handover for Cat-M1 UEs in CEModeA | 599 |
| A.5.1.15.1 | Test Purpose and Environment | 599 |
| A.5.1.15.2 | Test Requirements..... | 601 |
| A.5.1.16 | E-UTRAN FDD-FDD Intra frequency handover for Cat-M1 UEs in CEModeB..... | 601 |
| A.5.1.16.1 | Test Purpose and Environment | 601 |
| A.5.1.16.2 | Test Requirements..... | 602 |
| A.5.1.17 | E-UTRAN HD-FDD Intra frequency handover for Cat-M1 UEs in CEModeB..... | 603 |
| A.5.1.17.1 | Test Purpose and Environment | 603 |
| A.5.1.17.2 | Test Requirements..... | 604 |
| A.5.1.18 | E-UTRAN TDD Intra frequency handover for Cat-M1 UEs in CEModeB..... | 604 |
| A.5.1.18.1 | Test Purpose and Environment | 604 |
| A.5.1.18.2 | Test Requirements..... | 606 |
| A.5.2 | E-UTRAN Handover to other RATs | 606 |
| A.5.2.1 | E-UTRAN FDD – UTRAN FDD Handover..... | 606 |
| A.5.2.1.1 | Test Purpose and Environment | 606 |
| A.5.2.1.2 | Test Requirements..... | 608 |
| A.5.2.2 | E-UTRAN TDD - UTRAN FDD Handover | 609 |
| A.5.2.2.1 | Test Purpose and Environment | 609 |
| A.5.2.2.2 | Test Requirements..... | 611 |
| A.5.2.3 | E-UTRAN FDD- GSM Handover | 611 |
| A.5.2.3.1 | Test Purpose and Environment..... | 611 |
| A.5.2.3.2 | Test Requirements | 612 |
| A.5.2.4 | E-UTRAN TDD - UTRAN TDD Handover..... | 613 |
| A.5.2.4.1 | Test Purpose and Environment | 613 |
| A.5.2.4.1.1 | Void..... | 613 |
| A.5.2.4.1.2 | 1.28 Mcps TDD option..... | 613 |
| A.5.2.4.1.3 | Void..... | 615 |
| A.5.2.4.2 | Test Requirements..... | 615 |
| A.5.2.4.2.1 | Void..... | 615 |
| A.5.2.4.2.2 | 1.28 Mcps TDD option..... | 615 |
| A.5.2.4.2.3 | Void..... | 615 |
| A.5.2.5 | E-UTRAN FDD – UTRAN TDD Handover | 615 |
| A.5.2.5.1 | Test Purpose and Environment | 615 |
| A.5.2.5.1.3 | Void..... | 617 |
| A.5.2.5.2 | Test Requirements..... | 617 |
| A.5.2.5.2.1 | Void..... | 617 |
| A.5.2.5.2.2 | 1.28 Mcps TDD option..... | 617 |
| A.5.2.5.2.3 | Void..... | 617 |
| A.5.2.6 | E-UTRAN TDD - GSM Handover | 617 |
| A.5.2.6.1 | Test Purpose and Environment..... | 617 |
| A.5.2.6.2 | Test Requirements | 619 |
| A.5.2.7 | E-UTRAN FDD – UTRAN FDD Handover; Unknown Target Cell..... | 619 |
| A.5.2.7.1 | Test Purpose and Environment | 619 |
| A.5.2.7.2 | Test Requirements..... | 622 |
| A.5.2.8 | E-UTRAN FDD - GSM Handover; Unknown Target Cell..... | 622 |
| A.5.2.8.1 | Test Purpose and Environment | 622 |
| A.5.2.8.2 | Test Requirements..... | 623 |
| A.5.2.9 | E-UTRAN TDD - GSM Handover; Unknown Target Cell | 624 |
| A.5.2.9.1 | Test Purpose and Environment | 624 |
| A.5.2.9.2 | Test Requirements..... | 625 |
| A.5.2.10 | E-UTRAN TDD to UTRAN TDD handover: unknown target cell | 626 |
| A.5.2.10.1 | Test Purpose and Environment | 626 |
| A.5.2.10.2 | Test Requirements..... | 627 |
| A.5.2.10A | E-UTRAN FDD – UTRAN FDD Multicarrier Handover with two target cells | 628 |

| | | |
|-------------|--|-----|
| A.5.2.10A.1 | Test Purpose and Environment | 628 |
| A.5.2.10A.2 | Test Requirements..... | 630 |
| A.5.2.10B | E-UTRAN TDD – UTRAN FDD Multicarrier Handover with two target cells | 630 |
| A.5.2.10B.1 | Test Purpose and Environment | 630 |
| A.5.2.10B.2 | Test Requirements..... | 632 |
| A.5.2.11 | E-UTRAN FDD – UTRAN FDD Handover for 5MHz Bandwidth | 632 |
| A.5.2.11.1 | Test Purpose and Environment | 632 |
| A.5.2.11.2 | Test Requirements..... | 633 |
| A.5.3 | E-UTRAN Handover to Non-3GPP RATs | 633 |
| A.5.3.1 | E-UTRAN FDD – HRPD Handover | 633 |
| A.5.3.1.1 | Test Purpose and Environment | 633 |
| A.5.3.1.2 | Test Requirements..... | 636 |
| A.5.3.2 | E-UTRAN FDD – cdma2000 1X Handover | 636 |
| A.5.3.2.1 | Test Purpose and Environment | 636 |
| A.5.3.2.2 | Test Requirements..... | 639 |
| A.5.3.3 | E-UTRAN FDD – HRPD Handover; Unknown Target Cell..... | 639 |
| A.5.3.3.1 | Test Purpose and Environment | 639 |
| A.5.3.3.2 | Test Requirements..... | 641 |
| A.5.3.4 | E-UTRAN FDD – cdma2000 1X Handover; Unknown Target cell..... | 642 |
| A.5.3.4.1 | Test Purpose and Environment | 642 |
| A.5.3.4.2 | Test Requirements..... | 643 |
| A.5.3.5 | E-UTRAN TDD – HRPD Handover | 644 |
| A.5.3.5.1 | Test Purpose and Environment | 644 |
| A.5.3.5.2 | Test Requirements..... | 645 |
| A.5.3.6 | E-UTRAN TDD – cdma2000 1X Handover..... | 646 |
| A.5.3.6.1 | Test Purpose and Environment | 646 |
| A.5.3.6.2 | Test Requirements..... | 649 |
| A.6 | RRC Connection Control | 649 |
| A.6.1 | RRC Re-establishment | 649 |
| A.6.1.1 | E-UTRAN FDD Intra-frequency RRC Re-establishment..... | 649 |
| A.6.1.1.1 | Test Purpose and Environment | 649 |
| A.6.1.1.2 | Test Requirements..... | 650 |
| A.6.1.2 | E-UTRAN FDD Inter-frequency RRC Re-establishment..... | 651 |
| A.6.1.2.1 | Test Purpose and Environment | 651 |
| A.6.1.2.2 | Test Requirements..... | 652 |
| A.6.1.3 | E-UTRAN TDD Intra-frequency RRC Re-establishment | 653 |
| A.6.1.3.1 | Test Purpose and Environment | 653 |
| A.6.1.3.2 | Test Requirements..... | 654 |
| A.6.1.4 | E-UTRAN TDD Inter-frequency RRC Re-establishment | 654 |
| A.6.1.4.1 | Test Purpose and Environment | 654 |
| A.6.1.4.2 | Test Requirements..... | 656 |
| A.6.1.5 | E-UTRAN FDD Intra-frequency RRC Re-establishment for 5MHz bandwidth | 656 |
| A.6.1.5.1 | Test Purpose and Environment | 656 |
| A.6.1.5.2 | Test Requirements..... | 657 |
| A.6.1.6 | E-UTRAN FD-FDD Intra-frequency RRC Re-establishment for UE category 0..... | 657 |
| A.6.1.6.1 | Test Purpose and Environment | 657 |
| A.6.1.6.2 | Test Requirements..... | 658 |
| A.6.1.7 | E-UTRAN HD-FDD Intra-frequency RRC Re-establishment for UE category 0..... | 659 |
| A.6.1.7.1 | Test Purpose and Environment | 659 |
| A.6.1.7.2 | Test Requirements..... | 660 |
| A.6.1.8 | E-UTRAN TDD Intra-frequency RRC Re-establishment for UE category 0..... | 661 |
| A.6.1.8.1 | Test Purpose and Environment | 661 |
| A.6.1.8.2 | Test Requirements..... | 662 |
| A.6.1.9 | E-UTRAN FD-FDD Intra-frequency RRC Re-establishment for Cat-M1 UE in CEModeA..... | 663 |
| A.6.1.9.1 | Test Purpose and Environment | 663 |
| A.6.1.9.2 | Test Requirements..... | 664 |
| A.6.1.10 | E-UTRAN HD-FDD Intra-frequency RRC Re-establishment for Cat-M1 UE in CEModeA | 664 |
| A.6.1.10.1 | Test Purpose and Environment | 664 |
| A.6.1.10.2 | Test Requirements..... | 666 |
| A.6.1.11 | E-UTRAN TDD Intra-frequency RRC Re-establishment for Cat-M1 UE in CEModeA..... | 666 |
| A.6.1.11.1 | Test Purpose and Environment | 666 |

| | | |
|-------------|--|-----|
| A.6.1.11.2 | Test Requirements..... | 668 |
| A.6.1.12 | E-UTRAN FD-FDD Intra-frequency RRC Re-establishment for Cat-M1 UE in CEModeB | 668 |
| A.6.1.12.1 | Test Purpose and Environment | 668 |
| A.6.1.12.2 | Test Requirements..... | 669 |
| A.6.1.13 | E-UTRAN HD-FDD Intra-frequency RRC Re-establishment for Cat-M1 UE in CEModeB | 670 |
| A.6.1.13.1 | Test Purpose and Environment | 670 |
| A.6.1.13.2 | Test Requirements..... | 671 |
| A.6.1.14 | E-UTRAN TDD Intra-frequency RRC Re-establishment for Cat-M1 UE in CEModeB | 672 |
| A.6.1.14.1 | Test Purpose and Environment | 672 |
| A.6.1.14.2 | Test Requirements..... | 673 |
| A.6.1.15 | HD-FDD Intra-frequency RRC Re-establishment for UE category NB1 in In-Band mode under enhanced coverage..... | 674 |
| A.6.1.15.1 | Test Purpose and Environment | 674 |
| A.6.1.15.2 | Test Requirements..... | 675 |
| A.6.1.16 | HD-FDD Inter-frequency RRC Re-establishment for UE category NB1 in In-Band mode under normal coverage..... | 676 |
| A.6.1.16.1 | Test Purpose and Environment | 676 |
| A.6.1.16.2 | Test Requirements..... | 678 |
| A.6.2 | Random Access | 678 |
| A.6.2.1 | E-UTRAN FDD – Contention Based Random Access Test..... | 678 |
| A.6.2.1.1 | Test Purpose and Environment | 678 |
| A.6.2.1.2 | Test Requirements..... | 679 |
| A.6.2.1.2.1 | Random Access Response Reception..... | 679 |
| A.6.2.1.2.2 | No Random Access Response Reception | 680 |
| A.6.2.1.2.3 | Receiving a NACK on msg3 | 680 |
| A.6.2.1.2.4 | Reception of an Incorrect Message over Temporary C-RNTI..... | 680 |
| A.6.2.1.2.5 | Reception of a Correct Message over Temporary C-RNTI..... | 680 |
| A.6.2.1.2.6 | Contention Resolution Timer expiry | 680 |
| A.6.2.2 | E-UTRAN FDD – Non-Contention Based Random Access Test..... | 681 |
| A.6.2.2.1 | Test Purpose and Environment | 681 |
| A.6.2.2.2 | Test Requirements..... | 682 |
| A.6.2.2.2.1 | Random Access Response Reception..... | 682 |
| A.6.2.2.2.2 | No Random Access Response Reception | 682 |
| A.6.2.3 | E-UTRAN TDD – Contention Based Random Access Test..... | 682 |
| A.6.2.3.1 | Test Purpose and Environment | 682 |
| A.6.2.3.2 | Test Requirements..... | 684 |
| A.6.2.3.2.1 | Random Access Response Reception..... | 684 |
| A.6.2.3.2.2 | No Random Access Response reception | 684 |
| A.6.2.3.2.3 | Receiving a NACK on msg3 | 684 |
| A.6.2.3.2.4 | Reception of an Incorrect Message over Temporary C-RNTI..... | 684 |
| A.6.2.3.2.5 | Reception of a Correct Message over Temporary C-RNTI..... | 685 |
| A.6.2.3.2.6 | Contention Resolution Timer expiry | 685 |
| A.6.2.4 | E-UTRAN TDD – Non-Contention Based Random Access Test..... | 685 |
| A.6.2.4.1 | Test Purpose and Environment | 685 |
| A.6.2.4.2 | Test Requirements..... | 686 |
| A.6.2.4.2.1 | Random Access Response Reception..... | 686 |
| A.6.2.4.2.2 | No Random Access Response Reception | 686 |
| A.6.2.5 | E-UTRAN FDD – Contention Based Random Access Test for 5MHz bandwidth | 687 |
| A.6.2.5.1 | Test Purpose and Environment | 687 |
| A.6.2.5.2 | Test Requirements..... | 687 |
| A.6.2.6 | E-UTRAN FDD – Non-contention Based Random Access Test for 5MHz bandwidth | 687 |
| A.6.2.6.1 | Test Purpose and Environment | 687 |
| A.6.2.6.2 | Test Requirements..... | 688 |
| A.6.2.7 | E-UTRAN FDD – Non-Contention Based Random Access Test For SCell..... | 688 |
| A.6.2.7.1 | Test Purpose and Environment | 688 |
| A.6.2.7.2 | Test Requirements..... | 689 |
| A.6.2.7.2.1 | Random Access Response Reception..... | 689 |
| A.6.2.7.2.2 | No Random Access Response Reception | 689 |
| A.6.2.7.2.3 | Stop Preamble transmission if maximum number of preamble transmission counter has been reached..... | 690 |
| A.6.2.8 | E-UTRAN TDD – Non-Contention Based Random Access Test For SCell | 690 |
| A.6.2.8.1 | Test Purpose and Environment | 690 |

| | | |
|--------------|---|-----|
| A.6.2.8.2 | Test Requirements..... | 691 |
| A.6.2.8.2.1 | Random Access Response Reception..... | 691 |
| A.6.2.8.2.2 | No Random Access Response Reception..... | 692 |
| A.6.2.8.2.3 | Stop Preamble transmission if maximum number of preamble transmission counter has been reached..... | 692 |
| A.6.2.9 | 3DL/3UL TDD CA Non-Contention Based Random Access Test for 2 SCells..... | 692 |
| A.6.2.9.1 | Test Purpose and Environment..... | 692 |
| A.6.2.9.2 | Test Requirements..... | 694 |
| A.6.2.9.2.1 | Random Access Response Reception..... | 694 |
| A.6.2.9.2.2 | No Random Access Response Reception..... | 695 |
| A.6.2.9.2.3 | Stop Preamble transmission if maximum number of preamble transmission counter has been reached..... | 695 |
| A.6.2.10 | E-UTRAN FDD Contention Based Random Access Test for Cat-M1 UEs in Normal Coverage..... | 696 |
| A.6.2.10.1 | Test Purpose and Environment..... | 696 |
| A.6.2.10.2 | Test Requirements..... | 697 |
| A.6.2.10.2.1 | Random Access Response Reception..... | 698 |
| A.6.2.10.2.2 | No Random Access Response Reception..... | 698 |
| A.6.2.10.2.3 | Receiving a NACK on msg3..... | 698 |
| A.6.2.10.2.4 | Reception of an Incorrect Message over Temporary C-RNTI..... | 698 |
| A.6.2.10.2.5 | Reception of a Correct Message over Temporary C-RNTI..... | 698 |
| A.6.2.10.2.6 | Contention Resolution Timer expiry..... | 699 |
| A.6.2.10.2.7 | PRACH Resource Selection..... | 699 |
| A.6.2.11 | E-UTRAN HD-FDD Contention Based Random Access Test for Cat-M1 UEs in Normal Coverage..... | 699 |
| A.6.2.11.1 | Test Purpose and Environment..... | 699 |
| A.6.2.11.2 | Test Requirements..... | 701 |
| A.6.2.11.2.1 | Random Access Response Reception..... | 701 |
| A.6.2.11.2.2 | No Random Access Response Reception..... | 701 |
| A.6.2.11.2.3 | Receiving a NACK on msg3..... | 701 |
| A.6.2.11.2.4 | Reception of an Incorrect Message over Temporary C-RNTI..... | 701 |
| A.6.2.11.2.5 | Reception of a Correct Message over Temporary C-RNTI..... | 702 |
| A.6.2.11.2.6 | Contention Resolution Timer expiry..... | 702 |
| A.6.2.11.2.7 | PRACH Resource Selection..... | 702 |
| A.6.2.12 | E-UTRAN TDD Contention Based Random Access Test for Cat-M1 UEs in Normal Coverage..... | 702 |
| A.6.2.12.1 | Test Purpose and Environment..... | 702 |
| A.6.2.12.2 | Test Requirements..... | 704 |
| A.6.2.12.2.1 | Random Access Response Reception..... | 704 |
| A.6.2.12.2.2 | No Random Access Response Reception..... | 704 |
| A.6.2.12.2.3 | Receiving a NACK on msg3..... | 704 |
| A.6.2.12.2.4 | Reception of an Incorrect Message over Temporary C-RNTI..... | 705 |
| A.6.2.12.2.5 | Reception of a Correct Message over Temporary C-RNTI..... | 705 |
| A.6.2.12.2.6 | Contention Resolution Timer expiry..... | 705 |
| A.6.2.12.2.7 | PRACH Resource Selection..... | 705 |
| A.6.2.13 | E-UTRAN FDD Contention Based Random Access Test for Cat-M1 UEs in Enhanced Coverage..... | 705 |
| A.6.2.13.1 | Test Purpose and Environment..... | 705 |
| A.6.2.13.2 | Test Requirements..... | 707 |
| A.6.2.13.2.1 | Random Access Response Reception..... | 707 |
| A.6.2.13.2.2 | No Random Access Response Reception..... | 707 |
| A.6.2.13.2.3 | Receiving a NACK on msg3..... | 708 |
| A.6.2.13.2.4 | Reception of an Incorrect Message over Temporary C-RNTI..... | 708 |
| A.6.2.13.2.5 | Reception of a Correct Message over Temporary C-RNTI..... | 708 |
| A.6.2.13.2.6 | Contention Resolution Timer expiry..... | 708 |
| A.6.2.13.2.7 | PRACH Resource Selection..... | 708 |
| A.6.2.14 | E-UTRAN HD-FDD Contention Based Random Access Test for Cat-M1 UEs in Enhanced Coverage..... | 708 |
| A.6.2.14.1 | Test Purpose and Environment..... | 708 |
| A.6.2.14.2 | Test Requirements..... | 710 |
| A.6.2.14.2.1 | Random Access Response Reception..... | 710 |
| A.6.2.14.2.2 | No Random Access Response Reception..... | 711 |
| A.6.2.14.2.3 | Receiving a NACK on msg3..... | 711 |
| A.6.2.14.2.4 | Reception of an Incorrect Message over Temporary C-RNTI..... | 711 |
| A.6.2.14.2.5 | Reception of a Correct Message over Temporary C-RNTI..... | 711 |
| A.6.2.14.2.6 | Contention Resolution Timer expiry..... | 711 |

| | | |
|--------------|--|-----|
| A.6.2.14.2.7 | PRACH Resource Selection | 711 |
| A.6.2.15 | E-UTRAN TDD Contention Based Random Access Test for Cat-M1 UEs in Enhanced Coverage | 712 |
| A.6.2.15.1 | Test Purpose and Environment | 712 |
| A.6.2.15.2 | Test Requirements..... | 713 |
| A.6.2.15.2.1 | Random Access Response Reception | 714 |
| A.6.2.15.2.2 | No Random Access Response Reception | 714 |
| A.6.2.15.2.3 | Receiving a NACK on msg3 | 714 |
| A.6.2.15.2.4 | Reception of an Incorrect Message over Temporary C-RNTI..... | 714 |
| A.6.2.15.2.5 | Reception of a Correct Message over Temporary C-RNTI | 714 |
| A.6.2.15.2.6 | Contention Resolution Timer expiry | 715 |
| A.6.2.15.2.7 | PRACH Resource Selection | 715 |
| A.6.2.16 | Contention Based Random Access Test for UE category NB1 UEs In-band mode in normal coverage..... | 715 |
| A.6.2.16.1 | Test Purpose and Environment | 715 |
| A.6.2.16.2 | Test Requirements..... | 717 |
| A.6.2.16.2.1 | Random Access Response Reception | 717 |
| A.6.2.16.2.2 | No Random Access Response Reception | 717 |
| A.6.2.16.2.3 | Receiving a NACK on msg3 | 718 |
| A.6.2.16.2.4 | Reception of an Incorrect Message over Temporary C-RNTI..... | 718 |
| A.6.2.16.2.5 | Reception of a Correct Message over Temporary C-RNTI | 718 |
| A.6.2.16.2.6 | Contention Resolution Timer expiry | 718 |
| A.6.2.16.2.7 | NPRACH Resource Selection | 718 |
| A.6.2.17 | Contention Based Random Access Test for UE category NB1 UEs In-band mode in Enhanced Coverage..... | 718 |
| A.6.2.17.1 | Test Purpose and Environment | 718 |
| A.6.2.17.2 | Test Requirements..... | 720 |
| A.6.2.17.2.1 | Random Access Response Reception | 721 |
| A.6.2.17.2.2 | No Random Access Response Reception | 721 |
| A.6.2.17.2.3 | Receiving a NACK on msg3 | 721 |
| A.6.2.17.2.4 | Reception of an Incorrect Message over Temporary C-RNTI..... | 721 |
| A.6.2.17.2.5 | Reception of a Correct Message over Temporary C-RNTI | 721 |
| A.6.2.17.2.6 | Contention Resolution Timer expiry | 722 |
| A.6.2.17.2.7 | NPRACH Resource Selection | 722 |
| A.6.3 | RRC Connection Release with Redirection..... | 722 |
| A.6.3.1 | Redirection from E-UTRAN FDD to UTRAN FDD | 722 |
| A.6.3.1.1 | Test Purpose and Environment | 722 |
| A.6.3.1.2 | Test Requirements..... | 724 |
| A.6.3.2 | Redirection from E-UTRAN TDD to UTRAN FDD..... | 724 |
| A.6.3.2.1 | Test Purpose and Environment | 724 |
| A.6.3.2.2 | Test Requirements..... | 726 |
| A.6.3.3 | Redirection from E-UTRAN FDD to GERAN when System Information is provided..... | 726 |
| A.6.3.3.1 | Test Purpose and Environment | 726 |
| A.6.3.3.2 | Test Requirements..... | 727 |
| A.6.3.4 | Redirection from E-UTRAN TDD to GERAN when System Information is provided..... | 728 |
| A.6.3.4.1 | Test Purpose and Environment | 728 |
| A.6.3.4.2 | Test Requirements..... | 729 |
| A.6.3.5 | E-UTRA TDD RRC connection release redirection to UTRA TDD | 729 |
| A.6.3.5.1 | Test Purpose and Environment | 729 |
| A.6.3.5.2 | Test Requirements..... | 731 |
| A.6.3.6 | E-UTRA FDD RRC connection release redirection to UTRA TDD | 732 |
| A.6.3.6.1 | Test Purpose and Environment | 732 |
| A.6.3.6.2 | Test Requirements..... | 733 |
| A.6.3.7 | E-UTRA TDD RRC connection release redirection to UTRA TDD without SI provided | 734 |
| A.6.3.7.1 | Test Purpose and Environment | 734 |
| A.6.3.7.2 | Test Requirements..... | 735 |
| A.6.3.8 | E-UTRA FDD RRC connection release redirection to UTRA TDD without SI provided | 736 |
| A.6.3.8.1 | Test Purpose and Environment | 736 |
| A.6.3.8.2 | Test Requirements..... | 737 |
| A.6.3.9 | Redirection from E-UTRAN FDD to UTRAN FDD without System Information | 738 |
| A.6.3.9.1 | Test Purpose and Environment | 738 |
| A.6.3.9.2 | Test Requirements..... | 739 |
| A.6.3.10 | Redirection from E-UTRAN FDD to GERAN when System Information is not provided..... | 740 |

| | | |
|------------|--|-----|
| A.6.3.10.1 | Test Purpose and Environment | 740 |
| A.6.3.10.2 | Test Requirements..... | 741 |
| A.6.3.11 | Redirection from E-UTRAN TDD to GERAN when System Information is not provided..... | 742 |
| A.6.3.11.1 | Test Purpose and Environment | 742 |
| A.6.3.11.2 | Test Requirements..... | 743 |
| A.6.3.12 | E-UTRAN TDD RRC connection release redirection to UTRAN FDD without SI provided..... | 743 |
| A.6.3.12.1 | Test Purpose and Environment | 743 |
| A.6.3.12.2 | Test Requirements..... | 745 |
| A.7 | Timing and Signalling Characteristics | 746 |
| A.7.1 | UE Transmit Timing | 746 |
| A.7.1.1 | E-UTRAN FDD – UE Transmit Timing Accuracy Tests..... | 746 |
| A.7.1.1.1 | Test Purpose and Environment | 746 |
| A.7.1.1.2 | Test Requirements..... | 747 |
| A.7.1.2 | E-UTRAN TDD - UE Transmit Timing Accuracy Tests | 748 |
| A.7.1.2.1 | Test Purpose and Environment | 748 |
| A.7.1.2.2 | Test Requirements..... | 749 |
| A.7.1.3 | E-UTRAN FDD – UE Transmit Timing Accuracy Tests for SCell..... | 750 |
| A.7.1.3.1 | Test Purpose and Environment | 750 |
| A.7.1.3.2 | Test Requirements..... | 752 |
| A.7.1.4 | E-UTRAN TDD - UE Transmit Timing Accuracy Tests for SCell | 752 |
| A.7.1.4.1 | Test Purpose and Environment | 752 |
| A.7.1.4.2 | Test Requirements..... | 754 |
| A.7.1.4A | E-UTRAN TDD - UE Transmit Timing Accuracy Tests for SCell for 20 MHz + 10 MHz..... | 754 |
| A.7.1.4A.1 | Test Purpose and Environment | 754 |
| A.7.1.4A.2 | Test Requirements..... | 755 |
| A.7.1.5 | E-UTRAN FDD – UE Transmit Timing Accuracy Tests for 5MHz Bandwidth..... | 755 |
| A.7.1.5.1 | Test Purpose and Environment | 755 |
| A.7.1.5.2 | Test Requirements..... | 755 |
| A.7.1.6 | E-UTRAN FDD – UE Transmit Timing Accuracy Tests for SCell in sTAG..... | 755 |
| A.7.1.6.1 | Test Purpose and Environment | 755 |
| A.7.1.6.2 | Test Requirements..... | 757 |
| A.7.1.7 | E-UTRAN TDD - UE Transmit Timing Accuracy Tests for SCell in sTAG | 757 |
| A.7.1.7.1 | Test Purpose and Environment | 757 |
| A.7.1.7.2 | Test Requirements..... | 759 |
| A.7.1.7A | E-UTRAN TDD - UE Transmit Timing Accuracy Tests for SCell in sTAG for 20MHz +20MHz | 760 |
| A.7.1.7A.1 | Test Purpose and Environment | 760 |
| A.7.1.7A.2 | Test Requirements..... | 760 |
| A.7.1.7B | E-UTRAN TDD - UE Transmit Timing Accuracy Tests for SCell in sTAG for 20MHz +10MHz | 760 |
| A.7.1.7B.1 | Test Purpose and Environment | 760 |
| A.7.1.7B.2 | Test Requirements..... | 760 |
| A.7.1.8 | Void..... | 761 |
| A.7.1.9 | Void..... | 761 |
| A.7.1.10 | E-UTRAN FDD – UE Transmit Timing Accuracy Tests for Cat-M1 UE in CEModeA | 761 |
| A.7.1.10.1 | Test Purpose and Environment | 761 |
| A.7.1.10.2 | Test Requirements..... | 762 |
| A.7.1.11 | E-UTRAN HD-FDD – UE Transmit Timing Accuracy Tests for Cat-M1 UE in CEModeA | 763 |
| A.7.1.11.1 | Test Purpose and Environment | 763 |
| A.7.1.11.2 | Test Requirements..... | 764 |
| A.7.1.12 | E-UTRAN TDD - UE Transmit Timing Accuracy Tests for Cat-M1 UE in CEModeA | 764 |
| A.7.1.12.1 | Test Purpose and Environment | 764 |
| A.7.1.12.2 | Test Requirements..... | 766 |
| A.7.1.13 | 3DL/3UL TDD CA UE Transmit Timing Accuracy Tests for 2 SCells | 766 |
| A.7.1.13.1 | Test Purpose and Environment | 766 |
| A.7.1.13.2 | Test Requirements..... | 768 |
| A.7.1.14 | E-UTRAN FDD – UE Transmit Timing Accuracy Tests for Cat-M1 UE in CEModeB..... | 769 |
| A.7.1.14.1 | Test Purpose and Environment | 769 |
| A.7.1.14.2 | Test Requirements..... | 770 |
| A.7.1.15 | E-UTRAN HD-FDD – UE Transmit Timing Accuracy Tests for Cat-M1 UE in CEModeB..... | 770 |
| A.7.1.15.1 | Test Purpose and Environment | 770 |
| A.7.1.15.2 | Test Requirements..... | 771 |
| A.7.1.16 | E-UTRAN TDD - UE Transmit Timing Accuracy Tests for Cat-M1 UE in CEModeB | 772 |

| | | |
|------------|---|-----|
| A.7.1.16.1 | Test Purpose and Environment | 772 |
| A.7.1.16.2 | Test Requirements..... | 773 |
| A.7.1.17 | E-UTRAN HD-FDD – UE Transmit Timing Accuracy Tests for Category NB1 UE In-Band mode under normal coverage..... | 773 |
| A.7.1.17.1 | Test Purpose and Environment | 773 |
| A.7.1.17.2 | Test Requirements..... | 775 |
| A.7.1.18 | E-UTRAN HD-FDD – UE Transmit Timing Accuracy Tests for Category NB1 UE In-band mode under enhanced coverage..... | 775 |
| A.7.1.18.1 | Test Purpose and Environment | 775 |
| A.7.1.18.2 | Test Requirements..... | 777 |
| A.7.2 | UE Timing Advance..... | 778 |
| A.7.2.1 | E-UTRAN FDD – UE Timing Advance Adjustment Accuracy Test | 778 |
| A.7.2.1.1 | Test Purpose and Environment | 778 |
| A.7.2.1.2 | Test Requirements..... | 779 |
| A.7.2.2 | E-UTRAN TDD – UE Timing Advance Adjustment Accuracy Test..... | 780 |
| A.7.2.2.1 | Test Purpose and Environment | 780 |
| A.7.2.2.2 | Test Requirements..... | 781 |
| A.7.2.3 | E-UTRAN FDD – UE Timing Advance Adjustment Accuracy Test for 5MHz | 781 |
| A.7.2.3.1 | Test Purpose and Environment | 781 |
| A.7.2.3.2 | Test Requirements..... | 782 |
| A.7.2.4 | E-UTRAN FDD – UE Timing Advance Adjustment Accuracy Test for SCell in sTAG | 782 |
| A.7.2.4.1 | Test Purpose and Environment | 782 |
| A.7.2.4.2 | Test Requirements..... | 784 |
| A.7.2.5 | E-UTRAN TDD – UE Timing Advance Adjustment Accuracy Test for Scell in sTAG..... | 784 |
| A.7.2.5.1 | Test Purpose and Environment | 784 |
| A.7.2.5.2 | Test Requirements..... | 786 |
| A.7.2.5A | E-UTRAN TDD – UE Timing Advance Adjustment Accuracy Test for Scell in sTAG for 20 MHz +20 MHz..... | 786 |
| A.7.2.5A.1 | Test Purpose and Environment | 786 |
| A.7.2.5A.2 | Test Requirements..... | 787 |
| A.7.2.5B | E-UTRAN TDD – UE Timing Advance Adjustment Accuracy Test for Scell in sTAG for 20 MHz +10 MHz..... | 787 |
| A.7.2.5B.1 | Test Purpose and Environment | 787 |
| A.7.2.5B.2 | Test Requirements..... | 787 |
| A.7.2.6 | E-UTRAN FDD Timing Advance Adjustment Accuracy Test for Cat-M1 UE in CEModeA..... | 788 |
| A.7.2.6.1 | Test Purpose and Environment | 788 |
| A.7.2.6.2 | Test Requirements..... | 789 |
| A.7.2.7 | E-UTRAN HD-FDD UE Timing Advance Adjustment Accuracy Test for Cat-M1 UE in CEModeA.... | 790 |
| A.7.2.7.1 | Test Purpose and Environment | 790 |
| A.7.2.7.2 | Test Requirements..... | 791 |
| A.7.2.8 | E-UTRAN TDD Timing Advance Adjustment Accuracy Test for Cat-M1 UE in CEModeA..... | 792 |
| A.7.2.8.1 | Test Purpose and Environment | 792 |
| A.7.2.8.2 | Test Requirements..... | 793 |
| A.7.2.9 | Void | 794 |
| A.7.2.10 | Void | 794 |
| A.7.2.11 | Void | 794 |
| A.7.2.9 | HD-FDD UE Timing Advance Adjustment Accuracy Test for UE Category NB1 in Standalone Mode under Enhance Coverage..... | 794 |
| A.7.2.9.1 | Test Purpose and Environment | 794 |
| A.7.2.9.2 | Test Requirements..... | 795 |
| A.7.2.10 | E-UTRAN FDD UE Timing Advance Adjustment Accuracy Test in CEModeB | 795 |
| A.7.2.10.1 | Test Purpose and Environment | 795 |
| A.7.2.10.2 | Test Requirements..... | 797 |
| A.7.2.11 | E-UTRAN HD-FDD UE Timing Advance Adjustment Accuracy Test in CEModeB | 797 |
| A.7.2.11.1 | Test Purpose and Environment | 797 |
| A.7.2.11.2 | Test Requirements..... | 798 |
| A.7.2.12 | E-UTRAN TDD UE Timing Advance Adjustment Accuracy Test in CEModeB..... | 799 |
| A.7.2.12.1 | Test Purpose and Environment | 799 |
| A.7.2.12.2 | Test Requirements..... | 800 |
| A.7.3 | Radio Link Monitoring..... | 800 |
| A.7.3.1 | E-UTRAN FDD Radio Link Monitoring Test for Out-of-sync | 800 |
| A.7.3.1.1 | Test Purpose and Environment | 800 |

| | | |
|------------|---|-----|
| A.7.3.1.2 | Test Requirements..... | 804 |
| A.7.3.2 | E-UTRAN FDD Radio Link Monitoring Test for In-sync | 804 |
| A.7.3.2.1 | Test Purpose and Environment | 804 |
| A.7.3.2.2 | Test Requirements..... | 806 |
| A.7.3.3 | E-UTRAN TDD Radio Link Monitoring Test for Out-of-sync | 807 |
| A.7.3.3.1 | Test Purpose and Environment | 807 |
| A.7.3.3.2 | Test Requirements..... | 810 |
| A.7.3.4 | E-UTRAN TDD Radio Link Monitoring Test for In-sync | 810 |
| A.7.3.4.1 | Test Purpose and Environment | 810 |
| A.7.3.4.2 | Test Requirements..... | 812 |
| A.7.3.5 | E-UTRAN FDD Radio Link Monitoring Test for Out-of-sync in DRX..... | 813 |
| A.7.3.5.1 | Test Purpose and Environment | 813 |
| A.7.3.5.2 | Test Requirements..... | 816 |
| A.7.3.6 | E-UTRAN FDD Radio Link Monitoring Test for In-sync in DRX | 817 |
| A.7.3.6.1 | Test Purpose and Environment | 817 |
| A.7.3.6.2 | Test Requirements..... | 819 |
| A.7.3.7 | E-UTRAN TDD Radio Link Monitoring Test for Out-of-sync in DRX | 819 |
| A.7.3.7.1 | Test Purpose and Environment | 819 |
| A.7.3.7.2 | Test Requirements..... | 822 |
| A.7.3.8 | E-UTRAN TDD Radio Link Monitoring Test for In-sync in DRX..... | 822 |
| A.7.3.8.1 | Test Purpose and Environment | 822 |
| A.7.3.8.2 | Test Requirements..... | 825 |
| A.7.3.9 | E-UTRAN FDD Radio Link Monitoring Test for Out-of-sync under Time Domain Measurement Resource Restriction and Non-MBSFN ABS..... | 825 |
| A.7.3.9.2 | Test Requirements..... | 827 |
| A.7.3.10 | E-UTRAN TDD Radio Link Monitoring Test for Out-of-sync under Time Domain Measurement Resource Restriction with Non-MBSFN ABS..... | 828 |
| A.7.3.10.1 | Test Purpose and Environment | 828 |
| A.7.3.11 | E-UTRAN FDD Radio Link Monitoring Test for In-sync for Non-MBSFN ABS..... | 830 |
| A.7.3.11.1 | Test Purpose and Environment | 830 |
| A.7.3.11.2 | Test Requirements..... | 833 |
| A.7.3.12 | E-UTRAN TDD Radio Link Monitoring Test for In-sync for Non-MBSFN ABS | 833 |
| A.7.3.12.1 | Test Purpose and Environment | 833 |
| A.7.3.12.2 | Test Requirements..... | 836 |
| A.7.3.13 | E-UTRAN FDD Radio Link Monitoring Test for Out-of-sync under Time Domain Measurement Resource Restriction with MBSFN ABS..... | 837 |
| A.7.3.13.1 | Test Purpose and Environment | 837 |
| A.7.3.13.2 | Test Requirements..... | 839 |
| A.7.3.14 | E-UTRAN TDD Radio Link Monitoring Test for Out-of-sync under Time Domain Measurement Resource Restriction with MBSFN ABS..... | 839 |
| A.7.3.14.1 | Test Purpose and Environment | 839 |
| A.7.3.14.2 | Test Requirements..... | 842 |
| A.7.3.15 | E-UTRAN FDD Radio Link Monitoring Test for In-sync under Time Domain Measurement Resource Restriction with MBSFN ABS..... | 842 |
| A.7.3.15.1 | Test Purpose and Environment | 842 |
| A.7.3.15.2 | Test Requirements..... | 845 |
| A.7.3.16 | E-UTRAN TDD Radio Link Monitoring Test for In-sync under Time Domain Measurement Resource Restriction with MBSFN ABS..... | 845 |
| A.7.3.16.1 | Test Purpose and Environment | 845 |
| A.7.3.16.2 | Test Requirements..... | 848 |
| A.7.3.17 | E-UTRAN FDD Radio Link Monitoring Test for Out-of-sync under Time Domain Measurement Resource Restriction with CRS Assistance Information and Non-MBSFN ABS | 848 |
| A.7.3.17.1 | Test Purpose and Environment | 848 |
| A.7.3.17.2 | Test Requirements..... | 851 |
| A.7.3.18 | E-UTRAN TDD Radio Link Monitoring Test for Out-of-sync under Time Domain Measurement Resource Restriction with CRS Assistance Information and Non-MBSFN ABS | 851 |
| A.7.3.18.1 | Test Purpose and Environment | 851 |
| A.7.3.18.2 | Test Requirements..... | 854 |
| A.7.3.19 | E-UTRAN FDD Radio Link Monitoring Test for In-sync under Time Domain Measurement Resource Restriction with CRS assistance information and Non-MBSFN ABS | 854 |
| A.7.3.19.1 | Test Purpose and Environment | 854 |
| A.7.3.19.2 | Test Requirements..... | 857 |

| | | |
|------------|---|-----|
| A.7.3.20 | E-UTRAN TDD Radio Link Monitoring Test for In-sync under Time Domain Measurement Resource Restriction with CRS assistance information and Non-MBSFN ABS | 858 |
| A.7.3.20.1 | Test Purpose and Environment | 858 |
| A.7.3.20.2 | Test Requirements..... | 861 |
| A.7.3.21 | E-UTRAN FDD Radio Link Monitoring Test for In-sync under Time Domain Measurement Resource Restriction with CRS assistance information and MBSFN ABS | 861 |
| A.7.3.21.1 | Test Purpose and Environment | 861 |
| A.7.3.21.2 | Test Requirements..... | 864 |
| A.7.3.22 | E-UTRAN TDD Radio Link Monitoring Test for In-sync under Time Domain Measurement Resource Restriction with CRS assistance information and MBSFN ABS | 865 |
| A.7.3.22.1 | Test Purpose and Environment | 865 |
| A.7.3.22.2 | Test Requirements..... | 868 |
| A.7.3.23 | E-UTRAN FDD Radio Link Monitoring Test for Out-of-sync for 5MHz Bandwidth | 868 |
| A.7.3.23.1 | Test Purpose and Environment | 868 |
| A.7.3.23.2 | Test Requirements..... | 869 |
| A.7.3.24 | E-UTRAN FDD Radio Link Monitoring Test for In-sync for 5MHz Bandwidth | 869 |
| A.7.3.24.1 | Test Purpose and Environment | 869 |
| A.7.3.24.2 | Test Requirements..... | 870 |
| A.7.3.25 | E-UTRAN FDD Radio Link Monitoring Test for In-sync in DRX for 5MHz Bandwidth..... | 870 |
| A.7.3.25.1 | Test Purpose and Environment | 870 |
| A.7.3.25.2 | Test Requirements..... | 871 |
| A.7.3.26 | E-UTRAN FD-FDD Radio Link Monitoring Test for Out-of-sync for UE Category 0 | 871 |
| A.7.3.26.1 | Test Purpose and Environment | 871 |
| A.7.3.26.2 | Test Requirements..... | 873 |
| A.7.3.27 | E-UTRAN FD-FDD Radio Link Monitoring Test for In-sync for UE Category 0..... | 873 |
| A.7.3.27.1 | Test Purpose and Environment | 873 |
| A.7.3.27.2 | Test Requirements..... | 875 |
| A.7.3.28 | E-UTRAN FD-FDD Radio Link Monitoring Test for Out-of-sync in DRX for UE category 0..... | 875 |
| A.7.3.28.1 | Test Purpose and Environment | 875 |
| A.7.3.28.2 | Test Requirements..... | 879 |
| A.7.3.29 | E-UTRAN FD-FDD Radio Link Monitoring Test for In-sync in DRX for UE Category 0 | 879 |
| A.7.3.29.1 | Test Purpose and Environment | 879 |
| A.7.3.29.2 | Test Requirements..... | 882 |
| A.7.3.30 | E-UTRAN HD-FDD Radio Link Monitoring Test for Out-of-sync for UE Category 0..... | 882 |
| A.7.3.30.1 | Test Purpose and Environment | 882 |
| A.7.3.30.2 | Test Requirements..... | 884 |
| A.7.3.31 | E-UTRAN HD-FDD Radio Link Monitoring Test for In-sync for UE Category 0..... | 884 |
| A.7.3.31.1 | Test Purpose and Environment | 884 |
| A.7.3.31.2 | Test Requirements..... | 886 |
| A.7.3.32 | E-UTRAN HD-FDD Radio Link Monitoring Test for Out-of-sync in DRX for UE category 0..... | 886 |
| A.7.3.32.1 | Test Purpose and Environment | 886 |
| A.7.3.32.2 | Test Requirements..... | 888 |
| A.7.3.33 | E-UTRAN HD-FDD Radio Link Monitoring Test for In-sync in DRX for UE Category 0..... | 889 |
| A.7.3.33.1 | Test Purpose and Environment | 889 |
| A.7.3.33.2 | Test Requirements..... | 891 |
| A.7.3.34 | E-UTRAN TDD Radio Link Monitoring Test for Out-of-sync for UE Category 0..... | 892 |
| A.7.3.34.1 | Test Purpose and Environment | 892 |
| A.7.3.34.2 | Test Requirements..... | 894 |
| A.7.3.35 | E-UTRAN TDD Radio Link Monitoring Test for In-sync for UE category 0..... | 894 |
| A.7.3.35.1 | Test Purpose and Environment | 894 |
| A.7.3.35.2 | Test Requirements..... | 896 |
| A.7.3.36 | E-UTRAN TDD Radio Link Monitoring Test for Out-of-sync in DRX for UE category 0..... | 896 |
| A.7.3.36.1 | Test Purpose and Environment | 896 |
| A.7.3.36.2 | Test Requirements..... | 899 |
| A.7.3.37 | E-UTRAN TDD Radio Link Monitoring Test for In-sync in DRX for UE category 0 | 899 |
| A.7.3.37.1 | Test Purpose and Environment | 899 |
| A.7.3.37.2 | Test Requirements..... | 902 |
| A.7.3.38 | E-UTRAN FDD-FDD DC Radio Link Monitoring Test for Out-of-sync in DRX in synchronous DC ... | 902 |
| A.7.3.38.1 | Test Purpose and Environment | 902 |
| A.7.3.38.2 | Test Requirements..... | 904 |
| A.7.3.39 | E-UTRAN FDD-FDD DC Radio Link Monitoring Test for Out-of-sync in DRX in asynchronous DC..... | 905 |

| | | |
|------------|---|-----|
| A.7.3.39.1 | Test Purpose and Environment | 905 |
| A.7.3.39.2 | Test Requirements..... | 907 |
| A.7.3.40 | E-UTRAN TDD-TDD DC Radio Link Monitoring Test for Out-of-sync in DRX in synchronous DC ... | 908 |
| A.7.3.40.1 | Test Purpose and Environment | 908 |
| A.7.3.40.2 | Test Requirements..... | 910 |
| A.7.3.41 | E-UTRAN FDD-FDD Radio Link Monitoring Test for In-sync in DRX in synchronous dual connectivity..... | 911 |
| A.7.3.41.1 | Test Purpose and Environment | 911 |
| A.7.3.41.2 | Test Requirements..... | 913 |
| A.7.3.42 | E-UTRAN FDD-FDD DC Radio Link Monitoring Test for In-sync in DRX in asynchronous DC..... | 914 |
| A.7.3.42.1 | Test Purpose and Environment | 914 |
| A.7.3.42.2 | Test Requirements..... | 916 |
| A.7.3.43 | E-UTRAN TDD-TDD Radio Link Monitoring Test for In-sync in DRX in synchronous dual connectivity..... | 917 |
| A.7.3.43.1 | Test Purpose and Environment | 917 |
| A.7.3.43.2 | Test Requirements..... | 919 |
| A.7.3.44 | E-UTRAN TDD-FDD DC Radio Link Monitoring Test for Out-of-sync in DRX in synchronous DC with PCell in FDD | 920 |
| A.7.3.44.1 | Test Purpose and Environment | 920 |
| A.7.3.44.2 | Test Requirements..... | 922 |
| A.7.3.45 | E-UTRAN TDD-FDD DC Radio Link Monitoring Test for Out-of-sync in DRX in synchronous DC with PCell in TDD | 922 |
| A.7.3.45.1 | Test Purpose and Environment | 922 |
| A.7.3.45.2 | Test Requirements..... | 925 |
| A.7.3.46 | E-UTRAN TDD-FDD Radio Link Monitoring Test for In-sync in DRX for PSCell in synchronous DC with PCell in FDD..... | 925 |
| A.7.3.46.1 | Test Purpose and Environment | 925 |
| A.7.3.46.2 | Test Requirements..... | 928 |
| A.7.3.47 | E-UTRAN TDD-FDD Radio Link Monitoring Test for In-sync in DRX for PSCell in synchronous DC with PCell in TDD..... | 928 |
| A.7.3.47.1 | Test Purpose and Environment | 928 |
| A.7.3.47.2 | Test Requirements..... | 931 |
| A.7.3.48 | E-UTRAN FD-FDD Radio Link Monitoring Test for Out-of-sync for Cat-M1 UE in CEMode A | 931 |
| A.7.3.48.1 | Test Purpose and Environment | 931 |
| A.7.3.48.2 | Test Requirements..... | 933 |
| A.7.3.49 | E-UTRAN FD-FDD Radio Link Monitoring Test for In-Sync for Cat-M1 UE in CEMode A..... | 933 |
| A.7.3.49.1 | Test Purpose and Environment | 933 |
| A.7.3.49.2 | Test Requirements..... | 935 |
| A.7.3.50 | E-UTRAN FD-FDD Radio Link Monitoring Test for Out-of-sync in DRX for UE category M1 configured in CEMode A..... | 936 |
| A.7.3.50.1 | Test Purpose and Environment | 936 |
| A.7.3.50.2 | Test Requirements..... | 938 |
| A.7.3.51 | E-UTRAN FD-FDD Radio Link Monitoring Test for In-sync in DRX for UE Category M1 configured in CEMode A..... | 939 |
| A.7.3.51.1 | Test Purpose and Environment | 939 |
| A.7.3.51.2 | Test Requirements..... | 941 |
| A.7.3.52 | E-UTRAN HD-FDD Radio Link Monitoring Test for Out-of-sync for Cat-M1 UE in CEMode A..... | 941 |
| A.7.3.52.1 | Test Purpose and Environment | 941 |
| A.7.3.52.2 | Test Requirements..... | 943 |
| A.7.3.53 | E-UTRAN HD-FDD Radio Link Monitoring Test for In-Sync for Cat-M1 UE in CEMode A | 943 |
| A.7.3.53.1 | Test Purpose and Environment | 943 |
| A.7.3.53.2 | Test Requirements..... | 945 |
| A.7.3.54 | E-UTRAN HD-FDD Radio Link Monitoring Test for Out-of-sync in DRX for UE category M1 configured in CEMode A..... | 946 |
| A.7.3.54.1 | Test Purpose and Environment | 946 |
| A.7.3.54.2 | Test Requirements..... | 948 |
| A.7.3.55 | E-UTRAN HD-FDD Radio Link Monitoring Test for In-sync in DRX for UE Category M1 configured in CEMode A..... | 949 |
| A.7.3.55.1 | Test Purpose and Environment | 949 |
| A.7.3.55.2 | Test Requirements..... | 951 |
| A.7.3.56 | E-UTRAN TDD Radio Link Monitoring Test for Out-of-sync for Cat-M1 UE in CEMode A | 951 |
| A.7.3.56.1 | Test Purpose and Environment | 951 |

| | | |
|------------|---|-----|
| A.7.3.56.2 | Test Requirements..... | 953 |
| A.7.3.57 | E-UTRAN TDD Radio Link Monitoring Test for In-Sync for Cat-M1 UE in CEMode A..... | 953 |
| A.7.3.57.1 | Test Purpose and Environment | 953 |
| A.7.3.57.2 | Test Requirements..... | 956 |
| A.7.3.58 | E-UTRAN TDD Radio Link Monitoring Test for Out-of-sync in DRX for UE category M1 configured in CEMode A..... | 956 |
| A.7.3.58.1 | Test Purpose and Environment | 956 |
| A.7.3.58.2 | Test Requirements..... | 959 |
| A.7.3.59 | E-UTRAN TDD Radio Link Monitoring Test for In-sync in DRX for UE Category M1 configured in CEMode A..... | 959 |
| A.7.3.59.1 | Test Purpose and Environment | 959 |
| A.7.3.59.2 | Test Requirements..... | 961 |
| A.7.3.60 | HD-FDD Radio Link Monitoring Test for Out-of-sync in DRX for UE category NB1 In-band mode in normal coverage..... | 961 |
| A.7.3.60.1 | Test Purpose and Environment | 961 |
| A.7.3.60.2 | Test Requirements..... | 964 |
| A.7.3.61 | HD-FDD Radio Link Monitoring Test for Out-of-sync in DRX for UE category NB1 In-band mode in enhanced coverage..... | 964 |
| A.7.3.61.1 | Test Purpose and Environment | 964 |
| A.7.3.61.2 | Test Requirements..... | 967 |
| A.7.3.62 | HD-FDD Radio Link Monitoring Test for In-sync with DRX for UE Category NB1 In-Band mode in Enhanced Coverage | 967 |
| A.7.3.62.1 | Test Purpose and Environment | 967 |
| A.7.3.62.2 | Test Requirements..... | 970 |
| A.7.3.63 | HD-FDD Radio Link Monitoring Test for In-sync with DRX for UE Category NB1 In-Band mode in Normal Coverage..... | 971 |
| A.7.3.63.1 | Test Purpose and Environment | 971 |
| A.7.3.63.2 | Test Requirements..... | 974 |
| A.7.3.64 | HD-FDD Radio Link Monitoring Test for In-sync without DRX for UE Category NB1 In-Band mode in Normal Coverage..... | 974 |
| A.7.3.64.1 | Test Purpose and Environment | 974 |
| A.7.3.64.2 | Test Requirements..... | 977 |
| A.7.3.65 | HD-FDD Radio Link Monitoring Test for In-sync without DRX for UE Category NB1 In-Band mode in Enhanced Coverage | 977 |
| A.7.3.65.1 | Test Purpose and Environment | 977 |
| A.7.3.65.2 | Test Requirements..... | 980 |
| A.7.3.66 | HD-FDD Radio Link Monitoring Test for Out-of-sync without DRX for UE Category NB1 Standalone mode in Normal Coverage | 980 |
| A.7.3.66.1 | Test Purpose and Environment | 980 |
| A.7.3.66.2 | Test Requirements..... | 982 |
| A.7.3.67 | HD-FDD Radio Link Monitoring Test for Out-of-sync without DRX for UE Category NB1 guard band mode in Enhanced Coverage..... | 982 |
| A.7.3.67.1 | Test Purpose and Environment | 982 |
| A.7.3.67.2 | Test Requirements..... | 985 |
| A.7.3.68 | E-UTRAN FD-FDD Radio Link Monitoring Test for Out-of-sync for non-BL CE UE in CEMode A ... | 985 |
| A.7.3.68.1 | Test Purpose and Environment | 985 |
| A.7.3.68.2 | Test Requirements..... | 987 |
| A.7.3.69 | E-UTRAN FD-FDD Radio Link Monitoring Test for In-Sync for non-BL CE UE in CEMode A..... | 987 |
| A.7.3.69.1 | Test Purpose and Environment | 987 |
| A.7.3.69.2 | Test Requirements..... | 989 |
| A.7.3.70 | E-UTRAN FD-FDD Radio Link Monitoring Test for Out-of-sync in DRX for non-BL CE UE configured in CEMode A..... | 990 |
| A.7.3.70.1 | Test Purpose and Environment | 990 |
| A.7.3.70.2 | Test Requirements..... | 992 |
| A.7.3.71 | E-UTRAN FD-FDD Radio Link Monitoring Test for In-sync in DRX for non-BL CE UE configured in CEMode A..... | 993 |
| A.7.3.71.1 | Test Purpose and Environment | 993 |
| A.7.3.71.2 | Test Requirements..... | 995 |
| A.7.3.72 | E-UTRAN TDD Radio Link Monitoring Test for Out-of-sync for non-BL CE UE in CEMode A | 995 |
| A.7.3.72.1 | Test Purpose and Environment | 995 |
| A.7.3.72.2 | Test Requirements..... | 997 |
| A.7.3.73 | E-UTRAN TDD Radio Link Monitoring Test for In-Sync for non-BL CE UE in CEMode A..... | 998 |

| | | |
|------------|---|------|
| A.7.3.73.1 | Test Purpose and Environment | 998 |
| A.7.3.73.2 | Test Requirements..... | 1000 |
| A.7.3.74 | E-UTRAN TDD Radio Link Monitoring Test for Out-of-sync in DRX for non-BL CE UE configured in CEMode A..... | 1000 |
| A.7.3.74.1 | Test Purpose and Environment | 1000 |
| A.7.3.74.2 | Test Requirements..... | 1003 |
| A.7.3.75 | E-UTRAN TDD Radio Link Monitoring Test for In-sync in DRX for non-BL CE UE configured in CEMode A..... | 1003 |
| A.7.3.75.1 | Test Purpose and Environment | 1003 |
| A.7.3.75.2 | Test Requirements..... | 1005 |
| A.7.4 | Interruption for Dual Connectivity..... | 1005 |
| A.7.4.1 | E-UTRAN FDD-FDD DC interruption at transitions between active and non-active during DRX in synchronous DC..... | 1005 |
| A.7.4.1.1 | Test Purpose and Environment | 1005 |
| A.7.4.1.2 | Test Requirements..... | 1007 |
| A.7.4.2 | E-UTRAN TDD-TDD DC interruption at transitions between active and non-active during DRX in synchronous DC..... | 1007 |
| A.7.4.2.1 | Test Purpose and Environment | 1007 |
| A.7.4.2.2 | Test Requirements..... | 1009 |
| A.7.4.3 | E-UTRAN FDD-FDD Interruption at transitions between active and non-active during DRX in asynchronous dual connectivity..... | 1009 |
| A.7.4.3.1 | Test Purpose and Environment | 1009 |
| A.7.4.3.2 | Test Requirements..... | 1011 |
| A.7.4.4 | E-UTRAN FDD-TDD DC interruption at transitions between active and non-active during DRX in synchronous DC..... | 1011 |
| A.7.4.4.1 | Test Purpose and Environment | 1011 |
| A.7.4.4.2 | Test Requirements..... | 1013 |
| A.7.4.5 | E-UTRAN TDD-FDD DC interruption at transitions between active and non-active during DRX in synchronous DC..... | 1013 |
| A.7.4.5.1 | Test Purpose and Environment | 1013 |
| A.7.4.5.2 | Test Requirements..... | 1015 |
| A.7.5 | Proximity-based Services..... | 1015 |
| A.7.5.1 | E-UTRAN FDD – UE ProSe Direct Discovery Transmission Timing Accuracy Test..... | 1015 |
| A.7.5.1.1 | Test Purpose and Environment | 1015 |
| A.7.5.1.2 | Test Requirements..... | 1016 |
| A.7.5.2 | E-UTRAN TDD – UE ProSe Direct Discovery Transmission Timing Accuracy Test..... | 1017 |
| A.7.5.2.1 | Test Purpose and Environment | 1017 |
| A.7.5.1.2 | Test Requirements..... | 1018 |
| A.7.5.3 | E-UTRAN FDD - Interruptions due to ProSe Direct Discovery..... | 1018 |
| A.7.5.3.1 | Test Purpose and Environment | 1018 |
| A.7.5.3.2 | Test Requirements..... | 1020 |
| A.7.5.4 | E-UTRAN FDD – UE ProSe Direct Communication Transmission Timing Accuracy Test..... | 1020 |
| A.7.5.4.1 | Test Purpose and Environment | 1020 |
| A.7.5.4.2 | Test Requirements..... | 1021 |
| A.7.5.5 | E-UTRAN FDD - Interruptions due to ProSe Direct Communication | 1021 |
| A.7.5.5.1 | Test Purpose and Environment | 1021 |
| A.7.5.5.2 | Test Requirements..... | 1023 |
| A.7.5.6 | E-UTRAN FDD - Interruptions due to ProSe Direct Discovery with discovery period less than 320ms..... | 1024 |
| A.7.5.6.1 | Test Purpose and Environment | 1024 |
| A.7.5.6.2 | Test Requirements..... | 1025 |
| A.7.5.7 | E-UTRAN FDD-FDD - Interruptions due to ProSe Direct Discovery | 1026 |
| A.7.5.7.1 | Test Purpose and Environment | 1026 |
| A.7.5.7.2 | Test Requirements..... | 1027 |
| A.7.5.8 | E-UTRAN FDD-FDD - Cell reselection and timing accuracy for ProSe Direct Discovery transmission on non-serving frequency | 1028 |
| A.7.5.8.1 | Test Purpose and Environment | 1028 |
| A.7.5.8.2 | Test Requirements..... | 1030 |
| A.7.5.9 | E-UTRAN FDD-FDD - Interruptions due to ProSe Direct Discovery reception on non-serving frequency | 1030 |
| A.7.5.9.1 | Test Purpose and Environment | 1030 |
| A.7.5.9.2 | Test Requirements..... | 1032 |

| | | |
|------------|--|------|
| A.7.5.10 | E-UTRAN FDD-FDD - Interruptions due to ProSe Direct Discovery transmission on non-serving frequency | 1033 |
| A.7.5.10.1 | Test Purpose and Environment | 1033 |
| A.7.5.10.2 | Test Requirements..... | 1035 |
| A.7.5.11 | E-UTRAN FDD-FDD - Interruptions due to ProSe Direct Communication on non-serving frequency | 1035 |
| A.7.5.11.1 | Test Purpose and Environment | 1035 |
| A.7.5.11.2 | Test Requirements..... | 1037 |
| A.7.5.12 | E-UTRAN FDD - Selection / Reselection of ProSe relay UE | 1037 |
| A.7.5.12.1 | Test Purpose and Environment | 1037 |
| A.7.5.12.2 | Test Requirements..... | 1040 |
| A.8 | UE Measurements Procedures..... | 1040 |
| A.8.1 | E-UTRAN FDD Intra-frequency Measurements..... | 1041 |
| A.8.1.1 | E-UTRAN FDD-FDD intra-frequency event triggered reporting under fading propagation conditions in asynchronous cells | 1041 |
| A.8.1.1.1 | Test Purpose and Environment | 1041 |
| A.8.1.1.2 | Test Requirements..... | 1042 |
| A.8.1.2 | E-UTRAN FDD-FDD intra-frequency event triggered reporting under fading propagation conditions in synchronous cells..... | 1042 |
| A.8.1.2.1 | Test Purpose and Environment | 1042 |
| A.8.1.2.2 | Test Requirements..... | 1043 |
| A.8.1.3 | E-UTRAN FDD-FDD intra-frequency event triggered reporting under fading propagation conditions in synchronous cells with DRX | 1044 |
| A.8.1.3.1 | Test Purpose and Environment | 1044 |
| A.8.1.3.2 | Test Requirements..... | 1045 |
| A.8.1.4 | Void | 1046 |
| A.8.1.5 | E-UTRAN FDD - FDD Intra-frequency identification of a new CGI of E-UTRA cell using autonomous gaps | 1046 |
| A.8.1.5.1 | Test Purpose and Environment | 1046 |
| A.8.1.5.2 | Test Requirements..... | 1047 |
| A.8.1.6 | E-UTRAN FDD - FDD Intra-frequency identification of a new CGI of E-UTRA cell using autonomous gaps with DRX | 1048 |
| A.8.1.6.1 | Test Purpose and Environment | 1048 |
| A.8.1.6.2 | Test Requirements..... | 1049 |
| A.8.1.7 | E-UTRAN FDD-FDD Intra-Frequency Event-Triggered Reporting under Time Domain Measurement Resource Restriction with Non-MBSFN ABS | 1050 |
| A.8.1.7.1 | Test Purpose and Environment | 1050 |
| A.8.1.7.2 | Test Requirements..... | 1051 |
| A.8.1.8 | E-UTRAN FDD-FDD Intra-Frequency Event-Triggered Reporting under Time Domain Measurement Resource Restriction with CRS Assistance Information and Non-MBSFN ABS | 1052 |
| A.8.1.8.1 | Test Purpose and Environment | 1052 |
| A.8.1.8.2 | Test Requirements..... | 1054 |
| A.8.1.9 | E-UTRAN FDD-FDD intra-frequency event triggered reporting under fading propagation conditions in asynchronous cells for 5MHz bandwidth | 1054 |
| A.8.1.9.1 | Test Purpose and Environment | 1054 |
| A.8.1.9.2 | Test Requirements..... | 1055 |
| A.8.1.10 | E-UTRAN FDD-FDD Intra-Frequency Event Triggered Reporting under Fading Propagation Conditions in Synchronous Cells with DRX for 5 MHz Bandwidth | 1055 |
| A.8.1.10.1 | Test Purpose and Environment | 1055 |
| A.8.1.10.2 | Test Requirements..... | 1055 |
| A.8.1.11 | E-UTRAN FDD-FDD intra-frequency event triggered reporting under fading propagation conditions in asynchronous cells for UE category 0 | 1056 |
| A.8.1.11.1 | Test Purpose and Environment | 1056 |
| A.8.1.11.2 | Test Requirements..... | 1057 |
| A.8.1.12 | E-UTRAN FDD-FDD intra-frequency event triggered reporting under fading propagation conditions in synchronous cells for UE category 0 | 1057 |
| A.8.1.12.1 | Test Purpose and Environment | 1057 |
| A.8.1.12.2 | Test Requirements..... | 1059 |
| A.8.1.13 | E-UTRAN FDD-FDD intra-frequency event triggered reporting under fading propagation conditions in synchronous cells with DRX for UE category 0..... | 1059 |
| A.8.1.13.1 | Test Purpose and Environment | 1059 |
| A.8.1.13.2 | Test Requirements..... | 1061 |

| | | |
|------------|---|------|
| A.8.1.14 | E-UTRAN HD-FDD intra-frequency event triggered reporting under fading propagation conditions in asynchronous cells for UE category 0 | 1061 |
| A.8.1.14.1 | Test Purpose and Environment | 1061 |
| A.8.1.14.2 | Test Requirements..... | 1063 |
| A.8.1.15 | E-UTRAN HD-FDD intra-frequency event triggered reporting under fading propagation conditions in synchronous cells for UE category 0 | 1063 |
| A.8.1.15.1 | Test Purpose and Environment | 1063 |
| A.8.1.15.2 | Test Requirements..... | 1064 |
| A.8.1.16 | E-UTRAN HD-FDD intra-frequency event triggered reporting under fading propagation conditions in synchronous cells with DRX for UE category 0..... | 1065 |
| A.8.1.16.1 | Test Purpose and Environment | 1065 |
| A.8.1.16.2 | Test Requirements..... | 1067 |
| A.8.1.17 | Void | 1067 |
| A.8.1.18 | Void | 1067 |
| A.8.1.19 | E-UTRAN FDD-FDD Intra-frequency identification of a new CGI of E-UTRA cell using autonomous gaps for UE category 0..... | 1067 |
| A.8.1.19.1 | Test Purpose and Environment | 1067 |
| A.8.1.19.2 | Test Requirements..... | 1068 |
| A.8.1.20 | E-UTRAN FDD - FDD Intra-frequency identification of a new CGI of E-UTRA cell using autonomous gaps with DRX for UE category 0..... | 1069 |
| A.8.1.20.1 | Test Purpose and Environment | 1069 |
| A.8.1.20.2 | Test Requirements..... | 1071 |
| A.8.1.21 | E-UTRAN HD - FDD Intra-frequency identification of a new CGI of E-UTRA cell using autonomous gaps for UE category 0..... | 1071 |
| A.8.1.21.1 | Test Purpose and Environment | 1071 |
| A.8.1.21.2 | Test Requirements..... | 1072 |
| A.8.1.22 | E-UTRAN HD - FDD Intra-frequency identification of a new CGI of E-UTRA cell using autonomous gaps with DRX for UE category 0..... | 1073 |
| A.8.1.22.1 | Test Purpose and Environment | 1073 |
| A.8.1.22.2 | Test Requirements..... | 1074 |
| A.8.1.23 | E-UTRAN FDD-FDD intra-frequency event triggered reporting under fading propagation conditions in asynchronous cells for Cat-M1 UE in CEModeA | 1075 |
| A.8.1.23.1 | Test Purpose and Environment | 1075 |
| A.8.1.23.2 | Test Requirements..... | 1076 |
| A.8.1.24 | E-UTRAN FDD-FDD intra-frequency event triggered reporting under fading propagation conditions in synchronous cells for Cat-M1 UE in CEModeA | 1076 |
| A.8.1.24.1 | Test Purpose and Environment | 1076 |
| A.8.1.24.2 | Test Requirements..... | 1078 |
| A.8.1.25 | E-UTRAN FDD-FDD intra-frequency event triggered reporting under fading propagation conditions in synchronous cells for Cat-M1 UE in CEModeA in DRX..... | 1078 |
| A.8.1.25.1 | Test Purpose and Environment | 1078 |
| A.8.1.25.2 | Test Requirements..... | 1080 |
| A.8.1.26 | E-UTRAN HD-FDD intra-frequency event triggered reporting under fading propagation conditions in asynchronous cells for Cat-M1 UE in CEModeA | 1080 |
| A.8.1.26.1 | Test Purpose and Environment | 1080 |
| A.8.1.27 | E-UTRAN HD-FDD intra-frequency event triggered reporting under fading propagation conditions in synchronous cells for Cat-M1 UE in CEModeA | 1082 |
| A.8.1.27.1 | Test Purpose and Environment | 1082 |
| A.8.1.27.2 | Test Requirements..... | 1083 |
| A.8.1.28 | E-UTRAN HD-FDD intra-frequency event triggered reporting under fading propagation conditions in synchronous cells for Cat-M1 UE in CEModeA in DRX..... | 1084 |
| A.8.1.28.1 | Test Purpose and Environment | 1084 |
| A.8.1.28.2 | Test Requirements..... | 1085 |
| A.8.1.29 | E-UTRAN TDD intra-frequency event triggered reporting under fading propagation conditions in synchronous cells for Cat-M1 UE in CEModeA | 1086 |
| A.8.1.29.1 | Test Purpose and Environment | 1086 |
| A.8.1.29.2 | Test Requirements..... | 1087 |
| A.8.1.30 | E-UTRAN TDD intra-frequency event triggered reporting under fading propagation conditions in synchronous cells for Cat-M1 UE in CEModeA in DRX..... | 1087 |
| A.8.1.30.1 | Test Purpose and Environment | 1087 |
| A.8.1.30.2 | Test Requirements..... | 1089 |

| | | |
|------------|---|------|
| A.8.1.31 | E-UTRAN FDD-FDD intra-frequency event triggered reporting under fading propagation conditions in asynchronous cells for Cat-M1 UE in CEModeB..... | 1090 |
| A.8.1.31.1 | Test Purpose and Environment | 1090 |
| A.8.1.31.2 | Test Requirements..... | 1091 |
| A.8.1.32 | E-UTRAN FDD-FDD intra-frequency event triggered reporting under fading propagation conditions in synchronous cells for Cat-M1 UE in CEModeB | 1091 |
| A.8.1.32.1 | Test Purpose and Environment | 1091 |
| A.8.1.32.2 | Test Requirements..... | 1093 |
| A.8.1.33 | E-UTRAN HD-FDD intra-frequency event triggered reporting under fading propagation conditions in asynchronous cells for Cat-M1 UE in CEModeB..... | 1093 |
| A.8.1.33.1 | Test Purpose and Environment | 1093 |
| A.8.1.34 | E-UTRAN HD-FDD intra-frequency event triggered reporting under fading propagation conditions in synchronous cells for Cat-M1 UE in CEModeB | 1094 |
| A.8.1.34.1 | Test Purpose and Environment | 1094 |
| A.8.1.34.2 | Test Requirements..... | 1096 |
| A.8.1.35 | E-UTRAN TDD intra-frequency event triggered reporting under fading propagation conditions in synchronous cells for Cat-M1 UE in CEModeB..... | 1096 |
| A.8.1.35.1 | Test Purpose and Environment | 1096 |
| A.8.1.35.2 | Test Requirements..... | 1097 |
| A.8.1.36 | E-UTRAN FDD Intra-frequency identification of a new CGI of E-UTRA cell using autonomous gaps for Cat-M1 UE in CEModeB..... | 1098 |
| A.8.1.36.1 | Test Purpose and Environment | 1098 |
| A.8.1.36.2 | Test Requirements..... | 1099 |
| A.8.1.37 | E-UTRAN FDD Intra-frequency identification of a new CGI of E-UTRA cell using autonomous gaps with DRX for Cat-M1 UE in CEModeB | 1099 |
| A.8.1.37.1 | Test Purpose and Environment | 1099 |
| A.8.1.37.2 | Test Requirements..... | 1101 |
| A.8.1.38 | E-UTRAN HD - FDD Intra-frequency identification of a new CGI of E-UTRA cell using autonomous gaps for Cat-M1 UE in CEModeB | 1101 |
| A.8.1.38.1 | Test Purpose and Environment | 1101 |
| A.8.1.38.2 | Test Requirements..... | 1103 |
| A.8.1.39 | E-UTRAN HD - FDD Intra-frequency identification of a new CGI of E-UTRA cell using autonomous gaps with DRX for Cat-M1 UE in CEModeB..... | 1103 |
| A.8.1.39.1 | Test Purpose and Environment | 1103 |
| A.8.1.39.2 | Test Requirements..... | 1105 |
| A.8.2 | E-UTRAN TDD Intra-frequency Measurements | 1105 |
| A.8.2.1 | E-UTRAN TDD-TDD intra-frequency event triggered reporting under fading propagation conditions in synchronous cells | 1105 |
| A.8.2.1.1 | Test Purpose and Environment | 1105 |
| A.8.2.1.2 | Test Requirements..... | 1106 |
| A.8.2.2 | E-UTRAN TDD-TDD intra-frequency event triggered reporting under fading propagation conditions in synchronous cells with DRX..... | 1107 |
| A.8.2.2.1 | Test Purpose and Environment | 1107 |
| A.8.2.2.2 | Test Requirements..... | 1109 |
| A.8.2.3 | E-UTRAN TDD - TDD Intra-frequency identification of a new CGI of E-UTRA cell using autonomous gaps | 1109 |
| A.8.2.3.1 | Test Purpose and Environment | 1109 |
| A.8.2.3.2 | Test Requirements..... | 1110 |
| A.8.2.4 | E-UTRAN TDD - TDD Intra-frequency identification of a new CGI of E-UTRA cell using autonomous gaps with DRX | 1111 |
| A.8.2.4.1 | Test Purpose and Environment | 1111 |
| A.8.2.4.2 | Test Requirements..... | 1113 |
| A.8.2.5 | E-UTRAN TDD-TDD Intra-Frequency Event-Triggered Reporting under Time Domain Measurement Resource Restriction with Non-MBSFN ABS | 1113 |
| A.8.2.5.1 | Test Purpose and Environment | 1113 |
| A.8.2.5.2 | Test Requirements..... | 1115 |
| A.8.2.6 | E-UTRAN TDD-TDD Intra-Frequency Event-Triggered Reporting under Time Domain Measurement Resource Restriction with CRS Assistance Information and Non-MBSFN ABS..... | 1115 |
| A.8.2.6.1 | Test Purpose and Environment | 1115 |
| A.8.2.6.2 | Test Requirements..... | 1117 |
| A.8.2.7 | E-UTRAN TDD Intra-frequency identification of a new CGI of E-UTRA cell using autonomous gaps..... | 1117 |

| | | |
|------------|---|------|
| A.8.2.7.1 | Test Purpose and Environment | 1117 |
| A.8.2.7.2 | Test Requirements..... | 1119 |
| A.8.2.8 | E-UTRAN TDD Intra-frequency identification of a new CGI of E-UTRA cell using autonomous gaps with DRX | 1119 |
| A.8.2.8.1 | Test Purpose and Environment | 1119 |
| A.8.2.8.2 | Test Requirements..... | 1121 |
| A.8.2.9 | E-UTRAN TDD Intra-frequency identification of a new CGI of E-UTRA cell using autonomous gaps for Cat-M1 UE in CEModeB..... | 1121 |
| A.8.2.9.1 | Test Purpose and Environment | 1121 |
| A.8.2.9.2 | Test Requirements..... | 1123 |
| A.8.2.10 | E-UTRAN TDD Intra-frequency identification of a new CGI of E-UTRA cell using autonomous gaps with DRX for Cat-M1 UE in CEModeB | 1123 |
| A.8.2.10.1 | Test Purpose and Environment | 1123 |
| A.8.2.10.2 | Test Requirements..... | 1125 |
| A.8.2.11 | Void | 1126 |
| A.8.2.12 | E-UTRAN TDD-TDD intra-frequency event triggered reporting under fading propagation conditions in synchronous cells for UE category 0..... | 1126 |
| A.8.2.12.1 | Test Purpose and Environment | 1126 |
| A.8.2.12.2 | Test Requirements..... | 1127 |
| A.8.2.13 | E-UTRAN TDD-TDD intra-frequency event triggered reporting under fading propagation conditions in synchronous cells with DRX for UE category 0 | 1127 |
| A.8.2.13.1 | Test Purpose and Environment | 1127 |
| A.8.2.13.2 | Test Requirements..... | 1129 |
| A.8.3 | E-UTRAN FDD - FDD Inter-frequency Measurements | 1130 |
| A.8.3.1 | E-UTRAN FDD-FDD Inter-frequency event triggered reporting under fading propagation conditions in asynchronous cells | 1130 |
| A.8.3.1.1 | Test Purpose and Environment | 1130 |
| A.8.3.1.2 | Test Requirements..... | 1131 |
| A.8.3.2 | E-UTRAN FDD-FDD Inter-frequency event triggered reporting when DRX is used under fading propagation conditions in asynchronous cells | 1131 |
| A.8.3.2.1 | Test Purpose and Environment | 1131 |
| A.8.3.2.2 | Test Requirements..... | 1133 |
| A.8.3.3 | E-UTRAN FDD-FDD inter-frequency event triggered reporting under AWGN propagation conditions in asynchronous cells with DRX when L3 filtering is used | 1134 |
| A.8.3.3.1 | Test Purpose and Environment | 1134 |
| A.8.3.3.2 | Test Requirements..... | 1136 |
| A.8.3.4 | E-UTRAN FDD - FDD Inter-frequency identification of a new CGI of E-UTRA cell using autonomous gaps | 1136 |
| A.8.3.4.1 | Test Purpose and Environment | 1136 |
| A.8.3.4.2 | Test Requirements..... | 1137 |
| A.8.3.5 | E-UTRAN FDD - FDD Inter-frequency identification of a new CGI of E-UTRA cell using autonomous gaps with DRX | 1138 |
| A.8.3.5.2 | Test Requirements..... | 1139 |
| A.8.3.6 | E-UTRAN FDD-FDD Inter-frequency event triggered reporting without measurement gaps under AWGN propagation conditions in asynchronous cells | 1140 |
| A.8.3.6.1 | Test Purpose and Environment | 1140 |
| A.8.3.6.2 | Test Requirements..... | 1141 |
| A.8.3.7 | E-UTRAN FDD-FDD Inter-frequency event triggered reporting under fading propagation conditions in asynchronous cells for Increased Carrier Monitoring without Reduced Performance Group..... | 1141 |
| A.8.3.7.1 | Test Purpose and Environment | 1141 |
| A.8.3.7.2 | Test Requirements..... | 1144 |
| A.8.3.8 | FDD-FDD Interfrequency correct reporting of measurement events with reduced performance group configured, non DRX..... | 1144 |
| A.8.3.8.1 | Test Purpose and Environment | 1144 |
| A.8.3.8.2 | Test Requirements..... | 1147 |
| A.8.3.9 | FDD-FDD Inter-frequency correct reporting of measurement events with reduced performance group configured, DRX | 1147 |
| A.8.3.9.1 | Test Purpose and Environment | 1147 |
| A.8.3.9.2 | Test Requirements..... | 1151 |
| A.8.4 | E-UTRAN TDD - TDD Inter-frequency Measurements..... | 1152 |

| | | |
|-----------|---|------|
| A.8.4.1 | E-UTRAN TDD-TDD Inter-frequency event triggered reporting under fading propagation conditions in synchronous cells | 1152 |
| A.8.4.1.1 | Test Purpose and Environment | 1152 |
| A.8.4.1.2 | Test Requirements..... | 1153 |
| A.8.4.2 | E-UTRAN TDD-TDD Inter-frequency event triggered reporting when DRX is used under fading propagation conditions in synchronous cells | 1153 |
| A.8.4.2.1 | Test Purpose and Environment | 1153 |
| A.8.4.2.2 | Test Requirements..... | 1155 |
| A.8.4.3 | E-UTRAN TDD-TDD inter-frequency event triggered reporting under AWGN propagation conditions in synchronous cells with DRX when L3 filtering is used | 1156 |
| A.8.4.3.1 | Test Purpose and Environment | 1156 |
| A.8.4.3.2 | Test Requirements..... | 1157 |
| A.8.4.4 | E-UTRAN TDD - TDD Inter-frequency identification of a new CGI of E-UTRA cell using autonomous gaps | 1158 |
| A.8.4.4.1 | Test Purpose and Environment | 1158 |
| A.8.4.4.2 | Test Requirements..... | 1159 |
| A.8.4.5 | E-UTRAN TDD - TDD Inter-frequency identification of a new CGI of E-UTRA cell using autonomous gaps with DRX | 1159 |
| A.8.4.5.1 | Test Purpose and Environment | 1159 |
| A.8.4.5.2 | Test Requirements..... | 1161 |
| A.8.4.6 | E-UTRAN TDD-TDD Inter-frequency event triggered reporting for TDD UL/DL configuration 0 | 1162 |
| A.8.4.6.1 | Test Purpose and Environment | 1162 |
| A.8.4.6.2 | Test Requirements..... | 1163 |
| A.8.4.7 | E-UTRAN TDD-TDD Inter-frequency event triggered reporting under fading propagation conditions in synchronous cells for Increased Carrier Monitoring without Reduced Performance Group | 1163 |
| A.8.4.7.1 | Test Purpose and Environment | 1163 |
| A.8.4.7.2 | Test Requirements..... | 1166 |
| A.8.4.8 | TDD-TDD Interfrequency correct reporting of measurement events with reduced performance group configured, non DRX..... | 1166 |
| A.8.4.8.1 | Test Purpose and Environment | 1166 |
| A.8.4.8.2 | Test Requirements..... | 1169 |
| A.8.4.9 | TDD-TDD Inter-frequency correct reporting of measurement events with reduced performance group configured, DRX | 1169 |
| A.8.4.9.1 | Test Purpose and Environment | 1169 |
| A.8.4.9.2 | Test Requirements..... | 1173 |
| A.8.5 | E-UTRAN FDD - UTRAN FDD Measurements | 1174 |
| A.8.5.1 | E-UTRAN FDD - UTRAN FDD event triggered reporting under fading propagation conditions | 1174 |
| A.8.5.1.1 | Test Purpose and Environment | 1174 |
| A.8.5.1.2 | Test Requirements..... | 1175 |
| A.8.5.2 | E-UTRAN FDD - UTRAN FDD SON ANR cell search reporting under AWGN propagation conditions..... | 1175 |
| A.8.5.2.1 | Test Purpose and Environment | 1175 |
| A.8.5.2.2 | Test Requirements..... | 1177 |
| A.8.5.3 | E-UTRAN FDD-UTRAN FDD event triggered reporting when DRX is used under fading propagation conditions..... | 1177 |
| A.8.5.3.1 | Test Purpose and Environment | 1177 |
| A.8.5.3.2 | Test Requirements..... | 1180 |
| A.8.5.4 | E-UTRAN FDD - UTRAN FDD enhanced cell identification under AWGN propagation conditions .. | 1180 |
| A.8.5.4.1 | Test Purpose and Environment | 1180 |
| A.8.5.4.2 | Test Requirements..... | 1182 |
| A.8.5.5 | E- UTRAN FDD - UTRAN FDD identification of a new CGI of UTRAN cell using autonomous gaps..... | 1182 |
| A.8.5.5.1 | Test Purpose and Environment | 1182 |
| A.8.5.5.2 | Test Requirements..... | 1183 |
| A.8.5.6 | E-UTRAN FDD - UTRAN FDD event triggered reporting without measurement gaps under AWGN propagation conditions..... | 1184 |
| A.8.5.6.1 | Test Purpose and Environment | 1184 |
| A.8.5.6.2 | Test Requirements..... | 1185 |
| A.8.5.7 | E-UTRAN FDD - UTRAN FDD Event Triggered Reporting under Fading Propagation Conditions for 5 MHz Bandwidth..... | 1185 |
| A.8.5.7.1 | Test Purpose and Environment | 1185 |

| | | |
|-------------|---|------|
| A.8.5.7.2 | Test Requirements..... | 1186 |
| A.8.5.8 | E-UTRA FDD InterRAT UTRA FDD correct reporting of measurement events with reduced performance group configured, non DRX | 1186 |
| A.8.5.8.1 | Test Purpose and Environment | 1186 |
| A.8.5.8.2 | Test Requirements..... | 1188 |
| A.8.6 | E-UTRAN TDD - UTRAN FDD Measurements | 1188 |
| A.8.6.1 | E-UTRAN TDD - UTRAN FDD event triggered reporting under fading propagation conditions..... | 1188 |
| A.8.6.1.1 | Test Purpose and Environment | 1188 |
| A.8.6.1.2 | Test Requirements..... | 1190 |
| A.8.6.2 | E-UTRAN TDD - UTRAN FDD identification of a new CGI of UTRAN cell using autonomous gaps..... | 1190 |
| A.8.6.2.1 | Test Purpose and Environment | 1190 |
| A.8.6.2.2 | Test Requirements..... | 1192 |
| A.8.6.3 | E-UTRA TDD InterRAT UTRA FDD correct reporting of measurement events with reduced performance group configured, non DRX | 1192 |
| A.8.6.3.1 | Test Purpose and Environment | 1192 |
| A.8.6.3.2 | Test Requirements..... | 1194 |
| A.8.7 | E-UTRAN TDD – UTRAN TDD Measurements | 1194 |
| A.8.7.1 | E-UTRAN TDD to UTRAN TDD cell search under fading propagation conditions | 1194 |
| A.8.7.1.1 | Test Purpose and Environment | 1194 |
| A.8.7.1.1.1 | Void..... | 1194 |
| A.8.7.1.1.2 | 1.28 Mcps TDD option..... | 1194 |
| A.8.7.1.1.3 | Void..... | 1196 |
| A.8.7.1.2 | Test Requirements..... | 1196 |
| A.8.7.1.2.1 | Void..... | 1196 |
| A.8.7.1.2.2 | 1.28 Mcps TDD option..... | 1196 |
| A.8.7.1.2.3 | Void..... | 1196 |
| A.8.7.2 | E-UTRAN TDD-UTRAN TDD cell search when DRX is used under fading propagation conditions .. | 1196 |
| A.8.7.2.1 | Test Purpose and Environment | 1196 |
| A.8.7.2.2 | Test Requirements..... | 1199 |
| A.8.7.3 | E-UTRAN TDD - UTRAN TDD SON ANR cell search reporting in AWGN propagation conditions .. | 1199 |
| A.8.7.3.1 | Test Purpose and Environment | 1199 |
| A.8.7.3.2 | Test Parameters | 1199 |
| A.8.7.3.3 | Test Requirements..... | 1201 |
| A.8.7.4 | E-UTRAN TDD - UTRAN TDD enhanced cell identification under AWGN propagation conditions .. | 1201 |
| A.8.7.4.1 | Test Purpose and Environment | 1201 |
| A.8.7.4.2 | Test Requirements..... | 1203 |
| A.8.7.5 | E-UTRA TDD InterRAT UTRA TDD correct reporting of measurement events with reduced performance group configured, non DRX | 1203 |
| A.8.7.5.1 | Test Purpose and Environment | 1203 |
| A.8.7.5.2 | Test Requirements..... | 1205 |
| A.8.7A | TBD..... | 1205 |
| A.8.7A.1 | E-UTRA FDD InterRAT UTRA TDD correct reporting of measurement events with reduced performance group configured, non DRX | 1205 |
| A.8.7A.1.1 | Test Purpose and Environment | 1205 |
| A.8.7A.1.2 | Test Requirements..... | 1207 |
| A.8.8 | E-UTRAN FDD – GSM Measurements..... | 1207 |
| A.8.8.1 | E-UTRAN FDD – GSM event triggered reporting in AWGN | 1207 |
| A.8.8.1.1 | Test Purpose and Environment | 1207 |
| A.8.8.1.2 | Test Requirements..... | 1209 |
| A.8.8.2 | E-UTRAN FDD-GSM event triggered reporting when DRX is used in AWGN | 1209 |
| A.8.8.2.1 | Test Purpose and Environment | 1209 |
| A.8.8.2.2 | Test Requirements..... | 1211 |
| A.8.8.3 | E-UTRAN FDD – GSM event triggered reporting in AWGN with enhanced BSIC identification | 1211 |
| A.8.8.3.1 | Test Purpose and Environment | 1211 |
| A.8.8.3.2 | Test Requirements..... | 1213 |
| A.8.9 | E-UTRAN FDD - UTRAN TDD measurements..... | 1213 |
| A.8.9.1 | E-UTRAN FDD - UTRAN TDD event triggered reporting in fading propagation conditions..... | 1213 |
| A.8.9.1.1 | Test Purpose and Environment | 1213 |
| A.8.9.1.2 | Test Requirements..... | 1214 |
| A.8.9.2 | E-UTRAN FDD - UTRAN TDD enhanced cell identification under AWGN propagation conditions .. | 1215 |
| A.8.9.2.1 | Test Purpose and Environment | 1215 |

| | | |
|------------|---|------|
| A.8.9.2.2 | Test Requirements..... | 1216 |
| A.8.10 | E-UTRAN TDD – GSM Measurements..... | 1217 |
| A.8.10.1 | E-UTRAN TDD – GSM event triggered reporting in AWGN..... | 1217 |
| A.8.10.1.1 | Test Purpose and Environment..... | 1217 |
| A.8.10.1.2 | Test Requirements..... | 1218 |
| A.8.10.2 | E-UTRAN TDD-GSM event triggered reporting when DRX is used in AWGN..... | 1218 |
| A.8.10.2.1 | Test Purpose and Environment..... | 1218 |
| A.8.10.2.2 | Test Requirements..... | 1220 |
| A.8.11 | Monitoring of Multiple Layers..... | 1221 |
| A.8.11.1 | Multiple E-UTRAN FDD-FDD Inter-frequency event triggered reporting under fading propagation conditions..... | 1221 |
| A.8.11.1.1 | Test Purpose and Environment..... | 1221 |
| A.8.11.1.2 | Test Requirements..... | 1222 |
| A.8.11.2 | E-UTRAN TDD – E-UTRAN TDD and E-UTRAN TDD Inter-frequency event triggered reporting under fading propagation conditions..... | 1222 |
| A.8.11.2.1 | Test Purpose and Environment..... | 1222 |
| A.8.11.2.2 | Test Requirements..... | 1224 |
| A.8.11.3 | E-UTRAN FDD-FDD Inter-frequency and UTRAN FDD event triggered reporting under fading propagation conditions..... | 1224 |
| A.8.11.3.1 | Test Purpose and Environment..... | 1224 |
| A.8.11.3.2 | Test Requirements..... | 1226 |
| A.8.11.4 | InterRAT E-UTRA TDD to E-UTRA TDD and UTRA TDD cell search test case..... | 1226 |
| A.8.11.4.1 | Test Purpose and Environment..... | 1226 |
| A.8.11.4.2 | Test Requirements..... | 1228 |
| A.8.11.5 | Combined E-UTRAN FDD – E-UTRA FDD and GSM cell search. E-UTRA cells in fading; GSM cell in static propagation conditions..... | 1228 |
| A.8.11.5.1 | Test Purpose and Environment..... | 1228 |
| A.8.11.5.2 | Test Requirements..... | 1230 |
| A.8.11.6 | Combined E-UTRAN TDD – E-UTRA TDD and GSM cell search. E-UTRA cells in fading; GSM cell in static propagation conditions..... | 1230 |
| A.8.11.6.1 | Test Purpose and Environment..... | 1230 |
| A.8.11.6.2 | Test Requirements..... | 1232 |
| A.8.12 | RSTD Intra-frequency Measurements..... | 1232 |
| A.8.12.1 | E-UTRAN FDD intra-frequency RSTD measurement reporting delay test case..... | 1232 |
| A.8.12.1.1 | Test Purpose and Environment..... | 1232 |
| A.8.12.1.2 | Test Requirements..... | 1235 |
| A.8.12.2 | E-UTRAN TDD intra-frequency RSTD measurement reporting delay test case..... | 1236 |
| A.8.12.2.1 | Test Purpose and Environment..... | 1236 |
| A.8.12.2.2 | Test Requirements..... | 1239 |
| A.8.13 | RSTD Inter-frequency Measurements..... | 1239 |
| A.8.13.1 | E-UTRAN FDD-FDD inter-frequency RSTD measurement reporting delay test case with the reference cell on the serving carrier frequency..... | 1239 |
| A.8.13.1.1 | Test Purpose and Environment..... | 1239 |
| A.8.13.1.2 | Test Requirements..... | 1242 |
| A.8.13.2 | E-UTRAN TDD-TDD inter-frequency RSTD measurement reporting delay test case with the reference cell on the serving carrier frequency..... | 1243 |
| A.8.13.2.1 | Test Purpose and Environment..... | 1243 |
| A.8.13.2.2 | Test Requirements..... | 1246 |
| A.8.14 | E-UTRAN TDD - FDD Inter-frequency Measurements..... | 1246 |
| A.8.14.1 | E-UTRAN TDD-FDD Inter-frequency event triggered reporting under fading propagation conditions in asynchronous cells..... | 1246 |
| A.8.14.1.1 | Test Purpose and Environment..... | 1246 |
| A.8.14.1.2 | Test Requirements..... | 1248 |
| A.8.14.2 | E-UTRAN TDD-FDD Inter-frequency event triggered reporting when DRX is used under fading propagation conditions in asynchronous cells..... | 1248 |
| A.8.14.2.1 | Test Purpose and Environment..... | 1248 |
| A.8.14.2.2 | Test Requirements..... | 1250 |
| A.8.14.3 | E-UTRAN TDD - FDD Inter-frequency identification of a new CGI of E-UTRA cell using autonomous gaps..... | 1251 |
| A.8.14.3.1 | Test Purpose and Environment..... | 1251 |
| A.8.14.3.2 | Test Requirements..... | 1252 |
| A.8.15 | E-UTRAN FDD - TDD Inter-frequency Measurements..... | 1253 |

| | | |
|-------------|--|------|
| A.8.15.1 | E-UTRAN FDD-TDD Inter-frequency event triggered reporting under fading propagation conditions in asynchronous cells | 1253 |
| A.8.15.1.1 | Test Purpose and Environment | 1253 |
| A.8.15.1.2 | Test Requirements..... | 1254 |
| A.8.15.2 | E-UTRAN FDD-TDD Inter-frequency event triggered reporting when DRX is used under fading propagation conditions in asynchronous cells | 1254 |
| A.8.15.2.1 | Test Purpose and Environment | 1254 |
| A.8.15.2.2 | Test Requirements..... | 1256 |
| A.8.15.3 | E-UTRAN FDD - TDD Inter-frequency identification of a new CGI of E-UTRA cell using autonomous gaps | 1257 |
| A.8.15.3.1 | Test Purpose and Environment | 1257 |
| A.8.15.3.2 | Test Requirements..... | 1258 |
| A.8.16 | E-UTRAN Carrier Aggregation Measurements | 1258 |
| A.8.16.1 | E-UTRAN FDD event triggered reporting under deactivated SCell in non-DRX..... | 1258 |
| A.8.16.1.1 | Test Purpose and Environment | 1258 |
| A.8.16.1.2 | Test Requirements..... | 1260 |
| A.8.16.2 | E-UTRAN TDD event triggered reporting under deactivated SCell in non-DRX..... | 1260 |
| A.8.16.2.1 | Test Purpose and Environment | 1260 |
| A.8.16.2.2 | Test Requirements..... | 1262 |
| A.8.16.3 | E-UTRAN FDD-FDD Event triggered reporting on deactivated SCell with PCell interruption in non-DRX | 1262 |
| A.8.16.3.1 | Test Purpose and Environment | 1262 |
| A.8.16.3.2 | Test Requirements..... | 1264 |
| A.8.16.4 | E-UTRAN TDD-TDD Event triggered reporting on deactivated SCell with PCell interruption in non-DRX | 1264 |
| A.8.16.4.1 | Test Purpose and Environment | 1264 |
| A.8.16.4.2 | Test Requirements..... | 1266 |
| A.8.16.5 | E-UTRAN FDD event triggered reporting under deactivated SCell in non-DRX for 20 MHz bandwidth | 1266 |
| A.8.16.5.1 | Test Purpose and Environment | 1266 |
| A.8.16.5.2 | Test Requirements..... | 1267 |
| A.8.16.6 | E-UTRAN TDD event triggered reporting under deactivated SCell in non-DRX for 20 MHz bandwidth | 1267 |
| A.8.16.6.1 | Test Purpose and Environment | 1267 |
| A.8.16.6.2 | Test Requirements..... | 1268 |
| A.8.16.7 | E-UTRA FDD event triggered reporting on deactivated SCell with PCell interruption in non-DRX for 20 MHz bandwidth..... | 1268 |
| A.8.16.7.1 | Test Purpose and Environment | 1268 |
| A.8.16.7.2 | Test Requirements..... | 1268 |
| A.8.16.8 | E-UTRA TDD event triggered reporting on deactivated SCell with PCell interruption in non-DRX for 20 MHz bandwidth..... | 1269 |
| A.8.16.8.1 | Test Purpose and Environment | 1269 |
| A.8.16.8.2 | Test Requirements..... | 1269 |
| A.8.16.9 | E-UTRAN FDD event triggered reporting under deactivated SCell in non-DRX for 10MHz+5MHz... | 1269 |
| A.8.16.9.1 | Test Purpose and Environment | 1269 |
| A.8.16.9.2 | Test Requirements..... | 1270 |
| A.8.16.10 | E-UTRAN TDD event triggered reporting under deactivated SCell in non-DRX for 10MHz+5MHz .. | 1270 |
| A.8.16.10.1 | Test Purpose and Environment | 1270 |
| A.8.16.10.2 | Test Requirements..... | 1271 |
| A.8.16.11 | E-UTRAN FDD event triggered reporting on deactivating SCell with PCell interruption in non-DRX for 10MHz+5MHz..... | 1271 |
| A.8.16.11.1 | Test Purpose and Environment | 1271 |
| A.8.16.11.2 | Test Requirements..... | 1272 |
| A.8.16.12 | E-UTRAN TDD event triggered reporting on deactivating SCell with PCell interruption in non-DRX for 10MHz+5MHz..... | 1272 |
| A.8.16.12.1 | Test Purpose and Environment | 1272 |
| A.8.16.12.2 | Test Requirements..... | 1272 |
| A.8.16.13 | E-UTRAN FDD event triggered reporting under deactivated SCell in non-DRX for 5MHz +5 MHz bandwidth | 1272 |
| A.8.16.13.1 | Test Purpose and Environment | 1272 |
| A.8.16.13.2 | Test Requirements..... | 1273 |

| | | |
|--------------|---|------|
| A.8.16.14 | E-UTRAN TDD event triggered reporting under deactivated SCell in non-DRX for 5 MHz +5 MHz bandwidth | 1273 |
| A.8.16.14.1 | Test Purpose and Environment | 1273 |
| A.8.16.14.2 | Test Requirements..... | 1274 |
| A.8.16.15 | E-UTRA FDD event triggered reporting on deactivated SCell with PCell interruption in non-DRX for 5 +5 MHz bandwidth | 1274 |
| A.8.16.15.1 | Test Purpose and Environment | 1274 |
| A.8.16.7.2 | Test Requirements..... | 1274 |
| A.8.16.16 | E-UTRA TDD event triggered reporting on deactivated SCell with PCell interruption in non-DRX for 5+5 MHz bandwidth | 1274 |
| A.8.16.16.1 | Test Purpose and Environment | 1274 |
| A.8.16.16.2 | Test Requirements..... | 1275 |
| A.8.16.17 | E-UTRAN FDD activation and deactivation of known SCell in non-DRX | 1275 |
| A.8.16.17.1 | Test Purpose and Environment | 1275 |
| A.8.16.17.2 | Test Requirements..... | 1277 |
| A.8.16.17A | E-UTRAN FDD activation and deactivation of known SCell in non-DRX for 20MHz..... | 1277 |
| A.8.16.17A.1 | Test Purpose and Environment | 1277 |
| A.8.16.17A.2 | Test Requirements..... | 1278 |
| A.8.16.17B | E-UTRAN FDD activation and deactivation of known SCell in non-DRX for 10MHz + 5MHz | 1278 |
| A.8.16.17B.1 | Test Purpose and Environment | 1278 |
| A.8.16.17B.2 | Test Requirements..... | 1278 |
| A.8.16.17C | E-UTRAN FDD activation and deactivation of known SCell in non-DRX for 5MHz + 5MHz | 1278 |
| A.8.16.17C.1 | Test Purpose and Environment | 1278 |
| A.8.16.17C.2 | Test Requirements..... | 1279 |
| A.8.16.18 | E-UTRAN TDD activation and deactivation of known SCell in non-DRX | 1279 |
| A.8.16.18.1 | Test Purpose and Environment | 1279 |
| A.8.16.18.2 | Test Requirements..... | 1281 |
| A.8.16.18A | E-UTRAN TDD activation and deactivation of known SCell in non-DRX for 20MHz | 1281 |
| A.8.16.18A.1 | Test Purpose and Environment | 1281 |
| A.8.16.18A.2 | Test Requirements..... | 1281 |
| A.8.16.18B | E-UTRAN TDD activation and deactivation of known SCell in non-DRX for 10MHz + 5MHz | 1282 |
| A.8.16.18B.1 | Test Purpose and Environment | 1282 |
| A.8.16.18B.2 | Test Requirements..... | 1282 |
| A.8.16.18C | E-UTRAN TDD activation and deactivation of known SCell in non-DRX for 5MHz + 5MHz | 1282 |
| A.8.16.18C.1 | Test Purpose and Environment | 1282 |
| A.8.16.18C.2 | Test Requirements..... | 1283 |
| A.8.16.18D | E-UTRAN TDD activation and deactivation of known SCell in non-DRX for 20MHz + 10MHz | 1283 |
| A.8.16.18D.1 | Test Purpose and Environment | 1283 |
| A.8.16.18D.2 | Test Requirements..... | 1283 |
| A.8.16.19 | E-UTRAN FDD activation and deactivation of unknown SCell in non-DRX | 1283 |
| A.8.16.19.1 | Test Purpose and Environment | 1283 |
| A.8.16.19.2 | Test Requirements..... | 1285 |
| A.8.16.19A | E-UTRAN FDD activation and deactivation of unknown SCell in non-DRX for 20MHz..... | 1285 |
| A.8.16.19A.1 | Test Purpose and Environment | 1285 |
| A.8.16.19A.2 | Test Requirements..... | 1286 |
| A.8.16.19B | E-UTRAN FDD activation and deactivation of unknown SCell in non-DRX for 10MHz + 5MHz | 1286 |
| A.8.16.19B.1 | Test Purpose and Environment | 1286 |
| A.8.16.19B.2 | Test Requirements..... | 1286 |
| A.8.16.19C | E-UTRAN FDD activation and deactivation of unknown SCell in non-DRX for 5MHz + 5MHz | 1286 |
| A.8.16.19C.1 | Test Purpose and Environment | 1286 |
| A.8.16.19C.2 | Test Requirements..... | 1287 |
| A.8.16.20 | E-UTRAN TDD activation and deactivation of unknown SCell in non-DRX | 1287 |
| A.8.16.20.1 | Test Purpose and Environment | 1287 |
| A.8.16.20.2 | Test Requirements..... | 1289 |
| A.8.16.20A | E-UTRAN TDD activation and deactivation of unknown SCell in non-DRX for 20MHz | 1289 |
| A.8.16.20A.1 | Test Purpose and Environment | 1289 |
| A.8.16.20A.2 | Test Requirements..... | 1290 |
| A.8.16.20B | E-UTRAN TDD activation and deactivation of unknown SCell in non-DRX for 10MHz + 5MHz | 1290 |
| A.8.16.20B.1 | Test Purpose and Environment | 1290 |
| A.8.16.20B.2 | Test Requirements..... | 1290 |
| A.8.16.20C | E-UTRAN TDD activation and deactivation of unknown SCell in non-DRX for 5MHz + 5MHz | 1290 |
| A.8.16.20C.1 | Test Purpose and Environment | 1290 |

| | | |
|--------------|--|------|
| A.8.16.20C.2 | Test Requirements..... | 1291 |
| A.8.16.20D | E-UTRAN TDD activation and deactivation of unknown SCell in non-DRX for 20MHz + 10MHz | 1291 |
| A.8.16.20D.1 | Test Purpose and Environment | 1291 |
| A.8.16.20D.2 | Test Requirements..... | 1291 |
| A.8.16.21 | E-UTRAN TDD event triggered reporting under deactivated SCell in non-DRX for 20MHz+10MHz | 1291 |
| A.8.16.21.1 | Test Purpose and Environment | 1291 |
| A.8.16.21.2 | Test Requirements..... | 1293 |
| A.8.16.22 | E-UTRAN TDD event triggered reporting on deactivating SCell with PCell interruption in non-DRX for 20MHz+10MHz..... | 1293 |
| A.8.16.22.1 | Test Purpose and Environment | 1293 |
| A.8.16.22.2 | Test Requirements..... | 1295 |
| A.8.16.23 | E-UTRAN TDD-FDD CA Event Triggered Reporting Under Deactivated SCell in Non-DRX with PCell in FDD | 1295 |
| A.8.16.23.1 | Test Purpose and Environment | 1295 |
| A.8.16.23.2 | Test Requirements..... | 1297 |
| A.8.16.24 | E-UTRAN TDD-FDD CA Event Triggered Reporting Under Deactivated SCell in Non-DRX with PCell in TDD | 1297 |
| A.8.16.24.1 | Test Purpose and Environment | 1297 |
| A.8.16.24.2 | Test Requirements..... | 1299 |
| A.8.16.25 | E-UTRAN TDD-FDD CA Event triggered reporting on deactivated SCell with PCell interruption in non-DRX with PCell in FDD..... | 1300 |
| A.8.16.25.1 | Test Purpose and Environment | 1300 |
| A.8.16.25.2 | Test Requirements..... | 1301 |
| A.8.16.26 | E-UTRAN TDD-FDD CA Event triggered reporting on deactivated SCell with PCell interruption in non-DRX with PCell in TDD | 1302 |
| A.8.16.26.1 | Test Purpose and Environment | 1302 |
| A.8.16.26.2 | Test Requirements..... | 1304 |
| A.8.16.27 | 3 DL PCell in FDD CA Event Triggered Reporting with 2 Deactivated SCells in Non-DRX..... | 1304 |
| A.8.16.27.1 | Test Purpose and Environment | 1304 |
| A.8.16.27.2 | Test Requirements..... | 1308 |
| A.8.16.28 | 3 DL PCell in TDD CA Event Triggered Reporting with 2 Deactivated SCells in Non-DRX..... | 1308 |
| A.8.16.28.1 | Test Purpose and Environment | 1308 |
| A.8.16.28.2 | Test Requirements..... | 1312 |
| A.8.16.29 | 3 DL FDD CA Event Triggered Reporting under Deactivated SCells in Non-DRX..... | 1312 |
| A.8.16.29.1 | Test Purpose and Environment | 1312 |
| A.8.16.29.2 | Test Requirements..... | 1316 |
| A.8.16.30 | 3 DL TDD CA Event Triggered Reporting under Deactivated SCells in Non-DRX..... | 1316 |
| A.8.16.30.1 | Test Purpose and Environment | 1316 |
| A.8.16.30.2 | Test Requirements..... | 1320 |
| A.8.16.31 | E-UTRAN TDD-FDD 3 DL CA Event Triggered Reporting on Deactivated SCell with PCell and SCell Interruptions in Non-DRX and with PCell in FDD..... | 1320 |
| A.8.16.31.1 | Test Purpose and Environment | 1320 |
| A.8.16.31.2 | Test Requirements..... | 1324 |
| A.8.16.32 | E-UTRAN TDD-FDD 3 DL CA Event Triggered Reporting on Deactivated SCell with PCell and SCell Interruptions in Non-DRX and with PCell in TDD | 1324 |
| A.8.16.32.1 | Test Purpose and Environment | 1324 |
| A.8.16.32.2 | Test Requirements..... | 1328 |
| A.8.16.33 | E-UTRAN FDD 3 DL CA Event Triggered Reporting on Deactivated SCell with PCell and SCell Interruptions in Non-DRX | 1328 |
| A.8.16.33.1 | Test Purpose and Environment | 1328 |
| A.8.16.33.2 | Test Requirements..... | 1332 |
| A.8.16.34 | E-UTRAN TDD 3 DL CA Event Triggered Reporting on Deactivated SCell with PCell and SCell Interruptions in Non-DRX | 1332 |
| A.8.16.34.1 | Test Purpose and Environment | 1332 |
| A.8.16.34.2 | Test Requirements..... | 1336 |
| A.8.16.35 | 3 DL PCell in FDD CA Activation and Deactivation of Known SCell in Non-DRX | 1336 |
| A.8.16.35.1 | Test Purpose and Environment | 1336 |
| A.8.16.35.2 | Test Requirements..... | 1338 |
| A.8.16.36 | 3 DL PCell in TDD CA Activation and Deactivation of Known SCell in Non-DRX | 1338 |
| A.8.16.36.1 | Test Purpose and Environment | 1338 |
| A.8.16.36.2 | Test Requirements..... | 1340 |
| A.8.16.37 | 3 DL FDD CA activation and deactivation of known SCell in non-DRX | 1341 |

| | | |
|-------------|---|------|
| A.8.16.37.1 | Test Purpose and Environment | 1341 |
| A.8.16.37.2 | Test Requirements..... | 1343 |
| A.8.16.38 | 3 DL TDD CA activation and deactivation of known SCell in non-DRX | 1343 |
| A.8.16.38.1 | Test Purpose and Environment | 1343 |
| A.8.16.38.2 | Test Requirements..... | 1345 |
| A.8.16.39 | E-UTRA TDD-FDD 3DL CA Activation and Deactivation of Unknown SCell in Non-DRX with PCell in FDD | 1345 |
| A.8.16.39.1 | Test Purpose and Environment | 1345 |
| A.8.16.39.2 | Test Requirements..... | 1348 |
| A.8.16.40 | E-UTRA TDD-FDD 3DL CA Activation and Deactivation of Unknown SCell in Non-DRX with PCell in TDD | 1348 |
| A.8.16.40.1 | Test Purpose and Environment | 1348 |
| A.8.16.40.2 | Test Requirements..... | 1350 |
| A.8.16.41 | 3 DL FDD CA activation and deactivation of unknown SCell in non-DRX | 1351 |
| A.8.16.41.1 | Test Purpose and Environment | 1351 |
| A.8.16.41.2 | Test Requirements..... | 1353 |
| A.8.16.42 | 3 DL TDD CA activation and deactivation of unknown SCell in non-DRX | 1353 |
| A.8.16.42.1 | Test Purpose and Environment | 1353 |
| A.8.16.42.2 | Test Requirements..... | 1355 |
| A.8.16.43 | E-UTRAN TDD-FDD CA activation and deactivation of known SCell in non-DRX with PCell in FDD | 1355 |
| A.8.16.43.1 | Test Purpose and Environment | 1355 |
| A.8.16.43.2 | Test Requirements..... | 1357 |
| A.8.16.44 | E-UTRAN TDD-FDD CA activation and deactivation of unknown SCell in non-DRX with PCell in FDD | 1358 |
| A.8.16.44.1 | Test Purpose and Environment | 1358 |
| A.8.16.44.2 | Test Requirements..... | 1360 |
| A.8.16.45 | E-UTRAN TDD-FDD CA activation and deactivation of known SCell in non-DRX with PCell in TDD | 1360 |
| A.8.16.45.1 | Test Purpose and Environment | 1360 |
| A.8.16.45.2 | Test Requirements..... | 1362 |
| A.8.16.46 | E-UTRAN TDD-FDD CA activation and deactivation of unknown SCell in non-DRX with PCell in TDD | 1362 |
| A.8.16.46.1 | Test Purpose and Environment | 1362 |
| A.8.16.46.2 | Test Requirements..... | 1364 |
| A.8.16.47 | 2DL/2UL FDD CA activation and deactivation of known PUCCH SCell without valid TA in non-DRX..... | 1365 |
| A.8.16.47.1 | Test Purpose and Environment | 1365 |
| A.8.16.47.2 | Test Requirements..... | 1366 |
| A.8.16.48 | 2DL/2UL TDD CA activation and deactivation of known PUCCH SCell without valid TA in non-DRX..... | 1367 |
| A.8.16.48.1 | Test Purpose and Environment | 1367 |
| A.8.16.48.2 | Test Requirements..... | 1369 |
| A.8.16.49 | 2DL/2UL TDD-FDD CA (FDD PCell) activation and deactivation of known PUCCH SCell without valid TA in non-DRX | 1369 |
| A.8.16.49.1 | Test Purpose and Environment | 1369 |
| A.8.16.49.2 | Test Requirements..... | 1371 |
| A.8.16.50 | 2DL/2UL TDD-FDD CA (TDD PCell) activation and deactivation of known PUCCH SCell without valid TA in non-DRX | 1371 |
| A.8.16.50.1 | Test Purpose and Environment | 1371 |
| A.8.16.50.2 | Test Requirements..... | 1373 |
| A.8.16.51 | E-UTRAN 4 DL FDD CA Event Triggered Reporting with 3 deactivated SCells in Non-DRX | 1374 |
| A.8.16.51.1 | Test Purpose and Environment | 1374 |
| A.8.16.51.2 | Test Requirements..... | 1378 |
| A.8.16.52 | E-UTRAN 4 DL TDD CA Event Triggered Reporting with 3 deactivated SCells in Non-DRX | 1378 |
| A.8.16.52.1 | Test Purpose and Environment | 1378 |
| A.8.16.52.2 | Test Requirements..... | 1382 |
| A.8.16.53 | 4 DL PCell in FDD CA Event Triggered Reporting with 3 Deactivated SCells in Non-DRX..... | 1382 |
| A.8.16.53.1 | Test Purpose and Environment | 1382 |
| A.8.16.53.2 | Test Requirements..... | 1386 |
| A.8.16.54 | 4 DL PCell in TDD CA Event Triggered Reporting with 3 Deactivated SCells in Non-DRX..... | 1386 |
| A.8.16.54.1 | Test Purpose and Environment | 1386 |

| | | |
|-------------|---|------|
| A.8.16.54.2 | Test Requirements..... | 1390 |
| A.8.16.55 | E-UTRAN FDD 4 DL CA Event Triggered Reporting on Deactivated SCell with PCell and SCell Interruptions in Non-DRX..... | 1390 |
| A.8.16.55.1 | Test Purpose and Environment | 1390 |
| A.8.16.55.2 | Test Requirements..... | 1395 |
| A.8.16.56 | E-UTRAN TDD 4 DL CA Event Triggered Reporting on Deactivated SCell with PCell and SCell Interruptions in Non-DRX..... | 1395 |
| A.8.16.56.1 | Test Purpose and Environment | 1395 |
| A.8.16.56.2 | Test Requirements..... | 1400 |
| A.8.16.57 | E-UTRAN FDD 4DL CA activation and deactivation of know SCell in non-DRX..... | 1400 |
| A.8.16.57.1 | Test Purpose and Environment | 1400 |
| A.8.16.57.2 | Test Requirements..... | 1402 |
| A.8.16.58 | E-UTRAN TDD 4DL CA activation and deactivation of know SCell in non-DRX | 1402 |
| A.8.16.58.1 | Test Purpose and Environment | 1402 |
| A.8.16.58.2 | Test Requirements..... | 1405 |
| A.8.16.59 | E-UTRAN PCell in FDD FDD-TDD 4 DL CA activation and deactivation of known SCell in non-DRX..... | 1405 |
| A.8.16.59.1 | Test Purpose and Environment | 1405 |
| A.8.16.59.2 | Test Requirements..... | 1408 |
| A.8.16.60 | E-UTRAN PCell in TDD FDD-TDD 4 DL CA activation and deactivation of known SCell in non-DRX..... | 1409 |
| A.8.16.60.1 | Test Purpose and Environment | 1409 |
| A.8.16.60.2 | Test Requirements..... | 1412 |
| A.8.16.61 | E-UTRAN FDD 4DL CA activation and deactivation of unknown SCell in non-DRX..... | 1412 |
| A.8.16.61.1 | Test Purpose and Environment | 1412 |
| A.8.16.61.2 | Test Requirements..... | 1414 |
| A.8.16.62 | E-UTRAN TDD 4DL CA activation and deactivation of unknown SCell in non-DRX | 1415 |
| A.8.16.62.1 | Test Purpose and Environment | 1415 |
| A.8.16.62.2 | Test Requirements..... | 1417 |
| A.8.16.63 | E-UTRAN PCell in FDD FDD-TDD 4 DL CA activation and deactivation of unknown SCell in non-DRX | 1417 |
| A.8.16.63.1 | Test Purpose and Environment | 1417 |
| A.8.16.63.2 | Test Requirements..... | 1421 |
| A.8.16.64 | E-UTRAN PCell in TDD FDD-TDD 4 DL CA activation and deactivation of unknown SCell in non-DRX | 1421 |
| A.8.16.64.1 | Test Purpose and Environment | 1421 |
| A.8.16.64.2 | Test Requirements..... | 1424 |
| A.8.16.65 | 5 DL FDD-TDD with PCell in FDD CA Event Triggered Reporting with 4 Deactivated SCells in Non-DRX..... | 1424 |
| A.8.16.65.1 | Test Purpose and Environment | 1424 |
| A.8.16.65.2 | Test Requirements..... | 1429 |
| A.8.16.66 | 5 DL FDD-TDD with PCell in TDD CA Event Triggered Reporting with 4 Deactivated SCells in Non-DRX..... | 1429 |
| A.8.16.66.1 | Test Purpose and Environment | 1429 |
| A.8.16.66.2 | Test Requirements..... | 1433 |
| A.8.16.67 | 5 DL FDD-TDD with PCell in FDD CA activation and deactivation of Unknown SCell in non-DRX . | 1433 |
| A.8.16.67.1 | Test Purpose and Environment | 1433 |
| A.8.16.67.2 | Test Requirements..... | 1437 |
| A.8.16.68 | 5 DL FDD-TDD with PCell in TDD CA activation and deactivation of Unknown SCell in non-DRX. | 1437 |
| A.8.16.68.1 | Test Purpose and Environment | 1437 |
| A.8.16.68.2 | Test Requirements..... | 1440 |
| A.8.16.69 | 5 DL FDD CA activation and deactivation of unknown SCell in non-DRX | 1441 |
| A.8.16.69.1 | Test Purpose and Environment | 1441 |
| A.8.16.69.2 | Test Requirements..... | 1443 |
| A.8.16.70 | 5 DL TDD CA activation and deactivation of unknown SCell in non-DRX | 1444 |
| A.8.16.70.1 | Test Purpose and Environment | 1444 |
| A.8.16.70.2 | Test Requirements..... | 1446 |
| A.8.16.66 | Void | 1447 |
| A.8.16.71 | 5 DL FDD CA Event Triggered Reporting with Deactivated SCells in Non-DRX..... | 1447 |
| A.8.16.71.1 | Test Purpose and Environment | 1447 |
| A.8.16.71.2 | Test Requirements..... | 1451 |
| A.8.16.72 | 5 DL TDD CA Event Triggered Reporting with Deactivated SCells in Non-DRX..... | 1451 |

| | | |
|-------------|--|------|
| A.8.16.72.1 | Test Purpose and Environment | 1451 |
| A.8.16.72.2 | Test Requirements..... | 1455 |
| A.8.16.73 | 5 DL FDD CA Event Triggered Reporting on Deactivated SCell with PCell and SCell Interruptions in Non-DRX..... | 1455 |
| A.8.16.73.1 | Test Purpose and Environment | 1455 |
| A.8.16.73.2 | Test Requirements..... | 1460 |
| A.8.16.74 | 5 DL TDD CA Event Triggered Reporting on Deactivated SCell with PCell and SCell Interruptions in Non-DRX..... | 1460 |
| A.8.16.74.1 | Test Purpose and Environment | 1460 |
| A.8.16.74.2 | Test Requirements..... | 1465 |
| A.8.16.75 | 5 DL FDD-TDD with PCell in FDD CA activation and deactivation of known SCell in non-DRX..... | 1465 |
| A.8.16.75.1 | Test Purpose and Environment | 1465 |
| A.8.16.75.2 | Test Requirements..... | 1468 |
| A.8.16.76 | 5 DL FDD-TDD with PCell in TDD CA activation and deactivation of known SCell in non-DRX | 1469 |
| A.8.16.76.1 | Test Purpose and Environment | 1469 |
| A.8.16.76.2 | Test Requirements..... | 1472 |
| A.8.16.77 | 5 DL FDD CA activation and deactivation of know SCell in non-DRX..... | 1473 |
| A.8.16.77.1 | Test Purpose and Environment | 1473 |
| A.8.16.77.2 | Test Requirements..... | 1475 |
| A.8.16.78 | 5 DL TDD CA activation and deactivation of know SCell in non-DRX..... | 1476 |
| A.8.16.78.1 | Test Purpose and Environment | 1476 |
| A.8.16.78.2 | Test Requirements..... | 1478 |
| A.8.16.79 | E-UTRAN PCell in FDD FDD-TDD 4 DL CA Event Triggered Reporting on Deactivated SCell with PCell and SCell Interruptions in Non-DRX..... | 1479 |
| A.8.16.79.1 | Test Purpose and Environment | 1479 |
| A.8.16.79.2 | Test Requirements..... | 1484 |
| A.8.16.80 | E-UTRAN PCell in TDD TDD-FDD 4 DL CA Event Triggered Reporting on Deactivated SCell with PCell and SCell Interruptions in Non-DRX..... | 1484 |
| A.8.16.80.1 | Test Purpose and Environment | 1484 |
| A.8.16.80.2 | Test Requirements..... | 1489 |
| A.8.16.81 | E-UTRAN PCell in FDD FDD-TDD 5 DL CA Event Triggered Reporting on Deactivated SCell with PCell and SCell Interruptions in Non-DRX..... | 1489 |
| A.8.16.81.1 | Test Purpose and Environment | 1489 |
| A.8.16.81.2 | Test Requirements..... | 1494 |
| A.8.16.82 | E-UTRAN PCell in TDD TDD-FDD 5 DL CA Event Triggered Reporting on Deactivated SCell with PCell and SCell Interruptions in Non-DRX..... | 1494 |
| A.8.16.82.1 | Test Purpose and Environment | 1494 |
| A.8.16.82.2 | Test Requirements..... | 1499 |
| A.8.17 | RSTD Measurements for E-UTRAN Carrier Aggregation | 1499 |
| A.8.17.1 | E-UTRAN FDD RSTD measurement reporting delay test case | 1499 |
| A.8.17.1.1 | Test Purpose and Environment | 1499 |
| A.8.17.1.2 | Test Requirements..... | 1503 |
| A.8.17.2 | E-UTRAN TDD RSTD measurement reporting delay test case | 1503 |
| A.8.17.2.1 | Test Purpose and Environment | 1503 |
| A.8.17.2.2 | Test Requirements..... | 1507 |
| A.8.17.3 | E-UTRAN FDD RSTD Measurement Reporting Test Case for 20 MHz..... | 1508 |
| A.8.17.3.1 | Test Purpose and Environment | 1508 |
| A.8.17.3.2 | Test Requirements..... | 1509 |
| A.8.17.4 | E-UTRAN TDD RSTD Measurement Reporting Test Case for 20 MHz..... | 1509 |
| A.8.17.4.1 | Test Purpose and Environment | 1509 |
| A.8.17.4.2 | Test Requirements..... | 1510 |
| A.8.17.5 | E-UTRAN FDD RSTD Measurement Reporting Test Case for 10MHz+5MHz..... | 1510 |
| A.8.17.5.1 | Test Purpose and Environment | 1510 |
| A.8.17.5.2 | Test Requirements..... | 1511 |
| A.8.17.6 | E-UTRAN TDD RSTD Measurement Reporting Test Case for 10MHz+5MHz | 1511 |
| A.8.17.6.1 | Test Purpose and Environment | 1511 |
| A.8.17.6.2 | Test Requirements..... | 1512 |
| A.8.17.7 | E-UTRAN FDD RSTD Measurement Reporting Test Case for 5 + 5 MHz Bandwidth | 1512 |
| A.8.17.7.1 | Test Purpose and Environment | 1512 |
| A.8.17.7.2 | Test Requirements..... | 1513 |
| A.8.17.8 | E-UTRAN TDD RSTD Measurement Reporting Test Case for 5+5 MHz bandwidth..... | 1513 |
| A.8.17.8.1 | Test Purpose and Environment | 1513 |

| | | |
|---------------|--|------|
| A.8.17.8.2 | Test Requirements..... | 1514 |
| A.8.17.9 | E-UTRAN TDD RSTD Measurement Reporting Test Case for 20MHz+10MHz | 1514 |
| A.8.17.9.1 | Test Purpose and Environment | 1514 |
| A.8.17.9.2 | Test Requirements..... | 1515 |
| A.8.17.10 | E-UTRAN 3 DL FDD CA RSTD Measurement Reporting Delay Test Case | 1515 |
| A.8.17.10.1 | Test Purpose and Environment | 1515 |
| A.8.17.10.2 | Test Requirements..... | 1520 |
| A.8.17.11 | E-UTRAN 3 DL TDD CA RSTD Measurement Reporting Delay Test Case | 1520 |
| A.8.17.11.1 | Test Purpose and Environment | 1520 |
| A.8.17.11.2 | Test Requirements..... | 1525 |
| A.8.18 | E-UTRAN TDD – HRPD Measurements | 1526 |
| A.8.18.1 | E-UTRAN TDD-HRPD event triggered reporting under fading propagation conditions..... | 1526 |
| A.8.18.1.1 | Test Purpose and Environment | 1526 |
| A.8.18.1.2 | Test Requirements..... | 1528 |
| A.8.19 | E-UTRAN TDD – CDMA2000 1X Measurements | 1528 |
| A.8.19.1 | E-UTRAN TDD – CDMA2000 1X event triggered reporting under fading propagation conditions..... | 1528 |
| A.8.19.1.1 | Test Purpose and Environment | 1528 |
| A.8.19.1.2 | Test Requirements..... | 1530 |
| A.8.20 | Inter-frequency/RAT Measurements in CA mode | 1530 |
| A.8.20.1 | E-UTRAN FDD-FDD Inter-frequency event triggered reporting under fading propagation conditions in asynchronous cells | 1530 |
| A.8.20.1.1 | Test Purpose and Environment | 1530 |
| A.8.20.1.2 | Test Requirements..... | 1531 |
| A.8.20.2 | E-UTRAN TDD-TDD Inter-frequency event triggered reporting under fading propagation conditions in synchronous cells | 1532 |
| A.8.20.2.1 | Test Purpose and Environment | 1532 |
| A.8.20.2.2 | Test Requirements..... | 1533 |
| A.8.20.2A | E-UTRAN TDD-TDD Inter-frequency event triggered reporting under fading propagation conditions in synchronous cells for 20 MHz +20 MHz bandwidth. | 1534 |
| A.8.20.2A.1 | Test Purpose and Environment | 1534 |
| A.8.20.2A.2 | Test Requirements..... | 1534 |
| A.8.20.2B | E-UTRAN TDD-TDD Inter-frequency event triggered reporting under fading propagation conditions in synchronous cells for 20 MHz +10 MHz bandwidth. | 1534 |
| A.8.20.2B.1 | Test Purpose and Environment | 1534 |
| A.8.20.2B.2 | Test Requirements..... | 1536 |
| A.8.20.3 | E-UTRAN FDD - UTRAN FDD event triggered reporting under fading propagation conditions..... | 1536 |
| A.8.20.3.1 | Test Purpose and Environment | 1536 |
| A.8.20.3.2 | Test Requirements..... | 1538 |
| A.8.20.4 | E-UTRAN TDD to UTRAN TDD cell search under fading propagation conditions | 1538 |
| A.8.20.4.1 | Test Purpose and Environment | 1538 |
| A.8.20.4.1.1 | 1.28 Mcps TDD option..... | 1538 |
| A.8.20.4.2 | Test Requirements..... | 1540 |
| A.8.20.4.2.1 | 1.28 Mcps TDD option..... | 1540 |
| A.8.20.4A | E-UTRAN TDD with 20 MHz +20 MHz bandwidth to UTRAN TDD cell search under fading propagation conditions..... | 1540 |
| A.8.20.4A.1 | Test Purpose and Environment | 1540 |
| A.8.20.4A.1.1 | 1.28 Mcps TDD option..... | 1540 |
| A.8.20.4A.2 | Test Requirements..... | 1541 |
| A.8.20.4A.2.1 | 1.28 Mcps TDD option..... | 1541 |
| A.8.20.4B | E-UTRAN TDD with 20 MHz +10 MHz bandwidth to UTRAN TDD cell search under fading propagation conditions..... | 1541 |
| A.8.20.4B.1 | Test Purpose and Environment | 1541 |
| A.8.20.4B.1.1 | 1.28 Mcps TDD option..... | 1541 |
| A.8.20.4B.2 | Test Requirements..... | 1543 |
| A.8.20.4B.2.1 | 1.28 Mcps TDD option..... | 1543 |
| A.8.21 | CSG Proximity Indication Testing Case for E-UTRAN FDD – FDD Inter frequency | 1543 |
| A.8.21.1 | Test Purpose and Environment | 1543 |
| A.8.21.2 | Test Requirements | 1545 |
| A.8.22 | E-UTRAN Discovery Signal Measurements..... | 1546 |
| A.8.22.1 | E-UTRAN FDD-FDD intra-frequency event triggered reporting under fading propagation conditions in synchronous cells in DRX based on CRS based discovery signal..... | 1546 |
| A.8.22.1.1 | Test Purpose and Environment | 1546 |

| | | |
|-------------|---|------|
| A.8.22.1.2 | Test Requirements..... | 1548 |
| A.8.22.2 | E-UTRAN TDD-TDD intra-frequency event triggered reporting under fading propagation conditions in synchronous cells in DRX based on CRS based discovery signal | 1548 |
| A.8.22.2.1 | Test Purpose and Environment | 1548 |
| A.8.22.2.2 | Test Requirements..... | 1550 |
| A.8.22.3 | E-UTRAN FDD-FDD inter-frequency event triggered reporting under fading propagation conditions in DRX based on CRS based discovery signal | 1550 |
| A.8.22.3.1 | Test Purpose and Environment | 1550 |
| A.8.22.3.2 | Test Requirements..... | 1552 |
| A.8.22.4 | E-UTRAN TDD-TDD inter-frequency event triggered reporting under fading propagation conditions in DRX based on CRS based discovery signal | 1553 |
| A.8.22.4.1 | Test Purpose and Environment | 1553 |
| A.8.22.4.2 | Test Requirements..... | 1555 |
| A.8.22.5 | E-UTRAN FDD-FDD intra-frequency event triggered reporting in DRX based on CSI-RS based discovery signal | 1555 |
| A.8.22.5.1 | Test Purpose and Environment | 1555 |
| A.8.22.5.2 | Test Requirements..... | 1557 |
| A.8.22.6 | E-UTRAN TDD-TDD intra-frequency event triggered reporting in DRX based on CSI-RS based discovery signal | 1557 |
| A.8.22.6.1 | Test Purpose and Environment | 1557 |
| A.8.22.6.2 | Test Requirements..... | 1560 |
| A.8.22.7 | E-UTRAN FDD-FDD Inter-frequency event triggered reporting in DRX based on CSI-RS based discovery signal | 1560 |
| A.8.22.7.1 | Test Purpose and Environment | 1560 |
| A.8.22.7.2 | Test Requirements..... | 1562 |
| A.8.22.8 | E-UTRAN TDD-TDD inter-frequency event triggered reporting under fading propagation condition in DRX based on CSI-RS based discovery signal | 1562 |
| A.8.22.8.1 | Test Purpose and Environment | 1562 |
| A.8.22.8.2 | Test Requirements..... | 1565 |
| A.8.22.9 | E-UTRAN FDD event triggered reporting under deactivated SCell in non-DRX based on CRS based discovery signal | 1565 |
| A.8.22.9.1 | Test Purpose and Environment | 1565 |
| A.8.22.9.2 | Test Requirements..... | 1567 |
| A.8.22.10 | E-UTRAN TDD event triggered reporting under deactivated SCell in non-DRX based on CRS based discovery signal | 1567 |
| A.8.22.10.1 | Test Purpose and Environment | 1567 |
| A.8.22.10.2 | Test Requirements..... | 1569 |
| A.8.22.11 | E-UTRAN FDD event triggered reporting under deactivated SCell in non-DRX based on CSI-RS based discovery signal | 1569 |
| A.8.22.11.1 | Test Purpose and Environment | 1569 |
| A.8.22.11.2 | Test Requirements..... | 1572 |
| A.8.22.12 | E-UTRAN TDD event triggered reporting under deactivated SCell in non-DRX based on CSI-RS based discovery signal | 1572 |
| A.8.22.12.1 | Test Purpose and Environment | 1572 |
| A.8.22.12.2 | Test Requirements..... | 1574 |
| A.8.23 | E-UTRAN Dual Connectivity Measurements | 1575 |
| A.8.23.1 | E-UTRAN FDD-FDD DC intra-frequency event triggered reporting with DRX in synchronous DC ... | 1575 |
| A.8.23.1.1 | Test Purpose and Environment | 1575 |
| A.8.23.1.2 | Test Requirements..... | 1577 |
| A.8.23.2 | E-UTRAN FDD-FDD DC intra-frequency event triggered reporting with DRX in asynchronous DC . | 1577 |
| A.8.23.2.1 | Test Purpose and Environment | 1577 |
| A.8.23.2.2 | Test Requirements..... | 1580 |
| A.8.23.3 | E-UTRAN TDD-TDD DC intra-frequency event triggered reporting with DRX in synchronous DC... | 1580 |
| A.8.23.3.1 | Test Purpose and Environment | 1580 |
| A.8.23.3.2 | Test Requirements..... | 1582 |
| A.8.23.4 | E-UTRAN FDD-FDD DC inter-frequency event triggered reporting with DRX in synchronous DC ... | 1583 |
| A.8.23.4.1 | Test Purpose and Environment | 1583 |
| A.8.23.4.2 | Test Requirements..... | 1585 |
| A.8.23.5 | E-UTRAN FDD-FDD DC inter-frequency event triggered reporting with DRX in asynchronous DC . | 1585 |
| A.8.23.5.1 | Test Purpose and Environment | 1585 |
| A.8.23.5.2 | Test Requirements..... | 1587 |
| A.8.23.6 | E-UTRAN TDD-TDD DC inter-frequency event triggered reporting with DRX in synchronous DC... | 1588 |

| | | |
|-------------|--|------|
| A.8.23.6.1 | Test Purpose and Environment | 1588 |
| A.8.23.6.2 | Test Requirements..... | 1590 |
| A.8.23.7 | E-UTRAN FDD-FDD Addition and Release Delay of known PSCell in Synchronous DC | 1590 |
| A.8.23.7.1 | Test Purpose and Environment | 1590 |
| A.8.23.7.2 | Test Requirements..... | 1592 |
| A.8.23.8 | E-UTRAN FDD-FDD Addition and Release Delay of known PSCell in Asynchronous DC | 1592 |
| A.8.23.8.1 | Test Purpose and Environment | 1592 |
| A.8.23.8.2 | Test Requirements..... | 1594 |
| A.8.23.9 | E-UTRAN TDD Addition and Release Delay of known PSCell in Synchronous DC..... | 1595 |
| A.8.23.9.1 | Test Purpose and Environment | 1595 |
| A.8.23.9.2 | Test Requirements..... | 1597 |
| A.8.23.10 | E-UTRAN TDD-FDD DC intra-frequency event triggered reporting with DRX in synchronous DC with PCell in FDD | 1598 |
| A.8.23.10.1 | Test Purpose and Environment | 1598 |
| A.8.23.10.2 | Test Requirements..... | 1600 |
| A.8.23.11 | E-UTRAN TDD-FDD DC intra-frequency event triggered reporting with DRX in synchronous DC with PCell in TDD | 1600 |
| A.8.23.11.1 | Test Purpose and Environment | 1600 |
| A.8.23.11.2 | Test Requirements..... | 1603 |
| A.8.23.12 | E-UTRAN TDD-FDD DC inter-frequency event triggered reporting with DRX in synchronous DC with PCell in FDD | 1603 |
| A.8.23.12.1 | Test Purpose and Environment | 1603 |
| A.8.23.12.2 | Test Requirements..... | 1605 |
| A.8.23.13 | E-UTRAN TDD-FDD DC inter-frequency event triggered reporting with DRX in synchronous DC with PCell in TDD | 1606 |
| A.8.23.13.1 | Test Purpose and Environment | 1606 |
| A.8.23.13.2 | Test Requirements..... | 1608 |
| A.8.23.14 | E-UTRAN TDD-FDD Addition and Release Delay of known PSCell in Synchronous DC with PCell in FDD | 1608 |
| A.8.23.14.1 | Test Purpose and Environment | 1608 |
| A.8.23.14.2 | Test Requirements..... | 1610 |
| A.8.23.15 | E-UTRAN TDD-FDD Addition and Release Delay of known PSCell in Synchronous DC with PCell in TDD | 1611 |
| A.8.23.15.1 | Test Purpose and Environment | 1611 |
| A.8.23.15.2 | Test Requirements..... | 1613 |
| A.8.23.16 | E-UTRAN FDD-FDD DC SSTD measurement reporting delay with no DRX in asynchronous DC ... | 1613 |
| A.8.23.16.1 | Test Purpose and Environment | 1613 |
| A.8.23.16.2 | Test Requirements..... | 1615 |
| A.8.23.17 | E-UTRAN FDD-FDD DC SSTD measurement reporting delay with DRX in asynchronous DC | 1615 |
| A.8.23.17.1 | Test Purpose and Environment | 1615 |
| A.8.23.17.2 | Test Requirements..... | 1616 |
| A.8.23.18 | E-UTRAN FDD - FDD DC Intra-frequency identification of a new CGI of E-UTRA cell using autonomous gaps in synchronous DC | 1616 |
| A.8.23.18.1 | Test Purpose and Environment | 1616 |
| A.8.23.18.2 | Test Requirements..... | 1618 |
| A.8.23.19 | E-UTRAN FDD - FDD DC Intra-frequency identification of a new CGI of E-UTRA cell using autonomous gaps in asynchronous DC | 1618 |
| A.8.23.19.1 | Test Purpose and Environment | 1618 |
| A.8.23.19.2 | Test Requirements..... | 1620 |
| A.8.23.20 | E-UTRAN TDD - TDD DC Intra-frequency identification of a new CGI of E-UTRA cell using autonomous gaps in synchronous DC | 1620 |
| A.8.23.20.1 | Test Purpose and Environment | 1620 |
| A.8.23.20.2 | Test Requirements..... | 1622 |
| A.8.23.21 | E-UTRAN FDD - FDD DC Inter-frequency identification of a new CGI of E-UTRA cell using autonomous gaps in synchronous DC | 1623 |
| A.8.23.21.1 | Test Purpose and Environment | 1623 |
| A.8.23.21.2 | Test Requirements..... | 1624 |
| A.8.23.22 | E-UTRAN FDD - FDD DC Inter-frequency identification of a new CGI of E-UTRA cell using autonomous gaps in asynchronous DC | 1625 |
| A.8.23.22.1 | Test Purpose and Environment | 1625 |
| A.8.23.22.2 | Test Requirements..... | 1626 |

| | | |
|-------------|---|------|
| A.8.23.23 | E-UTRAN TDD - TDD DC Inter-frequency identification of a new CGI of E-UTRA cell using autonomous gaps in synchronous DC | 1627 |
| A.8.23.23.1 | Test Purpose and Environment | 1627 |
| A.8.23.23.2 | Test Requirements..... | 1628 |
| A.8.23.24 | E-UTRAN FDD-FDD DC activation and deactivation of known SCell in Non-DRX in synchronous DC..... | 1629 |
| A.8.23.24.1 | Test Purpose and Environment | 1629 |
| A.8.23.24.2 | Test Requirements..... | 1631 |
| A.8.23.25 | E-UTRAN FDD-FDD DC activation and deactivation of known SCell in Non-DRX in asynchronous DC..... | 1631 |
| A.8.23.25.1 | Test Purpose and Environment | 1631 |
| A.8.23.25.2 | Test Requirements..... | 1633 |
| A.8.23.26 | E-UTRAN TDD-TDD DC activation and deactivation of known SCell in Non-DRX in synchronous DC..... | 1634 |
| A.8.23.26.1 | Test Purpose and Environment | 1634 |
| A.8.23.26.2 | Test Requirements..... | 1636 |
| A.8.23.27 | E-UTRAN FDD-FDD DC event triggered reporting under deactivated SCell with PCell and PSCell interruption in non-DRX in synchronous DC | 1636 |
| A.8.23.27.1 | Test Purpose and Environment | 1636 |
| A.8.23.27.2 | Test Requirements..... | 1638 |
| A.8.23.28 | E-UTRAN FDD-FDD DC event triggered reporting under deactivated SCell with PCell and PSCell interruption in non-DRX in asynchronous DC | 1638 |
| A.8.23.28.1 | Test Purpose and Environment | 1638 |
| A.8.23.28.2 | Test Requirements..... | 1640 |
| A.8.23.29 | E-UTRAN TDD-TDD DC event triggered reporting under deactivated SCell with PCell and PSCell interruption in non-DRX in synchronous DC | 1641 |
| A.8.23.29.1 | Test Purpose and Environment | 1641 |
| A.8.23.29.2 | Test Requirements..... | 1643 |
| A.8.24 | Proximity-based Services | 1643 |
| A.8.24.1 | E-UTRAN FDD - Initiation/Cease of SLSS Transmission with ProSe Direct Discovery..... | 1643 |
| A.8.24.1.1 | Test Purpose and Environment | 1643 |
| A.8.24.1.2 | Test Requirements..... | 1644 |
| A.8.24.2 | E-UTRAN TDD - Initiation/Cease of SLSS Transmission with ProSe Direct Discovery..... | 1645 |
| A.8.24.2.1 | Test Purpose and Environment | 1645 |
| A.8.24.2.2 | Test Requirements..... | 1646 |
| A.8.24.3 | E-UTRAN FDD - Initiation/Cease of SLSS Transmission with ProSe Direct Communication..... | 1647 |
| A.8.24.3.1 | Test Purpose and Environment | 1647 |
| A.8.24.3.2 | Test Requirements..... | 1648 |
| A.8.25 | E-UTRAN-WLAN Measurements | 1649 |
| A.8.25.1 | E-UTRAN FDD-WLAN Event Triggered Reporting in non-DRX under AWGN..... | 1649 |
| A.8.25.1.1 | Test Purpose and Environment | 1649 |
| A.8.25.1.2 | Test Requirements..... | 1650 |
| A.8.25.2 | E-UTRAN TDD-WLAN Event Triggered Reporting in non-DRX under AWGN..... | 1651 |
| A.8.25.2.1 | Test Purpose and Environment | 1651 |
| A.8.25.2.2 | Test Requirements..... | 1652 |
| A.8.26 | Frame Structure 3 (FS3) | 1653 |
| A.8.26.1 | E-UTRAN FDD-FS3 Activation and deactivation of known FS3 SCell with FDD PCell in non-DRX | 1653 |
| A.8.26.1.1 | Test Purpose and Environment | 1653 |
| A.8.26.1.2 | Test Requirements..... | 1654 |
| A.8.26.2 | E-UTRAN TDD-FS3 Activation and deactivation of known FS3 SCell with TDD PCell in non-DRX | 1655 |
| A.8.26.2.1 | Test Purpose and Environment | 1655 |
| A.8.26.2.2 | Test Requirements..... | 1657 |
| A.8.26.3 | E-UTRAN FDD-FS3 Event triggered reporting on deactivated FS3 SCell and FDD PCell interruption in non-DRX..... | 1657 |
| A.8.26.3.1 | Test Purpose and Environment | 1657 |
| A.8.26.3.2 | Test Requirements..... | 1659 |
| A.8.26.4 | E-UTRAN TDD-FS3 Event triggered reporting on deactivated FS3 SCell and TDD PCell interruption in non-DRX..... | 1659 |
| A.8.26.4.1 | Test Purpose and Environment | 1659 |
| A.8.26.4.2 | Test Requirements..... | 1661 |
| A.8.26.5 | E-UTRAN FDD-FS3 Intra-frequency event triggered reporting in non-DRX for CRS based discovery signal | 1662 |

| | | |
|-------------|---|------|
| A.8.26.5.1 | Test Purpose and Environment | 1662 |
| A.8.26.5.2 | Test Requirements..... | 1663 |
| A.8.26.6 | E-UTRAN TDD-FS3 Intra-frequency event triggered reporting in non-DRX for CRS based discovery signal | 1664 |
| A.8.26.6.1 | Test Purpose and Environment | 1664 |
| A.8.26.6.2 | Test Requirements..... | 1665 |
| A.8.26.7 | E-UTRAN FDD-FS3 Intra-frequency event triggered reporting in DRX for CRS based discovery signal..... | 1666 |
| A.8.26.7.1 | Test Purpose and Environment | 1666 |
| A.8.26.7.2 | Test Requirements..... | 1668 |
| A.8.26.8 | E-UTRAN TDD-FS3 Intra-frequency event triggered reporting in DRX for CRS based discovery signal..... | 1668 |
| A.8.26.8.1 | Test Purpose and Environment | 1668 |
| A.8.26.8.2 | Test Requirements..... | 1670 |
| A.8.26.9 | E-UTRAN FDD-FS3 Inter-frequency event triggered reporting under fading propagation conditions in synchronous cells..... | 1671 |
| A.8.26.9.1 | Test Purpose and Environment | 1671 |
| A.8.26.9.2 | Test Requirements..... | 1672 |
| A.8.26.10 | E-UTRAN TDD-FS3 Inter-frequency event triggered reporting under fading propagation conditions in synchronous cells..... | 1673 |
| A.8.26.10.1 | Test Purpose and Environment | 1673 |
| A.8.26.10.2 | Test Requirements..... | 1675 |
| A.9 | Measurement Performance Requirements..... | 1676 |
| A.9.1 | RSRP..... | 1676 |
| A.9.1.1 | FDD Intra frequency case | 1676 |
| A.9.1.1.1 | Test Purpose and Environment | 1676 |
| A.9.1.1.2 | Test parameters | 1676 |
| A.9.1.1.3 | Test Requirements..... | 1677 |
| A.9.1.2 | TDD Intra frequency case..... | 1677 |
| A.9.1.2.1 | Test Purpose and Environment | 1677 |
| A.9.1.2.2 | Test parameters | 1677 |
| A.9.1.2.3 | Test Requirements..... | 1678 |
| A.9.1.3 | FDD—FDD Inter frequency case | 1679 |
| A.9.1.3.1 | Test Purpose and Environment | 1679 |
| A.9.1.3.2 | Test parameters | 1679 |
| A.9.1.3.3 | Test Requirements..... | 1680 |
| A.9.1.4 | TDD—TDD Inter frequency case..... | 1680 |
| A.9.1.4.1 | Test Purpose and Environment | 1680 |
| A.9.1.4.2 | Test parameters | 1680 |
| A.9.1.4.3 | Test Requirements..... | 1682 |
| A.9.1.5 | FDD—TDD Inter frequency case..... | 1682 |
| A.9.1.5.1 | Test Purpose and Environment | 1682 |
| A.9.1.5.2 | Test parameters | 1682 |
| A.9.1.5.3 | Test Requirements..... | 1684 |
| A.9.1.6 | FDD RSRP for E-UTRAN Carrier Aggregation | 1684 |
| A.9.1.6.1 | Test Purpose and Environment | 1684 |
| A.9.1.6.2 | Test parameters | 1684 |
| A.9.1.6.3 | Test Requirements..... | 1686 |
| A.9.1.7 | TDD RSRP for E-UTRAN Carrier Aggregation | 1686 |
| A.9.1.7.1 | Test Purpose and Environment | 1686 |
| A.9.1.7.2 | Test parameters | 1686 |
| A.9.1.7.3 | Test Requirements..... | 1687 |
| A.9.1.8 | FDD RSRP under Time-Domain Measurement Resource Restriction with Non-MBSFN ABS..... | 1688 |
| A.9.1.8.1 | Test Purpose and Environment | 1688 |
| A.9.1.8.2 | Test parameters | 1688 |
| A.9.1.8.3 | Test Requirements..... | 1690 |
| A.9.1.9 | TDD RSRP under Time-Domain Measurement Resource Restriction with Non-MBSFN ABS..... | 1690 |
| A.9.1.9.1 | Test Purpose and Environment | 1690 |
| A.9.1.9.2 | Test parameters | 1690 |
| A.9.1.9.3 | Test Requirements..... | 1692 |
| A.9.1.10 | FDD RSRP under Time-Domain Measurement Resource Restriction with MBSFN ABS | 1692 |

| | | |
|------------|--|------|
| A.9.1.10.1 | Test Purpose and Environment | 1692 |
| A.9.1.10.2 | Test parameters | 1692 |
| A.9.1.10.3 | Test Requirements..... | 1694 |
| A.9.1.11 | TDD RSRP under Time-Domain Measurement Resource Restriction with MBSFN ABS..... | 1695 |
| A.9.1.11.1 | Test Purpose and Environment | 1695 |
| A.9.1.11.2 | Test parameters | 1695 |
| A.9.1.11.3 | Test Requirements..... | 1697 |
| A.9.1.12 | FDD RSRP for E-UTRAN Carrier Aggregation for 20MHz..... | 1697 |
| A.9.1.12.1 | Test Purpose and Environment | 1697 |
| A.9.1.12.2 | Test parameters | 1697 |
| A.9.1.12.3 | Test Requirements..... | 1697 |
| A.9.1.13 | TDD RSRP for E-UTRAN Carrier Aggregation for 20MHz | 1698 |
| A.9.1.13.1 | Test Purpose and Environment | 1698 |
| A.9.1.13.2 | Test parameters | 1698 |
| A.9.1.13.3 | Test Requirements..... | 1698 |
| A.9.1.14 | FDD RSRP under Time-Domain Measurement Resource Restriction with CRS Assistance Information and Non-MBSFN ABS | 1698 |
| A.9.1.14.1 | Test Purpose and Environment | 1698 |
| A.9.1.14.2 | Test parameters | 1698 |
| A.9.1.14.3 | Test Requirements..... | 1701 |
| A.9.1.15 | TDD RSRP under Time-Domain Measurement Resource Restriction with CRS Assistance Information and Non-MBSFN ABS | 1701 |
| A.9.1.15.1 | Test Purpose and Environment | 1701 |
| A.9.1.15.2 | Test parameters | 1701 |
| A.9.1.15.3 | Test Requirements..... | 1703 |
| A.9.1.16 | FDD Intra frequency case for 5MHz Bandwidth..... | 1703 |
| A.9.1.16.1 | Test Purpose and Environment | 1703 |
| A.9.1.16.2 | Test parameters | 1703 |
| A.9.1.16.3 | Test Requirements..... | 1704 |
| A.9.1.17 | FDD—FDD Inter frequency case for 5MHz Bandwidth..... | 1704 |
| A.9.1.17.1 | Test Purpose and Environment | 1704 |
| A.9.1.17.2 | Test parameters | 1705 |
| A.9.1.17.3 | Test Requirements..... | 1706 |
| A.9.1.18 | FDD RSRP for E-UTRAN Carrier Aggregation for 10MHz + 5MHz | 1706 |
| A.9.1.18.1 | Test Purpose and Environment | 1706 |
| A.9.1.18.2 | Test parameters | 1706 |
| A.9.1.18.3 | Test Requirements..... | 1707 |
| A.9.1.19 | TDD RSRP for E-UTRAN Carrier Aggregation for 10MHz + 5MHz | 1707 |
| A.9.1.19.1 | Test Purpose and Environment | 1707 |
| A.9.1.19.2 | Test parameters | 1707 |
| A.9.1.19.3 | Test Requirements..... | 1708 |
| A.9.1.20 | FDD RSRP for E-UTRAN Carrier Aggregation for 5MHz + 5MHz bandwidth..... | 1708 |
| A.9.1.20.1 | Test Purpose and Environment | 1708 |
| A.9.1.20.2 | Test parameters | 1708 |
| A.9.1.20.3 | Test Requirements..... | 1709 |
| A.9.1.21 | TDD RSRP for E-UTRAN Carrier Aggregation for 5MHz + 5MHz bandwidth | 1709 |
| A.9.1.21.1 | Test Purpose and Environment | 1709 |
| A.9.1.21.2 | Test parameters | 1709 |
| A.9.1.21.3 | Test Requirements..... | 1710 |
| A.9.1.22 | RSRP for E-UTRAN TDD-FDD Carrier Aggregation with PCell in FDD | 1710 |
| A.9.1.22.1 | Test Purpose and Environment | 1710 |
| A.9.1.22.2 | Test parameters | 1710 |
| A.9.1.22.3 | Test Requirements..... | 1712 |
| A.9.1.23 | RSRP for E-UTRAN TDD-FDD Carrier Aggregation with PCell in TDD..... | 1712 |
| A.9.1.23.1 | Test Purpose and Environment | 1712 |
| A.9.1.23.2 | Test parameters | 1713 |
| A.9.1.23.3 | Test Requirements..... | 1715 |
| A.9.1.24 | TDD RSRP for E-UTRAN Carrier Aggregation for 20MHz + 10MHz | 1715 |
| A.9.1.24.1 | Test Purpose and Environment | 1715 |
| A.9.1.24.2 | Test parameters | 1715 |
| A.9.1.24.3 | Test Requirements..... | 1716 |
| A.9.1.25 | FDD intra-frequency absolute and relative RSRP accuracies in CRS based discovery signal | 1716 |

| | | |
|------------|--|------|
| A.9.1.25.1 | Test Purpose and Environment | 1716 |
| A.9.1.25.2 | Test parameters | 1716 |
| A.9.1.25.3 | Test Requirements..... | 1717 |
| A.9.1.26 | TDD intra-frequency absolute and relative RSRP accuracies in CRS based discovery signal | 1717 |
| A.9.1.26.1 | Test Purpose and Environment | 1717 |
| A.9.1.26.2 | Test parameters | 1717 |
| A.9.1.26.3 | Test Requirements..... | 1719 |
| A.9.1.27 | FDD—FDD inter-frequency absolute and relative RSRP accuracies in CRS based discovery signal ... | 1719 |
| A.9.1.27.1 | Test Purpose and Environment | 1719 |
| A.9.1.27.2 | Test parameters | 1719 |
| A.9.1.27.3 | Test Requirements..... | 1720 |
| A.9.1.28 | TDD—TDD inter-frequency absolute and relative RSRP accuracies in CRS based discovery signal .. | 1720 |
| A.9.1.28.1 | Test Purpose and Environment | 1720 |
| A.9.1.28.2 | Test parameters | 1721 |
| A.9.1.28.3 | Test Requirements..... | 1722 |
| A.9.1.29 | FDD intra frequency absolute and relative CSI-RSRP accuracies in CSI-RS based discovery signal ... | 1722 |
| A.9.1.29.1 | Test Purpose and Environment | 1722 |
| A.9.1.29.2 | Test parameters | 1722 |
| A.9.1.29.3 | Test Requirements..... | 1724 |
| A.9.1.30 | TDD intra frequency absolute and relative CSI-RSRP accuracies in CSI-RS based discovery signal ... | 1724 |
| A.9.1.30.1 | Test Purpose and Environment | 1724 |
| A.9.1.30.2 | Test parameters | 1724 |
| A.9.1.30.3 | Test Requirements..... | 1725 |
| A.9.1.31 | FDD—FDD inter-frequency absolute and relative CSI-RSRP accuracies in CSI-RS based discovery signal..... | 1726 |
| A.9.1.31.1 | Test Purpose and Environment | 1726 |
| A.9.1.31.2 | Test parameters | 1726 |
| A.9.1.31.3 | Test Requirements..... | 1728 |
| A.9.1.32 | TDD—TDD inter-frequency absolute and relative CSI-RSRP accuracies in CSI-RS based discovery signal..... | 1728 |
| A.9.1.32.1 | Test Purpose and Environment | 1728 |
| A.9.1.32.2 | Test parameters | 1728 |
| A.9.1.32.3 | Test Requirements..... | 1729 |
| A.9.1.33 | FDD absolute and relative RSRP accuracies for E-UTRAN Carrier Aggregation in CRS based discovery signal | 1729 |
| A.9.1.33.1 | Test Purpose and Environment | 1729 |
| A.9.1.33.2 | Test parameters | 1730 |
| A.9.1.33.3 | Test Requirements..... | 1731 |
| A.9.1.34 | TDD absolute and relative RSRP accuracies for E-UTRAN Carrier Aggregation in CRS based discovery signal | 1731 |
| A.9.1.34.1 | Test Purpose and Environment | 1731 |
| A.9.1.34.2 | Test parameters | 1731 |
| A.9.1.34.3 | Test Requirements..... | 1733 |
| A.9.1.35 | FDD absolute and relative CSI-RSRP accuracies for E-UTRAN Carrier Aggregation in CSI-RS based discovery signal | 1733 |
| A.9.1.35.1 | Test Purpose and Environment | 1733 |
| A.9.1.35.2 | Test parameters | 1733 |
| A.9.1.35.3 | Test Requirements..... | 1735 |
| A.9.1.36 | TDD absolute and relative CSI-RSRP accuracies for E-UTRAN Carrier Aggregation in CSI-RS based discovery signal | 1735 |
| A.9.1.36.1 | Test Purpose and Environment | 1735 |
| A.9.1.36.2 | Test parameters | 1735 |
| A.9.1.36.3 | Test Requirements..... | 1737 |
| A.9.1.37 | 3 DL PCell in FDD RSRP for E-UTRAN in Carrier Aggregation | 1737 |
| A.9.1.37.1 | Test Purpose and Environment | 1737 |
| A.9.1.37.2 | Test parameters | 1737 |
| A.9.1.37.3 | Test Requirements..... | 1739 |
| A.9.1.38 | 3 DL PCell in TDD RSRP for E-UTRAN in Carrier Aggregation | 1740 |
| A.9.1.38.1 | Test Purpose and Environment | 1740 |
| A.9.1.38.2 | Test parameters | 1740 |
| A.9.1.38.3 | Test Requirements..... | 1741 |
| A.9.1.39 | 3 DL FDD RSRP for E-UTRAN in Carrier Aggregation | 1742 |

| | | |
|-------------|--|------|
| A.9.1.39.1 | Test Purpose and Environment | 1742 |
| A.9.1.39.2 | Test parameters | 1742 |
| A.9.1.39.3 | Test Requirements..... | 1745 |
| A.9.1.40 | 3 DL TDD RSRP for E-UTRAN in Carrier Aggregation..... | 1745 |
| A.9.1.40.1 | Test Purpose and Environment | 1745 |
| A.9.1.40.2 | Test parameters | 1746 |
| A.9.1.40.3 | Test Requirements..... | 1748 |
| A.9.1.41 | FD-FDD RSRP Intra frequency case for UE category 0 | 1749 |
| A.9.1.41.1 | Test Purpose and Environment | 1749 |
| A.9.1.41.2 | Test parameters | 1749 |
| A.9.1.41.3 | Test Requirements..... | 1750 |
| A.9.1.42 | HD-FDD RSRP Intra frequency case for UE category 0..... | 1750 |
| A.9.1.42.1 | Test Purpose and Environment | 1750 |
| A.9.1.42.2 | Test parameters | 1750 |
| A.9.1.42.3 | Test Requirements..... | 1752 |
| A.9.1.43 | TDD RSRP Intra frequency case for UE category 0..... | 1752 |
| A.9.1.43.1 | Test Purpose and Environment | 1752 |
| A.9.1.43.2 | Test parameters | 1752 |
| A.9.1.43.3 | Test Requirements..... | 1753 |
| A.9.1.44 | 4 DL CA PCell in FDD FDD-TDD RSRP for E-UTRAN in Carrier Aggregation | 1753 |
| A.9.1.44.1 | Test Purpose and Environment | 1753 |
| A.9.1.44.2 | Test parameters | 1753 |
| A.9.1.44.3 | Test Requirements..... | 1757 |
| A.9.1.45 | 4 DL CA PCell in TDD FDD-TDD RSRP for E-UTRAN in Carrier Aggregation | 1757 |
| A.9.1.45.1 | Test Purpose and Environment | 1757 |
| A.9.1.45.2 | Test parameters | 1757 |
| A.9.1.45.3 | Test Requirements..... | 1761 |
| A.9.1.46 | 4 DL FDD RSRP for E-UTRAN in Carrier Aggregation | 1761 |
| A.9.1.46.1 | Test Purpose and Environment | 1761 |
| A.9.1.46.2 | Test parameters | 1761 |
| A.9.1.46.3 | Test Requirements..... | 1766 |
| A.9.1.47 | 4 DL TDD RSRP for E-UTRAN in Carrier Aggregation..... | 1766 |
| A.9.1.47.1 | Test Purpose and Environment | 1766 |
| A.9.1.47.2 | Test parameters | 1766 |
| A.9.1.47.3 | Test Requirements..... | 1770 |
| A.9.1.48 | 5 DL FDD-TDD with PCell in FDD RSRP for E-UTRAN in Carrier Aggregation..... | 1771 |
| A.9.1.48.1 | Test Purpose and Environment | 1771 |
| A.9.1.48.2 | Test parameters | 1771 |
| A.9.1.48.3 | Test Requirements..... | 1776 |
| A.9.1.49 | 5 DL FDD-TDD with PCell in TDD RSRP for E-UTRAN in Carrier Aggregation..... | 1777 |
| A.9.1.49.1 | Test Purpose and Environment | 1777 |
| A.9.1.49.2 | Test parameters | 1777 |
| A.9.1.49.3 | Test Requirements..... | 1782 |
| A.9.1.50 | 5 DL FDD RSRP for E-UTRAN in Carrier Aggregation | 1783 |
| A.9.1.50.1 | Test Purpose and Environment | 1783 |
| A.9.1.50.2 | Test parameters | 1783 |
| A.9.1.50.3 | Test Requirements..... | 1787 |
| A.9.1.51 | 5 DL TDD RSRP for E-UTRAN in Carrier Aggregation..... | 1787 |
| A.9.1.51.1 | Test Purpose and Environment | 1787 |
| A.9.1.51.2 | Test parameters | 1787 |
| A.9.1.51.3 | Test Requirements..... | 1790 |
| A.9.1.52 | FD-FDD RSRP Intra frequency case for Cat-M1 UE in CEModeA | 1791 |
| A.9.1.52.1 | Test Purpose and Environment | 1791 |
| A.9.1.52.2 | Test parameters | 1791 |
| A.9.1.52.3 | Test Requirements..... | 1792 |
| A.9.1.52A | FD-FDD RSRP Intra frequency case for Cat-M1 UE for 5MHz Bandwidth in CEModeA | 1793 |
| A.9.1.52A.1 | Test Purpose and Environment | 1793 |
| A.9.1.52A.2 | Test parameters | 1793 |
| A.9.1.52A.3 | Test Requirements..... | 1794 |
| A.9.1.53 | HD-FDD RSRP Intra frequency case for Cat-M1 UE in CEModeA..... | 1794 |
| A.9.1.53.1 | Test Purpose and Environment | 1794 |
| A.9.1.53.2 | Test parameters | 1794 |

| | | |
|-------------|---|------|
| A.9.1.53.3 | Test Requirements..... | 1795 |
| A.9.1.53A | HD-FDD RSRP Intra frequency case for Cat-M1 UE for 5MHz Bandwidth in CEModeA..... | 1795 |
| A.9.1.53A.1 | Test Purpose and Environment | 1795 |
| A.9.1.53A.2 | Test parameters | 1795 |
| A.9.1.53A.3 | Test Requirements..... | 1796 |
| A.9.1.54 | TDD RSRP Intra frequency case for Cat-M1 UE in CEModeA..... | 1796 |
| A.9.1.54.1 | Test Purpose and Environment | 1796 |
| A.9.1.54.2 | Test parameters | 1797 |
| A.9.1.54.3 | Test Requirements..... | 1798 |
| A.9.1.55 | FS3 Intra frequency absolute and relative RSRP accuracies with FDD PCell..... | 1798 |
| A.9.1.55.1 | Test Purpose and Environment | 1798 |
| A.9.1.55.2 | Test parameters | 1798 |
| A.9.1.55.3 | Test Requirements..... | 1801 |
| A.9.1.56 | FS3 Intra frequency absolute and relative RSRP accuracies with TDD PCell | 1801 |
| A.9.1.56.1 | Test Purpose and Environment | 1801 |
| A.9.1.56.2 | Test parameters | 1801 |
| A.9.1.56.3 | Test Requirements..... | 1803 |
| A.9.1.57 | FD-FDD RSRP Intra frequency case for Cat-M1 UE in CEModeB..... | 1803 |
| A.9.1.57.1 | Test Purpose and Environment | 1803 |
| A.9.1.57.2 | Test parameters | 1804 |
| A.9.1.57.3 | Test Requirements..... | 1805 |
| A.9.1.57A | FD-FDD RSRP Intra frequency case for Cat-M1 UE for 5MHz Bandwidth in CEModeB | 1805 |
| A.9.1.57A.1 | Test Purpose and Environment | 1805 |
| A.9.1.57A.2 | Test parameters | 1805 |
| A.9.1.57A.3 | Test Requirements..... | 1806 |
| A.9.1.58 | HD-FDD RSRP Intra frequency case for Cat-M1 UE in CEModeB | 1806 |
| A.9.1.58.1 | Test Purpose and Environment | 1806 |
| A.9.1.58.2 | Test parameters | 1806 |
| A.9.1.58.3 | Test Requirements..... | 1807 |
| A.9.1.58A | HD-FDD RSRP Intra frequency case for Cat-M1 UE for 5MHz Bandwidth in CEModeB..... | 1807 |
| A.9.1.58A.1 | Test Purpose and Environment | 1807 |
| A.9.1.58A.2 | Test parameters | 1808 |
| A.9.1.58A.3 | Test Requirements..... | 1808 |
| A.9.1.59 | TDD RSRP Intra frequency case for Cat-M1 UE in CEModeB..... | 1809 |
| A.9.1.59.1 | Test Purpose and Environment | 1809 |
| A.9.1.59.2 | Test parameters | 1809 |
| A.9.1.59.3 | Test Requirements..... | 1810 |
| A.9.1.60 | FS3 Absolute and relative CSI-RSRP accuracies in CSI-RS based discovery signal with FDD PCell.. | 1810 |
| A.9.1.60.1 | Test Purpose and Environment | 1810 |
| A.9.1.60.2 | Test parameters | 1810 |
| A.9.1.60.3 | Test Requirements..... | 1812 |
| A.9.1.61 | FS3 Absolute and relative CSI-RSRP accuracies for in CSI-RS based discovery signal with TDD PCell | 1812 |
| A.9.1.61.1 | Test Purpose and Environment | 1812 |
| A.9.1.61.2 | Test parameters | 1812 |
| A.9.1.61.3 | Test Requirements..... | 1814 |
| A.9.2 | RSRQ | 1814 |
| A.9.2.1 | FDD Intra frequency case | 1814 |
| A.9.2.1.1 | Test Purpose and Environment | 1814 |
| A.9.2.1.2 | Test parameters | 1815 |
| A.9.2.1.3 | Test Requirements..... | 1816 |
| A.9.2.2 | TDD Intra frequency case..... | 1816 |
| A.9.2.2.1 | Test Purpose and Environment | 1816 |
| A.9.2.2.2 | Test parameters | 1816 |
| A.9.2.2.3 | Test Requirements..... | 1818 |
| A.9.2.3 | FDD—FDD Inter frequency case | 1818 |
| A.9.2.3.1 | Test Purpose and Environment | 1818 |
| A.9.2.3.2 | Test parameters | 1818 |
| A.9.2.3.3 | Test Requirements..... | 1819 |
| A.9.2.4 | TDD—TDD Inter frequency case..... | 1819 |
| A.9.2.4.1 | Test Purpose and Environment | 1819 |
| A.9.2.4.2 | Test parameters | 1819 |

| | | |
|------------|--|------|
| A.9.2.4.3 | Test Requirements..... | 1821 |
| A.9.2.4A | FDD—TDD Inter frequency case..... | 1822 |
| A.9.2.4A.1 | Test Purpose and Environment | 1822 |
| A.9.2.4A.2 | Test parameters | 1822 |
| A.9.2.4A.3 | Test Requirements..... | 1824 |
| A.9.2.5 | FDD RSRQ for E-UTRA Carrier Aggregation..... | 1824 |
| A.9.2.5.1 | Test Purpose and Environment | 1824 |
| A.9.2.5.2 | Test parameters | 1824 |
| A.9.2.5.3 | Test Requirements..... | 1825 |
| A.9.2.6 | TDD RSRQ for E-UTRA Carrier Aggregation | 1826 |
| A.9.2.6.1 | Test Purpose and Environment | 1826 |
| A.9.2.6.2 | Test parameters | 1826 |
| A.9.2.6.3 | Test Requirements..... | 1827 |
| A.9.2.7 | FDD RSRQ under Time Domain Measurement Resource Restriction with Non-MBSFN ABS..... | 1827 |
| A.9.2.7.1 | Test Purpose and Environment | 1827 |
| A.9.2.7.2 | Test parameters | 1828 |
| A.9.2.7.3 | Test Requirements..... | 1830 |
| A.9.2.8 | TDD RSRQ under Time Domain Measurement Resource Restriction with Non-MBSFN ABS | 1830 |
| A.9.2.8.1 | Test Purpose and Environment | 1830 |
| A.9.2.8.2 | Test parameters | 1830 |
| A.9.2.8.3 | Test Requirements..... | 1832 |
| A.9.2.9 | FDD RSRQ under Time Domain Measurement Resource Restriction with MBSFN ABS..... | 1832 |
| A.9.2.9.1 | Test Purpose and Environment | 1832 |
| A.9.2.9.2 | Test parameters | 1832 |
| A.9.2.9.3 | Test Requirements..... | 1835 |
| A.9.2.10 | TDD Intra frequency case under time domain measurement resource restriction with MBSFN ABS ... | 1835 |
| A.9.2.10.1 | Test Purpose and Environment | 1835 |
| A.9.2.10.2 | Test parameters | 1835 |
| A.9.2.10.3 | Test Requirements..... | 1837 |
| A.9.2.11 | FDD RSRQ for E-UTRA Carrier Aggregation (20MHz bandwidth) | 1837 |
| A.9.2.11.1 | Test Purpose and Environment | 1837 |
| A.9.2.11.2 | Test parameters | 1837 |
| A.9.2.11.3 | Test Requirements..... | 1838 |
| A.9.2.12 | TDD RSRQ for E-UTRA Carrier Aggregation (20MHz bandwidth)..... | 1838 |
| A.9.2.12.1 | Test Purpose and Environment | 1838 |
| A.9.2.12.2 | Test parameters | 1838 |
| A.9.2.12.3 | Test Requirements..... | 1839 |
| A.9.2.13 | Void | 1839 |
| A.9.2.14 | Void | 1839 |
| A.9.2.15 | FDD RSRQ under Time Domain Measurement Resource Restriction with CRS Assistance Information and Non-MBSFN ABS | 1839 |
| A.9.2.15.1 | Test Purpose and Environment | 1839 |
| A.9.2.15.2 | Test parameters | 1839 |
| A.9.2.15.3 | Test Requirements..... | 1842 |
| A.9.2.16 | TDD RSRQ under Time Domain Measurement Resource Restriction with CRS Assistance Information and Non-MBSFN ABS | 1842 |
| A.9.2.16.1 | Test Purpose and Environment | 1842 |
| A.9.2.16.2 | Test parameters | 1842 |
| A.9.2.16.3 | Test Requirements..... | 1844 |
| A.9.2.17 | FDD Intra frequency case for 5 MHz bandwidth..... | 1845 |
| A.9.2.17.1 | Test Purpose and Environment | 1845 |
| A.9.2.17.2 | Test parameters | 1845 |
| A.9.2.17.3 | Test Requirements..... | 1846 |
| A.9.2.18 | FDD—FDD Inter frequency case for 5MHz bandwidth..... | 1846 |
| A.9.2.18.1 | Test Purpose and Environment | 1846 |
| A.9.2.18.2 | Test parameters | 1846 |
| A.9.2.18.3 | Test Requirements..... | 1847 |
| A.9.2.19 | FDD-FDD Inter Frequency WB-RSRQ..... | 1848 |
| A.9.2.19.1 | Test Purpose and Environment | 1848 |
| A.9.2.19.2 | Test parameters | 1848 |
| A.9.2.19.3 | Test Requirements..... | 1849 |
| A.9.2.20 | TDD—TDD Inter Frequency WB-RSRQ..... | 1849 |

| | | |
|------------|--|------|
| A.9.2.20.1 | Test Purpose and Environment | 1849 |
| A.9.2.20.2 | Test parameters | 1849 |
| A.9.2.20.3 | Test Requirements..... | 1850 |
| A.9.2.21 | FDD RSRQ for E-UTRAN Carrier Aggregation for 10MHz+5MHz..... | 1850 |
| A.9.2.21.1 | Test Purpose and Environment | 1850 |
| A.9.2.21.2 | Test parameters | 1851 |
| A.9.2.21.3 | Test Requirements..... | 1852 |
| A.9.2.22 | TDD RSRQ for E-UTRAN Carrier Aggregation for 10MHz+5MHz | 1852 |
| A.9.2.22.1 | Test Purpose and Environment | 1853 |
| A.9.2.22.2 | Test parameters | 1853 |
| A.9.2.22.3 | Test Requirements..... | 1853 |
| A.9.2.23 | FDD RSRQ for E-UTRA Carrier Aggregation (5MHz + 5MHz bandwidth)..... | 1853 |
| A.9.2.23.1 | Test Purpose and Environment | 1853 |
| A.9.2.23.2 | Test parameters | 1853 |
| A.9.2.23.3 | Test Requirements..... | 1855 |
| A.9.2.24 | TDD RSRQ for E-UTRA Carrier Aggregation (5MHz + 5MHz bandwidth)..... | 1855 |
| A.9.2.24.1 | Test Purpose and Environment | 1855 |
| A.9.2.24.2 | Test parameters | 1855 |
| A.9.2.24.3 | Test Requirements..... | 1856 |
| A.9.2.25 | RSRQ for E-UTRAN TDD-FDD Carrier Aggregation with PCell in FDD | 1856 |
| A.9.2.25.1 | Test Purpose and Environment | 1856 |
| A.9.2.25.2 | Test parameters | 1856 |
| A.9.2.25.3 | Test Requirements..... | 1858 |
| A.9.2.26 | RSRQ for E-UTRAN TDD-FDD Carrier Aggregation with PCell in TDD | 1858 |
| A.9.2.26.1 | Test Purpose and Environment | 1858 |
| A.9.2.26.2 | Test parameters | 1859 |
| A.9.2.26.3 | Test Requirements..... | 1861 |
| A.9.2.27 | TDD RSRQ for E-UTRAN Carrier Aggregation for 20MHz+10MHz | 1861 |
| A.9.2.27.1 | Test Purpose and Environment | 1861 |
| A.9.2.27.2 | Test parameters | 1861 |
| A.9.2.27.3 | Test Requirements..... | 1862 |
| A.9.2.28 | FDD intra-frequency absolute RSRQ accuracy with CRS based discovery signal..... | 1862 |
| A.9.2.28.1 | Test Purpose and Environment | 1862 |
| A.9.2.28.2 | Test parameters | 1862 |
| A.9.2.28.3 | Test Requirements..... | 1863 |
| A.9.2.29 | TDD intra-frequency absolute RSRQ accuracy with CRS based discovery signal | 1864 |
| A.9.2.29.1 | Test Purpose and Environment | 1864 |
| A.9.2.29.2 | Test parameters | 1864 |
| A.9.2.29.3 | Test Requirements..... | 1865 |
| A.9.2.30 | FDD-FDD inter-frequency absolute and relative RSRQ accuracies with CRS based discovery signal . | 1865 |
| A.9.2.30.1 | Test Purpose and Environment | 1865 |
| A.9.2.30.2 | Test parameters | 1865 |
| A.9.2.30.3 | Test Requirements..... | 1867 |
| A.9.2.31 | TDD-TDD inter-frequency absolute and relative RSRQ accuracies with CRS based discovery signal . | 1867 |
| A.9.2.31.1 | Test Purpose and Environment | 1867 |
| A.9.2.31.2 | Test parameters | 1867 |
| A.9.2.31.3 | Test Requirements..... | 1868 |
| A.9.2.32 | FDD absolute and relative RSRQ accuracy for E-UTRAN Carrier Aggregation in CRS based discovery signal | 1868 |
| A.9.2.32.1 | Test Purpose and Environment | 1868 |
| A.9.2.32.2 | Test parameters | 1868 |
| A.9.2.32.3 | Test Requirements..... | 1870 |
| A.9.2.33 | TDD absolute and relative RSRQ accuracy for E-UTRAN Carrier Aggregation in CRS based discovery signal | 1870 |
| A.9.2.33.1 | Test Purpose and Environment | 1870 |
| A.9.2.33.2 | Test parameters | 1870 |
| A.9.2.33.3 | Test Requirements..... | 1872 |
| A.9.2.34 | FDD—FDD Inter frequency new RSRQ | 1872 |
| A.9.2.34.1 | Test Purpose and Environment | 1872 |
| A.9.2.34.2 | Test parameters | 1872 |
| A.9.2.34.3 | Test Requirements..... | 1873 |
| A.9.2.35 | TDD—TDD Inter frequency new RSRQ..... | 1873 |

| | | |
|------------|--|------|
| A.9.2.35.1 | Test Purpose and Environment | 1873 |
| A.9.2.35.2 | Test parameters | 1874 |
| A.9.2.35.3 | Test Requirements..... | 1875 |
| A.9.2.36 | FDD—FDD Inter frequency RSRQ measured on all OFDM symbols..... | 1875 |
| A.9.2.36.1 | Test Purpose and Environment | 1875 |
| A.9.2.36.2 | Test parameters | 1875 |
| A.9.2.36.3 | Test Requirements..... | 1876 |
| A.9.2.37 | TDD—TDD Inter frequency RSRQ measurement on all OFDM symbols | 1876 |
| A.9.2.37.1 | Test Purpose and Environment | 1876 |
| A.9.2.37.2 | Test parameters | 1876 |
| A.9.2.37.3 | Test Requirements..... | 1877 |
| A.9.2.38 | 3 DL PCell in FDD RSRQ for E-UTRAN in Carrier Aggregation..... | 1878 |
| A.9.2.38.1 | Test Purpose and Environment | 1878 |
| A.9.2.38.2 | Test parameters | 1878 |
| A.9.2.38.3 | Test Requirements..... | 1880 |
| A.9.2.39 | 3 DL PCell in TDD RSRQ for E-UTRAN in Carrier Aggregation | 1880 |
| A.9.2.39.1 | Test Purpose and Environment | 1880 |
| A.9.2.39.2 | Test parameters | 1880 |
| A.9.2.39.3 | Test Requirements..... | 1883 |
| A.9.2.40 | 3 DL FDD RSRQ for E-UTRAN in Carrier Aggregation | 1883 |
| A.9.2.40.1 | Test Purpose and Environment | 1883 |
| A.9.2.40.2 | Test parameters | 1883 |
| A.9.2.40.3 | Test Requirements..... | 1885 |
| A.9.2.41 | 3 DL TDD RSRQ for E-UTRAN in Carrier Aggregation | 1885 |
| A.9.2.41.1 | Test Purpose and Environment | 1885 |
| A.9.2.41.2 | Test parameters | 1885 |
| A.9.2.41.3 | Test Requirements..... | 1887 |
| A.9.2.42 | FD-FDD RSRQ Intra frequency case for UE category 0..... | 1887 |
| A.9.2.42.1 | Test Purpose and Environment | 1887 |
| A.9.2.42.2 | Test parameters | 1887 |
| A.9.2.42.3 | Test Requirements..... | 1889 |
| A.9.2.43 | HD-FDD RSRQ Intra frequency case for UE category 0 | 1889 |
| A.9.2.43.1 | Test Purpose and Environment | 1889 |
| A.9.2.43.2 | Test parameters | 1889 |
| A.9.2.43.3 | Test Requirements..... | 1890 |
| A.9.2.44 | TDD RSRQ Intra frequency case for UE category 0..... | 1890 |
| A.9.2.44.1 | Test Purpose and Environment | 1890 |
| A.9.2.44.2 | Test parameters | 1891 |
| A.9.2.44.3 | Test Requirements..... | 1892 |
| A.9.2.45 | 4 DL CA PCell in FDD FDD-TDD RSRQ for E-UTRAN in Carrier Aggregation..... | 1892 |
| A.9.2.45.1 | Test Purpose and Environment | 1892 |
| A.9.2.45.2 | Test parameters | 1892 |
| A.9.2.45.3 | Test Requirements..... | 1895 |
| A.9.2.46 | 4 DL CA PCell in TDD TDD-FDD RSRQ for E-UTRAN in Carrier Aggregation | 1895 |
| A.9.2.46.1 | Test Purpose and Environment | 1895 |
| A.9.2.46.2 | Test parameters | 1895 |
| A.9.2.46.3 | Test Requirements..... | 1898 |
| A.9.2.47 | 5 DL FDD-TDD with PCell in FDD RSRQ for E-UTRAN in Carrier Aggregation | 1898 |
| A.9.2.47.1 | Test Purpose and Environment | 1898 |
| A.9.2.47.2 | Test parameters | 1899 |
| A.9.2.47.3 | Test Requirements..... | 1901 |
| A.9.2.48 | 5 DL FDD-TDD with PCell in TDD RSRQ for E-UTRAN in Carrier Aggregation | 1901 |
| A.9.2.48.1 | Test Purpose and Environment | 1901 |
| A.9.2.48.2 | Test parameters | 1901 |
| A.9.2.48.3 | Test Requirements..... | 1904 |
| A.9.2.49 | 5 DL FDD RSRQ for E-UTRAN in Carrier Aggregation | 1904 |
| A.9.2.49.1 | Test Purpose and Environment | 1904 |
| A.9.2.49.2 | Test parameters | 1904 |
| A.9.2.49.3 | Test Requirements..... | 1908 |
| A.9.2.50 | 5 DL TDD RSRQ for E-UTRAN in Carrier Aggregation | 1908 |
| A.9.2.50.1 | Test Purpose and Environment | 1908 |
| A.9.2.50.2 | Test parameters | 1908 |

| | | |
|------------|---|------|
| A.9.2.50.3 | Test Requirements..... | 1911 |
| A.9.2.51 | FS3 Intra frequency absolute and relative RSRQ accuracies with FDD PCell..... | 1912 |
| A.9.2.51.1 | Test Purpose and Environment | 1912 |
| A.9.2.51.2 | Test parameters | 1912 |
| A.9.2.51.3 | Test Requirements..... | 1914 |
| A.9.2.52 | FS3 Intra frequency absolute and relative RSRQ accuracies with TDD PCell..... | 1915 |
| A.9.2.52.1 | Test Purpose and Environment | 1915 |
| A.9.2.52.2 | Test parameters | 1915 |
| A.9.2.52.3 | Test Requirements..... | 1917 |
| A.9.2.53 | 4DL FDD RSRQ for E-UTRAN in Carrier Aggregation | 1917 |
| A.9.2.53.1 | Test Purpose and Environment | 1917 |
| A.9.2.53.2 | Test parameters | 1917 |
| A.9.2.53.3 | Test Requirements..... | 1921 |
| A.9.2.54 | 4DL TDD RSRQ for E-UTRAN in Carrier Aggregation | 1921 |
| A.9.2.54.1 | Test Purpose and Environment | 1921 |
| A.9.2.54.2 | Test parameters | 1921 |
| A.9.2.54.3 | Test Requirements..... | 1924 |
| A.9.3 | UTRAN FDD CPICH RSCP..... | 1925 |
| A.9.3.1 | E-UTRAN FDD..... | 1925 |
| A.9.3.1.1 | Test Purpose and Environment | 1925 |
| A.9.3.1.2 | Parameters..... | 1925 |
| A.9.3.1.3 | Test Requirements..... | 1926 |
| A.9.3.2 | E-UTRAN TDD | 1927 |
| A.9.3.2.1 | Test Purpose and Environment | 1927 |
| A.9.3.2.2 | Parameters..... | 1927 |
| A.9.3.2.3 | Test Requirements..... | 1928 |
| A.9.3.3 | E-UTRAN FDD for 5MHz Bandwidth..... | 1929 |
| A.9.3.3.1 | Test Purpose and Environment | 1929 |
| A.9.3.3.2 | Parameters..... | 1929 |
| A.9.3.3.3 | Test Requirements..... | 1930 |
| A.9.4 | UTRAN FDD CPICH Ec/No | 1930 |
| A.9.4.1 | E-UTRAN FDD..... | 1930 |
| A.9.4.1.1 | Test Purpose and Environment | 1930 |
| A.9.4.1.2 | Parameters..... | 1930 |
| A.9.4.1.3 | Test Requirements..... | 1932 |
| A.9.4.2 | E-UTRAN TDD..... | 1932 |
| A.9.4.2.1 | Test Purpose and Environment | 1932 |
| A.9.4.2.2 | Parameters..... | 1932 |
| A.9.4.2.3 | Test Requirements..... | 1934 |
| A.9.4.3 | E-UTRAN FDD for 5MHz Bandwidth..... | 1935 |
| A.9.4.3.1 | Test Purpose and Environment | 1935 |
| A.9.4.3.2 | Parameters..... | 1935 |
| A.9.4.3.3 | Test Requirements..... | 1936 |
| A.9.5 | UTRAN TDD measurement..... | 1936 |
| A.9.5.1 | P-CCPCH RSCP absolute accuracy for E-UTRAN FDD..... | 1936 |
| A.9.5.1.1 | Test Purpose and Environment | 1936 |
| A.9.5.1.2 | Test parameters | 1936 |
| A.9.5.1.3 | Test Requirements..... | 1937 |
| A.9.5.2 | P-CCPCH RSCP absolute accuracy for E-UTRAN TDD | 1937 |
| A.9.5.2.1 | Test Purpose and Environment | 1937 |
| A.9.5.2.2 | Test parameters | 1938 |
| A.9.5.2.3 | Test Requirements..... | 1939 |
| A.9.6 | GSM Carrier RSSI..... | 1939 |
| A.9.6.1 | E-UTRAN FDD..... | 1939 |
| A.9.6.1.1 | Test Purpose and Environment | 1939 |
| A.9.6.1.2 | Test Requirements..... | 1941 |
| A.9.6.2 | E-UTRAN TDD..... | 1941 |
| A.9.6.2.1 | Test Purpose and Environment | 1941 |
| A.9.6.2.2 | Test Requirements..... | 1942 |
| A.9.7 | UE Rx – Tx Time Difference | 1943 |
| A.9.7.1 | E-UTRAN FDD UE Rx – Tx time difference case..... | 1943 |
| A.9.7.1.1 | Test Purpose and Environment | 1943 |

| | | |
|------------|--|------|
| A.9.7.1.2 | Test parameters | 1943 |
| A.9.7.1.3 | Test Requirements..... | 1944 |
| A.9.7.2 | E-UTRA TDD | 1944 |
| A.9.7.2.1 | Test Purpose and Environment | 1944 |
| A.9.7.2.2 | Test parameters | 1944 |
| A.9.7.2.3 | Test Requirements..... | 1945 |
| A.9.7.3 | E-UTRAN FDD UE Rx–Tx Time Difference under Time-Domain Measurement Resource Restriction with Non-MBSFN ABS | 1946 |
| A.9.7.3.1 | Test Purpose and Environment | 1946 |
| A.9.7.3.2 | Test parameters | 1946 |
| A.9.7.3.3 | Test Requirements..... | 1948 |
| A.9.7.4 | E-UTRAN TDD UE Rx-Tx Time Difference under Time-Domain Measurement Resource Restriction with Non-MBSFN ABS | 1948 |
| A.9.7.4.1 | Test Purpose and Environment | 1948 |
| A.9.7.4.2 | Test Parameters | 1948 |
| A.9.7.4.3 | Test Requirements..... | 1950 |
| A.9.7.5 | E-UTRAN FDD UE Rx–Tx time difference under Time Domain Measurement Resource Restriction with CRS Assistance Information and Non-MBSFN ABS..... | 1950 |
| A.9.7.5.1 | Test Purpose and Environment | 1950 |
| A.9.7.5.2 | Test parameters | 1950 |
| A.9.7.5.3 | Test Requirements..... | 1952 |
| A.9.7.6 | E-UTRAN TDD UE Rx-Tx Time Difference under Time-Domain Measurement Resource Restriction with CRS Assistance Information and Non-MBSFN ABS | 1953 |
| A.9.7.6.1 | Test Purpose and Environment | 1953 |
| A.9.7.6.2 | Test Parameters | 1953 |
| A.9.7.6.3 | Test Requirements..... | 1955 |
| A.9.8 | RSTD..... | 1955 |
| A.9.8.1 | E-UTRAN FDD RSTD intra frequency case..... | 1955 |
| A.9.8.1.1 | Test Purpose and Environment | 1955 |
| A.9.8.1.2 | Test Requirements..... | 1957 |
| A.9.8.2 | E-UTRAN TDD RSTD intra frequency case | 1957 |
| A.9.8.2.1 | Test Purpose and Environment | 1957 |
| A.9.8.2.2 | Test Requirements..... | 1959 |
| A.9.8.3 | E-UTRAN FDD-FDD RSTD inter frequency case | 1959 |
| A.9.8.3.1 | Test Purpose and Environment | 1959 |
| A.9.8.3.2 | Test Requirements..... | 1961 |
| A.9.8.4 | E-UTRAN TDD-TDD RSTD inter frequency case | 1961 |
| A.9.8.4.1 | Test Purpose and Environment | 1961 |
| A.9.8.4.2 | Test Requirements..... | 1963 |
| A.9.8.5 | E-UTRAN FDD RSTD Measurement Accuracy in Carrier Aggregation..... | 1963 |
| A.9.8.5.1 | Test Purpose and Environment | 1963 |
| A.9.8.5.2 | Test Requirements..... | 1965 |
| A.9.8.6 | E-UTRAN TDD RSTD Measurement Accuracy in Carrier Aggregation..... | 1965 |
| A.9.8.6.1 | Test Purpose and Environment | 1965 |
| A.9.8.6.2 | Test Requirements..... | 1967 |
| A.9.8.7 | E-UTRAN FDD RSTD Measurement Accuracy in Carrier Aggregation for 20MHz bandwidth | 1967 |
| A.9.8.7.1 | Test Purpose and Environment | 1967 |
| A.9.8.7.2 | Test Requirements..... | 1968 |
| A.9.8.8 | E-UTRAN TDD RSTD Measurement Accuracy in Carrier Aggregation for 20MHz bandwidth | 1968 |
| A.9.8.8.1 | Test Purpose and Environment | 1968 |
| A.9.8.8.2 | Test Requirements..... | 1969 |
| A.9.8.9 | E-UTRAN FDD RSTD Measurement Accuracy in Carrier Aggregation for 10MHz+5MHz..... | 1969 |
| A.9.8.9.1 | Test Purpose and Environment | 1969 |
| A.9.8.9.2 | Test Requirements..... | 1970 |
| A.9.8.10 | E-UTRAN TDD RSTD Measurement Accuracy in Carrier Aggregation for 10MHz+5MHz | 1970 |
| A.9.8.10.1 | Test Purpose and Environment | 1970 |
| A.9.8.10.2 | Test Requirements..... | 1970 |
| A.9.8.11 | E-UTRAN FDD RSTD Measurement Accuracy in Carrier Aggregation for 5 + 5MHz bandwidth | 1971 |
| A.9.8.11.1 | Test Purpose and Environment | 1971 |
| A.9.8.11.2 | Test Requirements..... | 1971 |
| A.9.8.12 | E-UTRAN TDD RSTD Measurement Accuracy in Carrier Aggregation for 5+5MHz bandwidth..... | 1971 |
| A.9.8.12.1 | Test Purpose and Environment | 1971 |

| | | |
|------------|--|------|
| A.9.8.12.2 | Test Requirements..... | 1972 |
| A.9.8.13 | E-UTRAN TDD RSTD Measurement Accuracy in Carrier Aggregation for 20MHz+10MHz | 1972 |
| A.9.8.13.1 | Test Purpose and Environment | 1972 |
| A.9.8.13.2 | Test Requirements..... | 1973 |
| A.9.8.14 | E-UTRAN FDD RSTD Measurement Accuracy in 3DL Carrier Aggregation | 1973 |
| A.9.8.14.1 | Test Purpose and Environment | 1973 |
| A.9.8.14.2 | Test Requirements..... | 1976 |
| A.9.8.15 | E-UTRAN TDD RSTD Measurement Accuracy in 3DL Carrier Aggregation | 1976 |
| A.9.8.15.1 | Test Purpose and Environment | 1976 |
| A.9.8.15.2 | Test Requirements..... | 1979 |
| A.9.9 | RSRP and RSRQ on the serving cell..... | 1979 |
| A.9.9.1 | FDD Intra frequency serving cell case..... | 1979 |
| A.9.9.1.1 | Test Purpose and Environment | 1979 |
| A.9.9.1.2 | Test parameters | 1979 |
| A.9.9.1.3 | Test Requirements..... | 1981 |
| A.9.9.2 | TDD Intra frequency serving cell case | 1981 |
| A.9.9.2.1 | Test Purpose and Environment | 1981 |
| A.9.9.2.2 | Test parameters | 1981 |
| A.9.9.2.3 | Test Requirements..... | 1982 |
| A.9.10 | SSTD..... | 1982 |
| A.9.10.1 | EUTRAN FDD-FDD SSTD accuracy in asynchronous DC..... | 1982 |
| A.9.10.1.1 | Test Purpose and Environment | 1982 |
| A.9.10.1.2 | Test parameters | 1982 |
| A.9.10.1.3 | Test Requirements..... | 1984 |
| A.9.10.2 | Void | 1984 |
| A.9.10.3 | Void | 1984 |
| A.9.10.4 | Void | 1984 |
| A.9.11 | RSSI | 1984 |
| A.9.11.1 | FS3 average RSSI accuracy case (PCell using FDD) | 1984 |
| A.9.11.1.1 | Test Purpose and Environment | 1984 |
| A.9.11.1.2 | Test parameters | 1984 |
| A.9.11.1.3 | Test Requirements..... | 1986 |
| A.9.11.2 | FS3 average RSSI accuracy case (PCell using TDD)..... | 1986 |
| A.9.11.2.1 | Test Purpose and Environment | 1986 |
| A.9.11.2.2 | Test parameters | 1986 |
| A.9.11.2.3 | Test Requirements..... | 1987 |
| A.9.12 | Channel occupancy..... | 1987 |
| A.9.12.1 | FS3 channel occupancy test (PCell using FDD)..... | 1987 |
| A.9.12.1.1 | Test Purpose and Environment | 1987 |
| A.9.12.1.2 | Test parameters | 1987 |
| A.9.12.1.3 | Test Requirements..... | 1989 |
| A.9.12.2 | FS3 channel occupancy test (PCell using TDD)..... | 1989 |
| A.9.12.2.1 | Test Purpose and Environment | 1989 |
| A.9.12.2.2 | Test parameters | 1989 |
| A.9.12.2.3 | Test Requirements..... | 1991 |
| A.9.13 | RS-SINR | 1991 |
| A.9.13.1 | FDD Intra-Frequency Case | 1991 |
| A.9.13.1.1 | Test Purpose and Environment | 1991 |
| A.9.13.1.2 | Test parameters | 1991 |
| A.9.13.1.3 | Test Requirements..... | 1992 |
| A.9.13.2 | TDD Intra-Frequency Case..... | 1993 |
| A.9.13.2.1 | Test Purpose and Environment | 1993 |
| A.9.13.2.2 | Test parameters | 1993 |
| A.9.13.2.3 | Test Requirements..... | 1994 |
| A.9.13.3 | FDD—FDD Inter frequency case | 1994 |
| A.9.13.3.1 | Test Purpose and Environment | 1994 |
| A.9.13.3.2 | Test parameters | 1994 |
| A.9.13.3.3 | Test Requirements..... | 1997 |
| A.9.13.4 | TDD—TDD Inter frequency case..... | 1997 |
| A.9.13.4.1 | Test Purpose and Environment | 1997 |
| A.9.13.4.2 | Test parameters | 1997 |
| A.9.13.4.3 | Test Requirements..... | 2001 |

| | | |
|------------|--|------|
| A.9.13.5 | FDD—TDD Inter frequency case | 2002 |
| A.9.13.5.1 | Test Purpose and Environment | 2002 |
| A.9.13.5.2 | Test parameters | 2002 |
| A.9.13.5.3 | Test Requirements..... | 2004 |
| A.9.13.6 | TDD—FDD Inter frequency case | 2004 |
| A.9.13.6.1 | Test Purpose and Environment | 2004 |
| A.9.13.6.2 | Test parameters | 2004 |
| A.9.13.6.3 | Test Requirements..... | 2007 |
| A.10 | Proximity-based Services in Any Cell Selection State..... | 2007 |
| A.10.1 | E-UTRAN FDD – UE ProSe Direct Communication Transmission Timing Accuracy Test | 2007 |
| A.10.1.1 | Test Purpose and Environment | 2007 |
| A.10.1.2 | Test Requirements | 2008 |
| A.10.2 | E-UTRAN FDD – Initiation/Cease of SLSS Transmission with ProSe Direct Communication..... | 2009 |
| A.10.2.1 | Test Purpose and Environment | 2009 |
| A.10.2.2 | Test Requirements | 2010 |
| A.10.3 | E-UTRAN FDD – SyncRef UE Selection / Reselection Test | 2010 |
| A.10.3.1 | Test Purpose and Environment | 2010 |
| A.10.3.2 | Test Requirements | 2012 |
| A.10.4 | E-UTRAN FDD – Cell Identification on downlink frequency associated with ProSe frequency (when UE is transmitting for ProSe)..... | 2012 |
| A.10.4.1 | Test Purpose and Environment | 2012 |
| A.10.4.2 | Test Requirements..... | 2014 |

Annex B (normative): Conditions for RRM requirements applicability for operating bands .2015

| | | |
|----------|---|------|
| B.1 | Conditions for E-UTRAN RRC_IDLE state mobility | 2015 |
| B.1.1 | Conditions for measurements of intra-frequency E-UTRAN cells for cell re-selection..... | 2015 |
| B.1.2 | Conditions for measurements of inter-frequency E-UTRAN cells for cell re-selection..... | 2015 |
| B.1.3 | Conditions for measurements of intra-frequency E-UTRAN cells for cell re-selection for UE Category M1 | 2015 |
| B.1.4 | Conditions for measurements of intra-frequency NB-IoT cells for cell re-selection for UE Category NB1 | 2017 |
| B.1.5 | Conditions for measurements of inter-frequency NB-IoT cells for cell re-selection for UE Category NB1 | 2017 |
| B.2 | Conditions for UE Measurements Procedures in RRC_CONNECTED State | 2018 |
| B.2.1 | Conditions for E-UTRAN intra-frequency measurements | 2018 |
| B.2.2 | Conditions for E-UTRAN intra-frequency measurements with autonomous gaps | 2018 |
| B.2.3 | Conditions for E-UTRAN inter-frequency measurements | 2018 |
| B.2.4 | Conditions for E-UTRAN inter-frequency measurements with autonomous gaps | 2019 |
| B.2.5 | Conditions for E-UTRAN OTDOA intra-frequency RSTD Measurements..... | 2019 |
| B.2.6 | Conditions for E-UTRAN OTDOA inter-frequency RSTD Measurements..... | 2020 |
| B.2.7 | Conditions for Measurements of the secondary component carrier with deactivated SCell | 2020 |
| B.2.8 | Conditions for E-UTRAN Intra-Frequency Measurements under Time Domain Measurement Resource Restriction | 2020 |
| B.2.9 | Conditions for E-UTRAN Intra-Frequency Measurements under Time Domain Measurement Resource Restriction with CRS Assistance Information..... | 2021 |
| B.2.10 | Conditions for E-UTRAN intra-frequency discovery signal measurements | 2021 |
| B.2.10.1 | Conditions for E-UTRAN intra-frequency CRS-based measurements..... | 2021 |
| B.2.10.2 | Conditions for E-UTRAN intra-frequency CSI-RS based measurements | 2021 |
| B.2.11 | Conditions for E-UTRAN inter-frequency discovery signal measurements | 2022 |
| B.2.11.1 | Conditions for E-UTRAN inter-frequency CRS-based measurements..... | 2022 |
| B.2.11.2 | Conditions for E-UTRAN inter-frequency CSI-RS based measurements | 2022 |
| B.2.12 | Conditions for E-UTRAN intra-frequency discovery signal measurements under operation with frame structure 3..... | 2023 |
| B.2.13 | Conditions for E-UTRAN inter-frequency discovery signal measurements under operation with frame structure 3 | 2023 |
| B.2.13.1 | Conditions for E-UTRAN inter-frequency CRS-based measurements..... | 2023 |
| B.2.13.2 | Conditions for E-UTRAN inter-frequency CSI-RS based measurements | 2024 |
| B.2.14 | Conditions for E-UTRAN intra-frequency measurements by UE Category M1 | 2024 |
| B.2.15 | Conditions for NB-IoT intra-frequency measurements by UE Category NB1 | 2025 |

| | | |
|----------|--|------|
| B.3 | Conditions for measurements performance requirements for UE | 2026 |
| B.3.1 | Conditions for intra-frequency RSRP and RSRQ Accuracy Requirements | 2026 |
| B.3.2 | Void | 2026 |
| B.3.3 | Conditions for inter-frequency RSRP and RSRQ Accuracy Requirements | 2026 |
| B.3.4 | Conditions for inter-frequency relative RSRP and RSRQ Accuracy Requirements | 2026 |
| B.3.5 | Conditions for UE Rx – Tx time difference | 2027 |
| B.3.6 | Conditions for intra-frequency Reference Signal Time Difference (RSTD) measurements | 2027 |
| B.3.7 | Conditions for inter-frequency RSTD measurements | 2027 |
| B.3.8 | Conditions for Intra-Frequency Relative RSRP Accuracy Requirements | 2027 |
| B.3.9 | Conditions for Intra-Frequency Absolute RSRP and RSRQ Accuracy Requirements under Time Domain Measurement Resource Restriction | 2027 |
| B.3.10 | Conditions for Intra-Frequency Relative RSRP Accuracy Requirements under Time Domain Measurement Resource Restriction | 2028 |
| B.3.11 | Conditions for Intra-Frequency Absolute RSRP and RSRQ Accuracy Requirements under Time Domain Measurement Resource Restriction with CRS Assistance Information | 2028 |
| B.3.12 | Conditions for Intra-Frequency Relative RSRP Accuracy Requirements under Time Domain Measurement Resource Restriction with CRS Assistance Information | 2028 |
| B.3.13 | Conditions for UE Rx–Tx Time Difference Measurement under Time Domain Measurement Resource Restriction with CRS Assistance Information | 2028 |
| B.3.14 | Conditions for Intra-Frequency Absolute Discovery Signal Measurement Accuracy Requirements | 2028 |
| B.3.14.1 | Conditions for Intra-frequency CRS-based measurements | 2028 |
| B.3.14.2 | Conditions for Intra-frequency CSI-RS-based measurements | 2028 |
| B.3.15 | Conditions for Intra-Frequency Relative Discovery Signal Measurement Accuracy Requirements | 2029 |
| B.3.15.1 | Conditions for Intra-frequency CRS-based measurements | 2029 |
| B.3.15.2 | Conditions for Intra-frequency CSI-RS-based measurements | 2029 |
| B.3.16 | Conditions for Inter-Frequency Absolute Discovery Signal Measurement Accuracy Requirements | 2030 |
| B.3.16.1 | Conditions for Inter-frequency CRS-based measurements | 2030 |
| B.3.16.2 | Conditions for Inter-frequency CSI-RS-based measurements | 2030 |
| B.3.17 | Conditions for Inter-Frequency Relative Discovery Signal Measurement Accuracy Requirements | 2030 |
| B.3.17.1 | Conditions for Inter-frequency CRS-based measurements | 2030 |
| B.3.17.2 | Conditions for Inter-frequency CSI-RS-based measurements | 2030 |
| B.3.18 | Conditions for Intra-frequency Absolute RS-SINR Accuracy Requirements | 2030 |
| B.3.19 | Conditions for Inter-frequency Absolute RS-SINR Accuracy Requirements | 2030 |
| B.3.20 | Conditions for Inter-frequency Relative RS-SINR Accuracy Requirements | 2031 |
| B.3.21 | Conditions for Intra-Frequency Absolute Accuracy Requirements for Measurements under Operation with Frame Structure 3 | 2031 |
| B.3.21.1 | Conditions for RSRP measurements | 2031 |
| B.3.21.2 | Conditions for RSRQ measurements | 2031 |
| B.3.21.3 | Conditions for CSI-RSRP measurements | 2031 |
| B.3.22 | Conditions for Intra-Frequency Relative Accuracy Requirements for Measurements under Operation with Frame Structure 3 | 2032 |
| B.3.22.1 | Conditions for RSRP measurements | 2032 |
| B.3.22.2 | Void | 2032 |
| B.3.22.3 | Conditions for CSI-RSRP measurements | 2032 |
| B.3.23 | Conditions for Inter-Frequency Absolute Accuracy Requirements for Measurements under Operation with Frame Structure 3 | 2032 |
| B.3.23.1 | Conditions for RSRP measurements | 2032 |
| B.3.23.2 | Conditions for RSRQ measurements | 2032 |
| B.3.23.3 | Conditions for CSI-RSRP measurements | 2033 |
| B.3.24 | Conditions for Inter-Frequency Relative Accuracy Requirements for Measurements under Operation with Frame Structure 3 | 2033 |
| B.3.24.1 | Conditions for RSRP measurements | 2033 |
| B.3.24.2 | Conditions for RSRQ measurements | 2033 |
| B.3.24.3 | Conditions for CSI-RSRP measurements | 2033 |
| B.3.25 | Conditions for NB-IoT intra-frequency Absolute NRSRP and NRSRQ Accuracy Requirements for UE Category NB1 | 2033 |
| B.3.26 | Conditions for NB-IoT inter-frequency Absolute NRSRP and NRSRQ Accuracy Requirements for UE Category NB1 | 2033 |
| B.3.27 | Conditions for intra-frequency RSRP and RSRQ Accuracy Requirements for Category 0 | 2034 |
| B.3.28 | Conditions for Intra-Frequency Relative RSRP Accuracy Requirements for Category 0 | 2034 |
| B.4 | RRM Requirements Exceptions | 2034 |

B.4.1 General2034

B.4.2 Receiver sensitivity relaxation for UE supporting CA2034

B.4.3 Receiver sensitivity relaxation for UE configured with CA2035

B.4.3.1 Inter-band carrier aggregation.....2035

B.4.3.2 Intra-band non-contiguous carrier aggregation2035

B.4.3.3 Inter-band carrier aggregation with operating bands without uplink band2035

B.5 Conditions for Measurement Performance Requirements for ProSe UE2035

B.5.1 Conditions for S-RSRP Accuracy Requirements2035

B.5.2 Conditions for Relative S-RSRP Accuracy Requirements2036

B.5.3 Conditions for Selection/Reselection to Intra-frequency SyncRef UE.....2036

B.5.4 Conditions for SD-RSRP Accuracy Requirements2037

B.5.5 Conditions for Relative SD-RSRP Accuracy Requirements2037

Annex C (informative): Change history:.....2038

History2083

Foreword

This Technical Specification has been produced by the 3rd Generation Partnership Project (3GPP).

The contents of the present document are subject to continuing work within the TSG and may change following formal TSG approval. Should the TSG modify the contents of the present document, it will be re-released by the TSG with an identifying change of release date and an increase in version number as follows:

Version x.y.z

where:

- x the first digit:
 - 1 presented to TSG for information;
 - 2 presented to TSG for approval;
 - 3 or greater indicates TSG approved document under change control.
- y the second digit is incremented for all changes of substance, i.e. technical enhancements, corrections, updates, etc.
- z the third digit is incremented when editorial only changes have been incorporated in the document.

1 Scope

The present document specifies requirements for support of Radio Resource Management for the FDD and TDD modes of Evolved UTRA. These requirements include requirements on measurements in UTRAN and the UE as well as requirements on node dynamical behaviour and interaction, in terms of delay and response characteristics.

2 References

The following documents contain provisions which, through reference in this text, constitute provisions of the present document.

- References are either specific (identified by date of publication, edition number, version number, etc.) or non-specific.
- For a specific reference, subsequent revisions do not apply.
- For a non-specific reference, the latest version applies. In the case of a reference to a 3GPP document (including a GSM document), a non-specific reference implicitly refers to the latest version of that document *in the same Release as the present document*.

- [1] 3GPP TS 36.304: "Evolved Universal Terrestrial Radio Access (E-UTRA); User Equipment (UE) procedures in idle mode"
- [2] 3GPP TS 36.331: "Evolved Universal Terrestrial Radio Access (E-UTRA); Radio Resource Control (RRC) protocol specification".
- [3] 3GPP TS 36.213: "Evolved Universal Terrestrial Radio Access (E-UTRA); Physical layer procedures"
- [4] 3GPP TS 36.214: "Evolved Universal Terrestrial Radio Access (E-UTRA); Physical layer; Measurements"
- [5] 3GPP TS 36.101: "Evolved Universal Terrestrial Radio Access (E-UTRA); User Equipment (UE) radio transmission and reception"
- [6] 3GPP TS 25.302: "Services provided by the Physical Layer".
- [7] 3GPP TS 25.331: "RRC Protocol Specification".
- [8] 3GPP TS 45.008: "Radio subsystem link control".
- [9] 3GPP TS 45.005: "Radio transmission and reception".
- [10] 3GPP TS 45.010: "Radio subsystem synchronization".
- [11] 3GPP2 C.S0024-B: "cdma2000 High Rate Packet Data Air Interface Specification".
- [12] 3GPP2 C.S0002-D: "Physical Layer Standard for cdma2000 Spread Spectrum Systems - Release A".
- [13] 3GPP2 C.S0033-B: "Recommended Minimum Performance Standards for cdma2000 High Rate Packet Data Access Terminal".
- [14] 3GPP2 C.S0011-C: "Recommended Minimum Performance Standards for cdma2000 Spread Spectrum Mobile Stations".
- [15] 3GPP2 C.S0005-D: Upper Layer (Layer 3) Signaling Specification for cdma2000 Spread Spectrum Systems
- [16] 3GPP TS 36.211: "Evolved Universal Terrestrial Radio Access (E-UTRA); Physical Channels and Modulation"

- [17] 3GPP TS 36.321: "Evolved Universal Terrestrial Radio Access (E-UTRA); Medium Access Control (MAC) protocol specification".
- [18] 3GPP TS 25.133: "Requirements for Support of Radio Resource Management (FDD)".
- [19] 3GPP TS 25.123: "Requirements for Support of Radio Resource Management (TDD)".
- [20] 3GPP TS 25.214: "Physical layer procedures (FDD)".
- [21] 3GPP TS 36.212: "Evolved Universal Terrestrial Radio Access (E-UTRA); Multiplexing and channel coding".
- [22] 3GPP TS 36.302: "Evolved Universal Terrestrial Radio Access (E-UTRA); Services provided by the physical layer".
- [23] 3GPP TS 36.521-3: "Evolved Universal Terrestrial Radio Access (E-UTRA); User Equipment (UE) conformance specification; Radio transmission and reception; Part 3: Radio Resource Management conformance testing".
- [24] 3GPP TS 36.355: "Evolved Universal Terrestrial Radio Access (E-UTRA); LTE Positioning Protocol (LPP)".
- [25] 3GPP TS 36.300: "Evolved Universal Terrestrial Radio Access (E-UTRA) and Evolved Universal Terrestrial Radio Access Network (E-UTRAN); Overall description; Stage 2"
- [26] 3GPP TR 21.905: "Vocabulary for 3GPP Specifications".
- [27] 3GPP TS 37.320: "Universal Terrestrial Radio Access (UTRA) and Evolved Universal Terrestrial Radio Access (E-UTRA); Radio measurement collection for Minimization of Drive Tests (MDT); Overall description; Stage 2"
- [28] 3GPP TS 36.423: "Evolved Universal Terrestrial Radio Access Network (E-UTRAN); X2 Application Protocol (X2AP)".
- [29] 3GPP TS 25.101: "UE Radio transmission and reception (FDD)".
- [30] 3GPP TS 36.104: "Evolved Universal Terrestrial Radio Access (E-UTRA); Base Station (BS) radio transmission and reception".
- [31] 3GPP TS 36.306: "Evolved Universal Terrestrial Radio Access (E-UTRA); User Equipment (UE) radio access capabilities".
- [32] IEEE Standard 802.11: Wireless LAN Medium Access Control (MAC) and Physical Layer (PHY) Specifications.
- [33] 3GPP TS 23.303: "Technical Specification Group Services and System Aspects; Proximity-based services (ProSe); Stage 2".
- [34] 3GPP TS 24.008: "Mobile radio interface Layer 3 specification; Core network protocols; Stage 3".

3 Definitions, symbols and abbreviations

3.1 Definitions

For the purposes of the present document, the terms and definitions given in TR 21.905 [26] and the following apply. A term defined in the present document takes precedence over the definition of the same term, if any, in TR 21.905 [26].

Any Cell Selection state: as defined in TS 36.304 [1]

Asynchronous Dual Connectivity: As defined in TS 36.331 [2].

Carrier aggregation: aggregation of two or more component carriers in order to support wider transmission bandwidths TS 36.104 [30].

Dual Connectivity: As defined in TS 36.331 [2].

Extended IDLE-mode DRX: extended DRX cycles in IDLE mode as specified in TS 24.008 [34], where one extended DRX cycle is a time period between two first paging occasions within two consecutive PTWs.

Extended CONNECTED-mode DRX: extended DRX cycles in CONNECTED mode as specified in TS 36.331 [2].

Frame Structure 3: frame structure type 3 as defined in TS 36.211 [16].

High operating band: an operating band with a higher downlink frequency with respect to another, low, operating band.

Inter-band carrier aggregation: carrier aggregation of component carriers in different operating bands TS 36.104 [30].

Intra-band contiguous carrier aggregation: contiguous carriers aggregated in the same operating band TS 36.104 [30].

Intra-band non-contiguous carrier aggregation: non-contiguous carriers aggregated in the same operating band TS 36.104 [30].

IDC autonomous denial subframes: The maximum number of uplink subframes in which the UE is allowed not to transmit E-UTRAN signals when configured with IDC autonomous denial (TS 36.331 [2]).

IDC autonomous denial validity: It is the period over which the autonomous denial subframes are counted (TS 36.331 [2]).

IDC solution: This refers to DRX or IDC autonomous denial configured by eNodeB in response to receiving InDeviceCoexIndication from the UE (TS 36.331 [2]).

Low operating band: an operating band with a lower downlink frequency with respect to another, high, operating band.

Master Cell Group: As defined in TS 36.331 [2].

Master eNB: As defined in TS 36.300 [25]. **MBSFN ABS:** ABS configured in MBSFN-configurable subframe.

NB-IoT Cell: A cell for NB-IoT.

NB-IoT: As defined in TS 36.331 [2].

Non-MBSFN ABS: ABS configured in any downlink subframe.

Normal Performance Group: For UE which supports Increased UE carrier monitoring UTRA or E-UTRA the group of inter-frequency carriers or inter-RAT carriers is divided into two groups. The group which has a better delay performance compared to the other group is referred to as the normal performance group

Paging Time Window: As defined in TS 24.008 [34].

Primary Cell: As defined in TS 36.331 [2].

ProSe Direct Communication: As defined in TS 23.303 [33]

ProSe Direct Discovery: As defined in TS 23.303 [33]

Primary SCell: As defined in TS 36.331 [2].

Primary Secondary Timing Advance Group: Timing Advance Group containing the PSCell.

Primary Timing Advance Group: Timing Advance Group containing the PCell.

Reduced Performance Group: For UE which supports Increased UE carrier monitoring UTRA or E-UTRA the group of inter-frequency carriers or inter-RAT carriers is divided into two groups. The group which has worse delay performance compared to the other group is referred to as the reduced performance group

Secondary Cell: As defined in TS 36.331 [2].

Secondary eNB: As defined in TS 36.300 [25].

Serving Cell: As defined in TS 36.331 [2].

Secondary Cell Group: As defined in TS 36.331 [2].

Secondary Timing Advance Group: As defined in TS 36.331 [2].

Synchronous Dual Connectivity: As defined in TS 36.331 [2].

TDD-FDD carrier aggregation: Carrier aggregation of component carriers in E-UTRA TDD and E-UTRA FDD operating bands TS 36.104 [30].

Timing Advance Group: As defined in TS 36.331 [2].

WLAN RSSI: As defined in TS36.214 [4].

x_RA: x-to-RS EPRE ratio for the channel or physical signal x in all transmitted OFDM symbols not containing RS.

x_RB: x-to-RS EPRE ratio for the channel or physical signal x in all transmitted OFDM symbols containing RS.

3.2 Symbols

For the purposes of the present document, the following symbols apply:

| | |
|-------------------------|---|
| [...] | Values included in square bracket must be considered for further studies, because it means that a decision about that value was not taken. |
| BW_{Channel} | Channel bandwidth, defined in TS 36.101 subclause 3.2 |
| CPICH_Ec | Average energy per PN chip for the CPICH |
| CPICH_Ec/Io | The ratio of the received energy per PN chip for the CPICH to the total received power spectral density at the UE antenna connector. |
| Ec | Average energy per PN chip. |
| \hat{E}_s | Received energy per RE (power normalized to the subcarrier spacing) during the useful part of the symbol, i.e. excluding the cyclic prefix, at the UE antenna connector |
| Io | The total received power density, including signal and interference, as measured at the UE antenna connector. |
| Ioc | The power spectral density (integrated in a noise bandwidth equal to the chip rate and normalized to the chip rate) of a band limited noise source (simulating interference from cells, which are not defined in a test procedure) as measured at the UE antenna connector. |
| Iot | The received power spectral density of the total noise and interference for a certain RE (power integrated over the RE and normalized to the subcarrier spacing) as measured at the UE antenna connector |
| NSCH_RP | Received (linear) average power of the resource elements that carry Narrowband synchronisation signal, measured at the UE antenna connector |
| N_{oc} | The power spectral density of a white noise source (average power per RE normalised to the subcarrier spacing), simulating interference from cells that are not defined in a test procedure, as measured at the UE antenna connector |
| N_{PRS} | Number of consecutive downlink positioning subframes as defined in clause 6.10.4.3 in TS 36.211 |
| n_{PRB} | Physical Resource Block number as defined in clause 3.1 in TS 36.211. |
| N_{TA} | Timing offset between uplink and downlink radio frames at the UE, as defined in clause 3.1 in TS 36.211. |
| $N_{TA \text{ offset}}$ | Fixed timing advance offset, as defined in clause 3.1 in TS 36.211. |
| P_{CMAX} | Configured UE transmitted power as defined in clause 6.2.5 in TS 36.101. |
| $P_{\text{CMAX},c}$ | Configured UE transmitted power on a serving cell <i>c</i> as defined in clause 6.2.5A in TS 36.101. |
| PRP | Received (linear) average power of the resource elements that carry E-UTRA PRS, measured at the UE antenna connector. |
| S | Cell Selection Criterion defined in TS 36.304, subclause 5.2.3.2 for E-UTRAN |
| SCH_Ec/Ior | The ratio of the transmit energy per PN chip of the SCH to the total transmit power spectral density at the UTRA Node B antenna connector |
| SCH_RP | Received (linear) average power of the resource elements that carry E-UTRA synchronisation signal, measured at the UE antenna connector |

| | |
|-------------------------------|--|
| Srxlev | Cell selection RX level, defined in TS 36.304, subclause 5.2.3.2 |
| Squal | Cell selection quality, defined in TS 36.304, subclause 5.2.3.2 |
| Sintersearch | Defined in TS 25.304, subclause 5.2.6.1.5 |
| Sintrasearch | Defined in TS 25.304, subclause 5.2.6.1.5 for UTRAN and in TS 36.304 , subclause 5.2.4.7 for E-UTRAN |
| Snonintrasearch | Defined in TS 36.304 , subclause 5.2.4.7 |
| SsearchRAT | Defined in TS 25.304, subclause 5.2.6.1.5 |
| Thresh _{x, high} | Defined in TS 36.304 , subclause 5.2.4.7 |
| Thresh _{x, low} | Defined in TS 36.304 , subclause 5.2.4.7 |
| Thresh _{servng, low} | Defined in TS 36.304 , subclause 5.2.4.7 |
| T_{PRS} | Cell-specific positioning subframe configuration period as defined in clause 6.10.4.3 in TS 36.211 |
| T _{RE-ESTABLISH-REQ} | The RRC Re-establishment delay requirement, the time between the moment when erroneous CRCs are applied, to when the UE starts to send preambles on the PRACH. |
| Treselection | Defined in TS 25.304, subclause 5.2.6.1.5 |
| Treselection _{RAT} | Defined in TS 36.304 , subclause 5.2.4.7 |
| Treselection _{EUTRA} | Defined in TS 36.304 , subclause 5.2.4.7 |
| Treselection _{UTRA} | Defined in TS 36.304 , subclause 5.2.4.7 |
| Treselection _{GERA} | Defined in TS 36.304 , subclause 5.2.4.7 |
| T _s | Basic time unit, defined in TS 36.211, clause 4 |

3.3 Abbreviations

For the purposes of the present document, the abbreviations given in TR 21.905 [26] and the following apply. An abbreviation defined in the present document takes precedence over the definition of the same abbreviation, if any, in TR 21.905 [26].

| | |
|-------------|---|
| 1x RTT | CDMA2000 1x Radio Transmission Technology |
| ABS | Almost Blank Subframe |
| ARQ | Automatic Repeat Request |
| AP | Access Point |
| AWGN | Additive White Gaussian Noise |
| BCCH | Broadcast Control Channel |
| BCH | Broadcast Channel |
| CA | Carrier Aggregation |
| CC | Component Carrier |
| CCCH SDU | Common Control Channel SDU |
| CE | Coverage Enhancement |
| CGI | Cell Global Identifier |
| CPICH | Common Pilot Channel |
| CPICH Ec/No | CPICH Received energy per chip divided by the power density in the band |
| CRS | Cell-specific Reference Signals |
| C-RNTI | Cell RNTI |
| CSI | Channel-State Information |
| CSI-RS | CSI Reference Signal |
| DC | Dual Connectivity |
| DCCH | Dedicated Control Channel |
| DL | Downlink |
| DMTC | Discovery signal Measurement Timing Configuration |
| DRX | Discontinuous Reception |
| DTCH | Dedicated Traffic Channel |
| DUT | Device Under Test |
| E-CID | Enhanced Cell-ID (positioning method) |
| ECGI | Evolved CGI |
| eDRX_IDLE | Extended IDLE-mode DRX |
| eDRX_CONN | Extended CONNECTED-mode DRX |
| eNB | E-UTRAN NodeB |
| E-SMLC | Enhanced Serving Mobile Location Centre |
| E-UTRA | Evolved UTRA |
| E-UTRAN | Evolved UTRAN |

| | |
|-----------|--|
| FDD | Frequency Division Duplex |
| FS3 | Frame Structure type 3 |
| GERAN | GSM EDGE Radio Access Network |
| GSM | Global System for Mobile communication |
| HARQ | Hybrid Automatic Repeat Request |
| HD-FDD | Half-Duplex FDD |
| HO | Handover |
| HRPD | High Rate Packet Data |
| IDC | In-Device Coexistence |
| IEEE | Institute of Electrical and Electronics Engineers |
| LBT | Listen before talk |
| LPP | LTE Positioning Protocol |
| LWA | LTE-WLAN Aggregation |
| MAC | Medium Access Control |
| MCG | Master Cell Group |
| MeNB | Master eNB |
| MBSFN | Multimedia Broadcast multicast service Single Frequency Network |
| MBSFN ABS | MBSFN Almost Blank Subframe |
| MDT | Minimization of Drive Tests |
| MGRP | Measurement Gap Repetition Period |
| MIB | Master Information Block |
| MPDCCH | MTC Physical Downlink Control Channel |
| NPBCH | Narrowband Physical Broadcast CHannel |
| NPDCCH | Narrowband Physical Downlink Control CHannel |
| NPDSCH | Narrowband Physical Downlink Shared CHannel |
| NPRACH | Narrowband Physical Random Access CHannel |
| NPUSCH | Narrowband Physical Uplink Shared CHannel |
| NPSS | Narrowband Primary Synchronization Signal |
| NRS | Narrowband Reference Signal |
| NRSRP | Narrowband Reference Signal Received Power |
| NRSRQ | Narrowband Reference Signal Received Quality |
| NSCH | Narrowband Synchronization Channel |
| NSSS | Narrowband Secondary Synchronization Signal |
| OCNG | OFDMA Channel Noise Generator |
| OFDM | Orthogonal Frequency Division Multiplexing |
| OFDMA | Orthogonal Frequency Division Multiple Access |
| OTDOA | Observed Time Difference of Arrival |
| PBCH | Physical Broadcast Channel |
| P-CCPCH | Primary Common Control Physical Channel |
| PCell | Primary Cell |
| PCFICH | Physical Control Format Indicator CHannel |
| PDCCH | Physical Downlink Control CHannel |
| PDSCH | Physical Downlink Shared CHannel |
| PHICH | Physical Hybrid-ARQ Indicator CHannel |
| PLMN | Public Land Mobile Network |
| PMCH | Physical Multicast Channel |
| PRACH | Physical Random Access CHannel |
| ProSe | Proximity-based Services |
| PRS | Positioning Reference Signal |
| PSBCH | Physical Sidelink Broadcast CHannel |
| PSCCH | Physical Sidelink Control Channel |
| PSCell | Primary SCell |
| PSS | Primary Synchronization SignalPSSCH Physical Sidelink Shared CHannel |
| psTAG | Primary Secondary Timing Advance Group |
| pTAG | Primary Timing Advance Group |
| PTW | Paging Time Window |
| PUCCH | Physical Uplink Control CHannel |
| PUSCH | Physical Uplink Shared Channel |
| RS-SINR | Reference Signal Signal to Noise and Interference RatioRSCP Received Signal Code Power |
| RSRP | Reference Signal Received Power |
| RSRQ | Reference Signal Received Quality |
| RSSI | Received Signal Strength Indicator |

| | |
|---------|--|
| RSTD | Reference Signal Time Difference |
| QAM | Quadrature Amplitude Modulation |
| RACH | Random Access Channel |
| RAT | Radio Access Technology |
| RNC | Radio Network Controller |
| RNTI | Radio Network Temporary Identifier |
| RRC | Radio Resource Control |
| RRM | Radio Resource Management |
| SCE | Small Cell Enhancement |
| SCH | Synchronization Channel |
| SCell | Secondary Cell |
| SCG | Secondary Cell GroupSDU Service Data Unit |
| SeNB | Secondary eNB |
| SFN | System Frame Number |
| SI | System Information |
| SIB | System Information Block |
| SLSS | SideLink Synchronization Sequence |
| SON | Self Optimized Network |
| SRS | Sounding Reference Signal |
| SSS | Secondary Synchronization Signal |
| SSTD | SFN and subframe time difference |
| sTAG | Secondary Timing Advance Group |
| TAG | Timing Advance Group |
| TDD | Time Division Duplex |
| TP | Transmission Point |
| TTI | Transmission Time Interval |
| UE | User Equipment |
| UL | Uplink |
| UMTS | Universal Mobile Telecommunication System |
| UTRA | Universal Terrestrial Radio Access |
| UTRAN | Universal Terrestrial Radio Access Network |
| WLAN | Wireless Local Area Network |
| WB-RSRQ | Wide Bandwidth RSRQ |

3.4 Test tolerances

The requirements given in the present document make no allowance for measurement uncertainty. The test specification 36.521-3 [23] defines the test tolerances. These test tolerances are individually calculated for each test. The test tolerances are then added to the limits in this specification to create test limits. The measurement results are compared against the test limits as defined by the shared risk principle.

Shared Risk is defined in [ETR 273 Part 1 sub-part 2 clause 6.5].

3.5 Additional notation

3.5.1 Groups of bands

The intention with the band grouping below is to increase the readability of the specification.

Table 3.5.1-1: E-UTRA band groups

| Group | E-UTRA FDD | | E-UTRA TDD | | E-UTRA Frame Structure 3 | |
|-------|---------------------|--|---------------------|------------------------------------|--------------------------|-----------------|
| | Band group notation | Operating bands | Band group notation | Operating bands | Band group notation | Operating bands |
| A | FDD_A | 1, 4, 6, 10, 11, 18, 19, 21, 23, 24, 32 ^{Note 2} , 67 ^{Note 2} | TDD_A | 33, 34, 35, 36, 37, 38, 39, 40, 45 | FS3_A | - |
| B | FDD_B | 65, 66 ^{Note 5} | TDD_B | - | FS3_B | - |
| C | FDD_C | 9, 30 | TDD_C | 42, 43 | FS3_C | - |
| D | FDD_D | 28, 68 | TDD_D | - | FS3_D | - |

| | | | | | | |
|---|-------|--|-------|--------|-------|----------------------|
| E | FDD_E | 2, 5, 7, 27 | TDD_E | 41, 44 | FS3_E | - |
| F | FDD_F | 26 ^{Note 3} | TDD_F | - | FS3_F | - |
| G | FDD_G | 3, 8, 12, 13, 14, 17, 20, 22, 29 ^{Note 2} | TDD_G | - | FS3_G | 46 ^{Note 2} |
| H | FDD_H | 25 | TDD_H | - | FS3_H | - |
| I | FDD_I | - | TDD_I | - | FS3_I | - |
| J | FDD_J | - | TDD_J | - | FS3_J | - |
| K | FDD_K | - | TDD_K | - | FS3_K | - |
| L | FDD_L | - | TDD_L | - | FS3_L | - |
| M | FDD_M | - | TDD_M | - | FS3_M | - |
| N | FDD_N | 31 | TDD_N | - | FS3_N | - |

NOTE 1: The bands within the same group have the same lo conditions in a corresponding requirement in this specification.

NOTE 2: Bands 29, 32, 46, and 67 are used only as SCC for E-UTRA carrier aggregation with other E-UTRA bands.

NOTE 3: The minimum lo condition for Band 26 is reduced by 0.5 dB when the carrier frequency of the assigned E-UTRA channel bandwidth is within 865-894 MHz.

NOTE 4: Void

NOTE 5: The range 2180-2200 MHz of the DL operating band 66 is restricted to E-UTRA operation when carrier aggregation is configured.

NOTE 6: Void

Table 3.5.1-2: Band groups for NB-IoT

| Group | E-UTRA FDD | | E-UTRA TDD | |
|-------|---------------------|---|---------------------|-----------------|
| | Band group notation | Operating bands | Band group notation | Operating bands |
| A | NFDD_A | - | NTDD_A | - |
| B | NFDD_B | - | NTDD_B | - |
| C | NFDD_C | - | NTDD_C | - |
| D | NFDD_D | - | NTDD_D | - |
| E | NFDD_E | - | NTDD_E | - |
| F | NFDD_F | - | NTDD_F | - |
| G | NFDD_G | 1, 2, 3, 5, 8, 12, 13, 17, 18, 19, 20, 26, 28, 66 | NTDD_G | - |
| H | NFDD_H | - | NTDD_H | - |
| I | NFDD_I | - | NTDD_I | - |
| J | NFDD_J | - | NTDD_J | - |
| K | NFDD_K | - | NTDD_K | - |
| L | NFDD_L | - | NTDD_L | - |
| M | NFDD_M | - | NTDD_M | - |
| N | NFDD_N | - | NTDD_N | - |

Table 3.5.1-3: Band groups for Category 0

| Group | E-UTRA FDD | | E-UTRA TDD | |
|-------|---------------------|-----------------|---------------------|-----------------|
| | Band group notation | Operating bands | Band group notation | Operating bands |
| A | FDD-0_A | 4 | TDD-0_A | 39 |
| B | FDD-0_B | - | TDD-0_B | - |
| C | FDD-0_C | - | TDD-0_C | - |
| D | FDD-0_D | - | TDD-0_D | - |
| E | FDD-0_E | 2, 5 | TDD-0_E | 41 |
| F | FDD-0_F | - | TDD-0_F | - |
| G | FDD-0_G | 3, 8, 13, 20 | TDD-0_G | - |
| H | FDD-0_H | - | TDD-0_H | - |
| I | FDD-0_I | - | TDD-0_I | - |
| J | FDD-0_J | - | TDD-0_J | - |
| K | FDD-0_K | - | TDD-0_K | - |
| L | FDD-0_L | - | TDD-0_L | - |
| M | FDD-0_M | - | TDD-0_M | - |
| N | FDD-0_N | - | TDD-0_N | - |

Table 3.5.1-4: Band groups for Category M1

| Group | E-UTRA FDD | | E-UTRA TDD | |
|-------|---------------------|----------------------|---------------------|-----------------|
| | Band group notation | Operating bands | Band group notation | Operating bands |
| A | FDD-M1_A | 1, 4, 11, 18, 19, 21 | TDD-M1_A | 39 |
| B | FDD-M1_B | - | TDD-M1_B | - |
| C | FDD-M1_C | - | TDD-M1_C | - |
| D | FDD-M1_D | 28 | TDD-M1_D | - |
| E | FDD-M1_E | 2, 5, 7, 27 | TDD-M1_E | 41 |
| F | FDD-M1_F | 26 ^{Note 1} | TDD-M1_F | - |
| G | FDD-M1_G | 3, 8, 12, 13, 20 | TDD-M1_G | - |
| H | FDD-M1_H | - | TDD-M1_H | - |
| I | FDD-M1_I | - | TDD-M1_I | - |
| J | FDD-M1_J | - | TDD-M1_J | - |
| K | FDD-M1_K | - | TDD-M1_K | - |
| L | FDD-M1_L | - | TDD-M1_L | - |
| M | FDD-M1_M | - | TDD-M1_M | - |
| N | FDD-M1_N | 31 | TDD-M1_N | - |

NOTE 1: The minimum Io condition for Band 26 is reduced by 0.5 dB when the carrier frequency of the assigned E-UTRA channel bandwidth is within 865-894 MHz.

3.6 General

3.6.1 Applicability of requirements in this specification version

- The requirements for TDD-FDD carrier aggregation are specified for two downlink and one uplink component carriers. The requirements are specified for both cases when the PCell belongs to TDD or FDD.
- All the requirements for intra-band contiguous and non-contiguous CA apply under the assumption of the same uplink-downlink and special subframe configurations [16] in the PCell and SCell.
- All the requirements for inter-band CA apply for the same uplink-downlink and special subframe configurations [16] in the PCell and SCell. Different uplink-downlink and special subframe configurations [16] in the PCell and SCell are supported for inter-band CA for UEs which:
 - do not support simultaneous reception and transmission for inter-band TDD CA specified in TS 36.331 [2], and
 - are compliant to the requirements specified in TS 36.101 for inter-band CA with uplink in one E-UTRA band and without simultaneous Rx/Tx.
- All the inter-frequency requirements and requirements for measurements on deactivated carrier apply for the same uplink-downlink and special subframe configurations [16] in the PCell and SCell. Different uplink-downlink and special subframe configurations [16] in the PCell and SCell are supported for inter-frequency for UEs which:
 - do not support simultaneous reception and transmission for inter-band TDD CA specified in TS 36.331 [2], and are compliant to the requirements specified in TS 36.101 for inter-band CA with uplink in one E-UTRA band and without simultaneous Rx/Tx.
- Requirements for E-UTRA carrier aggregation are applicable for the CA capable UE which has been configured with at least one downlink SCell, but:
 - up to four downlink CCs and up to two uplink CCs for intra-band contiguous carrier aggregation, or
 - up to four downlink CCs and one uplink CCs for inter-band carrier aggregation, or
 - up to two downlink/uplink CCs intra-band contiguous and one downlink/uplink inter-band carrier aggregation, or
 - up to two downlink CCs intra-band contiguous and one downlink inter-band and up to two uplink CCs for inter-band carrier aggregation, or

- up to two downlink CCs intra-band non-contiguous and one downlink inter-band and up to two uplink CCs for inter-band carrier aggregation, or
 - up to three downlink CCs intra-band contiguous and one downlink intra-band non-contiguous and up to two uplink CCs intra-band contiguous for carrier aggregation, or
 - two sub-blocks intra-band non-contiguous with two downlink CCs intra-band contiguous per sub-blocks and up to two uplink CCs intra-band contiguous for carrier aggregation, or
 - two downlink CCs intra-band contiguous and three down link CCs inter-band and one uplink CC for carrier aggregation, or
 - two downlink CCs intra-band contiguous and two downlink CCs intra-band contiguous and one downlink CC inter-band and one uplink CC for carrier aggregation, or
 - up to two downlink CCs and up to two uplink CCs for intra-band non-contiguous carrier aggregation, or
 - up to two downlink CCs and up to two uplink CCs for inter-band carrier aggregation, or
 - up to two downlink CCs intra-band contiguous and one downlink inter-band and one uplink CC for carrier aggregation, or
 - up to two downlink CCs intra-band non-contiguous and one downlink inter-band and one uplink CC for carrier aggregation, or
 - up to two downlink CCs and one uplink CC for intra-band non-contiguous carrier aggregation.
- Requirements for E-UTRA carrier aggregation for discovery signal measurements are applicable for CA capable UE which has been configured with at least one downlink SCell, but:
- up to four downlink CCs and up to two uplink CCs for intra-band contiguous carrier aggregation, or
 - up to four downlink CCs and up to one uplink CCs for inter-band carrier aggregation, or
 - up to two downlink/uplink CCs intra-band contiguous and one downlink/uplink inter-band carrier aggregation, or
 - up to two downlink CCs intra-band contiguous and one downlink inter-band and up to two uplink CCs for inter-band carrier aggregation, or
 - up to two downlink CCs intra-band non-contiguous and one downlink inter-band and up to two uplink CCs for inter-band carrier aggregation, or
 - up to three downlink CCs intra-band contiguous and one downlink intra-band non-contiguous and up to two uplink CCs intra-band contiguous for carrier aggregation, or
 - two sub-blocks intra-band non-contiguous with two downlink CCs intra-band contiguous per sub-blocks and up to two uplink CCs intra-band contiguous for carrier aggregation, or
 - two downlink CCs intra-band contiguous and three down link CCs inter-band and one uplink CC for carrier aggregation, or
 - two downlink CCs intra-band contiguous and two downlink CCs intra-band contiguous and one downlink CC inter-band and one uplink CC for carrier aggregation, or
 - up to two downlink CCs and up to two uplink CCs for intra-band non-contiguous carrier aggregation, or
 - up to two downlink CCs and up to two uplink CCs for inter-band carrier aggregation, or
 - up to two downlink CCs intra-band contiguous and one downlink inter-band and one uplink CC for carrier aggregation, or
 - up to two downlink CCs intra-band non-contiguous and one downlink inter-band and one uplink CC for carrier aggregation, or
 - up to two downlink CCs and one uplink CC for intra-band non-contiguous carrier aggregation.

- Requirements for E-UTRA carrier aggregation, where the PCell is FDD PCell or TDD PCell and the downlink SCell follows the frame structure type 3 [16], are applicable for the CA capable UE, which has been configured with:
 - two downlink CCs for inter-band carrier aggregation and one uplink CC.
- The requirements for UE configured with eDRX_CONN cycle do not apply for CA requirements and dual connectivity requirements.
- The requirements for a UE category 0 are derived assuming UE category 0 [31] and a single antenna receiver.
- The requirements for UE category M1 are derived assuming: DL Category M1 and Uplink Category M1, operation in any LTE system bandwidth but with a channel bandwidth of 1.4 MHz and transmission bandwidth of 6 PRBs in downlink and uplink, and a single antenna receiver. DL UE category M1 and UL UE category M1 are defined in [31].
- The requirements for normal coverage in idle mode shall apply provided the UE category M1 is with the radio condition that $SCH \hat{E}s/Iot \geq -6$ dB and $CRS \hat{E}s/Iot \geq -6$ dB.
- The requirements for enhanced coverage in idle mode shall apply provided the UE category M1 is capable of ce-ModeB [2] and is with the radio condition that $SCH \hat{E}s/Iot \geq -15$ dB and $CRS \hat{E}s/Iot \geq -15$ dB.
- The requirements for CEMode A shall apply provided the UE category M1 is configured with CEMode A, $SCH \hat{E}s/Iot \geq -6$ dB and $CRS \hat{E}s/Iot \geq -6$ dB. The CEMode A and the number of repetition levels for different physical channels are defined in [3].
- The requirements for CEMode B shall apply provided the UE category M1 is configured with CEMode B, $SCH \hat{E}s/Iot \geq -15$ dB and $CRS \hat{E}s/Iot \geq -15$ dB. The CEMode B and the number of repetition levels for different physical channels are defined in [3].
- Requirements for E-UTRA ProSe Direct Discovery and E-UTRA ProSe Direct Communication are applicable for ProSe operation on either the uplink frequency of PCC, or SCC, or a non-serving carrier, but:
 - with ProSe operation limited to one carrier on a given subframe.
- Requirements for interruptions due to ProSe Direct Discovery and/or ProSe Direct Communications specified in clause 7.16.3 apply, but:
 - with configured serving carriers of up to two downlink CCs, unless the UE is configured with reception gap for ProSe operation, and
 - with configured serving carriers of up to two uplink CCs, unless the UE is configured with transmission gap for ProSe operation.
- The requirements for UE category NB1 are derived assuming UE category NB1 and a single antenna receiver. UE category NB1 is defined in [31].
- The requirements for normal coverage shall apply for UE category NB1 provided that the radio condition of its serving cell are: $NSCH \hat{E}s/Iot \geq -6$ dB and $NRS \hat{E}s/Iot \geq -6$ dB.
- The requirements for enhanced coverage shall apply for UE category NB1 provided that the radio condition of its serving cell are: -15 dB $\leq NSCH \hat{E}s/Iot < -6$ dB and -15 dB $\leq NRS \hat{E}s/Iot < -6$ dB.
- The measurement accuracy requirements in section 9.1.22 for intra-frequency and inter-frequency absolute NRSRQ accuracy for UE Category NB1 apply only in idle mode.
- The measurement accuracy requirements in section 9.1.22 for intra-frequency absolute NRSRP accuracy for UE Category NB1 apply in idle and connected mode.
- The measurement accuracy requirements in section 9.1.22 for inter-frequency absolute NRSRP accuracy for UE Category NB1 apply only in idle mode.
- The requirements for non-BL CE UE are derived assuming: DL and UL category other than Category 0/M1/NB1, operation in any LTE system bandwidth but with a channel bandwidth of 1.4 MHz and transmission bandwidth of 6 PRBs in downlink and uplink, when in RRC_IDLE mode camped on a cell acquired using SIB1-BR, or in RRC_CONNECTED configured with CE mode A/B. Non-BL CE UE is defined in TS 36.306 [31].

- The Cat-M1 UE requirements for normal coverage in idle mode shall apply provided the UE is non-BL CE and with the radio condition that the serving cell $SCH \hat{E}s/Iot \geq -6dB$ and $CRS \hat{E}s/Iot \geq -6 dB$.
- The Cat-M1 UE requirements for enhanced coverage in idle mode shall apply provided the UE is non-BL CE capable of ce-ModeB [2] and with the radio condition that the serving cell $-6dB \geq SCH \hat{E}s/Iot \geq -15 dB$ and $-6dB \geq CRS \hat{E}s/Iot \geq -15 dB$.
- The Cat-M1 UE requirements for CEMode A shall apply provided the UE is non-BL CE and is configured with CEModeA, the serving cell $SCH \hat{E}s/Iot \geq -6 dB$ and $CRS \hat{E}s/Iot \geq -6 dB$. The CEMode A and the number of repetition levels for different physical channels are defined in TS 36.213 [3].
- The Cat-M1 UE requirements for CEMode B shall apply provided the UE is non-BL CE and is configured with CEMode B, the serving cell $SCH \hat{E}s/Iot \geq -15 dB$ and $CRS \hat{E}s/Iot \geq -15 dB$. The CEMode B and the number of repetition levels for different physical channels are defined in TS 36.213 [3].
- The requirements for a non-BL CE UE are derived assuming non-BL CE UE [31] and a receiver with two antennas. The non-BL CE UE shall meet the following requirements:
 - Cell selection and re-selection requirements in section 4.7
 - Handover requirements in section 5.5 and 5.6
 - Random access requirements in section 6.2.3
 - RRC Re-establishment requirements in section 6.7
 - RRC Connection Release with Redirection requirements in section 6.8
 - UE transmit timing requirements in section 7.24
 - UE timer accuracy requirements in section 7.26
 - Timing advance requirements in section 7.25
 - Radio link monitoring requirements in section 7.19
 - E-UTRAN intra frequency measurement requirements in section 8.13.2.1 and 8.13.3.1
 - CGI reading requirements in section 8.13.3.1.4, 8.13.3.1.5, and 8.13.3.1.6
 - E-UTRAN E-CID measurement requirements in section 8.13.2.2 and 8.13.3.2
 - Intra-frequency RSRP Accuracy Requirements in section 9.1.21

4 E-UTRAN RRC_IDLE state mobility

4.1 Cell Selection

After a UE has switched on and a PLMN has been selected, the Cell selection process takes place, as described in TS36.304. This process allows the UE to select a suitable cell where to camp on in order to access available services. In this process the UE can use stored information (*Stored information cell selection*) or not (*Initial cell selection*).

4.2 Cell Re-selection

4.2.1 Introduction

The cell reselection procedure allows the UE to select a more suitable cell and camp on it.

When the UE is in either *Camped Normally* state or *Camped on Any Cell* state on a cell, the UE shall attempt to detect, synchronise, and monitor intra-frequency, inter-frequency and inter-RAT cells indicated by the serving cell. For intra-frequency and inter-frequency cells the serving cell may not provide explicit neighbour list but carrier frequency

information and bandwidth information only. UE measurement activity is also controlled by measurement rules defined in TS36.304, allowing the UE to limit its measurement activity.

4.2.2 Requirements

The UE shall search every layer of higher priority at least every $T_{\text{higher_priority_search}} = (60 * N_{\text{layers}})$ seconds when the UE is not configured with eDRX_IDLE cycle, and at least every $T_{\text{higher_priority_search}} = \text{MAX}(60 * N_{\text{layers}}, \text{one eDRX_IDLE cycle})$ when UE is configured with eDRX_IDLE cycle, where N_{layers} is the total number of configured higher priority E-UTRA, UTRA FDD, UTRA TDD, CDMA2000 1x and HRPD carrier frequencies and is additionally increased by one if one or more groups of GSM frequencies is configured as a higher priority.

In the requirements of Section 4.2.2 for the UE capable of CA, the applicable exceptions for side conditions are specified in Annex B, Section B.4.2.

For a UE which supports increased carrier monitoring E-UTRA or increased carrier monitoring UTRA, the reselection performance for different carriers may be configured by higher layers to be either normal or reduced. The following definitions are used in the requirements:

K_{carrier} : Total number of interfrequency carriers in the neighbour cell list

$K_{\text{carrier,normal}} = K_{\text{carrier}} - K_{\text{carrier,reduced}}$: Number of interfrequency carriers to be monitored in the normal performance group

$K_{\text{carrier,normal,FDD}}$: Number of interfrequency FDD carriers to be monitored in the normal performance group

$K_{\text{carrier,normal,TDD}}$: Number of interfrequency TDD carriers to be monitored in the normal performance group

$K_{\text{carrier,reduced}}$: Number of interfrequency carriers to be monitored in the reduced performance group

$N_{\text{UTRA_carrier}}$: Total number of configured UTRA FDD carriers in the neighbour cell list

$N_{\text{UTRA_carrier,normal}} = N_{\text{UTRA_carrier}} - N_{\text{UTRA_carrier,reduced}}$: Number of UTRA FDD carriers to be monitored in the normal performance group

$N_{\text{UTRA_carrier,reduced}}$: Number of UTRA FDD carriers to be monitored in the reduced performance group

$N_{\text{UTRA_carrier_TDD}}$: Total number of configured UTRA TDD carriers in the neighbour cell list

$N_{\text{UTRA_carrier_TDD,normal}} = N_{\text{UTRA_carrier_TDD}} - N_{\text{UTRA_carrier_TDD,reduced}}$: Number of UTRA TDD carriers to be monitored in the normal performance group

$N_{\text{UTRA_carrier_TDD,reduced}}$: Number of UTRA TDD carriers to be monitored in the reduced performance group

The minimum performance requirements for a UE which supports Increased UE carrier monitoring E-UTRA [2, 31] are calculated as defined in section 4.2.2.4 provided that $K_{\text{carrier,normal}} \leq 3$ for a UE capable of either FDD E-UTRA carrier monitoring or TDD E-UTRA carrier monitoring or $K_{\text{carrier,normal}} \leq 6$ for a UE capable of both FDD and TDD E-UTRA carrier monitoring provided $K_{\text{carrier,normal,FDD}} \leq 3$ and $K_{\text{carrier,normal,TDD}} \leq 3$ and the minimum performance requirements for a UE which supports Increased UE carrier monitoring UTRA [2, 31] are calculated as defined in section 4.2.2.5 provided that $N_{\text{UTRA_carrier_normal}} \leq 3$ and $N_{\text{UTRA_carrier_TDD,normal}} \leq 3$. In case the limits for the number of normal performance carriers is exceeded considering the broadcast neighbour cell list and the bands supported by the UE, the UE which supports Increased UE carrier monitoring E-UTRA shall measure at least 3 interfrequency carriers with normal performance and the UE which supports Increased UE carrier monitoring UTRA shall measure at least 3 UTRA carriers with normal performance. For a UE capable of monitoring E-UTRAN FDD and TDD carriers, in case the limits for the number of normal performance carriers is exceeded considering the broadcast neighbour cell list and the bands supported by the UE, the UE shall measure at least 3 FDD and 3 TDD E-UTRAN interfrequency carriers with normal performance. Additionally, reduced performance requirements shall be met for carriers for which the *Reduced measurement performance* IE is indicated, up to the UE measurement capability in section 4.2.2.9a. The minimum performance requirements for a UE which does not support Increased UE carrier monitoring E-UTRA [2,31] are calculated assuming all E-UTRA carriers required to be monitored for such UE, are having normal performance and are in normal performance group, i.e. $K_{\text{carrier,normal}} = K_{\text{carrier}}$ and $K_{\text{carrier,reduced}} = 0$. The minimum performance requirements for a UE which does not support Increased UE carrier monitoring UTRA [2,31] are calculated assuming all UTRA carriers required to be monitored for such UE, are having normal performance and are in normal performance group, i.e. $N_{\text{UTRA_carrier,normal}} = N_{\text{UTRA_carrier}}$, $N_{\text{UTRA_carrier_TDD,normal}} = N_{\text{UTRA_carrier_TDD}}$ and $N_{\text{UTRA_carrier,reduced}} = 0$ and $N_{\text{UTRA_carrier_TDD,reduced}} = 0$. No reduced performance carrier requirement applies to a UE not supporting Increased UE carrier monitoring E-UTRA or UTRA [2,

31]. Capabilities for number of carriers to monitor for a UE which does not support Increased carrier monitoring E-UTRA or Increased carrier monitoring UTRA are specified in section 4.2.2.9

4.2.2.1 Measurement and evaluation of serving cell

The UE shall measure the RSRP and RSRQ level of the serving cell and evaluate the cell selection criterion S defined in [1] for the serving cell at least every DRX cycle.

The UE shall filter the RSRP and RSRQ measurements of the serving cell using at least 2 measurements. Within the set of measurements used for the filtering, at least two measurements shall be spaced by, at least DRX cycle/2.

If the UE is not configured with eDRX_IDLE cycle and has evaluated according to Table 4.2.2.1-1 in N_{serv} consecutive DRX cycles that the serving cell does not fulfil the cell selection criterion S, the UE shall initiate the measurements of all neighbour cells indicated by the serving cell, regardless of the measurement rules currently limiting UE measurement activities. If the UE is configured with eDRX_IDLE cycle and has evaluated according to Table 4.2.2.1-2 in N_{serv} consecutive DRX cycles within a single PTW that the serving cell does not fulfil the cell selection criterion S, the UE shall initiate the measurements of all neighbour cells indicated by the serving cell, regardless of the measurement rules currently limiting UE measurement activities.

If the UE in RRC_IDLE has not found any new suitable cell based on searches and measurements using the intra-frequency, inter-frequency and inter-RAT information indicated in the system information during the time T, the UE shall initiate cell selection procedures for the selected PLMN as defined in [1], where $T=10$ s if the UE is not configured with eDRX_IDLE cycle, and $T=MAX(10$ s, one eDRX_IDLE cycle) if the UE is configured with eDRX_IDLE cycle.

Table 4.2.2.1-1: N_{serv}

| DRX cycle length [s] | N_{serv} [number of DRX cycles] |
|----------------------|-----------------------------------|
| 0.32 | 4 |
| 0.64 | 4 |
| 1.28 | 2 |
| 2.56 | 2 |

Table 4.2.2.1-2: N_{serv} for UE configured with eDRX_IDLE cycle

| eDRX_IDLE cycle length [s] | DRX cycle length [s] | PTW length [s] (number of 1.28s periods) | N_{serv} [number of DRX or eDRX] |
|--|----------------------|--|------------------------------------|
| 5.12 | N/A | N/A | 2 |
| $10.24 \leq \text{eDRX_IDLE cycle length} \leq 2621.44$ | 0.32 | ≥ 1.28 (1) | 2 |
| | 0.64 | ≥ 1.28 (1) | 2 |
| | 1.28 | ≥ 2.56 (2) | 2 |
| | 2.56 | ≥ 5.12 (4) | 2 |
| NOTE 1: The number of DRX cycles in this table is given for the DRX cycles within PTWs. NOTE 2: The eDRX_IDLE cycle lengths are as specified in Section 10.5.5.32 of TS 24.008 [34]. NOTE 3: Number of eDRX cycles when eDRX_IDLE cycle length equals 5.12s, number of DRX cycles otherwise. | | | |

For any requirement in this section, when the UE transitions between any two states when being configured with eDRX_IDLE, being configured with eDRX_IDLE cycle, changing eDRX_IDLE cycle length, or changing PTW configuration, the UE shall meet the transition requirement, which is the less stringent requirement of the two requirements corresponding to the first state and the second state, during the transition time interval which is the time corresponding to the transition requirement. After the transition time interval, the UE has to meet the requirement corresponding to the second state.

4.2.2.2 Void

4.2.2.3 Measurements of intra-frequency E-UTRAN cells

The UE shall be able to identify new intra-frequency cells and perform RSRP and RSRQ measurements of identified intra-frequency cells without an explicit intra-frequency neighbour list containing physical layer cell identities.

The UE shall be able to evaluate whether a newly detectable intra-frequency cell meets the reselection criteria defined in TS36.304 within $T_{\text{detect,EUTRAN_Intra}}$ when that $T_{\text{reselection}}=0$. An intra frequency cell is considered to be detectable according to RSRP, $\text{RSRP } \hat{E}_s/\text{Iot}$, SCH_RP and $\text{SCH } \hat{E}_s/\text{Iot}$ defined in Annex B.1.1

for a corresponding Band.

The UE shall measure RSRP and RSRQ at least every $T_{\text{measure,EUTRAN_Intra}}$ for intra-frequency cells that are identified and measured according to the measurement rules.

The UE shall filter RSRP and RSRQ measurements of each measured intra-frequency cell using at least 2 measurements. Within the set of measurements used for the filtering, at least two measurements shall be spaced by at least $T_{\text{measure,EUTRAN_Intra}}/2$

The UE shall not consider a E-UTRA neighbour cell in cell reselection, if it is indicated as not allowed in the measurement control system information of the serving cell.

For an intra-frequency cell that has been already detected, but that has not been reselected to, the filtering shall be such that the UE shall be capable of evaluating that the intra-frequency cell has met reselection criterion defined [1] within $T_{\text{evaluate,E-UTRAN_intra}}$ when $T_{\text{reselection}} = 0$, provided that the cell is at least 3 dB better ranked. When evaluating cells for reselection, the side conditions for RSRP and SCH apply to both serving and non-serving intra-frequency cells.

If $T_{\text{reselection}}$ timer has a non zero value and the intra-frequency cell is better ranked than the serving cell, the UE shall evaluate this intra-frequency cell for the $T_{\text{reselection}}$ time. If this cell remains better ranked within this duration, then the UE shall reselect that cell.

For UE not configured with eDRX_IDLE cycle, $T_{\text{detect,EUTRAN_Intra}}$, $T_{\text{measure,EUTRAN_Intra}}$ and $T_{\text{evaluate, E-UTRAN_intra}}$ are specified in Table 4.2.2.3-1. For UE configured with eDRX_IDLE cycle, $T_{\text{detect,EUTRAN_Intra}}$, $T_{\text{measure,EUTRAN_Intra}}$ and $T_{\text{evaluate, E-UTRAN_intra}}$ are specified in Table 4.2.2.3-2, where the requirements apply provided that the serving cell is configured with eDRX_IDLE and is the same in all PTWs during any of $T_{\text{detect,EUTRAN_Intra}}$, $T_{\text{measure,EUTRAN_Intra}}$ and $T_{\text{evaluate, E-UTRAN_intra}}$ when multiple PTWs are used.

Table 4.2.2.3-1 : $T_{\text{detect,EUTRAN_Intra}}$, $T_{\text{measure,EUTRAN_Intra}}$ and $T_{\text{evaluate, E-UTRAN_intra}}$

| DRX cycle length [s] | $T_{\text{detect,EUTRAN_Intra}}$ [s] (number of DRX cycles) | $T_{\text{measure,EUTRAN_Intra}}$ [s] (number of DRX cycles) | $T_{\text{evaluate,E-UTRAN_intra}}$ [s] (number of DRX cycles) |
|----------------------|--|---|---|
| 0.32 | 11.52 (36) | 1.28 (4) | 5.12 (16) |
| 0.64 | 17.92 (28) | 1.28 (2) | 5.12 (8) |
| 1.28 | 32(25) | 1.28 (1) | 6.4 (5) |
| 2.56 | 58.88 (23) | 2.56 (1) | 7.68 (3) |

Table 4.2.2.3-2: $T_{\text{detect,EUTRAN_Intra}}$, $T_{\text{measure,EUTRAN_Intra}}$ and $T_{\text{evaluate,E-UTRAN_intra}}$ for UE configured with eDRX_IDLE cycle

| eDRX_IDLE cycle length [s] | DRX cycle length [s] | PTW length [s] (number of 1.28s periods) | $T_{\text{detect,EUTRAN_Intra}}$ [s] (number of DRX or eDRX cycles Note 3) | $T_{\text{measure,EUTRAN_Intra}}$ [s] (number of DRX or eDRX cycles Note 3) | $T_{\text{evaluate,E-UTRAN_intra}}$ [s] (number of DRX or eDRX cycles Note 3) |
|---|----------------------|--|---|--|--|
| 5.12 | N/A | N/A | 117.76 (23) | 5.12 (1) | 10.24 (2) |
| $10.24 \leq$ eDRX_IDLE cycle length ≤ 2621.44 | 0.32 | ≥ 1.28 (1) | $eDRX_cycle_length \times \left\lceil \frac{23}{PTW / DRX_cycle_length} \right\rceil$ | 0.32 (1) | 0.64 (2) |
| | 0.64 | ≥ 1.28 (1) | | 0.64 (1) | 1.28 (2) |

| | | | | | |
|--|------|--------------------|------|----------|----------|
| | 1.28 | ≥ 2.56 (2) | (23) | 1.28 (1) | 2.56 (2) |
| | 2.56 | ≥ 5.12 (4) | | 2.56 (1) | 5.12 (2) |

NOTE 1: The number of DRX cycles in this table is given for the DRX cycles within PTWs.
NOTE 2: The eDRX_IDLE cycle lengths are as specified in Section 10.5.5.32 of TS 24.008 [34].
NOTE 3: Number of eDRX cycles when eDRX_IDLE cycle length equals 5.12s, number of DRX cycles otherwise.

For any requirement in this section, when the UE transitions between any two states when being configured with eDRX_IDLE, being configured with eDRX_IDLE cycle, changing eDRX_IDLE cycle length, or changing PTW configuration, the UE shall meet the transition requirement, which is the less stringent requirement of the two requirements corresponding to the first state and the second state, during the transition time interval which is the time corresponding to the transition requirement. After the transition time interval, the UE has to meet the requirement corresponding to the second state.

4.2.2.4 Measurements of inter-frequency E-UTRAN cells

The UE shall be able to identify new inter-frequency cells and perform RSRP or RSRQ measurements of identified inter-frequency cells if carrier frequency information is provided by the serving cell, even if no explicit neighbour list with physical layer cell identities is provided.

If $S_{rxlev} > S_{nonIntraSearchP}$ and $S_{qual} > S_{nonIntraSearchQ}$ then the UE shall search for inter-frequency layers of higher priority at least every $T_{higher_priority_search}$ where $T_{higher_priority_search}$ is described in clause 4.2.2.

If $S_{rxlev} \leq S_{nonIntraSearchP}$ or $S_{qual} \leq S_{nonIntraSearchQ}$ then the UE shall search for and measure inter-frequency layers of higher, equal or lower priority in preparation for possible reselection. In this scenario, the minimum rate at which the UE is required to search for and measure higher priority layers shall be the same as that defined below.

If the UE is not configured with eDRX_IDLE cycle or configured with an eDRX_IDLE cycle not longer than 20.48 s, the UE shall be able to evaluate whether a newly detectable inter-frequency cell in normal performance group meets the reselection criteria defined in TS36.304 within $K_{carrier,normal} * T_{detect,EUTRAN_Inter}$, and able to evaluate whether a newly detectable inter-frequency cell in reduced performance group meets the reselection criteria defined in TS36.304 within $6 * K_{carrier,reduced} * T_{detect,EUTRAN_Inter}$ if at least carrier frequency information is provided for inter-frequency neighbour cells by the serving cells when $T_{reselection} = 0$ provided that the reselection criteria is met by a margin of at least 5dB for reselections based on ranking or 6dB for RSRP reselections based on absolute priorities or 4dB for RSRQ reselections based on absolute priorities. If the UE is configured with eDRX_IDLE cycle longer than 20.48 s, the UE shall be able to evaluate whether a newly detectable inter-frequency cell in normal performance group meets the reselection criteria defined in TS36.304 within $K_{carrier,normal} * T_{detect,EUTRAN_Inter}$, and when $S_{rxlev} < 3$ dB or $S_{qual} < 3$ dB able to evaluate whether a newly detectable inter-frequency cell in reduced performance group meets the reselection criteria defined in TS36.304 within $6 * K_{carrier,reduced} * T_{detect,EUTRAN_Inter}$ if at least carrier frequency information is provided for inter-frequency neighbour cells by the serving cells when $T_{reselection} = 0$ provided that the reselection criteria is met by a margin of at least 5dB for reselections based on ranking or 6dB for RSRP reselections based on absolute priorities or 4dB for RSRQ reselections based on absolute priorities. An inter-frequency cell is considered to be detectable according to RSRP, RSRP \hat{E}_s/I_{ot} , SCH_RP and SCH \hat{E}_s/I_{ot} defined in Annex B.1.2 for a corresponding Band.

When higher priority cells are found by the higher priority search, they shall be measured at least every $T_{measure,E-UTRAN_Inter}$. If, after detecting a cell in a higher priority search, it is determined that reselection has not occurred then the UE is not required to continuously measure the detected cell to evaluate the ongoing possibility of reselection. However, the minimum measurement filtering requirements specified later in this clause shall still be met by the UE before it makes any determination that it may stop measuring the cell. If the UE detects on a E-UTRA carrier a cell whose physical identity is indicated as not allowed for that carrier in the measurement control system information of the serving cell, the UE is not required to perform measurements on that cell.

If the UE is configured with eDRX_IDLE cycle not longer than 20.48 s, the UE shall measure RSRP or RSRQ at least every $K_{carrier,normal} * T_{measure,EUTRAN_Inter}$ for identified lower or equal priority inter-frequency cells in normal performance group, and at least every $6 * K_{carrier,reduced} * T_{measure,EUTRAN_Inter}$ for identified lower or equal priority inter-frequency cells in reduced performance group. If the UE is configured with eDRX_IDLE cycle longer than 20.48 s, the UE shall measure RSRP or RSRQ at least every $K_{carrier,normal} * T_{measure,EUTRAN_Inter}$ for identified lower or equal priority inter-frequency cells in normal performance group, and when $S_{rxlev} < 3$ dB or $S_{qual} < 3$ dB at least every $6 * K_{carrier,reduced} * T_{measure,EUTRAN_Inter}$ for identified lower or equal priority inter-frequency cells in reduced performance group. If the UE detects on a E-UTRA carrier a cell whose physical identity is indicated as not allowed for that carrier in the

measurement control system information of the serving cell, the UE is not required to perform measurements on that cell.

The UE shall filter RSRP or RSRQ measurements of each measured higher, lower and equal priority inter-frequency cell using at least 2 measurements. Within the set of measurements used for the filtering, at least two measurements shall be spaced by at least $T_{\text{measure,E-UTRAN_Inter}}/2$.

The UE shall not consider a E-UTRA neighbour cell in cell reselection, if it is indicated as not allowed in the measurement control system information of the serving cell.

If the UE is configured with eDRX_IDLE cycle not longer than 20.48 s, for an inter-frequency cell that has been already detected, but that has not been reselected to, the filtering shall be such that the UE shall be capable of evaluating that the inter-frequency cell in normal performance group has met reselection criterion defined TS 36.304 within $K_{\text{carrier,normal}} * T_{\text{evaluate,E-UTRAN_Inter}}$, and capable of evaluating that the inter-frequency cell in reduced performance group has met reselection criterion defined TS 36.304 within $6 * K_{\text{carrier,reduced}} * T_{\text{evaluate,E-UTRAN_Inter}}$, when $T_{\text{reselection}} = 0$ provided that the reselection criteria is met by a margin of at least 5dB for reselections based on ranking or 6dB for RSRP reselections based on absolute priorities or 4dB for RSRQ reselections based on absolute priorities. If the UE is configured with eDRX_IDLE cycle longer than 20.48 s, for an inter-frequency cell that has been already detected, but that has not been reselected to, the filtering shall be such that the UE shall be capable of evaluating that the inter-frequency cell in normal performance group has met reselection criterion defined TS 36.304 within $K_{\text{carrier,normal}} * T_{\text{evaluate,E-UTRAN_Inter}}$, and when $S_{\text{rxlev}} < 3$ dB or $S_{\text{qual}} < 3$ dB capable of evaluating that the inter-frequency cell in reduced performance group has met reselection criterion defined TS 36.304 within $6 * K_{\text{carrier,reduced}} * T_{\text{evaluate,E-UTRAN_Inter}}$, when $T_{\text{reselection}} = 0$ provided that the reselection criteria is met by a margin of at least 5dB for reselections based on ranking or 6dB for RSRP reselections based on absolute priorities or 4dB for RSRQ reselections based on absolute priorities. When evaluating cells for reselection, the side conditions for RSRP and SCH apply to both serving and inter-frequency cells.

If $T_{\text{reselection}}$ timer has a non zero value and the inter-frequency cell is better ranked than the serving cell, the UE shall evaluate this inter-frequency cell for the $T_{\text{reselection}}$ time. If this cell remains better ranked within this duration, then the UE shall reselect that cell.

For UE not configured with eDRX_IDLE cycle, $T_{\text{detect,E-UTRAN_Inter}}$, $T_{\text{measure,E-UTRAN_Inter}}$ and $T_{\text{evaluate,E-UTRAN_inter}}$ are specified in Table 4.2.2.4-1. For UE configured with eDRX_IDLE cycle, $T_{\text{detect,E-UTRAN_Inter}}$, $T_{\text{measure,E-UTRAN_Inter}}$ and $T_{\text{evaluate,E-UTRAN_inter}}$ are specified in Table 4.2.2.4-2, where the requirements apply provided that the serving cell is configured with eDRX_IDLE and is the same in all PTWs during any of $T_{\text{detect,E-UTRAN_Inter}}$, $T_{\text{measure,E-UTRAN_Inter}}$ and $T_{\text{evaluate,E-UTRAN_inter}}$ when multiple PTWs are used.

Table 4.2.2.4-1 : $T_{\text{detect,E-UTRAN_Inter}}$, $T_{\text{measure,E-UTRAN_Inter}}$ and $T_{\text{evaluate,E-UTRAN_Inter}}$

| DRX cycle length [s] | $T_{\text{detect,E-UTRAN_Inter}}$ [s] (number of DRX cycles) | $T_{\text{measure,E-UTRAN_Inter}}$ [s] (number of DRX cycles) | $T_{\text{evaluate,E-UTRAN_Inter}}$ [s] (number of DRX cycles) |
|----------------------|---|--|---|
| 0.32 | 11.52 (36) | 1.28 (4) | 5.12 (16) |
| 0.64 | 17.92 (28) | 1.28 (2) | 5.12 (8) |
| 1.28 | 32(25) | 1.28 (1) | 6.4 (5) |
| 2.56 | 58.88 (23) | 2.56 (1) | 7.68 (3) |

Table 4.2.2.4-2: $T_{\text{detect,E-UTRAN_Inter}}$, $T_{\text{measure,E-UTRAN_Inter}}$ and $T_{\text{evaluate,E-UTRAN_inter}}$ for UE configured with eDRX_IDLE cycle

| eDRX_IDLE cycle length [s] | DRX cycle length [s] | PTW length [s] (number of 1.28s periods) | $T_{\text{detect,E-UTRAN_Inter}}$ [s] (number of DRX or eDRX cycles ^{Note 3}) | $T_{\text{measure,E-UTRAN_Inter}}$ [s] (number of DRX or eDRX cycles ^{Note 3}) | $T_{\text{evaluate,E-UTRAN_inter}}$ [s] (number of DRX or eDRX cycles ^{Note 3}) |
|--|----------------------|--|---|---|--|
| 5.12 | N/A | N/A | 117.76 (23) | 5.12 (1) | 10.24 (2) |
| 10.24 ≤ eDRX_IDLE cycle length ≤ 2621.44 | 0.32 | ≥1.28 (1) | $eDRX_cycle_length \times \left\lceil \frac{23}{PTW / DRX_cycle_length} \right\rceil$ | 0.32 (1) | 0.64 (2) |
| | 0.64 | ≥1.28 (1) | | 0.64 (1) | 1.28 (2) |

| | | | | | |
|--|------|--------------------|------|----------|----------|
| | 1.28 | ≥ 2.56 (2) | (23) | 1.28 (1) | 2.56 (2) |
| | 2.56 | ≥ 5.12 (4) | | 2.56 (1) | 5.12 (2) |
| NOTE 1: The number of DRX cycles in this table is given for the DRX cycles within PTWs. | | | | | |
| NOTE 2: The eDRX_IDLE cycle lengths are as specified in Section 10.5.5.32 of TS 24.008 [34]. | | | | | |
| NOTE 3: Number of eDRX cycles when eDRX_IDLE cycle length equals 5.12s, number of DRX cycles otherwise | | | | | |

For higher priority cells, a UE may optionally use a shorter value for $T_{\text{measureE-UTRA_Inter}}$, which shall not be less than $\text{Max}(0.64 \text{ s}, \text{one DRX cycle})$.

For any requirement in this section, when the UE transitions between any two states when being configured with eDRX_IDLE, being configured with eDRX_IDLE cycle, changing eDRX_IDLE cycle length, or changing PTW configuration, the UE shall meet the transition requirement, which is the less stringent requirement of the two requirements corresponding to the first state and the second state, during the transition time interval which is the time corresponding to the transition requirement. After the transition time interval, the UE has to meet the requirement corresponding to the second state.

4.2.2.5 Measurements of inter-RAT cells

If $S_{\text{rxlev}} > S_{\text{nonIntraSearchP}}$ and $S_{\text{qual}} > S_{\text{nonIntraSearchQ}}$ then the UE shall search for inter-RAT layers of higher priority at least every $T_{\text{higher_priority_search}}$ where $T_{\text{higher_priority_search}}$ is described in clause 4.2.2

If $S_{\text{rxlev}} \leq S_{\text{nonIntraSearchP}}$ or $S_{\text{qual}} \leq S_{\text{nonIntraSearchQ}}$ then the UE shall search for and measure inter-RAT layers of higher, lower priority in preparation for possible reselection. In this scenario, the minimum rate at which the UE is required to search for and measure higher priority inter-RAT layers shall be the same as that defined below for lower priority RATs.

For any requirement in this section, when the UE transitions between any two states when being configured with eDRX_IDLE, being configured with eDRX_IDLE cycle, changing eDRX_IDLE cycle length, or changing PTW configuration, the UE shall meet the transition requirement, which is the less stringent requirement of the two requirements corresponding to the first state and the second state, during the transition time interval which is the time corresponding to the transition requirement. After the transition time interval, the UE has to meet the requirement corresponding to the second state.

4.2.2.5.1 Measurements of UTRAN FDD cells

When the measurement rules indicate that UTRA FDD cells are to be measured, the UE shall measure CPICH Ec/Io and CPICH RSCP of detected UTRA FDD cells in the neighbour frequency list at the minimum measurement rate specified in this section. The UE shall filter CPICH Ec/Io and CPICH RSCP measurements of each measured UTRA FDD cell using at least 2 measurements. Within the set of measurements used for the filtering, at least two measurements shall be spaced by at least half the minimum specified measurement period.

If the UE is not configured with eDRX_IDLE cycle or configured with eDRX_IDLE cycle not longer than 20.48 s, the UE shall evaluate whether newly detectable UTRA FDD cells in normal performance group have met the reselection criteria in TS 36.304 within time $N_{\text{UTRA_carrier,normal}} * T_{\text{detectUTRA_FDD}}$, and evaluate whether newly detectable UTRA FDD cells in reduced performance group have met the reselection criteria in TS 36.304 within time $6 * N_{\text{UTRA_carrier,reduced}} * T_{\text{detectUTRA_FDD}}$ when $S_{\text{rxlev}} \leq S_{\text{nonIntraSearchP}}$ or $S_{\text{qual}} \leq S_{\text{nonIntraSearchQ}}$ when $T_{\text{reselectionRAT}} = 0$ provided that the reselection criteria is met by a margin of at least 6dB for reselections based on RSCP, or a margin of at least 3dB for reselections based on Ec/Io. If the UE is configured with eDRX_IDLE cycle longer than 20.48 s, the UE shall evaluate whether newly detectable UTRA FDD cells in normal performance group have met the reselection criteria in TS 36.304 within time $(N_{\text{UTRA_carrier,normal}}) * T_{\text{detectUTRA_FDD}}$, and when $S_{\text{rxlev}} < 3 \text{ dB}$ or $S_{\text{qual}} < 3 \text{ dB}$ evaluate whether newly detectable UTRA FDD cells in reduced performance group have met the reselection criteria in TS 36.304 within time $6 * N_{\text{UTRA_carrier,reduced}} * T_{\text{detectUTRA_FDD}}$ when $S_{\text{rxlev}} \leq S_{\text{nonIntraSearchP}}$ or $S_{\text{qual}} \leq S_{\text{nonIntraSearchQ}}$ when $T_{\text{reselectionRAT}} = 0$ provided that the reselection criteria is met by a margin of at least 6dB for reselections based on RSCP, or a margin of at least 3dB for reselections based on Ec/Io.

If the UE is not configured with eDRX_IDLE cycle or configured with eDRX_IDLE cycle not longer than 20.48 s, cells which have been detected shall be measured at least every $N_{\text{UTRA_carrier,normal}} * T_{\text{measureUTRA_FDD}}$ for the cells in normal performance group, and at least every $6 * N_{\text{UTRA_carrier,reduced}} * T_{\text{measureUTRA_FDD}}$ for the cells in reduced performance group when $S_{\text{rxlev}} \leq S_{\text{nonIntraSearchP}}$ or $S_{\text{qual}} \leq S_{\text{nonIntraSearchQ}}$. If the UE is configured with eDRX_IDLE cycle longer than 20.48 s, cells which have been detected shall be measured at least every $(N_{\text{UTRA_carrier,normal}}) * T_{\text{measureUTRA_FDD}}$ for the cells in

normal performance group, and when $S_{rxlev} < 3$ dB or $S_{qual} < 3$ dB at least every $6 * N_{UTRA_carrier, reduced} * T_{measureUTRA_FDD}$ for the cells in reduced performance group when $S_{rxlev} \leq S_{nonIntraSearchP}$ or $S_{qual} \leq S_{nonIntraSearchQ}$.

When higher priority UTRA FDD cells are found by the higher priority search, they shall be measured at least every $T_{measure,UTRA_FDD}$. If, after detecting a cell in a higher priority search, it is determined that reselection has not occurred then the UE is not required to continuously measure the detected cell to evaluate the ongoing possibility of reselection. However, the minimum measurement filtering requirements specified later in this clause shall still be met by the UE before it makes any determination that it may stop measuring the cell.

If the UE is not configured with eDRX_IDLE cycle or configured with eDRX_IDLE cycle not longer than 20.48 s, for a cell that has been already detected, but that has not been reselected to, the filtering shall be such that the UE shall be capable of evaluating that an already identified UTRA FDD cell has met reselection criterion defined in TS 36.304 [1] within $N_{UTRA_carrier, normal} * T_{evaluateUTRA_FDD}$ if the cell is in normal performance group and within $6 * N_{UTRA_carrier, reduced} * T_{evaluateUTRA_FDD}$ if the cell is in reduced performance group when $T_{reselection} = 0$ provided that the reselection criteria is met by a margin of at least 6dB for reselections based on RSCP, or a margin of at least 3dB for reselections based on Ec/Io. If the UE is configured with eDRX_IDLE cycle longer than 20.48 s, for a cell that has been already detected, but that has not been reselected to, the filtering shall be such that the UE shall be capable of evaluating that an already identified UTRA FDD cell has met reselection criterion defined in TS 36.304 [1] within $(N_{UTRA_carrier, normal}) * T_{evaluateUTRA_FDD}$ if the cell is in normal performance group and when $S_{rxlev} < 3$ dB or $S_{qual} < 3$ dB within $6 * N_{UTRA_carrier, reduced} * T_{evaluateUTRA_FDD}$ if the cell is in reduced performance group when $T_{reselection} = 0$ provided that the reselection criteria is met by a margin of at least 6dB for reselections based on RSCP, or a margin of at least 3dB for reselections based on Ec/Io.

If $T_{reselection}$ timer has a non zero value and the UTRA FDD cell is satisfied with the reselection criteria which are defined in [1], the UE shall evaluate this UTRA FDD cell for the $T_{reselection}$ time. If this cell remains satisfied with the reselection criteria within this duration, then the UE shall reselect that cell.

For UE not configured with eDRX_IDLE cycle, $T_{detectUTRA_FDD}$, $T_{measureUTRA_FDD}$ and $T_{evaluateUTRA_FDD}$ are specified in Table 4.2.2.5.1-1. For UE configured with eDRX_IDLE cycle, $T_{detectUTRA_FDD}$, $T_{measureUTRA_FDD}$ and $T_{evaluateUTRA_FDD}$ are specified in Table 4.2.2.5.1-2, where the requirements apply provided that the serving cell is configured with eDRX_IDLE and is the same in all PTWs during any of $T_{detectUTRA_FDD}$, $T_{measureUTRA_FDD}$ and $T_{evaluateUTRA_FDD}$ when multiple PTWs are used.

Table 4.2.2.5.1-1: $T_{detectUTRA_FDD}$, $T_{measureUTRA_FDD}$, and $T_{evaluateUTRA_FDD}$

| DRX cycle length [s] | $T_{detectUTRA_FDD}$ [s] | $T_{measureUTRA_FDD}$ [s] (number of DRX cycles) | $T_{evaluateUTRA_FDD}$ [s] (number of DRX cycles) |
|----------------------|---------------------------|---|--|
| 0.32 | 30 | 5.12 (16) | 15.36 (48) |
| 0.64 | | 5.12 (8) | 15.36 (24) |
| 1.28 | | 6.4(5) | 19.2 (15) |
| 2.56 | 60 | 7.68 (3) | 23.04 (9) |

Table 4.2.2.5.1-2: $T_{detectUTRA_FDD}$, $T_{measureUTRA_FDD}$ and $T_{evaluateUTRA_FDD}$ for UE configured with eDRX_IDLE cycle

| eDRX_IDLE cycle length [s] | DRX cycle length [s] | PTW length [s] (number of 1.28s periods) | $T_{detectUTRA_FDD}$ [s] (number of DRX or eDRX cycles ^{Note 4}) | $T_{measureUTRA_FDD}$ [s] (number of DRX or eDRX cycles ^{Note 4}) | $T_{evaluateUTRA_FDD}$ [s] (number of DRX or eDRX cycles ^{Note 4}) |
|---|----------------------|--|---|--|---|
| 5.12 | N/A | N/A | 117.76 (23) | 15.36 (3) | 46.08 (9) |
| $10.24 \leq$ eDRX_IDLE cycle length \leq 2621.44 | 0.32 | ≥ 1.28 (1) | Note 3 (23) | 0.96 (3) | Note 3 (9) |
| | 0.64 | ≥ 2.56 (2) | | 1.92 (3) | Note 3 (9) |
| | 1.28 | ≥ 3.84 (3) | | 3.84 (3) | Note 3 (9) |
| | 2.56 | ≥ 7.68 (6) | | 7.68 (3) | Note 3 (9) |

NOTE 1: The number of DRX cycles in this table is given for the DRX cycles within PTWs.
 NOTE 2: The eDRX_IDLE cycle lengths are as specified in Section 10.5.5.32 of TS 24.008 [34].
 NOTE 3: The time is calculated depending on the number N of DRX cycles as follows:

$$eDRX_cycle_length \times \left\lceil \frac{N}{PTW / DRX_cycle_length} \right\rceil$$

NOTE 4: Number of eDRX cycles when eDRX_IDLE cycle length equals 5.12s, number of DRX cycles otherwise.

For higher priority cells, a UE may optionally use a shorter value for $T_{measureUTRA_FDD}$, which shall not be less than $\text{Max}(0.64 \text{ s}, \text{one DRX cycle})$.

4.2.2.5.2 Measurements of UTRAN TDD cells

When the measurement rules indicate that UTRA TDD cells are to be measured, the UE shall measure P-CCPCH RSCP of detected UTRA TDD cells in the neighbour frequency list at the minimum measurement rate specified in this section. The UE shall filter P-CCPCH RSCP measurements of each measured UTRA TDD cell using at least 2 measurements. Within the set of measurements used for the filtering, at least two measurements shall be spaced by at least half the minimum specified measurement period. If the UE is not configured with eDRX_IDLE cycle, P-CCPCH RSCP of UTRAN TDD cells shall not be filtered over a longer period than that specified in table 4.2.2.5.2-1. If the UE is configured with eDRX_IDLE cycle, P-CCPCH RSCP of UTRAN TDD cells shall not be filtered over a longer period than that specified in table 4.2.2.5.2-2.

If the UE is not configured with eDRX_IDLE cycle or configured with eDRX_IDLE cycle not longer than 20.48 s, the UE shall evaluate whether newly detectable UTRA TDD cells in normal performance group have met the reselection criteria in TS 36.304 within time $N_{UTRA_carrier_TDD,normal} * T_{detectUTRA_TDD}$, and evaluate whether newly detectable UTRA TDD cells in reduced performance group have met the reselection criteria in TS 36.304 within time $6 * N_{UTRA_carrier_TDD,reduced} * T_{detectUTRA_TDD}$ when $S_{rxlev} \leq S_{nonIntraSearchP}$ or $S_{qual} \leq S_{nonIntraSearchQ}$ when $T_{reselection} = 0$ provided that the reselection criteria is met by a margin of at least 6dB. If the UE is configured with eDRX_IDLE cycle longer than 20.48 s, the UE shall evaluate whether newly detectable UTRA TDD cells in normal performance group have met the reselection criteria in TS 36.304 within time $(N_{UTRA_carrier_TDD,normal}) * T_{detectUTRA_TDD}$, and when $S_{rxlev} < 3 \text{ dB}$ or $S_{qual} < 3 \text{ dB}$ evaluate whether newly detectable UTRA TDD cells in reduced performance group have met the reselection criteria in TS 36.304 within time $6 * N_{UTRA_carrier_TDD,reduced} * T_{detectUTRA_TDD}$ when $S_{rxlev} \leq S_{nonIntraSearchP}$ or $S_{qual} \leq S_{nonIntraSearchQ}$ when $T_{reselection} = 0$ provided that the reselection criteria is met by a margin of at least 6dB.

If the UE is not configured with eDRX_IDLE cycle or configured with eDRX_IDLE cycle not longer than 20.48 s, cells which have been detected shall be measured at least every $N_{UTRA_carrier_TDD,normal} * T_{measureUTRA_TDD}$ for the cells in normal performance group, and at least every $6 * N_{UTRA_carrier_TDD,reduced} * T_{measureUTRA_TDD}$ for the cells in reduced performance group, when $S_{rxlev} \leq S_{nonIntraSearchP}$ or $S_{qual} \leq S_{nonIntraSearchQ}$. If the UE is configured with eDRX_IDLE cycle longer than 20.48 s, cells which have been detected shall be measured at least every $(N_{UTRA_carrier_TDD,normal}) * T_{measureUTRA_TDD}$ for the cells in normal performance group, and when $S_{rxlev} < 3 \text{ dB}$ or $S_{qual} < 3 \text{ dB}$ at least every $6 * N_{UTRA_carrier_TDD,reduced} * T_{measureUTRA_TDD}$ for the cells in reduced performance group, when $S_{rxlev} \leq S_{nonIntraSearchP}$ or $S_{qual} \leq S_{nonIntraSearchQ}$.

When higher priority UTRA TDD cells are found by the higher priority search, they shall be measured at least every $T_{measure,UTRA_TDD}$. If, after detecting a cell in a higher priority search, it is determined that reselection has not occurred then the UE is not required to continuously measure the detected cell to evaluate the ongoing possibility of reselection. However, the minimum measurement filtering requirements specified later in this clause shall still be met by the UE before it makes any determination that it may stop measuring the cell.

If the UE is not configured with eDRX_IDLE cycle or configured with eDRX_IDLE cycle not longer than 20.48 s, for a cell that has been already detected, but that has not been reselected to, the filtering shall be such that the UE shall be capable of evaluating that an already identified UTRA TDD cell has met reselection criterion defined in [1] within $N_{UTRA_carrier_TDD,normal} * T_{evaluateUTRA_TDD}$ if the cell is in normal performance group and within $6 * N_{UTRA_carrier_TDD,reduced} * T_{evaluateUTRA_TDD}$ if the cell is in reduced performance group when $T_{reselection} = 0$ provided that the reselection criteria is met by a margin of at least 6dB. If the UE is configured with eDRX_IDLE cycle longer than 20.48 s, for a cell that has been already detected, but that has not been reselected to, the filtering shall be such that the UE shall be capable of evaluating that an already identified UTRA TDD cell has met reselection criterion defined in [1] within $(N_{UTRA_carrier_TDD,normal}) * T_{evaluateUTRA_TDD}$ if the cell is in normal performance group and when $S_{rxlev} < 3 \text{ dB}$ or $S_{qual} < 3 \text{ dB}$ within $6 * N_{UTRA_carrier_TDD,reduced} * T_{evaluateUTRA_TDD}$ if the cell is in reduced performance group when $T_{reselection} = 0$ provided that the reselection criteria is met by a margin of at least 6dB.

If $T_{\text{reselection}}$ timer has a non zero value and the UTRA TDD cell is satisfied with the reselection criteria which are defined in [1], the UE shall evaluate this UTRA TDD cell for the $T_{\text{reselection}}$ time. If this cell remains satisfied with the reselection criteria within this duration, then the UE shall reselect that cell.

For UE not configured with eDRX_IDLE cycle, $T_{\text{detectUTRA_TDD}}$, $T_{\text{measureUTRA_TDD}}$ and $T_{\text{evaluateUTRA_TDD}}$ are specified in Table 4.2.2.5.2-1. For UE configured with eDRX_IDLE cycle, $T_{\text{detectUTRA_TDD}}$, $T_{\text{measureUTRA_TDD}}$ and $T_{\text{evaluateUTRA_TDD}}$ are specified in Table 4.2.2.5.2-2, where the requirements apply provided that the serving cell is configured with eDRX_IDLE and is the same in all PTWs during any of $T_{\text{detectUTRA_TDD}}$, $T_{\text{measureUTRA_TDD}}$ and $T_{\text{evaluateUTRA_TDD}}$ when multiple PTWs are used.

Table 4.2.2.5.2-1: $T_{\text{detectUTRA_TDD}}$, $T_{\text{measureUTRA_TDD}}$ and $T_{\text{evaluateUTRA_TDD}}$

| DRX cycle length [s] | $T_{\text{detectUTRA_TDD}}$ [s] | $T_{\text{measureUTRA_TDD}}$ [s] (number of DRX cycles) | $T_{\text{evaluateUTRA_TDD}}$ [s] (number of DRX cycles) |
|----------------------|----------------------------------|--|---|
| 0.32 | 30 | 5.12 (16) | 15.36 (48) |
| 0.64 | | 5.12 (8) | 15.36 (24) |
| 1.28 | | 6.4(5) | 19.2 (15) |
| 2.56 | 60 | 7.68 (3) | 23.04 (9) |

Table 4.2.2.5.2-2: $T_{\text{detectUTRA_TDD}}$, $T_{\text{measureUTRA_TDD}}$ and $T_{\text{evaluateUTRA_TDD}}$ for UE configured with eDRX_IDLE cycle

| eDRX_IDLE cycle length [s] | DRX cycle length [s] | PTW length [s] (number of 1.28s periods) | $T_{\text{detectUTRA_TDD}}$ [s] (number of DRX or eDRX cycles ^{Note 4}) | $T_{\text{measureUTRA_TDD}}$ [s] (number of DRX or eDRX cycles ^{Note 4}) | $T_{\text{evaluateUTRA_TDD}}$ [s] (number of DRX or eDRX cycles ^{Note 4}) |
|---|----------------------|--|--|---|--|
| 5.12 | N/A | N/A | 117.76 (23) | 15.36 (3) | 46.08 (9) |
| $10.24 \leq$ eDRX_IDLE cycle length \leq 2621.44 | 0.32 | ≥ 1.28 (1) | Note 3 (23) | 0.96 (3) | Note 3 (9) |
| | 0.64 | ≥ 2.56 (2) | | 1.92 (3) | Note 3 (9) |
| | 1.28 | ≥ 3.84 (3) | | 3.84 (3) | Note 3 (9) |
| | 2.56 | ≥ 7.68 (6) | | 7.68 (3) | Note 3 (9) |

NOTE 1: The number of DRX cycles in this table is given for the DRX cycles within PTWs.
NOTE 2: The eDRX_IDLE cycle lengths are as specified in Section 10.5.5.32 of TS 24.008 [34].
NOTE 3: The time is calculated depending on the number N of DRX cycles as follows:

$$eDRX_cycle_length \times \left\lceil \frac{N}{\lceil PTW / DRX_cycle_length \rceil} \right\rceil$$

NOTE 4: Number of eDRX cycles when eDRX_IDLE cycle length equals 5.12s, number of DRX cycles otherwise.

For higher priority cells, a UE may optionally use a shorter value for $T_{\text{measureUTRA_TDD}}$, which shall not be less than Max(0.64 s, one DRX cycle).

4.2.2.5.3 Measurements of GSM cells

When the measurement rules defined in [1] indicate that E-UTRAN inter-frequencies or inter-RAT frequency cells are to be measured, the UE shall measure the signal level of the GSM BCCH carriers if the GSM BCCH carriers are indicated in the measurement control system information of the serving cell. GSM BCCH carriers of lower priority than the serving cell shall be measured at least every $T_{\text{measure,GSM}}$.

When higher priority GSM BCCH carriers are found by the higher priority search, they shall be measured at least every $T_{\text{measure,GSM}}$, and the UE shall decode the BSIC of the GSM BCCH carrier. If, after detecting a cell in a higher priority search, it is determined that reselection has not occurred then the UE is not required to continuously measure the detected cell to evaluate the ongoing possibility of reselection, or to continuously verify the BSIC of the GSM BCCH carrier every 30s. However, the minimum measurement filtering requirements specified later in this clause shall still be met by the UE before it makes any determination that it may stop measuring the cell.

The UE shall maintain a running average of 4 measurements for each GSM BCCH carrier. The measurement samples for each cell shall be as far as possible uniformly distributed over the averaging period.

If continuous GSM measurements are required by the measurement rules in [1], the UE shall attempt to verify the BSIC at least every 30 seconds for each of the 4 strongest GSM BCCH carriers. If a change of BSIC is detected for one GSM cell then that GSM BCCH carrier shall be treated as a new GSM neighbour cell. If the UE detects on a BCCH carrier a BSIC which is indicated as not allowed for that carrier in the measurement control system information of the serving cell, the UE is not required to perform BSIC re-confirmation for that cell.

The UE shall not consider the GSM BCCH carrier in cell reselection, if the UE cannot demodulate the BSIC of that GSM BCCH carrier. Additionally, the UE shall not consider a GSM neighbour cell in cell reselection, if it is indicated as not allowed in the measurement control system information of the serving cell.

If $T_{\text{reselection}}$ timer has a non zero value and the GSM cell is satisfied with the reselection criteria which are defined in [1], the UE shall evaluate this GSM cell for the $T_{\text{reselection}}$ time. If this cell remains satisfied with the reselection criteria within this duration, then the UE shall reselect that cell.

For UE not configured with eDRX_IDLE cycle, $T_{\text{measure,GSM}}$ is specified in Table 4.2.2.5.3-1. For UE configured with eDRX_IDLE cycle, $T_{\text{measure,GSM}}$ is specified in Table 4.2.2.5.3-2, where the requirements apply provided that the serving cell is configured with eDRX_IDLE and is the same in all PTWs during $T_{\text{measure,GSM}}$ when multiple PTWs are used.

Table 4.2.2.5.3-1: $T_{\text{measure,GSM}}$,

| DRX cycle length [s] | $T_{\text{measure,GSM}}$ [s] (number of DRX cycles) |
|----------------------|---|
| 0.32 | 5.12 (16) |
| 0.64 | 5.12 (8) |
| 1.28 | 6.4(5) |
| 2.56 | 7.68 (3) |

Table 4.2.2.5.3-2: $T_{\text{measure,GSM}}$ for UE configured with eDRX_IDLE cycle

| eDRX_IDLE cycle length [s] | DRX cycle length [s] | PTW length [s] (number of 1.28s periods) | $T_{\text{measure,GSM}}$ [s] (number of DRX or eDRX cycles ^{Note 3}) |
|---|----------------------|--|--|
| 5.12 | N/A | N/A | 15.36 (3) |
| $10.24 \leq$ eDRX_IDLE cycle length \leq 2621.44 | 0.32 | ≥ 1.28 (1) | 0.96 (3) |
| | 0.64 | ≥ 2.56 (2) | 1.92 (3) |
| | 1.28 | ≥ 3.84 (3) | 3.84 (3) |
| | 2.56 | ≥ 7.68 (6) | 7.68 (3) |
| NOTE 1: The number of DRX cycles in this table is given for the DRX cycles within PTWs. | | | |
| NOTE 2: The eDRX_IDLE cycle lengths are as specified in Section 10.5.5.32 of TS 24.008 [34]. | | | |
| NOTE 3: Number of eDRX cycles when eDRX_IDLE cycle length equals 5.12s, number of DRX cycles otherwise. | | | |

4.2.2.5.4 Measurements of HRPD cells

In order to perform measurement and cell reselection to HRPD cell, the UE shall acquire the timing of HRPD cells.

When the measurement rules indicate that HRPD cells are to be measured, the UE shall measure CDMA2000 HRPD Pilot Strength of HRPD cells in the neighbour cell list at the minimum measurement rate specified in this section.

The parameter ‘Number of HRPD Neighbor Frequency’, which is transmitted on E-UTRAN BCCH, is the number of carriers used for all HRPD cells in the neighbour cell list.

When the E-UTRA serving cell fulfils $S_{\text{rxlev}} > S_{\text{nonIntraSearchP}}$ and $S_{\text{qual}} > S_{\text{nonIntraSearchQ}}$, the UE shall search for CDMA2000 HRPD layers of higher priority at least every $T_{\text{higher_priority_search}}$ where $T_{\text{higher_priority_search}}$ is defined in clause 4.2.2.

For CDMA2000 HRPD cells which have been detected, the UE shall measure CDMA2000 HRPD Pilot Strength at least every (Number of HRPD Neighbor Frequency)* $T_{\text{measureHRPD}}$, when the E-UTRA serving cell $S_{\text{rxlev}} \leq S_{\text{nonIntraSearchP}}$ or $S_{\text{qual}} \leq S_{\text{nonIntraSearchQ}}$.

The UE shall be capable of evaluating that the CDMA2000 HRPD cell has met cell reselection criterion defined in [1] within $T_{\text{evaluateHRPD}}$.

For UE not configured with eDRX_IDLE cycle, Table 4.2.2.5.4-1 gives values of $T_{\text{measureHRPD}}$ and $T_{\text{evaluateHRPD}}$. For UE configured with eDRX_IDLE cycle, $T_{\text{measureHRPD}}$ and $T_{\text{evaluateHRPD}}$ are specified in Table 4.2.2.5.4-2, where the requirements apply provided that the serving cell is configured with eDRX_IDLE and is the same in all PTWs during any of $T_{\text{measureHRPD}}$ and $T_{\text{evaluateHRPD}}$ when multiple PTWs are used.

Table 4.2.2.5.4-1: $T_{\text{measureHRPD}}$ and $T_{\text{evaluateHRPD}}$

| DRX cycle length [s] | $T_{\text{measureHRPD}}$ [s] (number of DRX cycles) | $T_{\text{evaluateHRPD}}$ [s] (number of DRX cycles) |
|----------------------|---|--|
| 0.32 | 5.12 (16) | 15.36 (48) |
| 0.64 | 5.12 (8) | 15.36 (24) |
| 1.28 | 6.4 (5) | 19.2 (15) |
| 2.56 | 7.68 (3) | 23.04 (9) |

Table 4.2.2.5.4-2: $T_{\text{measureHRPD}}$ and $T_{\text{evaluateHRPD}}$ for UE configured with eDRX_IDLE cycle

| eDRX_IDLE cycle length [s] | DRX cycle length [s] | PTW length [s] (number of 1.28s periods) | $T_{\text{measureHRPD}}$ [s] (number of DRX or eDRX cycles ^{Note 4}) | $T_{\text{evaluateHRPD}}$ [s] (number of DRX or eDRX cycles ^{Note 4}) |
|---|----------------------|--|--|---|
| 5.12 | N/A | N/A | 15.36 (3) | 46.08 (9) |
| 10.24 ≤ eDRX_IDLE cycle length ≤ 2621.44 | 0.32 | ≥1.28 (1) | 0.96 (3) | Note 3 (9) |
| | 0.64 | ≥2.56 (2) | 1.92 (3) | Note 3 (9) |
| | 1.28 | ≥3.84 (3) | 3.84 (3) | Note 3 (9) |
| | 2.56 | ≥7.68 (6) | 7.68 (3) | Note 3 (9) |
| NOTE 1: The number of DRX cycles in this table is given for the DRX cycles within PTWs. NOTE 2: The eDRX_IDLE cycle lengths are as specified in Section 10.5.5.32 of TS 24.008 [34]. NOTE 3: The time is calculated depending on the number N of DRX cycles as follows: $eDRX_cycle_length \times \left\lceil \frac{N}{\lceil PTW / DRX_cycle_length \rceil} \right\rceil$ NOTE 4: Number of eDRX cycles when eDRX_IDLE cycle length equals 5.12s, number of DRX cycles otherwise. | | | | |

If $T_{\text{reselection}}$ timer has a non zero value and the CDMA2000 HRPD cell is satisfied with the reselection criteria which are defined in [1], the UE shall evaluate this CDMA2000 HRPD cell for the $T_{\text{reselection}}$ time. If this cell remains satisfied with the reselection criteria within this duration, then the UE shall reselect that cell.

4.2.2.5.5 Measurements of cdma2000 1X

In order to perform measurement and cell reselection to cdma2000 1X cell, the UE shall acquire the timing of cdma2000 1X cells.

When the measurement rules indicate that cdma2000 1X cells are to be measured, the UE shall measure cdma2000 1x RTT Pilot Strength of cdma2000 1X cells in the neighbour cell list at the minimum measurement rate specified in this section.

The parameter 'Number of CDMA2000 1X Neighbor Frequency', which is transmitted on E-UTRAN BCCH, is the number of carriers used for all cdma2000 1X cells in the neighbour cell list.

When the E-UTRA serving cell fulfils $S_{rxlev} > S_{nonIntraSearchP}$ and $S_{qual} > S_{nonIntraSearchQ}$, the UE shall search for cdma2000 1X layers of higher priority at least every $T_{higher_priority_search}$ where $T_{higher_priority_search}$ is defined in clause 4.2.2.

For CDMA2000 1X cells which have been detected, the UE shall measure CDMA2000 1xRTT Pilot Strength at least every (Number of CDMA2000 1X Neighbor Frequency)* $T_{measureCDMA2000_1X}$, when the E-UTRA serving cell $S_{rxlev} \leq S_{nonIntraSearchP}$ or $S_{qual} \leq S_{nonIntraSearchQ}$. The UE shall be capable of evaluating that the cdma2000 1X cell has met cell reselection criterion defined in [1] within $T_{evaluateCDMA2000_1X}$.

For UE not configured with eDRX_IDLE cycle, Table 4.2.2.5.5-1 gives values of $T_{measureCDMA2000_1X}$ and $T_{evaluateCDMA2000_1X}$. For UE configured with eDRX_IDLE cycle, $T_{measureCDMA2000_1X}$ and $T_{evaluateCDMA2000_1X}$ are specified in Table 4.2.2.5.5-2 where the requirements apply provided that the serving cell is configured with eDRX_IDLE and is the same in all PTWs during any of $T_{measureCDMA2000_1X}$ and $T_{evaluateCDMA2000_1X}$ when multiple PTWs are used.

Table 4.2.2.5.5-1: $T_{measureCDMA2000_1X}$ and $T_{evaluateCDMA2000_1X}$

| DRX cycle length [s] | $T_{measureCDMA2000_1X}$ [s] (number of DRX cycles) | $T_{evaluateCDMA2000_1X}$ [s] (number of DRX cycles) |
|----------------------|--|---|
| 0.32 | 5.12 (16) | 15.36 (48) |
| 0.64 | 5.12 (8) | 15.36 (24) |
| 1.28 | 6.4 (5) | 19.2 (15) |
| 2.56 | 7.68 (3) | 23.04 (9) |

Table 4.2.2.5.5-2: $T_{measureCDMA2000_1X}$ and $T_{evaluateCDMA2000_1X}$ for UE configured with eDRX_IDLE cycle

| eDRX_IDLE cycle length [s] | DRX cycle length [s] | PTW length [s] (number of 1.28s periods) | $T_{measureCDMA2000_1X}$ [s] (number of DRX or eDRX cycles ^{Note 4}) | $T_{evaluateCDMA2000_1X}$ [s] (number of DRX or eDRX cycles ^{Note 4}) |
|---|----------------------|--|---|--|
| 5.12 | N/A | N/A | 15.36 (3) | 46.08 (9) |
| 10.24 ≤ eDRX_IDLE cycle length ≤ 2621.44 | 0.32 | ≥1.28 (1) | 0.96 (3) | Note 3 (9) |
| | 0.64 | ≥2.56 (2) | 1.92 (3) | Note 3 (9) |
| | 1.28 | ≥3.84 (3) | 3.84 (3) | Note 3 (9) |
| | 2.56 | ≥7.68 (6) | 7.68 (3) | Note 3 (9) |
| NOTE 1: The number of DRX cycles in this table is given for the DRX cycles within PTWs. | | | | |
| NOTE 2: The eDRX_IDLE cycle lengths are as specified in Section 10.5.5.32 of TS 24.008 [34]. | | | | |
| NOTE 3: The time is calculated depending on the number N of DRX cycles as follows: | | | | |
| $eDRX_cycle_length \times \left\lceil \frac{N}{\lceil PTW / DRX_cycle_length \rceil} \right\rceil$ | | | | |
| NOTE 4: Number of eDRX cycles when eDRX_IDLE cycle length equals 5.12s, number of DRX cycles otherwise. | | | | |

If $T_{reselection}$ timer has a non zero value and the CDMA2000 1X cell is satisfied with the reselection criteria which are defined in [1], the UE shall evaluate this CDMA2000 1X cell for the $T_{reselection}$ time. If this cell remains satisfied with the reselection criteria within this duration, then the UE shall reselect that cell.

4.2.2.6 Evaluation of cell re-selection criteria

The UE shall evaluate the intra-frequency, inter-frequency and inter-RAT cell reselection criteria defined in [1] at least every DRX cycle. When a non zero value of $T_{reselection}$ is used, the UE shall only perform reselection on an evaluation which occurs simultaneously to, or later than the expiry of the $T_{reselection}$ timer.

For UE configured with eDRX_IDLE cycle, the cell reselection criteria shall be evaluated within at least every DRX cycle within the PTW.

4.2.2.7 Maximum interruption in paging reception

UE shall perform the cell re-selection with minimum interruption in monitoring downlink channels for paging reception. When the UE is configured with eDRX_IDLE cycle, the UE shall not miss any paging in a PTW provided the paging is sent in at least [2] DRX cycles before the end of that PTW.

At intra-frequency and inter-frequency cell re-selection, the UE shall monitor the downlink of serving cell for paging reception until the UE is capable to start monitoring downlink channels of the target intra-frequency and inter-frequency cell for paging reception. The interruption time shall not exceed $T_{SI-EUTRA} + 50$ ms.

At inter-RAT cell re-selection, the UE shall monitor the downlink of serving cell for paging reception until the UE is capable to start monitoring downlink channels for paging reception of the target inter-RAT cell. For E-UTRAN to UTRA cell re-selection the interruption time must not exceed $T_{SI-UTRA} + 50$ ms. For E-UTRAN to GSM cell re-selection the interruption time must not exceed $T_{BCCH} + 50$ ms.

$T_{SI-EUTRA}$ is the time required for receiving all the relevant system information data according to the reception procedure and the RRC procedure delay of system information blocks defined in TS 36.331 [2] for a E-UTRAN cell.

$T_{SI-UTRA}$ is the time required for receiving all the relevant system information data according to the reception procedure and the RRC procedure delay of system information blocks defined in [7] for a UTRAN cell.

T_{BCCH} is the maximum time allowed to read BCCH data from a GSM cell defined in [8].

These requirements assume sufficient radio conditions, so that decoding of system information can be made without errors and does not take into account cell re-selection failure.

At cell re-selection to HRPD, the UE shall monitor the downlink of serving cell for paging reception until the UE is capable of starting to monitor downlink channels for paging reception of the target HRPD cell. For HRPD cell re-selection the interruption time must not exceed $T_{SI-HRPD} + 50$ ms.

$T_{SI-HRPD}$ is the time required for receiving all the relevant system information data according to the reception procedure and the upper layer (Layer 3) procedure delay of system information blocks defined in [11] in for HRPD cell.

At cell re-selection to cdma2000 1X, the UE shall monitor the downlink of serving cell for paging reception until the UE is capable of starting to monitor downlink channels for paging reception of the target cdma2000 1X cell. For cdma2000 1X cell re-selection the interruption time must not exceed $T_{SI-cdma2000_1X} + 50$ ms.

$T_{SI-cdma2000_1X}$ is the time required for receiving all the relevant system information data according to the reception procedure and the upper layer (Layer 3) procedure delay of system information blocks defined in [15] for cdma2000 1X cell.

For any requirement in this section, when the UE transitions between any two states when being configured with eDRX_IDLE, being configured with eDRX_IDLE cycle, changing eDRX_IDLE cycle length, or changing PTW configuration, the UE shall meet the transition requirement, which is the less stringent requirement of the two requirements corresponding to the first state and the second state, during the transition time interval which is the time corresponding to the transition requirement. After the transition time interval, the UE has to meet the requirement corresponding to the second state.

4.2.2.8 void

4.2.2.9 UE measurement capability

For idle mode cell re-selection purposes, the UE shall be capable of monitoring at least:

- Intra-frequency carrier, and
- Depending on UE capability, 3 FDD E-UTRA inter-frequency carriers, and
- Depending on UE capability, 3 TDD E-UTRA inter-frequency carriers, and
- Depending on UE capability, 3 FDD UTRA carriers, and
- Depending on UE capability, 3 TDD UTRA carriers, and
- Depending on UE capability, 32 GSM carriers, and

- Depending on UE capability, 3 cdma2000 1x carriers, and
- Depending on UE capability, 3 HRPD carriers.

In addition to the requirements defined above, a UE supporting E-UTRA measurements in RRC_IDLE state shall be capable of monitoring a total of at least 8 carrier frequency layers, which includes serving layer, comprising of any above defined combination of E-UTRA FDD, E-UTRA TDD, UTRA FDD, UTRA TDD, GSM (one GSM layer corresponds to 32 cells), cdma2000 1x and HRPD layers.

4.2.2.9a UE measurement capability (Increased UE carrier monitoring)

UE which support Increased UE carrier monitoring E-UTRA according to the capabilities in [2,31] shall be capable of monitoring at least

- Depending on UE capability, 8 FDD E-UTRA inter-frequency carriers, and
- Depending on UE capability, 8 TDD E-UTRA inter-frequency carriers

UE which support increased UE carrier monitoring UTRA according to the capabilities in [2,31] shall additionally be capable of monitoring at least

- Depending on UE capability, 6 FDD UTRA carriers, and
- Depending on UE capability, 7 TDD UTRA carriers, and

In addition to the requirements defined above, a UE supporting E-UTRA measurements in RRC_IDLE state and supporting Increased UE carrier monitoring E-UTRA or increased UE carrier monitoring UTRA according to the capabilities in [2,31] shall be capable of monitoring a total of at least 13 carrier frequency layers, which includes serving layer, comprising of any above defined combination of E-UTRA FDD, E-UTRA TDD, UTRA FDD, UTRA TDD, GSM (one GSM layer corresponds to 32 cells), cdma2000 1x and HRPD layers.

The requirements in this section apply for UE regardless of their capability to support eDRX_IDLE.

4.2.2.10 Reselection to CSG cells

Note: Requirements in this clause are minimum requirements defined to ensure the testability of autonomous CSG search. Further information on autonomous search times in practical deployments is available in [25].

Reselection from non CSG to CSG cells may be performed using UE autonomous search as defined in [1] when at least one CSG ID is included in the UE's CSG whitelist. The requirements in this clause are valid for reselection to CSG cells previously visited by the UE when the radio configuration parameters, including the carrier frequency and physical cell identity of the CSG cell, non CSG cell and other neighbour cells are unchanged from the most recent previous visit.

NOTE: According to [1], the UE autonomous search function, per UE implementation, determines when and/or where to search for allowed CSG cells.

4.2.2.10.1 Reselection from a non CSG to an inter-frequency CSG cell

The UE shall perform search and reselection to an allowed inter-frequency CSG cell that has met CSG reselection criterion defined in [1] and that is in its whitelist, within 6 minutes in the conditions shown in table 4.2.2.10.1-1. There is no need for statistical testing of this requirement.

Table 4.2.2.10.1-1: Parameters for CSG inter-frequency reselection

| Parameter | Unit | Cell 1 | Cell 2 |
|---|------|-----------|--|
| EARFCN ^{Note1} | | Channel 1 | Channel 2 |
| CSG indicator | | False | True |
| Physical cell identity ^{Note1} | | 1 | 2 |
| CSG identity | | Not sent | Sent (Already stored in UE whitelist from previous visit) |

| | | | |
|---|------------|-----------------------|------|
| Propagation conditions | | Static, non multipath | |
| CSG cell previously visited by UE | | Yes | |
| PBCH_RA | dB | 0 | 0 |
| PBCH_RB | dB | | |
| PSS_RA | dB | | |
| SSS_RA | dB | | |
| PCFICH_RB | dB | | |
| PHICH_RA | dB | | |
| PHICH_RB | dB | | |
| PDCCH_RA | dB | | |
| PDCCH_RB | dB | | |
| PDSCH_RA | dB | | |
| PDSCH_RB | dB | | |
| OCNG_RA ^{Note 1} | dB | | |
| OCNG_RB ^{Note 1} | dB | | |
| Qrxlevmin | dBm | -140 | -140 |
| N_{oc} | dBm/15 kHz | Off | |
| RSRP ^{Note 2} | dBm/15 KHz | -110 | -110 |
| <p>Note 1: For this requirement to be applicable, the EARFCN and physical cell identity for cell 1 and cell 2 shall be unchanged from when the CSG cell was visited previously</p> <p>Note 2: Chosen to ensure that CSG autonomous search has a high probability of success on every attempt made by UE</p> | | | |

4.2.2.10.2 Reselection from a non CSG to an inter-RAT UTRAN FDD CSG cell

The UE shall perform search and reselection to an allowed inter-RAT UTRAN FDD CSG cell that has met CSG reselection criterion defined in [1] and that is in its whitelist, within 6 minutes in the conditions shown in table 4.2.2.10.2-1. There is no need for statistical testing of this requirement.

Table 4.2.2.10.2-1: Parameters for CSG inter-RAT UTRAN FDD reselection

| Parameter | Unit | Cell 1 | Cell 2 |
|---|------------|-----------------------|--|
| EARFCN ^{Note 1} | | Channel 1 | N/A |
| UARFCN ^{Note 1} | | N/A | Channel 2 |
| CSG indicator | | False | True |
| Physical cell identity ^{Note 1} | | 1 | N/A |
| Primary scrambling code ^{Note 1} | | N/A | Scrambling code 2 |
| CSG identity | | Not sent | Sent (Already stored in UE whitelist from previous visit) |
| Propagation conditions | | Static, non multipath | |
| CSG cell previously visited by UE | | Yes | |
| PBCH_RA | dB | 0 | N/A |
| PBCH_RB | dB | | |
| PSS_RA | dB | | |
| SSS_RA | dB | | |
| PCFICH_RB | dB | | |
| PHICH_RA | dB | | |
| PHICH_RB | dB | | |
| PDCCH_RA | dB | | |
| PDCCH_RB | dB | | |
| PDSCH_RA | dB | | |
| PDSCH_RB | dB | | |
| OCNG_RA ^{Note 1} | dB | | |
| OCNG_RB ^{Note 1} | dB | | |
| Qrxlevmin | dBm | -140 | |
| N_{oc} | dBm/15 kHz | Off | |

| | | | |
|--|--------------|------|------|
| RSRP ^{Note2} | dBm/15 KHz | -110 | |
| CPICH_RSCP ^{Note2} | dBm | N/A | -100 |
| CPICH_Ec/Ior | dB | | -10 |
| PCCPCH_Ec/Ior | dB | | -12 |
| SCCPCH_Ec/Ior | dB | | -12 |
| AICH_Ec/Ior | dB | | -15 |
| SCH_Ec/Ior | dB | | -15 |
| PICH_Ec/Ior | dB | | -15 |
| I_{oc} | dBm/3.84 MHz | | Off |
| <p>Note 1: For this requirement to be applicable, the EARFCN and physical cell identity for cell 1 and the UARFCN and scrambling code for cell 2 shall be unchanged from when the CSG cell was visited previously</p> <p>Note 2: Chosen to ensure that CSG autonomous search has a high probability of success on every attempt made by UE</p> | | | |

4.2.2.11 Void

4.3 Minimization of Drive Tests (MDT)

UE supporting minimisation of drive tests in RRC_IDLE shall be capable of:

- logging measurements in RRC_IDLE, reporting the logged measurements and meeting requirements in this clause;
- logging of RRC connection establishment failure, reporting the logged failure and meeting requirements in this clause;
- logging of radio link failure and handover failure, reporting the logged failure and meeting requirements in this clause.

4.3.1 Introduction

The logged MDT requirements consist of measurement requirements as specified in clause 4.3.2 and relative time stamp accuracy requirements as specified in clause 4.3.3. Both sets of requirements are applicable for intra-frequency, inter-frequency and inter-RAT cases in RRC_IDLE state. The MDT procedures are described in [27].

For RRC connection establishment failure logging and reporting, the MDT requirements consist of requirements for measurements performed and logged in RRC_IDLE state specified in clause 4.3.2 and relative time stamp accuracy requirement for RRC connection establishment failure log reporting as specified in clause 4.3.4.

4.3.2 Measurements

The requirements specified in this clause apply for the measurements (GSM carrier RSSI, UTRA CPICH RSCP, UTRA CPICH Ec/Io, P-CCPCH RSCP for UTRA 1.28 TDD, E-UTRA RSRP, E-UTRA RSRQ, MBSFN RSRP, MBSFN RSRQ, and MCH BLER) performed and logged by the UE for MDT in RRC_IDLE. The requirements apply for the measurements included in logged MDT reports and RRC connection establishment failure reports.

4.3.2.1 Requirements

The measurement values that are used to meet

- serving cell and reselection requirements as specified in sections 4.2.2.1, 4.2.2.3, 4.2.2.4, 4.2.2.5,
- MBSFN measurement requirements as specified in section 4.4,

shall also apply to values logged for MDT measurements in RRC_IDLE state.

4.3.3 Relative Time Stamp Accuracy

The relative time stamp for a logged measurement is defined as the time from the moment the MDT configuration was received at the UE until the measurement was logged, see TS 36.331 [2].

4.3.3.1 Requirements

The accuracy of the relative time stamping is such that the drift of the time stamping shall be not more than ± 2 seconds per hour.

4.3.4 Relative Time Stamp Accuracy for RRC Connection Establishment Failure Log Reporting

Relative time stamp for RRC connection establishment failure log reporting is defined as the time elapsed from the last RRC connection establishment failure to the time when the log is included in the report TS 36.331 [2]. The UE shall report the RRC connection establishment failure log, while meeting the accuracy requirement specified in clause 4.3.4.1.

4.3.4.1 Requirements

The accuracy of the relative time stamping for RRC connection establishment failure log reporting is such that the drift of the time stamping shall not be larger than ± 0.72 seconds per hour and ± 10 seconds over 48 hours. The relative time stamp accuracy requirements shall apply provided that:

- no power off or detach occurs after the RRC connection establishment failure had been detected and until the log is time-stamped.

NOTE: This requirement does not need to be tested.

4.3.5 Relative Time Stamp Accuracy for Radio Link Failure and Handover Failure Log Reporting

The UE shall report the radio link and handover failure log, while meeting the accuracy requirements specified in this section.

4.3.5.1 Requirements for *timeSinceFailure*

Relative time stamp accuracy requirements for *timeSinceFailure* reported for MDT in a radio link failure or handover failure log are specified in this clause. *timeSinceFailure* determines the time elapsed from the last radio link failure or handover failure in E-UTRA to the time when the log is included in the report TS 36.331 [2].

The accuracy of the relative time stamping for *timeSinceFailure* is such that the drift of the time stamping shall not be larger than ± 0.72 seconds per hour and ± 10 seconds over 48 hours. These relative time stamp accuracy requirements shall apply provided that:

- no power off or detach occurs after the RLF or handover failure had been detected and until the log is time-stamped.

4.4 MBSFN Measurements

4.4.1 Introduction

The requirements specified in Section 4.4 apply for MBSFN measurements (MBSFN RSRP, MBSFN RSRQ, and MCH BLER defined in [4]), which are performed in RRC_IDLE state and logged for MDT by UEs which are MBMS-capable and also indicate their MBSFN measurement logging capability [2].

UE shall measure MBSFN RSRP, MBSFN RSRQ and MCH BLER only in subframes and on carriers where UE is decoding PMCH. The requirements are specified for any carrier where PMCH is received by UE. The requirements

specified in this section apply for any carrier frequency with configured MBSFN subframes with PMCH, which may be the same as or different from any serving unicast carrier.

The UE receiving PMCH on any non-serving carrier and performing MBSFN measurements shall not cause interruptions on any serving carrier in the subframes with paging and non-MBSFN multicast transmissions such as system information.

4.4.2 MBSFN RSRP measurements

For UE in RRC_IDLE, the physical layer shall be capable of performing the MBSFN RSRP measurement [4] within the MBSFN RSRP measurement period and log the measurement, while meeting the MBSFN RSRP measurement accuracy requirements specified in section 9.8.2. The MBSFN RSRP measurement logging shall be according to the MBSFN RSRP measurement report mapping specified in Section 9.8.2.2.

The MBSFN RSRP measurement period is defined as MAX(640 ms, period during which the UE decodes [5, Section 10] 5 subframes containing PMCH transmissions).

The same requirement applies for UE configured with DRX or eDRX_IDLE.

4.4.3 MBSFN RSRQ measurements

For UE in RRC_IDLE, the physical layer shall be capable of performing the MBSFN RSRQ measurement [4] within the MBSFN RSRP measurement period and report the measurement, while meeting the MBSFN RSRQ measurement accuracy requirements specified in section 9.8.3. The MBSFN RSRQ measurement logging shall be according to the MBSFN RSRQ measurement report mapping specified in Section 9.8.3.2.

The MBSFN RSRQ measurement period is defined as MAX(640 ms, period during which the UE decodes [5, Section 10] 5 subframes containing PMCH transmissions).

The same requirement applies for UE configured with DRX or eDRX_IDLE.

4.4.4 MCH BLER measurements

The UE physical layer shall be capable of performing and logging the MCH BLER measurement [4] within the MCH BLER measurement period.

The MCH BLER measurement period is equal to the MBSFN logging interval configured by higher layers [2].

The MCH BLER logging shall be according to the MCH BLER measurement report mapping specified in Section 9.8.4.

The same requirement applies for UE configured with DRX or eDRX_IDLE.

4.5 Proximity-based Services

4.5.1 Introduction

This section contains the requirements for the UE capable of ProSe Direct Communication and/or ProSe Direct Discovery in RRC_IDLE state.

4.5.2 Requirements

When a UE in RRC_IDLE state is participating in transmissions and/or reception for ProSe Direct Discovery and/or ProSe Direct Communication, the UE shall meet all the requirements of Section 4.

Note: The UE may need to interrupt ProSe operation in order to meet the requirements of Section 4.

4.5.2.1 Interruptions with ProSe Direct Discovery

A UE capable of ProSe direct discovery in RRC_IDLE state shall not cause any interruption for the reception of paging and system information:

- while switching reception between ProSe Direct Discovery and a serving cell, or
- when receiving ProSe direct discovery signals or
- while switching receiver chain ON/OFF for ProSe Direct Discovery reception if the UE has a dedicated receiver chain for ProSe Direct Discovery

4.5.2.2 Interruptions with ProSe Direct Communication

A UE capable of ProSe direct communication in RRC_IDLE state shall not cause any interruption for the reception of paging and system information:

- while switching reception between ProSe Direct Communication and a serving cell, or
- when receiving ProSe direct communication signals, or
- while switching receiver chain ON/OFF for ProSe Direct Communications reception.

4.5.2.3 Initiation/Cease of SLSS transmissions with ProSe Direct Discovery

The requirements in this subclause are applicable to a UE capable of ProSe Direct Discovery and SLSS transmission and reception.

The requirements apply when the conditions for SLSS transmissions specified in [2] are met; *networkControlledSyncTx* is not configured; and *syncTxThreshIC* is included in *SystemInformationBlockType19*. The UE shall be capable of measuring the RSRP of the cell used to transmit ProSe Direct Discovery announcements and evaluate to initiate/cease SLSS transmissions within $T_{\text{evaluate,SLSS}}$ as specified in Table 4.5.2.3-1.

Table 4.5.2.3-1: $T_{\text{evaluate,SLSS}}$ with ProSe Direct Discovery

| DRX cycle length [s] | $T_{\text{evaluate,SLSS}}$ [s] (number of DRX cycles) |
|----------------------|--|
| 0.32 | 1.92 (6) |
| 0.64 | 3.84 (6) |
| 1.28 | 7.68 (6) |
| 2.56 | 15.36 (6) |

For the cell used to transmit ProSe Direct Discovery announcements:

- RSRP related side conditions given in Sections 9.1.2.1 and 9.1.2.2 and RSRQ related side conditions given in Clause 9.1.5.1 are fulfilled for a corresponding Band,
- SCH_{RP} and SCH_{Es}/I_{ot} according to Annex B.2.1 for a corresponding Band are fulfilled.

4.5.2.4 Initiation/Cease of SLSS transmissions with ProSe Direct Communication

The requirements in this subclause are applicable to a UE capable of ProSe Direct Communication.

The requirements apply when the conditions for SLSS transmissions specified in [2] are met; *networkControlledSyncTx* is not configured; and *syncTxThreshIC* is included in *SystemInformationBlockType18*. The UE shall be capable of measuring the RSRP of the cell used to transmit ProSe Direct Communication and evaluate to initiate/cease SLSS transmissions within $T_{\text{evaluate,SLSS}}$ as specified in Table 4.5.2.4-1.

Table 4.5.2.4-1: $T_{\text{evaluate,SLSS}}$ with ProSe Direct Communication

| DRX cycle length [s] | $T_{\text{evaluate,SLSS}}$ [s] (number of DRX cycles) |
|----------------------|--|
|----------------------|--|

| | |
|------|-----------|
| 0.32 | 1.92 (6) |
| 0.64 | 3.84 (6) |
| 1.28 | 7.68 (6) |
| 2.56 | 15.36 (6) |

For the cell used to transmit ProSe Direct Communication:

- RSRP related side conditions given in Sections 9.1.2.1 and 9.1.2.2 and RSRQ related side conditions given in Clause 9.1.5.1 for a corresponding Band are fulfilled,
- SCH_{RP} and SCH_{Es}/Tot according to Annex B.2.1 for a corresponding Band are fulfilled.

4.6 Cell Selection and Re-selection Requirements for UE category NB1

The NB-IoT applicability of the requirements in section 4.6 is defined in Section 3.6.1.

4.6.1 Cell Selection

After a UE has switched on and a PLMN has been selected, the Cell selection process takes place, as described in TS36.304. This process allows the UE to select a suitable cell where to camp on in order to access available services. In this process the UE can use stored information (*Stored information cell selection*) or not (*Initial cell selection*).

4.6.2 Cell Re-selection

The cell reselection procedure allows the UE to select a more suitable cell and camp on it.

When the UE is in either *Camped Normally* state or *Camped on Any Cell* state on a cell, the UE shall attempt to detect, synchronise, and monitor intra-frequency and inter-frequency cells indicated by the serving NB-IoT cell. For intra-frequency and inter-frequency cells the serving NB-IoT cell may not provide explicit neighbour list but carrier frequency information and bandwidth information only. UE measurement activity is also controlled by measurement rules defined in TS36.304, allowing the UE to limit its measurement activity.

4.6.2.1 Measurement and evaluation of serving NB-IoT cell for UE category NB1 in normal coverage

The UE shall measure the NRSRP and NRSRQ level of the serving NB-IoT cell and evaluate the cell selection criterion S defined in [1] for the serving NB-IoT cell at least every DRX cycle.

The UE shall filter the NRSRP and NRSRQ measurements of the NB-IoT serving cell using at least 2 measurements. Within the set of measurements used for the filtering, at least two measurements shall be spaced by, at least DRX cycle/2.

If the UE is not configured with eDRX_IDLE cycle and has evaluated according to Table 4.6.2.1-1 in $N_{\text{serv_NB-IoT-NC}}$ consecutive DRX cycles that the serving NB-IoT cell does not fulfil the cell selection criterion S, the UE shall initiate the measurements of all neighbour cells indicated by the serving NB-IoT cell, regardless of the measurement rules currently limiting UE measurement activities. If the UE is configured with eDRX_IDLE cycle and has evaluated according to Table 4.6.2.1-2 in $N_{\text{serv_NB-NC}}$ consecutive DRX cycles within a single PTW that the serving NB-IoT cell does not fulfil the cell selection criterion S, the UE shall initiate the measurements of all neighbour cells indicated by the serving NB-IoT cell, regardless of the measurement rules currently limiting UE measurement activities.

If the UE in RRC_IDLE has not found any new suitable cell based on searches and measurements using the intra-frequency and inter-frequency information indicated in the system information during the time T, the UE shall initiate cell selection procedures for the selected PLMN as defined in [1], where $T=40$ s if the UE is not configured with eDRX_IDLE cycle, and $T=\text{MAX}(40 \text{ s, one eDRX_IDLE cycle})$ if the UE is configured with eDRX_IDLE cycle.

Table 4.6.2.1-1: $N_{\text{serv_NB-NC}}$

| DRX cycle length [s] | $N_{\text{serv_NB-IoT-NC}}$ [number of DRX cycles] |
|----------------------|---|
| 1.28 | 2 |
| 2.56 | 2 |
| 5.12 | 2 |
| 10.24 | 2 |

Table 4.6.2.1-2: $N_{\text{serv_NB-NC}}$ for UE configured with eDRX_IDLE cycle

| eDRX_IDLE cycle length [s] | DRX cycle length [s] | PTW length [s] (number of 2.56s periods) | $N_{\text{serv_NB-IoT-NC}}$ [number of DRX cycles] |
|---|----------------------|--|---|
| $20.48 \leq \text{eDRX_IDLE cycle length} \leq 10485.76$ | 1.28 | ≥ 5.12 (2) | 2 |
| | 2.56 | ≥ 7.68 (3) | 2 |
| | 5.12 | ≥ 12.8 (5) | 2 |
| | 10.24 | ≥ 23.04 (9) | 2 |
| NOTE 1: The number of DRX cycles in this table is given for the DRX cycles within PTWs. | | | |
| NOTE 2: The eDRX_IDLE cycle lengths are as specified in Section X of TS 24.008 [34]. | | | |

For any requirement in this section, when the UE transitions between any two states when being configured with eDRX_IDLE, being configured with eDRX_IDLE cycle, changing eDRX_IDLE cycle length, or changing PTW configuration, the UE shall meet the transition requirement, which is the less stringent requirement of the two requirements corresponding to the first state and the second state, during the transition time interval which is the time corresponding to the transition requirement. After the transition time interval, the UE has to meet the requirement corresponding to the second state.

4.6.2.2 Measurements of intra-frequency NB-IoT cells for UE category NB1 in normal coverage

The UE shall be able to identify new intra-frequency cells and perform NRSRP measurements of identified intra-frequency cells without an explicit intra-frequency neighbour list containing physical layer cell identities.

The UE shall be able to evaluate whether a newly detectable intra-frequency cell meets the reselection criteria defined in TS36.304 within $T_{\text{detect,NB_Intra_NC}}$ when $T_{\text{reselection}} = 0$. An intra frequency cell is considered to be detectable according to NRSRP, NRSRP \hat{E}_s/Iot , NSCH_RP and NSCH \hat{E}_s/Iot defined in Annex B.1.4 for a corresponding Band.

The UE shall measure NRSRP at least every $T_{\text{measure,NB_Intra_NC}}$ for intra-frequency cells that are identified and measured according to the measurement rules.

The UE shall filter NRSRP measurements of each measured intra-frequency cell using at least [2] measurements. Within the set of measurements used for the filtering, at least two measurements shall be spaced by at least $T_{\text{measure,NB_Intra_NC}}/2$

The UE shall not consider an NB-IoT neighbour cell in cell reselection if it is indicated as not allowed in the measurement control system information of the serving NB-IoT cell.

For an intra-frequency cell that has been already detected, but that has not been reselected to, the filtering shall be such that the UE shall be capable of evaluating that the intra-frequency cell has met reselection criterion defined [1] within $T_{\text{evaluate,NB_intra_NC}}$ when $T_{\text{reselection}} = 0$, provided that the cell is at least XdB better ranked, where 'X' is specified in Table 4.6.2.4-3. When evaluating cells for reselection, the side conditions for NRSRP, NRSRP \hat{E}_s/Iot , NSCH_RP and NSCH \hat{E}_s/Iot apply to both serving and non-serving NB-IoT intra-frequency cells.

If $T_{\text{reselection}}$ timer has a non zero value and the intra-frequency cell is better ranked than the serving NB-IoT cell, the UE shall evaluate this intra-frequency cell for the $T_{\text{reselection}}$ time. If this cell remains better ranked within this duration, then the UE shall reselect that cell.

For UE not configured with eDRX_IDLE cycle, $T_{\text{detect,NB_Intra_NC}}$, $T_{\text{measure,NB_Intra_NC}}$ and $T_{\text{evaluate,NB_intra_NC}}$ are specified in Table 4.6.2.2-1. For UE configured with eDRX_IDLE cycle, $T_{\text{detect,NB_Intra_NC}}$, $T_{\text{measure,NB_Intra_NC}}$ and $T_{\text{evaluate,NB_intra_NC}}$ are

specified in Table 4.6.2.2-2, where the requirements apply provided that the serving NB-IoT cell is configured with eDRX_IDLE and is the same in all PTWs during any of $T_{\text{detect,NB_Intra_NC}}$, $T_{\text{measure,NB_Intra_NC}}$ and $T_{\text{evaluate,NB_intra_NC}}$ when multiple PTWs are used.

Table 4.6.2.2-1 : $T_{\text{detect,NB_Intra_NB-IoT-NC}}$, $T_{\text{measure,NB_Intra_NB-IoT-NC}}$ and $T_{\text{evaluate,NB_intra_NB-IoT-NC}}$

| DRX cycle length [s] | $T_{\text{detect,NB_Intra_NC}}$ [s] (number of DRX cycles) | $T_{\text{measure,NB_Intra_NB_NC}}$ [s] (number of DRX cycles) | $T_{\text{evaluate,NB_intra_NB_NC}}$ [s] (number of DRX cycles) |
|----------------------|--|---|--|
| 1.28 | 51 (40) | 1.28 (1) | 6.5 (5) |
| 2.56 | 51 (20) | 2.56 (1) | 7.68 (3) |
| 5.12 | 102 (20) | 5.12 (1) | 10.24 (2) |
| 10.24 | 102 (10) | 10.24 (1) | 20.48 (2) |

Table 4.6.2.2-2: $T_{\text{detect,NB_Intra_NC}}$, $T_{\text{measure,NB_Intra_NC}}$ and $T_{\text{evaluate,NB_intra_NC}}$ for UE configured with eDRX_IDLE cycle

| eDRX_IDLE cycle length [s] | DRX cycle length [s] | PTW length [s] (number of 2.56s periods) | $T_{\text{detect,NB_Intra_NB-IoT-NC}}$ [s] (number of DRX cycles) | $T_{\text{measure,NB_Intra_NC}}$ [s] (number of DRX cycles) | $T_{\text{evaluate,NB_intra_NC}}$ [s] (number of DRX cycles) |
|---|----------------------|--|---|---|--|
| 20.48 ≤ eDRX_IDLE cycle length ≤ 10485.76 | 1.28 | ≥5.12 (2) | $eDRX_cycle_length \times \left\lceil \frac{20}{\lceil PTW / DRX_cycle_length \rceil} \right\rceil$ | 1.28 (1) | 2.56 (2) |
| | 2.56 | ≥7.68 (3) | | 2.56 (1) | 5.12 (2) |
| | 5.12 | ≥12.8 (5) | | 5.12 (1) | 10.24 (2) |
| | 10.24 | ≥23.04 (9) | | 10.24 (1) | 20.48 (2) |
| NOTE 1: The number of DRX cycles in this table is given for the DRX cycles within PTWs. | | | | | |
| NOTE 2: The eDRX_IDLE cycle lengths are as specified in Section X of TS 24.008 [34]. | | | | | |

For any requirement in this section, when the UE transitions between any two states when being configured with eDRX_IDLE, being configured with eDRX_IDLE cycle, changing eDRX_IDLE cycle length, or changing PTW configuration, the UE shall meet the transition requirement, which is the less stringent requirement of the two requirements corresponding to the first state and the second state, during the transition time interval which is the time corresponding to the transition requirement. After the transition time interval, the UE has to meet the requirement corresponding to the second state.

4.6.2.3 Measurement and evaluation of serving NB-IoT cell for UE category NB1 in enhanced coverage

The UE shall measure the NRSRP and NRSRQ level of the serving NB-IoT cell and evaluate the cell selection criterion S defined in [1] for the serving NB-IoT cell at least every DRX cycle.

The UE shall filter the NRSRP and NRSRQ measurements of the serving NB-IoT cell using at least [4] measurements. Within the set of measurements used for the filtering, at least two measurements shall be spaced by, at least DRX cycle/2.

If the UE is not configured with eDRX_IDLE cycle and has evaluated according to Table 4.6.2.3-1 in $N_{\text{serv_NB_EC}}$ consecutive DRX cycles that the serving NB-IoT cell does not fulfil the cell selection criterion S, the UE shall initiate the measurements of all neighbour cells indicated by the serving NB-IoT cell, regardless of the measurement rules currently limiting UE measurement activities. If the UE is configured with eDRX_IDLE cycle and has evaluated according to Table 4.6.2.3-2 in $N_{\text{serv_NB-IoT-EC}}$ consecutive DRX cycles within a single PTW that the serving NB-IoT cell does not fulfil the cell selection criterion S, the UE shall initiate the measurements of all neighbour cells indicated by the serving NB-IoT cell, regardless of the measurement rules currently limiting UE measurement activities.

If the UE in RRC_IDLE has not found any new suitable cell based on searches and measurements using the intra-frequency and inter-frequency information indicated in the system information during the time T, the UE shall initiate cell selection procedures for the selected PLMN as defined in [1], where $T=80$ s if the UE is not configured with eDRX_IDLE cycle, and $T=\text{MAX}(80 \text{ s, one eDRX_IDLE cycle})$ if the UE is configured with eDRX_IDLE cycle.

Table 4.6.2.3-1: $N_{\text{serv_NB_EC}}$

| DRX cycle length [s] | $N_{\text{serv_NB-LoT-EC}}$ [number of DRX cycles] |
|----------------------|---|
| 1.28 | 4 |
| 2.56 | 4 |
| 5.12 | 4 |
| 10.24 | 4 |

Table 4.6.2.3-2: $N_{\text{serv_NB_EC}}$ for UE configured with eDRX_IDLE cycle

| eDRX_IDLE cycle length [s] | DRX cycle length [s] | PTW length [s] (number of 2.56s periods) | $N_{\text{serv_NB_EC}}$ [number of DRX cycles] |
|---|----------------------|--|--|
| $20.48 \leq \text{eDRX_IDLE cycle length} \leq 10485.76$ | 1.28 | ≥ 7.68 (3) | 4 |
| | 2.56 | ≥ 12.8 (5) | 4 |
| | 5.12 | ≥ 23.04 (9) | 4 |
| | 10.24 | ≥ 43.52 (17) | 4 |
| NOTE 1: The number of DRX cycles in this table is given for the DRX cycles within PTWs. | | | |
| NOTE 2: The eDRX_IDLE cycle lengths are as specified in Section X of TS 24.008 [34]. | | | |

For any requirement in this section, when the UE transitions between any two states when being configured with eDRX_IDLE, being configured with eDRX_IDLE cycle, changing eDRX_IDLE cycle length, or changing PTW configuration, the UE shall meet the transition requirement, which is the less stringent requirement of the two requirements corresponding to the first state and the second state, during the transition time interval which is the time corresponding to the transition requirement. After the transition time interval, the UE has to meet the requirement corresponding to the second state.

4.6.2.4 Measurements of intra-frequency NB-IoT cells for UE category NB1 in enhanced coverage

The UE shall be able to identify new intra-frequency cells and perform NRSRP measurements of identified intra-frequency cells without an explicit intra-frequency neighbour list containing physical layer cell identities.

The UE shall be able to evaluate whether a newly detectable intra-frequency cell meets the reselection criteria defined in TS36.304 within $T_{\text{detect,NB_Intra_EC}}$ when that $T_{\text{reselection}} = 0$. An intra frequency cell is considered to be detectable according to NRSRP, NRSRP \hat{E}_s/Iot , NSCH_RP and NSCH \hat{E}_s/Iot defined in Annex B.1.4 for a corresponding Band.

The UE shall measure NRSRP at least every $T_{\text{measure,NB_Intra_EC}}$ for intra-frequency cells that are identified and measured according to the measurement rules.

The UE shall filter NRSRP measurements of each measured intra-frequency cell using at least 2 measurements. Within the set of measurements used for the filtering, at least two measurements shall be spaced by at least $T_{\text{measure,NB_Intra_EC}}/2$

The UE shall not consider a NB-IoT neighbour cell in cell reselection, if it is indicated as not allowed in the measurement control system information of the serving NB-IoT cell.

For an intra-frequency cell that has been already detected, but that has not been reselected to, the filtering shall be such that the UE shall be capable of evaluating that the intra-frequency cell has met reselection criterion defined [1] within $T_{\text{evaluate,NB_intra_EC}}$ when $T_{\text{reselection}} = 0$, provided that the cell is at least XdB better ranked, where 'X' is specified in Table 4.6.2.4-3. When evaluating cells for reselection, the side conditions for NRSRP, NRSRP \hat{E}_s/Iot , NSCH_RP and NSCH \hat{E}_s/Iot apply to both serving and non-serving NB-IoT intra-frequency cells.

If $T_{\text{reselection}}$ timer has a non zero value and the intra-frequency cell is better ranked than the serving NB-IoT cell, the UE shall evaluate this intra-frequency cell for the $T_{\text{reselection}}$ time. If this cell remains better ranked within this duration, then the UE shall reselect that cell.

For UE not configured with eDRX_IDLE cycle, $T_{\text{detect,NB_Intra_EC}}$, $T_{\text{measure,NB_Intra_EC}}$ and $T_{\text{evaluate,NB_intra_EC}}$ are specified in Table 4.6.2.4-1. For UE configured with eDRX_IDLE cycle, $T_{\text{detect,NB_Intra_EC}}$, $T_{\text{measure,NB_Intra_EC}}$ and $T_{\text{evaluate,NB_intra_EC}}$ are specified in Table 4.6.2.4-2, where the requirements apply provided that the serving NB-IoT cell is configured with

eDRX_IDLE and is the same in all PTWs during any of $T_{\text{detect,NB_Intra_EC}}$, $T_{\text{measure,NB_Intra_EC}}$ and $T_{\text{evaluate,NB_intra_EC}}$ when multiple PTWs are used.

Table 4.6.2.4-1 : $T_{\text{detect,NB_Intra_EC}}$, $T_{\text{measure,NB_Intra_EC}}$ and $T_{\text{evaluate,NB_intra_EC}}$

| SCH \hat{E} s/lot of neighboring cell: Q2 | DRX cycle length [s] | $T_{\text{detect,NB_Intra_EC}}$ [s] (number of DRX cycles) | $T_{\text{measure,NB_Intra_EC}}$ [s] (number of DRX cycles) | $T_{\text{evaluate,NB_intra_EC}}$ [s] (number of DRX cycles) |
|---|----------------------|--|---|--|
| $-15 \leq Q2 < -6$ | 1.28 | 532 (415) | 1.28 (1) | 12.8 (10) |
| | 2.56 | 532 (208) | 2.56 (1) | 15.36 (6) |
| | 5.12 | 1063 (208) | 5.12 (1) | 20.48 (4) |
| | 10.24 | 1063 (104) | 10.24 (1) | 30.72 (3) |
| $Q2 \geq -6$ | 1.28 | 58 (45) | 1.28 (1) | 12.8 (10) |
| | 2.56 | 59 (23) | 2.56 (1) | 15.36 (6) |
| | 5.12 | 113 (22) | 5.12 (1) | 20.48 (4) |
| | 10.24 | 113 (11) | 10.24 (1) | 30.72 (3) |

Table 4.6.2.4-2: $T_{\text{detect,NB_Intra_EC}}$, $T_{\text{measure,NB_Intra_EC}}$ and $T_{\text{evaluate,NB_intra_EC}}$ for UE configured with eDRX_IDLE cycle

| eDRX_IDLE cycle length [s] | DRX cycle length [s] | PTW length [s] (number of 2.56s periods) | $T_{\text{detect,NB_Intra_EC}}$ [s] (number of DRX cycles) | $T_{\text{measure,NB_Intra_EC}}$ [s] (number of DRX cycles) | $T_{\text{evaluate,NB_intra_EC}}$ [s] (number of DRX cycles) |
|---|----------------------|--|--|---|--|
| $20.48 \leq \text{eDRX_IDLE cycle length} \leq 10485.76$ | 1.28 | ≥ 15.36 (6) | $e\text{DRX_cycle_length} \times \left\lceil \frac{[406]}{\lceil \text{PTW} / \text{DRX_cycle_length} \rceil} \right\rceil$ (406) | 1.28 (1) | 12.8 (10) |
| | 2.56 | ≥ 17.92 (7) | | 2.56 (1) | 15.36 (6) |
| | 5.12 | ≥ 23.04 (9) | | 5.12 (1) | 20.48 (4) |
| | 10.24 | ≥ 33.28 (13) | | 10.24 (1) | 30.72 (3) |

NOTE 1: The number of DRX cycles in this table is given for the DRX cycles within PTWs.

NOTE 2: The eDRX_IDLE cycle lengths are as specified in Section X of TS 24.008 [34].

Table 4.6.2.4-3: Conditions on NSCH \hat{E} s/lot of identified and of the neighbour cell

| NSCH \hat{E} s/lot of already identified cell including serving cell: Q1 | Neighbouring cell NSCH \hat{E} s/lot: Q2 | Cell Reselection Margin 'X' |
|--|--|-----------------------------|
| $-15 \leq Q1 < -6$ | $-15 \leq Q2 < -6$ | 8.3 |
| $-15 \leq Q1 < -6$ | $Q2 \geq -6$ | 8.3 |
| $Q1 \geq -6$ | $Q2 \geq -6$ | 4 |

For any requirement in this section, when the UE transitions between any two states when being configured with eDRX_IDLE, being configured with eDRX_IDLE cycle, changing eDRX_IDLE cycle length, or changing PTW configuration, the UE shall meet the transition requirement, which is the less stringent requirement of the two requirements corresponding to the first state and the second state, during the transition time interval which is the time corresponding to the transition requirement. After the transition time interval, the UE has to meet the requirement corresponding to the second state.

4.6.2.5 Measurements of inter-frequency NB cells for UE category NB1 in normal coverage

The UE shall be able to identify new inter-frequency cells and perform NRSRP measurements of identified inter-frequency cells if carrier frequency information is provided by the serving NB-IoT cell, even if no explicit neighbour list with physical layer cell identities is provided.

If $S_{\text{rxlev}} \leq S_{\text{nonIntraSearchP}}$ then the UE shall search for and measure inter-frequency layers in preparation for possible reselection.

The UE shall be able to evaluate whether a newly detectable inter-frequency cell meets the reselection criteria defined in TS36.304 within $P_{carrier} * T_{detect,NB_Inter_NC}$, if at least carrier frequency information is provided for inter-frequency neighbour cells by the serving NB-IoT cells when $T_{reselection} = 0$ provided that the reselection criteria is met by a margin of at least YdB, where $P_{carrier}$ is number of inter-frequency measured and ‘Y’ is specified by Table 4.6.2.6-3. An inter-frequency cell is considered to be detectable according to NRSRP, $NRSRP \hat{E}_s/Iot$, NB-IoT_SCH_RP and $SCH \hat{E}_s/Iot$ defined in Annex B.1.5 for a corresponding Band.

The UE shall filter NRSRP measurements of each measured inter-frequency cell using at least [2] measurements. Within the set of measurements used for the filtering, at least two measurements shall be spaced by at least $T_{measure, Inter_NB_IoT_NC}/2$.

If an inter-frequency cell has been already detected but that has not been reselected to the filtering shall be such that the UE shall be capable of evaluating that the inter-frequency cell has met reselection criterion defined TS 36.304 within $P_{carrier} * T_{evaluate,NB_Inter_NC}$. When evaluating cells for reselection, the side conditions for NRSRP, $NRSRP \hat{E}_s/Iot$, NSCH_RP and NSCH \hat{E}_s/Iot apply to both serving and inter-frequency cells.

If $T_{reselection}$ timer has a non zero value and the inter-frequency cell is better ranked than the serving NB-IoT cell, the UE shall evaluate this inter-frequency cell for the $T_{reselection}$ time. If this cell remains better ranked within this duration, then the UE shall reselect that cell.

For UE not configured with eDRX_IDLE cycle, T_{detect,NB_Inter_NC} , $T_{measure,NB_Inter_NC}$ and $T_{evaluate, NB_inter_NC}$ are specified in Table 4.6.2.5-1. For UE configured with eDRX_IDLE cycle, T_{detect,NB_Inter_NC} , $T_{measure,NB_Inter_NC}$ and $T_{evaluate, NB_inter_NC}$ are specified in Table 4.6.2.5-2, where the requirements apply provided that the serving NB-IoT cell is configured with eDRX_IDLE and is the same in all PTWs during any of T_{detect,NB_Inter_NC} , $T_{measure,NB_Inter_NC}$ and $T_{evaluate, NB_inter_NC}$ when multiple PTWs are used.

Table 4.6.2.5-1 : T_{detect,NB_Inter_NC} , $T_{measure,NB_Inter_NC}$ and $T_{evaluate,NB_Inter_NC}$

| DRX cycle length [s] | T_{detect,NB_Inter_NC} [s] (number of DRX cycles) | $T_{measure,NB_Inter_NC}$ [s] (number of DRX cycles) | $T_{evaluate,NB_Inter_NC}$ [s] (number of DRX cycles) |
|----------------------|---|--|---|
| 1.28 | 51 (40) | 1.28 (1) | 6.5 (5) |
| 2.56 | 51 (20) | 2.56 (1) | 7.68 (3) |
| 5.12 | 102 (20) | 5.12 (1) | 10.24 (2) |
| 10.24 | 102 (10) | 10.24 (1) | 20.48 (2) |

Table 4.6.2.5-2: T_{detect,NB_Inter_NC} , $T_{measure,NB_Inter_NC}$ and $T_{evaluate, NB_inter_NC}$ for UE configured with eDRX_IDLE cycle

| eDRX_IDLE cycle length [s] | DRX cycle length [s] | PTW length [s] (number of 2.56s periods) | T_{detect,NB_inter_NC} [s] (number of DRX cycles) | $T_{measure,NB_Inter_NC}$ [s] (number of DRX cycles) | $T_{evaluate,NB_inter_NC}$ [s] (number of DRX cycles) |
|---|----------------------|--|---|--|---|
| $20.48 \leq eDRX_IDLE$ cycle length ≤ 10485.76 | 1.28 | ≥ 5.12 (2) | $eDRX_cycle_length \times \left\lceil \frac{[20]}{PTW / DRX_cycle_length} \right\rceil$ (20) | 1.28 (1) | 2.56 (2) |
| | 2.56 | ≥ 7.68 (3) | | 2.56 (1) | 5.12 (2) |
| | 5.12 | ≥ 12.8 (5) | | 5.12 (1) | 10.24 (2) |
| | 10.24 | ≥ 23.04 (9) | | 10.24 (1) | 20.48 (2) |
| NOTE 1: The number of DRX cycles in this table is given for the DRX cycles within PTWs. | | | | | |
| NOTE 2: The eDRX_IDLE cycle lengths are as specified in Section X of TS 24.008 [34]. | | | | | |

For any requirement in this section, when the UE transitions between any two states when being configured with eDRX_IDLE, being configured with eDRX_IDLE cycle, changing eDRX_IDLE cycle length, or changing PTW configuration, the UE shall meet the transition requirement, which is the less stringent requirement of the two requirements corresponding to the first state and the second state, during the transition time interval which is the time corresponding to the transition requirement. After the transition time interval, the UE has to meet the requirement corresponding to the second state.

4.6.2.6 Measurements of inter-frequency NB-IoT cells for UE category NB1 in enhanced coverage

The UE shall be able to identify new inter-frequency cells and perform NRSRP measurements of identified inter-frequency cells if carrier frequency information is provided by the serving NB-IoT cell, even if no explicit neighbour list with physical layer cell identities is provided.

The UE shall be able to evaluate whether a newly detectable inter-frequency cell meets the reselection criteria defined in TS36.304 within $P_{carrier} * T_{detect,NB_Inter_EC}$. An inter-frequency cell is considered to be detectable according to NRSRP, NRSRP \hat{E}_s/I_{ot} , NSCH_RP and NSCH \hat{E}_s/I_{ot} defined in Annex B.1.5 for a corresponding Band.

The UE shall not cause any interruption to the paging reception and acquisition of SI while performing measurement on serving or any neighbor cells.

The UE shall filter NRSRP measurements of each measured inter-frequency cell using at least 2 measurements. Within the set of measurements used for the filtering, at least two measurements shall be spaced by at least $T_{measure,NB_Inter_NB-IoT_EC}/2$.

If an inter-frequency cell has been already detected but that has not been reselected to the filtering shall be such that the UE shall be capable of evaluating that the inter-frequency cell has met reselection criterion defined TS 36.304 within $P_{carrier} * T_{evaluate,NB_Inter_EC}$, provided that the cell is at least YdB better ranked, where 'Y' is specified in Table 4.6.2.6-3. When evaluating cells for reselection, the side conditions for NRSRP, NRSRP \hat{E}_s/I_{ot} , NSCH_RP and NSCH \hat{E}_s/I_{ot} apply to both serving and inter-frequency NB-IoT cells.

If $T_{reselection}$ timer has a non zero value and the inter-frequency cell is better ranked than the serving NB-IoT cell, the UE shall evaluate this inter-frequency cell for the $T_{reselection}$ time. If this cell remains better ranked within this duration, then the UE shall reselect that cell.

For a UE not configured with eDRX_IDLE cycle, T_{detect,NB_Inter_EC} , $T_{measure,NB_Inter_EC}$ and $T_{evaluate,NB_inter_EC}$ are specified in Table 4.6.2.6-1. For UE configured with eDRX_IDLE cycle, T_{detect,NB_Inter_EC} , $T_{measure,NB_Inter_EC}$ and $T_{evaluate,NB_inter_EC}$ are specified in Table 4.6.2.6-2, where the requirements apply provided that the serving NB-IoT cell is configured with eDRX_IDLE and is the same in all PTWs during any of T_{detect,NB_Inter_EC} , $T_{measure,NB_Inter_EC}$ and $T_{evaluate,NB_inter_EC}$ when multiple PTWs are used.

Table 4.6.2.6-1 : T_{detect,NB_Inter_EC} , $T_{measure,NB_Inter_EC}$ and $T_{evaluate,NB_Inter_EC}$

| SCH \hat{E}_s/I_{ot} of neighboring cell: Q2 | DRX cycle length [s] | T_{detect,NB_Inter_EC} [s] (number of DRX cycles) | $T_{measure,NB_Inter_EC}$ [s] (number of DRX cycles) | $T_{evaluate,NB_Inter_EC}$ [s] (number of DRX cycles) |
|--|----------------------|---|--|---|
| $-15 \leq Q2 < -6$ | 1.28 | 532 (415) | 1.28 (1) | 12.8 (10) |
| | 2.56 | 532 (208) | 2.56 (1) | 15.36 (6) |
| | 5.12 | 1063 (208) | 5.12 (1) | 20.48 (4) |
| | 10.24 | 1063 (104) | 10.24 (1) | 30.72 (3) |
| $Q2 \geq -6$ | 1.28 | 58 (45) | 1.28 (1) | 12.8 (10) |
| | 2.56 | 59 (23) | 2.56 (1) | 15.36 (6) |
| | 5.12 | 113 (22) | 5.12 (1) | 20.48 (4) |
| | 10.24 | 113 (11) | 10.24 (1) | 30.72 (3) |

Table 4.6.2.6-2: T_{detect,NB_Inter_EC} , $T_{measure,NB_Inter_EC}$ and $T_{evaluate,NB_inter_EC}$ for UE configured with eDRX_IDLE cycle

| eDRX_IDLE cycle length [s] | DRX cycle length [s] | PTW length [s] (number of 2.56s periods) | T_{detect,NB_Inter_EC} [s] (number of DRX cycles) | $T_{measure,NB_Inter_EC}$ [s] (number of DRX cycles) | $T_{evaluate,NB_inter_EC}$ [s] (number of DRX cycles) |
|----------------------------|----------------------|--|---|--|---|
| $20.48 \leq$ | 1.28 | ≥ 15.36 (6) | $eDRX_cycle_length \times \left\lceil \frac{[406]}{PTW / DRX_cycle_length} \right\rceil$ (406) | 1.28 (1) | 12.8 (10) |
| eDRX_IDLE | 2.56 | ≥ 17.92 (7) | | 2.56 (1) | 15.36 (6) |
| cycle length | 5.12 | ≥ 23.04 (9) | | 5.12 (1) | 20.48 (4) |
| ≤ 10485.76 | 10.24 | ≥ 33.28 (13) | | 10.24 (1) | 30.72 (3) |

NOTE 1: The number of DRX cycles in this table is given for the DRX cycles within PTWs.

NOTE 2: The eDRX_IDLE cycle lengths are as specified in Section X of TS 24.008 [34].

Table 4.6.2.6-3: Conditions on NSCH \hat{E} s/lot of identified and of the neighbour cell

| NSCH \hat{E} s/lot of already identified cell including serving cell: Q1 | Neighbouring cell NSCH \hat{E} s/lot: Q2 | Cell Reselection Margin 'Y' |
|--|--|-----------------------------|
| $-15 \leq Q1 < -6$ | $-15 \leq Q2 < -6$ | 9.3 |
| $-15 \leq Q1 < -6$ | $Q2 \geq -6$ | 9.3 |
| $Q1 \geq -6$ | $Q2 \geq -6$ | 5 |

For any requirement in this section, when the UE transitions between any two states when being configured with eDRX_IDLE, being configured with eDRX_IDLE cycle, changing eDRX_IDLE cycle length, or changing PTW configuration, the UE shall meet the transition requirement, which is the less stringent requirement of the two requirements corresponding to the first state and the second state, during the transition time interval which is the time corresponding to the transition requirement. After the transition time interval, the UE has to meet the requirement corresponding to the second state.

4.6.2.7 Maximum interruption in paging reception in normal coverage

UE shall perform the cell re-selection with minimum interruption in monitoring downlink channels for paging reception. When the UE is configured with eDRX_IDLE cycle, the UE shall not miss any paging in a PTW provided the paging is sent in at least [2] DRX cycles before the end of that PTW.

At intra-frequency and inter-frequency cell re-selection, the UE shall monitor the downlink of serving NB-IoT cell for paging reception until the UE is capable to start monitoring downlink channels of the target intra-frequency and inter-frequency cell for paging reception. The interruption time shall not exceed $T_{SI-NB1-NC} + 100$ ms.

4.6.2.7A Maximum interruption in paging reception in enhanced coverage

UE shall perform the cell re-selection with minimum interruption in monitoring downlink channels for paging reception. When the UE is configured with eDRX_IDLE cycle, the UE shall not miss any paging in a PTW provided the paging is sent in at least [2] DRX cycles before the end of that PTW.

At intra-frequency and inter-frequency cell re-selection, the UE shall monitor the downlink of serving NB-IoT cell for paging reception until the UE is capable to start monitoring downlink channels of the target intra-frequency and inter-frequency cell for paging reception. The interruption time shall not exceed $T_{SI-NB1-EC} + 100$ ms.

4.6.2.8 UE measurement capability

For idle mode cell re-selection purposes, the UE shall be capable of monitoring at least:

- Depending on UE capability, an intra-frequency carrier.
- Depending on UE capability, at least 2 inter-frequency carriers.

4.7 Cell Selection and Re-selection Requirements for UE category M1

The UE category M1 applicability of the requirements in section 4.7 is defined in Section 3.6.1. The requirements in this subclause apply if category M1 UE is in normal and enhanced coverage area of the serving cell. The category M1 normal and enhanced coverage applicability of the requirements is defined in section 3.6.1.

4.7.1 Cell Selection

The requirements defined in section 4.1 apply for this section.

4.7.2 Cell Re-selection

The cell reselection procedure allows the UE to select a more suitable cell and camp on it.

When the UE is in either *Camped Normally* state or *Camped on Any Cell* state on a cell, the UE shall attempt to detect, synchronise, and monitor intra-frequency cells indicated by the serving cell. For intra-frequency cells the serving cell may not provide explicit neighbour list but carrier frequency information and bandwidth information only. UE measurement activity is also controlled by measurement rules defined in TS36.304, allowing the UE to limit its measurement activity.

If the UE is in normal coverage as defined in section 3.6.1, the requirements in section 4.7.2.1 apply. If the UE is in enhanced coverage as defined in section 3.6.1, the requirements in section 4.7.2.2 apply.

4.7.2.1 Cell Re-selection requirements for UE category M1 in normal coverage

4.7.2.1.1 Measurement and evaluation of serving cell for UE category M1 in normal coverage

The requirements in this subclause apply if UE is in the normal coverage area of the serving cell. The UE is considered to be in normal coverage area of serving cell according to RSRP, $RSRP_{\hat{E}s/Iot}$, SCH_RP and $SCH_{\hat{E}s/Iot}$ of the serving cell defined in Annex B.1.3 for a corresponding Band.

The requirements defined in section 4.2.2.1 apply for this section.

4.7.2.1.2 Measurements of intra-frequency cells for UE category M1 in normal coverage

The requirements in this subclause apply if UE is in the normal coverage area of the serving cell. The UE is considered to be in normal coverage area of serving cell according to RSRP, $RSRP_{\hat{E}s/Iot}$, SCH_RP and $SCH_{\hat{E}s/Iot}$ of the serving cell defined in Annex B.1.3 for a corresponding Band.

The UE shall be able to identify new intra-frequency cells and perform RSRP measurements of identified intra-frequency cells without an explicit intra-frequency neighbour list containing physical layer cell identities.

The UE shall be able to evaluate whether a newly detectable intra-frequency cell meets the reselection criteria defined in TS36.304 within $T_{detect,EUTRAN_Intra_NC}$ when that $T_{reselection} = 0$. An intra frequency cell is considered to be detectable according to RSRP, $RSRP_{\hat{E}s/Iot}$, SCH_RP and $SCH_{\hat{E}s/Iot}$ defined in Annex B.1.3 for a corresponding Band.

The UE shall measure RSRP at least every $T_{measure,EUTRAN_Intra_NC}$ for intra-frequency cells that are identified and measured according to the measurement rules.

The UE shall filter RSRP measurements of each measured intra-frequency cell using at least 2 measurements. Within the set of measurements used for the filtering, at least two measurements shall be spaced by at least $T_{measure,EUTRAN_Intra_NC}/2$.

The UE shall not consider a E-UTRA neighbour cell in cell reselection, if it is indicated as not allowed in the measurement control system information of the serving cell.

For an intra-frequency cell that has been already detected, but that has not been reselected to, the filtering shall be such that the UE shall be capable of evaluating that the intra-frequency cell has met reselection criterion defined [1] within $T_{evaluate,E-UTRAN_Intra_NC}$ when $T_{reselection} = 0$, provided that the cell is at least 4dB better ranked for Cat-M1 UE.

If $T_{reselection}$ timer has a non zero value and the intra-frequency cell is better ranked than the serving cell, the UE shall evaluate this intra-frequency cell for the $T_{reselection}$ time. If this cell remains better ranked within this duration, then the UE shall reselect that cell.

For UE not configured with eDRX_IDLE cycle, $T_{detect,EUTRAN_Intra_NC}$, $T_{measure,EUTRAN_Intra_NC}$ and $T_{evaluate,E-UTRAN_Intra_NC}$ are specified in Table 4.7.2.1.2-1. For UE configured with eDRX_IDLE cycle, $T_{detect,EUTRAN_Intra_NC}$, $T_{measure,EUTRAN_Intra_NC}$ and $T_{evaluate,E-UTRAN_Intra_NC}$ are specified in Table 4.7.2.1.2-2, where the requirements apply provided that the serving cell is configured with eDRX_IDLE and is the same in all PTWs during any of $T_{detect,EUTRAN_Intra_NC}$, $T_{measure,EUTRAN_Intra_NC}$ and $T_{evaluate,E-UTRAN_Intra_NC}$ when multiple PTWs are used.

Table 4.7.2.1.2-1 : $T_{\text{detect,EUTRAN_Intra_NC}}$, $T_{\text{measure,EUTRAN_Intra_NC}}$ and $T_{\text{evaluate,E-UTRAN_Intra_NC}}$

| DRX cycle length [s] | $T_{\text{detect,EUTRAN_Intra_NC}}$ [s] (number of DRX cycles) | $T_{\text{measure,EUTRAN_Intra_NC}}$ [s] (number of DRX cycles) | $T_{\text{evaluate,E-UTRAN_Intra_NC}}$ [s] (number of DRX cycles) |
|----------------------|--|---|---|
| 0.32 | 11.52 (36) | 1.28 (4) | 5.12 (16) |
| 0.64 | 17.92 (28) | 1.28 (2) | 5.12 (8) |
| 1.28 | 32(25) | 1.28 (1) | 6.4 (5) |
| 2.56 | 58.88 (23) | 2.56 (1) | 7.68 (3) |

Table 4.7.2.1.2-2: $T_{\text{detect,EUTRAN_Intra_NC}}$, $T_{\text{measure,EUTRAN_Intra_NC}}$ and $T_{\text{evaluate,E-UTRAN_Intra_NC}}$ for UE configured with eDRX_IDLE cycle

| eDRX_IDLE cycle length [s] | DRX cycle length [s] | PTW length [s] (number of 1.28s periods) | $T_{\text{detect,EUTRAN_Intra_NC}}$ [s] (number of DRX or eDRX cycles ^{Note 3}) | $T_{\text{measure,EUTRAN_Intra_NC}}$ [s] (number of DRX or eDRX cycles ^{Note 3}) | $T_{\text{evaluate,E-UTRAN_Intra_NC}}$ [s] (number of DRX or eDRX cycles ^{Note 3}) |
|--|----------------------|--|---|--|--|
| 5.12 | N/A | N/A | 117.76 (23) | 5.12 (1) | 10.24 (2) |
| 10.24 ≤ eDRX_IDLE cycle length ≤ 2621.44 | 0.32 | ≥1.28 (1) | $eDRX_cycle_length \times \left\lceil \frac{23}{PTW / DRX_cycle_length} \right\rceil$ (23) | 0.32 (1) | 0.64 (2) |
| | 0.64 | ≥1.28 (1) | | 0.64 (1) | 1.28 (2) |
| | 1.28 | ≥2.56 (2) | | 1.28 (1) | 2.56 (2) |
| | 2.56 | ≥5.12 (4) | | 2.56 (1) | 5.12 (2) |

NOTE 1: The number of DRX cycles in this table is given for the DRX cycles within PTWs.

NOTE 2: The eDRX_IDLE cycle lengths are as specified in Section 10.5.5.32 of TS 24.008 [34].

NOTE 3: Number of eDRX cycles when eDRX_IDLE cycle length equals 5.12s, number of DRX cycles otherwise.

For any requirement in this section, when the UE transitions between any two states when being configured with eDRX_IDLE, being configured with eDRX_IDLE cycle, changing eDRX_IDLE cycle length, or changing PTW configuration, the UE shall meet the transition requirement, which is the less stringent requirement of the two requirements corresponding to the first state and the second state, during the transition time interval which is the time corresponding to the transition requirement. After the transition time interval, the UE has to meet the requirement corresponding to the second state.

4.7.2.2 Cell Re-selection requirements for UE category M1 in enhanced coverage

4.7.2.2.1 Measurement and evaluation of serving cell for UE category M1 in enhanced coverage

The requirements in this subclause apply if UE is in the enhanced coverage area of the serving cell. The UE is considered to be in enhanced coverage area of serving cell according to RSRP, RSRP \hat{E}_s/I_{ot} , SCH_RP and SCH \hat{E}_s/I_{ot} of the serving cell defined in Annex B.1.3 for a corresponding Band.

The UE shall measure the RSRP level of the serving cell and evaluate the cell selection criterion S defined in [1] for the serving cell at least every DRX cycle.

The UE shall filter the RSRP measurements of the serving cell using at least 4 measurements. Within the set of measurements used for the filtering, at least two measurements shall be spaced by, at least DRX cycle/2.

If the UE is not configured with eDRX_IDLE cycle and has evaluated according to Table 4.7.2.2.1-1 in $N_{\text{serv_EC}}$ consecutive DRX cycles that the serving cell does not fulfil the cell selection criterion S, the UE shall initiate the measurements of all neighbour cells indicated by the serving cell, regardless of the measurement rules currently limiting UE measurement activities.

If the UE is configured with eDRX_IDLE cycle and has evaluated according to Table 4.7.2.2.1-2 in $N_{\text{serv_EC}}$ consecutive DRX cycles within a single PTW that the serving cell does not fulfil the cell selection criterion S, the UE shall initiate

the measurements of all neighbour cells indicated by the serving cell, regardless of the measurement rules currently limiting UE measurement activities.

If the UE in RRC_IDLE has not found any new suitable cell based on searches and measurements using the intra-frequency, inter-frequency and inter-RAT information indicated in the system information during the time T, the UE shall initiate cell selection procedures for the selected PLMN as defined in [1], where $T=20$ s if the UE is not configured with eDRX_IDLE cycle, and $T=\text{MAX}(20 \text{ s, one eDRX_IDLE cycle})$ if the UE is configured with eDRX_IDLE cycle.

Table 4.7.2.2.1-1: $N_{\text{serv_EC}}$

| DRX cycle length [s] | $N_{\text{serv_EC}}$ [number of DRX cycles] |
|----------------------|--|
| 0.32 | 8 |
| 0.64 | 8 |
| 1.28 | 4 |
| 2.56 | 4 |

Table 4.7.2.2.1-2: $N_{\text{serv_EC}}$ for UE configured with eDRX_IDLE cycle

| eDRX_IDLE cycle length [s] | DRX cycle length [s] | PTW length [s] (number of 1.28s periods) | N_{serv} [number of DRX or eDRX cycles ^{Note 3}] |
|---|----------------------|--|---|
| 5.12 | N/A | N/A | 4 |
| $10.24 \leq \text{eDRX_IDLE cycle length} \leq 2621.44$ | 0.32 | ≥ 1.28 (1) | 4 |
| | 0.64 | ≥ 2.56 (2) | 4 |
| | 1.28 | ≥ 5.12 (4) | 4 |
| | 2.56 | ≥ 10.24 (8) | 4 |
| NOTE 1: The number of DRX cycles in this table is given for the DRX cycles within PTWs. | | | |
| NOTE 2: The eDRX_IDLE cycle lengths are as specified in Section 10.5.5.32 of TS 24.008 [34]. | | | |
| NOTE 3: Number of eDRX cycles when eDRX_IDLE cycle length equals 5.12s, number of DRX cycles otherwise. | | | |

For any requirement in this section, when the UE transitions between any two states when being configured with eDRX_IDLE, being configured with eDRX_IDLE cycle, changing eDRX_IDLE cycle length, or changing PTW configuration, the UE shall meet the transition requirement, which is the less stringent requirement of the two requirements corresponding to the first state and the second state, during the transition time interval which is the time corresponding to the transition requirement. After the transition time interval, the UE has to meet the requirement corresponding to the second state.

4.7.2.2.2 Measurements of intra-frequency cells for UE category M1 in enhanced coverage

The requirements in this subclause apply if UE is in the enhanced coverage area of the serving cell. The UE is considered to be in enhanced coverage area of serving cell according to RSRP, $\text{RSRP } \hat{E}_s/\text{Tot}$, SCH_{RP} and $\text{SCH } \hat{E}_s/\text{Tot}$ of the serving cell defined in Annex B.1.3 for a corresponding Band.

The UE shall be able to identify new intra-frequency cells and perform RSRP measurements of identified intra-frequency cells without an explicit intra-frequency neighbour list containing physical layer cell identities. The UE shall not cause any interruption to the paging reception and acquisition of SI while performing measurement on serving or any neighbor cells.

The UE shall be able to evaluate whether a newly detectable intra-frequency cell meets the reselection criteria defined in TS36.304 within $T_{\text{detect,EUTRAN_Intra_EC}}$ when that $T_{\text{reselction}}=0$. An intra-frequency cell is considered to be detectable according to RSRP, $\text{RSRP } \hat{E}_s/\text{Tot}$, SCH_{RP} and $\text{SCH } \hat{E}_s/\text{Tot}$ defined in Annex B.1.3 for a corresponding Band.

The UE shall measure RSRP at least every $T_{\text{measure,EUTRAN_Intra_EC}}$ for intra-frequency cells that are identified and measured according to the measurement rules.

The UE shall filter RSRP measurements of each measured intra-frequency cell using at least 4 measurements. Within the set of measurements used for the filtering, at least two measurements shall be spaced by at least $T_{measure,EUTRAN_Intra_EC}/2$.

The UE shall not consider an E-UTRA neighbour cell in cell reselection, if it is indicated as not allowed in the measurement control system information of the serving cell.

For an intra-frequency cell that has been already detected, but that has not been reselected to, the filtering shall be such that the UE shall be capable of evaluating that the intra-frequency cell has met reselection criterion defined [1] within $T_{evaluate,E-UTRAN_intra_EC}$ when $T_{reselection} = 0$, provided that the cell is at least 5dB better ranked.

If $T_{reselection}$ timer has a non zero value and the intra-frequency cell is better ranked than the serving cell, the UE shall evaluate this intra-frequency cell for the $T_{reselection}$ time. If this cell remains better ranked within this duration, then the UE shall reselect that cell.

For UE not configured with eDRX_IDLE cycle, $T_{detect,EUTRAN_Intra_EC}$, $T_{measure,EUTRAN_Intra_EC}$ and $T_{evaluate,E-UTRAN_intra_EC}$ are specified in Table 4.7.2.2.2-1. For UE configured with eDRX_IDLE cycle, $T_{detect,EUTRAN_Intra_EC}$, $T_{measure,EUTRAN_Intra_EC}$ and $T_{evaluate,E-UTRAN_intra_EC}$ are specified in Table 4.7.2.2.2-2. Additionally, the requirements in Table 4.7.2.2.2-2 apply provided that the serving cell is configured with eDRX_IDLE and is the same in all PTWs during any of $T_{detect,EUTRAN_Intra_EC}$, $T_{measure,EUTRAN_Intra_EC}$ and $T_{evaluate,E-UTRAN_intra_EC}$ when multiple PTWs are used.

Table 4.7.2.2.2-1 : $T_{detect,EUTRAN_Intra_EC}$, $T_{measure,EUTRAN_Intra_EC}$ and $T_{evaluate,E-UTRAN_intra_EC}$

| SCH Es/lot of neighboring cell: Q2 [dB] | DRX cycle length [s] | $T_{detect,EUTRAN_Intra_EC}$ [s] (number of DRX cycles) | $T_{measure,EUTRAN_Intra_EC}$ [s] (number of DRX cycles) | $T_{evaluate,E-UTRAN_intra_EC}$ [s] (number of DRX cycles) |
|---|----------------------|---|--|--|
| $-15 \leq Q2 < -6$ | 0.32 | 330.24 (1032) | 1.28 (4) | 10.24 (32) |
| | 0.64 | 330.24 (516) | 1.28 (2) | 10.24 (16) |
| | 1.28 | 524.8 (410) | 1.28 (1) | 12.8 (10) |
| | 2.56 | 1039.36 (406) | 2.56 (1) | 15.36 (6) |
| $Q2 \geq -6$ | 0.32 | 16.64 (52) | 1.28 (4) | 10.24 (32) |
| | 0.64 | 23.04 (36) | 1.28 (2) | 10.24 (16) |
| | 1.28 | 38.4 (30) | 1.28 (1) | 12.8 (10) |
| | 2.56 | 66.56 (26) | 2.56 (1) | 15.36 (6) |

Table 4.7.2.2.2-2: $T_{detect,EUTRAN_Intra_EC}$, $T_{measure,EUTRAN_Intra_EC}$ and $T_{evaluate,E-UTRAN_intra_EC}$ for UE configured with eDRX_IDLE cycle

| eDRX_IDLE cycle length [s] | DRX cycle length [s] | PTW length [s] (number of 1.28s periods) | $T_{detect,EUTRAN_Intra_EC}$ [s] (number <i>N</i> of DRX or eDRX cycles ^{Note 4}) for neighboring cell with SCH Es/lot: $-15 \leq Q2 < -6$ [dB] | $T_{detect,EUTRAN_Intra_EC}$ [s] (number <i>N</i> of DRX or eDRX cycles ^{Note 4}) for neighboring cell with SCH Es/lot: $Q2 \geq -6$ [dB] | $T_{measure,EUTRAN_Intra_EC}$ [s] (number <i>N</i> of DRX or eDRX cycles ^{Note 4}) | $T_{evaluate,E-UTRAN_intra_EC}$ [s] (number <i>N</i> of DRX or eDRX cycles ^{Note 4}) |
|---|----------------------|--|---|---|--|--|
| 5.12 | N/A | N/A | 2078.72 (406) | 133.12 (26) | 5.12 (1) | 30.72 (6) |
| $10.24 \leq eDRX_IDLE$ cycle length ≤ 2621.44 | 0.32 | ≥ 1.28 (1) | Note 3 (406) | Note 3 (26) | 0.32 (1) | Note 3 (6) |
| | 0.64 | ≥ 1.28 (1) | | | 0.64 (1) | Note 3 (6) |
| | 1.28 | ≥ 2.28 (1) | | | 1.28 (1) | Note 3 (6) |
| | 2.56 | ≥ 2.56 (2) | | | 2.56 (1) | Note 3 (6) |

NOTE 1: The number of DRX cycles in this table is given for the DRX cycles within PTWs.
 NOTE 2: The eDRX_IDLE cycle lengths are as specified in Section 10.5.5.32 of TS 24.008 [34].
 NOTE 3: The detection period and the evaluation period depend on the number *N* of DRX cycles and are calculated according to the formula below:

$$eDRX_cycle_length \times \left\lceil \frac{N}{\lceil PTW / DRX_cycle_length \rceil} \right\rceil$$

NOTE 4: Number of eDRX cycles when eDRX_IDLE cycle length equals 5.12s, number of DRX cycles otherwise.

For any requirement in this section, when the UE transitions between any two states when being configured with eDRX_IDLE, being configured with eDRX_IDLE cycle, changing eDRX_IDLE cycle length, or changing PTW configuration, the UE shall meet the transition requirement, which is the less stringent requirement of the two requirements corresponding to the first state and the second state, during the transition time interval which is the time corresponding to the transition requirement. After the transition time interval, the UE has to meet the requirement corresponding to the second state.

5 E-UTRAN RRC_CONNECTED state mobility

Note 1: For the performance requirements specified hereafter, the state when no DRX is used is defined as follows:

- DRX and eDRX_CONN parameters are not configured; or
- DRX or eDRX_CONN parameters are configured and
 - o drx-InactivityTimer is running; or
 - o drx-RetransmissionTimer is running; or
 - o mac-ContentionResolutionTimer is running; or
 - o a Scheduling Request sent on PUCCH is pending; or
 - o an uplink grant for a pending HARQ retransmission can occur and there is data in the corresponding HARQ buffer; or
 - o a PDCCH indicating a new transmission addressed to the C-RNTI of the UE has not been received after successful reception of a Random Access Response for the explicitly signaled preamble (only applicable to UEs in RRC_CONNECTED).

Otherwise

- It is the state when DRX is used.

Note 2: Unless otherwise stated, the requirements in sections 5.1, 5.2.2.2, 5.2.2.3, 5.2.2.4, 5.3 and 5.4 are also applicable when a UE is configured with Scell(s) or PSCell.

5.1 E-UTRAN Handover

5.1.1 Introduction

5.1.2 Requirements

5.1.2.1 E-UTRAN FDD – FDD

The requirements in this clause are applicable to both intra-frequency and inter-frequency handovers.

5.1.2.1.1 Handover delay

Procedure delays for all procedures that can command a handover are specified in TS 36.331 [2].

When the UE receives a RRC message implying handover the UE shall be ready to start the transmission of the new uplink PRACH channel within D_{handover} seconds from the end of the last TTI containing the RRC command.

Where:

D_{handover} equals the maximum RRC procedure delay to be defined in clause 11.2 in TS 36.331 [2] plus the interruption time stated in clause 5.1.2.1.2.

5.1.2.1.2 Interruption time

The interruption time is the time between end of the last TTI containing the RRC command on the old PDSCH and the time the UE starts transmission of the new PRACH, excluding the RRC procedure delay. This requirement applies when UE is not required to perform any synchronisation procedure before transmitting on the new PRACH.

When intra-frequency or inter-frequency handover is commanded, the interruption time shall be less than $T_{\text{interrupt}}$

$$T_{\text{interrupt}} = T_{\text{search}} + T_{\text{IU}} + 20 \text{ ms}$$

Where:

T_{search} is the time required to search the target cell when the target cell is not already known when the handover command is received by the UE. If the target cell is known, then $T_{\text{search}} = 0$ ms. If the target cell is unknown and signal quality is sufficient for successful cell detection on the first attempt, then $T_{\text{search}} = 80$ ms. Regardless of whether DRX is in use by the UE, T_{search} shall still be based on non-DRX target cell search times.

T_{IU} is the interruption uncertainty in acquiring the first available PRACH occasion in the new cell. T_{IU} can be up to 30 ms.

NOTE: The actual value of T_{IU} shall depend upon the PRACH configuration used in the target cell.

In the interruption requirement a cell is known if it has been meeting the relevant cell identification requirement during the last 5 seconds otherwise it is unknown. Relevant cell identification requirements are described in Clause 8.1.2.2.1 for intra-frequency handover and Clause 8.1.2.3.1 for inter-frequency handover.

5.2.2.2 E-UTRAN FDD – TDD

The requirements in this clause are applicable to handover from FDD to TDD. The requirements in this clause shall apply to UE supporting FDD and TDD.

The requirements in clause 5.2.2.4 apply for this section.

5.2.2.2.1 (Void)

5.2.2.2.2 (Void)

5.2.2.3 E-UTRAN TDD – FDD

The requirements in this clause are applicable to handover from TDD to FDD. The requirements in this clause shall apply to UE supporting FDD and TDD.

The requirements in clause 5.1.2.1 apply for this section.

5.2.2.3.1 (Void)

5.2.2.3.2 (Void)

5.2.2.4 E-UTRAN TDD – TDD

The requirements in this clause are applicable to both intra-frequency and inter-frequency handovers.

5.2.2.4.1 Handover delay

Procedure delays for all procedures that can command a handover are specified in TS 36.331 [2].

When the UE receives a RRC message implying handover, the UE shall be ready to start the transmission of the new uplink PRACH channel within D_{handover} seconds from the end of the last TTI containing the RRC command.

Where:

D_{handover} equals the maximum RRC procedure delay to be defined in clause 11.2 in TS 36.331 [2] plus the interruption time stated in clause 5.2.2.4.2.

5.2.2.4.2 Interruption time

The interruption time is the time between end of the last TTI containing the RRC command on the old PDSCH and the time the UE starts transmission of the new PRACH, excluding the RRC procedure delay. This requirement applies when UE is not required to perform any synchronisation procedure before transmitting on the new PRACH.

When intra-frequency or inter-frequency handover is commanded, the interruption time shall be less than $T_{\text{interrupt}}$

$$T_{\text{interrupt}} = T_{\text{search}} + T_{\text{IU}} + 20 \text{ ms}$$

Where

T_{search} is the time required to search the target cell when the target cell is not already known when the handover command is received by the UE. If the target cell is known, then $T_{\text{search}} = 0$ ms. If the target cell is unknown and signal quality is sufficient for successful cell detection on the first attempt, then $T_{\text{search}} = 80$ ms. Regardless of whether DRX is in use by the UE, T_{search} shall still be based on non-DRX target cell search times.

T_{IU} is the interruption uncertainty in acquiring the first available PRACH occasion in the new cell. T_{IU} can be up to 30 ms.

NOTE: The actual value of T_{IU} shall depend upon the PRACH configuration used in the target cell.

In the interruption requirement a cell is known if it has been meeting the relevant cell identification requirement during the last 5 seconds otherwise it is unknown. Relevant cell identification requirements are described in Clause 8.1.2.2.2 for intra-frequency handover and Clause 8.1.2.3.4 for inter-frequency handover.

5.2.2.5 E-UTRAN HD-FDD

The requirements in this clause are applicable to intra-frequency handovers.

5.2.2.5.1 Handover delay

Procedure delays for all procedures that can command a handover are specified in TS 36.331 [2].

When the UE receives a RRC message implying handover the UE shall be ready to start the transmission of the new uplink PRACH channel within D_{handover} seconds from the end of the last TTI containing the RRC command.

Where:

D_{handover} equals the maximum RRC procedure delay to be defined in clause 11.2 in TS 36.331 [2] plus the interruption time stated in clause 5.2.2.5.2.

5.2.2.5.2 Interruption time

The interruption time is the time between end of the last TTI containing the RRC command on the old PDSCH and the time the UE starts transmission of the new PRACH, excluding the RRC procedure delay. This requirement applies when UE is not required to perform any synchronisation procedure before transmitting on the new PRACH.

When intra-frequency handover is commanded, the interruption time shall be less than $T_{\text{interrupt}}$

$$T_{\text{interrupt}} = T_{\text{search}} + T_{\text{IU}} + 20 \text{ ms}$$

Where:

T_{search} is the time required to search the target cell when the target cell is not already known when the handover command is received by the UE. If the target cell is known, then $T_{\text{search}} = 0$ ms. If the target cell is unknown and signal quality is sufficient for successful cell detection on the first attempt, then $T_{\text{search}} = 80$ ms. Regardless of whether DRX is in use by the UE, T_{search} shall still be based on non-DRX target cell search times.

T_{IU} is the interruption uncertainty in acquiring the first available PRACH occasion in the new cell. T_{IU} can be up to 30 ms.

NOTE: The actual value of T_{IU} shall depend upon the PRACH configuration used in the target cell.

In the interruption requirement a cell is known if it has been meeting the relevant cell identification requirement during the last 5 seconds otherwise it is unknown. Relevant cell identification requirements are described in Clause 8.5.2.1.2 for intra-frequency handover.

5.3 Handover to other RATs

5.3.1 E-UTRAN - UTRAN FDD Handover

5.3.1.1 Introduction

The purpose of inter-RAT handover from E-UTRAN to UTRAN FDD is to change the radio access mode from E-UTRAN to UTRAN FDD. The handover procedure is initiated from E-UTRAN with a RRC message that implies a hard handover as described in TS 36.331 [2].

5.3.1.1.1 Handover delay

When the UE receives a RRC message implying handover to UTRAN the UE shall be ready to start the transmission of the new UTRA uplink DPCH within $D_{handover}$ seconds from the end of the last E-UTRAN TTI containing the RRC MOBILITY FROM E-UTRA command.

where:

- $D_{handover}$ equals the RRC procedure delay, which is 50 ms plus the interruption time stated in clause 5.3.1.1.2.

5.3.1.1.2 Interruption time

The interruption time is the time between the end of the last TTI containing the RRC command on the E-UTRAN PDSCH and the time the UE starts transmission on the uplink DPCH in UTRAN FDD, excluding the RRC procedure delay. The interruption time depends on whether the target cell is known to the UE or not.

The target cell is known if it has been measured by the UE during the last 5 seconds otherwise it is unknown. The UE shall always perform a UTRA synchronisation procedure as part of the handover procedure.

If the target cell is known the interruption time shall be less than $T_{interrupt1}$

$$T_{interrupt1} = T_{IU} + T_{sync} + 50 + 10 * F_{max} + T_{MC} \text{ ms}$$

If the target cell is unknown the interruption time shall be less than $T_{interrupt2}$

$$T_{interrupt2} = T_{IU} + T_{sync} + 150 + 10 * F_{max} + T_{MC} \text{ ms}$$

This requirement shall be met, provided that there is one target cell in the MOBILITY FROM E-UTRA command. Performance requirements for E-UTRA to UTRA soft handover are not specified. When UE is connected to an E-UTRA cell, UTRA SFN timing measurements are not reported. This implies that the timing of the DPCH of the UTRA target cells in the active set cannot be configured by UTRAN to guarantee that all target cells fall within the UE reception window of $T_0 \pm 148$ chips.

Where:

T_{IU} is the interruption uncertainty when changing the timing from the E-UTRAN to the new UTRAN cell. T_{IU} can be up to one UTRA frame (10 ms).

F_{max} denotes the maximum number of radio frames within the transmission time intervals of all transport channels that are multiplexed into the same CCTrCH on the UTRA target cell. If HS-PDSCH is configured in the UTRA target cell, F_{max} is 4 radio frames.

T_{sync} is the time required for measuring the downlink DPCCCH channel as stated in TS 25.214 [20], clause 4.3.1.2. In case higher layers indicate the usage of a post-verification period $T_{\text{sync}}=0$ ms. Otherwise $T_{\text{sync}}=40$ ms.

T_{MC} T_{MC} is 0ms if a single UTRA cell is configured as the handover target, otherwise 20ms if handover to UTRA with 1, 2 or 3 UTRA carriers with secondary HS-PDSCH is configured.

The phase reference is the primary CPICH.

The requirements in this clause assume that N_{312} has the smallest possible value i.e. only one insync is required.

5.3.2 E-UTRAN - UTRAN TDD Handover

5.3.2.1 Introduction

The purpose of inter-RAT handover from E-UTRAN to UTRAN TDD is to change the radio access mode from E-UTRAN to UTRAN TDD. The handover procedure is initiated from E-UTRAN with a RRC message that implies a hard handover as described in TS 36.331 [2].

5.3.2.2 Requirements

The requirements in this clause shall apply to UE supporting E-UTRAN and UTRAN TDD.

5.3.2.2.1 Handover delay

When the UE receives a RRC message implying E-UTRAN/UTRAN TDD handover the UE shall be ready to start the transmission of the SYNC-UL within D_{handover} seconds from the end of the last TTI containing the RRC MOBILITY FROM E-UTRA command.

Where:

- D_{handover} equals the RRC procedure delay, which is 50 ms plus the interruption time stated in clause 5.3.2.2.2.

5.3.2.2.2 Interruption time

The interruption time is the time between the end of the last TTI containing the RRC command on the E-UTRAN PDSCH and the time the UE starts transmission on the SYNC-UL in UTRAN TDD, excluding the RRC procedure delay. The interruption time depends on whether the target cell is known to the UE or not.

The UE shall always perform a UTRA synchronisation procedure as part of the handover procedure.

If the target cell has been measured by the UE during the last 5 seconds, the interruption time shall be less than $T_{\text{interrupt1}}$

$$T_{\text{interrupt1}} = T_{\text{offset}} + T_{\text{UL}} + 30 * F_{\text{SFN}} + 20 \text{ ms}$$

If the target cell has not been measured by the UE during the last 5 seconds, the interruption time shall be less than $T_{\text{interrupt2}}$

$$T_{\text{interrupt2}} = T_{\text{offset}} + T_{\text{UL}} + 30 * F_{\text{SFN}} + 180 \text{ ms}$$

Where:

T_{offset} Equal to 10 ms, the frame timing uncertainty between the old cell and the target cell and the time that can elapse until the appearance of a Beacon channel

T_{UL} Equal to 10 ms, the time that can elapse until the appearance of the UL timeslot in the target cell

F_{SFN} Equal to 1 if SFN decoding is required and equal to 0 otherwise

The interruption time requirements for an unknown target cell shall apply only if the signal quality of the unknown target cell is sufficient for successful synchronisation with one attempt.

5.3.3 E-UTRAN - GSM Handover

5.3.3.1 Introduction

The purpose of inter-RAT handover from E-UTRAN to GSM is to transfer a connection between the UE and E-UTRAN to GSM. The handover procedure is initiated from E-UTRAN with a RRC message (MOBILITY FROM E-UTRA). The procedure is described in in TS 36.331 [2].

5.3.3.2 Requirements

The requirements in this clause shall apply to UE supporting E-UTRAN and GSM.

The requirements given below in Tables 5.3.3.2.1-1 and 5.3.3.2.2-1 for the case where the UE has not synchronised to the GSM cell before receiving the RRC MOBILITY FROM E-UTRA command are valid when the signal quality of the GSM cell is sufficient for successful synchronisation with one attempt. If the UE is unable to synchronise to the GSM cell on the first attempt, it shall continue to search for synchronisation information for up to 800 ms duration. If after 800 ms the UE has not synchronised to the GSM cell it shall follow the handover failure procedure specified in TS 36.331 [2].

5.3.3.2.1 Handover delay

When the UE receives a RRC MOBILITY FROM E-UTRA command the UE shall be ready to transmit (as specified in [10]) on the channel of the new RAT within the value in table 5.3.3.2.1-1 from the end of the last TTI containing the RRC command. The UE shall process the RRC procedures for the MOBILITY FROM E-UTRA command within 50 ms, which is noted as RRC procedure delay.

Table 5.3.3.2.1-1: E-UTRAN/GSM handover - handover delay

| UE synchronisation status | handover delay [ms] |
|---|----------------------------|
| The UE has synchronised to the GSM cell before the RRC MOBILITY FROM E-UTRA COMMAND is received | 90 |
| The UE has not synchronised to the GSM cell before the RRC MOBILITY FROM E-UTRA COMMAND is received | 190 |

5.3.3.2.2 Interruption time

The interruption time is the time between the end of the last TTI containing the RRC command on the E-UTRAN PDSCH and the time the UE starts transmission on the uplink channel in GSM, excluding the RRC procedure delay. The interruption time depends on whether the UE has synchronized to the target GSM cell or not and shall be less than the value specified in table 5.3.3.2.2-1.

Table 5.3.3.2.2-1: E-UTRAN/GSM handover - interruption time

| Synchronisation status | Interruption time [ms] |
|---|-------------------------------|
| The UE has synchronised to the GSM cell before the RRC MOBILITY FROM E-UTRA COMMAND is received | 40 |
| The UE has not synchronised to the GSM cell before the RRC MOBILITY FROM E-UTRA COMMAND is received | 140 |

5.4 Handover to Non-3GPP RATs

5.4.1 E-UTRAN – HRPD Handover

5.4.1.1 Introduction

The handover procedure from E-UTRAN to HRPD is initiated when E-UTRAN sends handover command to the UE through dedicated RRC signalling.

5.4.1.1.1 Handover delay

The handover delay (D_{handover}) is defined as the sum of the RRC procedure delay, which is 50 ms and the interruption time specified in clause 5.4.1.1.2.

When the UE receives a RRC message implying handover to HRPD, the UE shall be ready to start the transmission of the new reverse control channel in HRPD within D_{handover} from the end of the last E-UTRAN TTI containing the RRC command.

5.4.1.1.2 Interruption time

The interruption time is the time between the end of the last TTI containing the RRC command on the E-UTRAN PDSCH and the time the UE starts transmission of the reverse control channel in HRPD, excluding the RRC procedure delay. The interruption time depends on whether the target cell is known to the UE or not.

An HRPD cell is known if it has been measured by the UE during the last 5 seconds otherwise it is unknown. Under the reference conditions specified in sub-clause 6.6 of [13], the interruption time shall be less than $T_{\text{interrupt}}$

$$T_{\text{interrupt}} = T_{\text{IU}} + 40 + 10 \cdot \text{KC} \cdot \text{SW}_{\text{K}} + 10 \cdot \text{OC} \cdot \text{SW}_{\text{O}} \text{ ms}$$

Where:

T_{IU} It is the interruption uncertainty when changing the timing from the E-UTRAN to the new HRPD cell. T_{IU} can be up to one HRPD frame (26.66 ms).

SW_{K} is $\text{SW}_{\text{K}} = \left\lceil \frac{\text{srch_win_k}}{60} \right\rceil$ where srch_win_k is the number of HRPD chips indicated by the search window for known target HRPD cells in the message

SW_{O} is $\text{SW}_{\text{O}} = \left\lceil \frac{\text{srch_win_o}}{60} \right\rceil$ where srch_win_o is the number of HRPD chips indicated by the search window for unknown target HRPD cells in the message

KC It is the number of known target HRPD cells in the message, and

OC It is the number of unknown target HRPD cells in the message.

Note: An additional delay in the interruption time may occur due to the reverse link silence interval [11], which is specific to HRPD.

5.4.2 E-UTRAN – cdma2000 1X Handover

5.4.2.1 Introduction

The handover procedure from E-UTRAN to cdma2000 1X is initiated when E-UTRAN sends handover command to the UE through dedicated RRC signalling.

5.4.2.1.1 Handover delay

The handover delay (D_{handover}) is defined as the sum of the RRC procedure delay, which is 130 ms and the interruption time specified in clause 5.4.2.1.2.

When the UE receives a RRC message implying handover to cdma2000 1X, the UE shall be ready to start the transmission of the new reverse control channel in cdma2000 1X within D_{handover} from the end of the last E-UTRAN TTI containing the RRC command.

5.4.2.1.2 Interruption time

The interruption time is the time between the end of the last TTI containing the RRC command on the E-UTRAN PDSCH and the time the UE starts transmission of the reverse control channel in cdma2000 1X, excluding the RRC procedure delay. The interruption time depends on whether the target cell is known to the UE or not.

A cdma2000 1X cell is known if it has been measured by the UE during the last 5 seconds otherwise it is unknown. Under the reference conditions specified in sub-clause 4.2.1 of [14], the interruption time shall be less than $T_{\text{interrupt}}$:

$$T_{\text{interrupt}} = T_{\text{IU}} + 140 + 10 \cdot \text{KC} \cdot \text{SW}_K + 10 \cdot \text{OC} \cdot \text{SW}_O \text{ ms}$$

Where:

T_{IU} It is the interruption uncertainty when changing the timing from the E-UTRAN to the new cdma2000 1X cell. T_{IU} can be up to one cdma2000 1X frame (20 ms).

SW_K is $\text{SW}_K = \left\lceil \frac{\text{srch_win_k}}{300} \right\rceil$ where srch_win_k is the number of cdma2000 1x chips indicated by the search window for known target cdma2000 1x cells in the message

SW_O is $\text{SW}_O = \left\lceil \frac{\text{srch_win_o}}{300} \right\rceil$ where srch_win_o is the number of cdma2000 1x chips indicated by the search window for unknown target cdma2000 1x cells in the message

KC It is the number of known target cdma2000 1X cells in the message, and

OC It is the number of unknown target cdma2000 1X cells in the message.

5.5 E-UTRAN Handover for Cat-M1 UEs

5.5.1 Introduction

This section defines the E-UTRAN intra-frequency handover requirements for Cat-M1 UEs in CEModeA as required by TS 36.300 [25].

5.5.2 Requirements in CEModeA

5.5.2.1 E-UTRAN FDD – FDD for Cat-M1 FDD UEs

The requirements in this clause are applicable to FDD intra-frequency handovers for a Cat-M1 FDD UE in CEModeA.

5.5.2.1.1 Handover delay

Procedure delays for all procedures that can command a handover are specified in TS 36.331 [2].

When the UE receives a RRC message implying handover the UE shall finish the transmission of all repetitions of the new uplink PRACH channel within D_{handover} seconds from the end of the last TTI containing the RRC command,

Where:

D_{handover} equals the maximum RRC procedure delay to be defined in clause 11.2 in TS 36.331 [2] plus the interruption time stated in clause 5.5.2.1.2.

5.5.2.1.2 Interruption time

The interruption time is the time between the end of the last TTI containing the RRC command on the old PDSCH and the moment the UE has transmitted all repetitions of PRACH in the target cell, excluding the RRC procedure delay. This requirement applies when UE is not required to perform any synchronisation procedure before transmitting on the new PRACH.

When intra-frequency handover is commanded, the interruption time shall be less than $T_{\text{interrupt}}$

$$T_{\text{interrupt}} = T_{\text{search}} + T_{\text{MIB}} + T_{\text{IU}} + 20 \text{ ms}$$

Where:

T_{search} is the time required to search the target cell when the handover command is received by the UE. If the target cell is known, then $T_{\text{search}} = 0$ ms. If the target cell is unknown and signal quality is sufficient for successful cell detection on the first attempt, then $T_{\text{search}} = 80$ ms. Otherwise, T_{search} shall be according to the non-DRX cell identification requirements specified in Clause 8.13.2.1 for a UE configured with CEModeA. Regardless of whether DRX is in use by the UE, T_{search} shall still be based on non-DRX target cell search times.

T_{MIB} is the time required for acquiring the MIB information of the target cell.

T_{IU} is the time required to complete the transmission of PRACH in the target cell. The actual value of T_{IU} shall depend upon the uncertainty in acquiring the first available PRACH occasion based on the PRACH configuration used in the target cell the uncertainty in acquiring the first available PRACH occasion based on.

In the interruption requirement a cell is known if it has been meeting the relevant cell identification requirement for a time duration equal or longer than the time duration required for the cell identification. Otherwise, it is unknown. The time duration required for the cell identification is specified in relevant intra-frequency cell identification requirements as described in Clause 8.13.2.1 for CEModeA.

5.5.2.2 E-UTRAN FDD – FDD for Cat-M1 HD – FDD UEs

The requirements defined in clause 5.5.2.1 are applicable to FDD intra-frequency handovers for a Cat-M1 HD-FDD UE in CEModeA.

5.5.2.3 E-UTRAN TDD – TDD for Cat-M1 TDD UEs

The requirements defined in clause 5.5.2.1 are applicable to TDD intra-frequency handovers for a Cat-M1 TDD UE in CEModeA.

5.5.2.3.1 Void

5.5.2.3.2 Void

5.5.3 Requirements in CEModeB

5.5.3.1 E-UTRAN FDD – FDD for Cat-M1 FDD UEs

The requirements in this clause are applicable to FDD intra-frequency handovers for a Cat-M1 FDD UE configured with CEModeB.

5.5.3.1.1 Handover delay

Procedure delays for all procedures that can command a handover are specified in TS 36.331 [2].

When the UE receives a RRC message implying handover the UE the UE shall finish the transmission of all repetitions of the new uplink PRACH channel within D_{handover} seconds from the end of the last TTI containing the RRC command,

Where:

D_{handover} equals the maximum RRC procedure delay to be defined in clause 11.2 in TS 36.331 [2] plus the interruption time stated in clause 5.5.3.1.2.

5.5.3.1.2 Interruption time

The interruption time is the time between end of the last TTI containing the RRC command on the old PDSCH and the moment the UE has transmitted all repetitions of PRACH in the target cell, excluding the RRC procedure delay. This requirement applies when UE is not required to perform any synchronisation procedure before transmitting on the new PRACH.

When intra-frequency handover is commanded, the interruption time shall be less than $T_{\text{interrupt}}$

$$T_{\text{interrupt}} = T_{\text{search}} + T_{\text{MIB}} + T_{\text{IU}} + 20 \text{ ms}$$

Where:

T_{search} is the time required to search the target cell when the handover command is received by the UE. If the target cell is known, then $T_{\text{search}} = 0$ ms. If the target cell is unknown and signal quality is sufficient for successful cell detection on the first attempt, then $T_{\text{search}} = 80$ ms. Otherwise, T_{search} shall be according to the non-DRX cell identification requirements specified in Clause 8.13.3.1 for a UE configured with CEModeB. Regardless of whether DRX is in use by the UE, T_{search} shall still be based on non-DRX target cell search times.

T_{MIB} is the time required for acquiring the MIB information of the target cell.

T_{IU} is the time required to complete the transmission of PRACH in the target cell. The actual value of T_{IU} shall depend upon the uncertainty in acquiring the first available PRACH occasion based on the PRACH configuration used in the target cell and the PRACH coverage enhancement level used by the UE for sending the random access preamble to the target cell.

In the interruption requirement a cell is known if it has been meeting the relevant cell identification requirement for a time duration equal or longer than the time duration required for the cell identification. Otherwise, it is unknown. The time duration required for the cell identification is specified in relevant intra-frequency cell identification requirements as described in Clause 8.13.3.1 for a UE configured with CEModeB.

5.5.3.2 E-UTRAN FDD – FDD for Cat-M1 HD – FDD UEs

The requirements defined in clause 5.5.2.1 are applicable to FDD intra-frequency handovers for a Cat-M1 HD-FDD UE configured with CEModeB.

5.5.3.3 E-UTRAN TDD – TDD for Cat-M1 TDD UEs

The requirements defined in clause 5.5.2.1 are applicable to TDD intra-frequency handovers for a Cat-M1 TDD UE configured with CEModeB.

5.6 Void

6 RRC Connection Mobility Control

6.1 RRC Re-establishment

The requirements in this clause are applicable to both E-UTRAN FDD and TDD.

6.1.1 Introduction

RRC connection re-establishment is initiated when a UE in RRC connected mode loses RRC connection due to any of these reasons: radio link failure, handover failure or radio link problem. The RRC es-tablishment procedure is specified in clause 5.3.7 in TS 36.331 [2].

6.1.2 Requirements

In RRC connected mode the UE shall be capable of sending *RRCConnectionReestablishmentRequest* message within $T_{\text{re-establish_delay}}$ seconds from the moment it detects a loss in RRC connection. The total RRC connection delay ($T_{\text{re-establish_delay}}$) shall be less than:

$$T_{\text{re-establish_delay}} = T_{\text{UL_grant}} + T_{\text{UE_re-establish_delay}}$$

$T_{\text{UL_grant}}$: It is the time required to acquire and process uplink grant from the target PCell. The uplink grant is required to transmit *RRCConnectionReestablishmentRequest* message.

The UE re-establishment delay ($T_{\text{UE_re-establish_delay}}$) is specified in clause 6.1.2.1.

6.1.2.1 UE Re-establishment delay requirement

The UE re-establishment delay ($T_{\text{UE_re-establish_delay}}$) is the time between the moments when any of the conditions requiring RRC re-establishment as defined in clause 5.3.7 in TS 36.331 [2] is detected by the UE to the time when the UE sends PRACH to the target PCell. The UE re-establishment delay ($T_{\text{UE_re-establish_delay}}$) requirement shall be less than:

$$T_{\text{UE-re-establish_delay}} = 50 \text{ ms} + N_{\text{freq}} * T_{\text{search}} + T_{\text{SI}} + T_{\text{PRACH}}$$

T_{search} : It is the time required by the UE to search the target PCell.

$T_{\text{search}} =$ It is 100 ms if the target PCell is known by the UE; the target PCell is known if it has been measured by the UE in the last 5 seconds.

$T_{\text{search}} =$ It is 800 ms if the target PCell is unknown by the UE; the target PCell is unknown if it has not been measured by the UE in the last 5 seconds.

$T_{\text{SI}} =$ It is the time required for receiving all the relevant system information according to the reception procedure and the RRC procedure delay of system information blocks defined in TS 36.331 [2] for the target PCell.

$T_{\text{PRACH}} =$ The additional delay caused by the random access procedure; it will be at least 10 ms due to random access occasion and there might be additional delay due to ramping procedure.

N_{freq} : It is the total number of E-UTRA frequencies to be monitored for RRC re-establishment; $N_{\text{freq}} = 1$ if the target PCell is known.

There is no requirement if the target cell does not contain the UE context.

6.2 Random Access

6.2.1 Introduction

The random access procedure is used when establishing the layer 1 communication between the UE and E-UTRAN. The random access is specified in clause 6 of TS 36.213[3] and the control of the RACH transmission is specified in clause 5.1 of TS 36.321[17]. Contention based random access procedures can only be carried out on PCell and PSCell, while non-contention based random access procedures can be carried out on PCell, one or two activated SCell(s), and PSCell.

6.2.2 Requirements

The UE shall have capability to calculate PRACH transmission power according to the PRACH power formula defined in TS 36.213[3] and apply this power level at the first preamble or additional preambles. The absolute power applied to the first preamble shall have an accuracy as specified in table 6.3.5.1.1-1 of TS 36.101[5]. The relative power applied to additional preambles shall have an accuracy as specified in table 6.3.5.2.1-1 of 36.101[5].

The UE shall indicate a Random Access problem to upper layers if the maximum number of preamble transmission counter has been reached for the random access procedure on PCell or PSCell as specified in clause 5.1.4 in TS 36.321 [17].

The UE shall stop preamble transmission if maximum number of preamble transmission counter has been reached for the random access procedure on an activated Scell as specified in clause 5.1.4 in TS 36.321 [17].

6.2.2.1 Contention based random access

6.2.2.1.1 Correct behaviour when receiving Random Access Response reception

The UE may stop monitoring for Random Access Response(s) and shall transmit the msg3 if the Random Access Response contains a Random Access Preamble identifier corresponding to the transmitted Random Access Preamble.

The UE shall re-select a preamble and transmit with the calculated PRACH transmission power when the backoff time expires if all received Random Access Responses contain Random Access Preamble identifiers that do not match the transmitted Random Access Preamble.

6.2.2.1.2 Correct behaviour when not receiving Random Access Response reception

The UE shall re-select a preamble and transmit with the calculated PRACH transmission power when the backoff time expires if no Random Access Response is received within the RA Response window defined in clause 5.1.4 TS 36.321.

6.2.2.1.3 Correct behaviour when receiving a NACK on msg3

The UE shall re-transmit the msg3 upon the reception of a NACK on msg3.

6.2.2.1.4 Void

6.2.2.1.5 Correct behaviour when receiving a message over Temporary C-RNTI

The UE shall send ACK if the Contention Resolution is successful.

The UE shall re-select a preamble and transmit with the calculated PRACH transmission power when the backoff time expires unless the received message includes a UE Contention Resolution Identity MAC control element and the UE Contention Resolution Identity included in the MAC control element matches the CCCH SDU transmitted in the uplink message.

6.2.2.1.6 Correct behaviour when contention Resolution timer expires

The UE shall re-select a preamble and transmit with the calculated PRACH transmission power when the backoff time expires if the Contention Resolution Timer expires.

6.2.2.2 Non-Contention based random access

6.2.2.2.1 Correct behaviour when receiving Random Access Response

The UE may stop monitoring for Random Access Response(s) if the Random Access Response contains a Random Access Preamble identifier corresponding to the transmitted Random Access Preamble.

The UE shall re-transmit the preamble with the calculated PRACH transmission power if all received Random Access Responses contain Random Access Preamble identifiers that do not match the transmitted Random Access Preamble.

6.2.2.2.2 Correct behaviour when not receiving Random Access Response

The UE shall re-transmit the preamble with the calculated PRACH transmission power.

6.2.3 Requirements for Cat-M1 UEs

In addition to the requirements defined in 6.2.1 and 6.2.2, a Cat-M1 UE shall also execute the random access procedure defined in clause 5.1 in TS 36.321 [17] using the PRACH configuration contained in *PRACH-ConfigSIB* in TS 36.331 [2]

- Determines the enhanced coverage level based on the RSRP measurement and the configured criterion (*RSRP-ThresholdsPrach* [2]) as defined in section 5.1.1, TS 36,321 [17],
- Selects PRACH resources [2] configured for the corresponding enhanced coverage level as determined in the previous step and;
- Transmits or re- transmits PRACH preamble using the selected PRACH resources and PRACH configuration.

6.3 RRC Connection Release with Redirection

6.3.1 Introduction

RRC connection release with redirection is initiated by the UE upon receiving the “*RRCConnectionRelease*” message from the E-UTRAN, TS 36.331 [2]. The RRC connection release with redirection procedure is specified in clause 5.3.8 in TS 36.331 [2].

The requirements in this clause are applicable to both E-UTRAN FDD and TDD.

6.3.2 Requirements

6.3.2.1 RRC connection release with redirection to UTRAN FDD

The UE shall be capable of performing the RRC connection release with redirection to the target UTRAN FDD cell within $T_{\text{connection_release_redirect_UTRA FDD}}$.

The time delay ($T_{\text{connection_release_redirect_UTRA FDD}}$) is the time between the end of the last TTI containing the RRC command, “*RRCConnectionRelease*” (TS 36.331 [2]) on the E-UTRAN PDSCH and the time the UE starts to send random access to the target UTRA FDD cell. The time delay ($T_{\text{connection_release_redirect_UTRA FDD}}$) shall be less than:

$$T_{\text{connection_release_redirect_UTRA FDD}} = T_{\text{RRC_procedure_delay}} + T_{\text{identify-UTRA FDD}} + T_{\text{SI-UTRA FDD}} + T_{\text{RA}}$$

The target UTRA FDD cell shall be considered detectable when:

- CPICH $E_c/I_o \geq -15$ dB,
- SCH $E_c/I_o \geq -15$ dB for at least one channel tap and SCH E_c/I_o is equally divided between primary synchronisation code and secondary synchronisation code.

$T_{\text{RRC_procedure_delay}}$: It is the RRC procedure for processing the received message “*RRCConnectionRelease*”. It shall be less than 110 ms.

$T_{\text{identify-UTRA FDD}}$: It is the time to identify the target UTRA FDD cell. It shall be less than 500 ms.

$T_{\text{SI-UTRA FDD}}$: It is the time required for acquiring all the relevant system information of the target UTRA FDD cell. This time depends upon whether the UE is provided with the relevant system information of the target UTRA FDD cell or not by the E-UTRAN before the RRC connection is released.

T_{RA} : It is the delay caused due to the random access procedure when sending random access to the target UTRA FDD cell.

6.3.2.2 RRC connection release with redirection to GERAN

The UE shall be capable of performing the RRC connection release with redirection to the target GERAN cell within $T_{\text{connection_release_redirect_GERAN}}$.

The time delay ($T_{\text{connection_release_redirect_GERAN}}$) is the time between the end of the last TTI containing the RRC command, “*RRCConnectionRelease*” (TS 36.331 [2]) on the E-UTRAN PDSCH and the time the UE starts to send random access to the target GERAN cell. The time delay ($T_{\text{connection_release_redirect_GERAN}}$) shall be less than:

$$T_{\text{connection_release_redirect_GERAN}} = T_{\text{RRC_procedure_delay}} + T_{\text{identify-GERAN}} + T_{\text{SI-GERAN}} + T_{\text{RA}}$$

The target GERAN cell shall be considered detectable when the UE receives the GERAN cell at levels down to 10 dB + the reference sensitivity level or reference interference levels as specified in [9].

$T_{\text{RRC_procedure_delay}}$: It is the RRC procedure for processing the received message “*RRCConnectionRelease*”. It shall be less than 110 ms.

$T_{\text{identify-UTRA GERAN}}$: It is the time to identify the BSIC of the target GERAN cell. It shall be less than 1 second.

$T_{\text{SI-UTRA GERAN}}$: It is the time required for acquiring all the relevant system information of the target GERAN cell. This time depends upon whether the UE is provided with the relevant system information of the target GERAN cell or not by the E-UTRAN before the RRC connection is released.

T_{RA} : It is the delay caused due to the random access procedure when sending random access burst to the target GERAN cell.

6.3.2.3 RRC connection release with redirection to UTRAN TDD

The UE shall be capable of performing the RRC connection release with redirection to the target UTRAN TDD cell within $T_{\text{connection_release_redirect_UTRA TDD}}$.

The time delay ($T_{\text{connection_release_redirect_UTRA TDD}}$) is the time between the end of the last TTI containing the RRC command, “*RRCConnectionRelease*” (TS 36.331 [2]) on the E-UTRAN PDSCH and the time the UE starts to send random access to the target UTRA TDD cell. The time delay ($T_{\text{connection_release_redirect_UTRA TDD}}$) shall be less than:

$$T_{\text{connection_release_redirect_UTRA TDD}} = T_{\text{RRC_procedure_delay}} + T_{\text{identify-UTRA TDD}} * N_{\text{redirect-UTRA TDD}} + T_{\text{SI-UTRA TDD}} + T_{\text{RA}}$$

The target UTRA TDD cell shall be considered detectable when:

- P-CCPCH $E_c/I_o \geq -6$ dB,
- DwPCH $E_c/I_o \geq -1$ dB.

$T_{\text{RRC_procedure_delay}}$: It is the RRC procedure for processing the received message “*RRCConnectionRelease*”. It shall be less than 110 ms.

$T_{\text{identify-UTRA TDD}}$: It is the time to identify the target UTRA TDD cell. It shall be less than 500 ms.

$T_{\text{SI-UTRA TDD}}$: It is the time required for acquiring all the relevant system information of the target UTRA TDD cell. This time depends upon whether the UE is provided with the relevant system information of the target UTRA TDD cell or not by the E-UTRAN before the RRC connection is released.

T_{RA} : It is the delay caused due to the random access procedure when sending random access to the target UTRA TDD cell.

$N_{\text{redirect-UTRA TDD}}$: It is the total number of target UTRA TDD frequencies included in RedirectedCarrierInfo in “*RRCConnectionRelease*” message. It can be up to 4 UTRA TDD frequencies.

6.4 CSG Proximity Indication for E-UTRAN and UTRAN

6.4.1 Introduction

The requirements defined in this section are applicable to a UE supporting and configured with CSG proximity indication and are valid when a UE is entering the proximity of one or more CSG member cell(s) or leaving the proximity of all CSG member cell(s) on a UTRA or E-UTRA frequency as specified in [2].

The detection of CSG proximity is based on a UE autonomous search function.

6.4.2 Requirements

The UE shall initiate transmission of the ProximityIndication message with “entering” according to [2] within [6] minutes after entering the proximity of one or more CSG member cell(s) on a UTRA or E-UTRA frequency.

The UE shall initiate transmission of the ProximityIndication message with “leaving” according to [2] within [6] minutes after leaving the proximity of all CSG member cell(s) on a UTRA or E-UTRA frequency.

There is no need for statistical testing of this requirement.

NOTE: Entering the proximity of one or more CSG member cell(s) means that the UE is near a cell whose CSG ID is in the UE’s CSG whitelist (as determined based on autonomous search procedures). Leaving the proximity of one or more CSG member cell(s) means that the UE is no longer near any cell whose CSG ID is in the UE’s CSG whitelist.

6.5 RRC Re-establishment for NB-IoT UEs

6.5.1 Introduction

RRC connection re-establishment is initiated when a UE in RRC connected mode loses RRC connection due to any of these reasons: radio link failure or radio link problem. The RRC re-establishment procedure is specified in clause 5.3.7 in TS 36.331 [2].

6.5.2 Requirements

In RRC connected mode the UE shall be capable of sending *RRCConnectionReestablishmentRequest* message within $T_{\text{re-establish_delay_NB-IoT}}$ seconds from the moment it detects a loss in RRC connection. The total RRC connection delay ($T_{\text{re-establish_delay_NB-IoT}}$) shall be less than:

$$T_{\text{re-establish_delay_NB-IoT}} = T_{\text{UL_grant}} + T_{\text{UE_re-establish_delay_NB-IoT}}$$

$T_{\text{UL_grant}}$: It is the time required to acquire and process uplink grant from the target cell. The uplink grant is required to transmit *RRCConnectionReestablishmentRequest* message.

The UE re-establishment delay ($T_{\text{UE_re-establish_delay_NB-IoT}}$) is specified in clause 6.5.2.1 for a UE in normal coverage and in clause 6.5.2.2 for a UE in enhanced coverage.

These requirements are not applicable for UEs that only support the Control Plane CIoT EPS optimisation (see TS 24.301). Connection control in NB-IoT is defined in Clause 5.3.1.4 in TS 36.331 [2].

6.5.2.1 UE Re-establishment delay requirement in normal coverage

The UE re-establishment delay ($T_{\text{UE_re-establish_delay_NB-IoT}}$) is the time between the moments when any of the conditions requiring RRC re-establishment as defined in clause 5.3.7 in TS 36.331 [2] is detected by the UE to the time when the UE sends PRACH preamble to the target cell. The UE re-establishment delay ($T_{\text{UE_re-establish_delay_NB-IoT}}$) requirement shall be less than:

$$T_{\text{UE-re-establish_delay_NB-IoT}} = 100 \text{ ms} + N_{\text{NB-IoT-freq}} * T_{\text{search_NB1-NC}} + T_{\text{SI_NB1-NC}} + T_{\text{PRACH_NB-IoT}}$$

$T_{\text{search_NB1-NC}}$: It is the time required by the UE to search the target cell:

If the target cell is known, then $T_{\text{search_NB1-NC}} = 0$ ms. If the target cell is unknown and signal quality is sufficient for successful cell detection on the first attempt, then $T_{\text{search_NB1-NC}} = 80$ ms. Otherwise, $T_{\text{search_NB1-NC}} = 1400$ ms.

$T_{\text{SL_NB1-NC}}$: It is the time required for receiving all the relevant system information according to the reception procedure and the RRC procedure delay of system information blocks defined in TS 36.331 [2] for the target cell for a UE in normal coverage.

$T_{\text{PRACH_NB-IoT}}$: The additional delay caused by the random access procedure. The actual value of $T_{\text{PRACH_NB-IoT}}$ shall depend upon the NPRACH configuration used in the target cell and the number of repetition used by UE for sending random access to the target cell. There might be additional delay due to ramping procedure.

$N_{\text{NB-IoT-freq}}$: It is the total number of NB-IoT frequencies to be monitored for RRC re-establishment; $N_{\text{NB-IoT-freq}} = 1$ if the target cell is known.

There is no requirement if the target cell does not contain the UE context.

6.5.2.2 UE Re-establishment delay requirement in enhanced coverage

The UE re-establishment delay ($T_{\text{UE-re-establish_delay_NB-IoT}}$) is the time between the moments when any of the conditions requiring RRC re-establishment as defined in clause 5.3.7 in TS 36.331 [2] is detected by the UE to the time when the UE sends PRACH preamble to the target cell. The UE re-establishment delay ($T_{\text{UE-re-establish_delay_NB-IoT}}$) requirement shall be less than:

$$T_{\text{UE-re-establish_delay_NB-IoT}} = 100 \text{ ms} + N_{\text{NB-IoT-freq}} * T_{\text{search_NB1-EC}} + T_{\text{SL_NB1-EC}} + T_{\text{PRACH_NB-IoT}}$$

$T_{\text{search_NB1-EC}}$: It is the time required by the UE to search the target cell:

If the target cell is known, then $T_{\text{search_NB1-EC}} = 0$ ms. If the target cell is unknown and signal quality is sufficient for successful cell detection on the first attempt, then $T_{\text{search_NB1-EC}} = 80$ ms. Otherwise, $T_{\text{search_NB1-EC}} = 14800$ ms.

$T_{\text{SL_NB1-EC}}$: It is the time required for receiving all the relevant system information according to the reception procedure and the RRC procedure delay of system information blocks defined in TS 36.331 [2] for the target cell for a UE in enhanced coverage.

$T_{\text{PRACH_NB-IoT}}$: The additional delay caused by the random access procedure. The actual value of $T_{\text{PRACH_NB-IoT}}$ shall depend upon the NPRACH configuration used in the target cell and the number of repetition used by UE for sending random access to the target cell. There might be additional delay due to ramping procedure.

$N_{\text{NB-IoT-freq}}$: It is the total number of NB-IoT frequencies to be monitored for RRC re-establishment; $N_{\text{NB-IoT-freq}} = 1$ if the target cell is known.

There is no requirement if the target cell does not contain the UE context.

6.6 Random Access for UE category NB1

6.6.1 Introduction

The random access procedure is used when establishing the layer 1 communication between the UE and NB-IoT. The random access is specified in clause 6 of TS 36.213[3] and the control of the RACH transmission is specified in clause 5.1 of TS 36.321[17]. Only contention-based random access is supported for NB-IoT

6.6.2 Requirements

The UE shall have capability to calculate NPRACH transmission power according to the NPRACH power formula defined in TS 36.213[3] and apply this power level at the first preamble or additional preambles. The absolute power applied to the first preamble shall have an accuracy as specified in TS 36.101[5]. The relative power applied to additional preambles shall have an accuracy as specified in 36.101[5].

The UE shall indicate a Random Access problem to upper layers if the maximum number of preamble transmission counter has been reached for the random access procedure on target cell as specified in clause 5.1.4 in TS 36.321 [17].

6.6.2.1 Correct behaviour when receiving Random Access Response reception

The UE may stop monitoring for Random Access Response(s) and shall transmit the msg3 if the Random Access Response contains a Random Access Preamble identifier corresponding to the transmitted Random Access Preamble.

The UE shall re-select a preamble and transmit with the calculated NPRACH transmission power when the backoff time expires if all received Random Access Responses contain Random Access Preamble identifiers that do not match the transmitted Random Access Preamble.

6.6.2.2 Correct behaviour when not receiving Random Access Response reception

The UE shall re-select a preamble and transmit with the calculated NPRACH transmission power when the backoff time expires if no Random Access Response is received within the RA Response window defined in clause 5.1.4 TS 36.321.

6.6.2.3 Correct behaviour when receiving a NACK on msg3

The UE shall re-transmit the msg3 upon the reception of a NACK on msg3.

6.6.2.4 Correct behaviour when receiving a message over Temporary C-RNTI

The UE shall send ACK if the Contention Resolution is successful.

The UE shall re-select a preamble and transmit with the calculated NPRACH transmission power when the backoff time expires unless the received message includes a UE Contention Resolution Identity MAC control element and the UE Contention Resolution Identity included in the MAC control element matches the CCCH SDU transmitted in the uplink message.

6.6.2.5 Correct behaviour when contention Resolution timer expires

The UE shall re-select a preamble and transmit with the calculated NPRACH transmission power when the backoff time expires if the Contention Resolution Timer expires.

6.6.3 Requirements for NPRACH configuration

In addition to the requirements defined in 6.6.2, UE shall also execute the random access procedure defined in clause 5.1 in TS 36.321 [17] using the NPRACH configuration contained in *NPRACH-ConfigSIB-NB* in TS 36.331 [2]

- Determines the enhanced coverage level based on the NRSRP measurement and the configured criterion as defined in section 5.1.1, TS 36,321 [17],
- Selects NPRACH resources [2] configured for the corresponding enhanced coverage level as determined in the previous step and;
- Transmits or re-transmits NPRACH preamble using the selected NPRACH resources and NPRACH configuration.

6.7 RRC Re-establishment for Cat-M1 UEs

6.7.1 Introduction

RRC connection re-establishment is initiated when a Cat-M1 UE either configured with CEModeA or CEModeB in RRC connected mode loses RRC connection due to any of these reasons: radio link failure or radio link problem. The RRC re-establishment procedure is specified in clause 5.3.7 in TS 36.331 [2].

6.7.2 Requirements

In RRC connected mode the UE shall be capable of sending *RRCConnectionReestablishmentRequest* message within $T_{\text{re-establish_delay}}$ seconds from the moment it detects a loss in RRC connection. The total RRC connection delay ($T_{\text{re-establish_delay}}$) shall be less than:

$$T_{\text{re-establish_delay}} = T_{\text{UL_grant}} + T_{\text{UE_re-establish_delay}}$$

$T_{\text{UL_grant}}$: It is the time required to acquire and process uplink grant from the target cell. The uplink grant is required to transmit *RRCConnectionReestablishmentRequest* message.

The UE re-establishment delay ($T_{\text{UE_re-establish_delay}}$) is specified in clause 6.7.2.1 for a UE configured with CEModeA and in clause 6.7.2.2 for a UE configured with CEModeB.

6.7.2.1 UE Re-establishment delay requirement for CEModeA

The UE re-establishment delay ($T_{\text{UE_re-establish_delay}}$) is the time between the moments when any of the conditions requiring RRC re-establishment as defined in clause 5.3.7 in TS 36.331 [2] is detected by the UE to the moment the UE has transmitted all repetitions of the PRACH preamble to the target cell. The UE re-establishment delay ($T_{\text{UE_re-establish_delay}}$) requirement for a UE configured with CEModeA shall be less than:

$$T_{\text{UE-re-establish_delay}} = 50 \text{ ms} + N_{\text{freq}} * T_{\text{search}} + T_{\text{SI-EUTRA-M1-CEModeA}} + T_{\text{PRACH}}$$

T_{search} is the time required by the UE to search the target cell. $T_{\text{search}} = 100 \text{ ms}$ if the target cell is known by the UE. Otherwise, T_{search} is specified in relevant intra-frequency cell identification requirements as described in Clause 8.13.2.1 for a UE configured with CEModeA. Regardless of whether DRX is in use by the UE, T_{search} shall still be based on non-DRX target cell search times.

In the above requirement, a cell is known if it has been meeting the relevant cell identification requirement for a time duration equal to or longer than the time duration required for the cell identification. Otherwise, it is unknown.

$T_{\text{SI-EUTRA-M1-CEModeA}}$: It is the time required for receiving all the relevant system information according to the reception procedure and the RRC procedure delay of system information blocks defined in TS 36.331 [2] for the target cell for a UE configured with CEModeA. $T_{\text{SI-EUTRA-M1-CEModeA}}$ includes the time to acquire the MIB and all the relevant SIBs of the target cell.

T_{PRACH} is the interruption uncertainty in acquiring the first available PRACH occasion in the target cell. The actual value of T_{PRACH} shall depend upon the PRACH configuration used in the target cell and the PRACH coverage enhancement level used by the UE for sending the random access to the target cell.

N_{freq} : It is the total number of frequencies to be monitored for RRC re-establishment; $N_{\text{freq}} = 1$ if the target cell is known.

There is no requirement if the target cell does not contain the UE context.

6.7.2.2 UE Re-establishment delay requirement for CEModeB

The UE re-establishment delay ($T_{\text{UE_re-establish_delay}}$) is the time between the moments when any of the conditions requiring RRC re-establishment as defined in clause 5.3.7 in TS 36.331 [2] is detected by the UE to the moment the UE has transmitted all repetitions of PRACH preamble to the target cell. The UE re-establishment delay ($T_{\text{UE_re-establish_delay}}$) requirement for a UE configured with CEModeB shall be less than:

$$T_{\text{UE-re-establish_delay}} = 50 \text{ ms} + N_{\text{freq}} * T_{\text{search}} + T_{\text{SI-EUTRA-M1-CEModeB}} + T_{\text{PRACH}}$$

- T_{search} is the time required by the UE to search the target cell. $T_{\text{search}} = 100 \text{ ms}$ if the target cell is known by the UE. Otherwise, T_{search} is specified in relevant intra-frequency cell identification requirements as described in Clause 8.13.3.1 for a UE configured with CEModeB. Regardless of whether DRX is in use by the UE, T_{search} shall still be based on non-DRX target cell search times.

In the above requirement, a cell is known if it has been meeting the relevant cell identification requirement for a time duration equal to or longer than the time duration required for the cell identification. Otherwise, it is unknown.

- $T_{\text{SI-EUTRA-M1-CEModeB}}$: It is the time required for receiving all the relevant system information according to the reception procedure and the RRC procedure delay of system information blocks defined in TS 36.331 [2] for the target cell for a UE configured with CEModeA; $T_{\text{SI-EUTRA-M1-CEModeB}}$ includes the time to acquire the MIB and all the relevant SIBs of the target cell.

- T_{PRACH} is the interruption uncertainty in acquiring the first available PRACH occasion in the target cell. The actual value of T_{PRACH} shall depend upon the PRACH configuration used in the target cell and the PRACH coverage enhancement level used by the UE for sending the random access to the target cell.

N_{freq} : It is the total number of frequencies to be monitored for RRC re-establishment; $N_{\text{freq}} = 1$ if the target cell is known.

There is no requirement if the target cell does not contain the UE context.

6.8 RRC Connection Release with Redirection for Cat-M1 UEs

6.8.1 Introduction

RRC connection release with redirection is initiated by the UE upon receiving the “*RRCConnectionRelease*” message from the E-UTRAN, TS 36.331 [2]. The RRC connection release with redirection procedure is specified in clause 5.3.8 in TS 36.331 [2].

The requirements in this clause are applicable for UE category M1 capable of E-UTRA FDD, TDD or HD-FDD operation.

6.8.2 Requirements

6.8.2.1 RRC connection release with redirection to E-UTRAN with CE Mode A

The UE shall be capable of performing the RRC connection release with redirection to the target E-UTRA cell within $T_{\text{connection_release_redirect_E-UTRA cat-M1}}$.

The time delay ($T_{\text{connection_release_redirect_E-UTRA cat-M1}}$) is the time between the end of the last subframe in the repetition period of PDSCH containing the IE, “*RRCConnectionRelease*” and the end of the last subframe in the repetition period of the PRACH transmission to the target E-UTRA cell. The time delay ($T_{\text{connection_release_redirect_E-UTRA cat-M1}}$) shall be less than:

$$T_{\text{connection_release_redirect_E-UTRA cat-M1}} = T_{\text{RRC_procedure_delay}} + T_{\text{identify-E-UTRA cat-M1}} + T_{\text{SI-E-UTRA cat-M1}} + T_{\text{RA cat-M1}}$$

The target E-UTRA FDD or TDD cell shall be considered detectable for a category M1 UE capable of E-UTRA FDD or TDD provided that:

- RSRP related side conditions given in Section 9.1.21.2 are fulfilled for a corresponding Band,
- SCH_{RP} and $SCH_{\text{Es/Iot}}$ according to Annex Table B.2.14-1 for a corresponding Band.

The target E-UTRA FDD cell shall be considered detectable for a category M1 UE capable of E-UTRA HD-FDD provided that:

- RSRP related side conditions given in Section 9.1.21.2 are fulfilled for a corresponding Band,
- SCH_{RP} and $SCH_{\text{Es/Iot}}$ according to Annex Table B.2.14-2 for a corresponding Band.

$T_{\text{RRC_procedure_delay}}$: It is the RRC procedure for processing the received message “*RRCConnectionRelease*”. It shall be less than 110 ms.

$T_{\text{identify-E-UTRA cat-M1}}$: It is the time required to identify the target E-UTRA cell. It shall be less than 960 ms.

$T_{\text{SI-E-UTRA cat-M1}}$: It is the time required for acquiring all the relevant system information (SI) of the target E-UTRA cell. If old E-UTRA serving cell, before the release of the RRC connection, provides the UE with the SI (including MIB and all relevant SIBs) of the target E-UTRA cell, then $T_{\text{SI-E-UTRA FDD}} = 0$ ms. The value of $T_{\text{SI-E-UTRA cat-M1}}$ depends on the repetitions of PBCH and PDSCH used in the target cell.

$T_{\text{RA cat-M1}}$: It is the delay caused due to the random access procedure when sending random access to the target E-UTRA cell. The value of T_{RA} depends on the PRACH configuration and the repetition used in the target cell.

6.9 RRC Connection Redirection to Non-anchor Carrier in NB-IoT

6.9.1 Introduction

RRC connection redirection to a non-anchor carrier is initiated by the UE upon receiving the IE, “*CarrierConfigDedicated-NB*”, from the E-UTRAN, TS 36.331 [2]. The RRC redirection to procedure is specified in clause 6.7.3.2 in TS 36.331 [2].

The requirements in this section are applicable under the following conditions:

- The anchor and non-anchor carrier frequencies are within 20 MHz and
- The anchor and the non-anchor carrier frequencies are in the same base station or in co-located base stations.

6.9.2 Requirements

The UE shall be capable of performing the RRC connection redirection to the non-anchor carrier within $T_{\text{connection_redirect_non-anchor}}$.

The time delay ($T_{\text{connection_redirect_non-anchor}}$) is the time between the end of the last subframe in the repetition period of NPDSCH containing the IE, “*CarrierConfigDedicated-NB*” received on the anchor carrier and the end of the last subframe in the repetition period of NPUSCH transmitted on the target non-anchor carrier. The time delay ($T_{\text{connection_redirect_non-anchor}}$) shall be less than:

$$T_{\text{connection_redirect_non-anchor}} = T_{\text{RRC_procedure_delay}} + T_{\text{period_DL_bitmap}} + T_{\text{UL_grant}} + T_{\text{DL-UL switch}} + T_{\text{NPUSCH}}$$

$T_{\text{RRC_procedure_delay}}$: It is the RRC procedure for processing the received message “*CarrierConfigDedicated-NB*”. It shall be less than 110 ms.

$T_{\text{period_DL_bitmap}}$: It is the periodicity of the downlink subframe configuration for downlink transmission on the non-anchor carrier. It is configured via IE *DL-Bitmap-NB* [2] and can be 10 ms or 40 ms.

$T_{\text{UL_grant}}$: It is the time required to acquire uplink grant from the non-anchor carrier for transmitting NPUSCH on the non-anchor carrier. The value of $T_{\text{UL_grant}}$ depends on $T_{\text{period_DL_bitmap}}$ and the number of repetitions of NPDCCH used in the non-anchor carrier.

$T_{\text{DL-UL switch}}$: It is the time between the end of the last subframe in the repetition period of NPDCCH received on the non-anchor carrier and the start of the first subframe in the repetition period of the corresponding NPUSCH transmitted on the non-anchor carrier. $T_{\text{DL-UL switch}}$ is 8 ms.

T_{NPUSCH} : It is the time required to transmit NPUSCH on the non-anchor carrier. The value of T_{NPUSCH} depends on the number of repetitions of NPUSCH used in the non-anchor carrier.

When the NPUSCH ACK transmission for the received RRC message takes longer than 110ms, the overall RRC connection redirection delay may be extended.

7 Timing and signalling characteristics

7.1 UE transmit timing

7.1.1 Introduction

The UE shall have capability to follow the frame timing change of the connected eNode B. The uplink frame transmission takes place $(N_{\text{TA}} + N_{\text{TA offset}}) \times T_s$ before the reception of the first detected path (in time) of the corresponding downlink frame from the reference cell. The UE shall be configured with a pTAG containing the PCell. The pTAG may also contain up to four SCells, if configured. The UE capable of supporting multiple timing advances [2] may also be configured with one or two serving cells with uplink in one or two sTAG and pTAG.

The other downlink SCell(s), if configured, will be contained in either the pTAG or the sTAG(s). In pTAG, UE shall use the PCell as the reference cell for deriving the UE transmit timing for cells in the pTAG. When the UE capable of supporting multiple timing advance [2] is configured with one or two sTAG(s), the UE shall use an activated SCell from the sTAG for deriving the UE transmit timing for cells in the sTAG. UE initial transmit timing accuracy, maximum amount of timing change in one adjustment, minimum and maximum adjustment rate are defined in the following requirements. The requirements in clause 7 apply to all TAGs.

The UE capable of supporting dual connectivity shall be configured with one pTAG and may also be configured with one psTAG. The pTAG shall contain the PCell and may also contain one SCell, if configured. The psTAG shall contain the PSCell and may also contain one SCell, if configured. In pTAG, UE shall use the PCell as the reference cell for deriving the UE transmit timing for pTAG, and in psTAG, UE shall use the PSCell as the reference cell for deriving the UE transmit timing for psTAG. UE initial transmit timing accuracy, maximum amount of timing change in one adjustment, minimum and maximum adjustment rate are defined in the following requirements. The requirements in clause 7 apply to both TAGs.

7.1.2 Requirements

The UE initial transmission timing error shall be less than or equal to $\pm T_e$ where the timing error limit value T_e is specified in Table 7.1.2-1. This requirement applies when it is the first transmission in a DRX, eDRX_CONN cycle for PUCCH, PUSCH and SRS or it is the PRACH transmission. The reference point for the UE initial transmit timing control requirement shall be the downlink timing of the reference cell minus $(N_{TA_Ref} + N_{TA_offset}) \times T_s$. The downlink timing is defined as the time when the first detected path (in time) of the corresponding downlink frame is received from the reference cell. N_{TA_Ref} for PRACH is defined as 0. $(N_{TA_Ref} + N_{TA_offset})$ (in T_s units) for other channels is the difference between UE transmission timing and the Downlink timing immediately after when the last timing advance in clause 7.3 was applied. N_{TA_Ref} for other channels is not changed until next timing advance is received.

Table 7.1.2-1: T_e Timing Error Limit

| Downlink Bandwidth (MHz) | T_e |
|--------------------------|---|
| 1.4 | $24 * T_s$ |
| ≥ 3 | $12 * T_s$ |
| Note: | T_s is the basic timing unit defined in TS 36.211 |

When it is not the first transmission in a DRX or eDRX_CONN cycle or there is no DRX or no eDRX_CONN cycle, and when it is the transmission for PUCCH, PUSCH and SRS transmission, the UE shall be capable of changing the transmission timing according to the received downlink frame of the reference cell except when the timing advance in clause 7.3 is applied.

When in a TAG the transmission timing error between the UE and the reference timing exceeds $\pm T_e$, or in a sTAG the UE changes the downlink SCell for deriving the UE transmit timing for cells in the sTAG configured with one or two uplinks, the UE is required to adjust its timing to within $\pm T_e$ in that TAG, as long as,

- the UE is configured with a pTAG and one or two sTAG, the transmission timing difference between TAGs does not exceed the maximum transmission timing difference (i.e., 32.47us) after such adjustment, or
- the UE is configured with synchronous dual connectivity, the transmission timing difference between pTAG and psTAG does not exceed the maximum transmission timing difference (i.e., 35.21us) after such adjustment.

If the transmission timing difference after such adjustment is bigger than the maximum transmission timing difference UE may stop adjustment in this TAG. The reference timing shall be $(N_{TA_Ref} + N_{TA_offset}) \times T_s$ before the downlink timing of the reference cell. All adjustments made to the UE uplink timing under the above mentioned scenarios shall follow these rules:

- 1) The maximum amount of the magnitude of the timing change in one adjustment shall be T_q seconds.
- 2) The minimum aggregate adjustment rate shall be $7 * T_s$ per second.
- 3) The maximum aggregate adjustment rate shall be T_q per 200ms.

where the maximum autonomous time adjustment step T_q is specified in Table 7.1.2-2.

Table 7.1.2-2: T_q Maximum Autonomous Time Adjustment Step

| Downlink Bandwidth (MHz) | T_q |
|---|------------------|
| 1.4 | $17.5 \cdot T_S$ |
| 3 | $9.5 \cdot T_S$ |
| 5 | $5.5 \cdot T_S$ |
| ≥ 10 | $3.5 \cdot T_S$ |
| Note: T_S is the basic timing unit defined in TS 36.211 | |

7.2 UE timer accuracy

7.2.1 Introduction

UE timers are used in different protocol entities to control the UE behaviour.

7.2.2 Requirements

For UE timers specified in TS 36.331 [2], UE shall comply with the timer accuracies according to Table 7.2.2-1.

The requirements are only related to the actual timing measurements internally in the UE. They do not include the following:

- Inaccuracy in the start and stop conditions of a timer (e.g. UE reaction time to detect that start and stop conditions of a timer is fulfilled), or
- Inaccuracies due to restrictions in observability of start and stop conditions of a UE timer (e.g. TTI alignment when UE sends messages at timer expiry).

Table 7.2.2-1

| Timer value [s] | Accuracy |
|----------------------|-------------|
| timer value < 4 | $\pm 0.1s$ |
| timer value ≥ 4 | $\pm 2.5\%$ |

7.3 Timing Advance

7.3.1 Introduction

The timing advance is initiated from E-UTRAN with MAC message that implies and adjustment of the timing advance, see TS 36.321 [17] clause 5.2.

7.3.2 Requirements

7.3.2.1 Timing Advance adjustment delay

UE shall adjust the timing of its uplink transmission timing at sub-frame $n+6$ for a timing advance command received in sub-frame n .

7.3.2.2 Timing Advance adjustment accuracy

The UE shall adjust the timing of its transmissions with a relative accuracy better than or equal to $\pm 4 \cdot T_S$ seconds to the signalled timing advance value compared to the timing of preceding uplink transmission. The timing advance command is expressed in multiples of $16 \cdot T_S$ and is relative to the current uplink timing.

7.4 Cell phase synchronization accuracy (TDD)

7.4.1 Definition

Cell phase synchronization accuracy is defined as the maximum absolute deviation in frame start timing between any pair of cells on the same frequency that have overlapping coverage areas.

7.4.2 Minimum requirements

For Wide Area BS, the cell phase synchronization accuracy measured at BS antenna connectors shall be better than the requirement specified in table 7.4.2-1. If a cell's coverage area overlaps with another cell with different cell radius then the cell phase synchronization accuracy corresponding to the larger of the two cell sizes applies to the overlapping cells with different radii.

Table 7.4.2-1 Cell phase synchronization requirement for wide area BS (TDD)

| Cell Type | Cell Radius | Requirement |
|------------|-------------|-------------------|
| Small cell | ≤ 3 km | ≤ 3 μ s |
| Large cell | > 3 km | ≤ 10 μ s |

For Home BS, the cell phase synchronization accuracy measured at BS antenna connectors shall be better than the requirement specified in table 7.4.2-2.

Table 7.4.2-2 Cell phase synchronization requirement for Home BS (TDD)

| Source Cell Type | Propagation Distance | Requirement |
|------------------|----------------------|---------------------------------------|
| Small cell | ≤ 500 m | ≤ 3 μ s |
| Large cell | > 500 m | $\leq 1.33 + T_{propagation}$ μ s |

Note 1: $T_{propagation}$ is the propagation delay between the Home BS and the cell selected as the network listening synchronization source. In terms of the network listening synchronization source selection, the best accurate synchronization source to GNSS should be selected.

Note 2: If the Home BS obtains synchronization without using network listening, the small cell requirement applies.

7.5 Synchronization Requirements for E-UTRAN to 1xRTT and HRPD Handovers

7.5.1 Introduction

This clause contains the synchronization requirements for eNodeB capable of supporting E-UTRAN to CDMA 1xRTT and HRPD handovers. To facilitate E-UTRAN to CDMA 1xRTT and HRPD handovers, the CDMA System Time reference needs to be provided to the UE in order for the UE to report the pilot PN phases of the target 1xRTT or HRPD cells. This is achieved through the SIB8 message broadcasted by the serving eNodeB:

If the eNodeB is synchronized to the GPS time and the LTE system frame is aligned with the start of CDMA System Time, then the size of CDMA System Time information is 39 bits and the unit is 10 ms based on a 1.2288 Mcps chip rate.

If the eNodeB is not synchronized to the GPS time or if the eNodeB is synchronized to the GPS time but its LTE system frame not aligned with the start of CDMA System time, then the size of CDMA System Time information is 49 bits and the unit is 8 CDMA chips based on 1.2288 Mcps chip rate.

The CDMA system time reference provided by the serving eNodeB has to be within a certain level of accuracy in order to facilitate accurate reporting of the pilot PN phases of the target 1xRTT or HRPD cells and enable reliable handover to the 1xRTT or HRPD networks.

7.5.2 eNodeB Synchronization Requirements

7.5.2.1 Synchronized E-UTRAN

The eNodeB shall be synchronized to the GPS time. With external source of CDMA System Time disconnected, the eNodeB shall maintain the timing accuracy within $\pm 10 \mu\text{s}$ of CDMA System Time for a period of not less than 8 hours.

The timing deviation between the SFN boundary at or immediately after the ending boundary of the SI-window in which *SystemInformationBlockType8* is transmitted and the broadcasted CDMA System Time shall be within $10 \mu\text{s}$.

7.5.2.2 Non-Synchronized E-UTRAN

The timing deviation between the SFN boundary at or immediately after the end of the boundary of the SI-window in which *SystemInformationBlockType8* is transmitted and the broadcasted CDMA System Time shall be within $10 \mu\text{s}$. With external source of CDMA System Time disconnected the SFN boundary at or immediately after the broadcasted CDMA System Time in the SIB8 message shall maintain the timing accuracy within $\pm 10 \mu\text{s}$ of CDMA System Time for a period of not less than 8 hours.

7.6 Radio Link Monitoring

7.6.1 Introduction

The UE shall meet the radio link monitoring requirements specified for PCell in section 7.6 provided that the UE is configured with the parameters T313, N313 and N314 defined in [2].

The UE shall monitor the downlink link quality based on the cell-specific reference signal in order to detect the downlink radio link quality of the PCell and PSCell as specified in [3].

The UE shall estimate the downlink radio link quality and compare it to the thresholds Q_{out} and Q_{in} for the purpose of monitoring downlink radio link quality of the PCell and PSCell.

The threshold Q_{out} is defined as the level at which the downlink radio link cannot be reliably received and shall correspond to 10% block error rate of a hypothetical PDCCH transmission taking into account the PCFICH errors with transmission parameters specified in Table 7.6.1-1.

The threshold Q_{in} is defined as the level at which the downlink radio link quality can be significantly more reliably received than at Q_{out} and shall correspond to 2% block error rate of a hypothetical PDCCH transmission taking into account the PCFICH errors with transmission parameters specified in Table 7.6.1-2.

When higher-layer signalling indicates certain subframes for restricted radio link monitoring, the radio link quality shall be monitored as specified in [3].

The requirements in sections 7.6.2.1, 7.6.2.2 and 7.6.2.3 shall also apply when a time domain measurement resource restriction pattern for performing radio link monitoring measurements is configured by higher layers (TS 36.331 [2]), with or without CRS assistance information, provided that also the following additional condition is fulfilled:

The time domain measurement resource restriction pattern configured for the measured cell indicates at least one subframe per radio frame for performing the radio link monitoring measurements,

When the CRS assistance information is provided, the transmission bandwidth [30] in all intra-frequency cells in the CRS assistance information [2] is the same or larger than the transmission bandwidth of the PCell for which radio link monitoring is performed.

When the CRS assistance information is provided, the requirements in Section 7.6 shall also be met when the number of transmit antenna ports [16] of one or more cells whose CRS assistance information is provided [2] is different from the number of transmit antenna ports of the cell for which radio link monitoring is performed.

NOTE: If the UE is not provided with the CRS assistance information (TS 36.331 [2]) or the CRS assistance data is not valid throughout the entire evaluation period, then similar Release 8 and 9 requirements apply for time domain measurements restriction under colliding CRS with ABS configured in non-MBSFN subframes.

Table 7.6.1-1 PDCCH/PCFICH transmission parameters for out-of-sync

| Attribute | Value |
|---|---|
| DCI format | 1A |
| Number of control OFDM symbols | 2; Bandwidth ≥ 10 MHz 3; $3 \text{ MHz} \leq \text{Bandwidth} \leq 10 \text{ MHz}$ 4; Bandwidth = 1.4 MHz |
| Aggregation level (CCE) | 4; Bandwidth = 1.4 MHz 8; Bandwidth ≥ 3 MHz |
| Ratio of PDCCH RE energy to average RS RE energy | 4 dB; when single antenna port is used for cell-specific reference signal transmission by the PCell or PSCell. 1 dB: when two or four antenna ports are used for cell-specific reference signal transmission by the PCell or PSCell. |
| Ratio of PCFICH RE energy to average RS RE energy | 4 dB; when single antenna port is used for cell-specific reference signal transmission by the PCell or PSCell. 1 dB: when two or four antenna ports are used for cell-specific reference signal transmission by the PCell or PSCell. |
| Note 1: | DCI format 1A is defined in clause 5.3.3.1.3 in TS 36.212 [21]. |
| Note 2: | A hypothetical PCFICH transmission corresponding to the number of control symbols shall be assumed. |

Table 7.6.1-2 PDCCH/PCFICH transmission parameters for in-sync

| Attribute | Value |
|---|--|
| DCI format | 1C |
| Number of control OFDM symbols | 2; Bandwidth ≥ 10 MHz 3; $3 \text{ MHz} \leq \text{Bandwidth} \leq 10 \text{ MHz}$ 4; Bandwidth = 1.4 MHz |
| Aggregation level (CCE) | 4 |
| Ratio of PDCCH RE energy to average RS RE energy | 0 dB; when single antenna port is used for cell-specific reference signal transmission by the PCell or PSCell. -3 dB; when two or four antenna ports are used for cell-specific reference signal transmission by the PCell or PSCell. |
| Ratio of PCFICH RE energy to average RS RE energy | 4 dB; when single antenna port is used for cell-specific reference signal transmission by the PCell or PSCell. 1 dB: when two or four antenna ports are used for cell-specific reference signal transmission by the PCell or PSCell. |
| Note 1: | DCI format 1C is defined in clause 5.3.3.1.4 in TS 36.212 [21]. |
| Note 2: | A hypothetical PCFICH transmission corresponding to the number of control symbols shall be assumed. |

7.6.2 Requirements

7.6.2.1 Minimum requirement when no DRX is used

When the downlink radio link quality of the PCell or PSCell estimated over the last 200 ms period becomes worse than the threshold Q_{out} , Layer 1 of the UE shall send an out-of-sync indication for the PCell or PSCell to the higher layers within 200 ms Q_{out} evaluation period. A Layer 3 filter shall be applied to the out-of-sync indications as specified in TS 36.331 [2].

When the downlink radio link quality of the PCell or PSCell estimated over the last 100 ms period becomes better than the threshold Q_{in} , Layer 1 of the UE shall send an in-sync indication for the PCell or PSCell to the higher layers within 100 ms Q_{in} evaluation period. A L3 filter shall be applied to the in-sync indications as specified in TS 36.331 [2].

When the UE creates autonomous gaps for identification the CGI of an E-UTRA intra-frequency cell or an E-UTRA inter-frequency cell and when higher-layer signalling indicates certain subframes for restricted radio link monitoring, the UE shall also perform radio link monitoring. In this case, the Q_{out} evaluation period ($T_{Evaluate_Q_{out}}$) is 200 ms, and the Q_{in} evaluation period ($T_{Evaluate_Q_{in}}$) is 100 ms ^{Note 1}.

Note 1: This RLM requirement does not need to be tested.

The out-of-sync and in-sync evaluations of the PCell or PSCell shall be performed as specified in clause 4.2.1 in [3]. Two successive indications from Layer 1 shall be separated by at least 10 ms.

The transmitter power of the UE shall be turned off within 40 ms after expiry of T310 timer and the transmitter power of PSCell if configured shall be turned off within 40 ms after expiry of T313 timer as specified in clause 5.3.11 in TS 36.331 [2].

7.6.2.2 Minimum requirement when DRX is used

When DRX is used the Q_{out} evaluation period ($T_{Evaluate_Q_{out_DRX}}$) and the Q_{in} evaluation period ($T_{Evaluate_Q_{in_DRX}}$) specified in Table 7.6.2.2-1 will be used.

When higher-layer signalling indicates certain subframes for restricted radio link monitoring, the Q_{out} evaluation period ($T_{Evaluate_Q_{out_DRX}}$) and the Q_{in} evaluation period ($T_{Evaluate_Q_{in_DRX}}$) specified in Table 7.6.2.2-2 will be used.

When eDRX_CONN cycle is used, the Q_{out} evaluation period ($T_{Evaluate_Q_{out_DRX}}$) and the Q_{in} evaluation period ($T_{Evaluate_Q_{in_DRX}}$) specified in Table 7.6.2.2-3 will be used.

When the UE creates autonomous gaps for identification the CGI of an E-UTRA intra-frequency cell or an E-UTRA inter-frequency cell and when higher-layer signalling indicates certain subframes for restricted radio link monitoring, the UE shall also perform radio link monitoring. In this case, the Q_{out} evaluation period ($T_{Evaluate_Q_{out_DRX}}$) and the Q_{in} evaluation period ($T_{Evaluate_Q_{in_DRX}}$) specified in Table 7.6.2.2-2 will be used ^{Note 1}.

Note 1: This RLM requirement does not need to be tested.

When the downlink radio link quality of the PCell or PSCell estimated over the last $T_{Evaluate_Q_{out_DRX}}$ [s] period becomes worse than the threshold Q_{out} , Layer 1 of the UE shall send out-of-sync indication for the PCell or PSCell to the higher layers within $T_{Evaluate_Q_{out_DRX}}$ [s] evaluation period. A Layer 3 filter shall be applied to the out-of-sync indications as specified in TS 36.331 [2].

When the downlink radio link quality of the PCell or PSCell estimated over the last $T_{Evaluate_Q_{in_DRX}}$ [s] period becomes better than the threshold Q_{in} , Layer 1 of the UE shall send in-sync indications for the PCell or PSCell to the higher layers within $T_{Evaluate_Q_{in_DRX}}$ [s] evaluation period. A L3 filter shall be applied to the in-sync indications as specified in TS 36.331 [2].

The out-of-sync and in-sync evaluations of the PCell or PSCell shall be performed as specified in clause 4.2.1 in [3]. When DRX is used, two successive indications from Layer 1 shall be separated by at least $\max(10 \text{ ms}, \text{DRX_cycle_length})$. When the UE is configured with dual connectivity, then two successive indications from Layer 1 shall be separated by at least $\max(10 \text{ ms}, \text{MCG_DRX_cycle_length})$ for PCell and by at least $\max(10 \text{ ms}, \text{SCG_DRX_cycle_length})$ for PSCell. When eDRX_CONN is used, two successive indications from Layer 1 shall be separated by at least $\max(10 \text{ ms}, \text{eDRX_CONN cycle length})$.

Upon start of T310 timer or T313 timer as specified in clause 5.3.11 in TS 36.331 [2], the UE shall monitor the link of PCell or PSCell for recovery using the evaluation period and Layer 1 indication interval corresponding to the non-DRX mode until the expiry or stop of T310 timer or T313 timer.

The transmitter power of the UE shall be turned off within 40 ms after expiry of T310 timer and the transmitter power of PSCell if configured shall be turned off within 40 ms after expiry of T313 timer as specified in clause 5.3.11 in TS 36.331 [2].

Table 7.6.2.2-1: Q_{out} and Q_{in} Evaluation Period in DRX

| DRX cycle length (s) | $T_{Evaluate_Q_{out_DRX}}$ and $T_{Evaluate_Q_{in_DRX}}$ (s) (DRX cycles) |
|-------------------------------------|---|
| ≤ 0.01 | Non-DRX requirements in clause 7.6.2.1 are applicable. |
| $0.01 < \text{DRX cycle} \leq 0.04$ | Note 1 (20) |
| $0.04 < \text{DRX cycle} \leq 0.64$ | Note 1 (10) |

| | |
|-------------------------------------|--|
| $0.64 < \text{DRX cycle} \leq 2.56$ | Note 1 (5) |
| Note 1: | Evaluation period length in time depends on the length of the DRX cycle in use |
| Note 2: | MCG's DRX configuration is applied for PCell RLM evaluation and SCG's DRX configuration is applied for PSCell RLM evaluation |

Table 7.6.2.2-2: Q_{out} and Q_{in} Evaluation Period in DRX when higher-layer signalling restricted measurement resource

| DRX cycle length (s) | $T_{\text{Evaluate_}Q_{\text{out_DRX}}}$ and $T_{\text{Evaluate_}Q_{\text{in_DRX}}}$ (s) (DRX cycles) |
|-------------------------------------|--|
| ≤ 0.01 | Non-DRX requirements in clause 7.6.2.1 are applicable. |
| $0.01 < \text{DRX cycle} \leq 0.04$ | Note 1 (40) |
| $0.04 < \text{DRX cycle} \leq 0.16$ | Note 1 (20) |
| $0.16 < \text{DRX cycle} \leq 0.64$ | Note 1 (10) |
| $0.64 < \text{DRX cycle} \leq 2.56$ | Note 1 (5) |
| Note 1: | Evaluation period length in time depends on the length of the DRX cycle in use |
| Note 2: | MCG's DRX configuration is applied for PCell RLM evaluation and SCG's DRX configuration is applied for PSCell RLM evaluation |

Table 7.6.2.2-3: Q_{out} and Q_{in} Evaluation Period when eDRX_CONN cycle is configured

| eDRX_CONN cycle length [s] | $T_{\text{Evaluate_}Q_{\text{out_DRX}}}$ and $T_{\text{Evaluate_}Q_{\text{in_DRX}}}$ [s] (eDRX_CONN cycles) |
|---|---|
| $2.56 < \text{eDRX_CONN cycle} \leq 10.24$ | Note (5) |
| Note: | Evaluation period length in time depends on the length of the eDRX_CONN cycle in use |

7.6.2.3 Minimum requirement at transitions

When the UE transitions between any two of DRX, eDRX_CONN and non-DRX or when DRX or eDRX_CONN cycle periodicity changes, for a duration of time equal to the evaluation period corresponding to the second mode after the transition occurs, the UE shall use an evaluation period that is no less than the minimum of evaluation periods corresponding to the first mode and the second mode. Subsequent to this duration, the UE shall use an evaluation period corresponding to the second mode. This requirement shall be applied to both out-of-sync evaluation and in-sync evaluation of the PCell and PSCell.

7.6.2.4 Minimum requirement during SI Acquisition with autonomous gaps

For E-UTRAN FDD-UTRAN FDD measurements with autonomous gaps, for identification of the CGI of a UTRA FDD cell (clause 8.1.2.4.17), the UE shall also perform radio link monitoring. In this case the out-of sync and in-sync evaluation periods can be longer than those defined in sections 7.6.2.1-7.6.2.3.

For E-UTRAN TDD-UTRAN FDD measurements with autonomous gaps, for identification of the CGI of a UTRA FDD cell (clause 8.1.2.4.18), the UE shall also perform radio link monitoring. In this case the out-of sync and in-sync evaluation periods can be longer than those defined in sections 7.6.2.1-7.6.2.3.

7.6.2.5 Minimum requirement under IDC Interference

When the UE is provided with IDC solution, the UE shall also perform radio link monitoring and meet the corresponding requirements in clause 7.6.2.

7.7 SCell Activation and Deactivation Delay for E-UTRA Carrier Aggregation

7.7.1 Introduction

This section defines requirements for the delay within which the UE shall be able to activate a deactivated SCell and deactivate an activated SCell in E-UTRA carrier aggregation. The requirements are applicable to an E-UTRA carrier aggregation capable UE which has been configured with up to four downlink SCells.

If multiple downlink SCells are activated or deactivated in the same MAC control element as defined in [17], the requirements shall apply to each of the SCells in the MAC control element.

7.7.2 SCell Activation Delay Requirement for Deactivated SCell

The requirements in this section shall apply for the UE configured with one downlink SCell. The requirements in this section are applicable for E-UTRA FDD, E-UTRA TDD and E-UTRA TDD-FDD carrier aggregation.

The delay within which the UE shall be able to activate the deactivated SCell depends upon the specified conditions.

Upon receiving SCell activation command in subframe n , the UE shall be capable to transmit valid CSI report and apply actions related to the activation command as specified in [17] for the SCell being activated no later than in subframe $n+24$ provided the following conditions are met for the SCell:

- During the period equal to $\max(5 \text{ measCycleSCell}, 5 \text{ DRX cycles})$ before the reception of the SCell activation command:
 - the UE has sent a valid measurement report for the SCell being activated and
 - the SCell being activated remains detectable according to the cell identification conditions specified in section 8.3.3.2,
- SCell being activated also remains detectable during the SCell activation delay according to the cell identification conditions specified in section 8.3.3.2.

Otherwise upon receiving the SCell activation command in subframe n , the UE shall be capable to transmit valid CSI report and apply actions related to the activation command as specified in [17] for the SCell being activated no later than in subframe $n+34$ provided the SCell can be successfully detected on the first attempt.

If there is no reference signal received for the CSI measurement over the delay corresponding to the minimum requirements specified above, then the UE shall report corresponding valid CSI for the activated SCell on the next available uplink reporting resource after receiving the reference signal.

If there are no uplink resources for reporting the valid CSI in subframe $n+24$ or $n+34$ then the UE shall use the next available uplink resource for reporting the corresponding valid CSI.

The valid CSI is based on the UE measurement and corresponds to any CQI value specified in [3] with the exception of CQI index = 0 (out of range) provided:

- the conditions in section 7.7 are met over the entire SCell activation delay and
- the conditions for CQI reporting defined in Section 7.2.3 of [3] are met.

In addition to CSI reporting defined above, UE shall also apply other actions related to the activation command specified in [17] for an SCell at the first opportunities for the corresponding actions once the SCell is activated.

The PCell interruption specified in section 7.8.2 shall not occur before subframe $n+5$ and not occur after subframe $n+9$ when PCell belongs to E-UTRA FDD.

The PCell interruption specified in section 7.8.2 shall not occur before subframe $n+5$ and not occur after subframe $n+11$ when PCell belongs to E-UTRA TDD.

Starting from the subframe specified in section 4.3 of [3] and until the UE has completed the SCell activation, the UE shall report CQI index = 0 (out of range) if the UE has available uplink resources to report CQI for the SCell.

7.7.3 SCell Deactivation Delay Requirement for Activated SCell

The requirements in this section shall apply for the UE configured with one downlink SCell. The requirements in this section are applicable for E-UTRA FDD, E-UTRA TDD and E-UTRA TDD-FDD carrier aggregation.

Upon receiving SCell deactivation command or upon expiry of the *sCellDeactivationTimer* in subframe n , the UE shall accomplish the deactivation actions specified in [17] for the SCell being deactivated no later than in subframe $n+8$.

The PCell interruption specified in section 7.8.2 shall not occur before subframe $n+5$ and not occur after subframe $n+9$ when PCell belongs to E-UTRA FDD.

The PCell interruption specified in section 7.8.2 shall not occur before subframe $n+5$ and not occur after subframe $n+11$ when PCell belongs to E-UTRA TDD.

7.7.4 SCell Activation Delay Requirement for Deactivated SCell with Multiple Downlink SCells

The requirements in this section shall apply for the UE configured with up to four downlink SCells. The requirements in this section are applicable for E-UTRA FDD, E-UTRA TDD and E-UTRA TDD-FDD carrier aggregation.

While activating a SCell if the UE does not receive any command to activate, deactivate, configure or deconfigure any other SCell during the SCell activation delay then the UE shall meet the SCell activation delay requirements specified in section 7.7.2.

While activating a SCell if any other SCell is activated, deactivated, configured or deconfigured by the UE then the UE shall meet the SCell activation delay requirements ($T_{\text{activate_total}}$) according to the following expression:

$$T_{\text{activate_total}} = T_{\text{activate_basic}} + 5 \times \sum_{i=1}^{N-1} K_i$$

Where:

$T_{\text{activate_total}}$ is the total time to activate a SCell and is expressed in subframes.

$T_{\text{activate_basic}}$ is the SCell activation delay specified in section 7.7.2;

K_i ($0 \leq K_i \leq [3]$) is the number of times the other i^{th} SCell is activated, deactivated, configured or deconfigured while the SCell is being activated.

N ($2 \leq N \leq 4$) is the maximum number of SCells supported by the UE.

While activating a SCell:

- The interruption on the PCell and/or on the activated SCell due to the SCell activation specified in section 7.8.2 shall not occur before subframe $n+5$ and not occur after subframe $n+11$ if:
 - the PCell and/or the activated SCell being interrupted and the SCell being activated belong to E-UTRA TDD, or
 - the activated SCell being interrupted and the SCell being activated belong to E-UTRA FDD and the PCell belongs to E-UTRA TDD.
- Otherwise, the interruption on PCell and/or on the activated SCell due to the SCell activation specified in section 7.8.2 shall not occur before subframe $n+5$ and not occur after subframe $n+9$.

Starting from the subframe specified in section 4.3 of [3] and until the UE has completed the SCell activation, the UE shall report CQI index = 0 (out of range) if the UE has available uplink resources to report CQI for an SCell.

7.7.5 SCell Deactivation Delay Requirement for Activated SCell with Multiple Downlink SCells

The requirements in this section shall apply for the UE configured with up to four downlink SCells. The requirements in this section are applicable for E-UTRA FDD, E-UTRA TDD and E-UTRA TDD-FDD carrier aggregation.

The UE shall deactivate a SCell and meet the SCell deactivation delay requirements specified in section 7.7.3 regardless of whether any other SCell is activated, deactivated, configured or deconfigured or not by the UE during the SCell deactivation delay.

While deactivating a SCell:

- The interruption on the PCell and/or on the activated SCell due to the SCell deactivation specified in section 7.8.2 shall not occur before subframe $n+5$ and not occur after subframe $n+11$ if:
 - the PCell and/or the activated SCell being interrupted and the SCell being deactivated belong to E-UTRA TDD or
 - the activated SCell being interrupted and the SCell being deactivated belong to E-UTRA FDD and the PCell belongs to E-UTRA TDD.
- Otherwise, the interruption on PCell and/or the activated SCell due to the SCell deactivation specified in section 7.8.2 shall not occur before subframe $n+5$ and not occur after subframe $n+9$.

7.7.6 SCell Activation Delay Requirement for Deactivated PUCCH SCell

The requirements in this section shall apply for the UE configured with one downlink SCell and when PUCCH is configured for the SCell being activated.

If the UE has a valid TA for transmitting on an SCell then the UE shall be able to transmit valid CSI report and apply actions related to the SCell activation command as specified in [17] for the SCell being activated on the PUCCH SCell no later than in subframe $n+T_{\text{activate_basic}}$:

Where:

- A TA is considered to be valid provided that the *TimeAlignmentTimer* [2] associated with the TAG containing the PUCCH SCell is running.
- $T_{\text{activate_basic}}$ is the SCell activation delay as defined in section 7.7.2.

If the UE does not have a valid TA for transmitting on an SCell then the UE shall be capable to perform downlink actions related to the SCell activation command as specified in [17] for the SCell being activated on the PUCCH SCell no later than in subframe $n+T_{\text{activate_basic}}$ and shall be capable to perform uplink actions related to the SCell activation command as specified in [17] for the SCell being activated on the PUCCH SCell no later than in subframe $n+T_{\text{delay_PUCCH SCell}}$ and shall transmit valid CSI report for the SCell being activated on the PUCCH SCell no later than in subframe $n+T_{\text{delay_PUCCH SCell}}$, where:

$$T_{\text{delay_PUCCH SCell}} = T_{\text{activate_basic}} + T_1 + T_2 + T_3$$

Where:

- T_1 is the delay uncertainty in acquiring the first available PRACH occasion in the PUCCH SCell. T_1 is up to 25 subframes and the actual value of T_1 shall depend upon the PRACH configuration used in the PUCCH SCell.
- T_2 is the delay for obtaining a valid TA command for the sTAG to which the SCell configured with PUCCH belongs. T_2 is up to 13 subframes.
- T_3 is the delay for applying the received TA for uplink transmission. T_3 is 6 subframes.

The above delay requirement ($T_{\text{delay_PUCCH SCell}}$) shall apply provided that:

- The UE has received a PDCCH order to initiate RA procedure on the PUCCH SCell within $T_{\text{activate_basic}}$ otherwise additional delay to activate the SCell is expected; and

- The RA on PUCCH SCell is not interrupted by the RA on PCell otherwise additional delay to activate the SCell is expected.

The interruption on the PCell specified in section 7.8.2 shall meet all applicable requirements in clause 7.7.2.

7.7.7 SCell Activation Delay Requirement for Deactivated PUCCH SCell with Multiple SCells

The requirements in this section shall apply for the UE configured with up to four downlink SCells and when PUCCH is configured for the SCell being activated.

If the UE has a valid TA for transmitting on a PUCCH SCell then the UE shall be able to transmit valid CSI report and apply actions related to the SCell activation command as specified in [17] for the SCell being activated on the PUCCH SCell no later than in subframe $n + T_{\text{activate_total}}$:

Where:

- A TA is considered to be valid provided that the *TimeAlignmentTimer* [2] associated with the TAG containing the PUCCH SCell is running.
- $T_{\text{activate_total}}$ is the SCell activation delay as defined in section 7.7.4.

If the UE does not have a valid TA for transmitting on an SCell then the UE shall be capable to perform downlink actions related to the SCell activation command as specified in [17] for the SCell being activated on the PUCCH SCell no later than in subframe $n + T_{\text{activate_basic}}$ and shall be capable to perform uplink actions related to the SCell activation command as specified in [17] for the SCell being activated on the PUCCH SCell no later than in subframe $n + T_{\text{delay_PUCCH_multiple_SCells}}$ and shall transmit valid CSI report for the SCell being activated on the PUCCH SCell no later than in subframe $n + T_{\text{delay_PUCCH_multiple_SCells}}$, where:

$$T_{\text{delay_PUCCH_multiple_SCells}} = T_{\text{activate_total}} + T_1 + T_2 + T_3$$

Where:

- T_1 , T_2 and T_3 are defined in section 7.7.6

The above delay requirement ($T_{\text{delay_PUCCH_multiple_SCells}}$) shall apply provided that:

- The UE has received a PDCCH order to initiate RA procedure on the PUCCH SCell within $T_{\text{activate_basic}}$ otherwise additional delay to activate the SCell is expected; and
- The RA on PUCCH SCell is not interrupted by the RA on PCell otherwise additional delay to activate the SCell is expected.

The interruption on the PCell and/or on the activated SCell specified in section 7.8.2 shall meet all applicable requirements in clause 7.7.4.

7.7.8 SCell Deactivation Delay Requirement for Activated PUCCH SCell

The requirements in this section shall apply for the UE configured with one downlink SCell and when PUCCH is configured for the SCell being activated.

The UE shall deactivate a SCell configured with PUCCH and meet the SCell deactivation delay requirements specified in section 7.7.3.

The interruption on the PCell specified in section 7.8.2 shall meet all applicable requirements in clause 7.7.3.

7.7.9 SCell Deactivation Delay Requirement for Activated PUCCH SCell with Multiple SCells

The requirements in this section shall apply for the UE configured with up to four downlink SCells and when PUCCH is configured for the SCell being deactivated.

The UE shall deactivate a SCell configured with PUCCH and meet the SCell deactivation delay requirements specified in section 7.7.5.

The interruption on the PCell and/or on the activated SCell specified in section 7.8.2 shall meet all applicable requirements in clause 7.7.5.

7.7.10 SCell Activation Delay Requirement for Deactivated SCell under Frame Structure 3

The requirements in this section shall apply for E-UTRA carrier aggregation of one FDD PCell or one TDD PCell and one SCell following the frame structure type 3 [16].

The delay within which the UE shall be able to activate the deactivated SCell depends upon the specified conditions.

Upon receiving SCell activation command in subframe n , the UE shall be capable to transmit valid CSI report and apply actions related to the activation command as specified in [17] for the SCell being activated no later than in subframe $n+T_{\text{activate_basic_FS3}}$, provided the following conditions are met for the SCell:

- During the period equal to $\max(5 \text{ measCycleSCell}, 5 \text{ DRX cycles})$ before the reception of the SCell activation command:
 - the UE has sent a valid measurement report for the SCell being activated and
 - the SCell being activated remains detectable according to the cell identification conditions specified in section 8.3.3.2,
- SCell being activated also remains detectable during the SCell activation delay according to the cell identification conditions specified in section 8.3.3.2.

$T_{\text{activate_basic_FS3}} = 16 \text{ ms} + T_{\text{DMTC_duration}} + (L+2) * T_{\text{DMTC_periodicity}}$, where

$T_{\text{DMTC_duration}} = 6 \text{ ms}$ is the DMTC duration [2],

$T_{\text{DMTC_periodicity}}$ is the periodicity of the DMTC [2],

L is the number of times the discovery signal occasion is not available at the UE during the SCell activation time.

Otherwise upon receiving the SCell activation command in subframe n , the UE shall be capable to transmit a valid CSI report and apply actions related to the activation command as specified in [17] for the SCell being activated no later than in subframe $n+T_{\text{activate_basic_FS3}}$, provided the SCell can be successfully detected on the first attempt. In this case, $T_{\text{activate_basic_FS3}}$ is defined as follows.

$T_{\text{activate_basic_FS3}} = 16 \text{ ms} + T_{\text{DMTC_duration}} + (L+3) * T_{\text{DMTC_periodicity}}$, where

$T_{\text{DMTC_duration}} = 6 \text{ ms}$ is the DMTC duration [2],

$T_{\text{DMTC_periodicity}}$ is the periodicity of the DMTC [2],

L is the number of times the discovery signal occasion is not available at the UE during the SCell activation time.

If there is no reference signal received for the CSI measurement over the delay corresponding to the minimum requirements specified above, then the UE shall report corresponding valid CSI for the activated SCell on the next available uplink reporting resource after receiving the reference signal.

If there are no uplink resources for reporting the valid CSI in subframe $n+T_{\text{activate_basic_FS3}}$ then the UE shall use the next available uplink resource for reporting the corresponding valid CSI.

The valid CSI is based on the UE measurement and corresponds to any CQI value specified in [3] with the exception of CQI index = 0 (out of range) provided:

- the conditions in section 7.7 are met over the entire SCell activation delay and
- the conditions for CQI reporting defined in Section 7.2.3 of [3] are met.

In addition to CSI reporting defined above, UE shall also apply other actions related to the activation command specified in [17] for an SCell at the first opportunities for the corresponding actions once the SCell is activated.

The PCell interruption specified in section 7.8.2 shall not occur before subframe $n+5$ and not occur after subframe $n+9$ when PCell belongs to E-UTRA FDD.

The PCell interruption specified in section 7.8.2 shall not occur before subframe $n+5$ and not occur after subframe $n+11$ when PCell belongs to E-UTRA TDD.

Starting from the subframe specified in Section 4.3 of [3] and until the UE has completed the SCell activation, the UE shall send CSI with CQI index = 0 (out of range) if the UE has available uplink resources to report for the SCell.

7.7.11 SCell Deactivation Delay Requirement for Activated SCell under Frame Structure 3

The requirements in this section shall apply for the UE configured with one downlink SCell. The requirements in this section shall apply for E-UTRA carrier aggregation of one FDD PCell or one TDD PCell and the SCell following the frame structure type 3 [16].

Upon receiving SCell deactivation command or upon expiry of the *sCellDeactivationTimer* in subframe n , the UE shall accomplish the deactivation actions specified in [17] for the SCell being deactivated no later than in subframe $n+8$.

The PCell interruption specified in section 7.8.2 shall not occur before subframe $n+5$ and not occur after subframe $n+9$ when PCell belongs to E-UTRA FDD.

The PCell interruption specified in section 7.8.2 shall not occur before subframe $n+5$ and not occur after subframe $n+11$ when PCell belongs to E-UTRA TDD.

7.7.12 SCell Activation Delay Requirement for Deactivated SCell with Multiple Downlink SCells under Frame Structure 3

The requirements in this section shall apply for the UE configured with two or three downlink SCells. The requirements in this section shall apply for E-UTRA carrier aggregation of one FDD PCell or one TDD PCell and all the SCells following the frame structure type 3 [16].

While activating a SCell, if any other SCell is activated, deactivated, configured or deconfigured by the UE, the UE shall meet the SCell activation delay requirements ($T_{\text{activate_total_FS3}}$) according to the following expression:

$$T_{\text{activate_total_FS3}} = T_{\text{activate_basic_FS3}} + T_{\text{DMTC_periodicity}} \times \sum_{i=1}^{N-1} K_i$$

where

$T_{\text{activate_total_FS3}}$ is the total time to activate a SCell and is expressed in subframes,

$T_{\text{activate_basic_FS3}}$ is the SCell activation delay for the SCell, as specified in section 7.7.10,

$T_{\text{DMTC_periodicity}}$ is the periodicity of the DMTC [2],

K_i ($0 \leq K_i \leq [3]$) is the number of times the other i^{th} SCell is activated, deactivated, configured or deconfigured while the SCell is being activated,

N ($2 \leq N \leq 3$) is the maximum number of SCells supported by the UE.

While activating a SCell:

- The interruption on the PCell and/or on the activated SCell specified in section 7.8.2 shall not occur before subframe $n+5$ and not occur after subframe $n+9$ when PCell belongs to E-UTRA FDD.
- The interruption on the PCell and/or on the activated SCell specified in section 7.8.2 shall not occur before subframe $n+5$ and not occur after subframe $n+11$ when PCell belongs to E-UTRA TDD.

Starting from the subframe specified in section 4.3 of [3] and until the UE has completed the SCell activation, the UE shall send CSI with CQI index = 0 (out of range) if the UE has available uplink resources to report for the SCell being activated.

7.7.13 SCell Deactivation Delay Requirement for Activated SCell with Multiple Downlink SCells under Frame Structure 3

The requirements in this section shall apply for the UE configured with two or three downlink SCells. The requirements in this section shall apply for E-UTRA carrier aggregation of one FDD PCell or one TDD PCell and all the SCells following the frame structure type 3 [16].

The UE shall deactivate a SCell and meet the SCell deactivation delay requirements specified in section 7.7.11 regardless of whether any other SCell is activated, deactivated, configured or deconfigured or not by the UE during the SCell deactivation delay.

While deactivating a SCell:

- The interruption on the PCell and/or on the activated SCell specified in section 7.8.2 shall not occur before subframe $n+5$ and not occur after subframe $n+9$ when PCell belongs to E-UTRA FDD.
- The interruption on the PCell and/or on the activated SCell specified in section 7.8.2 shall not occur before subframe $n+5$ and not occur after subframe $n+11$ when PCell belongs to E-UTRA TDD.

7.8 Interruptions with Carrier Aggregation

7.8.1 Introduction

This section contains the requirements related to the interruptions on PCell and activated SCell if configured, when up to four SCells are configured, deconfigured, activated or deactivated. Unless explicitly stated otherwise, the requirements in Section 7.8 shall apply for:

- E-UTRA FDD CA,
- E-UTRA TDD CA,
- E-UTRA TDD-FDD CA,
- inter-band CA where PCell is FDD or TDD and all the SCells are following the frame structure type 3 [16].

Note: interruptions at SCell addition/release, activation/deactivation and during measurements on SCC may not be required by all UEs.

Editor's Note: The interruptions shall not interrupt RRC signalling or ACK/NACKs related to RRC reconfiguration procedure [2] for SCell addition/release or MAC control signalling [17] for SCell activation/deactivation command. How to specify this is FFS.

7.8.2 Requirements

7.8.2.1 Interruptions at SCell addition/release for intra-band CA

When an intra-band SCell is added or released as defined in [2] the UE is allowed an interruption of up to 5 subframes on PCell during the RRC reconfiguration procedure [2]. This interruption is for both uplink and downlink of PCell.

7.8.2.2 Interruptions at SCell addition/release for inter-band CA

When an inter-band SCell is added or released as defined in [2] the UE that requires interruption is allowed an interruption of up to 1 subframe on PCell during the RRC reconfiguration procedure [2]. This interruption is for both uplink and downlink of PCell.

7.8.2.3 Interruptions at SCell activation/deactivation for intra-band CA

When an intra-band SCell is activated or deactivated as defined in [17] the UE is allowed an interruption of up to 5 subframes on PCell during the activation/deactivation delay defined in Section 7.7. This interruption is for both uplink and downlink of PCell.

7.8.2.4 Interruptions at SCell activation/deactivation for inter-band CA

When an inter-band SCell is activated or deactivated as defined in [17] the UE that requires interruption is allowed an interruption of up to 1 subframe on PCell during the activation/deactivation delay defined in Section 7.7. This interruption is for both uplink and downlink of PCell.

7.8.2.5 Interruptions during measurements on SCC for intra-band CA

PCell interruptions due to measurements on SCC when the SCell is deactivated are allowed with up to 0.5% probability of missed ACK/NACK when the configured *measCycleSCell* [2] is 640 ms or longer.

If indicated by the network using IE *allowInterruptions* [2], PCell interruptions due to measurements on SCC when the SCell is deactivated are allowed with up to 0.5% probability of missed ACK/NACK regardless of the configured *measCycleSCell* [2].

Each interruption shall not exceed 5 subframes.

7.8.2.6 Interruptions during measurements on SCC for inter-band CA

PCell interruptions due to measurements on SCC when the SCell is deactivated are allowed with up to 0.5% probability of missed ACK/NACK when the configured *measCycleSCell* [2] is 640 ms or longer.

If indicated by the network using IE *allowInterruptions* [2], PCell interruptions due to measurements on SCC when the SCell is deactivated are allowed with up to 0.5% probability of missed ACK/NACK regardless of the configured *measCycleSCell* [2].

Each interruption shall not exceed 1 subframe.

7.8.2.7 Interruptions at SCell addition/release with multiple downlink SCells

When any number of SCells between one and four is added or released using the same *RRCConnectionReconfiguration* message as defined in [2], the UE is allowed an interruption on PCell and on any activated SCell during the RRC reconfiguration procedure as follows:

- an interruption on PCell:
 - of up to 1 subframe, if the PCell is not in the same band as any of the SCells being added or released, or
 - of up to 5 subframes, if the PCell is in the same band as any of the SCells being added or released;
- an interruption on any activated SCell:
 - of up to 1 subframe, if the activated SCell is not in the same band as any of the SCells being added or released, or
 - of up to 5 subframes, if the activated SCell is in the same band as any of the SCells being added or released.

7.8.2.8 Interruptions at SCell activation/deactivation with multiple downlink SCells

When any number of SCells between one and four is activated or deactivated using the same MAC control element as defined in [17], the UE is allowed an interruption on PCell and on any activated SCell during the SCell activation/deactivation procedure [17] as follows:

- an interruption on PCell:
 - of up to 1 subframe, if the PCell is not in the same band as any of the SCells being activated or deactivated, or

- of up to 5 subframes, if the PCell is in the same band as any of the SCells being activated or deactivated;
- an interruption on any activated SCell:
 - of up to 1 subframe, if the activated SCell is not in the same band as any of the SCells being activated or deactivated, or
 - of up to 5 subframes, if the activated SCell is in the same band as any of the SCells being activated or deactivated.

7.8.2.9 Interruptions during measurements on SCC with multiple downlink SCells

If one SCell is deactivated, the UE is allowed due to measurements on the SCC with deactivated SCell:

- an interruption on PCell with up to 0.5% probability of missed ACK/NACK when the configured *measCycleSCell* [2] for the deactivated SCell is 640 ms or longer.
- an interruption on PCell with up to 0.5% probability of missed ACK/NACK regardless of the configured *measCycleSCell* [2] for the deactivated SCell if indicated by the network using IE *allowInterruptions* [2],

Each interruption shall not exceed:

- 1 subframes if the PCell is not in the same band as the deactivated SCell
- 5 subframes if the PCell is in the same band as the deactivated SCell
- an interruption on any activated SCell with up to 0.5% probability of missed ACK/NACK when the configured *measCycleSCell* [2] for the deactivated SCell is 640 ms or longer .
- an interruption on any activated SCell with up to 0.5% probability of missed ACK/NACK regardless of the configured *measCycleSCell* [2] for the deactivated SCell if indicated by the network using IE *allowInterruptions* [2].

Each interruption shall not exceed:

- 1 subframes if the activated SCell is not in the same band as the deactivated SCell
- 5 subframes if the activated SCell is in the same band as the deactivated SCell

If two, three, or four SCells are deactivated, the UE is allowed due to measurements on the SCCs with deactivated SCells:

- an interruption on PCell with up to 0.5% probability of missed ACK/NACK when any of the configured *measCycleSCell* [2] for the deactivated SCells is 640 ms or longer.
- an interruption on PCell with up to 0.5% probability of missed ACK/NACK regardless of the configured *measCycleSCell* [2] for the deactivated SCells if indicated by the network using IE *allowInterruptions* [2].
- an interruption on an activated SCell with up to 0.5% probability of missed ACK/NACK when any of the configured *measCycleSCell* [2] for the deactivated SCells is 640 ms or longer.
- an interruption on an activated SCell with up to 0.5% probability of missed ACK/NACK regardless of the configured *measCycleSCell* [2] for the deactivated SCells if indicated by the network using IE *allowInterruptions* [2].

Each interruption on the PCell shall not exceed:

- 1 subframes if the PCell is not in the same band as any of the deactivated SCells
- 5 subframes if the PCell is in the same band as any of the deactivated SCells

Each interruption on the activated Cell shall not exceed:

- 1 subframe if the activated SCell is not in the same band as any of the deactivated SCells
- 5 subframes if the the activated SCell is in the same band as any of the deactivated SCells

7.8.2.10 Interruptions at overlapping addition/release/activation/deactivation of SCells

If a UE is commanded by the network to sequentially add/release/activate/deactivate SCells, and a new procedure of addition/release/activation/deactivation of SCell(s) takes place before the completion of previous procedure of addition/release/activation/deactivation of SCell(s), the interruptions on PCell due to sequential addition/release/activation/deactivation of SCells shall not exceed the sum of the allowed interruptions on the PCell caused by each of the addition/release/activation/deactivation procedures, and the interruptions on already activated SCell due to sequential addition/release/activation/deactivation of SCells shall not exceed the sum of the allowed interruptions on the SCell caused by each of the addition/release/activation/deactivation procedures, as defined in above sections.

7.8.2.11 Interruptions during RSSI measurements on one SCC under Frame Structure 3

The requirements in this section apply for inter-band CA where PCell belongs to FDD or TDD and all the configured SCells belong to the frame structure type 3 [16], and the UE is configured with one SCell.

PCell interruptions due to RSSI measurements on SCC when the SCell is deactivated are allowed with up to 0.5% probability of missed ACK/NACK when any of the configured *rmtc-Period* [2] and *measCycleSCell* [2] is 640 ms or longer.

Each allowed interruption on the PCell shall not exceed 1 subframe.

7.8.2.12 Interruptions during RSSI measurements on multiple SCCs under Frame Structure 3

The requirements in this section apply for inter-band CA where PCell belongs to FDD or TDD and all the configured SCells belong to the frame structure type 3 [16], and the UE is configured with up to four SCells.

If one SCell is deactivated,

- the UE is allowed due to RSSI measurements on the SCC with deactivated SCell:
 - an interruption on PCell with up to 0.5% probability of missed ACK/NACK when any of the configured *rmtc-Period* [2] and the configured *measCycleSCell* [2] for the deactivated SCell is 640 ms or longer,
 - an interruption on any activated SCell with up to 0.5% probability of missed ACK/NACK when any of the configured *rmtc-Period* [2] and the configured *measCycleSCell* [2] for the deactivated SCell is 640 ms or longer.
- no interruption is allowed if both of the configured *rmtc-Period* [2] and the configured *measCycleSCell* [2] for the deactivated SCell are below 640 ms.

If two, three, or four SCells are deactivated,

- the UE is allowed due to RSSI measurements on the SCCs with deactivated SCells:
 - an interruption on PCell with up to 0.5% probability of missed ACK/NACK when:
 - any of the configured *rmtc-Period* [2] and the configured *measCycleSCell* [2] for the deactivated SCells is 640 ms or longer, or
 - RSSI windows with the length of *measDuration* [2] for at least some of the SCCs with the deactivated SCells within their respective *rmtc-Period* [2] are not within [20] ms;
 - an interruption on an activated SCell with up to 0.5% probability of missed ACK/NACK when:
 - any of the configured *rmtc-Period* [2] and the configured and the configured *measCycleSCell* [2] for the deactivated SCells is 640 ms or longer, or
 - RSSI windows with the length of *measDuration* [2] for at least some of the SCCs with the deactivated SCells within their respective *rmtc-Period* [2] are not within [20] ms.

- no interruption is allowed if both of the configured *rmtc-Period* [2] and the configured *measCycleSCell* [2] for the deactivated SCell are below 640 ms and RSSI windows with the length of *measDuration* [2] for all the SCCs with the deactivated SCells within their respective *rmtc-Period* [2] are within [20] ms.

Each allowed interruption shall not exceed:

- 1 subframe on the PCell, and
- 5 subframes on the activated SCell.

7.9 Maximum Transmission Timing Difference in Carrier Aggregation

7.9.1 Introduction

A UE shall be capable of handling a relative received time difference between the PCell and SCell to be aggregated in inter-band CA and intra-band non-contiguous CA.

7.9.2 Minimum Requirements for Interband Carrier Aggregation

The UE shall be capable of handling at least a relative received time difference between the signals received from the PCell and the SCell at the UE receiver of up to 30.26 μ s when one SCell is configured.

When two, three, or four SCells are configured, the UE shall be capable of handling at least a relative propagation delay difference between the signals received from any pair of the serving cells (PCell and the SCells) at the UE receiver of up to 30.26 μ s.

The UE shall be capable of handling a maximum uplink transmission timing difference between the pTAG and the sTAG of at least 32.47 μ s provided that the UE is:

- configured with inter-band CA and
- configured with the pTAG and the sTAG,

A UE configured with pTAG and sTAG may stop transmitting on the SCell if after timing adjusting due to received TA command the uplink transmission timing difference between PCell and SCell exceeds the maximum value the UE can handle as specified above.

The UE shall be capable of handling a maximum uplink transmission timing difference between the pTAG and any of the two sTAGs or between the two sTAGs of at least 32.47 μ s provided that the UE is:

- configured with inter-band CA and
- configured with the two sTAGs,

A UE configured with two sTAGs may stop transmitting on the SCell if after timing adjusting due to received TA command the uplink transmission timing difference between SCell in one sTAG and SCell in other sTAG exceeds the maximum value the UE can handle as specified above.

7.9.3 Minimum Requirements for Intra-band non-contiguous Carrier Aggregation

The UE shall be capable of handling at least a relative received time difference between the signals received from the PCell and the SCell at the UE receiver of up to 30.26 μ s.

The UE shall be capable of handling a maximum uplink transmission timing difference between the pTAG and the sTAG of at least 32.47 μ s provided that the UE is:

- configured with intra-band non-contiguous CA and
- configured with the pTAG and the sTAG,

A UE configured with pTAG and sTAG may stop transmitting on the SCell if after timing adjusting due to received TA command the uplink transmission timing difference between PCell and SCell exceeds the maximum value the UE can handle as specified above.

7.9.4 Minimum Requirements for Inter-Band Carrier Aggregation under Frame Structure 3

The requirements in this section shall apply for E-UTRA inter-band carrier aggregation of one FDD PCell or one TDD PCell and the SCell(s) following the frame structure type 3 [16].

The UE shall be capable of handling at least a relative received time difference between the signals received from the PCell and the SCell at the UE receiver of up to 30.26 μ s when one SCell is configured.

When two or three SCells are configured, the UE shall be capable of handling at least a relative propagation delay difference between the signals received from any pair of the serving cells (PCell and the SCells) at the UE receiver of up to 30.26 μ s.

7.10 Interruptions with RSTD Measurements with Carrier Aggregation

7.10.1 Introduction

This section contains the requirements related to the interruptions on PCell and activated SCell if configured, when performing RSTD measurements on cells belonging to at least one SCC with deactivated SCell.

Note: Interruptions during RSTD measurements on PCell and activated SCell if configured may not be required by all UEs.

7.10.2 Requirements

When common DRX is used, no interruption is allowed for all carrier aggregation configurations while the On Duration timer is running.

The interruption requirement considers only missed ACK/NACK due to reconfiguration of the receiver bandwidth, and not due to other causes such as RF impairments or channel conditions.

7.10.2.1 Interruptions during RSTD measurements on SCC for intra-band CA with one downlink SCell

PCell interruptions due to RSTD measurements on SCC when the SCell is deactivated are allowed with up to 0.5% probability of missed ACK/NACK when the PRS periodicity T_{PRS} is 640 ms or longer. Each interruption shall not exceed 5 subframes.

7.10.2.2 Interruptions during RSTD measurements on SCC for inter-band CA with one downlink SCell

PCell interruptions due to RSTD measurements on SCC when the SCell is deactivated are allowed with up to 0.5% probability of missed ACK/NACK when the PRS periodicity T_{PRS} is 640 ms or longer. Each interruption shall not exceed 1 subframe.

7.10.2.3 Interruptions during RSTD measurements on SCC with multiple downlink SCells

If one SCell is activated and the other SCell is deactivated, then due to RSTD measurements on the SCC with deactivated SCell the UE is allowed:

- an interruption on PCell with up to 0.5% probability of missed ACK/NACK when the PRS periodicity T_{PRS} is 640 ms or longer. Each interruption shall not exceed:
 - 1 subframe if the PCell is not in the same band as the deactivated SCell
 - 5 subframes if the PCell is in the same band as the deactivated SCell
- an interruption on the activated SCell with up to 0.5% probability of missed ACK/NACK when the PRS periodicity T_{PRS} is 640 ms or longer. Each interruption shall not exceed:
 - 1 subframe if the activated SCell is not in the same band as the deactivated SCell
 - 5 subframes if the activated SCell is in the same band as the deactivated SCell

If both SCells are deactivated, then due to RSTD measurements on one or both SCCs with deactivated SCells the UE is allowed:

- an interruption on PCell with up to 1.0% probability of missed ACK/NACK when the configured PRS periodicity T_{PRS} is 640 ms or longer in any of the SCCs. Each interruption shall not exceed:
 - 1 subframe if the PCell is not in the same band as any of the deactivated SCells
 - 5 subframes if the PCell is in the same band as any of the deactivated SCells

7.10.2.4 Interruptions at overlapping RSTD and inter-frequency measurements

If the UE is configured for RSTD measurements on cells belonging to a SCC with deactivated SCell(s) and also with a *measCycleSCell* for performing E-UTRA carrier aggregation measurements as defined in Section 8.3 on the same SCC as configured for the RSTD measurements, then the total allowed interruption on the active serving cell(s) is the maximum of the interruption due to E-UTRA carrier aggregation measurements specified in Section 7.8 and the interruption due to the RSTD measurements on SCC specified in this Section.

7.11 Radio Link Monitoring for UE Category 0

7.11.1 Introduction

The UE category 0 applicability of the requirements for performing radio link monitoring in subclause 7.11 is defined in Section 3.6.1.

The UE shall monitor the downlink link quality based on the cell-specific reference signal in order to detect the downlink radio link quality of the PCell as specified in [3].

The UE shall estimate the downlink radio link quality and compare it to the thresholds Q_{out_Cat0} and Q_{in_Cat0} for the purpose of monitoring downlink radio link quality of the PCell.

The threshold Q_{out_Cat0} is defined as the level at which the downlink radio link cannot be reliably received and shall correspond to 10% block error rate of a hypothetical PDCCH transmission taking into account the PCFICH errors with transmission parameters specified in Table 7.11.1-1.

The threshold Q_{in_Cat0} is defined as the level at which the downlink radio link quality can be significantly more reliably received than at Q_{out_Cat0} and shall correspond to 2% block error rate of a hypothetical PDCCH transmission taking into account the PCFICH errors with transmission parameters specified in Table 7.11.1-2.

Table 7.11.1-1 PDCCH/PCFICH transmission parameters for out-of-sync for UE category 0

| Attribute | Value |
|--------------------------------|--|
| DCI format | 1A |
| Number of control OFDM symbols | 2; Bandwidth \geq 10 MHz 3; 3 MHz \leq Bandwidth < 10 MHz 4; Bandwidth = 1.4 MHz |

| | |
|---|---|
| Aggregation level (CCE) | 4; Bandwidth = 1.4 MHz 8; Bandwidth \geq 3 MHz |
| Ratio of PDCCH RE energy to average RS RE energy | 4 dB; when single antenna port is used for cell-specific reference signal transmission by the PCell. 4 dB; when two or four antenna ports are used for cell-specific reference signal transmission by the PCell. |
| Ratio of PCFICH RE energy to average RS RE energy | 4 dB; when single antenna port is used for cell-specific reference signal transmission by the PCell. 1 dB; when two or four antenna ports are used for cell-specific reference signal transmission by the PCell. |
| Note 1: | DCI format 1A is defined in clause 5.3.3.1.3 in TS 36.212 [21]. |
| Note 2: | A hypothetical PCFICH transmission corresponding to the number of control symbols shall be assumed. |

Table 7.11.1-2 PDCCH/PCFICH transmission parameters for in-sync for UE category 0

| Attribute | Value |
|---|---|
| DCI format | 1C |
| Number of control OFDM symbols | 2; Bandwidth \geq 10 MHz 3; 3 MHz \leq Bandwidth < 10 MHz 4; Bandwidth = 1.4 MHz |
| Aggregation level (CCE) | 4 |
| Ratio of PDCCH RE energy to average RS RE energy | 1 dB; when single antenna port is used for cell-specific reference signal transmission by the PCell. 1 dB; when two or four antenna ports are used for cell-specific reference signal transmission by the PCell. |
| Ratio of PCFICH RE energy to average RS RE energy | 4 dB; when single antenna port is used for cell-specific reference signal transmission by the PCell. 1 dB; when two or four antenna ports are used for cell-specific reference signal transmission by the PCell. |
| Note 1: | DCI format 1C is defined in clause 5.3.3.1.4 in TS 36.212 [21]. |
| Note 2: | A hypothetical PCFICH transmission corresponding to the number of control symbols shall be assumed. |

7.11.2 Requirements for FD-FDD and TDD

7.11.2.1 Minimum requirement when no DRX is used

When the downlink radio link quality of the PCell estimated over the last 200 ms period becomes worse than the threshold Q_{out_Cat0} , Layer 1 of the UE shall send an out-of-sync indication for the PCell to the higher layers within 200ms Q_{out_Cat0} evaluation period. A Layer 3 filter shall be applied to the out-of-sync indications as specified in TS 36.331 [2].

When the downlink radio link quality of the PCell estimated over the last 100 ms period becomes better than the threshold Q_{in_Cat0} , Layer 1 of the UE shall send an in-sync indication for the PCell to the higher layers within 100 ms Q_{in_Cat0} evaluation period. A L3 filter shall be applied to the in-sync indications as specified in TS 36.331 [2].

The out-of-sync and in-sync evaluations of the PCell shall be performed as specified in clause 4.2.1 in [3]. Two successive indications from Layer 1 shall be separated by at least 10ms.

The transmitter power of the UE shall be turned off within 40 ms after expiry of T310 timer as specified in clause 5.3.11 in TS 36.331 [2].

7.11.2.2 Minimum requirement when DRX is used

When DRX is used for FD-FDD and TDD category 0 UEs, the Q_{out_Cat0} evaluation period ($T_{Evaluate_Q_{out_DRX_Cat0}}$) and the Q_{in_Cat0} evaluation period ($T_{Evaluate_Q_{in_DRX_Cat0}}$) specified in Table 7.11.2.2-1 will be used.

When eDRX_CONN is used for FD-FDD and TDD category 0 UEs, the Q_{out_Cat0} evaluation period ($T_{Evaluate_Q_{out_DRX_Cat0}}$) and the Q_{in_Cat0} evaluation period ($T_{Evaluate_Q_{in_DRX_Cat0}}$) specified in Table 7.11.2.2-2 will be used.

When the downlink radio link quality of the PCell estimated over the last $T_{Evaluate_Q_{out_DRX_Cat0}}$ [s] period becomes worse than the threshold Q_{out_Cat0} , Layer 1 of the UE shall send out-of-sync indication for the PCell to the higher layers within $T_{Evaluate_Q_{out_DRX_Cat0}}$ [s] evaluation period. A Layer 3 filter shall be applied to the out-of-sync indications as specified in TS 36.331 [2].

When the downlink radio link quality of the PCell estimated over the last $T_{Evaluate_Q_{in_DRX_Cat0}}$ [s] period becomes better than the threshold Q_{in_Cat0} , Layer 1 of the UE shall send in-sync indications for the PCell to the higher layers within $T_{Evaluate_Q_{in_DRX_Cat0}}$ [s] evaluation period. A L3 filter shall be applied to the in-sync indications as specified in TS 36.331 [2].

The out-of-sync and in-sync evaluations of the PCell shall be performed as specified in clause 4.2.1 in [3]. When DRX is used, two successive indications from Layer 1 shall be separated by at least $\max(10\text{ms}, \text{DRX_cycle_length})$. When eDRX_CONN is used, two successive indications from Layer 1 shall be separated by at least $\max(10\text{ms}, \text{eDRX_CONN cycle length})$.

Upon start of T310 timer as specified in clause 5.3.11 in TS 36.331 [2], the UE shall monitor the link for recovery using the evaluation period and Layer 1 indication interval corresponding to the non-DRX mode until the expiry or stop of T310 timer.

The transmitter power of the UE shall be turned off within 40 ms after expiry of T310 timer as specified in clause 5.3.11 in TS 36.331 [2].

Table 7.11.2.2-1: Q_{out} and Q_{in} Evaluation Period in DRX for FD-FDD and TDD UE category 0

| DRX cycle length (s) | $T_{Evaluate_Q_{out_DRX_Cat0}}$ and $T_{Evaluate_Q_{in_DRX_Cat0}}$ (s) (DRX cycles) |
|--|---|
| ≤ 0.01 | Non-DRX requirements in clause 7.11.2.1 are applicable. |
| $0.01 < \text{DRX cycle} \leq 0.04$ | Note (20) |
| $0.04 < \text{DRX cycle} \leq 0.64$ | Note (10) |
| $0.64 < \text{DRX cycle} \leq 2.56$ | Note (5) |
| Note: Evaluation period length in time depends on the length of the DRX cycle in use | |

Table 7.11.2.2-2: Q_{out} and Q_{in} Evaluation Period for FD-FDD and TDD UE category 0 when eDRX_CONN cycle is used

| eDRX_CONN cycle length [s] | $T_{Evaluate_Q_{out_DRX_Cat0}}$ and $T_{Evaluate_Q_{in_DRX_Cat0}}$ [s] (eDRX_CONN cycles) |
|--|---|
| $2.56 < \text{eDRX_CONN cycle} \leq 10.24$ | Note (5) |
| Note: Evaluation period length in time depends on the length of the eDRX_CONN cycle in use | |

7.11.2.3 Minimum requirement at transitions

When the UE transitions between any two of DRX, eDRX_CONN, and non-DRX or when DRX or eDRX_CONN cycle periodicity changes, for a duration of time equal to the evaluation period corresponding to the second mode after the transition occurs, the UE shall use an evaluation period that is no less than the minimum of evaluation periods corresponding to the first mode and the second mode. Subsequent to this duration, the UE shall use an evaluation period corresponding to the second mode. This requirement shall be applied to both out-of-sync evaluation and in-sync evaluation of the PCell.

7.11.3 Requirements for HD-FDD

7.11.3.1 Minimum requirement when no DRX is used

The HD-FDD category 0 UE shall meet all applicable requirements specified in clause 7.11.2.1 under the following conditions

- at least 1 DL subframe per radio frame of PCell is available at the UE during Q_{in_Cat0} and Q_{out_Cat0} evaluation periods.

7.11.3.2 Minimum requirement when DRX is used

When DRX is used for HD-FDD category 0 UEs, the Q_{out} evaluation period ($T_{Evaluate_Q_{out_DRX_Cat0}}$) and the Q_{in} evaluation period ($T_{Evaluate_Q_{in_DRX_Cat0}}$) specified in Table 7.11.3.2-1 will be used.

When eDRX_CONN is used for HD-FDD category 0 UEs, the Q_{out} evaluation period ($T_{Evaluate_Q_{out_DRX_Cat0}}$) and the Q_{in} evaluation period ($T_{Evaluate_Q_{in_DRX_Cat0}}$) specified in Table 7.11.3.2-2 will be used.

When the downlink radio link quality of the PCell estimated over the last $T_{Evaluate_Q_{out_DRX_Cat0}}$ [s] period becomes worse than the threshold Q_{out_Cat0} , Layer 1 of the UE shall send out-of-sync indication for the PCell to the higher layers within $T_{Evaluate_Q_{out_DRX_Cat0}}$ [s] evaluation period. A Layer 3 filter shall be applied to the out-of-sync indications as specified in TS 36.331 [2].

When the downlink radio link quality of the PCell estimated over the last $T_{Evaluate_Q_{in_DRX_Cat0}}$ [s] period becomes better than the threshold Q_{in_Cat0} , Layer 1 of the UE shall send in-sync indications for the PCell to the higher layers within $T_{Evaluate_Q_{in_DRX_Cat0}}$ [s] evaluation period. A L3 filter shall be applied to the in-sync indications as specified in TS 36.331 [2].

The out-of-sync and in-sync evaluations of the PCell shall be performed as specified in clause 4.2.1 in [3]. When DRX is used, two successive indications from Layer 1 shall be separated by at least $\max(10\text{ms}, \text{DRX_cycle_length})$. When eDRX_CONN is used, two successive indications from Layer 1 shall be separated by at least $\max(10\text{ms}, \text{eDRX_CONN cycle length})$.

Upon start of T310 timer as specified in clause 5.3.11 in TS 36.331 [2], the UE shall monitor the link for recovery using the evaluation period and Layer 1 indication interval corresponding to the non-DRX mode until the expiry or stop of T310 timer.

The transmitter power of the UE shall be turned off within 40 ms after expiry of T310 timer as specified in clause 5.3.11 in TS 36.331 [2].

Table 7.11.3.2-1: Q_{out} and Q_{in} Evaluation Period in DRX for HD-FDD UE category 0

| DRX cycle length (s) | $T_{Evaluate_Q_{out_DRX}}$ and $T_{Evaluate_Q_{in_DRX}}$ (s) (DRX cycles) |
|--|---|
| ≤ 0.01 | Non-DRX requirements in clause 7.11.2.1 are applicable. |
| $0.01 < \text{DRX cycle} \leq 0.04$ | Note (40) |
| $0.04 < \text{DRX cycle} \leq 0.16$ | Note (20) |
| $0.16 < \text{DRX cycle} \leq 0.64$ | Note (10) |
| $0.64 < \text{DRX cycle} \leq 2.56$ | Note (5) |
| Note: Evaluation period length in time depends on the length of the DRX cycle in use | |

Table 7.11.3.2-2: Q_{out} and Q_{in} Evaluation Period for HD-FDD UE category 0 when eDRX_CONN cycle is used

| eDRX_CONN cycle length [s] | $T_{Evaluate_Q_{out_DRX}}$ and $T_{Evaluate_Q_{in_DRX}}$ [s] (eDRX_CONN cycles) |
|--|---|
| $2.56 < \text{eDRX_CONN cycle} \leq 10.24$ | Note (5) |
| Note: Evaluation period length in time depends on the length of the eDRX_CONN cycle in use | |

7.11.3.3 Minimum requirement at transitions

The minimum requirements at transitions defined in clause 7.11.2.3 also apply for this section under the following conditions:

at least 1 DL subframe per radio frame of PCell is available at the UE during Q_{in_Cat0} and Q_{out_Cat0} evaluation periods.

7.12 Interruptions with Dual Connectivity

7.12.1 Introduction

This section contains the requirements related to the interruptions on PCell, PSCell, and SCell, when

PSCell is added or released, or

transitions between active and non-active during DRX, or

transitions from non-DRX to DRX, or

SCell in either MCG or SCG is added or released, or

SCell in either MCG or SCG is activated or deactivated, or

measurements on SCC with deactivated SCell in either MCG or SCG.

The requirements shall apply for E-UTRA FDD, E-UTRA TDD and E-UTRA TDD-FDD dual connectivity.

7.12.2 Requirements

7.12.2.1 Interruptions at PSCell addition/release

When a PSCell is added or released as defined in [2] the UE is allowed an interruption of up to 1 subframe on PCell and the activated SCell in MCG if configured during the RRC reconfiguration procedure [2] in synchronous dual connectivity. This interruption is for both uplink and downlink of PCell.

The UE is allowed an interruption of up to 2 subframes on PCell and the activated SCell in MCG if configured during the RRC reconfiguration procedure [2] in asynchronous dual connectivity. This interruption is for both uplink and downlink of PCell.

7.12.2.2 Interruptions at transitions between active and non-active during DRX

When PCell is in non-DRX and PSCell is in DRX, interruptions on PCell and the activated SCell in MCG if configured due to transitions from active to non-active and from non-active to active during PSCell DRX are allowed with up to 1% probability of missed ACK/NACK when the configured PSCell DRX cycle is less than 640 ms, and 0.625% probability of missed ACK/NACK is allowed when the configured PSCell DRX cycle is 640 ms or longer. Each interruption shall not exceed 1 subframe.

When PSCell is in non-DRX and PCell is in DRX, interruptions on PSCell on the activated SCell in SCG if configured due to transitions from active to non-active and from non-active to active during PCell DRX are allowed with up to 1% probability of missed ACK/NACK when the configured PCell DRX cycle is less than 640 ms, and 0.625% probability of missed ACK/NACK is allowed when the configured PCell DRX cycle is 640 ms or longer. Each interruption shall not exceed 1 subframe.

When both PCell and PSCell are in DRX, no interruption is allowed.

7.12.2.3 Interruptions at transitions from non-DRX to DRX

Interruption on PCell and the activated SCell in MCG if configured due to PSCell transitions from non-DRX to DRX when PCell is in non-DRX shall not exceed 1 subframe.

Interruption on PSCell and the activated SCell in SCG if configured due to PCell transitions from non-DRX to DRX when PSCell is in non-DRX shall not exceed 1 subframe.

7.12.2.4 Interruptions at SCell addition/release

The requirements in this clause shall apply for the UE configured with PSCell.

In synchronous dual connectivity, when one SCell is added or released as defined in [2]:

- an interruption on PCell shall meet requirements in clause 7.8.2.7,
- an interruption on PSCell shall meet requirements in clause 7.8.2.7, where the term PCell in clause 7.8.2.7 shall be deemed to be replaced with PSCell.

In asynchronous dual connectivity, when one SCell belonging to MCG is added or released as defined in [2]:

- an interruption on PCell shall meet requirements in clause 7.8.2.7,
- an interruption on PSCell shall meet requirements in clause 7.8.2.7 except for the number of subframe, where the term PCell in clause 7.8.2.7 shall be deemed to be replaced with PSCell. The UE is allowed an interruption on PSCell of up to 2 subframes.

In asynchronous dual connectivity, when one SCell belonging to SCG is added or released as defined in [2]:

- an interruption on PCell shall meet requirements in clause 7.8.2.7 except for the number of subframe. The UE is allowed an interruption on PCell of up to 2 subframes.
- an interruption on PSCell shall meet requirements in clause 7.8.2.7, where the term PCell in clause 7.8.2.7 shall be deemed to be replaced with PSCell.

7.12.2.5 Interruptions at SCell activation/deactivation

The requirements in this clause shall apply for the UE configured with PSCell and one SCell.

In synchronous dual connectivity, when one SCell is activated or deactivated as defined in [17]:

- an interruption on PCell shall meet requirements in clause 7.8.2.8,
- an interruption on PSCell shall meet requirements in clause 7.8.2.8, where the term PCell in clause 7.8.2.8 shall be deemed to be replaced with PSCell.

In asynchronous dual connectivity, when one SCell belonging to MCG is activated or deactivated as defined in [17]:

- an interruption on PCell shall meet requirements in clause 7.8.2.8,
- an interruption on PSCell shall meet requirements in clause 7.8.2.8 except for the number of subframe, where the term PCell in clause 7.8.2.8 shall be deemed to be replaced with PSCell. The UE is allowed an interruption on PSCell of up to 2 subframes.

In asynchronous dual connectivity, when one SCell belonging to SCG is activated or deactivated as defined in [17]:

- an interruption on PCell shall meet requirements in clause 7.8.2.8 except for the number of subframe. The UE is allowed an interruption on PCell of up to 2 subframes,
- an interruption on PSCell shall meet requirements in clause 7.8.2.8, where the term PCell in clause 7.8.2.8 shall be deemed to be replaced with PSCell.

7.12.2.6 Interruptions during measurements on SCC

The requirements in this clause shall apply for the UE configured with PSCell and one SCell.

In synchronous dual connectivity, when one SCell is deactivated, the UE is allowed due to measurements on the SCC with the deactivated SCell:

- an interruption on PCell shall meet requirements in clause 7.8.2.9,
- an interruption on PSCell shall meet requirements in clause 7.8.2.9, where the term PCell in clause 7.8.2.8 shall be deemed to be replaced with PSCell.

In asynchronous dual connectivity, when one SCell belonging to MCG is deactivated, the UE is allowed due to measurements on the SCC with the deactivated SCell:

- an interruption on PCell shall meet requirements in clause 7.8.2.9,
- an interruption on PSCell shall meet requirements in clause 7.8.2.9 except for the number of subframe, where the term PCell in clause 7.8.2.9 shall be deemed to be replaced with PSCell. The UE is allowed an interruption on PSCell of up to 2 subframes.

In asynchronous dual connectivity, when one SCell belonging to SCG is deactivated, the UE is allowed due to measurements on the SCC with the deactivated SCell:

- an interruption on PCell shall meet requirements in clause 7.8.2.9 except for the number of subframe. The UE is allowed an interruption on PCell of up to 2 subframes
- an interruption on PSCell shall meet requirements in clause 7.8.2.9, where the term PCell in clause 7.8.2.9 shall be deemed to be replaced with PSCell.

7.13 Cell phase synchronization accuracy (Synchronized mode of dual connectivity)

7.13.1 Definition

Cell phase synchronization accuracy is defined as the maximum absolute timing mismatch between subframes which are transmitted by MeNB and SeNB and are scheduled for the same UE. The cell phase synchronization accuracy is defined only for synchronized mode of dual connectivity operation.

7.13.2 Minimum requirements

The cell phase synchronization accuracy shall not exceed the sum of absolute timing accuracy values declared by the manufacturer(s) for each BS. The cell phase synchronization accuracy requirement is optional.

NOTE: The sum of absolute timing accuracy values in synchronized mode of dual connectivity is assumed to be related to MRTD according to the following inequality:

$$T_{\text{CPSA}} + T_{\text{RPTD}} \leq \text{MRTD at the UE}$$

Where:

T_{CPSA} is the sum of absolute timing accuracy values declared by the manufacturer(s).

T_{RPTD} is the absolute propagation time difference between MeNB and SeNB, which serve the same UE.

MRTD is the Maximum Received Timing Difference at the UE. MRTD is equal to 33 μs .

7.14 PSCell Addition and Release Delay for E-UTRA Dual Connectivity

7.14.1 Introduction

This section defines requirements for the delay within which the UE shall be able to configure a PSCell in E-UTRA dual connectivity. The requirements are applicable to an E-UTRA dual connectivity capable UE. The requirements shall apply for E-UTRA FDD, E-UTRA TDD and E-UTRA TDD-FDD dual connectivity.

7.14.2 PSCell Addition Delay Requirement

The requirements in this section shall apply for the UE configured with only PCell.

Upon receiving PSCell addition in subframe n , the UE shall be capable to transmit PRACH preamble towards PSCell no later than in subframe $n + T_{\text{config_PSCell}}$:

Where:

$$T_{\text{config_PSCell}} = 20\text{ms} + T_{\text{activation_time}} + 50\text{ms} + T_{\text{PCell_DU}} + T_{\text{PSCell_DU}}$$

$T_{\text{activation_time}}$ is the PSCell activation delay. If the PSCell is known, then $T_{\text{activation_time}}$ is 20ms. If the PSCell is unknown, then $T_{\text{activation_time}}$ is 30ms provided the PSCell can be successfully detected on the first attempt.

$T_{\text{PCell_DU}}$ is the delay uncertainty due to PCell PRACH preamble transmission. $T_{\text{PCell_DU}}$ is up to 20ms if PSCell activation is interrupted by a PCell PRACH preamble transmission, otherwise it is 0.

$T_{\text{PSCell_DU}}$ is the delay uncertainty in acquiring the first available PRACH occasion in the PSCell. $T_{\text{PSCell_DU}}$ is up to 30ms.

PSCell is known if it has been meeting the following conditions:

During the last [5] seconds before the reception of the PSCell configuration command:

- the UE has sent a valid measurement report for the PSCell being configured and
- the PSCell being configured remains detectable according to the cell identification conditions specified in section 8.8,
- PSCell being configured also remains detectable during the PSCell configuration delay according to the cell identification conditions specified in section 8.8.

otherwise it is unknown. The PCell interruption specified in section 7.12 is allowed only during the RRC reconfiguration procedure [2].

7.14.3 PSCell Release Delay Requirement

The requirements in this section shall apply for a UE configured with PCell and one PSCell.

Upon receiving PSCell release in subframe n , the UE shall accomplish the release actions specified in [2] no later than in subframe $n+20$.

The PCell interruption specified in section 7.12 is allowed only during the RRC reconfiguration procedure [2].

7.15 Maximum Receive Timing Difference in Dual Connectivity

7.15.1 Introduction

A UE shall be capable of handling a relative receive timing difference between subframe timing boundaries of the PCell and PSCell to be aggregated for E-UTRA FDD-FDD, E-UTRA-TDD-TDD, E-UTRA TDD-FDD dual connectivity.

7.15.2 Minimum Requirements for Inter-band Dual Connectivity

The UE shall be capable of handling at least a relative receive timing difference between the subframe timing of the signals received from a cell belonging to the MCG and a cell belonging to the SCG at the UE receiver of up to 33 μ s provided the UE indicates that it is capable of synchronous dual connectivity [2]. The requirements for synchronous dual connectivity are only applicable for TDD-TDD, FDD-FDD, and TDD-FDD inter-band dual connectivity.

The UE shall be capable of handling at least a relative receive timing difference between the subframe timing of the signals received from a cell belonging to the MCG and a cell belonging to the SCG at the UE receiver of up to 500 μ s provided the UE indicates that it is capable of asynchronous dual connectivity [2]. The requirements for asynchronous dual connectivity are only applicable for FDD-FDD inter-band dual connectivity.

The UE shall be capable of handling a relative receive timing difference between the subframe timing of the signals received from any pair of the serving cells belonging to the same cell group according to the requirements in clause 7.9.2.

7.16 Proximity-based Services

7.16.1 Introduction

The requirements in this clause are applicable for UE performing transmissions and/or reception for ProSe Direct Discovery and/or ProSe Direct Communication in both RRC_IDLE and RRC_CONNECTED state.

7.16.2 Requirements

7.16.2.1 ProSe UE transmission timing

For ProSe transmission of sidelink channels and signals, UE shall have the capability to follow the timing change of the reference synchronization source.

7.16.2.1.1 Serving cell or PCell as timing reference

The requirements in this subclause are applicable when the reference timing used for ProSe transmissions is the serving cell (RRC_IDLE) or PCell (RRC_CONNECTED). The sidelink transmissions takes place $(N_{TA,SL} + N_{TA,offset}) \cdot T_s$ before the reception of the first detected path (in time) of the corresponding downlink frame from the reference cell, where $N_{TA,offset}$ is specified in Section 8.1 of [16]. The value of $N_{TA,SL}$ differs between sidelink channels and signals, and is either $N_{TA,SL} = N_{TA}$ or $N_{TA,SL} = 0$ as specified in Section 9.9 of [16].

7.16.2.1.1.1 Requirements when $N_{TA,SL} = 0$

For ProSe transmission of sidelink channels and signals employing $N_{TA,SL} = 0$, the requirements in Section 7.1 as specified for PRACH transmissions shall apply.

7.16.2.1.1.2 Requirements when $N_{TA,SL} = N_{TA}$

For ProSe transmission of sidelink channels and signals while employing $N_{TA,SL} = N_{TA}$, the requirements in Section 7.1 as specified for PUSCH shall apply.

When it is the first sidelink transmission in a DRX cycle, the requirements in Section 7.1 as specified for the first PUSCH transmission in a DRX cycle shall apply. The reference point for the UE initial transmit timing control requirement shall be $(N_{TA,SL,ref} + N_{TA,offset}) \cdot T_s$ seconds before the reception of the first detected path (in time) of the corresponding downlink frame from the reference cell. $(N_{TA,SL,ref} + N_{TA,offset})$ (in T_s units) for sidelink transmissions is the difference between UE transmission timing and the downlink timing immediately after when the last timing advance in Section 7.3 was applied.

When it is not the first sidelink transmission in a DRX cycle or there is no DRX cycle, the requirements as specified in Section 7.1 for PUSCH transmissions when the PUSCH transmission is not the first transmissions in a DRX cycle shall apply.

7.16.2.1.2 SCell or non-serving cell as timing reference

The requirements in this subclause are applicable when the reference timing used for ProSe transmissions is either a SCell (RRC_CONNECTED) or a non-serving cell selected on a non-serving ProSe carrier (RRC_IDLE or RRC_CONNECTED).

The transmission timing requirements are as specified in subclause 7.16.2.1.1, with reference cell as either the SCell or the selected non-serving cell.

7.16.3 Interruptions with ProSe

This section contains the requirements related to the interruptions on PCell and activated SCell(s) due ProSe Direct Discovery and ProSe Direct Communication. When ProSe is on a serving cell frequency, then the requirements in this subclause are applicable only to ProSe on E-UTRA FDD bands. When ProSe is on non-serving frequency, then the requirements are applicable to ProSe on both E-UTRA FDD and TDD bands.

When a UE capable of ProSe Direct Communication and/or ProSe Direct Discovery is configured with DRX and DRX is in use, interruptions specified in this section are not allowed while the *onDurationTimer*[17] is running.

7.16.3.1 Interruptions at ProSe Direct Discovery configuration

A UE capable of ProSe Direct Discovery may indicate its interest (initiation or termination) in ProSe Direct Discovery to the connected eNodeB using IE *SidelinkUEInformation* [2].

The UE is allowed an interruption of up to 1 subframe on PCell and on any activated SCell during the RRC reconfiguration procedure that includes the ProSe Direct Discovery configuration message *sl-DiscConfig* [2] (setup and release). This interruption is for both uplink and downlink of PCell and activated SCell(s).

7.16.3.2 Interruptions at ProSe Direct Communication configuration

A UE capable of ProSe Direct Communication may indicate its interest (initiation or termination) in ProSe Direct Communication to the connected eNodeB using IE *SidelinkUEInformation* [2].

The UE is allowed an interruption of up to 1 subframe on PCell and on any activated SCell during the RRC reconfiguration procedure that includes the ProSe Direct Communication configuration message *sl-CommConfig* [2] (setup and release). This interruption is for both uplink and downlink of PCell and activated SCell(s).

7.16.3.3 Interruptions during ProSe Direct Discovery

When ProSe Direct Discovery operation is on a serving cell (PCell/SCell) and when no request for transmission and/or reception gaps are signalled by the ProSe UE, the UE is allowed an interruption of up to 1 subframe that is N subframes before and after a UL subframe configured for ProSe Direct Discovery by a serving eNodeB. For discovery period less than 320ms, the allowed interruptions are additionally limited up to 0.625%.

The value of N is $\text{ceil}(w1 / 1\text{ms})$ subframes when the parameter *discSyncWindow*[2] is configured with value $w1$ in the sidelink synchronization resource configuration associated with the ProSe Direct Discovery subframe.

The value of N is 1 subframe otherwise.

When ProSe Direct Discovery is on a non-serving carrier, and when no request for transmission and/or reception gaps is signalled by the UE, interruptions to serving cell(s) is allowed with up to $\min\left(0.5\%, \frac{6}{\text{discPeriod}(\text{ms})} \times 100\%\right)$ probability of missed ACK/NACK. Furthermore, when ProSe Direct Discovery is on more than one non-serving carrier, and no request for transmission and/or reception gaps is signalled by the UE, the aggregate interruptions to serving

cells(s) are allowed with up to $\min\left(2\%, \sum_{i=1}^N \min\left(0.5\%, \frac{6}{discPeriod_i (ms)} \times 100\%\right)\right)$ probability of missed ACK/NACK with N non-serving carriers.

The interruptions are for both uplink and downlink of PCell and any activated SCell. The interruption for the ProSe UE may occur:

- while switching a receiver chain ON/OFF for ProSe Direct Discovery if the UE has a dedicated receiver chain for discovery, and/or
- while switching a transmitter chain ON/OFF for ProSe Direct Discovery transmissions on a non-serving carrier, and if the UE has a dedicated transmitted chain for discovery.

7.16.3.4 Interruptions during ProSe Direct Discovery with discovery gaps

When ProSe Direct Discovery is either on a serving cell (PCell/SCell) or a non-serving frequency, and when discovery reception and/or transmission gaps are configured by the serving cell, then only the following interruptions to the PCell and any activated SCell(s) are allowed:

- Uplink interruption is allowed on a subframe configured as downlink reception gap (using *discRxGapConfig*) if either the subframe immediately preceding or immediately following that subframe is not configured as reception gap; and,
- If ProSe Direct Discovery is on a non-serving FDD carrier and that carrier is used for ProSe synchronization, then uplink interruption is additionally allowed on 1 subframe in a discovery period. The interrupted subframe(s) shall be within the subframes configured as reception gap using *discRxGapConfig*; and,
- If ProSe Direct Discovery transmissions are on carrier that is not configured for uplink, then UE is allowed to additionally interrupt the serving cell(s) on up to 2 subframes for each discovery/SLSS transmission configured in a discovery period. The interrupted subframe(s) shall be within the subframes configured as transmission gaps using *discTxGapConfig*.

NOTE: The request and grant of discovery gaps is left up to UE and eNodeB implementations, respectively. When ProSe Direct Discovery is on a non-serving carrier and that carrier is used for ProSe synchronization, then the UE requested / eNodeB configured gaps may depend if inter-frequency measurements are additionally configured for that non-serving frequency.

7.16.3.5 Interruptions during ProSe Direct Communication

When ProSe Direct Communication is on a non-serving carrier and the PCell is not broadcasting SIB18, then interruptions to serving cell(s) is allowed with up to 0.5% probability of missed ACK/NACK. Furthermore, when ProSe Direct Communication is on more than one non-serving carrier, the aggregate interruptions to serving cell(s) is allowed with up to $\min(2\%, 0.5\% \times N)$ probability of missed ACK/NACK with N non-serving carriers.

The interruptions are for both uplink and downlink of PCell and any activated SCell.

7.16.4 Cell reselection for ProSe Direct Discovery on non-serving frequency

The requirements in this subclause apply when ProSe Direct Discovery transmissions are configured on a non-serving carrier and that non-serving carrier is used for downlink synchronization and measurements for ProSe Direct Discovery transmission, and provided the parameters required for cell selection / reselection are provided by the serving cell using *discCellSelectionInfo*.

NOTE: The requirements do not apply if the UE is required to acquire the cell selection/reselection parameters that are broadcast from the concerned cell for evaluation.

If the UE signals request for transmission and/or reception gaps, then the requirements apply if the gaps are configured as requested by the UE.

7.16.4.1 Measurement and evaluation of selected cell

The UE shall measure the RSRP and RSRQ level of the selected reference cell on the non-serving carrier used for ProSe Direct Discovery synchronization and evaluate the cell selection criterion S defined in [1] for the selected cell at least every discovery period.

The UE shall filter the RSRP and RSRQ measurements of the selected cell using at least 2 measurements. Within the set of measurements used for the filtering, at least two measurements shall be spaced by, at least $\text{discPeriod} / 2$.

7.16.4.2 Measurement of intra-frequency E-UTRAN cells

The UE shall be able to identify new intra-frequency cells on the non-serving carrier used for ProSe Direct Discovery transmission and perform RSRP and RSRQ measurements of identified intra-frequency cells.

The UE shall be able to evaluate whether a newly detectable intra-frequency cell meets the reselection criteria defined in TS36.304 [1, 11.4] within $T_{\text{detect,EUTRAN_ProSe_Intra}}$ when $T_{\text{reselection}} = 0$ (within *discCellSelectionInfo*). An intra frequency cell is considered to be detectable according to RSRP, $\text{RSRP } \hat{E}_s/\text{Iot}$, SCH_RP and $\text{SCH } \hat{E}_s/\text{Iot}$ defined in Annex B.1.1 for a corresponding Band.

The UE shall measure RSRP and RSRQ at least every $T_{\text{measure,EUTRAN_ProSe_Intra}}$ (see table 7.16.4.2-1) for intra-frequency cells that are identified and measured according to the measurement rules.

The UE shall filter RSRP and RSRQ measurements of each measured intra-frequency cell using at least 2 measurements. Within the set of measurements used for the filtering, at least two measurements shall be spaced by at least $T_{\text{measure,EUTRAN_ProSe_Intra}}/2$

For an intra-frequency cell that has been already detected, but that has not been reselected to, the filtering shall be such that the UE shall be capable of evaluating that the intra-frequency cell has met reselection criterion defined [1] within $T_{\text{evaluate,E-UTRAN_ProSe_Intra}}$ when $T_{\text{reselection}} = 0$ (within *discCellSelectionInfo*) as specified in table 7.16.4.2-1 provided that the cell is at least 3dB better ranked. When evaluating cells for reselection, the side conditions for RSRP and SCH apply to both the non-serving cell that is currently selected and the non-serving cell being reselected to for ProSe Direct Discovery synchronization.

If $T_{\text{reselection}}$ timer (within *discCellSelectionInfo*) has a non-zero value and the intra-frequency cell being reselected to is better ranked than the currently selected reference cell, the UE shall evaluate this intra-frequency cell for the $T_{\text{reselection}}$ time. If this cell remains better ranked within this duration, then the UE shall reselect that cell.

Table 7.16.4.2-1: $T_{\text{detect,EUTRAN_ProSe_Intra}}$, $T_{\text{measure,EUTRAN_ProSe_Intra}}$ and $T_{\text{evaluate,E-UTRAN_ProSe_Intra}}$

| Discovery Period [s] | $T_{\text{detect,EUTRAN_ProSe_Intra}}$ (number of discovery periods) | $T_{\text{measure,EUTRAN_ProSe_Intra}}$ (number of discovery periods) | $T_{\text{evaluate,E-UTRAN_ProSe_Intra}}$ (number of discovery periods) |
|--|---|--|--|
| Discovery Period ≤ 0.32 | Note 1 (36) | Note 1 (4) | Note 1 (16) |
| $0.32 < \text{Discovery Period} \leq 0.64$ | Note 1 (28) | Note 1 (2) | Note 1 (8) |
| $0.64 < \text{Discovery Period} \leq 1.28$ | Note 1 (25) | Note 1 (1) | Note 1 (5) |
| $1.28 < \text{Discovery Period} \leq 10.24$ | Note 1 (23) | Note 1 (1) | Note 1 (3) |
| NOTE 1: Time depends upon the configured Discovery period. | | | |

7.16.5 Selection / Reselection of ProSe relay UE

This subclause contains the requirements related to selection and reselection of ProSe relay UE if the serving frequency is used for ProSe Direct Communication via a ProSe relay UE.

For a remote UE configured by upper layer for relay operation, when the RSRP measurement of the serving cell (RRC_IDLE) or the PCell (RRC_CONNECTED) is below *threshHigh* (within *remoteUE-Config*), the remote UE shall search for candidate relay UEs for selection and/or reselection every discovery period.

If the remote UE has a selected sidelink relay UE, then the remote UE shall measure the SD-RSRP of the selected relay once in every four discovery periods and evaluate if it meets the relay selection criterion as defined in [TS 36.331, 5.10.11.4].

The remote UE shall measure SD-RSRP of the candidate relay UEs every $T_{\text{measure, ProSe_Relay_Intra}}$ for intra-frequency relay UEs that are detected and measured according to the measurement rules.

For an intra-frequency relay UEs that are detected, but that has not been selected or reselected to, the remote UE shall be capable of evaluating that the intra-frequency relay UE has met selection or reselection criterion defined in [2, 5.10.11.4] within $T_{\text{evaluate,ProSe_Relay_Intra}}$ as specified in table 7.16.5-1.

The minimum requirements are required to meet when the selected and candidate relay UEs are transmitting relay discovery message every discovery period.

Table 7.16.5-1: $T_{\text{measure, ProSe_Relay_Intra}}$ and $T_{\text{evaluate, ProSe_Relay_intra}}$

| Discovery Period [s] | $T_{\text{measure,ProSe_Relay_Intra}}$ [s] (number of discovery periods) | $T_{\text{evaluate, ProSe_Relay_intra}}$ [s] (number of discovery periods) |
|--|--|--|
| $0.04 \leq \text{Discovery period} \leq 10.24$ | Note 1 (4) | Note 1 (16) |
| NOTE 1: Time depends upon the configured Discovery period. | | |

7.16.6 ProSe operation under deactivated SCell

If the UE is configured for ProSe operation on a sidelink of an SCell then UE is allowed to perform ProSe operation on the sidelink of that SCell regardless of whether that SCell is activated or deactivated provided that there is no additional interruptions beyond what is specified in section 7.8.

7.17 Maximum Transmission Timing Difference in Dual Connectivity

7.17.1 Introduction

A UE shall be capable of handling a relative transmission timing difference between subframe timing boundaries of the PCell and PSCell to be aggregated for E-UTRA FDD-FDD, E-UTRA-TDD-TDD, E-UTRA TDD-FDD dual connectivity.

7.17.2 Minimum Requirements for maximum transmission timing difference Inter-band Dual Connectivity

The UE shall be capable of handling a maximum uplink transmission timing difference between PCell and PSCell of at least 35.21 μs provided the UE indicates that it is capable of synchronous dual connectivity [2]. The requirements for synchronous dual connectivity are only applicable for TDD-TDD, FDD-FDD, and TDD-FDD inter-band dual connectivity.

The UE shall be capable of handling a maximum uplink transmission timing difference between PCell and PSCell of at least 500 μs provided the UE indicates that it is capable of asynchronous dual connectivity [2]. The requirements for asynchronous dual connectivity are only applicable for FDD-FDD and inter-band dual connectivity.

If the UE is configured with higher layer parameter $\text{powerControlMode}<1>$, then the UE may stop transmission on the PSCell if the UL transmission timing difference exceeds 35.21 μs . If a UE supports both synchronous and asynchronous dual connectivity and if the UE is configured with higher layer parameter $\text{powerControlMode}<2>$, then the UE needs to constitute new subframes pair if the UL transmission timing difference exceeds 500 μs . 7.18 SCell Activation and Deactivation Delay for E-UTRA Dual Connectivity

7.18.1 Introduction

This section defines requirements for the delay within which the UE shall be able to activate a deactivated SCell and deactivate an activated SCell in E-UTRA dual connectivity. The requirements are applicable to an E-UTRA dual connectivity capable UE which has been configured with one SCell in either MCG or SCG and PSCell. In case where the SCell belongs to SCG, the term PCell in clause 7.7 shall be replaced with PSCell. The requirements shall apply for E-UTRA FDD, E-UTRA TDD and E-UTRA TDD-FDD dual connectivity.

7.18.2 SCell Activation Delay Requirement for Deactivated SCell

The requirements in this clause shall apply for a UE configured with PSCell and one SCell.

The SCell activation delay shall meet the requirements in clause 7.7.2.

7.18.3 SCell Deactivation Delay Requirement for Activated SCell

The requirements in this clause shall apply for a UE configured with PSCell and one SCell.

The SCell deactivation delay shall meet the requirements in clause 7.7.3.

7.19 Radio Link Monitoring for UE Category M1

7.19.1 Introduction

The UE category M1 applicability of the requirements for performing radio link monitoring in subclause 7.19 is defined in Section 3.6.

The UE shall monitor the downlink link quality based on the cell-specific reference signal in order to detect the downlink radio link quality of the PCell as specified in [3].

7.19.2 Requirements for FD-FDD and TDD CE mode A

The requirements defined in this subclause 7.19.2 for performing radio link monitoring are applicable for UE category M1 defined in Section 3.6.

The UE shall estimate the downlink radio link quality and compare it to the thresholds $Q_{\text{out_Cat M1}}$ and $Q_{\text{in_Cat M1}}$ for the purpose of monitoring downlink radio link quality of the PCell.

The threshold $Q_{\text{out_Cat M1}}$ is defined as the level at which the downlink radio link cannot be reliably received and shall correspond to 10% block error rate of a hypothetical MPDCCH transmission with transmission parameters specified in Table 7.19.2-1.

The threshold $Q_{\text{in_Cat M1}}$ is defined as the level at which the downlink radio link quality can be significantly more reliably received than at $Q_{\text{out_Cat M1}}$ and shall correspond to 2% block error rate of a hypothetical MPDCCH transmission with transmission parameters specified in Table 7.19.2-1.

Table 7.19.2-1 M-PDCCH transmission parameters for out-of-sync and in-sync for UE category M1 with CE mode A

| Attribute | Out-of-sync | In-sync |
|--|--|--|
| DCI format | 6-1A | 6-1A |
| Starting OFDM symbols | 2; Bandwidth $\geq 10\text{MHz}$ 3; $3\text{MHz} \leq \text{Bandwidth} < 10\text{MHz}$ 4; Bandwidth = 1.4MHz | 2; Bandwidth $\geq 10\text{MHz}$ 3; $3\text{MHz} \leq \text{Bandwidth} < 10\text{MHz}$ 4; Bandwidth = 1.4MHz |
| Maximum M-PDCCH repetition level | R_{max} ^{Note1} | $R_{\text{max}}/2$ ^{Note1} |
| Aggregation level (ECCE) | L'_{max} ^{Note2} | $L'_{\text{max}-2}$ ^{Note2} |
| M-PDCCH Transmission type | Distributed | Distributed |
| NOTE 1: R_{max} is determined by the configurable parameter <i>mPDCCH-NumRepetition</i> defined in 36.331 and $R_{\text{max}} > 1$. | | |
| NOTE 2: L'_{max} and $L'_{\text{max}-2}$ is derived from the configurable parameter <i>numberPRB-Pairs</i> defined in 36.331. L'_{max} is 24, 16 and 8, if <i>numberPRB-Pairs</i> is 6, 4 and 2, respectively. $L'_{\text{max}-2}$ is the aggregation level two levels below L'_{max} , and $L'_{\text{max}-2}$ is 8, 4 and 2, if <i>numberPRB-Pairs</i> is 6, 4 and 2, respectively. | | |

7.19.2.1 Minimum requirement when no DRX is used

When the downlink radio link quality of the PCell estimated over the last 400 ms period becomes worse than the threshold $Q_{\text{out_CatM1}}$, Layer 1 of the UE shall send an out-of-sync indication for the PCell to the higher layers within 400 ms $Q_{\text{out_CatM1}}$ evaluation period. A Layer 3 filter shall be applied to the out-of-sync indications as specified in TS 36.331 [2].

When the downlink radio link quality of the PCell estimated over the last 200 ms period becomes better than the threshold Q_{in_CatM1} , Layer 1 of the UE shall send an in-sync indication for the PCell to the higher layers within 200 ms Q_{in_CatM1} evaluation period. A L3 filter shall be applied to the in-sync indications as specified in TS 36.331 [2].

The out-of-sync and in-sync evaluations of the PCell shall be performed as specified in clause 4.2.1 in [3]. Two successive indications from Layer 1 shall be separated by at least 10ms.

The transmitter power of the UE shall be turned off within 40 ms after expiry of T310 timer as specified in clause 5.3.11 in TS 36.331 [2].

7.19.2.2 Minimum requirement when DRX is used

When DRX is used for FD-FDD and TDD UE category M1 UEs, the Q_{out_CatM1} evaluation period ($T_{Evaluate_Q_{out_DRX_CatM1}}$) and the Q_{in_CatM1} evaluation period ($T_{Evaluate_Q_{in_DRX_CatM1}}$) specified in Table 7.19.2.2-1 will be used.

When eDRX_CONN cycle is used for FD-FDD and TDD UE category M1 UEs, the Q_{out_CatM1} evaluation period ($T_{Evaluate_Q_{out_DRX_CatM1}}$) and the Q_{in_CatM1} evaluation period ($T_{Evaluate_Q_{in_DRX_CatM1}}$) specified in Table 7.19.2.2-2 will be used.

When the downlink radio link quality of the PCell estimated over the last $T_{Evaluate_Q_{out_DRX_CatM1}}$ [s] period becomes worse than the threshold Q_{out_CatM1} , Layer 1 of the UE shall send out-of-sync indication for the PCell to the higher layers within $T_{Evaluate_Q_{out_DRX_CatM1}}$ [s] evaluation period. A Layer 3 filter shall be applied to the out-of-sync indications as specified in TS 36.331 [2].

When the downlink radio link quality of the PCell estimated over the last $T_{Evaluate_Q_{in_DRX_CatM1}}$ [s] period becomes better than the threshold Q_{in_CatM1} , Layer 1 of the UE shall send in-sync indications for the PCell to the higher layers within $T_{Evaluate_Q_{in_DRX_CatM1}}$ [s] evaluation period. A L3 filter shall be applied to the in-sync indications as specified in TS 36.331 [2].

The out-of-sync and in-sync evaluations of the PCell shall be performed as specified in clause 4.2.1 in [3]. When DRX is used, two successive indications from Layer 1 shall be separated by at least $\max(10\text{ms}, \text{DRX_cycle_length})$. When eDRX_CONN is used, two successive indications from Layer 1 shall be separated by at least $\max(10\text{ ms}, \text{eDRX_CONN cycle length})$.

Upon start of T310 timer as specified in clause 5.3.11 in TS 36.331 [2], the UE shall monitor the link for recovery using the evaluation period and Layer 1 indication interval corresponding to the non-DRX mode until the expiry or stop of T310 timer.

The transmitter power of the UE shall be turned off within 40 ms after expiry of T310 timer as specified in clause 5.3.11 in TS 36.331 [2].

Table 7.19.2.2-1: Q_{out_CatM1} and Q_{in_CatM1} Evaluation Period in DRX for FD-FDD and TDD UE category M1

| DRX cycle length (s) | $T_{Evaluate_Q_{out_DRX_CatM1}}$ and $T_{Evaluate_Q_{in_DRX_CatM1}}$ (s) (DRX cycles) |
|--|---|
| ≤ 0.01 | Non-DRX requirements in clause 7.19.2.1 are applicable. |
| $0.01 < \text{DRX cycle} \leq 0.04$ | Note (20) |
| $0.04 < \text{DRX cycle} \leq 0.64$ | Note (10) |
| $0.64 < \text{DRX cycle} \leq 2.56$ | Note (5) |
| NOTE: Evaluation period length in time depends on the length of the DRX cycle in use | |

Table 7.19.2.2-2: Q_{out_CatM1} and Q_{in_CatM1} evaluation period when eDRX_CONN cycle is configured for FD-FDD and TDD UE category M1

| eDRX_CONN cycle length (s) | $T_{Evaluate_Q_{out_DRX_CatM1}}$ and $T_{Evaluate_Q_{in_DRX_CatM1}}$ (s) (eDRX_CONN cycles) |
|---|---|
| $2.56 < \text{eDRX_CONN cycle} \leq 10.24$ | Note (5) |

NOTE: Evaluation period length in time depends on the length of the eDRX_CONN cycle in use

7.19.2.3 Minimum requirement at transitions

When the UE transitions between any two of DRX, eDRX_CONN and non-DRX or when DRX or eDRX_CONN cycle periodicity changes, for a duration of time equal to the evaluation period corresponding to the second mode after the transition occurs, the UE shall use an evaluation period that is no less than the minimum of evaluation periods corresponding to the first mode and the second mode. Subsequent to this duration, the UE shall use an evaluation period corresponding to the second mode. This requirement shall be applied to both out-of-sync evaluation and in-sync evaluation of the PCell.

7.19.3 Requirements for HD-FDD with CE mode A

The requirements defined in this subclause 7.19.3 for performing radio link monitoring are applicable for UE category M1 defined in Section 3.6.

7.19.3.1 Minimum requirement when no DRX is used

The HD-FDD category M1 with CE mode A UE shall meet all applicable requirements specified in clause 7.19.2.1 under the following conditions

- at least 1 DL subframe per radio frame of PCell is available at the UE during Q_{in_CatM1} and Q_{out_CatM1} evaluation periods.

7.19.3.2 Minimum requirement when DRX is used

When DRX is used for HD-FDD category M1 with CE mode A UEs, the Q_{out_CatM1} evaluation period ($T_{Evaluate_Q_{out_DRX_CatM1}}$) and the Q_{in_CatM1} evaluation period ($T_{Evaluate_Q_{in_DRX_CatM1}}$) specified in Table 7.19.3.2-1 will be used.

When eDRX_CONN cycle is used for HD-FDD category M1 with CE mode A UEs, the Q_{out_CatM1} evaluation period ($T_{Evaluate_Q_{out_DRX_CatM1}}$) and the Q_{in_CatM1} evaluation period ($T_{Evaluate_Q_{in_DRX_CatM1}}$) specified in Table 7.19.3.2-2 will be used.

When the downlink radio link quality of the PCell estimated over the last $T_{Evaluate_Q_{out_DRX_CatM1}}$ [s] period becomes worse than the threshold Q_{out_CatM1} , Layer 1 of the UE shall send out-of-sync indication for the PCell to the higher layers within $T_{Evaluate_Q_{out_DRX_CatM1}}$ [s] evaluation period. A Layer 3 filter shall be applied to the out-of-sync indications as specified in TS 36.331 [2].

When the downlink radio link quality of the PCell estimated over the last $T_{Evaluate_Q_{in_DRX_CatM1}}$ [s] period becomes better than the threshold Q_{in_CatM1} , Layer 1 of the UE shall send in-sync indications for the PCell to the higher layers within $T_{Evaluate_Q_{in_DRX_CatM1}}$ [s] evaluation period. A L3 filter shall be applied to the in-sync indications as specified in TS 36.331 [2].

The out-of-sync and in-sync evaluations of the PCell shall be performed as specified in clause 4.2.1 in [3]. When DRX is used, two successive indications from Layer 1 shall be separated by at least $\max(10\text{ms}, \text{DRX_cycle_length})$. When eDRX_CONN is used, two successive indications from Layer 1 shall be separated by at least $\max(10\text{ ms}, \text{eDRX_CONN cycle length})$.

Upon start of T310 timer as specified in clause 5.3.11 in TS 36.331 [2], the UE shall monitor the link for recovery using the evaluation period and Layer 1 indication interval corresponding to the non-DRX mode until the expiry or stop of T310 timer.

The transmitter power of the UE shall be turned off within 40 ms after expiry of T310 timer as specified in clause 5.3.11 in TS 36.331 [2].

Table 7.19.3.2-1: Q_{out_CatM1} and Q_{in_CatM1} Evaluation Period in DRX for HD-FDD UE category M1 with CE mode A

| DRX cycle length (s) | $T_{Evaluate_Q_{out_DRX_CatM1}}$ and $T_{Evaluate_Q_{in_DRX_CatM1}}$ (s) (DRX cycles) |
|--|---|
| ≤ 0.01 | Non-DRX requirements in clause 7.19.3.1 are applicable. |
| $0.01 < DRX\ cycle \leq 0.04$ | Note (40) |
| $0.04 < DRX\ cycle \leq 0.16$ | Note (20) |
| $0.16 < DRX\ cycle \leq 0.64$ | Note (10) |
| $0.64 < DRX\ cycle \leq 2.56$ | Note (5) |
| Note: Evaluation period length in time depends on the length of the DRX cycle in use | |

Table 7.19.3.2-2: Q_{out_CatM1} and Q_{in_CatM1} evaluation period when eDRX_CONN cycle is configured for HD-FDD UE category M1 with CE mode A

| eDRX_CONN cycle length (s) | $T_{Evaluate_Q_{out_DRX_CatM1}}$ and $T_{Evaluate_Q_{in_DRX_CatM1}}$ (s) (eDRX_CONN cycles) |
|--|---|
| $2.56 < eDRX_CONN\ cycle \leq 10.24$ | Note (5) |
| NOTE: Evaluation period length in time depends on the length of the eDRX_CONN cycle in use | |

7.19.3.3 Minimum requirement at transitions

The minimum requirements at transitions defined in clause 7.19.2.3 also apply for this section under the following conditions:

- at least 1 DL subframe per radio frame of PCell is available at the UE during Q_{in_CatM1} and Q_{out_CatM1} evaluation periods.

7.19.4 Requirements for FD-FDD and TDD with CE mode B

The requirements defined in this subclause 7.19.4 for performing radio link monitoring are applicable for UE category M1 defined in Section 3.6.

The UE shall estimate the downlink radio link quality and compare it to the thresholds Q_{out_CatM1} and Q_{in_CatM1} for the purpose of monitoring downlink radio link quality of the PCell.

The threshold Q_{out_CatM1} is defined as the level at which the downlink radio link cannot be reliably received and shall correspond to 10% block error rate of a hypothetical MPDCCH transmission with transmission parameters specified in Table 7.19.4-1.

The threshold Q_{in_CatM1} is defined as the level at which the downlink radio link quality can be significantly more reliably received than at Q_{out_CatM1} and shall correspond to 2% block error rate of a hypothetical MPDCCH transmission with transmission parameters specified in Table 7.19.4-1.

Table 7.19.4-1 M-PDCCH transmission parameters for out-of-sync and in-sync for UE category M1 with CE mode B

| Attribute | Out-of-sync | In-sync |
|---|--|--|
| DCI format | 6-1B | 6-1B |
| Starting OFDM symbols | 2; Bandwidth ≥ 10 MHz 3; 3MHz \leq Bandwidth < 10 MHz 4; Bandwidth = 1.4MHz | 2; Bandwidth ≥ 10 MHz 3; 3MHz \leq Bandwidth < 10 MHz 4; Bandwidth = 1.4MHz |
| Maximum M-PDCCH repetition level | R_{max}^{Note1} | $R_{max}/2^{Note1}$ |
| Aggregation level (ECCE) | L'_{max}^{Note2} | L'_{max-2}^{Note2} |
| M-PDCCH Transmission type | Distributed | Distributed |
| NOTE 1: R_{max} is determined by the configurable parameter <i>mPDCCH-NumRepetition</i> defined in 36.331 and | | |

NOTE 2: $R_{max} > 1$.
 L'_{max} and L'_{max-2} is derived from the configurable parameter *numberPRB-Pairs* defined in 36.331.
 L'_{max} is 24, 16 and 8, if *numberPRB-Pairs* is 6, 4 and 2, respectively. L'_{max-2} is the aggregation levels
two levels below L'_{max} , and L'_{max-2} is 8, 4 and 2, if *numberPRB-Pairs* is 6, 4 and 2, respectively.

7.19.4.1 Minimum requirement when no DRX is used

When the downlink radio link quality of the PCell estimated over the last 4000 ms period becomes worse than the threshold Q_{out_CatM1} , Layer 1 of the UE shall send an out-of-sync indication for the PCell to the higher layers within 4000 ms Q_{out_CatM1} evaluation period. A Layer 3 filter shall be applied to the out-of-sync indications as specified in TS 36.331 [2].

When the downlink radio link quality of the PCell estimated over the last 2000 ms period becomes better than the threshold Q_{in_CatM1} , Layer 1 of the UE shall send an in-sync indication for the PCell to the higher layers within 2000 ms Q_{in_CatM1} evaluation period. A L3 filter shall be applied to the in-sync indications as specified in TS 36.331 [2].

The out-of-sync and in-sync evaluations of the PCell shall be performed as specified in clause 4.2.1 in [3]. Two successive indications from Layer 1 shall be separated by at least 10ms.

The transmitter power of the UE shall be turned off within 40 ms after expiry of T310 timer as specified in clause 5.3.11 in TS 36.331 [2].

7.19.4.2 Minimum requirement when DRX is used

When DRX is used for FD-FDD and TDD UE category M1 UEs, the Q_{out_CatM1} evaluation period ($T_{Evaluate_Q_{out_DRX_CatM1}}$) and the Q_{in_CatM1} evaluation period ($T_{Evaluate_Q_{in_DRX_CatM1}}$) specified in Table 7.19.4.2-1 will be used.

When eDRX_CONN cycle is used for FD-FDD and TDD UE category M1 UEs, the Q_{out_CatM1} evaluation period ($T_{Evaluate_Q_{out_DRX_CatM1}}$) and the Q_{in_CatM1} evaluation period ($T_{Evaluate_Q_{in_DRX_CatM1}}$) specified in Table 7.19.4.2-2 will be used.

When the downlink radio link quality of the PCell estimated over the last $T_{Evaluate_Q_{out_DRX_CatM1}}$ [s] period becomes worse than the threshold Q_{out_CatM1} , Layer 1 of the UE shall send out-of-sync indication for the PCell to the higher layers within $T_{Evaluate_Q_{out_DRX_CatM1}}$ [s] evaluation period. A Layer 3 filter shall be applied to the out-of-sync indications as specified in TS 36.331 [2].

When the downlink radio link quality of the PCell estimated over the last $T_{Evaluate_Q_{in_DRX_CatM1}}$ [s] period becomes better than the threshold Q_{in_CatM1} , Layer 1 of the UE shall send in-sync indications for the PCell to the higher layers within $T_{Evaluate_Q_{in_DRX_CatM1}}$ [s] evaluation period. A L3 filter shall be applied to the in-sync indications as specified in TS 36.331 [2].

The out-of-sync and in-sync evaluations of the PCell shall be performed as specified in clause 4.2.1 in [3]. When DRX is used, two successive indications from Layer 1 shall be separated by at least $\max(10\text{ms}, \text{DRX_cycle_length})$. When eDRX_CONN is used, two successive indications from Layer 1 shall be separated by at least $\max(10\text{ ms}, \text{eDRX_CONN cycle length})$.

Upon start of T310 timer as specified in clause 5.3.11 in TS 36.331 [2], the UE shall monitor the link for recovery using the evaluation period and Layer 1 indication interval corresponding to the non-DRX mode until the expiry or stop of T310 timer.

The transmitter power of the UE shall be turned off within 40 ms after expiry of T310 timer as specified in clause 5.3.11 in TS 36.331 [2].

Table 7.19.4.2-1: Q_{out_CatM1} and Q_{in_CatM1} Evaluation Period in DRX for FD-FDD and TDD UE category M1

| DRX cycle length (s) | $T_{Evaluate_Q_{out_DRX_CatM1}}$ and $T_{Evaluate_Q_{in_DRX_CatM1}}$ (s) (DRX cycles) |
|---|---|
| $\leq [0.16]$ | Non-DRX requirements in clause 7.19.4.1 are applicable. |
| $[0.160] < \text{DRX cycle} \leq [0.320]$ | Note (20) |
| $[0.320] < \text{DRX cycle} \leq 0.64$ | Note (10) |

| | |
|--|----------|
| $0.64 < \text{DRX cycle} \leq 2.56$ | Note (5) |
| NOTE: Evaluation period length in time depends on the length of the DRX cycle in use | |

Table 7.19.4.2-2: $Q_{\text{out_CatM1}}$ and $Q_{\text{in_CatM1}}$ evaluation period when eDRX_CONN cycle is configured for FD-FDD and TDD UE category M1

| eDRX_CONN cycle length (s) | $T_{\text{Evaluate_}Q_{\text{out_DRX_CatM1}}}$ and $T_{\text{Evaluate_}Q_{\text{in_DRX_CatM1}}}$ (s) (eDRX_CONN cycles) |
|--|---|
| $2.56 < \text{eDRX_CONN cycle} \leq 10.24$ | Note (5) |
| NOTE: Evaluation period length in time depends on the length of the eDRX_CONN cycle in use | |

7.19.4.3 Minimum requirement at transitions

When the UE transitions between any two of DRX, eDRX_CONN and non-DRX or when DRX or eDRX_CONN cycle periodicity changes, for a duration of time equal to the evaluation period corresponding to the second mode after the transition occurs, the UE shall use an evaluation period that is no less than the minimum of evaluation periods corresponding to the first mode and the second mode. Subsequent to this duration, the UE shall use an evaluation period corresponding to the second mode. This requirement shall be applied to both out-of-sync evaluation and in-sync evaluation of the PCell.

7.19.5 Requirements for HD-FDD with CE mode B

The requirements defined in this subclause 7.19.5 for performing radio link monitoring are applicable for UE category M1 defined in Section 3.6.

7.19.5.1 Minimum requirement when no DRX is used

The HD-FDD category M1 with CE mode B UE shall meet all applicable requirements specified in clause 7.19.4.1 under the following conditions

- at least 1 DL subframe per radio frame of PCell is available at the UE during $Q_{\text{in_CatM1}}$ and $Q_{\text{out_CatM1}}$ evaluation periods.

7.19.5.2 Minimum requirement when DRX is used

When DRX is used for HD-FDD category M1 with CE mode B UEs, the $Q_{\text{out_CatM1}}$ evaluation period ($T_{\text{Evaluate_}Q_{\text{out_DRX_CatM1}}}$) and the $Q_{\text{in_CatM1}}$ evaluation period ($T_{\text{Evaluate_}Q_{\text{in_DRX_CatM1}}}$) specified in Table 7.19.5.2-1 will be used.

When eDRX_CONN cycle is used for HD-FDD category M1 with CE mode B UEs, the $Q_{\text{out_CatM1}}$ evaluation period ($T_{\text{Evaluate_}Q_{\text{out_DRX_CatM1}}}$) and the $Q_{\text{in_CatM1}}$ evaluation period ($T_{\text{Evaluate_}Q_{\text{in_DRX_CatM1}}}$) specified in Table 7.19.5.2-2 will be used.

When the downlink radio link quality of the PCell estimated over the last $T_{\text{Evaluate_}Q_{\text{out_DRX_CatM1}}}$ [s] period becomes worse than the threshold $Q_{\text{out_CatM1}}$, Layer 1 of the UE shall send out-of-sync indication for the PCell to the higher layers within $T_{\text{Evaluate_}Q_{\text{out_DRX_CatM1}}}$ [s] evaluation period. A Layer 3 filter shall be applied to the out-of-sync indications as specified in TS 36.331 [2].

When the downlink radio link quality of the PCell estimated over the last $T_{\text{Evaluate_}Q_{\text{in_DRX_CatM1}}}$ [s] period becomes better than the threshold $Q_{\text{in_CatM1}}$, Layer 1 of the UE shall send in-sync indications for the PCell to the higher layers within $T_{\text{Evaluate_}Q_{\text{in_DRX_CatM1}}}$ [s] evaluation period. A L3 filter shall be applied to the in-sync indications as specified in TS 36.331 [2].

The out-of-sync and in-sync evaluations of the PCell shall be performed as specified in clause 4.2.1 in [3]. When DRX is used, two successive indications from Layer 1 shall be separated by at least $\max(10\text{ms}, \text{DRX_cycle_length})$. When

eDRX_CONN is used, two successive indications from Layer 1 shall be separated by at least $\max(10 \text{ ms}, \text{eDRX_CONN cycle length})$.

Upon start of T310 timer as specified in clause 5.3.11 in TS 36.331 [2], the UE shall monitor the link for recovery using the evaluation period and Layer 1 indication interval corresponding to the non-DRX mode until the expiry or stop of T310 timer.

The transmitter power of the UE shall be turned off within 40 ms after expiry of T310 timer as specified in clause 5.3.11 in TS 36.331 [2].

Table 7.19.5.2-1: $Q_{\text{out_CatM1}}$ and $Q_{\text{in_CatM1}}$ Evaluation Period in DRX for HD-FDD UE category M1 with CE mode B

| DRX cycle length (s) | $T_{\text{Evaluate_}Q_{\text{out_DRX_CatM1}}}$ and $T_{\text{Evaluate_}Q_{\text{in_DRX_CatM1}}}$ (s) (DRX cycles) |
|--|---|
| $\leq [0.08]$ | Non-DRX requirements in clause 7.19.5.1 are applicable. |
| $[0.08] < \text{DRX cycle} \leq [0.160]$ | Note (40) |
| $[0.160] < \text{DRX cycle} \leq [0.320]$ | Note (20) |
| $[0.320] < \text{DRX cycle} \leq 0.64$ | Note (10) |
| $0.64 < \text{DRX cycle} \leq 2.56$ | Note (5) |
| NOTE: Evaluation period length in time depends on the length of the DRX cycle in use | |

Table 7.19.5.2-2: $Q_{\text{out_CatM1}}$ and $Q_{\text{in_CatM1}}$ evaluation period when eDRX_CONN cycle is configured for HD-FDD UE category M1 with CE mode B

| eDRX_CONN cycle length (s) | $T_{\text{Evaluate_}Q_{\text{out_DRX_CatM1}}}$ and $T_{\text{Evaluate_}Q_{\text{in_DRX_CatM1}}}$ (s) (eDRX_CONN cycles) |
|--|---|
| $2.56 < \text{DRX cycle} \leq 10.24$ | Note (5) |
| NOTE: Evaluation period length in time depends on the length of the eDRX_CONN cycle in use | |

7.19.5.3 Minimum requirement at transitions

The minimum requirements at transitions defined in clause 7.19.4.3 also apply for this section under the following conditions:

- at least 1 DL subframe per radio frame of PCell is available at the UE during $Q_{\text{in_CatM1}}$ and $Q_{\text{out_CatM1}}$ evaluation periods.⁸ UE Measurements Procedures in RRC_CONNECTED State

7.20 UE transmit timing for NB-IoT

7.20.1 Introduction

The UE shall have capability to follow the frame timing change of the connected eNode B. The uplink frame transmission takes place ($N_{\text{TA_Ref}} + N_{\text{TA_offset}}$) before the reception of the first detected path (in time) of the corresponding downlink frame from the reference NB-IoT cell.

UE shall use the serving NB-IoT cell as the reference cell for deriving the UE transmit timing. UE initial transmit timing accuracy, maximum amount of timing change in one adjustment, minimum and maximum adjustment rate are defined in the following requirements.

7.20.2 Requirements

The UE initial transmission timing error shall be less than or equal to $\pm T_e$ where the timing error limit value T_e is specified in Table 7.20.2-1. This requirement applies when it is the first transmission in a DRX cycle or the first

transmission in a repetition period ($R>1$) for NPUSCH, the first transmission after an uplink transmission gap in a repetition period ($R>1$) for NPUSCH, or it is the NPRACH transmission. The reference point for the UE initial transmit timing control requirement shall be the downlink timing of the serving NB-IoT cell minus $(N_{TA_Ref} + N_{TA_offset}) \times T_s$. The downlink timing is defined as the time when the first detected path (in time) of the corresponding downlink frame is received from the serving NB-IoT cell. N_{TA_Ref} for NPRACH is defined as 0. $(N_{TA_Ref} + N_{TA_offset})$ (in T_s units) for other channels is the difference between UE transmission timing and the Downlink timing immediately after when the last timing advance in clause 7.22 was applied. N_{TA_Ref} for other channels is not changed until next timing advance is received.

Table 7.20.2-1: T_e Timing Error Limit

| Downlink Bandwidth (MHz) | T_e |
|---|-----------------|
| 0.18 | $80 \times T_s$ |
| Note 1: T_s is the basic timing unit defined in TS 36.211 | |

When it is not the first transmission in a DRX cycle or there is no DRX cycle, and when it is the transmission for NPUSCH the UE shall, when no repetitions are configured on the uplink or the repetition period is $R=1$, be capable of changing the transmission timing according to the received downlink frame of the serving NB-IoT cell except when the timing advance in clause 7.22 is applied.

The UE is required to adjust its timing to within $\pm T_e$ when the transmission timing error between the UE and the reference timing exceeds $\pm T_e$.

When no repetition period is configured, or the configured repetition period is $R=1$, all adjustments made to the UE uplink timing shall follow these rules:

- 1) The maximum amount of the magnitude of the timing change in one adjustment shall be $58.33 \times T_s$ seconds.
- 2) The minimum aggregate adjustment rate shall be $7 \times T_s$ per second.
- 3) The maximum aggregate adjustment rate shall be $58.33 \times T_s$ per 200ms.

When a repetition period is configured on the uplink for which $R>1$, the UE shall not adjust the uplink transmission timing autonomously during an ongoing repetition period other than at initial transmission as defined above.

7.21 UE timer accuracy for NB-IoT

7.21.1 Introduction

UE timers are used in different protocol entities to control the UE behaviour.

7.21.2 Requirements

For UE timers specified in TS 36.331 [2], UE shall comply with the timer accuracies according to Table 7.21.2-1.

The requirements are only related to the actual timing measurements internally in the UE. They do not include the following:

- Inaccuracy in the start and stop conditions of a timer (e.g. UE reaction time to detect that start and stop conditions of a timer is fulfilled), or
- Inaccuracies due to restrictions in observability of start and stop conditions of a UE timer (e.g. TTI alignment when UE sends messages at timer expiry).

Table 7.21.2-1

| Timer value [s] | Accuracy |
|----------------------|-------------|
| timer value < 4 | $\pm 0.1s$ |
| timer value ≥ 4 | $\pm 2.5\%$ |

7.22 Timing Advance for NB-IoT

7.22.1 Introduction

The timing advance is initiated from E-UTRAN with MAC message that implies and adjustment of the timing advance, see TS 36.321 [17] clause 5.2.

7.22.2 Requirements

7.22.2.1 Timing Advance adjustment delay

UE shall adjust the timing of its uplink transmission timing at sub-frame $n+12$ for a timing advance command received in sub-frame n . In case repetitions are used on the downlink, sub-frame n refers to the last subframe in the repetition period in which the message containing the MAC control information was received. The UE shall not apply a TA command during an uplink repetition period.

7.22.2.2 Timing Advance adjustment accuracy

The UE shall adjust the timing of its transmissions with a relative accuracy better than or equal to $\pm 13.33 * T_S$ seconds to the signalled timing advance value compared to the timing of preceding uplink transmission. The timing advance command is expressed in multiples of $16 * T_S$ and is relative to the current uplink timing.

7.23 Radio Link Monitoring for Category NB1 UE

7.23.1 Introduction

The applicability of the requirements for performing radio link monitoring for Category NB1 UE in subclause 7.23 is defined in Section 3.1.

The UE shall monitor the downlink link quality based on the narrowband reference signal in order to detect the downlink radio link quality of the NB-IoT cell as specified in [3].

7.23.2 Requirements for HD-FDD Category NB1 UE

The requirements defined in this subclause 7.23.2 for performing radio link monitoring are applicable for Category NB1 UE defined in Section 3.1.

The UE shall meet all applicable requirements specified in clause 7.23.2 under the following condition:

- at least 1 DL subframe per radio frame of serving NB-IoT cell is available at the UE during Q_{out_NB-IoT} and Q_{in_NB-IoT} evaluation periods.

The UE shall estimate the downlink radio link quality and compare it to the thresholds Q_{out_NB-IoT} and Q_{in_NB-IoT} for the purpose of monitoring downlink radio link quality of the NB-IoT cell.

The threshold Q_{out_NB-IoT} is defined as the level at which the downlink radio link cannot be reliably received and shall correspond to 10% block error rate of a hypothetical NPDCCH transmission with transmission parameters specified in Table 7.23.2-1.

The threshold Q_{in_NB-IoT} is defined as the level at which the downlink radio link quality can be significantly more reliably received than at Q_{out_NB-IoT} and shall correspond to 2% block error rate of a hypothetical NPDCCH transmission with transmission parameters specified in Table 7.23.2-1.

Table 7.23.2-1 NPDCCH transmission parameters for out-of-sync and in-sync for Category NB1 UE

| Attribute | Out-of-sync | In-sync |
|----------------------------|-------------|-----------|
| DCI format | Format N1 | Format N1 |
| Number of information bits | 23 bits | 23 bits |
| System Bandwidth | 200kHz | 200kHz |

| | | |
|--|-----------------------------|-------------------------------|
| Antenna configuration | 2x1 | 2x1 |
| Maximum NPDCCH Repetition level | R_{\max} ^{Note1} | $R_{\max}/4$ ^{Note1} |
| Aggregation level | 2 | 2 |
| DRX | OFF | OFF |
| NOTE 1: R_{\max} is a configurable parameter defined in TS 36.331 [2]. | | |

7.23.2.1 Minimum requirement when no DRX is used

When the downlink radio link quality of the NB-IoT cell estimated over the last $T_{\text{Evaluate_}Q_{\text{out_NB-IoT}}}$ period becomes worse than the threshold $Q_{\text{out_NB-IoT}}$, Layer 1 of the UE shall send an out-of-sync indication for the NB-IoT cell to the higher layers within $T_{\text{Evaluate_}Q_{\text{out_NB-IoT}}}$ evaluation period. A Layer 3 filter shall be applied to the out-of-sync indications as specified in TS 36.331 [2].

When the downlink radio link quality of the NB-IoT cell estimated over the last $T_{\text{Evaluate_}Q_{\text{in_NB-IoT}}}$ period becomes better than the threshold $Q_{\text{in_NB-IoT}}$, Layer 1 of the UE shall send an in-sync indication for the NB-IoT cell to the higher layers within $T_{\text{Evaluate_}Q_{\text{in_NB-IoT}}}$ evaluation period. A L3 filter shall be applied to the in-sync indications as specified in TS 36.331 [2].

The out-of-sync and in-sync evaluations of the NB-IoT cell shall be performed as specified in clause 4.2.1 in [3]. Two successive indications from Layer 1 shall be separated by at least 10ms.

The transmitter power of the UE shall be turned off within 40 ms after expiry of T310 timer as specified in clause 5.3.11 in TS 36.331 [2]. The following table 7.23.2.1-1 defines the $T_{\text{Evaluate_}Q_{\text{out_NB-IoT}}}$ and $T_{\text{Evaluate_}Q_{\text{in_NB-IoT}}}$.

Table 7.23.2.1-1 Q_{out} and Q_{in} Evaluation Period in non-DRX for HD-FDD Category NB1 UE

| Configured NPDCCH R_{\max} | $T_{\text{Evaluate_}Q_{\text{out_NB-IoT}}}$ | $T_{\text{Evaluate_}Q_{\text{in_NB-IoT}}}$ |
|------------------------------|---|--|
| $R_{\max} \leq 64$ | 400ms | 200ms |
| $R_{\max} > 64$ | 4000ms | 2000ms |

7.23.2.2 Minimum requirement when DRX is used

When DRX is used for FD-FDD and TDD Category NB1 UE UEs, the $Q_{\text{out_NB-IoT}}$ evaluation period ($T_{\text{Evaluate_}Q_{\text{out_DRX_NB-IoT}}}$) and the $Q_{\text{in_NB-IoT}}$ evaluation period ($T_{\text{Evaluate_}Q_{\text{in_DRX_NB-IoT}}}$) is specified in Table 7.23.2.2-1 will be used.

When the downlink radio link quality of the NB-IoT cell estimated over the last $T_{\text{Evaluate_}Q_{\text{out_DRX_NB-IoT}}}$ [s] period becomes worse than the threshold $Q_{\text{out_NB-IoT}}$, Layer 1 of the UE shall send out-of-sync indication for the NB-IoT cell to the higher layers within $T_{\text{Evaluate_}Q_{\text{out_DRX_NB-IoT}}}$ [s] evaluation period. A Layer 3 filter shall be applied to the out-of-sync indications as specified in TS 36.331 [2].

When the downlink radio link quality of the NB-IoT cell estimated over the last $T_{\text{Evaluate_}Q_{\text{in_DRX_NB-IoT}}}$ [s] period becomes better than the threshold $Q_{\text{in_NB-IoT}}$, Layer 1 of the UE shall send in-sync indications for the NB-IoT cell to the higher layers within $T_{\text{Evaluate_}Q_{\text{in_DRX_NB-IoT}}}$ [s] evaluation period. A L3 filter shall be applied to the in-sync indications as specified in TS 36.331 [2].

The out-of-sync and in-sync evaluations of the NB-IoT cell shall be performed as specified in clause 4.2.1 in [3]. Two successive indications from Layer 1 shall be separated by at least $\max(10\text{ms}, \text{DRX_cycle_length})$.

Upon start of T310 timer as specified in clause 5.3.11 in TS 36.331 [2], the UE shall monitor the link for recovery using the evaluation period and Layer 1 indication interval corresponding to the non-DRX mode until the expiry or stop of T310 timer.

The transmitter power of the UE shall be turned off within 40 ms after expiry of T310 timer as specified in clause 5.3.11 in TS 36.331 [2].

Table 7.23.2.2-1: Q_{out} and Q_{in} Evaluation Period in DRX for HD-FDD Category NB1 UE

| DRX cycle length (s) | $T_{\text{Evaluate_}Q_{\text{out_DRX_NB-IoT}}}$ and $T_{\text{Evaluate_}Q_{\text{in_DRX_NB-IoT}}}$ (s) | |
|----------------------|--|--------------------------------|
| | DRX cycles for $R_{\max} \leq 64$ | DRX cycles for $R_{\max} > 64$ |
| | | |

| | | |
|--|-------------|-------------|
| 0.256 < DRX cycle ≤ 1.024 | Note 1 (20) | Note 1 (40) |
| 1.024 < DRX cycle ≤ 3.072 | Note 1 (10) | Note 1 (20) |
| 4.096 < DRX cycle ≤ 9.216 | Note 1 (5) | Note 1 (10) |
| NOTE 1: Evaluation period length in time depends on the length of the DRX cycle in use | | |

7.23.2.3 Minimum requirement at transitions

When the UE transitions between DRX and non-DRX or when DRX cycle periodicity changes, for a duration of time equal to the evaluation period corresponding to the second mode after the transition occurs, the UE shall use an evaluation period that is no less than the minimum of evaluation periods corresponding to the first mode and the second mode. Subsequent to this duration, the UE shall use an evaluation period corresponding to the second mode. This requirement shall be applied to both out-of-sync evaluation and in-sync evaluation of the NB-IoT cell.

7.24 UE transmit timing for Category M1

7.24.1 Introduction

The Category M1 UE shall have the capability to follow the frame timing change of the connected eNode B. The uplink frame transmission takes place $(N_{TA} + N_{TA\ offset}) \times T_s$ before the reception of the first detected path (in time) of the corresponding downlink frame from the reference cell.

The UE shall use the serving cell as the reference cell for deriving the UE transmit timing. UE initial transmit timing accuracy, maximum amount of timing change in one adjustment, minimum and maximum adjustment rate are defined in the following requirements.

7.24.2 Requirements

The UE initial transmission timing error shall be less than or equal to $\pm T_e$ where the timing error limit value T_e is specified in Table 7.24.2-1. This requirement applies when it is the first transmission in a DRX cycle, eDRX_CONN cycle, or the first transmission in a repetition period ($R>1$) for PUCCH, PUSCH, and SRS, or the first transmission after an uplink transmission gap in a repetition period ($R>1$) for PUCCH or PUSCH, or it is the PRACH transmission. The reference point for the UE initial transmit timing control requirement shall be the downlink timing of the serving cell minus $(N_{TA_Ref} + N_{TA\ offset}) \times T_s$. The downlink timing is defined as the time when the first detected path (in time) of the corresponding downlink frame is received from the serving cell. N_{TA_Ref} for PRACH is defined as 0. $(N_{TA_Ref} + N_{TA\ offset})$ (in T_s units) for other channels is the difference between UE transmission timing and the Downlink timing immediately after when the last timing advance in clause 7.3 was applied. N_{TA_Ref} for other channels is not changed until the next timing advance is received.

Table 7.24.2-1: T_e Timing Error Limit

| CE Mode | T_e |
|--|-----------------|
| A | $24 \times T_s$ |
| B | $48 \times T_s$ |
| NOTE 1: T_s is the basic timing unit defined in TS 36.211. | |
| NOTE 2: This requirement applies regardless of the downlink carrier bandwidth. | |

When it is not the first transmission in a DRX or eDRX_CONN cycle or there is no DRX or no eDRX_CONN cycle, and when it is the transmission for PUCCH, PUSCH and SRS transmission, the UE shall, when no repetitions are configured on the uplink or the repetition period is $R=1$, be capable of changing the transmission timing according to the received downlink frame of the serving cell except when the timing advance in clause 7.3 is applied such that the UE transmission timing error shall be less than or equal to $\pm T_e$ where the timing error limit value T_e is specified in Table 7.24.2-1.

When no repetition period is configured, or the configured repetition period is $R=1$, all adjustments made to the UE uplink timing shall follow these rules:

- 1) The maximum amount of the magnitude of the timing change in one adjustment shall be T_q seconds.
- 2) The minimum aggregate adjustment rate shall be $7 \cdot T_s$ per second.
- 3) The maximum aggregate adjustment rate shall be T_q per 200ms.

where the maximum autonomous time adjustment step T_q is specified in Table 7.24.2-2.

Table 7.24.2-2: T_q Maximum Autonomous Time Adjustment Step

| CE Mode | T_q |
|--|------------------|
| A | $17.5 \cdot T_s$ |
| B | $17.5 \cdot T_s$ |
| NOTE 1: T_s is the basic timing unit defined in TS 36.211. | |
| NOTE 2: This requirement applies regardless of the downlink carrier bandwidth. | |

When a repetition period is configured on the uplink for which $R > 1$, the UE shall not adjust the uplink transmission timing autonomously during an ongoing repetition period other than at initial transmission as defined above.

7.25 Timing Advance for Category M1

7.25.1 Introduction

The timing advance is initiated from E-UTRAN with MAC message that implies and adjustment of the timing advance, see TS 36.321 [17] clause 5.2.

7.25.2 Requirements

The requirements defined in clause 7.3.2 also apply for this section.

7.26 UE timer accuracy for category M1

7.26.1 Introduction

UE timers are used in different protocol entities to control the UE behaviour.

7.26.2 Requirements

The requirements defined in clause 7.21.2 also apply for this section.

8 UE Measurements Procedures in RRC_CONNECTED State

8.1 General Measurement Requirements

8.1.1 Introduction

This clause contains requirements on the UE regarding measurement reporting in RRC_CONNECTED state. The requirements are split in E-UTRA intra frequency, E-UTRA inter frequency, Inter-RAT UTRA FDD, UTRA TDD and GSM measurements. These measurements may be used by the E-UTRAN, e.g. for handover decisions. The

measurement quantities are defined in [4], the measurement model is defined in [22] and measurement accuracies are specified in clause 9. Control of measurement reporting is specified in TS 36.331 [2].

When the UE is provided with IDC solution, the UE shall also perform RRM measurements and meet the corresponding requirements in clause 8.

In the requirements of Section 8.1 for the UE capable of CA and the UE configured with up to four SCells, the applicable exceptions for side conditions are specified in Annex B, Sections B.4.2 and B.4.3, respectively.

In the requirements of Section 8.1 for the UE capable of DC and the UE configured with one PSCell, the applicable exceptions for side conditions are specified in Annex B, Sections B.4.2 and B.4.3, respectively.

The requirements in Section 9 are applicable for a UE performing measurements according to Section 8.1.

8.1.2 Requirements

8.1.2.1 UE measurement capability

If the UE requires measurement gaps to identify and measure inter-frequency and/or inter-RAT cells, in order for the requirements in the following subsections to apply the E-UTRAN must provide a single measurement gap pattern with constant gap duration for concurrent monitoring of all frequency layers and RATs.

During the measurement gaps the UE:

- shall not transmit any data
- is not expected to tune its receiver on any of the E-UTRAN carrier frequencies of PCell and any SCell.
- is not expected to tune its receiver on any of the E-UTRAN carrier frequencies of PCell, PSCell, and SCell.

If the UE supporting dual connectivity is configured with PSCell, during the total interruption time as shown in Figure 8.1.2.1-1, the UE shall not transmit and receive any data in SCG.

In the uplink subframe occurring immediately after the measurement gap,

- if the following conditions are met then it is up to UE implementation whether or not the UE can transmit data:
 - all the serving cells belong to E-UTRAN TDD;
 - if the subframe occurring immediately before the measurement gap is an uplink subframe.
- Otherwise the UE shall not transmit any data.

In determining the above UE behaviour in the uplink subframe occurring immediately after the measurement gap the UE shall treat a special subframe as an uplink subframe if the special subframe occurs immediately before the measurement gap, Inter-frequency and inter-RAT measurement requirements within this clause rely on the UE being configured with one measurement gap pattern unless the UE has signaled that it is capable of conducting such measurements without gaps. UEs shall only support those measurement gap patterns listed in Table 8.1.2.1-1 that are relevant to its measurement capabilities.

ProSe capable UE is allowed to perform ProSe transmissions during the measurement gaps that are not used for measurements if the requirements specified in section 8 for inter-frequency and inter-RAT measurements are fulfilled.

Table 8.1.2.1-1: Gap Pattern Configurations supported by the UE

| Gap Pattern Id | MeasurementGap Length (MGL, ms) | Measurement Gap Repetition Period (MGRP, ms) | Minimum available time for inter-frequency and inter-RAT measurements during 480ms period (Tinter1, ms) | Measurement Purpose |
|----------------|---------------------------------|--|---|---|
| 0 | 6 | 40 | 60 | Inter-Frequency E-UTRAN FDD and TDD, UTRAN FDD, GERAN, LCR TDD, HRPD, CDMA2000 1x |

| | | | | |
|---|---|----|----|---|
| 1 | 6 | 80 | 30 | Inter-Frequency E-UTRAN FDD and TDD, UTRAN FDD, GERAN, LCR TDD, HRPD, CDMA2000 1x |
|---|---|----|----|---|

NOTE 1: When inter-frequency RSTD measurements are configured and the UE requires measurement gaps for performing such measurements, only Gap Pattern 0 can be used. For defining the inter-frequency and inter-RAT requirements $T_{inter1}=30ms$ shall be assumed.

NOTE 2: A measurement gap starts at the end of the latest subframe occurring immediately before the measurement gap among MCG serving cells subframes.

NOTE 3: MGL is the time from start of tuning to end of retuning, which is aligned between MCG and SCG.

NOTE 4: The total interruption time on SCG is 6 subframes for synchronous dual connectivity, and the total interruption time on SCG is 7 subframes for asynchronous dual connectivity. As shown in Figure 8.1.2.1-1, MCG subframes from $i+1$ to $i+6$ are included in total interruption time together with SCG subframes from $j+1$ to $j+6$ for synchronous dual connectivity and $j+1$ to $j+7$ for asynchronous dual connectivity.

NOTE 5: For asynchronous dual connectivity as shown in Figure 8.1.2.1-1 (b), subframe j is regarded as the subframe occurring immediately before the measurement gap for SCG, similarly, subframe $j+8$ is regarded as the subframe occurring immediately after the measurement gap for SCG.

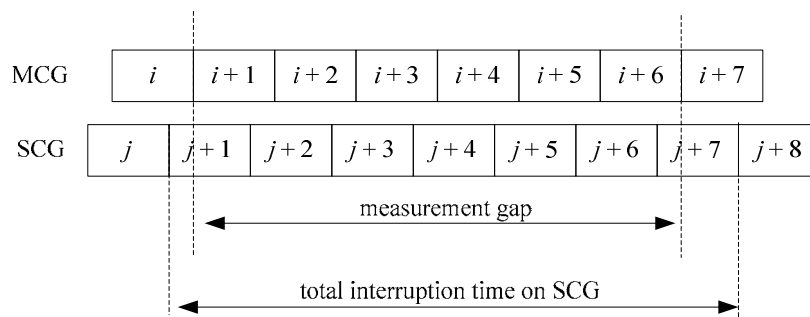
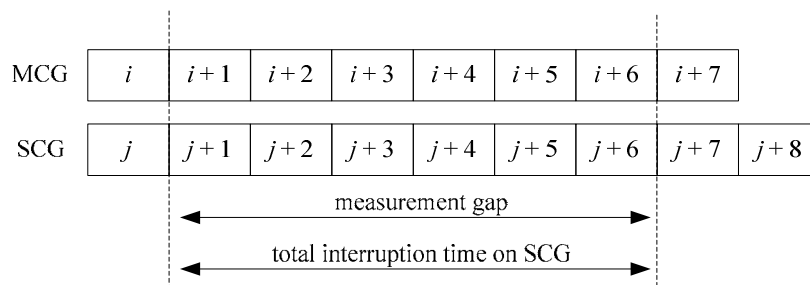

Figure 8.1.2.1-1: Measurement GAP and total interruption time on MCG and SCG

A UE that is capable of identifying and measuring inter-frequency and/or inter-RAT cells without gaps shall follow requirements as if Gap Pattern Id #0 had been used and the minimum available time T_{inter1} of 60 ms shall be assumed for the corresponding requirements.

If the UE supporting E-UTRA carrier aggregation when configured with up to four SCCs is performing measurements on cells on PCC, inter-frequency measurements, or inter-RAT measurements, and interruption occurs on PCell or any activated SCell or both due to measurements performed on cells on an SCC with a deactivated SCell according to section 8.3, then the UE shall meet the requirements specified for each measurement in Section 8 and Section 9.

If the UE supporting E-UTRA dual connectivity when configured with a PSCell is performing measurements on cells on PCC, inter-frequency measurements, or inter-RAT measurements, then the UE shall meet the requirements specified for each measurement in Section 8 and Section 9.

A UE which indicate support for Increased UE carrier monitoring E-UTRA according to the capabilities in [2, 31] and which is capable of identifying and measuring inter-frequency and/or inter-RAT cells without gaps, shall be able to monitor maximum number of layers as defined in 8.1.2.1.1a, and apply the *MeasScaleFactor* [2] defining the relaxation to the requirements for the configured carriers according to section 8.1.2.1.1a.

8.1.2.1.1 Monitoring of multiple layers using gaps

When monitoring of multiple inter-frequency E-UTRAN and inter-RAT (UTRAN, GSM) using gaps (or without using gaps provided the UE supports such capability) is configured, the UE shall be capable of performing one measurement of the configured measurement type (RSRP, RSRQ, RSTD, UTRAN TDD P-CCPCH RSCP, UTRAN FDD CPICH measurements, GSM carrier RSSI, etc.) of detected cells on all the layers

The effective total number of frequencies excluding the frequencies of the PCell, SCells, and PSCell being monitored is N_{freq} , which is defined as:

$$N_{\text{freq}} = N_{\text{freq, E-UTRA}} + N_{\text{freq, UTRA}} + M_{\text{gsm}} + N_{\text{freq, cdma2000}} + N_{\text{freq, HRPD}}$$

where

$N_{\text{freq, E-UTRA}}$ is the number of E-UTRA carriers being monitored (FDD and TDD)

$N_{\text{freq, UTRA}}$ is the number of UTRA carriers being monitored (FDD and TDD)

M_{GSM} is an integer which is a function of the number of GSM carriers on which measurements are being performed. M_{GSM} is equal to 0 if no GSM carrier is being monitored. For a MGRP of 40 ms, M_{GSM} is equal to 1 if cells on up to 32 GSM carriers are being measured. For a MGRP of 80 ms, M_{GSM} is equal to $\text{ceil}(N_{\text{carriers, GSM}}/20)$ where $N_{\text{carriers, GSM}}$ is the number of GSM carriers on which cells are being measured.

$N_{\text{freq, cdma2000}}$ is the number of cdma2000 1x carriers being monitored.

$N_{\text{freq, HRPD}}$ is the number of HRPD carriers being monitored.

8.1.2.1.1.1 Maximum allowed layers for multiple monitoring

The UE shall be capable of monitoring at least per RAT group:

- Depending on UE capability, 3 FDD E-UTRA inter-frequency carriers, and
- Depending on UE capability, 1 FDD E-UTRA inter-frequency carrier for RSTD measurements, and
- Depending on UE capability, 3 TDD E-UTRA inter-frequency carriers, and
- Depending on UE capability, 1 TDD E-UTRA inter-frequency carrier for RSTD measurements, and
- Depending on UE capability, 3 FDD UTRA carriers, and
- Depending on UE capability, 3 TDD UTRA carriers, and
- Depending on UE capability, 32 GSM carriers (one GSM layer corresponds to 32 carriers), and
- Depending on UE capability, 5 cdma2000 1x carriers, and
- Depending on UE capability, 5 HRPD carriers

In addition to the requirements defined above, the UE shall be capable of monitoring a total of at least 7 effective carrier frequency layers comprising of any above defined combination of E-UTRA FDD, E-UTRA TDD, UTRA FDD, UTRA TDD, GSM (one GSM layer corresponds to 32 carriers), cdma2000 1x and HRPD layers.

8.1.2.1.1.1a Maximum allowed layers for multiple monitoring (Increased UE carrier monitoring)

UE which indicate support for Increased UE carrier monitoring E-UTRA according to the capabilities in [2,31] shall be capable of monitoring at least

- Depending on UE capability, 8 FDD E-UTRA inter-frequency carriers, and
- Depending on UE capability, 8 TDD E-UTRA inter-frequency carriers

UE which indicate support for increased UE carrier monitoring UTRA according to the capabilities in [2,31] shall be capable of monitoring at least

- Depending on UE capability, 6 FDD UTRA carriers, and
- Depending on UE capability, 7 TDD UTRA carriers, and

In addition to the requirements defined above, the UE which indicate support for Increased UE carrier monitoring E-UTRA or increased UE carrier monitoring UTRA according to the capabilities in [2,31] shall be capable of monitoring a total of at least 12 carrier frequency layers comprising of any above defined combination of E-UTRA FDD, E-UTRA TDD, UTRA FDD, UTRA TDD, GSM (one GSM layer corresponds to 32 carriers), cdma2000 1x and HRPD layers

The minimum performance requirements for a UE which does not indicate support for Increased UE carrier monitoring E-UTRA [2,31] are calculated assuming all E-UTRA carriers which the UE is required to monitor, are having normal performance, i.e. $N_{\text{freq, E-UTRA, reduced}}=0$. The minimum performance requirements for a UE which does not indicate support for Increased UE carrier monitoring UTRA [2,31] are calculated assuming all UTRA carriers which the UE is required to monitor, are having normal performance, i.e. $N_{\text{freq, UTRA, reduced}}=0$. Capabilities for number of carriers to monitor for UE which do not support increased carrier monitoring E-UTRA or increased carrier monitoring UTRA are specified in section 8.1.2.1.1.1. A UE which do not indicate support for Increased UE carrier monitoring E-UTRA or UTRAN [2,31] does not have any reduced performance carrier requirements and $K_n=1$.

8.1.2.1.1a Monitoring of multiple layers using gaps (Increased UE carrier monitoring)

For UE which support increased carrier monitoring E-UTRA or increased carrier monitoring UTRA, the measurement performance for different carriers may be configured by higher layers to be either normal or reduced performance. A measurement scaling factor, *MeasScaleFactor* [2], defining the relaxation to be applied to the requirements for carriers measured with reduced measurement performance is signalled by higher layers and has the possible settings shown in table 8.1.2.1.1-1.

Table 8.1.2.1.1-1: Measurement Scaling factor Configurations supported by the UE

| | <i>MeasScaleFactor</i> information element setting | K_n | K_r |
|--------------|--|-------|-------|
| sf-EUTRA-cf1 | 8 | 8/7 | 8 |
| sf-EUTRA-cf2 | 16 | 16/15 | 16 |

If no reduced performance group carrier is configured, the UE shall consider all carriers to have normal performance

If no *MeasScaleFactor* is configured, a UE indicating support for increased carrier monitoring E-UTRA or increased carrier monitoring UTRA shall monitor at least the number of carriers specified in section 8.1.2.1.1.1 and is not required to monitor the increased number of carriers specified in section 8.1.2.1.1.1a.

The following definitions are used in the performance requirements:

$$N_{\text{freq}} = N_{\text{freq,n}} + N_{\text{freq,r}}$$

Where:

$N_{\text{freq,n}} = N_{\text{freq, E-UTRA, normal}} + N_{\text{freq, UTRA, normal}} + M_{\text{gsm}} + N_{\text{freq, cdma2000}} + N_{\text{freq, HRPD}}$: Total number of interfrequency carriers to be monitored with normal measurement performance

$N_{\text{freq,r}} = N_{\text{freq, E-UTRA, reduced}} + N_{\text{freq, UTRA, reduced}}$: Total number of interfrequency carriers to be monitored with reduced measurement performance

Where :

$N_{\text{freq, E-UTRA, normal}}$: Number of interfrequency carriers to be monitored with normal performance

$N_{\text{freq, E-UTRA, normal, FDD}}$: Number of interfrequency FDD carriers to be monitored with normal performance

$N_{\text{freq, E-UTRA,normal,TDD}}$: Number of interfrequency TDD carriers to be monitored with normal performance

$N_{\text{freq, E-UTRA,reduced}}$: Number of interfrequency carriers to be monitored with reduced performance

$N_{\text{freq, UTRA,normal}}$: Number of UTRA carriers (FDD and TDD) to be monitored with normal performance

$N_{\text{freq, E-UTRA,normal,FDD}}$: Number of interfrequency FDD carriers to be monitored with normal performance

$N_{\text{freq, E-UTRA,normal,TDD}}$: Number of interfrequency TDD carriers to be monitored with normal performance

$N_{\text{freq, UTRA,reduced}}$: Number of UTRA carriers (FDD and TDD) to be monitored with reduced performance

For interfrequency carriers, if $N_{\text{freq, E-UTRA,reduced}}$ is not equal to zero then K_n and K_r are as shown in table 8.1.2.1.1-1. Otherwise $K_n=1$ and all interfrequency layers have normal performance.

For UTRAN carriers, if $N_{\text{freq, UTRA,reduced}}$ is not equal to zero then K_n and K_r are as shown in table 8.1.2.1.1-1. Otherwise $K_n=1$ and all UTRA frequency layers have normal performance.

The minimum performance requirements for a UE which indicates support for Increased UE carrier monitoring E-UTRA [2, 31] are calculated as defined in sections 8.1.2.3.1 and 8.1.2.3.2 provided that $N_{\text{freq, E-UTRA,normal}} \leq 3$ for a UE capable of either FDD E-UTRA carrier monitoring or TDD E-UTRA carrier monitoring or $N_{\text{freq, E-UTRA,normal}} \leq 6$ for a UE capable of both FDD and TDD E-UTRA carrier monitoring provided $N_{\text{freq, E-UTRA,normal,FDD}} \leq 3$ E-UTRA carriers and $N_{\text{freq, E-UTRA,normal,TDD}} \leq 3$ TDD E-UTRA carriers or if $N_{\text{freq,n}} = N_{\text{freq}}$. The minimum performance requirements for a UE which indicates support for Increased UE carrier monitoring UTRA [2, 31] are calculated as defined in sections 8.1.2.4.1, 8.1.2.4.3, 8.1.2.4.7 and 8.1.2.4.13 provided that $N_{\text{freq, UTRA,normal}} \leq 3$ for UE capable of either FDD UTRA carrier monitoring or TDD UTRA carrier monitoring or $N_{\text{freq, UTRA,normal}} \leq 6$ for a UE capable of both FDD and TDD UTRA carrier monitoring provided $N_{\text{freq, UTRA,normal,FDD}} \leq 3$ FDD UTRA carriers and $N_{\text{freq, UTRA,normal,TDD}} \leq 3$ TDD UTRA carriers or if $N_{\text{freq,n}} = N_{\text{freq}}$. Capabilities for number of carriers to monitor for a UE which supports Increased carrier monitoring E-UTRA or Increased carrier monitoring UTRA are specified in section 8.1.2.1.1.a.

8.1.2.2 E-UTRAN intra frequency measurements

The UE shall be able to identify new intra-frequency cells and perform RSRP, RSRQ, and RS-SINR measurements of identified intra-frequency cells without an explicit intra-frequency neighbour cell list containing physical layer cell identities. During the RRC_CONNECTED state the UE shall continuously measure identified intra frequency cells and additionally search for and identify new intra frequency cells.

8.1.2.2.1 E-UTRAN FDD intra frequency measurements

8.1.2.2.1.1 E-UTRAN intra frequency measurements when no DRX is used

When no DRX is in use the UE shall be able to identify a new detectable FDD intra frequency cell within

$$T_{\text{identify intra}} = T_{\text{basic_identify_E-UTRA_FDD, intra}} \cdot \frac{T_{\text{Measurement_Period, Intra}}}{T_{\text{Intra}}} \quad \text{ms}$$

where

$T_{\text{basic_identify_E-UTRA_FDD, intra}}$ is 800 ms

A cell shall be considered detectable when

- RSRP related side conditions given in Sections 9.1.2.1 and 9.1.2.2 are fulfilled for a corresponding Band,
- RSRQ related side conditions given in Clause 9.1.5.1 are fulfilled for a corresponding Band,
- RS-SINR related side conditions given in Section 9.1.17.2.1 are fulfilled for a corresponding Band,
- SCH_RP and SCH \hat{E} s/Iot according to Annex B.2.1 for a corresponding Band.

T_{Intra} : This is the minimum time that is available for intra frequency measurements, during the measurement period with an arbitrarily chosen timing. Time is assumed to be available for performing intra frequency measurements whenever the receiver is guaranteed to be active on the intra frequency carrier.

Identification of a cell shall include detection of the cell and additionally performing a single measurement with measurement period of $T_{\text{Measurement_Period, Intra}}$. If higher layer filtering is used, an additional cell identification delay can be expected.

In the RRC_CONNECTED state the measurement period for intra frequency measurements is 200 ms. When no measurement gaps are activated, the UE shall be capable of performing RSRP, RSRQ, and RS-SINR measurements for 8 identified-intra-frequency cells, and the UE physical layer shall be capable of reporting measurements to higher layers with the measurement period of 200 ms. When measurement gaps are activated the UE shall be capable of performing measurements for at least $Y_{\text{measurement intra}}$ cells, where $Y_{\text{measurement intra}}$ is defined in the following equation. If the UE has identified more than $Y_{\text{measurement intra}}$ cells, the UE shall perform measurements of at least 8 identified intra-frequency cells but the reporting rate of RSRP, RSRQ, and RS-SINR measurements of cells from UE physical layer to higher layers may be decreased.

$$Y_{\text{measurement intra}} = \text{Floor} \left\{ X_{\text{basic measurement FDD}} \cdot \frac{T_{\text{Intra}}}{T_{\text{Measurement_Period, Intra}}} \right\} \text{ cells}$$

where

$X_{\text{basic measurement FDD}} = 8$ (cells),

$T_{\text{Measurement_Period, Intra}} = 200$ ms is the measurement period for intra frequency RSRP, RSRQ, and RS-SINR measurements.

The RSRP measurement accuracy for all measured cells shall be as specified in the sub-clauses 9.1.2.1 and 9.1.2.2, the RSRQ measurement accuracy for all measured cells shall be as specified in the sub-clause 9.1.5.1, and RS-SINR measurement accuracy for all measured cells shall be as specified in the sub-clause 9.1.17.2.1.

8.1.2.2.1.1.1 Measurement Reporting Requirements

8.1.2.2.1.1.1.1 Periodic Reporting

Reported RSRP, RSRQ, and RS-SINR measurements contained in periodically triggered measurement reports shall meet the requirements in sections 9.1.2.1, 9.1.2.2, 9.1.5.1, and 9.1.17.2.1, respectively.

8.1.2.2.1.1.1.2 Event-triggered Periodic Reporting

Reported RSRP, RSRQ, and RS-SINR measurements contained in event triggered periodic measurement reports shall meet the requirements in sections 9.1.2.1, 9.1.2.2, 9.1.5.1, and 9.1.17.2.1, respectively.

The first report in event triggered periodic measurement reporting shall meet the requirements specified in clause 8.1.2.2.1.1.1.3.

8.1.2.2.1.1.1.3 Event Triggered Reporting

Reported RSRP, RSRQ, and RS-SINR measurements contained in event triggered measurement reports shall meet the requirements in sections 9.1.2.1, 9.1.2.2, 9.1.5.1, and 9.1.17.2.1, respectively.

The UE shall not send any event triggered measurement reports, as long as no reporting criteria are fulfilled.

The measurement reporting delay is defined as the time between an event that will trigger a measurement report and the point when the UE starts to transmit the measurement report over the air interface. This requirement assumes that the measurement report is not delayed by other RRC signalling on the DCCH. This measurement reporting delay excludes a delay uncertainty resulted when inserting the measurement report to the TTI of the uplink DCCH. The delay uncertainty is: $2 \times TTI_{\text{DCCH}}$. This measurement reporting delay excludes a delay which caused by no UL resources for UE to send the measurement report.

The event triggered measurement reporting delay, measured without L3 filtering shall be less than $T_{\text{identify intra}}$ defined in Clause 8.1.2.2.1.1. When L3 filtering is used or IDC autonomous denial is configured or the UE is performing reception

and/or transmission for ProSe Direct Discovery and/or ProSe Direct Communication, an additional delay can be expected.

If a cell which has been detectable at least for the time period $T_{\text{identify_intra}}$ defined in clause 8.1.2.2.1.1 becomes undetectable for a period ≤ 5 seconds and then the cell becomes detectable again and triggers an event, the event triggered measurement reporting delay shall be less than $T_{\text{Measurement_Period, Intra}}$ provided the timing to that cell has not changed more than $\pm 50 T_s$ and the L3 filter has not been used. When L3 filtering is used or IDC autonomous denial is configured or the UE is performing reception and/or transmission for ProSe Direct Discovery and/or ProSe Direct Communication, an additional delay can be expected.

8.1.2.2.1.2 E-UTRAN intra frequency measurements when DRX is used

When DRX is in use the UE shall be able to identify a new detectable FDD intra frequency cell within $T_{\text{identify_intra}}$ as shown in table 8.1.2.2.1.2-1. When eDRX_CONN is in use the UE shall be able to identify a new detectable FDD intra frequency cell within $T_{\text{identify_intra}}$ as shown in table 8.1.2.2.1.2-1A.

Table 8.1.2.2.1.2-1: Requirement to identify a newly detectable FDD intrafrequency cell

| DRX cycle length (s) | $T_{\text{identify_intra}}$ (s) (DRX cycles) |
|---|---|
| ≤ 0.04 | 0.8 (Note1) |
| $0.04 < \text{DRX-cycle} \leq 0.08$ | Note2 (40) |
| 0.128 | 3.2 (25) |
| $0.128 < \text{DRX-cycle} \leq 2.56$ | Note2(20) |
| Note1: Number of DRX cycle depends upon the DRX cycle in use Note2: Time depends upon the DRX cycle in use | |

Table 8.1.2.2.1.2-1A: Requirement to identify a newly detectable FDD intra-frequency cell when eDRX_CONN cycle is used

| eDRX_CONN cycle length (s) | $T_{\text{identify_intra}}$ (s) (eDRX_CONN cycles) |
|--|---|
| $2.56 < \text{eDRX_CONN cycle} \leq 10.24$ | Note(20) |
| Note: Time depends upon the eDRX_CONN cycle in use | |

A cell shall be considered detectable when

- RSRP related side conditions given in Sections 9.1.2.1 and 9.1.2.2 are fulfilled for a corresponding Band,
- RSRQ related side conditions given in Clause 9.1.5.1 are fulfilled for a corresponding Band,
- RS-SINR related side conditions given in Section 9.1.17.2.1 are fulfilled for a corresponding Band,
- SCH_RP and SCH \hat{E}_s/I_{ot} according to Annex B.2.1 for a corresponding Band.

When DRX is used in the RRC_CONNECTED state the measurement period for intra frequency measurements is $T_{\text{measure_intra}}$ as shown in table 8.1.2.2.1.2-2. When eDRX_CONN is used in the RRC_CONNECTED state the measurement period for intra frequency measurements is $T_{\text{measure_intra}}$ as shown in table 8.1.2.2.1.2-3. The UE shall be capable of performing RSRP, RSRQ, and RS-SINR measurements for 8 identified-intra-frequency cells, and the UE physical layer shall be capable of reporting measurements to higher layers with the measurement period of $T_{\text{measure_intra}}$.

Table 8.1.2.2.1.2-2: Requirement to measure FDD intrafrequency cells

| DRX cycle length (s) | $T_{\text{measure_intra}}$ (s) (DRX cycles) |
|-------------------------------------|--|
| ≤ 0.04 | 0.2 (Note1) |
| $0.04 < \text{DRX-cycle} \leq 2.56$ | Note2 (5) |

Note1: Number of DRX cycle depends upon the DRX cycle in use
 Note2: Time depends upon the DRX cycle in use

Table 8.1.2.2.1.2-3: Requirement to measure FDD intra-frequency cells when eDRX_CONN cycle is used

| eDRX_CONN cycle length (s) | $T_{\text{measure_intra}}$ (s) (eDRX_CONN cycles) |
|--|--|
| $2.56 < \text{eDRX_CONN cycle} \leq 10.24$ | Note (5) |
| Note: Time depends upon the eDRX_CONN cycle in use | |

The RSRP measurement accuracy for all measured cells shall be as specified in the sub-clauses 9.1.2.1 and 9.1.2.2, the RSRQ measurement accuracy for all measured cells shall be as specified in the sub-clause 9.1.5.1, and RS-SINR measurement accuracy for all measured cells shall be as specified in the sub-clause 9.1.17.2.1.

8.1.2.2.1.2.1 Measurement Reporting Requirements

8.1.2.2.1.2.1.1 Periodic Reporting

Reported RSRP, RSRQ, and RS-SINR measurements contained in periodically triggered measurement reports shall meet the requirements in sections 9.1.2.1, 9.1.2.2, 9.1.5.1, and 9.1.17.2.1, respectively.

8.1.2.2.1.2.1.2 Event-triggered Periodic Reporting

Reported RSRP, RSRQ, and RS-SINR measurements contained in event triggered periodic measurement reports shall meet the requirements in sections 9.1.2.1, 9.1.2.2, 9.1.5.1, and 9.1.17.2.1, respectively.

The first report in event triggered periodic measurement reporting shall meet the requirements specified in clause 8.1.2.2.1.2.1.3.

8.1.2.2.1.2.1.3 Event Triggered Reporting

Reported RSRP, RSRQ, and RS-SINR measurements contained in event triggered measurement reports shall meet the requirements in sections 9.1.2.1, 9.1.2.2, 9.1.5.1, and 9.1.17.2.1, respectively.

The UE shall not send any event triggered measurement reports, as long as no reporting criteria are fulfilled.

The measurement reporting delay is defined as the time between an event that will trigger a measurement report and the point when the UE starts to transmit the measurement report over the air interface. This requirement assumes that the measurement report is not delayed by other RRC signalling on the DCCH. This measurement reporting delay excludes a delay uncertainty resulted when inserting the measurement report to the TTI of the uplink DCCH. The delay uncertainty is: $2 \times TTI_{\text{DCCH}}$. This measurement reporting delay excludes a delay which caused by no UL resources for UE to send the measurement report.

The event triggered measurement reporting delay, measured without L3 filtering shall be less than $T_{\text{identify_intra}}$ defined in Clause 8.1.2.2.1.2. When L3 filtering is used or IDC autonomous denial is configured or the UE is performing reception and/or transmission for ProSe Direct Discovery and/or ProSe Direct Communication, an additional delay can be expected.

If a cell which has been detectable at least for the time period $T_{\text{identify_intra}}$ defined in clause 8.1.2.2.1.2 becomes undetectable for a period ≤ 5 seconds and then the cell becomes detectable again and triggers an event, the event triggered measurement reporting delay shall be less than $T_{\text{measure_intra}}$ provided the timing to that cell has not changed more than $\pm 50 T_s$ and the L3 filter has not been used. When L3 filtering is used or IDC autonomous denial is configured or the UE is performing reception and/or transmission for ProSe Direct Discovery and/or ProSe Direct Communication, an additional delay can be expected.

8.1.2.2.2 E-UTRAN TDD intra frequency measurements

8.1.2.2.2.1 E-UTRAN intra frequency measurements when no DRX is used

When no DRX is in use the UE shall be able to identify a new detectable TDD intra frequency cell within

$$T_{\text{identify intra}} = T_{\text{basic identify E-UTRA_TDD, intra}} \cdot \frac{T_{\text{Measurement Period, Intra}}}{T_{\text{Intra}}} \quad \text{ms}$$

where

$T_{\text{basic identify E-UTRA_TDD, intra}}$ is 800 ms

A cell shall be considered detectable when

- RSRP related side conditions given in Sections 9.1.2.1 and 9.1.2.2 are fulfilled for a corresponding Band,
- RSRQ related side conditions given in Clause 9.1.5.1 are fulfilled for a corresponding Band,
- RS-SINR related side conditions given in Section 9.1.17.2.1 are fulfilled for a corresponding Band,
- SCH_{RP} and SCH_{Ês/Iot} according to Annex B.2.1 for a corresponding Band.

T_{Intra} : This is the minimum time that is available for intra frequency measurements, during the measurement period with an arbitrarily chosen timing. Time is assumed to be available for performing intra frequency measurements whenever the receiver is guaranteed to be active on the intra frequency carrier.

Identification of a cell shall include detection of the cell and additionally performing a single measurement with measurement period of $T_{\text{Measurement_Period Intra}}$. If higher layer filtering is used, an additional cell identification delay can be expected.

In the RRC_CONNECTED state the measurement period for intra frequency measurements is 200 ms. When no measurement gaps are activated, the UE shall be capable of performing RSRP, RSRQ, and RS-SINR measurements for 8 identified-intra-frequency cells, and the UE physical layer shall be capable of reporting measurements to higher layers with the measurement period of 200 ms. When measurement gaps are activated the UE shall be capable of performing measurements for at least $Y_{\text{measurement intra}}$ cells, where $Y_{\text{measurement intra}}$ is defined in the following equation. If the UE has identified more than $Y_{\text{measurement intra}}$ cells, the UE shall perform measurements of at least 8 identified intra-frequency cells but the reporting rate of RSRP, RSRQ, and RS-SINR measurements of cells from UE physical layer to higher layers may be decreased.

$$Y_{\text{measurement intra}} = \left\lfloor X_{\text{basic measurement TDD}} \cdot \frac{T_{\text{Intra}}}{T_{\text{Measurement_Period, Intra}}} \right\rfloor \text{ cells}$$

where

$X_{\text{basic measurement TDD}} = 8$ (cells),

$T_{\text{Measurement_Period Intra}} = 200$ ms is the measurement period for intra frequency RSRP, RSRQ, and RS-SINR measurements.

The RSRP measurement accuracy for all measured cells shall be as specified in the sub-clauses 9.1.2.1 and 9.1.2.2, the RSRQ measurement accuracy for all measured cells shall be as specified in the sub-clause 9.1.5.1, and RS-SINR measurement accuracy for all measured cells shall be as specified in the sub-clause 9.1.17.2.1.

8.1.2.2.2.1.1 Measurement Reporting Requirements

8.1.2.2.2.1.1.1 Periodic Reporting

Reported RSRP, RSRQ, and RS-SINR measurements contained in periodically triggered measurement reports shall meet the requirements in sections 9.1.2.1, 9.1.2.2, 9.1.5.1, and 9.1.17.2.1, respectively.

8.1.2.2.2.1.1.2 Event-triggered Periodic Reporting

Reported RSRP, RSRQ, and RS-SINR measurements contained in event triggered periodic measurement reports shall meet the requirements in sections 9.1.2.1, 9.1.2.2, 9.1.5.1, and 9.1.17.2.1, respectively.

The first report in event triggered periodic measurement reporting shall meet the requirements specified in clause 8.1.2.2.2.1.1.3.

8.1.2.2.2.1.1.3 Event Triggered Reporting

Reported RSRP, RSRQ, and RS-SINR measurements contained in event triggered measurement reports shall meet the requirements in sections 9.1.2.1, 9.1.2.2, 9.1.5.1, and 9.1.17.2.1, respectively.

The UE shall not send any event triggered measurement reports, as long as no reporting criteria are fulfilled.

The measurement reporting delay is defined as the time between an event that will trigger a measurement report and the point when the UE starts to transmit the measurement report over the air interface. This requirement assumes that the measurement report is not delayed by other RRC signalling on the DCCH. This measurement reporting delay excludes a delay uncertainty resulted when inserting the measurement report to the TTI of the uplink DCCH. The delay uncertainty is: $2 \times TTI_{DCCH}$. This measurement reporting delay excludes a delay which caused by no UL resources for UE to send the measurement report.

The event triggered measurement reporting delay, measured without L3 filtering shall be less than $T_{identify_intra}$ defined in Clause 8.1.2.2.2.1. When L3 filtering is used or IDC autonomous denial is configured or the UE is performing reception and/or transmission for ProSe Direct Discovery and/or ProSe Direct Communication, an additional delay can be expected.

If a cell which has been detectable at least for the time period $T_{identify_intra}$ defined in clause 8.1.2.2.2.1 becomes undetectable for a period ≤ 5 seconds and then the cell becomes detectable again and triggers an event, the event triggered measurement reporting delay shall be less than $T_{Measurement_Period\ Intra}$ provided the timing to that cell has not changed more than $\pm 50 T_s$ and the L3 filter has not been used. When L3 filtering is used or IDC autonomous denial is configured or the UE is performing reception and/or transmission for ProSe Direct Discovery and/or ProSe Direct Communication, an additional delay can be expected.

8.1.2.2.2.2 E-UTRAN intra frequency measurements when DRX is used

When DRX is in use the UE shall be able to identify a new detectable TDD intra frequency cell within $T_{identify_intra}$ as shown in table 8.1.2.2.2.2-1. When eDRX_CONN is in use, the UE shall be able to identify a new detectable TDD intra frequency cell within $T_{identify_intra}$ as shown in table 8.1.2.2.2.2-1A.

Table 8.1.2.2.2.2-1: Requirement to identify a newly detectable TDD intrafrequency cell

| DRX cycle length (s) | $T_{identify_intra}$ (s) (DRX cycles) |
|---|--|
| ≤ 0.04 | 0.8 (Note1) |
| $0.04 < \text{DRX-cycle} \leq 0.08$ | Note2 (40) |
| 0.128 | 3.2 (25) |
| $0.128 < \text{DRX-cycle} \leq 2.56$ | Note2(20) |
| Note1: Number of DRX cycle depends upon the DRX cycle in use Note2: Time depends upon the DRX cycle in use | |

Table 8.1.2.2.2.2-1A: Requirement to identify a newly detectable TDD intra-frequency cell when eDRX_CONN cycle is used

| eDRX_CONN cycle length (s) | $T_{identify_intra}$ (s) (eDRX_CONN cycles) |
|--|--|
| $2.56 < \text{eDRX_CONN cycle} \leq 10.24$ | Note(20) |
| Note: Time depends upon the eDRX_CONN cycle in use | |

A cell shall be considered detectable when

- RSRP related side conditions given in Clause 9.1.2.1 and 9.1.2.2 are fulfilled for a corresponding Band,
- RSRQ related side conditions given in Clause 9.1.5.1 are fulfilled for a corresponding Band,
- RS-SINR related side conditions given in Clause 9.1.17.2.1 are fulfilled for a corresponding Band,
- SCH_{RP} and SCH_{Es}/I_{ot} according to Annex B.2.1 for a corresponding Band.

When DRX is in use in the RRC_CONNECTED state the measurement period for intra frequency measurements is $T_{\text{measure_intra}}$ as shown in table 8.1.2.2.2-2. When eDRX_CONN is in use in the RRC_CONNECTED state, the measurement period for intra frequency measurements is $T_{\text{measure_intra}}$ as shown in table 8.1.2.2.2-3. The UE shall be capable of performing RSRP, RSRQ, and RS-SINR measurements for 8 identified intra-frequency cells and the UE physical layer shall be capable of reporting measurements to higher layers with the measurement period of $T_{\text{measure_intra}}$.

Table 8.1.2.2.2-2: Requirement to measure TDD intra frequency cells

| DRX cycle length (s) | $T_{\text{measure_intra}}$ (s) (DRX cycles) |
|---|--|
| ≤ 0.04 | 0.2 (Note1) |
| $0.04 < \text{DRX-cycle} \leq 2.56$ | Note2 (5) |
| Note1: Number of DRX cycle depends upon the DRX cycle in use. Note2: Time depends upon the DRX cycle in use. | |

Table 8.1.2.2.2-3: Requirement to measure TDD intra-frequency cells when eDRX_CONN cycle is used

| eDRX_CONN cycle length (s) | $T_{\text{measure_intra}}$ (s) (eDRX_CONN cycles) |
|---|--|
| $2.56 < \text{eDRX_CONN cycle} \leq 10.24$ | Note (5) |
| Note: Time depends upon the eDRX_CONN cycle in use. | |

The RSRP measurement accuracy for all measured cells shall be as specified in the sub-clauses 9.1.2.1 and 9.1.2.2, the RSRQ measurement accuracy for all measured cells shall be as specified in the sub-clause 9.1.5.1, and the RS-SINR measurement accuracy for all measured cells shall be as specified in the sub-clause 9.1.17.2.1.

8.1.2.2.2.1 Measurement Reporting Requirements

8.1.2.2.2.1.1 Periodic Reporting

Reported RSRP, RSRQ, and RS-SINR measurements contained in periodically triggered measurement reports shall meet the requirements in sections 9.1.2.1, 9.1.2.2, 9.1.5.1, and 9.1.17.2.1, respectively.

8.1.2.2.2.1.2 Event-triggered Periodic Reporting

Reported RSRP, RSRQ, and RS-SINR measurements contained in event triggered periodic measurement reports shall meet the requirements in sections 9.1.2.1, 9.1.2.2, 9.1.5.1, and 9.1.17.2.1, respectively.

The first report in event triggered periodic measurement reporting shall meet the requirements specified in clause 8.1.2.2.2.1.3.

8.1.2.2.2.1.3 Event Triggered Reporting

Reported RSRP, RSRQ, and RS-SINR measurements contained in event triggered measurement reports shall meet the requirements in sections 9.1.2.1, 9.1.2.2, 9.1.5.1, and 9.1.17.2.1, respectively.

The UE shall not send any event triggered measurement reports, as long as no reporting criteria are fulfilled.

The measurement reporting delay is defined as the time between an event that will trigger a measurement report and the point when the UE starts to transmit the measurement report over the air interface. This requirement assumes that the measurement report is not delayed by other RRC signalling on the DCCH. This measurement reporting delay excludes a delay uncertainty resulted when inserting the measurement report to the TTI of the uplink DCCH. The delay uncertainty is: $2 \times TTI_{DCCH}$. This measurement reporting delay excludes a delay which caused by no UL resources for UE to send the measurement report.

The event triggered measurement reporting delay, measured without L3 filtering shall be less than $T_{identify_intra}$ defined in Clause 8.1.2.2.2. When L3 filtering is used or IDC autonomous denial is configured or the UE is performing reception and/or transmission for ProSe Direct Discovery and/or ProSe Direct Communication, an additional delay can be expected.

If a cell which has been detectable at least for the time period $T_{identify_intra}$ defined in clause 8.1.2.2.2 becomes undetectable for a period ≤ 5 seconds and then the cell becomes detectable again and triggers an event, the event triggered measurement reporting delay shall be less than $T_{measure_intra}$ provided the timing to that cell has not changed more than $\pm 50 T_s$ and the L3 filter has not been used. When L3 filtering is used or IDC autonomous denial is configured or the UE is performing reception and/or transmission for ProSe Direct Discovery and/or ProSe Direct Communication, an additional delay can be expected.

8.1.2.2.3 E-UTRAN FDD intra frequency measurements with autonomous gaps

8.1.2.2.3.1 Identification of a new CGI of E-UTRA cell with autonomous gaps

No explicit neighbour list is provided to the UE for identifying a new CGI of E-UTRA cell. The UE shall identify and report the CGI when requested by the network for the purpose 'reportCGI'. The UE may make autonomous gaps in downlink reception and uplink transmission for receiving MIB and SIB1 message according to clause 5.5.3.1 of TS 36.331 [2]. Note that a UE is not required to use autonomous gap if si-RequestForHO is set to false. If autonomous gaps are used for measurement with the purpose of 'reportCGI', regardless of whether DRX or eDRX_CONN is used or not, or whether SCell(s) are configured or not, the UE shall be able to identify a new CGI of E-UTRA cell within:

$$T_{identify_CGI, intra} = T_{basic_identify_CGI, intra} \quad ms$$

Where

$T_{basic_identify_CGI, intra} = 150$ ms. This is the time period used in the above equation where the maximum allowed time for the UE to identify a new CGI of an E-UTRA cell is defined, provided that the E-UTRA cell has been already identified by the UE.

A cell shall be considered identifiable following conditions are fulfilled:

- RSRP related side conditions given in Clause 9.1 are fulfilled for a corresponding Band,
- SCH_{RP} and SCH_{Es/Iot} according to Annex B.2.2 for a corresponding Band

The MIB of an E-UTRA cell whose CGI is identified shall be considered decodable by the UE provided the PBCH demodulation requirements are met according to [5].

The requirement for identifying a new CGI of an E-UTRA cell within $T_{basic_identify_CGI, intra}$ is applicable when no DRX is used as well as when any of the DRX or eDRX_CONN cycles specified in TS 36.331 [2] is used.

Within the time, $T_{identify_CGI, intra}$ ms, over which the UE identifies the new CGI of E-UTRA cell, the UE shall transmit at least 60 ACK/NACKs on PCell or each of activated SCell(s), provided that:

- there is continuous DL data allocation,
- no DRX and no eDRX_CONN cycle is used,
- no measurement gaps are configured,

- only one code word is transmitted in each subframe,
- no MBSFN subframes are configured in the PCell or each of activated SCell(s).

8.1.2.2.3.2 ECGI Reporting Delay

The ECGI reporting delay occurs due to the delay uncertainty when inserting the ECGI measurement report to the TTI of the uplink DCCH. The delay uncertainty is twice the TTI of the uplink DCCH. In case DRX is used, the ECGI reporting may be delayed until the next DRX cycle. In case eDRX_CONN is used, the ECGI reporting may be delayed until the next eDRX_CONN cycle. If IDC autonomous denial is configured, an additional delay can be expected.

8.1.2.2.4 E-UTRAN TDD intra frequency measurements with autonomous gaps

8.1.2.2.4.1 Identification of a new CGI of E-UTRA cell with autonomous gaps

No explicit neighbour list is provided to the UE for identifying a new CGI of E-UTRA cell. The UE shall identify and report the CGI when requested by the network for the purpose 'reportCGI'. The UE may make autonomous gaps in downlink reception and uplink transmission for receiving MIB and SIB1 messages according to clause 5.5.3.1 of TS 36.331 [2]. Note that a UE is not required to use autonomous gap if si-RequestForHO is set to false. If autonomous gaps are used for measurement with the purpose of 'reportCGI', regardless of whether DRX or eDRX_CONN is used or not, or whether SCell(s) are configured or not, the UE shall be able to identify a new CGI of E-UTRA cell within:

$$T_{\text{identify_CGI, intra}} = T_{\text{basic_identify_CGI, intra}} \quad \text{ms}$$

Where

$T_{\text{basic_identify_CGI, intra}} = 150$ ms. This is the time period used in the above equation where the maximum allowed time for the UE to identify a new CGI of an E-UTRA cell is defined, provided that the E-UTRA cell has been already identified by the UE.

A cell shall be considered identifiable when the following conditions are fulfilled:

- RSRP related side conditions given in Clause 9.1 are fulfilled for a corresponding Band,
- SCH_RP and SCH Ês/Iot according to Annex B.2.2 for a corresponding Band

The MIB of an E-UTRA cell whose CGI is identified shall be considered decodable by the UE provided the PBCH demodulation requirements are met according to [5].

The requirement for identifying a new CGI of an E-UTRA cell within $T_{\text{basic_identify_CGI, intra}}$ is applicable when no DRX is used as well as when any of the DRX or eDRX_CONN cycles specified in TS 36.331 [2] is used.

Within the time, $T_{\text{identify_CGI, intra}}$ ms, over which the UE identifies the new CGI of E-UTRA cell, the UE shall be able to transmit at least the number of ACK/NACKs stated in Table 8.1.2.2.4.1-1 on PCell or each of activated SCell(s), provided that:

- there is continuous DL data allocation,
- no DRX and no eDRX_CONN cycle is used,
- no measurement gaps are configured,
- only one code word is transmitted in each subframe,
- no MBSFN subframes are configured in the PCell or each of activated SCell(s).

Table 8.1.2.2.4.1-1: Requirement on minimum number of ACK/NACKs to transmit during $T_{\text{basic_identify_CGI, intra}}$

| UL/DL configuration | Minimum number of transmitted ACK/NACKs |
|---------------------|---|
| 0 (Note 1) | 18 |
| 1 | 35 |
| 2 | 43 |

| | |
|---|----|
| 3 | 36 |
| 4 | 39 |
| 5 | 42 |
| 6 | 30 |
| Note 1: When a UE is configured with EIMTA- <i>MainConfigServCell</i> via RRC signalling [2] only this requirement shall apply. | |

8.1.2.2.4.2 ECGI Reporting Delay

The ECGI reporting delay occurs due to the delay uncertainty when inserting the ECGI measurement report to the TTI of the uplink DCCH. The delay uncertainty is twice the TTI of the uplink DCCH. In case DRX is used, the ECGI reporting may be delayed until the next DRX cycle. In case eDRX_CONN is used, the ECGI reporting may be delayed until the next eDRX_CONN cycle. If IDC autonomous denial is configured, an additional delay can be expected.

8.1.2.3 E-UTRAN inter frequency measurements

The UE shall be able to identify new inter-frequency cells and perform RSRP, RSRQ, and RS-SINR measurements of identified inter-frequency cells if carrier frequency information is provided by the PCell, even if no explicit neighbour list with physical layer cell identities is provided.

8.1.2.3.1 E-UTRAN FDD – FDD inter frequency measurements

8.1.2.3.1.1 E-UTRAN FDD – FDD inter frequency measurements when no DRX is used

When measurement gaps are scheduled, or the UE supports capability of conducting such measurements without gaps, the UE shall be able to identify a new FDD inter-frequency within $T_{\text{Identify_Inter}}$ according to the following expression:

$$T_{\text{Identify_Inter}} = T_{\text{Basic_Identify_Inter}} \cdot \frac{480}{T_{\text{Inter1}}} \cdot N_{\text{freq},n} \cdot K_n \quad \text{ms (normal performance) and}$$

$$T_{\text{Identify_Inter}} = T_{\text{Basic_Identify_Inter}} \cdot \frac{480}{T_{\text{Inter1}}} \cdot N_{\text{freq},r} \cdot K_r \quad \text{ms (reduced performance)}$$

Where:

$T_{\text{Basic_Identify_Inter}} = 480$ ms. It is the time period used in the inter frequency equation where the maximum allowed time for the UE to identify a new FDD inter-frequency cell is defined.

$N_{\text{freq},n}$, $N_{\text{freq},r}$, K_n and K_r are defined in clause 8.1.2.1.1 and T_{inter1} is defined in clause 8.1.2.1

A cell shall be considered detectable provided following conditions are fulfilled:

- RSRP_{dBm} and $\text{RSRP } \hat{E}_s/\text{Iot}$ according to Annex B.2.3 for a corresponding Band,
- other RSRP related side conditions given in Sections 9.1.3.1 and 9.1.3.2 are fulfilled for a corresponding Band,
- RSRQ related side conditions given in Sections 9.1.6.1 and 9.1.6.2 are fulfilled for a corresponding Band,
- RS-SINR related side conditions given in Sections 9.1.17.3.1 and 9.1.17.3.2 are fulfilled for a corresponding Band₂
- $\text{SCH_RP}_{\text{dBm}}$ and $\text{SCH } \hat{E}_s/\text{Iot}$ according to Annex B.2.3 for a corresponding Band.

When measurement gaps are scheduled for FDD inter frequency measurements, or the UE supports capability of conducting such measurements without gaps, the UE physical layer shall be capable of reporting RSRP, RSRQ, and RS-SINR measurements to higher layers with measurement accuracy as specified in sub-clauses 9.1.3.1, 9.1.3.2, 9.1.6.1, 9.1.6.2, 9.1.17.3.1 and 9.1.17.3.2, respectively, with measurement period given by table 8.1.2.3.1.1-1.

Table 8.1.2.3.1.1-1: Measurement period and measurement bandwidth

| Configuration | Physical Layer Measurement period: $T_{\text{Measurement_Period_Inter_FDD}}$ [ms] (normal performance) | Physical Layer Measurement period: $T_{\text{Measurement_Period_Inter_FDD}}$ [ms] (reduced performance) | Measurement bandwidth [RB] |
|--------------------------------------|---|--|----------------------------|
| 0 | $480 \times K_n \times N_{\text{freq},n}$ | $480 \times K_r \times N_{\text{freq},r}$ | 6 |
| 1 (Note) | $240 \times K_n \times N_{\text{freq},n}$ | $240 \times K_r \times N_{\text{freq},r}$ | 50 |
| Note: This configuration is optional | | | |

The UE shall be capable of performing RSRP, RSRQ, and RS-SINR measurements of at least 4 inter-frequency cells per FDD inter-frequency for up to 3 FDD inter-frequencies or 8 FDD inter-frequencies if the UE supports Increased UE carrier monitoring E-UTRA and the UE physical layer shall be capable of reporting RSRP, RSRQ, and RS-SINR measurements to higher layers with the measurement period defined in Table 8.1.2.3.1.1-1.

8.1.2.3.1.1.1 Measurement Reporting Requirements

8.1.2.3.1.1.1.1 Periodic Reporting

Reported RSRP, RSRQ, and RS-SINR measurements contained in periodically triggered measurement reports shall meet the requirements in sections 9.1.3.1, 9.1.3.2, 9.1.6.1, 9.1.6.2, 9.1.17.3.1 and 9.1.17.3.2, respectively.

8.1.2.3.1.1.1.2 Event-triggered Periodic Reporting

Reported RSRP, RSRQ, and RS-SINR measurements contained in event triggered periodic measurement reports shall meet the requirements in sections 9.1.3.1, 9.1.3.2, 9.1.6.1, 9.1.6.2, 9.1.17.3.1 and 9.1.17.3.2, respectively.

The first report in event triggered periodic measurement reporting shall meet the requirements specified in clause 8.1.2.3.1.1.1.3.

8.1.2.3.1.1.1.3 Event Triggered Reporting

Reported RSRP, RSRQ, and RS-SINR measurements contained in event triggered measurement reports shall meet the requirements in sections 9.1.3.1, 9.1.3.2, 9.1.6.1, 9.1.6.2, 9.1.17.3.1 and 9.1.17.3.2, respectively.

The UE shall not send any event triggered measurement reports, as long as no reporting criteria are fulfilled.

The measurement reporting delay is defined as the time between an event that will trigger a measurement report and the point when the UE starts to transmit the measurement report over the air interface. This requirement assumes that the measurement report is not delayed by other RRC signalling on the DCCH. This measurement reporting delay excludes a delay uncertainty resulted when inserting the measurement report to the TTI of the uplink DCCH. The delay uncertainty is: $2 \times TTI_{\text{DCCH}}$. This measurement reporting delay excludes a delay which caused by no UL resources for UE to send the measurement report.

The event triggered measurement reporting delay, measured without L3 filtering shall be less than $T_{\text{identify_inter}}$ defined in clause 8.1.2.3.1.1. When L3 filtering is used or IDC autonomous denial is configured or the UE is performing reception and/or transmission for ProSe Direct Discovery and/or ProSe Direct Communication, an additional delay can be expected.

If a cell which has been detectable at least for the time period $T_{\text{identify_inter}}$ defined in clause 8.1.2.3.1.1 and then triggers the measurement report as per TS 36.331 [2], the event triggered measurement reporting delay shall be less than $T_{\text{Measurement_Period_Inter_FDD}}$ defined in clause 8.1.2.3.1.1 provided the timing to that cell has not changed more than ± 50 Ts while measurement gap has not been available and the L3 filter has not been used. When L3 filtering is used or IDC autonomous denial is configured or the UE is performing reception and/or transmission for ProSe Direct Discovery and/or ProSe Direct Communication, an additional delay can be expected.

8.1.2.3.1.2 E-UTRAN FDD – FDD inter frequency measurements when DRX is used

When DRX or eDRX_CONN is in use, either measurement gaps are scheduled or the UE supports capability of conducting such measurements without gaps, the UE shall be able to identify a new detectable E-UTRAN FDD inter frequency cell within $T_{\text{identify_inter}}$. When DRX is in use, $T_{\text{identify_inter}}$ is as defined in Table 8.1.2.3.1.2-1, and when eDRX_CONN is in use, $T_{\text{identify_inter}}$ is as defined in Table 8.1.2.3.1.2-1A.

Table 8.1.2.3.1.2-1: Requirement to identify a newly detectable FDD interfrequency cell

| DRX cycle length (s) | T _{identify_inter} (s) (DRX cycles), normal performance | | T _{identify_inter} (s) (DRX cycles), reduced performance | |
|--|--|--|--|--|
| | Gap period = 40 ms | Gap period = 80 ms | Gap period = 40 ms | Gap period = 80 ms |
| ≤0.16 | Non DRX Requirements in clause 8.1.2.3.1.1 are applicable | Non DRX Requirements in clause 8.1.2.3.1.1 are applicable | Non DRX Requirements in clause 8.1.2.3.1.1 are applicable | Non DRX Requirements in clause 8.1.2.3.1.1 are applicable |
| 0.256 | $5.12 \cdot K_n \cdot N_{\text{freq},n}$ ($20 \cdot K_n \cdot N_{\text{freq},n}$) | $7.68 \cdot K_n \cdot N_{\text{freq},n}$ ($30 \cdot K_n \cdot N_{\text{freq},n}$) | $5.12 \cdot K_r \cdot N_{\text{freq},r}$ ($20 \cdot K_r \cdot N_{\text{freq},r}$) | $7.68 \cdot K_r \cdot N_{\text{freq},r}$ ($30 \cdot K_r \cdot N_{\text{freq},r}$) |
| 0.32 | $6.4 \cdot K_n \cdot N_{\text{freq},n}$ ($20 \cdot K_n \cdot N_{\text{freq},n}$) | $7.68 \cdot K_n \cdot N_{\text{freq},n}$ ($24 \cdot K_n \cdot N_{\text{freq},n}$) | $6.4 \cdot K_r \cdot N_{\text{freq},r}$ ($20 \cdot K_r \cdot N_{\text{freq},r}$) | $7.68 \cdot K_r \cdot N_{\text{freq},r}$ ($24 \cdot K_r \cdot N_{\text{freq},r}$) |
| 0.32 < DRX-cycle ≤ 2.56 | Note ($20 \cdot K_n \cdot N_{\text{freq},n}$) | Note ($20 \cdot K_n \cdot N_{\text{freq},n}$) | Note ($20 \cdot K_r \cdot N_{\text{freq},r}$) | Note ($20 \cdot K_r \cdot N_{\text{freq},r}$) |
| Note: Time depends upon the DRX cycle in use | | | | |

Table 8.1.2.3.1.2-1A: Requirement to identify a newly detectable FDD inter-frequency cell when eDRX_CONN cycle is used

| eDRX_CONN cycle length (s) | T _{identify_inter} (s) (eDRX_CONN cycles), normal performance | | T _{identify_inter} (s) (eDRX_CONN cycles), reduced performance | |
|--|--|---|---|---|
| | Gap period = 40 ms | Gap period = 80 ms | Gap period = 40 ms | Gap period = 80 ms |
| 2.56 < eDRX_CONN cycle ≤ 10.24 | Note ($20 \cdot K_n \cdot N_{\text{freq},n}$) | Note ($20 \cdot K_n \cdot N_{\text{freq},n}$) | Note ($20 \cdot K_r \cdot N_{\text{freq},r}$) | Note ($20 \cdot K_r \cdot N_{\text{freq},r}$) |
| Note: Time depends upon the eDRX_CONN cycle in use | | | | |

A cell shall be considered detectable provided following conditions are fulfilled:

- $RSRP_{\text{dBm}}$ and $RSRP \hat{E}_s / I_{\text{ot}}$ according to Annex B.2.3 for a corresponding Band,
- other RSRP related side conditions given in Clause 9.1.3.1 and 9.1.3.2 are fulfilled for a corresponding Band,
- RSRQ related side conditions given in Sections 9.1.6.1 and 9.1.6.2 are fulfilled for a corresponding Band,
- RS-SINR related side conditions given in Sections 9.1.17.3.1 and 9.1.17.3.2 are fulfilled for a corresponding Band_x
- SCH_RP_{dBm} $SCH \hat{E}_s / I_{\text{ot}}$ according to Annex B.2.3 for a corresponding Band.

When DRX or eDRX_CONN is in use, the UE shall be capable of performing RSRP, RSRQ, and RS-SINR measurements of at least 4 inter-frequency cells per FDD inter-frequency and the UE physical layer shall be capable of reporting RSRP, RSRQ, and RS-SINR measurements to higher layers with the measurement period $T_{\text{measure_inter}}$, either measurement gaps are scheduled or the UE supports capability of conducting such measurements without gaps. When DRX is used, $T_{\text{measure_inter}}$ is as defined in Table 8.1.2.3.1.2-2, and when eDRX_CONN is in use, $T_{\text{measure_inter}}$ is as defined in Table 8.1.2.3.1.2-3.

Table 8.1.2.3.1.2-2: Requirement to measure FDD interfrequency cells

| DRX cycle length (s) | T _{measure_inter} (s) (DRX cycles) (normal performance) | T _{measure_inter} (s) (DRX cycles) (reduced performance) |
|--|--|---|
| ≤0.08 | Non DRX Requirements in clause 8.1.2.3.1.1 are applicable | Non DRX Requirements in clause 8.1.2.3.1.1 are applicable |
| 0.08 < DRX-cycle ≤ 2.56 | Note ($5 \cdot K_n \cdot N_{\text{freq},n}$) | Note ($5 \cdot K_r \cdot N_{\text{freq},r}$) |
| Note: Time depends upon the DRX cycle in use | | |

Table 8.1.2.3.1.2-3: Requirement to measure FDD inter-frequency cells when eDRX_CONN cycle is used

| eDRX_CONN cycle length (s) | $T_{\text{measure_inter}}$ (s) (eDRX_CONN cycles) (normal performance) | $T_{\text{measure_inter}}$ (s) (eDRX_CONN cycles) (reduced performance) |
|--|---|--|
| $2.56 < \text{eDRX_CONN cycle} \leq 10.24$ | Note ($5 * K_n * N_{\text{freq},n}$) | Note ($5 * K_r * N_{\text{freq},r}$) |
| Note: Time depends upon the eDRX_CONN cycle in use | | |

The RSRP measurement accuracy for all measured cells shall be as specified in the sub-clauses 9.1.3.1 and 9.1.3.2, the RSRQ measurement accuracy for all measured cells shall be as specified in the sub-clauses 9.1.6.1 and 9.1.6.2, and the RS-SINR measurement accuracy for all measured cells shall be as specified in the sub-clauses 9.1.17.3.1 and 9.1.17.3.2.

8.1.2.3.1.2.1 Measurement Reporting Requirements

8.1.2.3.1.2.1.1 Periodic Reporting

Reported RSRP, RSRQ, and RS-SINR measurements contained in periodically triggered measurement reports shall meet the requirements in sections 9.1.3.1, 9.1.3.2, 9.1.6.1, 9.1.6.2, 9.1.17.3.1 and 9.1.17.3.2, respectively.

8.1.2.3.1.2.1.2 Event-triggered Periodic Reporting

Reported RSRP, RSRQ, and RS-SINR measurements contained in event triggered periodic measurement reports shall meet the requirements in sections 9.1.3.1, 9.1.3.2, 9.1.6.1, 9.1.6.2, 9.1.17.3.1 and 9.1.17.3.2, respectively.

The first report in event triggered periodic measurement reporting shall meet the requirements specified in clause 8.1.2.3.1.2.1.3.

8.1.2.3.1.2.1.3 Event Triggered Reporting

Reported RSRP, RSRQ, and RS-SINR measurements contained in event triggered measurement reports shall meet the requirements in sections 9.1.3.1, 9.1.3.2, 9.1.6.1, 9.1.6.2, 9.1.17.3.1 and 9.1.17.3.2, respectively.

The UE shall not send any event triggered measurement reports, as long as no reporting criteria are fulfilled.

The measurement reporting delay is defined as the time between an event that will trigger a measurement report and the point when the UE starts to transmit the measurement report over the air interface. This requirement assumes that that the measurement report is not delayed by other RRC signalling on the DCCH. This measurement reporting delay excludes a delay uncertainty resulted when inserting the measurement report to the TTI of the uplink DCCH. The delay uncertainty is: $2 \times TTI_{\text{DCCH}}$. This measurement reporting delay excludes a delay which caused by no UL resources for UE to send the measurement report.

The event triggered measurement reporting delay, measured without L3 filtering shall be less than $T_{\text{identify_inter}}$ defined in clause 8.1.2.3.1.2. When L3 filtering is used or IDC autonomous denial is configured or the UE is performing reception and/or transmission for ProSe Direct Discovery and/or ProSe Direct Communication, an additional delay can be expected.

If a cell which has been detectable at least for the time period $T_{\text{identify_inter}}$ defined in clause 8.1.2.3.1.2 and then triggers the measurement report as per TS 36.331 [2], the event triggered measurement reporting delay shall be less than $T_{\text{measure_inter}}$ defined in clause 8.1.2.3.1.2 provided the timing to that cell has not changed more than $\pm 50 T_s$ while measurement gap has not been available and the L3 filter has not been used. When L3 filtering is used or IDC autonomous denial is configured or the UE is performing reception and/or transmission for ProSe Direct Discovery and/or ProSe Direct Communication, an additional delay can be expected.

8.1.2.3.2 E-UTRAN TDD – TDD inter frequency measurements

8.1.2.3.2.1 E-UTRAN TDD – TDD inter frequency measurements when no DRX is used

When measurement gaps are scheduled, or the UE supports capability of conducting such measurements without gaps, the UE shall be able to identify a new TDD inter-frequency within $T_{\text{Identify_Inter}}$ according to the following expression:

- When configuration 0 or configuration 1 in Table 8.1.2.3.2.1-1 is applied,

$$T_{\text{Identify_Inter}} = T_{\text{Basic_Identify_Inter}} \cdot \frac{480}{T_{\text{Inter1}}} \cdot N_{\text{freq}} \quad \text{ms},$$

- When configuration 2 or configuration 3 in Table 8.1.2.3.2.1-1 is applied,

$$T_{\text{Identify_Inter}} = T_{\text{Basic_Identify_Inter}} \cdot \frac{480}{T_{\text{Inter1}}} \cdot N_{\text{freq}} + 240 \cdot N_{\text{freq}} \quad \text{ms}.,$$

$T_{\text{Basic_Identify_Inter}} = 480$ ms. It is the time period used in the inter frequency equation where the maximum allowed time for the UE to identify a new TDD inter-frequency cell is defined.

N_{freq} is defined in clause 8.1.2.1.1 and T_{inter1} is defined in clause 8.1.2.1

A cell shall be considered detectable provided following conditions are fulfilled:

- RSRP_{dBm} and $\text{RSRP } \hat{E}_s/\text{Iot}$ according to Annex B.2.3 for a corresponding Band,
- other RSRP related side conditions given in Clause 9.1.3.1 and 9.1.3.2 are fulfilled for a corresponding Band,
- RSRQ related side conditions given in Sections 9.1.6.1 and 9.1.6.2 are fulfilled for a corresponding Band,
- RS-SINR related side conditions given in Sections 9.1.17.3.1 and 9.1.17.3.2 are fulfilled for a corresponding Band,
- $\text{SCH_RP}_{\text{dBm}}$ and $\text{SCH } \hat{E}_s/\text{Iot}$ according to Annex B.2.3 for a corresponding Band.

When measurement gaps are scheduled for TDD inter frequency measurements, or the UE supports capability of conducting such measurements without gaps, the UE physical layer shall be capable of reporting RSRP, RSRQ, and RS-SINR measurements to higher layers with measurement accuracy as specified in sub-clauses 9.1.3.1, 9.1.3.2, 9.1.6.1, 9.1.6.2, 9.1.17.3.1 and 9.1.17.3.2, respectively, with measurement period ($T_{\text{Measurement_Period_TDD_Inter}}$) given by table 8.1.2.3.2.1-1:

Table 8.1.2.3.2.1-1: $T_{\text{Measurement_Period_TDD_Inter}}$ for different configurations

| Configuration | Measurement bandwidth [RB] | Number of UL/DL sub-frames per half frame (5 ms) | | DwPTS | | $T_{\text{Measurement_Period_TDD_Inter}}$ [ms] (normal performance) | $T_{\text{Measurement_Period_TDD_Inter}}$ [ms] (reduced performance) |
|--|----------------------------|--|----|-------------------|-------------------|--|---|
| | | DL | UL | Normal CP | Extended CP | | |
| 0 | 6 | 2 | 2 | $19760 \cdot T_s$ | $20480 \cdot T_s$ | $480 \times K_n \times N_{\text{freq},n}$ | $480 \times K_r \times N_{\text{freq},r}$ |
| 1 (Note 1) | 50 | 2 | 2 | $19760 \cdot T_s$ | $20480 \cdot T_s$ | $240 \times K_n \times N_{\text{freq},n}$ | $240 \times K_r \times N_{\text{freq},r}$ |
| 2 | 6 | 1 | 3 | $19760 \cdot T_s$ | $20480 \cdot T_s$ | $720 \times K_n \times N_{\text{freq},n}$ | $720 \times K_r \times N_{\text{freq},r}$ |
| 3 (Note 1) | 50 | 1 | 3 | $19760 \cdot T_s$ | $20480 \cdot T_s$ | $480 \times K_n \times N_{\text{freq},n}$ | $480 \times K_r \times N_{\text{freq},r}$ |
| Note 1: This configuration is optional | | | | | | | |
| Note 2: T_s is defined in TS 36.211 [16] | | | | | | | |
| Note 3: N/A. | | | | | | | |

The UE shall be capable of performing RSRP, RSRQ, RS-SINR measurements of at least 4 inter-frequency cells per TDD inter-frequency and the UE physical layer shall be capable of reporting RSRP, RSRQ, and RS-SINR measurements to higher layers with the measurement period $T_{\text{Measurement_Period_TDD_Inter}}$.

8.1.2.3.2.1.1 Measurement Reporting Requirements

8.1.2.3.2.1.1.1 Periodic Reporting

Reported RSRP, RSRQ, and RS-SINR measurements contained in periodically triggered measurement reports shall meet the requirements in sections 9.1.3.1, 9.1.3.2, 9.1.6.1, 9.1.6.2, 9.1.17.3.1 and 9.1.17.3.2, respectively.

8.1.2.3.2.1.1.2 Event-triggered Periodic Reporting

Reported RSRP, RSRQ, and RS-SINR measurements contained in event triggered periodic measurement reports shall meet the requirements in sections 9.1.3.1, 9.1.3.2, 9.1.6.1, 9.1.6.2, 9.1.17.3.1 and 9.1.17.3.2, respectively.

The first report in event triggered periodic measurement reporting shall meet the requirements specified in clause 8.1.2.3.2.1.1.3.

8.1.2.3.2.1.1.3 Event Triggered Reporting

Reported RSRP, RSRQ, and RS-SINR measurements contained in event triggered measurement reports shall meet the requirements in sections 9.1.3.1, 9.1.3.2, 9.1.6.1, 9.1.6.2, 9.1.17.3.1 and 9.1.17.3.2, respectively.

The UE shall not send any event triggered measurement reports, as long as no reporting criteria are fulfilled.

The measurement reporting delay is defined as the time between an event that will trigger a measurement report and the point when the UE starts to transmit the measurement report over the air interface. This requirement assumes that the measurement report is not delayed by other RRC signalling on the DCCH. This measurement reporting delay excludes a delay uncertainty resulted when inserting the measurement report to the TTI of the uplink DCCH. The delay uncertainty is: $2 \times TTI_{\text{DCCH}}$. This measurement reporting delay excludes a delay which caused by no UL resources for UE to send the measurement report.

The event triggered measurement reporting delay, measured without L3 filtering shall be less than $T_{\text{Identify_Inter}}$ defined in clause 8.1.2.3.2.1. When L3 filtering is used or IDC autonomous denial or the UE is performing reception and/or transmission for ProSe Direct Discovery and/or ProSe Direct Communication, an additional delay can be expected.

If a cell which has been detectable at least for the time period $T_{\text{Identify_Inter}}$ defined in clause 8.1.2.3.2.1 and then triggers the measurement report as per TS 36.331 [2], the event triggered measurement reporting delay shall be less than $T_{\text{Measurement_Period_TDD_Inter}}$ defined in clause 8.1.2.3.2.1 provided the timing to that cell has not changed more than $\pm 50 T_s$ while measurementgap has not been available and the L3 filter has not been used. When L3 filtering is used or IDC autonomous denial is configured or the UE is performing reception and/or transmission for ProSe Direct Discovery and/or ProSe Direct Communication, an additional delay can be expected.

8.1.2.3.2.2 E-UTRAN TDD – TDD inter frequency measurements when DRX is used

When DRX or eDRX_CONN is in use, either measurement gaps are scheduled or the UE supports capability of conducting such measurements without gaps, the UE shall be able to identify a new detectable E-UTRAN TDD inter frequency cell within $T_{\text{Identify_inter}}$. When DRX is in use, $T_{\text{Identify_inter}}$ is as defined in Table 8.1.2.3.2.2-1, and when eDRX_CONN is in use $T_{\text{Identify_inter}}$ is as defined in Table 8.1.2.3.2.2-1A.

Table 8.1.2.3.2.2-1: Requirement to identify a newly detectable TDD interfrequency cell

| DRX cycle length (s) | $T_{\text{Identify_inter}}$ (s) (DRX cycles) (normal performance) | | $T_{\text{Identify_inter}}$ (s) (DRX cycles) (reduced performance) | |
|----------------------|--|---|---|---|
| | Gap period = 40 ms | Gap period = 80 ms | Gap period = 40 ms | Gap period = 80 ms |
| ≤ 0.16 | Non DRX Requirements in clause 8.1.2.3.2.1 are applicable | Non DRX Requirements in clause 8.1.2.3.2.1 are applicable | Non DRX Requirements in clause 8.1.2.3.2.1 are applicable | Non DRX Requirements in clause 8.1.2.3.2.1 are applicable |

| | | | | |
|--|--|--|--|--|
| 0.256 | $5.12 \cdot K_n \cdot N_{freq,n}$ ($20 \cdot K_n \cdot N_{freq,n}$) | $7.68 \cdot K_n \cdot N_{freq,n}$ ($30 \cdot K_n \cdot N_{freq,n}$) | $5.12 \cdot K_r \cdot N_{freq,r}$ ($20 \cdot K_r \cdot N_{freq,r}$) | $7.68 \cdot K_r \cdot N_{freq,r}$ ($30 \cdot K_r \cdot N_{freq,r}$) |
| 0.32 | $6.4 \cdot K_n \cdot N_{freq,n}$ ($20 \cdot K_n \cdot N_{freq,n}$) | $7.68 \cdot K_n \cdot N_{freq,n}$ ($24 \cdot K_n \cdot N_{freq,n}$) | $6.4 \cdot K_r \cdot N_{freq,r}$ ($20 \cdot K_r \cdot N_{freq,r}$) | $7.68 \cdot K_r \cdot N_{freq,r}$ ($24 \cdot K_r \cdot N_{freq,r}$) |
| 0.32 < DRX-cycle ≤ 2.56 | Note ($20 \cdot K_n \cdot N_{freq,n}$) | Note ($20 \cdot K_n \cdot N_{freq,n}$) | Note ($20 \cdot K_r \cdot N_{freq,r}$) | Note ($20 \cdot K_r \cdot N_{freq,r}$) |
| Note: Time depends upon the DRX cycle in use | | | | |

Table 8.1.2.3.2-1A: Requirement to identify a newly detectable TDD inter-frequency cell when eDRX_CONN cycle is used

| eDRX_CONN cycle length (s) | T _{identify_inter} (s) (eDRX_CONN cycles) (normal performance) | | T _{identify_inter} (s) (eDRX_CONN cycles) (reduced performance) | |
|--|---|--|--|--|
| | Gap period = 40 ms | Gap period = 80 ms | Gap period = 40 ms | Gap period = 80 ms |
| 2.56 < eDRX_CONN cycle ≤ 10.24 | Note ($20 \cdot K_n \cdot N_{freq,n}$) | Note ($20 \cdot K_n \cdot N_{freq,n}$) | Note ($20 \cdot K_r \cdot N_{freq,r}$) | Note ($20 \cdot K_r \cdot N_{freq,r}$) |
| Note: Time depends upon the eDRX_CONN cycle in use | | | | |

A cell shall be considered detectable provided following conditions are fulfilled:

- RSRP_{dBm} and RSRP Ês/Iot according to Annex B.2.3 for a corresponding Band,
- other RSRP related side conditions given in Clause 9.1.3.1 and 9.1.3.2 are fulfilled for a corresponding Band,
- RSRQ related side conditions given in Sections 9.1.6.1 and 9.1.6.2 are fulfilled for a corresponding Band,
- RS-SINR related side conditions given in Sections 9.1.17.3.1 and 9.1.17.3.2 are fulfilled for a corresponding Band,
- SCH_RP_{dBm} and SCH Ês/Iot according to Annex B.2.3 for a corresponding Band.

When DRX or eDRX_CONN is in use, the UE shall be capable of performing RSRP, RSRQ, and RS-SINR measurements of at least 4 inter-frequency cells per TDD inter-frequency for up to 3 TDD inter-frequencies and the UE physical layer shall be capable of reporting RSRP, RSRQ, and RS-SINR measurements to higher layers with the measurement period T_{measure_inter}, either measurement gaps are scheduled or the UE supports capability of conducting such measurements without gaps. When DRX is in use, T_{measure_inter} is as defined in Table 8.1.2.3.2.2-2, and when eDRX_CONN is in use, T_{measure_inter} is as defined in Table 8.1.2.3.2.2-3.

Table 8.1.2.3.2.2-2: Requirement to measure TDD interfrequency cells

| DRX cycle length (s) | T _{measure_inter} (s) (DRX cycles) (normal requirement) | T _{measure_inter} (s) (DRX cycles) (reduced requirement) |
|--|---|---|
| ≤ 0.08 | Non DRX Requirements in clause 8.1.2.3.2.1 are applicable | Non DRX Requirements in clause 8.1.2.3.2.1 are applicable |
| 0.128 | When configuration 2 non DRX Requirements in clause 8.1.2.3.2.1 are applicable, Otherwise Note ($5 \cdot K_n \cdot N_{freq,n}$) | When configuration 2 non DRX Requirements in clause 8.1.2.3.2.1 are applicable, Otherwise Note ($5 \cdot K_r \cdot N_{freq,r}$) |
| 0.128 < DRX-cycle ≤ 2.56 | Note ($5 \cdot K_n \cdot N_{freq,n}$) | Note ($5 \cdot K_r \cdot N_{freq,r}$) |
| Note: Time depends upon the DRX cycle in use | | |

Table 8.1.2.3.2.2-3: Requirement to measure TDD inter-frequency cells when eDRX_CONN cycle is used

| eDRX_CONN cycle length (s) | $T_{\text{measure_inter}}$ (s) (eDRX_CONN cycles) (normal requirement) | $T_{\text{measure_inter}}$ (s) (eDRX_CONN cycles) (reduced requirement) |
|--|---|--|
| $2.56 < \text{eDRX_CONN cycle} \leq 10.24$ | Note ($5 * K_n * N_{\text{freq},n}$) | Note ($5 * K_r * N_{\text{freq},r}$) |
| Note: Time depends upon the eDRX_CONN cycle in use | | |

The RSRP measurement accuracy for all measured cells shall be as specified in the sub-clauses 9.1.3.1 and 9.1.3.2, the RSRQ measurement accuracy for all measured cells shall be as specified in the sub-clauses 9.1.6.1 and 9.1.6.2, and the RS-SINR measurement accuracy for all measured cells shall be as specified in the sub-clauses 9.1.17.3.1 and 9.1.17.3.2.

8.1.2.3.2.2.1 Measurement Reporting Requirements

8.1.2.3.2.2.1.1 Periodic Reporting

Reported RSRP, RSRQ, and RS-SINR measurements contained in periodically triggered measurement reports shall meet the requirements in sections 9.1.3.1, 9.1.3.2, 9.1.6.1, 9.1.6.2, 9.1.17.3.1 and 9.1.17.3.2, respectively.

8.1.2.3.2.2.1.2 Event-triggered Periodic Reporting

Reported RSRP, RSRQ, and RS-SINR measurements contained in event triggered periodic measurement reports shall meet the requirements in clause 9.1.3.1, 9.1.3.2, 9.1.6.1, 9.1.6.2, 9.1.17.3.1 and 9.1.17.3.2, respectively.

The first report in event triggered periodic measurement reporting shall meet the requirements specified in clause 8.1.2.3.2.2.1.3.

8.1.2.3.2.2.1.3 Event Triggered Reporting

Reported RSRP, RSRQ, and RS-SINR measurements contained in event triggered measurement reports shall meet the requirements in clause 9.1.3.1, 9.1.3.2, 9.1.6.1, 9.1.6.2, 9.1.17.3.1 and 9.1.17.3.2, respectively.

The UE shall not send any event triggered measurement reports, as long as no reporting criteria are fulfilled.

The measurement reporting delay is defined as the time between an event that will trigger a measurement report and the point when the UE starts to transmit the measurement report over the air interface. This requirement assumes that the measurement report is not delayed by other RRC signalling on the DCCH. This measurement reporting delay excludes a delay uncertainty resulted when inserting the measurement report to the TTI of the uplink DCCH. The delay uncertainty is: $2 \times TTI_{\text{DCCH}}$. This measurement reporting delay excludes a delay which caused by no UL resources for UE to send the measurement report.

The event triggered measurement reporting delay, measured without L3 filtering shall be less than $T_{\text{Identify_Inter}}$ defined in Clause 8.1.2.3.2.2. When L3 filtering is used or IDC autonomous denial is configured or the UE is performing reception and/or transmission for ProSe Direct Discovery and/or ProSe Direct Communication, an additional delay can be expected.

If a cell which has been detectable at least for the time period $T_{\text{Identify_Inter}}$ in clause 8.1.2.3.2.2 and then triggers the measurement report as per TS 36.331 [2], the event triggered measurement reporting delay shall be less than $T_{\text{measure_inter}}$ in clause 8.1.2.3.2.2 provided the timing to that cell has not changed more than ± 50 Ts while measurement gap has not been available and the L3 filter has not been used. When L3 filtering is used or IDC autonomous denial is configured or the UE is performing reception and/or transmission for ProSe Direct Discovery and/or ProSe Direct Communication, an additional delay can be expected.

8.1.2.3.3 E-UTRAN TDD – FDD inter frequency measurements

8.1.2.3.3.1 E-UTRAN TDD – FDD inter frequency measurements when no DRX is used

The requirements in this clause shall apply to UE supporting FDD and TDD.

The requirements in clause 8.1.2.3.1.1 also apply for this section.

8.1.2.3.3.2 E-UTRAN TDD – FDD inter frequency measurements when DRX is used

The requirements in this clause shall apply to UE supporting FDD and TDD.

When DRX or eDRX_CONN cycle is used, the requirements in clause 8.1.2.3.1.2 shall also apply for this section.

8.1.2.3.4 E-UTRAN FDD – TDD inter frequency measurements

8.1.2.3.4.1 E-UTRAN FDD – TDD inter frequency measurements when no DRX is used

The requirements in this clause shall apply to UE supporting FDD and TDD.

The requirements in clause 8.1.2.3.2.1 also apply for this section.

8.1.2.3.4.2 E-UTRAN FDD – TDD inter frequency measurements when DRX is used

The requirements in this clause shall apply to UE supporting FDD and TDD.

When DRX or eDRX_CONN cycle is used, the requirements in clause 8.1.2.3.2.2 shall also apply for this section.

8.1.2.3.5 E-UTRAN FDD-FDD inter frequency measurements with autonomous gaps

8.1.2.3.5.1 Identification of a new CGI of E-UTRA FDD cell with autonomous gaps

No explicit neighbour list is provided to the UE for identifying a new CGI of E-UTRA cell. The UE shall identify and report the CGI when requested by the network for the purpose of ‘reportCGI’. The UE may make autonomous gaps in both downlink reception and uplink transmission for receiving MIB and SIB1 message according to clause 5.5.3.1 of TS 36.331 [2]. Note that a UE is not required to use autonomous gap if si-RequestForHO is set to false. If autonomous gaps are used for measurement with the purpose of ‘reportCGI’, regardless of whether DRX or eDRX_CONN is used or not, or whether SCell(s) are configured or not, the UE shall be able to identify a new CGI of E-UTRA cell within:

$$T_{\text{identify_CGI,inter}} = T_{\text{basic_identify_CGI,inter}} \quad ms$$

Where

$T_{\text{basic_identify_CGI,inter}} = 150$ ms. This is the time period used in the above equation where the maximum allowed time for the UE to identify a new CGI of E-UTRA cell is defined, provided that the E-UTRA cell has been already identified by the UE.

A cell shall be considered identifiable following conditions are fulfilled:

- RSRP related side conditions given in Clause 9.1 are fulfilled for a corresponding Band,
- $SCH_RP|_{dBm}$ and $SCH\ \hat{E}s/Iot$ according to Annex B.2.3 for a corresponding Band.

The MIB of an E-UTRA cell whose CGI is identified shall be considered decodable by the UE provided the PBCH demodulation requirements are met according to [5].

The requirement for identifying a new CGI of an E-UTRA cell within $T_{\text{basic_identify_CGI,inter}}$ is applicable when no DRX is used as well as when any of the DRX or eDRX_CONN cycles specified in TS 36.331 [2] is used.

Within the time, $T_{\text{identify_CGI,intra}}$ ms, over which the UE identifies the new CGI of E-UTRA cell, the UE shall transmit at least 60 ACK/NACKs on PCell or each of activated SCell(s), provided that:

- there is continuous DL data allocation,
- no DRX and no eDRX_CONN cycle is used,
- no measurement gaps are configured,
- only one code word is transmitted in each subframe,
- no MBSFN subframes are configured in the PCell or each of activated SCell(s).

8.1.2.3.5.2 ECGI Reporting Delay

The ECGI reporting delay occurs due to the delay uncertainty when inserting the ECGI measurement report to the TTI of the uplink DCCH. The delay uncertainty is twice the TTI of the uplink DCCH. In case DRX is used, the ECGI reporting may be delayed until the next DRX cycle. In case eDRX_CONN is used, the ECGI reporting may be delayed until the next eDRX_CONN cycle. If IDC autonomous denial is configured, an additional delay can be expected.

8.1.2.3.6 E-UTRAN TDD-FDD inter frequency measurements using autonomous gaps

The requirements in this clause shall apply to UE supporting FDD and TDD.

8.1.2.3.6.1 Identification of a new CGI of E-UTRA FDD cell with autonomous gaps

No explicit neighbour list is provided to the UE for identifying a new CGI of E-UTRA cell. The UE shall identify and report the CGI when requested by the network for the purpose of 'reportCGI'. The UE may make autonomous gaps in both downlink reception and uplink transmission for receiving MIB and SIB1 message according to clause 5.5.3.1 of TS 36.331 [2]. Note that a UE is not required to use autonomous gap if si-RequestForHO is set to false. If autonomous gaps are used for measurement with the purpose of 'reportCGI', regardless of whether DRX or eDRX_CONN is used or not, or whether SCell(s) are configured or not, the UE shall be able to identify a new CGI of E-UTRA cell within:

$$T_{\text{identify_CGI,inter}} = T_{\text{basic_identify_CGI,inter}} \text{ ms}$$

Where

$T_{\text{basic_identify_CGI,inter}} = 150$ ms. This is the time period used in the above equation where the maximum allowed time for the UE to identify a new CGI of E-UTRA cell is defined, provided that the E-UTRA cell has been already identified by the UE.

A cell shall be considered identifiable following conditions are fulfilled:

- RSRP related side conditions given in Clause 9.1 are fulfilled for a corresponding Band,
- $SCH_RP|_{dBm}$ and $SCH\ \hat{E}s/Iot$ according to Annex B.2.4 for a corresponding Band.

The MIB of an E-UTRA cell whose CGI is identified shall be considered decodable by the UE provided the PBCH demodulation requirements are met according to [5].

The requirement for identifying a new CGI of an E-UTRA cell within $T_{\text{basic_identify_CGI,inter}}$ is applicable when no DRX is used as well as when any of the DRX or eDRX_CONN cycles specified in TS 36.331 [2] is used.

Within the time, $T_{\text{identify_CGI,inter}}$ ms, over which the UE identifies the new CGI of E-UTRA cell, the UE shall be able to transmit at least the number of ACK/NACKs stated in Table 8.1.2.3.6.1-1 on PCell or each of activated SCell(s), provided that:

- there is continuous DL data allocation,
- no DRX and no eDRX_CONN cycle is used,
- no measurement gaps are configured,
- only one code word is transmitted in each subframe,
- no MBSFN subframes are configured in the PCell or each of activated SCell(s).

Table 8.1.2.3.6.1-1: Requirement on minimum number of ACK/NACKs to transmit during $T_{\text{basic_identify_CGI,inter}}$

| TDD UL/DL configuration for serving cell | Minimum number of transmitted ACK/NACKs |
|--|---|
| 0 (Note 1) | 18 |
| 1 | 30 |
| Note 1: When a UE is configured with <i>EIMTA-MainConfigServCell</i> via RRC signalling [2] only this requirement shall apply. | |

Note 2: The requirement for other TDD UL/DL configuration is TBD.

8.1.2.3.6.2 ECGI Reporting Delay

The ECGI reporting delay occurs due to the delay uncertainty when inserting the ECGI measurement report to the TTI of the uplink DCCH. The delay uncertainty is twice the TTI of the uplink DCCH. In case DRX is used, the ECGI reporting may be delayed until the next DRX cycle. In case eDRX_CONN is used, the ECGI reporting may be delayed until the next eDRX_CONN cycle. If IDC autonomous denial is configured, an additional delay can be expected.

8.1.2.3.7 E-UTRAN TDD-TDD inter frequency measurements with autonomous gaps

8.1.2.3.7.1 Identification of a new CGI of E-UTRA TDD cell with autonomous gaps

No explicit neighbour list is provided to the UE for identifying a new CGI of E-UTRA cell. The UE shall identify and report the CGI when requested by the network for the purpose of 'reportCGI'. The UE may make autonomous gaps in both downlink reception and uplink transmission for receiving MIB and SIB1 message according to clause 5.5.3.1 of TS 36.331 [2]. Note that a UE is not required to use autonomous gap if si-RequestForHO is set to false. If autonomous gaps are used for measurement with the purpose of 'reportCGI', regardless of whether DRX or eDRX_CONN is used or not, or whether SCell(s) are configured or not, the UE shall be able to identify a new CGI of E-UTRA cell within:

$$T_{\text{identify_CGI,inter}} = T_{\text{basic_identify_CGI,inter}} \quad ms$$

Where

$T_{\text{basic_identify_CGI,inter}} = 150$ ms. This is the time period used in the above equation where the maximum allowed time for the UE to identify a new CGI of E-UTRA cell is defined, provided that the E-UTRA cell has been already identified by the UE.

A cell shall be considered identifiable following conditions are fulfilled:

- RSRP related side conditions given in Clause 9.1 are fulfilled for a corresponding Band,
- SCH_RP and SCH Ês/Iot according to Annex B.2.4 for a corresponding Band.

The MIB of an E-UTRA cell whose CGI is identified shall be considered decodable by the UE provided the PBCH demodulation requirements are met according to [5].

The requirement for identifying a new CGI of an E-UTRA cell within $T_{\text{basic_identify_CGI,inter}}$ is applicable when no DRX is used as well as when any of the DRX or eDRX_CONN cycles specified in TS 36.331 [2] is used.

Within the time, $T_{\text{identify_CGI,inter}}$ ms, over which the UE identifies the new CGI of E-UTRA cell, the UE shall be able to transmit at least the number of ACK/NACKs stated in Table 8.1.2.3.7.1-1 on PCell or each of activated SCell(s), provided that:

- there is continuous DL data allocation,
- no DRX and no eDRX_CONN cycle is used,
- no measurement gaps are configured,
- only one code word is transmitted in each subframe,
- no MBSFN subframes are configured in the PCell or each of activated SCell(s).

Table 8.1.2.3.7.1-1: Requirement on minimum number of ACK/NACKs to transmit during $T_{\text{basic_identify_CGI,inter}}$

| TDD UL/DL configuration for serving cell | Minimum number of transmitted ACK/NACKs |
|--|---|
| 0 (Note 1) | 18 |
| 1 | 30 |

Note 1: When a UE is configured with *EIMTA-MainConfigServCell* via RRC signalling [2] only this requirement shall apply cell.

Note 2: The requirement for other TDD UL/DL configuration is TBD.

8.1.2.3.7.2 ECGI Reporting Delay

The ECGI reporting delay occurs due to the delay uncertainty when inserting the ECGI measurement report to the TTI of the uplink DCCH. The delay uncertainty is twice the TTI of the uplink DCCH. In case DRX is used, the ECGI reporting may be delayed until the next DRX cycle. In case eDRX_CONN is used, the ECGI reporting may be delayed until the next eDRX_CONN cycle. If IDC autonomous denial is configured, an additional delay can be expected.

8.1.2.3.8 E-UTRAN FDD-TDD inter frequency measurements using autonomous gaps

The requirements in this clause shall apply to UE supporting FDD and TDD.

8.1.2.3.8.1 Identification of a new CGI of E-UTRA TDD cell with autonomous gaps

No explicit neighbour list is provided to the UE for identifying a new CGI of E-UTRA cell. The UE shall identify and report the CGI when requested by the network for the purpose of 'reportCGI'. The UE may make autonomous gaps in both downlink reception and uplink transmission for receiving MIB and SIB1 message according to clause 5.5.3.1 of TS 36.331 [2]. Note that a UE is not required to use autonomous gap if si-RequestForHO is set to false. If autonomous gaps are used for measurement with the purpose of 'reportCGI', regardless of whether DRX or eDRX_CONN is used or not, or whether SCell(s) are configured or not, the UE shall be able to identify a new CGI of E-UTRA cell within:

$$T_{\text{identify_CGI, inter}} = T_{\text{basic_identify_CGI, inter}} \quad ms$$

Where

$T_{\text{basic_identify_CGI, inter}} = 150$ ms. This is the time period used in the above equation where the maximum allowed time for the UE to identify a new CGI of E-UTRA cell is defined, provided that the E-UTRA cell has been already identified by the UE.

A cell shall be considered identifiable following conditions are fulfilled:

- RSRP related side conditions given in Clause 9.1 are fulfilled for a corresponding Band,
- SCH_RP and SCH Ês/Iot according to Annex B.2.4 for a corresponding Band.

The MIB of an E-UTRA cell whose CGI is identified shall be considered decodable by the UE provided the PBCH demodulation requirements are met according to [5].

The requirement for identifying a new CGI of an E-UTRA cell within $T_{\text{basic_identify_CGI, inter}}$ is applicable when no DRX is used as well as when any of the DRX or eDRX_CONN cycles specified in TS 36.331 [2] is used.

Within the time, $T_{\text{identify_CGI, inter}} \quad ms$, over which the UE identifies the new CGI of E-UTRA cell, the UE shall have more than 60 ACK/NACKs transmitted on PCell or each of activated SCell(s), provided that:

- there is continuous DL data allocation,
- no DRX and no eDRX_CONN cycle is used,
- no measurement gaps are configured,
- only one code word is transmitted in each subframe,
- no MBSFN subframes are configured in the PCell or each of activated SCell(s).

8.1.2.3.8.2 ECGI Reporting Delay

The ECGI reporting delay occurs due to the delay uncertainty when inserting the ECGI measurement report to the TTI of the uplink DCCH. The delay uncertainty is twice the TTI of the uplink DCCH. In case DRX is used, the ECGI reporting may be delayed until the next DRX cycle. In case eDRX_CONN is used, the ECGI reporting may be delayed until the next eDRX_CONN cycle. If IDC autonomous denial is configured, an additional delay can be expected.

8.1.2.4 Inter RAT measurements

8.1.2.4.1 E-UTRAN FDD – UTRAN FDD measurements

8.1.2.4.1.1 E-UTRAN FDD – UTRAN FDD measurements when no DRX is used

8.1.2.4.1.1.1 Identification of a new UTRA FDD cell

When explicit neighbour list is provided and no DRX is used, either measurement gaps are scheduled or the UE supports capability of conducting such measurements without gaps, the UE shall be able to identify a new detectable cell belonging to the monitored set within

$$T_{\text{identify, UTRA_FDD}} = T_{\text{basic_identify_UTRA_FDD}} \cdot \frac{480}{T_{\text{inter1}}} \cdot K_n \cdot N_{\text{freq},n} \quad \text{ms (normal performance),}$$

and

$$T_{\text{identify, UTRA_FDD}} = T_{\text{basic_identify_UTRA_FDD}} \cdot \frac{480}{T_{\text{inter1}}} \cdot K_r \cdot N_{\text{freq},r} \quad \text{ms (reduced performance)}$$

A cell shall be considered detectable when

- CPICH $E_c/I_0 \geq -20$ dB,
- SCH $E_c/I_0 \geq -17$ dB for at least one channel tap and SCH E_c/I_0 is equally divided between primary synchronisation code and secondary synchronisation code. When L3 filtering is used an additional delay can be expected.

8.1.2.4.1.1.1a Enhanced UTRA FDD cell identification requirements

When explicit neighbour list is provided and no DRX is used or when DRX cycle length ≤ 40 ms, either measurement gaps are scheduled or the UE supports capability of conducting such measurements without gaps, the UE shall be able to identify a new detectable cell belonging to the monitored set within $T_{\text{identify, enhanced_UTRA_FDD}}$:

$$T_{\text{identify, enhanced_UTRA_FDD}} = (T_{\text{basic_identify_enhanced_UTRA_FDD}} \cdot \frac{480}{T_{\text{inter1}}} + 480) K_n N_{\text{freq},n} \quad \text{ms (normal performance)}$$

and

$$T_{\text{identify, enhanced_UTRA_FDD}} = (T_{\text{basic_identify_enhanced_UTRA_FDD}} \cdot \frac{480}{T_{\text{inter1}}} + 480) K_r N_{\text{freq},r} \quad \text{ms (reduced performance)}$$

A cell shall be considered detectable when:

- CPICH $E_c/I_0 \geq -15$ dB,
- SCH $E_c/I_0 \geq -15$ dB for at least one channel tap and SCH E_c/I_0 is equally divided between primary synchronisation code and secondary synchronisation code. When L3 filtering is used an additional delay can be expected.

8.1.2.4.1.1.2 UE UTRA FDD CPICH measurement capability

When measurement gaps are scheduled for UTRA FDD inter RAT measurements, or the UE supports capability of conducting such measurements without gaps, the UE physical layer shall be capable of reporting measurements to higher layers with measurement accuracy as specified in Clause 9.2 with measurement period given by

$$T_{\text{measurement_UTRA_FDD}} = \text{Max} \left\{ T_{\text{Measurement_Period_UTRA_FDD}}, T_{\text{basic_measurement_UTRA_FDD}} \cdot \frac{480}{T_{\text{inter1}}} \cdot K_n \cdot N_{\text{freq,n}} \right\} \text{ms} \text{ (normal performance),}$$

and

$$T_{\text{measurement_UTRA_FDD}} = \text{Max} \left\{ T_{\text{Measurement_Period_UTRA_FDD}}, T_{\text{basic_measurement_UTRA_FDD}} \cdot \frac{480}{T_{\text{inter1}}} \cdot K_r \cdot N_{\text{freq,r}} \right\} \text{ms} \text{ (reduced performance)}$$

The UE shall be capable of performing UTRA FDD CPICH measurements for $X_{\text{basic_measurement_UTRA_FDD}}$ inter-frequency cells per FDD frequency and the UE physical layer shall be capable of reporting measurements to higher layers with the measurement period of $T_{\text{Measurement_UTRA_FDD}}$.

$$X_{\text{basic_measurement_UTRA_FDD}} = 6$$

$T_{\text{Measurement_Period_UTRA_FDD}} = 480$ ms. The period used for calculating the measurement period $T_{\text{measurement_UTRA_FDD}}$ for UTRA FDD CPICH measurements.

$T_{\text{basic_identify_UTRA_FDD}} = 300$ ms. This is the time period used in the inter RAT equation in clause 8.1.2.4.1.1.1 where the maximum allowed time for the UE to identify a new UTRA FDD cell is defined.

$T_{\text{basic_identify_enhanced_UTRA_FDD}} = 60$ ms. This is the time period used in the inter RAT equation in clause 8.1.2.4.1.1.a where the maximum allowed time for the UE to identify a new UTRA FDD cell is defined.

$T_{\text{basic_measurement_UTRA_FDD}} = 50$ ms. This is the time period used in the equation for defining the measurement period for inter RAT CPICH measurements.

$N_{\text{freq,n}}$, $N_{\text{freq,r}}$, K_n and K_r are defined in clause 8.1.2.1.1 and T_{inter1} is defined in clause 8.1.2.1

8.1.2.4.1.1.3 Periodic Reporting

Reported measurements in periodically triggered measurement reports shall meet the requirements in clause 9.

8.1.2.4.1.1.4 Event Triggered Reporting

Reported measurements in event triggered measurement reports shall meet the requirements in clause 9.

The UE shall not send any event triggered measurement reports, as long as the reporting criteria is not fulfilled.

The measurement reporting delay is defined as the time between any event that will trigger a measurement report until the UE starts to transmit the measurement report over the Uu interface. This requirement assumes that the measurement report is not delayed by other RRC signalling on the DCCH. This measurement reporting delay excludes a delay uncertainty resulted when inserting the measurement report to the TTI of the uplink DCCH. The delay uncertainty is twice the TTI of the uplink DCCH. This measurement reporting delay excludes a delay which caused by no UL resources for UE to send the measurement report.

The event triggered measurement reporting delay, measured without L3 filtering shall be less than $T_{\text{identify, UTRA_FDD}}$ defined in Clause 8.1.2.4.1.1.1 for the minimum requirements or $T_{\text{identify, enhanced_UTRA_FDD}}$ defined in Clause 8.1.2.4.1.1.a for the enhanced requirements When L3 filtering is used or IDC autonomous denial or the UE is performing reception and/or transmission for ProSe Direct Discovery and/or ProSe Direct Communication, is configured an additional delay can be expected.

If a cell which has been detectable at least for the time period $T_{\text{identify, UTRA_FDD}}$ defined in clause 8.1.2.4.1.1.1 for the minimum requirements or $T_{\text{identify, enhanced_UTRA_FDD}}$ defined in Clause 8.1.2.4.1.1.a for the enhanced requirements and then triggers the measurement report as per TS 36.331 [2], the event triggered measurement reporting delay shall be less than $T_{\text{measurement_UTRA_FDD}}$ defined in clause 8.1.2.4.1.1.2 provided the timing to that cell has not changed more than ± 32

chips while measurement gap has not been available and the L3 filter has not been used. When L3 filtering is used or IDC autonomous denial is configured or the UE is performing reception and/or transmission for ProSe Direct Discovery and/or ProSe Direct Communication, an additional delay can be expected.

8.1.2.4.1.1.5 Event-triggered Periodic Reporting

Reported measurements contained in event triggered periodic measurement reports shall meet the requirements in clause 9.

The first report in event triggered periodic measurement reporting shall meet the requirements specified in clause 8.1.2.4.1.1.4.

8.1.2.4.1.2 E-UTRAN FDD – UTRAN FDD measurements when DRX is used

When explicit neighbour list is provided and DRX or eDRX_CONN is used, either measurement gaps are scheduled or the UE supports capability of conducting such measurements without gaps, the UE shall be able to identify a new detectable cell belonging to the neighbour cell list within $T_{identify,UTRA_FDD}$. When DRX is used, $T_{identify,UTRA_FDD}$ is as defined in table 8.1.2.4.1.2-1, and when eDRX_CONN is used, $T_{identify,UTRA_FDD}$ is as defined in table 8.1.2.4.1.2-1A.

Table 8.1.2.4.1.2-1: Requirement to identify a newly detectable UTRA FDD cell

| DRX cycle length (s) | $T_{identify_UTRA_FDD}$ (s) (DRX cycles) normal requirement | | $T_{identify_UTRA_FDD}$ (s) (DRX cycles) reduced requirement | |
|-------------------------|---|---|---|--|
| | Gap period = 40 ms | Gap period = 80 ms | Gap period = 40 ms | Gap period = 80 ms |
| ≤0.04 | Non DRX Requirements in clause 8.1.2.4.1.1 are applicable | Non DRX Requirements in clause 8.1.2.4.1.1 are applicable | Non DRX Requirements in clause 8.1.2.4.1.1 are applicable | Non DRX Requirements in clause 8.1.2.4.1.1 are applicable |
| 0.064 | $2.56 \cdot K_n \cdot N_{freq,n}$ ($40 \cdot N_{freq,n}$) | $4.8 \cdot K_n \cdot N_{freq,n}$ ($75 \cdot K_n \cdot N_{freq,n}$) | $2.56 \cdot K_r \cdot N_{freq,r}$ ($40 \cdot K_r \cdot N_{freq,r}$) | $4.8 \cdot K_r \cdot N_{freq,r}$ ($75 \cdot K_r \cdot N_{freq,r}$) |
| 0.08 | $3.2 \cdot K_n \cdot N_{freq,n}$ ($40 \cdot K_n \cdot N_{freq,n}$) | $4.8 \cdot K_n \cdot N_{freq,n}$ ($60 \cdot K_n \cdot N_{freq,n}$) | $3.2 \cdot K_r \cdot N_{freq,r}$ ($40 \cdot K_r \cdot N_{freq,r}$) | $4.8 \cdot K_r \cdot N_{freq,r}$ ($60 \cdot K_r \cdot N_{freq,r}$) |
| 0.128 | $3.2 \cdot K_n \cdot N_{freq,n}$ ($25 \cdot K_n \cdot N_{freq}$) | $4.8 \cdot K_n \cdot N_{freq,n}$ ($37.5 \cdot K_n \cdot N_{freq,n}$) | $3.2 \cdot K_r \cdot N_{freq,r}$ ($25 \cdot K_r \cdot N_{freq,r}$) | $4.8 \cdot K_r \cdot N_{freq,r}$ ($37.5 \cdot K_r \cdot N_{freq,r}$) |
| 0.16 | $3.2 \cdot K_n \cdot N_{freq,n}$ ($20 \cdot K_n \cdot N_{freq,n}$) | $4.8 \cdot K_n \cdot N_{freq,n}$ ($30 \cdot K_n \cdot N_{freq,n}$) | $3.2 \cdot K_r \cdot N_{freq,r}$ ($20 \cdot K_r \cdot N_{freq,r}$) | $4.8 \cdot K_r \cdot N_{freq,r}$ ($30 \cdot K_r \cdot N_{freq,r}$) |
| 0.16 < DRX-cycle ≤ 2.56 | Note ($20 \cdot K_n \cdot N_{freq,n}$) | Note ($20 \cdot K_n \cdot N_{freq,n}$) | Note ($20 \cdot K_r \cdot N_{freq,r}$) | Note ($20 \cdot K_r \cdot N_{freq,r}$) |

Note: Time depends upon the DRX cycle in use

Table 8.1.2.4.1.2-1A: Requirement to identify a newly detectable UTRA FDD cell when eDRX_CONN cycle is used

| eDRX_CONN cycle length (s) | $T_{identify_UTRA_FDD}$ (s) (eDRX_CONN cycles) normal requirement | | $T_{identify_UTRA_FDD}$ (s) (eDRX_CONN cycles) reduced requirement | |
|-----------------------------------|---|--|--|--|
| | Gap period = 40 ms | Gap period = 80 ms | Gap period = 40 ms | Gap period = 80 ms |
| $2.56 < eDRX_CONN$ cycle ≤ 10.24 | Note ($20 \cdot K_n \cdot N_{freq,n}$) | Note ($20 \cdot K_n \cdot N_{freq,n}$) | Note ($20 \cdot K_r \cdot N_{freq,r}$) | Note ($20 \cdot K_r \cdot N_{freq,r}$) |

Note: Time depends upon the eDRX_CONN cycle in use

A cell shall be considered detectable provided following conditions are fulfilled: A cell shall be considered detectable when

- CPICH $E_c/I_o \geq -20$ dB,
- SCH $E_c/I_o \geq -17$ dB for at least one channel tap and SCH E_c/I_o is equally divided between primary synchronisation code and secondary synchronisation code. When L3 filtering is used an additional delay can be expected.

When DRX or eDRX_CONN is used, the UE shall be capable of performing RSCP and E_c/I_o measurements of at least 6 UTRA cells per UTRA FDD carrier for up to 3 UTRA FDD carriers and the UE physical layer shall be capable of reporting RSCP and E_c/I_o measurements to higher layers within the measurement period $T_{\text{measure_UTRA_FDD}}$, either measurement gaps are scheduled or the UE supports capability of conducting such measurements without gaps. UE supporting Increased UE carrier monitoring UTRA shall be capable of performing RSCP and E_c/I_o measurements of at least 6 UTRA cells per UTRA FDD carrier for up to 6 UTRA FDD carriers with maximum of 80 cells consisting of at most 32 cells per frequency layer in the neighbour cell list. When DRX is used, $T_{\text{measure_UTRA_FDD}}$ is defined in Table 8.1.2.3.1.2-2, and when eDRX_CONN cycle is used, $T_{\text{measure_UTRA_FDD}}$ is defined in Table 8.1.2.3.1.2-3.

Table 8.1.2.4.1.2-2: Requirement to measure UTRA FDD cells

| DRX cycle length (s) | $T_{\text{measure_UTRA_FDD}}$ (s) (DRX cycles) normal requirement | | $T_{\text{measure_UTRA_FDD}}$ (s) (DRX cycles) normal requirement | |
|--------------------------------------|---|---|---|---|
| | Gap period = 40 ms | Gap period = 80 ms | Gap period = 40 ms | Gap period = 80 ms |
| ≤ 0.04 | Non DRX Requirements in clause 8.1.2.4.1.1 are applicable | Non DRX Requirements in clause 8.1.2.4.1.1 are applicable | Non DRX Requirements in clause 8.1.2.4.1.1 are applicable | Non DRX Requirements in clause 8.1.2.4.1.1 are applicable |
| 0.064 | $0.48 \cdot K_n \cdot N_{\text{freq},n}$ ($7.5 \cdot K_n \cdot N_{\text{freq},n}$) | $0.8 \cdot K_n \cdot N_{\text{freq},n}$ ($12.5 \cdot K_n \cdot N_{\text{freq},n}$) | $0.48 \cdot K_r \cdot N_{\text{freq},r}$ ($7.5 \cdot K_r \cdot N_{\text{freq},r}$) | $0.8 \cdot K_r \cdot N_{\text{freq},r}$ ($12.5 \cdot K_r \cdot N_{\text{freq},r}$) |
| 0.08 | $0.48 \cdot K_n \cdot N_{\text{freq},n}$ ($6 \cdot K_n \cdot N_{\text{freq},n}$) | $0.8 \cdot K_n \cdot N_{\text{freq},n}$ ($10 \cdot N_{\text{freq},n}$) | $0.48 \cdot K_r \cdot N_{\text{freq},r}$ ($6 \cdot K_r \cdot N_{\text{freq},r}$) | $0.8 \cdot K_r \cdot N_{\text{freq},r}$ ($10 \cdot K_r \cdot N_{\text{freq},r}$) |
| 0.128 | $0.64 \cdot K_n \cdot N_{\text{freq},n}$ ($5 \cdot K_n \cdot N_{\text{freq},n}$) | $0.8 \cdot K_n \cdot N_{\text{freq},n}$ ($6.25 \cdot N_{\text{freq},n}$) | $0.64 \cdot K_r \cdot N_{\text{freq},r}$ ($5 \cdot K_r \cdot N_{\text{freq},r}$) | $0.8 \cdot K_r \cdot N_{\text{freq},r}$ ($6.25 \cdot N_{\text{freq},r}$) |
| $0.128 < \text{DRX-cycle} \leq 2.56$ | Note ($5 \cdot K_n \cdot N_{\text{freq},n}$) | Note ($5 \cdot K_n \cdot N_{\text{freq},n}$) | Note ($5 \cdot K_r \cdot N_{\text{freq},r}$) | Note ($5 \cdot K_r \cdot N_{\text{freq},r}$) |

Note: Time depends upon the DRX cycle in use

Table 8.1.2.4.1.2-3: Requirement to measure UTRA FDD cells when eDRX_CONN cycle is used

| eDRX_CONN cycle length (s) | $T_{\text{measure_UTRA_FDD}}$ (s) (eDRX_CONN cycles) normal requirement | | $T_{\text{measure_UTRA_FDD}}$ (s) (eDRX_CONN cycles) normal requirement | |
|---|---|--|---|--|
| | Gap period = 40 ms | Gap period = 80 ms | Gap period = 40 ms | Gap period = 80 ms |
| $2.56 < \text{eDRX_CONN cycle} \leq 10.24$ | Note ($5 \cdot K_n \cdot N_{\text{freq},n}$) | Note ($5 \cdot K_n \cdot N_{\text{freq},n}$) | Note ($5 \cdot K_r \cdot N_{\text{freq},r}$) | Note ($5 \cdot K_r \cdot N_{\text{freq},r}$) |

Note: Time depends upon the eDRX_CONN cycle in use

The measurement accuracy for all measured cells shall be as specified in the sub-clause 9.1.

8.1.2.4.1.2.1 Periodic Reporting

Reported measurements in periodically triggered measurement reports shall meet the requirements in clause 9.

8.1.2.4.1.2.2 Event Triggered Reporting

Reported measurements in event triggered measurement reports shall meet the requirements in clause 9.

The UE shall not send any event triggered measurement reports, as long as the reporting criteria is not fulfilled.

The measurement reporting delay is defined as the time between any event that will trigger a measurement report until the UE starts to transmit the measurement report over the Uu interface. This requirement assumes that the measurement report is not delayed by other RRC signalling on the DCCH. This measurement reporting delay excludes a delay

uncertainty resulted when inserting the measurement report to the TTI of the uplink DCCH. The delay uncertainty is twice the TTI of the uplink DCCH. This measurement reporting delay excludes a delay which caused by no UL resources for UE to send the measurement report.

The event triggered measurement reporting delay, measured without L3 filtering shall be less than $T_{\text{identify,UTRA_FDD}}$ defined in Clause 8.1.2.4.1.2. When L3 filtering is used or IDC autonomous denial is configured or the UE is performing reception and/or transmission for ProSe Direct Discovery and/or ProSe Direct Communication, an additional delay can be expected.

If a cell which has been detectable at least for the time period $T_{\text{identify,UTRA_FDD}}$ defined in clause 8.1.2.4.1.2 and then triggers the measurement report as per TS 36.331 [2], the event triggered measurement reporting delay shall be less than $T_{\text{measurement_UTRA_FDD}}$ defined in clause 8.1.2.4.1.2 provided the timing to that cell has not changed more than ± 32 chips while measurement gap has not been available and the L3 filter has not been used. When L3 filtering is used or IDC autonomous denial is configured or the UE is performing reception and/or transmission for ProSe Direct Discovery and/or ProSe Direct Communication, an additional delay can be expected.

8.1.2.4.1.2.3 Event-triggered Periodic Reporting

Reported measurements contained in event triggered periodic measurement reports shall meet the requirements in clause 9.

The first report in event triggered periodic measurement reporting shall meet the requirements specified in clause 8.1.2.4.1.2.2.

8.1.2.4.2 E-UTRAN TDD – UTRAN FDD measurements

The requirements in clause 8.1.2.4.1 also apply for this section.

8.1.2.4.2.1 E-UTRAN TDD – UTRAN FDD measurements when no DRX is used

8.1.2.4.2.2 E-UTRAN TDD – UTRAN FDD measurements when DRX is used

8.1.2.4.3 E-UTRAN TDD – UTRAN TDD measurements

8.1.2.4.3.1 E-UTRAN TDD – UTRAN TDD measurements when no DRX is used

8.1.2.4.3.1.1 Identification of a new UTRA TDD cell

When explicit neighbour list is provided and no DRX is used, either measurement gaps are scheduled or the UE supports capability of conducting such measurements without gaps, the UE shall be able to identify a new detectable cell belonging to the monitored set within

$$T_{\text{identify,UTRA_TDD}} = \text{Max} \left\{ 5000, T_{\text{basic identify UTRA_TDD}} \cdot \frac{480}{T_{\text{interl}}} \cdot K_n \cdot N_{\text{freq},n} \right\} \text{ms (normal performance),}$$

and

$$T_{\text{identify,UTRA_TDD}} = \text{Max} \left\{ 5000, T_{\text{basic identify UTRA_TDD}} \cdot \frac{480}{T_{\text{interl}}} \cdot K_r \cdot N_{\text{freq},r} \right\} \text{ms (reduced performance)}$$

A cell shall be considered detectable when

- P-CCPCH $E_c/I_o \geq -8$ dB,
- DwPCH $E_c/I_o \geq -5$ dB.

When L3 filtering is used an additional delay can be expected.

8.1.2.4.3.1.1a Enhanced UTRA TDD cell identification requirements

When explicit neighbour list is provided and no DRX is used or when DRX cycle length ≤ 40 ms, either measurement gaps are scheduled or the UE supports capability of conducting such measurements without gaps, the UE shall be able to identify a new detectable cell belonging to the monitored set within $T_{\text{identify, enhanced_UTRA_TDD}}$:

$$T_{\text{identify, enhanced_UTRA_TDD}} = (T_{\text{basic_identify_enhanced_UTRA_TDD}} \cdot \frac{480}{T_{\text{inter1}}} + 480) \cdot K_n \cdot N_{\text{freq},n} \quad \text{ms (normal performance),}$$

and

$$T_{\text{identify, enhanced_UTRA_TDD}} = (T_{\text{basic_identify_enhanced_UTRA_TDD}} \cdot \frac{480}{T_{\text{inter1}}} + 480) \cdot K_r \cdot N_{\text{freq},r} \quad \text{ms (reduced performance)}$$

A cell shall be considered detectable when:

- P-CCPCH_{Ec}/I_o \geq -6 dB,
- DwPCH_{Ec}/I_o \geq -1 dB

When L3 filtering is used an additional delay can be expected.

8.1.2.4.3.1.2 UE UTRA TDD P-CCPCH RSCP measurement capability

When measurement gaps are scheduled for UTRA TDD inter RAT measurements, or the UE supports capability of conducting such measurements without gaps, the UE physical layer shall be capable of reporting measurements to higher layers with measurement accuracy as specified in Clause 9.3 with measurement period given by

$$T_{\text{measurement_UTRA_TDD}} = \text{Max} \left\{ T_{\text{Measurement_Period_UTRA_TDD}}, T_{\text{basic_measurement_UTRA_TDD}} \cdot \frac{480}{T_{\text{inter1}}} \cdot K_n \cdot N_{\text{freq},n} \right\} \text{ms (normal performance)}$$

$$T_{\text{measurement_UTRA_TDD}} = \text{Max} \left\{ T_{\text{Measurement_Period_UTRA_TDD}}, T_{\text{basic_measurement_UTRA_TDD}} \cdot \frac{480}{T_{\text{inter1}}} \cdot K_r \cdot N_{\text{freq},r} \right\} \text{ms (reduced performance)}$$

The UE shall be capable of performing UTRA TDD P-CCPCH RSCP measurements for $X_{\text{basic_measurement_UTRA_TDD}}$ inter-frequency cells per TDD frequency of the monitored set, and the UE physical layer shall be capable of reporting measurements to higher layers with the measurement period of $T_{\text{Measurement_UTRA_TDD}}$.

$$X_{\text{basic_measurement_UTRA_TDD}} = 6$$

$T_{\text{Measurement_Period_UTRA_TDD}} = 480$ ms is the period used for calculating the measurement period $T_{\text{measurement_UTRA_TDD}}$ for UTRA TDD P-CCPCH RSCP measurements.

$T_{\text{basic_identify_UTRA_TDD}} = 800$ ms is the time period used in the inter RAT equation in clause 8.1.2.4.3.1.1 where the maximum allowed time for the UE to identify a new UTRA TDD cell is defined.

$T_{\text{basic_identify_enhanced_UTRA_TDD}} = 80$ ms is the time period used in the inter RAT equation in clause 8.1.2.4.3.1.1a where the maximum allowed time for the UE to identify a new UTRA TDD cell is defined.

$T_{\text{basic_measurement_UTRA_TDD}} = 50$ ms is the time period used in the equation for defining the measurement period for inter RAT P-CCPCH RSCP measurements.

$N_{\text{freq},n}$, $N_{\text{freq},r}$, K_n and K_r are defined in clause 8.1.2.1.1 and T_{inter1} is defined in clause 8.1.2.1

8.1.2.4.3.1.3 Periodic Reporting

Reported measurements in periodically triggered measurement reports shall meet the requirements in clause 9.

8.1.2.4.3.1.4 Event Triggered Reporting

Reported measurements in event triggered measurement reports shall meet the requirements in clause 9.

The UE shall not send any event triggered measurement reports, as long as the reporting criteria is not fulfilled.

The measurement reporting delay is defined as the time between any event that will trigger a measurement report until the UE starts to transmit the measurement report over the Uu interface. This requirement assumes that the measurement report is not delayed by other RRC signalling on the DCCH. This measurement reporting delay excludes a delay uncertainty resulted when inserting the measurement report to the TTI of the uplink DCCH. The delay uncertainty is twice the TTI of the uplink DCCH. This measurement reporting delay excludes a delay which caused by no UL resources for UE to send the measurement report.

The event triggered measurement reporting delay, measured without L3 filtering shall be less than $T_{\text{identify, UTRA_TDD}}$ defined in Clause 8.1.2.4.3.1.1 for the minimum requirements or $T_{\text{identify, enhanced_UTRA_TDD}}$ defined in Clause 8.1.2.4.3.1.1a for the enhanced requirements. When L3 filtering is used or IDC autonomous denial is configured or the UE is performing reception and/or transmission for ProSe Direct Discovery and/or ProSe Direct Communication, an additional delay can be expected.

If a cell which has been detectable at least for the time period $T_{\text{identify, UTRA_TDD}}$ defined in clause 8.1.2.4.3.1.1 for the minimum requirements and then triggers the measurement report as per TS 36.331 [2], the event triggered measurement reporting delay shall be less than $T_{\text{measurement_UTRA_TDD}}$ defined in clause 8.1.2.4.3.1.2 provided the timing to that cell has not changed more than ± 10 chips while measurement gap has not been available and the L3 filter has not been used. When L3 filtering is used or IDC autonomous denial is configured or the UE is performing reception and/or transmission for ProSe Direct Discovery and/or ProSe Direct Communication, an additional delay can be expected.

8.1.2.4.3.1.5 Event-triggered Periodic Reporting

Reported measurements contained in event triggered periodic measurement reports shall meet the requirements in clause 9.

The first report in event triggered periodic measurement reporting shall meet the requirements specified in clause 8.1.2.4.3.1.4.

8.1.2.4.3.2 E-UTRAN TDD – UTRAN TDD measurements when DRX is used

When explicit neighbour list is provided and DRX or eDRX_CONN is used, either measurement gaps are scheduled or the UE supports capability of conducting such measurements without gaps, the UE shall be able to identify a new detectable cell belonging to the neighbour cell list within $T_{\text{identify,UTRA_TDD}}$. When DRX is used, $T_{\text{identify,UTRA_TDD}}$ is as defined in table 8.1.2.4.3.2-1, and when eDRX_CONN is used, $T_{\text{identify,UTRA_TDD}}$ is as defined in table 8.1.2.4.3.2-1A.

Table 8.1.2.4.3.2-1: Requirement to identify a newly detectable UTRA TDD cell

| DRX cycle length (s) | $T_{\text{identify_UTRA_TDD}}$ (s) (DRX cycles) (normal requirement) | | $T_{\text{identify_UTRA_TDD}}$ (s) (DRX cycles) (reduced requirement) | |
|--|--|---|---|---|
| | Gap period = 40 ms | Gap period = 80 ms | Gap period = 40 ms | Gap period = 80 ms |
| ≤ 0.32 | Non DRX Requirements in clause 8.1.2.4.3.1 are applicable | Non DRX Requirements in clause 8.1.2.4.3.1 are applicable | Non DRX Requirements in clause 8.1.2.4.3.1 are applicable | Non DRX Requirements in clause 8.1.2.4.3.1 are applicable |
| $0.32 < \text{DRX-cycle} \leq 0.512$ | Note ($20 \cdot K_n \cdot N_{\text{freq},n}$) | Note ($25 \cdot K_n \cdot N_{\text{freq},n}$) | Note ($20 \cdot K_r \cdot N_{\text{freq},r}$) | Note ($25 \cdot K_r \cdot N_{\text{freq},r}$) |
| $0.512 < \text{DRX-cycle} \leq 2.56$ | Note ($20 \cdot K_n \cdot N_{\text{freq},n}$) | Note ($20 \cdot K_n \cdot N_{\text{freq},n}$) | Note ($20 \cdot K_r \cdot N_{\text{freq},r}$) | Note ($20 \cdot K_r \cdot N_{\text{freq},r}$) |
| Note: Time depends upon the DRX cycle in use | | | | |

Table 8.1.2.4.3.2-1A: Requirement to identify a newly detectable UTRA TDD cell when eDRX_CONN cycle is used

| eDRX_CONN cycle length (s) | T _{identify_UTRA_TDD} (s) (eDRX_CONN cycles) (normal requirement) | | T _{identify_UTRA_TDD} (s) (eDRX_CONN cycles) (reduced requirement) | |
|--|--|---|---|---|
| | Gap period = 40 ms | Gap period = 80 ms | Gap period = 40 ms | Gap period = 80 ms |
| 2.56 < eDRX_CONN cycle ≤ 10.24 | Note (20 * K _n * N _{freq,n}) | Note (20 * K _n * N _{freq,n}) | Note (20 * K _r * N _{freq,r}) | Note (20 * K _r * N _{freq,r}) |
| Note: Time depends upon the eDRX_CONN cycle in use | | | | |

A cell shall be considered detectable provided following conditions are fulfilled: A cell shall be considered detectable when

- P-CCPCH Ec/Io ≥ -8 dB,
- DwPCH_Ec/Io ≥ -5 dB.

When L3 filtering is used an additional delay can be expected.

When DRX or eDRX_CONN is in use, the UE shall be capable of performing UTRA TDD P-CCPCH RSCP measurements of at least 6 UTRA cells per UTRA TDD carrier for up to 3 UTRA TDD carriers and the UE physical layer shall be capable of reporting measurements to higher layers with the measurement period T_{measure_UTRA_TDD}, either measurement gaps are scheduled or the UE supports capability of conducting such measurements without gaps. UE supporting Increased UE carrier monitoring UTRA shall be capable of performing UTRA TDD P-CCPCH RSCP measurements of at least 6 UTRA cells per UTRA TDD carrier for up to 7 UTRA TDD carriers with maximum of 80 cells consisting of at most 32 cells per frequency layer in the neighbour cell list. When DRX is used, T_{measure_UTRA_TDD} is as defined in Table 8.1.2.4.3.2-2, and when eDRX_CONN is used, T_{measure_UTRA_TDD} is as defined in Table 8.1.2.4.3.2-3.

Table 8.1.2.4.3.2-2: Requirement to measure UTRA TDD cells

| DRX cycle length (s) | T _{measure_UTRA_TDD} (s) (DRX cycles) (normal requirement) | | T _{measure_UTRA_TDD} (s) (DRX cycles) (reduced requirement) | |
|--|--|--|--|--|
| | Gap period = 40 ms | Gap period = 80 ms | Gap period = 40 ms | Gap period = 80 ms |
| ≤ 0.04 | Non DRX Requirements in clause 8.1.2.4.3.1 are applicable | Non DRX Requirements in clause 8.1.2.4.3.1 are applicable | Non DRX Requirements in clause 8.1.2.4.3.1 are applicable | Non DRX Requirements in clause 8.1.2.4.3.1 are applicable |
| 0.064 | 0.48 * K _n * N _{freq,n} (7.5 * K _n * N _{freq,n}) | 0.8 * K _n * N _{freq,n} (12.5 * K _n * N _{freq,n}) | 0.48 * K _r * N _{freq,r} (7.5 * K _r * N _{freq,r}) | 0.8 * K _r * N _{freq,r} (12.5 * K _r * N _{freq,r}) |
| 0.08 | 0.48 * K _n * N _{freq,n} (6 * K _n * N _{freq,n}) | 0.8 * K _n * N _{freq,n} (10 * K _n * N _{freq,n}) | 0.48 * K _r * N _{freq,r} (6 * K _r * N _{freq,r}) | 0.8 * K _r * N _{freq,r} (10 * K _r * N _{freq,r}) |
| 0.128 | 0.64 * K _n * N _{freq,n} (5 * K _n * N _{freq,n}) | 0.8 * K _n * N _{freq,n} (6.25 * K _n * N _{freq,n}) | 0.64 * K _r * N _{freq,r} (5 * K _r * N _{freq,r}) | 0.8 * K _r * N _{freq,r} (6.25 * N _{freq,r}) |
| 0.128 < DRX-cycle ≤ 2.56 | Note (5 * K _n * N _{freq,n}) | Note (5 * K _n * N _{freq,n}) | Note (5 * K _r * N _{freq,r}) | Note (5 * K _r * N _{freq,r}) |
| Note: Time depends upon the DRX cycle in use | | | | |

Table 8.1.2.4.3.2-3: Requirement to measure UTRA TDD cells when eDRX_CONN cycle is used

| eDRX_CONN cycle length (s) | T _{measure_UTRA_TDD} (s) (eDRX_CONN cycles) (normal requirement) | | T _{measure_UTRA_TDD} (s) (eDRX_CONN cycles) (reduced requirement) | |
|--|---|--|--|--|
| | Gap period = 40 ms | Gap period = 80 ms | Gap period = 40 ms | Gap period = 80 ms |
| 2.56 < eDRX_CONN cycle ≤ 10.24 | Note (5 * K _n * N _{freq,n}) | Note (5 * K _n * N _{freq,n}) | Note (5 * K _r * N _{freq,r}) | Note (5 * K _r * N _{freq,r}) |
| Note: Time depends upon the eDRX_CONN cycle in use | | | | |

The measurement accuracy for all measured cells shall be as specified in the sub-clause 9.1.

8.1.2.4.3.2.1 Periodic Reporting

Reported measurements in periodically triggered measurement reports shall meet the requirements in clause 9.

8.1.2.4.3.2.2 Event Triggered Reporting

Reported measurements in event triggered measurement reports shall meet the requirements in clause 9.

The UE shall not send any event triggered measurement reports, as long as the reporting criteria is not fulfilled.

The measurement reporting delay is defined as the time between any event that will trigger a measurement report until the UE starts to transmit the measurement report over the Uu interface. This requirement assumes that the measurement report is not delayed by other RRC signalling on the DCCH. This measurement reporting delay excludes a delay uncertainty resulted when inserting the measurement report to the TTI of the uplink DCCH. The delay uncertainty is twice the TTI of the uplink DCCH. This measurement reporting delay excludes a delay which caused by no UL resources for UE to send the measurement report.

The event triggered measurement reporting delay, measured without L3 filtering shall be less than $T_{\text{identify, UTRA_TDD}}$ defined in Clause 8.1.2.4.3.2 When L3 filtering is used or IDC autonomous denial is configured or the UE is performing reception and/or transmission for ProSe Direct Discovery and/or ProSe Direct Communication, an additional delay can be expected.

If a cell which has been detectable at least for the time period $T_{\text{identify, UTRA_TDD}}$ defined in clause 8.1.2.4.3.2 and then triggers the measurement report as per TS 36.331 [2], the event triggered measurement reporting delay shall be less than $T_{\text{measurement_UTRA_TDD}}$ defined in clause 8.1.2.4.3.2 provided the timing to that cell has not changed more than ± 10 chips while measurement gap has not been available and the L3 filter has not been used. When L3 filtering is used or IDC autonomous denial is configured or the UE is performing reception and/or transmission for ProSe Direct Discovery and/or ProSe Direct Communication, an additional delay can be expected.

8.1.2.4.3.2.3 Event-triggered Periodic Reporting

Reported measurements contained in event triggered periodic measurement reports shall meet the requirements in clause 9.

The first report in event triggered periodic measurement reporting shall meet the requirements specified in clause 8.1.2.4.3.2.2.

8.1.2.4.4 E-UTRAN FDD – UTRAN TDD measurements

The requirements in clause 8.1.2.4.3 also apply for this section.

8.1.2.4.5 E-UTRAN FDD – GSM measurements

8.1.2.4.5.1 E-UTRAN FDD – GSM measurements when no DRX is used

The requirements in this clause apply only to UE supporting E-UTRAN FDD and GSM.

Measurements on GSM cells can be requested with BSIC verified.

In RRC_CONNECTED state when a supported measurement gap pattern sequence according to Table 8.1.2.1-1 is configured by E-UTRAN, or the UE supports capability of conducting such measurements without gaps, the UE shall continuously measure GSM cells, search for new GSM cells given in the monitored set and re-confirm the BSIC for already detected cells.

8.1.2.4.5.1.1 GSM carrier RSSI

This measurement shall be based on measurement gaps allocated for GSM carrier RSSI measurement as described in clause 8.1.2.1. A UE supporting GSM measurements shall measure minimum number of 10 GSM carrier RSSI measurement samples ($N_{\text{GSM carrier RSSI}}$) per measurement gap. In RRC_CONNECTED state the measurement period, $T_{\text{Measurement Period, GSM}}$, for the GSM carrier RSSI measurement is $K_n * N_{\text{freq,n}} * 480$ ms. The parameters $N_{\text{freq,n}}$ and K_n are defined in clause 8.1.2.1.1.

The UE shall meet the measurement accuracy requirements stated for RXLEV in [8], when the given measurement time allows the UE to take at least 3 GSM carrier RSSI samples per GSM carrier in the monitored set during the measurement period.

In case the UE is not able to acquire the required number of samples per GSM carrier during one measurement period, the UE shall measure as many GSM carriers as possible during that measurement period using at least 3 samples per GSM carrier. The GSM carriers that were not measured during that measurement period shall be measured in the following measurement periods.

8.1.2.4.5.1.2 BSIC verification

Measurements on a GSM cell can be requested with BSIC verified. The UE shall be able to report the GSM cells with BSIC verified for those cells where the verification of BSIC has been successful.

The procedure for BSIC verification on a GSM cell can be divided into the following two tasks:

- **Initial BSIC identification:** Includes searching for the BSIC and decoding the BSIC for the first time when there is no knowledge about the relative timing between the E-UTRAN FDD and GSM cells. The UE shall trigger the initial BSIC identification within the available measurement gap pattern sequence. The requirements for BSIC re-confirmation can be found in clause 8.1.2.4.5.1.2.1.
- **BSIC re-confirmation:** Tracking and decoding the BSIC of a GSM cell after initial BSIC identification is performed. The UE shall trigger the BSIC re-confirmation within the available measurement gap pattern. The requirements for BSIC re-confirmation can be found in clause 8.1.2.4.5.1.2.2.

If the network requests measurements on a GSM cell the UE shall behave as follows:

- The UE shall perform GSM carrier RSSI measurements according to clause 8.1.2.4.5.1 when a measurement gap pattern sequence is activated, or the UE supports capability of conducting such measurements without gaps.

The UE shall perform measurement reporting as defined in TS 36.331 [2].

- The UE shall perform BSIC identification. The UE shall use the most recently available GSM carrier RSSI measurement results for arranging GSM cells in signal strength order for performing BSIC identification.
- The UE shall perform BSIC re-confirmation on all the GSM cells that have been successfully identified.
- The UE shall perform all configured event evaluation for event-triggered reporting after the BSIC has been verified for a GSM cell. The UE shall use the most recently available GSM carrier RSSI measurement results in event evaluation and event-triggered reporting.
- Event-triggered and periodic reports shall be triggered according to TS 36.331 [2].

The BSIC of a GSM cell is considered to be “verified” if the UE has decoded the SCH of the BCCH carrier and identified the BSIC at least one time (initial BSIC identification). Once a GSM cell has been identified the BSIC shall be re-confirmed at least once every $8 \cdot T_{\text{re-confirm,GSM}}$ seconds. Otherwise the BSIC of the GSM cell is considered as “non-verified”. If a measurement gap pattern sequence is deactivated by the network after BSIC has been identified or verified, the UE shall consider the BSIC as non-verified.

$T_{\text{identify,GSM}}$ indicates the maximum time allowed for the UE to decode the unknown BSIC of the GSM cell in one GSM BCCH carrier in the initial BSIC identification procedure.

$T_{\text{re-confirm,GSM}}$ indicates the maximum time allowed for the re-confirmation of the BSIC of one GSM cell in the BSIC re-confirmation procedure.

The UE shall be able to decode a BSIC within a measurement gap when the time difference between the middle of the received GSM synchronisation burst at the UE and the middle of the effective measurement gap is within the limits specified in table 8.1.2.4.5.1.2-1.

Table 8.1.2.4.5.1.2-1: The gap length and maximum time difference for BSIC verification

| Gap length [ms] | Maximum time difference [μs] |
|-----------------|------------------------------|
| 6 | ± 2350 μs |

The UE shall be able to perform BSIC verification at levels down to the reference sensitivity level or reference interference levels as specified in [9].

8.1.2.4.5.1.2.1 Initial BSIC identification

This measurement shall be based on the measurement gaps used for Initial BSIC identification as described in clause 8.1.2.4.5.1.2.

The UE shall continuously attempt to decode the BSIC of SCH on the BCCH carrier of the 8 strongest BCCH carriers of the GSM cells indicated in the Inter-RAT cell info list. The UE shall give priority for BSIC decoding attempts in decreasing signal strength order to BCCH carriers with unknown BSIC. The strongest BCCH carrier is defined as the BCCH carrier having the highest measured GSM carrier RSSI value.

If the BSIC of the GSM BCCH carrier has been successfully decoded the UE shall immediately continue BSIC identification with the next GSM BCCH carrier, in signal strength order, with unknown BSIC. The GSM cell for which the BSIC has been successfully identified shall be moved to the BSIC re-confirmation procedure.

If the UE has not successfully decoded the BSIC of the GSM BCCH carrier within $T_{\text{identify,GSM}}$ ms, the UE shall abort the BSIC identification attempts for that GSM BCCH carrier. The UE shall continue to try to perform BSIC identification of the next GSM BCCH carrier in signal strength order. The GSM BCCH carrier for which the BSIC identification failed shall not be re-considered for BSIC identification until BSIC identification attempts have been made for all the rest of the 8 strongest GSM BCCH carriers in the monitored set with unknown BSIC.

$T_{\text{identify,GSM}}$ values are given for a set of reference gap patterns in table 8.1.2.4.5.1.2.1-1. The requirements in the table represent the time required to guarantee at least two attempts to decode the BSIC for one GSM BCCH carrier. If inter-frequency RSTD measurements are configured and the UE requires measurement gaps for performing such measurements, then $T_{\text{identify,GSM}}$ shall be based on the 80ms gap configuration.

Table 8.1.2.4.5.1.2.1-1

| $\text{ceil}(N_{\text{freq},n} * K_n - M_{\text{gsm}})$ | $T_{\text{identify,gsm}}(\text{ms})$ | | $T_{\text{reconfirm,gsm}}(\text{ms})$ | |
|---|--------------------------------------|-------------------------------|---------------------------------------|-------------------------------|
| | 40ms gap configuration (ID 0) | 80ms gap configuration (ID 1) | 40ms gap configuration (ID 0) | 80ms gap configuration (ID 1) |
| 0 | 2160 | 5280 | 1920 | 5040 |
| 1 | 5280 | 21760 | 5040 | 17280 |
| 2 | 5280 | 31680 | 5040 | 29280 |
| 3 | 19440 | No requirement | 13320 | No requirement |
| 4 | 31680 | No requirement | 29280 | No requirement |
| 5 | 31680 | No requirement | 29280 | No requirement |

8.1.2.4.5.1.2.2 BSIC re-confirmation

The UE shall maintain the timing information of up to 8 identified GSM cells. Initial timing information is obtained from the initial BSIC identification. The timing information shall be updated every time the BSIC is decoded.

For each measurement gap used for GSM BSIC reconfirmation as described in clause 8.1.2.4.5.1.2, the UE shall attempt to decode the BSIC falling within the measurement gap according to table 8.1.2.4.5.1.2.1-1. If more than one BSIC can be decoded within the same measurement gap, priority shall be given to the least recently decoded BSIC. If inter-frequency RSTD measurements are configured and the UE requires measurement gaps for performing such measurements, then $T_{\text{re-confirm,GSM}}$ shall be based on the 80ms gap configuration.

If the UE fails to decode the BSIC after two successive attempts or if the UE has not been able to re-confirm the BSIC for a GSM cell within $T_{\text{re-confirm,GSM}}$ seconds, the UE shall abort the BSIC re-confirmation attempts for that GSM cell. The GSM cell shall be treated as a new GSM cell with unidentified BSIC and the GSM cell shall be moved to the initial BSIC identification procedure, see clause 8.1.2.4.5.1.2.1.

8.1.2.4.5.1.2a Enhanced BSIC verification

In addition to the BSIC verification requirements in clause 8.1.2.4.5.1.2, when the UE receives the GSM cell at levels down to 10 dB + the reference sensitivity level or reference interference levels as specified in [9] the BSIC identification requirement in table 8.1.2.4.5.1.2a-1 applies. The BSIC verification requirements in table 8.1.2.4.5.1.2a-1 shall apply when no DRX is used or when DRX cycle length ≤ 40 ms.

Table 8.1.2.4.5.1.2a-1

| | $T_{\text{enhanced_identify,gsm}}(\text{ms})$ | | $T_{\text{enhanced_reconfirm,gsm}}(\text{ms})$ | |
|---|--|--|---|--|
| | 40ms gap configuration (ID 0) | 40ms gap configuration when interfrequency RSTD measurement is also configured and the UE requires measurement gaps for performing such measurements | 40ms gap configuration (ID 0) | 40ms gap configuration when interfrequency RSTD measurement is also configured and the UE requires measurement gaps for performing such measurements |
| $\text{ceil}(N_{\text{freq},n} * K_n - M_{\text{gsm}})$ | | | | |
| 0 | 1320 | 2160 | 1080 | 1920 |

8.1.2.4.5.1.3 Periodic Reporting

Reported measurements in periodically triggered measurement reports shall meet the requirements in clause 9.

8.1.2.4.5.1.4 Event Triggered Reporting

Reported measurements in event triggered measurement reports shall meet the requirements in clause 9.

The UE shall not send any event triggered measurement reports, as long as no reporting criteria are fulfilled.

The measurement reporting delay is defined as the time between an event that will trigger a measurement report and the point when the UE starts to transmit the measurement report over the air interface. This requirement assumes that the measurement report is not delayed by other RRC signalling on the DCCH.

The event triggered reporting delay requirement is valid when the UE for each GSM carrier in the monitored set can take the required number of samples during the measurement period $T_{\text{Measurement Period, GSM}}$ (see clause 8.1.2.4.5.1).

The event triggered measurement reporting delay for a GSM cell with verified BSIC, measured without L3 filtering shall be less than $2 * T_{\text{Measurement Period, GSM}}$, where $T_{\text{Measurement Period, GSM}}$ is defined in clause 8.1.2.4.5.1. When L3 filtering is used or IDC autonomous denial is configured or the UE is performing reception and/or transmission for ProSe Direct Discovery and/or ProSe Direct Communication, an additional delay can be expected.

8.1.2.4.5.1.5 Event-triggered Periodic Reporting

Reported measurements contained in event triggered periodic measurement reports shall meet the requirements in clause 9.

The first report in event triggered periodic measurement reporting shall meet the requirements specified in clause 8.1.2.4.5.1.4.

8.1.2.4.5.2 E-UTRAN FDD – GSM measurements when DRX is used

The requirements in this clause apply only to UE supporting E-UTRAN FDD and GSM.

Measurements on GSM cells can be requested with BSIC verified.

In RRC_CONNECTED state when a supported measurement gap pattern sequence according to Table 8.1.2.1-1 is configured by E-UTRAN, or the UE supports capability of conducting such measurements without gaps, the UE shall continuously measure GSM cells, search for new GSM cells given in the monitored set and re-confirm the BSIC for already detected cells. During DRX or eDRX_CONN periods the UE may use other periods of time outside the specified measurement gap patterns. The UE is not required to make measurements of GSM cells during DRX or eDRX_CONN periods if a measurement gap pattern has not been configured, unless the UE supports capability of conducting such measurements without gaps.

8.1.2.4.5.2.1 GSM carrier RSSI

This measurement shall be based on measurement gaps allocated for GSM carrier RSSI measurement as described in clause 8.1.2.1. A UE supporting GSM measurements shall measure minimum number of 10 GSM carrier RSSI measurement samples ($N_{\text{GSM carrier RSSI}}$) per DRX or eDRX_CONN cycle. When DRX is used in RRC_CONNECTED state, the measurement period, $T_{\text{Measurement Period, GSM}}$, for the GSM carrier RSSI measurement is shown in table 8.1.2.4.5.2.1-1. When eDRX_CONN is used in RRC_CONNECTED state, the measurement period, $T_{\text{Measurement Period, GSM}}$, for the GSM carrier RSSI measurement is shown in table 8.1.2.4.5.2.1-2. The parameters $N_{\text{freq,n}}$ and K_n are defined in clause 8.1.2.1.1.

Table 8.1.2.4.5.2.1-1: GSM measurement period for large DRX

| DRX cycle length (s) | $T_{\text{measure,GSM}}$ (s) (DRX cycles) |
|--|---|
| ≤ 0.064 | Non DRX Requirements are applicable |
| $0.064 < \text{DRX-cycle} \leq 0.08$ | Note ($6 * K_n * N_{\text{freq,n}}$) |
| $0.08 < \text{DRX-cycle} \leq 2.56$ | Note ($5 * K_n * N_{\text{freq,n}}$) |
| Note: Time depends upon the DRX cycle in use | |

Table 8.1.2.4.5.2.1-2: GSM measurement period for large DRX when eDRX_CONN cycle is used

| eDRX_CONN cycle length (s) | $T_{\text{measure,GSM}}$ (s) (eDRX_CONN cycles) |
|--|---|
| $2.56 < \text{eDRX_CONN cycle} \leq 10.24$ | Note ($5 * K_n * N_{\text{freq,n}}$) |
| Note: Time depends upon the eDRX_CONN cycle in use | |

The UE shall meet the measurement accuracy requirements stated for RXLEV in [8], when the given measurement time allows the UE to take at least 3 GSM carrier RSSI samples per GSM carrier in the monitored set during the measurement period.

In case the UE is not able to acquire the required number of samples per GSM carrier during one measurement period, the UE shall measure as many GSM carriers as possible during that measurement period using at least 3 samples per GSM carrier. The GSM carriers that were not measured during that measurement period shall be measured in the following measurement periods.

8.1.2.4.5.2.2 BSIC verification

Measurements on a GSM cell can be requested with BSIC verified. The UE shall be able to report the GSM cells with BSIC verified for those cells where the verification of BSIC has been successful.

The procedure for BSIC verification on a GSM cell can be divided into the following two tasks:

- **Initial BSIC identification:** Includes searching for the BSIC and decoding the BSIC for the first time when there is no knowledge about the relative timing between the E-UTRAN FDD and GSM cells.
- **BSIC re-confirmation:** Tracking and decoding the BSIC of a GSM cell after initial BSIC identification is performed. The UE shall trigger the BSIC re-confirmation within the available measurement gap pattern

If the network requests measurements on a GSM cell, the UE shall behave as follows:

- The UE shall perform GSM carrier RSSI measurements according to clause 8.1.2.4.5.2.1 when a measurement gap pattern sequence is activated, or the UE supports capability of conducting such measurements without gaps.

The UE shall perform measurement reporting as defined in TS 36.331 [2].

- The UE shall perform BSIC identification. The UE shall use the most recently available GSM carrier RSSI measurement results for arranging GSM cells in signal strength order for performing BSIC identification.
- The UE shall perform BSIC re-confirmation on all the GSM cells that have been successfully identified.
- The UE shall perform all configured event evaluation for event-triggered reporting after the BSIC has been verified for a GSM cell. The UE shall use the most recently available GSM carrier RSSI measurement results in event evaluation and event-triggered reporting.
- Event-triggered and periodic reports shall be triggered according to TS 36.331 [2].

The BSIC of a GSM cell is considered to be “verified” if the UE has decoded the SCH of the BCCH carrier and identified the BSIC at least one time (initial BSIC identification). Once a GSM cell has been identified the BSIC shall be re-confirmed at least once every 30 seconds. Otherwise the BSIC of the GSM cell is considered as "non-verified".

The UE shall be able to perform BSIC verification at levels down to the reference sensitivity level or reference interference levels as specified in [9].

8.1.2.4.5.2.2.1 Initial BSIC identification

This measurement shall be made on GSM cells that are requested with BSIC verified.

For DRX cycle length ≤ 40 ms, the initial GSM BSIC identification requirements corresponding to the non DRX requirements as specified in clause 8.1.2.4.5.1.2.1 shall apply.

For DRX cycle length > 40 ms and any eDRX_CONN cycle, the UE shall make at least one attempt every $K_n \cdot N_{\text{freq},n} \cdot 30$ s to decode the BSIC of SCH on the BCCH carrier of the 8 strongest BCCH carriers of the GSM cells indicated in the Inter-RAT cell info list. If the UE has not successfully decoded the BSIC of the GSM BCCH carrier within $K_n \cdot N_{\text{freq},n} \cdot 60$ s, the UE shall abort the BSIC identification attempts for that GSM BCCH carrier. The UE shall give priority for BSIC decoding attempts in decreasing signal strength order to BCCH carriers with unknown BSIC. The strongest BCCH carrier is defined as the BCCH carrier having the highest measured GSM carrier RSSI value. The parameters $N_{\text{freq},n}$ and K_n are defined in clause 8.1.2.1.1.

If the BSIC of the GSM BCCH carrier has been successfully decoded the UE shall continue BSIC identification with the next GSM BCCH carrier, in signal strength order, with unknown BSIC. The GSM cell for which the BSIC has been successfully identified shall be moved to the BSIC re-confirmation procedure.

8.1.2.4.5.2.2.2 BSIC re-confirmation

The UE shall maintain the timing information of up to 8 identified GSM cells. Initial timing information is obtained from the initial BSIC identification. The timing information shall be updated every time the BSIC is decoded.

For DRX cycle length ≤ 40 ms, the GSM BSIC re-confirmation requirements corresponding to the non DRX requirements as specified in clause 8.1.2.4.5.1.2.2 shall apply.

For DRX cycle length > 40 ms and any eDRX_CONN cycle, at least every $K_n \cdot N_{\text{freq},n} \cdot 30$ seconds, the UE shall attempt to decode the BSIC of each identified GSM cell. If the UE fails to decode the BSIC after two successive attempts or if the UE has not been able to re-confirm the BSIC for a GSM cell within $K_n \cdot N_{\text{freq},n} \cdot 60$ seconds, the UE shall abort the BSIC re-confirmation attempts for that GSM cell. The GSM cell shall be treated as a new GSM cell with unidentified BSIC and the GSM cell shall be moved to the initial BSIC identification procedure, see clause 8.1.2.4.5.2.2.1. The parameters $N_{\text{freq},n}$ and k_n are defined in clause 8.1.2.1.1.

8.1.2.4.5.2.3 Periodic Reporting

Reported measurements in periodically triggered measurement reports shall meet the requirements in clause 9.

8.1.2.4.5.2.4 Event Triggered Reporting

Reported measurements in event triggered measurement reports shall meet the requirements in clause 9.

The UE shall not send any event triggered measurement reports, as long as no reporting criteria are fulfilled.

The measurement reporting delay is defined as the time between an event that will trigger a measurement report and the point when the UE starts to transmit the measurement report over the air interface. This requirement assumes that the measurement report is not delayed by other RRC signalling on the DCCH.

The event triggered reporting delay requirement is valid when the UE for each GSM carrier in the monitored set can take the required number of samples during the measurement period $T_{\text{Measurement Period, GSM}}$ (see clause 8.1.2.4.5.2.1).

The event triggered measurement reporting delay for a GSM cell with verified BSIC, measured without L3 filtering shall be less than $2 \cdot T_{\text{Measurement Period, GSM}}$, where $T_{\text{Measurement Period, GSM}}$ is defined in clause 8.1.2.4.5.2.1. When L3 filtering is used or IDC autonomous denial is configured or the UE is performing reception and/or transmission for ProSe Direct Discovery and/or ProSe Direct Communication, an additional delay can be expected.

8.1.2.4.5.2.5 Event-triggered Periodic Reporting

Reported measurements contained in event triggered periodic measurement reports shall meet the requirements in clause 9.

The first report in event triggered periodic measurement reporting shall meet the requirements specified in clause 8.1.2.4.5.2.4.

8.1.2.4.6 E-UTRAN TDD – GSM measurements

The requirements in clause 8.1.2.4.5 also apply for this section.

8.1.2.4.7 E-UTRAN FDD – UTRAN FDD measurements for SON

8.1.2.4.7.1 Identification of a new UTRA FDD cell for SON

No explicit neighbour list is provided to the UE for identifying a UTRA cell for SON. The UE shall identify and report only the strongest cell when requested by the network for the purpose of SON.

8.1.2.4.7.1.1 Requirements when no DRX is used

When no DRX is used, either measurement gaps are scheduled or the UE supports capability of conducting such measurements without gaps, the UE shall be able to identify a new cell within:

$$T_{\text{identify, UTRA_FDD}} = T_{\text{basic_identify_UTRA_FDD}} \cdot \frac{480}{T_{\text{interl}}} \cdot K_n N_{\text{freq},n} \quad \text{ms (normal performance)}$$

and

$$T_{\text{identify, UTRA_FDD}} = T_{\text{basic_identify_UTRA_FDD}} \cdot \frac{480}{T_{\text{interl}}} \cdot K_r N_{\text{freq},r} \quad \text{ms (reduced performance)}$$

$T_{\text{basic_identify_UTRA_FDD}} = 300$ ms. This is the time period used in the above equation where the maximum allowed time for the UE to identify a new UTRA FDD cell is defined.

A cell shall be considered identifiable following conditions are fulfilled:

- CPICH $E_c/I_o \geq -20$ dB,
- SCH $E_c/I_o \geq -17$ dB for at least one channel tap and SCH E_c/I_o is equally divided between primary synchronisation code and secondary synchronisation code. When L3 filtering is used an additional delay can be expected.

If the UE is unable to identify the UTRA cell for SON within $8 \cdot T_{\text{identify, UTRA_FDD}}$ ms, the UE may stop searching UTRA cells for SON.

8.1.2.4.7.1.2 Requirements when DRX is used

When DRX or eDRX_CONN is used, either measurement gaps are scheduled or the UE supports capability of conducting such measurements without gaps, the UE shall be able to identify a new cell within $T_{\text{identify, UTRA_FDD}}$. When

DRX is used, $T_{\text{identify, UTRA_FDD}}$ is as defined in table 8.1.2.4.7.1.2-1, and when eDRX_CONN is used, $T_{\text{identify, UTRA_FDD}}$ is as defined in table 8.1.2.4.7.1.2-2.

Table 8.1.2.4.7.1.2-1: Requirement to identify a new UTRA FDD cell for SON

| DRX cycle length (s) | $T_{\text{identify, UTRA_FDD}}$ (s) (DRX cycles) (normal requirement) | | $T_{\text{identify, UTRA_FDD}}$ (s) (DRX cycles) (reduced requirement) | |
|--|---|--|---|--|
| | Gap period = 40 ms | Gap period = 80 ms | Gap period = 40 ms | Gap period = 80 ms |
| ≤ 0.04 | Non DRX Requirements in clause 8.1.2.4.7.1.1 are applicable | Non DRX Requirements in clause 8.1.2.4.7.1.1 are applicable | Non DRX Requirements in clause 8.1.2.4.7.1.1 are applicable | Non DRX Requirements in clause 8.1.2.4.7.1.1 are applicable |
| $0.04 < \text{DRX cycle} \leq 0.08$ | Note ($45 \cdot K_n \cdot N_{\text{freq},n}$) | Note ($95 \cdot K_n \cdot N_{\text{freq},n}$) | Note ($45 \cdot K_r \cdot N_{\text{freq},r}$) | Note ($95 \cdot K_r \cdot N_{\text{freq},r}$) |
| 0.128 | $3.84 \cdot K_n \cdot N_{\text{freq},n}$ ($30 \cdot K_n \cdot N_{\text{freq},n}$) | $8.0 \cdot K_n \cdot N_{\text{freq},n}$ ($62.5 \cdot K_n \cdot N_{\text{freq},n}$) | $3.84 \cdot K_r \cdot N_{\text{freq},r}$ ($30 \cdot K_r \cdot N_{\text{freq},r}$) | $8.0 \cdot K_r \cdot N_{\text{freq},r}$ ($62.5 \cdot K_r \cdot N_{\text{freq},r}$) |
| 0.16 | $4.0 \cdot K_n \cdot N_{\text{freq},n}$ ($25 \cdot K_n \cdot N_{\text{freq},n}$) | $8.0 \cdot K_n \cdot N_{\text{freq},n}$ ($50 \cdot K_n \cdot N_{\text{freq},n}$) | $4.0 \cdot K_r \cdot N_{\text{freq},r}$ ($25 \cdot K_r \cdot N_{\text{freq},r}$) | $8.0 \cdot K_r \cdot N_{\text{freq},r}$ ($50 \cdot K_r \cdot N_{\text{freq},r}$) |
| 0.256 | $6.4 \cdot K_n \cdot N_{\text{freq},n}$ ($25 \cdot K_n \cdot N_{\text{freq},n}$) | $8.96 \cdot K_n \cdot N_{\text{freq},n}$ ($35 \cdot K_n \cdot N_{\text{freq},n}$) | $6.4 \cdot K_r \cdot N_{\text{freq},r}$ ($25 \cdot K_r \cdot N_{\text{freq},r}$) | $8.96 \cdot K_r \cdot N_{\text{freq},r}$ ($35 \cdot K_r \cdot N_{\text{freq},r}$) |
| 0.32 | $8 \cdot K_n \cdot N_{\text{freq},n}$ ($25 \cdot K_n \cdot N_{\text{freq},n}$) | $8.96 \cdot K_n \cdot N_{\text{freq},n}$ ($28 \cdot K_n \cdot N_{\text{freq},n}$) | $8 \cdot K_r \cdot N_{\text{freq},r}$ ($25 \cdot K_r \cdot N_{\text{freq},r}$) | $8.96 \cdot K_r \cdot N_{\text{freq},r}$ ($28 \cdot K_r \cdot N_{\text{freq},r}$) |
| $0.32 < \text{DRX cycle} \leq 2.56$ | Note ($25 \cdot K_n \cdot N_{\text{freq},n}$) | Note ($25 \cdot K_n \cdot N_{\text{freq},n}$) | Note ($25 \cdot K_r \cdot N_{\text{freq},r}$) | Note ($25 \cdot K_r \cdot N_{\text{freq},r}$) |
| Note: Time depends upon the DRX cycle in use | | | | |

Table 8.1.2.4.7.1.2-2: Requirement to identify a new UTRA FDD cell for SON when eDRX_CONN cycle is used

| eDRX_CONN cycle length (s) | $T_{\text{identify, UTRA_FDD}}$ (s) (eDRX_CONN cycles) (normal requirement) | | $T_{\text{identify, UTRA_FDD}}$ (s) (eDRX_CONN cycles) (reduced requirement) | |
|--|--|---|---|---|
| | Gap period = 40 ms | Gap period = 80 ms | Gap period = 40 ms | Gap period = 80 ms |
| $2.56 < \text{eDRX_CONN cycle} \leq 10.24$ | Note ($25 \cdot K_n \cdot N_{\text{freq},n}$) | Note ($25 \cdot K_n \cdot N_{\text{freq},n}$) | Note ($25 \cdot K_r \cdot N_{\text{freq},r}$) | Note ($25 \cdot K_r \cdot N_{\text{freq},r}$) |
| Note: Time depends upon the eDRX_CONN cycle in use | | | | |

A cell shall be considered identifiable provided following conditions are fulfilled:

- CPICH $E_c/I_o \geq -20$ dB,
- SCH $E_c/I_o \geq -17$ dB for at least one channel tap and SCH E_c/I_o is equally divided between primary synchronisation code and secondary synchronisation code. When L3 filtering is used an additional delay can be expected.

If the UE is unable to identify the UTRA cell for SON within $8 \cdot T_{\text{identify, UTRA_FDD}}$ seconds, the UE may stop searching UTRA cells for SON; when DRX is used $T_{\text{identify, UTRA_FDD}}$ is defined in table 8.1.2.4.7.1.2-1, and when eDRX_CONN is used $T_{\text{identify, UTRA_FDD}}$ is defined in table 8.1.2.4.7.1.2-2.

8.1.2.4.7.1.3 Reporting Delay

The UE shall not report the physical cell identity of an identifiable cell for SON as long as the reporting criteria are not fulfilled.

The reporting delay is defined as the time between the identification of the strongest cell for SON until the UE starts to transmit its physical cell identity over the Uu interface. This requirement assumes that the reporting of the physical cell identity is not delayed by other RRC signalling on the DCCH. This reporting delay excludes a delay uncertainty resulted when inserting the physical cell identity of the strongest cell for SON to the TTI of the uplink DCCH. The delay uncertainty is twice the TTI of the uplink DCCH. This reporting delay excludes any delay caused by unavailability of UL resources for UE sending the physical cell identity of the strongest cell for SON.

The reporting delay of the physical cell identity of the strongest cell for SON without L3 filtering shall be less than $T_{\text{identify, UTRA_FDD}}$ defined in clause 8.1.2.4.7.1.1 and in clause 8.1.2.4.7.1.2 for non DRX and DRX or eDRX_CONN

cases respectively. When L3 filtering is used or IDC autonomous denial is configured, an additional delay can be expected.

8.1.2.4.8 E-UTRAN TDD – UTRAN FDD measurements for SON

The requirements in clause 8.1.2.4.7 also apply for this section.

8.1.2.4.9 E-UTRAN FDD – cdma2000 1xRTT measurements

UE shall perform cdma2000 1xRTT measurements according to the procedure defined in [15] on the cdma2000 1xRTT neighbor cells indicated by the serving eNode B. If measurement gaps are required, the UE shall perform cdma2000 1xRTT measurements only during the measurement gaps configured by the serving eNode B.

8.1.2.4.9.1A E-UTRAN FDD – cdma2000 1xRTT measurements when no DRX is used

When measurement gaps are scheduled for CDMA2000 1xRTT inter RAT measurements, or the UE supports capability of conducting such measurements without gaps, the UE physical layer shall be capable of reporting CDMA2000 1xRTT Pilot Strength measurements to higher layers with measurement accuracy as specified in Clause 9.5, corresponding to a 90% measurement success rate, with measurement period given by

$$T_{\text{measurement_CDMA2000_1x}} = T_{\text{basic_measurement_CDMA2000_1x}} \cdot N_{\text{freq,n}} \cdot K_n \cdot S_{\text{gap}}$$

where $T_{\text{basic_measurement_CDMA2000_1x}} = 100$ ms and the measurement gap specific scale factor S_{gap} is based on the measurement gap pattern in use as defined in Table 8.1.2.4.9.1-1. If inter-frequency RSTD measurements are configured and the UE requires measurement gaps for performing such measurements, then S_{gap} shall be based to the Gap Pattern Id 1.

Table 8.1.2.4.9.1-1: Gap Pattern Specific Scale Factor

| Gap Pattern Id | S_{gap} |
|----------------|------------------|
| 0 | 32/3 |
| 1 | 64/3 |

8.1.2.4.9.1 Periodic Reporting

Reported measurements in periodically triggered measurement reports shall meet the requirements in clause 9.

The measurement reporting delay of each periodic report is defined as the time between the end of the last measurement period and the moment when the UE starts to transmit the measurement report over the Uu interface. This delay shall be less than T_{71m} defined in [15] for each periodic report. This measurement reporting delay excludes a delay which is caused by the unavailability of the uplink resources for the UE to send the measurement report.

8.1.2.4.10 E-UTRAN TDD – cdma2000 1xRTT measurements

The requirements in clause 8.1.2.4.9 also apply for this section.

8.1.2.4.11 E-UTRAN FDD – HRPD measurements

UE shall perform HRPD measurements according to the procedure defined in [11] on the HRPD neighbor cells indicated by the serving eNode B. If measurement gaps are required, the UE shall perform HRPD measurements only during the measurement gaps configured by the serving eNode B.

8.1.2.4.12 E-UTRAN TDD – HRPD measurements

The requirements in clause 8.1.2.4.11 also apply for this section.

8.1.2.4.13 E-UTRAN TDD – UTRAN TDD measurements for SON

8.1.2.4.13.1 Identification of a new UTRA TDD cell for SON

No explicit neighbour list is provided to the UE for identifying a UTRA TDD cell for SON. The UE shall identify and report only the strongest cell when requested by the network for the purpose of SON.

8.1.2.4.13.1.1 Requirements when no DRX is used

When no DRX is used, either measurement gaps are scheduled or the UE supports capability of conducting such measurements without gaps, the UE shall be able to identify a new cell within:

$$T_{\text{identify, UTRA_TDD}} = T_{\text{basic_identify_UTRA_TDD}} \cdot \frac{480}{T_{\text{inter1}}} \cdot K_n \cdot N_{\text{freq},n} \quad \text{ms (normal performance)}$$

and

$$T_{\text{identify, UTRA_TDD}} = T_{\text{basic_identify_UTRA_TDD}} \cdot \frac{480}{T_{\text{inter1}}} \cdot K_r \cdot N_{\text{freq},r} \quad \text{ms (reduced performance)}$$

$T_{\text{basic_identify_UTRA_TDD}} = 800$ ms. This is the time period used in the above equation where the maximum allowed time for the UE to identify a new UTRA TDD cell is defined.

A cell shall be considered identifiable following conditions are fulfilled:

- P-CCPCH $E_c/I_0 \geq -8$ dB,
- DwPCH $E_c/I_0 \geq -5$ dB.

When L3 filtering is used an additional delay can be expected.

If the UE is unable to identify the UTRA TDD cell for SON within $8 \cdot T_{\text{identify, UTRA_TDD}}$ ms, the UE may stop searching UTRA TDD cells for SON.

8.1.2.4.13.1.2 Requirements when DRX is used

When DRX or eDRX_CONN is used, either measurement gaps are scheduled or the UE supports capability of conducting such measurements without gaps, the UE shall be able to identify a new cell within $T_{\text{identify, UTRA_TDD}}$. When DRX is used, $T_{\text{identify, UTRA_TDD}}$ is as defined in table 8.1.2.4.13.1.2-1, and when eDRX_CONN is used, $T_{\text{identify, UTRA_TDD}}$ is as defined in table 8.1.2.4.13.1.2-2.

Table 8.1.2.4.13.1.2-1: Requirement to identify a new UTRA TDD cell for SON

| DRX cycle length (s) | $T_{\text{identify, UTRA_TDD}}$ (s) (DRX cycles) | | $T_{\text{identify, UTRA_TDD}}$ (s) (DRX cycles) | $T_{\text{identify, UTRA_TDD}}$ (s) (DRX cycles) |
|--|---|---|---|---|
| | Gap period = 40 ms | Gap period = 80 ms | Gap period = 40 ms | Gap period = 80 ms |
| ≤ 0.16 | Non DRX Requirements in clause 8.1.2.4.3.1 are applicable | Non DRX Requirements in clause 8.1.2.4.3.1 are applicable | Non DRX Requirements in clause 8.1.2.4.3.1 are applicable | Non DRX Requirements in clause 8.1.2.4.3.1 are applicable |
| $0.16 < \text{DRX cycle} \leq 0.256$ | Note ($25 \cdot K_n \cdot N_{\text{freq},n}$) | Note ($50 \cdot K_n \cdot N_{\text{freq},n}$) | Note ($25 \cdot K_r \cdot N_{\text{freq},r}$) | Note ($50 \cdot K_r \cdot N_{\text{freq},r}$) |
| $0.256 < \text{DRX cycle} \leq 0.32$ | Note ($25 \cdot K_n \cdot N_{\text{freq},n}$) | Note ($45 \cdot K_n \cdot N_{\text{freq},n}$) | Note ($25 \cdot K_r \cdot N_{\text{freq},r}$) | Note ($45 \cdot K_r \cdot N_{\text{freq},r}$) |
| $0.32 < \text{DRX cycle} \leq 2.56$ | Note ($25 \cdot K_n \cdot N_{\text{freq},n}$) | Note ($25 \cdot K_n \cdot N_{\text{freq},n}$) | Note ($25 \cdot K_r \cdot N_{\text{freq},r}$) | Note ($25 \cdot K_r \cdot N_{\text{freq},r}$) |
| Note: Time depends upon the DRX cycle in use | | | | |

Table 8.1.2.4.13.1.2-2: Requirement to identify a new UTRA TDD cell for SON when eDRX_CONN cycle is used

| eDRX_CONN cycle length (s) | T _{identify, UTRA_TDD} (s) (eDRX_CONN cycles) | | T _{identify, UTRA_TDD} (s) (eDRX_CONN cycles) | |
|--|--|---|--|---|
| | Gap period = 40 ms | Gap period = 80 ms | Gap period = 40 ms | Gap period = 80 ms |
| 2.56 < eDRX_CONN cycle ≤ 10.24 | Note (25 * K _n * N _{freq,n}) | Note (25 * K _n * N _{freq,n}) | Note (25 * K _r * N _{freq,r}) | Note (25 * K _r * N _{freq,r}) |
| Note: Time depends upon the eDRX_CONN cycle in use | | | | |

A cell shall be considered identifiable provided following conditions are fulfilled:

- P-CCPCH Ec/Io ≥ -8 dB,
- DwPCH_Ec/Io ≥ -5 dB.

When L3 filtering is used an additional delay can be expected.

If the UE is unable to identify the UTRA TDD cell for SON within 8 * T_{identify, UTRA_TDD} seconds, the UE may stop searching UTRA TDD cells for SON; when DRX is used T_{identify, UTRA_TDD} is defined in table 8.1.2.4.13.1.2-1, and when eDRX_CONN is used T_{identify, UTRA_TDD} is defined in table 8.1.2.4.13.1.2-2.

8.1.2.4.13.1.3 Reporting Delay

The UE shall not report the physical cell identity of an identifiable cell for SON as long as the reporting criteria are not fulfilled.

The reporting delay is defined as the time between the identification of the strongest cell for SON until the UE starts to transmit its physical cell identity over the Uu interface. This requirement assumes that the reporting of the physical cell identity is not delayed by other RRC signalling on the DCCH. This reporting delay excludes a delay uncertainty resulted when inserting the physical cell identity of the strongest cell for SON to the TTI of the uplink DCCH. The delay uncertainty is twice the TTI of the uplink DCCH. This reporting delay excludes any delay caused by unavailability of UL resources for UE sending the physical cell identity of the strongest cell for SON.

The reporting delay of the physical cell identity of the strongest cell for SON without L3 filtering shall be less than T_{identify, UTRA_TDD} defined in clause 8.1.2.4.13.1.1 and in clause 8.1.2.4.13.1.2 for non DRX and DRX and eDRX_CONN cases respectively. When L3 filtering is used or IDC autonomous denial is configured, an additional delay can be expected.

8.1.2.4.14 E-UTRAN FDD – UTRAN TDD measurements for SON

The requirements in clause 8.1.2.4.13 also apply for this section.

8.1.2.4.15 E-UTRAN FDD – cdma2000 1xRTT measurements for SON ANR

8.1.2.4.15.1 Identification of a new cdma2000 1xRTT cell for SON ANR

No explicit neighbour list is provided to the UE for identifying a cdma2000 1xRTT cell for SON ANR. The UE shall identify and report only the strongest cell when requested by the network for the purpose of SON ANR.

8.1.2.4.15.1.1 Requirement when no DRX is used

When measurement gaps are scheduled for CDMA2000 1xRTT inter RAT measurements, or the UE supports capability of conducting such measurements without gaps, the UE physical layer shall be capable of reporting CDMA2000 1xRTT Pilot Strength measurements to higher layers with measurement accuracy as specified in Clause 9.5, corresponding to a 90% measurement success rate, with measurement period given by

$$T_{\text{measurement_CDMA2000_1x}} = T_{\text{basic_measurement_CDMA2000_1x}} \cdot N_{\text{freq,n}} \cdot K_n \cdot S_{\text{gap}}$$

where T_{basic_measurement_CDMA2000_1x} = 100 ms and the measurement gap specific scale factor S_{gap} is based on the measurement gap pattern in use as defined in Table 8.1.2.4.15.1.1-1. If inter-frequency RSTD measurements are

configured and the UE requires measurement gaps for performing such measurements, then S_{gap} shall be based to the Gap Pattern Id 1.

Table 8.1.2.4.15.1.1-1: Gap Pattern Specific Scale Factor

| Gap Pattern Id | S_{gap} |
|----------------|------------------|
| 0 | 32/3 |
| 1 | 64/3 |

If the UE is unable to identify the CDMA2000 1xRTT cell for SON ANR within [TBD] ms, the UE may stop searching CDMA2000 1xRTT cells for SON ANR.

8.1.2.4.15.1.2 Reporting Delay

The UE shall not report the physical cell identity of an identifiable cell for SON ANR as long as the reporting criteria are not fulfilled.

The reporting delay is defined as the time between the identification of the strongest cell for SON ANR until the UE starts to transmit its physical cell identity over the Uu interface. This delay shall be less than T_{71m} defined in [15]. This measurement reporting delay excludes a delay which is caused by the unavailability of the uplink resources for the UE to send the measurement report.

8.1.2.4.16 E-UTRAN TDD – cdma2000 1xRTT measurements for SON ANR

The requirements in clause 8.1.2.4.15 also apply for this section.

8.1.2.4.17 E-UTRAN FDD-UTRAN FDD measurements with autonomous gaps

The requirements in this clause apply only to UE supporting E-UTRA FDD and UTRA FDD.

8.1.2.4.17.1 Identification of a new CGI of UTRA FDD cell with autonomous gaps

No explicit neighbour list is provided to the UE for identifying a new CGI of UTRA FDD cell. The UE shall identify and report the CGI when requested by the network for the purpose of 'reportCGI'. The UE may make autonomous gaps in both downlink reception and uplink transmission for decoding SFN and receiving UTRAN MIB and SIB3 messages according to clause 5.5.3.1 of TS 36.331 [2]. Note that a UE is not required to use autonomous gap if si-RequestForHO is set to false. If autonomous gaps are used for measurement with the purpose of 'reportCGI', regardless of whether DRX or eDRX_CONN is used or not, the UE shall be able to identify a new CGI of UTRA FDD cell within:

$$T_{\text{identify_CGI, UTRAN FDD}} = 630 + 40 * \text{SIB3_REP ms}$$

where SIB3_REP is the repetition period at which the UTRAN cell schedules SIB3 blocks in units of frames specified in TS 25.331 [7], provided that the UTRAN cell has been already identified by the UE.

This requirement is applicable for UTRA FDD target cell configurations where the information required to make the SI report can be determined from the MIB and SIB3 alone, and MIB and SIB3 are not segmented into multiple TTIs. Additionally, for the requirement to be applicable, the reception conditions shall be such that the system frame number of the target UTRA FDD cell, the MIB and SIB3 can each be successfully decoded in no more than four attempts.

According to the reception conditions:

A cell shall be considered identifiable following conditions are fulfilled:

- CPICH $E_c/I_o \geq -20$ dB,
- SCH $E_c/I_o \geq -17$ dB for at least one channel tap and SCH E_c/I_o is equally divided between primary synchronisation code and secondary synchronisation code. When L3 filtering is used an additional delay can be expected. The system frame number, the MIB and SIB3 of the target cell shall be considered decodable provided the BCH demodulation requirements are met according to [29].

The requirement for identifying a new CGI of an UTRA FDD cell within $T_{\text{identify_CGI, UTRAN FDD}}$ is applicable when no DRX is used as well as when any of the DRX or eDRX_CONN cycles specified in TS 36.331 [2] is used.

8.1.2.4.17.2 CGI Reporting Delay

The CGI reporting delay occurs due to the delay uncertainty when inserting the CGI measurement report to the TTI of the uplink DCCH. The delay uncertainty is twice the TTI of the uplink DCCH. In case DRX is used, the CGI reporting may be delayed until the next DRX cycle. In case eDRX is used, the CGI reporting may be delayed until the next eDRX_CONN cycle. If IDC autonomous denial is configured, an additional delay can be expected.

8.1.2.4.18 E-UTRAN TDD-UTRAN FDD measurements with autonomous gaps

The requirements in this clause apply only to UE supporting E-UTRA TDD and UTRA FDD.

8.1.2.4.18.1 Identification of a new CGI of UTRA FDD cell with autonomous gaps

The requirements in clause 8.1.2.4.17.1 also apply for this section.

8.1.2.4.18.2 CGI Reporting Delay

The requirements in clause 8.1.2.4.17.2 also apply for this section.

8.1.2.4.19 E-UTRAN FDD – WLAN measurements

8.1.2.4.19.1 Introduction

The requirements in this section shall apply for a UE capable of E-UTRA FDD and LTE-WLAN Aggregation [2].

8.1.2.4.19.2 Requirements

8.1.2.4.19.2.1 E-UTRAN FDD – WLAN measurements when no DRX is used

In the RRC_CONNECTED state when no DRX is used the measurement period for WLAN RSSI shall be T_{WLAN_RSSI} as defined in table 8.1.2.4.19.2.1-1.

The value of T_{WLAN_RSSI} depends upon whether the WLAN RSSI measurement is performed on the serving access point (AP) or on a neighbour AP and in case of the neighbour AP whether the neighbour AP is known or unknown to the UE:

- Measurement of known single neighbor AP is time-sensitive and is performed on the AP for which information about the operating channel is known to the UE; and
- - Measurement of unknown neighbor AP is not time-sensitive and is performed on the AP for which information about the operating channel is not known to the UE.

The UE shall be capable of performing WLAN RSSI measurements for certain minimum number of APs during T_{WLAN_RSSI} as defined in table 8.1.2.4.19.2.1-1 provided that the beacon frame of the measured AP is available at the UE at least once every 102.4 ms. The UE physical layer shall be capable of reporting WLAN RSSI measurements to higher layers with the measurement period of T_{WLAN_RSSI} .

Table 8.1.2.4.19.2.1-1: WLAN RSSI measurement period

| WLAN RSSI measurement configuration | | T_{WLAN_RSSI} [seconds] |
|--|--|----------------------------|
| Type of Measurement | Minimum number of APs measured during T_{WLAN_RSSI} | |
| Measurement of serving AP | 1 | 0.5 |
| Measurement of known neighbor AP on a single channel | 1 | 5 |
| Measurement of multiple unknown neighbor APs | 3 | 30 |

The WLAN RSSI measurement accuracy for all measured access points shall be fulfilled according to the accuracy as specified in the sub-clause 9.7.1.

8.1.2.4.19.2.2 E-UTRAN FDD – WLAN measurements when DRX is used

In the RRC_CONNECTED state when DRX is used the measurement period for WLAN RSSI shall be $T_{\text{RSSI_DRX}}$ as defined in table 8.1.2.4.19.2.2-1.

The value of $T_{\text{WLAN_RSSI_DRX}}$ depends upon whether the WLAN RSSI measurement is performed on the serving access point (AP) or on a neighbour AP and in case of the neighbour AP whether the neighbour AP is known or unknown to the UE:

- Measurement of known single neighbor AP is time-sensitive and is performed on the AP for which information about the operating channel is known to the UE; and
- Measurement of unknown neighbor AP is not time-sensitive and is performed on the AP for which information about the operating channel is not known to the UE

The UE shall be capable of performing WLAN RSSI measurements for certain minimum number of APs during $T_{\text{WLAN_RSSI_DRX}}$ as defined in table 8.1.2.4.19.2.2-1 provided that the beacon frame of the measured AP is available at the UE at least once every 102.4 ms. The UE physical layer shall be capable of reporting WLAN RSSI measurements to higher layers with the measurement period of $T_{\text{WLAN_RSSI_DRX}}$.

Table 8.1.2.4.19.2.2-1: Requirement to measure WLAN RSSI in DRX

| WLAN RSSI measurement configuration | | DRX cycle length (s) | $T_{\text{WLAN_RSSI_DRX}}$ (s) |
|--|---|--|---------------------------------------|
| Type of Measurement | Minimum number of APs measured during $T_{\text{WLAN_RSSI}}$ | | |
| Measurement of serving AP | 1 | $0.002 \leq \text{DRX-cycle} \leq 0.320$ | MAX (0.5, $5 \cdot L_{\text{DRX}}$) |
| Measurement of one known neighbor AP on a single channel | 1 | $0.002 \leq \text{DRX-cycle} \leq 0.320$ | MAX (5, $25 \cdot L_{\text{DRX}}$) |
| | | $0.320 < \text{DRX-cycle} \leq 2.56$ | MAX (5, $20 \cdot L_{\text{DRX}}$) |
| Measurement of 3 unknown neighbor APs | 3 | $0.002 \leq \text{DRX-cycle} \leq 0.320$ | MAX (30, $150 \cdot L_{\text{DRX}}$) |
| | | $0.320 < \text{DRX-cycle} \leq 2.56$ | MAX (30, $120 \cdot L_{\text{DRX}}$) |
| Note 1: L_{DRX} is the length of DRX cycle in second(s) | | | |

The WLAN RSSI measurement accuracy for all measured access points shall be fulfilled according to the accuracy as specified in the sub-clause 9.7.1.

8.1.2.4.19.2.3 Void

8.1.2.4.19.2.4 Event Triggered Reporting

Reported measurements in event triggered measurement reports shall meet the requirements in clause 9.7.1.

The UE shall not send any event triggered measurement reports, as long as the reporting criteria is not fulfilled.

The measurement reporting delay is defined as the time between any event that will trigger a measurement report until the UE starts to transmit the measurement report over the Uu interface. This requirement assumes that the measurement report is not delayed by other RRC signalling on the DCCH. This measurement reporting delay excludes a delay uncertainty resulted when inserting the measurement report to the TTI of the uplink DCCH. The delay uncertainty is twice the TTI of the uplink DCCH. This measurement reporting delay excludes a delay which caused by no UL resources for UE to send the measurement report.

The event triggered measurement reporting delay, measured without L3 filtering shall be less than $T_{\text{WLAN_RSSI}}$ when no DRX is used as defined in section 8.1.2.4.19.2.1 and $T_{\text{WLAN_RSSI_DRX}}$ when DRX is used as defined in section 8.1.2.4.19.2.2. When L3 filtering is used or IDC autonomous denial or the UE is performing reception and/or transmission for ProSe Direct Discovery and/or ProSe Direct Communication, is configured an additional delay can be expected.

8.1.2.4.19.2.5 Event-triggered Periodic Reporting

Reported measurements contained in event triggered periodic measurement reports shall meet the requirements in clause 9.7.1.

The first report in event triggered periodic measurement reporting shall meet the requirements specified in clause 8.1.2.4.19.2.3.

8.1.2.4.20 E-UTRAN TDD – WLAN measurements

The requirements in this section shall apply for a UE capable of E-UTRA TDD and LTE-WLAN Aggregation [2].

The requirements in clause 8.1.2.4.19 also apply for this section.

8.1.2.5 E-UTRAN OTDOA Intra-Frequency RSTD Measurements

All intra-frequency RSTD measurement requirements specified in Sections 8.1.2.5.1 and 8.1.2.5.2 shall apply without DRX as well as for any DRX and eDRX_CONN cycles specified in TS 36.331 [2].

8.1.2.5.1 E-UTRAN FDD Intra-Frequency OTDOA Measurements

When the physical layer cell identities of neighbour cells together with the OTDOA assistance data are provided, the UE shall be able to detect and measure intra-frequency RSTD, specified in TS 36.214 [4], for at least $n=16$ cells, including the reference cell, on the same carrier frequency f_1 as that of the reference cell within

$T_{\text{RSTD IntraFreqFDD, E-UTRAN}}$ ms as given below (see also Figure 8.1.2.5.1-1):

$$T_{\text{RSTD IntraFreqFDD, E-UTRAN}} = T_{\text{PRS}} \cdot (M - 1) + \Delta \quad \text{ms} \quad ,$$

where

$T_{\text{RSTD IntraFreqFDD, E-UTRAN}}$ is the total time for detecting and measuring at least n cells,

T_{PRS} is the cell-specific positioning subframe configuration period as defined in TS 36.211 [16],

M is the number of PRS positioning occasions as defined in Table 8.1.2.5.1-1, where each PRS positioning occasion comprises of N_{PRS} ($1 \leq N_{\text{PRS}} \leq 6$) consecutive downlink positioning subframes defined in TS 36.211 [16], and

$\Delta = 160 \cdot \left\lceil \frac{n}{M} \right\rceil$ ms is the measurement time for a single PRS positioning occasion which includes the sampling time and the processing time.

Table 8.1.2.5.1-1: Number of PRS positioning occasions within $T_{\text{RSTD IntraFreqFDD, E-UTRAN}}$

| Positioning subframe configuration period T_{PRS} | Number of PRS positioning occasions M | |
|---|---|-----------------------|
| | f_1 Note1 | f_1 and f_2 Note2 |
| 160 ms | 16 | 32 |
| >160 ms | 8 | 16 |
| Note 1: When only intra-frequency RSTD measurements are performed over cells belonging to the serving FDD carrier frequency f_1 . | | |
| Note 2: When intra-frequency RSTD and inter-frequency RSTD measurements are performed over cells belonging to the serving FDD carrier frequency f_1 and one inter-frequency carrier frequency f_2 , respectively. | | |

The UE physical layer shall be capable of reporting RSTD for the reference cell and all the neighbor cells i out of at least $(n-1)$ neighbor cells within $T_{\text{RSTD IntraFreqFDD, E-UTRAN}}$ provided:

$$\left(\text{PRS } \hat{E}_s / \text{Iot} \right)_{\text{ref}} \geq -6 \text{ dB for all Frequency Bands for the reference cell,}$$

$$\left(\text{PRS } \hat{E}_s / \text{Iot} \right)_i \geq -13 \text{ dB for all Frequency Bands for neighbour cell } i,$$

$$\left(\text{PRS } \hat{E}_s / \text{Iot} \right)_{\text{ref}} \text{ and } \left(\text{PRS } \hat{E}_s / \text{Iot} \right)_i \text{ conditions apply for all subframes of at least } L = \frac{M}{2} \text{ PRS positioning}$$

occasions,

PRP 1,2_{dBm} according to Annex B.2.5 for a corresponding Band

$\text{PRS } \hat{E}_s / I_{ot}$ is defined as the ratio of the average received energy per PRS RE during the useful part of the symbol to the average received power spectral density of the total noise and interference for this RE, where the ratio is measured over all REs which carry PRS.

The time $T_{\text{RSTD IntraFreqFDD, E-UTRAN}}$ starts from the first subframe of the PRS positioning occasion closest in time after both the OTDOA-RequestLocationInformation message and the OTDOA assistance data in the OTDOA-ProvideAssistanceData message as specified in TS 36.355 [24], are delivered to the physical layer of the UE as illustrated in Figure 8.1.2.5.1-1.

The RSTD measurement accuracy for all measured neighbor cells i shall be fulfilled according to the accuracy as specified in the sub-clause 9.1.10.1.

If the intra-frequency handover occurs while intra-frequency RSTD measurements are being performed then the UE shall complete the ongoing OTDOA measurement session. The UE shall also meet the intra-frequency OTDOA measurement and accuracy requirements. However in this case the RSTD measurement period ($T_{\text{RSTD IntraFreqFDD, E-UTRAN, HO}}$) shall be according to the following expression:

$$T_{\text{RSTD IntraFreqFDD, E-UTRAN, HO}} = T_{\text{RSTD IntraFreqFDD, E-UTRAN}} + K \times T_{\text{PRS}} + T_{\text{HO}} \quad \text{ms} ,$$

where:

K is the number of times the intra-frequency handover occurs during $T_{\text{RSTD IntraFreqFDD, E-UTRAN, HO}}$.

T_{HO} is the time during which the intra-frequency RSTD measurement may not be possible due to intra-frequency handover; it can be up to 45 ms.

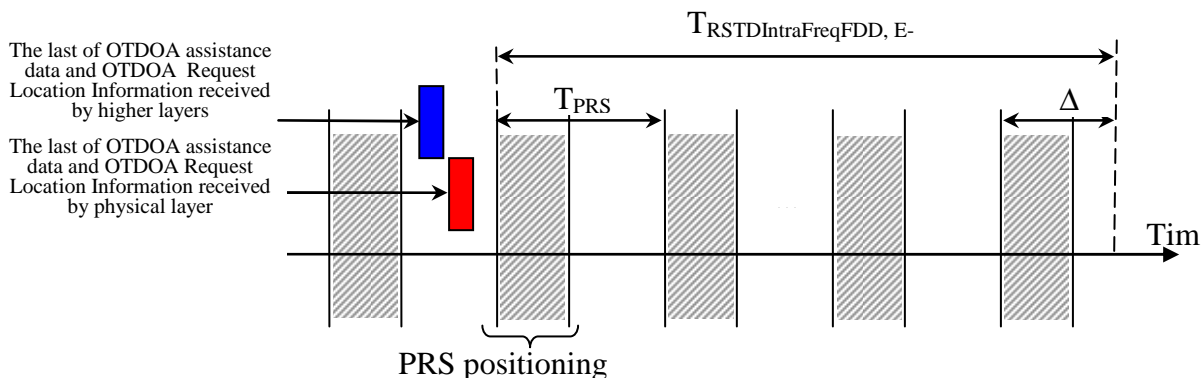

Figure 8.1.2.5.1-1. Illustration of the RSTD reporting time requirement in an FDD system.

Furthermore, due to the intra-frequency handover the UE shall meet the RSTD measurement accuracy for a PRS bandwidth which is not larger than the minimum channel bandwidth of all the PCells during the RSTD measurement period.

8.1.2.5.1.1 RSTD Measurement Reporting Delay

This requirement assumes that the measurement report is not delayed by other LPP signalling on the DCCH. This measurement reporting delay excludes a delay uncertainty resulted when inserting the measurement report to the TTI of the uplink DCCH. The delay uncertainty is: $2 \times T_{\text{TI}_{\text{DCCH}}}$. This measurement reporting delay excludes any delay caused by no UL resources for UE to send the measurement report.

8.1.2.5.2 E-UTRAN TDD Intra-Frequency OTDOA Measurements

When the physical layer cell identities of neighbour cells together with the OTDOA assistance data are provided, the UE shall be able to detect and measure intra-frequency RSTD, specified in TS 36.214 [4], for at least $n=16$ cells, including the reference cell, on the same carrier frequency f_1 as that of the reference cell within

$T_{\text{RSTD IntraFreqTDD, E-UTRAN}}$ ms as given below:

$$T_{\text{RSTD IntraFreqTDD, E-UTRAN}} = T_{\text{PRS}} \cdot (M - 1) + \Delta \quad \text{ms} \quad ,$$

where

$T_{\text{RSTD IntraFreqTDD, E-UTRAN}}$ is the total time for detecting and measuring at least n cells,

T_{PRS} is the cell-specific positioning subframe configuration period as defined in TS 36.211 [16],

M is the number of PRS positioning occasions as defined in Table 8.1.2.5.2-1, where a PRS positioning occasion is as defined in Clause 8.1.2.5.1, and

$\Delta = 160 \cdot \left\lceil \frac{n}{M} \right\rceil$ ms is the measurement time for a single PRS positioning occasion which includes the sampling time

and the processing time.

Table 8.1.2.5.2-1: Number of PRS positioning occasions within $T_{\text{RSTD IntraFreqTDD, E-UTRAN}}$

| Positioning subframe configuration period T_{PRS} | Number of PRS positioning occasions M | |
|--|---|----------------------------|
| | f1 ^{Note1} | f1 and f2 ^{Note2} |
| 160 ms | 16 | 32 |
| >160 ms | 8 | 16 |

Note 1: When only intra-frequency RSTD measurements are performed over cells belonging to the serving TDD carrier frequency f1.
Note 2: When intra-frequency RSTD and inter-frequency RSTD measurements are performed over cells belonging to the serving TDD carrier frequency f1 and one inter-frequency carrier frequency f2 respectively.

The UE physical layer shall be capable of reporting RSTD for the reference cell and all the neighbor cells i out of at least $(n-1)$ neighbor cells within $T_{\text{RSTD IntraFreqTDD, E-UTRAN}}$ provided:

$(\text{PRS } \hat{E}_s / \text{Iot})_{\text{ref}} \geq -6$ dB for all Frequency Bands for the reference cell,

$(\text{PRS } \hat{E}_s / \text{Iot})_i \geq -13$ dB for all Frequency Bands for neighbour cell i ,

$(\text{PRS } \hat{E}_s / \text{Iot})_{\text{ref}}$ and $(\text{PRS } \hat{E}_s / \text{Iot})_i$ conditions apply for all subframes of at least $L = \frac{M}{2}$ PRS positioning

occasions,

PRP 1,2|dBm according to Annex B.2.5 for a corresponding Band

$\text{PRS } \hat{E}_s / \text{Iot}$ is as defined in Clause 8.1.2.5.1.

The time $T_{\text{RSTD IntraFreqTDD, E-UTRAN}}$ starts from the first subframe of the PRS positioning occasion closest in time after both the OTDOA-RequestLocationInformation message and the OTDOA assistance data in the OTDOA-ProvideAssistanceData message as specified in TS 36.355 [24], are delivered to the physical layer of the UE.

The RSTD measurement accuracy for all measured neighbor cells i shall be fulfilled according to the accuracy as specified in the sub-clause 9.1.10.1.

If the intra-frequency handover occurs while intra-frequency RSTD measurements are being performed then the UE shall complete the ongoing OTDOA measurement session. The UE shall also meet the intra-frequency OTDOA measurement and accuracy requirements. However in this case the RSTD measurement period

$(T_{\text{RSTD IntraFreqTDD, E-UTRAN, HO}})$ shall be according to the following expression:

$$T_{\text{RSTD IntraFreqTDD, E-UTRAN, HO}} = T_{\text{RSTD IntraFreqTDD, E-UTRAN}} + K \times T_{\text{PRS}} + T_{\text{HO}} \quad \text{ms} \quad ,$$

where:

K is the number of times the intra-frequency handover occurs during $T_{\text{RSTD IntraFreqTDD, E-UTRAN, HO}}$,

T_{HO} is the time during which the intra-frequency RSTD measurement may not be possible due to intra-frequency handover; it can be up to 45 ms.

Furthermore, due to the intra-frequency handover the UE shall meet the RSTD measurement accuracy for a PRS bandwidth which is not larger than the minimum channel bandwidth of all the PCells during the RSTD measurement period.

The intra-frequency requirements in this clause (8.1.2.5.2) shall apply for all TDD special subframe configurations specified in TS 36.211 [16] and for the TDD uplink-downlink configurations as specified in Table 8.1.2.5.2-2.

Table 8.1.2.5.2-2: TDD uplink-downlink subframe configurations applicable for TDD intra-frequency requirements

| PRS Transmission Bandwidth [RB] | Applicable TDD uplink-downlink configurations |
|--|---|
| 6, 15 | 1, 2, 3, 4 and 5 |
| 25, 50, 75, 100 | 0, 1, 2, 3, 4, 5 and 6 |
| Note: Uplink-downlink configurations are specified in Table 4.2-2 in TS 36.211 [16]. | |

8.1.2.5.2.1 RSTD Measurement Reporting Delay

This requirement assumes that the measurement report is not delayed by other LPP signalling on the DCCH. This measurement reporting delay excludes a delay uncertainty resulted when inserting the measurement report to the TTI of the uplink DCCH. The delay uncertainty is: $2 \times TTI_{DCCH}$. This measurement reporting delay excludes any delay caused by no UL resources for UE to send the measurement report.

8.1.2.6 E-UTRAN Inter-Frequency OTDOA Measurements

All inter-frequency RSTD measurement requirements specified in Sections 8.1.2.6.1-8.1.2.6.4 shall apply, provided that

- the UE is capable of inter-frequency RSTD measurements for OTDOA [24], and
- either the measurement gap pattern ID # 0 specified in Clause 8.1.2.1 is used or the UE supports capability of conducting inter-frequency measurements without gaps.

All inter-frequency RSTD measurement requirements specified in Sections 8.1.2.6.1-8.1.2.6.4 shall apply without DRX as well as for any DRX or eDRX_CONN cycles specified in TS 36.331 [2].

8.1.2.6.1 E-UTRAN FDD-FDD Inter-Frequency OTDOA Measurements

When the physical layer cell identities of neighbour cells together with the OTDOA assistance data are provided, the UE shall be able to detect and measure inter-frequency RSTD, specified in TS 36.214 [4], for at least $n=16$ cells, including the reference cell, within $T_{RSTD \text{ InterFreqFDD, E-UTRAN}}$ ms as given below:

$$T_{RSTD \text{ InterFreqFDD, E-UTRAN}} = T_{PRS} \cdot (M - 1) + \Delta \quad ms \quad ,$$

where

$T_{RSTD \text{ InterFreqFDD, E-UTRAN}}$ is the total time for detecting and measuring at least n cells,

T_{PRS} is the the largest value of the cell-specific positioning subframe configuration period, defined in TS 36.211 [16], among the measured n cells including the reference cell,

M is the number of PRS positioning occasions as defined in Table 8.1.2.6.1-1, where a PRS positioning occasion is as defined in clause 8.1.2.5.1,

$\Delta = 160 \cdot \left\lceil \frac{n}{M} \right\rceil$ ms is the measurement time for a single PRS positioning occasion which includes the sampling time and the processing time, and

the n cells are distributed on up to two carrier frequencies including a serving carrier frequency and one inter-frequency carrier.

Table 8.1.2.6.1-1: Number of PRS positioning occasions within $T_{\text{RSTD InterFreqFDD, E-UTRAN}}$

| Positioning subframe configuration period T_{PRS} | Number of PRS positioning occasions M | |
|--|---|----------------------------|
| | f2 ^{Note1} | f1 and f2 ^{Note2} |
| 160 ms | 16 | 32 |
| >160 ms | 8 | 16 |

Note 1: When inter-frequency RSTD measurements are performed over the reference cell and neighbour cells, which belong to the FDD inter-frequency carrier frequency f2.
Note 2: When inter-frequency RSTD measurements are performed over the reference cell and the neighbour cells, which belong to the serving FDD carrier frequency f1 and the FDD inter-frequency carrier frequency f2 respectively.

The UE physical layer shall be capable of reporting RSTD for the reference cell and all the neighbor cells i out of at least $(n-1)$ neighbor cells within $T_{\text{RSTD InterFreqFDD, E-UTRAN}}$ provided:

$(\text{PRS } \hat{E}_s / \text{Iot})_{\text{ref}} \geq -6 \text{ dB}$ for all Frequency Bands for the reference cell,
 $(\text{PRS } \hat{E}_s / \text{Iot})_i \geq -13 \text{ dB}$ for all Frequency Bands for neighbour cell i ,
 $(\text{PRS } \hat{E}_s / \text{Iot})_{\text{ref}}$ and $(\text{PRS } \hat{E}_s / \text{Iot})_i$ conditions apply for all subframes of at least $L = \frac{M}{2}$ PRS positioning occasions,
PRP 1,2_{dBm} according to Annex B.2.6 for a corresponding Band

$\text{PRS } \hat{E}_s / \text{Iot}$ is as defined in Clause 8.1.2.5.1.

The time $T_{\text{RSTD InterFreqFDD, E-UTRAN}}$ starts from the first subframe of the PRS positioning occasion closest in time after both the OTDOA-RequestLocationInformation message and the OTDOA assistance data in the OTDOA-ProvideAssistanceData message as specified in TS 36.355 [24], are delivered to the physical layer of the UE.

If the inter-frequency handover occurs while inter-frequency RSTD measurements are being performed, and the inter-frequency carrier on which RSTD is measured becomes the new serving carrier frequency after the inter-frequency handover, the UE shall complete the ongoing OTDOA measurement session. The UE shall also meet the inter-frequency OTDOA measurement and accuracy requirements. However in this case the RSTD measurement period ($T_{\text{RSTD InterFreqFDD, E-UTRAN, HO}}$) shall be according to the following expression:

$$T_{\text{RSTD InterFreqFDD, E-UTRAN, HO}} = T_{\text{RSTD InterFreqFDD, E-UTRAN}} + K \times T_{\text{PRS}} + T_{\text{HO}} \quad \text{ms},$$

where:

K is the number of times the inter-frequency handover occurs during $T_{\text{RSTD InterFreqFDD, E-UTRAN, HO}}$,

T_{HO} is the time during which the inter-frequency RSTD measurement may not be possible due to inter-frequency handover; it can be up to 45 ms.

The RSTD measurement accuracy for all measured neighbor cells i shall be fulfilled according to the accuracy as specified in the sub-clause 9.1.10.2.

Furthermore, due to the inter-frequency handover the UE shall meet the RSTD measurement accuracy for a PRS bandwidth which is not larger than the minimum channel bandwidth of those PCells on whose carriers RSTD measurement is performed during the RSTD measurement period.

8.1.2.6.1.1 RSTD Measurement Reporting Delay

This requirement assumes that the measurement report is not delayed by other LPP signalling on the DCCH. This measurement reporting delay excludes a delay uncertainty resulted when inserting the measurement report to the TTI of the uplink DCCH. The delay uncertainty is: $2 \times \text{TTI}_{\text{DCCH}}$. This measurement reporting delay excludes any delay caused by no UL resources for UE to send the measurement report.

8.1.2.6.2 E-UTRAN TDD-FDD Inter-Frequency OTDOA Measurements

When the physical layer cell identities of neighbour cells together with the OTDOA assistance data are provided, the UE shall be able to detect and measure inter-frequency RSTD, specified in TS 36.214 [4], for at least $n=16$ cells,

including the reference cell, within $T_{\text{RSTD InterFreqTDDFDD, E-UTRAN}}$ ms as given below:

$$T_{\text{RSTD InterFreqTDDFDD, E-UTRAN}} = T_{\text{PRS}} \cdot (M - 1) + \Delta \quad \text{ms}$$

where

$T_{\text{RSTD InterFreqTDDFDD, E-UTRAN}}$ is the total time for detecting and measuring at least n cells,

T_{PRS} is the largest value of the cell-specific positioning subframe configuration period, defined in TS 36.211 [16], among the measured n cells including the reference cell,

M is the number of PRS positioning occasions as defined in Table 8.1.2.6.2-1, where a PRS positioning occasion is as defined in clause 8.1.2.5.1,

$\Delta = 160 \cdot \left\lceil \frac{n}{M} \right\rceil$ ms is the measurement time for a single PRS positioning occasion which includes the sampling time and the processing time, and

the n cells are distributed on up to two carrier frequencies including a serving carrier frequency and one inter-frequency carrier.

Table 8.1.2.6.2-1: Number of PRS positioning occasions within $T_{\text{RSTD InterFreqTDDFDD, E-UTRAN}}$

| Positioning subframe configuration period T_{PRS} | Number of PRS positioning occasions M | |
|---|---|----------------------------|
| | f2 ^{Note1} | f1 and f2 ^{Note2} |
| 160 ms | 16 | 32 |
| >160 ms | 8 | 16 |
| NOTE 1: When inter-frequency RSTD measurements are performed over the reference cell and neighbour cells, which belong to the FDD inter-frequency carrier frequency f2. | | |
| NOTE 2: When inter-frequency RSTD measurements are performed over the reference cell and the neighbour cells, which belong to the serving TDD carrier frequency f1 and the FDD inter-frequency carrier frequency f2 respectively. | | |

The UE physical layer shall be capable of reporting RSTD for the reference cell and all the neighbor cells i out of at least $(n-1)$ neighbor cells within $T_{\text{RSTD InterFreqTDDFDD, E-UTRAN}}$, provided:

$$\left(\text{PRS } \hat{E}_s / \text{Iot} \right)_{\text{ref}} \geq -6 \text{ dB for all Frequency Bands for the reference cell,}$$

$$\left(\text{PRS } \hat{E}_s / \text{Iot} \right)_i \geq -13 \text{ dB for all Frequency Bands for neighbour cell } i,$$

$\left(\text{PRS } \hat{E}_s / \text{Iot} \right)_{\text{ref}}$ and $\left(\text{PRS } \hat{E}_s / \text{Iot} \right)_i$ conditions apply for all subframes of at least $L = \frac{M}{2}$ PRS positioning occasions,

PRP 1,2]_{dBm} according to Annex B.2.6 for a corresponding Band,

$\text{PRS } \hat{E}_s / \text{Iot}$ is as defined in Clause 8.1.2.5.1.

The time $T_{\text{RSTD InterFreqTDDFDD, E-UTRAN}}$ starts from the first subframe of the PRS positioning occasion closest in time after both the OTDOA-RequestLocationInformation message and the OTDOA assistance data in the OTDOA-ProvideAssistanceData message as specified in TS 36.355 [24], are delivered to the physical layer of the UE.

If the inter-frequency handover occurs while inter-frequency RSTD measurements are being performed, and the inter-frequency carrier on which RSTD is measured becomes the new serving carrier frequency after the inter-frequency handover, the UE shall complete the ongoing OTDOA measurement session. The UE shall also meet the inter-frequency OTDOA measurement and accuracy requirements. However in this case the RSTD measurement period ($T_{\text{RSTD InterFreqTDDFDD, E-UTRAN, HO}}$) shall be according to the following expression:

$$T_{\text{RSTD InterFreqTDDFDD, E-UTRAN, HO}} = T_{\text{RSTD InterFreqTDDFDD, E-UTRAN}} + K \times T_{\text{PRS}} + T_{\text{HO}} \quad \text{ms},$$

where:

K is the number of times the inter-frequency handover occurs during $T_{\text{RSTD InterFreqTDDFDD, E-UTRAN, HO}}$,

T_{HO} is the time during which the inter-frequency RSTD measurement may not be possible due to inter-frequency handover; it can be up to 45 ms.

The RSTD measurement accuracy for all measured neighbor cells i shall be fulfilled according to the accuracy as specified in the sub-clause 9.1.10.2.

Furthermore, due to the inter-frequency handover the UE shall meet the RSTD measurement accuracy for a PRS bandwidth which is not larger than the minimum channel bandwidth of those PCells on whose carriers RSTD measurement is performed during the RSTD measurement period.

The inter-frequency requirements in this clause (8.1.2.6.2) shall apply for all TDD special subframe configurations specified in TS 36.211 [16] and for the TDD uplink-downlink configurations as specified in Table 8.1.2.6.2-2.

Table 8.1.2.6.2-2: TDD uplink-downlink subframe configurations applicable for TDD-FDD inter-frequency requirements

| PRS Transmission Bandwidth [RB] | Applicable TDD uplink-downlink configurations |
|--|---|
| 6, 15 | 1, 2, 3, 4 and 5 |
| 25, 50, 75, 100 | 0, 1, 2, 3, 4, 5 and 6 |
| NOTE: Uplink-downlink configurations are specified in Table 4.2-2 in TS 36.211 [16]. | |

8.1.2.6.2.1 RSTD Measurement Reporting Delay

This requirement assumes that the measurement report is not delayed by other LPP signalling on the DCCH. This measurement reporting delay excludes a delay uncertainty resulted when inserting the measurement report to the TTI of the uplink DCCH. The delay uncertainty is: $2 \times T_{\text{TI}_{\text{DCCH}}}$. This measurement reporting delay excludes any delay caused by no UL resources for UE to send the measurement report.

8.1.2.6.3 E-UTRAN TDD-TDD Inter-Frequency OTDOA Measurements

When the physical layer cell identities of neighbour cells together with the OTDOA assistance data are provided, the UE shall be able to detect and measure inter-frequency RSTD, specified in TS 36.214 [4], for at least $n=16$ cells, including the reference cell, within $T_{\text{RSTD InterFreqTDD, E-UTRAN}}$ ms as given below:

$$T_{\text{RSTD InterFreqTDD, E-UTRAN}} = T_{\text{PRS}} \cdot (M - 1) + \Delta \quad \text{ms},$$

where

$T_{\text{RSTD InterFreqTDD, E-UTRAN}}$ is the total time for detecting and measuring at least n cells,

T_{PRS} is the largest value of the cell-specific positioning subframe configuration period, defined in TS 36.211 [16], among the measured n cells including the reference cell,

M is the number of PRS positioning occasions as defined in Table 8.1.2.6.1-1, where a PRS positioning occasion is as defined in clause 8.1.2.5.1,

$\Delta = 160 \cdot \left\lceil \frac{n}{M} \right\rceil$ ms is the measurement time for a single PRS positioning occasion which includes the sampling time and the processing time, and

the n cells are distributed on up to two carrier frequencies including a serving carrier frequency and one inter-frequency carrier.

Table 8.1.2.6.3-1: Number of PRS positioning occasions within $T_{\text{RSTD InterFreqTDD, E-UTRAN}}$

| Positioning subframe configuration period T_{PRS} | Number of PRS positioning occasions M | |
|--|---|----------------------------|
| | f2 ^{Note1} | f1 and f2 ^{Note2} |
| 160 ms | 16 | 32 |
| >160 ms | 8 | 16 |

Note 1: When inter-frequency RSTD measurements are performed over the reference cell and neighbour cells, which belong to the TDD inter-frequency carrier frequency f2.
Note 2: When inter-frequency RSTD measurements are performed over the reference cell and the neighbour cells, which belong to the serving TDD carrier frequency f1 and the TDD inter-frequency carrier frequency f2 respectively.

The inter-frequency requirements in this clause (8.1.2.6.3) shall apply for all TDD special subframe configurations specified in TS 36.211 [16] and for the TDD uplink-downlink configurations as specified in Table 8.1.2.6.3-2.

Table 8.1.2.6.3-2: TDD uplink-downlink subframe configurations applicable for inter-frequency requirements

| PRS Transmission Bandwidth [RB] | Applicable TDD uplink-downlink configurations |
|---------------------------------|---|
| 6, 15 | 3, 4 and 5 |
| 25 | 1, 2, 3, 4, 5 and 6 |
| 50, 75, 100 | 0, 1, 2, 3, 4, 5 and 6 |

Note 1: Uplink-downlink configurations are specified in Table 4.2-2 in TS 36.211 [16].
Note 2: For UEs capable of performing inter-frequency measurements without measurement gaps, TDD uplink-downlink subframe configurations as specified in Table 8.1.2.5.2-2 shall apply.

The UE physical layer shall be capable of reporting RSTD for the reference cell and all the neighbor cells i out of at least $(n-1)$ neighbor cells within $T_{\text{RSTD InterFreqTDD, E-UTRAN}}$ provided:

$$\left(\text{PRS } \hat{E}_s / \text{Iot} \right)_{\text{ref}} \geq -6 \text{ dB for all Frequency Bands for the reference cell,}$$

$$\left(\text{PRS } \hat{E}_s / \text{Iot} \right)_i \geq -13 \text{ dB for all Frequency Bands for neighbour cell } i,$$

$$\left(\text{PRS } \hat{E}_s / \text{Iot} \right)_{\text{ref}} \text{ and } \left(\text{PRS } \hat{E}_s / \text{Iot} \right)_i \text{ conditions apply for all subframes of at least } L = \frac{M}{2} \text{ PRS positioning}$$

occasions,

PRP 1,2_{dBm} according to Annex B.2.6 for a corresponding Band

$\text{PRS } \hat{E}_s / \text{Iot}$ is as defined in Clause 8.1.2.5.1.

The time $T_{\text{RSTD InterFreqTDD, E-UTRAN}}$ starts from the first subframe of the PRS positioning occasion closest in time after both the OTDOA-RequestLocationInformation message and the OTDOA assistance data in the OTDOA-ProvideAssistanceData message as specified in TS 36.355 [24], are delivered to the physical layer of the UE.

If the inter-frequency handover occurs while inter-frequency RSTD measurements are being performed, and the inter-frequency carrier on which RSTD is measured becomes the new serving carrier frequency after the inter-frequency handover, the UE shall complete the ongoing OTDOA measurement session. The UE shall also meet the inter-frequency OTDOA measurement and accuracy requirements. However in this case the RSTD measurement period ($T_{\text{RSTD InterFreqTDD, E-UTRAN, HO}}$) shall be according to the following expression:

$$T_{\text{RSTD InterFreqTDD, E-UTRAN, HO}} = T_{\text{RSTD InterFreqTDD, E-UTRAN}} + K \times T_{\text{PRS}} + T_{\text{HO}} \quad \text{ms},$$

where:

K is the number of times the inter-frequency handover occurs during $T_{\text{RSTD InterFreqTDD, E-UTRAN, HO}}$,

T_{HO} is the time during which the inter-frequency RSTD measurement may not be possible due to inter-frequency handover; it can be up to 45 ms.

The RSTD measurement accuracy for all measured neighbor cells i shall be fulfilled according to the accuracy as specified in the sub-clause 9.1.10.2.

Furthermore, due to the inter-frequency handover the UE shall meet the RSTD measurement accuracy for a PRS bandwidth which is not larger than the minimum channel bandwidth of those PCells on whose carriers RSTD measurement is performed during the RSTD measurement period.

8.1.2.6.3.1 RSTD Measurement Reporting Delay

This requirement assumes that the measurement report is not delayed by other LPP signalling on the DCCH. This measurement reporting delay excludes a delay uncertainty resulted when inserting the measurement report to the TTI of the uplink DCCH. The delay uncertainty is: $2 \times TTI_{\text{DCCH}}$. This measurement reporting delay excludes any delay caused by no UL resources for UE to send the measurement report.

8.1.2.6.4 E-UTRAN FDD-TDD Inter-Frequency OTDOA Measurements

When the physical layer cell identities of neighbour cells together with the OTDOA assistance data are provided, the UE shall be able to detect and measure inter-frequency RSTD, specified in TS 36.214 [4], for at least $n=16$ cells, including the reference cell, within $T_{\text{RSTD InterFreqFDDTDD, E-UTRAN}}$ ms as given below:

$$T_{\text{RSTD InterFreqFDDTDD, E-UTRAN}} = T_{\text{PRS}} \cdot (M - 1) + \Delta \quad \text{ms},$$

where

$T_{\text{RSTD InterFreqFDDTDD, E-UTRAN}}$ is the total time for detecting and measuring at least n cells,

T_{PRS} is the largest value of the cell-specific positioning subframe configuration period, defined in TS 36.211 [16], among the measured n cells including the reference cell,

M is the number of PRS positioning occasions as defined in Table 8.1.2.6.4-1, where a PRS positioning occasion is as defined in clause 8.1.2.5.1,

$\Delta = 160 \cdot \left\lceil \frac{n}{M} \right\rceil$ ms is the measurement time for a single PRS positioning occasion which includes the sampling time and the processing time, and

the n cells are distributed on up to two carrier frequencies including a serving carrier frequency and one inter-frequency carrier.

Table 8.1.2.6.4-1: Number of PRS positioning occasions within $T_{\text{RSTD InterFreqFDDTDD, E-UTRAN}}$

| Positioning subframe | Number of PRS positioning occasions M |
|----------------------|---|
|----------------------|---|

| configuration period T_{PRS} | f2 ^{Note1} | f1 and f2 ^{Note2} |
|--|---------------------|----------------------------|
| 160 ms | 16 | 32 |
| >160 ms | 8 | 16 |
| Note 1: When inter-frequency RSTD measurements are performed over the reference cell and neighbour cells, which belong to the TDD inter-frequency carrier frequency f2. Note 2: When inter-frequency RSTD measurements are performed over the reference cell and the neighbour cells, which belong to the serving FDD carrier frequency f1 and the TDD inter-frequency carrier frequency f2 respectively. | | |

The UE physical layer shall be capable of reporting RSTD for the reference cell and all the neighbor cells i out of at least $(n-1)$ neighbor cells within $T_{RSTD\ InterFreqFDDTDD, E-UTRAN}$, provided:

$$\left(PRS \hat{E}_s / Iot \right)_{ref} \geq -6 \text{ dB for all Frequency Bands for the reference cell,}$$

$$\left(PRS \hat{E}_s / Iot \right)_i \geq -13 \text{ dB for all Frequency Bands for neighbour cell } i,$$

$\left(PRS \hat{E}_s / Iot \right)_{ref}$ and $\left(PRS \hat{E}_s / Iot \right)_i$ conditions apply for all subframes of at least $L = \frac{M}{2}$ PRS positioning occasions,

PRP 1,2|dBm according to Annex B.2.6 for a corresponding Band

$PRS \hat{E}_s / Iot$ is as defined in Clause 8.1.2.5.1.

The time $T_{RSTD\ InterFreqFDDTDD, E-UTRAN}$ starts from the first subframe of the PRS positioning occasion closest in time after both the OTDOA-RequestLocationInformation message and the OTDOA assistance data in the OTDOA-ProvideAssistanceData message as specified in TS 36.355 [24], are delivered to the physical layer of the UE.

If the inter-frequency handover occurs while inter-frequency RSTD measurements are being performed, and the inter-frequency carrier on which RSTD is measured becomes the new serving carrier frequency after the inter-frequency handover, the UE shall complete the ongoing OTDOA measurement session. The UE shall also meet the inter-frequency OTDOA measurement and accuracy requirements. However in this case the RSTD measurement period ($T_{RSTD\ InterFreqFDDTDD, E-UTRAN, HO}$) shall be according to the following expression:

$$T_{RSTD\ InterFreqFDDTDD, E-UTRAN, HO} = T_{RSTD\ InterFreqFDDTDD, E-UTRAN} + K \times T_{PRS} + T_{HO} \quad ms,$$

where:

K is the number of times the inter-frequency handover occurs during $T_{RSTD\ InterFreqFDDTDD, E-UTRAN, HO}$,

T_{HO} is the time during which the inter-frequency RSTD measurement may not be possible due to inter-frequency handover; it can be up to 45 ms.

The RSTD measurement accuracy for all measured neighbor cells i shall be fulfilled according to the accuracy as specified in the sub-clause 9.1.10.2.

Furthermore, due to the inter-frequency handover the UE shall meet the RSTD measurement accuracy for a PRS bandwidth which is not larger than the minimum channel bandwidth of those PCells on whose carriers RSTD measurement is performed during the RSTD measurement period.

The inter-frequency requirements in this clause (8.1.2.6.4) shall apply for all TDD special subframe configurations specified in TS 36.211 [16] and for the TDD uplink-downlink configurations as specified in Table 8.1.2.6.4-2.

Table 8.1.2.6.4-2: TDD uplink-downlink subframe configurations applicable for inter-frequency requirements

| PRS Transmission Bandwidth [RB] | Applicable TDD uplink-downlink configurations |
|---------------------------------|---|
| 6, 15 | 3, 4 and 5 |
| 25 | 1, 2, 3, 4, 5 and 6 |
| 50, 75, 100 | 0, 1, 2, 3, 4, 5 and 6 |
| Note 1: | Uplink-downlink configurations are specified in Table 4.2-2 in TS 36.211 [16]. |
| Note2: | For UEs capable of performing inter-frequency measurements without measurement gaps, TDD uplink-downlink subframe configurations as specified in Table 8.1.2.5.2-2 shall apply. |

8.1.2.6.4.1 RSTD Measurement Reporting Delay

This requirement assumes that the measurement report is not delayed by other LPP signalling on the DCCH. This measurement reporting delay excludes a delay uncertainty resulted when inserting the measurement report to the TTI of the uplink DCCH. The delay uncertainty is: $2 \times TTI_{DCCH}$. This measurement reporting delay excludes any delay caused by no UL resources for UE to send the measurement report.

8.1.2.7 E-UTRAN E-CID Measurements

8.1.2.7.1 E-UTRAN FDD UE Rx-Tx Time Difference Measurements

When no DRX is used the physical layer measurement period of the UE Rx-Tx time difference measurement shall be 200 ms.

When DRX is used in RRC_CONNECTED state the physical layer measurement period ($T_{\text{measure_FDD_UE_Rx_Tx1}}$) of the UE Rx-Tx time difference measurement shall be as specified in table 8.1.2.7.1-1. When eDRX_CONN is used in RRC_CONNECTED state, the physical layer measurement period ($T_{\text{measure_FDD_UE_Rx_Tx1}}$) of the UE Rx-Tx time difference measurement shall be as specified in table 8.1.2.7.1-2.

Table 8.1.2.7.1-1: FDD UE Rx-Tx time difference measurement requirement when DRX is used

| DRX cycle length (s) | $T_{\text{measure_FDD_UE_Rx_Tx1}}$ (s) (DRX cycles) |
|---|---|
| ≤ 0.04 | 0.2 (Note1) |
| $0.04 < \text{DRX-cycle} \leq 2.56$ | Note2 (5) |
| Note1: Number of DRX cycle depends upon the DRX cycle in use Note2: Time depends upon the DRX cycle in use | |

Table 8.1.2.7.1-2: FDD UE Rx-Tx time difference measurement requirement when eDRX_CONN is used

| eDRX_CONN cycle length (s) | $T_{\text{measure_FDD_UE_Rx_Tx1}}$ (s) (eDRX_CONN cycles) |
|--|---|
| $2.56 < \text{eDRX_CONN cycle} \leq 10.24$ | Note (5) |
| Note: Time depends upon the eDRX_CONN cycle in use | |

If the UE is performing UE Rx-Tx time difference measurement while the PCell is changed due to the handover then the UE shall restart the Rx-Tx measurement on the new cell. In this case the UE shall also meet the UE Rx-Tx time difference measurement and accuracy requirements. However the physical layer measurement period of the UE Rx-Tx measurement shall not exceed $T_{\text{measure_FDD_UE_Rx_Tx3}}$ as defined in the following expression:

$$T_{\text{measure_FDD_UE_Rx_Tx3}} = (K+1) \cdot (T_{\text{measure_FDD_UE_Rx_Tx1}}) + K \cdot T_{\text{PCell_change_handover}}$$

Where:

K is the number of times the PCell is changed over the measurement period ($T_{\text{measure_FDD_UE_Rx_Tx3}}$),

$T_{\text{PCell_change_handover}}$ is the time necessary to change the PCell due to handover; it can be up to 45 ms.

If the UE supporting E-UTRA carrier aggregation when configured with the secondary component carrier(s) is performing UE Rx-Tx time difference measurement while the PCell is changed regardless whether the primary component carrier is changed or not then the UE shall restart the Rx-Tx measurement on the new PCell. In this case the UE shall also meet the UE Rx-Tx time difference measurement and accuracy requirements corresponding to the new PCell. However the physical layer measurement period of the UE Rx-Tx measurement shall not exceed $T_{\text{measure_FDD_UE_Rx_Tx2}}$ as defined in the following expression:

$$T_{\text{measure_FDD_UE_Rx_Tx2}} = (N+1) \cdot (T_{\text{measure_FDD_UE_Rx_Tx1}}) + N \cdot T_{\text{PCell_change_CA}}$$

Where:

N is the number of times the PCell is changed over the measurement period ($T_{\text{measure_FDD_UE_Rx_Tx2}}$),

$T_{\text{PCell_change_CA}}$ is the time necessary to change the PCell; it can be up to 25 ms.

If IDC autonomous denial is configured then the UE shall also meet the requirements, provided not more than 30 IDC autonomous denial subframes are configured over an IDC autonomous denial validity period of at least 200 ms.

The measurement accuracy for the UE Rx-Tx time difference measurement when DRX or eDRX_CONN is used as well as when no DRX is used shall be as specified in the sub-clause 9.1.9.

8.1.2.7.1.1 UE Rx-Tx Measurement Reporting Delay

This requirement assumes that the measurement report is not delayed by other RRC or LPP signalling on the DCCH. This measurement reporting delay excludes a delay uncertainty resulted when inserting the measurement report to the TTI of the uplink DCCH. The delay uncertainty is: $2 \times TTI_{\text{DCCH}}$. This measurement reporting delay excludes any delay caused by no UL resources for UE to send the measurement report.

Reported measurements contained in periodically triggered measurement reports shall meet the requirements in sub-clause 9.1.9.

8.1.2.7.2 E-UTRAN TDD UE Rx-Tx Time Difference Measurements

When no DRX is used the physical layer measurement period of the UE Rx-Tx time difference measurement shall be 200 ms.

When DRX is used in RRC_CONNECTED state the physical layer measurement period ($T_{\text{measure_TDD_UE_Rx_Tx1}}$) of the UE Rx-Tx time difference measurement shall be as specified in table 8.1.2.7.2-1. When eDRX_CONN is used in RRC_CONNECTED state the physical layer measurement period ($T_{\text{measure_TDD_UE_Rx_Tx1}}$) of the UE Rx-Tx time difference measurement shall be as specified in table 8.1.2.7.2-2.

Table 8.1.2.7.2-1: TDD UE Rx-Tx time difference measurement requirement when DRX is used

| DRX cycle length (s) | $T_{\text{measure_TDD_UE_Rx_Tx1}}$ (s) (DRX cycles) |
|---|---|
| ≤ 0.04 | 0.2 (Note1) |
| $0.04 < \text{DRX-cycle} \leq 2.56$ | Note2 (5) |
| Note1: Number of DRX cycle depends upon the DRX cycle in use Note2: Time depends upon the DRX cycle in use | |

Table 8.1.2.7.2-2: TDD UE Rx-Tx time difference measurement requirement when eDRX_CONN is used

| eDRX_CONN cycle length (s) | $T_{\text{measure_TDD_UE_Rx_Tx1}}$ (s) (eDRX_CONN cycles) |
|--|---|
| $2.56 < \text{eDRX_CONN cycle} \leq 10.24$ | Note (5) |
| Note: Time depends upon the eDRX_CONN cycle in use | |

If the UE is performing UE Rx-Tx time difference measurement while the PCell is changed due to the handover then the UE shall restart the Rx-Tx measurement on the new cell. In this case the UE shall also meet the UE Rx-Tx time difference measurement and accuracy requirements. However the physical layer measurement period of the UE Rx-Tx measurement shall not exceed $T_{\text{measure_TDD_UE_Rx_Tx3}}$ as defined in the following expression:

$$T_{\text{measure_TDD_UE_Rx_Tx3}} = (K+1) \cdot (T_{\text{measure_TDD_UE_Rx_Tx1}}) + K \cdot T_{\text{PCell_change_handover}}$$

Where:

K is the number of times the PCell is changed over the measurement period ($T_{\text{measure_TDD_UE_Rx_Tx3}}$),

$T_{\text{PCell_change_handover}}$ is the time necessary to change the PCell due to handover; it can be up to 45 ms.

If the UE supporting E-UTRA carrier aggregation when configured with the secondary component carrier(s) is performing UE Rx-Tx time difference measurement while the PCell is changed regardless whether the primary component carrier is changed or not then the UE shall restart the Rx-Tx measurement on the new PCell. In this case the UE shall also meet the UE Rx-Tx time difference measurement and accuracy requirements corresponding to the new PCell. However the physical layer measurement period of the UE Rx-Tx measurement shall not exceed $T_{\text{measure_TDD_UE_Rx_Tx2}}$ as defined in the following expression:

$$T_{\text{measure_TDD_UE_Rx_Tx2}} = (N+1) \cdot (T_{\text{measure_TDD_UE_Rx_Tx1}}) + N \cdot T_{\text{PCell_change_CA}}$$

Where:

N is the number of times the PCell is changed over the measurement period ($T_{\text{measure_TDD_UE_Rx_Tx2}}$),

$T_{\text{PCell_change_CA}}$ is the time necessary to change the PCell; it can be up to 25 ms.

If IDC autonomous denial is configured then the UE shall also meet the requirements, provided not more than 30 IDC autonomous denial subframes are configured over an IDC autonomous denial validity period of at least 200 ms.

The measurement accuracy for the UE Rx-Tx time difference measurement when DRX or eDRX_CONN is used as well as when no DRX is used shall be as specified in the sub-clause 9.1.9.

For UE, which does not support simultaneous reception and transmission for inter-band TDD CA specified in TS 36.331 [2], and is compliant to the requirements for inter-band CA with uplink in one E-UTRA band and without simultaneous Rx/Tx specified in TS 36.101 [5], the UE Rx-Tx time difference measurement requirements in Section 8.1.2.7.2 shall apply also with different TDD UL/DL subframe configurations and/or different special subframe configurations used in CCs of different bands, under the following additional conditions:

- UE is not simultaneously scheduled in UL and DL on the different CCs, and
- At least one downlink and one uplink subframes per radio frame are available for the UE Rx-Tx time difference measurement in the measured cell.

8.1.2.7.2.1 UE Rx-Tx Measurement Reporting Delay

This requirement assumes that the measurement report is not delayed by other RRC or LPP signalling on the DCCH. This measurement reporting delay excludes a delay uncertainty resulted when inserting the measurement report to the TTI of the uplink DCCH. The delay uncertainty is: $2 \times TTI_{\text{DCCH}}$. This measurement reporting delay excludes any delay caused by no UL resources for UE to send the measurement report.

Reported measurements contained in periodically triggered measurement reports shall meet the requirements in sub-clause 9.1.9.

8.1.2.7.3 E-UTRAN FDD Intra-frequency E-CID RSRP and RSRQ Measurements

8.1.2.7.3.1 Introduction

The requirements in section 8.1.2.7.3 shall apply provided the UE has received ECID-RequestLocationInformation message from E-SMLC via LPP requesting the UE to report E-CID E-UTRAN FDD intra-frequency RSRP and RSRQ measurements [24].

8.1.2.7.3.2 Measurement Requirements

The requirements in section 8.1.2.2.1 and section 8.1.2.8.1 also apply for this section except the measurement reporting requirements. The measurement reporting requirements for E-CID RSRP and RSRQ are defined in section 8.1.2.7.3.3.

8.1.2.7.3.3 Measurement Reporting Delay

This requirement assumes that the measurement report is not delayed by other LPP signalling on the DCCH. This measurement reporting delay excludes a delay uncertainty resulted when inserting the measurement report to the TTI of the uplink DCCH. The delay uncertainty is: $2 \times TTI_{DCCH}$. This measurement reporting delay excludes any delay caused by no UL resources for UE to send the measurement report.

Reported RSRP and RSRQ measurements contained in periodically triggered measurement reports shall meet the requirements in section 9.1.2 and 9.1.5 respectively.

8.1.2.7.4 E-UTRAN TDD Intra-frequency E-CID RSRP and RSRQ Measurements

8.1.2.7.4.1 Introduction

The requirements in section 8.1.2.7.4 shall apply provided the UE has received ECID-RequestLocationInformation message from E-SMLC via LPP requesting the UE to report E-CID E-UTRAN TDD intra-frequency RSRP and RSRQ measurements [24].

8.1.2.7.4.2 Measurement Requirements

The requirements in section 8.1.2.2.2 and section 8.1.2.8.2 also apply for this section except the measurement reporting requirements. The measurement reporting requirements for E-CID RSRP and RSRQ are defined in section 8.1.2.7.4.3.

8.1.2.7.4.3 Measurement Reporting Delay

This requirement assumes that the measurement report is not delayed by other LPP signalling on the DCCH. This measurement reporting delay excludes a delay uncertainty resulted when inserting the measurement report to the TTI of the uplink DCCH. The delay uncertainty is: $2 \times TTI_{DCCH}$. This measurement reporting delay excludes any delay caused by no UL resources for UE to send the measurement report.

Reported RSRP and RSRQ measurements contained in periodically triggered measurement reports shall meet the requirements in section 9.1.2 and 9.1.5 respectively.

8.1.2.8 E-UTRAN intra-frequency measurements under time domain measurement resource restriction

The requirements in sections 8.1.2.8.1 and 8.1.2.8.2 shall apply for cells for which time domain measurement resource restriction patterns for performing E-UTRAN FDD intra-frequency measurements and E-UTRAN TDD intra-frequency measurements, respectively, are configured by higher layers (TS 36.331 [2]), provided that also the following additional conditions are fulfilled:

The time domain measurement resource restriction pattern configured for the measured cell indicates at least one subframe per radio frame for performing the intra-frequency measurements, and

Four symbols containing CRS are available in all subframes indicated by the time domain measurement resource restriction pattern.

For cells which are not configured for measurements in the subframes indicated by the time-domain measurement resource restriction pattern, the corresponding requirements specified in Clause 8.1.2.2 apply.

8.1.2.8.1 E-UTRAN FDD intra-frequency measurements

8.1.2.8.1.1 E-UTRAN intra-frequency measurements when no DRX is used

When no DRX is in use the UE shall be able to identify a new detectable FDD intra-frequency cell within

$$T_{\text{identify_intra_eICIC}} = T_{\text{basic_identify_E-UTRA_FDD_eICIC, intra}} \cdot \frac{T_{\text{Measurement_Period_eICIC, Intra}}}{T_{\text{Intra}}} \quad \text{ms}$$

where

$T_{\text{basic_identify_E-UTRA_FDD_eICIC, intra}}$ is 1000 ms.

T_{Intra} is the minimum time available for intra-frequency measurements, during the measurement period with an arbitrarily chosen timing. The time is assumed to be available for performing intra-frequency measurements whenever the receiver is guaranteed to be active on the intra-frequency carrier.

A cell shall be considered detectable when

- RSRP related side conditions given in Sections 9.1.2.3 and 9.1.2.4 and RSRQ related side conditions given in Clause 9.1.5.2 are fulfilled for a corresponding Band,
- SCH_RP and $SCH\ \hat{E}s/Iot$ according to Annex B.2.8 for a corresponding Band.

Identification of a cell shall include detection of the cell and additionally performing a single measurement with measurement period of $T_{\text{Measurement_Period_eICIC, Intra}}$. If higher layer filtering is used, an additional cell identification delay can be expected.

In the RRC_CONNECTED state the measurement period for intra-frequency measurements is 200 ms. When no measurement gaps are activated, the UE shall be capable of performing RSRP and RSRQ measurements for 8 identified intra-frequency cells, including also the cells which are not measured in the subframes indicated by the time-domain measurement resource restriction pattern, and the UE physical layer shall be capable of reporting measurements to higher layers with the measurement period of 200 ms. When measurement gaps are activated the UE shall be capable of performing measurements for at least $Y_{\text{measurement_intra_eICIC}}$ cells, where $Y_{\text{measurement_intra_eICIC}}$ is defined in the following equation. If the UE has identified more than $Y_{\text{measurement_intra_eICIC}}$ cells, the UE shall perform measurements of at least 8 identified intra-frequency cells but the reporting rate of RSRP and RSRQ measurements of cells from UE physical layer to higher layers may be decreased.

$$Y_{\text{measurement_intra_eICIC}} = \text{Floor} \left\{ X_{\text{basic_measurement_FDD_eICIC}} \cdot \frac{T_{\text{Intra}}}{T_{\text{Measurement_Period_eICIC, Intra}}} \right\} \text{ cells}$$

where

$X_{\text{basic_measurement_FDD_eICIC}} = 8$ (cells)

$T_{\text{Measurement_Period_eICIC, Intra}} = 200$ ms is the measurement period for intra-frequency RSRP and RSRQ measurements.

The RSRP and RSRQ measurement accuracy for the measured cells configured with a time-domain measurement resource restriction pattern for RRM intra-frequency measurements shall be as specified in the sub-clauses 9.1.2.3, 9.1.2.4, and 9.1.5.2, respectively.

8.1.2.8.1.1.1 Measurement Reporting Requirements

8.1.2.8.1.1.1.1 Periodic Reporting

Reported RSRP and RSRQ measurements contained in periodically triggered measurement reports shall meet the requirements in sections 9.1.2.3, 9.1.2.4, and 9.1.5.2, respectively.

8.1.2.8.1.1.1.2 Event-triggered Periodic Reporting

Reported RSRP and RSRQ measurements contained in event triggered periodic measurement reports shall meet the requirements in sections 9.1.2.3, 9.1.2.4, and 9.1.5.2, respectively.

The first report in event triggered periodic measurement reporting shall meet the requirements specified in clause 8.1.2.8.1.1.1.3.

8.1.2.8.1.1.1.3 Event Triggered Reporting

Reported RSRP and RSRQ measurements contained in event triggered measurement reports shall meet the requirements in sections 9.1.2.3, 9.1.2.4, and 9.1.5.2, respectively.

The UE shall not send any event triggered measurement reports, as long as no reporting criteria are fulfilled.

The measurement reporting delay is defined as the time between an event that will trigger a measurement report and the point when the UE starts to transmit the measurement report over the air interface. This requirement assumes that the measurement report is not delayed by other RRC signalling on the DCCH. This measurement reporting delay excludes a delay uncertainty resulted when inserting the measurement report to the TTI of the uplink DCCH. The delay uncertainty is: $2 \times TTI_{DCCH}$. This measurement reporting delay excludes a delay which caused by no UL resources for UE to send the measurement report.

The event triggered measurement reporting delay, measured without L3 filtering shall be less than $T_{identify_intra_eICIC}$ defined in Clause 8.1.2.8.1.1. When L3 filtering is used or IDC autonomous denial is configured an additional delay can be expected.

If a cell which has been detectable at least for the time period $T_{identify_intra_eICIC}$ defined in clause 8.1.2.8.1.1 becomes undetectable for a period ≤ 5 seconds and then the cell becomes detectable again and triggers an event, the event triggered measurement reporting delay shall be less than $T_{Measurement_Period_eICIC, Intra}$ provided the timing to that cell has not changed more than $\pm 50 T_s$ and the L3 filter has not been used. When L3 filtering is used or IDC autonomous denial is configured, an additional delay can be expected.

8.1.2.8.1.2 E-UTRAN intra-frequency measurements when DRX is used

When DRX is in use the UE shall be able to identify a new detectable FDD intra frequency cell within $T_{identify_intra_eICIC}$ as shown in table 8.1.2.8.1.2-1.

Table 8.1.2.8.1.2-1: Requirement to identify a newly detectable FDD intra-frequency cell

| DRX cycle length (s) | $T_{identify_intra_eICIC}$ (s) (DRX cycles) |
|---|---|
| ≤ 0.04 | 1 (Note1) |
| $0.04 < DRX\text{-}cycle \leq 0.08$ | Note2 (52) |
| 0.128 | 4.22 (33) |
| $0.128 < DRX\text{-}cycle \leq 2.56$ | Note2 (28) |
| Note1: Number of DRX cycle depends upon the DRX cycle in use Note2: Time depends upon the DRX cycle in use | |

A cell shall be considered detectable when

- RSRP related side conditions given in Sections 9.1.2.3 and 9.1.2.4 and RSRQ related side conditions given in Clause 9.1.5.2 are fulfilled for a corresponding Band,
- SCH_RP and $SCH\ \hat{E}s/Iot$ according to Annex B.2.8 for a corresponding Band.

In the RRC_CONNECTED state the measurement period for intra-frequency measurements is $T_{measure_intra_eICIC}$ as shown in table 8.1.2.8.1.2-2. The UE shall be capable of performing RSRP and RSRQ measurements for 8 identified intra-frequency cells, including also the cells which are not measured in the subframes indicated by the time-domain measurement resource restriction pattern, and the UE physical layer shall be capable of reporting measurements to higher layers with the measurement period of $T_{measure_intra_eICIC}$.

Table 8.1.2.8.1.2-2: Requirement to measure FDD intra-frequency cells

| DRX cycle length (s) | $T_{measure_intra_eICIC}$ (s) (DRX cycles) |
|-------------------------------------|--|
| ≤ 0.04 | 0.2 (Note1) |
| $0.04 < DRX\text{-}cycle \leq 0.16$ | Note2 (7) |
| $0.16 < DRX\text{-}cycle \leq 2.56$ | Note2 (5) |

Note1: Number of DRX cycle depends upon the DRX cycle in use

Note2: Time depends upon the DRX cycle in use

The RSRP and RSRQ measurement accuracy for the measured cells configured with a time-domain measurement resource restriction pattern for RRM intra-frequency measurements shall be as specified in the sub-clauses 9.1.2.3, 9.1.2.4, and 9.1.5.2, respectively.

8.1.2.8.1.2.1 Measurement Reporting Requirements

8.1.2.8.1.2.1.1 Periodic Reporting

Reported RSRP and RSRQ measurements contained in periodically triggered measurement reports shall meet the requirements in sections 9.1.2.3, 9.1.2.4, and 9.1.5.2, respectively.

8.1.2.8.1.2.1.2 Event-triggered Periodic Reporting

Reported RSRP and RSRQ measurements contained in event triggered periodic measurement reports shall meet the requirements in sections 9.1.2.3, 9.1.2.4, and 9.1.5.2, respectively.

The first report in event triggered periodic measurement reporting shall meet the requirements specified in clause 8.1.2.8.1.2.1.3.

8.1.2.8.1.2.1.3 Event Triggered Reporting

Reported RSRP and RSRQ measurements contained in event triggered measurement reports shall meet the requirements in sections 9.1.2.3, 9.1.2.4, and 9.1.5.2, respectively.

The UE shall not send any event triggered measurement reports, as long as no reporting criteria are fulfilled.

The measurement reporting delay is defined as the time between an event that will trigger a measurement report and the point when the UE starts to transmit the measurement report over the air interface. This requirement assumes that the measurement report is not delayed by other RRC signalling on the DCCH. This measurement reporting delay excludes a delay uncertainty resulted when inserting the measurement report to the TTI of the uplink DCCH. The delay uncertainty is: $2 \times TTI_{DCCH}$. This measurement reporting delay excludes a delay which caused by no UL resources for UE to send the measurement report.

The event triggered measurement reporting delay, measured without L3 filtering shall be less than $T_{identify_intra_eICIC}$ defined in Clause 8.1.2.8.1.2. When L3 filtering is used or IDC autonomous denial is configured an additional delay can be expected.

If a cell which has been detectable at least for the time period $T_{identify_intra_eICIC}$ defined in clause 8.1.2.8.1.2 becomes undetectable for a period ≤ 5 seconds and then the cell becomes detectable again and triggers an event, the event triggered measurement reporting delay shall be less than $T_{measure_intra_eICIC}$ provided the timing to that cell has not changed more than $\pm 50 T_s$ and the L3 filter has not been used. When L3 filtering is used or IDC autonomous denial is configured, an additional delay can be expected.

8.1.2.8.2 E-UTRAN TDD intra-frequency measurements

8.1.2.8.2.1 E-UTRAN intra-frequency measurements when no DRX is used

When no DRX is in use the UE shall be able to identify a new detectable TDD intra-frequency cell within

$$T_{identify_intra_eICIC} = T_{basic_identify_E-UTRA_TDD_eICIC, intra} \cdot \frac{T_{Measurement_Period_eICIC, Intra}}{T_{Intra}} \quad ms$$

where

$T_{basic_identify_E-UTRA_TDD_eICIC, intra}$ is 1000 ms.

T_{Intra} is the minimum time available for intra-frequency measurements, during the measurement period with an arbitrarily chosen timing. The time is assumed to be available for performing intra-frequency measurements whenever the receiver is guaranteed to be active on the intra-frequency carrier.

A cell shall be considered detectable when

- RSRP related side conditions given in Sections 9.1.2.3 and 9.1.2.4 and RSRQ related side conditions given in Clause 9.1.5.2 are fulfilled for a corresponding Band,
- SCH_RP and SCH \hat{E}_s/lot according to Annex B.2.8 for a corresponding Band.

Identification of a cell shall include detection of the cell and additionally performing a single measurement with measurement period of $T_{\text{Measurement_Period_eICIC, Intra}}$. If higher layer filtering is used, an additional cell identification delay can be expected.

In the RRC_CONNECTED state the measurement period for intra-frequency measurements is 200 ms. When no measurement gaps are activated, the UE shall be capable of performing RSRP and RSRQ measurements for 8 identified intra-frequency cells, including also the cells which are not measured in the subframes indicated by the time-domain measurement resource restriction pattern, and the UE physical layer shall be capable of reporting measurements to higher layers with the measurement period of 200 ms. When measurement gaps are activated the UE shall be capable of performing measurements for at least $Y_{\text{measurement_intra_eICIC}}$ cells, where $Y_{\text{measurement_intra_eICIC}}$ is defined in the following equation. If the UE has identified more than $Y_{\text{measurement_intra_eICIC}}$ cells, the UE shall perform measurements of at least 8 identified intra-frequency cells but the reporting rate of RSRP and RSRQ measurements of cells from UE physical layer to higher layers may be decreased.

$$Y_{\text{measurement_intra_eICIC}} = \text{Floor} \left\{ X_{\text{basic_measurement_TDD_eICIC}} \cdot \frac{T_{\text{Intra}}}{T_{\text{Measurement_Period_eICIC, Intra}}} \right\} \text{ cells}$$

where

$$X_{\text{basic_measurement_TDD_eICIC}} = 8 \text{ (cells)}$$

$T_{\text{Measurement_Period_eICIC, Intra}} = 200 \text{ ms}$ is the measurement period for intra-frequency RSRP and RSRQ measurements.

The RSRP and RSRQ measurement accuracy for the measured cells configured with a time-domain measurement resource restriction pattern for RRM intra-frequency measurements shall be as specified in the sub-clauses 9.1.2.3, 9.1.2.4, and 9.1.5.2, respectively.

8.1.2.8.2.1.1 Measurement Reporting Requirements

8.1.2.8.2.1.1.1 Periodic Reporting

Reported RSRP and RSRQ measurements contained in periodically triggered measurement reports shall meet the requirements in sections 9.1.2.3, 9.1.2.4, and 9.1.5.2, respectively.

8.1.2.8.2.1.1.2 Event-triggered Periodic Reporting

Reported RSRP and RSRQ measurements contained in event triggered periodic measurement reports shall meet the requirements in sections 9.1.2.3, 9.1.2.4, and 9.1.5.2, respectively.

The first report in event triggered periodic measurement reporting shall meet the requirements specified in clause 8.1.2.8.2.1.1.3.

8.1.2.8.2.1.1.3 Event Triggered Reporting

Reported RSRP and RSRQ measurements contained in event triggered measurement reports shall meet the requirements in sections 9.1.2.3, 9.1.2.4, and 9.1.5.2, respectively.

The UE shall not send any event triggered measurement reports, as long as no reporting criteria are fulfilled.

The measurement reporting delay is defined as the time between an event that will trigger a measurement report and the point when the UE starts to transmit the measurement report over the air interface. This requirement assumes that the measurement report is not delayed by other RRC signalling on the DCCH. This measurement reporting delay excludes a delay uncertainty resulted when inserting the measurement report to the TTI of the uplink DCCH. The delay uncertainty is: $2 \times TTI_{DCCH}$. This measurement reporting delay excludes a delay which caused by no UL resources for UE to send the measurement report.

The event triggered measurement reporting delay, measured without L3 filtering shall be less than $T_{identify_intra_eICIC}$ defined in Clause 8.1.2.8.2.1. When L3 filtering is used or IDC autonomous denial is configured an additional delay can be expected.

If a cell which has been detectable at least for the time period $T_{identify_intra_eICIC}$ defined in clause 8.1.2.8.2.1 becomes undetectable for a period ≤ 5 seconds and then the cell becomes detectable again and triggers an event, the event triggered measurement reporting delay shall be less than $T_{Measurement_Period_eICIC, Intra}$ provided the timing to that cell has not changed more than $\pm 50 T_s$ and the L3 filter has not been used. When L3 filtering is used or IDC autonomous denial is configured, an additional delay can be expected.

8.1.2.8.2.2 E-UTRAN intra-frequency measurements when DRX is used

When DRX is in use the UE shall be able to identify a new detectable TDD intra frequency cell within $T_{identify_intra_eICIC}$ as shown in table 8.1.2.8.2.2-1.

Table 8.1.2.8.2.2-1: Requirement to identify a newly detectable TDD intra-frequency cell

| DRX cycle length (s) | $T_{identify_intra_eICIC}$ (s) (DRX cycles) |
|---|---|
| ≤ 0.04 | 1 (Note1) |
| $0.04 < DRX\text{-}cycle \leq 0.08$ | Note2 (52) |
| 0.128 | 4.22 (33) |
| $0.128 < DRX\text{-}cycle \leq 2.56$ | Note2 (28) |
| Note1: Number of DRX cycle depends upon the DRX cycle in use Note2: Time depends upon the DRX cycle in use | |

A cell shall be considered detectable when

- RSRP related side conditions given in Sections 9.1.2.3 and 9.1.2.4 and RSRQ related side conditions given in Clause 9.1.5.2 are fulfilled for a corresponding Band,
- SCH_RP and SCH_Es/Iot according to Annex B.2.8 for a corresponding Band.

In the RRC_CONNECTED state the measurement period for intra frequency measurements is $T_{measure_intra_eICIC}$ as shown in table 8.1.2.8.2.2-2. The UE shall be capable of performing RSRP and RSRQ measurements for 8 identified intra-frequency cells, including also the cells which are not measured in the subframes indicated by the time-domain measurement resource restriction pattern, and the UE physical layer shall be capable of reporting measurements to higher layers with the measurement period of $T_{measure_intra_eICIC}$.

Table 8.1.2.8.2.2-2: Requirement to measure TDD intra-frequency cells

| DRX cycle length (s) | $T_{measure_intra_eICIC}$ (s) (DRX cycles) |
|-------------------------------------|--|
| ≤ 0.04 | 0.2 (Note1) |
| $0.04 < DRX\text{-}cycle \leq 0.16$ | Note2 (7) |
| $0.16 < DRX\text{-}cycle \leq 2.56$ | Note2 (5) |

| | |
|--------|--|
| Note1: | Number of DRX cycle depends upon the DRX cycle in use. |
| Note2: | Time depends upon the DRX cycle in use. |

The RSRP and RSRQ measurement accuracy for the measured cells configured with a time-domain measurement resource restriction pattern for RRM intra-frequency measurements shall be as specified in the sub-clauses 9.1.2.3, 9.1.2.4, and 9.1.5.2, respectively.

8.1.2.8.2.2.1 Measurement Reporting Requirements

8.1.2.8.2.2.1.1 Periodic Reporting

Reported RSRP and RSRQ measurements contained in periodically triggered measurement reports shall meet the requirements in sections 9.1.2.3, 9.1.2.4, and 9.1.5.2, respectively.

8.1.2.8.2.2.1.2 Event-triggered Periodic Reporting

Reported RSRP and RSRQ measurements contained in event triggered periodic measurement reports shall meet the requirements in sections 9.1.2.3, 9.1.2.4, and 9.1.5.2, respectively.

The first report in event triggered periodic measurement reporting shall meet the requirements specified in clause 8.1.2.8.2.2.1.3.

8.1.2.8.2.2.1.3 Event Triggered Reporting

Reported RSRP and RSRQ measurements contained in event triggered measurement reports shall meet the requirements in sections 9.1.2.3, 9.1.2.4, and 9.1.5.2, respectively.

The UE shall not send any event triggered measurement reports, as long as no reporting criteria are fulfilled.

The measurement reporting delay is defined as the time between an event that will trigger a measurement report and the point when the UE starts to transmit the measurement report over the air interface. This requirement assumes that the measurement report is not delayed by other RRC signalling on the DCCH. This measurement reporting delay excludes a delay uncertainty resulted when inserting the measurement report to the TTI of the uplink DCCH. The delay uncertainty is: $2 \times TTI_{DCCH}$. This measurement reporting delay excludes a delay which caused by no UL resources for UE to send the measurement report.

The event triggered measurement reporting delay, measured without L3 filtering shall be less than $T_{identify_intra_eICIC}$ defined in Clause 8.1.2.8.2.2. When L3 filtering is used or IDC autonomous denial is configured an additional delay can be expected.

If a cell which has been detectable at least for the time period $T_{identify_intra_eICIC}$ defined in clause 8.1.2.8.2.2 becomes undetectable for a period ≤ 5 seconds and then the cell becomes detectable again and triggers an event, the event triggered measurement reporting delay shall be less than $T_{measure_intra_eICIC}$ provided the timing to that cell has not changed more than $\pm 50 T_s$ and the L3 filter has not been used. When L3 filtering is used or IDC autonomous denial is configured, an additional delay can be expected.

8.1.2.8.3 E-UTRAN FDD intra-frequency measurements with CRS assistance information

The requirements in clause 8.1.2.8.3 shall apply for the UEs supporting the PSS/SSS and common channel interference handling, and CRS interference handling features. Moreover, the core requirements shall be satisfied provided that the following additional conditions are fulfilled:

- The UE is provided with the CRS assistance information via higher layers (TS 36.331 [2]),
- The CRS assistance information is valid during the entire measurement period.

The requirements in this section shall also be met when the number of transmit antenna ports [16] of one or more cells whose CRS assistance information is provided [2] is different from the number of transmit antenna ports of the measured cell.

8.1.2.8.3.1 E-UTRAN intra-frequency measurements when no DRX is used

When no DRX is in use the UE shall be able to identify a new detectable FDD intra-frequency cell within:

$$T_{\text{identify_intra_FeICIC}} = T_{\text{basic_identify_E-UTRA_FDD_FeICIC, intra}} \cdot \frac{T_{\text{Measurement_Period_FeICIC, Intra}}}{T_{\text{Intra}}} \text{ ms}$$

where

$T_{\text{basic_identify_E-UTRA_FDD_FeICIC, intra}}$ is 1000 ms.

T_{Intra} is the minimum time available for intra-frequency measurements, during the measurement period with an arbitrarily chosen timing. The time is assumed to be available for performing intra-frequency measurements whenever the receiver is guaranteed to be active on the intra-frequency carrier.

A cell shall be considered detectable when:

- RSRP related side conditions given in Sections 9.1.2.5 and 9.1.2.6 and RSRQ related side conditions given in Section 9.1.5.3 are fulfilled for a corresponding Band,
- SCH_RP and $SCH \hat{E}s/Iot$ according to Annex B, clause B.2.9 for a corresponding Band (Notes 1, 2).

Note 1: Part of the Iot includes the interference from at least:

- the PCell , or
- PCell and one intra-frequency neighbouring cell indicated in the CRS assistance information, or
- One or two intra-frequency neighbouring cells indicated in the CRS assistance information.

CRS assistance information has been provided for the intra-frequency neighbouring cells that generate interference. UE may use the CRS assistance information to mitigate the interference.

Note 2: An intra-frequency cell is known if it has been meeting the relevant cell identification requirement during the last 5 seconds.

Identification of a cell shall include detection of the cell and additionally performing a single measurement with measurement period of $T_{\text{Measurement_Period_FeICIC, Intra}}$. If higher layer filtering is used, an additional cell identification delay can be expected.

In the RRC_CONNECTED state the measurement period for intra-frequency measurements is 200 ms. When no measurement gaps are activated, the UE shall be capable of performing RSRP and RSRQ measurements for 8 identified intra-frequency cells, including also the cells which are not measured in the subframes indicated by the time-domain measurement resource restriction pattern and the cells indicated in the CRS assistance information, and the UE physical layer shall be capable of reporting measurements to higher layers with the measurement period of 200 ms. When measurement gaps are activated the UE shall be capable of performing measurements for at least

$Y_{\text{measurement_intra_FeICIC}}$ cells , where $Y_{\text{measurement_intra_FeICIC}}$ is defined in the following equation. If the UE has identified more than $Y_{\text{measurement_intra_FeICIC}}$ cells, the UE shall perform measurements of at least 8 identified intra-frequency cells but the reporting rate of RSRP and RSRQ measurements of cells from UE physical layer to higher layers may be decreased.

$$Y_{\text{measurement_intra_FeICIC}} = \text{Floor} \left\{ X_{\text{basic_measurement_FDD_FeICIC}} \cdot \frac{T_{\text{Intra}}}{T_{\text{Measurement_Period_FeICIC, Intra}}} \right\} \text{ cells}$$

where

$X_{\text{basic_measurement_FDD_FeICIC}} = 8$ (cells).

$T_{\text{Measurement_Period_FeICIC, Intra}} = 200$ ms is the measurement period for intra-frequency RSRP and RSRQ measurements.

The RSRP and RSRQ measurement accuracy for the measured cells configured with a time-domain measurement resource restriction pattern for RRM intra-frequency measurements with CRS assistance information shall be as specified in the sub-clauses 9.1.2.5, 9.1.2.6, and 9.1.5.3, respectively.

8.1.2.8.3.1.1 Measurement Reporting Requirements

8.1.2.8.3.1.1.1 Periodic Reporting

Reported RSRP and RSRQ measurements contained in periodically triggered measurement reports shall meet the requirements in sections 9.1.2.5, 9.1.2.6, and 9.1.5.3, respectively.

8.1.2.8.3.1.1.2 Event-triggered Periodic Reporting

Reported RSRP and RSRQ measurements contained in event triggered periodic measurement reports shall meet the requirements in sections 9.1.2.5, 9.1.2.6, and 9.1.5.3, respectively.

The first report in event triggered periodic measurement reporting shall meet the requirements specified in clause 8.1.2.8.3.1.1.3.

8.1.2.8.3.1.1.3 Event Triggered Reporting

Reported RSRP and RSRQ measurements contained in event triggered measurement reports shall meet the requirements in sections 9.1.2.5, 9.1.2.6, and 9.1.5.3, respectively.

The UE shall not send any event triggered measurement reports, as long as no reporting criteria are fulfilled.

The measurement reporting delay is defined as the time between an event that will trigger a measurement report and the point when the UE starts to transmit the measurement report over the air interface. This requirement assumes that the measurement report is not delayed by other RRC signalling on the DCCH. This measurement reporting delay excludes a delay uncertainty resulted when inserting the measurement report to the TTI of the uplink DCCH. The delay uncertainty is: $2 \times T_{TI_{DCCH}}$. This measurement reporting delay excludes a delay which caused by no UL resources for UE to send the measurement report.

The event triggered measurement reporting delay, measured without L3 filtering shall be less than $T_{identify_intra_FeICIC}$ defined in Clause 8.1.2.8.3.1. When L3 filtering is used or IDC autonomous denial is configured, an additional delay can be expected.

If a cell which has been detectable at least for the time period $T_{identify_intra_FeICIC}$ defined in clause 8.1.2.8.3.1 becomes undetectable for a period ≤ 5 seconds and then the cell becomes detectable again and triggers an event, the event triggered measurement reporting delay shall be less than $T_{Measurement_Period_FeICIC, Intra}$ provided the timing to that cell has not changed more than $\pm 50 T_s$ and the L3 filter has not been used. When L3 filtering is used or IDC autonomous denial is configured, an additional delay can be expected.

8.1.2.8.3.2 E-UTRAN intra-frequency measurements when DRX is used

When DRX is in use the UE shall be able to identify a new detectable FDD intra frequency cell within $T_{identify_intra_FeICIC}$ as shown in table 8.1.2.8.3.2-1.

Table 8.1.2.8.3.2-1: Requirement to identify a newly detectable FDD intra-frequency cell

| DRX cycle length (s) | $T_{identify_intra_FeICIC}$ (s) (DRX cycles) |
|--|---|
| ≤ 0.04 | 1 (Note 1) |
| $0.04 < DRX\text{-}cycle \leq 0.08$ | Note 2 (52) |
| 0.128 | 4.22 (33) |
| $0.128 < DRX\text{-}cycles \leq 2.56$ | Note 2 (28] |
| NOTE 1: Number of DRX cycle depends upon the DRX cycle in use. | |
| NOTE 2: Time depends upon the DRX cycle in use. | |

A cell shall be considered detectable when:

- RSRP related side conditions given in Sections 9.1.2.5 and 9.1.2.6 and RSRQ related side conditions given in Section 9.1.5.3 are fulfilled for a corresponding Band,
- SCH_{RP} and SCH_{Ês/Iot} according to Annex B, clause B.2.9 for a corresponding Band (Notes 1, 2).

Note 1: Part of the Iot includes the interference from at least:

- the PCell, or
- PCell and one intra-frequency neighbouring cell indicated in the CRS assistance information, or
- One or two intra-frequency neighbouring cells indicated in the CRS assistance information.

CRS assistance information has been provided for the intra-frequency neighbouring cells that generate interference. UE may use the CRS assistance information to mitigate the interference.

Note 2: An intra-frequency cell is known if it has been meeting the relevant cell identification requirement during the last 5 seconds.

In the RRC_CONNECTED state the measurement period for intra-frequency measurements is $T_{\text{measure_intra_FeICIC}}$ as shown in table 8.1.2.8.3.2-2. The UE shall be capable of performing RSRP and RSRQ measurements for 8 identified intra-frequency cells, including also the cells which are not measured in the subframes indicated by the time-domain measurement resource restriction pattern and the cell indicated in CRS assistance information, and the UE physical layer shall be capable of reporting measurements to higher layers with the measurement period of $T_{\text{measure_intra_FeICIC}}$.

Table 8.1.2.8.3.2-2: Requirement to measure FDD intra-frequency cells

| DRX cycle length (s) | $T_{\text{identify_intra_FeICIC}}$ (s) (DRX cycles) |
|---|--|
| ≤ 0.04 | 0.2 (Note 1) |
| $0.04 < \text{DRX-cycle} \leq 0.16$ | Note 2 (7) |
| $0.16 < \text{DRX-cycle} \leq 2.56$ | Note 2 (5) |
| NOTE 1: Number of DRX cycle depends upon the DRX cycle in use. NOTE 2: Time depends upon the DRX cycle in use. | |

The RSRP and RSRQ measurement accuracy for the measured cells configured with a time-domain measurement resource restriction pattern for RRM intra-frequency measurements shall be as specified in the sub-clauses 9.1.2.5, 9.1.2.6, and 9.1.5.3, respectively.

8.1.2.8.3.2.1 Measurement Reporting Requirements

8.1.2.8.3.2.1.1 Periodic Reporting

Reported RSRP and RSRQ measurements contained in periodically triggered measurement reports shall meet the requirements in sections 9.1.2.5, 9.1.2.6, and 9.1.5.3, respectively.

8.1.2.8.3.2.1.2 Event-triggered Periodic Reporting

Reported RSRP and RSRQ measurements contained in event triggered periodic measurement reports shall meet the requirements in sections 9.1.2.5, 9.1.2.6, and 9.1.5.3, respectively.

The first report in event triggered periodic measurement reporting shall meet the requirements specified in clause 8.1.2.8.3.2.1.3.

8.1.2.8.3.2.1.3 Event Triggered Reporting

Reported RSRP and RSRQ measurements contained in event triggered measurement reports shall meet the requirements in sections 9.1.2.5, 9.1.2.6, and 9.1.5.3, respectively.

The UE shall not send any event triggered measurement reports, as long as no reporting criteria are fulfilled.

The measurement reporting delay is defined as the time between an event that will trigger a measurement report and the point when the UE starts to transmit the measurement report over the air interface. This requirement assumes that that

the measurement report is not delayed by other RRC signalling on the DCCH. This measurement reporting delay excludes a delay uncertainty resulted when inserting the measurement report to the TTI of the uplink DCCH. The delay uncertainty is: $2 \times T_{TI_{DCCH}}$. This measurement reporting delay excludes a delay which caused by no UL resources for UE to send the measurement report.

The event triggered measurement reporting delay, measured without L3 filtering shall be less than $T_{identify_intra_FeICIC}$ defined in clause 8.1.2.8.3.2. When L3 filtering is used or IDC autonomous denial is configured, an additional delay can be expected.

If a cell which has been detectable at least for the time period $T_{identify_intra_FeICIC}$ defined in clause 8.1.2.8.3.2 becomes undetectable for a period ≤ 5 seconds and then the cell becomes detectable again and triggers an event, the event triggered measurement reporting delay shall be less than $T_{measure_intra_FeICIC}$ provided the timing to that cell has not changed more than $\pm 50 T_s$ and the L3 filter has not been used. When L3 filtering is used or IDC autonomous denial is configured, an additional delay can be expected.

8.1.2.8.4 E-UTRAN TDD intra-frequency measurements with CRS assistance information

The requirements in clause 8.1.2.8.3 shall apply for the UEs supporting the PSS/SSS and common channel interference handling, and CRS interference handling features. Moreover, the core requirements shall be satisfied provided that the following additional conditions are fulfilled:

- The UE is provided with the CRS assistance information via higher layers (TS 36.331 [2]),
- The CRS assistance information is valid during the entire measurement period.

The requirements in this section shall also be met when the number of transmit antenna ports [16] of one or more cells whose CRS assistance information is provided [2] is different from the number of transmit antenna ports of the measured cell.

8.1.2.8.4.1 E-UTRAN intra-frequency measurements when no DRX is used

When no DRX is in use the UE shall be able to identify a new detectable TDD intra-frequency cell within

$$T_{identify_intra_FeICIC} = T_{basic_identify_E-UTRA_TDD_FeICIC, intra} \cdot \frac{T_{Measurement_Period_FeICIC, Intra}}{T_{Intra}} \quad ms$$

where

$T_{basic_identify_E-UTRA_TDD_FeICIC, intra}$ is 1000 ms.

T_{Intra} is the minimum time available for intra-frequency measurements, during the measurement period with an arbitrarily chosen timing. The time is assumed to be available for performing intra-frequency measurements whenever the receiver is guaranteed to be active on the intra-frequency carrier.

A cell shall be considered detectable when:

- RSRP related side conditions given in Sections 9.1.2.5 and 9.1.2.6 and RSRQ related side conditions given in Section 9.1.5.3 are fulfilled for a corresponding Band,
- SCH_RP and SCH_Es/Iot according to Annex B.2.9 for a corresponding Band (Notes 1, 2).

Note 1: Part of the Iot includes the interference from at least:

- the PCell, or
- PCell and one intra-frequency neighbouring cell indicated in the CRS assistance information, or
- One or two intra-frequency neighbouring cells indicated in the CRS assistance information

CRS assistance information has been provided for the intra-frequency neighbouring cells that generate interference. UE may use the CRS assistance information to mitigate the interference.

Note 2: An intra-frequency cell is known if it has been meeting the relevant cell identification requirement during the last 5 seconds.

Identification of a cell shall include detection of the cell and additionally performing a single measurement with measurement period of $T_{\text{Measurement_Period_FeICIC, Intra}}$. If higher layer filtering is used, an additional cell identification delay can be expected.

In the RRC_CONNECTED state the measurement period for intra-frequency measurements is 200 ms. When no measurement gaps are activated, the UE shall be capable of performing RSRP and RSRQ measurements for 8 identified intra-frequency cells, including also the cells which are not measured in the subframes indicated by the time-domain measurement resource restriction pattern and the cells indicated in the CRS assistance information, and the UE physical layer shall be capable of reporting measurements to higher layers with the measurement period of 200 ms. When measurement gaps are activated the UE shall be capable of performing measurements for at least $Y_{\text{measurement_intra_FeICIC}}$ cells, where $Y_{\text{measurement_intra_FeICIC}}$ is defined in the following equation. If the UE has identified more than $Y_{\text{measurement_intra_FeICIC}}$ cells, the UE shall perform measurements of at least 8 identified intra-frequency cells but the reporting rate of RSRP and RSRQ measurements of cells from UE physical layer to higher layers may be decreased.

$$Y_{\text{measurement_intra_FeICIC}} = \text{Floor} \left\{ X_{\text{basic_measurement_TDD_FeICIC}} \cdot \frac{T_{\text{Intra}}}{T_{\text{Measurement_Period_FeICIC, Intra}}} \right\} \text{ cells}$$

where

$$X_{\text{basic_measurement_TDD_FeICIC}} = 8 \text{ (cells)}$$

$T_{\text{Measurement_Period_FeICIC, Intra}} = 200\text{ms}$ is the measurement period for intra-frequency RSRP and RSRQ measurements.

The RSRP and RSRQ measurement accuracy for the measured cells configured with a time-domain measurement resource restriction pattern for RRM intra-frequency measurements with CRS assistance information shall be as specified in the sub-clauses 9.1.2.5, 9.1.2.6, and 9.1.5.3, respectively.

8.1.2.8.4.1.1 Measurement Reporting Requirements

8.1.2.8.4.1.1.1 Periodic Reporting

Reported RSRP and RSRQ measurements contained in periodically triggered measurement reports shall meet the requirements in sections 9.1.2.5, 9.1.2.6, and 9.1.5.3, respectively.

8.1.2.8.4.1.1.2 Event-triggered Periodic Reporting

Reported RSRP and RSRQ measurements contained in event triggered periodic measurement reports shall meet the requirements in sections 9.1.2.5, 9.1.2.6, and 9.1.5.3, respectively.

The first report in event triggered periodic measurement reporting shall meet the requirements specified in clause 8.1.2.8.4.1.1.3.

8.1.2.8.4.1.1.3 Event Triggered Reporting

Reported RSRP and RSRQ measurements contained in event triggered measurement reports shall meet the requirements in sections 9.1.2.5, 9.1.2.6, and 9.1.5.3, respectively.

The UE shall not send any event triggered measurement reports, as long as no reporting criteria are fulfilled.

The measurement reporting delay is defined as the time between an event that will trigger a measurement report and the point when the UE starts to transmit the measurement report over the air interface. This requirement assumes that the measurement report is not delayed by other RRC signalling on the DCCH. This measurement reporting delay excludes a delay uncertainty resulted when inserting the measurement report to the TTI of the uplink DCCH. The delay uncertainty is: $2 \times TTI_{\text{DCCH}}$. This measurement reporting delay excludes a delay which caused by no UL resources for UE to send the measurement report.

The event triggered measurement reporting delay, measured without L3 filtering shall be less than $T_{\text{identify_intra_FeICIC}}$ defined in clause 8.1.2.8.4.1. When L3 filtering is used or IDC autonomous denial is configured, an additional delay can be expected.

If a cell which has been detectable at least for the time period $T_{\text{identify_intra_FeICIC}}$ defined in clause 8.1.2.8.4.1 becomes undetectable for a period ≤ 5 seconds and then the cell becomes detectable again and triggers an event, the event triggered measurement reporting delay shall be less than $T_{\text{Measurement_Period_FeICIC, Intra}}$ provided the timing to that cell has not changed more than $\pm 50 T_s$ and the L3 filter has not been used. When L3 filtering is used or IDC autonomous denial is configured, an additional delay can be expected.

8.1.2.8.4.2 E-UTRAN intra-frequency measurements when DRX is used

When DRX is in use the UE shall be able to identify a new detectable TDD intra frequency cell within $T_{\text{identify_intra_FeICIC}}$ as shown in table 8.1.2.8.4.2-1.

Table 8.1.2.8.4.2-1: Requirement to identify a newly detectable TDD intra-frequency cell

| DRX cycle length (s) | $T_{\text{identify_intra_FeICIC}}$ (s) (DRX cycles) |
|---|--|
| ≤ 0.04 | 1 (Note 1) |
| $0.04 < \text{DRX-cycle} \leq 0.08$ | Note 2 (52) |
| 0.128 | 4.22 (33) |
| $0.128 < \text{DRX-cycle} \leq 2.56$ | Note 2 (28) |
| NOTE 1: Number of DRX cycle depends upon the DRX cycle in use. NOTE 2: Time depends upon the DRX cycle in use. | |

A cell shall be considered detectable when:

- RSRP related side conditions given in Sections 9.1.2.5 and 9.1.2.6 and RSRQ related side conditions given in Section 9.1.5.3 are fulfilled for a corresponding Band,
- SCH_{RP} and SCH_{Es/Iot} according to Annex B.2.9 for a corresponding Band (Notes 1, 2).

Note 1: Part of the Iot includes the interference from at least:

- the PCell, or
- PCell and one intra-frequency neighbouring cell indicated in the CRS assistance information, or
- One or two intra-frequency neighbouring cells indicated in the CRS assistance information.

CRS assistance information has been provided for the intra-frequency neighbouring cells that generate interference. UE may use the CRS assistance information to mitigate the interference.

Note 2: An intra-frequency cell is known if it has been meeting the relevant cell identification requirement during the last 5 seconds.

In the RRC_CONNECTED state the measurement period for intra frequency measurements is $T_{\text{measure_intra_FeICIC}}$ as shown in table 8.1.2.8.4.2-2. The UE shall be capable of performing RSRP and RSRQ measurements for 8 identified intra-frequency cells, including also the cells which are not measured in the subframes indicated by the time-domain measurement resource restriction pattern and the cell indicated in CRS assistance information, and the UE physical layer shall be capable of reporting measurements to higher layers with the measurement period of $T_{\text{measure_intra_FeICIC}}$.

Table 8.1.2.8.4.2-2: Requirement to measure TDD intra-frequency cells

| DRX cycle length (s) | $T_{\text{identify_intra_FeICIC}}$ (s) (DRX cycles) |
|---|--|
| ≤ 0.04 | 0.2 (Note 1) |
| $0.04 < \text{DRX-cycle} \leq 0.16$ | Note 2 (7) |
| $0.16 < \text{DRX-cycle} \leq 2.56$ | Note 2 (5) |
| NOTE 1: Number of DRX cycle depends upon the DRX cycle in use. NOTE 2: Time depends upon the DRX cycle in use. | |

The RSRP and RSRQ measurement accuracy for the measured cells configured with a time-domain measurement resource restriction pattern for RRM intra-frequency measurements shall be as specified in the sub-clauses 9.1.2.5, 9.1.2.6, and 9.1.5.3, respectively.

8.1.2.8.4.2.1 Measurement Reporting Requirements

8.1.2.8.4.2.1.1 Periodic Reporting

Reported RSRP and RSRQ measurements contained in periodically triggered measurement reports shall meet the requirements in sections 9.1.2.5, 9.1.2.6, and 9.1.5.3, respectively.

8.1.2.8.4.2.1.2 Event-triggered Periodic Reporting

Reported RSRP and RSRQ measurements contained in event triggered periodic measurement reports shall meet the requirements in sections 9.1.2.5, 9.1.2.6, and 9.1.5.3, respectively.

The first report in event triggered periodic measurement reporting shall meet the requirements specified in clause 8.1.2.8.2.2.1.3.

8.1.2.8.4.2.1.3 Event Triggered Reporting

Reported RSRP and RSRQ measurements contained in event triggered measurement reports shall meet the requirements in sections 9.1.2.5, 9.1.2.6, and 9.1.5.3, respectively.

The UE shall not send any event triggered measurement reports, as long as no reporting criteria are fulfilled.

The measurement reporting delay is defined as the time between an event that will trigger a measurement report and the point when the UE starts to transmit the measurement report over the air interface. This requirement assumes that the measurement report is not delayed by other RRC signalling on the DCCH. This measurement reporting delay excludes a delay uncertainty resulted when inserting the measurement report to the TTI of the uplink DCCH. The delay uncertainty is: $2 \times TTI_{DCCH}$. This measurement reporting delay excludes a delay which caused by no UL resources for UE to send the measurement report.

The event triggered measurement reporting delay, measured without L3 filtering shall be less than $T_{identify_intra_FeICIC}$ defined in clause 8.1.2.8.4.2. When L3 filtering is used or IDC autonomous denial is configured, an additional delay can be expected.

If a cell which has been detectable at least for the time period $T_{identify_intra_FeICIC}$ defined in clause 8.1.2.8.4.2 becomes undetectable for a period ≤ 5 seconds and then the cell becomes detectable again and triggers an event, the event triggered measurement reporting delay shall be less than $T_{measure_intra_FeICIC}$ provided the timing to that cell has not changed more than $\pm 50 T_s$ and the L3 filter has not been used. When L3 filtering is used or IDC autonomous denial is configured, an additional delay can be expected.

8.1.2.9 E-UTRAN E-CID Measurements when Time Domain Measurement Resource Restriction Pattern is Configured

8.1.2.9.1 E-UTRAN FDD UE Rx-Tx Time Difference Measurements

The requirements in this clause apply for UE configured with a time-domain measurement resource restriction pattern for PCell measurements, provided that also the following additional conditions are fulfilled:

- The time domain measurement resource restriction pattern configured for the PCell (TS 36.331 [2]) indicates at least one subframe per radio frame for performing the PCell measurements, and
- Four symbols containing CRS are available in all subframes indicated by the time domain measurement resource restriction pattern.

When the UE is provided with a time-domain measurement resource restriction pattern for PCell measurements, the UE Rx-Tx time difference measurement shall meet the measurement requirements specified in Clause 8.1.2.7.1 and accuracy requirements specified in Clause 9.1.9.3, where the condition $\hat{\epsilon}_{s}/I_{ot} \geq -3\text{dB}$ in Table 9.1.9.3-1 corresponds to the CRS $\hat{\epsilon}_{s}/I_{ot}$ in subframes indicated by the time-domain measurement resource restriction pattern for PCell measurements (TS 36.331 [2]).

NOTE: It is up to the UE implementation whether the UE Rx-Tx time difference measurement is performed in any subframe or in subframes indicated by the time-domain measurement resource restriction pattern.

8.1.2.9.2 E-UTRAN TDD UE Rx-Tx Time Difference Measurements

The requirements in this clause apply for UE configured with a time-domain measurement resource restriction pattern for PCell measurements, provided that also the following additional conditions are fulfilled:

- The time domain measurement resource restriction pattern configured for the PCell (TS 36.331 [2]) indicates at least one subframe per radio frame for performing the PCell measurements, and
- Four symbols containing CRS are available in all subframes indicated by the time domain measurement resource restriction pattern.

When the UE is provided with a time-domain measurement resource restriction pattern for PCell measurements, the UE Rx-Tx time difference measurement shall meet the measurement requirements specified in Clause 8.1.2.7.2 and accuracy requirements specified in Clause 9.1.9.3, where the condition $\hat{\epsilon}_{s}/I_{ot} \geq -3\text{dB}$ in Table 9.1.9.3-1 corresponds to the CRS $\hat{\epsilon}_{s}/I_{ot}$ in subframes indicated by the time-domain measurement resource restriction pattern for PCell measurements (TS 36.331 [2]).

NOTE: It is up to the UE implementation whether the UE Rx-Tx time difference measurement is performed in any subframe or in subframes indicated by the time-domain measurement resource restriction pattern.

8.1.2.9.3 E-UTRAN FDD UE Rx-Tx Time Difference Measurements with CRS Assistance Information

For UE configured with a time-domain measurement resource restriction pattern for PCell measurements, the requirements in this section apply under the following conditions:

- The time domain measurement resource restriction pattern configured for the PCell (TS 36.331 [2]) indicates at least one subframe per radio frame for performing the PCell measurements, and
- Four symbols containing CRS are available in all subframes indicated by the time domain measurement resource restriction pattern, and
- The UE is provided with the CRS assistance information (TS 36.331 [2]) and the CRS assistance information is valid throughout the entire evaluation period.

When the UE is provided with a time-domain measurement resource restriction pattern for serving cell measurements, the UE Rx-Tx time difference measurement shall meet the measurement requirements specified in Section 8.1.2.7.1 and accuracy requirements specified in Section 9.1.9.4.

The requirements in this section shall also be met when the number of transmit antenna ports [16] of one or more cells whose CRS assistance information is provided [2] is different from the number of transmit antenna ports of the measured cell.

NOTE: It is up to the UE implementation whether the UE Rx-Tx time difference measurement is performed in any subframe or in subframes indicated by the time-domain measurement resource restriction pattern.

8.1.2.9.4 E-UTRAN TDD UE Rx-Tx Time Difference Measurements with CRS Assistance Information

For UE configured with a time-domain measurement resource restriction pattern for PCell measurements, the requirements in this section apply under the following conditions:

- The time domain measurement resource restriction pattern configured for the PCell (TS 36.331 [2]) indicates at least one subframe per radio frame for performing the PCell measurements, and

- Four symbols containing CRS are available in all subframes indicated by the time domain measurement resource restriction pattern, and
- The UE is provided with the CRS assistance information (TS 36.331 [2]) and the CRS assistance information is valid throughout the entire evaluation period.

When the UE is provided with a time-domain measurement resource restriction pattern for serving cell measurements, the UE Rx-Tx time difference measurement shall meet the measurement requirements specified in Section 8.1.2.7.2 and accuracy requirements specified in Section 9.1.9.4.

The requirements in this section shall also be met when the number of transmit antenna ports [16] of one or more cells whose CRS assistance information is provided [2] is different from the number of transmit antenna ports of the measured cell.

NOTE: It is up to the UE implementation whether the UE Rx-Tx time difference measurement is performed in any subframe or in subframes indicated by the time-domain measurement resource restriction pattern.

8.2 Capabilities for Support of Event Triggering and Reporting Criteria

8.2.1 Introduction

This clause contains requirements on UE capabilities for support of event triggering and reporting criteria. As long as the measurement configuration does not exceed the requirements stated in clause 8.2.2, the UE shall meet the performance requirements defined in clause 9.

The UE can be requested to make measurements under different measurement identities defined in TS 36.331 [2]. Each measurement identity corresponds to either event based reporting, periodic reporting, logged measurement reporting [2] or no reporting. In case of event based reporting, each measurement identity is associated with an event. In case of periodic reporting, a measurement identity is associated with one periodic reporting criterion. In case of logged measurement reporting, a measurement identity is associated with one logged measurement reporting criterion. In case of no reporting, a measurement identity is associated with one no reporting criterion.

The purpose of this clause is to set some limits on the number of different event, periodic, logged measurement and no reporting criteria the UE may be requested to track in parallel.

8.2.2 Requirements

In this clause a reporting criterion corresponds to either one event (in the case of event based reporting), or one periodic reporting criterion (in case of periodic reporting), or one logged measurement reporting criterion (in case of logged measurement reporting), or one no reporting criterion (in case of no reporting). For event based reporting, each instance of event, with the same or different event identities, is counted as separate reporting criterion in table 8.2.2-1.

The UE shall be able to support in parallel per category up to E_{cat} reporting criteria according to table 8.2.2-1. For the measurement categories belonging to measurements on: E-UTRA intra-frequency cells, E-UTRA inter-frequency cells, and inter-RAT per supported RAT (i.e. without counting other categories that the UE shall always support in parallel), the UE need not support more than the total number of reporting criteria as follows:

- 26 reporting criteria in total if the UE is not configured with any SCell or PSCell carrier frequency,
- 35 reporting criteria in total if the UE is configured with one SCell carrier frequency,
- 44 reporting criteria in total if the UE is configured with two SCell carrier frequencies,
- 53 reporting criteria in total if the UE is configured with three SCell carrier frequencies,
- 62 reporting criteria in total if the UE is configured with four SCell carrier frequencies,
- 35 reporting criteria in total if the UE is configured with one PSCell carrier frequency, and
- 44 reporting criteria in total if the UE is configured with one PSCell carrier frequency and one SCell carrier frequency.

Editor's note: the total reporting criteria above are to be updated if all UEs will have to support RS-SINR measurements; the total reporting criteria are to be verified when the UE capabilities related to frame structure 3 are decided.

A UE supporting increased number of carriers to monitor beyond 3 carriers shall be able to support up to 20 reporting criteria for inter-frequency measurement category according to table 8.2.2-1. Additionally such UE shall be able to support in parallel per category up to E_{cat} reporting criteria according to table 8.2.2-1. For the measurement categories belonging to measurements on: E-UTRA intra-frequency cells, E-UTRA inter-frequency cells, and inter-RAT per supported RAT, the UE need not support more than the total number of reporting criteria as follows:

- 39 reporting criteria in total if the UE is not configured with any SCell carrier frequency,
- 48 reporting criteria in total if the UE is configured with one SCell carrier frequency,
- 57 reporting criteria in total if the UE is configured with two SCell carrier frequencies,
- 48 reporting criteria in total if the UE is configured with one PSCell carrier frequency,
- 57 reporting criteria in total if the UE is configured with one PSCell carrier frequency and one SCell carrier frequencies,
- 66 reporting criteria in total if the UE is configured with three SCell carrier frequencies, and
- 75 reporting criteria in total if the UE is configured with four SCell carrier frequencies.

Editor's note: the total reporting criteria above are to be updated if all UEs will have to support RS-SINR measurements; the total reporting criteria are to be verified when the UE capabilities related to frame structure 3 are decided.

Table 8.2.2-1: Requirements for reporting criteria per measurement category

| Measurement category | E_{cat} | Note |
|--|-----------|--|
| Intra-frequency ^{Note 1} | 10 | Events for any one or a combination of intra-frequency RSRP, RSRQ, and RS-SINR ^{Note4} for E-UTRA intra-frequency cells |
| Intra-frequency UE Rx-Tx time difference | 2 | Intra-frequency UE Rx-Tx time difference measurements reported to E-UTRAN via RRC and to positioning server via LPP. Applies for UE supporting both LPP and UE Rx-Tx time difference measurement. |
| Intra-frequency RSTD ^{Note 2} | 1 | Intra-frequency RSTD measurement reporting for UE supporting OTDOA; 1 report capable of minimum 16 cell measurements for the intra-frequency |
| Intra-frequency RSRP and RSRQ measurements for E-CID | 1 | Intra-frequency RSRP and RSRQ measurements for E-CID reported to E-SMLC via LPP [24]. One report capable of at least in total 9 intra-frequency RSRP and RSRQ measurements. Applicable to UE capable of reporting RSRP and RSRQ to E-SMLC via LPP. |
| Intra-frequency RSSI and channel occupancy measurements under operation with frame structure 3 | 1 | One report capable of one UE RSSI and channel occupancy measurements per serving carrier frequency. Applicable for UE capable of performing and reporting UE RSSI and channel occupancy under operation with frame structure 3. |
| Inter-frequency | 10 / 28 | Events for any one or a combination of inter-frequency RSRP, RSRQ, and RS-SINR ^{Note4} for E-UTRA inter-frequency cells (see note 3) |
| Inter-frequency RSTD ^{Note 2} | 1 | Inter-frequency RSTD measurement reporting for UE supporting OTDOA; 1 report capable of minimum 16 cell measurements for at least one inter-frequency. Only applicable as specified in Section 8.1.2.6. |

| | | |
|---|---------|--|
| Inter-frequency RSSI and channel occupancy measurements under operation with frame structure 3 | 1 | One report capable of one UE RSSI and channel occupancy measurements for an inter-frequency. Applicable for UE capable of performing and reporting UE RSSI and channel occupancy under operation with frame structure 3. |
| Inter-RAT (GSM, cdma2000 1 x RTT and HRPD) | 5 | Only applicable for UE with this (inter-RAT) capability. This requirement ($E_{cat} = 5$) is per supported RAT. |
| Inter-RAT (UTRAN FDD, UTRAN TDD) | 5 or 11 | Only applicable for UE with this (inter-RAT) capability. This requirement ($E_{cat} = 5$ or 11) is per supported RAT. For UE which indicate support for Increased UE carrier monitoring UTRA $E_{cat} = 11$. |
| MBSFN measurements for MDT | 1 | MBSFN measurement reporting for UE supporting MBSFN measurements (MBSFN RSRP, MBSFN RSRQ, and MCH BLER) for MDT [2]; 1 report capable of minimum 1 MBSFN RSRP measurement [4], 1 MBSFN RSRQ measurement [4], and 1 MCH BLER measurement [4]. |
| <p>Note 1: When the UE is configured with SCell, PCell or PCell carrier frequency, E_{cat} for Intra-frequency is applied per serving frequency.</p> <p>Note 2: When the UE is configured with one SCell carrier frequency, the UE shall be capable of supporting at least 2 reporting criteria for all RSTD measurements configured to be performed on PCell carrier frequency, SCell carrier frequency and inter-frequency carrier. When the UE is configured with two SCell carrier frequencies, the UE shall be capable of supporting at least 3 reporting criteria for all RSTD measurements configured to be performed on PCell carrier frequency, the two SCell carrier frequencies and inter-frequency carrier. These requirements apply when there is a single on-going LPP OTDOA location session.</p> <p>Note 3: Support of E_{cat} of 28 for Measurement category Inter-frequency is applied for a UE supporting increased number of carriers to monitor beyond 3.</p> <p>Note 4: For UEs supporting RS-SINR measurements (Editor's note: the note is to be removed if the RS-SINR measurement support is mandatory).</p> | | |

8.3 Measurements for E-UTRA carrier aggregation

8.3.1 Introduction

Requirements in this clause are applicable to UE supporting E-UTRA FDD, E-UTRA TDD and/or E-UTRA TDD-FDD carrier aggregation.

Non configured frequencies may be measured with measurement gaps or autonomous gaps according to the requirements in clause 8.1.2.3 (E-UTRAN inter frequency measurements and E-UTRAN inter frequency measurements with autonomous gaps).

For UE, which does not support simultaneous reception and transmission for inter-band TDD CA specified in TS 36.331, and is compliant to the requirements for inter-band CA with uplink in one E-UTRA band and without simultaneous Rx/Tx specified in TS 36.101, the inter-band CA requirements in Section 8.3 shall apply also with different TDD UL/DL subframe configurations and/or different special subframe configurations used in CCs of different bands, under the following additional conditions:

- UE is not simultaneously scheduled in UL and DL on the different CCs, and
- at least DL subframe #0 or DL subframe #5 are available for measurements in the measured cell.

8.3.2 Measurements of the primary component carrier

Measurements of cells on the primary component carrier shall meet all applicable requirements (FDD or TDD) in clause 8.1.2.2 (E-UTRAN intra frequency measurements and E-UTRAN intra frequency measurements with autonomous gaps)

8.3.3 Measurements of a secondary component carrier

A Secondary component carrier may be activated and deactivated by MAC-CE commands as specified in [17]. The applicable performance requirements depend on whether the SCell on the corresponding frequency is activated or deactivated.

8.3.3.1 Measurements of a secondary component carrier with active SCell

When the SCell is activated, measurement performance requirements for the frequency are those given in clause 8.1.2.2(E-UTRAN intra frequency measurements and E-UTRAN intra frequency measurements with autonomous gaps). If common DRX is in use, then the requirements for that secondary component carrier are given by the applicable DRX requirements (FDD or TDD) in clause 8.1.2.2, otherwise the non DRX requirements are applicable. The applicable measurement accuracy requirements are in clause 9.1.11 (Carrier aggregation measurement accuracy)

8.3.3.2 Measurements of a secondary component carrier with deactivated SCell

This clause defines the measurement requirements of a secondary component carrier with deactivated SCell based on the parameter *measCycleSCell* defined in TS 36.331 [2].

8.3.3.2.1 E-UTRAN secondary component carrier measurements when no common DRX is used

When no DRX is in use the UE shall be able to identify a new detectable FDD or TDD cell on a secondary component carrier within $T_{\text{identify_scc}}$, according to the parameter *measCycleSCell* where $T_{\text{identify_scc}} = 20 \text{ measCycleSCell}$

A cell shall be considered detectable when

- RSRP related side conditions given in Clause 9.1 are fulfilled for a corresponding Band,
- RSRQ related side conditions given in Clause 9.1 are fulfilled for a corresponding Band,
- RS-SINR related side conditions given in Clause 9.1.17.2.1 are fulfilled for a corresponding Band,
- $SCH_RP|_{\text{dBm}}$ and $SCH \hat{E}s/Iot$ according to Annex B.2.7 for a corresponding Band.

The measurement period for deactivated scc measurements is $T_{\text{measure_scc}}$ according to the parameter *measCycleSCell* where $T_{\text{measure_scc}} = 5 \text{ measCycleSCell}$. The UE shall be capable of performing RSRP, RSRQ, and RS-SINR measurements for 8 identified cells on a secondary component carrier, and the UE physical layer shall be capable of reporting measurements to higher layers with the measurement period of $T_{\text{measure_scc}}$.

The measurement accuracy for all measured cells shall be as specified in the sub-clause 9.1.11 (Carrier aggregation measurement accuracy)

A UE may reconfigure the receiver bandwidth or turn on/off one of the RF chains when performing measurements on up to four SCCs with deactivated SCell. This may cause interruptions on PCell or activated SCell(s) or both that are specified in Section 7.8.

8.3.3.2.1.1 Measurement Reporting Requirements

8.3.3.2.1.1.1 Periodic Reporting

Reported RSRP, RSRQ, and RS-SINR measurements contained in periodically triggered measurement reports shall meet the applicable requirements in clause 9.

8.3.3.2.1.1.2 Event-triggered Periodic Reporting

Reported RSRP, RSRQ, and RS-SINR measurements contained in event triggered periodic measurement reports shall meet the applicable requirements in clause 9.

The first report in event triggered periodic measurement reporting shall meet the requirements specified in clause 8.3.3.2.1.1.3.

8.3.3.2.1.1.3 Event Triggered Reporting

Reported RSRP, RSRQ, and RS-SINR measurements contained in event triggered measurement reports shall meet the applicable requirements in clause 9.

The UE shall not send any event triggered measurement reports, as long as no reporting criteria are fulfilled.

The measurement reporting delay is defined as the time between an event that will trigger a measurement report and the point when the UE starts to transmit the measurement report over the air interface. This requirement assumes that the measurement report is not delayed by other RRC signalling on the DCCH. This measurement reporting delay excludes a delay uncertainty resulted when inserting the measurement report to the TTI of the uplink DCCH. The delay uncertainty is: $2 \times TTI_{DCCH}$. This measurement reporting delay excludes a delay which is caused by no UL resources for UE to send the measurement report.

The event triggered measurement reporting delay, measured without L3 filtering shall be less than $T_{identify_scc}$ defined in Clause 8.3.3.2.1. When L3 filtering is used or IDC autonomous denial is configured an additional delay can be expected.

If a cell which has been detectable at least for the time period $T_{identify_scc}$ defined in clause 8.3.3.2.1 becomes undetectable for a period ≤ 5 seconds and then the cell becomes detectable again and triggers an event, the event triggered measurement reporting delay shall be less than $T_{measure_scc}$ provided the timing to that cell has not changed more than $\pm 50 T_s$ and the L3 filter has not been used. When L3 filtering is used an additional delay can be expected.

8.3.3.2.2 E-UTRAN secondary component carrier measurements when common DRX is used

When DRX is in use the UE shall be able to identify a new detectable FDD or TDD cell on a secondary component carrier within $T_{identify_scc}$, according to the parameter *measCycleSCell* where $T_{identify_scc} = \max(20 \text{ measCycleSCell}, T_{identify_scc1})$. $T_{identify_scc1}$ is given in table 8.3.3.2.2-1.

Table 8.3.3.2.2-1: Requirement for $T_{identify_scc1}$

| DRX cycle length (s) | $T_{identify_scc1}$ (s) (DRX cycles) |
|--------------------------------------|---|
| ≤ 0.04 | 0.8 (Note1) |
| $0.04 < \text{DRX-cycle} \leq 0.08$ | Note2 (40) |
| 0.128 | 3.2 (25) |
| $0.128 < \text{DRX-cycle} \leq 2.56$ | Note2(20) |
| Note1: | Number of DRX cycle depends upon the DRX cycle in use |
| Note2: | Time depends upon the DRX cycle in use |

A cell shall be considered detectable when

- RSRP related side conditions given in Clause 9.1 are fulfilled for a corresponding Band,
- RSRQ related side conditions given in Clause 9.1 are fulfilled for a corresponding Band,
- RS-SINR related side conditions given in Clause 9.1.17.2.1 are fulfilled for a corresponding Band,
- $SCH_RP|_{dBm}$ and $SCH \hat{E}_s/I_{ot}$ according to Annex B.2.7 for a corresponding Band.

The measurement period for deactivated scell measurements is $T_{measure_scc}$ according to the parameter *measCycleSCell* where $T_{measure_scc} = \max(5 \text{ measCycleSCell}, T_{measure_scc1})$. The UE shall be capable of performing RSRP, RSRQ, and RS-SINR measurements for 8 identified cells on a secondary component carrier, and the UE physical layer shall be capable of reporting measurements to higher layers with the measurement period of $T_{measure_scc}$. $T_{measure_scc1}$ is given in table 8.3.3.2.2-2

Table 8.3.3.2.2-2: Requirement for $T_{\text{measure_scc1}}$

| DRX cycle length (s) | $T_{\text{measure_scc1}}$ (s) (DRX cycles) |
|---|---|
| ≤ 0.04 | 0.2 (Note1) |
| $0.04 < \text{DRX-cycle} \leq 2.56$ | Note2 (5) |
| Note1: Number of DRX cycle depends upon the DRX cycle in use Note2: Time depends upon the DRX cycle in use | |

The measurement accuracy for all measured cells shall be as specified in the sub-clause 9.1.11 (Carrier aggregation measurement accuracy).

A UE may reconfigure receiver bandwidth taking into account the SCell activation/deactivation status, and when making measurements of cells on up to four SCCs with deactivated SCell. This may cause interruptions (packet drops) to a PCell or activated SCell(s) or both when the PCell and the SCell belong to the same frequency band. No interruptions while the On Duration timer is running shall be allowed when common DRX is used. The requirement considers only interruptions due to reconfiguration of the receiver bandwidth, and not due to other causes such as RF impairments or channel conditions.

8.3.3.2.2.1 Measurement Reporting Requirements

8.3.3.2.2.1.1 Periodic Reporting

Reported RSRP, RSRQ, and RS-SINR measurements contained in periodically triggered measurement reports shall meet the applicable requirements in clause 9.

8.3.3.2.2.1.2 Event-triggered Periodic Reporting

Reported RSRP, RSRQ, and RS-SINR measurements contained in event triggered periodic measurement reports shall meet the applicable requirements in clause 9.

The first report in event triggered periodic measurement reporting shall meet the requirements specified in clause 8.3.3.2.2.1.3.

8.3.3.2.2.1.3 Event Triggered Reporting

Reported RSRP, RSRQ, and RS-SINR measurements contained in event triggered measurement reports shall meet the applicable requirements in clause 9.

The UE shall not send any event triggered measurement reports, as long as no reporting criteria are fulfilled.

The measurement reporting delay is defined as the time between an event that will trigger a measurement report and the point when the UE starts to transmit the measurement report over the air interface. This requirement assumes that the measurement report is not delayed by other RRC signalling on the DCCH. This measurement reporting delay excludes a delay uncertainty resulted when inserting the measurement report to the TTI of the uplink DCCH. The delay uncertainty is: $2 \times TTI_{\text{DCCH}}$. This measurement reporting delay excludes a delay which is caused by no UL resources for UE to send the measurement report.

The event triggered measurement reporting delay, measured without L3 filtering shall be less than $T_{\text{identify_scc}}$ defined in Clause 8.3.3.2.2. When L3 filtering is used or IDC autonomous denial is configured an additional delay can be expected.

If a cell which has been detectable at least for the time period $T_{\text{identify_scc}}$ defined in clause 8.3.3.2.2 becomes undetectable for a period ≤ 5 seconds and then the cell becomes detectable again and triggers an event, the event triggered measurement reporting delay shall be less than $T_{\text{measure_scc}}$ provided the timing to that cell has not changed more than $\pm 50 T_s$ and the L3 filter has not been used. When L3 filtering is used an additional delay can be expected.

8.4 OTDOA RSTD Measurements for E-UTRAN carrier aggregation

8.4.1 Introduction

This clause contains RSTD measurement requirements on UE capabilities for support of E-UTRA carrier aggregation. Requirements in this clause are applicable to all carrier aggregation capable UE which have been configured with one or two downlink Scell(s). Non-configured frequencies may be measured with measurement gaps according to the requirements in clause 8.1.2.6, i.e., E-UTRAN inter-frequency RSTD measurement period applies. Requirements in this clause are applicable for E-UTRA FDD, E-UTRA TDD and E-UTRA TDD-FDD carrier aggregation.

For UE, which does not support simultaneous reception and transmission for inter-band TDD CA specified in TS 36.331 [2], and is compliant to the requirements for inter-band CA with uplink in one E-UTRA band and without simultaneous Rx/Tx specified in TS 36.101 [5], RSTD requirements in Section 8.4 shall apply also with different TDD UL/DL subframe configurations and/or different special subframe configurations used in CCs of different bands, under the following additional conditions:

- all positioning subframes indicated in the OTDOA assistance data and specified in Section 9.1.10 are available for RSTD measurements in the measured and reference cells; and
- UE is not simultaneously scheduled in UL and DL on the different CCs.

8.4.2 Measurements on the primary component carrier

The RSTD measurements on cells belonging to the primary component carrier shall meet all applicable requirements (FDD or TDD) specified in clause 8.1.2.5, i.e., E-UTRAN intra-frequency RSTD measurement period applies.

The RSTD measurement accuracy for all the measurements on the primary component carrier shall be fulfilled according to the accuracy as specified in the sub-clause 9.1.12.

If the PCell is changed, regardless whether the primary component carrier is changed or not while the RSTD measurements are being performed on cells belonging to the primary component carrier, then the UE shall complete the ongoing OTDOA measurement session. In case of change of the primary component carrier, the requirements shall apply only if the primary component carrier is swapped with any of the currently configured secondary component carrier(s). The UE shall also meet the OTDOA measurement and accuracy requirements for the primary component carrier. However in this case the total RSTD measurement period ($T_{\text{RSTD, E-UTRAN, PCell_change}}$) shall be according to the following expression:

$$T_{\text{RSTD, E-UTRAN, PCell_change}} = T_{\text{RSTD, E-UTRAN}} + K \times T_{\text{PRS}} + T_{\text{PCell_change}} \quad \text{ms} ,$$

where:

K is the number of times the PCell is changed during $T_{\text{RSTD, E-UTRAN, PCell_change}}$,

T_{PRS} is defined in clause 8.1.2.5,

$T_{\text{PCell_change}}$ is the time during which the RSTD measurement may not be possible due to PCell change; it can be up to 25 ms,

$T_{\text{RSTD, E-UTRAN}}$ corresponds to the E-UTRAN intra-frequency RSTD measurement period as specified in clause 8.1.2.5.

Furthermore, due to the PCell changing the UE shall meet the RSTD measurement accuracy for a PRS bandwidth which is not larger than the minimum channel bandwidth of those PCell/SCell(s) on whose carriers RSTD measurement is performed during the RSTD measurement period.

8.4.3 Measurements on a secondary component carrier

The RSTD measurements when all cells are on a configured secondary component carrier shall meet all applicable requirements (FDD or TDD) specified in clause 8.1.2.5, i.e., E-UTRAN intra-frequency RSTD measurement period applies, regardless of whether the SCell on the corresponding frequency is activated or deactivated by the MAC-CE commands as specified in [17].

The RSTD measurement accuracy for all the measurements on the secondary component carrier shall be fulfilled according to the accuracy as specified in the sub-clause 9.1.12.

A UE may reconfigure receiver bandwidth taking into account the SCell activation/deactivation status, and when making RSTD measurements on cells belonging to SCC with deactivated SCell. This may cause interruptions (packet drops) to a PCell when the PCell and the SCell belong to the adjacent or non-adjacent component carriers in the same frequency band or to different frequency bands. In this case, the UE shall follow the interruption requirements specified in Section 7.10. No interruption to the PCell shall be allowed during the PRS positioning occasion on the PCell.

If the PCell is changed, regardless whether the primary component carrier is changed or not while the RSTD measurements are being performed on cells belonging to the secondary component carrier, then the UE shall complete the ongoing OTDOA measurement session. In case of change of the primary component carrier, the requirements shall apply only if the primary component carrier is swapped with any of the currently configured secondary component carrier(s). The UE shall also meet the OTDOA measurement and accuracy requirements for the secondary component carrier. However in this case the total RSTD measurement period ($T_{\text{RSTD, E-UTRAN, PCell_change}}$) shall be according to the following expression:

$$T_{\text{RSTD, E-UTRAN, PCell_change}} = T_{\text{RSTD, E-UTRAN}} + K \times T_{\text{PRS}} + T_{\text{PCell_change}} \quad \text{ms},$$

where:

K is the number of times the PCell is changed during $T_{\text{RSTD, E-UTRAN, PCell_change}}$,

T_{PRS} is defined in clause 8.1.2.5,

$T_{\text{PCell_change}}$ is the time during which the RSTD measurement may not be possible due to PCell change; it can be up to 25 ms,

$T_{\text{RSTD, E-UTRAN}}$ corresponds to the E-UTRAN intra-frequency RSTD measurement period as specified in clause 8.1.2.5.

Furthermore, due to the PCell changing the UE shall meet the RSTD measurement accuracy for a PRS bandwidth which is not larger than the minimum channel bandwidth of those PCell/SCell(s) on whose carriers RSTD measurement is performed during the RSTD measurement period.

8.4.4 Measurements on both primary component carrier and a secondary component carrier

The RSTD measurements of cells on both primary component carrier and a configured secondary component carrier shall meet all applicable requirements (FDD-FDD, TDD-TDD, TDD-FDD or FDD-TDD inter-Frequency OTDOA) specified in clause 8.1.2.6, i.e., E-UTRAN inter-frequency RSTD measurement period applies regardless of whether the SCell on the corresponding frequency is activated or deactivated by the MAC-CE commands as specified in [17], with the following exceptions

- the number of PRS positioning occasions is as specified in Table 8.4.4-1 shall apply, and
- TDD uplink-downlink subframes configurations as specified in Clause 8.1.2.5.2, Table 8.1.2.5.2-2 shall apply.

Table 8.4.4-1: Number of PRS positioning occasions within measurement period

| Positioning subframe configuration period T_{PRS} | Number of PRS positioning occasions M |
|--|---|
|--|---|

| | |
|---------|----|
| 160 ms | 32 |
| >160 ms | 16 |

The RSTD measurement accuracy for all the measurements on both primary component carrier and the secondary component carrier shall be fulfilled according to the accuracy as specified in the sub-clause 9.1.12.

A UE may reconfigure its receiver bandwidth taking into account the SCell activation/deactivation status, and when performing RSTD measurements on cells belonging to at least SCC with deactivated SCell. This may cause interruptions (packet drops) on a PCell when the PCell and the SCell belong to the adjacent or non-adjacent component carriers in the same frequency band or to different frequency bands. In this case, the UE shall follow the interruption requirements specified in Section 7.10. No interruption to the PCell shall be allowed during the PRS positioning occasion on the PCell.

If the PCell is changed regardless whether the primary component carrier is changed or not while the RSTD measurements are being performed on cells belonging to both the primary component carrier and the secondary component carrier then the UE shall complete the ongoing OTDOA measurement session. In case of change of the primary component carrier, the requirements shall apply only if the primary component carrier is swapped with any of the currently configured secondary component carrier(s). The UE shall also meet the OTDOA measurement and accuracy requirements for the primary and secondary component carrier. However in this case the total RSTD measurement period ($T_{\text{RSTD, E-UTRAN, PCell_change}}$) shall be according to the following expression:

$$T_{\text{RSTD, E-UTRAN, PCell_change}} = T_{\text{RSTD, E-UTRAN}} + K \times T_{\text{PRS}} + T_{\text{PCell_change}} \quad \text{ms} ,$$

where:

K is the number of times the PCell is changed during $T_{\text{RSTD, E-UTRAN, PCell_change}}$,

T_{PRS} is defined in clause 8.1.2.6,

$T_{\text{PCell_change}}$ is the time during which the RSTD measurement may not be possible due to PCell change; it can be up to 25 ms,

$T_{\text{RSTD, E-UTRAN}}$ corresponds to the E-UTRAN inter-frequency RSTD measurement period as specified in clause 8.1.2.6 with the exception that the number of PRS positioning occasions is as specified in Table 8.4.4-1.

Furthermore, due to the PCell changing the UE shall meet the RSTD measurement accuracy for a PRS bandwidth which is not larger than the minimum channel bandwidth of those PCell/SCell(s) on whose carriers RSTD measurement is performed during the RSTD measurement period.

8.4.5 Measurements on different secondary component carriers

The RSTD measurements of cells on a configured secondary component carrier and another configured secondary component carrier shall meet all applicable requirements (FDD-FDD, TDD-TDD, TDD-FDD or FDD-TDD inter-Frequency OTDOA) specified in clause 8.1.2.6, i.e., E-UTRAN inter-frequency RSTD measurement period applies regardless of whether the SCell on the corresponding frequency is activated or deactivated by the MAC-CE commands as specified in [17], with the following exceptions

- the number of PRS positioning occasions is as specified in Table 8.4.4-1 shall apply, and
- TDD uplink-downlink subframes configurations as specified in Clause 8.1.2.5.2, Table 8.1.2.5.2-2 shall apply.

Table 8.4.4-1: Number of PRS positioning occasions within measurement period

| Positioning subframe configuration period T_{PRS} | Number of PRS positioning occasions M |
|--|---|
| 160 ms | 32 |
| >160 ms | 16 |

The RSTD measurement accuracy for all the measurements on the secondary component carriers shall be fulfilled according to the accuracy as specified in the sub-clause 9.1.12.

A UE may reconfigure its receiver bandwidth taking into account the SCell activation/deactivation status, and when performing RSTD measurements on cells belonging to at least SCC with deactivated SCell. This may cause interruptions (packet drops) on a PCell when the PCell and the SCell belong to the adjacent or non-adjacent component carriers in the same frequency band or to different frequency bands. In this case, the UE shall follow the interruption requirements specified in Section 7.10. No interruption to the PCell shall be allowed during the PRS positioning occasion on the PCell. No interruption to the SCells shall be allowed during the PRS positioning occasion on the SCells.

If the PCell is changed regardless whether the primary component carrier is changed or not while the RSTD measurements are being performed on cells belonging to the secondary component carriers then the UE shall complete the ongoing OTDOA measurement session. In case of change of the primary component carrier, the requirements shall apply only if the primary component carrier is swapped with any of the currently configured secondary component carrier(s). The UE shall also meet the OTDOA measurement and accuracy requirements for the secondary component carriers. However in this case the total RSTD measurement period ($T_{\text{RSTD, E-UTRAN, PCell_change}}$) shall be according to the following expression:

$$T_{\text{RSTD, E-UTRAN, PCell_change}} = T_{\text{RSTD, E-UTRAN}} + K \times T_{\text{PRS}} + T_{\text{PCell_change}} \quad \text{ms},$$

where:

K is the number of times the PCell is changed during $T_{\text{RSTD, E-UTRAN, PCell_change}}$,

T_{PRS} is defined in clause 8.1.2.6,

$T_{\text{PCell_change}}$ is the time during which the RSTD measurement may not be possible due to PCell change; it can be up to 25 ms,

$T_{\text{RSTD, E-UTRAN}}$ corresponds to the E-UTRAN inter-frequency RSTD measurement period as specified in clause 8.1.2.6 with the exception that the number of PRS positioning occasions is as specified in Table 8.4.4-1.

Furthermore, due to the PCell changing the UE shall meet the RSTD measurement accuracy for a PRS bandwidth which is not larger than the minimum channel bandwidth of those PCell/SCell(s) on whose carriers RSTD measurement is performed during the RSTD measurement period.

8.5 Measurements for UE category 0

8.5.1 Introduction

The UE category 0 applicability of the requirements in subclause 8.5 is defined in Section 3.6.1.

This clause contains requirements on the UE regarding measurement reporting in RRC_CONNECTED state. The requirements are specified for E-UTRA intra frequency measurements. These measurements may be used by the E-UTRAN, e.g. for handover decisions. The measurement quantities are defined in [4], the measurement model is defined in [22] and measurement accuracies are specified in clause 9. Control of measurement reporting is specified in TS 36.331 [2].

When the UE is provided with IDC solution, the UE shall also perform RRM measurements and meet the corresponding requirements in clause 8.

8.5.2 Requirements

8.5.2.1 E-UTRAN intra frequency measurements

The UE shall be able to identify new intra-frequency cells and perform RSRP measurements of identified intra-frequency cells without an explicit intra-frequency neighbour cell list containing physical layer cell identities. During

the RRC_CONNECTED state the UE shall continuously measure identified intra frequency cells and additionally search for and identify new intra frequency cells.

8.5.2.1.1 E-UTRAN FDD intra frequency measurements

8.5.2.1.1.1 E-UTRAN intra frequency measurements when no DRX is used

When no DRX is in use the UE shall be able to identify a new detectable FDD intra frequency cell within

$$T_{\text{identify_intra_UE cat 0}} = T_{\text{basic_identify_E-UTRA_FDD_UE cat 0}} \cdot \frac{T_{\text{Measurement_Period_UE cat 0, Intra}}}{T_{\text{Intra}}} \text{ ms}$$

where

$T_{\text{basic_identify_E-UTRA_FDD_UE cat 0, intra}}$ is 1000 ms

A cell shall be considered detectable when

- RSRP related side conditions given in Sections 9.1.13.1 and 9.1.13.2 and RSRQ related side conditions given in Clause 9.1.13.3 are fulfilled for a corresponding Band,
- SCH_RP and SCH_Ês/Iot according to Annex B.2.1 for a corresponding Band.

T_{Intra} : This is the minimum time that is available for intra frequency measurements, during the measurement period with an arbitrarily chosen timing. Time is assumed to be available for performing intra frequency measurements whenever the receiver is guaranteed to be active on the intra frequency carrier.

Identification of a cell shall include detection of the cell and additionally performing a single measurement with measurement period of $T_{\text{Measurement_Period_UE cat 0, Intra}}$. If higher layer filtering is used, an additional cell identification delay can be expected.

In the RRC_CONNECTED state the measurement period for intra frequency measurements is 400 ms. When no measurement gaps are activated, the low complexity UE shall be capable of performing RSRP and RSRQ measurements for 8 identified-intra-frequency cells, and the UE physical layer shall be capable of reporting measurements to higher layers with the measurement period of 400 ms. When measurement gaps are activated the UE shall be capable of performing measurements for at least $Y_{\text{measurement_intra_UE cat 0}}$ cells, where $Y_{\text{measurement_intra_UE cat 0}}$ is defined in the following equation. If the UE has identified more than $Y_{\text{measurement_intra_UE cat 0}}$ cells, the UE shall perform measurements of at least 8 identified intra-frequency cells but the reporting rate of RSRP and RSRQ measurements of cells from UE physical layer to higher layers may be decreased.

$$Y_{\text{measurement_intra_UE cat 0}} = \text{Floor} \left\{ X_{\text{basic_measurement_FDD_UE cat 0}} \cdot \frac{T_{\text{Intra}}}{T_{\text{Measurement_Period_UE cat 0, Intra}}} \right\}$$

cells where

$X_{\text{basic_measurement_FDD_UE cat 0}} = 8$ (cells)

$T_{\text{Measurement_Period_UE cat 0, Intra}} = 400$ ms. The measurement period for Intra frequency RSRP and RSRQ measurements.

The RSRP measurement accuracy for all measured cells shall be as specified in the sub-clauses 9.1.13.1 and 9.1.13.2, and the RSRQ measurement accuracy for all measured cells shall be as specified in the sub-clause 9.1.13.3.

8.5.2.1.1.1.1 Measurement Reporting Requirements

8.5.2.1.1.1.1.1 Periodic Reporting

Reported RSRP and RSRQ measurements contained in periodically triggered measurement reports shall meet the requirements in sections 9.1.13.1, 9.1.13.2 and 9.1.13.3, respectively.

8.5.2.1.1.1.2 Event-triggered Periodic Reporting

Reported RSRP and RSRQ measurements contained in event triggered periodic measurement reports shall meet the requirements in sections 9.1.13.1, 9.1.13.2 and 9.1.13.3, respectively.

The first report in event triggered periodic measurement reporting shall meet the requirements specified in clause 8.5.2.1.1.1.3.

8.5.2.1.1.1.3 Event Triggered Reporting

Reported RSRP and RSRQ measurements contained in event triggered measurement reports shall meet the requirements in sections 9.1.13.1, 9.1.13.2 and 9.1.13.3, respectively.

The UE shall not send any event triggered measurement reports, as long as no reporting criteria are fulfilled.

The measurement reporting delay is defined as the time between an event that will trigger a measurement report and the point when the UE starts to transmit the measurement report over the air interface. This requirement assumes that the measurement report is not delayed by other RRC signalling on the DCCH. This measurement reporting delay excludes a delay uncertainty resulted when inserting the measurement report to the TTI of the uplink DCCH. The delay uncertainty is: $2 \times TTI_{DCCH}$. This measurement reporting delay excludes a delay which caused by no UL resources for UE to send the measurement report.

The event triggered measurement reporting delay, measured without L3 filtering shall be less than $T_{identify_intra_UE\ cat\ 0}$ defined in Clause 8.5.2.1.1.1. When L3 filtering is used or IDC autonomous denial is configured an additional delay can be expected.

If a cell which has been detectable at least for the time period $T_{identify_intra_UE\ cat\ 0}$ defined in clause 8.5.2.1.1.1 becomes undetectable for a period ≤ 5 seconds and then the cell becomes detectable again and triggers an event, the event triggered measurement reporting delay shall be less than $T_{Measurement_Period_UE\ cat\ 0, Intra}$ provided the timing to that cell has not changed more than $\pm 50 T_s$ and the L3 filter has not been used. When L3 filtering is used or IDC autonomous denial is configured, an additional delay can be expected.

8.5.2.1.1.2 E-UTRAN intra frequency measurements when DRX is used

When DRX is in use the UE shall be able to identify a new detectable FDD intra frequency cell within $T_{identify_intra_UE\ cat\ 0}$ as shown in table 8.5.2.1.1.2-1. When eDRX_CONN is in use the UE shall be able to identify a new detectable FDD intra-frequency cell within $T_{identify_intra_UE\ cat\ 0}$ as shown in table 8.5.2.1.1.2-1A.

Table 8.5.2.1.1.2-1: Requirement to identify a newly detectable FDD intrafrequency cell

| DRX cycle length (s) | $T_{identify_intra_UE\ cat\ 0}$ (s) (DRX cycles) |
|---|--|
| ≤ 0.04 | [1] (Note1) |
| $0.04 < DRX\text{-}cycle \leq 0.08$ | Note2 (40) |
| 0.128 | 3.2 (25) |
| $0.128 < DRX\text{-}cycle \leq 2.56$ | Note2(20) |
| Note1: Number of DRX cycle depends upon the DRX cycle in use Note2: Time depends upon the DRX cycle in use | |

Table 8.5.2.1.1.2-1A: Requirement to identify a newly detectable FDD intra-frequency cell when eDRX_CONN cycle is used

| eDRX_CONN cycle length (s) | $T_{identify_intra_UE\ cat\ 0}$ (eDRX_CONN cycles) |
|--|--|
| $2.56 < eDRX_CONN\ cycles \leq 10.24$ | Note(20) |
| Note: Time depends upon the eDRX_CONN cycle in use | |

A cell shall be considered detectable when

- RSRP related side conditions given in Sections 9.1.13.1 and 9.1.13.2 and RSRQ related side conditions given in Clause 9.1.13.3 are fulfilled for a corresponding Band,
- SCH_RP and SCH \hat{E}_s/I_{ot} according to Annex B.2.1 for a corresponding Band

In the RRC_CONNECTED state the measurement period for intra frequency measurements is $T_{\text{measure_intra_UE cat 0}}$. When DRX is used, $T_{\text{measure_intra_UE cat 0}}$ is as defined in table 8.5.2.1.1.2-2, when eDRX_CONN is used, $T_{\text{measure_intra_UE cat 0}}$ is as defined in table 8.5.2.1.1.2-3. The UE shall be capable of performing RSRP and RSRQ measurements for 8 identified-intra-frequency cells, and the UE physical layer shall be capable of reporting measurements to higher layers with the measurement period of $T_{\text{measure_intra_UE cat 0}}$.

Table 8.5.2.1.1.2-2: Requirement to measure FDD intrafrequency cells

| DRX cycle length (s) | $T_{\text{measure_intra_UE cat 0}}$ (s) (DRX cycles) |
|---|--|
| ≤ 0.08 | 0.4 (Note1) |
| $0.08 < \text{DRX-cycle} \leq 2.56$ | Note2 (5) |
| Note1: Number of DRX cycle depends upon the DRX cycle in use Note2: Time depends upon the DRX cycle in use | |

Table 8.5.2.1.1.2-3: Requirement to measure FDD intra-frequency cells when eDRX_CONN cycle is used

| eDRX_CONN cycle length (s) | $T_{\text{measure_intra_UE cat 0}}$ (s) (eDRX_CONN cycles) |
|--|--|
| $2.56 < \text{eDRX_CONN cycle} \leq 10.24$ | Note (5) |
| Note: Time depends upon the eDRX_CONN cycle in use | |

The RSRP measurement accuracy for all measured cells shall be as specified in the sub-clauses 9.1.13.1 and 9.1.13.2, and the RSRQ measurement accuracy for all measured cells shall be as specified in the sub-clause 9.1.13.3.

8.5.2.1.1.2.1 Measurement Reporting Requirements

8.5.2.1.1.2.1.1 Periodic Reporting

Reported RSRP and RSRQ measurements contained in periodically triggered measurement reports shall meet the requirements in sections 9.1.13.1, 9.1.13.2 and 9.1.13.3, respectively.

8.5.2.1.1.2.1.2 Event-triggered Periodic Reporting

Reported RSRP and RSRQ measurements contained in event triggered periodic measurement reports shall meet the requirements in sections 9.1.13.1, 9.1.13.2 and 9.1.13.3, respectively.

The first report in event triggered periodic measurement reporting shall meet the requirements specified in clause 8.5.2.1.1.2.1.3.

8.5.2.1.1.2.1.3 Event Triggered Reporting

Reported RSRP and RSRQ measurements contained in event triggered measurement reports shall meet the requirements in sections 9.1.13.1, 9.1.13.2 and 9.1.13.3, respectively.

The UE shall not send any event triggered measurement reports, as long as no reporting criteria are fulfilled.

The measurement reporting delay is defined as the time between an event that will trigger a measurement report and the point when the UE starts to transmit the measurement report over the air interface. This requirement assumes that that the measurement report is not delayed by other RRC signalling on the DCCH. This measurement reporting delay excludes a delay uncertainty resulted when inserting the measurement report to the TTI of the uplink DCCH. The delay

uncertainty is: $2 \times TTI_{DCC}$. This measurement reporting delay excludes a delay which caused by no UL resources for UE to send the measurement report.

The event triggered measurement reporting delay, measured without L3 filtering shall be less than $T_{identify_intra_UE\ cat\ 0}$ defined in Clause 8.5.2.1.1.2. When L3 filtering is used or IDC autonomous denial is configured an additional delay can be expected.

If a cell which has been detectable at least for the time period $T_{identify_intra_UE\ cat\ 0}$ defined in clause 8.5.2.1.1.2 becomes undetectable for a period ≤ 5 seconds and then the cell becomes detectable again and triggers an event, the event triggered measurement reporting delay shall be less than $T_{measure_intra_UE\ cat\ 0}$ provided the timing to that cell has not changed more than $\pm 50 T_s$ and the L3 filter has not been used. When L3 filtering is used or IDC autonomous denial is configured, an additional delay can be expected.

8.5.2.1.2 E-UTRAN intra frequency measurements for HD-FDD

8.5.2.1.2.1 E-UTRAN intra frequency measurements when no DRX is used

The requirements in this section are applicable for the UE which supports half duplex operation on one or more supported frequency bands [2].

The requirements defined in clause 8.5.2.1.1.1 also apply for this section provided the following conditions are met:

- at least downlink subframe # 0 or downlink subframe # 5 per radio frame of an intra-frequency cell to be identified by the UE is available at the UE over $T_{identify_intra_UE\ cat\ 0}$;
- at least one downlink subframe per radio frame of measured cell is available at the UE for RSRP and RSRQ measurements assuming measured cell is identified cell over $T_{measure_intra_UE\ cat\ 0}$.

8.5.2.1.2.2 E-UTRAN intra frequency measurements when DRX is used

When DRX is in use the UE shall be able to identify a new detectable FDD intra frequency cell within $T_{identify_intra_UE\ cat\ 0}$ as shown in table 8.5.2.1.2.2-1. When eDRX_CONN is in use the UE shall be able to identify a new detectable FDD intra-frequency cell within $T_{identify_intra_UE\ cat\ 0}$ as shown in table 8.5.2.1.2.2-1A.

Table 8.5.2.1.2.2-1: Requirement to identify a newly detectable HD-FDD intrafrequency cell

| DRX cycle length (s) | $T_{identify_intra_UE\ cat\ 0}$ (s) (DRX cycles) |
|---|--|
| ≤ 0.04 | 1 (Note1) |
| $0.04 < \text{DRX-cycle} \leq 0.08$ | Note2 (50) |
| 0.128 | 3.2 (32) |
| $0.128 < \text{DRX-cycle} \leq 2.56$ | Note2(25) |
| Note1: Number of DRX cycle depends upon the DRX cycle in use Note2: Time depends upon the DRX cycle in use | |

Table 8.5.2.1.2.2-1A: Requirement to identify a newly detectable HD-FDD intra-frequency cell when eDRX_CONN cycle is used

| eDRX_CONN cycle length (s) | $T_{identify_intra_UE\ cat\ 0}$ (s) (eDRX_CONN cycles) |
|--|--|
| $2.56 < \text{eDRX_CONN cycle} \leq 10.24$ | Note (25) |
| Note: Time depends upon the eDRX_CONN cycle in use | |

A cell shall be considered detectable when

- RSRP related side conditions given in Sections 9.1.13.1 and 9.1.13.2 and RSRQ related side conditions given in Clause 9.1.13.3 are fulfilled for a corresponding Band,

- SCH_{RP} and SCH_{Ês/Iot} according to Annex B.2.1 for a corresponding Band

When DRX is in use, in the RRC_CONNECTED state the measurement period for intra frequency measurements is $T_{\text{measure_intra_UE cat 0}}$ as shown in table 8.5.2.1.2.2-2. When eDRX_CONN is in use in the RRC_CONNECTED state, the measurement period for intra-frequency measurements is $T_{\text{measure_intra_UE cat 0}}$ as shown in table 8.5.2.1.2.2-3. The UE shall be capable of performing RSRP and RSRQ measurements for 8 identified-intra-frequency cells, and the UE physical layer shall be capable of reporting measurements to higher layers with the measurement period of $T_{\text{measure_intra_UE cat 0}}$.

Table 8.5.2.1.2.2-2: Requirement to measure HD-FDD intrafrequency cells

| DRX cycle length (s) | $T_{\text{measure_intra_UE cat 0}}$ (s) (DRX cycles) |
|---|--|
| ≤ 0.04 | 0.4 (Note1) |
| $0.04 < \text{DRX-cycle} \leq 0.16$ | Note2 (7) |
| $0.16 < \text{DRX-cycle} \leq 2.56$ | Note2(5) |
| Note1: Number of DRX cycle depends upon the DRX cycle in use Note2: Time depends upon the DRX cycle in use | |

Table 8.5.2.1.2.2-3: Requirement to measure HD-FDD intra-frequency cells when eDRX_CONN cycle is used

| eDRX_CONN cycle length (s) | $T_{\text{measure_intra_UE cat 0}}$ (s) (eDRX_CONN cycles) |
|--|--|
| $2.56 < \text{eDRX_CONN cycle} \leq 10.24$ | Note (5) |
| Note: Time depends upon the eDRX_CONN cycle in use | |

The RSRP measurement accuracy for all measured cells shall be as specified in the sub-clauses 9.1.13.1 and 9.1.13.2, and the RSRQ measurement accuracy for all measured cells shall be as specified in the sub-clause 9.1.13.3.

8.5.2.1.1.2.1 Measurement Reporting Requirements

8.5.2.1.1.2.1.1 Periodic Reporting

Reported RSRP and RSRQ measurements contained in periodically triggered measurement reports shall meet the requirements in sections 9.1.13.1, 9.1.13.2 and 9.1.13.3, respectively.

8.5.2.1.1.2.1.2 Event-triggered Periodic Reporting

Reported RSRP and RSRQ measurements contained in event triggered periodic measurement reports shall meet the requirements in sections 9.1.13.1, 9.1.13.2 and 9.1.13.3, respectively.

The first report in event triggered periodic measurement reporting shall meet the requirements specified in clause 8.5.2.1.1.2.1.3.

8.5.2.1.1.2.1.3 Event Triggered Reporting

Reported RSRP and RSRQ measurements contained in event triggered measurement reports shall meet the requirements in sections 9.1.13.1, 9.1.13.2 and 9.1.13.3, respectively.

The UE shall not send any event triggered measurement reports, as long as no reporting criteria are fulfilled.

The measurement reporting delay is defined as the time between an event that will trigger a measurement report and the point when the UE starts to transmit the measurement report over the air interface. This requirement assumes that the measurement report is not delayed by other RRC signalling on the DCCH. This measurement reporting delay excludes a delay uncertainty resulted when inserting the measurement report to the TTI of the uplink DCCH. The delay uncertainty is: $2 \times TTI_{\text{DCCH}}$. This measurement reporting delay excludes a delay which caused by no UL resources for UE to send the measurement report.

The event triggered measurement reporting delay, measured without L3 filtering shall be less than $T_{\text{identify_intra_UE cat 0}}$ defined in Clause 8.5.2.1.1.2. When L3 filtering is used or IDC autonomous denial is configured an additional delay can be expected.

If a cell which has been detectable at least for the time period $T_{\text{identify_intra_UE cat 0}}$ defined in clause 8.5.2.1.1.2 becomes undetectable for a period ≤ 5 seconds and then the cell becomes detectable again and triggers an event, the event triggered measurement reporting delay shall be less than $T_{\text{measure_intra_UE cat 0}}$ provided the timing to that cell has not changed more than $\pm 50 T_s$ and the L3 filter has not been used. When L3 filtering is used or IDC autonomous denial is configured, an additional delay can be expected.

8.5.2.1.3 E-UTRAN TDD intra frequency measurements

8.5.2.1.3.1 E-UTRAN intra frequency measurements when no DRX is used

When no DRX is in use the UE shall be able to identify a new detectable TDD intra frequency cell within

$$T_{\text{identify_intra_UE cat 0}} = T_{\text{basic_identify_E-UTRA_TDD_UE cat 0, intra}} \cdot \frac{T_{\text{Measurement_Period_UE cat 0, Intra}}}{T_{\text{Intra}}} \quad \text{ms}$$

where

$T_{\text{basic_identify_E-UTRA_TDD_UE cat 0, intra}}$ is 1000 ms

A cell shall be considered detectable when

- RSRP related side conditions given in Sections 9.1.13.1 and 9.1.13.2 and RSRQ related side conditions given in Clause 9.1.13.3 are fulfilled for a corresponding Band,
- SCH_{RP} and SCH_{Ês/Iot} according to Annex B.2.1 for a corresponding Band

T_{Intra} : This is the minimum time that is available for intra frequency measurements, during the measurement period with an arbitrarily chosen timing. Time is assumed to be available for performing intra frequency measurements whenever the receiver is guaranteed to be active on the intra frequency carrier.

Identification of a cell shall include detection of the cell and additionally performing a single measurement with measurement period of $T_{\text{Measurement_Period_UE cat 0, Intra}}$. If higher layer filtering is used, an additional cell identification delay can be expected.

In the RRC_CONNECTED state the measurement period for intra frequency measurements is 400 ms. When no measurement gaps are activated, the UE shall be capable of performing RSRP and RSRQ measurements for 8 identified-intra-frequency cells, and the UE physical layer shall be capable of reporting measurements to higher layers with the measurement period of 400 ms. When measurement gaps are activated the UE shall be capable of performing measurements for at least $Y_{\text{measurement_intra_UE cat 0}}$ cells, where $Y_{\text{measurement_intra_UE cat 0}}$ is defined in the following equation. If the UE has identified more than $Y_{\text{measurement_intra_UE cat 0}}$ cells, the UE shall perform measurements of at least 8 identified intra-frequency cells but the reporting rate of RSRP and RSRQ measurements of cells from UE physical layer to higher layers may be decreased.

$$Y_{\text{measurement_intra_UE cat 0}} = \text{Floor} \left\{ X_{\text{basic_measurement_TDD_UE cat 0}} \cdot \frac{T_{\text{Intra}}}{T_{\text{Measurement_Period_UE cat 0, Intra}}} \right\}$$

cells where

$X_{\text{basic_measurement_TDD_UE cat 0}} = 8$ (cells)

$T_{\text{Measurement_Period_intra_UE cat 0}} = 400$ ms. The measurement period for Intra frequency RSRP and RSRQ measurements.

The RSRP measurement accuracy for all measured cells shall be as specified in the sub-clauses 9.1.13.1 and 9.1.13.2, and the RSRQ measurement accuracy for all measured cells shall be as specified in the sub-clause 9.1.13.3.

8.5.2.1.3.1.1 Measurement Reporting Requirements

8.5.2.1.3.1.1.1 Periodic Reporting

Reported RSRP and RSRQ measurements contained in periodically triggered measurement reports shall meet the requirements in sections 9.1.13.1, 9.1.13.2 and 9.1.13.3, respectively.

8.5.2.1.3.1.1.2 Event-triggered Periodic Reporting

Reported RSRP and RSRQ measurements contained in event triggered periodic measurement reports shall meet the requirements in sections 9.1.13.1, 9.1.13.2 and 9.1.13.3, respectively.

The first report in event triggered periodic measurement reporting shall meet the requirements specified in clause 8.5.2.1.3.1.1.3.

8.5.2.1.3.1.1.3 Event Triggered Reporting

Reported RSRP and RSRQ measurements contained in event triggered measurement reports shall meet the requirements in sections 9.1.13.1, 9.1.13.2 and 9.1.13.3, respectively.

The UE shall not send any event triggered measurement reports, as long as no reporting criteria are fulfilled.

The measurement reporting delay is defined as the time between an event that will trigger a measurement report and the point when the UE starts to transmit the measurement report over the air interface. This requirement assumes that the measurement report is not delayed by other RRC signalling on the DCCH. This measurement reporting delay excludes a delay uncertainty resulted when inserting the measurement report to the TTI of the uplink DCCH. The delay uncertainty is: $2 \times TTI_{DCCH}$. This measurement reporting delay excludes a delay which caused by no UL resources for UE to send the measurement report.

The event triggered measurement reporting delay, measured without L3 filtering shall be less than $T_{\text{identify_intra_UE cat 0}}$ defined in Clause 8.5.2.1.3.1. When L3 filtering is used or IDC autonomous denial is configured an additional delay can be expected.

If a cell which has been detectable at least for the time period $T_{\text{identify_intra_UE cat 0}}$ defined in clause 8.5.2.1.3.1 becomes undetectable for a period ≤ 5 seconds and then the cell becomes detectable again and triggers an event, the event triggered measurement reporting delay shall be less than $T_{\text{Measurement_Period Intra_UE cat 0}}$ provided the timing to that cell has not changed more than $\pm 50 T_s$ and the L3 filter has not been used. When L3 filtering is used or IDC autonomous denial is configured, an additional delay can be expected.

8.5.2.1.3.2 E-UTRAN intra frequency measurements when DRX is used

When DRX is in use the UE shall be able to identify a new detectable TDD intra frequency cell within $T_{\text{identify_intra_UE cat 0}}$ as shown in table 8.5.2.1.3.2-1. When eDRX_CONN is in use the UE shall be able to identify a new detectable TDD intra-frequency cell within $T_{\text{identify_intra_UE cat 0}}$ as defined in table 8.5.2.1.3.2-1A.

Table 8.5.2.1.3.2-1: Requirement to identify a newly detectable TDD intrafrequency cell

| DRX cycle length (s) | $T_{\text{identify_intra_UE cat 0}}$ (s) (DRX cycles) |
|---|---|
| ≤ 0.04 | 1 (Note1) |
| $0.04 < \text{DRX-cycle} \leq 0.08$ | Note2 (40) |
| 0.128 | 3.2 (25) |
| $0.128 < \text{DRX-cycle} \leq 2.56$ | Note2(20) |
| Note1: Number of DRX cycle depends upon the DRX cycle in use Note2: Time depends upon the DRX cycle in use | |

Table 8.5.2.1.3.2-1A: Requirement to identify a newly detectable TDD intra-frequency cell when eDRX_CONN cycle is used

| eDRX_CONN cycle length (s) | $T_{\text{identify_intra_UE cat 0}}$ (s) (eDRX_CONN cycles) |
|--|---|
| $2.56 < \text{eDRX_CONN cycle} \leq 10.24$ | Note (20) |
| Note: Time depends upon the eDRX_CONN cycle in use | |

A cell shall be considered detectable when

- RSRP related side conditions given in Clause 9.1.13.1 and 9.1.13.2 and RSRQ related side conditions given in Clause 9.1.13.3 are fulfilled for a corresponding Band,
- SCH_RP and SCH_Ês/Iot according to Annex B.2.1 for a corresponding Band

When DRX is in use in the RRC_CONNECTED state the measurement period for intra frequency measurements is $T_{\text{measure_intra_UE cat 0}}$ as shown in table 8.5.2.1.3.2-2. When eDRX_CONN in the RRC_CONNECTED state is in use, the measurement period for intra-frequency measurements is $T_{\text{measure_intra_UE cat 0}}$ as defined in table 8.5.2.1.3.2-3. The UE shall be capable of performing RSRP and RSRQ measurements for 8 identified intra-frequency cells and the UE physical layer shall be capable of reporting measurements to higher layers with the measurement period of $T_{\text{measure_intra_UE cat 0}}$.

Table 8.5.2.1.3.2-2: Requirement to measure TDD intra frequency cells

| DRX cycle length (s) | $T_{\text{measure_intra_UE cat 0}}$ (s) (DRX cycles) |
|---|--|
| ≤ 0.08 | 0.4 (Note1) |
| $0.08 < \text{DRX-cycle} \leq 2.56$ | Note2 (5) |
| Note1: Number of DRX cycle depends upon the DRX cycle in use. Note2: Time depends upon the DRX cycle in use. | |

Table 8.5.2.1.3.2-3: Requirement to measure TDD intra-frequency cells when eDRX_CONN cycle is used

| eDRX_CONN cycle length (s) | $T_{\text{measure_intra_UE cat 0}}$ (s) (eDRX_CONN cycles) |
|---|--|
| $2.56 < \text{eDRX_CONN cycle} \leq 10.24$ | Note (5) |
| Note: Time depends upon the eDRX_CONN cycle in use. | |

The RSRP measurement accuracy for all measured cells shall be as specified in the sub-clauses 9.1.13.1 and 9.1.13.2, and the RSRQ measurement accuracy for all measured cells shall be as specified in the sub-clause 9.1.13.3.

8.5.2.1.3.2.1 Measurement Reporting Requirements

8.5.2.1.3.2.1.1 Periodic Reporting

Reported RSRP and RSRQ measurements contained in periodically triggered measurement reports shall meet the requirements in sections 9.1.13.1, 9.1.13.2 and 9.1.13.3, respectively.

8.5.2.1.3.2.1.2 Event-triggered Periodic Reporting

Reported RSRP and RSRQ measurements contained in event triggered periodic measurement reports shall meet the requirements in sections 9.1.13.1, 9.1.13.2 and 9.1.13.3, respectively.

The first report in event triggered periodic measurement reporting shall meet the requirements specified in clause 8.5.2.1.3.2.1.3.

8.5.2.1.3.2.1.3 Event Triggered Reporting

Reported RSRP and RSRQ measurements contained in event triggered measurement reports shall meet the requirements in sections 9.1.13.1, 9.1.13.2 and 9.1.13.3, respectively.

The UE shall not send any event triggered measurement reports, as long as no reporting criteria are fulfilled.

The measurement reporting delay is defined as the time between an event that will trigger a measurement report and the point when the UE starts to transmit the measurement report over the air interface. This requirement assumes that the measurement report is not delayed by other RRC signalling on the DCCH. This measurement reporting delay excludes a delay uncertainty resulted when inserting the measurement report to the TTI of the uplink DCCH. The delay uncertainty is: $2 \times TTI_{DCCH}$. This measurement reporting delay excludes a delay which caused by no UL resources for UE to send the measurement report.

The event triggered measurement reporting delay, measured without L3 filtering shall be less than $T_{identify_intra_UE\ cat\ 0}$ defined in Clause 8.5.2.1.3.2. When L3 filtering is used or IDC autonomous denial is configured an additional delay can be expected.

If a cell which has been detectable at least for the time period $T_{identify_intra_UE\ cat\ 0}$ defined in clause 8.5.2.1.3.2 becomes undetectable for a period ≤ 5 seconds and then the cell becomes detectable again and triggers an event, the event triggered measurement reporting delay shall be less than $T_{measure_intra_UE\ cat\ 0}$ provided the timing to that cell has not changed more than $\pm 50 T_s$ and the L3 filter has not been used. When L3 filtering is used or IDC autonomous denial is configured, an additional delay can be expected.

8.5.2.1.4 E-UTRAN FDD intra frequency measurements with autonomous gaps for UE category 0

The requirements defined in this subclause 8.5.2.1.4 apply provided the following condition is met:

- Tx diversity or transmission using multiple antennas are supported in the target cell to be detected.

8.5.2.1.4.1 Identification of a new CGI of E-UTRA cell with autonomous gaps

No explicit neighbour list is provided to the UE for identifying a new CGI of E-UTRA cell. The UE shall identify and report the CGI when requested by the network for the purpose 'reportCGI'. The UE may make autonomous gaps in downlink reception and uplink transmission for receiving MIB and SIB1 message according to clause 5.5.3.1 of TS 36.331 [2]. Note that a UE is not required to use autonomous gap if si-RequestForHO is set to false. If autonomous gaps are used for measurement with the purpose of 'reportCGI', regardless of whether DRX or eDRX_CONN is used or not, or whether SCell(s) are configured or not, the UE shall be able to identify a new CGI of E-UTRA cell within:

$$T_{identify_CGI_LC-UE, intra} = T_{basic_identify_CGI_LC-UE, intra} \quad ms$$

Where

$T_{basic_identify_CGI_LC-UE, intra} = 190$ ms. This is the time period used in the above equation where the maximum allowed time for the UE to identify a new CGI of an E-UTRA cell is defined, provided that the E-UTRA cell has been already identified by the UE.

A cell shall be considered identifiable following conditions are fulfilled:

- RSRP related side conditions given in Clause 9.1 are fulfilled for a corresponding Band,
- SCH_RP and SCH_Ês/Iot according to Annex B.2.2 for a corresponding Band

The MIB of an E-UTRA cell whose CGI is identified shall be considered decodable by the UE provided the PBCH demodulation requirements are met according to [5].

The requirement for identifying a new CGI of an E-UTRA cell within $T_{basic_identify_CGI_LC-UE, intra}$ is applicable when no DRX is used as well as when any of the DRX or eDRX_CONN cycles specified in TS 36.331 [2] is used.

Within the time, $T_{\text{identify_CGI_LC-UE, intra}}$ *ms*, over which the UE identifies the new CGI of E-UTRA cell, the UE shall transmit at least 92 ACK/NACKs on PCell provided that:

- there is continuous DL data allocation,
- no DRX and no eDRX_CONN cycle is used,
- no measurement gaps are configured,
- only one code word is transmitted in each subframe,
- no MBSFN subframes are configured in the PCell or each of activated SCell(s).

8.5.2.1.4.2 ECGI Reporting Delay

The ECGI reporting delay occurs due to the delay uncertainty when inserting the ECGI measurement report to the TTI of the uplink DCCH. The delay uncertainty is twice the TTI of the uplink DCCH. In case DRX is used, the ECGI reporting may be delayed until the next DRX cycle. In case eDRX_CONN is used, the ECGI reporting may be delayed until the next eDRX_CONN cycle. If IDC autonomous denial is configured, an additional delay can be expected.

8.5.2.1.5 E-UTRAN intra frequency measurements with autonomous gaps for HD-FDD UE category 0

The requirements in this section are applicable for the UE which supports half duplex FDD operation on one or more supported frequency bands [2].

The requirements defined in this subclause 8.5.2.1.5 apply provided the following condition is met:

- Tx diversity or transmission using multiple antennas are supported in the target cell to be detected.

8.5.2.1.5.1 Identification of a new CGI of E-UTRA cell with autonomous gaps

All the CGI requirements with the exception of requirement on the number of ACK/NACK transmission on PCell defined in clause 8.5.2.1.4.1 also apply for this section.

For the UE supporting half duplex FDD operation there is no requirement in terms of number of ACK/NACK transmission on PCell.

8.5.2.1.5.2 ECGI Reporting Delay

The ECGI reporting delay defined in clause 8.5.2.1.4.2 also apply for this section.

8.5.2.1.6 E-UTRAN TDD intra frequency measurements with autonomous gaps for UE category 0

The requirements defined in this subclause 8.5.2.1.6 apply provided the following condition is met:

- Tx diversity or transmission using multiple antennas are supported in the target cell to be detected.

8.5.2.1.6.1 Identification of a new CGI of E-UTRA cell with autonomous gaps

No explicit neighbour list is provided to the UE for identifying a new CGI of E-UTRA cell. The UE shall identify and report the CGI when requested by the network for the purpose 'reportCGI'. The UE may make autonomous gaps in downlink reception and uplink transmission for receiving MIB and SIB1 messages according to clause 5.5.3.1 of TS 36.331 [2]. Note that a UE is not required to use autonomous gap if si-RequestForHO is set to false. If autonomous gaps are used for measurement with the purpose of 'reportCGI', regardless of whether DRX or eDRX_CONN is used or not, or whether SCell(s) are configured or not, the UE shall be able to identify a new CGI of E-UTRA cell within:

$$T_{\text{identify_CGI_LC-UE, intra}} = T_{\text{basic_identify_CGI_LC-UE, intra}} \quad \textit{ms}$$

Where

$T_{\text{basic_identify_CGI_LC-UE, intra}} = 190$ ms. This is the time period used in the above equation where the maximum allowed time for the UE to identify a new CGI of an E-UTRA cell is defined, provided that the E-UTRA cell has been already identified by the UE.

A cell shall be considered identifiable when the following conditions are fulfilled:

- RSRP related side conditions given in Clause 9.1 are fulfilled for a corresponding Band,
- SCH_RP and $SCH\ \hat{E}s/Iot$ according to Annex B.2.2 for a corresponding Band

The MIB of an E-UTRA cell whose CGI is identified shall be considered decodable by the UE provided the PBCH demodulation requirements are met according to [5].

The requirement for identifying a new CGI of an E-UTRA cell within $T_{\text{basic_identify_CGI_LC-UE, intra}}$ is applicable when no DRX is used as well as when any of the DRX or eDRX_CONN cycles specified in TS 36.331 [2] is used.

Within the time, $T_{\text{identify_CGI_LC-UE, intra}}$ ms, over which the UE identifies the new CGI of E-UTRA cell, the UE shall be able to transmit at least the number of ACK/NACKs stated in Table 8.5.2.1.6.1-1 on PCell provided that:

- there is continuous DL data allocation,
- no DRX and no eDRX_CONN cycle is used,
- no measurement gaps are configured,
- only one code word is transmitted in each subframe,
- no MBSFN subframes are configured in the PCell or each of activated SCell(s).

Table 8.5.2.1.6.1-1: Requirement on minimum number of ACK/NACKs to transmit during $T_{\text{basic_identify_CGI_LC-UE, intra}}$

| UL/DL configuration | Minimum number of transmitted ACK/NACKs |
|---------------------|---|
| 0 | 30 |
| 1 | 54 |
| 2 | 68 |
| 3 | 56 |
| 4 | 61 |
| 5 | 66 |
| 6 | 46 |

8.5.2.1.6.2 ECGI Reporting Delay

The ECGI reporting delay occurs due to the delay uncertainty when inserting the ECGI measurement report to the TTI of the uplink DCCH. The delay uncertainty is twice the TTI of the uplink DCCH. In case DRX is used, the ECGI reporting may be delayed until the next DRX cycle. In case eDRX_CONN is used, the ECGI reporting may be delayed until the next eDRX_CONN cycle. If IDC autonomous denial is configured, an additional delay can be expected.

8.6 Discovery signal measurements

8.6.1 Introduction

This clause contains requirements on the UE for measurement reporting in RRC_CONNECTED state when discovery signal [16] is configured. The requirements are specified for E-UTRA CRS based discovery signal measurements and CSI-RS based discovery signal measurements. These measurements may be used by the E-UTRAN, e.g. for handover decisions. The measurement quantities are defined in [4], the measurement model is defined in [22] and measurement accuracy requirements are specified in clause 9. Control of measurement reporting is specified in TS 36.331 [2].

The requirements in Section 9 are applicable for a UE performing measurements according to Section 8.6.

8.6.2 Requirements for CRS based discovery signal measurements

8.6.2.1 E-UTRAN intra frequency measurements

The UE shall be able to identify new intra-frequency cells and perform measurements of identified intra-frequency cells without an explicit intra-frequency neighbour cell list containing physical layer cell identities. During the RRC_CONNECTED state the UE shall continuously measure identified intra frequency cells and additionally search for and identify new intra frequency cells.

8.6.2.1.1 E-UTRAN FDD intra frequency measurements

8.6.2.1.1.1 E-UTRAN FDD intra frequency measurements when no DRX is used

When no DRX is in use the UE shall be able to identify a new detectable FDD intra frequency cell within $T_{\text{identify_intra_SCE}}$,

$$T_{\text{identify_intra_SCE}} = 12 * T_{\text{DMTC_periodicity}} + T_{\text{Measurement_Period_intra_FDD_CRS}}$$

A cell shall be considered detectable when

- RSRP related side conditions given in Sections 9.1.14.2 and RSRQ related side conditions given in Clause 9.1.14.4 are fulfilled for a corresponding Band,
- SCH_RP and SCH \hat{E} s/Iot according to Annex B.2.10 for a corresponding Band

$T_{\text{DMTC_periodicity}}$ is the discovery signal measurement timing configuration periodicity of higher layer.

$T_{\text{Measurement_Period_intra_FDD_CRS}}$ is the intra-frequency period for measurements as shown in table 8.6.2.1.1.1-1

Identification of a cell shall include detection of the cell and additionally performing a single measurement with measurement period of $T_{\text{Measurement_Period_intra_FDD_CRS}}$ when no DRX is used. If higher layer filtering is used, an additional cell identification delay can be expected.

In the RRC_CONNECTED state the measurement period for intra frequency measurements is $T_{\text{Measurement_Period_intra_FDD_CRS}}$ as shown in table 8.6.2.1.1.1-1, when no DRX is in use. The UE shall be capable of performing RSRP and RSRQ measurements for 3 identified intra-frequency cells, and the UE physical layer shall be capable of reporting measurements to higher layers with the measurement period of $T_{\text{Measurement_Period_intra_FDD_CRS}}$

Table 8.6.2.1.1.1-1: Requirement to measure FDD intra frequency cell

| Measurement bandwidth [RB] | Discovery signal occasion duration (<i>ds-OccasionDuration</i>) [ms] | $T_{\text{Measurement_Period_intra_FDD_CRS}}$ [ms] |
|----------------------------|---|--|
| ≥ 6 | ≥ 1 | $5 * T_{\text{DMTC_periodicity}}$ |
| ≥ 25 | ≥ 1 | $3 * T_{\text{DMTC_periodicity}}$ |

The RSRP measurement accuracy for all measured cells shall be as specified in the sub-clauses 9.1.14.2, and the RSRQ measurement accuracy for all measured cells shall be as specified in the sub-clause 9.1.14.4.

8.6.2.1.1.1.1 Measurement Reporting Requirements

8.6.2.1.1.1.1.1 Periodic Reporting

Reported RSRP and RSRQ measurements contained in periodically triggered measurement reports shall meet the requirements in sections 9.1.14.2 and 9.1.14.4 respectively.

8.6.2.1.1.1.1.2 Event-triggered Periodic Reporting

Reported RSRP and RSRQ measurements contained in event triggered periodic measurement reports shall meet the requirements in sections 9.1.14.2 and 9.1.14.4 respectively.

The first report in event triggered periodic measurement reporting shall meet the requirements specified in clause 8.6.2.1.1.1.3.

8.6.2.1.1.1.3 Event Triggered Reporting

Reported RSRP and RSRQ measurements contained in event triggered measurement reports shall meet the requirements in sections 9.1.14.2 and 9.1.14.4 respectively.

The UE shall not send any event triggered measurement reports, as long as no reporting criteria are fulfilled.

The measurement reporting delay is defined as the time between an event that will trigger a measurement report and the point when the UE starts to transmit the measurement report over the air interface. This requirement assumes that the measurement report is not delayed by other RRC signalling on the DCCH. This measurement reporting delay excludes a delay uncertainty resulted when inserting the measurement report to the TTI of the uplink DCCH. The delay uncertainty is: $2 \times TTI_{DCCH}$. This measurement reporting delay excludes a delay which caused by no UL resources for UE to send the measurement report.

The event triggered measurement reporting delay, measured without L3 filtering shall be less than $T_{\text{identify_intra_SCE}}$ defined in Clause 8.6.2.1.1.1. When L3 filtering is used or IDC autonomous denial is configured an additional delay can be expected.

If a cell which has been detectable at least for the time period $T_{\text{identify_intra_SCE}}$ defined in clause 8.6.2.1.1.1 becomes undetectable for a period ≤ 5 seconds and then the cell becomes detectable again and triggers an event, the event triggered measurement reporting delay shall be less than $T_{\text{Measurement_Period_intra_FDD_CRS}}$ provided the timing to that cell has not changed more than $\pm 50 T_s$ and the L3 filter has not been used. When L3 filtering is used or IDC autonomous denial is configured, an additional delay can be expected.

8.6.2.1.1.2 E-UTRAN FDD intra frequency measurements when DRX is used

When DRX is in use the UE shall be able to identify a new detectable FDD intra frequency cell within $T_{\text{identify_intra_SCE_DRX}}$.

$$T_{\text{identify_intra_SCE_DRX}} = 16 * \text{Max} \{ T_{\text{DMTC_periodicity}}, \text{DRX cycle length} \} + T_{\text{Measurement_Period_intra_FDD_CRS_DRX}}$$

A cell shall be considered detectable when

- RSRP related side conditions given in Sections 9.1.14.2 and RSRQ related side conditions given in Clause 9.1.14.4 are fulfilled for a corresponding Band,
- SCH_RP and $SCH\ \hat{E}_s/I_{ot}$ according to Annex B.2.10 for a corresponding Band

$T_{\text{DMTC_periodicity}}$ is the discovery signal measurement timing configuration periodicity of higher layer.

$T_{\text{Measurement_Period_intra_FDD_CRS_DRX}}$ is the intra-frequency period for measurements as shown in table 8.6.2.1.1.2-1

Identification of a cell shall include detection of the cell and additionally performing a single measurement with measurement period of $T_{\text{Measurement_Period_intra_FDD_CRS_DRX}}$ when DRX is used. If higher layer filtering is used, an additional cell identification delay can be expected.

In the RRC_CONNECTED state the measurement period for intra frequency measurements is $T_{\text{Measurement_Period_intra_FDD_CRS_DRX}}$ as shown in table 8.6.2.1.1.2-1, when DRX is in use. The UE shall be capable of performing RSRP and RSRQ measurements for 3 identified intra-frequency cells, and the UE physical layer shall be capable of reporting measurements to higher layers with the measurement period of $T_{\text{Measurement_Period_intra_FDD_CRS_DRX}}$.

Table 8.6.2.1.1.2-1: Requirement to measure FDD intra frequency cell

| Measurement bandwidth [RB] | Discovery signal occasion duration (<i>ds-OccasionDuration</i>) [ms] | $T_{\text{Measurement_Period_intra_FDD_CRS_DRX}}$ [ms] |
|----------------------------|--|--|
| ≥ 6 | ≥ 1 | $5 * \text{Max} \{ T_{\text{DMTC_periodicity}}, \text{DRX cycle length} \}$ |
| ≥ 25 | ≥ 1 | $3 * \text{Max} \{ T_{\text{DMTC_periodicity}}, \text{DRX cycle length} \}$ |

The RSRP measurement accuracy for all measured cells shall be as specified in the sub-clauses 9.1.14.2, and the RSRQ measurement accuracy for all measured cells shall be as specified in the sub-clause 9.1.14.4.

8.6.2.1.1.2.1 Measurement Reporting Requirements

8.6.2.1.1.2.1.1 Periodic Reporting

Reported RSRP and RSRQ measurements contained in periodically triggered measurement reports shall meet the requirements in sections 9.1.14.2 and 9.1.14.4 respectively.

8.6.2.1.1.2.1.2 Event-triggered Periodic Reporting

Reported RSRP and RSRQ measurements contained in event triggered periodic measurement reports shall meet the requirements in sections 9.1.14.2 and 9.1.14.4 respectively.

The first report in event triggered periodic measurement reporting shall meet the requirements specified in clause 8.6.2.1.1.2.1.3.

8.6.2.1.1.2.1.3 Event Triggered Reporting

Reported RSRP and RSRQ measurements contained in event triggered measurement reports shall meet the requirements in sections 9.1.14.2 and 9.1.14.4 respectively.

The UE shall not send any event triggered measurement reports, as long as no reporting criteria are fulfilled.

The measurement reporting delay is defined as the time between an event that will trigger a measurement report and the point when the UE starts to transmit the measurement report over the air interface. This requirement assumes that the measurement report is not delayed by other RRC signalling on the DCCH. This measurement reporting delay excludes a delay uncertainty resulted when inserting the measurement report to the TTI of the uplink DCCH. The delay uncertainty is: $2 \times TTI_{DCCH}$. This measurement reporting delay excludes a delay which caused by no UL resources for UE to send the measurement report.

The event triggered measurement reporting delay, measured without L3 filtering shall be less than $T_{\text{identify_intra_SCE_DRX}}$ defined in Clause 8.6.2.1.1.2. When L3 filtering is used or IDC autonomous denial is configured an additional delay can be expected.

If a cell which has been detectable at least for the time period $T_{\text{identify_intra_SCE_DRX}}$ defined in clause 8.6.2.1.1.2 becomes undetectable for a period ≤ 5 seconds and then the cell becomes detectable again and triggers an event, the event triggered measurement reporting delay shall be less than $T_{\text{Measurement_Period_intra_FDD_CRS_DRX}}$ provided the timing to that cell has not changed more than ± 50 Ts and the L3 filter has not been used. When L3 filtering is used or IDC autonomous denial is configured, an additional delay can be expected.

8.6.2.1.2 E-UTRAN TDD intra frequency measurements

8.6.2.1.2.1 E-UTRAN TDD intra frequency measurements when no DRX is used

When no DRX is in use the UE shall be able to identify a new detectable TDD intra frequency cell within $T_{\text{identify_intra_SCE}}$,

$$T_{\text{identify_intra_SCE}} = 12 * T_{\text{DMTC_periodicity}} + T_{\text{Measurement_Period_intra_TDD_CRS}}$$

A cell shall be considered detectable when

- RSRP related side conditions given in Sections 9.1.14.2 and RSRQ related side conditions given in Clause 9.1.14.4 are fulfilled for a corresponding Band,
- SCH_RP and $SCH\ \hat{E}s/Iot$ according to Annex B.2.10 for a corresponding Band

$T_{\text{DMTC_periodicity}}$ is the discovery signal measurement timing configuration periodicity of higher layer.

$T_{\text{Measurement_Period_intra_TDD_CRS}}$ is the intra-frequency period for measurements

Identification of a cell shall include detection of the cell and additionally performing a single measurement with measurement period of $T_{\text{Measurement_Period_intra_TDD_CRS}}$ when no DRX is used. If higher layer filtering is used, an additional cell identification delay can be expected.

In the RRC_CONNECTED state the measurement period for intra frequency measurements is $T_{\text{Measurement_Period_intra_TDD_CRS}}$ as shown in table 8.6.2.1.2.1-1, when no DRX is in use. The UE shall be capable of performing RSRP and RSRQ measurements for 3 identified intra-frequency cells, and the UE physical layer shall be capable of reporting measurements to higher layers with the measurement period of $T_{\text{Measurement_Period_intra_TDD_CRS}}$

Table 8.6.2.1.2.1-1: Requirement to measure TDD intra frequency cell

| Measurement bandwidth[RB] | Discovery signal occasion duration (<i>ds-OccasionDuration</i>) [ms] | $T_{\text{Measurement_Period_intra_TDD_CRS}}$ [ms] |
|---------------------------|---|--|
| ≥ 6 | ≥ 2 | $5 * T_{\text{DMTC_periodicity}}$ |
| ≥ 25 | ≥ 2 | $3 * T_{\text{DMTC_periodicity}}$ |

The RSRP measurement accuracy for all measured cells shall be as specified in the sub-clauses 9.1.14.2, and RSRQ measurement accuracy for all measured cells shall be as specified in the sub-clause 9.1.14.4.

8.6.2.1.2.1.1 Measurement Reporting Requirements

8.6.2.1.2.1.1.1 Periodic Reporting

Reported RSRP and RSRQ measurements contained in periodically triggered measurement reports shall meet the requirements in sections 9.1.14.2 and 9.1.14.4 respectively.

8.6.2.1.2.1.1.2 Event-triggered Periodic Reporting

Reported RSRP and RSRQ measurements contained in event triggered periodic measurement reports shall meet the requirements in sections 9.1.14.2 and 9.1.14.4 respectively.

The first report in event triggered periodic measurement reporting shall meet the requirements specified in clause 8.6.2.1.2.1.1.3.

8.6.2.1.2.1.1.3 Event Triggered Reporting

Reported RSRP and RSRQ measurements contained in event triggered measurement reports shall meet the requirements in sections 9.1.14.2 and 9.1.14.4 respectively.

The UE shall not send any event triggered measurement reports, as long as no reporting criteria are fulfilled.

The measurement reporting delay is defined as the time between an event that will trigger a measurement report and the point when the UE starts to transmit the measurement report over the air interface. This requirement assumes that that the measurement report is not delayed by other RRC signalling on the DCCH. This measurement reporting delay excludes a delay uncertainty resulted when inserting the measurement report to the TTI of the uplink DCCH. The delay uncertainty is: $2 \times TTI_{\text{DCCH}}$. This measurement reporting delay excludes a delay which caused by no UL resources for UE to send the measurement report.

The event triggered measurement reporting delay, measured without L3 filtering shall be less than $T_{\text{identify_intra_SCE}}$ defined in Clause 8.6.2.1.2.1. When L3 filtering is used or IDC autonomous denial is configured an additional delay can be expected.

If a cell which has been detectable at least for the time period $T_{\text{identify_intra_SCE}}$ defined in clause 8.6.2.1.2.1 becomes undetectable for a period ≤ 5 seconds and then the cell becomes detectable again and triggers an event, the event triggered measurement reporting delay shall be less than $T_{\text{Measurement_Period_intra_TDD_CRS}}$ provided the timing to that cell has not changed more than $\pm 50 T_s$ and the L3 filter has not been used. When L3 filtering is used or IDC autonomous denial is configured, an additional delay can be expected.

8.6.2.1.2.2 E-UTRAN TDD intra frequency measurements when DRX is used

When DRX is in use the UE shall be able to identify a new detectable TDD intra frequency cell within $T_{\text{identify_intra_SCE_DRX}}$.

$$T_{\text{identify_intra_SCE_DRX}} = 16 * \max \{ T_{\text{DMTC_periodicity}}, \text{DRX cycle length} \} + T_{\text{Measurement_Period_intra_TDD_CRS_DRX}}$$

A cell shall be considered detectable when

- RSRP related side conditions given in Sections 9.1.14.2 and RSRQ related side conditions given in Clause 9.1.14.4 are fulfilled for a corresponding Band,
- SCH_{RP} and SCH_{Es/Iot} according to Annex B.2.10 for a corresponding Band

$T_{\text{DMTC_periodicity}}$ is the discovery signal measurement timing configuration periodicity of higher layer.

Identification of a cell shall include detection of the cell and additionally performing a single measurement with measurement period of $T_{\text{Measurement_Period_intra_TDD_CRS_DRX}}$ when DRX is used. If higher layer filtering is used, an additional cell identification delay can be expected.

In the RRC_CONNECTED state the measurement period for intra frequency measurements is $T_{\text{Measurement_Period_intra_TDD_CRS_DRX}}$ as shown in table 8.6.2.1.2.2-1, when DRX is in use. The UE shall be capable of performing RSRP and RSRQ measurements for 3 identified intra-frequency cells, and the UE physical layer shall be capable of reporting measurements to higher layers with the measurement period of $T_{\text{Measurement_Period_intra_TDD_CRS_DRX}}$

Table 8.6.2.1.2.2-1: Requirement to measure TDD intra frequency cell

| Measurement bandwidth[RB] | Discovery signal occasion duration (<i>ds-OccasionDuration</i>) [ms] | $T_{\text{Measurement_Period_intra_TDD_CRS_DRX}}$ [ms] |
|---------------------------|--|---|
| ≥ 6 | ≥ 2 | 5 * $\text{Max}\{ T_{\text{DMTC_periodicity}}, \text{DRX cycle length} \}$ |
| ≥ 25 | ≥ 2 | 3 * $\text{Max}\{ T_{\text{DMTC_periodicity}}, \text{DRX cycle length} \}$ |

The RSRP measurement accuracy for all measured cells shall be as specified in the sub-clauses 9.1.14.2, and the RSRQ measurement accuracy for all measured cells shall be as specified in the sub-clause 9.1.14.4.

8.6.2.1.2.2.1 Measurement Reporting Requirements

8.6.2.1.2.2.1.1 Periodic Reporting

Reported RSRP and RSRQ measurements contained in periodically triggered measurement reports shall meet the requirements in sections 9.1.14.2 and 9.1.14.4 respectively.

8.6.2.1.2.2.1.2 Event-triggered Periodic Reporting

Reported RSRP and RSRQ measurements contained in event triggered periodic measurement reports shall meet the requirements in sections 9.1.14.2 and 9.1.14.4 respectively.

The first report in event triggered periodic measurement reporting shall meet the requirements specified in clause 8.6.2.1.2.2.1.3.

8.6.2.1.2.2.1.3 Event Triggered Reporting

Reported RSRP and RSRQ measurements contained in event triggered measurement reports shall meet the requirements in sections 9.1.14.2 and 9.1.14.4 respectively.

The UE shall not send any event triggered measurement reports, as long as no reporting criteria are fulfilled.

The measurement reporting delay is defined as the time between an event that will trigger a measurement report and the point when the UE starts to transmit the measurement report over the air interface. This requirement assumes that the measurement report is not delayed by other RRC signalling on the DCCH. This measurement reporting delay

excludes a delay uncertainty resulted when inserting the measurement report to the TTI of the uplink DCCH. The delay uncertainty is: $2 \times TTI_{DCCH}$. This measurement reporting delay excludes a delay which caused by no UL resources for UE to send the measurement report. When L3 filtering is used or IDC autonomous denial is configured an additional delay can be expected.

The event triggered measurement reporting delay, measured without L3 filtering shall be less than $T_{\text{identify_intra_SCE_DRX}}$ defined in Clause 8.6.2.1.2.2. When L3 filtering is used or IDC autonomous denial is configured an additional delay can be expected.

If a cell which has been detectable at least for the time period $T_{\text{identify_intra_SCE_DRX}}$ defined in clause 8.6.2.1.2.2 becomes undetectable for a period ≤ 5 seconds and then the cell becomes detectable again and triggers an event, the event triggered measurement reporting delay shall be less than $T_{\text{Measurement_Period_intra_TDD_CRS_DRX}}$ provided the timing to that cell has not changed more than $\pm 50 T_s$ and the L3 filter has not been used. When L3 filtering is used or IDC autonomous denial is configured, an additional delay can be expected.

8.6.2.2 E-UTRAN inter frequency measurements

The UE shall be able to identify new inter-frequency cells and perform RSRP and RSRQ measurements of identified inter-frequency cells if carrier frequency information is provided by the PCell, even if no explicit neighbour list with physical layer cell identities is provided. The discovery signal occasion and the measurement gap should be aligned, provided that also the following additional conditions are fulfilled:

Entire discovery signal occasion should be contained in the measurement gap.

The subframe contained discovery signal for the measurement is not overlapped with the first 0.5ms period and the last 0.5ms period in every gap.

8.6.2.2.1 E-UTRAN FDD – FDD inter-frequency measurements

8.6.2.2.1.1 E-UTRAN FDD – FDD inter frequency measurements when no DRX is used

When measurement gaps are scheduled, or the UE supports capability of conducting such measurements without gaps, the UE shall be able to identify a new FDD inter-frequency within $T_{\text{Identify_Inter_SCE}}$ according to the following expression:

$$T_{\text{Identify_Inter_SCE}} = 13 * \text{Max} \{ T_{\text{DMTC_periodicity}}, \text{MGRP} \} * N_{\text{freq}} + T_{\text{Measurement_Period_inter_FDD_CRS}}$$

A cell shall be considered detectable provided following conditions are fulfilled:

- RSRP related side conditions given in Clause 9.1.14.2 and RSRQ related side conditions given in Sections 9.1.14.4 are fulfilled,
- $SCH_RP|_{\text{dBm}} \leq SCH_Es/Iot$ according to Annex B.2.11 for a corresponding Band,

$T_{\text{DMTC_periodicity}}$ is the discovery signal measurement timing configuration periodicity of higher layer.

$T_{\text{Measurement_Period_intra_FDD_CRS}}$ is the inter-frequency period for measurements as shown in table 8.6.2.2.1.1-1. N_{freq} is defined in clause 8.1.2.1.1.

When measurement gaps are scheduled for FDD inter frequency measurements, or the UE supports capability of conducting such measurements without gaps, the UE physical layer shall be capable of reporting RSRP and RSRQ measurements to higher layers with measurement accuracy as specified in sub-clauses 9.1.14.2 and 9.1.14.4, respectively, with measurement period given by table 8.6.2.2.1.1-1.

The UE shall be capable of performing RSRP and RSRQ measurements of at least 3 identified inter-frequency cells per FDD inter-frequency for up to 3 FDD inter-frequencies and the UE physical layer shall be capable of reporting RSRP and RSRQ measurements to higher layers with the measurement period defined in table 8.6.2.2.1.1-1 when no DRX is in use, either measurement gaps are scheduled or the UE supports capability of conducting such measurements without gaps.

Table 8.6.2.2.1.1-1: Requirement to measure FDD inter frequency cell

| Measurement bandwidth[RB] | Discovery signal occasion duration (<i>ds-OccasionDuration</i>) [ms] | $T_{\text{Measurement_Period_inter_FDD_CRS}}$ [ms] |
|---------------------------|--|--|
|---------------------------|--|--|

| | | |
|-----------|----------|--|
| ≥ 6 | ≥ 1 | $5 * \text{Max}\{ T_{\text{DMTC_periodicity}}, \text{MGRP}\} * N_{\text{freq}}$ |
| ≥ 25 | ≥ 1 | $3 * \text{Max}\{ T_{\text{DMTC_periodicity}}, \text{MGRP}\} * N_{\text{freq}}$ |

The RSRP measurement accuracy for all measured cells shall be as specified in the sub-clauses 9.1.14.2, and the RSRQ measurement accuracy for all measured cells shall be as specified in the sub-clause 9.1.14.4.

8.6.2.2.1.1.1 Measurement Reporting Requirements

8.6.2.2.1.1.1.1 Periodic Reporting

Reported RSRP and RSRQ measurements contained in periodically triggered measurement reports shall meet the requirements in sections 9.1.14.2 and 9.1.14.4, respectively.

8.6.2.2.1.1.1.2 Event-triggered Periodic Reporting

Reported RSRP and RSRQ measurements contained in event triggered periodic measurement reports shall meet the requirements in sections 9.1.14.2, and 9.1.14.4, respectively.

The first report in event triggered periodic measurement reporting shall meet the requirements specified in clause 8.6.2.2.1.1.1.3.

8.6.2.2.1.1.1.3 Event Triggered Reporting

Reported RSRP and RSRQ measurements contained in event triggered measurement reports shall meet the requirements in sections 9.1.14.2 and 9.1.14.4, respectively.

The UE shall not send any event triggered measurement reports, as long as no reporting criteria are fulfilled.

The measurement reporting delay is defined as the time between an event that will trigger a measurement report and the point when the UE starts to transmit the measurement report over the air interface. This requirement assumes that that the measurement report is not delayed by other RRC signalling on the DCCH. This measurement reporting delay excludes a delay uncertainty resulted when inserting the measurement report to the TTI of the uplink DCCH. The delay uncertainty is: $2 \times T_{\text{TTI}_{\text{DCCH}}}$. This measurement reporting delay excludes a delay which caused by no UL resources for UE to send the measurement report.

The event triggered measurement reporting delay, measured without L3 filtering shall be less than $T_{\text{Identify_Inter_SCE}}$ defined in Clause 8.6.2.2.1.1. When L3 filtering is used or IDC autonomous denial is configured an additional delay can be expected.

If a cell which has been detectable at least for the time period $T_{\text{Identify_Inter_SCE}}$ defined in clause 8.6.2.2.1.1 and then triggers the measurement report as per TS 36.331 [2], the event triggered measurement reporting delay shall be less than $T_{\text{Measurement_Period_inter_FDD_CRS}}$ provided the timing to that cell has not changed more than $\pm 50 T_s$ while measurement gap has not been available and the L3 filter has not been used. When L3 filtering is used or IDC autonomous denial is configured, an additional delay can be expected.

8.6.2.2.1.2 E-UTRAN FDD – FDD inter frequency measurements when DRX is used

When DRX is in use, either measurement gaps are scheduled or the UE supports capability of conducting such measurements without gaps, the UE shall be able to identify a new detectable E-UTRAN FDD inter frequency cell within $T_{\text{Identify_inter_SCE_DRX}}$.

$$T_{\text{Identify_inter_SCE_DRX}} = 17 * \text{Max}\{ T_{\text{DMTC_periodicity}}, \text{DRX cycle length}, \text{MGRP}\} * N_{\text{freq}} + T_{\text{Measurement_Period_inter_FDD_CRS_DRX}}$$

A cell shall be considered detectable when

- RSRP related side conditions given in Sections 9.1.14.2 and RSRQ related side conditions given in Clause 9.1.14.4 are fulfilled for a corresponding Band,
- SCH_{RP} and SCH_{Es/Iot} according to Annex B.2.11 for a corresponding Band

$T_{\text{DMTC_periodicity}}$ is the discovery signal measurement timing configuration periodicity of higher layer.

$T_{\text{Measurement_Period_inter_FDD_CRS_DRX}}$ is the inter-frequency period for measurements as shown in Table 8.6.2.2.1.2-1. N_{freq} is defined in clause 8.1.2.1.1.

Identification of a cell shall include detection of the cell and additionally performing a single measurement with measurement period of $T_{\text{Measurement_Period_inter_FDD_CRS_DRX}}$ when DRX is used. If higher layer filtering is used, an additional cell identification delay can be expected.

The UE shall be capable of performing RSRP and RSRQ measurements of at least 3 identified inter-frequency cells per FDD inter-frequency for up to 3 FDD inter-frequencies and the UE physical layer shall be capable of reporting RSRP and RSRQ measurements to higher layers with the measurement period defined in table 8.6.2.2.1.2-1 when DRX is in use, either measurement gaps are scheduled or the UE supports capability of conducting such measurements without gaps.

Table 8.6.2.2.1.2-1: Requirement to measure FDD interfrequency cell

| Measurement bandwidth[RB] | Discovery signal occasion duration (<i>ds-OccasionDuration</i>) [ms] | $T_{\text{Measurement_Period_inter_FDD_CRS_DRX}}$ [ms] |
|---------------------------|---|--|
| ≥ 6 | ≥ 1 | $5 * \text{Max}\{ T_{\text{DMTC_periodicity}}, \text{DRX cycle length, MGRP}\} * N_{\text{freq}}$ |
| ≥ 25 | ≥ 1 | $3 * \text{Max}\{ T_{\text{DMTC_periodicity}}, \text{DRX cycle length, MGRP}\} * N_{\text{freq}}$ |

The RSRP measurement accuracy for all measured cells shall be as specified in the sub-clauses 9.1.14.2, and the RSRQ measurement accuracy for all measured cells shall be as specified in the sub-clause 9.1.14.4.

8.6.2.2.1.2.1 Measurement Reporting Requirements

8.6.2.2.1.2.1.1 Periodic Reporting

Reported RSRP and RSRQ measurements contained in periodically triggered measurement reports shall meet the requirements in sections 9.1.14.2, and 9.1.14.4 respectively.

8.6.2.2.1.2.1.2 Event-triggered Periodic Reporting

Reported RSRP and RSRQ measurements contained in event triggered periodic measurement reports shall meet the requirements in sections 9.1.14.2 and 9.1.14.4 respectively.

The first report in event triggered periodic measurement reporting shall meet the requirements specified in clause 8.6.2.2.1.2.1.3.

8.6.2.2.1.2.1.3 Event Triggered Reporting

Reported RSRP and RSRQ measurements contained in event triggered measurement reports shall meet the requirements in sections 9.1.14.2, and 9.1.14.4 respectively.

The UE shall not send any event triggered measurement reports, as long as no reporting criteria are fulfilled.

The measurement reporting delay is defined as the time between an event that will trigger a measurement report and the point when the UE starts to transmit the measurement report over the air interface. This requirement assumes that that the measurement report is not delayed by other RRC signalling on the DCCH. This measurement reporting delay excludes a delay uncertainty resulted when inserting the measurement report to the TTI of the uplink DCCH. The delay uncertainty is: $2 \times TTI_{\text{DCCH}}$. This measurement reporting delay excludes a delay which caused by no UL resources for UE to send the measurement report.

The event triggered measurement reporting delay, measured without L3 filtering shall be less than $T_{\text{identify_inter_SCE_DRX}}$ defined in Clause 8.6.2.2.1.2. When L3 filtering is used or IDC autonomous denial is configured an additional delay can be expected.

If a cell which has been detectable at least for the time period $T_{\text{identify_inter_SCE_DRX}}$ defined in clause 8.6.2.2.1.2 becomes undetectable for a period ≤ 5 seconds and then the cell becomes detectable again and triggers an event, the event triggered measurement reporting delay shall be less than $T_{\text{Measurement_Period_inter_FDD_CRS_DRX}}$ provided the timing to that cell

has not changed more than ± 50 Ts and the L3 filter has not been used. When L3 filtering is used or IDC autonomous denial is configured, an additional delay can be expected.

8.6.2.2.2 E-UTRAN TDD – TDD inter frequency measurements

8.6.2.2.2.1 E-UTRAN TDD – TDD inter frequency measurements when no DRX is used

When measurement gaps are scheduled, or the UE supports capability of conducting such measurements without gaps, the UE shall be able to identify a new TDD inter-frequency within $T_{\text{Identify_Inter_SCE}}$ according to the following expression:

$$T_{\text{Identify_inter_SCE}} = 13 * \text{Max} \{ T_{\text{DMTC_periodicity}}, \text{MGRP} \} * N_{\text{freq}} + T_{\text{Measurement_Period_inter_TDD_CRS}}$$

A cell shall be considered detectable provided following conditions are fulfilled:

- RSRP related side conditions given in Clause 9.1.14.2 and RSRQ related side conditions given in Sections 9.1.14.4 are fulfilled,
- $\text{SCH_RP}_{\text{dBm}}$ and $\text{SCH } \hat{E}_s/\text{Iot}$ according to Annex B.2.11 for a corresponding Band

$T_{\text{DMTC_periodicity}}$ is the discovery signal measurement timing configuration periodicity of higher layer.

$T_{\text{Measurement_Period_inter_TDD_CRS}}$ is the inter-frequency period for measurements as shown in Table 8.6.2.2.2.1-1. N_{freq} is defined in clause 8.1.2.1.1.

When measurement gaps are scheduled for TDD inter frequency measurements, or the UE supports capability of conducting such measurements without gaps, the UE physical layer shall be capable of reporting RSRP and RSRQ measurements to higher layers with measurement accuracy as specified in sub-clauses 9.1.14.2, and 9.1.14.4, respectively, with measurement period $T_{\text{Measurement_Period_inter_TDD_CRS}}$ given by table 8.6.2.2.2.1-1:

Table 8.6.2.2.2.1-1: Requirement to measure TDD interfrequency cell

| Measurement bandwidth[RB] | Discovery signal occasion duration (<i>ds-OccasionDuration</i>) [ms] | $T_{\text{Measurement_Period_inter_TDD_CRS}}$ [ms] |
|---------------------------|---|---|
| ≥ 6 | ≥ 2 | $5 * \text{Max}\{ T_{\text{DMTC_periodicity}}, \text{MGRP} \} * N_{\text{freq}}$ |
| ≥ 25 | ≥ 2 | $3 * \text{Max}\{ T_{\text{DMTC_periodicity}}, \text{MGRP} \} * N_{\text{freq}}$ |

The UE shall be capable of performing RSRP and RSRQ measurements of at least 3 identified inter-frequency cells per TDD inter-frequency for up to 3TDD inter-frequencies and the UE physical layer shall be capable of reporting RSRP and RSRQ measurements to higher layers with the measurement period defined in table 8.6.2.2.2.1-1 when no DRX is in use, either measurement gaps are scheduled or the UE supports capability of conducting such measurements without gaps.

8.6.2.2.2.1.1 Measurement Reporting Requirements

8.6.2.2.2.1.1.1 Periodic Reporting

Reported RSRP and RSRQ measurements contained in periodically triggered measurement reports shall meet the requirements in sections 9.1.14.2, and 9.1.14.4, respectively.

8.6.2.2.2.1.1.2 Event-triggered Periodic Reporting

Reported RSRP and RSRQ measurements contained in event triggered periodic measurement reports shall meet the requirements in sections 9.1.14.2, and 9.1.14.4, respectively.

The first report in event triggered periodic measurement reporting shall meet the requirements specified in clause 8.6.2.2.2.1.1.3.

8.6.2.2.2.1.1.3 Event Triggered Reporting

Reported RSRP and RSRQ measurements contained in event triggered measurement reports shall meet the requirements in sections 9.1.14.2, and 9.1.14.4, respectively.

The UE shall not send any event triggered measurement reports, as long as no reporting criteria are fulfilled.

The measurement reporting delay is defined as the time between an event that will trigger a measurement report and the point when the UE starts to transmit the measurement report over the air interface. This requirement assumes that the measurement report is not delayed by other RRC signalling on the DCCH. This measurement reporting delay excludes a delay uncertainty resulted when inserting the measurement report to the TTI of the uplink DCCH. The delay uncertainty is: $2 \times TTI_{DCCH}$. This measurement reporting delay excludes a delay which caused by no UL resources for UE to send the measurement report.

The event triggered measurement reporting delay, measured without L3 filtering shall be less than $T_{Identify_Inter}$ defined in clause 8.6.2.2.2.1. When L3 filtering is used or IDC autonomous denial is configured an additional delay can be expected.

If a cell which has been detectable at least for the time period $T_{Identify_Inter_SCE}$ defined in clause 8.6.2.2.2.1 and then triggers the measurement report as per TS 36.331 [2], the event triggered measurement reporting delay shall be less than $T_{Measurement_Period_inter_TDD_CRS}$ defined in clause 8.6.2.2.2.1 provided the timing to that cell has not changed more than ± 50 Ts while measurementgap has not been available and the L3 filter has not been used. When L3 filtering is used or IDC autonomous denial is configured, an additional delay can be expected.

8.6.2.2.2.2 E-UTRAN TDD – TDD inter frequency measurements when DRX is used

When DRX is in use, either measurement gaps are scheduled or the UE supports capability of conducting such measurements without gaps, the UE shall be able to identify a new detectable E-UTRAN TDD inter frequency cell within $T_{Identify_inter_SCE_DRX}$

$$T_{Identify_inter_SCE_DRX} = 17 * \text{Max} \{ T_{DMTC_periodicity}, \text{DRX cycle length}, \text{MGRP} \} * N_{freq} + T_{Measurement_Period_inter_TDD_CRS_DRX}$$

A cell shall be considered detectable when

- RSRP related side conditions given in Clause 9.1.14.2 and RSRQ related side conditions given in Sections 9.1.14.4 are fulfilled,
- $SCH_RP|_{dBm}$ and $SCH \hat{E}s/Iot$ according to Annex B.2.11 for a corresponding Band

$T_{DMTC_periodicity}$ is the discovery signal measurement timing configuration periodicity of higher layer.

$T_{Measurement_Period_inter_TDD_CRS_DRX}$ is the inter-frequency period for measurements as shown in Table 8.6.2.2.2.2-1. N_{freq} is defined in clause 8.1.2.1.1.

Identification of a cell shall include detection of the cell and additionally performing a single measurement with measurement period of $T_{Measurement_Period_intra_TDD_CRS_DRX}$ when DRX is used. If higher layer filtering is used, an additional cell identification delay can be expected.

The UE shall be capable of performing RSRP and RSRQ measurements of at least 3 identified inter-frequency cells per TDD inter-frequency for up to 3 TDD inter-frequencies and the UE physical layer shall be capable of reporting RSRP and RSRQ measurements to higher layers with the measurement period defined in table 8.6.2.2.2.2-1 when DRX is in use, either measurement gaps are scheduled or the UE supports capability of conducting such measurements without gaps.

Table 8.6.2.2.2.2-1: Requirement to measure TDD interfrequency cell

| Measurement bandwidth[RB] | Discovery signal occasion duration (<i>ds-OccasionDuration</i>) [ms] | $T_{Measurement_Period_inter_TDD_CRS_DRX}$ [ms] |
|---------------------------|---|--|
| ≥ 6 | ≥ 2 | $5 * \text{Max}\{ T_{DMTC_periodicity}, \text{DRX cycle length}, \text{MGRP} \} * N_{freq}$ |
| ≥ 25 | ≥ 2 | $3 * \text{Max}\{ T_{DMTC_periodicity}, \text{DRX cycle length}, \text{MGRP} \} * N_{freq}$ |

The RSRP measurement accuracy for all measured cells shall be as specified in the sub-clauses 9.1.14.2, and the RSRQ measurement accuracy for all measured cells shall be as specified in the sub-clause 9.1.14.4.

8.6.2.2.2.1 Measurement Reporting Requirements

8.6.2.2.2.1.1 Periodic Reporting

Reported RSRP and RSRQ measurements contained in periodically triggered measurement reports shall meet the requirements in sections 9.1.14.2, and 9.1.14.4, respectively.

8.6.2.2.2.1.2 Event-triggered Periodic Reporting

Reported RSRP and RSRQ measurements contained in event triggered periodic measurement reports shall meet the requirements in sections 9.1.14.2, and 9.1.14.4, respectively.

The first report in event triggered periodic measurement reporting shall meet the requirements specified in clause 8.6.2.2.2.1.3.

8.6.2.2.2.1.3 Event Triggered Reporting

Reported RSRP and RSRQ measurements contained in event triggered measurement reports shall meet the requirements in sections 9.1.14.2, and 9.1.14.4, respectively.

The UE shall not send any event triggered measurement reports, as long as no reporting criteria are fulfilled.

The measurement reporting delay is defined as the time between an event that will trigger a measurement report and the point when the UE starts to transmit the measurement report over the air interface. This requirement assumes that the measurement report is not delayed by other RRC signalling on the DCCH. This measurement reporting delay excludes a delay uncertainty resulted when inserting the measurement report to the TTI of the uplink DCCH. The delay uncertainty is: $2 \times TTI_{DCCH}$. This measurement reporting delay excludes a delay which caused by no UL resources for UE to send the measurement report.

The event triggered measurement reporting delay, measured without L3 filtering shall be less than $T_{Identify_Inter}$ defined in clause 8.6.2.2.2. When L3 filtering is used or IDC autonomous denial is configured an additional delay can be expected.

If a cell which has been detectable at least for the time period $T_{Identify_inter_SCE_DRX}$ defined in clause 8.6.2.2.2 and then triggers the measurement report as per TS 36.331 [2], the event triggered measurement reporting delay shall be less than $T_{Measurement_Period_inter_TDD_CRS_DRX}$ defined in clause 8.6.2.2.2 provided the timing to that cell has not changed more than $\pm 50 T_s$ while measurement gap has not been available and the L3 filter has not been used. When L3 filtering is used or IDC autonomous denial is configured, an additional delay can be expected.

8.6.2.2.3 E-UTRAN TDD – FDD inter frequency measurements

8.6.2.2.3.1 E-UTRAN TDD – FDD inter frequency measurements when no DRX is used

The requirements in this clause shall apply to UE supporting FDD and TDD.

The requirements in clause 8.6.2.2.1.1 also apply for this section.

8.6.2.2.3.2 E-UTRAN TDD – FDD inter frequency measurements when DRX is used

The requirements in this clause shall apply to UE supporting FDD and TDD.

The requirements in clause 8.6.2.2.1.2 also apply for this section.

8.6.2.2.4 E-UTRAN FDD – TDD inter frequency measurements

8.6.2.2.4.1 E-UTRAN FDD – TDD inter frequency measurements when no DRX is used

The requirements in this clause shall apply to UE supporting FDD and TDD.

The requirements in clause 8.6.2.2.1 also apply for this section.

8.6.2.4.2 E-UTRAN FDD – TDD inter frequency measurements when DRX is used

The requirements in this clause shall apply to UE supporting FDD and TDD.

The requirements in clause 8.6.2.2.2 also apply for this section.

8.6.3 Requirements for CSI-RS based discovery signal measurements

8.6.3.1 E-UTRAN intra frequency measurements

The UE shall be able to identify new intra-frequency TPs and perform CSI-RSRP measurements of intra-frequency TPs with an explicit intra-frequency TP list containing physical layer cell identities. During the RRC_CONNECTED state the UE shall continuously measure identified intra frequency TPs and additionally search for and identify new intra frequency TPs.

8.6.3.1.1 E-UTRAN FDD intra frequency measurements

8.6.3.1.1.1 E-UTRAN FDD intra frequency measurements when no DRX is used

When no DRX is in use the UE shall be able to identify a new detectable FDD intra frequency TP within $T_{\text{identify_intra_TP_SCE}}$,

$$T_{\text{identify_intra_TP_SCE}} = T_{\text{identify_intra_SCE}} + T_{\text{Measurement_Period_intra_FDD_CSI-RS}}$$

A TP shall be considered detectable when

- CSI-RSRP related side conditions given in Sections 9.1.14.3 are fulfilled for a corresponding Band,
- SCH_{RP} and SCH_{Es/Iot} according to Annex B.2.10 for a corresponding Band

$T_{\text{identify_intra_SCE}}$ is the intra-frequency period for cell identification in section 8.6.2.1.1.1. $T_{\text{Measurement_Period_intra_FDD_CSI-RS}}$ is the intra-frequency period for TP measurement as shown in table 8.6.3.1.1.1-1.

Identification of a TP shall include identification of the cell and additionally performing a single measurement with measurement period of $T_{\text{Measurement_Period_intra_FDD_CSI-RS}}$ when no DRX is used. If higher layer filtering is used, an additional TP identification delay can be expected.

In the RRC_CONNECTED state the measurement period for intra frequency measurements is $T_{\text{Measurement_Period_intra_FDD_CSI-RS}}$ as shown in table 8.6.3.1.1.1-1, when no DRX is in use. The UE shall be capable of performing CSI-RSRP measurements for 3 identified intra-frequency TPs, and the UE physical layer shall be capable of reporting measurements to higher layers with the measurement period of $T_{\text{Measurement_Period_intra_FDD_CSI-RS}}$

Table 8.6.3.1.1.1-1: Requirement to measure FDD intra frequency TP

| Measurement bandwidth [RB] | Discovery signal occasion duration (<i>ds-OccasionDuration</i>) [ms] | $T_{\text{Measurement_Period_intra_FDD_CSI-RS}}$ [ms] |
|----------------------------|--|---|
| ≥ 6 | ≥ 1 | 5* $T_{\text{DMTC_periodicity}}$ |
| ≥ 25 | ≥ 1 | 3* $T_{\text{DMTC_periodicity}}$ |

$T_{\text{DMTC_periodicity}}$ is the discovery signal measurement timing configuration periodicity of higher layer.

The CSI-RSRP measurement accuracy for all measured TPs shall be as specified in the sub-clauses 9.1.14.3.

8.6.3.1.1.1.1 Measurement Reporting Requirements

8.6.3.1.1.1.1.1 Periodic Reporting

Reported CSI-RSRP measurements contained in periodically triggered measurement reports shall meet the requirements in sections 9.1.14.3.

8.6.3.1.1.1.1.2 Event-triggered Periodic Reporting

Reported CSI-RSRP measurements contained in event triggered periodic measurement reports shall meet the requirements in sections 9.1.14.3.

The first report in event triggered periodic measurement reporting shall meet the requirements specified in clause 8.6.3.1.1.1.1.3.

8.6.3.1.1.1.1.3 Event Triggered Reporting

Reported CSI-RSRP measurements contained in event triggered measurement reports shall meet the requirements in sections 9.1.14.3.

The UE shall not send any event triggered measurement reports, as long as no reporting criteria are fulfilled.

The measurement reporting delay is defined as the time between an event that will trigger a measurement report and the point when the UE starts to transmit the measurement report over the air interface. This requirement assumes that the measurement report is not delayed by other RRC signalling on the DCCH. This measurement reporting delay excludes a delay uncertainty resulted when inserting the measurement report to the TTI of the uplink DCCH. The delay uncertainty is: $2 \times TTI_{DCCH}$. This measurement reporting delay excludes a delay which caused by no UL resources for UE to send the measurement report.

The event triggered measurement reporting delay, measured without L3 filtering shall be less than $T_{\text{identify_intra_TP_SCE}}$ defined in Clause 8.6.3.1.1.1. When L3 filtering is used or IDC autonomous denial is configured an additional delay can be expected.

If a TP which has been detectable at least for the time period $T_{\text{identify_intra_TP_SCE}}$ defined in clause 8.6.3.1.1.1 becomes undetectable for a period ≤ 5 seconds and then the TP becomes detectable again and triggers an event, the event triggered measurement reporting delay shall be less than $T_{\text{Measurement_Period_intra_FDD_CSI-RS}}$ provided the timing to that TP has not changed more than $\pm 50 T_s$ and the L3 filter has not been used. When L3 filtering is used or IDC autonomous denial is configured, an additional delay can be expected.

8.6.3.1.1.2 E-UTRAN FDD intra frequency measurements when DRX is used

When DRX is in use the UE shall be able to identify a new detectable FDD intra frequency TP within $T_{\text{identify_intra_TP_SCE_DRX}}$.

$$T_{\text{identify_intra_TP_SCE_DRX}} = T_{\text{identify_intra_SCE_DRX}} + T_{\text{Measurement_Period_intra_FDD_CSI-RS_DRX}}$$

A TP shall be considered detectable when

- CSI-RSRP related side conditions given in Sections 9.1.14.3 are fulfilled for a corresponding Band,
- SCH_RP and $SCH \hat{E}_s/I_{ot}$ according to Annex B.2.10 for a corresponding Band

$T_{\text{identify_intra_SCE_DRX}}$ is the intra-frequency period for cell identification in section 8.6.2.1.1.2. $T_{\text{Measurement_Period_intra_FDD_CSI-RS_DRX}}$ is the intra-frequency period for TP measurement as shown in table 8.6.3.1.1.2-1.

Identification of a TP shall include identification of the cell and additionally performing a single measurement with measurement period of $T_{\text{Measurement_Period_intra_FDD_CSI-RS_DRX}}$ when DRX is used. If higher layer filtering is used, an additional TP identification delay can be expected.

In the RRC_CONNECTED state the measurement period for intra frequency measurements is $T_{\text{Measurement_Period_intra_FDD_CSI-RS_DRX}}$ as shown in table 8.6.3.1.1.2-1, when DRX is in use. The UE shall be capable of performing CSI-RSRP measurements for 3 identified intra-frequency TPs, and the UE physical layer shall be capable of reporting measurements to higher layers with the measurement period of $T_{\text{Measurement_Period_intra_FDD_CSI-RS_DRX}}$.

Table 8.6.3.1.1.2-1: Requirement to measure FDD intra frequency TP

| Measurement bandwidth [RB] | Discovery signal occasion duration (<i>ds-OccasionDuration</i>) [ms] | $T_{\text{Measurement_Period intra_FDD_CSI-RS_DRX}}$ [ms] |
|----------------------------|--|---|
| ≥ 6 | ≥ 1 | $5 * \text{Max}\{T_{\text{DMTC_periodicity}}, \text{DRX cycle length}\}$ |
| ≥ 25 | ≥ 1 | $3 * \text{Max}\{T_{\text{DMTC_periodicity}}, \text{DRX cycle length}\}$ |

$T_{\text{DMTC_periodicity}}$ is the discovery signal measurement timing configuration periodicity of higher layer.

The CSI-RSRP measurement accuracy for all measured TPs shall be as specified in the sub-clauses 9.1.14.3.

8.6.3.1.1.2.1 Measurement Reporting Requirements

8.6.3.1.1.2.1.1 Periodic Reporting

Reported CSI-RSRP measurements contained in periodically triggered measurement reports shall meet the requirements in sections 9.1.14.3.

8.6.3.1.1.2.1.2 Event-triggered Periodic Reporting

Reported CSI-RSRP measurements contained in event triggered periodic measurement reports shall meet the requirements in sections 9.1.14.3.

The first report in event triggered periodic measurement reporting shall meet the requirements specified in clause 8.6.3.1.1.2.1.3.

8.6.3.1.1.2.1.3 Event Triggered Reporting

Reported CSI-RSRP measurements contained in event triggered measurement reports shall meet the requirements in sections 9.1.14.3.

The UE shall not send any event triggered measurement reports, as long as no reporting criteria are fulfilled.

The measurement reporting delay is defined as the time between an event that will trigger a measurement report and the point when the UE starts to transmit the measurement report over the air interface. This requirement assumes that that the measurement report is not delayed by other RRC signalling on the DCCH. This measurement reporting delay excludes a delay uncertainty resulted when inserting the measurement report to the TTI of the uplink DCCH. The delay uncertainty is: $2 \times T_{\text{TTI}_{\text{DCCH}}}$. This measurement reporting delay excludes a delay which caused by no UL resources for UE to send the measurement report.

The event triggered measurement reporting delay, measured without L3 filtering shall be less than $T_{\text{identify_intra_TP_SCE_DRX}}$ defined in Clause 8.6.3.1.1.2. When L3 filtering is used or IDC autonomous denial is configured an additional delay can be expected.

If a TP which has been detectable at least for the time period $T_{\text{identify_intra_TP_SCE_DRX}}$ defined in clause 8.6.3.1.1.2 becomes undetectable for a period ≤ 5 seconds and then the TP becomes detectable again and triggers an event, the event triggered measurement reporting delay shall be less than $T_{\text{Measurement_Period_intra_FDD_CSI-RS_DRX}}$ provided the timing to that TP has not changed more than $\pm 50 T_s$ and the L3 filter has not been used. When L3 filtering is used or IDC autonomous denial is configured, an additional delay can be expected.

8.6.3.1.2 E-UTRAN TDD intra frequency measurements

8.6.3.1.2.1 E-UTRAN TDD intra frequency measurements when no DRX is used

When no DRX is in use the UE shall be able to identify a new detectable TDD intra frequency TP within $T_{\text{identify_intra_TP_SCE}}$.

$$T_{\text{identify_intra_TP_SCE}} = T_{\text{identify_intra_SCE}} + T_{\text{Measurement_Period_intra_TDD_CSI-RS}}$$

A TP shall be considered detectable when

- CSI-RSRP related side conditions given in Sections 9.1.14.3 are fulfilled for a corresponding Band,

- SCH_{RP} and SCH_{Es/Iot} according to Annex B.2.10 for a corresponding Band

$T_{\text{identify_intra_SCE}}$ is the intra-frequency period for cell identification in section 8.6.2.1.2.1. $T_{\text{Measurement_Period_intra_TDD_CSI-RS}}$ is the intra-frequency period for TP measurement as shown in table 8.6.3.1.2.1-1.

Identification of a TP shall include identification of the cell and additionally performing a single measurement with measurement period of $T_{\text{Measurement_Period_intra_TDD_CSI-RS}}$ when no DRX is used. If higher layer filtering is used, an additional TP identification delay can be expected.

In the RRC_CONNECTED state the measurement period for intra frequency measurements is $T_{\text{Measurement_Period_intra_TDD_CSI-RS}}$ as shown in table 8.6.3.1.2.1-1, when no DRX is in use. The UE shall be capable of performing measurements for 3 identified intra-frequency TPs, and the UE physical layer shall be capable of reporting measurements to higher layers with the measurement period of $T_{\text{Measurement_Period_intra_TDD_CSI-RS}}$

Table 8.6.3.1.2.1-1: Requirement to measure TDD intra frequency TP

| Measurement bandwidth [RB] | Discovery signal occasion duration (<i>ds-OccasionDuration</i>) [ms] | $T_{\text{Measurement_Period_intra_TDD_CSI-RS}}$ [ms] |
|----------------------------|---|--|
| ≥ 6 | ≥ 2 | $5 * T_{\text{DMTC_periodicity}}$ |
| ≥ 25 | ≥ 2 | $3 * T_{\text{DMTC_periodicity}}$ |

$T_{\text{DMTC_periodicity}}$ is the discovery signal measurement timing configuration periodicity of higher layer.

The CSI-RSRP measurement accuracy for all measured TPs shall be as specified in the sub-clauses 9.1.14.3.

8.6.3.1.2.1.1 Measurement Reporting Requirements

8.6.3.1.2.1.1.1 Periodic Reporting

Reported CSI-RSRP measurements contained in periodically triggered measurement reports shall meet the requirements in sections 9.1.14.3.

8.6.3.1.2.1.1.2 Event-triggered Periodic Reporting

Reported CSI-RSRP measurements contained in event triggered periodic measurement reports shall meet the requirements in sections 9.1.14.3.

The first report in event triggered periodic measurement reporting shall meet the requirements specified in clause 8.6.3.1.2.1.1.3.

8.6.3.1.2.1.1.3 Event Triggered Reporting

Reported CSI-RSRP measurements contained in event triggered measurement reports shall meet the requirements in sections 9.1.14.3.

The UE shall not send any event triggered measurement reports, as long as no reporting criteria are fulfilled.

The measurement reporting delay is defined as the time between an event that will trigger a measurement report and the point when the UE starts to transmit the measurement report over the air interface. This requirement assumes that that the measurement report is not delayed by other RRC signalling on the DCCH. This measurement reporting delay excludes a delay uncertainty resulted when inserting the measurement report to the TTI of the uplink DCCH. The delay uncertainty is: $2 \times TTI_{\text{DCCH}}$. This measurement reporting delay excludes a delay which caused by no UL resources for UE to send the measurement report. When L3 filtering is used or IDC autonomous denial is configured an additional delay can be expected.

The event triggered measurement reporting delay, measured without L3 filtering shall be less than $T_{\text{identify_intra_TP_SCE}}$ defined in Clause 8.6.3.1.2.1. When L3 filtering is used or IDC autonomous denial is configured an additional delay can be expected.

If a TP which has been detectable at least for the time period $T_{\text{identify_intra_TP_SCE}}$ defined in clause 8.6.3.1.2.1 becomes undetectable for a period ≤ 5 seconds and then the TP becomes detectable again and triggers an event, the event triggered measurement reporting delay shall be less than $T_{\text{Measurement_Period_intra_TDD_CSI-RS}}$ provided the timing to that TP

has not changed more than ± 50 Ts and the L3 filter has not been used. When L3 filtering is used or IDC autonomous denial is configured, an additional delay can be expected.

8.6.3.1.2.2 E-UTRAN TDD intra frequency measurements when DRX is used

When DRX is in use the UE shall be able to identify a new detectable TDD intra frequency TP within

$T_{\text{identify_intra_TP_SCE_DRX}}$.

$$T_{\text{identify_intra_TP_SCE_DRX}} = T_{\text{identify_intra_SCE_DRX}} + T_{\text{Measurement_Period_intra_TDD_CSI-RS_DRX}}$$

A TP shall be considered detectable when

- CSI-RSRP related side conditions given in Sections 9.1.14.3 are fulfilled for a corresponding Band,
- SCH_{RP} and SCH_{Ês}/Iot according to Annex B.2.10 for a corresponding Band

$T_{\text{identify_intra_SCE_DRX}}$ is the intra-frequency period for cell identification as shown in section 8.6.2.1.2.2.

$T_{\text{Measurement_Period_intra_TDD_CSI-RS_DRX}}$ is the intra-frequency period for TP measurement as shown in table 8.6.3.1.2.2-1.

Identification of a TP shall include identification of the cell and additionally performing a single measurement with measurement period of $T_{\text{Measurement_Period_intra_TDD_CSI-RS_DRX}}$ when DRX is used. If higher layer filtering is used, an additional TP identification delay can be expected.

In the RRC_CONNECTED state the measurement period for intra frequency measurements is $T_{\text{Measurement_Period_intra_TDD_CSI-RS_DRX}}$ as shown in table 8.6.3.1.2.2-1, when DRX is in use. The UE shall be capable of performing CSI-RSRP measurements for 3 identified intra-frequency TPs, and the UE physical layer shall be capable of reporting measurements to higher layers with the measurement period of $T_{\text{Measurement_Period_intra_TDD_CSI-RS_DRX}}$

Table 8.6.3.1.2.2-1: Requirement to measure TDD intrafrequency TP

| Measurement bandwidth [RB] | Discovery signal occasion duration (<i>ds-OccasionDuration</i>) [ms] | $T_{\text{Measurement_Period_intra_TDD_CSI-RS_DRX}}$ [ms] |
|----------------------------|--|---|
| ≥ 6 | ≥ 2 | $5 * \text{Max}\{T_{\text{DMTC_periodicity}}, \text{DRX cycle length}\}$ |
| ≥ 25 | ≥ 2 | $3 * \text{Max}\{T_{\text{DMTC_periodicity}}, \text{DRX cycle length}\}$ |

$T_{\text{DMTC_periodicity}}$ is the discovery signal measurement timing configuration periodicity of higher layer.

The CSI-RSRP measurement accuracy for all measured TPs shall be as specified in the sub-clauses 9.1.14.3.

8.6.3.1.2.2.1 Measurement Reporting Requirements

8.6.3.1.2.2.1.1 Periodic Reporting

Reported CSI-RSRP measurements contained in periodically triggered measurement reports shall meet the requirements in sections 9.1.14.3.

8.6.3.1.2.2.1.2 Event-triggered Periodic Reporting

Reported CSI-RSRP measurements contained in event triggered periodic measurement reports shall meet the requirements in sections 9.1.14.3.

The first report in event triggered periodic measurement reporting shall meet the requirements specified in clause 8.6.3.1.2.2.1.3.

8.6.3.1.2.2.1.3 Event Triggered Reporting

Reported CSI-RSRP measurements contained in event triggered measurement reports shall meet the requirements in sections 9.1.14.3.

The UE shall not send any event triggered measurement reports, as long as no reporting criteria are fulfilled.

The measurement reporting delay is defined as the time between an event that will trigger a measurement report and the point when the UE starts to transmit the measurement report over the air interface. This requirement assumes that the measurement report is not delayed by other RRC signalling on the DCCH. This measurement reporting delay excludes a delay uncertainty resulted when inserting the measurement report to the TTI of the uplink DCCH. The delay uncertainty is: $2 \times TTI_{DCCH}$. This measurement reporting delay excludes a delay which caused by no UL resources for UE to send the measurement report.

The event triggered measurement reporting delay, measured without L3 filtering shall be less than $T_{identify_intra_TP_SCE_DRX}$ defined in Clause 8.6.3.1.2.2. When L3 filtering is used or IDC autonomous denial is configured an additional delay can be expected.

If a TP which has been detectable at least for the time period $T_{identify_intra_TP_SCE_DRX}$ defined in clause 8.6.3.1.2.2 becomes undetectable for a period ≤ 5 seconds and then the TP becomes detectable again and triggers an event, the event triggered measurement reporting delay shall be less than $T_{Measurement_Period_intra_TDD_CSI-RS_DRX}$ provided the timing to that TP has not changed more than $\pm 50 T_s$ and the L3 filter has not been used. When L3 filtering is used or IDC autonomous denial is configured, an additional delay can be expected.

8.6.3.2 E-UTRAN inter frequency measurements

The UE shall be able to identify new inter-frequency TPs and perform CSI-RSRP measurements of inter-frequency TP with an explicit inter-frequency TP list containing physical layer cell identities. The discovery signal occasion and the measurement gap should be aligned, provided that also the following additional conditions are fulfilled:

Entire discovery signal occasion should be contained in the measurement gap.

The subframe contained discovery signal for the measurement is not overlapped with the first 0.5ms period and the last 0.5ms period in every gap.

8.6.3.2.1 E-UTRAN FDD – FDD inter frequency measurements

8.6.3.2.1.1 E-UTRAN FDD – FDD inter frequency measurements when no DRX is used

When measurement gaps are scheduled, or the UE supports capability of conducting such measurements without gaps, the UE shall be able to identify a new FDD inter-frequency TP within $T_{identify_inter_TP_SCE}$ according to the following expression:

$$T_{identify_inter_TP_SCE} = T_{identify_Inter_SCE} + T_{Measurement_Period_inter_FDD_CSI-RS}$$

A TP shall be considered detectable when

- CSI-RSRP related side conditions given in Sections 9.1.14.3 are fulfilled for a corresponding Band,
- SCH_RP and $SCH\ \hat{E}_s/I_{ot}$ according to Annex B.2.11 for a corresponding Band

$T_{identify_inter_SCE}$ is the inter-frequency period for cell identification as shown in section 8.6.2.2.1.1. N_{freq} is defined in clause 8.1.2.1.1. $T_{Measurement_Period_inter_FDD_CSI-RS}$ is the inter-frequency period for TP measurement as shown in table 8.6.3.2.1.1-1.

When measurement gaps are scheduled for FDD inter frequency measurements, or the UE supports capability of conducting such measurements without gaps, the UE physical layer shall be capable of reporting CSI-RSRP measurements to higher layers with measurement accuracy as specified in sub-clauses 9.1.14.3, with measurement period given by table 8.6.3.2.1.1-1.

The UE shall be capable of performing CSI-RSRP measurements of at least 3 identified inter-frequency TPs per FDD inter-frequency for up to 3 FDD inter-frequencies and the UE physical layer shall be capable of reporting CSI-RSRP measurements to higher layers with the measurement period defined in table 8.6.3.2.1.1-1 when no DRX is in use, either measurement gaps are scheduled or the UE supports capability of conducting such measurements without gaps.

Table 8.6.3.2.1.1-1: Requirement to measure FDD inter frequency TP

| Measurement bandwidth [RB] | Discovery signal occasion duration (<i>ds-OccasionDuration</i>) [ms] | $T_{Measurement_Period\ inter_FDD_CSI-RS}$ [ms] |
|----------------------------|--|--|
|----------------------------|--|--|

| | | |
|-----------|----------|---|
| ≥ 6 | ≥ 1 | $5 * \text{Max}\{T_{\text{DMTC_periodicity}}, \text{MGRP}\} * N_{\text{freq}}$ |
| ≥ 25 | ≥ 1 | $3 * \text{Max}\{T_{\text{DMTC_periodicity}}, \text{MGRP}\} * N_{\text{freq}}$ |

$T_{\text{DMTC_periodicity}}$ is the discovery signal measurement timing configuration periodicity of higher layer.

The CSI-RSRP measurement accuracy for all measured TPs shall be as specified in the sub-clauses 9.1.14.3.

8.6.3.2.1.1.1 Measurement Reporting Requirements

8.6.3.2.1.1.1.1 Periodic Reporting

Reported CSI-RSRP measurements contained in periodically triggered measurement reports shall meet the requirements in sections 9.1.14.3.

8.6.3.2.1.1.1.2 Event-triggered Periodic Reporting

Reported CSI-RSRP measurements contained in event triggered periodic measurement reports shall meet the requirements in sections 9.1.14.3.

The first report in event triggered periodic measurement reporting shall meet the requirements specified in clause 8.6.3.2.1.1.1.3.

8.6.3.2.1.1.1.3 Event Triggered Reporting

Reported CSI-RSRP measurements contained in event triggered measurement reports shall meet the requirements in sections 9.1.14.3.

The UE shall not send any event triggered measurement reports, as long as no reporting criteria are fulfilled.

The measurement reporting delay is defined as the time between an event that will trigger a measurement report and the point when the UE starts to transmit the measurement report over the air interface. This requirement assumes that the measurement report is not delayed by other RRC signalling on the DCCH. This measurement reporting delay excludes a delay uncertainty resulted when inserting the measurement report to the TTI of the uplink DCCH. The delay uncertainty is: $2 \times TTI_{\text{DCCH}}$. This measurement reporting delay excludes a delay which caused by no UL resources for UE to send the measurement report.

The event triggered measurement reporting delay, measured without L3 filtering shall be less than $T_{\text{identify_inter_TP_SCE}}$ defined in Clause 8.6.3.2.1.1. When L3 filtering is used or IDC autonomous denial is configured an additional delay can be expected.

If a TP which has been detectable at least for the time period $T_{\text{identify_inter_TP_SCE}}$ defined in clause 8.6.3.2.1.1 becomes undetectable for a period ≤ 5 seconds and then the TP becomes detectable again and triggers an event, the event triggered measurement reporting delay shall be less than $T_{\text{Measurement_Period_inter_FDD_CSI-RS}}$ provided the timing to that TP has not changed more than ± 50 Ts and the L3 filter has not been used. When L3 filtering is used or IDC autonomous denial is configured, an additional delay can be expected.

8.6.3.2.1.2 E-UTRAN FDD – FDD inter frequency measurements when DRX is used

When DRX is in use, either measurement gaps are scheduled or the UE supports capability of conducting such measurements without gaps, the UE shall be able to identify a new detectable E-UTRAN FDD inter frequency TP within $T_{\text{identify_inter_TP_SCE_DRX}}$ according to the following expression:

$$T_{\text{identify_inter_TP_SCE_DRX}} = T_{\text{identify_inter_SCE_DRX}} + T_{\text{Measurement_Period_inter_FDD_CSI-RS_DRX}}$$

A TP shall be considered detectable when

- CSI-RSRP related side conditions given in Sections 9.1.14.3 are fulfilled for a corresponding Band,
- SCH_RP and $SCH \hat{E}s/Iot$ according to Annex B.2.11 for a corresponding Band

$T_{\text{identify_inter_SCE_DRX}}$ is the inter-frequency period for cell identification as shown in section 8.6.2.2.1.2. N_{freq} is defined in clause 8.1.2.1.1. $T_{\text{Measurement_Period_inter_FDD_CSI-RS_DRX}}$ is the inter-frequency period for TP measurement as shown in table 8.6.3.2.1.2-1.

When measurement gaps are scheduled for FDD inter frequency measurements, or the UE supports capability of conducting such measurements without gaps, the UE physical layer shall be capable of reporting CSI-RSRP measurements to higher layers with measurement accuracy as specified in sub-clauses 9.1.14.3, with measurement period given by table 8.6.3.2.1.2-1.

The UE shall be capable of performing CSI-RSRP measurements of at least 3 identified inter-frequency TPs per FDD inter-frequency for up to 3 FDD inter-frequencies and the UE physical layer shall be capable of reporting CSI-RSRP measurements to higher layers with the measurement period defined in table 8.6.3.2.1.2-1 when DRX is in use, either measurement gaps are scheduled or the UE supports capability of conducting such measurements without gaps.

Table 8.6.3.2.1.2-1: Requirement to measure FDD inter frequency TP

| Measurement bandwidth [RB] | Discovery signal occasion duration (<i>ds-OccasionDuration</i>) [ms] | $T_{\text{Measurement_Period_inter_FDD_CSI-RS_DRX}}$ [ms] |
|----------------------------|--|---|
| ≥ 6 | ≥ 1 | $5 * \text{Max}\{T_{\text{DMTC_periodicity}}, \text{DRX cycle length, MGRP}\} * N_{\text{freq}}$ |
| ≥ 25 | ≥ 1 | $3 * \text{Max}\{T_{\text{DMTC_periodicity}}, \text{DRX cycle length, MGRP}\} * N_{\text{freq}}$ |

$T_{\text{DMTC_periodicity}}$ is the discovery signal measurement timing configuration periodicity of higher layer.

The CSI-RSRP measurement accuracy for all measured TPs shall be as specified in the sub-clauses 9.1.14.3.

8.6.3.2.1.2.1 Measurement Reporting Requirements

8.6.3.2.1.2.1.1 Periodic Reporting

Reported CSI-RSRP measurements contained in periodically triggered measurement reports shall meet the requirements in sections 9.1.14.3 respectively.

8.6.3.2.1.2.1.2 Event-triggered Periodic Reporting

Reported CSI-RSRP measurements contained in event triggered periodic measurement reports shall meet the requirements in sections 9.1.14.3.

The first report in event triggered periodic measurement reporting shall meet the requirements specified in clause 8.6.3.2.1.2.1.3.

8.6.3.2.1.2.1.3 Event Triggered Reporting

Reported CSI-RSRP measurements contained in event triggered measurement reports shall meet the requirements in sections 9.1.14.3.

The UE shall not send any event triggered measurement reports, as long as no reporting criteria are fulfilled.

The measurement reporting delay is defined as the time between an event that will trigger a measurement report and the point when the UE starts to transmit the measurement report over the air interface. This requirement assumes that the measurement report is not delayed by other RRC signalling on the DCCH. This measurement reporting delay excludes a delay uncertainty resulted when inserting the measurement report to the TTI of the uplink DCCH. The delay uncertainty is: $2 \times TTI_{\text{DCCH}}$. This measurement reporting delay excludes a delay which caused by no UL resources for UE to send the measurement report. When L3 filtering is used or IDC autonomous denial is configured an additional delay can be expected.

The event triggered measurement reporting delay, measured without L3 filtering shall be less than $T_{\text{identify_inter_TP_SCE_DRX}}$ defined in clause 8.6.3.2.1.2. When L3 filtering is used or IDC autonomous denial is configured an additional delay can be expected.

If a TP which has been detectable at least for the time period $T_{\text{identify_inter_TP_SCE_DRX}}$ defined in clause 8.6.3.2.1.2 and then triggers the measurement report as per TS 36.331 [2], the event triggered measurement reporting delay shall be less than $T_{\text{Measurement_Period_inter_FDD_CSI-RS_DRX}}$ provided the timing to that TP has not changed more than $\pm 50 T_s$ while measurement gap has not been available and the L3 filter has not been used. When L3 filtering is used or IDC autonomous denial is configured, an additional delay can be expected.

8.6.3.2.2 E-UTRAN TDD – TDD inter frequency measurements

8.6.3.2.2.1 E-UTRAN TDD – TDD inter frequency measurements when no DRX is used

When measurement gaps are scheduled, or the UE supports capability of conducting such measurements without gaps, the UE shall be able to identify a new TDD inter-frequency TP within $T_{\text{identify_inter_TP_SCE}}$ according to the following expression:

$$T_{\text{identify_inter_TP_SCE}} = T_{\text{identify_inter_SCE}} + T_{\text{Measurement_Period_inter_TDD_CSI-RS}}$$

A TP shall be considered detectable when

- CSI-RSRP related side conditions given in Sections 9.1.14.3 are fulfilled for a corresponding Band,
- SCH_RP and $SCH\ \hat{E}s/Iot$ according to Annex B.2.11 for a corresponding Band

$T_{\text{identify_inter_SCE}}$ is the inter-frequency period for cell identification as shown in section 8.6.2.2.1. N_{freq} is defined in clause 8.1.2.1.1. $T_{\text{Measurement_Period_inter_TDD_CSI-RS}}$ is the inter-frequency period for TP measurement as shown in table 8.6.3.2.2.1-1.

When measurement gaps are scheduled for TDD inter frequency measurements, or the UE supports capability of conducting such measurements without gaps, the UE physical layer shall be capable of reporting RSRP measurements to higher layers with measurement accuracy as specified in sub-clauses 9.1.14.3, with measurement period given by table 8.6.3.2.2.1-1.

The UE shall be capable of performing CSI-RSRP measurements of at least 3 identified inter-frequency TP per TDD inter-frequency for up to 3TDD inter-frequencies and the UE physical layer shall be capable of reporting CSI-RSRP measurements to higher layers with the measurement period defined in table 8.6.3.2.2.1-1 when no DRX is in use, either measurement gaps are scheduled or the UE supports capability of conducting such measurements without gaps.

Table 8.6.3.2.2.1-1: Requirement to measure TDD inter frequency TP

| Measurement bandwidth [RB] | Discovery signal occasion duration (<i>ds-OccasionDuration</i>) [ms] | $T_{\text{Measurement_Period_inter_TDD_CSI-RS}}$ [ms] |
|----------------------------|--|---|
| ≥ 6 | ≥ 2 | $5 * \text{Max}\{T_{\text{DMTC_periodicity}}, \text{MGRP}\} * N_{\text{freq}}$ |
| ≥ 25 | ≥ 2 | $3 * \text{Max}\{T_{\text{DMTC_periodicity}}, \text{MGRP}\} * N_{\text{freq}}$ |

$T_{\text{DMTC_periodicity}}$ is the discovery signal measurement timing configuration periodicity of higher layer.

The CSI-RSRP measurement accuracy for all measured TPs shall be as specified in the sub-clauses 9.1.14.3.

8.6.3.2.2.1.1 Measurement Reporting Requirements

8.6.3.2.2.1.1.1 Periodic Reporting

Reported CSI-RSRP measurements contained in periodically triggered measurement reports shall meet the requirements in sections 9.1.14.3.

8.6.3.2.2.1.1.2 Event-triggered Periodic Reporting

Reported CSI-RSRP measurements contained in event triggered periodic measurement reports shall meet the requirements in sections 9.1.14.3.

The first report in event triggered periodic measurement reporting shall meet the requirements specified in clause 8.6.3.2.2.1.1.3.

8.6.3.2.2.1.1.3 Event Triggered Reporting

Reported CSI-RSRP measurements contained in event triggered measurement reports shall meet the requirements in sections 9.1.14.3.

The UE shall not send any event triggered measurement reports, as long as no reporting criteria are fulfilled.

The measurement reporting delay is defined as the time between an event that will trigger a measurement report and the point when the UE starts to transmit the measurement report over the air interface. This requirement assumes that the measurement report is not delayed by other RRC signalling on the DCCH. This measurement reporting delay excludes a delay uncertainty resulted when inserting the measurement report to the TTI of the uplink DCCH. The delay uncertainty is: $2 \times TTI_{DCCH}$. This measurement reporting delay excludes a delay which caused by no UL resources for UE to send the measurement report. When L3 filtering is used or IDC autonomous denial is configured an additional delay can be expected.

The event triggered measurement reporting delay, measured without L3 filtering shall be less than $T_{\text{identify_inter_TP_SCE}}$ defined in clause 8.6.3.2.2.1. When L3 filtering is used or IDC autonomous denial is configured an additional delay can be expected.

If a TP which has been detectable at least for the time period $T_{\text{identify_inter_TP_SCE}}$ defined in clause 8.6.3.2.2.1 and then triggers the measurement report as per TS 36.331 [2], the event triggered measurement reporting delay shall be less than $T_{\text{Measurement_Period_inter_TDD_CSI-RS}}$ provided the timing to that TP has not changed more than $\pm 50 T_s$ while measurement gap has not been available and the L3 filter has not been used. When L3 filtering is used or IDC autonomous denial is configured, an additional delay can be expected.

8.6.3.2.2.2 E-UTRAN CSI-RS based TDD – TDD inter frequency measurements when DRX is used

When DRX is in use, either measurement gaps are scheduled or the UE supports capability of conducting such measurements without gaps, the UE shall be able to identify a new detectable E-UTRAN TDD inter frequency TP within $T_{\text{identify_inter_TP_SCE_DRX}}$ according to the following expression:

$$T_{\text{identify_inter_TP_SCE_DRX}} = T_{\text{identify_inter_SCE_DRX}} + T_{\text{Measurement_Period_inter_TDD_CSI-RS_DRX}}$$

A TP shall be considered detectable when

- RSRP related side conditions given in Sections 9.1.14.3 are fulfilled for a corresponding Band,
- SCH_RP and $SCH\ \hat{E}_s/I_{ot}$ according to Annex B.2.11 for a corresponding Band

$T_{\text{identify_inter_SCE_DRX}}$ is the inter-frequency period for cell identification as shown in section 8.6.2.2.2.2. N_{freq} is defined in clause 8.1.2.1.1. $T_{\text{Measurement_Period_inter_TDD_CSI-RS_DRX}}$ is the inter-frequency period for TP measurement as shown in table 8.6.3.2.2.2-1.

When measurement gaps are scheduled for TDD inter frequency measurements, or the UE supports capability of conducting such measurements without gaps, the UE physical layer shall be capable of reporting CSI-RSRP measurements to higher layers with measurement accuracy as specified in sub-clauses 9.1.14.3, with measurement period given by table 8.6.3.2.2.2-1.

The UE shall be capable of performing CSI-RSRP measurements of at least 3 identified inter-frequency TPs per TDD inter-frequency for up to 3 TDD inter-frequencies and the UE physical layer shall be capable of reporting CSI-RSRP measurements to higher layers with the measurement period defined in table 8.6.3.2.2.2-1 when DRX is in use, either measurement gaps are scheduled or the UE supports capability of conducting such measurements without gaps.

Table 8.6.3.2.2.2-1: Requirement to measure TDD inter frequency TP

| Measurement bandwidth [RB] | Discovery signal occasion duration (<i>ds-OccasionDuration</i>) [ms] | $T_{\text{Measurement_Period_inter_TDD_CSI-RS_DRX}}$ [ms] |
|----------------------------|--|--|
| ≥ 6 | ≥ 2 | $5 * \text{Max}\{T_{\text{DMTC_periodicity}}, \text{DRX cycle length, MGRP}\} * N_{freq}$ |
| ≥ 25 | ≥ 2 | $3 * \text{Max}\{T_{\text{DMTC_periodicity}}, \text{DRX cycle length, MGRP}\} * N_{freq}$ |

$T_{\text{DMTC_periodicity}}$ is the discovery signal measurement timing configuration periodicity of higher layer.

The CSI-RSRP measurement accuracy for all measured TPs shall be as specified in the sub-clauses 9.1.14.3.

8.6.3.2.2.2.1 Measurement Reporting Requirements

8.6.3.2.2.2.1.1 Periodic Reporting

Reported CSI-RSRP measurements contained in periodically triggered measurement reports shall meet the requirements in sections 9.1.14.3.

8.6.3.2.2.2.1.2 Event-triggered Periodic Reporting

Reported CSI-RSRP measurements contained in event triggered periodic measurement reports shall meet the requirements in sections 9.1.14.3.

The first report in event triggered periodic measurement reporting shall meet the requirements specified in clause 8.6.3.2.2.2.1.3.

8.6.3.2.2.2.1.3 Event Triggered Reporting

Reported CSI-RSRP measurements contained in event triggered measurement reports shall meet the requirements in sections 9.1.14.3.

The UE shall not send any event triggered measurement reports, as long as no reporting criteria are fulfilled.

The measurement reporting delay is defined as the time between an event that will trigger a measurement report and the point when the UE starts to transmit the measurement report over the air interface. This requirement assumes that the measurement report is not delayed by other RRC signalling on the DCCH. This measurement reporting delay excludes a delay uncertainty resulted when inserting the measurement report to the TTI of the uplink DCCH. The delay uncertainty is: $2 \times T_{\text{TTI}_{\text{DCCH}}}$. This measurement reporting delay excludes a delay which caused by no UL resources for UE to send the measurement report. When L3 filtering is used or IDC autonomous denial is configured an additional delay can be expected.

The event triggered measurement reporting delay, measured without L3 filtering shall be less than $T_{\text{identify_inter_TP_SCE_DRX}}$ defined in Clause 8.6.3.2.2.2. When L3 filtering is used or IDC autonomous denial is configured an additional delay can be expected.

If a TP which has been detectable at least for the time period $T_{\text{identify_inter_TP_SCE_DRX}}$ in clause 8.6.3.2.2.2 and then triggers the measurement report as per TS 36.331 [2], the event triggered measurement reporting delay shall be less than $T_{\text{Measurement_Period_inter_TDD_CSI-RS_DRX}}$ provided the timing to that TP has not changed more than $\pm 50 T_s$ while measurement gap has not been available and the L3 filter has not been used. When L3 filtering is used or IDC autonomous denial is configured, an additional delay can be expected.

8.6.3.2.3 E-UTRAN TDD – FDD inter frequency measurements

8.6.3.2.3.1 E-UTRAN TDD – FDD inter frequency measurements when no DRX is used

The requirements in this clause shall apply to UE supporting FDD and TDD.

The requirements in clause 8.6.3.2.1.1 also apply for this section.

8.6.3.2.3.2 E-UTRAN TDD – FDD inter frequency measurements when DRX is used

The requirements in this clause shall apply to UE supporting FDD and TDD.

The requirements in clause 8.6.3.2.1.2 also apply for this section.

8.6.3.2.4 E-UTRAN FDD – TDD inter frequency measurements

8.6.3.2.4.1 E-UTRAN FDD – TDD inter frequency measurements when no DRX is used

The requirements in this clause shall apply to UE supporting FDD and TDD.

The requirements in clause 8.6.3.2.2.1 also apply for this section.

8.6.3.2.4.2 E-UTRAN FDD – TDD inter frequency measurements when DRX is used

The requirements in this clause shall apply to UE supporting FDD and TDD.

The requirements in clause 8.6.3.2.2.2 also apply for this section.

8.7 Discovery signal measurements for E-UTRA carrier aggregation

8.7.1 Introduction

Requirements in this clause are applicable to UE supporting E-UTRA FDD, E-UTRA TDD and/or E-UTRA TDD-FDD carrier aggregation.

Non configured frequencies may be measured with measurement gaps according to the requirements in clause 8.6.2.2 and clause 8.6.3.2 (E-UTRAN CRS based inter frequency measurements and E-UTRAN CSI-RS based inter frequency measurements).

8.7.2 Requirements for CRS based discovery signal measurements for E-UTRA carrier aggregation

8.7.2.1 Measurements of the primary component carrier

CRS based measurements of cells on the primary component carrier shall meet all applicable requirements (FDD or TDD) in clause 8.6.2.1.

8.7.2.2 Measurements of a secondary component carrier

A Secondary component carrier may be activated and deactivated by MAC-CE commands as specified in [17]. The applicable performance requirements depend on whether the SCell on the corresponding frequency is activated or deactivated.

8.7.2.3 Measurements of a secondary component carrier with active SCell

When the SCell is activated, measurement performance requirements for the frequency are those given in clause 8.6.2.1. If common DRX is in use, then the requirements for that secondary component carrier are given by the applicable DRX requirements (FDD or TDD) in clause 8.6.2.1, otherwise the non DRX requirements are applicable. The applicable measurement accuracy requirements are in clause 9.1.15.

8.7.2.4 Measurements of a secondary component carrier with deactivated SCell

This clause defines the measurement requirements of a secondary component carrier with deactivated SCell based on the parameter *measCycleSCell* defined in TS 36.331 [2].

8.7.2.4.1 E-UTRAN secondary component carrier measurements when no common DRX is used

When no DRX is in use the UE shall be able to identify a new detectable FDD or TDD cell on a secondary component carrier within $T_{\text{identify_scc_SCE}}$, according to the parameter *measCycleSCell* where $T_{\text{identify_scc_CRS}} = 13 * \text{measCycleSCell} + T_{\text{measure_scc_CRS}}$

A cell shall be considered detectable when

- RSRP related side condition given in Clause 9.1.15 are fulfilled for a corresponding Band,
- $SCH_RP|_{dBm}$ and $SCH \hat{E}s/Iot$ according to Annex B.2.10 for a corresponding Band

The measurement period for deactivated scell measurements is $T_{\text{measure_scell_CRS}}$ according to the parameter *measCycleSCell* shown in Tables 8.7.2.4.1-1 and 8.7.2.4.1-2.

Table 8.7.2.4.1-1: Requirement to measure intra frequency cell on FDD SCC with deactivated SCell

| Measurement bandwidth[RB] | Discovery signal occasion duration (<i>ds-OccasionDuration</i>) [ms] | $T_{\text{measure_scell_CRS}}$ [ms] |
|---------------------------|---|---------------------------------------|
| ≥ 6 | ≥ 1 | $5 * \text{measCycleSCell}$ |
| ≥ 25 | ≥ 1 | $3 * \text{measCycleSCell}$ |

Table 8.7.2.4.1-2: Requirement to measure intra frequency cell on TDD SCC with deactivated SCell

| Measurement bandwidth [RB] | Discovery signal occasion duration (<i>ds-OccasionDuration</i>) [ms] | $T_{\text{measure_scell_CRS}}$ [ms] |
|----------------------------|---|---------------------------------------|
| ≥ 6 | ≥ 2 | $5 * \text{measCycleSCell}$ |
| ≥ 25 | ≥ 2 | $3 * \text{measCycleSCell}$ |

The UE shall be capable of performing RSRP and RSRQ measurements for 3 identified cells on a secondary component carrier, and the UE physical layer shall be capable of reporting measurements to higher layers with the measurement period of $T_{\text{measure_scell_CRS}}$.

The measurement accuracy for all measured cells shall be as specified in the sub-clause 9.1.15.

A UE may reconfigure the receiver bandwidth or turn on/off one of the RF chains when performing measurements on up to four SCCs with deactivated SCell. This may cause interruptions on PCell or activated SCell(s) or both that are specified in Section 7.8.

8.7.2.4.1.1 Measurement Reporting Requirements

8.7.2.4.1.1.1 Periodic Reporting

Reported measurements contained in periodically triggered measurement reports shall meet the requirements in clause 9.

8.7.2.4.1.1.2 Event-triggered Periodic Reporting

Reported measurements contained in event triggered periodic measurement reports shall meet the requirements in clause 9.

The first report in event triggered periodic CRS based measurement reporting shall meet the requirements specified in clause 8.7.2.4.1.1.3.

8.7.2.4.1.1.3 Event Triggered Reporting

Reported measurements contained in event triggered measurement reports shall meet the requirements in clause 9.

The UE shall not send any event triggered measurement reports, as long as no reporting criteria are fulfilled.

The measurement reporting delay is defined as the time between an event that will trigger a measurement report and the point when the UE starts to transmit the measurement report over the air interface. This requirement assumes that the measurement report is not delayed by other RRC signalling on the DCCH. This measurement reporting delay excludes a delay uncertainty resulted when inserting the measurement report to the TTI of the uplink DCCH. The delay uncertainty is: $2 \times TTI_{\text{DCCH}}$. This measurement reporting delay excludes a delay which is caused by no UL resources for UE to send the measurement report.

The event triggered measurement reporting delay, measured without L3 filtering shall be less than $T_{\text{identify_scell_CRS}}$ defined in Clause 8.7.2.4.1. When L3 filtering is used or IDC autonomous denial is configured an additional delay can be expected.

If a cell which has been detectable at least for the time period $T_{\text{identify_scc_SCE}}$ defined in clause 8.7.2.4.1 becomes undetectable for a period ≤ 5 seconds and then the cell becomes detectable again and triggers an event, the event triggered measurement reporting delay shall be less than $T_{\text{measure_scc_CRS}}$ provided the timing to that cell has not changed more than $\pm 50 T_s$ and the L3 filter has not been used. When L3 filtering is used an additional delay can be expected.

8.7.2.4.2 E-UTRAN secondary component carrier measurements when common DRX is used

When DRX is in use the UE shall be able to identify a new detectable FDD or TDD cell on a secondary component carrier within $T_{\text{identify_scc}}$, according to the parameter *measCycleSCell* where $T_{\text{identify_scc_SCE_DRX}} = 17 * \text{Max}\{\text{measCycleSCell}, \text{DRX cycle length}\} + T_{\text{measure_scc_CRS_DRX}}$.

A cell shall be considered detectable when

- RSRP related side condition given in Clause 9.1.15 are fulfilled for a corresponding Band,
- $\text{SCH_RP}|_{\text{dBm}}$ and $\text{SCH } \hat{E}_s/\text{Iot}$ according to Annex B.2.10 for a corresponding Band

The measurement period for deactivated scell measurements is $T_{\text{measure_scc_CRS_DRX}}$ according to the parameter *measCycleSCell* shown in Tables 8.7.2.4.2-1 and 8.7.2.4.2-2.

Table 8.7.2.4.2-1: Requirement to measure intrafrequency cell on FDD SCC with deactivated SCell

| Measurement bandwidth[RB] | Discovery signal occasion duration (<i>ds-OccasionDuration</i>) [ms] | $T_{\text{measure_scc_CRS_DRX}}$ [ms] |
|---------------------------|--|--|
| ≥ 6 | ≥ 1 | $5 * \text{Max}\{\text{measCycleSCell}, \text{DRX cycle length}\}$ |
| ≥ 25 | ≥ 1 | $3 * \text{Max}\{\text{measCycleSCell}, \text{DRX cycle length}\}$ |

Table 8.7.2.4.2-2: Requirement to measure intrafrequency cell on TDD SCC with deactivated SCell

| Measurement bandwidth[RB] | Discovery signal occasion duration (<i>ds-OccasionDuration</i>) [ms] | $T_{\text{measure_scc_CRS_DRX}}$ [ms] |
|---------------------------|--|--|
| ≥ 6 | ≥ 2 | $5 * \text{Max}\{\text{measCycleSCell}, \text{DRX cycle length}\}$ |
| ≥ 25 | ≥ 2 | $3 * \text{Max}\{\text{measCycleSCell}, \text{DRX cycle length}\}$ |

The UE shall be capable of performing RSRP and RSRQ measurements for 3 identified cells on a secondary component carrier, and the UE physical layer shall be capable of reporting measurements to higher layers with the measurement period of $T_{\text{measure_scc_CRS_DRX}}$.

The measurement accuracy for all measured cells shall be as specified in the sub-clause 9.1.15.

A UE may reconfigure receiver bandwidth taking into account the SCell activation/deactivation status, and when making measurements of cells on up to four SCCs with deactivated SCell. This may cause interruptions (packet drops) to a PCell or activated SCell(s) or both when the PCell and the SCell belong to the same frequency band. No interruptions while the On Duration timer is running shall be allowed when common DRX is used. The requirement considers only interruptions due to reconfiguration of the receiver bandwidth, and not due to other causes such as RF impairments or channel conditions.

8.7.2.4.2.1 Measurement Reporting Requirements

8.7.2.4.2.1.1 Periodic Reporting

Reported measurements contained in periodically triggered measurement reports shall meet the requirements in clause 9.

8.7.2.4.2.1.2 Event-triggered Periodic Reporting

Reported measurements contained in event triggered periodic measurement reports shall meet the requirements in clause 9.

The first report in event triggered periodic measurement reporting shall meet the requirements specified in clause 8.7.2.4.2.1.3.

8.7.2.4.2.1.3 Event Triggered Reporting

Reported measurements contained in event triggered measurement reports shall meet the requirements in clause 9.

The UE shall not send any event triggered CRS based measurement reports, as long as no reporting criteria are fulfilled.

The measurement reporting delay is defined as the time between an event that will trigger a measurement report and the point when the UE starts to transmit the measurement report over the air interface. This requirement assumes that the measurement report is not delayed by other RRC signalling on the DCCH. This measurement reporting delay excludes a delay uncertainty resulted when inserting the measurement report to the TTI of the uplink DCCH. The delay uncertainty is: $2 \times TTI_{DCCH}$. This measurement reporting delay excludes a delay which is caused by no UL resources for UE to send the measurement report.

The event triggered measurement reporting delay, measured without L3 filtering shall be less than $T_{identify_scc_CRS}$ defined in Clause 8.7.2.4.2. When L3 filtering is used or IDC autonomous denial is configured an additional delay can be expected.

If a cell which has been detectable at least for the time period $T_{identify_scc_SCE_DRX}$ defined in clause 8.7.2.4.2 becomes undetectable for a period ≤ 5 seconds and then the cell becomes detectable again and triggers an event, the event triggered measurement reporting delay shall be less than $T_{measure_scc_CRS_DRX}$ provided the timing to that cell has not changed more than $\pm 50 T_s$ and the L3 filter has not been used. When L3 filtering is used an additional delay can be expected.

8.7.3 Requirements for CSI-RS based discovery signal measurements for E-UTRA carrier aggregation

8.7.3.1 Measurements of the primary component carrier

Measurements of cells on the primary component carrier shall meet all applicable requirements (FDD or TDD) in clause 8.6.3.1.

8.7.3.2 Measurements of a secondary component carrier

A Secondary component carrier may be activated and deactivated by MAC-CE commands as specified in [17]. The applicable performance requirements depend on whether the SCell on the corresponding frequency is activated or deactivated.

8.7.3.3 Measurements of a secondary component carrier with active SCell

When the SCell is activated, measurement performance requirements for the frequency are those given in clause 8.6.3.1. If common DRX is in use, then the requirements for that secondary component carrier are given by the applicable DRX requirements (FDD or TDD) in clause 8.6.3.1, otherwise the non DRX requirements are applicable. The applicable measurement accuracy requirements are in clause 9.1.15.

8.7.3.4 Measurements of a secondary component carrier with deactivated SCell

This clause defines the measurement requirements of a secondary component carrier with deactivated SCell based on the parameter *measCycleSCell* defined in TS 36.331 [2].

8.7.3.4.1 E-UTRAN secondary component carrier measurements when no common DRX is used

When no DRX is in use the UE shall be able to identify a new detectable FDD or TDD TP on a secondary component carrier within $T_{identify_scc_TP_SCE}$, according to the parameter *measCycleSCell*, where $T_{identify_scc_TP_SCE} = T_{identify_scc_SCE} + T_{measure_scc_CSI-RS}$,

A cell shall be considered detectable when

- CSI-RSRP related side condition given in Clause 9.1.15 are fulfilled for a corresponding Band,
- $SCH_RP|_{dBm}$ and $SCH\ \hat{E}s/Iot$ according to Annex B.2.10 for a corresponding Band

$T_{identify_scc_SCe}$ is the intra-frequency period for cell identification in section 8.7.2.4.1. $T_{measure_scc_CSI-RS}$ is the intra-frequency period for TP measurement in table 8.7.3.4.1-1.

The measurement period for deactivated scell measurements is $T_{measure_scc_CSI-RS}$ according to the parameter *measCycleSCell* as shown in tables 8.7.3.4.1-1 and 8.7.3.4.1-2.

Table 8.7.3.4.1-1: Requirement to measure intra frequency TP on FDD SCC with deactivated SCell

| Measurement bandwidth [RB] | Discovery signal occasion duration (<i>ds-OccasionDuration</i>) [ms] | $T_{measure_scc_CSI-RS}$ [ms] |
|----------------------------|--|---------------------------------|
| ≥ 6 | ≥ 1 | 5* <i>measCycleSCell</i> |
| ≥ 25 | ≥ 1 | 3* <i>measCycleSCell</i> |

Table 8.7.3.4.1-2: Requirement to measure intra frequency TP on TDD SCC with deactivated SCell

| Measurement bandwidth [RB] | Discovery signal occasion duration (<i>ds-OccasionDuration</i>) [ms] | $T_{measure_scc_CSI-RS}$ [ms] |
|----------------------------|--|---------------------------------|
| ≥ 6 | ≥ 2 | 5* <i>measCycleSCell</i> |
| ≥ 25 | ≥ 2 | 3* <i>measCycleSCell</i> |

The UE shall be capable of performing RSRP measurements for 3 identified TPs on a secondary component carrier, and the UE physical layer shall be capable of reporting measurements to higher layers with the measurement period of $T_{measure_scc_CSI-RS}$.

The measurement accuracy for all measured TPs shall be as specified in the sub-clause 9.1.15.

A UE may reconfigure the receiver bandwidth or turn on/off one of the RF chains when performing measurements on up to four SCCs with deactivated SCell. This may cause interruptions on PCell or activated SCell(s) or both that are specified in Section 7.8.

8.7.3.4.1.1 Measurement Reporting Requirements

8.7.3.4.1.1.1 Periodic Reporting

Reported measurements contained in periodically triggered measurement reports shall meet the requirements in clause 9.

8.7.3.4.1.1.2 Event-triggered Periodic Reporting

Reported measurements contained in event triggered periodic measurement reports shall meet the requirements in clause 9.

The first report in event triggered periodic measurement reporting shall meet the requirements specified in clause 8.7.3.4.1.1.3.

8.7.3.4.1.1.3 Event Triggered Reporting

Reported measurements contained in event triggered measurement reports shall meet the requirements in clause 9.

The UE shall not send any event triggered measurement reports, as long as no reporting criteria are fulfilled.

The measurement reporting delay is defined as the time between an event that will trigger a measurement report and the point when the UE starts to transmit the measurement report over the air interface. This requirement assumes that the measurement report is not delayed by other RRC signalling on the DCCH. This measurement reporting delay excludes a

delay uncertainty resulted when inserting the measurement report to the TTI of the uplink DCCH. The delay uncertainty is: $2 \times TTI_{DCCH}$. This measurement reporting delay excludes a delay which is caused by no UL resources for UE to send the measurement report.

The event triggered measurement reporting delay, measured without L3 filtering shall be less than $T_{identify_scc_TP_SCE}$ defined in Clause 8.7.3.4.1. When L3 filtering is used or IDC autonomous denial is configured an additional delay can be expected.

If a TP which has been detectable at least for the time period $T_{identify_scc_TP_SCE}$ defined in clause 8.7.3.4.1 becomes undetectable for a period ≤ 5 seconds and then the TP becomes detectable again and triggers an event, the event triggered measurement reporting delay shall be less than $T_{measure_scc_CSI-RS}$ provided the timing to that TP has not changed more than $\pm 50 T_s$ and the L3 filter has not been used. When L3 filtering is used an additional delay can be expected.

8.7.3.4.2 E-UTRAN secondary component carrier measurements when common DRX is used

When DRX is in use the UE shall be able to identify a new detectable FDD or TDD TP on a secondary component carrier within $T_{identify_scc_TP_SCE_DRX}$, according to the parameter *measCycleSCell*, where $T_{identify_scc_TP_SCE_DRX} = T_{identify_scc_SCE_DRX} + T_{measure_scc_CSI-RS_DRX}$,

A cell shall be considered detectable when

- CSI-RSRP related side condition given in Clause 9.1.15 are fulfilled for a corresponding Band,
- $SCH_RP|_{dBm}$ and $SCH\ \hat{E}s/Iot$ according to Annex B.2.10 for a corresponding Band

$T_{identify_scc_SCE_DRX}$ is the intra-frequency period for cell identification in section 8.7.2.4.2. $T_{measure_scc_CSI-RS_DRX}$ is the intra-frequency period for TP measurement in table 8.7.3.4.2-1.

The measurement period for deactivated scell measurements is $T_{measure_scc_CSI-RS_DRX}$ according to the parameter *measCycleSCell* as shown in tables 8.7.3.4.2-1 and 8.7.3.4.2-2.

Table 8.7.3.4.2-1: Requirement to measure intrafrequency TP on FDD SCC with deactivated SCell

| Measurement bandwidth [RB] | Discovery signal occasion duration (<i>ds-OccasionDuration</i>) [ms] | $T_{measure_scc_CSI-RS_DRX}$ [ms] |
|----------------------------|--|---|
| ≥ 6 | ≥ 1 | $5 * \max \{ measCycleSCell, DRX\ cycle\ length \}$ |
| ≥ 25 | ≥ 1 | $3 * \max \{ measCycleSCell, DRX\ cycle\ length \}$ |

Table 8.7.3.4.2-2: Requirement to measure intrafrequency TP on TDD SCC with deactivated SCell

| Measurement bandwidth [RB] | Discovery signal occasion duration (<i>ds-OccasionDuration</i>) [ms] | $T_{measure_scc_CSI-RS_DRX}$ [ms] |
|----------------------------|--|---|
| ≥ 6 | ≥ 2 | $5 * \max \{ measCycleSCell, DRX\ cycle\ length \}$ |
| ≥ 25 | ≥ 2 | $3 * \max \{ measCycleSCell, DRX\ cycle\ length \}$ |

The UE shall be capable of performing CSI-RSRP measurements for 3 identified TPs on a secondary component carrier, and the UE physical layer shall be capable of reporting measurements to higher layers with the measurement period of $T_{measure_scc_CSI-RS_DRX}$.

The measurement accuracy for all measured TPs shall be as specified in the sub-clause 9.1.15.

A UE may reconfigure receiver bandwidth taking into account the SCell activation/deactivation status, and when making measurements of TPs on up to four SCCs with deactivated SCell. This may cause interruptions (packet drops) to a PCell or activated SCell(s) or both when the PCell and the SCell belong to the same frequency band. No interruptions while the On Duration timer is running shall be allowed when common DRX is used. The requirement considers only interruptions due to reconfiguration of the receiver bandwidth, and not due to other causes such as RF impairments or channel conditions.

8.7.3.4.2.1 Measurement Reporting Requirements

8.7.3.4.2.1.1 Periodic Reporting

Reported measurements contained in periodically triggered measurement reports shall meet the requirements in clause 9.

8.7.3.4.2.1.2 Event-triggered Periodic Reporting

Reported measurements contained in event triggered periodic measurement reports shall meet the requirements in clause 9.

The first report in event triggered periodic measurement reporting shall meet the requirements specified in clause 8.7.3.4.2.1.3.

8.7.3.4.2.1.3 Event Triggered Reporting

Reported measurements contained in event triggered measurement reports shall meet the requirements in clause 9.

The UE shall not send any event triggered measurement reports, as long as no reporting criteria are fulfilled.

The measurement reporting delay is defined as the time between an event that will trigger a measurement report and the point when the UE starts to transmit the measurement report over the air interface. This requirement assumes that the measurement report is not delayed by other RRC signalling on the DCCH. This measurement reporting delay excludes a delay uncertainty resulted when inserting the measurement report to the TTI of the uplink DCCH. The delay uncertainty is: $2 \times TTI_{DCCH}$. This measurement reporting delay excludes a delay which is caused by no UL resources for UE to send the measurement report.

The event triggered measurement reporting delay, measured without L3 filtering shall be less than $T_{identify_scc_TP_SCE_DRX}$ defined in Clause 8.7.3.4.2. When L3 filtering is used or IDC autonomous denial is configured an additional delay can be expected.

If a TP which has been detectable at least for the time period $T_{identify_scc_TP_SCE_DRX}$ defined in clause 8.7.3.4.2 becomes undetectable for a period ≤ 5 seconds and then the TP becomes detectable again and triggers an event, the event triggered measurement reporting delay shall be less than $T_{measure_scc_CSI-RS_DRX}$ provided the timing to that TP has not changed more than $\pm 50 T_s$ and the L3 filter has not been used. When L3 filtering is used an additional delay can be expected.

8.8 Measurements for E-UTRA dual connectivity

8.8.1 Introduction

This clause contains requirements for UE supporting E-UTRA dual connectivity. Requirements in this clause are applicable to UEs which have been configured with one SCell in either MCG or SCG and one PCell for inter-band dual connectivity. Requirements in this clause are applicable to E-UTRA FDD, E-UTRA TDD and E-UTRA TDD-FDD dual connectivity.

8.8.2 Intra-frequency measurements requirements on PCell

PCell intra-frequency measurements shall meet all applicable requirements in clause 8.1.2.2. If MCG DRX is in use, then the PCell intra-frequency requirements for when DRX is in use in clause 8.1.2.2 shall apply and shall depend on the MCG DRX cycle. Otherwise, the requirements for when DRX is not in use shall apply. The applicable measurement accuracy requirements are in clause 9.1.

8.8.3 Intra-frequency measurements requirements on PSCell

PSCell starts with activated state upon configuration and cannot be deactivated. PSCell intra-frequency measurements shall meet all applicable requirements in clause 8.1.2.2. If SCG DRX is in use, then the PSCell intra-frequency requirements for when DRX is in use in clause 8.1.2.2 shall apply and shall depend on the SCG DRX cycle. Otherwise,

the requirements for when DRX is not in use shall apply. The applicable measurement accuracy requirements are in clause 9.1.

8.8.4 Inter-frequency and inter-RAT measurement requirements

Inter-frequency measurements shall meet all applicable requirements in clause 8.1.2.3. If MCG DRX is in use, then the inter-frequency requirements for when DRX is in use in clause 8.1.2.3 shall apply and shall depend on the MCG DRX cycle. Otherwise, the requirements for when DRX is not in use shall apply. The applicable measurement accuracy requirements are in clause 9.1.

Inter-RAT measurements shall meet all applicable requirements in clause 8.1.2.4. If MCG DRX is in use, then the inter-RAT requirements for when DRX is in use in clause 8.1.2.4 shall apply and shall depend on the MCG DRX cycle. Otherwise, the requirements for when DRX is not in use shall apply. The applicable measurement accuracy requirements are in clause 9.2, 9.3, 9.4 and 9.5.

8.8.5 Intra-frequency measurements with autonomous gaps

8.8.5.1 Identification of a new CGI of E-UTRA cell with autonomous gaps

No explicit neighbour list is provided to the UE for identifying a new CGI of E-UTRA cell. The UE shall identify and report the CGI when requested by the network for the purpose 'reportCGI'. The UE may make autonomous gaps in both MCG and SCG in downlink reception and uplink transmission for receiving MIB and SIB1 messages according to clause 5.5.3.1 of TS 36.331 [2]. Note that a UE is not required to use autonomous gap if si-RequestForHO is set to false. If autonomous gaps are used for measurement with the purpose of 'reportCGI', regardless of whether DRX is used or whether the SCell is configured, the UE shall be able to identify a new CGI of E-UTRA cell within:

$$T_{\text{identify_CGI, intra}} = T_{\text{basic_identify_CGI, intra}} \text{ ms}$$

where

$T_{\text{basic_identify_CGI, intra}} = 150$ ms. This is the time period used in the above equation where the maximum allowed time for the UE to identify a new CGI of an E-UTRA cell is defined, provided that the E-UTRA cell has been already identified by the UE.

A cell shall be considered identifiable following conditions are fulfilled:

- RSRP related side conditions given in Clause 9.1 are fulfilled for a corresponding Band,
- SCH_{RP} and SCH_{Ês/Iot} according to Annex B.2.2 for a corresponding Band

The MIB of an E-UTRA cell whose CGI is identified shall be considered decodable by the UE provided that the PBCH demodulation requirements in [5] are met.

The requirement for identifying a new CGI of an E-UTRA cell within $T_{\text{basic_identify_CGI, intra}}$ is applicable when no DRX is used as well as when any of the DRX cycles specified in TS 36.331 [2] is used.

Within the time $T_{\text{identify_CGI, intra}}$ ms, over which the UE identifies the CGI of a new E-UTRA cell, the UE shall transmit at least a minimum number of ACK/NACKs on cells in MCG and SCG, respectively, as specified in Table 8.8.5.1-1. The requirement depends on duplex mode, dual connectivity mode of operation, and whether a cell belongs to MCG or SCG, and is further conditioned on:

- there is continuous DL data allocation,
- no DRX cycle is used,
- no measurement gaps are configured,
- only one code word is transmitted in each subframe,
- no MBSFN subframes are configured.

Table 8.8.5.1-1: Requirement on minimum number of ACK/NACKs to transmit during $T_{\text{identify_CGI, intra-}}$

| Serving cell configuration | Minimum number of transmitted ACK/NACKs | | | |
|----------------------------|---|-----|------------------------|-----|
| | Synchronous operation | | Asynchronous operation | |
| | MCG | SCG | MCG | SCG |
| FDD | 60 | | 60 | 49 |
| TDD UL/DL configuration 0 | 18 | | N/A | N/A |
| TDD UL/DL configuration 1 | 35 | | N/A | N/A |
| TDD UL/DL configuration 2 | 43 | | N/A | N/A |
| TDD UL/DL configuration 3 | 36 | | N/A | N/A |
| TDD UL/DL configuration 4 | 39 | | N/A | N/A |
| TDD UL/DL configuration 5 | 42 | | N/A | N/A |
| TDD UL/DL configuration 6 | 30 | | N/A | N/A |

8.8.5.2 ECGI reporting delay

The ECGI reporting delay occurs due to the delay uncertainty when inserting the ECGI measurement report to the TTI of the uplink DCCH. The delay uncertainty is twice the TTI of the uplink DCCH. In case DRX is used, the ECGI reporting may be delayed until the next DRX cycle. If IDC autonomous denial is configured, an additional delay can be expected.

8.8.6 Inter-frequency measurements with autonomous gaps

8.8.6.1 Identification of a new CGI of E-UTRA cell with autonomous gaps

No explicit neighbour list is provided to the UE for identifying a new CGI of E-UTRA cell. The UE shall identify and report the CGI when requested by the network for the purpose 'reportCGI'. The UE may make autonomous gaps in both MCG and SCG in downlink reception and uplink transmission for receiving MIB and SIB1 messages according to clause 5.5.3.1 of TS 36.331 [2]. Note that a UE is not required to use autonomous gap if si-RequestForHO is set to false. If autonomous gaps are used for measurement with the purpose of 'reportCGI', regardless of whether DRX is used or whether the SCell is configured, the UE shall be able to identify a new CGI of E-UTRA cell within:

$$T_{\text{identify_CGI, inter}} = T_{\text{basic_identify_CGI, inter}} \text{ ms}$$

where

$T_{\text{basic_identify_CGI, inter}} = 150$ ms. This is the time period used in the above equation where the maximum allowed time for the UE to identify a new CGI of an E-UTRA cell is defined, provided that the E-UTRA cell has been already identified by the UE.

A cell shall be considered identifiable following conditions are fulfilled:

- RSRP related side conditions given in Clause 9.1 are fulfilled for a corresponding Band,
- SCH_{RP} and SCH_{Ês/Iot} according to Annex B.2.2 for a corresponding Band

The MIB of an E-UTRA cell whose CGI is identified shall be considered decodable by the UE provided that the PBCH demodulation requirements in [5] are met.

The requirement for identifying a new CGI of an E-UTRA cell within $T_{\text{basic_identify_CGI, inter}}$ is applicable when no DRX is used as well as when any of the DRX cycles specified in TS 36.331 [2] is used.

Within the time $T_{\text{identify_CGI, inter}}$ ms, over which the UE identifies the CGI of a new E-UTRA cell, the UE shall transmit at least a minimum number of ACK/NACKs on cells in MCG and SCG, respectively, as specified in Table 8.8.6.1-1. The requirement depends on duplex mode, dual connectivity mode of operation, and whether a cell belongs to MCG or SCG, and is further conditioned on:

- there is continuous DL data allocation,
- no DRX cycle is used,
- no measurement gaps are configured,
- only one code word is transmitted in each subframe,
- no MBSFN subframes are configured.

Table 8.8.6.1-1: Requirement on minimum number of ACK/NACKs to transmit during $T_{\text{identify_CGI, inter-}}$

| Serving cell configuration | Minimum number of transmitted ACK/NACKs | | | |
|----------------------------|---|-----|------------------------|-----|
| | Synchronous operation | | Asynchronous operation | |
| | MCG | SCG | MCG | SCG |
| FDD | 60 | | 60 | 49 |
| TDD UL/DL configuration 0 | 18 | | N/A | N/A |
| TDD UL/DL configuration 1 | 30 | | N/A | N/A |

8.8.6.2 ECGI reporting delay

The ECGI reporting delay occurs due to the delay uncertainty when inserting the ECGI measurement report to the TTI of the uplink DCCH. The delay uncertainty is twice the TTI of the uplink DCCH. In case DRX is used, the ECGI reporting may be delayed until the next DRX cycle. If IDC autonomous denial is configured, an additional delay can be expected.

8.8.7 SSTD Measurements

8.8.7.1 Introduction

This clause contains SSTD measurement requirements on UE capabilities for support of E-UTRA dual connectivity.

8.8.7.2 SSTD Measurement requirements

When no DRX is used the physical layer measurement period of the SSTD measurement shall be $T_{\text{measure_SSTD1}} = 200$ ms.

When either MCG DRX or SCG DRX is used, or both MCG DRX and SCG DRX are used in RRC_CONNECTED state the physical layer measurement period ($T_{\text{measure_SSTD1}}$) of the SSTD measurement shall be as specified in table 8.8.7.2-1.

Table 8.8.7.2-1: SSTD measurement requirement when DRX is used

| DRX cycle length (s) | $T_{\text{measure_SSTD1}}$ (s) (DRX cycles) |
|--|--|
| ≤ 0.04 | 0.2 (Note1) |
| $0.04 < \text{DRX-cycle} \leq 2.56$ | Note2 (5) |
| Note1: Number of DRX cycle depends upon the DRX cycle in use Note2: Time depends upon the DRX cycle in use Note3: DRX cycle length in this table refers to the DRX cycle length configured on the CG in which DRX is used. When DRX is used in both MCG and SCG, DRX cycle length in this table refers to the longer DRX cycle length between MCG DRX and SCG DRX. | |

If PCell is changed without changing PCC, and/or if PSCell is changed without changing a frequency of PSCell or if both PCell and PSCell are change by swapping the PCC with the frequency of PSCell while the UE is performing SSTD measurements, then the UE shall also meet the SSTD measurement and accuracy requirements corresponding to the new PCell and/or PSCell. However in this case the UE shall restart the SSTD measurement. In this case the total physical layer measurement period of the SSTD measurement shall not exceed $T_{\text{measure_SSTD2}}$ as defined in the following expression:

$$T_{\text{measure_SSTD2}} = (N+M+1) \cdot (T_{\text{measure_SSTD1}}) + N \cdot T_{\text{PCell_change_DC}} + M \cdot T_{\text{PSCell_change_DC}}$$

Where:

N is the number of times the PCell is changed over the measurement period ($T_{\text{measure_SSTD2}}$),

M is the number of times the PSCell is changed over the measurement period ($T_{\text{measure_SSTD2}}$),

$T_{\text{PCell_change_DC}}$ is the time necessary to change the PCell; it can be up to 25 ms,

$T_{\text{PSCell_change_DC}}$ is the time necessary to change the PSCell; it can be up to 25 ms.

The measurement accuracy for the SSTD measurement when DRX is used as well as when no DRX is used shall be as specified in the sub-clause 9.1.20.

8.8.7.3 SSTD Measurement Reporting Delay

This requirement assumes that the measurement report is not delayed by other RRC signalling on the DCCH. This measurement reporting delay excludes a delay uncertainty resulted when inserting the measurement report to the TTI of the uplink DCCH. The delay uncertainty is: $2 \times T_{\text{TI_DCCH}}$. This measurement reporting delay excludes any delay caused by no UL resources for UE to send the measurement report.

Reported measurements contained in periodically triggered measurement reports shall meet the requirements in sub-clause 9.1.20.

8.8.8 Intra-frequency measurements requirements on SCell

SCell intra-frequency measurements shall meet all applicable requirements in clause 8.3.3. In case where the SCell belongs to MCG, the term “common DRX” in clause 8.3.3 shall be deemed to be replaced with “MCG DRX”. In case where the SCell belongs to SCG, the term “common DRX” and PCell in clause 8.3.3 shall be replaced with “SCG DRX” and PSCell, respectively.

8.9 MBSFN Measurements

8.9.1 Introduction

The requirements specified in Section 8.9 apply for MBSFN measurements (MBSFN RSRP, MBSFN RSRQ, and MCH BLER defined in [4]), which are performed in RRC_CONNECTED and logged for MDT by UEs which are MBMS-capable and also indicate their MBSFN measurement logging capability [2].

UE shall measure MBSFN RSRP, MBSFN RSRQ and MCH BLER only in subframes and on carriers where UE is decoding PMCH. The requirements are specified for any carrier where PMCH is received by UE. The requirements specified in this section apply for any carrier frequency with configured MBSFN subframes with PMCH, which may be the same as or different from any serving unicast carrier.

The UE receiving PMCH on any non-serving carrier and performing MBSFN measurements shall not cause interruptions on any serving carrier in unicast subframes and in the subframes with non-MBSFN multicast transmissions such as system information.

8.9.2 MBSFN RSRP Measurements

The UE physical layer shall be capable of performing the MBSFN RSRP measurement [4] within the MBSFN RSRP measurement period and report the measurement, while meeting the MBSFN RSRP measurement accuracy requirements specified in section 9.8.2.

The MBSFN RSRP measurement period is defined as the maximum between 640ms and the period during which the UE decodes [5, Section 10] 5 subframes containing PMCH transmissions.

The MBSFN RSRP measurement period is the same for UE using any DRX cycle, any eDRX_CONN cycle, or no DRX.

8.9.3 MBSFN RSRQ Measurements

The UE physical layer shall be capable of performing the MBSFN RSRQ measurement [4] within the MBSFN RSRP measurement period and report the measurement, while meeting the MBSFN RSRQ measurement accuracy requirements specified in section 9.8.3.

The MBSFN RSRQ measurement period is defined as the maximum between 640ms and the period during which the UE decodes [5, Section 10] 5 subframes containing PMCH transmissions.

The MBSFN RSRQ measurement period is the same for UE using any DRX cycle, any eDRX_CONN cycle, and no DRX.

8.9.4 MCH BLER Measurements

The UE physical layer shall be capable of performing and reporting the MCH BLER measurement [4] to higher layers within the MCH BLER measurement period. The MCH BLER measurement reporting is according to section 9.8.4.

The MCH BLER measurement period is equal to the MBSFN logging interval configured by higher layers [2].

8.10 Proximity-based Services

8.10.1 Introduction

This section contains the requirements for the UE capable of ProSe Direct Communication and/or ProSe Direct Discovery in RRC_CONNECTED state.

8.10.2 Requirements

When a UE in RRC_CONNECTED state is performing transmissions and/or reception for ProSe Direct Discovery and/or ProSe Direct Communication, the UE shall meet all the requirements specified in Section 8.

Note: The UE may need to interrupt ProSe operation in order to meet the measurement requirements of Section 8.

8.10.2.1 Initiation/Cease of SLSS transmissions with ProSe Direct Discovery

The requirements in this subclause are applicable to a UE capable of ProSe Direct Discovery and SLSS transmission and reception.

The requirements apply when the conditions for SLSS transmissions specified in [2] are met; *networkControlledSyncTx* is not configured; and *syncTxThreshIC* is included in *SystemInformationBlockType19*. The UE shall be capable of measuring the RSRP of the cell used to transmit Prose Direct Discovery announcements and evaluate to initiate/cease SLSS transmissions within $T_{\text{evaluate,SLSS}}$ where,

- $T_{\text{evaluate,SLSS}} = 0.4$ seconds when UE is not configured with DRX, or,
- $T_{\text{evaluate,SLSS}} =$ as specified in Table 8.10.2.1-1 when UE is configured with DRX.

Table 8.10.2.1-1: $T_{\text{evaluate,SLSS}}$ with ProSe Direct Discovery

| DRX cycle length [s] | $T_{\text{evaluate,SLSS}}$ [s] (number of DRX cycles) |
|--------------------------------------|--|
| ≤ 0.04 | 0.4 (Note 1) |
| $0.04 < \text{DRX-cycles} \leq 2.56$ | Note 2 (6) |
| Note1: | Number of DRX cycles depends upon the DRX cycle in use |
| Note2: | Time depends upon the DRX cycles in use |

If higher layer filtering is configured, an additional delay in evaluation to initiate/cease SLSS transmissions can be expected.

For the cell used to transmit ProSe Direct Discovery announcements:

- RSRP related side conditions given in Sections 9.1.2.1 and 9.1.2.2 and RSRQ related side conditions given in Clause 9.1.5.1 for a corresponding Band are fulfilled,
- SCH_{RP} and SCH_{Es/Iot} according to Annex B.2.1 for a corresponding Band are fulfilled.

8.10.2.2 Initiation/Cease of SLSS transmissions with ProSe Direct Communication

The requirements in this subclause are applicable to a UE capable of ProSe Direct Communication.

The requirements apply when the conditions for SLSS transmissions specified in [2] are met; *networkControlledSyncTx* is not configured; and *syncTxThreshIC* is included in *SystemInformationBlockType18*. The UE shall be capable of measuring the RSRP of the cell used to transmit ProSe Direct Communication to evaluate to initiate/cease SLSS transmissions within $T_{\text{evaluate,SLSS}}$

where,

- $T_{\text{evaluate,SLSS}} = 0.4$ seconds when UE is not configured with DRX.
- $T_{\text{evaluate,SLSS}} =$ as specified in Table 8.10.2.2-1 when UE is configured with DRX.

Table 8.10.2.2-1: $T_{\text{evaluate,SLSS}}$ with ProSe Direct Communication

| DRX cycle length [s] | $T_{\text{evaluate,SLSS}}$ [s] (number of DRX cycles) |
|-------------------------------------|--|
| ≤ 0.04 | 0.4 (Note 1) |
| $0.04 < \text{DRX-cycle} \leq 2.56$ | Note 2 (6) |
| Note1: | Number of DRX cycles depends upon the DRX cycle in use |
| Note2: | Time depends upon the DRX cycles in use |

If higher layer filtering is configured, an additional delay in evaluation to initiate/cease SLSS transmissions can be expected.

For the cell used to transmit ProSe Direct Communication:

- RSRP related side conditions given in Sections 9.1.2.1 and 9.1.2.2 and RSRQ related side conditions given in Clause 9.1.5.1 for a corresponding Band are fulfilled,
- SCH_{RP} and SCH_{Es/Iot} according to Annex B.2.1 for a corresponding Band are fulfilled.

8.11 Discovery Signal Measurements under Operation with Frame Structure 3

8.11.1 Introduction

This section contains requirements on the UE for measurement reporting in RRC_CONNECTED state when discovery signal [16] is configured. The requirements are specified for E-UTRA CRS based discovery signal measurements and CSI-RS based discovery signal measurements.

The requirements in Section 8.11.2 shall apply for CRS based discovery signal measurements comprising RSRP and RSRQ measurements [4]. The requirements in Section 8.11.3 shall apply for CSI-RS based discovery signal measurements comprising CSI-RSRP measurements [4]. The requirements in Section 8.11.4 shall apply for UE RSSI measurements [4]. The requirements in Section 8.11.5 shall apply for UE channel occupancy measurements [2].

The measurement quantities are defined in [4], the measurement model is defined in [22] and measurement accuracy requirements are specified in Section 9. Control of measurement reporting is specified in TS 36.331 [2].

The requirements in this Section shall apply for carrier with E-UTRA operation following the frame structure type 3 [16].

The requirements in Section 9 are applicable for a UE performing measurements according to Section 8.11.

8.11.2 CRS based discovery signal measurements

8.11.2.1 E-UTRAN intra-frequency measurements

NOTE: The requirements in this section are applicable only for measurements on SCC following the frame structure type 3 [16].

The UE shall be able to identify new intra-frequency FS3 cells and perform measurements of identified intra-frequency cells without an explicit intra-frequency neighbour cell list containing physical layer cell identities. During the RRC_CONNECTED state the UE shall continuously measure identified intra-frequency cells and additionally search for and identify new intra-frequency cells.

8.11.2.1.1 Requirements

8.11.2.1.1.1 Requirements when no DRX is used

When no DRX is in use the UE shall be able to identify a new detectable FS3 intra-frequency cell within the cell identification time $T_{\text{identify_intra_FS3}}$, where the identification time of a cell shall include detection of the cell and additionally performing a single measurement with measurement period of $T_{\text{measure_intra_FS3_CRS}}$, where:

$T_{\text{identify_intra_FS3}}$ is the intra-frequency cell identification period as specified in Table 8.11.2.1.1.1-1,

$T_{\text{measure_intra_FS3_CRS}}$ is the intra-frequency period for measurements as shown in Table 8.11.2.1.1.1-2,

$T_{\text{DMTC_periodicity}}$ is the discovery signal measurement timing configuration periodicity of higher layer,

L is the number of configured discovery signal occasions which are not available during $T_{\text{identify_intra_FS3}}$ for cell identification at the UE due to the absence of the necessary radio signals from the cell,

M is the number of configured discovery signal occasions which are not available during $T_{\text{measure_intra_FS3_CRS}}$ for the measurements at the UE due to the absence of the necessary radio signals from the cell.

Table 8.11.2.1.1.1-1: Intra-frequency cell identification requirement under operation with frame structure 3

| SCH \dot{E} s/lot | CRS measurement bandwidth [RB] Note2 | CRS \dot{E} s/lot | $T_{\text{identify_intra_FS3}}$ [ms] |
|---|---|---|---|
| $0 \leq \text{SCH } \dot{E}\text{s/lot}$ | <25 | $-6 \leq \text{CRS } \dot{E}\text{s/lot}$ | $(6+L) * k * T_{\text{DMTC_periodicity}}$ |
| $-6 \leq \text{SCH } \dot{E}\text{s/lot} < 0$ | <25 | | $(24+L) * k * T_{\text{DMTC_periodicity}}$ |
| $0 \leq \text{SCH } \dot{E}\text{s/lot}$ | ≥ 25 | $0 \leq \text{CRS } \dot{E}\text{s/lot}$ | $(2+L) * k * T_{\text{DMTC_periodicity}}$ |
| $-6 \leq \text{SCH } \dot{E}\text{s/lot} < 0$ | ≥ 25 | | $(8+L) * k * T_{\text{DMTC_periodicity}}$ |

NOTE 1 : Discovery signal occasion duration (*ds-OccasionDuration*) is 1 ms.
NOTE 2 : The requirements for measurement bandwidth ≥ 25 RB are optional.
NOTE 3 : $k=2$ when the measurement gaps configured for inter-frequency measurements in DMTC occasions or for inter-frequency RSSI measurements in RMTC occasions on a carrier with frame structure 3 overlap with some but not all DMTC occasions of the measured cell; otherwise, $k=1$, e.g., when measurement gaps configured for inter-frequency measurements on a carrier with frame structure 3 do not overlap with DMTC occasions of the measured cell or when the UE does not require the measurement gaps for the inter-frequency measurements. The requirements apply, provided that the inter-frequency measurement gap pattern does not overlap with all DMTC occasions of the measured cell.
NOTE 4 : The requirements apply, provided that L is such that the intra-frequency cell identification period $T_{\text{identify_intra_FS3}}$ does not exceed $72 * k * T_{\text{DMTC_periodicity}}$.

A cell shall be considered detectable when the following conditions are met during the discovery signal occasions which are available during $T_{\text{identify_intra_FS3}}$:

- RSRP related side conditions given in Section 9.1.18.2 are fulfilled for a corresponding Band,
- RSRQ related side conditions given in Section 9.1.18.3 are fulfilled for a corresponding Band,
- SCH_RP is according to Annex B.2.12 for a corresponding Band and SCH \hat{E} s/lot is according to Table 8.11.2.1.1.1-1.

If higher layer filtering is used, an additional cell identification delay can be expected.

In the RRC_CONNECTED state the measurement period for intra-frequency measurements is $T_{\text{measure_intra_FS3_CRS}}$ as shown in Table 8.11.2.1.1.1-2, when no DRX is in use. The UE shall be capable of performing RSRP and RSRQ measurements for 3 identified intra-frequency cells, and the UE physical layer shall be capable of reporting measurements to higher layers within the measurement period of $T_{\text{measure_intra_FS3_CRS}}$.

Table 8.11.2.1.1.1-2: Intra-frequency measurement requirements under operation with frame structure 3

| SCH \hat{E} s/lot | CRS measurement bandwidth [RB] ^{Note2} | CRS \hat{E} s/lot | $T_{\text{measure_intra_FS3_CRS}}$ [ms] |
|---|---|---|---|
| $0 \leq \text{SCH } \hat{E}\text{s/lot}$ | <25 | $-6 \leq \text{CRS } \hat{E}\text{s/lot}$ | $(5+M) * k * T_{\text{DMTC_periodicity}}$ |
| $-6 \leq \text{SCH } \hat{E}\text{s/lot} < 0$ | <25 | | $(20+M) * k * T_{\text{DMTC_periodicity}}$ |
| $0 \leq \text{SCH } \hat{E}\text{s/lot}$ | ≥ 25 | $0 \leq \text{CRS } \hat{E}\text{s/lot}$ | $(1+M) * k * T_{\text{DMTC_periodicity}}$ |
| $-6 \leq \text{SCH } \hat{E}\text{s/lot} < 0$ | ≥ 25 | | $(4+M) * k * T_{\text{DMTC_periodicity}}$ |

NOTE 1: Discovery signal occasion duration (*ds-OccasionDuration*) is 1 ms.
NOTE 2: The requirements for measurement bandwidth ≥ 25 RB are optional.
NOTE 3: $k=2$ when the measurement gaps configured for inter-frequency measurements in DMTC occasions or for inter-frequency RSSI measurements in RMTC occasions on a carrier with frame structure 3 overlap with some but not all DMTC occasions of the measured cell; otherwise, $k=1$, e.g., when measurement gaps configured for inter-frequency measurements on a carrier with frame structure 3 do not overlap with DMTC occasions of the measured cell or when the UE does not require the measurement gaps for the inter-frequency measurements. The requirements apply, provided that the inter-frequency measurement gap pattern does not overlap with all DMTC occasions of the measured cell.
NOTE 4: The requirements apply, provided that M is such that the intra-frequency measurement period $T_{\text{measure_intra_FS3_CRS}}$ does not exceed $60 * k * T_{\text{DMTC_periodicity}}$.

The RSRP measurement accuracy for all measured cells shall be as specified in Section 9.1.18.2, and the RSRQ measurement accuracy for all measured cells shall be as specified in Section 9.1.18.3.

8.11.2.1.1.1 Measurement Reporting Requirements

8.11.2.1.1.1.1 Periodic Reporting

Reported RSRP and RSRQ measurements contained in periodically triggered measurement reports shall meet the requirements in Sections 9.1.18.2 and 9.1.18.3, respectively.

8.11.2.1.1.1.1.2 Event-triggered Periodic Reporting

Reported RSRP and RSRQ measurements contained in event triggered periodic measurement reports shall meet the requirements in Sections 9.1.18.2 and 9.1.18.3, respectively.

The first report in event triggered periodic measurement reporting shall meet the requirements specified in Section 8.11.2.1.1.1.1.3.

8.11.2.1.1.1.1.3 Event Triggered Reporting

Reported RSRP and RSRQ measurements contained in event triggered measurement reports shall meet the requirements in Sections 9.1.18.2 and 9.1.18.3, respectively.

The UE shall not send any event triggered measurement reports, as long as no reporting criteria are fulfilled.

The measurement reporting delay is defined as the time between an event that will trigger a measurement report and the point when the UE starts to transmit the measurement report over the air interface. This requirement assumes that the measurement report is not delayed by other RRC signalling on the DCCH. This measurement reporting delay excludes a delay uncertainty resulted when inserting the measurement report to the TTI of the uplink DCCH. The delay uncertainty is: $2 \times TTI_{DCCH}$. This measurement reporting delay excludes a delay which caused by no UL resources for UE to send the measurement report.

The event triggered measurement reporting delay, measured without L3 filtering shall be less than $T_{identify_intra_FS3}$ defined in Section 8.11.2.1.1.1. When L3 filtering is used or IDC autonomous denial is configured an additional delay can be expected.

If a cell which has been detectable at least for the time period $T_{identify_intra_FS3}$ defined in Section 8.11.2.1.1.1 becomes undetectable for a period ≤ 8 seconds and then the cell becomes detectable again and triggers an event, the event triggered measurement reporting delay shall be less than $T_{identify_intra_FS3_CRS}$ provided the timing to that cell has not changed more than $\pm 50 T_s$ and the L3 filter has not been used. When L3 filtering is used or IDC autonomous denial is configured, an additional delay can be expected.

8.11.2.1.1.2 Requirements when DRX is used

When DRX is in use the UE shall be able to identify a new detectable FS3 intra-frequency cell within the cell identification time $T_{identify_intra_FS3_DRX}$, where the cell identification time of a cell shall include detection of the cell and additionally performing a single measurement with measurement period of $T_{measure_intra_FS3_CRS_DRX}$, where:.

$T_{identify_intra_FS3_DRX}$ is the intra-frequency period for cell identification as shown in Table 8.11.2.1.1.2-1,

$T_{measure_intra_FS3_CRS_DRX}$ is the intra-frequency period for measurements as shown in Table 8.11.2.1.1.2-2,

$T_{DMTC_periodicity}$ is the discovery signal measurement timing configuration periodicity of higher layer,

L is the number of configured discovery signal occasions during ON DURATION and which are not available during $T_{identify_intra_FS3_DRX}$ for cell identification at the UE due to the absence of the necessary radio signals from the cell,

M is the number of configured discovery signal occasions during ON DURATION and which are not available during $T_{measure_intra_FS3_CRS_DRX}$ for the measurements at the UE due to the absence of the necessary radio signals from the cell.

Table 8.11.2.1.1.2-1: Intra-frequency cell identification requirements under operation with frame structure 3

| SCH $\dot{E}s/lot$ | CRS measurement bandwidth [RB] Note2 | CRS $\dot{E}s/lot$ | $T_{identify_intra_FS3_DRX}$ [ms] |
|--|---|----------------------------|--|
| $0 \leq SCH \dot{E}s/lot$ | <25 | $-6 \leq CRS \dot{E}s/lot$ | $(6+L) \cdot k \cdot \text{Max}\{T_{DMTC_periodicity}, DRX \text{ cycle length}\}$ |
| $-6 \leq SCH \dot{E}s/lot < 0$ | <25 | | $(24+L) \cdot k \cdot \text{Max}\{T_{DMTC_periodicity}, DRX \text{ cycle length}\}$ |
| $0 \leq SCH \dot{E}s/lot$ | ≥ 25 | $0 \leq CRS \dot{E}s/lot$ | $(2+L) \cdot k \cdot \text{Max}\{T_{DMTC_periodicity}, DRX \text{ cycle length}\}$ |
| $-6 \leq SCH \dot{E}s/lot < 0$ | ≥ 25 | | $(8+L) \cdot k \cdot \text{Max}\{T_{DMTC_periodicity}, DRX \text{ cycle length}\}$ |
| NOTE 1: Discovery signal occasion duration (<i>ds-OccasionDuration</i>) is 1 ms. | | | |
| NOTE 2: The requirements for measurement bandwidth ≥ 25 RB are optional. | | | |
| NOTE 3: $k=2$ when the measurement gaps configured for inter-frequency measurements in DMTC occasions or for inter-frequency RSSI measurements in RMTC occasions on a carrier with frame structure 3 overlap with some but not all DMTC occasions of the measured cell during ON DURATION; otherwise, $k=1$, e.g., when measurement gaps configured for inter-frequency measurements on a carrier with frame structure 3 do not overlap with DMTC occasions of the measured cell during ON DURATION or when the UE does not require the measurement gaps for the inter-frequency measurements. The requirements apply, provided that the inter-frequency measurement gap pattern does not overlap with all DMTC occasions of the measured cell. | | | |
| NOTE 4: The requirements apply, provided that L is such that the intra-frequency cell identification | | | |

| |
|--|
| period $T_{\text{identify_intra_FS3_DRX}}$ does not exceed $72 \cdot k \cdot \text{Max}\{T_{\text{DMTC_periodicity}}, \text{DRX cycle length}\}$. |
|--|

A cell shall be considered detectable when the following conditions are met during the discovery signal occasions which are available during $T_{\text{identify_intra_FS3_DRX}}$:

- RSRP related side conditions given in Section 9.1.18.2 are fulfilled for a corresponding Band,
- RSRQ related side conditions given in Section 9.1.18.3 are fulfilled for a corresponding Band,
- SCH_RP is according to Annex B.2.12 for a corresponding Band and SCH \hat{E} s/lot is according to Table 8.11.2.1.1.2-1.

If higher layer filtering is used, an additional cell identification delay can be expected.

In the RRC_CONNECTED state the measurement period for intra-frequency measurements is $T_{\text{measure_intra_FS3_CRS_DRX}}$ as shown in Table 8.11.2.1.1.2-2, when DRX is in use. The UE shall be capable of performing RSRP and RSRQ measurements for 3 identified intra-frequency cells, and the UE physical layer shall be capable of reporting measurements to higher layers within the measurement period of $T_{\text{measure_intra_FS3_CRS_DRX}}$.

Table 8.11.2.1.1.2-2: Intra-frequency measurement requirements under operation with frame structure 3

| SCH \hat{E} s/lot | CRS measurement bandwidth [RB] Note2 | CRS \hat{E} s/lot | $T_{\text{measure_intra_FS3_CRS_DRX}}$ [ms] |
|--|---|---|--|
| $0 \leq \text{SCH } \hat{E}\text{s/lot}$ | <25 | $-6 \leq \text{CRS } \hat{E}\text{s/lot}$ | $(5+M) \cdot k \cdot \text{Max}\{T_{\text{DMTC_periodicity}}, \text{DRX cycle length}\}$ |
| $-6 \leq \text{SCH } \hat{E}\text{s/lot} < 0$ | <25 | | $(20+M) \cdot k \cdot \text{Max}\{T_{\text{DMTC_periodicity}}, \text{DRX cycle length}\}$ |
| $0 \leq \text{SCH } \hat{E}\text{s/lot}$ | ≥ 25 | $0 \leq \text{CRS } \hat{E}\text{s/lot}$ | $(1+M) \cdot k \cdot \text{Max}\{T_{\text{DMTC_periodicity}}, \text{DRX cycle length}\}$ |
| $-6 \leq \text{SCH } \hat{E}\text{s/lot} < 0$ | ≥ 25 | | $(4+M) \cdot k \cdot \text{Max}\{T_{\text{DMTC_periodicity}}, \text{DRX cycle length}\}$ |
| NOTE 1: Discovery signal occasion duration (<i>ds-OccasionDuration</i>) is 1 ms. | | | |
| NOTE 2: The requirements for measurement bandwidth ≥ 25 RB are optional. | | | |
| NOTE 3: $k=2$ when the measurement gaps configured for inter-frequency measurements in DMTC occasions or for inter-frequency RSSI measurements in RMTC occasions on a carrier with frame structure 3 overlap with some but not all DMTC occasions of the measured cell during ON DURATION; otherwise, $k=1$, e.g., when measurement gaps configured for inter-frequency measurements on a carrier with frame structure 3 do not overlap with DMTC occasions of the measured cell during ON DURATION or when the UE does not require the measurement gaps for the inter-frequency measurements. The requirements apply, provided that the inter-frequency measurement gap pattern does not overlap with all DMTC occasions of the measured cell. | | | |
| NOTE 4: The requirements apply, provided that M is such that the intra-frequency measurement period $T_{\text{measure_intra_FS3_CRS_DRX}}$ does not exceed $60 \cdot k \cdot \text{Max}\{T_{\text{DMTC_periodicity}}, \text{DRX cycle length}\}$. | | | |

The RSRP measurement accuracy for all measured cells shall be as specified in Section 9.1.18.2, and the RSRQ measurement accuracy for all measured cells shall be as specified in Section 9.1.18.3.

8.11.2.1.1.2.1 Measurement Reporting Requirements

8.11.2.1.1.2.1.1 Periodic Reporting

Reported RSRP and RSRQ measurements contained in periodically triggered measurement reports shall meet the requirements in Sections 9.1.18.2 and 9.1.18.3, respectively.

8.11.2.1.1.2.1.2 Event-triggered Periodic Reporting

Reported RSRP and RSRQ measurements contained in event triggered periodic measurement reports shall meet the requirements in Sections 9.1.18.2 and 9.1.18.3, respectively.

The first report in event triggered periodic measurement reporting shall meet the requirements specified in Section 8.11.2.1.1.2.1.3.

8.11.2.1.1.2.1.3 Event Triggered Reporting

Reported RSRP and RSRQ measurements contained in event triggered measurement reports shall meet the requirements in Sections 9.1.18.2 and 9.1.18.3, respectively.

The UE shall not send any event triggered measurement reports, as long as no reporting criteria are fulfilled.

The measurement reporting delay is defined as the time between an event that will trigger a measurement report and the point when the UE starts to transmit the measurement report over the air interface. This requirement assumes that the measurement report is not delayed by other RRC signalling on the DCCH. This measurement reporting delay excludes a delay uncertainty resulted when inserting the measurement report to the TTI of the uplink DCCH. The delay uncertainty is: $2 \times TTI_{DCCH}$. This measurement reporting delay excludes a delay which caused by no UL resources for UE to send the measurement report.

The event triggered measurement reporting delay, measured without L3 filtering shall be less than $T_{\text{identify_intra_FS3_DRX}}$ defined in Section 8.11.2.1.1.2. When L3 filtering is used or IDC autonomous denial is configured an additional delay can be expected.

If a cell which has been detectable at least for the time period $T_{\text{identify_intra_FS3_DRX}}$ defined in Section 8.11.2.1.1.2 becomes undetectable for a period ≤ 8 seconds and then the cell becomes detectable again and triggers an event, the event triggered measurement reporting delay shall be less than $T_{\text{identify_intra_FS3_CRS_DRX}}$ provided the timing to that cell has not changed more than $\pm 50 T_s$ and the L3 filter has not been used. When L3 filtering is used or IDC autonomous denial is configured, an additional delay can be expected.

8.11.2.2 E-UTRAN inter-frequency measurements

The UE shall be able to identify new inter-frequency cells and perform RSRP and RSRQ measurements of identified inter-frequency cells if carrier frequency information is provided by the PCell, even if no explicit neighbour list with physical layer cell identities is provided. The discovery signal occasion and the measurement gap should be aligned, provided that also the following additional conditions are fulfilled:

Entire discovery signal occasion should be contained in the measurement gap.

The subframe contained discovery signal for the measurement is not overlapped with the first 0.5 ms period and the last 0.5 ms period in every gap.

8.11.2.2.1 E-UTRAN FDD-FS3 inter-frequency measurements

8.11.2.2.1.1 E-UTRAN FDD – FS3 inter-frequency measurements when no DRX is used

When measurement gaps are scheduled or the UE supports capability of conducting such measurements without gaps, the UE shall be able to identify a new detectable FS3 inter-frequency cell within the cell identification time $T_{\text{identify_inter_FS3}}$, which shall include detection of the cell and additionally performing a single measurement within the measurement period of $T_{\text{measure_inter_FS3_CRS}}$ when no DRX is used, where:

$T_{\text{identify_inter_FS3}}$ is the inter-frequency period for cell identification as shown in Table 8.11.2.2.1.1-1,

$T_{\text{measure_inter_FS3_CRS}}$ is the inter-frequency period for measurements as shown in Table 8.11.2.2.1.1-2,

$T_{\text{DMTC_periodicity}}$ is the discovery signal measurement timing configuration periodicity of higher layer,

N_{freq} is defined in Section 8.1.2.1.1,

N is the number of carriers operating under FS3 and which are subject to the channel assessment prior to transmissions,

L is the number of configured discovery signal occasions which are not available during the time for cell identification at the UE during measurement gaps due to the absence of the necessary radio signals from the measured cell,

M is the number of configured discovery signal occasions which are not available during $T_{\text{measure_inter_FS3_CRS}}$ for the measurements at the UE during measurement gaps due to the absence of the necessary radio signals from the measured cell.

If higher layer filtering is used, an additional cell identification delay can be expected.

The requirements in this section apply, provided that L and M are such that: the inter-frequency cell identification period $T_{\text{identify_inter_FS3}}$ does not exceed $75 * N_{\text{freq}} * \text{Max}\{T_{\text{DMTC_periodicity}}, \text{MGRP}\}$, and the inter-frequency period $T_{\text{measure_inter_FS3_CRS}}$ for measurements does not exceed $60 * N_{\text{freq}} * \text{Max}\{T_{\text{DMTC_periodicity}}, \text{MGRP}\}$.

Table 8.11.2.2.1.1-1: Inter-frequency cell identification requirements under operation with frame structure 3

| SCH \hat{E} s/lot | CRS measurement bandwidth ^{Note2} [RB] | CRS \hat{E} s/lot | $T_{\text{identify_inter_FS3}}$ [ms] |
|---|---|---|--|
| $0 \leq \text{SCH } \hat{E}\text{s/lot}$ | <25 | $-6 \leq \text{CRS } \hat{E}\text{s/lot}$ | $(7 * N_{\text{freq}} + L * N) * \text{Max}\{T_{\text{DMTC_periodicity}}, \text{MGRP}\}$ |
| $-6 \leq \text{SCH } \hat{E}\text{s/lot} < 0$ | <25 | | $(25 * N_{\text{freq}} + L * N) * \text{Max}\{T_{\text{DMTC_periodicity}}, \text{MGRP}\}$ |
| $0 \leq \text{SCH } \hat{E}\text{s/lot}$ | ≥ 25 | $0 \leq \text{CRS } \hat{E}\text{s/lot}$ | $(3 * N_{\text{freq}} + L * N) * \text{Max}\{T_{\text{DMTC_periodicity}}, \text{MGRP}\}$ |
| $-6 \leq \text{SCH } \hat{E}\text{s/lot} < 0$ | ≥ 25 | | $(9 * N_{\text{freq}} + L * N) * \text{Max}\{T_{\text{DMTC_periodicity}}, \text{MGRP}\}$ |

NOTE 1: Discovery signal occasion duration (*ds-OccasionDuration*) is 1 ms.
NOTE 2: The requirements for measurement bandwidth ≥ 25 RB are optional.

Table 8.11.2.2.1.1-2: Inter-frequency measurement requirements under operation with frame structure 3

| SCH \hat{E} s/lot | CRS measurement bandwidth ^{Note2} [RB] | CRS \hat{E} s/lot | $T_{\text{measure_inter_FS3_CRS}}$ [ms] |
|---|---|---|--|
| $0 \leq \text{SCH } \hat{E}\text{s/lot}$ | <25 | $-6 \leq \text{CRS } \hat{E}\text{s/lot}$ | $(5 * N_{\text{freq}} + M * N) * \text{Max}\{T_{\text{DMTC_periodicity}}, \text{MGRP}\}$ |
| $-6 \leq \text{SCH } \hat{E}\text{s/lot} < 0$ | <25 | | $(20 * N_{\text{freq}} + M * N) * \text{Max}\{T_{\text{DMTC_periodicity}}, \text{MGRP}\}$ |
| $0 \leq \text{SCH } \hat{E}\text{s/lot}$ | ≥ 25 | $0 \leq \text{CRS } \hat{E}\text{s/lot}$ | $(1 * N_{\text{freq}} + M * N) * \text{Max}\{T_{\text{DMTC_periodicity}}, \text{MGRP}\}$ |
| $-6 \leq \text{SCH } \hat{E}\text{s/lot} < 0$ | ≥ 25 | | $(4 * N_{\text{freq}} + M * N) * \text{Max}\{T_{\text{DMTC_periodicity}}, \text{MGRP}\}$ |

NOTE 1: Discovery signal occasion duration (*ds-OccasionDuration*) is 1 ms.
NOTE 2: The requirements for measurement bandwidth ≥ 25 RB are optional.

A cell shall be considered detectable when the following conditions are met during the discovery signal occasions which are available during $T_{\text{identify_inter_FS3}}$:

- RSRP related side conditions given in Section 9.1.18.2 are fulfilled for a corresponding Band,
- RSRQ related side conditions given in Section 9.1.18.3 are fulfilled for a corresponding Band,
- $\text{SCH_RP}_{\text{dBm}}$ is according to Annex B.2.13.1 for a corresponding Band,
- $\text{SCH } \hat{E}\text{s/lot}$ is according to Table 8.11.2.2.1.1-1.

When measurement gaps are scheduled for FS3 inter-frequency measurements or the UE supports capability of conducting such measurements without gaps, the UE physical layer shall be capable of reporting RSRP and RSRQ measurements to higher layers with measurement accuracy as specified in Sections 9.1.18.2 and 9.1.18.3, respectively, with measurement period given by table 8.11.2.2.1.1-2.

The UE shall be capable of performing RSRP and RSRQ measurements of at least 3 identified inter-frequency cells per FS3 inter-frequency for up to 3 FS3 inter-frequencies and the UE physical layer shall be capable of reporting RSRP and RSRQ measurements to higher layers with the measurement period defined in table 8.11.2.2.1.1-2 when no DRX is in use, either measurement gaps are scheduled or the UE supports capability of conducting such measurements without gaps.

The RSRP measurement accuracy for all measured cells shall be as specified in Section 9.1.18.2, and the RSRQ measurement accuracy for all measured cells shall be as specified in Section 9.1.18.3.

8.11.2.2.1.1.1 Measurement Reporting Requirements

8.11.2.2.1.1.1.1 Periodic Reporting

Reported RSRP and RSRQ measurements contained in periodically triggered measurement reports shall meet the requirements in sections 9.1.18.2 and 9.1.18.3, respectively.

8.11.2.2.1.1.1.2 Event-triggered Periodic Reporting

Reported RSRP and RSRQ measurements contained in event triggered periodic measurement reports shall meet the requirements in sections 9.1.18.2, and 9.1.18.3, respectively.

The first report in event triggered periodic measurement reporting shall meet the requirements specified in Section 8.11.2.2.1.1.1.3.

8.11.2.2.1.1.1.3 Event Triggered Reporting

Reported RSRP and RSRQ measurements contained in event triggered measurement reports shall meet the requirements in sections 9.1.18.2 and 9.1.18.3, respectively.

The UE shall not send any event triggered measurement reports, as long as no reporting criteria are fulfilled.

The measurement reporting delay is defined as the time between an event that will trigger a measurement report and the point when the UE starts to transmit the measurement report over the air interface. This requirement assumes that the measurement report is not delayed by other RRC signalling on the DCCH. This measurement reporting delay excludes a delay uncertainty resulted when inserting the measurement report to the TTI of the uplink DCCH. The delay uncertainty is: $2 \times T_{TI_{DCCH}}$. This measurement reporting delay excludes a delay which caused by no UL resources for UE to send the measurement report.

The event triggered measurement reporting delay, measured without L3 filtering shall be less than $T_{identify_inter_FS3}$ defined in Section 8.11.2.2.1.1. When L3 filtering is used or IDC autonomous denial is configured an additional delay can be expected.

If a cell which has been detectable at least for the time period $T_{identify_inter_FS3}$ defined in Section 8.11.2.2.1.1 and then triggers the measurement report as per TS 36.331 [2], the event triggered measurement reporting delay shall be less than $T_{measure_inter_FS3_CRS}$ provided the timing to that cell has not changed more than $\pm 50 T_s$ while measurement gap has not been available and the L3 filter has not been used. When L3 filtering is used or IDC autonomous denial is configured, an additional delay can be expected.

8.11.2.2.1.2 E-UTRAN FDD – FS3 inter-frequency measurements when DRX is used

When measurement gaps are scheduled or the UE supports capability of conducting such measurements without gaps, the UE shall be able to identify a new detectable FS3 inter-frequency cell within the cell identification time $T_{identify_inter_FS3_DRX}$, which shall include detection of the cell and additionally performing a single measurement within the measurement period of $T_{measure_inter_FS3_CRS_DRX}$ when DRX is used, where:

$T_{identify_inter_FS3_DRX}$ is the inter-frequency period for measurements as shown in Table 8.11.2.2.1.2-1,

$T_{measure_inter_FS3_CRS_DRX}$ is the inter-frequency period for measurements as shown in Table 8.11.2.2.1.2-2,

$T_{DMTC_periodicity}$ is the discovery signal measurement timing configuration periodicity of higher layer,

N_{freq} is defined in Section 8.1.2.1.1,

N is the number of carriers operating under FS3 and which are subject to the channel assessment prior to transmissions,

L is the number of configured discovery signal occasions which are not available during the time for cell identification at the UE during measurement gaps due to the absence of the necessary radio signals from the measured cell,

M is the number of configured discovery signal occasions which are not available during $T_{measure_inter_FS3_CRS_DRX}$ for the measurements at the UE during measurement gaps due to the absence of the necessary radio signals from the measured cell.

The requirements in this section apply, provided that L and M are such that: the inter-frequency cell identification period $T_{\text{identify_inter_FS3_DRX}}$ does not exceed $75 * N_{\text{freq}} * \text{Max}\{T_{\text{DMTC_periodicity}}, \text{MGRP}, \text{DRX cycle length}\}$, and the inter-frequency period $T_{\text{measure_inter_FS3_CRS_DRX}}$ for measurements does not exceed $60 * N_{\text{freq}} * \text{Max}\{T_{\text{DMTC_periodicity}}, \text{MGRP}, \text{DRX cycle length}\}$.

If higher layer filtering is used, an additional cell identification delay can be expected.

Table 8.11.2.2.1.2-1: Inter-frequency cell identification requirements under operation with frame structure 3

| SCH $\hat{E}s/\text{lot}$ | CRS measurement bandwidth ^{Note2} [RB] | CRS $\hat{E}s/\text{lot}$ | $T_{\text{identify_inter_FS3_DRX}}$ [ms] |
|---|---|---|---|
| $0 \leq \text{SCH } \hat{E}s/\text{lot}$ | <25 | $-6 \leq \text{CRS } \hat{E}s/\text{lot}$ | $(7 * N_{\text{freq}} + L * N) * \text{Max}\{T_{\text{DMTC_periodicity}}, \text{MGRP}, \text{DRX cycle length}\}$ |
| $-6 \leq \text{SCH } \hat{E}s/\text{lot} < 0$ | <25 | | $(25 * N_{\text{freq}} + L * N) * \text{Max}\{T_{\text{DMTC_periodicity}}, \text{MGRP}, \text{DRX cycle length}\}$ |
| $0 \leq \text{SCH } \hat{E}s/\text{lot}$ | ≥ 25 | $0 \leq \text{CRS } \hat{E}s/\text{lot}$ | $(3 * N_{\text{freq}} + L * N) * \text{Max}\{T_{\text{DMTC_periodicity}}, \text{MGRP}, \text{DRX cycle length}\}$ |
| $-6 \leq \text{SCH } \hat{E}s/\text{lot} < 0$ | ≥ 25 | | $(9 * N_{\text{freq}} + L * N) * \text{Max}\{T_{\text{DMTC_periodicity}}, \text{MGRP}, \text{DRX cycle length}\}$ |

NOTE 1: Discovery signal occasion duration (*ds-OccasionDuration*) is 1 ms.
NOTE 2: The requirements for measurement bandwidth ≥ 25 RB are optional.

Table 8.11.2.2.1.2-2: Inter-frequency measurement requirements under operation with frame structure 3

| SCH $\hat{E}s/\text{lot}$ | CRS measurement bandwidth ^{Note2} [RB] | CRS $\hat{E}s/\text{lot}$ | $T_{\text{measure_inter_FS3_CRS_DRX}}$ [ms] |
|---|---|---|---|
| $0 \leq \text{SCH } \hat{E}s/\text{lot}$ | <25 | $-6 \leq \text{CRS } \hat{E}s/\text{lot}$ | $(5 * N_{\text{freq}} + M * N) * \text{Max}\{T_{\text{DMTC_periodicity}}, \text{MGRP}, \text{DRX cycle length}\}$ |
| $-6 \leq \text{SCH } \hat{E}s/\text{lot} < 0$ | <25 | | $(20 * N_{\text{freq}} + M * N) * \text{Max}\{T_{\text{DMTC_periodicity}}, \text{MGRP}, \text{DRX cycle length}\}$ |
| $0 \leq \text{SCH } \hat{E}s/\text{lot}$ | ≥ 25 | $0 \leq \text{CRS } \hat{E}s/\text{lot}$ | $(1 * N_{\text{freq}} + M * N) * \text{Max}\{T_{\text{DMTC_periodicity}}, \text{MGRP}, \text{DRX cycle length}\}$ |
| $-6 \leq \text{SCH } \hat{E}s/\text{lot} < 0$ | ≥ 25 | | $(4 * N_{\text{freq}} + M * N) * \text{Max}\{T_{\text{DMTC_periodicity}}, \text{MGRP}, \text{DRX cycle length}\}$ |

NOTE 1: Discovery signal occasion duration (*ds-OccasionDuration*) is 1 ms.
NOTE 2: The requirements for measurement bandwidth ≥ 25 RB are optional.

A cell shall be considered detectable when the following conditions are met during the discovery signal occasions which are available during $T_{\text{identify_inter_FS3_DRX}}$:

- RSRP related side conditions given in Section 9.1.18.2 are fulfilled for a corresponding Band,
- RSRQ related side conditions given in Section 9.1.18.3 are fulfilled for a corresponding Band,
- $\text{SCH_RP}_{\text{dBm}}$ is according to Annex B.2.13.1 for a corresponding Band,
- $\text{SCH } \hat{E}s/\text{lot}$ is according to Table 8.11.2.2.1.2-1.

The UE shall be capable of performing RSRP and RSRQ measurements of at least 3 identified inter-frequency cells per FS3 inter-frequency for up to 3 FS3 inter-frequencies and the UE physical layer shall be capable of reporting RSRP and RSRQ measurements to higher layers with the measurement period defined in table 8.11.2.2.1.2-2 when DRX is in use, either measurement gaps are scheduled or the UE supports capability of conducting such measurements without gaps.

The RSRP measurement accuracy for all measured cells shall be as specified in Section 9.1.18.2, and the RSRQ measurement accuracy for all measured cells shall be as specified in Section 9.1.18.3.

8.11.2.2.1.2.1 Measurement Reporting Requirements

8.11.2.2.1.2.1.1 Periodic Reporting

Reported RSRP and RSRQ measurements contained in periodically triggered measurement reports shall meet the requirements in sections 9.1.18.2 and 9.1.18.3, respectively.

8.11.2.2.1.2.1.2 Event-triggered Periodic Reporting

Reported RSRP and RSRQ measurements contained in event triggered periodic measurement reports shall meet the requirements in sections 9.1.18.2 and 9.1.18.3, respectively.

The first report in event triggered periodic measurement reporting shall meet the requirements specified in Section 8.11.2.2.1.2.1.3.

8.11.2.2.1.2.1.3 Event Triggered Reporting

Reported RSRP and RSRQ measurements contained in event triggered measurement reports shall meet the requirements in sections 9.1.18.2, and 9.1.18.3, respectively.

The UE shall not send any event triggered measurement reports, as long as no reporting criteria are fulfilled.

The measurement reporting delay is defined as the time between an event that will trigger a measurement report and the point when the UE starts to transmit the measurement report over the air interface. This requirement assumes that the measurement report is not delayed by other RRC signalling on the DCCH. This measurement reporting delay excludes a delay uncertainty resulted when inserting the measurement report to the TTI of the uplink DCCH. The delay uncertainty is: $2 \times TTI_{DCCH}$. This measurement reporting delay excludes a delay which caused by no UL resources for UE to send the measurement report.

The event triggered measurement reporting delay, measured without L3 filtering shall be less than $T_{identify_inter_FS3_DRX}$ defined in Section 8.11.2.2.1.2. When L3 filtering is used or IDC autonomous denial is configured an additional delay can be expected.

If a cell which has been detectable at least for the time period $T_{identify_inter_FS3_DRX}$ defined in Section 8.11.2.2.1.2 becomes undetectable for a period ≤ 8 seconds and then the cell becomes detectable again and triggers an event, the event triggered measurement reporting delay shall be less than $T_{identify_inter_FS3_CRS_DRX}$ provided the timing to that cell has not changed more than $\pm 50 T_s$ and the L3 filter has not been used. When L3 filtering is used or IDC autonomous denial is configured, an additional delay can be expected.

8.11.2.2.2 E-UTRAN TDD – FS3 inter-frequency measurements

8.11.2.2.2.1 E-UTRAN TDD – FS3 inter-frequency measurements when no DRX is used

The requirements in this section for UE configured with TDD PCell and no DRX are the same as the requirements in Section 8.11.2.2.1.1.

8.11.2.2.2.2 E-UTRAN TDD – FS3 inter-frequency measurements when DRX is used

The requirements in this section for UE configured with TDD PCell and DRX are the same as the requirements in Section 8.11.2.2.1.2.

8.11.3 CSI-RS based discovery signal measurements

8.11.3.1 E-UTRAN intra-frequency measurements

The UE shall be able to identify new intra-frequency FS3 TPs and perform CSI-RSRP measurements of intra-frequency TPs with an explicit intra-frequency TP list containing physical layer cell identities. During the RRC_CONNECTED state the UE shall continuously measure identified intra-frequency TPs and additionally search for and identify new intra-frequency TPs.

8.11.3.1.1 Requirements

8.11.3.1.1.1 Requirements when no DRX is used

When no DRX is in use the UE shall be able to identify a new detectable FS3 intra-frequency TP within the identification period $T_{\text{identify_intra_TP_FS3}}$, where identification of a TP shall include cell identification and additionally performing a single measurement on the TP.

$$T_{\text{identify_intra_TP_FS3}} = T_{\text{identify_intra_FS3}} + T_{\text{measure_intra_FS3_CSI-RS}},$$

where

$T_{\text{identify_intra_FS3}}$ is the intra-frequency period for cell identification in Section 8.11.2.1.1.1,

$T_{\text{measure_intra_FS3_CSI-RS}}$ is the intra-frequency period for TP measurement as shown in Table 8.11.3.1.1.1-1,

$T_{\text{DMTC_periodicity}}$ is the discovery signal measurement timing configuration periodicity of higher layer,

M is the number of configured discovery signal occasions which are not available during $T_{\text{measure_intra_FS3_CSI-RS}}$ for the measurements at the UE due to the absence of the necessary radio signals from the TP.

During $T_{\text{identify_intra_TP_FS3}}$ over multiple discovery signal occasions, the UE may assume the following:

- in all the discovery signal occasions, which are available at the UE, the corresponding necessary cell-specific discovery signals are always available from the same set of TPs in the measured cell, and
- in all the discovery signal occasions, which are not available at the UE, the corresponding necessary cell-specific discovery signals are not available from any TP within the same measured cell.

A TP shall be considered detectable when the following conditions are met during the discovery signal occasions which are available during $T_{\text{identify_intra_TP_FS3}}$:

- CSI-RSRP related side conditions given in Section 9.1.18.4 are fulfilled for a corresponding Band,
- SCH_RP is according to Annex B.2.12 for a corresponding Band and $SCH \hat{E}s/lot$ is according to Section 8.11.2.1.1.1.

Identification of a TP shall include identification of the cell and additionally performing a single measurement on the TP within the measurement period of $T_{\text{measure_intra_FS3_CSI-RS}}$ when no DRX is used. If higher layer filtering is used, an additional TP identification delay can be expected.

In the RRC_CONNECTED state the measurement period for intra-frequency measurements is $T_{\text{measure_intra_FS3_CSI-RS}}$ as shown in table 8.11.3.1.1.1-1, when no DRX is in use. The UE shall be capable of performing CSI-RSRP measurements for 3 identified intra-frequency TPs, and the UE physical layer shall be capable of reporting measurements to higher layers with the measurement period of $T_{\text{measure_intra_FS3_CSI-RS}}$

Table 8.11.3.1.1.1-1: Intra-frequency TP measurement requirements under operation with frame structure 3

| SCH $\hat{E}s/lot$ | CRS measurement bandwidth [RB] ^{Note2} | CSI-RS $\hat{E}s/lot$ | $T_{\text{measure_intra_FS3_CSI-RS}}$ [ms] |
|--------------------------------|---|------------------------------|---|
| $0 \leq SCH \hat{E}s/lot$ | <25 | $0 \leq CSI-RS \hat{E}s/lot$ | $(5+M) * k * T_{\text{DMTC_periodicity}}$ |
| $-6 \leq SCH \hat{E}s/lot < 0$ | <25 | | $(20+M) * k * T_{\text{DMTC_periodicity}}$ |
| $0 \leq SCH \hat{E}s/lot$ | ≥ 25 | $0 \leq CSI-RS \hat{E}s/lot$ | $(1+M) * k * T_{\text{DMTC_periodicity}}$ |
| $-6 \leq SCH \hat{E}s/lot < 0$ | ≥ 25 | | $(4+M) * k * T_{\text{DMTC_periodicity}}$ |

NOTE 1: Discovery signal occasion duration (*ds-OccasionDuration*) is 1 ms.
NOTE 2: The requirements for measurement bandwidth ≥ 25 RB are optional.
NOTE 3: $k=2$ when the measurement gaps configured for inter-frequency measurements in DMTC occasions or for inter-frequency RSSI measurements in RMTC occasions on a carrier with frame structure 3 overlap with some but not all DMTC occasions of the measured TP; otherwise, $k=1$, e.g., when measurement gaps configured for inter-frequency measurements on a carrier with frame structure 3 do not overlap with DMTC occasions of the measured TP or when the UE does not require the measurement gaps for the inter-frequency measurements. The requirements apply, provided that the inter-frequency measurement gap pattern does not overlap with all DMTC occasions of the measured cell.
NOTE 4: The requirements apply, provided that M is such that the intra-frequency period for TP measurement

$T_{\text{measure_intra_FS3_CSI-RS}}$ does not exceed $60 \cdot k \cdot T_{\text{DMTC_periodicity}}$.

The CSI-RSRP measurement accuracy for all measured TPs shall be as specified in Section 9.1.18.4.

8.11.3.1.1.1.1 Measurement Reporting Requirements

8.11.3.1.1.1.1.1 Periodic Reporting

Reported CSI-RSRP measurements contained in periodically triggered measurement reports shall meet the requirements in Section 9.1.18.4.

8.11.3.1.1.1.1.2 Event-triggered Periodic Reporting

Reported CSI-RSRP measurements contained in event triggered periodic measurement reports shall meet the requirements in Section 9.1.18.4.

The first report in event triggered periodic measurement reporting shall meet the requirements specified in Section 8.11.3.1.1.1.1.3.

8.11.3.1.1.1.1.3 Event Triggered Reporting

Reported CSI-RSRP measurements contained in event triggered measurement reports shall meet the requirements in Section 9.1.18.4.

The UE shall not send any event triggered measurement reports, as long as no reporting criteria are fulfilled.

The measurement reporting delay is defined as the time between an event that will trigger a measurement report and the point when the UE starts to transmit the measurement report over the air interface. This requirement assumes that the measurement report is not delayed by other RRC signalling on the DCCH. This measurement reporting delay excludes a delay uncertainty resulted when inserting the measurement report to the TTI of the uplink DCCH. The delay uncertainty is: $2 \times TTI_{\text{DCCH}}$. This measurement reporting delay excludes a delay which caused by no UL resources for UE to send the measurement report.

The event triggered measurement reporting delay, measured without L3 filtering shall be less than $T_{\text{identify_intra_TP_FS3}}$ defined in Section 8.11.3.1.1.1. When L3 filtering is used or IDC autonomous denial is configured an additional delay can be expected.

If a TP which has been detectable at least for the time period $T_{\text{identify_intra_TP_FS3}}$ defined in Section 8.11.3.1.1.1 becomes undetectable for a period ≤ 8 seconds and then the TP becomes detectable again and triggers an event, the event triggered measurement reporting delay shall be less than $T_{\text{identify_intra_FS3_CSI-RS}}$ provided the timing to that TP has not changed more than $\pm 50 T_s$ and the L3 filter has not been used. When L3 filtering is used or IDC autonomous denial is configured, an additional delay can be expected.

8.11.3.1.1.2 Requirements when DRX is used

When DRX is in use the UE shall be able to identify a new detectable FS3 intra-frequency TP within the identification period $T_{\text{identify_intra_TP_FS3_DRX}}$, where identification of a TP shall include cell identification and additionally performing a single measurement on the TP.

$$T_{\text{identify_intra_TP_FS3_DRX}} = T_{\text{identify_intra_FS3_DRX}} + T_{\text{measure_intra_FS3_CSI-RS_DRX}},$$

where:

$T_{\text{identify_intra_FS3_DRX}}$ is the intra-frequency period for cell identification in Section 8.11.2.1.1.2.

$T_{\text{measure_intra_FS3_CSI-RS_DRX}}$ is the intra-frequency period for TP measurement as shown in Table 8.11.3.1.1.2-1, where

$T_{\text{DMTC_periodicity}}$ is the discovery signal measurement timing configuration periodicity of higher layer,

M is the number of configured discovery signal occasions during ON DURATION and which are not available during $T_{\text{measure_intra_FS3_CSI-RS_DRX}}$ for the measurements at the UE due to the absence of the necessary radio signals from the TP.

During $T_{\text{identify_intra_TP_FS3_DRX}}$ over multiple discovery signal occasions, the UE may assume the following:

- in all the discovery signal occasions, which are available at the UE, the corresponding necessary cell-specific discovery signals are always available from the same set of TPs in the measured cell, and
- in all the discovery signal occasions, which are not available at the UE, the corresponding necessary cell-specific discovery signals are not available from any TP within the same measured cell.

A TP shall be considered detectable when the following conditions are met during the discovery signal occasions which are available during $T_{\text{identify_intra_TP_FS3_DRX}}$:

- CSI-RSRP related side conditions given in Section 9.1.18.4 are fulfilled for a corresponding Band,
- SCH_RP is according to Annex B.2.12 for a corresponding Band and $SCH \hat{E}s/lot$ is according to Section 8.11.2.1.1.2.

Identification of a TP shall include identification of the cell and additionally performing a single measurement on the TP within measurement period of $T_{\text{measure_intra_FS3_CSI-RS_DRX}}$ when DRX is used. If higher layer filtering is used, an additional TP identification delay can be expected.

In the RRC_CONNECTED state the measurement period for intra frequency measurements is $T_{\text{measure_intra_FS3_CSI-RS_DRX}}$ as shown in Table 8.11.3.1.1.2-1, when DRX is in use. The UE shall be capable of performing CSI-RSRP measurements for 3 identified intra-frequency TPs, and the UE physical layer shall be capable of reporting measurements to higher layers with the measurement period of $T_{\text{measure_intra_FS3_CSI-RS_DRX}}$.

Table 8.11.3.1.1.2-1: Intra-frequency TP measurement requirements under operation with frame structure 3

| SCH $\hat{E}s/lot$ | CRS measurement bandwidth [RB] ^{Note2} | CSI-RS $\hat{E}s/lot$ | $T_{\text{measure_intra_FS3_CSI-RS_DRX}}$ [ms] |
|--------------------------------|---|------------------------------|--|
| $0 \leq SCH \hat{E}s/lot$ | <25 | $0 \leq CSI-RS \hat{E}s/lot$ | $(5+M) * k * \text{Max}\{ T_{\text{DMTC_periodicity}}, \text{DRX cycle length} \}$ |
| $-6 \leq SCH \hat{E}s/lot < 0$ | <25 | | $(20+M) * k * \text{Max}\{ T_{\text{DMTC_periodicity}}, \text{DRX cycle length} \}$ |
| $0 \leq SCH \hat{E}s/lot$ | ≥ 25 | $0 \leq CSI-RS \hat{E}s/lot$ | $(1+M) * k * \text{Max}\{ T_{\text{DMTC_periodicity}}, \text{DRX cycle length} \}$ |
| $-6 \leq SCH \hat{E}s/lot < 0$ | ≥ 25 | | $(4+M) * k * \text{Max}\{ T_{\text{DMTC_periodicity}}, \text{DRX cycle length} \}$ |

NOTE 1: Discovery signal occasion duration (*ds-OccasionDuration*) is 1 ms.
 NOTE 2: The requirements for measurement bandwidth ≥ 25 RB are optional.
 NOTE 3: $k=2$ when the measurement gaps configured for inter-frequency measurements in DMTC occasions or for inter-frequency RSSI measurements in RMTC occasions on a carrier with frame structure 3 overlap with some but not all DMTC occasions of the measured TP during ON DURATION; otherwise, $k=1$, e.g., when measurement gaps configured for inter-frequency measurements on a carrier with frame structure 3 do not overlap with DMTC occasions of the measured TP during ON DURATION or when the UE does not require the measurement gaps for the inter-frequency measurements. The requirements apply, provided that the inter-frequency measurement gap pattern does not overlap with all DMTC occasions of the measured cell.
 NOTE 4: The requirements apply, provided that M is such that the intra-frequency period for TP measurement $T_{\text{measure_intra_FS3_CSI-RS_DRX}}$ does not exceed $60 * k * \text{Max}\{ T_{\text{DMTC_periodicity}}, \text{DRX cycle length} \}$.

The CSI-RSRP measurement accuracy for all measured TPs shall be as specified in Section 9.1.18.4.

8.11.3.1.1.2.1 Measurement Reporting Requirements

8.11.3.1.1.2.1.1 Periodic Reporting

Reported CSI-RSRP measurements contained in periodically triggered measurement reports shall meet the requirements in Section 9.1.18.4.

8.11.3.1.1.2.1.2 Event-triggered Periodic Reporting

Reported CSI-RSRP measurements contained in event triggered periodic measurement reports shall meet the requirements in Section 9.1.18.4.

The first report in event triggered periodic measurement reporting shall meet the requirements specified in Section 8.11.3.1.1.2.1.3.

8.11.3.1.1.2.1.3 Event Triggered Reporting

Reported CSI-RSRP measurements contained in event triggered measurement reports shall meet the requirements in Section 9.1.18.4.

The UE shall not send any event triggered measurement reports, as long as no reporting criteria are fulfilled.

The measurement reporting delay is defined as the time between an event that will trigger a measurement report and the point when the UE starts to transmit the measurement report over the air interface. This requirement assumes that the measurement report is not delayed by other RRC signalling on the DCCH. This measurement reporting delay excludes a delay uncertainty resulted when inserting the measurement report to the TTI of the uplink DCCH. The delay uncertainty is: $2 \times TTI_{DCCH}$. This measurement reporting delay excludes a delay which caused by no UL resources for UE to send the measurement report.

The event triggered measurement reporting delay, measured without L3 filtering shall be less than $T_{identify_intra_TP_FS3_DRX}$ defined in Section 8.11.3.1.1.2. When L3 filtering is used or IDC autonomous denial is configured an additional delay can be expected.

If a TP which has been detectable at least for the time period $T_{identify_intra_TP_FS3_DRX}$ defined in Section 8.11.3.1.1.2 becomes undetectable for a period ≤ 8 seconds and then the TP becomes detectable again and triggers an event, the event triggered measurement reporting delay shall be less than $T_{identify_intra_FS3_CSI-RS_DRX}$ provided the timing to that TP has not changed more than ± 50 Ts and the L3 filter has not been used. When L3 filtering is used or IDC autonomous denial is configured, an additional delay can be expected.

8.11.3.2 E-UTRAN inter-frequency measurements

The UE shall be able to identify new inter-frequency TPs and perform CSI-RSRP measurements of the identified inter-frequency TPs with an explicit inter-frequency TP list containing physical layer cell identities. The discovery signal occasion and the measurement gap should be aligned, provided that also the following additional conditions are fulfilled:

Entire discovery signal occasion should be contained in the measurement gap.

The subframe contained discovery signal for the measurement is not overlapped with the first 0.5 ms period and the last 0.5 ms period in every gap.

8.11.3.2.1 E-UTRAN FDD – FS3 inter-frequency measurements

8.11.3.2.1.1 E-UTRAN FDD – FS3 inter-frequency measurements when no DRX is used

When measurement gaps are scheduled or the UE supports capability of conducting such measurements without gaps, the UE shall be able to identify a new detectable FS3 inter-frequency TP within the TP identification time $T_{identify_inter_TP_FS3}$ according to the following expression:

$$T_{identify_inter_TP_FS3} = T_{identify_inter_FS3} + T_{measure_inter_FS3_CSI-RS}$$

where

$T_{identify_inter_FS3}$ is the inter-frequency period for cell identification in Section 8.11.2.2.1.1,

$T_{measure_inter_FS3_CSI-RS}$ is the inter-frequency period for TP measurement as shown in Table 8.11.3.2.1.1-1,

$T_{DMTC_periodicity}$ is the discovery signal measurement timing configuration periodicity of higher layer,

N_{freq} is defined in section 8.1.2.1.1,

N is the number of carriers operating under FS3 and which are subject to the channel assessment prior to transmissions,

M is the number of configured discovery signal occasions which are not available during $T_{\text{measure_inter_FS3_CSI-RS}}$ for the measurements at the UE during measurement gaps due to the absence of the necessary radio signals from the measured TP.

The requirements in this section apply, provided that M is such that: the inter-frequency period $T_{\text{measure_inter_FS3_CSI-RS}}$ for TP measurements does not exceed $60 * N_{\text{freq}} * \text{Max}\{T_{\text{DMTC_periodicity}}, \text{MGRP}\}$.

During $T_{\text{identify_inter_TP_FS3}}$ over multiple discovery signal occasions, the UE may assume the following:

- in all the discovery signal occasions, which are available at the UE, the corresponding necessary cell-specific discovery signals are always available from the same set of TPs in the measured cell, and
- in all the discovery signal occasions, which are not available at the UE, the corresponding necessary cell-specific discovery signals are not available from any TP within the same measured cell.

A TP shall be considered detectable when the following conditions are met during the discovery signal occasions which are available during $T_{\text{identify_inter_TP_FS3}}$:

- CSI-RSRP related side conditions given in Section 9.1.18.4 are fulfilled for a corresponding Band,
- SCH_{RP} is according to Annex B.2.13.2 for a corresponding Band,
- SCH \hat{E} s/lot is according to Table 8.11.2.2.1.1-1.

When measurement gaps are scheduled for FS3 inter-frequency measurements or the UE supports capability of conducting such measurements without gaps, the UE physical layer shall be capable of reporting CSI-RSRP measurements to higher layers with measurement accuracy as specified in section 9.1.18.4, with measurement period given by table 8.11.3.2.1.1-1.

The UE shall be capable of performing CSI-RSRP measurements of at least 3 identified inter-frequency TPs per FS3 inter-frequency for up to 3 FS3 inter-frequencies and the UE physical layer shall be capable of reporting CSI-RSRP measurements to higher layers with the measurement period defined in table 8.11.3.2.1.1-1 when no DRX is in use, either measurement gaps are scheduled or the UE supports capability of conducting such measurements without gaps.

Table 8.11.3.2.1.1-1: Requirements to measure FS3 inter-frequency TP

| SCH \hat{E} s/lot | CSI-RS measurement bandwidth ^{Note2} [RB] | CSI-RS \hat{E} s/lot | $T_{\text{measure_inter_FS3_CSI-RS}}$ [ms] |
|---|--|---|--|
| $0 \leq \text{SCH } \hat{E}\text{s/lot}$ | <25 | $0 \leq \text{CSI-RS } \hat{E}\text{s/lot}$ | $(5 * N_{\text{freq}} + M * N) * \text{Max}\{T_{\text{DMTC_periodicity}}, \text{MGRP}\}$ |
| $-6 \leq \text{SCH } \hat{E}\text{s/lot} < 0$ | <25 | | $(20 * N_{\text{freq}} + M * N) * \text{Max}\{T_{\text{DMTC_periodicity}}, \text{MGRP}\}$ |
| $0 \leq \text{SCH } \hat{E}\text{s/lot}$ | ≥ 25 | $0 \leq \text{CSI-RS } \hat{E}\text{s/lot}$ | $(1 * N_{\text{freq}} + M * N) * \text{Max}\{T_{\text{DMTC_periodicity}}, \text{MGRP}\}$ |
| $-6 \leq \text{SCH } \hat{E}\text{s/lot} < 0$ | ≥ 25 | | $(4 * N_{\text{freq}} + M * N) * \text{Max}\{T_{\text{DMTC_periodicity}}, \text{MGRP}\}$ |
| NOTE 1: Discovery signal occasion duration (<i>ds-OccasionDuration</i>) is 1 ms. | | | |
| NOTE 2: The requirements for measurement bandwidth $\hat{\geq}$ 25 RB are optional. | | | |

The CSI-RSRP measurement accuracy for all measured TPs shall be as specified in section 9.1.18.4.

8.11.3.2.1.1.1 Measurement Reporting Requirements

8.11.3.2.1.1.1.1 Periodic Reporting

Reported CSI-RSRP measurements contained in periodically triggered measurement reports shall meet the requirements in section 9.1.18.4.

8.11.3.2.1.1.1.2 Event-triggered Periodic Reporting

Reported CSI-RSRP measurements contained in event triggered periodic measurement reports shall meet the requirements in section 9.1.18.4.

The first report in event triggered periodic measurement reporting shall meet the requirements specified in section 8.11.3.2.1.1.1.3.

8.11.3.2.1.1.3 Event Triggered Reporting

Reported CSI-RSRP measurements contained in event triggered measurement reports shall meet the requirements in section 9.1.18.4.

The UE shall not send any event triggered measurement reports, as long as no reporting criteria are fulfilled.

The measurement reporting delay is defined as the time between an event that will trigger a measurement report and the point when the UE starts to transmit the measurement report over the air interface. This requirement assumes that the measurement report is not delayed by other RRC signalling on the DCCH. This measurement reporting delay excludes a delay uncertainty resulted when inserting the measurement report to the TTI of the uplink DCCH. The delay uncertainty is: $2 \times T_{TI_{DCCH}}$. This measurement reporting delay excludes a delay which caused by no UL resources for UE to send the measurement report.

The event triggered measurement reporting delay, measured without L3 filtering shall be less than $T_{identify_inter_TP_FS3}$ defined in Section 8.11.3.2.1.1. When L3 filtering is used or IDC autonomous denial is configured an additional delay can be expected.

If a TP which has been detectable at least for the time period $T_{identify_inter_TP_FS3}$ defined in Section 8.11.3.2.1.1 becomes undetectable for a period ≤ 8 seconds and then the TP becomes detectable again and triggers an event, the event triggered measurement reporting delay shall be less than $T_{identify_inter_FS3_CSI-RS}$ provided the timing to that TP has not changed more than $\pm 50 T_s$ and the L3 filter has not been used. When L3 filtering is used or IDC autonomous denial is configured, an additional delay can be expected.

8.11.3.2.1.2 E-UTRAN FDD – FS3 inter-frequency measurements when DRX is used

When DRX is in use, either measurement gaps are scheduled or the UE supports capability of conducting such measurements without gaps, the UE shall be able to identify a new detectable FS3 inter-frequency TP within $T_{identify_inter_TP_FS3_DRX}$ according to the following expression:

$$T_{identify_inter_TP_FS3_DRX} = T_{identify_inter_FS3_DRX} + T_{measure_inter_FS3_CSI-RS_DRX} ,$$

where

$T_{identify_inter_FS3_DRX}$ is the inter-frequency period for cell identification in Section 8.11.2.2.1.2,

$T_{measure_inter_FS3_CSI-RS_DRX}$ is the inter-frequency period for TP measurement as shown in Table 8.11.3.2.1.2-1,

$T_{DMTC_periodicity}$ is the discovery signal measurement timing configuration periodicity of higher layer,

N_{freq} is defined in section 8.1.2.1.1,

N is the number of carriers operating under FS3 and which are subject to the channel assessment prior to transmissions,

M is the number of configured discovery signal occasions which are not available during $T_{measure_inter_FS3_CSI-RS_DRX}$ for the measurements at the UE during measurement gaps due to the absence of the necessary radio signals from the measured cell.

The requirements in this section apply, provided that M is such that: the inter-frequency period $T_{measure_inter_FS3_CSI-RS_DRX}$ for TP measurements does not exceed $60 * N_{freq} * \text{Max}\{T_{DMTC_periodicity}, \text{MGRP}, \text{DRX cycle length}\}$.

During $T_{identify_inter_TP_FS3_DRX}$ over multiple discovery signal occasions, the UE may assume the following:

- in all the discovery signal occasions, which are available at the UE, the corresponding necessary cell-specific discovery signals are always available from the same set of TPs in the measured cell, and
- in all the discovery signal occasions, which are not available at the UE, the corresponding necessary cell-specific discovery signals are not available from any TP within the same measured cell.

A TP shall be considered detectable when the following conditions are met during the discovery signal occasions which are available during $T_{identify_inter_TP_FS3_DRX}$:

- CSI-RSRP related side conditions given in Sections 9.1.18.4 are fulfilled for a corresponding Band,
- SCH_RP is according to Annex B.2.13.2 for a corresponding Band,

- SCH $\hat{E}s/lot$ is according to Table 8.11.2.2.1.2-1.

When measurement gaps are scheduled for FS3 inter-frequency measurements or the UE supports capability of conducting such measurements without gaps, the UE physical layer shall be capable of reporting CSI-RSRP measurements to higher layers with measurement accuracy as specified in section 9.1.18.4, with measurement period given by table 8.11.3.2.1.2-1.

The UE shall be capable of performing CSI-RSRP measurements of at least 3 identified inter-frequency TPs per FS3 inter-frequency for up to 3 FS3 inter-frequencies and the UE physical layer shall be capable of reporting CSI-RSRP measurements to higher layers with the measurement period defined in table 8.11.3.2.1.2-1 when DRX is in use, either measurement gaps are scheduled or the UE supports capability of conducting such measurements without gaps.

Table 8.11.3.2.1.2-1: Requirements to measure FS3 inter-frequency TP

| SCH $\hat{E}s/lot$ | CSI-RS measurement bandwidth ^{Note2} [RB] | CSI-RS $\hat{E}s/lot$ | $T_{measure_inter_FS3_CSI-RS_DRX}$ [ms] |
|--|--|------------------------------|---|
| $0 \leq SCH \hat{E}s/lot$ | <25 | $0 \leq CSI-RS \hat{E}s/lot$ | $(5 * N_{freq} + M * N) * \text{Max}\{T_{DMTC_periodicity}, MGRP, DRX \text{ cycle length}\}$ |
| $-6 \leq SCH \hat{E}s/lot < 0$ | <25 | | $(20 * N_{freq} + M * N) * \text{Max}\{T_{DMTC_periodicity}, MGRP, DRX \text{ cycle length}\}$ |
| $0 \leq SCH \hat{E}s/lot$ | ≥ 25 | $0 \leq CSI-RS \hat{E}s/lot$ | $(1 * N_{freq} + M * N) * \text{Max}\{T_{DMTC_periodicity}, MGRP, DRX \text{ cycle length}\}$ |
| $-6 \leq SCH \hat{E}s/lot < 0$ | ≥ 25 | | $(4 * N_{freq} + M * N) * \text{Max}\{T_{DMTC_periodicity}, MGRP, DRX \text{ cycle length}\}$ |
| NOTE 1: Discovery signal occasion duration (<i>ds-OccasionDuration</i>) is 1 ms. | | | |
| NOTE 2: The requirements for measurement bandwidth ≥ 25 RB are optional. | | | |

The CSI-RSRP measurement accuracy for all measured TPs shall be as specified in section 9.1.18.4.

8.11.3.2.1.2.1 Measurement Reporting Requirements

8.11.3.2.1.2.1.1 Periodic Reporting

Reported CSI-RSRP measurements contained in periodically triggered measurement reports shall meet the requirements in section 9.1.18.4.

8.11.3.2.1.2.1.2 Event-triggered Periodic Reporting

Reported CSI-RSRP measurements contained in event triggered periodic measurement reports shall meet the requirements in section 9.1.18.4.

The first report in event triggered periodic measurement reporting shall meet the requirements specified in section 8.11.3.2.1.2.1.3.

8.11.3.2.1.2.1.3 Event Triggered Reporting

Reported CSI-RSRP measurements contained in event triggered measurement reports shall meet the requirements in section 9.1.18.4.

The UE shall not send any event triggered measurement reports, as long as no reporting criteria are fulfilled.

The measurement reporting delay is defined as the time between an event that will trigger a measurement report and the point when the UE starts to transmit the measurement report over the air interface. This requirement assumes that that the measurement report is not delayed by other RRC signalling on the DCCH. This measurement reporting delay excludes a delay uncertainty resulted when inserting the measurement report to the TTI of the uplink DCCH. The delay uncertainty is: $2 \times TTI_{DCCH}$. This measurement reporting delay excludes a delay which caused by no UL resources for UE to send the measurement report. When L3 filtering is used or IDC autonomous denial is configured an additional delay can be expected.

The event triggered measurement reporting delay, measured without L3 filtering shall be less than $T_{\text{identify_inter_TP_FS3_DRX}}$ defined in section 8.11.3.2.1.2. When L3 filtering is used or IDC autonomous denial is configured an additional delay can be expected.

If a TP which has been detectable at least for the time period $T_{\text{identify_inter_TP_SCE_DRX}}$ defined in clause 8.11.3.2.1.2 and then triggers the measurement report as per TS 36.331 [2], the event triggered measurement reporting delay shall be less than $T_{\text{measure_inter_FS3_CSI-RS_DRX}}$ provided the timing to that TP has not changed more than ± 50 Ts while measurement gap has not been available and the L3 filter has not been used. When L3 filtering is used or IDC autonomous denial is configured, an additional delay can be expected.

8.11.3.2.2 E-UTRAN TDD – FS3 inter-frequency measurements

8.11.3.2.2.1 E-UTRAN TDD – FS3 inter-frequency measurements when no DRX is used

The requirements in this section for UE configured with TDD PCell and no DRX are the same as the requirements in Section 8.11.3.2.1.1.

8.11.3.2.2.2 E-UTRAN TDD – FS3 inter-frequency measurements when DRX is used

The requirements in this section for UE configured with TDD PCell and DRX are the same as the requirements in Section 8.11.3.2.1.2.

8.11.4 RSSI measurements

8.11.4.1 E-UTRAN intra-frequency measurements

NOTE: The requirements in this section are applicable only for measurements on SCC following the frame structure type 3 [16].

The UE physical layer shall be capable of performing the RSSI measurements [4] on one or more serving carriers operating under frame structure type 3 [16], if the carrier(s) are indicated by higher layers [2], and reporting the RSSI measurements to higher layers. The UE physical layer shall provide to higher layers a single RSSI sample for each OFDM symbol within each configured RSSI measurement duration [2] occurring with a configured RSSI measurement timing configuration periodicity [2]. The RSSI measurement period corresponds to $\max(\text{reportInterval}, \text{rmtc-Period})$ when no DRX is used and $\max(\text{reportInterval}, \text{rmtc-Period}, \text{DRX cycle length})$ when DRX is used, where *reportInterval* and *rmtc-Period* [2] are configured for the RSSI measurement by higher layers.

The RSSI measurement performed and reported according to this section shall meet the RSSI measurement accuracy requirement in Section 9.1.18.5.2.

8.11.4.2 E-UTRAN inter-frequency measurements

The UE physical layer shall be capable of performing the RSSI measurements [4] on one or more inter-frequency carriers operating under frame structure type 3 [16], if the carrier(s) are indicated by higher layers [2], and reporting the RSSI measurements to higher layers. The UE physical layer shall provide to higher layers a single RSSI sample for each OFDM symbol within each configured RSSI measurement duration [2] occurring with a configured RSSI measurement timing configuration periodicity [2]. The RSSI measurement period corresponds to $\max(\text{reportInterval}, \text{rmtc-Period} * N_{\text{freq}}, \text{MGRP} * N_{\text{freq}})$ when no DRX is used and $\max(\text{reportInterval}, N_{\text{freq}} * \max(\text{rmtc-Period}, \text{MGRP}, \text{DRX cycle length}))$ when DRX is used, where *reportInterval* and *rmtc-Period* [2] are configured for the RSSI measurement by higher layers, and N_{freq} is defined in clause 8.1.2.1.1.

If the UE requires measurement gaps to perform inter-frequency measurements, a single measurement gap pattern is used for all concurrent inter-frequency measurements, including inter-frequency RSSI measurements. The RSSI measurement duration and the measurement gap should be aligned, and the following additional condition should be fulfilled:

Entire RSSI measurement duration should be contained in the measurement gap.

UE is not required to perform RSSI measurement on symbols overlapped with the first 0.5 ms period and the last 0.5 ms period in every gap

The RSSI measurement performed and reported according to this section shall meet the RSSI measurement accuracy requirement in Section 9.1.18.5.3.

8.11.5 Channel occupancy measurements

8.11.5.1 E-UTRAN intra-frequency channel occupancy measurements

NOTE: The requirements in this section are applicable only for measurements on SCC following the frame structure type 3 [16].

The UE shall be capable of estimating the channel occupancy on one or more serving carrier frequencies indicated by higher layers [2], based on RSSI samples provided by the physical layer. The channel occupancy measurement period corresponds to $\max(\text{reportInterval}, \text{rmtc-Period})$ when no DRX is used and $\max(\text{reportInterval}, \text{rmtc-Period}, \text{DRX cycle length})$ when DRX is used, where *reportInterval* and *rmtc-Period* [2] are configured for the channel occupancy measurement by higher layers.

The channel occupancy measurement performed and reported according to this section shall meet the channel occupancy measurement accuracy requirements in Section 9.1.18.6.1.

8.11.5.2 E-UTRAN inter-frequency channel occupancy measurements

The UE shall be capable of estimating the channel occupancy on one or more carrier frequencies indicated by higher layers [2], based on RSSI samples provided by the physical layer. The channel occupancy measurement period corresponds to $\max(\text{reportInterval}, \text{rmtc-Period} * N_{\text{freq}}, \text{MGRP} * N_{\text{freq}})$ when no DRX is used and $\max(\text{reportInterval}, N_{\text{freq}} * \max(\text{rmtc-Period}, \text{MGRP}, \text{DRX cycle length}))$ when DRX is used, where *reportInterval* and *rmtc-Period* [2] are configured for the channel occupancy measurement by higher layers, and N_{freq} is defined in clause 8.1.2.1.1.

If the UE requires measurement gaps to perform inter-frequency measurements, a single measurement gap pattern is used for all concurrent inter-frequency measurements, including inter-frequency channel occupancy measurements.

The channel occupancy measurement performed and reported according to this section shall meet the channel occupancy measurement accuracy requirements in Section 9.1.18.6.2.

8.12 Discovery Signal Measurements for E-UTRA Carrier Aggregation under Operation with Frame Structure 3

8.12.1 Introduction

This section contains requirements on UE capabilities for support of E-UTRA carrier aggregation under operation with frame structure 3.

Non configured frequencies may be measured with measurement gaps according to the requirements in Section 8.11.2.2 and Section 8.11.3.2.

The requirements in Section 8.12 shall apply for E-UTRA carrier aggregation of one FDD PCell or one TDD PCell and SCell on one SCC, where the SCC is following the frame structure type 3 [16].

8.12.2 CRS based discovery signal measurements for E-UTRA carrier aggregation

8.12.2.1 Introduction

The requirements in Section 8.12.2 shall apply for CRS based discovery signal measurements comprising RSRP and RSRQ measurements [4].

8.12.2.2 Measurements of a secondary component carrier

A secondary component carrier may be activated and deactivated by MAC-CE commands as specified in [17]. The applicable performance requirements depend on whether the SCell on the corresponding frequency is activated or deactivated.

8.12.2.3 Measurements of a secondary component carrier with active SCell

When the SCell is activated, measurement performance requirements for the frequency are those given in Section 8.11.2.1. If common DRX is in use, then the requirements for that secondary component carrier are given by the DRX requirements in Section 8.11.2.1.1.2, otherwise the non-DRX requirements are applicable. The applicable measurement accuracy requirements are in Section 9.1.19.

8.12.2.4 Measurements of a secondary component carrier with deactivated SCell

This section defines the measurement requirements of a secondary component carrier with deactivated SCell based on the parameter *measCycleSCell* defined in TS 36.331 [2].

8.12.2.4.1 E-UTRAN secondary component carrier measurements when no common DRX is used

When no DRX is in use the UE shall be able to identify a new detectable cell on a secondary component carrier within the cell identification time $T_{\text{identify_SCC_FS3}}$, where the cell identification of a cell shall include detection of the cell and additionally performing a single measurement with measurement period of $T_{\text{measure_SCC_FS3_CRS}}$.

$T_{\text{identify_SCC_FS3}}$ is the time period for cell identification as specified in Table 8.12.2.4.1-1,

$T_{\text{measure_SCC_FS3_CRS}}$ is the time period for measurements as shown in Table 8.12.2.4.1-2,

$T_{\text{DMTC_periodicity}}$ is the discovery signal measurement timing configuration periodicity of higher layer,

L is the number of configured discovery signal occasions which are not available during $T_{\text{identify_SCC_FS3}}$ for cell identification at the UE due to the absence of the necessary radio signals from the cell,

M is the number of configured discovery signal occasions which are not available during $T_{\text{measure_SCC_FS3_CRS}}$ for the measurements at the UE due to the absence of the necessary radio signals from the cell.

Table 8.12.2.4.1-1: Cell identification with deactivated SCell on SCC under operation with frame structure 3

| SCH \hat{E} s/lot | CRS measurement bandwidth [RB] Note2 | CRS \hat{E} s/lot | $T_{\text{identify_SCC_FS3}}$ [ms] |
|--|---|---|---------------------------------------|
| $0 \leq \text{SCH } \hat{E}\text{s/lot}$ | <25 | $-6 \leq \text{CRS } \hat{E}\text{s/lot}$ | $(7+L) * k1 * \text{measCycleSCell}$ |
| $-6 \leq \text{SCH } \hat{E}\text{s/lot} < 0$ | <25 | | $(25+L) * k1 * \text{measCycleSCell}$ |
| $0 \leq \text{SCH } \hat{E}\text{s/lot}$ | ≥ 25 | $0 \leq \text{CRS } \hat{E}\text{s/lot}$ | $(3+L) * k1 * \text{measCycleSCell}$ |
| $-6 \leq \text{SCH } \hat{E}\text{s/lot} < 0$ | ≥ 25 | | $(9+L) * k1 * \text{measCycleSCell}$ |
| Note1: Discovery signal occasion duration (<i>ds-OccasionDuration</i>) is 1 ms. Note2: The requirements for measurement bandwidth ≥ 25 RB are optional. Note 3: $k1=2$ when the measurement gaps configured for inter-frequency measurements in DMTC occasions or for inter-frequency RSSI measurements in RMTC occasions on a carrier with frame structure 3 overlap with some but not all DMTC occasions of the measured cell; otherwise, $k1=1$, e.g., when measurement gaps configured for inter-frequency measurements on a carrier with frame structure 3 do not overlap with DMTC occasions of the measured cell or when the UE does not require the measurement gaps for the inter-frequency measurements. The requirements apply, provided that the inter-frequency measurement gap pattern does not overlap with all DMTC occasions of the measured cell. NOTE 4: The requirements apply, provided that L is such that the cell identification period $T_{\text{identify_SCC_FS3}}$ does not exceed $75 * k1 * \text{measCycleSCell}$. | | | |

A cell shall be considered detectable when the following conditions are met during the discovery signal occasions which are available during $T_{\text{identify_SCC_FS3}}$:

- RSRP related side condition given in Section 9.1.19 are fulfilled for a corresponding Band,
- $SCH_RP|_{dBm}$ is according to Annex B.2.12 for a corresponding Band and $SCH\ \hat{E}s/lot$ is according to Table 8.12.2.4.1-1.

The measurement period for deactivated SCell measurements is $T_{measure_SCC_FS3_CRS}$ according to the parameter *measCycleSCell* shown in Table 8.12.2.4.1-1.

Table 8.12.2.4.1-2: Measurement requirements on SCC with deactivated SCell under operation with frame structure 3 with deactivated SCell

| SCH $\hat{E}s/lot$ | CRS measurement bandwidth [RB] Note2 | CRS $\hat{E}s/lot$ | $T_{measure_SCC_FS3_CRS}$ [ms] |
|--|---|-----------------------------|-----------------------------------|
| $0 \leq SCH\ \hat{E}s/lot$ | <25 | $-6 \leq CRS\ \hat{E}s/lot$ | $(5+M) * k1 * measCycleSCell$ |
| $-6 \leq SCH\ \hat{E}s/lot < 0$ | <25 | | $(20+M) * k1 * measCycleSCell$ |
| $0 \leq SCH\ \hat{E}s/lot$ | ≥ 25 | $0 \leq CRS\ \hat{E}s/lot$ | $(1+M) * k1 * measCycleSCell$ |
| $-6 \leq SCH\ \hat{E}s/lot < 0$ | ≥ 25 | | $(4+M) * k1 * measCycleSCell$ |
| Note1: Discovery signal occasion duration (<i>ds-OccasionDuration</i>) is 1 ms. | | | |
| Note2: The requirements for measurement bandwidth ≥ 25 RB are optional. | | | |
| Note 3: $k1=2$ when the measurement gaps configured for inter-frequency measurements in DMTC occasions or for inter-frequency RSSI measurements in RMTC occasions on a carrier with frame structure 3 overlap with some but not all DMTC occasions of the measured cell; otherwise, $k1=1$, e.g., when measurement gaps configured for inter-frequency measurements on a carrier with frame structure 3 do not overlap with DMTC occasions of the measured cell or when the UE does not require the measurement gaps for the inter-frequency measurements. The requirements apply, provided that the inter-frequency measurement gap pattern does not overlap with all DMTC occasions of the measured cell. | | | |
| NOTE 4: The requirements apply, provided that M is such that the time period $T_{measure_SCC_FS3_CRS}$ for measurements does not exceed $60 * k1 * measCycleSCell$. | | | |

The UE shall be capable of performing RSRP and RSRQ measurements for 3 identified cells on a secondary component carrier, and the UE physical layer shall be capable of reporting measurements to higher layers within the measurement period of $T_{measure_SCC_FS3_CRS}$.

The measurement accuracy for all measured cells shall be as specified in Section 9.1.19.

A UE may reconfigure the receiver bandwidth or turn on/off one of the RF chains when performing measurements on one SCC with deactivated SCell. This may cause interruptions on PCell that are specified in Section 7.8.

8.12.2.4.1.1 Measurement Reporting Requirements

8.12.2.4.1.1.1 Periodic Reporting

Reported measurements contained in periodically triggered measurement reports shall meet the requirements in Section 9.

8.12.2.4.1.1.2 Event-triggered Periodic Reporting

Reported measurements contained in event triggered periodic measurement reports shall meet the requirements in Section 9.

The first report in event triggered periodic CRS based measurement reporting shall meet the requirements specified in Section 8.12.2.4.1.1.3.

8.12.2.4.1.1.3 Event Triggered Reporting

Reported measurements contained in event triggered measurement reports shall meet the requirements in Section 9.

The UE shall not send any event triggered measurement reports, as long as no reporting criteria are fulfilled.

The measurement reporting delay is defined as the time between an event that will trigger a measurement report and the point when the UE starts to transmit the measurement report over the air interface. This requirement assumes that the measurement report is not delayed by other RRC signalling on the DCCH. This measurement reporting delay excludes a delay uncertainty resulted when inserting the measurement report to the TTI of the uplink DCCH. The delay uncertainty is: $2 \times TTI_{DCCH}$. This measurement reporting delay excludes a delay which is caused by no UL resources for UE to send the measurement report.

The event triggered measurement reporting delay, measured without L3 filtering shall be less than $T_{identify_SCC_FS3}$ defined in Section 8.12.2.4.1. When L3 filtering is used or IDC autonomous denial is configured an additional delay can be expected.

If a cell which has been detectable at least for the time period $T_{identify_SCC_FS3}$ defined in Section 8.12.2.4.1 becomes undetectable for a period ≤ 8 seconds and then the cell becomes detectable again and triggers an event, the event triggered measurement reporting delay shall be less than $T_{identify_SCC_FS3_CRS}$ provided the timing to that cell has not changed more than $\pm 50 T_s$ and the L3 filter has not been used. When L3 filtering is used an additional delay can be expected.

8.12.2.4.2 E-UTRAN secondary component carrier measurements when common DRX is used

When DRX is in use the UE shall be able to identify a new detectable FS3 cell on a secondary component carrier within the cell identification time $T_{identify_SCC_FS3_DRX}$, according to the parameter *measCycleSCell*, where the cell identification time of a cell shall include detection of the cell and additionally performing a single measurement with measurement period of $T_{measure_SCC_FS3_CRS_DRX}$.

$T_{identify_SCC_FS3_DRX}$ is the time period for cell identification as shown in Table 8.12.2.4.2-1,

$T_{measure_SCC_FS3_CRS_DRX}$ is the time period for measurements as shown in Table 8.12.2.4.2-2,

$T_{DMTC_periodicity}$ is the discovery signal measurement timing configuration periodicity of higher layer,

L is the number of configured discovery signal occasions during ON DURATION and which are not available during $T_{identify_SCC_FS3_DRX}$ for cell identification at the UE due to the absence of the necessary radio signals from the cell,

M is the number of configured discovery signal occasions during ON DURATION and which are not available during $T_{measure_SCC_FS3_CRS_DRX}$ for the measurements at the UE due to the absence of the necessary radio signals from the cell.

Table 8.12.2.4.2-1: Cell identification on SCC with deactivated SCell under operation with frame structure 3

| SCH $\hat{E}s/lot$ | CRS measurement bandwidth [RB] Note2 | CRS $\hat{E}s/lot$ | $T_{identify_SCC_FS3_DRX}$ [ms] |
|--|---|------------------------------|---|
| $0 \leq SCH \hat{E}s/lot$ | <25 | $[-6] \leq CRS \hat{E}s/lot$ | $(7+L) * k1 * \text{Max}\{ measCycleSCell, DRX \text{ cycle length}\}$ |
| $-6 \leq SCH \hat{E}s/lot < 0$ | <25 | | $(25+L) * k1 * \text{Max}\{ measCycleSCell, DRX \text{ cycle length}\}$ |
| $0 \leq SCH \hat{E}s/lot$ | ≥ 25 | $[0] \leq CRS \hat{E}s/lot$ | $(3+L) * k1 * \text{Max}\{ measCycleSCell, DRX \text{ cycle length}\}$ |
| $-6 \leq SCH \hat{E}s/lot < 0$ | ≥ 25 | | $(9+L) * k1 * \text{Max}\{ measCycleSCell, DRX \text{ cycle length}\}$ |
| Note 1: Discovery signal occasion duration (<i>ds-OccasionDuration</i>) is 1 ms. Note 2: The requirements for measurement bandwidth ≥ 25 RB are optional. Note 3: $k1=2$ when the measurement gaps configured for inter-frequency measurements in DMTC occasions or for inter-frequency RSSI measurements in RMTC occasions on a carrier with frame structure 3 overlap with some but not all DMTC occasions of the measured cell during ON DURATION; otherwise, $k1=1$, e.g., when measurement gaps configured for inter-frequency measurements on a carrier with frame structure 3 do not overlap with DMTC occasions of the measured cell during ON DURATION or when the UE does not require the measurement gaps for the inter-frequency measurements. The requirements apply, provided that the inter-frequency measurement gap pattern does not overlap with all DMTC occasions of the measured cell. NOTE 4: The requirements apply, provided that L is such that the cell identification period $T_{identify_SCC_FS3_DRX}$ does not exceed $75 * k1 * \text{Max}\{ measCycleSCell, DRX \text{ cycle length}\}$. | | | |

A cell shall be considered detectable when the following conditions are met during the discovery signal occasions which are available during $T_{\text{identify_SCC_FS3_DRX}}$:

- RSRP related side condition given in Section 9.1.19 are fulfilled for a corresponding Band,
- $SCH_RP|_{\text{dBm}}$ is according to Annex B.2.12 for a corresponding Band and $SCH \hat{E}s/lot$ is according to Table 8.12.2.4.2-1.

The measurement period for deactivated scell measurements is $T_{\text{measure_SCC_FS3_CRS_DRX}}$ according to the parameter *measCycleSCell* shown in Table 8.12.2.4.2-2.

Table 8.12.2.4.2-2: Measurement requirements on SCC with deactivated SCell under operation with frame structure 3

| SCH $\hat{E}s/lot$ | CRS measurement bandwidth [RB] Note2 | CRS $\hat{E}s/lot$ | $T_{\text{measure_SCC_FS3_CRS_DRX}}$ [ms] |
|---|---|----------------------------|---|
| $0 \leq SCH \hat{E}s/lot$ | <25 | $-6 \leq CRS \hat{E}s/lot$ | $(5 + M) * k1 * \text{Max}\{ \text{measCycleSCell}, \text{DRX cycle length}\}$ |
| $-6 \leq SCH \hat{E}s/lot < 0$ | <25 | | $(20 + M) * k1 * \text{Max}\{ \text{measCycleSCell}, \text{DRX cycle length}\}$ |
| $0 \leq SCH \hat{E}s/lot$ | ≥ 25 | $0 \leq CRS \hat{E}s/lot$ | $(1 + M) * k1 * \text{Max}\{ \text{measCycleSCell}, \text{DRX cycle length}\}$ |
| $-6 \leq SCH \hat{E}s/lot < 0$ | ≥ 25 | | $(4 + M) * k1 * \text{Max}\{ \text{measCycleSCell}, \text{DRX cycle length}\}$ |
| Note 1: Discovery signal occasion duration (<i>ds-OccasionDuration</i>) is 1 ms. Note 2: The requirements for measurement bandwidth ≥ 25 RB are optional. Note 3: $k1=2$ when the measurement gaps configured for inter-frequency measurements in DMTC occasions or for inter-frequency RSSI measurements in RMTC occasions on a carrier with frame structure 3 overlap with some but not all DMTC occasions of the measured cell during ON DURATION; otherwise, $k1=1$, e.g., when measurement gaps configured for inter-frequency measurements on a carrier with frame structure 3 do not overlap with DMTC occasions of the measured cell during ON DURATION or when the UE does not require the measurement gaps for the inter-frequency measurements. The requirements apply, provided that the inter-frequency measurement gap pattern does not overlap with all DMTC occasions of the measured cell. NOTE 4: The requirements apply, provided that M is such that the time period $T_{\text{measure_SCC_FS3_CRS_DRX}}$ for measurements does not exceed $60 * k1 * \text{Max}\{ \text{measCycleSCell}, \text{DRX cycle length}\}$. | | | |

The UE shall be capable of performing RSRP and RSRQ measurements for 3 identified cells on a secondary component carrier, and the UE physical layer shall be capable of reporting measurements to higher layers with the measurement period of $T_{\text{measure_SCC_FS3_CRS_DRX}}$.

The measurement accuracy for all measured cells shall be as specified in Section 9.1.19.

A UE may reconfigure receiver bandwidth taking into account the SCell activation/deactivation status, and when making measurements of cells on one SCC with deactivated SCell. This may cause interruptions (packet drops) to a PCell. No interruptions while the On Duration timer is running shall be allowed when common DRX is used. The requirement considers only interruptions due to reconfiguration of the receiver bandwidth, and not due to other causes such as RF impairments or channel conditions.

8.12.2.4.2.1 Measurement Reporting Requirements

8.12.2.4.2.1.1 Periodic Reporting

Reported measurements contained in periodically triggered measurement reports shall meet the requirements in Section 9.

8.12.2.4.2.1.2 Event-triggered Periodic Reporting

Reported measurements contained in event triggered periodic measurement reports shall meet the requirements in Section 9.

The first report in event triggered periodic measurement reporting shall meet the requirements specified in Section 8.12.2.4.2.1.3.

8.12.2.4.2.1.3 Event Triggered Reporting

Reported measurements contained in event triggered measurement reports shall meet the requirements in Section 9.

The UE shall not send any event triggered CRS based measurement reports, as long as no reporting criteria are fulfilled.

The measurement reporting delay is defined as the time between an event that will trigger a measurement report and the point when the UE starts to transmit the measurement report over the air interface. This requirement assumes that the measurement report is not delayed by other RRC signalling on the DCCH. This measurement reporting delay excludes a delay uncertainty resulted when inserting the measurement report to the TTI of the uplink DCCH. The delay uncertainty is: $2 \times TTI_{DCCH}$. This measurement reporting delay excludes a delay which is caused by no UL resources for UE to send the measurement report.

The event triggered measurement reporting delay, measured without L3 filtering shall be less than $T_{identify_SCC_FS3}$ defined in Section 8.12.2.4.2. When L3 filtering is used or IDC autonomous denial is configured an additional delay can be expected.

If a cell which has been detectable at least for the time period $T_{identify_SCC_FS3_DRX}$ defined in Section 8.12.2.4.2 becomes undetectable for a period ≤ 8 seconds and then the cell becomes detectable again and triggers an event, the event triggered measurement reporting delay shall be less than $T_{identify_SCC_FS3_CRS_DRX}$ provided the timing to that cell has not changed more than $\pm 50 T_s$ and the L3 filter has not been used. When L3 filtering is used an additional delay can be expected.

8.12.3 Requirements for CSI-RS based discovery signal measurements for E-UTRA carrier aggregation

8.12.3.1 Introduction

The requirements in Section 8.12.3 shall apply for CSI-RS based discovery signal measurements comprising CSI-RSRP measurements [4].

8.12.3.2 Measurements of a secondary component carrier

A Secondary component carrier may be activated and deactivated by MAC-CE commands as specified in [17]. The applicable performance requirements depend on whether the SCell on the corresponding frequency is activated or deactivated.

8.12.3.3 Measurements of a secondary component carrier with active SCell

When the SCell is activated, measurement performance requirements for the frequency are those given in Section 8.11.3.1. If common DRX is in use, then the requirements for that secondary component carrier are given by the DRX requirements in Section 8.11.3.1.1.2, otherwise the non DRX requirements are applicable. The applicable measurement accuracy requirements are in Section 9.1.19.

8.12.3.4 Measurements of a secondary component carrier with deactivated SCell

This section defines the measurement requirements of a secondary component carrier with deactivated SCell based on the parameter *measCycleSCell* defined in TS 36.331 [2].

8.12.3.4.1 E-UTRAN secondary component carrier measurements when no common DRX is used

When no DRX is in use the UE shall be able to identify a new detectable FS3 TP on a secondary component carrier within the cell identification time $T_{identify_SCC_TP_FS3}$, where the identification of a TP shall include cell identification and a single measurement on the TP within the measurement period $T_{measure_SCC_FS3_CSI-RS}$.

$$T_{identify_SCC_TP_FS3} = T_{identify_SCC_FS3} + T_{measure_SCC_FS3_CSI-RS}$$

where:

$T_{\text{identify_SCC_FS3}}$ is the time period for cell identification in Section 8.12.2.4.1,

$T_{\text{measure_SCC_FS3_CSI-RS}}$ is the time period for TP measurement in Table 8.12.3.4.1-1,

M is the number of configured discovery signal occasions which are not available for the measurements at the UE during $T_{\text{measure_SCC_FS3_CSI-RS}}$ due to the absence of the necessary radio signals from the cell.

During $T_{\text{identify_SCC_TP_FS3}}$ over multiple discovery signal occasions, the UE may assume the following:

- in all the discovery signal occasions, which are available at the UE, the corresponding necessary cell-specific discovery signals are always available from the same set of TPs in the measured cell, and
- in all the discovery signal occasions, which are not available at the UE, the corresponding necessary cell-specific discovery signals are not available from any TP within the same measured cell.

Table 8.12.3.4.1-1: Measurement requirements for a TP on SCC with deactivated SCell under operation with frame structure 3

| SCH \hat{E}_s/lot | CSI-RS measurement bandwidth [RB] ^{Note2} | CSI-RS \hat{E}_s/lot | $T_{\text{measure_SCC_FS3_CSI-RS}}$ [ms] |
|--|--|--|---|
| $[0] \leq \text{SCH } \hat{E}_s/\text{lot}$ | <25 | $[0] \leq \text{CSI-RS } \hat{E}_s/\text{lot}$ | $([5]+M) * k1 * \text{measCycleSCell}$ |
| $[-6] \leq \text{SCH } \hat{E}_s/\text{lot} < [0]$ | <25 | | $([20]+M) * k1 * \text{measCycleSCell}$ |
| $[0] \leq \text{SCH } \hat{E}_s/\text{lot}$ | ≥ 25 | $[0] \leq \text{CSI-RS } \hat{E}_s/\text{lot}$ | $([1]+M) * k1 * \text{measCycleSCell}$ |
| $[-6] \leq \text{SCH } \hat{E}_s/\text{lot} < [0]$ | ≥ 25 | | $([4]+M) * k1 * \text{measCycleSCell}$ |
| Note1: Discovery signal occasion duration (<i>ds-OccasionDuration</i>) is 1 ms. | | | |
| Note2: The requirements for measurement bandwidth ≥ 25 RB are optional. | | | |
| Note 3: $k1=2$ when the measurement gaps configured for inter-frequency measurements in DMTC occasions or for inter-frequency RSSI measurements in RMTC occasions on a carrier with frame structure 3 overlap with some but not all DMTC occasions of the measured TP; otherwise, $k1=1$, e.g., when measurement gaps configured for inter-frequency measurements on a carrier with frame structure 3 do not overlap with DMTC occasions of the measured TP or when the UE does not require the measurement gaps for the inter-frequency measurements. The requirements apply, provided that the inter-frequency measurement gap pattern does not overlap with all DMTC occasions of the measured cell. | | | |
| NOTE 4: The requirements apply, provided that M is such that the time period $T_{\text{measure_SCC_FS3_CSI-RS}}$ for TP measurement does not exceed $[60]*k1 * \text{measCycleSCell}$. | | | |

A TP shall be considered detectable when the following conditions are met during the discovery signal occasions which are available during $T_{\text{identify_SCC_TP_FS3}}$:

- CSI-RSRP related side condition given in Section 9.1.19 are fulfilled for a corresponding Band,
- $\text{SCH_RP}|_{\text{dBm}}$ is according to Annex B.2.12 for a corresponding Band and SCH \hat{E}_s/lot is according to Table 8.12.2.4.1-1.

The UE shall be capable of performing RSRP measurements for 3 identified TPs on a secondary component carrier, and the UE physical layer shall be capable of reporting measurements to higher layers with the measurement period of $T_{\text{measure_SCC_FS3_CSI-RS}}$.

The measurement accuracy for all measured TPs shall be as specified in Section 9.1.19.

A UE may reconfigure the receiver bandwidth or turn on/off one of the RF chains when performing measurements on one SCC with deactivated SCell. This may cause interruptions on PCell that are specified in Section 7.8.

8.12.3.4.1.1 Measurement Reporting Requirements

8.12.3.4.1.1.1 Periodic Reporting

Reported measurements contained in periodically triggered measurement reports shall meet the requirements in Section 9.

8.12.3.4.1.1.2 Event-triggered Periodic Reporting

Reported measurements contained in event triggered periodic measurement reports shall meet the requirements in Section 9.

The first report in event triggered periodic measurement reporting shall meet the requirements specified in Section 8.12.3.4.1.1.3.

8.12.3.4.1.1.3 Event Triggered Reporting

Reported measurements contained in event triggered measurement reports shall meet the requirements in Section 9.

The UE shall not send any event triggered measurement reports, as long as no reporting criteria are fulfilled.

The measurement reporting delay is defined as the time between an event that will trigger a measurement report and the point when the UE starts to transmit the measurement report over the air interface. This requirement assumes that the measurement report is not delayed by other RRC signalling on the DCCH. This measurement reporting delay excludes a delay uncertainty resulted when inserting the measurement report to the TTI of the uplink DCCH. The delay uncertainty is: $2 \times TTI_{DCCH}$. This measurement reporting delay excludes a delay which is caused by no UL resources for UE to send the measurement report.

The event triggered measurement reporting delay, measured without L3 filtering shall be less than $T_{identify_SCC_TP_FS3}$ defined in Section 8.12.3.4.1. When L3 filtering is used or IDC autonomous denial is configured an additional delay can be expected.

If a TP which has been detectable at least for the time period $T_{identify_SCC_TP_FS3}$ defined in Section 8.12.3.4.1 becomes undetectable for a period $\leq [8]$ seconds and then the TP becomes detectable again and triggers an event, the event triggered measurement reporting delay shall be less than $T_{identify_SCC_FS3_CSI-RS}$ provided the timing to that TP has not changed more than $\pm 50 T_s$ and the L3 filter has not been used. When L3 filtering is used an additional delay can be expected.

8.12.3.4.2 E-UTRAN secondary component carrier measurements when common DRX is used

When DRX is in use the UE shall be able to identify a new detectable FS3 TP on a secondary component carrier within $T_{identify_SCC_TP_FS3_DRX}$, according to the parameter *measCycleSCell*, where the identification of a TP shall include cell identification and a single measurement on the TP within the measurement period $T_{measure_SCC_FS3_CSI-RS_DRX}$.

$$T_{identify_SCC_TP_FS3_DRX} = T_{identify_SCC_FS3_DRX} + T_{measure_SCC_FS3_CSI-RS_DRX},$$

where:

$T_{identify_SCC_FS3_DRX}$ is the time period for cell identification in Section 8.12.2.4.2,

$T_{measure_SCC_FS3_CSI-RS_DRX}$ is the time period for TP measurement in Table 8.12.3.4.2-1,

M is the number of configured discovery signal occasions during ON DURATION and which are not available during $T_{measure_SCC_FS3_CSI-RS_DRX}$ for the measurements at the UE due to the absence of the necessary radio signals from the cell.

During $T_{identify_SCC_TP_FS3_DRX}$ over multiple discovery signal occasions, the UE may assume the following:

- in all the discovery signal occasions, which are available at the UE, the corresponding necessary cell-specific discovery signals are always available from the same set of TPs in the measured cell, and
- in all the discovery signal occasions, which are not available at the UE, the corresponding necessary cell-specific discovery signals are not available from any TP within the same measured cell.

Table 8.12.3.4.2-1: Measurement requirements for a TP on SCC with deactivated SCell under operation with frame structure 3

| SCH \hat{E} s/lot | CSI-RS measurement bandwidth [RB] ^{Note2} | CSI-RS \hat{E} s/lot | $T_{measure_SCC_FS3_CSI-RS_DRX}$ [ms] |
|--|--|---|---|
| $[0] \leq \text{SCH } \hat{E}\text{s/lot}$ | <25 | $[0] \leq \text{CSI-RS } \hat{E}\text{s/lot}$ | $([5]+M) * k1 * \text{Max}\{ \text{measCycleSCell}, \text{DRX cycle length} \}$ |

| | | | |
|--|-----------|---|--|
| $[-6] \leq \text{SCH } \hat{E}s/\text{lot} < [0]$ | < 25 | | $([20]+M) * k1 * \text{Max}\{ \text{measCycleSCell}, \text{DRX cycle length} \}$ |
| $[0] \leq \text{SCH } \hat{E}s/\text{lot}$ | ≥ 25 | $[0] \leq \text{CSI-RS } \hat{E}s/\text{lot}$ | $([1]+M) * k1 * \text{Max}\{ \text{measCycleSCell}, \text{DRX cycle length} \}$ |
| $[-6] \leq \text{SCH } \hat{E}s/\text{lot} < [0]$ | ≥ 25 | | $([4]+M) * k1 * \text{Max}\{ \text{measCycleSCell}, \text{DRX cycle length} \}$ |
| <p>Note1: Discovery signal occasion duration (<i>ds-OccasionDuration</i>) is 1 ms.</p> <p>Note2: The requirements for measurement bandwidth ≥ 25 RB are optional.</p> <p>Note 3: $k1=2$ when the measurement gaps configured for inter-frequency measurements in DMTC occasions or for inter-frequency RSSI measurements in RMTTC occasions on a carrier with frame structure 3 overlap with some but not all DMTC occasions of the measured TP during ON DURATION; otherwise, $k1=1$, e.g., when measurement gaps configured for inter-frequency measurements on a carrier with frame structure 3 do not overlap with DMTC occasions of the measured TP during ON DURATION or when the UE does not require the measurement gaps for the inter-frequency measurements. The requirements apply, provided that the inter-frequency measurement gap pattern does not overlap with all DMTC occasions of the measured cell.</p> <p>NOTE 4: The requirements apply, provided that M is such that the time period $T_{\text{measure_SCC_FS3_CSI-RS_DRX}}$ for TP measurement does not exceed $[60]*k1*\text{Max}\{\text{measCycleSCell}, \text{DRX cycle length}\}$.</p> | | | |

A TP shall be considered detectable when the following conditions are met during the discovery signal occasions which are available during $T_{\text{identify_SCC_TP_FS3_DRX}}$:

- CSI-RSRP related side condition given in Section 9.1.19 are fulfilled for a corresponding Band,
- $\text{SCH_RP}|_{\text{dBm}}$ is according to Annex B.2.12 for a corresponding Band and $\text{SCH } \hat{E}s/\text{lot}$ is according to Table 8.12.2.4.2-1.

The UE shall be capable of performing CSI-RSRP measurements for 3 identified TPs on a secondary component carrier, and the UE physical layer shall be capable of reporting measurements to higher layers with the measurement period of $T_{\text{measure_SCC_FS3_CSI-RS_DRX}}$.

The measurement accuracy for all measured TPs shall be as specified in Section 9.1.19.

A UE may reconfigure receiver bandwidth taking into account the SCell activation/deactivation status, and when making measurements of TPs on one SCC with deactivated SCell. This may cause interruptions (packet drops) to a PCell. No interruptions while the On Duration timer is running shall be allowed when common DRX is used. The requirement considers only interruptions due to reconfiguration of the receiver bandwidth, and not due to other causes such as RF impairments or channel conditions.

8.12.3.4.2.1 Measurement Reporting Requirements

8.12.3.4.2.1.1 Periodic Reporting

Reported measurements contained in periodically triggered measurement reports shall meet the requirements in Section 9.

8.12.3.4.2.1.2 Event-triggered Periodic Reporting

Reported measurements contained in event triggered periodic measurement reports shall meet the requirements in Section 9.

The first report in event triggered periodic measurement reporting shall meet the requirements specified in Section 8.12.3.4.2.1.3.

8.12.3.4.2.1.3 Event Triggered Reporting

Reported measurements contained in event triggered measurement reports shall meet the requirements in Section 9.

The UE shall not send any event triggered measurement reports, as long as no reporting criteria are fulfilled.

The measurement reporting delay is defined as the time between an event that will trigger a measurement report and the point when the UE starts to transmit the measurement report over the air interface. This requirement assumes that the measurement report is not delayed by other RRC signalling on the DCCH. This measurement reporting delay excludes a

delay uncertainty resulted when inserting the measurement report to the TTI of the uplink DCCH. The delay uncertainty is: $2 \times TTI_{DCCH}$. This measurement reporting delay excludes a delay which is caused by no UL resources for UE to send the measurement report.

The event triggered measurement reporting delay, measured without L3 filtering shall be less than $T_{identify_SCC_TP_FS3_DRX}$ defined in Section 8.12.3.4.2. When L3 filtering is used or IDC autonomous denial is configured an additional delay can be expected.

If a TP which has been detectable at least for the time period $T_{identify_SCC_TP_FS3_DRX}$ defined in Section 8.12.3.4.2 becomes undetectable for a period $\leq [8]$ seconds and then the TP becomes detectable again and triggers an event, the event triggered measurement reporting delay shall be less than $T_{identify_SCC_FS3_CSI-RS_DRX}$ provided the timing to that TP has not changed more than $\pm 50 T_s$ and the L3 filter has not been used. When L3 filtering is used an additional delay can be expected.

8.13 Measurements for UE Category M1

8.13.1 Introduction

The UE category M1 applicability of the requirements in subclause 8.13 is defined in Section 3.6.

This clause contains requirements on the UE regarding measurement reporting in RRC_CONNECTED state. The requirements are specified for E-UTRA intra frequency measurements. These measurements may be used by the E-UTRAN, e.g. for handover decisions. The measurement quantities are defined in [4], the measurement model is defined in [22] and measurement accuracies are specified in clause 9. Control of measurement reporting is specified in TS 36.331 [2].

When the UE is provided with IDC solution, the UE shall also perform RRM measurements and meet the corresponding requirements in clause 8.

8.13.2 Requirements for UE category M1 with CE mode A

The UE category M1 applicability of the requirements in subclause 8.13.2 is defined in Section 3.6. The requirements defined in clause 8.13.2 apply provided the following conditions are met:

- UE is configured with measurement gap according to any of gap patterns defined in Table 8.1.2.1-1.

Alternatively, the UE shall meet the requirements in subclause 8.13.2 defined for Gap Pattern ID#0 without using any measurement gaps provided:

- UE indicates it does not need gaps with the capability `intraFreq-CE-NeedForGaps-r13` [2, TS36.331] for the frequency band of the serving cell.

8.13.2.1 E-UTRAN intra frequency measurements by UE category M1 with CE mode A

The UE shall be able to identify new intra-frequency cells and perform RSRP measurements of identified intra-frequency cells without an explicit intra-frequency neighbour cell list containing physical layer cell identities. During the RRC_CONNECTED state the UE shall continuously measure identified intra frequency cells and additionally search for and identify new intra frequency cells.

8.13.2.1.1 E-UTRAN FDD intra frequency measurements

8.13.2.1.1.1 E-UTRAN intra frequency measurements when no DRX is used

When no DRX is in use the UE shall be able to identify and measure a new detectable FDD intra frequency cell according to requirements in Table 8.13.2.1.1.1-1 when $SCH \hat{E}_s/I_{ot} \geq -6$ dB

Table 8.13.2.1.1.1-1: Requirement on cell identification delay and measurement delay for FDD intrafrequency cell

| Gap pattern ID | Cell identification delay ($T_{\text{identify_intra_UE cat M1}}$) | Measurement delay ($T_{\text{measure_intra_UE cat M1}}$) |
|----------------|---|--|
| 0 | 1.44 seconds | 480 ms |
| 1 | 2.88 seconds | 960 ms |

A cell shall be considered detectable when

- RSRP related side conditions given in Sections 9.1.21.1 and 9.1.21.2 are fulfilled for a corresponding Band,
- SCH_RP and SCH \hat{E}_s/Tot according to Annex Table B.2.14-1 for a corresponding Band.

Identification of a cell shall include detection of the cell and additionally performing a single measurement with measurement period of $T_{\text{measure_intra_UE cat M1}}$. If higher layer filtering is used, an additional cell identification delay can be expected.

In the RRC_CONNECTED state the measurement period for intra frequency measurements is according to Table 8.13.2.1.1.1-1. When measurement gaps are activated the UE shall be capable of performing measurements for at least 6 cells. If the UE has identified more than 6 cells, the UE shall perform measurements but the reporting rate of RSRP measurement of cells from UE physical layer to higher layers may be decreased.

The RSRP measurement accuracy for all measured cells shall be as specified in the sub-clauses 9.1.21.1 and 9.1.21.2.

8.13.2.1.1.1.1 Measurement Reporting Requirements

8.13.2.1.1.1.1.1 Periodic Reporting

Reported RSRP measurement contained in periodically triggered measurement reports shall meet the requirements in sections 9.1.21.1 and 9.1.21.2.

8.13.2.1.1.1.1.2 Event-triggered Periodic Reporting

Reported RSRP measurement contained in event triggered periodic measurement reports shall meet the requirements in sections 9.1.21.1 and 9.1.21.2.

The first report in event triggered periodic measurement reporting shall meet the requirements specified in clause 8.13.2.1.1.1.1.3.

8.13.2.1.1.1.1.3 Event Triggered Reporting

Reported RSRP measurement contained in event triggered measurement reports shall meet the requirements in sections 9.1.21.1 and 9.1.21.2.

The UE shall not send any event triggered measurement reports, as long as no reporting criteria are fulfilled.

The measurement reporting delay is defined as the time between an event that will trigger a measurement report and the point when the UE starts to transmit the measurement report over the air interface. This requirement assumes that the measurement report is not delayed by other RRC signalling on the DCCH. This measurement reporting delay excludes a delay uncertainty resulted when inserting the measurement report to the TTI of the uplink DCCH. The delay uncertainty is: $2 \times TTI_{\text{DCCH}}$. This measurement reporting delay excludes a delay which caused by no UL resources for UE to send the measurement report.

The event triggered measurement reporting delay, measured without L3 filtering shall be less than $T_{\text{identify_intra_UE cat M1}}$ defined in Clause 8.13.2.1.1.1. When L3 filtering is used or IDC autonomous denial is configured an additional delay can be expected.

If a cell which has been detectable at least for the time period $T_{\text{identify_intra_UE cat M1}}$ defined in clause 8.13.2.1.1.1 becomes undetectable for a period ≤ 5 seconds and then the cell becomes detectable again and triggers an event, the event triggered measurement reporting delay shall be less than $T_{\text{measure_intra_UE cat M1}}$ provided the timing to that cell has not changed more than $\pm 50 T_s$ and the L3 filter has not been used. When L3 filtering is used or IDC autonomous denial is configured, an additional delay can be expected.

8.13.2.1.1.2 E-UTRAN intra frequency measurements when DRX is used

When DRX is in use the UE shall be able to identify a new detectable FDD intra frequency cell within $T_{\text{identify_intra_UE cat M1}}$ as shown in table 8.13.2.1.1.2-1.

When eDRX_CONN is in use the UE shall be able to identify a new detectable FDD intra frequency cell within $T_{\text{identify_intra_UE cat M1}}$ as shown in table 8.13.2.1.1.2-1A.

Table 8.13.2.1.1.2-1: Requirement to identify a newly detectable FDD intrafrequency cell

| Gap pattern ID | DRX cycle length (s) | $T_{\text{identify_intra_UE cat M1}}$ (s) (DRX cycles) |
|--|--------------------------------------|--|
| 0 | ≤ 0.04 | 1.44 (Note1) |
| | $0.04 < \text{DRX-cycle} \leq 0.08$ | Note2 (40) |
| | 0.128 | 3.2 (25) |
| | $0.128 < \text{DRX-cycle} \leq 2.56$ | Note2(20) |
| 1 | < 0.128 | 2.88 (Note1) |
| | 0.128 | 3.2 (25) |
| | $0.128 < \text{DRX-cycle} \leq 2.56$ | Note2(20) |
| Note1: Number of DRX cycle depends upon the DRX cycle in use | | |
| Note2: Time depends upon the DRX cycle in use | | |

Table 8.13.2.1.1.2-1A: Requirement to identify a newly detectable FDD intrafrequency cell when eDRX_CONN cycle is used

| eDRX_CONN cycle length (s) | $T_{\text{identify_intra_UE cat M1}}$ (s) (eDRX_CONN cycles) |
|--|--|
| $2.56 < \text{eDRX_CONN cycle} \leq 10.24$ | Note (20) |
| NOTE: Time depends upon the eDRX_CONN cycle in use | |

A cell shall be considered detectable when

- RSRP related side conditions given in Sections 9.1.21.1 and 9.1.21.2 are fulfilled for a corresponding Band,
- SCH_RP and SCH \hat{E}_s/I_{ot} according to Annex B.2.14-1 for a corresponding Band

In the RRC_CONNECTED state the measurement period for intra frequency measurements is $T_{\text{measure_intra_UE cat M1}}$. When DRX is used, $T_{\text{measure_intra_UE cat M1}}$ is as specified in table 8.13.2.1.1.2-2. When eDRX_CONN is used, $T_{\text{measure_intra_UE cat M1}}$ is as specified in table 8.13.2.1.1.2-3. The UE shall be capable of performing RSRP measurements for 6 identified-intra-frequency cells, and the UE physical layer shall be capable of reporting measurements to higher layers with the measurement period of $T_{\text{measure_intra_UE cat M1}}$.

Table 8.13.2.1.1.2-2: Requirement to measure FDD intrafrequency cells

| Gap pattern ID | DRX cycle length (s) | $T_{\text{measure_intra_UE cat M1}}$ (s) (DRX cycles) |
|--|---|---|
| 0 | < 0.128 | 0.48 (Note1) |
| | $0.128 \leq \text{DRX-cycle} \leq 2.56$ | Note2 (5) |
| 1 | < 0.256 | 0.96 (Note1) |
| | $0.256 \leq \text{DRX-cycle} \leq 2.56$ | Note2 (5) |
| Note1: Number of DRX cycle depends upon the DRX cycle in use | | |
| Note2: Time depends upon the DRX cycle in use | | |

Table 8.13.2.1.1.2-3: Requirement to measure FDD intrafrequency cells when eDRX_CONN cycle is used

| eDRX_CONN cycle length (s) | $T_{\text{measure_intra_UE cat M1}}$ (s) (eDRX_CONN cycles) |
|--|--|
| $2.56 < \text{eDRX_CONN cycle} \leq 10.24$ | Note (5) |
| NOTE: Time depends upon the eDRX_CONN cycle in use | |

The RSRP measurement accuracy for all measured cells shall be as specified in the sub-clauses 9.1.21.1 and 9.1.21.2.

8.13.2.1.1.2.1 Measurement Reporting Requirements

8.13.2.1.1.2.1.1 Periodic Reporting

Reported RSRP measurement contained in periodically triggered measurement reports shall meet the requirements in sections 9.1.21.1 and 9.1.21.2.

8.13.2.1.1.2.1.2 Event-triggered Periodic Reporting

Reported RSRP measurement contained in event triggered periodic measurement reports shall meet the requirements in sections 9.1.21.1 and 9.1.21.2.

The first report in event triggered periodic measurement reporting shall meet the requirements specified in clause 8.13.2.1.1.2.1.3.

8.13.2.1.1.2.1.3 Event Triggered Reporting

Reported RSRP measurement contained in event triggered measurement reports shall meet the requirements in sections 9.1.21.1 and 9.1.21.2.

The UE shall not send any event triggered measurement reports, as long as no reporting criteria are fulfilled.

The measurement reporting delay is defined as the time between an event that will trigger a measurement report and the point when the UE starts to transmit the measurement report over the air interface. This requirement assumes that the measurement report is not delayed by other RRC signalling on the DCCH. This measurement reporting delay excludes a delay uncertainty resulted when inserting the measurement report to the TTI of the uplink DCCH. The delay uncertainty is: $2 \times TTI_{\text{DCCH}}$. This measurement reporting delay excludes a delay which caused by no UL resources for UE to send the measurement report.

The event triggered measurement reporting delay, measured without L3 filtering shall be less than $T_{\text{identify_intra_UE cat M1}}$ defined in Clause 8.13.2.1.1.2. When L3 filtering is used or IDC autonomous denial is configured an additional delay can be expected.

If a cell which has been detectable at least for the time period $T_{\text{identify_intra_UE cat M1}}$ defined in clause 8.13.2.1.1.2 becomes undetectable for a period ≤ 5 seconds and then the cell becomes detectable again and triggers an event, the event triggered measurement reporting delay shall be less than $T_{\text{measure_intra_UE cat M1}}$ provided the timing to that cell has not changed more than $\pm 50 T_s$ and the L3 filter has not been used. When L3 filtering is used or IDC autonomous denial is configured, an additional delay can be expected.

8.13.2.1.2 E-UTRAN intra frequency measurements for HD-FDD

8.13.2.1.2.1 E-UTRAN intra frequency measurements when no DRX is used

The requirements in this section are applicable for the UE which supports half duplex operation on one or more supported frequency bands [2].

The requirements defined in clause 8.13.2.1.1.1 also apply for this section provided the following conditions are met:

- at least downlink subframe # 0 or downlink subframe # 5 per radio frame of an intra-frequency cell to be identified by the UE is available at the UE over $T_{\text{identify_intra_UE cat M1}}$;

- at least one downlink subframe per radio frame of measured cell is available at the UE for RSRP measurement assuming measured cell is identified cell over $T_{measure_intra_UE\ cat\ M1}$.
- SCH_RP and $SCH\ \hat{E}s/Iot$ according to Annex Table B.2.14-2 for a corresponding Band

8.13.2.1.2.2 E-UTRAN intra frequency measurements when DRX is used

The requirements in this section are applicable for the UE which supports half duplex operation on one or more supported frequency bands [2].

When DRX is in use the UE shall be able to identify a new detectable HD-FDD intra frequency cell within $T_{identify_intra_UE\ cat\ M1}$ as shown in table 8.13.2.1.2.2-1.

When eDRX_CONN is in use, the UE shall be able to identify a new detectable FDD intra frequency cell within $T_{identify_intra_UE\ cat\ M1}$ as shown in table 8.13.2.1.2.2-1A.

Table 8.13.2.1.2.2-1: Requirement to identify a newly detectable HD-FDD intrafrequency cell

| Gap pattern ID | DRX cycle length (s) | $T_{identify_intra_UE\ cat\ M1}$ (s) (DRX cycles) |
|--|--------------------------------------|---|
| 0 | ≤ 0.04 | 1.44 (Note1) |
| | $0.04 < DRX\text{-}cycle \leq 0.08$ | Note2 (40) |
| | 0.128 | 3.2 (32) |
| | $0.128 < DRX\text{-}cycle \leq 2.56$ | Note2(25) |
| 1 | ≤ 0.08 | 2.88 (Note1) |
| | 0.128 | 3.2 (32) |
| | $0.128 < DRX\text{-}cycle \leq 2.56$ | Note2(25) |
| Note1: Number of DRX cycle depends upon the DRX cycle in use | | |
| Note2: Time depends upon the DRX cycle in use | | |

Table 8.13.2.1.2.2-1A: Requirement to identify a newly detectable HD-FDD intrafrequency cell when eDRX_CONN cycle is used

| eDRX_CONN cycle length (s) | $T_{identify_intra_UE\ cat\ M1}$ (s) (eDRX_CONN cycles) |
|--|---|
| $2.56 < eDRX_CONN\ cycle \leq 10.24$ | Note (25) |
| NOTE: Time depends upon the eDRX_CONN cycle in use | |

A cell shall be considered detectable when

- RSRP related side conditions given in Sections 9.1.21.1 and 9.1.21.2 are fulfilled for a corresponding Band,
- SCH_RP and $SCH\ \hat{E}s/Iot$ according to Annex Table B.2.14-2 for a corresponding Band

In the RRC_CONNECTED state the measurement period for intra frequency measurements is $T_{measure_intra_UE\ cat\ M1}$. When DRX is used, $T_{measure_intra_UE\ cat\ M1}$ is as specified in table 8.13.2.1.2.2-2. When eDRX_CONN is used, $T_{measure_intra_UE\ cat\ M1}$ is as specified in table 8.13.2.1.2.2-3. The UE shall be capable of performing RSRP measurements for 6 identified-intra-frequency cells, and the UE physical layer shall be capable of reporting measurements to higher layers with the measurement period of $T_{measure_intra_UE\ cat\ M1}$.

Table 8.13.2.1.2.2-2: Requirement to measure HD-FDD intrafrequency cells

| Gap pattern ID | DRX cycle length (s) | $T_{identify_intra_UE\ cat\ M1}$ (s) (DRX cycles) |
|----------------|--|---|
| 0 | < 0.08 | 0.48 (Note1) |
| | $0.08 \leq DRX\text{-}cycle \leq 0.16$ | Note2 (7) |
| | $0.16 < DRX\text{-}cycle \leq 2.56$ | Note2(5) |

| | | |
|--|---------------------|--------------|
| 1 | <0.16 | 0.96 (Note1) |
| | DRX-cycle=0.16 | 1.12 (7) |
| | 0.16<DRX-cycle≤2.56 | Note2(5) |
| Note1: Number of DRX cycle depends upon the DRX cycle in use | | |
| Note2: Time depends upon the DRX cycle in use | | |

Table 8.13.2.1.2.2-3: Requirement to measure HD-FDD intrafrequency cells when eDRX_CONN cycle is used

| eDRX_CONN cycle length (s) | $T_{\text{measure_intra_UE cat M1}}$ (s) (eDRX_CONN cycles) |
|--|--|
| 2.56<eDRX_CONN cycle≤10.24 | Note (5) |
| NOTE: Time depends upon the eDRX_CONN cycle in use | |

The RSRP measurement accuracy for all measured cells shall be as specified in the sub-clauses 9.1.21.1 and 9.1.21.2.

8.13.2.1.2.2.1 Measurement Reporting Requirements

8.13.2.1.2.2.1.1 Periodic Reporting

Reported RSRP measurement contained in periodically triggered measurement reports shall meet the requirements in sections 9.1.21.1 and 9.1.21.2.

8.13.2.1.2.2.1.2 Event-triggered Periodic Reporting

Reported RSRP measurement contained in event triggered periodic measurement reports shall meet the requirements in sections 9.1.21.1 and 9.1.21.2.

The first report in event triggered periodic measurement reporting shall meet the requirements specified in clause 8.13.2.1.2.2.1.3.

8.13.2.1.2.2.1.3 Event Triggered Reporting

Reported RSRP measurement contained in event triggered measurement reports shall meet the requirements in sections 9.1.21.1 and 9.1.21.2.

The UE shall not send any event triggered measurement reports, as long as no reporting criteria are fulfilled.

The measurement reporting delay is defined as the time between an event that will trigger a measurement report and the point when the UE starts to transmit the measurement report over the air interface. This requirement assumes that the measurement report is not delayed by other RRC signalling on the DCCH. This measurement reporting delay excludes a delay uncertainty resulted when inserting the measurement report to the TTI of the uplink DCCH. The delay uncertainty is: $2 \times TTI_{\text{DCCH}}$. This measurement reporting delay excludes a delay which caused by no UL resources for UE to send the measurement report.

The event triggered measurement reporting delay, measured without L3 filtering shall be less than $T_{\text{identify_intra_UE cat M1}}$ defined in Clause 8.13.2.1.2.2 When L3 filtering is used or IDC autonomous denial is configured an additional delay can be expected.

If a cell which has been detectable at least for the time period $T_{\text{identify_intra_UE cat M1}}$ defined in clause 8.13.2.1.2.2 becomes undetectable for a period ≤ 5 seconds and then the cell becomes detectable again and triggers an event, the event triggered measurement reporting delay shall be less than $T_{\text{measure_intra_UE cat M1}}$ provided the timing to that cell has not changed more than $\pm 50 T_s$ and the L3 filter has not been used. When L3 filtering is used or IDC autonomous denial is configured, an additional delay can be expected.

8.13.2.1.3 E-UTRAN TDD intra frequency measurements

8.13.2.1.3.1 E-UTRAN intra frequency measurements when no DRX is used

When no DRX is in use, the UE shall be able to identify and measure a new detectable TDD intra frequency cell according to requirements in Table 8.13.2.1.3.1-1 when $SCH \hat{E}s/Iot \geq -6$ dB

Table 8.13.2.1.3.1-1: Requirement on cell identification delay and measurement delay for TDD intrafrequency cell

| Gap pattern ID | Cell identification delay ($T_{\text{identify_intra_UE cat M1}}$) | Measurement delay ($T_{\text{measure_intra_UE cat M1}}$) |
|----------------|---|--|
| 0 | 1.44 seconds | 480 ms |
| 1 | 2.88 seconds | 960 ms |

A cell shall be considered detectable when

- RSRP related side conditions given in Sections 9.1.21.1 and 9.1.21.2 are fulfilled for a corresponding Band,
- SCH_RP and $SCH \hat{E}s/Iot$ according to Annex Table B.2.14-1 for a corresponding Band.

Identification of a cell shall include detection of the cell and additionally performing a single measurement with measurement period of $T_{\text{measure_intra_UE cat M1}}$. If higher layer filtering is used, an additional cell identification delay can be expected.

In the RRC_CONNECTED state the measurement period for intra frequency measurements is according to Table 8.13.2.1.3.1-1. When measurement gaps are activated the UE shall be capable of performing measurements for at least 6 cells. If the UE has identified more than 6 cells, the UE shall perform measurements but the reporting rate of RSRP measurements of cells from UE physical layer to higher layers may be decreased.

The RSRP measurement accuracy for all measured cells shall be as specified in the sub-clauses 9.1.21.1 and 9.1.21.2.

8.13.2.1.3.1.1 Measurement Reporting Requirements

8.13.2.1.3.1.1.1 Periodic Reporting

Reported RSRP measurement contained in periodically triggered measurement reports shall meet the requirements in sections 9.1.21.1 and 9.1.21.2.

8.13.2.1.3.1.1.2 Event-triggered Periodic Reporting

Reported RSRP measurement contained in event triggered periodic measurement reports shall meet the requirements in sections 9.1.21.1 and 9.1.21.2.

The first report in event triggered periodic measurement reporting shall meet the requirements specified in clause 8.13.2.1.3.1.1.3.

8.13.2.1.3.1.1.3 Event Triggered Reporting

Reported RSRP measurement contained in event triggered measurement reports shall meet the requirements in sections 9.1.21.1 and 9.1.21.2.

The UE shall not send any event triggered measurement reports, as long as no reporting criteria are fulfilled.

The measurement reporting delay is defined as the time between an event that will trigger a measurement report and the point when the UE starts to transmit the measurement report over the air interface. This requirement assumes that that the measurement report is not delayed by other RRC signalling on the DCCH. This measurement reporting delay excludes a delay uncertainty resulted when inserting the measurement report to the TTI of the uplink DCCH. The delay uncertainty is: $2 \times TTI_{DCCH}$. This measurement reporting delay excludes a delay which caused by no UL resources for UE to send the measurement report.

The event triggered measurement reporting delay, measured without L3 filtering shall be less than $T_{\text{identify_intra_UE cat M1}}$ defined in Clause 8.13.2.1.3.1. When L3 filtering is used or IDC autonomous denial is configured an additional delay can be expected.

If a cell which has been detectable at least for the time period $T_{\text{identify_intra_UE cat M1}}$ defined in clause 8.13.2.1.3.1 becomes undetectable for a period ≤ 5 seconds and then the cell becomes detectable again and triggers an event, the event triggered measurement reporting delay shall be less than $T_{\text{measure_intra_UE cat M1}}$ provided the timing to that cell has not changed more than $\pm 50 T_s$ and the L3 filter has not been used. When L3 filtering is used or IDC autonomous denial is configured, an additional delay can be expected.

8.13.2.1.3.2 E-UTRAN intra frequency measurements when DRX is used

When DRX is in use the UE shall be able to identify a new detectable TDD intra frequency cell within $T_{\text{identify_intra_UE cat M1}}$ as shown in table 8.13.2.1.3.2-1.

When eDRX_CONN is in use the UE shall be able to identify a new detectable TDD intra frequency cell within $T_{\text{identify_intra_UE cat M1}}$ as shown in table 8.13.2.1.3.2-1A.

Table 8.13.2.1.3.2-1: Requirement to identify a newly detectable TDD intrafrequency cell

| Gap pattern ID | DRX cycle length (s) | $T_{\text{identify_intra_UE cat M1}}$ (s) (DRX cycles) |
|--|--------------------------------------|--|
| 0 | ≤ 0.04 | 1.44 (Note1) |
| | $0.04 < \text{DRX-cycle} \leq 0.08$ | Note2 (40) |
| | 0.128 | 3.2 (25) |
| | $0.128 < \text{DRX-cycle} \leq 2.56$ | Note2(20) |
| 1 | < 0.128 | 2.88 (Note1) |
| | 0.128 | 3.2 (25) |
| | $0.128 < \text{DRX-cycle} \leq 2.56$ | Note2(20) |
| Note1: Number of DRX cycle depends upon the DRX cycle in use | | |
| Note2: Time depends upon the DRX cycle in use | | |

Table 8.13.2.1.3.2-1A: Requirement to identify a newly detectable TDD intrafrequency cell when eDRX_CONN cycle is used

| eDRX_CONN cycle length (s) | $T_{\text{identify_intra_UE cat M1}}$ (s) (eDRX_CONN cycles) |
|--|--|
| $2.56 < \text{eDRX_CONN cycle} \leq 10.24$ | Note (20) |
| NOTE: Time depends upon the eDRX_CONN cycle in use | |

A cell shall be considered detectable when

- RSRP related side conditions given in Clause 9.1.21.1 and 9.1.21.2 are fulfilled for a corresponding Band,
- SCH_RP and SCH \hat{E}_s/Iot according to Annex Table B.2.14-1 for a corresponding Band

In the RRC_CONNECTED state the measurement period for intra frequency measurements is $T_{\text{measure_intra_UE cat M1}}$. When DRX is used, $T_{\text{measure_intra_UE cat M1}}$ is as specified in table 8.13.2.1.3.2-2. When eDRX_CONN is used, $T_{\text{measure_intra_UE cat M1}}$ is as specified in table 8.13.2.1.3.2-3. The UE shall be capable of performing RSRP measurements for 6 identified intra-frequency cells and the UE physical layer shall be capable of reporting measurements to higher layers with the measurement period of $T_{\text{measure_intra_UE cat M1}}$.

Table 8.13.2.1.3.2-2: Requirement to measure TDD intra frequency cells

| Gap pattern ID | DRX cycle length (s) | $T_{\text{measure_intra_UE cat M1}}$ (s) (DRX cycles) |
|----------------|---|---|
| 0 | < 0.128 | 0.48 (Note1) |
| | $0.128 \leq \text{DRX-cycle} \leq 2.56$ | Note2 (5) |

| | | |
|--|---|--------------|
| 1 | <0.256 | 0.96 (Note1) |
| | $0.256 \leq \text{DRX-cycle} \leq 2.56$ | Note2 (5) |
| Note1: Number of DRX cycle depends upon the DRX cycle in use | | |
| Note2: Time depends upon the DRX cycle in use | | |

Table 8.13.2.1.3.2-3: Requirement to measure TDD intra frequency cells when eDRX_CONN cycle is used

| eDRX_CONN cycle length (s) | $T_{\text{measure_intra_UE cat M1}}$ (s) (eDRX_CONN cycles) |
|---|--|
| $2.56 < \text{eDRX_CONN cycle} \leq 10.24$ | Note (5) |
| NOTE: Time depends upon the eDRX_CONN cycle in use. | |

The RSRP measurement accuracy for all measured cells shall be as specified in the sub-clauses 9.1.21.1 and 9.1.21.2.

8.13.2.1.3.2.1 Measurement Reporting Requirements

8.13.2.1.3.2.1.1 Periodic Reporting

Reported RSRP measurement contained in periodically triggered measurement reports shall meet the requirements in sections 9.1.21.1 and 9.1.21.2.

8.13.2.1.3.2.1.2 Event-triggered Periodic Reporting

Reported RSRP measurement contained in event triggered periodic measurement reports shall meet the requirements in sections 9.1.21.1 and 9.1.21.2.

The first report in event triggered periodic measurement reporting shall meet the requirements specified in clause 8.13.2.1.3.2.1.3.

8.13.2.1.3.2.1.3 Event Triggered Reporting

Reported RSRP measurement contained in event triggered measurement reports shall meet the requirements in sections 9.1.21.1 and 9.1.21.2.

The UE shall not send any event triggered measurement reports, as long as no reporting criteria are fulfilled.

The measurement reporting delay is defined as the time between an event that will trigger a measurement report and the point when the UE starts to transmit the measurement report over the air interface. This requirement assumes that that the measurement report is not delayed by other RRC signalling on the DCCH. This measurement reporting delay excludes a delay uncertainty resulted when inserting the measurement report to the TTI of the uplink DCCH. The delay uncertainty is: $2 \times TTI_{\text{DCCH}}$. This measurement reporting delay excludes a delay which caused by no UL resources for UE to send the measurement report.

The event triggered measurement reporting delay, measured without L3 filtering shall be less than $T_{\text{identify_intra_UE cat M1}}$ defined in Clause 8.13.2.1.3.2. When L3 filtering is used or IDC autonomous denial is configured an additional delay can be expected.

If a cell which has been detectable at least for the time period $T_{\text{identify_intra_UE cat M1}}$ defined in clause 8.13.2.1.3.2 becomes undetectable for a period ≤ 5 seconds and then the cell becomes detectable again and triggers an event, the event triggered measurement reporting delay shall be less than $T_{\text{measure_intra_UE cat M1}}$ provided the timing to that cell has not changed more than $\pm 50 T_s$ and the L3 filter has not been used. When L3 filtering is used or IDC autonomous denial is configured, an additional delay can be expected.

8.13.2.2 E-UTRAN E-CID Measurements Requirements for UE category M1 with CE mode A

8.13.2.2.1 E-UTRAN FDD Intra-frequency E-CID RSRP Measurements

8.13.2.2.1.1 Introduction

The requirements in section 8.13.2.2.1 shall apply provided the UE has received ECID-RequestLocationInformation message from E-SMLC via LPP requesting the UE to report E-CID E-UTRAN FDD intra-frequency RSRP measurements [24].

8.13.2.2.1.2 Measurement Requirements

The requirements in section 8.13.2.1.1 also apply for this section except the measurement reporting requirements. The measurement reporting requirements for E-CID RSRP are defined in section 8.13.2.2.1.3.

8.13.2.2.1.3 Measurement Reporting Delay

This requirement assumes that that the measurement report is not delayed by other LPP signalling on the DCCH. This measurement reporting delay excludes a delay uncertainty resulted when inserting the measurement report to the TTI of the uplink DCCH. The delay uncertainty is: $2 \times TTI_{DCCH}$. This measurement reporting delay excludes any delay caused by no UL resources for UE to send the measurement report.

Reported RSRP measurements contained in periodically triggered measurement reports shall meet the requirements in section 9.1.21.1.

8.13.2.2.2 E-UTRAN HD-FDD Intra-frequency E-CID RSRP Measurements

8.13.2.2.2.1 Introduction

The requirements in this section are applicable for the UE which supports half duplex operation on one or more supported frequency bands [2].

The requirements defined in clause 8.13.2.2.1.1 also apply for this section provided the following conditions are met:

- at least downlink subframe # 0 and downlink subframe # 5 per radio frame of an intra-frequency cell to be identified by the UE is available at the UE over $T_{\text{identify_intra_UE cat M1}}$;
- at least two consecutive downlink subframe per radio frame of measured cell is available at the UE for RSRP measurements assuming measured cell is identified cell over $T_{\text{measure_intra_UE cat M1}}$.
- SCH_{RP} and $SCH_{\hat{E}s/Iot}$ according to Annex Table B.2.14-2

8.13.2.2.2.2 Measurement Requirements

The requirements in section 8.13.2.1.2 also apply for this section except the measurement reporting requirements. The measurement reporting requirements for E-CID RSRP are defined in section 8.13.2.2.2.3.

8.13.2.2.2.3 Measurement Reporting Delay

This requirement assumes that that the measurement report is not delayed by other LPP signalling on the DCCH. This measurement reporting delay excludes a delay uncertainty resulted when inserting the measurement report to the TTI of the uplink DCCH. The delay uncertainty is: $2 \times TTI_{DCCH}$. This measurement reporting delay excludes any delay caused by no UL resources for UE to send the measurement report.

Reported RSRP measurements contained in periodically triggered measurement reports shall meet the requirements in section 9.1.21.1.

8.13.2.2.3 E-UTRAN TDD Intra-frequency E-CID RSRP Measurements

8.13.2.2.3.1 Introduction

The requirements in section 8.13.2.2.3 shall apply provided the UE has received ECID-RequestLocationInformation message from E-SMLC via LPP requesting the UE to report E-CID E-UTRAN TDD intra-frequency RSRP measurements [24].

8.13.2.2.3.2 Measurement Requirements

The requirements in section 8.13.2.1.3 also apply for this section except the measurement reporting requirements. The measurement reporting requirements for E-CID RSRP are defined in section 8.13.2.2.3.3.

8.13.2.2.3.3 Measurement Reporting Delay

This requirement assumes that the measurement report is not delayed by other LPP signalling on the DCCH. This measurement reporting delay excludes a delay uncertainty resulted when inserting the measurement report to the TTI of the uplink DCCH. The delay uncertainty is: $2 \times TTI_{DCCH}$. This measurement reporting delay excludes any delay caused by no UL resources for UE to send the measurement report.

Reported RSRP measurements contained in periodically triggered measurement reports shall meet the requirements in section 9.1.21.1.

8.13.3 Requirements for UE category M1 with CE mode B

The UE category M1 applicability of the requirements in subclause 8.13.3 is defined in Section 3.6. The requirements defined in clause 8.13.3 apply provided the following conditions are met:

- UE is configured with measurement gap according to any of gap patterns defined in Table 8.1.2.1-1.

Alternatively, the UE shall meet the requirements in subclause 8.13.3 defined for Gap Pattern ID#0 without using any measurement gaps provided:

- UE indicates it does not need gaps with the capability `intraFreq-CE-NeedForGaps-r13` [2, TS36.331] for the frequency band of the serving cell.

8.13.3.1 E-UTRAN intra frequency measurements by UE category M1 with CE mode B

The UE shall be able to identify new intra-frequency cells and perform RSRP measurements of identified intra-frequency cells without an explicit intra-frequency neighbour cell list containing physical layer cell identities. During the RRC_CONNECTED state the UE shall continuously measure identified intra frequency cells and additionally search for and identify new intra frequency cells.

8.13.3.1.1 E-UTRAN FDD intra frequency measurements

8.13.3.1.1.1 E-UTRAN intra frequency measurements when no DRX is used

When no DRX is in use the UE shall be able to identify and measure a new detectable FDD intra frequency cell according to requirements in Table 8.13.3.1.1-1 provided that additional conditions Table 8.13.3.1.1-1 is met.

Table 8.13.3.1.1-1: Requirement on cell identification delay and measurement delay for FDD intrafrequency cell

| Neighbouring cell SCH Ês/lot: Q2 | Gap pattern ID | Cell identification delay ($T_{\text{identify_intra_UE cat M1}}$) | Measurement delay ($T_{\text{measure_intra_UE cat M1}}$) |
|-------------------------------------|-------------------|--|---|
| $-15 \leq Q2 < -6$ | 0 | 320.8 s | 800 ms |
| | 1 | 321.6 s | 1600ms |
| $Q2 \geq -6$ | 0 | 21.8 | 800 ms |
| | 1 | 22.6 | 1600ms |

Table 8.13.3.1.1.1-2: Void

A cell shall be considered detectable when

- RSRP related side conditions given in Sections 9.1.21.3 and 9.1.21.4 are fulfilled for a corresponding Band,
- SCH_RP and $SCH\ \hat{E}s/lot$ according to Annex Table B.2.14-3 for a corresponding Band.

Identification of a cell shall include detection of the cell and additionally performing a single measurement with measurement period of $T_{measure_intra_UE\ cat\ M1}$. If higher layer filtering is used, an additional cell identification delay can be expected.

In the RRC_CONNECTED state the measurement period for intra frequency measurements is according to Table 8.13.3.1.1.1-1. When measurement gaps are activated the UE shall be capable of performing measurements for at least 6 cells. If the UE has identified more than 6 cells, the UE shall perform measurements but the reporting rate of RSRP measurements of cells from UE physical layer to higher layers may be decreased.

The RSRP measurement accuracy for all measured cells shall be as specified in the sub-clauses 9.1.21.3 and 9.1.21.4.

8.13.3.1.1.1.1 Measurement Reporting Requirements

8.13.3.1.1.1.1.1 Periodic Reporting

Reported RSRP measurement contained in periodically triggered measurement reports shall meet the requirements in sections 9.1.21.3 and 9.1.21.4.

8.13.3.1.1.1.1.2 Event-triggered Periodic Reporting

Reported RSRP measurement contained in event triggered periodic measurement reports shall meet the requirements in sections 9.1.21.3 and 9.1.21.4.

The first report in event triggered periodic measurement reporting shall meet the requirements specified in clause 8.13.3.1.1.1.1.3.

8.13.3.1.1.1.1.3 Event Triggered Reporting

Reported RSRP measurement contained in event triggered measurement reports shall meet the requirements in sections 9.1.21.3 and 9.1.21.4.

The UE shall not send any event triggered measurement reports, as long as no reporting criteria are fulfilled.

The measurement reporting delay is defined as the time between an event that will trigger a measurement report and the point when the UE starts to transmit the measurement report over the air interface. This requirement assumes that the measurement report is not delayed by other RRC signalling on the DCCH. This measurement reporting delay excludes a delay uncertainty resulted when inserting the measurement report to the TTI of the uplink DCCH. The delay uncertainty is: $pusch-maxNumRepetitionCEmodeB \times TTI_{DCCH}$, where $pusch-maxNumRepetitionCEmodeB$ [2] is the maximum number of PUSCH repetitions configured for the UE in CE Mode B provided that $pusch-maxNumRepetitionCEmodeB > 1$, otherwise uncertainty is defined as $2 \times TTI_{DCCH}$. This measurement reporting delay excludes a delay which caused by no UL resources for UE to send the measurement report.

The event triggered measurement reporting delay, measured without L3 filtering shall be less than $T_{identify_intra_UE\ cat\ M1}$ defined in Clause 8.13.3.1.1.1. When L3 filtering is used or IDC autonomous denial is configured an additional delay can be expected.

If a cell which has been detectable at least for the time period $T_{identify_intra_UE\ cat\ M1}$ defined in clause 8.13.3.1.1.1 becomes undetectable for a period ≤ 5 seconds and then the cell becomes detectable again and triggers an event, the event triggered measurement reporting delay shall be less than $T_{measure_intra_UE\ cat\ M1}$ provided the timing to that cell has not changed more than $\pm 50 T_s$ and the L3 filter has not been used. When L3 filtering is used or IDC autonomous denial is configured, an additional delay can be expected.

8.13.3.1.1.2 E-UTRAN intra frequency measurements when DRX is used

When DRX is in use the UE shall be able to identify a new detectable FDD intra frequency cell within $T_{\text{identify_intra_UE cat M1}}$ as shown in table 8.13.3.1.1.2-1 provided that additional conditions Table 8.13.3.1.1.2-1 is met.

When eDRX_CONN is in use the UE shall be able to identify a new detectable FDD intra frequency cell within $T_{\text{identify_intra_UE cat M1}}$ as shown in table 8.13.3.1.1.2-1B.

Table 8.13.3.1.1.2-1: Requirement to identify a newly detectable FDD intrafrequency cell

| Neighbouring cell SCH \hat{E} s/lot: Q2 | Gap pattern ID | DRX cycle length (s) | $T_{\text{identify_intra_UE cat M1}}$ (s) (DRX cycles) |
|--|----------------|-------------------------|--|
| -15 ≤ Q2 < -6 | 0 | ≤0.64 | 320.8 (Note1) |
| | | 0.64 < DRX-cycle ≤ 2.56 | Note2(400) |
| | 1 | DRX-cycle ≤ 0.640 | 321.6 (Note1) |
| | | 0.64 < DRX-cycle ≤ 2.56 | Note2(400) |
| Q2 ≥ -6 | 0 | ≤0.64 | 21.8 (Note1) |
| | | 0.64 < DRX-cycle ≤ 2.56 | Note2(24) |
| | 1 | DRX-cycle ≤ 0.640 | 22.6 (Note1) |
| | | 0.64 < DRX-cycle ≤ 2.56 | Note2(24) |
| Note1: Number of DRX cycle depends upon the DRX cycle in use | | | |
| Note2: Time depends upon the DRX cycle in use | | | |

Table 8.13.3.1.1.2-1A: Void**Table 8.13.3.1.1.2-1B: Requirement to identify a newly detectable FDD intrafrequency cell when eDRX_CONN is used**

| eDRX_CONN cycle length (s) | $T_{\text{identify_intra_UE cat M1}}$ (s) (eDRX_CONN cycles) |
|--|--|
| 2.56 < eDRX_CONN cycle ≤ 10.24 | Note (400) |
| NOTE: Time depends upon the eDRX_CONN cycle in use | |

A cell shall be considered detectable when

- RSRP related side conditions given in Sections 9.1.21.3 and 9.1.21.4 are fulfilled for a corresponding Band,
- SCH_RP and SCH \hat{E} s/lot according to Annex Table B.2.14-3 for a corresponding Band

In the RRC_CONNECTED state the measurement period for intra frequency measurements is $T_{\text{measure_intra_UE cat M1}}$. When DRX is used, $T_{\text{measure_intra_UE cat M1}}$ is as specified in table 8.13.3.1.1.2-2 provided that additional conditions table 8.13.3.1.1.2-2 is met. When eDRX_CONN is used, $T_{\text{measure_intra_UE cat M1}}$ is as specified in table 8.13.3.1.1.2-4. The UE shall be capable of performing RSRP measurements for 6 identified-intra-frequency cells, and the UE physical layer shall be capable of reporting measurements to higher layers with the measurement period of $T_{\text{measure_intra_UE cat M1}}$.

Table 8.13.3.1.1.2-2: Requirement to measure FDD intrafrequency cells

| Target cell SCH \hat{E} s/lot: Q2 | Gap pattern ID | DRX cycle length (s) | $T_{\text{measure_intra_UE cat M1}}$ (s) (DRX cycles) |
|-------------------------------------|----------------|-------------------------|---|
| Q2 ≥ -15 | 0 | ≤0.16 | 0.8 (Note1) |
| | | 0.16 < DRX-cycle ≤ 2.56 | Note2(5) |
| | 1 | ≤0.32 | 1.6 (Note1) |

| | | | |
|--------|---|---------------------|----------|
| | | 0.32<DRX-cycle≤2.56 | Note2(5) |
| Note1: | Number of DRX cycle depends upon the DRX cycle in use | | |
| Note2: | Time depends upon the DRX cycle in use | | |

Table 8.13.3.1.1.2-3: Void**Table 8.13.3.1.1.2-4: Requirement to measure FDD intrafrequency cells when eDRX_CONN cycle is used**

| eDRX_CONN cycle length (s) | T _{measure_intra_UE cat M1} (s) (eDRX_CONN cycles) |
|--|--|
| 2.56<eDRX_CONN cycle≤10.24 | Note (5) |
| NOTE: Time depends upon the eDRX_CONN cycle in use | |

The RSRP measurement accuracy for all measured cells shall be as specified in the sub-clauses 9.1.21.3 and 9.1.21.4.

8.13.3.1.1.2.1 Measurement Reporting Requirements

8.13.3.1.1.2.1.1 Periodic Reporting

Reported RSRP measurement contained in periodically triggered measurement reports shall meet the requirements in sections 9.1.21.3 and 9.1.21.4.

8.13.3.1.1.2.1.2 Event-triggered Periodic Reporting

Reported RSRP measurement contained in event triggered periodic measurement reports shall meet the requirements in sections 9.1.21.3 and 9.1.21.4.

The first report in event triggered periodic measurement reporting shall meet the requirements specified in clause 8.13.3.1.1.2.1.3.

8.13.3.1.1.2.1.3 Event Triggered Reporting

Reported RSRP measurement contained in event triggered measurement reports shall meet the requirements in sections 9.1.21.3 and 9.1.21.4.

The UE shall not send any event triggered measurement reports, as long as no reporting criteria are fulfilled.

The measurement reporting delay is defined as the time between an event that will trigger a measurement report and the point when the UE starts to transmit the measurement report over the air interface. This requirement assumes that that the measurement report is not delayed by other RRC signalling on the DCCH. This measurement reporting delay excludes a delay uncertainty resulted when inserting the measurement report to the TTI of the uplink DCCH. The delay uncertainty is: $2 \times TTI_{DCCH}$. This measurement reporting delay excludes a delay which caused by no UL resources for UE to send the measurement report.

The event triggered measurement reporting delay, measured without L3 filtering shall be less than $T_{identify_intra_UE\ cat\ M1}$ defined in Clause 8.13.3.1.1.2 When L3 filtering is used or IDC autonomous denial is configured an additional delay can be expected.

If a cell which has been detectable at least for the time period $T_{identify_intra_UE\ cat\ M1}$ defined in clause 8.13.3.1.1.2 becomes undetectable for a period ≤ 5 seconds and then the cell becomes detectable again and triggers an event, the event triggered measurement reporting delay shall be less than $T_{measure_intra_UE\ cat\ M1}$ provided the timing to that cell has not changed more than $\pm 50 T_s$ and the L3 filter has not been used. When L3 filtering is used or IDC autonomous denial is configured, an additional delay can be expected.

8.13.3.1.2 E-UTRAN intra frequency measurements for HD-FDD

8.13.3.1.2.1 E-UTRAN intra frequency measurements when no DRX is used

The requirements in this section are applicable for the UE which supports half duplex operation on one or more supported frequency bands [2].

The requirements defined in clause 8.13.3.1.1.1 also apply for this section provided the following conditions are met:

- at least downlink subframe # 0 and downlink subframe # 5 per radio frame of an intra-frequency cell to be identified by the UE is available at the UE over $T_{\text{identify_intra_UE cat M1}}$;
- at least two consecutive downlink subframe per radio frame of measured cell is available at the UE for RSRP measurements assuming measured cell is identified cell over $T_{\text{measure_intra_UE cat M1}}$.
- SCH_{RP} and SCH Ês/Iot according to Annex Table B.2.14-4

8.13.3.1.2.2 E-UTRAN intra frequency measurements when DRX is used

The requirements in this section are applicable for the UE which supports half duplex operation on one or more supported frequency bands [2].

When DRX is in use the UE shall be able to identify a new detectable HD-FDD intra frequency cell within $T_{\text{identify_intra_UE cat M1}}$ as shown in table 8.13.3.1.2.2-1 provided that additional conditions table 8.13.3.1.2.2-1 is met.

When eDRX_CONN is in use, the UE shall be able to identify a new detectable FDD intra frequency cell within $T_{\text{identify_intra_UE cat M1}}$ as shown in table 8.13.3.1.2.2-1B.

Table 8.13.3.1.2.2-1: Requirement to identify a newly detectable HD-FDD intrafrequency cell

| Neighbouring cell SCH Ês/Iot: Q2 | Gap pattern ID | DRX cycle length (s) | $T_{\text{identify_intra_UE cat M1}}$ (s) (DRX cycles) |
|--|----------------|-------------------------|--|
| -15 ≤ Q2 < -6 | 0 | ≤0.64 | 320.8 (Note1) |
| | | 0.64 < DRX-cycle ≤ 2.56 | Note2(400) |
| | 1 | DRX-cycle ≤ 0.640 | 321.6 (Note1) |
| | | 0.64 < DRX-cycle ≤ 2.56 | Note2(400) |
| Q2 ≥ -6 | 0 | ≤0.64 | 21.8 (Note1) |
| | | 0.64 < DRX-cycle ≤ 2.56 | Note2(24) |
| | 1 | DRX-cycle ≤ 0.640 | 22.6 (Note1) |
| | | 0.64 < DRX-cycle ≤ 2.56 | Note2(24) |
| Note1: Number of DRX cycle depends upon the DRX cycle in use | | | |
| Note2: Time depends upon the DRX cycle in use | | | |

Table 8.13.3.1.2.2-1A: Void

Table 8.13.3.1.2.2-1B: Requirement to identify a newly detectable HD-FDD intrafrequency cell when eDRX_CONN cycle is used

| eDRX_CONN cycle length (s) | $T_{\text{identify_intra_UE cat M1}}$ (s) (eDRX_CONN cycles) |
|--|--|
| 2.56 < eDRX_CONN cycle ≤ 10.24 | Note (400) |
| NOTE: Time depends upon the eDRX_CONN cycle in use | |

A cell shall be considered detectable when

- RSRP related side conditions given in Sections 9.1.21.3 and 9.1.21.4 are fulfilled for a corresponding Band,
- SCH_{RP} and SCH_{Es/lot} according to Annex Table B.2.14-4 for a corresponding Band

In the RRC_CONNECTED state the measurement period for intra frequency measurements is $T_{\text{measure_intra_UE cat M1}}$. When DRX is used, $T_{\text{measure_intra_UE cat M1}}$ is as specified in table 8.13.3.1.2.2-2 provided that additional conditions Table 8.13.3.1.2.2-2 is met. When eDRX_CONN cycle is used, $T_{\text{measure_intra_UE cat M1}}$ is as specified in table 8.13.3.1.2.2-4. The UE shall be capable of performing RSRP measurements for 6 identified-intra-frequency cells, and the UE physical layer shall be capable of reporting measurements to higher layers with the measurement period of $T_{\text{measure_intra_UE cat M1}}$.

Table 8.13.3.1.2.2-2: Requirement to measure HD-FDD intrafrequency cells

| Neighbouring cell SCH _{Es/lot} : Q2 | Gap pattern ID | DRX cycle length (s) | $T_{\text{measure_intra_UE cat M1}}$ (s) (DRX cycles) |
|--|----------------|--------------------------|---|
| Q2 ≥ -15 | 0 | <0.128 | 0.8 (Note1) |
| | | 0.128 ≤ DRX-cycle ≤ 0.16 | Note2 (7) |
| | | 0.16 < DRX-cycle ≤ 2.56 | Note2(5) |
| | 1 | ≤ 0.32 | 1.6 (Note1) |
| | | 0.32 < DRX-cycle ≤ 2.56 | Note2(5) |
| Note1: Number of DRX cycle depends upon the DRX cycle in use | | | |
| Note2: Time depends upon the DRX cycle in use | | | |

Table 8.13.3.1.2.2-3: Void

Table 8.13.3.1.2.2-4: Requirement to measure HD-FDD intrafrequency cells when eDRX_CONN cycle is used

| eDRX_CONN cycle length (s) | $T_{\text{measure_intra_UE cat M1}}$ (s) (eDRX_CONN cycles) |
|--|---|
| 2.56 < eDRX_CONN cycle ≤ 10.24 | Note (5) |
| NOTE: Time depends upon the eDRX_CONN cycle in use | |

The RSRP measurement accuracy for all measured cells shall be as specified in the sub-clauses 9.1.21.3 and 9.1.21.4.

8.13.3.1.2.2.1 Measurement Reporting Requirements

8.13.3.1.2.2.1.1 Periodic Reporting

Reported RSRP measurement contained in periodically triggered measurement reports shall meet the requirements in sections 9.1.21.3 and 9.1.21.4.

8.13.3.1.2.2.1.2 Event-triggered Periodic Reporting

Reported RSRP measurement contained in event triggered periodic measurement reports shall meet the requirements in sections 9.1.21.3 and 9.1.21.4.

The first report in event triggered periodic measurement reporting shall meet the requirements specified in clause 8.13.3.1.2.2.1.3.

8.13.3.1.2.2.1.3 Event Triggered Reporting

Reported RSRP measurements contained in event triggered measurement reports shall meet the requirements in sections 9.1.21.3 and 9.1.21.4.

The UE shall not send any event triggered measurement reports, as long as no reporting criteria are fulfilled.

The measurement reporting delay is defined as the time between an event that will trigger a measurement report and the point when the UE starts to transmit the measurement report over the air interface. This requirement assumes that the measurement report is not delayed by other RRC signalling on the DCCH. This measurement reporting delay excludes a delay uncertainty resulted when inserting the measurement report to the TTI of the uplink DCCH. The delay uncertainty is: $pusch-maxNumRepetitionCEmodeB \times TTI_{DCCH}$, where $pusch-maxNumRepetitionCEmodeB$ [2] is the maximum number of PUSCH repetitions configured for the UE in CE Mode B provided that $pusch-maxNumRepetitionCEmodeB > 1$, otherwise uncertainty is defined as $2 \times TTI_{DCCH}$. This measurement reporting delay excludes a delay which caused by no UL resources for UE to send the measurement report.

The event triggered measurement reporting delay, measured without L3 filtering shall be less than $T_{identify_intra_UE\ cat\ M1}$ defined in Clause 8.13.3.1.2.2 When L3 filtering is used or IDC autonomous denial is configured an additional delay can be expected.

If a cell which has been detectable at least for the time period $T_{identify_intra_UE\ cat\ M1}$ defined in clause 8.13.3.1.2.2 becomes undetectable for a period ≤ 5 seconds and then the cell becomes detectable again and triggers an event, the event triggered measurement reporting delay shall be less than $T_{measure_intra_UE\ cat\ M1}$ provided the timing to that cell has not changed more than $\pm 50 T_s$ and the L3 filter has not been used. When L3 filtering is used or IDC autonomous denial is configured, an additional delay can be expected.

8.13.3.1.3 E-UTRAN TDD intra frequency measurements

8.13.3.1.3.1 E-UTRAN intra frequency measurements when no DRX is used

When no DRX is in use the UE shall be able to identify and measure a new detectable TDD intra frequency cell according to requirements in Table 8.13.3.1.3.1-1 provided that additional conditions Table 8.13.3.1.3.1-1 is met.

Table 8.13.3.1.3.1-1: Requirement on cell identification delay and measurement delay for TDD intrafrequency cell

| Neighbouring cell SCH \hat{E}_s/lot : Q2 | Gap pattern ID | Cell identification delay ($T_{identify_intra_UE\ cat\ M1}$) for neighbouring cell SCH \hat{E}_s/lot (Q): $-15 \leq Q2 < -6$ | Measurement delay ($T_{measure_intra_UE\ cat\ M1}$) |
|--|----------------|---|---|
| $-15 \leq Q2 < -6$ | 0 | 320.8 s | 800 ms ^{Note1} [1600 ms] ^{Note2} |
| | 1 | 321.6 s | 1600 ms ^{Note1} [3200 ms] ^{Note2} |
| $Q2 \geq -6$ | 0 | 21.8 | 800 ms ^{Note1} [1600 ms] ^{Note2} |
| | 1 | 22.6 | 1600 ms ^{Note1} [3200 ms] ^{Note2} |
| Note1: Under TDD UL/DL configuration other than 0. | | | |
| Note2: Under TDD UL/DL configuration 0. | | | |

Table 8.13.3.1.3.1-2: Void

A cell shall be considered detectable when

- RSRP related side conditions given in Sections 9.1.21.3 and 9.1.21.4 are fulfilled for a corresponding Band,
- SCH_{RP} and SCH \hat{E}_s/lot according to Annex Table B.2.14-3 for a corresponding Band.

Identification of a cell shall include detection of the cell and additionally performing a single measurement with measurement period of $T_{measure_intra_UE\ cat\ M1}$. If higher layer filtering is used, an additional cell identification delay can be expected.

In the RRC_CONNECTED state the measurement period for intra frequency measurements is according to Table 8.13.3.1.3.1-1. When measurement gaps are activated the UE shall be capable of performing measurements for at least 6 cells. If the UE has identified more than 6 cells, the UE shall perform measurements but the reporting rate of RSRP measurements of cells from UE physical layer to higher layers may be decreased.

The RSRP measurement accuracy for all measured cells shall be as specified in the sub-clauses 9.1.21.3 and 9.1.21.4.

8.13.3.1.3.1.1 Measurement Reporting Requirements

8.13.3.1.3.1.1.1 Periodic Reporting

Reported RSRP measurement contained in periodically triggered measurement reports shall meet the requirements in sections 9.1.21.3 and 9.1.21.4.

8.13.3.1.3.1.1.2 Event-triggered Periodic Reporting

Reported RSRP measurement contained in event triggered periodic measurement reports shall meet the requirements in sections 9.1.21.3 and 9.1.21.4.

The first report in event triggered periodic measurement reporting shall meet the requirements specified in clause 8.13.3.1.3.1.1.3.

8.13.3.1.3.1.1.3 Event Triggered Reporting

Reported RSRP measurement contained in event triggered measurement reports shall meet the requirements in sections 9.1.21.3 and 9.1.21.4.

The UE shall not send any event triggered measurement reports, as long as no reporting criteria are fulfilled.

The measurement reporting delay is defined as the time between an event that will trigger a measurement report and the point when the UE starts to transmit the measurement report over the air interface. This requirement assumes that the measurement report is not delayed by other RRC signalling on the DCCH. This measurement reporting delay excludes a delay uncertainty resulted when inserting the measurement report to the TTI of the uplink DCCH. The delay uncertainty is: $pusch-maxNumRepetitionCEmodeB$ consecutive uplink TTI_{DCCH} , where $pusch-maxNumRepetitionCEmodeB$ [2] is the maximum number of PUSCH repetitions configured for the UE in CE Mode B provided that $pusch-maxNumRepetitionCEmodeB > 1$, otherwise uncertainty is defined as $2 \times TTI_{DCCH}$. This measurement reporting delay excludes a delay which caused by no UL resources for UE to send the measurement report.

The event triggered measurement reporting delay, measured without L3 filtering shall be less than $T_{identify_intra_UE\ cat\ M1}$ defined in Clause 8.13.3.1.3.1. When L3 filtering is used or IDC autonomous denial is configured an additional delay can be expected.

If a cell which has been detectable at least for the time period $T_{identify_intra_UE\ cat\ M1}$ defined in clause 8.13.3.1.3.1 becomes undetectable for a period ≤ 5 seconds and then the cell becomes detectable again and triggers an event, the event triggered measurement reporting delay shall be less than $T_{measure_intra_UE\ cat\ M1}$ provided the timing to that cell has not changed more than $\pm 50 T_s$ and the L3 filter has not been used. When L3 filtering is used or IDC autonomous denial is configured, an additional delay can be expected.

8.13.3.1.3.2 E-UTRAN intra frequency measurements when DRX is used

When DRX is in use the UE shall be able to identify a new detectable TDD intra frequency cell within $T_{identify_intra_UE\ cat\ M1}$ as shown in table 8.13.3.1.3.2-1 provided that additional conditions table 8.13.3.1.3.2-1 is met.

When eDRX_CONN is in use the UE shall be able to identify a new detectable TDD intra frequency cell within $T_{identify_intra_UE\ cat\ M1}$ as shown in table 8.13.3.1.3.2-1B.

Table 8.13.3.1.3.2-1: Requirement to identify a newly detectable TDD intrafrequency cell

| Neighbouring cell SCH Es/lot: Q2 | Gap pattern ID | DRX cycle length (s) | $T_{identify_intra_UE\ cat\ M1}$ (s) (DRX cycles) |
|----------------------------------|----------------|-------------------------|---|
| -15 ≤ Q2 < -6 | 0 | ≤ 0.64 | 320.8 (Note1) |
| | | 0.64 < DRX-cycle ≤ 2.56 | Note2(400) |
| | 1 | DRX-cycle ≤ 0.640 | 321.6 (Note1) |
| | | 0.64 < DRX-cycle ≤ 2.56 | Note2(400) |
| | | ≤ 0.64 | 21.8 (Note1) |

| | | | |
|--|---|----------------------|--------------|
| Q2≥6 | 0 | 0.64< DRX-cycle≤2.56 | Note2(24) |
| | 1 | DRX-cycle ≤ 0.640 | 22.6 (Note1) |
| | | 0.64< DRX-cycle≤2.56 | Note2(24) |
| Note1: Number of DRX cycle depends upon the DRX cycle in use | | | |
| Note2: Time depends upon the DRX cycle in use | | | |

Table 8.13.3.1.3.2-1A: Void

Table 8.13.3.1.3.2-1B: Requirement to identify a newly detectable TDD intrafrequency cell when eDRX_CONN cycle is used

| eDRX_CONN cycle length (s) | T _{identify_intra_UE cat M1} (s) (eDRX_CONN cycles) |
|--|--|
| 2.56<eDRX_CONN cycle≤10.24 | Note (400) |
| NOTE: Time depends upon the eDRX_CONN cycle in use | |

A cell shall be considered detectable when

- RSRP related side conditions given in Clause 9.1.21.3 and 9.1.21.4 are fulfilled for a corresponding Band,
- SCH_RP and SCH Ês/Iot according to Annex Table B.2.14-3 for a corresponding Band

In the RRC_CONNECTED state the measurement period for intra frequency measurements is T_{measure_intra_UE cat M1}. When DRX is used, T_{measure_intra_UE cat M1} is as shown in table 8.13.3.1.3.2-2 provided that additional conditions Table 8.13.3.1.3.2-2 is met. When eDRX_CONN is used, T_{measure_intra_UE cat M1} is as shown in table 8.13.3.1.3.2-4. The UE shall be capable of performing RSRP measurement for 6 identified intra-frequency cells and the UE physical layer shall be capable of reporting measurements to higher layers with the measurement period of T_{measure_intra_UE cat M1}.

Table 8.13.3.1.3.2-2: Requirement to measure TDD intra frequency cells

| Neighbouring cell SCH Ês/Iot: Q2 | TDD Uplink-downlink configuration | Gap pattern ID | DRX cycle length (s) | T _{measure_intra_UE cat M1} (s) (DRX cycles) |
|--|-----------------------------------|----------------|----------------------|---|
| Q2≥-15 | Other than 0 | 0 | ≤0.16 | 0.8 (Note1) |
| | | | 0.16<DRX-cycle≤2.56 | Note2(5) |
| | | 1 | ≤0.32 | 1.6 (Note1) |
| | | | 0.32<DRX-cycle≤2.56 | Note2(5) |
| | 0 | 0 | ≤0.32 | [1.6] (Note1) |
| | | | 0.32<DRX-cycle≤2.56 | Note2(5) |
| | | 1 | ≤0.64 | [3.2] (Note1) |
| | | | 0.64<DRX-cycle≤2.56 | Note2(5) |
| Note1: Number of DRX cycle depends upon the DRX cycle in use | | | | |
| Note2: Time depends upon the DRX cycle in use | | | | |

Table 8.13.3.1.3.2-3: Void

Table 8.13.3.1.3.2-4: Requirement to measure TDD intra frequency cells when eDRX_CONN cycle is used

| eDRX_CONN cycle length (s) | T _{measure_intra_UE cat M1} (s) (eDRX_CONN cycles) |
|----------------------------|---|
| 2.56<eDRX_CONN cycle≤10.24 | Note (5) |

| |
|---|
| NOTE: Time depends upon the eDRX_CONN cycle in use. |
|---|

The RSRP measurement accuracy for all measured cells shall be as specified in the sub-clauses 9.1.21.3 and 9.1.21.4.

8.13.3.1.3.2.1 Measurement Reporting Requirements

8.13.3.1.3.2.1.1 Periodic Reporting

Reported RSRP measurement contained in periodically triggered measurement reports shall meet the requirements in sections 9.1.21.3 and 9.1.21.4.

8.13.3.1.3.2.1.2 Event-triggered Periodic Reporting

Reported RSRP measurement contained in event triggered periodic measurement reports shall meet the requirements in sections 9.1.21.3 and 9.1.21.4.

The first report in event triggered periodic measurement reporting shall meet the requirements specified in clause 8.13.3.1.3.2.1.3.

8.13.3.1.3.2.1.3 Event Triggered Reporting

Reported RSRP measurement contained in event triggered measurement reports shall meet the requirements in sections 9.1.21.3 and 9.1.21.4.

The UE shall not send any event triggered measurement reports, as long as no reporting criteria are fulfilled.

The measurement reporting delay is defined as the time between an event that will trigger a measurement report and the point when the UE starts to transmit the measurement report over the air interface. This requirement assumes that the measurement report is not delayed by other RRC signalling on the DCCH. This measurement reporting delay excludes a delay uncertainty resulted when inserting the measurement report to the TTI of the uplink DCCH. The delay uncertainty is: $2 \times TTI_{DCCH}$. This measurement reporting delay excludes a delay which caused by no UL resources for UE to send the measurement report.

The event triggered measurement reporting delay, measured without L3 filtering shall be less than $T_{identify_intra_UE\ cat\ M1}$ defined in Clause 8.13.3.1.3.2. When L3 filtering is used or IDC autonomous denial is configured an additional delay can be expected.

If a cell which has been detectable at least for the time period $T_{identify_intra_UE\ cat\ M1}$ defined in clause 8.13.3.1.3.2 becomes undetectable for a period ≤ 5 seconds and then the cell becomes detectable again and triggers an event, the event triggered measurement reporting delay shall be less than $T_{measure_intra_UE\ cat\ M1}$ provided the timing to that cell has not changed more than ± 50 Ts and the L3 filter has not been used. When L3 filtering is used or IDC autonomous denial is configured, an additional delay can be expected.

8.13.3.1.4 E-UTRAN FDD intra frequency measurements with autonomous gaps for UE category M1 with CE mode B

The requirements defined in this subclause 8.13.3.1.4 apply provided the following condition is met:

- Tx diversity or transmission using multiple antennas are supported in the target cell to be detected.
- Repetitions of MIB/SIB1-BR are supported in the target cell to be detected.

8.13.3.1.4.1 Identification of a new CGI of E-UTRA cell with autonomous gaps

No explicit neighbour list is provided to the UE for identifying a new CGI of E-UTRA cell. The UE shall identify and report the CGI when requested by the network for the purpose 'reportCGI'. The UE may make autonomous gaps in downlink reception and uplink transmission for receiving MIB and SIB1-BR message according to clause 5.5.3.1 of TS 36.331 [2]. Note that a UE is not required to use autonomous gap if si-RequestForHO is set to false. If autonomous gaps are used for measurement with the purpose of 'reportCGI', regardless of whether DRX or eDRX_CONN is used or not, or whether SCell(s) are configured or not, the UE shall be able to identify a new CGI of E-UTRA cell within:

$$T_{\text{identify_CGI_Cat M1, intra}} = T_{\text{basic_identify_CGI_Cat M1, intra}} \text{ ms}$$

Where

$T_{\text{basic_identify_CGI_Cat M1, intra}} = 5120$ ms. This is the time period used in the above equation where the maximum allowed time for the UE to identify a new CGI of an E-UTRA cell is defined, provided that the E-UTRA cell has been already identified by the UE.

A cell shall be considered identifiable following conditions are fulfilled:

- RSRP related side conditions given in Clause 9.1 are fulfilled for a corresponding Band,
- SCH_RP and $SCH \hat{E}s/Iot$ according to Annex B.2.14 for a corresponding Band

The MIB of an E-UTRA cell whose CGI is identified shall be considered decodable by the UE provided the PBCH demodulation requirements are met according to [5].

The requirement for identifying a new CGI of an E-UTRA cell within $T_{\text{basic_identify_CGI_Cat M1, intra}}$ is applicable when no DRX is used as well as when any of DRX and eDRX_CONN cycles specified in TS 36.331 [2] is used.

Within the time, $T_{\text{identify_CGI_Cat M1, intra}}$ ms, over which the UE identifies the new CGI of E-UTRA cell, the PBCH repetition and SIB1-BR repetition level in the target cell shall be as specified in Table 8.13.3.1.4.1-1:

Table 8.13.3.1.4.1-1: Conditions in target cell during $T_{\text{basic_identify_CGI_Cat M1, intra}}$

| Target cell | | | |
|---------------------|---|--------------------------|-------------|
| $\hat{E}s/Iot$ [dB] | PBCH repetition | SIB1-BR repetition level | SIB1-BR TBS |
| ≥ -15 | Configured as specified in TS 36.211 [16] | 16 | 208 |

8.13.3.1.4.2 ECGI Reporting Delay

The ECGI reporting delay occurs due to the delay uncertainty when inserting the ECGI measurement report to the TTI of the uplink DCCH. The delay uncertainty is twice the TTI of the uplink DCCH. In case DRX is used, the ECGI reporting may be delayed until the next DRX cycle. In case eDRX_CONN is used, the ECGI reporting may be delayed until the next eDRX_CONN cycle. If IDC autonomous denial is configured, an additional delay can be expected.

8.13.3.1.5 E-UTRAN intra frequency measurements with autonomous gaps for HD-FDD UE category M1 with CE mode B

The requirements in this section are applicable for the UE which supports half duplex FDD operation on one or more supported frequency bands [2].

The requirements defined in this subclause 8.13.3.1.5 apply provided the following condition is met:

- Tx diversity or transmission using multiple antennas are supported in the target cell to be detected.
- Repetitions of MIB/SIB1-BR are supported in the target cell to be detected.

8.13.3.1.5.1 Identification of a new CGI of E-UTRA cell with autonomous gaps

The CGI requirements defined in clause 8.13.3.1.4.1 also apply for this section.

8.13.3.1.5.2 ECGI Reporting Delay

The ECGI reporting delay defined in clause 8.13.3.1.5.2 also apply for this section

8.13.3.1.6 E-UTRAN TDD intra frequency measurements with autonomous gaps for UE category M1 with CE mode B

The requirements defined in this subclause 8.13.3.1.6 apply provided the following condition is met:

- Tx diversity or transmission using multiple antennas are supported in the target cell to be detected.
- Repetitions of MIB/SIB1-BR are supported in the target cell to be detected.

8.13.3.1.6.1 Identification of a new CGI of E-UTRA cell with autonomous gaps

No explicit neighbour list is provided to the UE for identifying a new CGI of E-UTRA cell. The UE shall identify and report the CGI when requested by the network for the purpose 'reportCGI'. The UE may make autonomous gaps in downlink reception and uplink transmission for receiving MIB and SIB1-BR messages according to clause 5.5.3.1 of TS 36.331 [2]. Note that a UE is not required to use autonomous gap if si-RequestForHO is set to false. If autonomous gaps are used for measurement with the purpose of 'reportCGI', regardless of whether DRX or eDRX_CONN is used or not, or whether SCell(s) are configured or not, the UE shall be able to identify a new CGI of E-UTRA cell within:

$$T_{\text{identify_CGI_Cat M1, intra}} = T_{\text{basic_identify_CGI_Cat M1, intra}} \quad \text{ms}$$

Where

$T_{\text{basic_identify_CGI_Cat M1, intra}} = 5120$ ms. This is the time period used in the above equation where the maximum allowed time for the UE to identify a new CGI of an E-UTRA cell is defined, provided that the E-UTRA cell has been already identified by the UE.

A cell shall be considered identifiable when the following conditions are fulfilled:

- RSRP related side conditions given in Clause 9.1 are fulfilled for a corresponding Band,
- SCH_{RP} and SCH_{Ês}/lot according to Annex B.2.14 for a corresponding Band

The MIB of an E-UTRA cell whose CGI is identified shall be considered decodable by the UE provided the PBCH demodulation requirements are met according to [5].

The requirement for identifying a new CGI of an E-UTRA cell within $T_{\text{basic_identify_CGI_Cat M1, intra}}$ is applicable when no DRX is used as well as when any of the DRX or eDRX_CONN cycles specified in TS 36.331 [2] is used.

Within the time, $T_{\text{identify_CGI_Cat M1, intra}}$ ms, over which the UE identifies the new CGI of E-UTRA cell, the PBCH repetition and SIB1-BR repetition level in the target cell shall be as specified in Table 8.13.3.1.6.1-2:

Table 8.13.3.1.6.1-1: Conditions in target cell during $T_{\text{basic_identify_CGI_Cat M1, intra}}$

| Target cell | | | |
|-------------|---|--------------------------|-------------|
| Ês/lot [dB] | PBCH repetition | SIB1-BR repetition level | SIB1-BR TBS |
| ≥ -15 | Configured as specified in TS 36.211 [16] | 16 | 208 |

8.13.3.1.6.2 ECGI Reporting Delay

The ECGI reporting delay occurs due to the delay uncertainty when inserting the ECGI measurement report to the TTI of the uplink DCCH. The delay uncertainty is twice the TTI of the uplink DCCH. In case DRX is used, the ECGI reporting may be delayed until the next DRX cycle. In case eDRX_CONN is used, the ECGI reporting may be delayed until the next eDRX_CONN cycle. If IDC autonomous denial is configured, an additional delay can be expected.

8.13.3.2 E-UTRAN E-CID Measurements Requirements for UE category M1 with CE mode B

8.13.3.2.1 E-UTRAN FDD Intra-frequency E-CID RSRP Measurements

8.13.3.2.1.1 Introduction

The requirements in section 8.13.3.2.1 shall apply provided the UE has received ECID-RequestLocationInformation message from E-SMLC via LPP requesting the UE to report E-CID E-UTRAN FDD intra-frequency RSRP measurements [24].

8.13.3.2.1.2 Measurement Requirements

The requirements in section 8.13.3.1.1 also apply for this section except the measurement reporting requirements. The measurement reporting requirements for E-CID RSRP are defined in section 8.13.3.2.1.3.

8.13.3.2.1.3 Measurement Reporting Delay

This requirement assumes that that the measurement report is not delayed by other LPP signalling on the DCCH. This measurement reporting delay excludes a delay uncertainty resulted when inserting the measurement report to the TTI of the uplink DCCH. The delay uncertainty is: $pusch-maxNumRepetitionCEmodeB \times TTI_{DCCH}$, where $pusch-maxNumRepetitionCEmodeB$ [2] is the maximum number of PUSCH repetitions configured for the UE in CE Mode B provided that $pusch-maxNumRepetitionCEmodeB > 1$, otherwise uncertainty is defined as $2 \times TTI_{DCCH}$. This measurement reporting delay excludes any delay caused by no UL resources for UE to send the measurement report.

Reported RSRP measurements contained in periodically triggered measurement reports shall meet the requirements in section 9.1.21.3 and 9.1.21.4 respectively.

8.13.3.2.2 E-UTRAN HD-FDD Intra-frequency E-CID RSRP Measurements

8.13.3.2.2.1 Introduction

The requirements in this section are applicable for the UE which supports half duplex operation on one or more supported frequency bands [2].

The requirements defined in clause 8.13.3.2.1.1 also apply for this section provided the following conditions are met:

- at least downlink subframe # 0 and downlink subframe # 5 per radio frame of an intra-frequency cell to be identified by the UE is available at the UE over $T_{identify_intra_UE \text{ cat M1}}$;
- at least two consecutive downlink subframe per radio frame of measured cell is available at the UE for RSRP measurements assuming measured cell is identified cell over $T_{measure_intra_UE \text{ cat M1}}$.
- SCH_RP and $SCH \hat{E}s/lot$ according to Annex Table B.2.14-4

8.13.3.2.2.2 Measurement Requirements

The requirements in section 8.13.3.1.2 also apply for this section except the measurement reporting requirements. The measurement reporting requirements for E-CID RSRP are defined in section 8.13.3.2.2.3.

8.13.3.2.2.3 Measurement Reporting Delay

This requirement assumes that that the measurement report is not delayed by other LPP signalling on the DCCH. This measurement reporting delay excludes a delay uncertainty resulted when inserting the measurement report to the TTI of the uplink DCCH. The delay uncertainty is: $pusch-maxNumRepetitionCEmodeB \times TTI_{DCCH}$, where $pusch-maxNumRepetitionCEmodeB$ [2] is the maximum number of PUSCH repetitions configured for the UE in CE Mode B provided that $pusch-maxNumRepetitionCEmodeB > 1$, otherwise uncertainty is defined as $2 \times TTI_{DCCH}$. This measurement reporting delay excludes any delay caused by no UL resources for UE to send the measurement report.

Reported RSRP measurements contained in periodically triggered measurement reports shall meet the requirements in section 9.1.21.3 and 9.1.21.4 respectively.

8.13.3.2.3 E-UTRAN TDD Intra-frequency E-CID RSRP Measurements

8.13.3.2.3.1 Introduction

The requirements in section 8.13.3.2.3 shall apply provided the UE has received ECID-RequestLocationInformation message from E-SMLC via LPP requesting the UE to report E-CID E-UTRAN TDD intra-frequency RSRP measurements [24].

8.13.3.2.3.2 Measurement Requirements

The requirements in section 8.13.3.1.3 also apply for this section except the measurement reporting requirements. The measurement reporting requirements for E-CID RSRP are defined in section 8.13.3.2.3.3.

8.13.3.2.3.3 Measurement Reporting Delay

This requirement assumes that the measurement report is not delayed by other LPP signalling on the DCCH. This measurement reporting delay excludes a delay uncertainty resulted when inserting the measurement report to the TTI of the uplink DCCH. The delay uncertainty is: $pusch-maxNumRepetitionCEmodeB \times TTI_{DCCH}$, where $pusch-maxNumRepetitionCEmodeB$ [2] is the maximum number of PUSCH repetitions configured for the UE in CE Mode B provided that $pusch-maxNumRepetitionCEmodeB > 1$, otherwise uncertainty is defined as $2 \times TTI_{DCCH}$. This measurement reporting delay excludes any delay caused by no UL resources for UE to send the measurement report.

Reported RSRP measurements contained in periodically triggered measurement reports shall meet the requirements in section 9.1.21.3 and 9.1.21.4 respectively.

8.14 Measurements for UE category NB1

8.14.1 Introduction

This clause contains requirements on the UE category NB1 regarding measurement in RRC_CONNECTED state. The requirements are specified for NB-IoT intra frequency measurements for serving NB-IoT cell. These measurements may be used by the NB-IoT for uplink power control. The measurement quantities are defined in [4], the measurement model is defined in [22] and measurement accuracies are specified in clause 9. During the RRC_CONNECTED state the UE shall continuously measure serving NB-IoT cell.

The UE shall meet all applicable requirements specified in clause 8.14 under the following conditions:

- at least 1 DL subframe per radio frame of serving NB-IoT cell is available at the UE during measurement period.

8.14.2 NB-IoT intra frequency measurements under normal coverage

8.14.2.1 NB-IoT intra frequency measurements when no DRX is used

In the RRC_CONNECTED state the measurement period for intra frequency measurements is 800ms. The NRSRP measurement accuracy shall be as specified in the sub-clauses 9.1.22.1.

8.14.2.2 NB-IoT intra frequency measurements when DRX is used

When DRX is used in the RRC_CONNECTED state the measurement period for intra frequency measurements is $T_{measure_intra}$ as shown in table 8.14.2.2-1.

Table 8.14.2.2-1: Requirement for intrafrequency measurement

| DRX cycle length (s) | $T_{measure_intra}$ (s) (DRX cycles) |
|---|---------------------------------------|
| $0.256 < DRX-cycle \leq 9.216$ | Note1 ([5]) |
| Note1: Time depends upon the DRX cycle in use | |

The NRSRP measurement accuracy shall be as specified in the sub-clauses 9.1.22.1.

8.14.3 NB-IoT intra frequency measurements under enhanced coverage

8.14.3.1 NB-IoT intra frequency measurements when no DRX is used

In the RRC_CONNECTED state the measurement period for intra frequency measurements is 1600ms. The NRSRP measurement accuracy shall be as specified in the sub-clauses 9.1.22.1.

8.14.3.2 NB-IoT intra frequency measurements when DRX is used

When DRX is used in the RRC_CONNECTED state the measurement period for intra frequency measurements is $T_{\text{measure_intra}}$ as shown in table 8.14.3.2-1.

Table 8.14.3.2-1: Requirement for intrafrequency measurement

| DRX cycle length (s) | $T_{\text{measure_intra}}$ (s) (DRX cycles) |
|---|---|
| $0.256 < \text{DRX-cycle} \leq 9.216$ | Note1 ([5]) |
| Note1: Time depends upon the DRX cycle in use | |

The NRSRP measurement accuracy shall be as specified in the sub-clauses 9.1.22.1.

9 Measurements performance requirements for UE

One of the key services provided by the physical layer is the measurements used to trigger or perform a multitude of functions. Both the UE and the E-UTRAN are required to perform measurements. The physical layer measurement model and a complete list of measurements are specified in [25] and [22] respectively. The physical layer measurements are described and defined in [4]. In this clause for each measurement the relevant requirements on the measurement period, reporting range, granularity and performance in terms of accuracy are specified.

Since the UE reference sensitivity requirements are different depending on supported band, this is noted in each case with definition of the range I_0 for each frequency band. Definitions of each frequency bands can be found in [5].

Except for requirements in sections 9.1.2A, 9.1.3A, 9.1.5A and 9.1.6A, the accuracy requirements in this clause are applicable for AWGN radio propagation conditions and assume independent interference (noise) at each receiver antenna port.

9.1 E-UTRAN measurements

9.1.1 Introduction

Unless otherwise specified, the requirements in this clause are applicable for a UE:

- in state RRC_CONNECTED
- performing measurements with appropriate measurement gaps as defined in Clause 8.1.2.1.
- that is synchronised to the cell that is measured.

The reported measurement result after layer 1 filtering shall be an estimate of the average value of the measured quantity over the measurement period. The reference point for the measurement result after layer 1 filtering is referred to as point B in the measurement model described in [25].

The accuracy requirements in this clause are valid for the reported measurement result after layer 1 filtering. The accuracy requirements are verified from the measurement report at point D in the measurement model having the higher layer filtering disabled.

In the requirements of Section 9 for the UE capable of CA and the UEs configured with up to four downlink SCell(s), the applicable exceptions for side conditions are specified in Annex B, Sections B.4.2 and B.4.3, respectively.

9.1.2 Intra-frequency RSRP Accuracy Requirements

9.1.2.1 Absolute RSRP Accuracy

The requirements for absolute accuracy of RSRP in this clause apply to a cell on the same frequency as that of the serving cell.

The accuracy requirements in Table 9.1.2.1-1 are valid under the following conditions:

Cell specific reference signals are transmitted either from one, two or four antenna ports.

Conditions defined in 36.101 Clause 7.3 for reference sensitivity are fulfilled.

RSRP_{dBm} according to Annex B.3.1 for a corresponding Band

Table 9.1.2.1-1: RSRP Intra frequency absolute accuracy

| Accuracy | | Conditions | | | | |
|------------------|-------------------|------------|--|-----------------------------|---------------------------|---------------------------|
| Normal condition | Extreme condition | Ês/lot | I _o ^{Note 1} range | | | |
| | | | E-UTRA operating band groups ^{Note 3} | Minimum I _o | | Maximum I _o |
| dB | dB | dB | | dBm/15kHz ^{Note 2} | dBm/BW _{Channel} | dBm/BW _{Channel} |
| ±4.5 | ±9 | ≥-6 dB | FDD_A, TDD_A | -121 | N/A | -70 |
| | | | FDD_B | -120.5 | N/A | -70 |
| | | | FDD_C, TDD_C | -120 | N/A | -70 |
| | | | FDD_D | -119.5 | N/A | -70 |
| | | | FDD_E, TDD_E | -119 | N/A | -70 |
| | | | FDD_F | -118.5 | N/A | -70 |
| | | | FDD_G | -118 | N/A | -70 |
| | | | FDD_H | -117.5 | N/A | -70 |
| | | | FDD_N | -114.5 | N/A | -70 |
| ±8 | ±11 | ≥-6 dB | FDD_A, TDD_A, FDD_B, FDD_C, TDD_C, FDD_D, FDD_E, TDD_E, FDD_F, FDD_G, FDD_H, FDD_N | N/A | -70 | -50 |

NOTE 1: I_o is assumed to have constant EPRE across the bandwidth.
 NOTE 2: The condition level is increased by Δ>0, when applicable, as described in Sections B.4.2 and B.4.3.
 NOTE 3: E-UTRA operating band groups are as defined in Section 3.5.

9.1.2.2 Relative Accuracy of RSRP

The relative accuracy of RSRP is defined as the RSRP measured from one cell compared to the RSRP measured from another cell on the same frequency.

The accuracy requirements in Table 9.1.2.2-1 are valid under the following conditions:

Cell specific reference signals are transmitted either from one, two or four antenna ports.

Conditions defined in 36.101 Clause 7.3 for reference sensitivity are fulfilled.

RSRP_{1,2}_{dBm} according to Annex B.3.8 for a corresponding Band.

Table 9.1.2.2-1: RSRP Intra frequency relative accuracy

| Accuracy | | Conditions | | | |
|------------------|-------------------|--------------------------|--|---------------------------|---------------------------|
| Normal condition | Extreme condition | Ês/lot ^{Note 2} | I _o ^{Note 1} range | | |
| | | | E-UTRA operating band groups ^{Note 5} | Minimum I _o | Maximum I _o |
| dB | dB | dB | dBm/15kHz ^{Note 4} | dBm/BW _{Channel} | dBm/BW _{Channel} |
| ±2 | ±3 | ≥-3 dB | FDD_A, TDD_A | -121 | -50 |
| | | | FDD_B | -120.5 | -50 |
| | | | FDD_C, TDD_C | -120 | -50 |
| | | | FDD_D | -119.5 | -50 |
| | | | FDD_E, TDD_E | -119 | -50 |
| | | | FDD_F | -118.5 | -50 |
| | | | FDD_G | -118 | -50 |
| | | | FDD_H | -117.5 | -50 |
| | | | FDD_N | -114.5 | -50 |
| ±3 | ±3 | ≥-6 dB | Note 3 | Note 3 | Note 3 |

NOTE 1: I_o is assumed to have constant EPRE across the bandwidth.

NOTE 2: The parameter \bar{E}_s/lot is the minimum \bar{E}_s/lot of the pair of cells to which the requirement applies.
 NOTE 3: The same bands and the same l_0 conditions for each band apply for this requirement as for the corresponding highest accuracy requirement.
 NOTE 4: The condition level is increased by $\Delta > 0$, when applicable, as described in Sections B.4.2 and B.4.3.
 NOTE 5: E-UTRA operating band groups are as defined in Section 3.5.

9.1.2.3 Absolute RSRP Accuracy under Time Domain Measurement Resource Restriction

The requirements for absolute accuracy of RSRP in this clause shall apply to a cell on the same frequency as that of the serving cell when a time domain measurement resource restriction pattern for performing RSRP measurements on this cell is configured by higher layers (TS 36.331 [2]).

The accuracy requirements in Table 9.1.2.3-1 are valid under the following conditions:

Cell specific reference signals in the measured cell are transmitted either from one, two or four antenna ports,

Conditions defined in 36.101 Clause 7.3 for reference sensitivity are fulfilled,

$RSRP|_{dBm}$ according to Annex B.3.9 for a corresponding Band,

The time domain measurement resource restriction pattern configured for the measured cell indicates at least one subframe per radio frame for performing the RSRP measurement,

Four symbols containing CRS are available in all subframes indicated by the time domain measurement resource restriction pattern.

Table 9.1.2.3-1: RSRP Intra frequency absolute accuracy under time domain measurement resource restriction

| Accuracy | | Conditions | | | | |
|------------------|-------------------|------------------------|--|------------------------------------|---------------------------|---------------------------|
| Normal condition | Extreme condition | \bar{E}_s/lot | l_0 ^{Note 2} range | | | |
| | | | E-UTRA operating band groups ^{Note 4} | Minimum l_0 | | Maximum l_0 |
| dB | dB | dB | | dBm/ 15kHz ^{Note 1, 3} | dBm/BW _{Channel} | dBm/BW _{Channel} |
| ±4.5 | ±9 | ≥-4 dB | FDD_A, TDD_A | -121 | N/A | -70 |
| | | | FDD_B | -120.5 | N/A | -70 |
| | | | FDD_C, TDD_C | -120 | N/A | -70 |
| | | | FDD_D | -119.5 | N/A | -70 |
| | | | FDD_E, TDD_E | -119 | N/A | -70 |
| | | | FDD_F | -118.5 | N/A | -70 |
| | | | FDD_G | -118 | N/A | -70 |
| | | | FDD_H | -117.5 | N/A | -70 |
| | | | FDD_N | -114.5 | N/A | -70 |
| ±8 | ±11 | ≥-4 dB | FDD_A, TDD_A, FDD_B, FDD_C, TDD_C, FDD_D, FDD_E, TDD_E, FDD_F, FDD_G, FDD_H, FDD_N | N/A | -70 | -50 |

NOTE 1: This minimum l_0 condition is expressed as the average l_0 per RE over all REs in that symbol.
 NOTE 2: l_0 is defined in subframes indicated by the time domain measurement resource restriction pattern configured for performing RSRP measurements of this cell. The l_0 range defined by the minimum and the maximum l_0 levels applies to CRS and non-CRS symbols. l_0 may be different in different symbols within a subframe.
 NOTE 3: The condition level is increased by $\Delta > 0$, when applicable, as described in Sections B.4.2 and B.4.3.
 NOTE 4: E-UTRA operating band groups are as defined in Section 3.5.

For time domain measurements restriction under colliding CRS with ABS configured in non-MBSFN subframes, requirements in Section 9.1.2.1 apply.

9.1.2.4 Relative Accuracy of RSRP under Time Domain Measurement Resource Restriction

The requirements for relative accuracy of RSRP in this clause shall apply to a cell on the same frequency as that of the serving cell when a time domain measurement resource restriction pattern for performing RSRP measurements for this cell is configured by higher layers (TS 36.331 [2]).

The accuracy requirements in Table 9.1.2.4-1 are valid under the following conditions:

Cell specific reference signals in the measured cell are transmitted either from one, two or four antenna ports,

Conditions defined in 36.101 Clause 7.3 for reference sensitivity are fulfilled,

RSRP_{1,2}_{dBm} according to Annex B.3.10 for a corresponding Band,

The time domain measurement resource restriction pattern configured for the measured cell indicates at least one subframe per radio frame for performing the RSRP measurement,

Four symbols containing CRS are available in all subframes indicated by the time domain measurement resource restriction pattern.

Table 9.1.2.4-1: RSRP Intra frequency relative accuracy under time domain measurement resource restriction

| Accuracy | | Conditions | | | |
|------------------|-------------------|----------------------------------|--|------------------------------------|---------------------------|
| Normal condition | Extreme condition | $\hat{E}s/lot$ ^{Note 2} | l_o ^{Note 3} range | | |
| | | | E-UTRA operating band groups ^{Note 6} | Minimum l_o | Maximum l_o |
| dB | dB | dB | | dBm/ 15kHz ^{Note 1, 5} | dBm/BW _{Channel} |
| ±2 | ±3 | ≥-2 dB | FDD_A, TDD_A | -121 | -50 |
| | | | FDD_B | -120.5 | -50 |
| | | | FDD_C, TDD_C | -120 | -50 |
| | | | FDD_D | -119.5 | -50 |
| | | | FDD_E, TDD_E | -119 | -50 |
| | | | FDD_F | -118.5 | -50 |
| | | | FDD_G | -118 | -50 |
| | | | FDD_H | -117.5 | -50 |
| | | | FDD_N | -114.5 | -50 |
| ±3 | ±3 | ≥-4 dB | Note 4 | Note 4 | Note 4 |

NOTE 1: This minimum l_o condition is expressed as the average l_o per RE over all REs in that symbol.
 NOTE 2: The parameter $\hat{E}s/lot$ is the minimum $\hat{E}s/lot$ of the pair of cells to which the requirement applies.
 NOTE 3: l_o is defined in subframes indicated by the time domain measurement resource restriction pattern configured for performing RSRP measurements of this cell. The l_o range defined by the minimum and the maximum l_o levels applies to CRS and non-CRS symbols. l_o may be different in different symbols within a subframe.
 NOTE 4: The same bands and the same l_o conditions for each band apply for this requirement as for the corresponding highest accuracy requirement.
 NOTE 5: The condition level is increased by $\Delta > 0$, when applicable, as described in Sections B.4.2 and B.4.3.
 NOTE 6: E-UTRA operating band groups are as defined in Section 3.5.

For time domain measurements restriction under colliding CRS with ABS configured in non-MBSFN subframes, requirements in Section 9.1.2.2 apply.

9.1.2.5 Absolute RSRP Accuracy under Time Domain Measurement Resource Restriction with CRS assistance information

The requirements for absolute accuracy of RSRP in this clause shall apply to a cell on the same frequency as that of the serving cell when a time domain measurement resource restriction pattern for performing RSRP measurements on this cell is configured by higher layers (TS 36.331 [2]) and the CRS assistance information is provided. The requirements apply for UEs supporting CRS interference handling.

The accuracy requirements in Table 9.1.2.5-1 are valid under the following conditions:

Cell specific reference signals in the measured cell are transmitted either from one, two or four antenna ports,
 Conditions defined in 36.101 Section 7.3 for reference sensitivity are fulfilled,

RSRP_{dBm} according to Annex B.3.11 for a corresponding Band,

The time domain measurement resource restriction pattern configured for the measured cell indicates at least one subframe per radio frame for performing the RSRP measurement,

Four symbols containing CRS are available in all subframes indicated by the time domain measurement resource restriction pattern,

The UE is provided with the CRS assistance information (TS 36.331 [2]) and the CRS assistance information is valid throughout the entire evaluation period.

The requirements in this section shall also be met when the number of transmit antenna ports [16] of one or more cells whose CRS assistance information is provided [2] is different from the number of transmit antenna ports of the measured cell.

Table 9.1.2.5-1: RSRP Intra frequency absolute accuracy under Time Domain Measurement Resource Restriction with CRS assistance information

| Accuracy | | Conditions | | | | |
|------------------|-------------------|------------|--|--------------------------------|---------------------------|---------------------------|
| Normal condition | Extreme condition | Ês/lot | I _o ^{Note 2} range | | | |
| | | | E-UTRA operating band groups ^{Note 4} | Minimum I _o | | Maximum I _o |
| dB | dB | dB | | dBm/15kHz ^{Note 1, 3} | dBm/BW _{Channel} | dBm/BW _{Channel} |
| ±4.5 | ±9 | ≥-9.46 | FDD_A, TDD_A | -121 | N/A | -70 |
| | | | FDD_B | -120.5 | N/A | -70 |
| | | | FDD_C, TDD_C | -120 | N/A | -70 |
| | | | FDD_D | -119.5 | N/A | -70 |
| | | | FDD_E, TDD_E | -119 | N/A | -70 |
| | | | FDD_F | -118.5 | N/A | -70 |
| | | | FDD_G | -118 | N/A | -70 |
| | | | FDD_H | -117.5 | N/A | -70 |
| | | | FDD_N | -114.5 | N/A | -70 |
| ±8 | ±11 | ≥-9.46 | FDD_A, TDD_A, FDD B, FDD_C, TDD_C, FDD_D, FDD_E, TDD_E, FDD_F, FDD_G, FDD_H, FDD_N | N/A | -70 | -50 |

NOTE 1: This I_o condition is expressed as the average I_o per RE over all REs in an OFDM symbol.
 NOTE 2: I_o is defined in subframes indicated by the time domain measurement resource restriction pattern configured for performing RSRP measurements of this cell. The specified I_o range applies to CRS and non-CRS symbols. I_o may be different in different symbols within a subframe.
 NOTE 3: The condition level is increased by Δ>0, when applicable, as described in Sections B.4.2 and B.4.3.
 NOTE 4: E-UTRA operating band groups are as defined in Section 3.5.

9.1.2.6 Relative Accuracy of RSRP under Time Domain Measurement Resource Restriction with CRS assistance information

The requirements for relative accuracy of RSRP in this clause shall apply to a cell on the same frequency as that of the serving cell when a time domain measurement resource restriction pattern for performing RSRP measurements for this cell is configured by higher layers (TS 36.331 [2]) and the CRS assistance information is provided. The requirements apply for UEs supporting CRS interference handling.

The accuracy requirements in Table 9.1.2.6-1 are valid under the following conditions:

Cell specific reference signals in the measured cell are transmitted either from one, two or four antenna ports,

Conditions defined in 36.101 Section 7.3 for reference sensitivity are fulfilled,

RSRP_{1,2|dBm} according to Annex B.3.12 for a corresponding Band,

The time domain measurement resource restriction pattern configured for the measured cell indicates at least one subframe per radio frame for performing the RSRP measurement,

Four symbols containing CRS are available in all subframes indicated by the time domain measurement resource restriction pattern,

The UE is provided with the CRS assistance information (TS 36.331 [2]) and the CRS assistance information is valid throughout the entire evaluation period.

The requirements in this section shall also be met also when the number of transmit antenna ports [16] of one or more cells whose CRS assistance information is provided [2] is different from the number of transmit antenna ports of the measured cell.

Table 9.1.2.6-1: RSRP Intra frequency relative accuracy under Time Domain Measurement Resource Restriction with CRS assistance information

| Accuracy | | Conditions | | | |
|------------------|-------------------|-------------------------------------|--|--------------------------------|---------------------------|
| Normal condition | Extreme condition | $\hat{E}s/lot$ ^{Note 2, 6} | Io ^{Note 3} range | | |
| | | | E-UTRA operating band groups ^{Note 7} | Minimum Io | Maximum Io |
| dB | dB | dB | | dBm/15kHz ^{Note 1, 5} | dBm/BW _{Channel} |
| ±2 | ±3 | ≥-6.96 | FDD_A, TDD_A | -121 | -50 |
| | | | FDD_B | -120.5 | -50 |
| | | | FDD_C, TDD_C | -120 | -50 |
| | | | FDD_D | -119.5 | -50 |
| | | | FDD_E, TDD_E | -119 | -50 |
| | | | FDD_F | -118.5 | -50 |
| | | | FDD_G | -118 | -50 |
| | | | FDD_H | -117.5 | -50 |
| | | | FDD_N | -114.5 | -50 |
| ±3 | ±3 | ≥-9.46 | Note 4 | Note 4 | Note 4 |

NOTE 1: This Io condition is expressed as the average Io per RE over all REs in an OFDM symbol.
 NOTE 2: The parameter $\hat{E}s/lot$ is the minimum $\hat{E}s/lot$ of the pair of cells to which the requirement applies.
 NOTE 3: Io is defined in subframes indicated by the time domain measurement resource restriction pattern configured for performing RSRP measurements of this cell. The specified Io range applies to CRS and non-CRS symbols. Io may be different in different symbols within a subframe.
 NOTE 4: The same bands and the same Io conditions for each band apply for this requirement as for the corresponding highest accuracy requirement.
 NOTE 5: The condition level is increased by $\Delta > 0$, when applicable, as described in Sections B.4.2 and B.4.3.
 NOTE 6: The gap between the $\hat{E}s/lot$ level in table 9.1.2.6-1 and 9.1.2.4-1 is due to the interference from either PCell or at least one neighbour cell indicated within the CRS assistance information.
 NOTE 7: E-UTRA operating band groups are as defined in Section 3.5.

9.1.2A Intra-frequency RSRP Accuracy Requirements in High Doppler Conditions

The accuracy requirements in this clause are applicable for [EVA300 and EVA600] propagation conditions and assume independent interference (noise) at each receiver antenna port.

9.1.2A.1 Absolute RSRP Accuracy in high Doppler conditions

The requirements for absolute accuracy of RSRP in this clause apply to a cell on the same frequency as that of the serving cell.

The accuracy requirements in Table 9.1.2A.1-1 are valid under the following conditions:

Cell specific reference signals are transmitted either from one, two or four antenna ports.

Conditions defined in 36.101 Clause 7.3 for reference sensitivity are fulfilled.

RSRP[dBm] according to Annex B.3.1 for a corresponding Band

Table 9.1.2A1-1: RSRP Intra frequency absolute accuracy

| Accuracy | | Conditions | | | | |
|------------------|-------------------|------------|--|-----------------------------|---------------------------|---------------------------|
| Normal condition | Extreme condition | Ês/lot | I _o ^{Note 1} range | | | |
| | | | E-UTRA operating band groups ^{Note 3} | Minimum I _o | | Maximum I _o |
| dB | dB | dB | | dBm/15kHz ^{Note 2} | dBm/BW _{Channel} | dBm/BW _{Channel} |
| ±6 | ±10.5 | ≥-6 dB | FDD_A, TDD_A | -121 | N/A | -70 |
| | | | FDD_B | -120.5 | N/A | -70 |
| | | | FDD_C, TDD_C | -120 | N/A | -70 |
| | | | FDD_D | -119.5 | N/A | -70 |
| | | | FDD_E, TDD_E | -119 | N/A | -70 |
| | | | FDD_F | -118.5 | N/A | -70 |
| | | | FDD_G | -118 | N/A | -70 |
| | | | FDD_H | -117.5 | N/A | -70 |
| | | | FDD_N | -114.5 | N/A | -70 |
| ±9.5 | ±12.5 | ≥-6 dB | FDD_A, TDD_A, FDD_B, FDD_C, TDD_C, FDD_D, FDD_E, TDD_E, FDD_F, FDD_G, FDD_H, FDD_N | N/A | -70 | -50 |

NOTE 1: I_o is assumed to have constant EPRE across the bandwidth.
 NOTE 2: The condition level is increased by Δ>0, when applicable, as described in Sections B.4.2 and B.4.3.
 NOTE 3: E-UTRA operating band groups are as defined in Section 3.5.

9.1.2A.2 Relative Accuracy of RSRP in high Doppler conditions

The relative accuracy of RSRP is defined as the RSRP measured from one cell compared to the RSRP measured from another cell on the same frequency.

The accuracy requirements in Table 9.1.2A.2-1 are valid under the following conditions:

Cell specific reference signals are transmitted either from one, two or four antenna ports.

Conditions defined in 36.101 Clause 7.3 for reference sensitivity are fulfilled.

RSRP_{1,2}_{dBm} according to Annex B.3.8 for a corresponding Band.

Table 9.1.2A.2-1: RSRP Intra frequency relative accuracy

| Accuracy | | Conditions | | | |
|------------------|-------------------|--------------------------|--|---------------------------|------------------------|
| Normal condition | Extreme condition | Ês/lot ^{Note 2} | I _o ^{Note 1} range | | |
| | | | E-UTRA operating band groups ^{Note 5} | Minimum I _o | Maximum I _o |
| dB | dB | dB | dBm/15kHz ^{Note 4} | dBm/BW _{Channel} | |
| ±3.3 | ±4.3 | ≥-3 dB | FDD_A, TDD_A | -121 | -50 |
| | | | FDD_B | -120.5 | -50 |
| | | | FDD_C, TDD_C | -120 | -50 |
| | | | FDD_D | -119.5 | -50 |
| | | | FDD_E, TDD_E | -119 | -50 |
| | | | FDD_F | -118.5 | -50 |
| | | | FDD_G | -118 | -50 |
| | | | FDD_H | -117.5 | -50 |
| | | | FDD_N | -114.5 | -50 |
| ±4.3 | ±4.3 | ≥-6 dB | Note 3 | Note 3 | Note 3 |

NOTE 1: I_o is assumed to have constant EPRE across the bandwidth.
 NOTE 2: The parameter Ês/lot is the minimum Ês/lot of the pair of cells to which the requirement applies.
 NOTE 3: The same bands and the same I_o conditions for each band apply for this requirement as for the corresponding highest accuracy requirement.
 NOTE 4: The condition level is increased by Δ>0, when applicable, as described in Sections B.4.2 and B.4.3.
 NOTE 5: E-UTRA operating band groups are as defined in Section 3.5.

9.1.3 Inter-frequency RSRP Accuracy Requirements

9.1.3.1 Absolute RSRP Accuracy

The requirements for absolute accuracy of RSRP in this clause apply to a cell that has different carrier frequency from the serving cell.

The accuracy requirements in Table 9.1.3.1-1 are valid under the following conditions:

Cell specific reference signals are transmitted either from one, two or four antenna ports.

Conditions defined in 36.101 Clause 7.3 for reference sensitivity are fulfilled.

RSRP_{dBm} according to Annex B.3.3 for a corresponding Band

Table 9.1.3.1-1: RSRP Inter frequency absolute accuracy

| Accuracy | | Conditions | | | | |
|------------------|-------------------|------------|--|-----------------------------|---------------------------|---------------------------|
| Normal condition | Extreme condition | Ês/lot | I _o ^{Note 1} range | | | |
| | | | E-UTRA operating band groups ^{Note 3} | Minimum I _o | | Maximum I _o |
| dB | dB | dB | | dBm/15kHz ^{Note 2} | dBm/BW _{Channel} | dBm/BW _{Channel} |
| ±4.5 | ±9 | ≥-6 dB | FDD_A, TDD_A | -121 | N/A | -70 |
| | | | FDD_B | -120.5 | N/A | -70 |
| | | | FDD_C, TDD_C | -120 | N/A | -70 |
| | | | FDD_D | -119.5 | N/A | -70 |
| | | | FDD_E, TDD_E | -119 | N/A | -70 |
| | | | FDD_F | -118.5 | N/A | -70 |
| | | | FDD_G | -118 | N/A | -70 |
| | | | FDD_H | -117.5 | N/A | -70 |
| | | | FDD_N | -114.5 | N/A | -70 |
| ±8 | ±11 | ≥-6 dB | FDD_A, TDD_A, FDD_B, FDD_C, TDD_C, FDD_D, FDD_E, TDD_E, FDD_F, FDD_G, FDD_H, FDD_N | N/A | -70 | -50 |

NOTE 1: I_o is assumed to have constant EPRE across the bandwidth.
 NOTE 2: The condition level is increased by Δ>0, when applicable, as described in Sections B.4.2 and B.4.3.
 NOTE 3: E-UTRA operating band groups are as defined in Section 3.5.

9.1.3.2 Relative Accuracy of RSRP

The relative accuracy of RSRP in inter frequency case is defined as the RSRP measured from one cell compared to the RSRP measured from another cell on a different frequency.

The accuracy requirements in Table 9.1.3.2-1 are valid under the following conditions:

Cell specific reference signals are transmitted either from one, two or four antenna ports.

Conditions defined in 36.101 Clause 7.3 for reference sensitivity are fulfilled.

RSRP_{1,2}_{dBm} according to Annex B.3.4 for a corresponding Band

$$|RSRP1|_{dBm} - RSRP2|_{dBm}| \leq 27dB$$

$$|Channel 1_{I_o} - Channel 2_{I_o}| \leq 20 dB$$

Table 9.1.3.2-1: RSRP Inter frequency relative accuracy

| Accuracy | | Conditions | | |
|------------------|-------------------|--------------------------|--|------------------------|
| Normal condition | Extreme condition | Ês/lot ^{Note 2} | I _o ^{Note 1} range | |
| | | | E-UTRA operating band groups ^{Note 4} | Minimum I _o |

| dB | dB | dB | | dBm/15kHz ^{Note 3} | dBm/BW _{Channel} |
|------|----|--------|--------------|-----------------------------|---------------------------|
| ±4.5 | ±6 | ≥-6 dB | FDD_A, TDD_A | -121 | -50 |
| | | | FDD_B | -120.5 | -50 |
| | | | FDD_C, TDD_C | -120 | -50 |
| | | | FDD_D | -119.5 | -50 |
| | | | FDD_E, TDD_E | -119 | -50 |
| | | | FDD_F | -118.5 | -50 |
| | | | FDD_G | -118 | -50 |
| | | | FDD_H | -117.5 | -50 |
| | | | FDD_N | -114.5 | -50 |

NOTE 1: I_0 is assumed to have constant EPRE across the bandwidth.
NOTE 2: The parameter \hat{E}_s/lot is the minimum \hat{E}_s/lot of the pair of cells to which the requirement applies.
NOTE 3: The condition level is increased by $\Delta > 0$, when applicable, as described in Sections B.4.2 and B.4.3.
NOTE 4: E-UTRA operating band groups are as defined in Section 3.5.

9.1.3A Inter-frequency RSRP Accuracy Requirements in High Doppler Conditions

The accuracy requirements in this clause are applicable for [EVA300 and EVA600] propagation conditions and assume independent interference (noise) at each receiver antenna port.

9.1.3A.1 Absolute RSRP Accuracy in high Doppler conditions

The requirements for absolute accuracy of RSRP in this clause apply to a cell that has different carrier frequency from the serving cell.

The accuracy requirements in Table 9.1.3A.1-1 are valid under the following conditions:

Cell specific reference signals are transmitted either from one, two or four antenna ports.

Conditions defined in 36.101 Clause 7.3 for reference sensitivity are fulfilled.

RSRP|dBm according to Annex B.3.3 for a corresponding Band

Table 9.1.3A.1-1: RSRP Inter frequency absolute accuracy

| Accuracy | | Conditions | | | | |
|------------------|-------------------|------------------------|--|-----------------------------|---------------------------|---------------------------|
| Normal condition | Extreme condition | \hat{E}_s/lot | I_0 ^{Note 1} range | | | |
| | | | E-UTRA operating band groups ^{Note 3} | Minimum I_0 | | Maximum I_0 |
| dB | dB | dB | | dBm/15kHz ^{Note 2} | dBm/BW _{Channel} | dBm/BW _{Channel} |
| ±6 | ±10.5 | ≥-6 dB | FDD_A, TDD_A | -121 | N/A | -70 |
| | | | FDD_B | -120.5 | N/A | -70 |
| | | | FDD_C, TDD_C | -120 | N/A | -70 |
| | | | FDD_D | -119.5 | N/A | -70 |
| | | | FDD_E, TDD_E | -119 | N/A | -70 |
| | | | FDD_F | -118.5 | N/A | -70 |
| | | | FDD_G | -118 | N/A | -70 |
| | | | FDD_H | -117.5 | N/A | -70 |
| | | | FDD_N | -114.5 | N/A | -70 |
| ±9.5 | ±12.5 | ≥-6 dB | FDD_A, TDD_A, FDD_B, FDD_C, TDD_C, FDD_D, FDD_E, TDD_E, FDD_F, FDD_G, FDD_H, FDD_N | N/A | -70 | -50 |

NOTE 1: I_0 is assumed to have constant EPRE across the bandwidth.
NOTE 2: The condition level is increased by $\Delta > 0$, when applicable, as described in Sections B.4.2 and B.4.3.
NOTE 3: E-UTRA operating band groups are as defined in Section 3.5.

9.1.3A.2 Relative Accuracy of RSRP in high Doppler conditions

The relative accuracy of RSRP in inter frequency case is defined as the RSRP measured from one cell compared to the RSRP measured from another cell on a different frequency.

The accuracy requirements in Table 9.1.3A.2-1 are valid under the following conditions:

Cell specific reference signals are transmitted either from one, two or four antenna ports.

Conditions defined in 36.101 Clause 7.3 for reference sensitivity are fulfilled.

RSRP_{1,2}_{dBm} according to Annex B.3.4 for a corresponding Band

$$\left| RSRP1 \Big|_{dBm} - RSRP2 \Big|_{dBm} \right| \leq 27 dB$$

$$| \text{Channel 1}_{Io} - \text{Channel 2}_{Io} | \leq 20 dB$$

Table 9.1.3A.2-1: RSRP Inter frequency relative accuracy

| Accuracy | | Conditions | | | |
|------------------|-------------------|--------------------------|--|---------------------------|------------|
| Normal condition | Extreme condition | Ês/Iot ^{Note 2} | Io ^{Note 1} range | | |
| | | | E-UTRA operating band groups ^{Note 4} | Minimum Io | Maximum Io |
| dB | dB | dB | dBm/15kHz ^{Note 3} | dBm/BW _{Channel} | |
| ±5.8 | ±7.3 | ≥-6 dB | FDD_A, TDD_A | -121 | -50 |
| | | | FDD_B | -120.5 | -50 |
| | | | FDD_C, TDD_C | -120 | -50 |
| | | | FDD_D | -119.5 | -50 |
| | | | FDD_E, TDD_E | -119 | -50 |
| | | | FDD_F | -118.5 | -50 |
| | | | FDD_G | -118 | -50 |
| | | | FDD_H | -117.5 | -50 |
| | | | FDD_N | -114.5 | -50 |

NOTE 1: Io is assumed to have constant EPRE across the bandwidth.
 NOTE 2: The parameter Ês/Iot is the minimum Ês/Iot of the pair of cells to which the requirement applies.
 NOTE 3: The condition level is increased by Δ>0, when applicable, as described in Sections B.4.2 and B.4.3.
 NOTE 4: E-UTRA operating band groups are as defined in Section 3.5.

9.1.4 RSRP Measurement Report Mapping

The reporting range of RSRP is defined from -156 dBm to -44 dBm with 1 dB resolution.

The mapping of measured quantity is defined in Table 9.1.4-1. The range in the signalling may be larger than the guaranteed accuracy range.

Table 9.1.4-1: RSRP measurement report mapping

| Reported value | Measured quantity value | Unit |
|----------------|-------------------------|------|
| RSRP_-17 | RSRP < -156 | dBm |
| RSRP_-16 | -156 ≤ RSRP < -155 | dBm |
| ... | ... | ... |
| RSRP_-03 | -143 ≤ RSRP < -142 | dBm |
| RSRP_-02 | -142 ≤ RSRP < -141 | dBm |
| RSRP_-01 | -141 ≤ RSRP < -140 | dBm |
| RSRP_00 | RSRP < -140 | dBm |
| RSRP_01 | -140 ≤ RSRP < -139 | dBm |
| RSRP_02 | -139 ≤ RSRP < -138 | dBm |
| ... | ... | ... |
| RSRP_95 | -46 ≤ RSRP < -45 | dBm |
| RSRP_96 | -45 ≤ RSRP < -44 | dBm |

| | | |
|---------|------------------------|-----|
| RSRP_97 | $-44 \leq \text{RSRP}$ | dBm |
|---------|------------------------|-----|

9.1.5 Intra-frequency RSRQ Accuracy Requirements

9.1.5.1 Absolute RSRQ Accuracy

The requirements for absolute accuracy of RSRQ in this clause apply to a cell on the same frequency as that of the serving cell.

The accuracy requirements in Table 9.1.5.1-1 are valid under the following conditions:

Cell specific reference signals are transmitted either from one, two or four antenna ports.

Conditions defined in 36.101 Clause 7.3 for reference sensitivity are fulfilled.

RSRP_{dBm} according to Annex B.3.1 for a corresponding Band

Table 9.1.5.1-1: RSRQ Intra frequency absolute accuracy

| Accuracy | | Conditions | | | |
|------------------|-------------------|------------|--|---------------------------|------------------------|
| Normal condition | Extreme condition | Ês/lot | I _o ^{Note 1} range | | |
| | | | E-UTRA operating band groups ^{Note 4} | Minimum I _o | Maximum I _o |
| dB | dB | dB | dBm/15kHz ^{Note 3} | dBm/BW _{Channel} | |
| ±2.5 | ±4 | ≥-3 dB | FDD_A, TDD_A | -121 | -50 |
| | | | FDD_B | -120.5 | -50 |
| | | | FDD_C, TDD_C | -120 | -50 |
| | | | FDD_D | -119.5 | -50 |
| | | | FDD_E, TDD_E | -119 | -50 |
| | | | FDD_F | -118.5 | -50 |
| | | | FDD_G | -118 | -50 |
| | | | FDD_H | -117.5 | -50 |
| | | | FDD_N | -114.5 | -50 |
| ±3.5 | ±4 | ≥-6 dB | Note 2 | Note 2 | Note 2 |

NOTE 1: I_o is assumed to have constant EPRE across the bandwidth.
NOTE 2: The same bands and the same I_o conditions for each band apply for this requirement as for the corresponding highest accuracy requirement.
NOTE 3: The condition level is increased by Δ>0, when applicable, as described in Sections B.4.2 and B.4.3.
NOTE 4: E-UTRA operating band groups are as defined in Section 3.5.

9.1.5.2 Absolute RSRQ Accuracy under Time Domain Measurement Resource Restriction

The requirements for absolute accuracy of RSRQ in this clause shall apply to a cell on the same frequency as that of the serving cell when a time domain measurement resource restriction pattern for performing RSRQ measurements of this cell is configured by higher layers (TS 36.331 [2]).

The accuracy requirements in Table 9.1.5.2-1 are valid under the following conditions:

Cell specific reference signals in the measured cell are transmitted either from one, two or four antenna ports,

Conditions defined in 36.101 Clause 7.3 for reference sensitivity are fulfilled,

RSRP_{dBm} according to Annex B.3.9 for a corresponding Band,

The time domain measurement resource restriction pattern configured for the measured cell indicates at least one subframe per radio frame for performing the RSRQ measurement,

The RSRQ measurement is not performed in any subframe other than those indicated by the time domain measurement resource restriction pattern configured for the measured cell,

Four symbols containing CRS are available in all subframes indicated by the time domain measurement resource restriction pattern.

Table 9.1.5.2-1: RSRQ Intra frequency absolute accuracy under time domain measurement resource restriction

| Accuracy | | Conditions | | | |
|------------------|-------------------|-------------------------------|--|------------------------------------|---------------------------|
| Normal condition | Extreme condition | $\hat{\epsilon}_s/\text{lot}$ | l_o ^{Note 2} range | | |
| | | | E-UTRA operating band groups ^{Note 5} | Minimum l_o | Maximum l_o |
| dB | dB | dB | | dBm/ 15kHz ^{Note 1, 4} | dBm/BW _{Channel} |
| ± 2.5 | ± 4 | ≥ -2 dB | FDD_A, TDD_A | -121 | -50 |
| | | | FDD_B | -120.5 | -50 |
| | | | FDD_C, TDD_C | -120 | -50 |
| | | | FDD_D | -119.5 | -50 |
| | | | FDD_E, TDD_E | -119 | -50 |
| | | | FDD_F | -118.5 | -50 |
| | | | FDD_G | -118 | -50 |
| | | | FDD_H | -117.5 | -50 |
| | | | FDD_N | -114.5 | -50 |
| ± 3.5 | ± 4 | ≥ -4 dB | Note 3 | Note 3 | Note 3 |

NOTE 1: This minimum l_o condition is expressed as the average l_o per RE over all REs in that symbol.
NOTE 2: l_o is defined in subframes indicated by the time domain measurement resource restriction pattern configured for performing RSRQ measurements of this cell. The l_o range defined by the minimum and the maximum l_o levels applies to CRS and non-CRS symbols. l_o may be different in different symbols within a subframe.
NOTE 3: The same bands and the same l_o conditions for each band apply for this requirement as for the corresponding highest accuracy requirement.
NOTE 4: The condition level is increased by $\Delta > 0$, when applicable, as described in Sections B.4.2 and B.4.3.
NOTE 5: E-UTRA operating band groups are as defined in Section 3.5.

For time domain measurements restriction under colliding CRS with ABS configured in non-MBSFN subframes, requirements in Section 9.1.5.1 apply.

9.1.5.3 Absolute RSRQ Accuracy under Time Domain Measurement Resource Restriction with CRS assistance information

The requirements for absolute accuracy of RSRQ in this section shall apply to a cell on the same frequency as that of the serving cell when a time domain measurement resource restriction pattern for performing RSRQ measurements of this cell is configured by higher layers (TS 36.331 [2]) and the CRS assistance information is provided. The requirements apply for UEs supporting CRS interference handling.

The accuracy requirements in Table 9.1.5.3-1 are valid under the following conditions:

Cell specific reference signals in the measured cell are transmitted either from one, two or four antenna ports,

Conditions defined in 36.101 Section 7.3 for reference sensitivity are fulfilled,

$RSRP|_{dBm}$ according to Annex B.3.11 for a corresponding Band,

The time domain measurement resource restriction pattern configured for the measured cell indicates at least one subframe per radio frame for performing the RSRQ measurement,

The RSRQ measurement is not performed in any subframe other than those indicated by the time domain measurement resource restriction pattern configured for the measured cell,

Four symbols containing CRS are available in all subframes indicated by the time domain measurement resource restriction pattern,

The UE is provided with the CRS assistance information (TS 36.331 [2]) and the CRS assistance information is valid throughout the entire evaluation period.

The requirements in this section shall also be met when the number of transmit antenna ports [16] of one or more cells whose CRS assistance information is provided [2] is different from the number of transmit antenna ports of the measured cell.

Table 9.1.5.3-1: RSRQ Intra frequency absolute accuracy under Time Domain Measurement Resource Restriction with CRS assistance information

| Accuracy | | Conditions | | | |
|------------------|-------------------|----------------------------------|--|--------------------------------|---------------------------|
| Normal condition | Extreme condition | $\hat{E}s/lot$ ^{Note 5} | l_o ^{Note 2} range | | |
| | | | E-UTRA operating band groups ^{Note 6} | Minimum l_o | Maximum l_o |
| dB | dB | dB | | dBm/15kHz ^{Note 1, 4} | dBm/BW _{Channel} |
| ±2.5 | ±4 | ≥-6.96 | FDD_A, TDD_A | -121 | -50 |
| | | | FDD_B | -120.5 | -50 |
| | | | FDD_C, TDD_C | -120 | -50 |
| | | | FDD_D | -119.5 | -50 |
| | | | FDD_E, TDD_E | -119 | -50 |
| | | | FDD_F | -118.5 | -50 |
| | | | FDD_G | -118 | -50 |
| | | | FDD_H | -117.5 | -50 |
| ±3.5 | ±4 | ≥-9.46 | Note 3 | Note 3 | Note 3 |

NOTE 1: This l_o condition is expressed as the average l_o per RE over all REs in that symbol.
 NOTE 2: l_o is defined in subframes indicated by the time domain measurement resource restriction pattern configured for performing RSRQ measurements of this cell. The specified l_o range applies to CRS and non-CRS symbols. l_o may be different in different symbols within a subframe.
 NOTE 3: The same bands and the same l_o conditions for each band apply for this requirement as for the corresponding highest accuracy requirement.
 NOTE 4: The condition level is increased by $\Delta > 0$, when applicable, as described in Sections B.4.2 and B.4.3.
 NOTE 5: The gap between the E_s/lot level in table 9.1.5.3-1 and 9.1.5.2-1 is due to the interference from either PCell or at least one neighbour cell indicated within the CRS assistance information.
 NOTE 6: E-UTRA operating band groups are as defined in Section 3.5.

9.1.5.4 Absolute WB-RSRQ Accuracy

The requirements in this section shall apply when the measurement configuration message received by the UE contains *widebandRSRQ-Meas* parameter in TS 36.331 [2]. The WB-RSRQ accuracy figures in Table 9.1.5.4-1 are relative to the value that would be obtained by using the *AllowedMeasBandwidth* in TS 36.331 [2].

The accuracy requirements in Table 9.1.5.4-1 are valid under the following conditions:

The value of the parameter, *AllowedMeasBandwidth* in TS 36.331 [2], is 50 resource blocks or larger

Cell specific reference signals are transmitted either from one, two or four antenna ports.

Conditions defined in TS 36.101 [5] Clause 7.3 for reference sensitivity are fulfilled.

RSRP|dBm according to Annex B.3.1 for a corresponding Band.

Table 9.1.5.4-1: WB-RSRQ Intra frequency absolute accuracy

| Accuracy | | Conditions | | | | |
|------------------|-------------------|----------------------------------|-----------------------------------|--|---------------------------------|---------------|
| Normal condition | Extreme condition | $\hat{E}s/lot$ ^{Note 3} | $l_{o1}-l_{o2}$ ^{Note 2} | l_o range ^{Note 1} | | |
| | | | | E-UTRA operating band groups ^{Note 6} | Minimum l_o ^{Note 5} | Maximum l_o |
| dB | dB | dB | dB | dBm/15kHz | dBm/BW _{Channel} | |
| ±2.5 | ±4 | ≥-3 dB | 0 ≤ l_{o1} - l_{o2} | FDD_A, TDD_A | -121 | -50 |
| | | | | FDD_B | -120.5 | -50 |
| | | | | FDD_C, TDD_C | -120 | -50 |
| | | | | FDD_D | -119.5 | -50 |
| | | | | FDD_E, TDD_E | -119 | -50 |
| | | | | FDD_F | -118.5 | -50 |
| | | | | FDD_G | -118 | -50 |
| | | | | FDD_H | -117.5 | -50 |

| | | | | | | |
|------|----|--------|--|--------|--------|--------|
| | | | | FDD_N | -114.5 | -50 |
| ±3.5 | ±4 | ≥-6 dB | | Note 4 | Note 4 | Note 4 |

NOTE 1: I_o is the average across all the resource blocks within the *AllowedMeasBandwidth* in TS 36.331 [2].
 NOTE 2: I_{o1} is the I_o level in the resource blocks other than central 6 resource blocks within the *AllowedMeasBandwidth* in TS 36.331 [2] and I_{o2} is the I_o level in central 6 resource blocks. The I_{o1} and I_{o2} have the same range as defined for I_o .
 NOTE 3: I_{ot} is the received power spectrum density of total interference and noise for all the resource blocks, other than central 6 resource blocks.
 NOTE 4: The same bands and the same I_o conditions for each band apply for this requirement as for the corresponding highest accuracy requirement.
 NOTE 5: The condition level is increased by $\Delta > 0$, when applicable, as described in Sections B.4.2 and B.4.3.
 NOTE 6: E-UTRA operating band groups are as defined in Section 3.5.

9.1.5A Intra-frequency RSRQ Accuracy Requirements in High Doppler Conditions

The accuracy requirements in this clause are applicable for [EVA300 and EVA600] propagation conditions and assume independent interference (noise) at each receiver antenna port.

9.1.5A.1 Absolute RSRQ Accuracy in high Doppler conditions

The requirements for absolute accuracy of RSRQ in this clause apply to a cell on the same frequency as that of the serving cell.

The accuracy requirements in Table 9.1.5A.1-1 are valid under the following conditions:

Cell specific reference signals are transmitted either from one, two or four antenna ports.

Conditions defined in 36.101 Clause 7.3 for reference sensitivity are fulfilled.

RSRP[dBm] according to Annex B.3.1 for a corresponding Band

Table 9.1.5A.1-1: RSRQ Intra frequency absolute accuracy

| Accuracy | | Conditions | | | |
|------------------|-------------------|--------------------|--|-----------------------------|---------------------------|
| Normal condition | Extreme condition | \hat{E}_s/I_{ot} | I_o ^{Note 1} range | | |
| | | | E-UTRA operating band groups ^{Note 4} | Minimum I_o | Maximum I_o |
| dB | dB | dB | | dBm/15kHz ^{Note 3} | dBm/BW _{Channel} |
| ±4 | ±5.5 | ≥-3 dB | FDD_A, TDD_A | -121 | -50 |
| | | | FDD_B | -120.5 | -50 |
| | | | FDD_C, TDD_C | -120 | -50 |
| | | | FDD_D | -119.5 | -50 |
| | | | FDD_E, TDD_E | -119 | -50 |
| | | | FDD_F | -118.5 | -50 |
| | | | FDD_G | -118 | -50 |
| | | | FDD_H | -117.5 | -50 |
| ±5 | ±5.5 | ≥-6 dB | Note 2 | Note 2 | Note 2 |

NOTE 1: I_o is assumed to have constant EPRE across the bandwidth.
 NOTE 2: The same bands and the same I_o conditions for each band apply for this requirement as for the corresponding highest accuracy requirement.
 NOTE 3: The condition level is increased by $\Delta > 0$, when applicable, as described in Sections B.4.2 and B.4.3.
 NOTE 4: E-UTRA operating band groups are as defined in Section 3.5.

9.1.6 Inter-frequency RSRQ Accuracy Requirements

9.1.6.1 Absolute RSRQ Accuracy

The requirements for absolute accuracy of RSRQ in this clause apply to a cell that has different carrier frequency from the serving cell.

The accuracy requirements in Table 9.1.6.1-1 are valid under the following conditions:

Cell specific reference signals are transmitted either from one, two or four antenna ports.

Conditions defined in 36.101 Clause 7.3 for reference sensitivity are fulfilled.

$RSRP|_{dBm}$ according to Annex B.3.3 for a corresponding Band

Table 9.1.6.1-1: RSRQ Inter frequency absolute accuracy

| Accuracy | | Conditions | | | |
|------------------|-------------------|----------------|--|---------------------------|---------------|
| Normal condition | Extreme condition | $\hat{E}s/lot$ | I_o ^{Note 1} range | | |
| | | | E-UTRA operating band groups ^{Note 4} | Minimum I_o | Maximum I_o |
| dB | dB | dB | dBm/15kHz ^{Note 3} | dBm/BW _{Channel} | |
| ±2.5 | ±4 | ≥-3 dB | FDD_A, TDD_A | -121 | -50 |
| | | | FDD_B | -120.5 | -50 |
| | | | FDD_C, TDD_C | -120 | -50 |
| | | | FDD_D | -119.5 | -50 |
| | | | FDD_E, TDD_E | -119 | -50 |
| | | | FDD_F | -118.5 | -50 |
| | | | FDD_G | -118 | -50 |
| | | | FDD_H | -117.5 | -50 |
| | | | FDD_N | -114.5 | -50 |
| ±3.5 | ±4 | ≥-6 dB | Note 2 | Note 2 | Note 2 |

NOTE 1: I_o is assumed to have constant EPRE across the bandwidth.
NOTE 2: The same bands and the same I_o conditions for each band apply for this requirement as for the corresponding highest accuracy requirement.
NOTE 3: The condition level is increased by $\Delta > 0$, when applicable, as described in Sections B.4.2 and B.4.3.
NOTE 4: E-UTRA operating band groups are as defined in Section 3.5.

9.1.6.2 Relative Accuracy of RSRQ

The relative accuracy of RSRQ in inter frequency case is defined as the RSRQ measured from one cell compared to the RSRQ measured from another cell on a different frequency.

The accuracy requirements in Table 9.1.6.2-1 are valid under the following conditions:

Cell specific reference signals are transmitted either from one, two or four antenna ports.

Conditions defined in 36.101 Clause 7.3 for reference sensitivity are fulfilled.

$RSRP_{1,2}|_{dBm}$ according to Annex B.3.4 for a corresponding Band

$$\left| RSRP1|_{dBm} - RSRP2|_{dBm} \right| \leq 27 dB$$

$$| Channel\ 1\ I_o - Channel\ 2\ I_o | \leq 20\ dB$$

Table 9.1.6.2-1: RSRQ Inter frequency relative accuracy

| Accuracy | | Conditions | | |
|------------------|-------------------|----------------------------------|--|---------------------------|
| Normal condition | Extreme condition | $\hat{E}s/lot$ ^{Note 2} | I_o ^{Note 1} range | |
| | | | E-UTRA operating band groups ^{Note 5} | Minimum I_o |
| dB | dB | dB | dBm/15kHz ^{Note 4} | dBm/BW _{Channel} |

| | | | | | |
|----|----|--------|--------------|--------|--------|
| ±3 | ±4 | ≥-3 dB | FDD_A, TDD_A | -121 | -50 |
| | | | FDD_B | -120.5 | -50 |
| | | | FDD_C, TDD_C | -120 | -50 |
| | | | FDD_D | -119.5 | -50 |
| | | | FDD_E, TDD_E | -119 | -50 |
| | | | FDD_F | -118.5 | -50 |
| | | | FDD_G | -118 | -50 |
| | | | FDD_H | -117.5 | -50 |
| ±4 | ±4 | ≥-6 dB | Note 3 | Note 3 | Note 3 |

NOTE 1: I_0 is assumed to have constant EPRE across the bandwidth.
 NOTE 2: The parameter \hat{E}_s/I_{0T} is the minimum \hat{E}_s/I_{0T} of the pair of cells to which the requirement applies.
 NOTE 3: The same bands and the same I_0 conditions for each band apply for this requirement as for the corresponding highest accuracy requirement.
 NOTE 4: The condition level is increased by $\Delta > 0$, when applicable, as described in Sections B.4.2 and B.4.3.
 NOTE 5: E-UTRA operating band groups are as defined in Section 3.5.

9.1.6.3 Absolute WB-RSRQ Accuracy

The requirements in this section shall apply when the measurement configuration message received by the UE contains *widebandRSRQ-Meas* parameter in TS 36.331 [2]. The WB-RSRQ accuracy figures in Table 9.1.6.3-1 are relative to the value that would be obtained by using the *AllowedMeasBandwidth* in TS 36.331 [2].

The accuracy requirements in Table 9.1.6.3-1 are valid under the following conditions:

The value of the parameter, *AllowedMeasBandwidth* in TS 36.331 [2], is 50 resource blocks or larger

Cell specific reference signals are transmitted either from one, two or four antenna ports.

Conditions defined in TS 36.101 [5] Clause 7.3 for reference sensitivity are fulfilled.

RSRP[dBm] according to Annex B.3.1 for a corresponding Band.

Table 9.1.6.3-1: WB-RSRQ Inter frequency absolute accuracy

| Accuracy | | Conditions | | | | |
|------------------|-------------------|------------------------------|---------------------------|--|---------------------------|---------------|
| Normal condition | Extreme condition | \hat{E}_s/I_{0T} Note 3 | $I_{01}-I_{02}$ Note 2 | I_0 range ^{Note 1} | | |
| | | | | E-UTRA operating band groups ^{Note 6} | Minimum I_0 Note 5 | Maximum I_0 |
| dB | dB | dB | dB | dBm/15kHz | dBm/BW _{Channel} | |
| ±2.5 | ±4 | ≥-3 dB | 0 ≤ $I_{01}-I_{02}$ | FDD_A, TDD_A | -121 | -50 |
| | | | | FDD_B | -120.5 | -50 |
| | | | | FDD_C, TDD_C | -120 | -50 |
| | | | | FDD_D | -119.5 | -50 |
| | | | | FDD_E, TDD_E | -119 | -50 |
| | | | | FDD_F | -118.5 | -50 |
| | | | | FDD_G | -118 | -50 |
| | | | | FDD_H | -117.5 | -50 |
| ±3.5 | ±4 | ≥-6 dB | | Note 4 | Note 4 | Note 4 |

NOTE 1: I_0 is the average across all the resource blocks within the *AllowedMeasBandwidth* in TS 36.331 [2].
 NOTE 2: I_{01} is the I_0 level in the resource blocks other than central 6 resource blocks within the *AllowedMeasBandwidth* in TS 36.331 [2] and I_{02} is the I_0 level in central 6 resource blocks. The I_{01} and I_{02} have the same range as defined for I_0 .
 NOTE 3: I_{0T} is the received power spectrum density of total interference and noise for all the resource blocks, other than central 6 resource blocks.
 NOTE 4: The same bands and the same I_0 conditions for each band apply for this requirement as for the corresponding highest accuracy requirement.
 NOTE 5: The condition level is increased by $\Delta > 0$, when applicable, as described in Sections B.4.2 and B.4.3.
 NOTE 6: E-UTRA operating band groups are as defined in Section 3.5.

9.1.6.4 Relative WB-RSRQ Accuracy

The requirements in this section shall apply when the measurement configuration message received by the UE contains *widebandRSRQ-Meas* parameter in TS 36.331 [2]. The WB-RSRQ accuracy figures in Table 9.1.6.4-1 are relative to the value that would be obtained by using the *AllowedMeasBandwidth* in TS 36.331 [2].

The accuracy requirements in Table 9.1.6.4-1 are valid under the following conditions:

The value of the parameter, *AllowedMeasBandwidth* in TS 36.331 [2], is 50 resource blocks or larger for the measured cells from different frequencies

Cell specific reference signals are transmitted either from one, two or four antenna ports.

Conditions defined in TS 36.101 [5] Clause 7.3 for reference sensitivity are fulfilled.

RSRP_{1,2}_{dBm} according to Annex B.3.4 for a corresponding Band

$$\left| RSRP1 \Big|_{dBm} - RSRP2 \Big|_{dBm} \right| \leq 27 dB$$

$$| \text{Channel 1}_{Io} - \text{Channel 2}_{Io} | \leq 20 \text{ dB}$$

Table 9.1.6.4-1: WB-RSRQ Inter frequency relative accuracy

| Accuracy | | Conditions | | | | |
|------------------|-------------------|--------------------------|-------------------|--|------------------------------|---------------------------|
| Normal condition | Extreme condition | $\hat{E}s/lot$ Note 3 | Io1-Io2 Note 2 | Io range ^{Note 1} | | |
| | | | | E-UTRA operating band groups ^{Note 6} | Minimum Io ^{Note 5} | Maximum Io |
| dB | dB | dB | dB | | dBm/15kHz | dBm/BW _{Channel} |
| ±3 | ±4 | ≥-3 dB | 0 ≤ Io1 - Io2 | FDD_A, TDD_A | -121 | -50 |
| | | | | FDD_B | -120.5 | -50 |
| | | | | FDD_C, TDD_C | -120 | -50 |
| | | | | FDD_D | -119.5 | -50 |
| | | | | FDD_E, TDD_E | -119 | -50 |
| | | | | FDD_F | -118.5 | -50 |
| | | | | FDD_G | -118 | -50 |
| | | | | FDD_H | -117.5 | -50 |
| ±4 | ±4 | ≥-6 dB | | Note 4 | Note 4 | Note 4 |

NOTE 1: Io is the average across all the resource blocks within the *AllowedMeasBandwidth* in TS 36.331 [2].

NOTE 2: Io1 is the Io level in the resource blocks other than central 6 resource blocks within the *AllowedMeasBandwidth* in TS 36.331 [2] and Io2 is the Io level in central 6 resource blocks. The Io1 and Io2 have the same range as defined for Io.

NOTE 3: lot is the received power spectrum density of total interference and noise for all the resource blocks, other than central 6 resource blocks. The parameter $\hat{E}s/lot$ is the minimum $\hat{E}s/lot$ of the pair of cells to which the requirement applies

NOTE 4: The same bands and the same Io conditions for each band apply for this requirement as for the corresponding highest accuracy requirement.

NOTE 5: The condition level is increased by $\Delta > 0$, when applicable, as described in Sections B.4.2 and B.4.3.

NOTE 6: E-UTRA operating band groups are as defined in Section 3.5.

9.1.6A Inter-frequency RSRQ Accuracy Requirements in High Doppler Conditions

The accuracy requirements in this clause are applicable for [EVA300 and EVA600] propagation conditions and assume independent interference (noise) at each receiver antenna port.

9.1.6A.1 Absolute RSRQ Accuracy in high Doppler conditions

The requirements for absolute accuracy of RSRQ in this clause apply to a cell that has different carrier frequency from the serving cell.

The accuracy requirements in Table 9.1.6A.1-1 are valid under the following conditions:

Cell specific reference signals are transmitted either from one, two or four antenna ports.

Conditions defined in 36.101 Clause 7.3 for reference sensitivity are fulfilled.

RSRP_{dBm} according to Annex B.3.3 for a corresponding Band

Table 9.1.6A.1-1: RSRQ Inter frequency absolute accuracy

| Accuracy | | Conditions | | | |
|------------------|-------------------|------------|--|---------------------------|------------------------|
| Normal condition | Extreme condition | Ês/lot | I _o ^{Note 1} range | | |
| | | | E-UTRA operating band groups ^{Note 4} | Minimum I _o | Maximum I _o |
| dB | dB | dB | dBm/15kHz ^{Note 3} | dBm/BW _{Channel} | |
| ±4 | ±5.5 | ≥-3 dB | FDD_A, TDD_A | -121 | -50 |
| | | | FDD_B | -120.5 | -50 |
| | | | FDD_C, TDD_C | -120 | -50 |
| | | | FDD_D | -119.5 | -50 |
| | | | FDD_E, TDD_E | -119 | -50 |
| | | | FDD_F | -118.5 | -50 |
| | | | FDD_G | -118 | -50 |
| | | | FDD_H | -117.5 | -50 |
| | | | FDD_N | -114.5 | -50 |
| ±5 | ±5.5 | ≥-6 dB | Note 2 | Note 2 | Note 2 |

NOTE 1: I_o is assumed to have constant EPRE across the bandwidth.
 NOTE 2: The same bands and the same I_o conditions for each band apply for this requirement as for the corresponding highest accuracy requirement.
 NOTE 3: The condition level is increased by Δ>0, when applicable, as described in Sections B.4.2 and B.4.3.
 NOTE 4: E-UTRA operating band groups are as defined in Section 3.5.

9.1.6A.2 Relative Accuracy of RSRQ in high Doppler conditions

The relative accuracy of RSRQ in inter frequency case is defined as the RSRQ measured from one cell compared to the RSRQ measured from another cell on a different frequency.

The accuracy requirements in Table 9.1.6A.2-1 are valid under the following conditions:

Cell specific reference signals are transmitted either from one, two or four antenna ports.

Conditions defined in 36.101 Clause 7.3 for reference sensitivity are fulfilled.

RSRP_{1,2}_{dBm} according to Annex B.3.4 for a corresponding Band

$$|RSRP1|_{dBm} - RSRP2|_{dBm} | \leq 27 dB$$

$$| Channel 1_Io - Channel 2_Io | \leq 20 dB$$

Table 9.1.6A.2-1: RSRQ Inter frequency relative accuracy

| Accuracy | | Conditions | | | |
|------------------|-------------------|--------------------------|--|---------------------------|------------------------|
| Normal condition | Extreme condition | Ês/lot ^{Note 2} | I _o ^{Note 1} range | | |
| | | | E-UTRA operating band groups ^{Note 5} | Minimum I _o | Maximum I _o |
| dB | dB | dB | dBm/15kHz ^{Note 4} | dBm/BW _{Channel} | |
| ±3.5 | ±5.0 | ≥-3 dB | FDD_A, TDD_A | -121 | -50 |
| | | | FDD_B | -120.5 | -50 |
| | | | FDD_C, TDD_C | -120 | -50 |
| | | | FDD_D | -119.5 | -50 |
| | | | FDD_E, TDD_E | -119 | -50 |
| | | | FDD_F | -118.5 | -50 |
| | | | FDD_G | -118 | -50 |
| | | | FDD_H | -117.5 | -50 |
| | | | FDD_N | -114.5 | -50 |
| ±4.5 | ±5.0 | ≥-6 dB | Note 3 | Note 3 | Note 3 |

NOTE 1: l_0 is assumed to have constant EPRE across the bandwidth.
 NOTE 2: The parameter \hat{E}_s/l_0 is the minimum \hat{E}_s/l_0 of the pair of cells to which the requirement applies.
 NOTE 3: The same bands and the same l_0 conditions for each band apply for this requirement as for the corresponding highest accuracy requirement.
 NOTE 4: The condition level is increased by $\Delta > 0$, when applicable, as described in Sections B.4.2 and B.4.3.
 NOTE 5: E-UTRA operating band groups are as defined in Section 3.5.

9.1.7 RSRQ Measurement Report Mapping

The reporting range of RSRQ is defined from -34 dB to 2.5 dB with 0.5 dB resolution.

The mapping of measured quantity is defined in table 9.1.7-1. The range in the signalling may be larger than the guaranteed accuracy range.

Table 9.1.7-1: RSRQ measurement report mapping

| Reported value | Measured quantity value | Unit |
|----------------|-------------------------|------|
| RSRQ_-30 | RSRQ < -34 | dB |
| RSRQ_-29 | -34 ≤ RSRQ < -33.5 | dB |
| ... | ... | ... |
| RSRQ_-02 | -20.5 ≤ RSRQ < -20 | dB |
| RSRQ_-01 | -20 ≤ RSRQ < -19.5 | dB |
| RSRQ_00 | RSRQ < -19.5 | dB |
| RSRQ_01 | -19.5 ≤ RSRQ < -19 | dB |
| RSRQ_02 | -19 ≤ RSRQ < -18.5 | dB |
| ... | ... | ... |
| RSRQ_32 | -4 ≤ RSRQ < -3.5 | dB |
| RSRQ_33 | -3.5 ≤ RSRQ < -3 | dB |
| RSRQ_34 | -3 ≤ RSRQ | dB |
| RSRQ_35 | -3 ≤ RSRQ < -2.5 | dB |
| RSRQ_36 | -2.5 ≤ RSRQ < -2 | dB |
| ... | ... | ... |
| RSRQ_45 | 2 ≤ RSRQ < 2.5 | dB |
| RSRQ_46 | 2.5 ≤ RSRQ | dB |

Note: The ranges from RSRQ_-30 to RSRQ_-01 and from RSRQ_35 to RSRQ_46 apply for the UE who can support extended RSRQ range in [31].

9.1.8 Power Headroom

The requirements in this clause shall apply for power headroom Type 1 and for power headroom Type 2, which are specified in clause 5.1.1.2 in [3].

For a UE not configured with a secondary cell, the power headroom provides the serving eNB with information about the differences between the UE configured maximum output power (P_{CMAX}) defined in TS 36.101 [5] and the estimated power for UL-SCH transmission of the serving cell [3]. In this case the UE shall meet requirements for power headroom Type 1.

For a UE configured with a secondary cell, the power headroom provides the serving eNB with information about the differences between the UE configured maximum output power ($P_{\text{CMAX},c}$) defined in TS 36.101[5] and the estimated power for UL-SCH transmission per activated serving cell c , or the estimated power for simultaneous PUSCH and PUCCH transmission on PCell [3]. In this case the UE shall meet requirements for both power headroom Type 1 and Type 2.

9.1.8.1 Period

The reported power headroom shall be estimated over 1 subframe.

When *extendedPHR* is not configured [17], the Type 1 power headroom shall be estimated for the primary serving cell as defined in clause 5.1.1.2 in TS 36.213 [3].

When *extendedPHR* is configured [17], the Type 1 and Type 2 power headroom shall be estimated for each activated serving cell with configured uplink as defined in clause 5.1.1.2 in TS 36.213 [3].

9.1.8.2 Reporting Delay

The power headroom reporting delay is defined as the time between the beginning of the power headroom reference period and the time when the UE starts transmitting the power headroom over the radio interface. The reporting delay of the power headroom shall be 0 ms, which is applicable for all configured triggering mechanisms for power headroom reporting.

9.1.8.3 Void

9.1.8.4 Report Mapping

The power headroom reporting range is from -23 ...+40 dB. Table 9.1.8.4-1 defines the report mapping.

Table 9.1.8.4-1: Power headroom report mapping

| Reported value | Measured quantity value (dB) |
|-------------------|------------------------------|
| POWER_HEADROOM_0 | -23 ≤ PH < -22 |
| POWER_HEADROOM_1 | -22 ≤ PH < -21 |
| POWER_HEADROOM_2 | -21 ≤ PH < -20 |
| POWER_HEADROOM_3 | -20 ≤ PH < -19 |
| POWER_HEADROOM_4 | -19 ≤ PH < -18 |
| POWER_HEADROOM_5 | -18 ≤ PH < -17 |
| ... | ... |
| POWER_HEADROOM_57 | 34 ≤ PH < 35 |
| POWER_HEADROOM_58 | 35 ≤ PH < 36 |
| POWER_HEADROOM_59 | 36 ≤ PH < 37 |
| POWER_HEADROOM_60 | 37 ≤ PH < 38 |
| POWER_HEADROOM_61 | 38 ≤ PH < 39 |
| POWER_HEADROOM_62 | 39 ≤ PH < 40 |
| POWER_HEADROOM_63 | PH ≥ 40 |

9.1.9 UE Rx – Tx time difference

9.1.9.1 Measurement Requirement

The UE RX-TX time difference is measured from the PCell.

The accuracy requirements in Table 9.1.9.1-1 are valid under the following conditions:

Cell specific reference signals are transmitted either from one, two or four antenna ports.

Conditions defined in 36.101 Clause 7.3 for reference sensitivity are fulfilled.

No changes to the uplink transmission timing are applied during the measurement period.

RSRP_{dBm} according to Annex B.3.5 for a corresponding Band

Table 9.1.9.1-1: UE Rx – Tx time difference measurement accuracy

| Accuracy | Conditions | | | | |
|----------------------------------|------------|--|--|---------------------------|------------------------|
| | Ês/lot | Downlink transmission bandwidth of PCell | I _o ^{Note 1} range | | |
| | | | E-UTRA operating band groups ^{Note 6} | Minimum I _o | Maximum I _o |
| T _s ^{Note 2} | dB | MHz | dBm/15kHz ^{Note 5} | dBm/BW _{Channel} | |
| ±20 | ≥-3 dB | ≥1.4 MHz | FDD_A ^{Note 7} , TDD_A | -121 | -50 |
| | | | FDD_B | -120.5 | -50 |
| | | | FDD_C, TDD_C | -120 | -50 |

| | | | | | |
|-----|--------|---------|-------------------------|--------|--------|
| | | | FDD_D | -119.5 | -50 |
| | | | FDD_E, TDD_E | -119 | -50 |
| | | | FDD_F | -118.5 | -50 |
| | | | FDD_G ^{Note 4} | -118 | -50 |
| | | | FDD_H | -117.5 | -50 |
| | | | FDD_N | -114.5 | -50 |
| ±14 | ≥-3 dB | ≥ 3 MHz | Note 3 | Note 3 | Note 3 |
| ±10 | ≥-3 dB | ≥ 5 MHz | Note 3 | Note 3 | Note 3 |
| ±7 | ≥-3 dB | ≥10 MHz | Note 3 | Note 3 | Note 3 |

NOTE 1: When in dBm/15kHz, the minimum Io condition is expressed as the average Io per RE over all REs in that symbol. Io may be different in different symbols within a subframe.
 NOTE 2: Ts is the basic timing unit defined in TS 36.211.
 NOTE 3: The same bands and the same Io conditions for each band apply for this requirement as for the corresponding requirement with downlink bandwidth ≥1.4 MHz.
 NOTE 4: Except Band 29.
 NOTE 5: The condition level is increased by Δ>0, when applicable, as described in Sections B.4.2 and B.4.3.
 NOTE 6: E-UTRA operating band groups are as defined in Section 3.5.
 NOTE 7: Except Band 32.

9.1.9.2 Measurement Report mapping

The reporting range of EUTRAN FDD UE Rx - Tx time difference is defined from 0 to 20472Ts with 2Ts resolution for UE Rx - Tx time difference less than 4096Ts, and 8Ts for UE Rx - Tx time difference equal to or greater than 4096Ts.

The mapping of measured quantity is defined in Table 9.1.9.2-1.

Table 9.1.9.2-1: EUTRAN FDD UE Rx - Tx time difference measurement report mapping

| Reported value | Measured quantity value | Unit |
|--------------------------------|------------------------------------|------|
| RX-TX_TIME_DIFFERENCE_FDD_0000 | $T_{UE\ Rx-Tx} < 2$ | Ts |
| RX-TX_TIME_DIFFERENCE_FDD_0001 | $2 \leq T_{UE\ Rx-Tx} < 4$ | Ts |
| RX-TX_TIME_DIFFERENCE_FDD_0002 | $4 \leq T_{UE\ Rx-Tx} < 6$ | Ts |
| ... | ... | ... |
| RX-TX_TIME_DIFFERENCE_FDD_2046 | $4092 \leq T_{UE\ Rx-Tx} < 4094$ | Ts |
| RX-TX_TIME_DIFFERENCE_FDD_2047 | $4094 \leq T_{UE\ Rx-Tx} < 4096$ | Ts |
| RX-TX_TIME_DIFFERENCE_FDD_2048 | $4096 \leq T_{UE\ Rx-Tx} < 4104$ | Ts |
| RX-TX_TIME_DIFFERENCE_FDD_2049 | $4104 \leq T_{UE\ Rx-Tx} < 4112$ | Ts |
| ... | ... | ... |
| RX-TX_TIME_DIFFERENCE_FDD_4093 | $20456 \leq T_{UE\ Rx-Tx} < 20464$ | Ts |
| RX-TX_TIME_DIFFERENCE_FDD_4094 | $20464 \leq T_{UE\ Rx-Tx} < 20472$ | Ts |
| RX-TX_TIME_DIFFERENCE_FDD_4095 | $20472 \leq T_{UE\ Rx-Tx}$ | Ts |

The reporting range of EUTRAN TDD UE Rx - Tx time difference is defined from 624 to 21096Ts with 2Ts resolution for UE Rx - Tx time difference less than 4720Ts, and 8Ts for UE Rx - Tx time difference equal to or greater than 4720Ts.

The mapping of measured quantity is defined in Table 9.1.9.2-2.

Table 9.1.9.2-2: EUTRAN TDD UE Rx - Tx time difference measurement report mapping

| Reported value | Measured quantity value | Unit |
|--------------------------------|------------------------------------|------|
| RX-TX_TIME_DIFFERENCE_TDD_0000 | $T_{UE\ Rx-Tx} < 626$ | Ts |
| RX-TX_TIME_DIFFERENCE_TDD_0001 | $626 \leq T_{UE\ Rx-Tx} < 628$ | Ts |
| RX-TX_TIME_DIFFERENCE_TDD_0002 | $628 \leq T_{UE\ Rx-Tx} < 630$ | Ts |
| ... | ... | ... |
| RX-TX_TIME_DIFFERENCE_TDD_2046 | $4716 \leq T_{UE\ Rx-Tx} < 4718$ | Ts |
| RX-TX_TIME_DIFFERENCE_TDD_2047 | $4718 \leq T_{UE\ Rx-Tx} < 4720$ | Ts |
| RX-TX_TIME_DIFFERENCE_TDD_2048 | $4720 \leq T_{UE\ Rx-Tx} < 4728$ | Ts |
| RX-TX_TIME_DIFFERENCE_TDD_2049 | $4728 \leq T_{UE\ Rx-Tx} < 4736$ | Ts |
| ... | ... | ... |
| RX-TX_TIME_DIFFERENCE_TDD_4093 | $21080 \leq T_{UE\ Rx-Tx} < 21088$ | Ts |

| | | |
|--------------------------------|------------------------------------|-------|
| RX-TX_TIME_DIFFERENCE_TDD_4094 | $21088 \leq T_{UE\ Rx-Tx} < 21096$ | T_s |
| RX-TX_TIME_DIFFERENCE_TDD_4095 | $21096 \leq T_{UE\ Rx-Tx}$ | T_s |

9.1.9.3 Measurement Requirement under Time Domain Measurement Resource Restriction

The requirements in this section apply for UE configured with a time-domain measurement resource restriction pattern for PCell measurements. The UE Rx-Tx time difference is measured from the Pcell.

The accuracy requirements in Table 9.1.9.3-1 are valid under the following conditions:

- Cell specific reference signals are transmitted either from one, two or four antenna ports,
- Conditions defined in 36.101 Clause 7.3 for reference sensitivity are fulfilled,
- No changes to the uplink transmission timing are applied during the measurement period,

RSRP_{dBm} according to Annex B.3.5 for a corresponding Band,

- The time domain measurement resource restriction pattern configured for the PCell indicates at least one subframe per radio frame for performing the PCell measurements [2],
- Four symbols containing CRS are available in all subframes indicated by the time domain measurement resource restriction pattern.

Table 9.1.9.3-1: UE Rx–Tx time difference measurement accuracy under time domain measurement resource restriction

| Accuracy | Conditions | | | | |
|--|--|--|----------------------------------|-----------------------------|---------------------------|
| | \hat{E}_s/lot ^{Note 6} | Downlink transmission bandwidth of PCell | I_o ^{Note 1, 5} range | | |
| E-UTRA operating band groups ^{Note 8} | | | Minimum I_o | Maximum I_o | |
| T_s ^{Note 2} | dB | MHz | | dBm/15kHz ^{Note 7} | dBm/BW _{Channel} |
| ± 20 | ≥ -3 dB | ≤ 3 MHz | FDD_A ^{Note 9} , TDD_A | -121 | -50 |
| | | | FDD_B | -120.5 | -50 |
| | | | FDD_C, TDD_C | -120 | -50 |
| | | | FDD_D | -119.5 | -50 |
| | | | FDD_E, TDD_E | -119 | -50 |
| | | | FDD_F | -118.5 | -50 |
| | | | FDD_G ^{Note 4} | -118 | -50 |
| | | | FDD_H | -117.5 | -50 |
| | | | FDD_N | -114.5 | -50 |
| ± 10 | ≥ -3 dB | ≥ 5 MHz | Note 3 | Note 3 | Note 3 |

NOTE 1: When in dBm/15kHz, the minimum I_o condition is expressed as the average I_o per RE over all REs in that symbol. I_o may be different in different symbols within a subframe.

NOTE 2: T_s is the basic timing unit defined in TS 36.211.

NOTE 3: The same bands and the same I_o conditions for each band apply for this requirement as for the corresponding requirement with downlink bandwidth ≤ 3 MHz.

NOTE 4: Except Band 29.

NOTE 5: I_o is defined for the subframes indicated by the time-domain measurement resource restriction pattern for serving cell measurements. The specified I_o range applies to CRS and non-CRS symbols. I_o may be different in different symbols within a subframe.

NOTE 6: CRS \hat{E}_s/lot is in subframes indicated for PCell measurements by the time-domain measurement resource restriction pattern.

NOTE 7: The condition level is increased by $\Delta > 0$, when applicable, as described in Sections B.4.2 and B.4.3.

NOTE 8: E-UTRA operating band groups are as defined in Section 3.5.

NOTE 9: Except Band 32.

NOTE: It is up to the UE implementation whether the UE Rx-Tx time difference measurement is performed in any subframe or in subframes indicated by the time-domain measurement resource restriction pattern.

9.1.9.4 Measurement Requirement when Time Domain Measurement Resource Restriction Pattern is Configured with CRS Assistance Information

The UE Rx-Tx time difference measurement is performed for the PCell.

For UE configured with a time-domain measurement resource restriction pattern for PCell measurements, the accuracy requirements in Table 9.1.9.4-1 apply provided that the following conditions are met for the PCell:

- PCell cell specific reference signals are transmitted from one, two or four antenna ports,
- Conditions defined in 36.101 Section 7.3 for reference sensitivity are fulfilled,
- No changes to the uplink transmission timing are applied during the measurement period,
- $RSRP_{dBm}$ according to Annex B.3.13 for a corresponding Band,
- The time domain measurement resource restriction pattern configured for the measured cell indicates at least one subframe per radio frame for performing the RSRP measurement,
- Four symbols containing CRS are available in all subframes indicated by the time domain measurement resource restriction pattern, and
- The UE is provided via PCell with the CRS assistance information (TS 36.331 [2]) and the CRS assistance information is valid throughout the entire evaluation period.

The requirements in this section shall also be met when the number of transmit antenna ports [16] of one or more cells whose CRS assistance information is provided [2] is different from the number of transmit antenna ports of the measured cell.

When the CRS assistance information is provided, the transmission bandwidth [30] in all intra-frequency cells in the CRS assistance information [2] is the same or larger than the transmission bandwidth of the PCell for which measurement is performed.

Table 9.1.9.4-1: UE Rx–Tx time difference measurement accuracy

| Accuracy | Conditions | | | | |
|----------------------|--------------------------------------|--|--|---------------------------------|---------------------------|
| | CRS $\hat{E}s/lot$ ^{Note 6} | Downlink transmission bandwidth of PCell | Io range ^{Note 5} | | |
| | | | E-UTRA operating band groups ^{Note 8} | Minimum Io ^{Note 1, 7} | Maximum Io |
| Ts ^{Note 2} | dB | MHz | | dBm/15kHz ^{Note 7} | dBm/BW _{Channel} |
| ±20 | ≥-7.76 | ≤ 3 MHz | FDD_A ^{Note 9} , TDD_A | -121 | -50 |
| | | | FDD_B | -120.5 | -50 |
| | | | FDD_C, TDD_C | -120 | -50 |
| | | | FDD_D | -119.5 | -50 |
| | | | FDD_E, TDD_E | -119 | -50 |
| | | | FDD_F | -118.5 | -50 |
| | | | FDD_G ^{Note 4} | -118 | -50 |
| | | | FDD_H | -117.5 | -50 |
| ±10 | ≥-7.76 | ≥ 5 MHz | FDD_N | -114.5 | -50 |
| | | | Note 3 | Note 3 | Note 3 |

NOTE 1: This Io condition is expressed as the average Io per RE over all REs in an OFDM symbol.
 NOTE 2: Ts is the basic timing unit defined in TS 36.211.
 NOTE 3: The same bands and the same Io conditions for each band apply for this requirement as for the corresponding requirement with downlink bandwidth ≤ 3 MHz.
 NOTE 4: Except Band 29.
 NOTE 5: Io is defined in subframes indicated for PCell measurements by the time domain measurement resource restriction pattern. The specified Io range applies to CRS and non-CRS symbols. Io may be different in different symbols within a subframe.
 NOTE 6: CRS $\hat{E}s/lot$ is in subframes indicated for PCell measurements by the time-domain measurement resource restriction pattern.
 NOTE 7: The condition level is increased by $\Delta > 0$, when applicable, as described in Sections B.4.2 and B.4.3.
 NOTE 8: E-UTRA operating band groups are as defined in Section 3.5.
 NOTE 9: Except Band 32.

NOTE: It is up to the UE implementation whether the UE Rx-Tx time difference measurement is performed in any subframe or in subframes indicated by the time-domain measurement resource restriction pattern.

9.1.10 Reference Signal Time Difference (RSTD)

NOTE: This measurement is used for UE positioning purposes.

9.1.10.1 Intra-Frequency Accuracy Requirement

The accuracy requirements in Table 9.1.10.1-1 are valid under the following conditions:

Conditions defined in 36.101 Clause 7.3 for reference sensitivity are fulfilled.

PRP 1,2_{dBm} according to Annex B.3.6 for a corresponding Band

There are no measurement gaps overlapping with the PRS subframes of the measured serving cell.

The parameter expectedRSTDUncertainty signalled over LPP by E-SMLC as defined in TS 36.355 [24] is less than 5 μs.

Table 9.1.10.1-1: RSTD measurement accuracy

| Accuracy | Conditions | | | | | |
|-------------------------|--|--|--|--|--------------------------------|---------------------------|
| | PRS \hat{E}_s/lot | Minimum PRS bandwidth, which is minimum of serving cell channel bandwidth and the PRS bandwidths of the reference cell and the measured neighbour cell i ^{Note 5} | Minimum number of available measurement subframes among the reference cell and the measured neighbour cell i | E-UTRA operating band groups ^{Note 8} | Minimum Io ^{Note 1} | Maximum Io |
| T_s ^{Note 2} | dB | RB | | | dBm/15kHz ^{Note 6} | dBm/BW _{Channel} |
| ±15 | (PRS \hat{E}_s/lot) _{ref} ≥ -6dB and (PRS \hat{E}_s/lot) _i ≥ -13dB | ≥ 6 | 6 | FDD_A, TDD_A | -121 | -50 |
| | | | | FDD_B | -120.5 | -50 |
| | | | | FDD_C, TDD_C | -120 | -50 |
| | | | | FDD_D | -119.5 | -50 |
| | | | | FDD_E, TDD_E | -119 | -50 |
| | | | | FDD_F | -118.5 | -50 |
| | | | | FDD_G | -118 | -50 |
| | | | | FDD_H | -117.5 | -50 |
| | | | | FDD_N | -114.5 | -50 |
| ±10 | (PRS \hat{E}_s/lot) _{ref} ≥ -6dB and (PRS \hat{E}_s/lot) _i ≥ -13dB | ≥ 15 | 6 | Note 4 | Note 4 | Note 4 |
| ±6 | (PRS \hat{E}_s/lot) _{ref} ≥ -6dB and (PRS \hat{E}_s/lot) _i ≥ -13dB | ≥ 25 | ≥ 2 | Note 4 | Note 4 | Note 4 |
| ±5 | (PRS \hat{E}_s/lot) _{ref} ≥ -6dB and (PRS \hat{E}_s/lot) _i ≥ -13dB | ≥ 50 | ≥ 1 | Note 4 | Note 4 | Note 4 |
| ±4 | (PRS \hat{E}_s/lot) _{ref} ≥ -6dB and | ≥ 75 | ≥ 1 | Note 4 | Note 4 | Note 4 |

| | | | | | |
|---|--|--|--|--|--|
| | $(\text{PRS } \hat{E}_s/\text{lot})_i \geq -13\text{dB}$ | | | | |
| <p>NOTE 1: This minimum l_0 condition is expressed as the average l_0 per RE over all REs in an OFDM symbol.</p> <p>NOTE 2: T_s is the basic timing unit defined in TS 36.211 [16].</p> <p>NOTE 3: PRS bandwidth is as indicated in <i>prs-Bandwidth</i> in the OTDOA assistance data defined in [24].</p> <p>NOTE 4: The same bands and the same l_0 conditions for each band apply for this requirement as for the corresponding requirement with the PRS bandwidth ≥ 6 RB.</p> <p>NOTE 5: The serving cell, the reference cell, and the measured neighbour cell i are on the same carrier frequency.</p> <p>NOTE 6: The condition level is increased by $\Delta > 0$, when applicable, as described in Sections B.4.2 and B.4.3.</p> <p>NOTE 7: The l_0 is defined in PRS positioning subframes. The same l_0 range applies to PRS and non-PRS symbols. l_0 levels are different in PRS and non-PRS symbols within the same subframe.</p> <p>NOTE 8: E-UTRA operating band groups are as defined in Section 3.5.</p> | | | | | |

9.1.10.2 Inter-Frequency Accuracy Requirement

The accuracy requirements in Table 9.1.10.2-1 are valid under the following conditions:

Conditions defined in 36.101 Clause 7.3 for reference sensitivity are fulfilled.

PRP $1,2_{\text{dBm}}$ according to Annex B.3.7 for a corresponding Band

There are no measurement gaps overlapping with the PRS subframes in cells belonging to the serving carrier frequency.

The parameter $\text{expectedRSTDUncertainty}$ signalled over LPP by E-SMLC as defined in TS 36.355 [24] is less than $5 \mu\text{s}$.

Table 9.1.10.2-1: RSTD measurement accuracy

| Accuracy | Conditions | | | | | |
|-------------------------|---|---|--|--|---------------------------------|---------------------------------------|
| | PRS \hat{E}_s/lot | Minimum PRS bandwidth which is minimum of serving cell channel bandwidth ^{Note 7} and the PRS bandwidths of the reference cell and the measured neighbour cell i | Minimum number of available measurement subframes among the reference cell and the measured neighbour cell i | l_0 ^{Note 6} range | | |
| | | | | E-UTRA operating band groups ^{Note 8} | Minimum l_0 ^{Note 1} | Maximum l_0 |
| T_s ^{Note 2} | dB | RB | | | dBm/15kHz ^{Note 5} | dBm/BW _{Chan} ^{nel} |
| ±21 | $(\text{PRS } \hat{E}_s/\text{lot})_{\text{ref}} \geq -6\text{dB}$ and $(\text{PRS } \hat{E}_s/\text{lot})_i \geq -13\text{dB}$ | ≥ 6 | 4 | FDD_A, TDD_A | -121 | -50 |
| | | | | FDD_B | -120.5 | -50 |
| | | | | FDD_C, TDD_C | -120 | -50 |
| | | | | FDD_D | -119.5 | -50 |
| | | | | FDD_E, TDD_E | -119 | -50 |
| | | | | FDD_F | -118.5 | -50 |
| | | | | FDD_G | -118 | -50 |
| | | | | FDD_H | -117.5 | -50 |
| | | | FDD_N | -114.5 | -50 | |
| ±16 | $(\text{PRS } \hat{E}_s/\text{lot})_{\text{ref}} \geq -6\text{dB}$ and $(\text{PRS } \hat{E}_s/\text{lot})_i \geq -13\text{dB}$ | ≥ 15 | 4 | Note 4 | Note 4 | Note 4 |
| ±10 | $(\text{PRS } \hat{E}_s/\text{lot})_{\text{ref}} \geq -6\text{dB}$ and $(\text{PRS } \hat{E}_s/\text{lot})_i \geq -13\text{dB}$ | ≥ 25 | ≥ 2 | Note 4 | Note 4 | Note 4 |
| ±9 | $(\text{PRS } \hat{E}_s/\text{lot})_{\text{ref}} \geq -6\text{dB}$ and $(\text{PRS } \hat{E}_s/\text{lot})_i \geq -13\text{dB}$ | ≥ 50 | ≥ 1 | Note 4 | Note 4 | Note 4 |

| | | | | | | |
|--|---|-----------|----------|--------|--------|--------|
| ± 8 | $(\text{PRS } \dot{E}_s/\text{lot})_{\text{ref}} \geq -6\text{dB}$ and $(\text{PRS } \dot{E}_s/\text{lot})_i \geq -13\text{dB}$ | ≥ 75 | ≥ 1 | Note 4 | Note 4 | Note 4 |
| <p>NOTE 1: This minimum lo condition is expressed as the average lo per RE over all REs in an OFDM symbol.</p> <p>NOTE 2: T_s is the basic timing unit defined in TS 36.211 [16].</p> <p>NOTE 3: PRS bandwidth is as indicated in <i>prs-Bandwidth</i> in the OTDOA assistance data defined in [24].</p> <p>NOTE 4: The same bands and the same lo conditions for each band apply for this requirement as for the corresponding requirement with the PRS bandwidth ≥ 6 RB.</p> <p>NOTE 5: The condition level is increased by $\Delta > 0$, when applicable, as described in Sections B.4.2 and B.4.3.</p> <p>NOTE 6: The lo is defined in PRS positioning subframes. The same lo range applies to PRS and non-PRS symbols. lo levels are different in PRS and non-PRS symbols within the same subframe.</p> <p>NOTE 7: If a CA capable UE is configured with one or two SCell(s), the serving cell channel bandwidth is the minimum of the serving cell channel bandwidths in the component carriers involved in the RSTD measurement. If any of the serving cells is not involved in this RSTD measurement for CA, the channel bandwidth of that serving cell is not included in the determination of the minimum PRS bandwidth.</p> <p>NOTE 8: E-UTRA operating band groups are as defined in Section 3.5.</p> | | | | | | |

9.1.10.3 RSTD Measurement Report Mapping

The reporting range of RSTD is defined from $-15391T_s$ to $15391T_s$ with $1T_s$ resolution for absolute value of RSTD less or equal to $4096T_s$ and $5T_s$ for absolute value of RSTD greater than $4096T_s$.

The mapping of measured quantity is defined in Table 9.1.10.3-1.

Table 9.1.10.3-1: RSTD report mapping

| Reported Value | Measured Quantity Value | Unit |
|----------------|------------------------------------|-------|
| RSTD_0000 | $-15391 > \text{RSTD}$ | T_s |
| RSTD_0001 | $-15391 \leq \text{RSTD} < -15386$ | T_s |
| ... | ... | ... |
| RSTD_2258 | $-4106 \leq \text{RSTD} < -4101$ | T_s |
| RSTD_2259 | $-4101 \leq \text{RSTD} < -4096$ | T_s |
| RSTD_2260 | $-4096 \leq \text{RSTD} < -4095$ | T_s |
| RSTD_2261 | $-4095 \leq \text{RSTD} < -4094$ | T_s |
| ... | ... | ... |
| RSTD_6353 | $-3 \leq \text{RSTD} < -2$ | T_s |
| RSTD_6354 | $-2 \leq \text{RSTD} < -1$ | T_s |
| RSTD_6355 | $-1 \leq \text{RSTD} \leq 0$ | T_s |
| RSTD_6356 | $0 < \text{RSTD} \leq 1$ | T_s |
| RSTD_6357 | $1 < \text{RSTD} \leq 2$ | T_s |
| RSTD_6358 | $2 < \text{RSTD} \leq 3$ | T_s |
| ... | ... | ... |
| RSTD_10450 | $4094 < \text{RSTD} \leq 4095$ | T_s |
| RSTD_10451 | $4095 < \text{RSTD} \leq 4096$ | T_s |
| RSTD_10452 | $4096 < \text{RSTD} \leq 4101$ | T_s |
| RSTD_10453 | $4101 < \text{RSTD} \leq 4106$ | T_s |
| ... | ... | ... |
| RSTD_12709 | $15381 < \text{RSTD} \leq 15386$ | T_s |
| RSTD_12710 | $15386 < \text{RSTD} \leq 15391$ | T_s |
| RSTD_12711 | $15391 < \text{RSTD}$ | T_s |

9.1.11 Carrier aggregation measurement accuracy

This clause contains requirements on UE capabilities for support of E-UTRA FDD, TDD and TDD-FDD carrier aggregation. Requirements in this clause are applicable to all carrier aggregation capable UEs which have been configured with up to four downlink SCell(s). Note: This clause covers measurement accuracy requirements for frequencies corresponding to those used for the PCell and SCell(s); measurements of any other frequency are considered to be inter-frequency measurements covered by the accuracy requirements in clause 9.1.3 for inter-frequency RSRP, clause 9.1.6 for inter-frequency RSRQ, and clause 9.1.17.3 for inter-frequency RS-SINR.

The requirements in this clause apply for bandwidths defined in the bandwidth combination set for the CA configurations supported by the UE [5].

9.1.11.1 Primary component carrier accuracy requirement

RSRP measurements of cells on the primary component carrier shall meet the intra-frequency absolute accuracy requirements in section 9.1.2.1.

RSRQ measurements of cells on the primary component carrier shall meet the intra-frequency absolute accuracy requirements in section 9.1.5.1.

RS-SINR measurements of cells on the primary component carrier shall meet the intra-frequency absolute accuracy requirements in section 9.1.17.2.1.

Comparisons between RSRP of cells on the primary component carrier shall also meet the intra-frequency relative accuracy requirements in sections 9.1.2.2.

9.1.11.2 Secondary component carrier accuracy requirement

RSRP measurements of cells on any of the secondary component carrier(s) shall meet the intra-frequency absolute accuracy requirements in section 9.1.2.1.

RSRQ measurements of cells on any of the secondary component carrier(s) shall meet the intra-frequency absolute accuracy requirements in section 9.1.5.1.

RS-SINR measurements of cells on any of the secondary component carrier(s) shall meet the intra-frequency absolute accuracy requirements in section 9.1.17.2.1.

Comparisons between RSRP of cells on the same secondary component carrier shall meet the intra-frequency relative accuracy requirements in sections 9.1.2.2.

9.1.11.3 Primary and secondary component carrier relative accuracy requirement

When measurements of cells on the primary component carrier are compared with measurements of cells on any of the secondary component carrier(s), the applicable relative accuracy requirements are:

RSRP inter-frequency accuracy requirements in section 9.1.3.2,

RSRQ inter-frequency accuracy requirements in section 9.1.6.2,

RS-SINR inter-frequency accuracy requirements in section 9.1.17.3.2.

9.1.11.4 Secondary component carrier relative accuracy requirement

When measurements of cells on any of the secondary component carrier(s) are compared with measurements of cells on the other secondary component carrier, the applicable relative accuracy requirements are:

RSRP inter-frequency accuracy requirements in section 9.1.3.2,

RSRQ inter-frequency accuracy requirements in section 9.1.6.2,

RS-SINR inter-frequency accuracy requirements in section 9.1.17.3.2.

9.1.12 Reference Signal Time Difference (RSTD) Measurement Accuracy Requirements for Carrier Aggregation

This clause contains requirements for E-UTRA FDD, TDD and TDD-FDD carrier aggregation. This clause contains RSTD measurement accuracy requirements for a UE configured with one or two downlink SCell(s). The UE may operate in one of the E-UTRA carrier aggregations listed in clause 8.3.1. The requirements in this clause shall apply regardless whether the configured downlink secondary cell is activated or deactivated by the MAC-CE command [17]. The requirements apply for bandwidths defined in the bandwidth combination set for the CA configurations supported by the UE [5].

The RSTD measurements, which are obtained when both the reference cell and neighbouring cell belong to the primary component carrier, shall meet the intra-frequency RSTD accuracy requirements defined in clause 9.1.10.1.

The RSTD measurements, which are obtained when both the reference cell and neighbouring cell belong to the same secondary component carrier, shall meet the intra-frequency RSTD accuracy requirements defined in clause 9.1.10.1.

The RSTD measurements, which are obtained when the reference cell and neighbouring cell do not belong to the same carrier, shall meet the inter-frequency RSTD accuracy requirements defined in clause 9.1.10.2.

9.1.13 Measurement accuracy for UE category 0

9.1.13.1 Intra-frequency Absolute RSRP Accuracy for UE category 0

The requirements for absolute accuracy of RSRP in this clause apply to a cell on the same frequency as that of the serving cell for UE category 0.

The accuracy requirements in Table 9.1.13.1-1 are valid under the following conditions:

Cell specific reference signals are transmitted either from one, two or four antenna ports.

Conditions defined in 36.101 Clause 7.3 for reference sensitivity are fulfilled.

RSRP[dBm] according to Annex B.3.27 for a corresponding Band

At least 1 DL subframe per radio frame of measured cell is available at the UE for RSRP measurement assuming measured cell is identified cell.

Table 9.1.13.1-1: RSRP Intra frequency absolute accuracy for UE category 0

| Accuracy | | Conditions | | | | |
|------------------|-------------------|------------------------|--|-----------------------------|---------------------------|---------------------------|
| Normal condition | Extreme condition | \hat{E}_s/lot | I_0 ^{Note 1} range | | | |
| | | | E-UTRA operating band groups ^{Note 3} | Minimum I_0 | | Maximum I_0 |
| dB | dB | dB | | dBm/15kHz ^{Note 2} | dBm/BW _{Channel} | dBm/BW _{Channel} |
| ±7 | ±10 | ≥-6 dB | FDD-0_A, TDD-0_A | -121 | N/A | -70 |
| | | | FDD-0_B | -120.5 | N/A | -70 |
| | | | FDD-0_C, TDD-0_C | -120 | N/A | -70 |
| | | | FDD-0_D | -119.5 | N/A | -70 |
| | | | FDD-0_E, TDD-0_E | -119 | N/A | -70 |
| | | | FDD-0_F | -118.5 | N/A | -70 |
| | | | FDD-0_G | -118 | N/A | -70 |
| | | | FDD-0_H | -117.5 | N/A | -70 |
| | | | FDD-0_N | -114.5 | N/A | -70 |
| ±9 | ±12 | ≥-6 dB | FDD-0_A, TDD-0_A, FDD-0_B, FDD-0_C, TDD-0_C, FDD-0_D, FDD-0_E, TDD-0_E, FDD-0_F, FDD-0_G, FDD-0_H, FDD-0_N | N/A | -70 | -50 |

NOTE 1: I_0 is assumed to have constant EPRE across the bandwidth.
NOTE 2: The condition level is increased by $\Delta > 0$, when applicable, as described in Sections B.4.2 and B.4.3.
NOTE 3: E-UTRA operating band groups are as defined in Section 3.5.

9.1.13.2 Intra-frequency Relative Accuracy of RSRP for UE category 0

The relative accuracy of RSRP is defined as the RSRP measured from one cell compared to the RSRP measured from another cell on the same frequency for category 0 UE.

The accuracy requirements in Table 9.1.13.2-1 are valid under the following conditions:

Cell specific reference signals are transmitted either from one, two or four antenna ports.

Conditions defined in 36.101 Clause 7.3 for reference sensitivity are fulfilled.

RSRP_{1,2}_{dBm} according to Annex B.3.28 for a corresponding Band.

At least 1 DL subframe per radio frame of measured cell is available at the UE for RSRP measurement assuming measured cell is identified cell.

Table 9.1.13.2-1: RSRP Intra frequency relative accuracy for UE category 0

| Accuracy | | Conditions | | | |
|------------------|-------------------|--------------------------|--|-----------------------------|---------------------------|
| Normal condition | Extreme condition | Ês/lot ^{Note 2} | I _o ^{Note 1} range | | |
| | | | E-UTRA operating band groups ^{Note 5} | Minimum I _o | Maximum I _o |
| dB | dB | dB | | dBm/15kHz ^{Note 4} | dBm/BW _{Channel} |
| ±3 | ±4 | ≥-3 dB | FDD-0_A, TDD-0_A | -121 | -50 |
| | | | FDD-0_B | -120.5 | -50 |
| | | | FDD-0_C, TDD-0_C | -120 | -50 |
| | | | FDD-0_D | -119.5 | -50 |
| | | | FDD-0_E, TDD-0_E | -119 | -50 |
| | | | FDD-0_F | -118.5 | -50 |
| | | | FDD-0_G | -118 | -50 |
| | | | FDD-0_H | -117.5 | -50 |
| | | | FDD-0_N | -114.5 | -50 |
| ±4 | ±4 | ≥-6 dB | Note 3 | Note 3 | Note 3 |

NOTE 1: I_o is assumed to have constant EPRE across the bandwidth.
 NOTE 2: The parameter Ês/lot is the minimum Ês/lot of the pair of cells to which the requirement applies.
 NOTE 3: The same bands and the same I_o conditions for each band apply for this requirement as for the corresponding highest accuracy requirement.
 NOTE 4: The condition level is increased by Δ>0, when applicable, as described in Sections B.4.2 and B.4.3.
 NOTE 5: E-UTRA operating band groups are as defined in Section 3.5.

9.1.13.3 Intra-frequency Absolute RSRQ Accuracy for UE category 0

The requirements for absolute accuracy of RSRQ in this clause apply to a cell on the same frequency as that of the serving cell for category 0 UE.

The accuracy requirements in Table 9.1.13.3-1 are valid under the following conditions:

Cell specific reference signals are transmitted either from one, two or four antenna ports.

Conditions defined in 36.101 Clause 7.3 for reference sensitivity are fulfilled.

RSRP_{dBm} according to Annex B.3.27 for a corresponding Band

At least 1 DL subframe per radio frame of measured cell is available at the UE for RSRQ measurement assuming measured cell is identified cell.

Table 9.1.13.3-1: RSRQ Intra frequency absolute accuracy for UE category 0

| Accuracy | | Conditions | | | |
|------------------|-------------------|------------|--|-----------------------------|---------------------------|
| Normal condition | Extreme condition | Ês/lot | I _o ^{Note 1} range | | |
| | | | E-UTRA operating band groups ^{Note 4} | Minimum I _o | Maximum I _o |
| dB | dB | dB | | dBm/15kHz ^{Note 3} | dBm/BW _{Channel} |
| ±3.5 | ±5 | ≥-3 dB | FDD-0_A, TDD-0_A | -121 | -50 |
| | | | FDD-0_B | -120.5 | -50 |
| | | | FDD-0_C, TDD-0_C | -120 | -50 |
| | | | FDD-0_D | -119.5 | -50 |
| | | | FDD-0_E, TDD-0_E | -119 | -50 |
| | | | FDD-0_F | -118.5 | -50 |
| | | | FDD-0_G | -118 | -50 |
| | | | FDD-0_H | -117.5 | -50 |
| | | | FDD-0_N | -114.5 | -50 |
| ±4.5 | ±5 | ≥-6 dB | Note 2 | Note 2 | Note 2 |

NOTE 1: I_o is assumed to have constant EPRE across the bandwidth.
 NOTE 2: The same bands and the same I_o conditions for each band apply for this requirement as for the

corresponding highest accuracy requirement.
 NOTE 3: The condition level is increased by $\Delta > 0$, when applicable, as described in Sections B.4.2 and B.4.3.
 NOTE 4: E-UTRA operating band groups are as defined in Section 3.5.

9.1.14 Accuracy requirements for Discovery Signal Measurements

9.1.14.1 Introduction

Discovery signal measurements are performed when higher layers indicate measurements based on discovery signals according to DMTC configuration [2]. The discovery measurement accuracy requirements are defined for the following physical layer measurements performed in discovery signal occasions [16],

RSRP measured in subframes of the configured discovery signal occasions as specified in [4],

CSI-RSRP measurements specified in [4],

RSRQ measured in subframes of the configured discovery signal occasions as specified in [4].

9.1.14.2 RSRP measurements in discovery signal occasions

Intra-frequency absolute RSRP measurement accuracy requirements in discovery signal occasions are the same as specified in Section 9.1.2.1.

Intra-frequency relative RSRP measurement accuracy requirements in discovery signal occasions are the same as specified in Section 9.1.2.2.

Inter-frequency absolute RSRP measurement accuracy requirements in discovery signal occasions are the same as specified in Section 9.1.3.1.

Inter-frequency relative RSRP measurement accuracy requirements in discovery signal occasions are the same as specified in Section 9.1.3.2.

Measurement report mapping for RSRP measurements in discovery signal occasions are the same as specified in Section 9.1.4.

9.1.14.3 CSI-RSRP measurements in discovery signal occasions

9.1.14.3.1 Intra-frequency CSI-RSRP measurements

9.1.14.3.1.1 Absolute CSI-RSRP measurement requirements

In this clause, absolute CSI-RSRP measurement accuracy requirements in discovery signal occasions apply to a cell or TP on the same frequency as that of the serving cell.

The accuracy requirements in Table 9.1.14.3.1.1-1 are valid under the following conditions:

CSI reference signals in discovery signal occasions are transmitted on one antenna port only from each TP,

Conditions defined in 36.101 Clause 7.3 for reference sensitivity are fulfilled.

CSI-RSRP is specified in Annex B.3.14 for a corresponding Band.

Table 9.1.14.3.1.1-1: Intra-frequency absolute CSI-RSRP measurement accuracy

| Accuracy | | Conditions | | | | |
|------------------|-------------------|----------------------------|--|-----------------------------|---------------------------|---------------------------|
| Normal condition | Extreme condition | CSI \hat{E}_s/lot | I_0 ^{Note 1} range | | | |
| | | | E-UTRA operating band groups ^{Note 3} | Minimum I_0 | | Maximum I_0 |
| dB | dB | dB | | dBm/15kHz ^{Note 2} | dBm/BW _{Channel} | dBm/BW _{Channel} |
| ±4.5 | ±9 | ≥ 0 dB | FDD_A, TDD_A | -121 | N/A | -70 |

| | | | | | | |
|----|-----|-------|---|--------|-----|-----|
| | | | FDD_B | -120.5 | N/A | -70 |
| | | | FDD_C, TDD_C | -120 | N/A | -70 |
| | | | FDD_D | -119.5 | N/A | -70 |
| | | | FDD_E, TDD_E | -119 | N/A | -70 |
| | | | FDD_F | -118.5 | N/A | -70 |
| | | | FDD_G | -118 | N/A | -70 |
| | | | FDD_H | -117.5 | N/A | -70 |
| | | | FDD_N | -114.5 | N/A | -70 |
| ±8 | ±11 | ≥0 dB | FDD_A, TDD_A, FDD B, FDD_C, TDD_C, FDD_D, FDD_E, TDD_E, FDD_F, FDD_G, FDD_H, FDD_N | N/A | -70 | -50 |

NOTE 1: I_0 is assumed to have constant EPRE across the bandwidth.
 NOTE 2: The condition level is increased by $\Delta > 0$, when applicable, as described in Sections B.4.2 and B.4.3.
 NOTE 3: E-UTRA operating band groups are as defined in Section 3.5.

9.1.14.3.1.2 Relative CSI-RSRP measurement requirements

In this section, the relative CSI-RSRP measurement is defined as the CSI-RSRP measured from one cell or TP compared to the CSI-RSRP measured on the same frequency from another cell or from another TP. If two TPs are compared, they may belong to the same or different cells.

The accuracy requirements in Table 9.1.14.3.1.2-1 are valid under the following conditions:

CSI reference signals in discovery signal occasions are transmitted on one antenna port only from each TP.

Conditions defined in 36.101 Clause 7.3 for reference sensitivity are fulfilled.

CSI-RSRP is specified in Annex B.3.15 for a corresponding Band.

Table 9.1.14.3.1.2-1: Intra-frequency relative CSI-RSRP measurement accuracy

| Accuracy | | Conditions | | | |
|------------------|-------------------|--|--|-----------------------------|---------------------------|
| Normal condition | Extreme condition | CSI \hat{E}_s/I_{ot} ^{Note 2} | I_0 ^{Note 1} range | | |
| | | | E-UTRA operating band groups ^{Note 5} | Minimum I_0 | Maximum I_0 |
| dB | dB | dB | | dBm/15kHz ^{Note 4} | dBm/BW _{Channel} |
| ±2 | ±3 | ≥0 dB | FDD_A, TDD_A | -121 | -50 |
| | | | FDD_B | -120.5 | -50 |
| | | | FDD_C, TDD_C | -120 | -50 |
| | | | FDD_D | -119.5 | -50 |
| | | | FDD_E, TDD_E | -119 | -50 |
| | | | FDD_F | -118.5 | -50 |
| | | | FDD_G | -118 | -50 |
| | | | FDD_H | -117.5 | -50 |
| | | | FDD_N | -114.5 | -50 |

NOTE 1: I_0 is assumed to have constant EPRE across the bandwidth.
 NOTE 2: The parameter CSI \hat{E}_s/I_{ot} is the minimum CSI \hat{E}_s/I_{ot} of the pair of cells or TPs to which the requirement applies.
 NOTE 3: Void
 NOTE 4: The condition level is increased by $\Delta > 0$, when applicable, as described in Sections B.4.2 and B.4.3.
 NOTE 5: E-UTRA operating band groups are as defined in Section 3.5.

9.1.14.3.2 Inter-frequency CSI-RSRP measurements

9.1.14.3.2.1 Absolute CSI-RSRP measurement requirements

In this clause, absolute CSI-RSRP measurement accuracy requirements for discovery signal measurements apply to a cell or TP on a different carrier frequency from that of the serving cell.

The accuracy requirements in Table 9.1.14.3.2.1-1 are valid under the following conditions:

CSI reference signals in discovery signal occasions are transmitted on one antenna port only from each TP.

Conditions defined in 36.101 Clause 7.3 for reference sensitivity are fulfilled.

CSI-RSRP is specified in Annex B.3.16 for a corresponding Band.

Table 9.1.14.3.2.1-1: Inter-frequency absolute CSI-RSRP measurement accuracy

| Accuracy | | Conditions | | | | |
|------------------|-------------------|------------|--|-----------------------------|---------------------------|---------------------------|
| Normal condition | Extreme condition | CSI Ês/lot | Io ^{Note 1} range | | | |
| | | | E-UTRA operating band groups ^{Note 3} | Minimum Io | | Maximum Io |
| dB | dB | dB | | dBm/15kHz ^{Note 2} | dBm/BW _{Channel} | dBm/BW _{Channel} |
| ±4.5 | ±9 | ≥0 dB | FDD_A, TDD_A | -121 | N/A | -70 |
| | | | FDD_B | -120.5 | N/A | -70 |
| | | | FDD_C, TDD_C | -120 | N/A | -70 |
| | | | FDD_D | -119.5 | N/A | -70 |
| | | | FDD_E, TDD_E | -119 | N/A | -70 |
| | | | FDD_F | -118.5 | N/A | -70 |
| | | | FDD_G | -118 | N/A | -70 |
| | | | FDD_H | -117.5 | N/A | -70 |
| | | | FDD_N | -114.5 | N/A | -70 |
| ±8 | ±11 | ≥0 dB | FDD_A, TDD_A, FDD_B, FDD_C, TDD_C, FDD_D, FDD_E, TDD_E, FDD_F, FDD_G, FDD_H, FDD_N | N/A | -70 | -50 |

NOTE 1: Io is assumed to have constant EPRE across the bandwidth.
 NOTE 2: The condition level is increased by Δ>0, when applicable, as described in Sections B.4.2 and B.4.3.
 NOTE 3: E-UTRA operating band groups are as defined in Section 3.5.

9.1.14.3.2.2 Relative CSI-RSRP measurement requirements

In this section, the relative CSI-RSRP measurement is defined as the CSI-RSRP measured from one cell or TP compared to the CSI-RSRP measured on a different frequency from another cell or from another TP.

The accuracy requirements in Table 9.1.14.3.2.2-1 are valid under the following conditions:

CSI reference signals in discovery signal occasions are transmitted on one antenna port only from each TP.

Conditions defined in 36.101 Clause 7.3 for reference sensitivity are fulfilled.

CSI-RSRP is specified in Annex B.3.17 for a corresponding Band.

$$|CSI_RSRP1|_{dBm} - CSI_RSRP2|_{dBm} | \leq 27dB$$

$$|Channel\ 1_Io - Channel\ 2_Io| \leq 20\ dB$$

Table 9.1.14.3.2.2-1: Inter-frequency relative CSI-RSRP measurement accuracy

| Accuracy | | Conditions | | | |
|------------------|-------------------|------------------------------|--|-----------------------------|---------------------------|
| Normal condition | Extreme condition | CSI Ês/lot ^{Note 2} | Io ^{Note 1} range | | |
| | | | E-UTRA operating band groups ^{Note 4} | Minimum Io | |
| dB | dB | dB | | dBm/15kHz ^{Note 3} | dBm/BW _{Channel} |
| ±4.5 | ±6 | ≥0 dB | FDD_A, TDD_A | -121 | -50 |
| | | | FDD_B | -120.5 | -50 |
| | | | FDD_C, TDD_C | -120 | -50 |
| | | | FDD_D | -119.5 | -50 |
| | | | FDD_E, TDD_E | -119 | -50 |
| | | | FDD_F | -118.5 | -50 |
| | | | FDD_G | -118 | -50 |
| | | | FDD_H | -117.5 | -50 |
| | | | FDD_N | -114.5 | -50 |

NOTE 1: Io is assumed to have constant EPRE across the bandwidth.

NOTE 2: The parameter CSI \bar{E} s/lot is the minimum CSI \bar{E} s/lot of the pair of cells or TPs to which the requirement applies.

NOTE 3: The condition level is increased by $\Delta > 0$, when applicable, as described in Sections B.4.2 and B.4.3.

NOTE 4: E-UTRA operating band groups are as defined in Section 3.5.

9.1.14.3.3 CSI-RSRP measurement report mapping

The reporting range of CSI-RSRP is defined from -140 dBm to -44 dBm with 1 dB resolution.

The mapping of measured quantity is defined in Table 9.1.14.3.3-1. The range in the signalling may be larger than the guaranteed accuracy range.

Table 9.1.14.3.3-1: CSI-RSRP measurement report mapping

| Reported value | Measured quantity value | Unit |
|----------------|-------------------------------------|------|
| CSI_RSRP_00 | CSI_RSRP < -140 | dBm |
| CSI_RSRP_01 | $-140 \leq \text{CSI_RSRP} < -139$ | dBm |
| CSI_RSRP_02 | $-139 \leq \text{CSI_RSRP} < -138$ | dBm |
| ... | ... | ... |
| CSI_RSRP_95 | $-46 \leq \text{CSI_RSRP} < -45$ | dBm |
| CSI_RSRP_96 | $-45 \leq \text{CSI_RSRP} < -44$ | dBm |
| CSI_RSRP_97 | $-44 \leq \text{CSI_RSRP}$ | dBm |

9.1.14.4 RSRQ measurements in discovery signal occasions

Intra-frequency absolute RSRQ measurement accuracy requirements in discovery signal occasions are the same as specified in Section 9.1.5.1.

Inter-frequency absolute RSRQ measurement accuracy requirements in discovery signal occasions are the same as specified in Section 9.1.6.1.

Inter-frequency relative RSRQ measurement accuracy requirements in discovery signal occasions are the same as specified in Section 9.1.6.2.

Measurement report mapping for RSRQ measurements in discovery signal occasions are the same as specified in Section 9.1.7.

9.1.15 Discovery signal measurements accuracy for E-UTRAN carrier aggregation

This clause contains requirements on UE capabilities for support of E-UTRA FDD, TDD and TDD-FDD carrier aggregation when discovery signal [16] is configured. Requirements in this clause are applicable to all carrier aggregation capable UEs which have been configured with up to four downlink SCell(s). Note : This clause covers measurement accuracy requirements for frequencies corresponding to those used for the PCell and SCell(s). Measurements of any other frequency are considered to be inter-frequency measurements covered by the accuracy requirements in clause 9.1.14.

The requirements in this clause apply for bandwidths defined in the bandwidth combination set for the CA configurations supported by the UE [5].

9.1.15.1 Requirements for CRS based discovery signal measurements accuracy for E-UTRAN carrier aggregation

9.1.15.1.1 Primary component carrier accuracy requirement

RSRP and RSRQ measurements of cells on the primary component carrier shall meet the intrafrequency absolute accuracy requirements in sections 9.1.14.2 and 9.1.14.4. Comparisons between RSRP of cells on the primary component carrier shall also meet the intra-frequency relative accuracy requirements in sections 9.1.14.2.

9.1.15.1.2 Secondary component carrier accuracy requirement

RSRP and RSRQ measurements of cells on any of the secondary component carrier(s) shall meet the intrafrequency absolute accuracy requirements in sections 9.1.14.2 and 9.1.14.4. Comparisons between RSRP of cells on the same secondary component carrier shall meet the intra-frequency relative accuracy requirements in sections 9.1.14.2.

9.1.15.1.3 Primary and secondary component carrier relative accuracy requirement

When measurements of cells on the primary component carrier are compared with measurements of cells on any of the secondary component carrier(s), the applicable relative accuracy requirements are the RSRP and RSRQ inter-frequency accuracy requirements in sections 9.1.14.2 and 9.1.14.4.

9.1.15.1.4 Secondary component carrier relative accuracy requirement

When measurements of cells on any of the secondary component carrier(s) are compared with measurements of cells on the other secondary component carrier, the applicable relative accuracy requirements are the RSRP and RSRQ inter-frequency accuracy requirements in sections 9.1.14.2 and 9.1.14.4.

9.1.15.2 Requirements for CSI-RS based discovery signal measurements accuracy for E-UTRAN carrier aggregation

9.1.15.2.1 Primary component carrier accuracy requirement

RSRP measurements of cells on the primary component carrier shall meet the intrafrequency absolute accuracy requirements in sections 9.1.14.3.1.1. Comparisons between RSRP of cells on the primary component carrier shall also meet the intra-frequency relative accuracy requirements in sections 9.1.14.3.1.2.

9.1.15.2.2 Secondary component carrier accuracy requirement

RSRP measurements of cells on any of the secondary component carrier(s) shall meet the intrafrequency absolute accuracy requirements in sections 9.1.14.3.1.1. Comparisons between RSRP of cells on the same secondary component carrier shall meet the intra-frequency relative accuracy requirements in sections 9.1.14.3.1.2.

9.1.15.2.3 Primary and secondary component carrier relative accuracy requirement

When measurements of cells on the primary component carrier are compared with measurements of cells on any of the secondary component carrier(s), the applicable relative accuracy requirements are the RSRP inter-frequency accuracy requirements in sections 9.1.14.3.2.2.

9.1.15.2.4 Secondary component carrier relative accuracy requirement

When measurements of cells on any of the secondary component carrier(s) are compared with measurements of cells on the other secondary component carrier, the applicable relative accuracy requirements are the RSRP inter-frequency accuracy requirements in sections 9.1.14.3.2.2.

9.1.16 Accuracy requirements for RSRQ measurement on all OFDM symbols

This clause contains requirements for RSRQ measurement when measurement configuration message received by the UE contains *measRSRQ-OnAllSymbols-r12* parameter in TS 36.331 [2].

Intra-frequency absolute RSRQ measurement accuracy requirements when measured on all OFDM symbols are the same as specified in Section 9.1.5.1.

Inter-frequency absolute RSRQ measurement accuracy requirements when measured on all OFDM symbols are the same as specified in Section 9.1.6.1.

Inter-frequency relative RSRQ measurement accuracy requirements when measured on all OFDM symbols are the same as specified in Section 9.1.6.2.

NOTE: The minimum I_o condition in Table 9.1.5.1-1, Table 9.1.6.1-1 and Table 9.1.6.2-1 is expressed as the average I_o per RE over all REs in that symbol.

NOTE: The I_o range defined by the minimum and the maximum I_o levels in Table 9.1.5.1-1, Table 9.1.6.1-1 and Table 9.1.6.2-1 applies to CRS and non-CRS symbols. I_o may be different in different symbols within a subframe.

NOTE: I_{ot} in Table 9.1.5.1-1, Table 9.1.6.1-1 and Table 9.1.6.2-1 is the received power spectrum density of total interference and noise averaged over CRS REs.

Intra-frequency absolute WB-RSRQ measurement accuracy requirements when measured on all OFDM symbols are the same as specified in Section 9.1.5.4.

Inter-frequency absolute WB-RSRQ measurement accuracy requirements when measured on all OFDM symbols are the same as specified in Section 9.1.6.3.

Inter-frequency relative WB-RSRQ measurement accuracy requirements when measured on all OFDM symbols are the same as specified in Section 9.1.6.4.

NOTE: The minimum I_o condition in Table 9.1.5.4-1, Table 9.1.6.3-1 and Table 9.1.6.4-1 is expressed as the average I_o per RE over all REs in that symbol across all the resource blocks within the *AllowedMeasBandwidth* in TS 36.331 [2].

NOTE: The I_{o1} , I_{o2} and I_o range defined by the minimum and the maximum I_o levels in Table 9.1.5.4-1, Table 9.1.6.3-1 and Table 9.1.6.4-1 applies to CRS and non-CRS symbols. I_{o1} , I_{o2} and I_o may be different in different symbols within a subframe.

NOTE: I_{ot} in Table 9.1.5.4-1, Table 9.1.6.3-1 and Table 9.1.6.4-1 is the received power spectrum density of total interference and noise averaged over CRS REs.

9.1.17 RS-SINR Measurements

9.1.17.1 Measurement Report Mapping

The reporting range of RS-SINR measurement is defined from -23 dB to 40 dB with 0.5 dB resolution.

The mapping of the measured quantity is defined in table 9.1.17.1-1. The range in the signalling may be larger than the guaranteed accuracy range.

Table 9.1.17.1-1: RS-SINR measurement report mapping

| Reported Value | Measured Quantity Value | Unit |
|----------------|----------------------------|------|
| RS-SINR_000 | $RS-SINR < -23$ | dB |
| RS-SINR_001 | $-23 \leq RS-SINR < -22.5$ | dB |
| ... | ... | ... |
| RS-SINR_126 | $39.5 \leq RS-SINR < 40$ | dB |
| RS-SINR_127 | $40 \leq RS-SINR$ | dB |

9.1.17.2 Intra-frequency RS-SINR Measurement Accuracy Requirements

9.1.17.2.1 Absolute RS-SINR Measurement Accuracy Requirements

The requirements for absolute accuracy of intra-frequency RS-SINR in this clause apply to a cell on the same frequency as that of the serving cell.

The accuracy requirements in Table 9.1.17.2.1-1 are valid under the following conditions:

Cell specific reference signals are transmitted either from one, two or four antenna ports.

Conditions defined in 36.101 Clause 7.3 for reference sensitivity are fulfilled.

RSRP[dBm] according to Annex B.3.18 for a corresponding Band.

Table 9.1.17.2.1-1: Intra-frequency RS-SINR absolute accuracy

| Accuracy | | Conditions | | | |
|------------------|-------------------|--------------------------|--|---------------------------|---------------|
| Normal condition | Extreme condition | $\hat{E}s/lot$ | I_o ^{Note 1} range | | |
| | | | E-UTRA operating band groups ^{Note 4} | Minimum I_o | Maximum I_o |
| dB | dB | dB | dBm/15kHz ^{Note 3} | dBm/BW _{Channel} | |
| ±3.0 | ±4 | ≥-3 dB ^{Note 5} | FDD_A, TDD_A | -121 | -50 |
| | | | FDD_B | -120.5 | -50 |
| | | | FDD_C, TDD_C | -120 | -50 |
| | | | FDD_D | -119.5 | -50 |
| | | | FDD_E, TDD_E | -119 | -50 |
| | | | FDD_F | -118.5 | -50 |
| | | | FDD_G | -118 | -50 |
| | | | FDD_H | -117.5 | -50 |
| | | | FDD_N | -114.5 | -50 |
| ±3.5 | ±4 | ≥-6 dB | Note 2 | Note 2 | Note 2 |

NOTE 1: I_o is assumed to have constant EPRE across the bandwidth.
NOTE 2: The same bands and the same I_o conditions for each band apply for this requirement as for the corresponding highest accuracy requirement.
NOTE 3: The condition level is increased by $\Delta > 0$, when applicable, as described in Sections B.4.2 and B.4.3.
NOTE 4: E-UTRA operating band groups are as defined in Section 3.5.
NOTE 5: The requirements apply for $\hat{E}s/lot \leq 25$ dB.

9.1.17.3 Inter-frequency RS-SINR Measurement Accuracy Requirements

9.1.17.3.1 Absolute RS-SINR Measurement Accuracy Requirements

The requirements for absolute accuracy of inter-frequency RS-SINR in this clause apply to a cell that has different carrier frequency from the serving cell.

The accuracy requirements in Table 9.1.17.3-1 are valid under the following conditions:

Cell specific reference signals are transmitted either from one, two or four antenna ports.

Conditions defined in 36.101 Clause 7.3 for reference sensitivity are fulfilled.

RSRP|dBm according to Annex B.3.19 for a corresponding Band.

Table 9.1.17.3.1-1: Inter-frequency RS-SINR absolute accuracy

| Accuracy | | Conditions | | | |
|------------------|-------------------|--------------------------|--|---------------------------|---------------|
| Normal condition | Extreme condition | $\hat{E}s/lot$ | I_o ^{Note 1} range | | |
| | | | E-UTRA operating band groups ^{Note 4} | Minimum I_o | Maximum I_o |
| dB | dB | dB | dBm/15kHz ^{Note 3} | dBm/BW _{Channel} | |
| ±3.0 | ±4 | ≥-3 dB ^{Note 5} | FDD_A, TDD_A | -121 | -50 |
| | | | FDD_B | -120.5 | -50 |
| | | | FDD_C, TDD_C | -120 | -50 |
| | | | FDD_D | -119.5 | -50 |
| | | | FDD_E, TDD_E | -119 | -50 |
| | | | FDD_F | -118.5 | -50 |
| | | | FDD_G | -118 | -50 |
| | | | FDD_H | -117.5 | -50 |
| | | | FDD_N | -114.5 | -50 |
| ±3.5 | ±4 | ≥-6 dB | Note 2 | Note 2 | Note 2 |

NOTE 1: I_o is assumed to have constant EPRE across the bandwidth.
NOTE 2: The same bands and the same I_o conditions for each band apply for this requirement as for the corresponding highest accuracy requirement.
NOTE 3: The condition level is increased by $\Delta > 0$, when applicable, as described in Sections B.4.2 and B.4.3.
NOTE 4: E-UTRA operating band groups are as defined in Section 3.5.

NOTE 5: The requirements apply for $\hat{E}s/lot \leq 25$ dB.

9.1.17.3.2 Relative RS-SINR Measurement Accuracy Requirements

The relative accuracy of inter-frequency RS-SINR in this clause is defined as the RS-SINR measured from one cell compared to the RS-SINR measured from another cell on a different frequency.

The accuracy requirements in Table 9.1.17.3.2-1 are valid under the following conditions:

Cell specific reference signals are transmitted either from one, two or four antenna ports.

Conditions defined in 36.101 Clause 7.3 for reference sensitivity are fulfilled.

$RSRP_{1,2}_{dBm}$ according to Annex B.3.20 for a corresponding Band.

$$|RSRP1|_{dBm} - RSRP2|_{dBm} \leq 27dB$$

$$|Channel\ 1_Io - Channel\ 2_Io| \leq 20\ dB$$

Table 9.1.17.3.2-1: Inter-frequency RS-SINR relative accuracy

| Accuracy | | Conditions | | | |
|------------------|-------------------|----------------------------------|--|-----------------------------|---------------------------|
| Normal condition | Extreme condition | $\hat{E}s/lot$ ^{Note 2} | Io ^{Note 1} range | | |
| | | | E-UTRA operating band groups ^{Note 5} | Minimum Io | Maximum Io |
| dB | dB | dB | | dBm/15kHz ^{Note 4} | dBm/BW _{Channel} |
| ±3.5 | ±4 | ≥-3 dB ^{Note 6} | FDD_A, TDD_A | -121 | -50 |
| | | | FDD_B | -120.5 | -50 |
| | | | FDD_C, TDD_C | -120 | -50 |
| | | | FDD_D | -119.5 | -50 |
| | | | FDD_E, TDD_E | -119 | -50 |
| | | | FDD_F | -118.5 | -50 |
| | | | FDD_G | -118 | -50 |
| | | | FDD_H | -117.5 | -50 |
| | | | FDD_N | -114.5 | -50 |
| ±4.0 | ±4 | ≥-6 dB | Note 3 | Note 3 | Note 3 |

NOTE 1: Io is assumed to have constant EPRE across the bandwidth.
 NOTE 2: The parameter $\hat{E}s/lot$ is the minimum $\hat{E}s/lot$ of the pair of cells to which the requirement applies.
 NOTE 3: The same bands and the same Io conditions for each band apply for this requirement as for the corresponding highest accuracy requirement.
 NOTE 4: The condition level is increased by $\Delta > 0$, when applicable, as described in Sections B.4.2 and B.4.3.
 NOTE 5: E-UTRA operating band groups are as defined in Section 3.5.
 NOTE 6: The requirements apply for $\hat{E}s/lot \leq 25$ dB.

9.1.18 Accuracy Requirements for Measurements under Operation with Frame Structure 3

9.1.18.1 Introduction

The accuracy requirements in this section are defined for the following physical layer measurements: RSRP, RSRQ, CSI-RSRP, and RSSI, where the measurements are performed on cells of E-UTRA carriers during the configured DMTC occasion [2] under operation with frame structure 3 [16].

9.1.18.2 RSRP measurements

9.1.18.2.1 RSRP measurement report mapping

The measurement report mapping for RSRP measurements is as defined in Section 9.1.4.

9.1.18.2.2 Inter-frequency absolute RSRP measurement accuracy requirements

The requirements for absolute accuracy of RSRP in this clause apply to a cell that has a different carrier frequency from the serving cell.

The accuracy requirements in Table 9.1.18.2.2-2 are valid under the following conditions:

Cell specific reference signals are transmitted either from one, two or four antenna ports.

Conditions defined in 36.101 Clause 7.3 for reference sensitivity are fulfilled.

RSRP_{dBm} according to Annex B.3.23.1 for a corresponding Band.

The discovery signal occasion does not contain any MBSFN subframe and contains at least four CRS symbols over two adjacent slots.

Table 9.1.18.2.2-1: RSRP inter-frequency absolute accuracy

| Accuracy | | Conditions | | | | |
|------------------|-------------------|------------|--|-----------------------------|---------------------------|---------------------------|
| Normal condition | Extreme condition | Ês/lot | I _o ^{Note 1} range | | | |
| | | | E-UTRA operating band groups ^{Note 3} | Minimum I _o | | Maximum I _o |
| dB | dB | dB | | dBm/15kHz ^{Note 2} | dBm/BW _{Channel} | dBm/BW _{Channel} |
| ±4.5 | ±9 | ≥-6 dB | FS3_G | -118 | N/A | -70 |
| ±8 | ±11 | ≥-6 dB | FS3_G | N/A | -70 | -50 |

NOTE 1: I_o is assumed to have constant EPRE across the bandwidth.
NOTE 2: The condition level is increased by Δ>0, when applicable, as described in Sections B.4.2 and B.4.3.
NOTE 3: E-UTRA operating band groups are as defined in Section 3.5.

9.1.18.2.3 Inter-frequency relative RSRP measurement accuracy requirements

The relative accuracy of inter-frequency RSRP measurement is defined as the RSRP measured from one cell compared to the RSRP measured from another cell on a different frequency.

The accuracy requirements in Table 9.1.18.2.3-1 are valid under the following conditions:

Cell specific reference signals are transmitted either from one, two or four antenna ports.

Conditions defined in 36.101 Clause 7.3 for reference sensitivity are fulfilled.

RSRP_{1,2}_{dBm} according to Annex B.3.4 for a corresponding Band

$$\left| RSRP1 \Big|_{dBm} - RSRP2 \Big|_{dBm} \right| \leq 27 dB$$

$$| \text{Channel 1}_{I_o} - \text{Channel 2}_{I_o} | \leq 20 dB$$

The discovery signal occasion does not contain any MBSFN subframe and contains at least four CRS symbols over two adjacent slots.

Table 9.1.18.2.3-1: RSRP inter-frequency relative accuracy

| Accuracy | | Conditions | | | |
|------------------|-------------------|--------------------------|--|-----------------------------|---------------------------|
| Normal condition | Extreme condition | Ês/lot ^{Note 2} | I _o ^{Note 1} range | | |
| | | | E-UTRA operating band groups ^{Note 4} | Minimum I _o | Maximum I _o |
| dB | dB | dB | | dBm/15kHz ^{Note 3} | dBm/BW _{Channel} |
| ±4.5 | ±6 | ≥-6 dB | FS3_G | -118 | -50 |

NOTE 1: I_o is assumed to have constant EPRE across the bandwidth.
NOTE 2: The parameter Ês/lot is the minimum Ês/lot of the pair of cells to which the requirement applies.
NOTE 3: The condition level is increased by Δ>0, when applicable, as described in Sections B.4.2 and B.4.3.
NOTE 4: E-UTRA operating band groups are as defined in Section 3.5.

9.1.18.2.4 Intra-frequency absolute RSRP measurement accuracy requirements

NOTE: These requirements are applicable only for CA under operation with frame structure 3 [16].

The requirements for absolute accuracy of RSRP in this clause apply to a cell on a serving carrier frequency.

The accuracy requirements in Table 9.1.18.2.4-1 are valid under the following conditions:

Cell specific reference signals are transmitted either from one, two or four antenna ports.

Conditions defined in 36.101 Clause 7.3 for reference sensitivity are fulfilled.

RSRP_{dBm} according to Annex B.3.21.1 for a corresponding Band.

The discovery signal occasion does not contain any MBSFN subframe and contains at least four CRS symbols over two adjacent slots.

Table 9.1.18.2.4-1: RSRP intra frequency absolute accuracy

| Accuracy | | Conditions | | | | |
|------------------|-------------------|------------|--|-----------------------------|---------------------------|---------------------------|
| Normal condition | Extreme condition | Ês/lot | I _o ^{Note 1} range | | | |
| | | | E-UTRA operating band groups ^{Note 3} | Minimum I _o | Maximum I _o | |
| dB | dB | dB | | dBm/15kHz ^{Note 2} | dBm/BW _{Channel} | dBm/BW _{Channel} |
| ±4.5 | ±9 | ≥-6 dB | FS3_G | -118 | N/A | -70 |
| ±8 | ±11 | ≥-6 dB | FS3_G | N/A | -70 | -50 |

NOTE 1: I_o is assumed to have constant EPRE across the bandwidth.
 NOTE 2: The condition level is increased by Δ>0, when applicable, as described in Sections B.4.2 and B.4.3.
 NOTE 3: E-UTRA operating band groups are as defined in Section 3.5.

9.1.18.2.5 Intra-frequency relative RSRP measurement accuracy requirements

NOTE: These requirements are applicable only for CA under operation with frame structure 3 [16].

The relative accuracy of RSRP is defined as the RSRP measured from one cell compared to the RSRP measured from another cell on the same carrier frequency.

The accuracy requirements in Table 9.1.18.2.5-1 are valid under the following conditions:

Cell specific reference signals are transmitted either from one, two or four antenna ports.

Conditions defined in 36.101 Clause 7.3 for reference sensitivity are fulfilled.

RSRP_{1,2}_{dBm} according to Annex B.3.22.1 for a corresponding Band.

The discovery signal occasion does not contain any MBSFN subframe and contains at least four CRS symbols over two adjacent slots.

Table 9.1.18.2.5-1: RSRP intra frequency relative accuracy

| Accuracy | | Conditions | | | |
|------------------|-------------------|--------------------------|--|-----------------------------|---------------------------|
| Normal condition | Extreme condition | Ês/lot ^{Note 2} | I _o ^{Note 1} range | | |
| | | | E-UTRA operating band groups ^{Note 5} | Minimum I _o | Maximum I _o |
| dB | dB | dB | | dBm/15kHz ^{Note 4} | dBm/BW _{Channel} |
| ±2 | ±3 | ≥-3 dB | FS3_G | -118 | -50 |
| ±3 | ±3 | ≥-6 dB | Note 3 | Note 3 | Note 3 |

NOTE 1: I_o is assumed to have constant EPRE across the bandwidth.
 NOTE 2: The parameter Ês/lot is the minimum Ês/lot of the pair of cells to which the requirement applies.
 NOTE 3: The same bands and the same I_o conditions for each band apply for this requirement as for the corresponding highest accuracy requirement.
 NOTE 4: The condition level is increased by Δ>0, when applicable, as described in Sections B.4.2 and B.4.3.
 NOTE 5: E-UTRA operating band groups are as defined in Section 3.5.

9.1.18.3 RSRQ measurements

9.1.18.3.1 RSRQ measurement report mapping

The measurement report mapping for RSRQ measurements is as defined in Section 9.1.7.

9.1.18.3.2 Inter-frequency absolute RSRQ measurement accuracy requirements

The requirements for absolute accuracy of RSRQ in this clause apply to a cell that has different carrier frequency from the serving cell.

The accuracy requirements in Table 9.1.18.3.2-1 are valid under the following conditions:

Cell specific reference signals are transmitted either from one, two or four antenna ports.

Conditions defined in 36.101 Clause 7.3 for reference sensitivity are fulfilled.

RSRP_{dBm} according to Annex B.3.23.2 for a corresponding Band.

The discovery signal occasion does not contain any MBSFN subframe and contains at least four CRS symbols over two adjacent slots.

Table 9.1.18.3.2-1: RSRQ inter-frequency absolute accuracy

| Accuracy | | Conditions | | | |
|------------------|-------------------|------------|--|-----------------------------|---------------------------|
| Normal condition | Extreme condition | Ês/lot | I _o ^{Note 1} range | | |
| | | | E-UTRA operating band groups ^{Note 4} | Minimum I _o | Maximum I _o |
| dB | dB | dB | | dBm/15kHz ^{Note 3} | dBm/BW _{Channel} |
| ±2.5 | ±4 | ≥-3 dB | FS3_G | -118 | -50 |
| ±3.5 | ±4 | ≥-6 dB | Note 2 | Note 2 | Note 2 |

NOTE 1: I_o is assumed to have constant EPRE across the bandwidth.
 NOTE 2: The same bands and the same I_o conditions for each band apply for this requirement as for the corresponding highest accuracy requirement.
 NOTE 3: The condition level is increased by Δ>0, when applicable, as described in Sections B.4.2 and B.4.3.
 NOTE 4: E-UTRA operating band groups are as defined in Section 3.5.

9.1.18.3.3 Inter-frequency relative RSRQ measurement accuracy requirements

The relative accuracy of RSRQ in inter frequency case is defined as the RSRQ measured from one cell compared to the RSRQ measured from another cell on a different frequency.

The accuracy requirements in Table 9.1.18.3.3-1 are valid under the following conditions:

Cell specific reference signals are transmitted either from one, two or four antenna ports.

Conditions defined in 36.101 Clause 7.3 for reference sensitivity are fulfilled.

RSRP_{1,2}_{dBm} according to Annex B.3.24.2 for a corresponding Band.

$$\left| RSRP1 \Big|_{dBm} - RSRP2 \Big|_{dBm} \right| \leq 27 dB$$

$$\left| Channel\ 1_I_o - Channel\ 2_I_o \right| \leq 20 dB$$

The discovery signal occasion does not contain any MBSFN subframe and contains at least four CRS symbols over two adjacent slots.

Table 9.1.18.3.3-1: RSRQ inter-frequency relative accuracy

| Accuracy | | Conditions | | | |
|------------------|-------------------|--------------------------|--|------------------------|------------------------|
| Normal condition | Extreme condition | Ês/lot ^{Note 2} | I _o ^{Note 1} range | | |
| | | | E-UTRA operating band groups ^{Note 5} | Minimum I _o | Maximum I _o |

| dB | dB | dB | | dBm/15kHz ^{Note 4} | dBm/BW _{Channel} |
|----|----|--------|--------|-----------------------------|---------------------------|
| ±3 | ±4 | ≥-3 dB | FS3_G | -118 | -50 |
| ±4 | ±4 | ≥-6 dB | Note 3 | Note 3 | Note 3 |

NOTE 1: I_0 is assumed to have constant EPRE across the bandwidth.
NOTE 2: The parameter \hat{E}_s/I_0 is the minimum \hat{E}_s/I_0 of the pair of cells to which the requirement applies.
NOTE 3: The same bands and the same I_0 conditions for each band apply for this requirement as for the corresponding highest accuracy requirement.
NOTE 4: The condition level is increased by $\Delta > 0$, when applicable, as described in Sections B.4.2 and B.4.3.
NOTE 5: E-UTRA operating band groups are as defined in Section 3.5.

9.1.18.3.4 Intra-frequency absolute RSRQ measurement accuracy requirements

NOTE: These requirements are applicable only for CA under operation with frame structure 3 [16].

The requirements for absolute accuracy of RSRQ in this clause apply to a cell on a serving carrier frequency.

The accuracy requirements in Table 9.1.18.3.4-1 are valid under the following conditions:

Cell specific reference signals are transmitted either from one, two or four antenna ports.

Conditions defined in 36.101 Clause 7.3 for reference sensitivity are fulfilled.

RSRP[dBm] according to Annex B.3.21.2 for a corresponding Band.

The discovery signal occasion does not contain any MBSFN subframe and contains at least four CRS symbols over two adjacent slots.

Table 9.1.18.3.4-1: RSRQ intra frequency absolute accuracy

| Accuracy | | Conditions | | | |
|------------------|-------------------|-----------------|--|-----------------------------|---------------------------|
| Normal condition | Extreme condition | \hat{E}_s/I_0 | I_0 ^{Note 1} range | | |
| | | | E-UTRA operating band groups ^{Note 4} | Minimum I_0 | Maximum I_0 |
| dB | dB | dB | | dBm/15kHz ^{Note 3} | dBm/BW _{Channel} |
| ±2.5 | ±4 | ≥-3 dB | FS3_G | -118 | -50 |
| ±3.5 | ±4 | ≥-6 dB | Note 2 | Note 2 | Note 2 |

NOTE 1: I_0 is assumed to have constant EPRE across the bandwidth.
NOTE 2: The same bands and the same I_0 conditions for each band apply for this requirement as for the corresponding highest accuracy requirement.
NOTE 3: The condition level is increased by $\Delta > 0$, when applicable, as described in Sections B.4.2 and B.4.3.
NOTE 4: E-UTRA operating band groups are as defined in Section 3.5.

9.1.18.4 CSI-RSRP measurements

9.1.18.4.1 CSI-RSRP measurement report mapping

The measurement report mapping for CSI-RSRP measurements is as defined in Section 9.1.14.3.3.

9.1.18.4.2 Inter-frequency absolute CSI-RSRP measurement accuracy requirements

In this clause, absolute CSI-RSRP measurement accuracy requirements for discovery signal measurements apply to a cell or TP operating under frame structure 3 [3] on a different carrier frequency from that of the serving cell.

The accuracy requirements in Table 9.1.18.4.2-1 are valid under the following conditions:

CSI reference signals in discovery signal occasions are transmitted on one antenna port only from each TP.

Conditions defined in 36.101 Clause 7.3 for reference sensitivity are fulfilled.

CSI-RSRP is as specified in Annex B.3.23.3 for a corresponding Band.

The discovery signal occasion does not contain any MBSFN subframe and contains at least two CSI REs per resource block within the measured bandwidth in two adjacent slots.

Table 9.1.18.4.2-1: Inter-frequency absolute CSI-RSRP measurement accuracy

| Accuracy | | Conditions | | | | |
|------------------|-------------------|----------------------------|--|-----------------------------|---------------------------|---------------------------|
| Normal condition | Extreme condition | CSI \hat{E}_s/lot | Io ^{Note 1} range | | | |
| | | | E-UTRA operating band groups ^{Note 3} | Minimum Io | | Maximum Io |
| dB | dB | dB | | dBm/15kHz ^{Note 2} | dBm/BW _{Channel} | dBm/BW _{Channel} |
| ±4.5 | ±9 | ≥0 dB | FS3_G | -118 | N/A | -70 |
| ±8 | ±11 | ≥0 dB | FS3_G | N/A | -70 | -50 |

NOTE 1: Io is assumed to have constant EPRE across the bandwidth.
NOTE 2: The condition level is increased by Δ>0, when applicable, as described in Sections B.4.2 and B.4.3.
NOTE 3: E-UTRA operating band groups are as defined in Section 3.5.

9.1.18.4.3 Inter-frequency relative CSI-RSRP measurement accuracy requirements

In this section, the relative CSI-RSRP measurement is defined as the CSI-RSRP measured from one cell or TP compared to the CSI-RSRP measured on a different frequency from another cell or from another TP, where at least one measured cell or TP is operating under frame structure 3 [3].

The accuracy requirements in Table 9.1.18.4.3-1 are valid under the following conditions:

CSI reference signals in discovery signal occasions are transmitted on one antenna port only from each TP.

Conditions defined in 36.101 Clause 7.3 for reference sensitivity are fulfilled.

CSI-RSRP is as specified in Annex B.3.24.3 for a corresponding Band.

$$\left| CSI_RSRP1 \Big|_{dBm} - CSI_RSRP2 \Big|_{dBm} \right| \leq 27 dB$$

$$| \text{Channel 1_Io} - \text{Channel 2_Io} | \leq 20 \text{ dB}$$

The discovery signal occasion does not contain any MBSFN subframe and contains at least two CSI REs per resource block within the measured bandwidth in two adjacent slots.

Table 9.1.18.4.3-1: Inter-frequency relative CSI-RSRP measurement accuracy

| Accuracy | | Conditions | | | |
|------------------|-------------------|--|--|-----------------------------|---------------------------|
| Normal condition | Extreme condition | CSI \hat{E}_s/lot ^{Note 2} | Io ^{Note 1} range | | |
| | | | E-UTRA operating band groups ^{Note 4} | Minimum Io | Maximum Io |
| dB | dB | dB | | dBm/15kHz ^{Note 3} | dBm/BW _{Channel} |
| ±4.5 | ±6 | ≥0 dB | FS3_G | -118 | -50 |

NOTE 1: Io is assumed to have constant EPRE across the bandwidth.
NOTE 2: The parameter CSI \hat{E}_s/lot is the minimum CSI \hat{E}_s/lot of the pair of cells or TPs to which the requirement applies.
NOTE 3: The condition level is increased by Δ>0, when applicable, as described in Sections B.4.2 and B.4.3.
NOTE 4: E-UTRA operating band groups are as defined in Section 3.5.

9.1.18.4.4 Intra-frequency absolute CSI-RSRP measurement accuracy requirements

NOTE: These requirements are applicable only for CA under operation with frame structure 3 [16].

In this clause, absolute CSI-RSRP measurement accuracy requirements in discovery signal occasions apply to a cell or TP on a serving carrier frequency operating under frame structure 3 [3].

The accuracy requirements in Table 9.1.18.4.4-1 are valid under the following conditions:

CSI reference signals in discovery signal occasions are transmitted on one antenna port only from each TP,

Conditions defined in 36.101 Clause 7.3 for reference sensitivity are fulfilled.

CSI-RSRP is as specified in Annex B.3.21.3 for a corresponding Band.

The discovery signal occasion does not contain any MBSFN subframe and contains at least two CSI REs per resource block within the measured bandwidth in two adjacent slots of the same subframe or different subframes.

Table 9.1.18.4.4-1: Intra-frequency absolute CSI-RSRP measurement accuracy

| Accuracy | | Conditions | | | |
|------------------|-------------------|------------|--|-----------------------------|---------------------------|
| Normal condition | Extreme condition | CSI Ês/lot | I _o ^{Note 1} range | | |
| | | | E-UTRA operating band groups ^{Note 3} | Minimum I _o | |
| dB | dB | dB | | dBm/15kHz ^{Note 2} | dBm/BW _{Channel} |
| ±4.5 | ±9 | ≥0 dB | FS3_G | -118 | N/A |
| ±8 | ±11 | ≥0 dB | FS3_G | N/A | -70 |

NOTE 1: I_o is assumed to have constant EPRE across the bandwidth.
 NOTE 2: The condition level is increased by Δ>0, when applicable, as described in Sections B.4.2 and B.4.3.
 NOTE 3: E-UTRA operating band groups are as defined in Section 3.5.

9.1.18.4.5 Intra-frequency relative CSI-RSRP measurement accuracy requirements

NOTE: These requirements are applicable only for CA under operation with frame structure 3 [16].

In this section, the relative CSI-RSRP measurement is defined as the CSI-RSRP measured from one cell or TP compared to the CSI-RSRP measured on the same frequency from another cell or from another TP operating under frame structure 3 [16]. If two TPs are compared, they may belong to the same or different cells.

The accuracy requirements in Table 9.1.18.4.5-1 are valid under the following conditions:

CSI reference signals in discovery signal occasions are transmitted on one antenna port only from each TP.

Conditions defined in 36.101 Clause 7.3 for reference sensitivity are fulfilled.

CSI-RSRP is as specified in Annex B.3.22.3 for a corresponding Band.

The discovery signal occasion does not contain any MBSFN subframe and contains at least two CSI REs per resource block within the measured bandwidth in two adjacent slots of the same subframe or different subframes.

Table 9.1.18.4.5-1: Intra-frequency relative CSI-RSRP measurement accuracy

| Accuracy | | Conditions | | | |
|------------------|-------------------|------------------------------|--|-----------------------------|---------------------------|
| Normal condition | Extreme condition | CSI Ês/lot ^{Note 2} | I _o ^{Note 1} range | | |
| | | | E-UTRA operating band groups ^{Note 5} | Minimum I _o | Maximum I _o |
| dB | dB | dB | | dBm/15kHz ^{Note 4} | dBm/BW _{Channel} |
| ±2 | ±3 | ≥ 0 dB | FS3_G | -118 | -50 |
| ±3 | ±3 | ≥ 0 dB | Note 3 | Note 3 | Note 3 |

NOTE 1: I_o is assumed to have constant EPRE across the bandwidth.
 NOTE 2: The parameter CSI Ês/lot is the minimum CSI Ês/lot of the pair of cells or TPs to which the requirement applies.
 NOTE 3: The same bands and the same I_o conditions for each band apply for this requirement as for the corresponding highest accuracy requirement.
 NOTE 4: The condition level is increased by Δ>0, when applicable, as described in Sections B.4.2 and B.4.3.
 NOTE 5: E-UTRA operating band groups are as defined in Section 3.5.

9.1.18.5 RSSI measurements

9.1.18.5.1 RSSI measurement report mapping

The reporting range of RSSI measurement is defined from -100 dBm to -25 dBm with 1 dBm resolution.

The mapping of the measured quantity is defined in table 9.1.18.5.1-1. The range in the signalling may be larger than the guaranteed accuracy range.

Table 9.1.18.5.1-1: RSSI measurement report mapping

| Reported value | Measured quantity value | Unit |
|----------------|-------------------------|------|
| RSSI_00 | RSSI < -100 | dBm |
| RSSI_01 | -100 ≤ RSSI < -99 | dBm |
| RSSI_02 | -99 ≤ RSSI < -98 | dBm |
| ... | ... | ... |
| RSSI_74 | -27 ≤ RSSI < -26 | dBm |
| RSSI_75 | -26 ≤ RSSI < -25 | dBm |
| RSSI_76 | -25 ≤ RSSI | dBm |

9.1.18.5.2 Intra-frequency absolute RSSI measurement accuracy requirements

NOTE: These requirements are applicable only for CA under operation with frame structure 3 [16].

The intra-frequency RSSI requirements are specified in Table 9.1.18.5.2-1. The requirements apply for any configured RSSI *measDuration* [2], provided that:

- All symbols during each RSSI measurement duration are available for RSSI sampling within the same reporting interval.

Table 9.1.18.5.2-1: Intra-frequency RSSI accuracy

| Accuracy | | Conditions | | |
|---|-------------------|--|-----------------------------|---------------------------|
| Normal condition | Extreme condition | Io ^{Note 1} range | | |
| | | E-UTRA operating band groups ^{Note 4} | Minimum Io | Maximum Io |
| dB | dB | | dBm/15kHz ^{Note 3} | dBm/BW _{Channel} |
| ±3.5 | ±6.5 | FS3_G | -118 | -50 |
| ±5.5 | ±8.5 | Note 2 | Note 2 | Note 2 |
| NOTE 1: Io is assumed to have constant EPRE across the bandwidth. | | | | |
| NOTE 2: The same bands and the same Io conditions for each band apply for this requirement as for the corresponding highest accuracy requirement. | | | | |
| NOTE 3: The condition level is increased by Δ>0, when applicable, as described in Sections B.4.2 and B.4.3. | | | | |
| NOTE 4: E-UTRA operating band groups are as defined in Section 3.5. | | | | |

The RSSI measurement bandwidth assumed in defining the accuracy requirements in Table 9.1.18.5.2-1 is 6 RB. UE may measure according to *AllowedMeasBandwidth*. UE which measures with a bandwidth other than 6RB shall scale the measured RSSI to report a nominal RSSI equivalent to 6RB measurement.

9.1.18.5.3 Inter-frequency absolute RSSI measurement accuracy requirements

The inter-frequency RSSI requirements are the same as specified in Section 9.1.18.5.2.

9.1.18.6 Channel occupancy measurements

9.1.18.6.1 Intra-frequency channel occupancy measurement accuracy requirements

NOTE: These requirements are applicable only for CA under operation with frame structure 3 [16].

The UE shall be able to correctly evaluate the intra-frequency channel occupancy configured according to 36.331 [2], provided that the following conditions are met:

- All symbols during each RSSI measurement duration are available for RSSI sampling within the same reporting interval,

- RSSI at the UE receiver meets the following condition with respect to the configured *channelOccupancyThreshold* [2]:
 - RSSI at the UE receiver is below $channelOccupancyThreshold - \Delta_{RSSI}$, or
 - RSSI at the UE receiver is above $channelOccupancyThreshold + \Delta_{RSSI}$,

where Δ_{RSSI} is the applicable RSSI measurement accuracy value from the RSSI measurement accuracy requirements specified in Section 9.1.18.5.2.

The UE expects that *channelOccupancyThreshold* [2] is configured assuming RSSI measurement bandwidth of 6 RB.

9.1.18.6.2 Inter-frequency channel occupancy measurement accuracy requirements

The UE shall be able to correctly evaluate the inter-frequency channel occupancy configured according to 36.331 [2], provided that the following conditions are met:

- All symbols during each RSSI measurement duration are available for RSSI sampling within the same reporting interval,
- RSSI at the UE receiver meets the following condition with respect to the configured *channelOccupancyThreshold* [2]:
 - RSSI at the UE receiver is below $channelOccupancyThreshold - \Delta_{RSSI}$, or
 - RSSI at the UE receiver is above $channelOccupancyThreshold + \Delta_{RSSI}$,

where Δ_{RSSI} is the applicable RSSI measurement accuracy value from the RSSI measurement accuracy requirements specified in Section 9.1.18.5.3.

The UE expects that *channelOccupancyThreshold* [2] is configured assuming RSSI measurement bandwidth of 6 RB.

9.1.19 Accuracy Requirements for Carrier Aggregation for Measurements under Operation with Frame Structure 3

9.1.19.1 Introduction

The accuracy requirements in this section are defined for the following physical layer measurements: RSRP, RSRQ, CSI-RSRP, and RSSI, where the measurements are performed on cells of E-UTRA carriers during the configured DMTC occasion [2] under operation with frame structure 3 [16].

9.1.19.2 Accuracy requirements for measurements on SCC

The requirements in this section are for the measurements on cells of E-UTRA carriers operated under frame structure 3 on one SCC.

Absolute RSRP measurements of cells on SCC shall meet the intra-frequency absolute accuracy requirements in Section 9.1.18.2.4.

Comparisons between RSRP measurements of cells on the same SCC shall meet the intra-frequency relative accuracy requirements in Section 9.1.18.2.5.

Absolute RSRQ measurements of cells on SCC shall meet the intra-frequency absolute accuracy requirements in Section 9.1.18.3.4.

CSI-RSRP measurements of cells on SCC shall meet the intra-frequency absolute accuracy requirements in Section 9.1.18.4.4.

Comparisons between CSI-RSRP measurements of cells on the same SCC shall meet the intra-frequency relative accuracy requirements in Section 9.1.18.4.5.

RSSI measurements on SCC shall meet the intra-frequency absolute accuracy requirements in Section 9.1.18.5.3.

9.1.19.3 Relative accuracy requirements for measurements on different SCCs

The requirements in this section are for the measurements on cells of E-UTRA carriers operated under frame structure 3 on two different SCCs.

When RSRP measurements of cells on any of the SCC are compared with RSRP measurements of cells on the other SCC, the applicable relative accuracy requirements are the inter-frequency relative RSRP measurement accuracy requirements in Section 9.1.18.2.3.

When RSRQ measurements of cells on any of the SCC are compared with RSRQ measurements of cells on the other SCC, the applicable relative accuracy requirements are the inter-frequency relative RSRQ measurement accuracy requirements in Section 9.1.18.3.3.

When CSI-RSRP measurements of cells on any of the SCC are compared with CSI-RSRP measurements of cells on the other SCC, the applicable relative accuracy requirements are the inter-frequency relative CSI-RSRP measurement accuracy requirements in Section 9.1.18.4.3.

9.1.19.4 Relative accuracy requirements for measurements on SCC and PCC

The requirements in this section are for the measurements on cells of an E-UTRA carrier operated under frame structure 3 on SCC and cells on an E-UTRA carrier operated under frame structure 1 or 2 on PCC.

When RSRP measurements of cells on any of the SCC are compared with RSRP measurements of cells on the PCC, the applicable relative accuracy requirements are the inter-frequency relative RSRP measurement accuracy requirements in Section 9.1.18.2.3.

When RSRQ measurements of cells on any of the SCC are compared with RSRQ measurements of cells on the PCC, the applicable relative accuracy requirements are the inter-frequency relative RSRQ measurement accuracy requirements in Section 9.1.18.3.3.

When CSI-RSRP measurements of cells on any of the SCC are compared with CSI-RSRP measurements of cells on the PCC, the applicable relative accuracy requirements are the inter-frequency relative CSI-RSRP measurement accuracy requirements in Section 9.1.18.4.3.

9.1.20 SFN and Subframe Time Difference (SSTD)

9.1.20.1 SSTD Accuracy Requirement

The SFN and subframe time difference (SSTD) is measured between MeNB and SeNB.

The accuracy requirements in Table 9.1.20.1-1 are valid under the following conditions:

Cell specific reference signals are transmitted either from one, two or four antenna ports.

Conditions defined in 36.101 Clause 7.3 for reference sensitivity are fulfilled.

No changes to the uplink transmission timing are applied during the measurement period.

$RSRP|_{dBm}$ according to Annex B.3.5 for a corresponding Band

Table 9.1.20.1-1: SFN and subframe time difference measurement accuracy

| Accuracy | Conditions | | | | |
|-------------------------|-----------------|--|--|-----------------------------|---------------------------|
| | \hat{E}_s/lot | MIN(PCell downlink transmission Bandwidth, PSCell downlink transmission Bandwidth) | I_o ^{Note 1} range | | |
| | | | E-UTRA operating band groups ^{Note 6} | Minimum I_o | Maximum I_o |
| T_s ^{Note 2} | dB | MHz | | dBm/15kHz ^{Note 5} | dBm/BW _{Channel} |
| ±52 | ≥-3 dB | ≥1.4 MHz | FDD_A ^{Note 7} , TDD_A | -121 | -50 |

| | | | | | |
|--|--------|---------|-------------------------|--------|--------|
| | | | FDD_C, TDD_C | -120 | -50 |
| | | | FDD_D | -119.5 | -50 |
| | | | FDD_E, TDD_E | -119 | -50 |
| | | | FDD_F | -118.5 | -50 |
| | | | FDD_G ^{Note 4} | -118 | -50 |
| | | | FDD_H | -117.5 | -50 |
| | | | FDD_N | -114.5 | -50 |
| ±40 | ≥-3 dB | ≥ 3 MHz | Note 3 | Note 3 | Note 3 |
| <p>NOTE 1: When in dBm/15kHz, the minimum Io condition is expressed as the average Io per RE over all REs in that symbol. Io may be different in different symbols within a subframe.</p> <p>NOTE 2: Ts is the basic timing unit defined in TS 36.211.</p> <p>NOTE 3: The same bands and the same Io conditions for each band apply for this requirement as for the corresponding requirement with downlink bandwidth ≥1.4 MHz.</p> <p>NOTE 4: Except Band 29.</p> <p>NOTE 5: The condition level is increased by Δ>0, when applicable, as described in Sections B.4.2 and B.4.3.</p> <p>NOTE 6: E-UTRA operating band groups are as defined in Section 3.5.</p> <p>NOTE 7: Except Band 32.</p> | | | | | |

9.1.20.2 SSTD Measurement Report Mapping

SFN and subframe timing difference (SSTD) measurement report comprises 3 elements:

SFN offset between MeNB and SeNB (ΔX)

Reporting range of ΔX is between frame number # 0 to frame number # 1023 as defined in TS 36.331 [2].

Frame boundary offset between MeNB and SeNB (ΔY)

Reporting range of ΔY is between subframe number #-5 and subframe number# 4 as defined in TS 36.331 [2].

Subframe boundary offset between MeNB and SeNB (ΔZ)

The reporting range of value of ΔZ is within [-1320Ts, -700Ts] and [700Ts, 1320Ts] with reporting granularity of 10Ts.

The mapping of measured Subframe boundary offset (ΔZ) is defined in Table 9.1.20.2-1.

Table 9.1.20.2-1: SSTD report mapping

| Reported Value | Measured Quantity Value | Unit |
|------------------------------|-------------------------------|------|
| SUBFRAME_BOUNDARY_OFFSET_00 | $\Delta Z \leq -1320$ | Ts |
| SUBFRAME_BOUNDARY_OFFSET_01 | $-1320 < \Delta Z \leq -1310$ | Ts |
| SUBFRAME_BOUNDARY_OFFSET_02 | $-1310 < \Delta Z \leq -1300$ | Ts |
| ... | ... | ... |
| SUBFRAME_BOUNDARY_OFFSET_62 | $-710 < \Delta Z \leq -700$ | Ts |
| SUBFRAME_BOUNDARY_OFFSET_63 | $-700 < \Delta Z \leq 0$ | Ts |
| SUBFRAME_BOUNDARY_OFFSET_64 | $0 < \Delta Z \leq 700$ | Ts |
| SUBFRAME_BOUNDARY_OFFSET_65 | $700 < \Delta Z \leq 710$ | Ts |
| ... | ... | ... |
| SUBFRAME_BOUNDARY_OFFSET_125 | $1300 < \Delta Z \leq 1310$ | Ts |
| SUBFRAME_BOUNDARY_OFFSET_126 | $1310 < \Delta Z \leq 1320$ | Ts |
| SUBFRAME_BOUNDARY_OFFSET_127 | $1320 < \Delta Z$ | Ts |

9.1.21 Measurement accuracy for UE category M1

9.1.21.1 Intra-frequency Absolute RSRP Accuracy for UE category M1 with CE mode A

The requirements for absolute accuracy of RSRP in this clause apply to a cell on the same frequency as that of the serving cell for UE category M1.

The accuracy requirements in Table 9.1.21.1-1 and Table 9.1.21.1-2 are valid under the following conditions:

Cell specific reference signals are transmitted either from one, two or four antenna ports.

Conditions defined in 36.101 Clause 7.3 for reference sensitivity are fulfilled.

RSRP|dBm according to Annex B.3.1 for a corresponding Band

At least 1 DL subframe per radio frame of measured cell is available at the UE for RSRP measurement assuming measured cell is identified cell.

Table 9.1.21.1-1: RSRP Intra frequency absolute accuracy for UE category M1 with CE mode A for FDD and TDD

| Accuracy | | Conditions | | | | |
|------------------|-------------------|------------------------|--|-----------------------------|---------------------------|---------------------------|
| Normal condition | Extreme condition | \hat{E}_s/lot | I_o ^{Note 1} range | | | |
| | | | E-UTRA operating band groups ^{Note 3} | Minimum I_o | | Maximum I_o |
| dB | dB | dB | | dBm/15kHz ^{Note 2} | dBm/BW _{Channel} | dBm/BW _{Channel} |
| ±7 | ±10 | ≥-6 dB | FDD-M1_A, TDD-M1_A | -121 | N/A | -70 |
| | | | FDD-M1_D | -119.5 | N/A | -70 |
| | | | FDD-M1_E, TDD-M1_E | -119 | N/A | -70 |
| | | | FDD-M1_F | -118.5 | N/A | -70 |
| | | | FDD-M1_G | -118 | N/A | -70 |
| | | | FDD-M1_N | -114.5 | N/A | -70 |
| ±9 | ±12 | ≥-6 dB | FDD-M1_A, TDD-M1_A, FDD-M1_D, FDD-M1_E, TDD-M1_E, FDD-M1_F, FDD-M1_G, FDD-M1_N | N/A | -70 | -50 |

NOTE 1: I_o is assumed to have constant EPRE across the bandwidth.
NOTE 2: The condition level is increased by $\Delta > 0$, when applicable, as described in Sections B.4.2 and B.4.3.
NOTE 3: E-UTRA operating band groups are as defined in Section 3.5.

Table 9.1.21.1-2: RSRP Intra frequency absolute accuracy for UE category M1 with CE mode A for HD-FDD

| Accuracy | | Conditions | | | | |
|------------------|-------------------|------------------------|--|-----------------------------|---------------------------|---------------------------|
| Normal condition | Extreme condition | \hat{E}_s/lot | I_o ^{Note 1} range | | | |
| | | | E-UTRA operating band groups ^{Note 3} | Minimum I_o | | Maximum I_o |
| dB | dB | dB | | dBm/15kHz ^{Note 2} | dBm/BW _{Channel} | dBm/BW _{Channel} |
| ±7 | ±10 | ≥-6 dB | FDD-M1_A | -121 | N/A | -70 |
| | | | FDD-M1_D | -119.5 | N/A | -70 |
| | | | FDD-M1_E | -119 | N/A | -70 |
| | | | FDD-M1_F | -118.5 | N/A | -70 |
| | | | FDD-M1_G | -118 | N/A | -70 |
| | | | FDD-M1_N | -114.5 | N/A | -70 |
| ±9 | ±12 | ≥-6 dB | FDD-M1_A, FDD-M1_D, FDD-M1_E, FDD-M1_F, FDD-M1_G, FDD-M1_N | N/A | -70 | -50 |

NOTE 1: I_o is assumed to have constant EPRE across the bandwidth.
NOTE 2: The condition level is increased by $\Delta > 0$, when applicable, as described in Sections B.4.2 and B.4.3.
NOTE 3: E-UTRA operating band groups are as defined in Section 3.5.

9.1.21.2 Intra-frequency Relative Accuracy of RSRP for UE category M1 with CE mode A

The relative accuracy of RSRP is defined as the RSRP measured from one cell compared to the RSRP measured from another cell on the same frequency for category M1 UE.

The accuracy requirements in Table 9.1.21.2-1 and Table 9.1.21.2-2 are valid under the following conditions:

Cell specific reference signals are transmitted either from one, two or four antenna ports.

Conditions defined in 36.101 Clause 7.3 for reference sensitivity are fulfilled.

RSRP_{1,2}_{dBm} according to Annex B.3.8 for a corresponding Band.

At least 1 DL subframe per radio frame of measured cell is available at the UE for RSRP measurement assuming measured cell is identified cell.

Table 9.1.21.2-1: RSRP Intra frequency relative accuracy for UE category M1 with CE mode A for FDD and TDD

| Accuracy | | Conditions | | | |
|------------------|-------------------|----------------------------------|--|-----------------------------|---------------------------|
| Normal condition | Extreme condition | $\hat{E}s/lot$ ^{Note 2} | Io ^{Note 1} range | | |
| | | | E-UTRA operating band groups ^{Note 5} | Minimum Io | Maximum Io |
| dB | dB | dB | | dBm/15kHz ^{Note 4} | dBm/BW _{Channel} |
| ±3 | ±4 | ≥-3 dB | FDD-M1_A, TDD-M1_A | -121 | -50 |
| | | | FDD-M1_D | -119.5 | -50 |
| | | | FDD-M1_E, TDD-M1_E | -119 | -50 |
| | | | FDD-M1_F | -118.5 | -50 |
| | | | FDD-M1_G | -118 | -50 |
| | | | FDD-M1_N | -114.5 | -50 |
| ±4 | ±4 | ≥-6 dB | Note 3 | Note 3 | Note 3 |

NOTE 1: Io is assumed to have constant EPRE across the bandwidth.
 NOTE 2: The parameter $\hat{E}s/lot$ is the minimum $\hat{E}s/lot$ of the pair of cells to which the requirement applies.
 NOTE 3: The same bands and the same Io conditions for each band apply for this requirement as for the corresponding highest accuracy requirement.
 NOTE 4: The condition level is increased by $\Delta > 0$, when applicable, as described in Sections B.4.2 and B.4.3.
 NOTE 5: E-UTRA operating band groups are as defined in Section 3.5.

Table 9.1.21.2-2: RSRP Intra frequency relative accuracy for UE category M1 with CE mode A for HD-FDD

| Accuracy | | Conditions | | | |
|------------------|-------------------|----------------------------------|--|-----------------------------|---------------------------|
| Normal condition | Extreme condition | $\hat{E}s/lot$ ^{Note 2} | Io ^{Note 1} range | | |
| | | | E-UTRA operating band groups ^{Note 5} | Minimum Io | Maximum Io |
| dB | dB | dB | | dBm/15kHz ^{Note 4} | dBm/BW _{Channel} |
| ±3 | ±4 | ≥-3 dB | FDD-M1_A | -121 | -50 |
| | | | FDD-M1_D | -119.5 | -50 |
| | | | FDD-M1_E | -119 | -50 |
| | | | FDD-M1_F | -118.5 | -50 |
| | | | FDD-M1_G | -118 | -50 |
| | | | FDD-M1_N | -114.5 | -50 |
| ±4 | ±4 | ≥-6 dB | Note 3 | Note 3 | Note 3 |

NOTE 1: Io is assumed to have constant EPRE across the bandwidth.
 NOTE 2: The parameter $\hat{E}s/lot$ is the minimum $\hat{E}s/lot$ of the pair of cells to which the requirement applies.
 NOTE 3: The same bands and the same Io conditions for each band apply for this requirement as for the corresponding highest accuracy requirement.
 NOTE 4: The condition level is increased by $\Delta > 0$, when applicable, as described in Sections B.4.2 and B.4.3.
 NOTE 5: E-UTRA operating band groups are as defined in Section 3.5.

9.1.21.3 Intra-frequency Absolute RSRP Accuracy for UE category M1 with CE mode B

The requirements for absolute accuracy of RSRP in this clause apply to a cell on the same frequency as that of the serving cell for UE category M1.

The accuracy requirements in Table 9.1.21.3-1 and Table 9.1.21.3-2 are valid under the following conditions:

Cell specific reference signals are transmitted either from one, two or four antenna ports.

Conditions defined in 36.101 Clause 7.3 for reference sensitivity are fulfilled.

RSRP[dBm] according to Annex B.3.1 for a corresponding Band

At least 1 DL subframe per radio frame of measured cell is available at the UE for RSRP measurement assuming measured cell is identified cell.

Table 9.1.21.3-1: RSRP Intra frequency absolute accuracy for UE category M1 with CE mode B for FDD and TDD

| Accuracy | | Conditions | | | | |
|------------------|-------------------|----------------------|--|-----------------------------|---------------------------|---------------------------|
| Normal condition | Extreme condition | Ês/lot | Io ^{Note 1} range | | | |
| | | | E-UTRA operating band groups ^{Note 3} | Minimum Io | | Maximum Io |
| dB | dB | dB | | dBm/15kHz ^{Note 2} | dBm/BW _{Channel} | dBm/BW _{Channel} |
| ±8 | ±11 | 15 ≤ Ês/lot ≤ -12 dB | FDD-M1_A, TDD-M1_A | -121 | N/A | -70 |
| | | | FDD-M1_D | -119.5 | N/A | -70 |
| | | | FDD-M1_E, TDD-M1_E | -119 | N/A | -70 |
| | | | FDD-M1_F | -118.5 | N/A | -70 |
| ±7 | ±10 | ≥ -12 dB | FDD-M1_G | -118 | N/A | -70 |
| | | | FDD-M1_N | -114.5 | N/A | -70 |
| ±10 | ±13 | 15 ≤ Ês/lot ≤ -12 dB | FDD-M1_A, TDD-M1_A, FDD-M1_D, FDD-M1_E, TDD-M1_E, FDD-M1_F, FDD-M1_G, FDD-M1_N | N/A | -70 | -50 |
| ±9 | ±12 | ≥ -12 dB | | | | |

NOTE 1: Io is assumed to have constant EPRE across the bandwidth.
 NOTE 2: The condition level is increased by Δ>0, when applicable, as described in Sections B.4.2 and B.4.3.
 NOTE 3: E-UTRA operating band groups are as defined in Section 3.5.

Table 9.1.21.3-2: RSRP Intra frequency absolute accuracy for UE category M1 with CE mode B for HD-FDD

| Accuracy | | Conditions | | | | |
|------------------|-------------------|----------------------|--|-----------------------------|---------------------------|---------------------------|
| Normal condition | Extreme condition | Ês/lot | Io ^{Note 1} range | | | |
| | | | E-UTRA operating band groups ^{Note 3} | Minimum Io | | Maximum Io |
| dB | dB | dB | | dBm/15kHz ^{Note 2} | dBm/BW _{Channel} | dBm/BW _{Channel} |
| ±8 | ±11 | 15 ≤ Ês/lot ≤ -12 dB | FDD-M1_A | -121 | N/A | -70 |
| | | | FDD-M1_D | -119.5 | N/A | -70 |
| | | | FDD-M1_E | -119 | N/A | -70 |
| | | | FDD-M1_F | -118.5 | N/A | -70 |
| ±7 | ±10 | ≥ -12 dB | FDD-M1_G | -118 | N/A | -70 |
| | | | FDD-M1_N | -114.5 | N/A | -70 |
| ±10 | ±13 | 15 ≤ Ês/lot ≤ -12 dB | FDD-M1_A, FDD-M1_D, FDD-M1_E, FDD-M1_F, FDD-M1_G, FDD-M1_N | N/A | -70 | -50 |
| ±9 | ±12 | ≥ -12 dB | | | | |

NOTE 1: Io is assumed to have constant EPRE across the bandwidth.
 NOTE 2: The condition level is increased by Δ>0, when applicable, as described in Sections B.4.2 and B.4.3.
 NOTE 3: E-UTRA operating band groups are as defined in Section 3.5.

9.1.21.4 Intra-frequency Relative Accuracy of RSRP for UE category M1 with CE mode B

The relative accuracy of RSRP is defined as the RSRP measured from one cell compared to the RSRP measured from another cell on the same frequency for category M1 UE.

The accuracy requirements in Table 9.1.21.4-1 and Table 9.1.21.4-2 are valid under the following conditions:

Cell specific reference signals are transmitted either from one, two or four antenna ports.

Conditions defined in 36.101 Clause 7.3 for reference sensitivity are fulfilled.

$RSRP_{1,2|dBm}$ according to Annex B.3.8 for a corresponding Band.

At least 1 DL subframe per radio frame of measured cell is available at the UE for RSRP measurement assuming measured cell is identified cell.

Table 9.1.21.4-1: RSRP Intra frequency relative accuracy for UE category M1 with CE mode B for FDD and TDD

| Accuracy | | Conditions | | | |
|------------------|-------------------|------------------------------------|--|-----------------------------|---------------------------|
| Normal condition | Extreme condition | $\hat{E}s/lot$ ^{Note 2} | I_o ^{Note 1} range | | |
| | | | E-UTRA operating band groups ^{Note 5} | Minimum I_o | Maximum I_o |
| dB | dB | dB | | dBm/15kHz ^{Note 4} | dBm/BW _{Channel} |
| ±4 | ±4 | ≥-12 dB | FDD-M1_A, TDD-M1_A | -121 | -50 |
| | | | FDD-M1_D | -119.5 | -50 |
| | | | FDD-M1_E, TDD-M1_E | -119 | -50 |
| | | | FDD-M1_F | -118.5 | -50 |
| | | | FDD-M1_G | -118 | -50 |
| | | | FDD-M1_N | -114.5 | -50 |
| ±5 | ±5 | $15 \leq \hat{E}s/lot \leq -12$ dB | Note 3 | Note 3 | Note 3 |

NOTE 1: I_o is assumed to have constant EPRE across the bandwidth.
NOTE 2: The parameter $\hat{E}s/lot$ is the minimum $\hat{E}s/lot$ of the pair of cells to which the requirement applies.
NOTE 3: The same bands and the same I_o conditions for each band apply for this requirement as for the corresponding highest accuracy requirement.
NOTE 4: The condition level is increased by $\Delta > 0$, when applicable, as described in Sections B.4.2 and B.4.3.
NOTE 5: E-UTRA operating band groups are as defined in Section 3.5.

Table 9.1.21.4-2: RSRP Intra frequency relative accuracy for UE category M1 with CE mode B for HD-FDD

| Accuracy | | Conditions | | | |
|------------------|-------------------|------------------------------------|--|-----------------------------|---------------------------|
| Normal condition | Extreme condition | $\hat{E}s/lot$ ^{Note 2} | I_o ^{Note 1} range | | |
| | | | E-UTRA operating band groups ^{Note 5} | Minimum I_o | Maximum I_o |
| dB | dB | dB | | dBm/15kHz ^{Note 4} | dBm/BW _{Channel} |
| ±4 | ±4 | ≥-12 dB | FDD-M1_A | -121 | -50 |
| | | | FDD-M1_D | -119.5 | -50 |
| | | | FDD-M1_E | -119 | -50 |
| | | | FDD-M1_F | -118.5 | -50 |
| | | | FDD-M1_G | -118 | -50 |
| | | | FDD-M1_N | -114.5 | -50 |
| ±5 | ±5 | $15 \leq \hat{E}s/lot \leq -12$ dB | Note 3 | Note 3 | Note 3 |

NOTE 1: I_o is assumed to have constant EPRE across the bandwidth.
NOTE 2: The parameter $\hat{E}s/lot$ is the minimum $\hat{E}s/lot$ of the pair of cells to which the requirement applies.
NOTE 3: The same bands and the same I_o conditions for each band apply for this requirement as for the corresponding highest accuracy requirement.
NOTE 4: The condition level is increased by $\Delta > 0$, when applicable, as described in Sections B.4.2 and B.4.3.
NOTE 5: E-UTRA operating band groups are as defined in Section 3.5.

9.1.21.5 RSRP Measurement Report Mapping

The reporting range of RSRP is the same as defined in section 9.1.4.

9.1.22 Measurement accuracy for UE Category NB1

9.1.22.1 Intra-frequency Absolute NRSRP Accuracy for UE Category NB1

The requirements for absolute accuracy of NRSRP in this clause apply to a cell on the same frequency as that of the serving cell for UE Category NB1 for stand-alone, guard-band and in-band deployments.

The accuracy requirements in Table 9.1.22.1-1 are valid under the following conditions:

Cell specific reference signals are transmitted either from one or two ports.

Conditions defined in 36.101 Clause 7.3 for reference sensitivity are fulfilled.

NRSRP[dBm] according to Annex B.3.25 for a corresponding Band

At least 1 DL subframe per radio frame of measured cell is available at the UE for NRSRP measurement assuming measured cell is identified cell.

Table 9.1.22.1-1: NRSRP Intra frequency absolute accuracy for UE Category NB1 for HD-FDD

| Accuracy | | Conditions | | | | |
|------------------|-------------------|--|--|---------------|---------------------------|---------------------------|
| Normal condition | Extreme condition | $\hat{\epsilon}_s/\text{lot}$ | I_o ^{Note 1} range | | | |
| | | | E-UTRA operating band groups ^{Note 2} | Minimum I_o | | Maximum I_o |
| dB | dB | dB | | dBm/15kHz | dBm/BW _{Channel} | dBm/BW _{Channel} |
| ± 6 | ± 9 | ≥ -6 dB | NFDD_G | -122.9 | N/A | -70 |
| ± 8 | ± 11 | ≥ -6 dB | NFDD_G | N/A | -70 | -50 |
| ± 10.3 | ± 13.3 | $15 \leq \hat{\epsilon}_s/\text{lot} \leq -6$ dB | NFDD_G | -122.9 | N/A | -70 |
| ± 12.3 | ± 15.3 | $15 \leq \hat{\epsilon}_s/\text{lot} \leq -6$ dB | NFDD_G | N/A | -70 | -50 |

NOTE 1: I_o is assumed to have constant EPRE across the bandwidth.
NOTE 2: E-UTRA operating band groups are as defined in Section 3.5.

9.1.22.2 Void

9.1.22.3 Intra-frequency Absolute NRSRQ Accuracy for UE Category NB1

The requirements for absolute accuracy of NRSRQ in this clause apply to a cell on the same frequency as that of the serving cell for NB-IoT UE for stand-alone, guard-band and in-band deployments.

The accuracy requirements in Table 9.1.22.3-1 are valid under the following conditions:

Cell specific reference signals are transmitted either from one or two antenna ports.

Conditions defined in 36.101 Clause 7.3 for reference sensitivity are fulfilled.

NRSRQ[dBm] according to Annex B.3.25 for a corresponding Band

At least 1 DL subframe per radio frame of measured cell is available at the UE for NRSRQ measurement assuming measured cell is identified cell.

Table 9.1.22.3-1: NRSRQ Intra frequency absolute accuracy for UE Category NB1 for HD-FDD

| Accuracy | | Conditions | | | |
|------------------|-------------------|-------------------------------|--|---------------|---------------------------|
| Normal condition | Extreme condition | $\hat{\epsilon}_s/\text{lot}$ | I_o ^{Note 1} range | | |
| | | | E-UTRA operating band groups ^{Note 3} | Minimum I_o | Maximum I_o |
| dB | dB | dB | | dBm/15kHz | dBm/BW _{Channel} |
| ± 5.2 | ± 8.2 | ≥ -3 dB | NFDD_G | -122.9 | -50 |
| ± 7.2 | ± 10.2 | ≥ -6 dB | Note 2 | Note 2 | Note 2 |

| | | | | | |
|-------|-------|--|--------|--------|--------|
| ±9.5 | ±12.5 | $-15 \leq \hat{E}_s/\text{lot} \leq -6$ dB | NFDD_G | -122.9 | -50 |
| ±11.5 | ±14.5 | $-15 \leq \hat{E}_s/\text{lot} \leq -6$ dB | Note 2 | Note 2 | Note 2 |

NOTE 1: I_0 is assumed to have constant EPRE across the bandwidth.
NOTE 2: The same bands and the same I_0 conditions for each band apply for this requirement as for the corresponding highest accuracy requirement.
NOTE 3: E-UTRA operating band groups are as defined in Section 3.5.

9.1.22.4 Void

9.1.22.5 Inter-frequency Absolute NRSRP Accuracy for UE Category NB1

The requirements for absolute accuracy of NRSRP in this clause apply to a cell that has different carrier frequency from the serving cell.

The accuracy requirements in Table 9.1.22.5-1 are valid under the following conditions:

Cell specific reference signals are transmitted either from one or two antenna ports.

Conditions defined in 36.101 Clause 7.3 for reference sensitivity are fulfilled.

NRSRP[dBm] according to Annex B.3.26 for a corresponding Band

At least 1 DL subframe per radio frame of measured cell is available at the UE for NRSRP measurement assuming measured cell is identified cell.

Table 9.1.22.5-1: NRSRP Inter frequency absolute accuracy for UE Category NB1 for HD-FDD

| Accuracy | | Conditions | | | | |
|------------------|-------------------|---|--|---------------|---------------------------|---------------------------|
| Normal condition | Extreme condition | \hat{E}_s/lot | I_0 ^{Note 1} range | | | |
| | | | E-UTRA operating band groups ^{Note 2} | Minimum I_0 | | Maximum I_0 |
| dB | dB | dB | | dBm/15kHz | dBm/BW _{Channel} | dBm/BW _{Channel} |
| ±6 | ±9 | ≥-6 dB | NFDD_G | -122.9 | N/A | -70 |
| ±8 | ±11 | ≥-6 dB | NFDD_G | N/A | -70 | -50 |
| ±10.3 | ±13.3 | $15 \leq \hat{E}_s/\text{lot} \leq -6$ dB | NFDD_G | -122.9 | N/A | -70 |
| ±12.3 | ±15.3 | $15 \leq \hat{E}_s/\text{lot} \leq -6$ dB | NFDD_G | N/A | -70 | -50 |

NOTE 1: I_0 is assumed to have constant EPRE across the bandwidth.
NOTE 2: E-UTRA operating band groups are as defined in Section 3.5.

9.1.22.6 Void

9.1.22.7 Inter-frequency Absolute NRSRQ Accuracy for UE Category NB1

The requirements for absolute accuracy of NRSRQ in this clause apply to a cell that has different carrier frequency from the serving cell.

The accuracy requirements in Table 9.1.22.7-1 are valid under the following conditions:

Cell specific reference signals are transmitted either from one or two antenna ports.

Conditions defined in 36.101 Clause 7.3 for reference sensitivity are fulfilled.

NRSRQ[dBm] according to Annex B.3.26 for a corresponding Band

At least 1 DL subframe per radio frame of measured cell is available at the UE for NRSRQ measurement assuming measured cell is identified cell.

Table 9.1.22.7-1: NRSRQ Inter frequency absolute accuracy for UE Category NB1 for HD-FDD

| Accuracy | | Conditions | | | |
|------------------|-------------------|--------------------------------------|--|---------------|---------------------------|
| Normal condition | Extreme condition | \hat{E}_s/lot | l_o ^{Note 1} range | | |
| | | | E-UTRA operating band groups ^{Note 3} | Minimum l_o | Maximum l_o |
| dB | dB | dB | | dBm/15kHz | dBm/BW _{Channel} |
| ±5.2 | ±8.2 | ≥-3 dB | NFDD_G | -122.9 | -50 |
| ±7.2 | ±10.2 | ≥-6 dB | Note 2 | Note 2 | Note 2 |
| ±9.5 | ±12.5 | -15 ≤ \hat{E}_s/lot ≤ -6 dB | NFDD_G | -122.9 | -50 |
| ±11.5 | ±14.5 | -15 ≤ \hat{E}_s/lot ≤ -6 dB | Note 2 | Note 2 | Note 2 |

NOTE 1: l_o is assumed to have constant EPRE across the bandwidth.
NOTE 2: The same bands and the same l_o conditions for each band apply for this requirement as for the corresponding highest accuracy requirement.
NOTE 3: E-UTRA operating band groups are as defined in Section 3.5.

9.1.22.8 Void

9.1.23 Power Headroom for UE Category NB1

The requirements in this clause shall apply for power headroom for UE Category NB1 as defined in [31].

The power headroom provides the serving eNB with information about the differences between the UE configured maximum output power (P_{CMAX}) defined in TS 36.101 [5] and the estimated power for UL-NSCH transmission of the serving cell [3].

9.1.23.1 Period

The reported power headroom shall be estimated over 1 slot of NPUSCH transmissions.

9.1.23.2 Reporting Delay

The power headroom reporting delay is defined as the time between the beginning of the power headroom reference period and the time when the UE starts transmitting the power headroom over the radio interface. The reporting delay of the power headroom shall be 0 ms, which is applicable for all configured triggering mechanisms for power headroom reporting.

9.1.23.3 Report Mapping for UE Category NB1

The power headroom reporting range is from -54 ...+11 dB for UE category NB1 when the enhanced coverage level 0 is selected during random access procedure [17]. The report mapping is defined in Table 9.1.23.3-1.

Table 9.1.23.3-1: Power headroom report mapping for UE category NB1 when the enhanced coverage level 0 is selected during random access procedure [17]

| Reported value | Measured quantity value (dB) |
|------------------|------------------------------|
| POWER_HEADROOM_0 | -54 ≤ PH < 5 |
| POWER_HEADROOM_1 | 5 ≤ PH < 8 |
| POWER_HEADROOM_2 | 8 ≤ PH < 11 |
| POWER_HEADROOM_3 | PH ≥ 11 |

The power headroom reporting range is from -54 ...+6 dB for UE category NB1 when the enhanced coverage level other than 0 is selected during random access procedure [17]. The report mapping is defined in Table 9.1.23.3-2.

Table 9.1.23.3-2: NB-IOT power headroom report mapping in enhanced coverage when the enhanced coverage level other than 0 is selected during random access procedure [17]

| Reported value | Measured quantity value (dB) |
|----------------|------------------------------|
|----------------|------------------------------|

| | |
|------------------|---------------------|
| POWER_HEADROOM_0 | $-54 \leq PH < -10$ |
| POWER_HEADROOM_1 | $-10 \leq PH < -2$ |
| POWER_HEADROOM_2 | $-2 \leq PH < 6$ |
| POWER_HEADROOM_3 | $PH \geq 6$ |

9.2 UTRAN FDD Measurements

The requirements in this clause are applicable for a UE:

- in state RRC_CONNECTED
- performing measurements according to clause 8.1.2.4 with appropriate measurement gaps
- that is synchronised to the cell that is measured.

The reported measurement result after layer 1 filtering shall be an estimate of the average value of the measured quantity over the measurement period. The reference point for the measurement result after layer 1 filtering is referred to as point B in the measurement model described in TS 25.302 [6].

The accuracy requirements in this clause are valid for the reported measurement result after layer 1 filtering. The accuracy requirements are verified from the measurement report at point D in the measurement model having the layer 3 filtering disabled.

9.2.1 UTRAN FDD CPICH RSCP

NOTE: This measurement is for handover between E-UTRAN and UTRAN FDD and for SON.

The requirements in this clause are valid for terminals supporting this capability.

The measurement period for RRC_CONNECTED state is specified in clauses 8.1.2.4.1 and 8.1.2.4.2.

In RRC_CONNECTED state the accuracy requirements shall meet the absolute accuracy requirements in table 9.2.1-1, under the following conditions:

- CPICH Ec/Io condition for a detectable cell is as specified in clauses 8.1.2.4.1, 8.1.2.4.2, 8.1.2.4.7, 8.1.2.4.8;
- SCH_Ec/Io condition for a detectable cell is as specified in clauses 8.1.2.4.1, 8.1.2.4.2, 8.1.2.4.7, 8.1.2.4.8.

Table 9.2.1-1: UTRAN FDD CPICH_RSCP absolute accuracy

| Accuracy | | Conditions | | |
|--|-------------------|--|--------------|--------------|
| Normal condition | Extreme condition | Io range | | |
| | | UTRA operating bands | Minimum Io | Maximum Io |
| dB | dB | | dBm/3.84 MHz | dBm/3.84 MHz |
| ±6 | ±9 | Band I, IV, VI, X XI, XIX and XXI | -94 | -70 |
| | | Band IX | -93 | -70 |
| | | Band II, V and VII | -92 | -70 |
| | | Band III, VIII, XII, XIII, XIV , XX and XXII | -91 | -70 |
| | | Band XXV, XXVI ^{Note 1} | -90.5 | -70 |
| ±8 | ±11 | Note 2 | -70 | -50 |
| NOTE 1: For Band XXVI, the condition has the minimum Io of -92 dBm/3.84 MHz when the carrier frequency of the assigned UTRA channel is within 869-894 MHz for the UE which supports both Band V and Band XXVI operating frequencies. | | | | |
| NOTE 2: The same bands apply for this requirement as for the corresponding highest accuracy requirement. | | | | |

If the UE, in RRC_CONNECTED state, needs measurement gaps to perform UTRAN FDD measurements, the relevant UTRAN FDD measurement procedure and measurement gap pattern stated in clause 8.1.2.4 shall apply.

The reporting range and mapping specified for FDD CPICH RSCP in TS 25.133 [18] shall apply.

9.2.2 Void

9.2.3 UTRAN FDD CPICH Ec/No

NOTE: This measurement is for handover between E-UTRAN and UTRAN FDD and for SON.

The requirements in this clause are valid for terminals supporting this capability.

The measurement period for RRC_CONNECTED state is specified in clauses 8.1.2.4.1 and 8.1.2.4.2.

In RRC_CONNECTED state the accuracy requirements shall be the same as the inter-frequency measurement accuracy requirements for FDD CPICH Ec/No in TS 25.133 [18].

If the UE, in RRC_CONNECTED state, needs measurement gaps to perform UTRAN FDD measurements, the UTRAN FDD measurement procedure and measurement gap pattern stated in clause 8.1.2.4.1 shall apply.

The reporting range and mapping specified for FDD CPICH Ec/No in TS 25.133 [18] shall apply.

9.3 UTRAN TDD Measurements

The requirements in this clause are applicable for a UE:

- in state RRC_CONNECTED
- performing measurements according to clause 8.1.2.4 with appropriate measurement gaps
- that is synchronised to the cell that is measured.

The reported measurement result after layer 1 filtering shall be an estimate of the average value of the measured quantity over the measurement period. The reference point for the measurement result after layer 1 filtering is referred to as point B in the measurement model described in TS 25.302 [6].

The accuracy requirements in this clause are valid for the reported measurement result after layer 1 filtering. The accuracy requirements are verified from the measurement report at point D in the measurement model having the layer 3 filtering disabled.

9.3.1 UTRAN TDD P-CCPCH RSCP

NOTE: This measurement is for handover between E-UTRAN and UTRAN TDD and for SON.

The requirements in this clause are valid for terminals supporting this capability.

The measurement period for RRC_CONNECTED state is specified in clauses 8.1.2.4.3 and 8.1.2.4.4.

In RRC_CONNECTED state the accuracy requirements shall be the same as the inter-frequency measurement accuracy requirements for TDD P-CCPCH in TS 25.123 [19].

If the UE, in RRC_CONNECTED state, needs measurement gaps to perform UTRAN TDD measurements, the relevant UTRAN TDD measurement procedure and measurement gap pattern stated in clause 8.1.2.4 shall apply.

The reporting range and mapping specified for TDD P-CCPCH RSCP in TS 25.123 [19] shall apply.

9.3.2 Void

9.3.3 Void

9.4 GSM Measurements

The requirements in this clause are applicable for a UE:

- in state RRC_CONNECTED
- performing measurements according to clause 8.1.2.4.5 with appropriate measurement gaps
- that is synchronised to the cell that is measured.

The reported measurement result after layer 1 filtering shall be an estimate of the average value of the measured quantity over the measurement period. The reference point for the measurement result after layer 1 filtering is referred to as point B in the measurement model described in TS 25.302 [6].

The accuracy requirements in this clause are valid for the reported measurement result after layer 1 filtering. The accuracy requirements are verified from the measurement report at point D in the measurement model having the layer 3 filtering disabled.

9.4.1 GSM carrier RSSI

NOTE: This measurement is for handover between E-UTRAN and GSM.

The requirements in this clause are valid for terminals supporting this capability.

The measurement period for RRC_CONNECTED state is specified in clause 8.1.2.4.5.

In RRC_CONNECTED state the measurement accuracy requirements for RXLEV in TS 45.008 [8] shall apply.

If the UE, in RRC_CONNECTED state, needs measurement gaps to perform GSM measurements, the GSM measurement procedure and measurement gap pattern stated in clause 8.1.2.4.5 shall apply.

The reporting range and mapping specified for RXLEV in TS 45.008 [8] shall apply.

9.5 CDMA2000 1x RTT Measurements

The requirements in this clause are applicable for a UE:

- in RRC_CONNECTED state.
- synchronised to the cell that is measured.

9.5.1 CDMA2000 1x RTT Pilot Strength

NOTE: This measurement is for handover between E-UTRAN and cdma2000 1 x RTT.

The requirements in this clause are valid for terminals supporting this capability.

CDMA2000 1xRTT Pilot Strength defined in sub-clause 5.1.10 of [4] shall meet the performance requirement defined in sub-clause 3.2.4 of [14] on the cdma2000 1xRTT neighbour cells indicated by the serving eNode B.

9.6 $P_{\text{CMAX},c}$

For a UE configured with a secondary cell, the UE is required to report the UE configured maximum output power ($P_{\text{CMAX},c}$) together with the power headroom. This clause defines the requirements for the $P_{\text{CMAX},c}$ reporting.

9.6.1 Report Mapping

The $P_{\text{CMAX},c}$ reporting range is defined from -29dBm to 33 dBm with 1 dB resolution. Table 9.6.1-1 defines the reporting mapping.

Table 9.6.1-1 Mapping of $P_{\text{CMAX},c}$

| Reported value | Measured quantity value | Unit |
|----------------|------------------------------------|------|
| PCMAX_C_00 | $P_{\text{CMAX},c} < -29$ | dBm |
| PCMAX_C_01 | $-29 \leq P_{\text{CMAX},c} < -28$ | dBm |
| PCMAX_C_02 | $-28 \leq P_{\text{CMAX},c} < -27$ | dBm |
| ... | ... | ... |
| PCMAX_C_61 | $31 \leq P_{\text{CMAX},c} < 32$ | dBm |
| PCMAX_C_62 | $32 \leq P_{\text{CMAX},c} < 33$ | dBm |
| PCMAX_C_63 | $33 \leq P_{\text{CMAX},c}$ | dBm |

9.6.2 Estimation Period

When *extendedPHR* is configured and UE is required to include $P_{\text{CMAX},c}$ in Extended PHR MAC control element as defined in subclause 5.4.6 in [17], the UE shall calculate the $P_{\text{CMAX},c}$ per activated serving cell c for UL-SCH transmission according to subclause 6.2.5A of TS 36.101 [5] over 1 subframe.

9.6.3 Reporting Delay

The $P_{\text{CMAX},c}$ reporting delay is defined as the time between the beginning of the $P_{\text{CMAX},c}$ reference period and the time when the UE starts transmitting $P_{\text{CMAX},c}$ over the radio interface. The reporting delay of the $P_{\text{CMAX},c}$ shall be 0 ms, which is applicable for all configured triggering mechanisms for $P_{\text{CMAX},c}$ reporting.

9.7 IEEE802.11 Measurements

The requirements in this clause are applicable for a UE:

- in RRC_CONNECTED state.
- synchronised to the IEEE 802.11 access point that is measured.

9.7.1 WLAN RSSI

NOTE: This measurement is for access network selection and traffic steering between E-UTRAN and WLAN.

The requirements in this clause are valid for terminals supporting this capability.

WLAN RSSI defined in sub-clause 5.1.16 of [4] shall meet the performance requirement defined in [32].

9.7.2 WLAN RSSI Measurement Report Mapping

This sub-clause 9.7.2 doesn't apply to LPP *WLAN-MeasurementInformation*. The WLAN RSSI measurement report mapping is defined in [32] for LPP *WLAN-MeasurementInformation*.

The reporting range of WLAN RSSI is defined from -100 dBm to 40 dBm with 1 dB resolution.

The mapping of measured quantity is defined in Table 9.7.2-1. The range in the signalling may be larger than the guaranteed accuracy range.

Table 9.7.2-1: WLAN RSSI measurement report mapping

| Reported value | Measured quantity value | Unit |
|----------------|------------------------------------|------|
| WLAN RSSI_00 | WLAN RSSI < -100 | dBm |
| WLAN RSSI_01 | $-100 \leq \text{WLAN RSSI} < -99$ | dBm |

| | | |
|---------------|-----------------------------------|-----|
| WLAN RSSI_02 | $-99 \leq \text{WLAN RSSI} < -98$ | dBm |
| ... | ... | ... |
| WLAN RSSI_139 | $38 \leq \text{WLAN RSSI} < 39$ | dBm |
| WLAN RSSI_140 | $39 \leq \text{WLAN RSSI} < 40$ | dBm |
| WLAN RSSI_141 | $40 \leq \text{WLAN RSSI}$ | dBm |

9.8 MBSFN Measurements

9.8.1 Introduction

MBSFN measurements include MBSFN RSRP, MBSFN RSRQ, and MCH BLER, which are defined in [4]. The measurements are used for MDT.

9.8.2 MBSFN RSRP

9.8.2.1 Absolute MBSFN RSRP measurement accuracy requirements

The requirements for absolute accuracy of MBSFN RSRP in this clause apply to any carrier, which may be the same as or different from any serving unicast carrier, where PMCH is received while meeting performance requirements in Section 10 of [5].

The accuracy requirements in Table 9.8.2.1-1 are valid under the following conditions:

MBSFN RS are transmitted from antenna port 4 in the MBSFN subframes where PMCH is received.

Conditions defined in 36.101 Clause 7.3 for reference sensitivity are fulfilled.

MBSFN RSRP[dBm/15kHz] is the same as RSRP[dBm/15kHz] specified in Annex B.3.1 for each corresponding Band.

Table 9.8.2.1-1: Absolute MBSFN RSRP measurement accuracy

| Accuracy | | Conditions | | | | |
|------------------|-------------------|------------------------|--|-----------------------------|---------------------------|---------------------------|
| Normal condition | Extreme condition | \hat{E}_s/lot | I_o ^{Note 1} range | | | |
| | | | E-UTRA operating band groups ^{Note 3} | Minimum I_o | | Maximum I_o |
| dB | dB | dB | | dBm/15kHz ^{Note 2} | dBm/BW _{Channel} | dBm/BW _{Channel} |
| ±4.5 | ±9 | ≥-6 dB | FDD_A, TDD_A | -121 | N/A | -70 |
| | | | FDD_B | -120.5 | N/A | -70 |
| | | | FDD_C, TDD_C | -120 | N/A | -70 |
| | | | FDD_D | -119.5 | N/A | -70 |
| | | | FDD_E, TDD_E | -119 | N/A | -70 |
| | | | FDD_F | -118.5 | N/A | -70 |
| | | | FDD_G | -118 | N/A | -70 |
| | | | FDD_H | -117.5 | N/A | -70 |
| | | | FDD_N | -114.5 | N/A | -70 |
| ±8 | ±11 | ≥-6 dB | FDD_A, TDD_A, FDD_B, FDD_C, TDD_C, FDD_D, FDD_E, TDD_E, FDD_F, FDD_G, FDD_H, FDD_N | N/A | -70 | -50 |

NOTE 1: I_o is assumed to have constant EPRE across the bandwidth.
NOTE 2: The condition level is increased by $\Delta > 0$, when applicable, as described in Sections B.4.2 and B.4.3.
NOTE 3: E-UTRA operating band groups are as defined in Section 3.5.

9.8.2.2 MBSFN RSRP measurement report mapping

The reporting range of MBSFN RSRP is defined from -140 dBm to -44 dBm with 1 dB resolution.

The mapping of measured quantity is defined in Table 9.8.2.2-1. The range in the signalling may be larger than the guaranteed accuracy range.

Table 9.8.2.2-1: MBSFN RSRP measurement report mapping

| Reported value | Measured quantity value | Unit |
|----------------|--------------------------|------|
| MBSFN_RSRP_00 | MBSFN_RSRP < -140 | dBm |
| MBSFN_RSRP_01 | -140 ≤ MBSFN_RSRP < -139 | dBm |
| MBSFN_RSRP_02 | -139 ≤ MBSFN_RSRP < -138 | dBm |
| ... | ... | ... |
| MBSFN_RSRP_95 | -46 ≤ MBSFN_RSRP < -45 | dBm |
| MBSFN_RSRP_96 | -45 ≤ MBSFN_RSRP < -44 | dBm |
| MBSFN_RSRP_97 | -44 ≤ MBSFN_RSRP | dBm |

9.8.3 MBSFN RSRQ

9.8.3.1 Absolute MBSFN RSRQ measurement accuracy requirements

The requirements for absolute accuracy of MBSFN RSRQ in this clause apply to any carrier, which may be the same as or different from a serving unicast carrier, where PMCH is received while meeting performance requirements in Section 10 of [5].

The accuracy requirements in Table 9.8.3.1-1 are valid under the following conditions:

MBSFN RS are transmitted from antenna port 4 in the MBSFN subframes where PMCH is received.

Conditions defined in 36.101 Clause 7.3 for reference sensitivity are fulfilled.

MBSFN RSRP|dBm/15kHz is the same as RSRP|dBm/15kHz specified in Annex B.3.1 for each corresponding Band.

Table 9.8.3.1-1: Absolute MBSFN RSRQ measurement accuracy

| Accuracy | | Conditions | | | |
|------------------|-------------------|------------|--|---------------------------|------------------------|
| Normal condition | Extreme condition | Ês/lot | I _o ^{Note 1} range | | |
| | | | E-UTRA operating band groups ^{Note 4} | Minimum I _o | Maximum I _o |
| dB | dB | dB | dBm/15kHz ^{Note 3} | dBm/BW _{Channel} | |
| ±2.5 | ±4 | ≥-3 dB | FDD_A, TDD_A | -121 | -50 |
| | | | FDD_B | -120.5 | -50 |
| | | | FDD_C, TDD_C | -120 | -50 |
| | | | FDD_D | -119.5 | -50 |
| | | | FDD_E, TDD_E | -119 | -50 |
| | | | FDD_F | -118.5 | -50 |
| | | | FDD_G | -118 | -50 |
| | | | FDD_H | -117.5 | -50 |
| | | | FDD_N | -114.5 | -50 |
| ±3.5 | ±4 | ≥-6 dB | Note 2 | Note 2 | Note 2 |

NOTE 1: I_o is assumed to have constant EPRE across the bandwidth.
NOTE 2: The same bands and the same I_o conditions for each band apply for this requirement as for the corresponding highest accuracy requirement.
NOTE 3: The condition level is increased by Δ>0, when applicable, as described in Sections B.4.2 and B.4.3.
NOTE 4: E-UTRA operating band groups are as defined in Section 3.5.

9.8.3.2 MBSFN RSRQ measurement report mapping

The reporting range of MBSFN RSRQ is defined from -23 dB to -7.5 dB with 0.5 dB resolution.

The mapping of measured quantity is defined in Table 9.8.3.2-1. The range in the signalling may be larger than the guaranteed accuracy range.

Table 9.8.3.2-1: MBSFN RSRQ measurement report mapping

| Reported value | Measured quantity value | Unit |
|----------------|--------------------------|------|
| MBSFN_RSRQ_00 | MBSFN_RSRQ < -23 | dB |
| MBSFN_RSRQ_01 | -23 ≤ MBSFN_RSRQ < -22.5 | dB |
| MBSFN_RSRQ_02 | -22.5 ≤ MBSFN_RSRQ < -22 | dB |
| ... | ... | ... |
| MBSFN_RSRQ_30 | -8.5 ≤ MBSFN_RSRQ < -8 | dB |
| MBSFN_RSRQ_31 | -8 ≤ MBSFN_RSRQ | dB |

9.8.4 MCH BLER

MCH BLER shall be measured as defined in [4].

9.8.4.1 Measurement report mapping for MCH BLER

The UE shall report MCH BLER together with the corresponding total number of MCH blocks, which were received by the UE during the MCH BLER measurement period and used for calculating the reported MCH BLER.

The reporting range of MCH BLER is defined from 0.1% to 50% with uniform quantization in log domain.

The mapping of measured quantity is defined in Table 9.8.4.1-1. The range in the signalling may be larger than the range specified in the table below.

Table 9.8.4.1-1: MCH BLER measurement report mapping

| Reported value | Measured quantity value | Unit |
|----------------|----------------------------|------|
| MCH BLER_00 | MCH BLER < 0.1 | % |
| MCH BLER_01 | 0.1 ≤ MCH BLER < 0.123 | % |
| MCH BLER_02 | 0.123 ≤ MCH BLER < 0.151 | % |
| MCH BLER_03 | 0.151 ≤ MCH BLER < 0.186 | % |
| MCH BLER_04 | 0.186 ≤ MCH BLER < 0.229 | % |
| MCH BLER_05 | 0.229 ≤ MCH BLER < 0.282 | % |
| MCH BLER_06 | 0.282 ≤ MCH BLER < 0.347 | % |
| MCH BLER_07 | 0.347 ≤ MCH BLER < 0.426 | % |
| MCH BLER_08 | 0.426 ≤ MCH BLER < 0.525 | % |
| MCH BLER_09 | 0.525 ≤ MCH BLER < 0.645 | % |
| MCH BLER_10 | 0.645 ≤ MCH BLER < 0.794 | % |
| MCH BLER_11 | 0.794 ≤ MCH BLER < 0.976 | % |
| MCH BLER_12 | 0.976 ≤ MCH BLER < 1.201 | % |
| MCH BLER_13 | 1.201 ≤ MCH BLER < 1.478 | % |
| MCH BLER_14 | 1.478 ≤ MCH BLER < 1.818 | % |
| MCH BLER_15 | 1.818 ≤ MCH BLER < 2.236 | % |
| MCH BLER_16 | 2.236 ≤ MCH BLER < 2.751 | % |
| MCH BLER_17 | 2.751 ≤ MCH BLER < 3.384 | % |
| MCH BLER_18 | 3.384 ≤ MCH BLER < 4.163 | % |
| MCH BLER_19 | 4.163 ≤ MCH BLER < 5.121 | % |
| MCH BLER_20 | 5.121 ≤ MCH BLER < 6.300 | % |
| MCH BLER_21 | 6.300 ≤ MCH BLER < 7.750 | % |
| MCH BLER_22 | 7.750 ≤ MCH BLER < 9.533 | % |
| MCH BLER_23 | 9.533 ≤ MCH BLER < 11.728 | % |
| MCH BLER_24 | 11.728 ≤ MCH BLER < 14.427 | % |
| MCH BLER_25 | 14.427 ≤ MCH BLER < 17.478 | % |
| MCH BLER_26 | 17.478 ≤ MCH BLER < 21.833 | % |
| MCH BLER_27 | 21.833 ≤ MCH BLER < 26.858 | % |
| MCH BLER_28 | 26.858 ≤ MCH BLER < 33.040 | % |
| MCH BLER_29 | 33.040 ≤ MCH BLER < 40.645 | % |
| MCH BLER_30 | 40.645 ≤ MCH BLER < 50 | % |
| MCH BLER_31 | 50 ≤ MCH BLER | % |

9.8.4.2 Measurement report mapping for MCH Block Number

The reporting range of the total number of received MCH blocks during the measurement period is defined from 0 to 65152. The total number of received MCH blocks is quantized to two values n and m with the mappings defined in Table 9.8.4.2-1 and Table 9.8.4.2-2, respectively.

The range in the signalling may be larger than the range specified in the table below.

N_R in Table 9.8.4.2-1 and Table 9.8.4.2-2 represents the total number of received MCH blocks. $f(N_R)$ is a function of N_R

with the definition that $f(N_R) = \frac{N_R - (2^n - 1) \times 2^8}{2^n}$, from where the quantized total number of MCH blocks is

found as $(2^n - 1) \times 2^8 + m \times 2^n$.

Table 9.8.4.2-1: Number of received MCH blocks mapping to n

| Reported value, n | Number of received MCH blocks |
|---------------------|-------------------------------|
| MCH_NR_N_00 | $0 \leq N_R < 256$ |
| MCH_NR_N_01 | $256 \leq N_R < 768$ |
| MCH_NR_N_02 | $768 \leq N_R < 1792$ |
| MCH_NR_N_03 | $1792 \leq N_R < 3840$ |
| MCH_NR_N_04 | $3840 \leq N_R < 7936$ |
| MCH_NR_N_05 | $7936 \leq N_R < 16128$ |
| MCH_NR_N_06 | $16128 \leq N_R < 32512$ |
| MCH_NR_N_07 | $32512 \leq N_R$ |

Table 9.8.4.2-2: Number of received MCH blocks mapping to m

| Reported value, m | $f(N_R)$ |
|---------------------|-------------------------|
| MCH_NR_M_00 | $0 \leq f(N_R) < 1$ |
| MCH_NR_M_01 | $1 \leq f(N_R) < 2$ |
| MCH_NR_M_02 | $2 \leq f(N_R) < 3$ |
| ... | ... |
| MCH_NR_M_253 | $253 \leq f(N_R) < 254$ |
| MCH_NR_M_254 | $254 \leq f(N_R) < 255$ |
| MCH_NR_M_255 | $255 \leq f(N_R)$ |

9.9 ProSe Measurements

9.9.1 Introduction

The requirements in this section are applicable for a UE capable of ProSe Direct Communication and/or ProSe Direct Discovery.

The reported measurement result after layer 1 filtering shall be an estimate of the average value of the measured quantity over the measurement period. The reference point for the measurement result after layer 1 filtering is referred to as point B in the measurement model described in [25].

The accuracy requirements in this clause are:

- applicable for AWGN radio propagation conditions,
- assume independent interference (noise) at each receiver antenna port.
- valid for the reported measurement result after layer 1 filtering,
- are verified from the measurement report at point D in the measurement model having the higher layer filtering disabled.

9.9.2 Intra-Frequency S-RSRP Measurement Accuracy Requirements

9.9.2.1 Absolute S-RSRP Accuracy

The requirements for absolute accuracy of S-RSRP in this clause apply to a ProSe synchronization source on the same frequency as that of the own ProSe UE performing the measurement.

The accuracy requirements in Table 9.9.2.1-1 are valid under the following conditions:

- Demodulation reference signals are transmitted from one port.
- Conditions defined in 36.101 Clause 7.3D for reference sensitivity are fulfilled.
- S-RSRP_{dBm} according to Annex B.5.1 for a corresponding Band are fulfilled.

Table 9.9.2.1-1: Intra-frequency S-RSRP absolute accuracy for UE capable of ProSe Direct Communication and/or ProSe Direct Discovery

| Accuracy | | Conditions | | | | |
|------------------|-------------------|----------------------------------|---|---------------------|---------------------------|---------------------------|
| Normal condition | Extreme condition | \hat{E}_s/lot Note 4 | I_o Note 1 range | | | |
| | | | E-UTRA ProSe operating band groups Note 3 | Minimum I_o | | Maximum I_o |
| dB | dB | dB | | dBm/15kHz Note 2 | dBm/BW _{Channel} | dBm/BW _{Channel} |
| ±4.5 | ±9 | ≥-6 dB | FDD_A | -121 | N/A | -70 |
| | | | FDD_D | -119.5 | N/A | -70 |
| | | | FDD_E, TDD_E | -119 | N/A | -70 |
| | | | FDD_F | -118.5 | N/A | -70 |
| | | | FDD_G | -118 | N/A | -70 |
| | | | FDD_N | -114.5 | N/A | -70 |
| ±8 | ±11 | ≥-6 dB | FDD_A, FDD_D, FDD_E, TDD_E, FDD_F, FDD_G, FDD_N | N/A | -70 | -50 |

NOTE 1: I_o is assumed to have constant EPRE across the bandwidth.
 NOTE 2: The condition level is increased by $\Delta > 0$, when applicable, as described in Sections B.4.2 and B.4.3.
 NOTE 3: E-UTRA ProSe operating band groups are as defined in Section 3.5 for the corresponding E-UTRA operating bands.
 NOTE 4: \hat{E}_s/lot for a SyncRef UE is the minimum of the \hat{E}_s/lot of PSSS/PSBCH and the \hat{E}_s/lot of SSSS

9.9.2.2 Relative Accuracy of S-RSRP

The relative accuracy of S-RSRP is defined as the S-RSRP measured from one ProSe synchronization source compared to the S-RSRP measured from another ProSe synchronization source on the same frequency.

The accuracy requirements in Table 9.9.2.2-1 are valid under the following conditions:

- Demodulation reference signals are transmitted from one port.
- Conditions defined in 36.101 Clause 7.3D for reference sensitivity are fulfilled.
- S-RSRP_{1,2|dBm} according to Annex B.5.2 for a corresponding Band.

Table 9.9.2.2-1: S-RSRP Intra frequency relative accuracy for UE capable of ProSe direct communication and/or ProSe Direct Discovery

| Accuracy | | Conditions | | | |
|------------------|-------------------|----------------------------------|--|---------------------------|---------------|
| Normal condition | Extreme condition | \hat{E}_s/lot Note 2, 6 | I_o Note 1 range | | |
| | | | E-UTRA ProSe operating band groups Note 5 | Minimum I_o | Maximum I_o |
| dB | dB | dB | dBm/15kHz Note 4 | dBm/BW _{Channel} | |
| ±2 | ±3 | ≥-3 dB | FDD_A | -121 | -50 |

| | | | | | |
|---|----|--------|--------------|--------|--------|
| | | | FDD_D | -119.5 | -50 |
| | | | FDD_E, TDD_E | -119 | -50 |
| | | | FDD_F | -118.5 | -50 |
| | | | FDD_G | -118 | -50 |
| | | | FDD_N | -114.5 | -50 |
| ±3 | ±3 | ≥-6 dB | Note 3 | Note 3 | Note 3 |
| <p>NOTE 1: I_0 is assumed to have constant EPRE across the bandwidth.</p> <p>NOTE 2: The parameter \hat{E}_s/I_0 is the minimum \hat{E}_s/I_0 of the pair of SyncRef UEs to which the requirement applies.</p> <p>NOTE 3: The same bands and the same I_0 conditions for each band apply for this requirement as for the corresponding highest accuracy requirement.</p> <p>NOTE 4: The condition level is increased by $\Delta > 0$, when applicable, as described in Sections B.4.2 and B.4.3.</p> <p>NOTE 5: E-UTRA ProSe operating band groups are as defined in Section 3.5 for the corresponding E-UTRA operating bands.</p> <p>NOTE 6: \hat{E}_s/I_0 for a SyncRef UE is the minimum of the \hat{E}_s/I_0 of PSSS/PSBCH and the \hat{E}_s/I_0 of SSSS</p> | | | | | |

9.9.3 Intra-Frequency SD-RSRP Measurement Accuracy Requirements

The requirements in this clause are applicable for a remote ProSe UE:

- in state RRC_IDLE or RRC_CONNECTED if the frequency used for ProSe is the serving frequency, or
- is out of coverage on the frequency used for ProSe, and
- that is synchronised to the ProSe relay UE that is measured.

9.9.3.1 Absolute SD-RSRP Accuracy

The requirements for absolute accuracy of SD-RSRP in this clause apply to a ProSe UE performing SD-RSRP measurements on the same frequency as used by the ProSe relay UE transmitting the relay Discovery message.

The accuracy requirements in Table 9.9.3.1-1 are valid under the following conditions:

- Demodulation reference signals are transmitted from one port.
- Conditions defined in 36.101 Clause 7.3D for reference sensitivity are fulfilled.
- SD-RSRP[dBm] according to Annex B.5.4 for a corresponding Band are fulfilled.
- $numReTx$ is configured as 3 for the relay Discovery transmissions. For $numReTx < 3$, the minimum \hat{E}_s/N_{oc} at which the accuracy requirements are fulfilled is expected to be higher than as specified for $numReTx=3$.

Table 9.9.3.1-1: Intra-frequency SD-RSRP absolute accuracy for remote UE [2] capable of ProSe Direct Communication and ProSe Direct Discovery and configured by upper layers for relay operation.

| Accuracy | | Conditions | | | | |
|------------------|-------------------|------------------------------|--|---------------------|---------------------------|---------------------------|
| Normal condition | Extreme condition | \hat{E}_s/N_{oc} Note 4 | I_0 Note 1 range | | | |
| | | | E-UTRA ProSe operating band groups Note 3 | Minimum I_0 | | Maximum I_0 |
| dB | dB | dB | | dBm/15kHz Note 2 | dBm/BW _{Channel} | dBm/BW _{Channel} |
| ±4.5 | ±9 | ≥-1.5 dB | FDD_D | -119.5 | N/A | -70 |
| | | | FDD_E | -119 | N/A | -70 |
| | | | FDD_F | -118.5 | N/A | -70 |
| | | | FDD_G | -118 | N/A | -70 |
| | | | FDD_N | -114.5 | N/A | -70 |

| | | | | | | |
|--|-----|---------|--------------------------------------|-----|-----|-----|
| ±8 | ±11 | ≥1.5 dB | FDD_D, FDD_E, FDD_F, FDD_G, FDD_N | N/A | -70 | -50 |
| <p>NOTE 1: I_0 is assumed to have constant EPRE across the bandwidth.</p> <p>NOTE 2: The condition level is increased by $\Delta > 0$, when applicable, as described in Sections B.4.2 and B.4.3.</p> <p>NOTE 3: E-UTRA ProSe operating band groups are as defined in Section 3.5 for the corresponding E-UTRA operating bands.</p> <p>NOTE 4: When $numReTx$ is configured as 3 for the relay Discovery transmissions. For $numReTx < 3$, the minimum $\hat{E}s/N_{oc}$ at which the accuracy requirements are fulfilled is expected to be higher than as specified for $numReTx=3$.</p> <p>NOTE 5: Layer 1 filtering for SD-RSRP is performed using PSDCH (re)transmissions within a discovery period.</p> | | | | | | |

9.9.3.2 Relative Accuracy of SD-RSRP

The relative accuracy of SD-RSRP in this clause apply to a ProSe UE performing SD-RSRP measurements on the same frequency as used by the ProSe relay UE transmitting the relay Discovery message.

The accuracy requirements in Table 9.9.3.2-1 are valid under the following conditions:

- Demodulation reference signals are transmitted from one port.
- Conditions defined in 36.101 Clause 7.3D for reference sensitivity are fulfilled.
- SD-RSRP[dBm] according to Annex B.5.5 for a corresponding Band are fulfilled.
- $numReTx$ is configured as 3 for the relay Discovery transmissions. For $numReTx < 3$, the minimum $\hat{E}s/N_{oc}$ at which the accuracy requirements are fulfilled is expected to be higher than as specified for $numReTx=3$.

Table 9.9.3.2-1: Intra-frequency SD-RSRP relative accuracy for remote UE [2] capable of ProSe Direct Communication and ProSe Direct Discovery and configured by upper layers for relay operation.

| Accuracy | | Conditions | | | |
|--|-------------------|-------------------------------------|--|-----------------------------|---------------------------|
| Normal condition | Extreme condition | $\hat{E}s/N_{oc}$ ^{Note 6} | I_0 ^{Note 1} range | | |
| | | | E-UTRA ProSe operating band groups ^{Note 5} | Minimum I_0 | Maximum I_0 |
| dB | dB | dB | | dBm/15kHz ^{Note 4} | dBm/BW _{Channel} |
| ±2 | ±3 | ≥-1.5 dB | FDD_D | -119.5 | -50 |
| | | | FDD_E | -119 | -50 |
| | | | FDD_F | -118.5 | -50 |
| | | | FDD_G | -118 | -50 |
| | | | FDD_N | -114.5 | -50 |
| ±3 | ±3 | ≥-1.5 dB | Note 3 | Note 3 | Note 3 |
| <p>NOTE 1: I_0 is assumed to have constant EPRE across the bandwidth.</p> <p>NOTE 2: The parameter $\hat{E}s/N_{oc}$ is the minimum $\hat{E}s/N_{oc}$ of the pair of ProSe Relay UEs to which the requirement applies.</p> <p>NOTE 3: The same bands and the same I_0 conditions for each band apply for this requirement as for the corresponding highest accuracy requirement.</p> <p>NOTE 4: The condition level is increased by $\Delta > 0$, when applicable, as described in Sections B.4.2 and B.4.3.</p> <p>NOTE 5: E-UTRA ProSe operating band groups are as defined in Section 3.5 for the corresponding E-UTRA operating bands.</p> <p>NOTE 6: When $numReTx$ is configured as 3 for the relay Discovery transmissions. For $numReTx < 3$, the minimum $\hat{E}s/N_{oc}$ at which the accuracy requirements are fulfilled is expected to be higher than as specified for $numReTx=3$.</p> <p>NOTE 7: Layer 1 filtering for SD-RSRP is performed using PSDCH (re)transmissions within a discovery period.</p> | | | | | |

10 Measurements Performance Requirements for E-UTRAN

10.1 Received Interference Power

The measurement period shall be 100 ms.

10.1.1 Absolute accuracy requirement

Table 10.1.1-1: Received Interference Power absolute accuracy

| Parameter | Unit | Accuracy [dB] | Conditions |
|-----------|-------------|---------------|-------------------|
| | | | lob [dBm/180 kHz] |
| lob | dBm/180 kHz | ± 4 | -117 ... -96 |

10.1.2 Relative accuracy requirement

The relative accuracy is defined as the Received Interference Power measured at one frequency compared to the Received Interference Power measured from the same frequency at a different time.

Table 10.1.2-1: Received Interference Power relative accuracy

| Parameter | Unit | Accuracy [dB] | Conditions |
|-----------|-------------|---------------|---|
| | | | lob [dBm/180 kHz] |
| lob | dBm/180 kHz | ± 0.5 | -117 ... -96 AND for changes $\leq \pm 9.0$ dB |

10.1.3 Received Interference Power measurement report mapping

The reporting range for *Received Interference Power (RIP)* is from -126 ... -75 dBm.

In table 10.2.3-1 the mapping of measured quantity is defined. The range in the signalling may be larger than the guaranteed accuracy range.

Table 10.1.3-1: Received Interference Power measurement reporting range

| Reported value | Measured quantity value | Unit |
|----------------|-----------------------------------|------|
| RTWP_LEV_000 | RIP < -126.0 | dBm |
| RTWP_LEV_001 | $-126.0 \leq \text{RIP} < -125.9$ | dBm |
| RTWP_LEV_002 | $-125.9 \leq \text{RIP} < -125.8$ | dBm |
| ... | ... | ... |
| RTWP_LEV_509 | $-75.2 \leq \text{RIP} < -75.1$ | dBm |
| RTWP_LEV_510 | $-75.1 \leq \text{RIP} < -75.0$ | dBm |
| RTWP_LEV_511 | $-75.0 \leq \text{RIP}$ | dBm |

10.2 Angle of Arrival (AOA)

10.2.1 Range/mapping

The reporting range for AOA measurement is from 0 to 360 degree, with resolution of 0.5 degree.

The mapping of the measured quantity is defined in table 10.2.1-1.

Table 10.2.1-1: AOA measurement report mapping

| Reported value | Measured quantity value | Unit |
|----------------|--------------------------------------|--------|
| AOA_ANGLE_000 | $0 \leq \text{AOA_ANGLE} < 0.5$ | degree |
| AOA_ANGLE_001 | $0.5 \leq \text{AOA_ANGLE} < 1$ | degree |
| AOA_ANGLE_002 | $1 \leq \text{AOA_ANGLE} < 1.5$ | degree |
| ... | ... | ... |
| AOA_ANGLE_717 | $358.5 \leq \text{AOA_ANGLE} < 359$ | degree |
| AOA_ANGLE_718 | $359 \leq \text{AOA_ANGLE} < 359.5$ | degree |
| AOA_ANGLE_719 | $359.5 \leq \text{AOA_ANGLE} < 360$ | degree |

10.3 Timing Advance (T_{ADV})

10.3.1 Report mapping

The reporting range of T_{ADV} is defined from 0 to $49232T_s$ with $2T_s$ resolution for timing advance less or equal to $4096T_s$ and $8T_s$ for timing advance greater than $4096T_s$.

The mapping of measured quantity is defined in Table 10.3.1-1.

Table 10.3.1-1: T_{ADV} measurement report mapping

| Reported value | Measured quantity value | Unit |
|-------------------|------------------------------|-------|
| TIME_ADVANCE_00 | $T_{ADV} < 2$ | T_s |
| TIME_ADVANCE_01 | $2 \leq T_{ADV} < 4$ | T_s |
| TIME_ADVANCE_02 | $4 \leq T_{ADV} < 6$ | T_s |
| ... | ... | ... |
| TIME_ADVANCE_2046 | $4092 \leq T_{ADV} < 4094$ | T_s |
| TIME_ADVANCE_2047 | $4094 \leq T_{ADV} < 4096$ | T_s |
| TIME_ADVANCE_2048 | $4096 \leq T_{ADV} < 4104$ | T_s |
| TIME_ADVANCE_2049 | $4104 \leq T_{ADV} < 4112$ | T_s |
| ... | ... | ... |
| TIME_ADVANCE_7688 | $49216 \leq T_{ADV} < 49224$ | T_s |
| TIME_ADVANCE_7689 | $49224 \leq T_{ADV} < 49232$ | T_s |
| TIME_ADVANCE_7690 | $49232 \leq T_{ADV}$ | T_s |

NOTE: For report mapping of type2 TADV for TDD, the TADV equal to (eNB Rx – Tx time difference) + $624T_s$.

11 ProSe Requirements in Any Cell Selection state

11.1 Introduction

This section contains the requirements for the UE capable of ProSe Direct Communication and/or ProSe Direct Discovery when the UE is out of coverage on the carrier used for ProSe operation, as defined in [1]. The ProSe requirements shall apply provided that the sidelink used by the UE for ProSe Direct Communication and/or ProSe Direct Discovery is on the carrier that is preconfigured in the ProSe UE for out-of-coverage operation. The requirement apply when the UE is:

- in any cell selection state, or,
- out of coverage on the ProSe carrier and is associated with a serving cell on a non-ProSe carrier.

Note: Any cell selection state refers to a UE that is out of network coverage and is not associated with a serving cell on any carrier [1].

11.2 UE Transmit Timing for ProSe in Any Cell Selection State

11.2.1 Introduction

This clause contains requirements on the UE capable of ProSe Direct Communication and/or ProSe Direct Discovery regarding transmit timing if the UE is out of coverage on the carrier used for ProSe operation.

11.2.2 ProSe UE transmission timing

The requirements in this subclause are applicable when the reference timing used for deriving ProSe transmission is from another ProSe UE transmitting sidelink synchronization signals.

The sidelink transmissions takes place $(N_{TA,SL} + N_{TA,offset}) \cdot T_s$ before the reception of the first detected path (in time) of the corresponding timing reference frame from the UE, with $N_{TA,offset} = 0$ and $N_{TA,SL} = 0$ [16]. The transmission timing error for sidelink transmissions shall be less than or equal to $\pm T_e$ where the timing error limit value T_e is specified in Table 11.2.2-1.

Table 11.2.2-1: T_e Timing Error Limit

| Sidelink Bandwidth (MHz) | T_e |
|--------------------------|---|
| ≥ 1.4 | $24 \cdot T_s$ |
| Note: | T_s is the basic timing unit defined in TS 36.211 |

11.3 Initiation/Cease of SLSS Transmissions

11.3.1 Introduction

The requirements in this subclause apply when the conditions for SLSS transmissions specified in [2] are met and if *syncTxThreshOoC* is included in the preconfigured ProSe parameters.

11.3.2 Requirements

The UE shall be capable of measuring the S-RSRP of the selected SyncRef UE used to derive transmission timing for Prose Direct Communication and/or ProSe Direct Discovery and evaluate it to initiate/cease SLSS transmissions within $T_{evaluate,SLSS} = 0.8$ seconds.

If higher layer filtering for S-RSRP measurements is pre-configured, an additional delay in evaluation to initiate/cease SLSS transmissions can be expected.

For the selected SyncRef UE [2] used to derive transmission timing for ProSe Direct Communication and/or ProSe Direct Discovery:

- S-RSRP related side conditions given in Section 11.5 for a corresponding Band are fulfilled,
- ProSe SCH_{RP} and SCH_{Es/Iot} according to Annex B.5.1 for a corresponding Band are fulfilled.

11.4 Measurements for ProSe in Any Cell Selection State

11.4.1 Introduction

This clause contains requirements for E-UTRA cell identification for the UE capable of ProSe Direct Communication and/or ProSe Direct Discovery if the UE is out of coverage on the carrier used for ProSe operation.

The UE can be preconfigured with ProSe resources for out of coverage ProSe operation.

The requirements in this section are applicable for the ProSe if the UE is out of coverage on the carrier used for ProSe operation using the preconfigured ProSe resources. The ProSe UE shall:

- continuously search for any detectable E-UTRA cell on the downlink carrier frequency associated with the preconfigured ProSe carrier frequency for out of coverage ProSe operation, and
- if in any cell selection state, then search cells also on other carriers and perform cell selection according to the procedure specified in section 4.1.

11.4.2 Requirements

11.4.2.1 E-UTRA FDD

The requirements in this subclause are applicable when the preconfigured ProSe carrier is FDD (parameter *tdd-ConfigSL* is configured as *none*).

The UE capable of ProSe Direct Communication and/or ProSe Direct Discovery immediately upon being out of coverage on the ProSe carrier shall search for any detectable cell on the carrier preconfigured with ProSe resources.

The UE shall be able to identify a newly detectable E-UTRA FDD cell on the downlink carrier frequency associated with the preconfigured with ProSe carrier frequency:

- within $T_{\text{basic_identify_OoC_ProSe Tx_ON}}$ if the UE is performing ProSe transmissions on the sidelink, or
- within $T_{\text{basic_identify_OoC_ProSe Tx_OFF}}$ if the UE is not performing ProSe transmissions on the sidelink.

where,

$T_{\text{basic_identify_OoC_ProSe Tx_ON}} = 6.4$ seconds, and

$T_{\text{basic_identify_OoC_ProSe Tx_OFF}} = 32$ seconds.

An E-UTRA cell is considered detectable provided it meets the intra-frequency cell identification conditions specified in section 8.1.2.2.

11.4.2.2 E-UTRA TDD

The requirements in this subclause are applicable when the preconfigured ProSe carrier is configured as TDD.

The UE capable of ProSe Direct Discovery immediately upon being out of coverage on the ProSe carrier shall search for any detectable cell on the carrier preconfigured with ProSe resources.

The UE shall be able to identify a newly detectable E-UTRA TDD cell on TDD carrier frequency preconfigured for ProSe operation:

- within $T_{\text{basic_identify_OoC_ProSe Tx_ON}}$ if the UE is performing ProSe transmissions on the sidelink, or
- within $T_{\text{basic_identify_OoC_ProSe Tx_OFF}}$ if the UE is not performing ProSe transmissions on the sidelink.

where,

$T_{\text{basic_identify_OoC_ProSe Tx_ON}} = 6.4$ seconds, and

$T_{\text{basic_identify_OoC_ProSe Tx_OFF}} = 32$ seconds.

An E-UTRA cell is considered detectable provided it meets the intra-frequency cell identification conditions specified in section 8.1.2.2.

The UE shall be allowed to interrupt ProSe Direct Discovery operation in order to meet the requirements in this subclause.

11.5 Selection / Reselection of ProSe Synchronization Reference

11.5.1 Introduction

This clause contains requirements for the measurements performed by the UE capable of ProSe Direct Communication and/or ProSe Direct Discovery if the UE is out of coverage on the carrier used for ProSe operation.

11.5.2 Selection/Reselection to intra-frequency SyncRef UE

11.5.2.1 Introduction

This clause contains requirements for the measurement for the ProSe synchronization on the UE capable of ProSe Direct Communication and/or ProSe Direct Discovery if the UE is out of coverage on the carrier used for ProSe operation.

11.5.2.2 Requirements

The UE shall be able to identify newly detectable SyncRef UE within $T_{\text{detect,SyncRef UE}}$ seconds if SyncRef UE meets the selection / reselection criterion defined in TS 36.331 [2].

ProSe synchronization source, SyncRef UE, is defined as a ProSe synchronization source which is capable to transmit ProSe synchronization signals.

A SyncRef UE is considered to be detectable when

- S-RSRP related side conditions given in Section 9.9.2 are fulfilled for a corresponding Band,
- ProSe SCH_{RP} and SCH_{Es/Iot} are fulfilled according to Annex B.5.3 for a corresponding Band.

$T_{\text{detect,SyncRef UE}}$ is defined as 20 seconds at SCH_{Es/Iot} ≥ -4 dB, provided that the ProSe UE is allowed to drop a maximum of 2% of its ProSe Direct Communication and ProSe Direct Discovery transmissions at the physical layer for the purpose of SyncRef UE selection / reselection.

The UE capable of ProSe Direct Communication and/or ProSe Direct Discovery shall be capable of performing S-RSRP measurements for 6 identified ProSe synchronization sources with the measurement period of 400 ms. It is assumed that the ProSe synchronization sources do not drop or delay more than one SLSS transmission within the measurement period. Otherwise, the measurement period may be extended.

11.6 Void

11.7 Selection / Reselection of ProSe relay UE

11.7.1 Introduction

This section contains the requirements related to selection and reselection of ProSe relay UE when the remote UE is out of coverage on the frequency used for ProSe Direct Communication.

The requirements apply for the selection and reselection of candidate relay UEs that are transmitting relay discovery signals within the discovery resource pool as configured for the remote UE, and follow a synchronization source that either the same or is synchronized to the one use by remote UE.

11.7.2 Selection / Reselection of intra-frequency ProSe relay UE

For a remote UE configured by upper layer for relay operation, the remote UE shall search for candidate relay UEs for selection and/or reselection every discovery period.

If the remote UE has a selected sidelink relay UE, then the remote UE shall measure the SD-RSRP of the selected relay once in every four discovery periods and evaluate if it meets the relay selection criterion as defined in [TS 36.331, 5.10.11.4].

The remote UE shall measure SD-RSRP of the candidate relay UEs every $T_{\text{measure, ProSe_Relay_Intra}}$ for intra-frequency relay UEs that are detected and measured according to the measurement rules.

For an intra-frequency relay UEs that are detected, but that has not been selected or reselected to, the remote UE shall be capable of evaluating that the intra-frequency relay UE has met selection or reselection criterion defined in [2, 5.10.11.4] within $T_{\text{evaluate, ProSe_Relay_Intra}}$ as specified in table 11.7.2-1.

The minimum requirements are required to meet when the selected and candidate relay UEs are transmitting relay discovery message every discovery period.

Table 11.7.2-1: $T_{\text{measure, ProSe_Relay_Intra}}$ and $T_{\text{evaluate, ProSe_Relay_intra}}$

| Discovery Period [s] | $T_{\text{measure, ProSe_Relay_Intra}}$ [s] (number of discovery periods) | $T_{\text{evaluate, ProSe_Relay_intra}}$ [s] (number of discovery periods) |
|--|---|--|
| $0.04 \leq \text{Discovery period} \leq 10.24$ | Note 1 (4) | Note 1 (16) |
| NOTE 1: Time depends upon the configured Discovery period. | | |

Annex A (normative): Test Cases

A.1 Purpose of annex

This Annex specifies test specific parameters for some of the functional requirements in sections 4 to 9. The tests provide additional information to how the requirements should be interpreted for the purpose of conformance testing. The tests in this Annex are described such that one functional requirement may be tested in one or several test and one test may verify several requirements. Some requirements may lack a test.

The conformance tests are specified in TS 36.521-3 [23]. Statistical interpretation of the requirements is described in Annex A.2.

A.2 Requirement classification for statistical testing

Requirements in this specification are either expressed as absolute requirements with a single value stating the requirement, or expressed as a success rate. There are no provisions for the statistical variations that will occur when the parameter is tested.

Annex A outlines the tests in more detail and lists the test parameters needed. The test will result in an outcome of a test variable value for the device under test (DUT) inside or outside the test limit. Overall, the probability of a "good" DUT being inside the test limit(s) and the probability of a "bad" DUT being outside the test limit(s) should be as high as possible. For this reason, when selecting the test variable and the test limit(s), the statistical nature of the test is accounted for.

The statistical nature depends on the type of requirement. Some have large statistical variations, while others are not statistical in nature at all. When testing a parameter with a statistical nature, a confidence level is set. This establishes the probability that a DUT passing the test actually meets the requirements and determines how many times a test has to be repeated and what the pass and fail criteria are. Those aspects are not covered by TS 36.133. The details of the tests on how many times to run it and how to establish confidence in the tests are described in TS 36.521-3 [23]. This Annex establishes the variable to be used in the test and whether it can be viewed as statistical in nature or not.

A.2.1 Types of requirements in TS 36.133

A.2.1.1 Time and delay requirements on UE higher layer actions

A very large part of the RRM requirements are delay requirements:

- In E-UTRAN RRC_IDLE state mobility (clause A.4) there is cell re-selection delay.
- In E-UTRAN RRC_CONNECTED state mobility (clauses A.5 and A.8) there is handover delay, cell search delay and measurement reporting delay.
- In RRC Connection Control (clause A.6) there is RRC re-establishment delay.

All have in common that the UE is required to perform an action observable in higher layers (e.g. camp on the correct cell) within a certain time after a specific event (e.g. when a new strong pilot or reference signal appears). The delay time is statistical in nature for several reasons, among others that several of the measurements are performed by the UE in a fading radio environment.

The variations make a strict limit unsuitable for a test. Instead there is a condition set for a correct action by the UE, e.g. that the UE shall camp on the correct cell within X seconds. Then the rate of correct events is observed during repeated tests and a limit is set on the rate of correct events, usually 90% correct events are required. How the limit is applied in the test depends on the confidence required, further detailed are in TS 36.521-3 [23].

A.2.1.2 Measurements of power levels, relative powers and time

A very large number of requirements are on measurements that the UE performs:

- In E-UTRAN RRC_CONNECTED state mobility (clause A.5) there are measurement reports.
- In Measurement Performance Requirements (clause A.9) there are requirements for all type of measurements.

The accuracy requirements on measurements are expressed in this specification as a fixed limit (e.g. +/-X dB), but the measurement error will have a distribution that is not easily confined in fixed limits. Assuming a Gaussian distribution of the error, the limits will have to be set at $\pm 3.29\sigma$ if the probability of failing a "good DUT" in a single test is to be kept at 0.1%. It is more reasonable to set the limit tighter and test the DUT by counting the rate of measurements that are within the limits, in a way similar to the requirements on delay.

A.2.1.3 Implementation requirements

A few requirements are strict actions the UE should take or capabilities the UE should have, without any allowance for deviations. These requirements are absolute and should be tested as such. Examples are:

- "Event triggered report rate" in E-UTRAN RRC_CONNECTED state mobility (clauses A.5 and A.8)
- "Correct behaviour at time-out" in RRC connection control (clause A.6)

A.2.1.4 Physical layer timing requirements

There are requirements on Timing and Signaling Characteristics (clauses A.7). There are both absolute and relative limits on timing accuracy depending upon the type of requirement. Examples are:

- Initial Transmit Timing (clause A.7.1) has an absolute limit on timing accuracy.
- Timing Advance (clause A.7.2) has a relative limit on timing accuracy.

A.3 RRM test configurations

A.3.1 Reference Measurement Channels

A.3.1.1 PDSCH

A.3.1.1.1 FDD

Table A.3.1.1.1-1: PDSCH Reference Measurement Channels for FDD

| Parameter | Unit | Value | | | | | | | | |
|--|------|------------|---|------------|------------|------------|------------|------------|------------|------------|
| | | R.2 FDD | | R.5 FDD | R.7 FDD | R.0 FDD | R.1 FDD | R.3 FDD | R.4 FDD | R.6 FDD |
| Reference channel | | | | | | | | | | |
| Channel bandwidth | MHz | 1.4 | 3 | 5 | 5 | 10 | 10 | 10 | 20 | 20 |
| Number of transmitter antennas | | 1 | | 1 | 1 | 1 | 2 | 1 | 1 | 1 |
| Allocated resource blocks (Note 4) | | 2 | | 11 | 11 | 24 | 24 | 24 | 24 | 24 |
| Allocated subframes per Radio Frame | | 10 | | 10 | 10 | 10 | 10 | 10 | 10 | 10 |
| Modulation | | QPS K | | QPS K | QPS K | QPS K | QPS K | QPS K | QPS K | QPS K |
| Target Coding Rate | | 1/3 | | 1/3 | 1/3 | 1/3 | 1/3 | 1/3 | 1/3 | 1/3 |
| Information Bit Payload | | | | | | | | | | |
| For Sub-Frames 4, 9 | Bits | 120 | | 968 | 968 | 2088 | 2088 | 2088 | 2088 | 2088 |
| For Sub-Frame 5 | Bits | 104 | | 776 | 776 | 2088 | 1736 | 2088 | 2088 | 2088 |
| For Sub-Frame 0 | Bits | 32 | | 616 | 616 | 1736 | 1736 | 1736 | 1736 | 1736 |
| For Sub-Frame 1, 2, 3, 6, 7, 8 | Bits | 0 | | 0 | 968 | 0 | 0 | 2088 | 0 | 2088 |
| Number of Code Blocks per Sub-Frame (Note 5) | | | | | | | | | | |

| | | | | | | | | | | |
|---|------|------|--|-------|-------|------|------|------|------|------|
| For Sub-Frames 4, 9 | | 1 | | 1 | 1 | 1 | 1 | 1 | 1 | 1 |
| For Sub-Frame 5 | | 1 | | 1 | 1 | 1 | 1 | 1 | 1 | 1 |
| For Sub-Frame 0 | | 1 | | 1 | 1 | 1 | 1 | 1 | 1 | 1 |
| For Sub-Frame 1, 2, 3, 6, 7, 8 | | 0 | | 0 | 1 | 0 | 0 | 1 | 0 | 1 |
| Binary Channel Bits Per Sub-Frame | | | | | | | | | | |
| For Sub-Frames 4, 9 | Bits | 456 | | 2772 | 2772 | 6624 | 6336 | 6624 | 6624 | 6624 |
| For Sub-Frame 5 | Bits | 360 | | 2484 | 2484 | 6336 | 6048 | 6336 | 6336 | 6336 |
| For Sub-Frame 0 | Bits | 176 | | 1932 | 1932 | 5784 | 5520 | 5784 | 5784 | 5784 |
| For Sub-Frame 1, 2, 3, 6, 7, 8 | Bits | 0 | | 0 | 2772 | 0 | 0 | 6624 | 0 | 6624 |
| Max. Throughput averaged over 1 frame | kbps | 37.6 | | 332.8 | 913.6 | 800 | 765 | 2053 | 800 | 2053 |
| <p>Note 1: 2 symbols allocated to PDCCH for 10 MHz channel BW. 4 symbols allocated to PDCCH for 1.4 MHz channel BW. 3 OFDM symbols allocated to PDCCH for 5 MHz channel BW.</p> <p>Note 2: Reference signal, synchronization signals and PBCH allocated as defined in 3GPP TS 36.211 [16].</p> <p>Note 3: If necessary the information bit payload size can be adjusted to facilitate the test implementation. The payload sizes are defined in 3GPP TS 36.213 [3].</p> <p>Note 4: Allocation is located in the middle of bandwidth.</p> <p>Note 5: If more than one Code Block is present, an additional CRC sequence of L = 24 Bits is attached to each Code Block (otherwise L = 0 Bit)</p> <p>Note 6: PDSCH allocation applies only to subframes not configured as PRS subframes.</p> | | | | | | | | | | |

A.3.1.1.2 TDD

Table A.3.1.1.2-1: PDSCH Reference Measurement Channels for TDD UL/DL configuration1

| Parameter | Unit | Value | | | | | |
|---|------|---------|---|---------|---------|---------|---------|
| | | R.2 TDD | | R.4 TDD | R.0 TDD | R.1 TDD | R.3 TDD |
| Reference channel | | | | | | | |
| Channel bandwidth | MHz | 1.4 | 3 | 5 | 10 | 10 | 20 |
| Number of transmitter antennas | | 1 | | 1 | 1 | 2 | 1 |
| Allocated resource blocks (Note 4) | | 2 | | 11 | 24 | 24 | 24 |
| Uplink-Downlink Configuration (Note 5) | | 1 | | 1 | 1 | 1 | 1 |
| Special Subframe Configuration (Note 6) | | 6 | | 6 | 6 | 6 | 6 |
| Allocated subframes per Radio Frame | | 6 | | 6 | 6 | 6 | 6 |
| Modulation | | QPSK | | QPSK | QPSK | QPSK | QPSK |
| Target Coding Rate | | 1/3 | | 1/3 | 1/3 | 1/3 | 1/3 |
| Information Bit Payload | | | | | | | |
| For Sub-Frames 4,9 | Bits | 120 | | 968 | 2088 | 2088 | 2088 |
| For Sub-Frame 5 | Bits | 104 | | 968 | 2088 | 2088 | 2088 |
| For Sub-Frame 0 | Bits | 56 | | 616 | 2088 | 1736 | 2088 |
| For Sub-Frame 1, 6 (DwPTS) | Bits | 56 | | 552 | 1032 | 1032 | 1032 |
| Number of Code Blocks per Sub-Frame (Note 7) | | 1 | | 1 | 1 | 1 | 1 |
| For Sub-Frames 4,9 | | 1 | | 1 | 1 | 1 | 1 |
| For Sub-Frame 5 | | 1 | | 1 | 1 | 1 | 1 |
| For Sub-Frame 0 | | 1 | | 1 | 1 | 1 | 1 |
| For Sub-Frame 1, 6 (DwPTS) | | 1 | | 1 | 1 | 1 | 1 |
| Binary Channel Bits Per Sub-Frame | | | | | | | |
| For Sub-Frames 4,9 | Bits | 456 | | 2772 | 6624 | 6336 | 6624 |
| For Sub-Frame 5 | Bits | 408 | | 2628 | 6480 | 6192 | 6480 |
| For Sub-Frame 0 | Bits | 224 | | 2076 | 5928 | 5664 | 5928 |
| For Sub-Frame 1, 6 (DwPTS) | Bits | 272 | | 1616 | 3696 | 3504 | 3696 |
| Max. Throughput averaged over 1 frame | Mbps | 0.051 | | 0.462 | 1.041 | 1.006 | 1.0416 |
| | | 2 | | 4 | 6 | 4 | |
| <p>Note 1: 2 symbols allocated to PDCCH for 10 MHz channel BW. 3 OFDM symbols allocated to PDCCH for 5MHz channel BW. 4 symbols allocated to PDCCH for 1.4 MHz channel BW. For special subframe (1 & 6) only 2 OFDM symbols are allocated to PDCCH for all bandwidths.</p> <p>Note 2: Reference signal, synchronization signals and PBCH allocated as defined in TS 36.211 [16].</p> <p>Note 3: If necessary the information bit payload size can be adjusted to facilitate the test implementation. The payload sizes are defined in TS 36.213 [3].</p> <p>Note 4: Allocation is located in the middle of bandwidth.</p> <p>Note 5: As per Table 4.2-2 in TS 36.211 [16]</p> <p>Note 6: As per Table 4.2-1 in TS 36.211 [16]</p> <p>Note 7: If more than one Code Block is present, an additional CRC sequence of L = 24 Bits is attached to each Code Block (otherwise L = 0 Bit)</p> | | | | | | | |

| |
|---|
| Note 8: PDSCH allocation applies only to subframes not configured as PRS subframes. |
|---|

Table A.3.1.1.2-2: PDSCH Reference Measurement Channels for TDD UL/DL configuration 0

| Parameter | Unit | Value | | | | | |
|--|---|-------|---|---|---------|----|----|
| | | | | | R.5 TDD | | |
| Reference channel | | | | | | | |
| Channel bandwidth | MHz | 1.4 | 3 | 5 | 10 | 10 | 20 |
| Number of transmitter antennas | | | | | 1 | | |
| Allocated resource blocks (Note 4) | | | | | 24 | | |
| Uplink-Downlink Configuration (Note 5) | | | | | 0 | | |
| Special Subframe Configuration (Note 6) | | | | | 6 | | |
| Allocated subframes per Radio Frame | | | | | 4 | | |
| Modulation | | | | | QPSK | | |
| Target Coding Rate | | | | | 1/3 | | |
| Information Bit Payload | | | | | | | |
| For Sub-Frames 4,9 | Bits | | | | N/A | | |
| For Sub-Frame 5 | Bits | | | | 2088 | | |
| For Sub-Frame 0 | Bits | | | | 2088 | | |
| For Sub-Frame 1, 6 (DwPTS) | Bits | | | | 1032 | | |
| Number of Code Blocks per Sub-Frame (Note 7) | | | | | 1 | | |
| For Sub-Frames 4,9 | | | | | N/A | | |
| For Sub-Frame 5 | | | | | 1 | | |
| For Sub-Frame 0 | | | | | 1 | | |
| For Sub-Frame 1, 6 (DwPTS) | | | | | 1 | | |
| Binary Channel Bits Per Sub-Frame | | | | | | | |
| For Sub-Frames 4,9 | Bits | | | | N/A | | |
| For Sub-Frame 5 | Bits | | | | 6480 | | |
| For Sub-Frame 0 | Bits | | | | 5928 | | |
| For Sub-Frame 1, 6 (DwPTS) | Bits | | | | 3696 | | |
| Max. Throughput averaged over 1 frame | Mbps | | | | 0.624 | | |
| Note 1: | 2 symbols allocated to PDCCH for 10 MHz channel BW. 3 OFDM symbols allocated to PDCCH for 5MHz channel BW. 4 symbols allocated to PDCCH for 1.4 MHz channel BW. For special subframe (1 & 6) only 2 OFDM symbols are allocated to PDCCH for all bandwidths. | | | | | | |
| Note 2: | Reference signal, synchronization signals and PBCH allocated as defined in TS 36.211 [16]. | | | | | | |
| Note 3: | If necessary the information bit payload size can be adjusted to facilitate the test implementation. The payload sizes are defined in TS 36.213 [3]. | | | | | | |
| Note 4: | Allocation is located in the middle of bandwidth. | | | | | | |
| Note 5: | As per Table 4.2-2 in TS 36.211 [16] | | | | | | |
| Note 6: | As per Table 4.2-1 in TS 36.211 [16] | | | | | | |
| Note 7: | If more than one Code Block is present, an additional CRC sequence of L = 24 Bits is attached to each Code Block (otherwise L = 0 Bit) | | | | | | |
| Note 8: | PDSCH allocation applies only to subframes not configured as PRS subframes. | | | | | | |

A.3.1.1.3 FDD for UE category 0

Table A.3.1.1.3-1: PDSCH Reference Measurement Channels for FDD

| Parameter | Unit | Value | | |
|-------------------------------------|------|----------|----------|----------|
| | | R.13 FDD | R.14 FDD | R.15 FDD |
| Reference channel | | | | |
| Channel bandwidth | MHz | 10 | 10 | 10 |
| Number of transmitter antennas | | 1 | 2 | 2 |
| Allocated resource blocks (Note 4) | | 24 | 24 | 24 |
| Allocated subframes per Radio Frame | | 10 | 10 | 10 |
| Modulation | | QPSK | QPSK | QPSK |
| Target Coding Rate | | 1/10 | 1/10 | 1/10 |
| Information Bit Payload | | | | |
| For Sub-Frames 4, 9 | Bits | 648 | 648 | 648 |
| For Sub-Frame 5 | Bits | 648 | 648 | 648 |
| For Sub-Frame 0 | Bits | 648 | 648 | 648 |
| For Sub-Frame 1, 2, 3, 6, 7, 8 | Bits | 0 | 0 | 648 |
| Number of Code Blocks per Sub-Frame | | | | |

| | | | | |
|---------------------------------------|--|-------|-------|------|
| (Note 5) | | | | |
| For Sub-Frames 4, 9 | | 1 | 1 | 1 |
| For Sub-Frame 5 | | 1 | 1 | 1 |
| For Sub-Frame 0 | | 1 | 1 | 1 |
| For Sub-Frame 1, 2, 3, 6, 7, 8 | | 0 | 0 | 1 |
| Binary Channel Bits Per Sub-Frame | | | | |
| For Sub-Frames 4, 9 | Bits | 6624 | 6336 | 6636 |
| For Sub-Frame 5 | Bits | 6336 | 6048 | 6408 |
| For Sub-Frame 0 | Bits | 5784 | 5520 | 5520 |
| For Sub-Frame 1, 2, 3, 6, 7, 8 | Bits | 0 | 0 | 6636 |
| Max. Throughput averaged over 1 frame | kbps | 259.2 | 259.2 | 648 |
| Note 1: | 2 symbols allocated to PDCCH for 10 MHz channel BW. 4 symbols allocated to PDCCH for 1.4 MHz channel BW. 3 OFDM symbols allocated to PDCCH for 5 MHz channel BW. | | | |
| Note 2: | Reference signal, synchronization signals and PBCH allocated as defined in 3GPP TS 36.211 [16]. | | | |
| Note 3: | If necessary the information bit payload size can be adjusted to facilitate the test implementation. The payload sizes are defined in 3GPP TS 36.213 [3]. | | | |
| Note 4: | Allocation is located in the middle of bandwidth. | | | |
| Note 5: | If more than one Code Block is present, an additional CRC sequence of L = 24 Bits is attached to each Code Block (otherwise L = 0 Bit) | | | |
| Note 6: | PDSCH allocation applies only to subframes not configured as PRS subframes. | | | |

A.3.1.1.4 HD-FDD for UE category 0

Table A.3.1.1.4-1: PDSCH Reference Measurement Channels for HD-FDD

| Parameter | Unit | R.1 HD-FDD | R.2 HD-FDD |
|--|--|------------|------------|
| Reference channel | | R.1 HD-FDD | R.2 HD-FDD |
| Channel bandwidth | MHz | 10 | 10 |
| Number of transmitter antennas | | 1 | 2 |
| Allocated resource blocks (Note 4) | | 24 | 24 |
| Allocated subframes per Radio Frame | | 10 | 10 |
| Modulation | | QPSK | QPSK |
| Target Coding Rate | | 1/10 | 1/10 |
| Information Bit Payload | | | |
| For Sub-Frames 4, 9, | Bits | 0 | 0 |
| For Sub-Frame 5 (Note 7) | Bits | 424 | 424 |
| For Sub-Frame 0 (Note 7) | Bits | 648 | 648 |
| For Sub-Frame 1, 2, 3, 6, 7, 8 | Bits | 0 | 0 |
| Number of Code Blocks per Sub-Frame (Note 5) | | | |
| For Sub-Frames 4, 9 | | 0 | 0 |
| For Sub-Frame 5 | | 1 | 1 |
| For Sub-Frame 0 | | 1 | 1 |
| For Sub-Frame 1, 2, 3, 6, 7, 8 | | 0 | 0 |
| Binary Channel Bits Per Sub-Frame | | | |
| For Sub-Frames 4, 9 | Bits | 0 | 0 |
| For Sub-Frame 5 | Bits | 6336 | 6048 |
| For Sub-Frame 0 | Bits | 5784 | 5520 |
| For Sub-Frame 1, 2, 3, 6, 7, 8 | Bits | 0 | 0 |
| Max. Throughput averaged over 1 frame | kbps | - | - |
| Note 1: | 2 symbols allocated to PDCCH for 10 MHz channel BW. 4 symbols allocated to PDCCH for 1.4 MHz channel BW. 3 OFDM symbols allocated to PDCCH for 5 MHz channel BW. | | |
| Note 2: | Reference signal, synchronization signals and PBCH allocated as defined in 3GPP TS 36.211 [16]. | | |
| Note 3: | If necessary the information bit payload size can be adjusted to facilitate the test implementation. The payload sizes are defined in 3GPP TS 36.213 [3]. | | |
| Note 4: | Allocation is located in the middle of bandwidth. | | |
| Note 5: | If more than one Code Block is present, an additional CRC sequence of L = 24 Bits is attached to each Code Block (otherwise L = 0 Bit) | | |
| Note 6: | PDSCH allocation applies only to subframes not configured as PRS subframes. | | |
| Note 7: | Sub-frame 0 or sub-frame 5 is randomly scheduled in downlink. | | |

A.3.1.1.5 TDD for UE category 0

Table A.3.1.1.5-1: PDSCH Reference Measurement Channels for TDD UL/DL configuration1

| Parameter | Unit | Value | |
|--|---|----------|----------|
| | | R.12 TDD | R.13 TDD |
| Reference channel | | | |
| Channel bandwidth | MHz | 10 | 10 |
| Number of transmitter antennas | | 1 | 2 |
| Allocated resource blocks (Note 4) | | 24 | 24 |
| Uplink-Downlink Configuration (Note 5) | | 1 | 1 |
| Special Subframe Configuration (Note 6) | | 6 | 6 |
| Allocated subframes per Radio Frame | | 6 | 6 |
| Modulation | | QPSK | QPSK |
| Target Coding Rate | | 1/10 | 1/10 |
| Information Bit Payload | | | |
| For Sub-Frames 4,9 | Bits | 648 | 648 |
| For Sub-Frame 5 | Bits | 648 | 648 |
| For Sub-Frame 0 | Bits | 648 | 648 |
| For Sub-Frame 1, 6 (DwPTS) | Bits | 488 | 488 |
| Number of Code Blocks per Sub-Frame (Note 7) | | 1 | 1 |
| For Sub-Frames 4,9 | | 1 | 1 |
| For Sub-Frame 5 | | 1 | 1 |
| For Sub-Frame 0 | | 1 | 1 |
| For Sub-Frame 1, 6 (DwPTS) | | 1 | 1 |
| Binary Channel Bits Per Sub-Frame | | | |
| For Sub-Frames 4,9 | Bits | 6624 | 6336 |
| For Sub-Frame 5 | Bits | 6580 | 6192 |
| For Sub-Frame 0 | Bits | 5928 | 5664 |
| For Sub-Frame 1, 6 (DwPTS) | Bits | 3696 | 3408 |
| Max. Throughput averaged over 1 frame | Mbps | 0.3552 | 0.3552 |
| Note 1: | 2 symbols allocated to PDCCH for 10 MHz channel BW. 3 OFDM symbols allocated to PDCCH for 5MHz channel BW. 4 symbols allocated to PDCCH for 1.4 MHz channel BW. For special subframe (1 & 6) only 2 OFDM symbols are allocated to PDCCH for all bandwidths. | | |
| Note 2: | Reference signal, synchronization signals and PBCH allocated as defined in TS 36.211 [16]. | | |
| Note 3: | If necessary the information bit payload size can be adjusted to facilitate the test implementation. The payload sizes are defined in TS 36.213 [3]. | | |
| Note 4: | Allocation is located in the middle of bandwidth. | | |
| Note 5: | As per Table 4.2-2 in TS 36.211 [16] | | |
| Note 6: | As per Table 4.2-1 in TS 36.211 [16] | | |
| Note 7: | If more than one Code Block is present, an additional CRC sequence of L = 24 Bits is attached to each Code Block (otherwise L = 0 Bit) | | |
| Note 8: | PDSCH allocation applies only to subframes not configured as PRS subframes. | | |

A.3.1.1.6 Frame Structure 3

Table A.3.1.1.6-1: PDSCH Reference Measurement Channels for FS 3

| Parameter | Unit | Value | |
|--|------|---------|---------------|
| | | R.0 FS3 | R.1 FS3 |
| Reference channel | | | |
| Channel bandwidth | MHz | 20 | 20 |
| Number of transmitter antennas | | 1 | 1 |
| Allocated resource blocks (Note 4) | | 24 | 24 |
| Allocated subframes per Radio Frame | | 10 | 10 |
| Modulation | | QPSK | QPSK |
| Target Coding Rate | | 1/3 | 1/3 |
| Information Bit Payload | | | |
| For Sub-Frames 4, 9 | Bits | 2088 | 2088 |
| For Sub-Frame 5 | Bits | 2088 | 2088 |
| For Sub-Frame 0 | Bits | 2088 | 2088 (Note 7) |
| For Sub-Frame 1, 2, 3, 6, 7, 8 | Bits | 2088 | 0 |
| Number of Code Blocks per Sub-Frame (Note 5) | | | |

| | | | | | | |
|--|------|--|--|--|------|------|
| For Sub-Frames 4, 9 | | | | | 1 | 1 |
| For Sub-Frame 5 | | | | | 1 | 1 |
| For Sub-Frame 0 | | | | | 1 | 1 |
| For Sub-Frame 1, 2, 3, 6, 7, 8 | | | | | 1 | 1 |
| Binary Channel Bits Per Sub-Frame | | | | | | |
| For Sub-Frames 4, 9 | Bits | | | | 6624 | 6624 |
| For Sub-Frame 5 | Bits | | | | 6336 | 6336 |
| For Sub-Frame 0 | Bits | | | | 6336 | 6336 |
| For Sub-Frame 1, 2, 3, 6, 7, 8 | Bits | | | | 6624 | 0 |
| Max. Throughput averaged over 1 frame | kbps | | | | 2088 | 2088 |
| <p>Note 1: 2 symbols allocated to PDCCH for 20 MHz channel BW.</p> <p>Note 2: Reference signal, synchronization signals allocated as defined in 3GPP TS 36.211 [16].</p> <p>Note 3: If necessary the information bit payload size can be adjusted to facilitate the test implementation. The payload sizes are defined in 3GPP TS 36.213 [3].</p> <p>Note 4: Allocation is located in the middle of bandwidth.</p> <p>Note 5: If more than one Code Block is present, an additional CRC sequence of L = 24 Bits is attached to each Code Block (otherwise L = 0 Bit)</p> <p>Note 6: PDSCH allocation applies only to subframes not configured as PRS subframes.</p> <p>Note 7: PDSCH allocation applies only to subframes where there is no DRS transmission</p> <p>Note 8: PDSCH is not transmitted in subframes where it is determined that transmission should not occur according to the listen before talk (LBT model).</p> <p>Note 9: Max throughput averaged over 1 frame does not account for missed PDSCH transmission due to LBT or DRS transmission</p> | | | | | | |

A.3.1.2 PCFICH/PDCCH/PHICH

A.3.1.2.1 FDD

Table A.3.1.2.1-1: PCFICH/PDCCH/PHICH Reference Channel for FDD

| Parameter | Unit | Value | | | | | | | | |
|--|---------|---------------|---------------|----------|----------|----------|----------|---------|---------|---------|
| | | R.8 FDD | R.14 FDD | R.11 FDD | R.12 FDD | R.10 FDD | R.13 FDD | R.6 FDD | R.7 FDD | R.9 FDD |
| Reference channel | | | | | | | | | | |
| Channel bandwidth | MHz | 1.4 | 1.4 | 5 | 5 | 20 | 20 | 10 | 10 | 10 |
| Number of transmitter antennas | | 1 | 1 | 1 | 2 | 1 | 2 | 1 | 2 | 2 |
| Control region OFDM symbols ^{Note1} | symbols | 4 | 3 | 3 | 3 | 2 | 2 | 2 | 2 | 3 |
| Aggregation level | CCE | 2 (Note 6) | 2 (Note 6) | 8 | 8 | 8 | 8 | 8 | 8 | 8 |
| DCI Format | | Note 3 | Note 3 | Note 3 | Note 3 | Note 3 | Note 3 | Note 3 | Note 3 | Note 3 |
| Cell ID | | Note 4 | Note 4 | Note 4 | Note 4 | Note 4 | Note 4 | Note 4 | Note 4 | Note 4 |
| Payload (without CRC) | Bits | Note 5 | Note 5 | Note 5 | Note 5 | Note 5 | Note 5 | Note 5 | Note 5 | Note 5 |
| <p>Note 1: The control region consists of PCFICH, PHICH and PDCCH.</p> <p>Note 2: DCI formats are defined in TS 36.212.</p> <p>Note 3: DCI format shall depend upon the test configuration.</p> <p>Note 4: Cell ID shall depend upon the test configuration.</p> <p>Note 5: Payload size shall depend upon the test configuration.</p> <p>Note 6: For PDCCH using SI/RA/P-RNTI, Aggregation level 4 is used.</p> | | | | | | | | | | |

A.3.1.2.2 TDD

Table A.3.1.2.2-1: PCFICH/PDCCH/PHICH Reference Channel for TDD

| Parameter | Unit | Value | | | | | | | | |
|--|---------|---------------|---------------|----------|----------|----------|----------|---------|---------|---------|
| | | R.8 TDD | R.14 TDD | R.11 TDD | R.12 TDD | R.10 TDD | R.13 TDD | R.6 TDD | R.7 TDD | R.9 TDD |
| Reference channel | | | | | | | | | | |
| Channel bandwidth | MHz | 1.4 | 1.4 | 5 | 5 | 20 | 20 | 10 | 10 | 10 |
| Number of transmitter antennas | | 1 | 1 | 1 | 2 | 1 | 2 | 1 | 2 | 2 |
| Control region OFDM symbols ^{Note1} | symbols | 4 (Note 6) | 3 (Note 6) | 3 | 3 | 2 | 2 | 2 | 2 | 3 |
| Aggregation level | CCE | 2 (Note 7) | 2 (Note 7) | 8 | 8 | 8 | 8 | 8 | 8 | 8 |

| | | | | | | | | | | |
|-----------------------|------|--|--------|--------|--------|--------|--------|--------|--------|--------|
| DCI Format | | Note 3 | Note 3 | Note 3 | Note 3 | Note 3 | Note 3 | Note 3 | Note 3 | Note 3 |
| Cell ID | | Note 4 | Note 4 | Note 4 | Note 4 | Note 4 | Note 4 | Note 4 | Note 4 | Note 4 |
| Payload (without CRC) | Bits | Note 5 | Note 5 | Note 5 | Note 5 | Note 5 | Note 5 | Note 5 | Note 5 | Note 5 |
| | | <p>Note 1: The control region consists of PCFICH, PHICH and PDCCH. Note 2: DCI formats are defined in TS 36.212. Note 3: DCI format shall depend upon the test configuration. Note 4: Cell ID shall depend upon the test configuration. Note 5: Payload size shall depend upon the test configuration. Note 6: Only 2 OFDM symbols for special subframes 1 and 6. Note 7: For PDCCH using SI/RA/P-RNTI, Aggregation level 4 is used.</p> | | | | | | | | |

A.3.1.2.3 HD-FDD for UE category 0

Table A.3.1.2.3-1: PCFICH/PDCCH/PHICH Reference Channel for HD-FDD

| Parameter | Unit | Value | | |
|---|---------|------------|------------|------------|
| | | R.3 HD-FDD | R.4 HD-FDD | R.5 HD-FDD |
| Reference channel | | | | |
| Channel bandwidth | MHz | 10 | 10 | 10 |
| Number of transmitter antennas | | 1 | 2 | 2 |
| Control region OFDM symbols ^{Note1} | symbols | 2 | 2 | 3 |
| Aggregation level | CCE | 8 | 8 | 8 |
| DCI Format | | Note 3 | Note 3 | Note 3 |
| Cell ID | | Note 4 | Note 4 | Note 4 |
| Payload (without CRC) | Bits | Note 5 | Note 5 | Note 5 |
| <p>Note 1: The control region consists of PCFICH, PHICH and PDCCH. Note 2: DCI formats are defined in TS 36.212. Note 3: DCI format shall depend upon the test configuration. Note 4: Cell ID shall depend upon the test configuration. Note 5: Payload size shall depend upon the test configuration. Note 6: For PDCCH using SI/RA/P-RNTI, Aggregation level 4 is used. Note 7: Sub-frame 0 or sub-frame 5 is randomly scheduled in downlink.</p> | | | | |

A.3.1.2.4 FS 3

Table A.3.1.2.4-1: PCFICH/PDCCH/PHICH Reference Channel for FS 3

| Parameter | Unit | Value | | | |
|--|---------|-------|----|----|---------|
| | | | | | R.0 FS3 |
| Reference channel | | | | | |
| Channel bandwidth | MHz | 10 | 10 | 10 | 20 |
| Number of transmitter antennas | | | | | 1 |
| Control region OFDM symbols ^{Note1} | symbols | | | | 2 |
| Aggregation level | CCE | | | | 8 |
| DCI Format | | | | | Note 3 |
| Cell ID | | | | | Note 4 |
| Payload (without CRC) | Bits | | | | Note 5 |
| <p>Note 1: The control region consists of PCFICH, PHICH and PDCCH. Note 2: DCI formats are defined in TS 36.212. Note 3: DCI format shall depend upon the test configuration. Note 4: Cell ID shall depend upon the test configuration. Note 5: Payload size shall depend upon the test configuration. Note 6: For PDCCH using SI/RA/P-RNTI, Aggregation level 4 is used. Note 7: PCFICH/PDCCH/PHICH allocation applies only to subframes where there is no DRS transmission Note 8: PCFICH/PDCCH/PHICH are not transmitted in subframes where it is determined that transmission should not occur according to the listen before talk (LBT model).</p> | | | | | |

A.3.1.3 MPDCCH Reference Channels for Cat-M1 UEs

A.3.1.3.1 FDD in CEModeA

Table A.3.1.3.1-1: MPDCCH Reference Channel for Cat-M1 FDD UEs in CEModeA

| Parameter | Unit | Value | | | |
|--|-------------|-----------------|-----------------|-----------------|-----------------|
| | | R.16 FDD | R.17 FDD | R.24 FDD | R.25 FDD |
| MPDCCH Reference channel | - | R.16 FDD | R.17 FDD | R.24 FDD | R.25 FDD |
| Carrier bandwidth | MHz | 10 | 10 | 5 | 5 |
| Number of transmitter antennas | - | 1 | 2 | 1 | 2 |
| DCI Format | - | 6-1A | 6-1A | 6-1A | 6-1A |
| Transmission Type | - | Distributed | Distributed | Distributed | Distributed |
| Number of PRB pairs per M-PDCCH set | - | 4 | 4 | 4 | 4 |
| Aggregation level | ECCE | 16 | 16 | 16 | 16 |
| Maximum number of repetitions | - | 8 | 8 | 8 | 8 |
| Frequency hopping | - | ON | ON | ON | ON |
| Number of narrowbands | - | 2 | 2 | 2 | 2 |
| MPDCCH Narrowband | - | 7 th | 7 th | 4 th | 4 th |
| Frequency HoppingOffset | narrowbands | 7 | 7 | 3 | 3 |
| MPDCCH start subframe | subframes | 1 | 1 | 1 | 1 |
| MPDCCH start symbol | symbols | 2 | 2 | 2 | 2 |
| Frequency hopping interval | subframes | 4 | 4 | 4 | 4 |
| Payload (without CRC) | Bits | Note 1 | Note 1 | Note 1 | Note 1 |
| Cell ID | - | Note 2 | Note 2 | Note 2 | Note 2 |
| Note 1: Payload size shall depend upon the test configuration. | | | | | |
| Note 2: Cell ID shall depend upon the test configuration. | | | | | |

A.3.1.3.2 HD-FDD in CEModeA

Table A.3.1.3.2-1: MPDCCH Reference Channel for Cat-M1 HD-FDD UEs in CEModeA

| Parameter | Unit | Value | | | |
|--|-------------|-----------------|-----------------|-----------------|-----------------|
| | | R.6 HD-FDD | R.7 HD-FDD | R.14 HD-FDD | R.15 HD-FDD |
| MPDCCH Reference channel | - | R.6 HD-FDD | R.7 HD-FDD | R.14 HD-FDD | R.15 HD-FDD |
| Carrier bandwidth | MHz | 10 | 10 | 5 | 5 |
| Number of transmitter antennas | - | 1 | 2 | 1 | 2 |
| DCI Format | - | 6-1A | 6-1A | 6-1A | 6-1A |
| Transmission Type | - | Distributed | Distributed | Distributed | Distributed |
| Number of PRB pairs per M-PDCCH set | - | 4 | 4 | 4 | 4 |
| Aggregation level | ECCE | 16 | 16 | 16 | 16 |
| Maximum number of repetitions | - | 8 | 8 | 8 | 8 |
| Frequency hopping | - | ON | ON | ON | ON |
| Number of narrowbands | - | 2 | 2 | 2 | 2 |
| MPDCCH Narrowband | - | 7 th | 7 th | 4 th | 4 th |
| Frequency HoppingOffset | narrowbands | 7 | 7 | 3 | 3 |
| MPDCCH start subframe | subframes | 1 | 1 | 1 | 1 |
| MPDCCH start symbol | symbols | 2 | 2 | 2 | 2 |
| Frequency hopping interval | subframes | 4 | 4 | 4 | 4 |
| Payload (without CRC) | Bits | Note 1 | Note 1 | Note 1 | Note 1 |
| Cell ID | - | Note 2 | Note 2 | Note 2 | Note 2 |
| Note 1: Payload size shall depend upon the test configuration. | | | | | |
| Note 2: Cell ID shall depend upon the test configuration. | | | | | |

A.3.1.3.3 TDD in CEModeA

Table A.3.1.3.3-1: MPDCCH Reference Channel for Cat-M1 TDD UEs in CEModeA

| Parameter | Unit | Value |
|-----------|------|-------|
|-----------|------|-------|

| | | | |
|--|-------------|-----------------|-----------------|
| MPDCCH Reference channel | - | R.14 TDD | R.15 TDD |
| Carrier bandwidth | MHz | 10 | 10 |
| Number of transmitter antennas | - | 1 | 2 |
| DCI Format | - | 6-1A | 6-1A |
| Transmission Type | - | Distributed | Distributed |
| Number of PRB pairs per M-PDCCH set | - | 4 | 4 |
| Aggregation level | ECCE | 16 | 16 |
| Maximum number of repetitions | - | 8 | 8 |
| Frequency hopping | - | ON | ON |
| Number of narrowbands | - | 2 | 2 |
| MPDCCH Narrowband | - | 7 th | 7 th |
| Frequency HoppingOffset | narrowbands | 7 | 7 |
| MPDCCH start subframe | subframes | 1 | 1 |
| MPDCCH start symbol | symbols | 2 | 2 |
| Frequency hopping interval | subframes | 10 | 10 |
| Payload (without CRC) | Bits | Note 1 | Note 1 |
| Cell ID | - | Note 2 | Note 2 |
| Note 1: Payload size shall depend upon the test configuration. | | | |
| Note 2: Cell ID shall depend upon the test configuration. | | | |

A.3.1.3.4 FDD in CEModeB

Table A.3.1.3.4-1: MPDCCH Reference Channel for Cat-M1 FDD UEs in CEModeB

| Parameter | Unit | Value | | | |
|---|-------------|-----------------|-----------------|-----------------|-----------------|
| | | R.18 FDD | R.19 FDD | R.26 FDD | R.27 FDD |
| MPDCCH Reference channel | - | R.18 FDD | R.19 FDD | R.26 FDD | R.27 FDD |
| Carrier bandwidth | MHz | 10 | 10 | 5 | 5 |
| Number of transmitter antennas | - | 1 | 2 | 1 | 2 |
| DCI Format | - | 6-1B | 6-1B | 6-1B | 6-1B |
| Transmission Type | - | Distributed | Distributed | Distributed | Distributed |
| Number of PRB pairs per M-PDCCH set | - | 6 | 6 | 6 | 6 |
| Aggregation level | ECCE | 24 | 24 | 24 | 24 |
| Maximum number of repetitions | - | 128 | 128 | 128 | 128 |
| Frequency hopping | - | ON | ON | ON | ON |
| Number of narrowbands | - | 2 | 2 | 2 | 2 |
| MPDCCH Narrowband | - | 7 th | 7 th | 4 th | 4 th |
| Frequency HoppingOffset | narrowbands | 7 | 7 | 3 | 3 |
| MPDCCH start subframe | subframes | 1 | 1 | 1 | 1 |
| MPDCCH start symbol | symbols | 2 | 2 | 2 | 2 |
| Frequency hopping interval | subframes | 8 | 8 | 8 | 8 |
| Payload (without CRC) | Bits | 18 | 18 | 17 | 17 |
| Cell ID | - | Note 1 | Note 1 | Note 1 | Note 1 |
| Note 1: Cell ID shall depend upon the test configuration. | | | | | |

A.3.1.3.5 HD-FDD in CEModeB

Table A.3.1.3.5-1: MPDCCH Reference Channel for Cat-M1 HD-FDD UEs in CEModeB

| Parameter | Unit | Value | | | |
|-------------------------------------|------|-------------|-------------|-------------|-------------|
| | | R.8 HD-FDD | R.9 HD-FDD | R.16 HD-FDD | R.17 HD-FDD |
| MPDCCH Reference channel | - | R.8 HD-FDD | R.9 HD-FDD | R.16 HD-FDD | R.17 HD-FDD |
| Carrier bandwidth | MHz | 10 | 10 | 5 | 5 |
| Number of transmitter antennas | - | 1 | 2 | 1 | 2 |
| DCI Format | - | 6-1B | 6-1B | 6-1B | 6-1B |
| Transmission Type | - | Distributed | Distributed | Distributed | Distributed |
| Number of PRB pairs per M-PDCCH set | - | 6 | 6 | 6 | 6 |
| Aggregation level | ECCE | 24 | 24 | 24 | 24 |

| | | | | | |
|---|-------------|-----------------|-----------------|-----------------|-----------------|
| Maximum number of repetitions | - | 128 | 128 | 128 | 128 |
| Frequency hopping | - | ON | ON | ON | ON |
| Number of narrowbands | - | 2 | 2 | 2 | 2 |
| MPDCCH Narrowband | - | 7 th | 7 th | 4 th | 4 th |
| Frequency HoppingOffset | narrowbands | 7 | 7 | 3 | 3 |
| MPDCCH start subframe | subframes | 1 | 1 | 1 | 1 |
| MPDCCH start symbol | symbols | 2 | 2 | 2 | 2 |
| Frequency hopping interval | subframes | 8 | 8 | 8 | 8 |
| Payload (without CRC) | Bits | 18 | 18 | 17 | 17 |
| Cell ID | - | Note 1 | Note 1 | Note 1 | Note 1 |
| Note 1: Cell ID shall depend upon the test configuration. | | | | | |

A.3.1.3.6 TDD in CEModeB

Table A.3.1.3.6-1: MPDCCH Reference Channel for Cat-M1 TDD UEs in CEModeB

| Parameter | Unit | Value | |
|---|-------------|-----------------|-----------------|
| | | R.16 TDD | R.17 TDD |
| MPDCCH Reference channel | - | R.16 TDD | R.17 TDD |
| Carrier bandwidth | MHz | 10 | 10 |
| Number of transmitter antennas | - | 1 | 2 |
| DCI Format | - | 6-1B | 6-1B |
| Transmission Type | - | Distributed | Distributed |
| Number of PRB pairs per M-PDCCH set | - | 6 | 6 |
| Aggregation level | ECCE | 24 | 24 |
| Maximum number of repetitions | - | 128 | 128 |
| Frequency hopping | - | ON | ON |
| Number of narrowbands | - | 2 | 2 |
| MPDCCH Narrowband | - | 7 th | 7 th |
| Frequency HoppingOffset | narrowbands | 7 | 7 |
| MPDCCH start subframe | subframes | 1 | 1 |
| MPDCCH start symbol | symbols | 2 | 2 |
| Frequency hopping interval | subframes | 20 | 20 |
| Payload (without CRC) | Bits | 18 | 18 |
| Cell ID | - | Note 1 | Note 1 |
| Note 1: Cell ID shall depend upon the test configuration. | | | |

A.3.1.4 PDSCH Reference Channel for Cat-M1 UEs

A.3.1.4.1 FDD in CEModeA

Table A.3.1.4.1-1: PDSCH Reference Channel for Cat-M1 FDD in CEModeA

| Parameter | Unit | Value | | | | | |
|--|-----------|----------|----------|----------|----------|----------|----------|
| | | R.20 FDD | R.21 FDD | R.28 FDD | R.29 FDD | R.32 FDD | R.33 FDD |
| PDSCH Reference channel | | R.20 FDD | R.21 FDD | R.28 FDD | R.29 FDD | R.32 FDD | R.33 FDD |
| Carrier bandwidth | MHz | 10 | 10 | 5 | 5 | 10 | 10 |
| Number of transmitter antennas | | 1 | 2 | 1 | 2 | 1 | 2 |
| Allocated resource blocks ^{Note1} | PRBs | 2 | 2 | 2 | 2 | 2 | 2 |
| Allocated subframes per Radio Frame | subframes | 10 | 10 | 10 | 10 | 10 | 10 |
| Modulation | | QPSK | QPSK | QPSK | QPSK | QPSK | QPSK |
| Target coding rate | | 1/3 | 1/3 | 1/3 | 1/3 | 1/3 | 1/3 |
| Information Bit Payload | | | | | | | |
| Sub-Frames 0 ~ 9 | Bits | 32 | 32 | 32 | 32 | 32 | 32 |
| Number of Code Blocks | | | | | | | |

| | | | | | | | |
|--|-------------|-----------------|-----------------|-----------------|-----------------|-----------------|-----------------|
| per Sub-Frame | | | | | | | |
| Sub-Frames 0 ~ 9 | | 1 | 1 | 1 | 1 | 1 | 1 |
| Maximum number of repetitions | | 16 | 16 | 16 | 16 | 1 | 1 |
| Frequency hopping | | ON | ON | ON | ON | ON | ON |
| Number of narrowbands for frequency hopping | narrowbands | 2 | 2 | 2 | 2 | 2 | 2 |
| PDSCH Narrowband | | 2 nd | 2 nd | 2 nd | 2 nd | 2 nd | 2 nd |
| Frequency HoppingOffset | narrowbands | 7 | 7 | 3 | 3 | 7 | 7 |
| PDSCH start symbol | symbols | 2 | 2 | 2 | 2 | 2 | 2 |
| Frequency hopping interval | subframes | 4 | 4 | 4 | 4 | 4 | 4 |
| Cell ID | | Note 2 | Note 2 | Note 2 | Note 2 | Note 2 | Note 2 |
| Note 1: Allocation is located in the middle of narrowband. | | | | | | | |
| Note 2: Cell ID shall depend upon the test configuration. | | | | | | | |

A.3.1.4.2 HD-FDD in CEModeA

Table A.3.1.4.2-1: PDSCH Reference Channel for Cat-M1 HD-FDD in CEModeA

| Parameter | Unit | Value | | | | | |
|--|-------------|-----------------|-----------------|-----------------|-----------------|-----------------|-----------------|
| | | R.10 HD-FDD | R.11 HD-FDD | R.18 HD-FDD | R.19 HD-FDD | R.24 HD-FDD | R.25 HD-FDD |
| PDSCH Reference channel | | | | | | | |
| Carrier bandwidth | MHz | 10 | 10 | 5 | 5 | 10 | 10 |
| Number of transmitter antennas | | 1 | 2 | 1 | 2 | 1 | 2 |
| Allocated resource blocks ^{Note1} | PRBs | 2 | 2 | 2 | 2 | 2 | 2 |
| Allocated subframes per Radio Frame | subframes | 10 | 10 | 10 | 10 | 10 | 10 |
| Modulation | | QPSK | QPSK | QPSK | QPSK | QPSK | QPSK |
| Target coding rate | | 1/3 | 1/3 | 1/3 | 1/3 | 1/3 | 1/3 |
| Information Bit Payload | | | | | | | |
| Sub-Frames 0 ~ 9 | Bits | 32 | 32 | 32 | 32 | 32 | 32 |
| Number of Code Blocks per Sub-Frame | | | | | | | |
| Sub-Frames 0 ~ 9 | | 1 | 1 | 1 | 1 | 1 | 1 |
| Maximum number of repetitions | | 16 | 16 | 16 | 16 | 1 | 1 |
| Frequency hopping | | ON | ON | ON | ON | ON | ON |
| Number of narrowbands for frequency hopping | narrowbands | 2 | 2 | 2 | 2 | 2 | 2 |
| PDSCH Narrowband | | 1 st | 1 st | 1 st | 1 st | 1 st | 1 st |
| Frequency HoppingOffset | narrowbands | 7 | 7 | 3 | 3 | 7 | 7 |
| PDSCH start symbol | symbols | 2 | 2 | 2 | 2 | 2 | 2 |
| Frequency hopping interval | subframes | 4 | 4 | 4 | 4 | 4 | 4 |
| Cell ID | | Note 2 | Note 2 | Note 2 | Note 2 | Note 2 | Note 2 |
| Note 1: Allocation is located in the middle of narrowband. | | | | | | | |
| Note 2: Cell ID shall depend upon the test configuration. | | | | | | | |

A.3.1.4.3 TDD in CEModeA

Table A.3.1.4.3-1: PDSCH Reference Channel for Cat-M1 TDD in CEModeA

| Parameter | Unit | Value | |
|--|------|----------|----------|
| | | R.16 TDD | R.17 TDD |
| PDSCH Reference channel | | | |
| Carrier bandwidth | MHz | 10 | 10 |
| Number of transmitter antennas | | 1 | 2 |
| Allocated resource blocks ^{Note1} | PRBs | 2 | 2 |

| | | | |
|--|-------------|-----------------|-----------------|
| Allocated subframes per Radio Frame | | 4 | 4 |
| TDD Uplink-Downlink Configuration | | 0 | 0 |
| TDD Special Subframe Configuration | | 6 | 6 |
| Modulation | | QPSK | QPSK |
| Target coding rate | | 1/3 | 1/3 |
| Information Bit Payload | | | |
| All Sub-Frames except 1, 6 (TDD) | Bits | 32 | 32 |
| All Sub-Frames except 1, 6 (TDD DwPTS) | - | 0 | 0 |
| Number of Code Blocks per Sub-Frame | | 1 | 1 |
| All Sub-Frames except 1, 6 (TDD) | | 1 | 1 |
| All Sub-Frames except 1, 6 (TDD DwPTS) | | 0 | 0 |
| Maximum number of repetitions | | 16 | 16 |
| Frequency hopping | | ON | ON |
| Number of narrowbands for frequency hopping | | 2 | 2 |
| PDSCH Narrowband | | 2 nd | 2 nd |
| Frequency HoppingOffset | narrowbands | 7 | 7 |
| PDSCH start symbol | symbols | 2 | 2 |
| Frequency hopping interval | subframes | 10 | 10 |
| Cell ID | | Note 2 | Note 2 |
| Note 1: Allocation is located in the middle of narrowband. | | | |
| Note 2: Cell ID shall depend upon the test configuration. | | | |

A.3.1.4.4 FDD in CEModeB

Table A.3.1.4.4-1: PDSCH Reference Channel for Cat-M1 FDD in CEModeB

| Parameter | Unit | Value | | | |
|--|-------------|-----------------|-----------------|-----------------|-----------------|
| | | R.22 FDD | R.23 FDD | R.30 FDD | R.31 FDD |
| PDSCH Reference channel | | R.22 FDD | R.23 FDD | R.30 FDD | R.31 FDD |
| Carrier bandwidth | MHz | 10 | 10 | 5 | 5 |
| Number of transmitter antennas | | 1 | 2 | 1 | 2 |
| Allocated resource blocks ^{Note1} | | 2 | 2 | 2 | 2 |
| Allocated subframes per Radio Frame | - | 10 | 10 | 10 | 10 |
| Modulation | - | QPSK | QPSK | QPSK | QPSK |
| Target coding rate | - | 1/3 | 1/3 | 1/3 | 1/3 |
| Information Bit Payload | | | | | |
| Sub-Frames 0 ~ 9 | Bits | 32 | 32 | 32 | 32 |
| Number of Code Blocks per Sub-Frame | | | | | |
| Sub-Frames 0 ~ 9 | - | 1 | 1 | 1 | 1 |
| Maximum number of repetitions | - | 192 | 192 | 192 | 192 |
| Frequency hopping | - | ON | ON | ON | ON |
| Number of narrowbands for frequency hopping | narrowbands | 2 | 2 | 2 | 2 |
| PDSCH Narrowband | - | 2 nd | 2 nd | 2 nd | 2 nd |
| Frequency HoppingOffset | narrowbands | 7 | 7 | 3 | 3 |
| PDSCH start symbol | symbols | 2 | 2 | 2 | 2 |
| Frequency hopping interval | subframes | 8 | 8 | 8 | 8 |
| Cell ID | | Note 2 | Note 2 | Note 2 | Note 2 |
| Note 1: Allocation is located in the middle of narrowband. | | | | | |
| Note 2: Cell ID shall depend upon the test configuration. | | | | | |

A.3.1.4.5 HD-FDD in CEModeB

Table A.3.1.4.5-1: PDSCH Reference Channel for Cat-M1 HD-FDD in CEModeB

| Parameter | Unit | Value | | | |
|--|-------------|-----------------|-----------------|-----------------|-----------------|
| | | R.12 HD-FDD | R.13 HD-FDD | R.20 HD-FDD | R.21 HD-FDD |
| PDSCH Reference channel | | | | | |
| Carrier bandwidth | MHz | 10 | 10 | 5 | 5 |
| Number of transmitter antennas | | 1 | 2 | 1 | 2 |
| Allocated resource blocks ^{Note1} | PRBs | 2 | 2 | 2 | 2 |
| Allocated subframes per Radio Frame | subframes | 10 | 10 | 10 | 10 |
| Modulation | | QPSK | QPSK | QPSK | QPSK |
| Target coding rate | | 1/3 | 1/3 | 1/3 | 1/3 |
| Information Bit Payload | | | | | |
| Sub-Frames 0 ~ 9 | Bits | 32 | 32 | 32 | 32 |
| Number of Code Blocks per Sub-Frame | | | | | |
| Sub-Frames 0 ~ 9 | | 1 | 1 | 1 | 1 |
| Maximum number of repetitions | | 192 | 192 | 192 | 192 |
| Frequency hopping | | ON | ON | ON | ON |
| Number of narrowbands for frequency hopping | narrowbands | 2 | 2 | 2 | 2 |
| PDSCH Narrowband | | 1 st | 1 st | 1 st | 1 st |
| Frequency HoppingOffset | narrowbands | 7 | 7 | 3 | 3 |
| PDSCH start symbol | symbols | 2 | 2 | 2 | 2 |
| Frequency hopping interval | subframes | 8 | 8 | 8 | 8 |
| Cell ID | | Note 2 | Note 2 | Note 2 | Note 2 |
| Note 1: Allocation is located in the middle of narrowband. | | | | | |
| Note 2: Cell ID shall depend upon the test configuration. | | | | | |

A.3.1.4.6 TDD in CEModeB

Table A.3.1.4.6-1: PDSCH Reference Channel for Cat-M1 TDD in CEModeB

| Parameter | Unit | Value | |
|--|-------------|-----------------|-----------------|
| | | R.18 TDD | R.19 TDD |
| PDSCH Reference channel | | | |
| Carrier bandwidth | MHz | 10 | 10 |
| Number of transmitter antennas | | 1 | 2 |
| Allocated resource blocks ^{Note1} | PRBs | 2 | 2 |
| Allocated subframes per Radio Frame | | 4 | 4 |
| TDD Uplink-Downlink Configuration | | 0 | 0 |
| TDD Special Subframe Configuration | | 6 | 6 |
| Modulation | | QPSK | QPSK |
| Target coding rate | | 1/3 | 1/3 |
| Information Bit Payload | | | |
| All Sub-Frames except 1, 6 (TDD) | Bits | 32 | 32 |
| All Sub-Frames except 1, 6 (TDD DwPTS) | - | 0 | 0 |
| Number of Code Blocks per Sub-Frame | | 1 | 1 |
| All Sub-Frames except 1, 6 (TDD) | | 1 | 1 |
| All Sub-Frames except 1, 6 (TDD DwPTS) | | 0 | 0 |
| Maximum number of repetitions | | 192 | 192 |
| Frequency hopping | | ON | ON |
| Number of narrowbands for frequency hopping | | 2 | 2 |
| PDSCH Narrowband | | 2 nd | 2 nd |
| Frequency HoppingOffset | narrowbands | 7 | 7 |
| PDSCH start symbol | symbols | 2 | 2 |
| Frequency hopping interval | subframes | 20 | 20 |
| Cell ID | | Note 2 | Note 2 |
| Note 1: Allocation is located in the middle of narrowband. | | | |
| Note 2: Cell ID shall depend upon the test configuration. | | | |

A.3.1.5 NPDSCH Reference Channel for UE category NB1

A.3.1.5.1 HD-FDD in-band operation

Table A.3.1.5.1-1: NPDSCH Reference Channel for UE category NB1 for in-band operation

| Parameter | Unit | Value | |
|---|-----------|----------------------|----------------------|
| NPDSCH Reference channel | - | R.14 HD-FDD | R.15 HD-FDD |
| LTE Carrier bandwidth | MHz | 10 | 10 |
| Allocated resource blocks | PRB | 1 | 1 |
| Number of transmitter antennas | - | 1 | 2 |
| Allocated subframes per Radio Frame | subframes | Note 1 | Note 1 |
| Modulation | | QPSK | QPSK |
| Target coding rate | | 1/3 | 1/3 |
| Information Bit Payload | | | |
| For Sub-Frame 1, 2, 3, 6, 7, 8 | Bits | 40 ^{Note 2} | 40 ^{Note 2} |
| For Sub-Frame 4, 9 | Bits | Note 3 | Note 3 |
| For Sub-Frame 0, 5 | Bits | 0 | 0 |
| Number of Code Blocks per Sub-Frame | | | |
| For Sub-Frame 1, 2, 3, 6, 7, 8 | | 1 ^{Note 4} | 1 ^{Note 4} |
| For Sub-Frame 4, 9 | | Note 5 | Note 5 |
| For Sub-Frame 0, 5 | | 0 | 0 |
| Maximum number of repetitions | - | Note 6 | Note 6 |
| NPDCCH start symbol | symbols | 3 | 3 |
| Cell ID | - | Note 7 | Note 7 |
| Note 1: Shall depend upon the NPDSCH scheduling. Note 2: Only apply for subframes scheduled with NPDSCH. Note 3: 40 for subframes scheduled with NPDSCH when $n_f \bmod 2 \neq 0$. Otherwise 0. Note 4: Only apply for subframes scheduled with NPDSCH. Note 5: 1 for subframes scheduled with NPDSCH when $n_f \bmod 2 \neq 0$. Otherwise 0. Note 6: Maximum number of repetitions shall depend upon the test configuration. Note 7: Cell ID shall depend upon the test configuration. | | | |

A.3.1.5.2 Void

A.3.1.5.3 HD-FDD standalone operation

Table A.3.1.5.3-1: NPDSCH Reference Channel for UE category NB1 for standalone operation

| Parameter | Unit | Value | |
|-------------------------------------|-----------|----------------------|----------------------|
| NPDSCH Reference channel | - | R.18 HD-FDD | R.19 HD-FDD |
| Channel bandwidth | KHz | 200 | 200 |
| Number of transmitter antennas | - | 1 | 2 |
| Allocated subframes per Radio Frame | subframes | Note 1 | Note 1 |
| Modulation | | QPSK | QPSK |
| Target coding rate | | 1/3 | 1/3 |
| Information Bit Payload | | | |
| For Sub-Frame 1, 2, 3, 6, 7, 8 | Bits | 72 ^{Note 2} | 72 ^{Note 2} |
| For Sub-Frame 4, 9 | Bits | Note 3 | Note 3 |
| For Sub-Frame 0, 5 | Bits | 0 | 0 |
| Number of Code Blocks per Sub-Frame | | | |
| For Sub-Frame 1, 2, 3, 6, 7, 8 | | 1 ^{Note 4} | 1 ^{Note 4} |
| For Sub-Frame 4, 9 | | Note 5 | Note 5 |
| For Sub-Frame 0, 5 | | 0 | 0 |
| Maximum number of repetitions | - | Note 6 | Note 6 |

| | | | |
|---------|---|--------|--------|
| Cell ID | - | Note 7 | Note 7 |
| Note 1: | Shall depend upon the NPDSCH scheduling. | | |
| Note 2: | Only apply for subframes scheduled with NPDSCH. | | |
| Note 3: | 72 for subframes scheduled with NPDSCH when $n_f \bmod 2 \neq 0$. Otherwise 0. | | |
| Note 4: | only apply for subframes scheduled with NPDSCH.. | | |
| Note 5: | 1 for subframes scheduled with NPDSCH when $n_f \bmod 2 \neq 0$. Otherwise 0. | | |
| Note 6: | Maximum number of repetitions shall depend upon the test configuration. | | |
| Note 7: | Cell ID shall depend upon the test configuration. | | |

A.3.1.5.4 Void

A.3.1.5.5 HD-FDD guard band operation

Table A.3.1.5.5-1: NPDSCH Reference Channel for UE category NB1 for guard band operation

| Parameter | Unit | Value | |
|--------------------------------------|---|----------------------|----------------------|
| NPDSCH Reference channel | - | R.22 HD-FDD | R.23 HD-FDD |
| LTE Carrier bandwidth | MHz | 10 | 10 |
| Allocated resource blocks for NB-IoT | PRB | 1 | 1 |
| Number of transmitter antennas | - | 1 | 2 |
| Allocated subframes per Radio Frame | subframes | Note 1 | Note 1 |
| Modulation | | QPSK | QPSK |
| Target coding rate | | 1/3 | 1/3 |
| Information Bit Payload | | | |
| For Sub-Frame 1, 2, 3, 6, 7, 8 | Bits | $72^{\text{Note 2}}$ | $72^{\text{Note 2}}$ |
| For Sub-Frame 4, 9 | Bits | Note 3 | Note 3 |
| For Sub-Frame 0, 5 | Bits | 0 | 0 |
| Number of Code Blocks per Sub-Frame | | | |
| For Sub-Frame 1, 2, 3, 6, 7, 8 | | $1^{\text{Note 4}}$ | $1^{\text{Note 4}}$ |
| For Sub-Frame 4, 9 | | Note 5 | Note 5 |
| For Sub-Frame 0, 5 | | 0 | 0 |
| Maximum number of repetitions | - | Note 6 | Note 6 |
| Cell ID | - | Note 7 | Note 7 |
| Note 1: | Shall depend upon the NPDSCH scheduling. | | |
| Note 2: | Only apply for subframes scheduled with NPDSCH. | | |
| Note 3: | 72 for subframes scheduled with NPDSCH when $n_f \bmod 2 \neq 0$. Otherwise 0. | | |
| Note 4: | Only apply for subframes scheduled with NPDSCH. | | |
| Note 5: | 1 for subframes scheduled with NPDSCH when $n_f \bmod 2 \neq 0$. Otherwise 0. | | |
| Note 6: | Maximum number of repetitions shall depend upon the test configuration. | | |
| Note 7: | Cell ID shall depend upon the test configuration. | | |

A.3.1.5.6 Void

A.3.1.6 NPDCCH Reference Channel for UE category NB1

A.3.1.6.1 HD-FDD in-band operation

Table A.3.1.6.1-1: NPDCCH Reference Channel for UE category NB1 for in-band operation

| Parameter | Unit | Value | | | |
|--|------|-------------|-------------|-------------|-------------|
| NPDCCH Reference channel | - | R.26 HD-FDD | R.27 HD-FDD | R.28 HD-FDD | R.29 HD-FDD |
| LTE Carrier bandwidth | MHz | 10 | 10 | 10 | 10 |
| Allocated resource blocks ^{Note1} | PRB | 1 | 1 | 1 | 1 |
| Number of transmitter antennas | - | 1 | 2 | 1 | 2 |
| DCI Format | - | N1 | N1 | N0 | N0 |

| | | | | | |
|---|---------|--------|--------|--------|--------|
| Aggregation level | NCCE | 2 | 2 | 2 | 2 |
| Maximum number of repetitions | - | Note 2 | Note 2 | Note 2 | Note 2 |
| NPDCCH start symbol | symbols | 3 | 3 | 3 | 3 |
| Payload (without CRC) | Bits | Note 3 | Note 3 | Note 3 | Note 3 |
| Cell ID | - | Note 4 | Note 4 | Note 4 | Note 4 |
| <p>Note 1: Allocation is located in the middle of narrowband.</p> <p>Note 2: Maximum number of repetitions shall depend upon the test configuration.</p> <p>Note 3: Payload size shall depend upon the test configuration.</p> <p>Note 4: Cell ID shall depend upon the test configuration.</p> | | | | | |

A.3.1.6.2 Void

A.3.1.6.3 HD-FDD standalone operation

Table A.3.1.6.3-1: NPDCCH Reference Channel for UE category NB1 for standalone operation

| Parameter | Unit | Value | | | |
|---|------|-------------|-------------|-------------|-------------|
| NPDCCH Reference channel | - | R.30 HD-FDD | R.31 HD-FDD | R.32 HD-FDD | R.33 HD-FDD |
| Channel bandwidth | KHz | 200 | 200 | 200 | 200 |
| Number of transmitter antennas | - | 1 | 2 | 1 | 2 |
| DCI Format | - | N1 | N1 | N0 | N0 |
| Aggregation level | NCCE | 2 | 2 | 2 | 2 |
| Maximum number of repetitions | - | Note 2 | Note 2 | Note 2 | Note 2 |
| Payload (without CRC) | Bits | Note 3 | Note 3 | Note 3 | Note 3 |
| Cell ID | - | Note 4 | Note 4 | Note 4 | Note 4 |
| <p>Note 1: Allocation is located in the middle of narrowband.</p> <p>Note 2: Maximum number of repetitions shall depend upon the test configuration.</p> <p>Note 3: Payload size shall depend upon the test configuration.</p> <p>Note 4: Cell ID shall depend upon the test configuration.</p> | | | | | |

A.3.1.6.4 Void

A.3.1.6.5 HD-FDD guard band operation

Table A.3.1.6.5-1: NPDCCH Reference Channel for UE category NB1 for guard band operation

| Parameter | Unit | Value | | | |
|---|------|-------------|-------------|-------------|-------------|
| NPDCCH Reference channel | - | R.34 HD-FDD | R.35 HD-FDD | R.36 HD-FDD | R.37 HD-FDD |
| LTE Carrier bandwidth | MHz | 10 | 10 | 10 | 10 |
| Allocated resource blocks for NB- IoT ^{Note1} | PRB | 1 | 1 | 1 | 1 |
| Number of transmitter antennas | - | 1 | 2 | 1 | 2 |
| DCI Format | - | N1 | N1 | N0 | N0 |
| Aggregation level | NCCE | 2 | 2 | 2 | 2 |
| Maximum number of repetitions | - | Note 2 | Note 2 | Note 2 | Note 2 |
| Payload (without CRC) | Bits | Note 3 | Note 3 | Note 3 | Note 3 |
| Cell ID | - | Note 4 | Note 4 | Note 4 | Note 4 |
| <p>Note 1: Allocation is located in the middle of narrowband.</p> <p>Note 2: Maximum number of repetitions shall depend upon the test configuration.</p> <p>Note 3: Payload size shall depend upon the test configuration.</p> <p>Note 4: Cell ID shall depend upon the test configuration.</p> | | | | | |

A.3.1.6.6 Void

A.3.2 OFDMA Channel Noise Generator (OCNG)

A.3.2.1 OCNG Patterns for FDD

The following OCNG patterns are used for modelling allocations to virtual UEs (which are not under test) and/or allocations used for MBSFN. The OCNG pattern for each sub frame specifies the allocations that shall be filled with OCNG, and furthermore, the relative power level of each such allocation.

In each test case the OCNG is expressed by parameters OCNG_RA and OCNG_RB which together with a relative power level (γ) specifies the PDSCH EPRE-to-RS EPRE ratios in OFDM symbols without and with reference symbols, respectively. The relative power, which is used for modelling boosting per virtual UE allocation, is expressed by:

$$\gamma_i = PDSCH_i_RA / OCNG_RA = PDSCH_i_RB / OCNG_RB,$$

where γ_i denotes the relative power level of the i :th virtual UE. The parameter settings of OCNG_RA, OCNG_RB, and the set of relative power levels γ are chosen such that when also taking allocations to the UE under test into account, as given by a PDSCH reference channel, a constant transmitted power spectral density that is constant on an OFDM symbol basis is targeted.

Moreover the OCNG pattern is accompanied by a PCFICH/PDCCH/PHICH reference channel which specifies the control region. The number of PDCCH OFDM symbols in the non-MBSFN subframes is the same as specified in the RMC used in the test. The number of PDCCH OFDM symbols in the MBSFN subframe is the maximal allowed according to TS 36.213 [16]. For any aggregation and PHICH allocation, the PDCCH and any unused PHICH groups are padded with resource element groups with a power level given by PDCCH_RA/RB and PHICH_RA/RB as specified in the test case such that a total power spectral density in the control region that is constant on an OFDM symbol basis is targeted.

For subframes configured as PRS subframes the PDSCH allocation defined in the OCNG pattern does not apply.

For subframes configured as ABS subframes the PDSCH and PMCH allocation defined in the OCNG pattern does not apply.

The system information is scheduled in the allocations reserved for the OCNG patterns, in the subframes not configured for MBSFN. For this purpose the number of the RB-s allocated with PDSCH defined in the OCNG pattern can be reduced as necessary.

A.3.2.1.1 OCNG FDD pattern 1: outer resource blocks allocation in 10 MHz

Table A.3.2.1.1-1: OP.1 FDD: OCNG FDD Pattern 1

| Allocation n_{PRB} | Relative power level γ_{PRB} [dB] | | | | PDSCH Data | PMCH Data |
|--|--|-----|-----|----------|---------------|--------------|
| | Subframe | | | | | |
| | 0 | 5 | 4,9 | 1-3, 6-8 | | |
| 0 – 12 | 0 | 0 | 0 | N/A | Note 1 | N/A |
| 37 – 49 | 0 | 0 | 0 | N/A | | |
| 0-49 | N/A | N/A | N/A | Note 4 | N/A | Note 2 |
| <p>Note 1: These physical resource blocks are assigned to an arbitrary number of virtual UEs with one PDSCH per virtual UE; the data transmitted over the OCNG PDSCHs shall be uncorrelated pseudo random data, which is QPSK modulated. The parameter γ_{PRB} is used to scale the power of PDSCH.</p> <p>Note 2: Each physical resource block (PRB) is assigned to MBSFN transmission. The data in each PRB shall be uncorrelated with data in other PRBs over the period of any measurement. The MBSFN data shall be QPSK modulated. PMCH symbols shall not contain cell-specific Reference Signals. PMCH subframes shall contain cell-specific</p> | | | | | | |

Reference Signals only in the first symbol of the first time slot. The parameter γ_{PRB} is used to scale the power of PMCH.

Note 3: If two or more transmit antennas with CRS are used in the test, the PDSCH part of OCNG shall be transmitted to the virtual users by all the transmit antennas with CRS and according to the antenna transmission mode 2. The parameter γ_{PRB} applies to each antenna port separately, so the transmit power of the PDSCH part of OCNG is equal between all the transmit antennas with CRS used in the test. The antenna transmission modes are specified in clause 7.1 in TS 36.213.

Note 4: 0dB for 1 transmit antenna with CRS, +3dB for 2 transmit antennas with CRS

N/A: Not Applicable

A.3.2.1.2 OCNG FDD pattern 2: full bandwidth allocation in 10 MHz

Table A.3.2.1.2-1: OP.2 FDD: OCNG FDD Pattern 2

| Allocation n_{PRB} | Relative power level γ_{PRB} [dB] | | | | PDSCH Data | PMCH Data |
|--|--|-----|------|----------|------------|-----------|
| | Subframe | | | | | |
| | 0 | 5 | 4, 9 | 1-3, 6-8 | | |
| 0-49 | 0 | 0 | 0 | N/A | Note 1 | N/A |
| 0-49 | N/A | N/A | N/A | Note 4 | N/A | Note 2 |
| <p>Note 1: These physical resource blocks are assigned to an arbitrary number of virtual UEs with one PDSCH per virtual UE; the data transmitted over the OCNG PDSCHs shall be uncorrelated pseudo random data, which is QPSK modulated. The parameter γ_{PRB} is used to scale the power of PDSCH.</p> <p>Note 2: Each physical resource block (PRB) is assigned to MBSFN transmission. The data in each PRB shall be uncorrelated with data in other PRBs over the period of any measurement. The MBSFN data shall be QPSK modulated. PMCH subframes shall contain cell-specific Reference Signals only in the first symbol of the first time slot. The parameter γ_{PRB} is used to scale the power of PMCH.</p> <p>Note 3: If two or more transmit antennas with CRS are used in the test, the PDSCH part of OCNG shall be transmitted to the virtual users by all the transmit antennas with CRS and according to the antenna transmission mode 2. The parameter γ_{PRB} applies to each antenna port separately, so the transmit power of the PDSCH part of OCNG is equal between all the transmit antennas with CRS used in the test. The antenna transmission modes are specified in clause 7.1 in TS 36.213.</p> <p>Note 4: 0dB for 1 transmit antenna with CRS, +3dB for 2 transmit antennas with CRS</p> <p>N/A: Not Applicable</p> | | | | | | |

A.3.2.1.3 OCNG FDD pattern 3: outer resource blocks allocation in 1.4 MHz

Table A.3.2.1.3-1: OP.3 FDD: OCNG FDD Pattern 3

| Allocation n_{PRB} | Relative power level γ_{PRB} [dB] | | | | PDSCH Data | PMCH Data |
|--|--|-----|-----|----------|------------|-----------|
| | Subframe | | | | | |
| | 0 | 5 | 4,9 | 1-3, 6-8 | | |
| 0-1 | 0 | 0 | 0 | N/A | Note 1 | N/A |
| 4-5 | 0 | 0 | 0 | N/A | | |
| 0-5 | N/A | N/A | N/A | Note 4 | N/A | Note 2 |
| <p>Note 1: These physical resource blocks are assigned to an arbitrary number of virtual UEs with one PDSCH per virtual UE; the data transmitted over the OCNG PDSCHs shall be uncorrelated pseudo random data, which is QPSK modulated. The parameter</p> | | | | | | |

| | |
|---------------------|---|
| | γ_{PRB} is used to scale the power of PDSCH. |
| Note 2: | Each physical resource block (PRB) is assigned to MBSFN transmission. The data in each PRB shall be uncorrelated with data in other PRBs over the period of any measurement. The MBSFN data shall be QPSK modulated. PMCH symbols shall not contain cell-specific Reference Signals. PMCH subframes shall contain cell-specific Reference Signals only in the first symbol of the first time slot. The parameter γ_{PRB} is used to scale the power of PMCH. |
| Note 3: | If two or more transmit antennas with CRS are used in the test, the PDSCH part of OCNG shall be transmitted to the virtual users by all the transmit antennas with CRS and according to the antenna transmission mode 2. The parameter γ_{PRB} applies to each antenna port separately, so the transmit power of the PDSCH part of OCNG is equal between all the transmit antennas with CRS used in the test. The antenna transmission modes are specified in clause 7.1 in TS 36.213. |
| Note 4: | 0dB for 1 transmit antenna with CRS, +3dB for 2 transmit antennas with CRS |
| N/A: Not Applicable | |

A.3.2.1.4 OCNG FDD pattern 4: full bandwidth allocation in 1.4 MHz

Table A.3.2.1.4-1: OP.4 FDD: OCNG FDD Pattern 4

| Allocation n_{PRB} | Relative power level γ_{PRB} [dB] | | | | PDSCH Data | PMCH Data |
|--|--|-----|------|----------|------------|-----------|
| | Subframe | | | | | |
| | 0 | 5 | 4, 9 | 1-3, 6-8 | | |
| 0-5 | 0 | 0 | 0 | N/A | Note 1 | N/A |
| 0-5 | N/A | N/A | N/A | Note 4 | N/A | Note 2 |
| <p>Note 1: These physical resource blocks are assigned to an arbitrary number of virtual UEs with one PDSCH per virtual UE; the data transmitted over the OCNG PDSCHs shall be uncorrelated pseudo random data, which is QPSK modulated. The parameter γ_{PRB} is used to scale the power of PDSCH.</p> <p>Note 2: Each physical resource block (PRB) is assigned to MBSFN transmission. The data in each PRB shall be uncorrelated with data in other PRBs over the period of any measurement. The MBSFN data shall be QPSK modulated. PMCH subframes shall contain cell-specific Reference Signals only in the first symbol of the first time slot. The parameter γ_{PRB} is used to scale the power of PMCH.</p> <p>Note 3: If two or more transmit antennas with CRS are used in the test, the PDSCH part of OCNG shall be transmitted to the virtual users by all the transmit antennas with CRS and according to the antenna transmission mode 2. The parameter γ_{PRB} applies to each antenna port separately, so the transmit power of the PDSCH part of OCNG is equal between all the transmit antennas with CRS used in the test. The antenna transmission modes are specified in clause 7.1 in TS 36.213.</p> <p>Note 4: 0dB for 1 transmit antenna with CRS, +3dB for 2 transmit antennas with CRS</p> <p>N/A: Not Applicable</p> | | | | | | |

A.3.2.1.5 OCNG FDD pattern 5: outer resource blocks allocation in 10 MHz (without MBSFN)

Table A.3.2.1.5-1: OP.5 FDD: OCNG FDD Pattern 5

| Allocation n_{PRB} | Relative power level γ_{PRB} [dB] | | | | PDSCH Data |
|-------------------------|--|---|-----|----------|------------|
| | Subframe (Note 1) | | | | |
| | 0 | 5 | 4,9 | 1-3, 6-8 | |
| 0-12 | 0 | 0 | 0 | N/A | Note 2 |

| | | | | |
|--|-----|-----|-----|-----|
| 37 – 49 | 0 | 0 | 0 | N/A |
| 0 – 49 | N/A | N/A | N/A | 0 |
| <p>Note 1: The allocation of any PDSCH with or without SIB1 applies only to the subframes not configured as PRS subframes.</p> <p>Note 2: These physical resource blocks are assigned to an arbitrary number of virtual UEs with one PDSCH per virtual UE; the data transmitted over the OCNG PDSCHs shall be uncorrelated pseudo random data, which is QPSK modulated. The parameter γ_{PRB} is used to scale the power of PDSCH.</p> <p>Note 3: If two or more transmit antennas with CRS are used in the test, the PDSCH part of OCNG shall be transmitted to the virtual users by all the transmit antennas with CRS and according to the antenna transmission mode 2.</p> <p>The parameter γ_{PRB} applies to each antenna port separately, so the transmit power of the PDSCH part of OCNG is equal between all the transmit antennas with CRS used in the test. The antenna transmission modes are specified in clause 7.1 in TS 36.213.</p> <p>N/A: Not Applicable</p> | | | | |

A.3.2.1.6 OCNG FDD pattern 6: full bandwidth allocation in 10 MHz (without MBSFN)

Table A.3.2.1.6-1: OP.6 FDD: OCNG FDD Pattern 6

| Allocation n_{PRB} | Relative power level γ_{PRB} [dB] | | | | PDSCH Data |
|---|--|---|------|--------------|------------|
| | Subframe (Note 1) | | | | |
| | 0 | 5 | 4, 9 | 1 – 3, 6 – 8 | |
| 0 – 49 | 0 | 0 | 0 | 0 | Note 2 |
| <p>Note 1: The allocation of any PDSCH with or without SIB1 applies only to the subframes not configured as PRS subframes.</p> <p>Note 2: These physical resource blocks are assigned to an arbitrary number of virtual UEs with one PDSCH per virtual UE; the data transmitted over the OCNG PDSCHs shall be uncorrelated pseudo random data, which is QPSK modulated. The parameter γ_{PRB} is used to scale the power of PDSCH.</p> <p>Note 3: If two or more transmit antennas with CRS are used in the test, the PDSCH part of OCNG shall be transmitted to the virtual users by all the transmit antennas with CRS and according to the antenna transmission mode 2. The parameter γ_{PRB} applies to each antenna port separately, so the transmit power of the PDSCH part of OCNG is equal between all the transmit antennas with CRS used in the test. The antenna transmission modes are specified in clause 7.1 in TS 36.213.</p> <p>N/A: Not Applicable</p> | | | | | |

A.3.2.1.7 OCNG FDD pattern 7: full bandwidth allocation in 1.4 MHz (without MBSFN)

Table A.3.2.1.7-1: OP.7 FDD: OCNG FDD Pattern 7

| Allocation n_{PRB} | Relative power level γ_{PRB} [dB] | | | | PDSCH Data |
|--|--|---|------|--------------|------------|
| | Subframe (Note 1) | | | | |
| | 0 | 5 | 4, 9 | 1 – 3, 6 – 8 | |
| 0 – 5 | 0 | 0 | 0 | 0 | Note 2 |
| <p>Note 1: The allocation of any PDSCH with or without SIB1 applies only to the subframes not configured as PRS subframes.</p> <p>Note 2: These physical resource blocks are assigned to an arbitrary number of virtual UEs with one PDSCH per virtual UE; the data transmitted over the</p> | | | | | |

| | |
|---------|---|
| | OCNG PDSCHs shall be uncorrelated pseudo random data, which is QPSK modulated. The parameter γ_{PRB} is used to scale the power of PDSCH. |
| Note 3: | If two or more transmit antennas with CRS are used in the test, the PDSCH part of OCNG shall be transmitted to the virtual users by all the transmit antennas with CRS and according to the antenna transmission mode 2. The parameter γ_{PRB} applies to each antenna port separately, so the transmit power of the PDSCH part of OCNG is equal between all the transmit antennas with CRS used in the test. The antenna transmission modes are specified in clause 7.1 in TS 36.213. |
| N/A: | Not Applicable |

A.3.2.1.8 OCNG FDD pattern 8: outer resource blocks allocation in 10 MHz for MBSFN ABS

Table A.3.2.1.8-1: OP.8 FDD: OCNG FDD Pattern 8

| Allocation n_{PRB} | Relative power level γ_{PRB} [dB] | | | | PDSCH Data |
|-------------------------|---|-----|-----|-----------------------------|------------|
| | Subframe (Note 1) | | | | |
| | 0 | 5 | 4,9 | (1-3, 6-8) ^{Note4} | |
| 0 – 12 | 0 | 0 | 0 | N/A | Note 2 |
| 37 – 49 | 0 | 0 | 0 | N/A | |
| 0 – 49 | N/A | N/A | N/A | 0 | |
| Note 1: | PDSCH allocation does not apply to subframes configured as PRS subframes. | | | | |
| Note 2: | These physical resource blocks are assigned to an arbitrary number of virtual UEs with one PDSCH per virtual UE; the data transmitted over the OCNG PDSCHs shall be uncorrelated pseudo random data, which is QPSK modulated. The parameter γ_{PRB} is used to scale the power of PDSCH. | | | | |
| Note 3: | If two or more transmit antennas with CRS are used in the test, the PDSCH part of OCNG shall be transmitted to the virtual users by all the transmit antennas with CRS and according to the antenna transmission mode 2. The parameter γ_{PRB} applies to each antenna port separately, so the transmit power of the PDSCH part of OCNG is equal between all the transmit antennas with CRS used in the test. The antenna transmission modes are specified in clause 7.1 in TS 36.213. | | | | |
| Note 4: | The subframe(s) configured as MBSFN ABS in a test shall not contain any PMCH data and shall contain CRS only in the first symbol of the first time slot. The subframe(s) configured as MBSFN ABS depend upon the MBSFN ABS pattern used in the test. | | | | |
| N/A: | Not Applicable | | | | |

A.3.2.1.9 OCNG FDD pattern 9: full bandwidth allocation in 10 MHz for MBSFN ABS

Table A.3.2.1.9-1: OP.9 FDD: OCNG FDD Pattern 9

| Allocation n_{PRB} | Relative power level γ_{PRB} [dB] | | | | PDSCH Data |
|-------------------------|---|---|------|-----------------------------|------------|
| | Subframe (Note 1) | | | | |
| | 0 | 5 | 4, 9 | (1-3, 6-8) ^{Note4} | |
| 0 – 49 | 0 | 0 | 0 | 0 | Note 2 |
| Note 1: | PDSCH allocation applies only to subframes not configured as PRS subframes. | | | | |
| Note 2: | These physical resource blocks are assigned to an arbitrary number of | | | | |

| | |
|---------|---|
| | virtual UEs with one PDSCH per virtual UE; the data transmitted over the OCNG PDSCHs shall be uncorrelated pseudo random data, which is QPSK modulated. The parameter γ_{PRB} is used to scale the power of PDSCH. |
| Note 3: | If two or more transmit antennas with CRS are used in the test, the PDSCH part of OCNG shall be transmitted to the virtual users by all the transmit antennas with CRS and according to the antenna transmission mode 2. The parameter γ_{PRB} applies to each antenna port separately, so the transmit power of the PDSCH part of OCNG is equal between all the transmit antennas with CRS used in the test. The antenna transmission modes are specified in clause 7.1 in TS 36.213. |
| Note 4: | The subframe(s) configured as MBSFN ABS in a test shall not contain any PMCH data and shall contain CRS only in the first symbol of the first time slot. The subframe(s) configured as MBSFN ABS depend upon the MBSFN ABS pattern used in the test. |
| N/A: | Not Applicable |

A.3.2.1.10 OCNG FDD pattern 10: outer resource blocks allocation in 10 MHz with user data in every subframe (without MBSFN)

Table A.3.2.1.10-1: OP.10 FDD: OCNG FDD Pattern 10

| Allocation n_{PRB} | Relative power level γ_{PRB} [dB] | | | | PDSCH Data |
|-------------------------|--|---|------|--------------|------------|
| | Subframe (Note 1) | | | | |
| | 0 | 5 | 4, 9 | 1 - 3, 6 - 8 | |
| 0 - 12 | 0 | 0 | 0 | 0 | Note 2 |
| 37 - 49 | 0 | 0 | 0 | 0 | |
| Note 1: | The allocation of any PDSCH with or without SIB1 applies only to the subframes not configured as PRS subframes. | | | | |
| Note 2: | These physical resource blocks are assigned to an arbitrary number of virtual UEs with one PDSCH per virtual UE; the data transmitted over the OCNG PDSCHs shall be uncorrelated pseudo random data, which is QPSK modulated. | | | | |
| Note 3: | The parameter γ_{PRB} is used to scale the power of PDSCH. If two or more transmit antennas with CRS are used in the test, the PDSCH part of OCNG shall be transmitted to the virtual users by all the transmit antennas with CRS and according to the antenna transmission mode 2. The parameter γ_{PRB} applies to each antenna port separately, so the transmit power of the PDSCH part of OCNG is equal between all the transmit antennas with CRS used in the test. The antenna transmission modes are specified in section 7.1 in 3GPP TS 36.213. | | | | |
| N/A: | Not Applicable | | | | |

A.3.2.1.11 OCNG FDD pattern 11: outer resource blocks allocation in 20 MHz

Table A.3.2.1.11-1: OP.11 FDD: OCNG FDD Pattern 11

| Allocation n_{PRB} | Relative power level γ_{PRB} [dB] | | | | PDSCH Data | PMCH Data |
|-------------------------|---|-----|-----|----------|------------|-----------|
| | Subframe | | | | | |
| | 0 | 5 | 4,9 | 1-3, 6-8 | | |
| 0 – 37 | 0 | 0 | 0 | N/A | Note 1 | N/A |
| 62 – 99 | 0 | 0 | 0 | N/A | | |
| 0-99 | N/A | N/A | N/A | Note 4 | N/A | Note 2 |
| Note 1: | These physical resource blocks are assigned to an arbitrary number of virtual UEs with one PDSCH per virtual UE; the data transmitted over the OCNG PDSCHs shall be uncorrelated pseudo random data, which is QPSK modulated. The parameter | | | | | |

| | |
|---------|---|
| | γ_{PRB} is used to scale the power of PDSCH. |
| Note 2: | Each physical resource block (PRB) is assigned to MBSFN transmission. The data in each PRB shall be uncorrelated with data in other PRBs over the period of any measurement. The MBSFN data shall be QPSK modulated. PMCH symbols shall not contain cell-specific Reference Signals. PMCH subframes shall contain cell-specific Reference Signals only in the first symbol of the first time slot. The parameter γ_{PRB} is used to scale the power of PMCH. |
| Note 3: | If two or more transmit antennas with CRS are used in the test, the PDSCH part of OCNG shall be transmitted to the virtual users by all the transmit antennas with CRS and according to the antenna transmission mode 2. The parameter γ_{PRB} applies to each antenna port separately, so the transmit power of the PDSCH part of OCNG is equal between all the transmit antennas with CRS used in the test. The antenna transmission modes are specified in section 7.1 in 3GPP TS 36.213. |
| Note 4: | 0dB for 1 transmit antenna with CRS, +3dB for 2 transmit antennas with CRS |
| N/A: | Not Applicable |

A.3.2.1.12 OCNG FDD pattern 12: full bandwidth allocation in 20 MHz

Table A.3.2.1.12-1: OP.12 FDD: OCNG FDD Pattern 12

| Allocation n_{PRB} | Relative power level γ_{PRB} [dB] | | | | PDSCH Data | PMCH Data |
|--|--|-----|------|--------------|------------|-----------|
| | Subframe | | | | | |
| | 0 | 5 | 4, 9 | 1 – 3, 6 – 8 | | |
| 0 – 99 | 0 | 0 | 0 | N/A | Note 1 | N/A |
| 0 – 99 | N/A | N/A | N/A | Note 4 | N/A | Note 2 |
| <p>Note 1: These physical resource blocks are assigned to an arbitrary number of virtual UEs with one PDSCH per virtual UE; the data transmitted over the OCNG PDSCHs shall be uncorrelated pseudo random data, which is QPSK modulated. The parameter γ_{PRB} is used to scale the power of PDSCH.</p> <p>Note 2: Each physical resource block (PRB) is assigned to MBSFN transmission. The data in each PRB shall be uncorrelated with data in other PRBs over the period of any measurement. The MBSFN data shall be QPSK modulated. PMCH subframes shall contain cell-specific Reference Signals only in the first symbol of the first time slot. The parameter γ_{PRB} is used to scale the power of PMCH.</p> <p>Note 3: If two or more transmit antennas with CRS are used in the test, the PDSCH part of OCNG shall be transmitted to the virtual users by all the transmit antennas with CRS and according to the antenna transmission mode 2. The parameter γ_{PRB} applies to each antenna port separately, so the transmit power of the PDSCH part of OCNG is equal between all the transmit antennas with CRS used in the test. The antenna transmission modes are specified in section 7.1 in 3GPP TS 36.213.</p> <p>Note 4: 0dB for 1 transmit antenna with CRS, +3dB for 2 transmit antennas with CRS</p> <p>N/A: Not Applicable</p> | | | | | | |

A.3.2.1.13 OCNG FDD pattern 13: outer resource blocks allocation in 20 MHz (without MBSFN)

Table A.3.2.1.13-1: OP.13 FDD: OCNG FDD Pattern 13

| Allocation n_{PRB} | Relative power level γ_{PRB} [dB] | | | | PDSCH Data |
|-------------------------|--|---|-----|----------|------------|
| | Subframe (Note 1) | | | | |
| | 0 | 5 | 4,9 | 1-3, 6-8 | |
| 0 – 37 | 0 | 0 | 0 | N/A | Note 2 |
| 62 – 99 | 0 | 0 | 0 | N/A | |

| | | | | | |
|---------|---|-----|-----|---|--|
| 0 – 99 | N/A | N/A | N/A | 0 | |
| Note 1: | The allocation of any PDSCH with or without SIB1 applies only to the subframes not configured as PRS subframes. | | | | |
| Note 2: | These physical resource blocks are assigned to an arbitrary number of virtual UEs with one PDSCH per virtual UE; the data transmitted over the OCNG PDSCHs shall be uncorrelated pseudo random data, which is QPSK modulated. The parameter γ_{PRB} is used to scale the power of PDSCH. | | | | |
| Note 3: | If two or more transmit antennas with CRS are used in the test, the PDSCH part of OCNG shall be transmitted to the virtual users by all the transmit antennas with CRS and according to the antenna transmission mode 2. The parameter γ_{PRB} applies to each antenna port separately, so the transmit power of the PDSCH part of OCNG is equal between all the transmit antennas with CRS used in the test. The antenna transmission modes are specified in section 7.1 in 3GPP TS 36.213. | | | | |
| N/A: | Not Applicable | | | | |

A.3.2.1.14 OCNG FDD pattern 14: full bandwidth allocation in 20 MHz (without MBSFN)

Table A.3.2.1.14-1: OP.14 FDD: OCNG FDD Pattern 14

| Allocation n_{PRB} | Relative power level γ_{PRB} [dB] | | | | PDSCH Data |
|-------------------------|---|---|------|--------------|------------|
| | Subframe (Note 1) | | | | |
| | 0 | 5 | 4, 9 | 1 – 3, 6 – 8 | |
| 0 – 99 | 0 | 0 | 0 | 0 | Note 2 |
| Note 1: | The allocation of any PDSCH with or without SIB1 applies only to the subframes not configured as PRS subframes. | | | | |
| Note 2: | These physical resource blocks are assigned to an arbitrary number of virtual UEs with one PDSCH per virtual UE; the data transmitted over the OCNG PDSCHs shall be uncorrelated pseudo random data, which is QPSK modulated. The parameter γ_{PRB} is used to scale the power of PDSCH. | | | | |
| Note 3: | If two or more transmit antennas with CRS are used in the test, the PDSCH part of OCNG shall be transmitted to the virtual users by all the transmit antennas with CRS and according to the antenna transmission mode 2. The parameter γ_{PRB} applies to each antenna port separately, so the transmit power of the PDSCH part of OCNG is equal between all the transmit antennas with CRS used in the test. The antenna transmission modes are specified in section 7.1 in 3GPP TS 36.213. | | | | |
| N/A: | Not Applicable | | | | |

A.3.2.1.15 OCNG FDD pattern 15: outer resource blocks allocation in 5 MHz

Table A.3.2.1.15-1: OP.15 FDD: OCNG FDD Pattern 15

| Allocation n_{PRB} | Relative power level γ_{PRB} [dB] | | | | PDSCH Data | PMCH Data |
|-------------------------|--|-----|-----|----------|------------|-----------|
| | Subframe | | | | | |
| | 0 | 5 | 4,9 | 1-3, 6-8 | | |
| 0 – 6 | 0 | 0 | 0 | N/A | Note 1 | N/A |
| 18 – 24 | 0 | 0 | 0 | N/A | | |
| 0-24 | N/A | N/A | N/A | Note 4 | N/A | Note 2 |
| Note 1: | These physical resource blocks are assigned to an arbitrary number of virtual UEs with one PDSCH per virtual UE; the data transmitted over the OCNG PDSCHs shall | | | | | |

be uncorrelated pseudo random data, which is QPSK modulated. The parameter γ_{PRB} is used to scale the power of PDSCH.

Note 2: Each physical resource block (PRB) is assigned to MBSFN transmission. The data in each PRB shall be uncorrelated with data in other PRBs over the period of any measurement. The MBSFN data shall be QPSK modulated. PMCH symbols shall not contain cell-specific Reference Signals. PMCH subframes shall contain cell-specific Reference Signals only in the first symbol of the first time slot. The parameter γ_{PRB} is used to scale the power of PMCH.

Note 3: If two or more transmit antennas with CRS are used in the test, the PDSCH part of OCNG shall be transmitted to the virtual users by all the transmit antennas with CRS and according to the antenna transmission mode 2. The parameter γ_{PRB} applies to each antenna port separately, so the transmit power of the PDSCH part of OCNG is equal between all the transmit antennas with CRS used in the test. The antenna transmission modes are specified in section 7.1 in 3GPP TS 36.213.

Note 4: 0dB for 1 transmit antenna with CRS, +3dB for 2 transmit antennas with CRS

N/A: Not Applicable

A.3.2.1.16 OCNG FDD pattern 16: full bandwidth allocation in 5 MHz

Table A.3.2.1.16-1: OP.16 FDD: OCNG FDD Pattern 16

| Allocation n_{PRB} | Relative power level γ_{PRB} [dB] | | | | PDSCH Data | PMCH Data |
|--|--|-----|------|--------------|------------|-----------|
| | Subframe | | | | | |
| | 0 | 5 | 4, 9 | 1 - 3, 6 - 8 | | |
| 0 - 24 | 0 | 0 | 0 | N/A | Note 1 | N/A |
| 0 - 24 | N/A | N/A | N/A | Note 4 | N/A | Note 2 |
| <p>Note 1: These physical resource blocks are assigned to an arbitrary number of virtual UEs with one PDSCH per virtual UE; the data transmitted over the OCNG PDSCHs shall be uncorrelated pseudo random data, which is QPSK modulated. The parameter γ_{PRB} is used to scale the power of PDSCH.</p> <p>Note 2: Each physical resource block (PRB) is assigned to MBSFN transmission. The data in each PRB shall be uncorrelated with data in other PRBs over the period of any measurement. The MBSFN data shall be QPSK modulated. PMCH subframes shall contain cell-specific Reference Signals only in the first symbol of the first time slot. The parameter γ_{PRB} is used to scale the power of PMCH.</p> <p>Note 3: If two or more transmit antennas with CRS are used in the test, the PDSCH part of OCNG shall be transmitted to the virtual users by all the transmit antennas with CRS and according to the antenna transmission mode 2. The parameter γ_{PRB} applies to each antenna port separately, so the transmit power of the PDSCH part of OCNG is equal between all the transmit antennas with CRS used in the test. The antenna transmission modes are specified in section 7.1 in 3GPP TS 36.213.</p> <p>Note 4: 0dB for 1 transmit antenna with CRS, +3dB for 2 transmit antennas with CRS</p> <p>N/A: Not Applicable</p> | | | | | | |

A.3.2.1.17 OCNG FDD pattern 17: outer resource blocks allocation in 20 MHz with user data in every subframe (without MBSFN)

Table A.3.2.1.17-1: OP.17 FDD: OCNG FDD Pattern 17

| Allocation n_{PRB} | Relative power level γ_{PRB} [dB] | | | | PDSCH Data |
|--|--|---|------|--------------|------------|
| | Subframe (Note 1) | | | | |
| | 0 | 5 | 4, 9 | 1 - 3, 6 - 8 | |
| 0 - 37 | 0 | 0 | 0 | 0 | Note 2 |
| 62 - 99 | 0 | 0 | 0 | 0 | |
| <p>Note 1: The allocation of any PDSCH with or without SIB1 applies only to the subframes not configured as PRS subframes.</p> | | | | | |

| | |
|---------|--|
| Note 2: | These physical resource blocks are assigned to an arbitrary number of virtual UEs with one PDSCH per virtual UE; the data transmitted over the OCNG PDSCHs shall be uncorrelated pseudo random data, which is QPSK modulated. |
| Note 3: | The parameter γ_{PRB} is used to scale the power of PDSCH. If two or more transmit antennas with CRS are used in the test, the PDSCH part of OCNG shall be transmitted to the virtual users by all the transmit antennas with CRS and according to the antenna transmission mode 2. The parameter γ_{PRB} applies to each antenna port separately, so the transmit power of the PDSCH part of OCNG is equal between all the transmit antennas with CRS used in the test. The antenna transmission modes are specified in section 7.1 in 3GPP TS 36.213. |
| N/A: | Not Applicable. |

A.3.2.1.18 OCNG FDD pattern 18: outer resource blocks allocation in 5 MHz (without MBSFN)

Table A.3.2.1.18-1: OP.18 FDD: OCNG FDD Pattern 18

| Allocation n_{PRB} | Relative power level γ_{PRB} [dB] | | | | PDSCH Data |
|-------------------------|---|-----|-----|----------|------------|
| | Subframe (Note 1) | | | | |
| | 0 | 5 | 4,9 | 1-3, 6-8 | |
| 0 – 6 | 0 | 0 | 0 | N/A | Note 2 |
| 18 – 24 | 0 | 0 | 0 | N/A | |
| 0 – 24 | N/A | N/A | N/A | 0 | |
| Note 1: | The allocation of any PDSCH with or without SIB1 applies only to the subframes not configured as PRS subframes. | | | | |
| Note 2: | These physical resource blocks are assigned to an arbitrary number of virtual UEs with one PDSCH per virtual UE; the data transmitted over the OCNG PDSCHs shall be uncorrelated pseudo random data, which is QPSK modulated. The parameter γ_{PRB} is used to scale the power of PDSCH. | | | | |
| Note 3: | If two or more transmit antennas with CRS are used in the test, the PDSCH part of OCNG shall be transmitted to the virtual users by all the transmit antennas with CRS and according to the antenna transmission mode 2. The parameter γ_{PRB} applies to each antenna port separately, so the transmit power of the PDSCH part of OCNG is equal between all the transmit antennas with CRS used in the test. The antenna transmission modes are specified in section 7.1 in 3GPP TS 36.213. | | | | |
| N/A: | Not Applicable | | | | |

A.3.2.1.19 OCNG FDD pattern 19: full bandwidth allocation in 5 MHz (without MBSFN)

Table A.3.2.1.19-1: OP.19 FDD: OCNG FDD Pattern 19

| Allocation n_{PRB} | Relative power level γ_{PRB} [dB] | | | | PDSCH Data |
|-------------------------|---|---|------|--------------|------------|
| | Subframe (Note 1) | | | | |
| | 0 | 5 | 4, 9 | 1 – 3, 6 – 8 | |
| 0 – 24 | 0 | 0 | 0 | 0 | Note 2 |
| Note 1: | The allocation of any PDSCH with or without SIB1 applies only to the subframes not configured as PRS subframes. | | | | |
| Note 2: | These physical resource blocks are assigned to an arbitrary number of virtual UEs with one PDSCH per virtual UE; the data transmitted over the OCNG PDSCHs shall be uncorrelated pseudo random data, which is | | | | |

| | |
|---------|--|
| Note 3: | QPSK modulated. The parameter γ_{PRB} is used to scale the power of PDSCH. If two or more transmit antennas with CRS are used in the test, the PDSCH part of OCNG shall be transmitted to the virtual users by all the transmit antennas with CRS and according to the antenna transmission mode 2. The parameter γ_{PRB} applies to each antenna port separately, so the transmit power of the PDSCH part of OCNG is equal between all the transmit antennas with CRS used in the test. The antenna transmission modes are specified in section 7.1 in 3GPP TS 36.213. |
| N/A: | Not Applicable |

A.3.2.1.20 OCNG FDD pattern 20: outer resource blocks allocation in 5 MHz with user data in every subframe (without MBSFN)

Table A.3.2.1.20-1: OP.20 FDD: OCNG FDD Pattern 20

| Allocation n_{PRB} | Relative power level γ_{PRB} [dB] | | | | PDSCH Data |
|-------------------------|--|---|------|--------------|------------|
| | Subframe (Note 1) | | | | |
| | 0 | 5 | 4, 9 | 1 - 3, 6 - 8 | |
| 0 - 6 | 0 | 0 | 0 | 0 | Note 2 |
| 18 - 24 | 0 | 0 | 0 | 0 | |
| Note 1: | The allocation of any PDSCH with or without SIB1 applies only to the subframes not configured as PRS subframes. | | | | |
| Note 2: | These physical resource blocks are assigned to an arbitrary number of virtual UEs with one PDSCH per virtual UE; the data transmitted over the OCNG PDSCHs shall be uncorrelated pseudo random data, which is QPSK modulated. | | | | |
| Note 3: | The parameter γ_{PRB} is used to scale the power of PDSCH. If two or more transmit antennas with CRS are used in the test, the PDSCH part of OCNG shall be transmitted to the virtual users by all the transmit antennas with CRS and according to the antenna transmission mode 2. The parameter γ_{PRB} applies to each antenna port separately, so the transmit power of the PDSCH part of OCNG is equal between all the transmit antennas with CRS used in the test. The antenna transmission modes are specified in section 7.1 in 3GPP TS 36.213. | | | | |
| N/A: | Not Applicable. | | | | |

A.3.2.1.21 OCNG FDD pattern 21: Generic resource blocks allocation (without MBSFN)

Table A.3.2.1.21-1: OP.21 FDD: OCNG FDD Pattern 21

| OCNG Pattern Name | Bandwidth (MHz) | Allocation n_{PRB} | Relative power level γ_{PRB} [dB] | | | | PDSCH Data |
|-------------------|---|----------------------------|--|---|------|--------------|------------|
| | | | Subframe | | | | |
| | | | 0 | 5 | 4, 9 | 1 - 3, 6 - 8 | |
| OP.21 FDD | 10 | 0 - 49 ^{Note 1,2} | 0 | 0 | 0 | 0 | Note 3 |
| Note 1: | The OCNG pattern is used only for a serving cell of the UE under test. | | | | | | |
| Note 2: | The OCNG allocation applied to all downlink physical resource blocks (PRBs) except the REs that are allocated for the PDSCH for the UE under test. | | | | | | |
| Note 3: | OCNG PRBs are assigned to an arbitrary number of virtual UEs with one PDSCH per virtual UE; the data transmitted over the OCNG PDSCHs shall be uncorrelated pseudo random data, which is QPSK modulated. The parameter γ_{PRB} is used to scale the power of PDSCH. | | | | | | |
| Note 4: | If two or more transmit antennas with CRS are used in the test, the PDSCH part of OCNG shall be transmitted to the virtual users by all the transmit antennas with CRS and according to the antenna transmission mode 2. The parameter γ_{PRB} applies to each antenna port separately, so the transmit power of the PDSCH part of OCNG is equal between all the transmit antennas with CRS used in the test. The antenna transmission modes are specified in clause 7.1 in TS 36.213. | | | | | | |

A.3.2.1.22 OCNG FDD pattern 22: Generic resource blocks allocation in 5MHz (without MBSFN)

Table A.3.2.1.22-1: OP.22 FDD: OCNG FDD Pattern 22

| OCNG Pattern Name | Bandwidth (MHz) | Allocation n_{PRB} | Relative power level γ_{PRB} [dB] | | | | PDSCH Data |
|--|-----------------|----------------------------|--|---|------|--------------|------------|
| | | | Subframe | | | | |
| | | | 0 | 5 | 4, 9 | 1 – 3, 6 – 8 | |
| OP.22 FDD | 5 | 0 – 24 ^{Note 1,2} | 0 | 0 | 0 | 0 | Note 3 |
| <p>Note 1: The OCNG pattern is used only for a serving cell of the UE under test.</p> <p>Note 2: The OCNG allocation applied to all downlink physical resource blocks (PRBs) except the REs that are allocated for the PDSCH for the UE under test.</p> <p>Note 3: OCNG PRBs are assigned to an arbitrary number of virtual UEs with one PDSCH per virtual UE; the data transmitted over the OCNG PDSCHs shall be uncorrelated pseudo random data, which is QPSK modulated. The parameter γ_{PRB} is used to scale the power of PDSCH.</p> <p>Note 4: If two or more transmit antennas with CRS are used in the test, the PDSCH part of OCNG shall be transmitted to the virtual users by all the transmit antennas with CRS and according to the antenna transmission mode 2. The parameter γ_{PRB} applies to each antenna port separately, so the transmit power of the PDSCH part of OCNG is equal between all the transmit antennas with CRS used in the test. The antenna transmission modes are specified in clause 7.1 in TS 36.213.</p> | | | | | | | |

A.3.2.2 OCNG Patterns for TDD

The following OCNG patterns are used for modelling allocations to virtual UEs (which are not under test). The OCNG pattern for each sub frame specifies the allocations that shall be filled with OCNG, and furthermore, the relative power level of each such allocation.

In each test case the OCNG is expressed by parameters OCNG_RA and OCNG_RB which together with a relative power level (γ) specifies the PDSCH EPRE-to-RS EPRE ratios in OFDM symbols without and with reference symbols, respectively. The relative power, which is used for modelling boosting per virtual UE allocation, is expressed by:

$$\gamma_i = PDSCH_i_RA / OCNG_RA = PDSCH_i_RB / OCNG_RB,$$

where γ_i denotes the relative power level of the i :th virtual UE. The parameter settings of OCNG_RA, OCNG_RB, and the set of relative power levels γ are chosen such that when also taking allocations to the UE under test into account, as given by a PDSCH reference channel, a transmitted power spectral density that is constant on an OFDM symbol basis is targeted.

Moreover the OCNG pattern is accompanied by a PCFICH/PDCCH/PHICH reference channel which specifies the control region. The number of PDCCH OFDM symbols in the non-MBSFN subframes is the same as specified in the RMC used in the test. The number of PDCCH OFDM symbols in the MBSFN subframe is the maximal allowed according to TS 36.213 [16]. For any aggregation and PHICH allocation, the PDCCH and any unused PHICH groups are padded with resource element groups with a power level given by PDCCH_RA/RB and PHICH_RA/RB as specified in the test case such that a total power spectral density in the control region that is constant on an OFDM symbol basis is targeted.

For subframes configured as PRS subframes the PDSCH allocation defined in the OCNG pattern does not apply.

For subframes configured as ABS subframes the PDSCH and PMCH allocation defined in the OCNG pattern does not apply.

The system information is scheduled in the allocations reserved for the OCNG patterns, in the subframes not configured for MBSFN. For this purpose the number of the RB-s allocated with PDSCH defined in the OCNG pattern can be reduced as necessary.

A.3.2.2.1 OCNG TDD pattern 1: outer resource blocks allocation in 10 MHz

Table A.3.2.2.1-1: OP.1 TDD: OCNG TDD Pattern 1 for 5ms downlink-to-uplink switch-point periodicity

| Allocation n_{PRB} | Relative power level γ_{PRB} [dB] | | | | PDSCH Data |
|--|--|---|--|--|------------|
| | Subframe (Note 1) | | | | |
| | 0 | 5 | 3, 4, 8, 9 and 6 (as normal subframe) ^{Note 3} | 1 and 6 (as special subframe) ^{Note 3} | |
| 0 – 12 | 0 | 0 | 0 | Table A.3.2.2.1-2 | Note 2 |
| 37 – 49 | 0 | 0 | 0 | | |
| <p>Note 1: The allocation of any PDSCH with or without SIB1 applies only to the subframes not configured as PRS subframes.</p> <p>Note 2: These physical resource blocks are assigned to an arbitrary number of virtual UEs with one PDSCH per virtual UE; the data transmitted over the OCNG PDSCHs shall be uncorrelated pseudo random data, which is QPSK modulated. The parameter γ_{PRB} is used to scale the power of PDSCH.</p> <p>Note 3: Subframes available for DL transmission depends on the Uplink-Downlink configuration defined in Table 4.2-2 in TS 36.211 [16].</p> <p>Note 4: If two or more transmit antennas with CRS are used in the test, the OCNG shall be transmitted to the virtual users by all the transmit antennas with CRS and according to the antenna transmission mode 2. The parameter γ_{PRB} applies to each antenna port separately, so the transmit power is equal between all the transmit antennas with CRS used in the test. The antenna transmission modes are specified in clause 7.1 in TS 36.213.</p> | | | | | |

Table A.3.2.2.1-2: OP.1 TDD: OCNG TDD Pattern 1 for special subframe configuration with 5ms downlink-to-uplink switch-point periodicity

| Allocation n_{PRB} | Relative power level γ_{PRB} [dB] | | | | | | | | | | | | | | | | | |
|-------------------------|--|---|---|---|---|---|---|---|---|---|---|---|---|---|---|---|---|---|
| | Special subframe configuration | | | | | | | | | | | | | | | | | |
| | 0 | | 1 | | 2 | | 3 | | 4 | | 5 | | 6 | | 7 | | 8 | |
| | Control region OFDM symbols | | | | | | | | | | | | | | | | | |
| | 1 | 2 | 1 | 2 | 1 | 2 | 1 | 2 | 1 | 2 | 1 | 2 | 1 | 2 | 1 | 2 | 1 | 2 |
| 0 – 12 | 0 | 0 | 0 | 0 | 0 | 0 | 0 | 0 | 0 | 0 | 0 | 0 | 0 | 0 | 0 | 0 | 0 | 0 |
| 37 – 49 | 0 | 0 | 0 | 0 | 0 | 0 | 0 | 0 | 0 | 0 | 0 | 0 | 0 | 0 | 0 | 0 | 0 | 0 |

Note 1: Special subframe configurations are defined in Table 4.2-1 in TS 36.211 [16].

A.3.2.2.2 OCNG TDD pattern 2: full bandwidth allocation in 10 MHz

Table A.3.2.2.2-1: OP.2 TDD: OCNG TDD Pattern 2 for 5ms downlink-to-uplink switch-point periodicity

| Allocation n_{PRB} | Relative power level γ_{PRB} [dB] | | | | PDSCH Data |
|--|--|---|---|--|------------|
| | Subframe (Note 1) | | | | |
| | 0 | 5 | 3, 4, 8, 9 and 6 (as normal subframe) ^{Note 3} | 1 and 6 (as special subframe) ^{Note 3} | |
| 0 – 49 | 0 | 0 | 0 | 0 | Note 2 |
| <p>Note 1: The allocation of any PDSCH with or without SIB1 applies only to the subframes not configured as PRS subframes.</p> <p>Note 2: These physical resource blocks are assigned to an arbitrary number of virtual UEs with one PDSCH per virtual UE; the data transmitted over the OCNG PDSCHs shall be uncorrelated pseudo random data, which is QPSK</p> | | | | | |

modulated. The parameter γ_{PRB} is used to scale the power of PDSCH.

Note 3: Subframes available for DL transmission depends on the Uplink-Downlink configuration in Table 4.2-2 in TS 36.211 [16].

Note 4: If two or more transmit antennas with CRS are used in the test, the OCNG shall be transmitted to the virtual users by all the transmit antennas with CRS and according to the antenna transmission mode 2. The parameter γ_{PRB} applies to each antenna port separately, so the transmit power is equal between all the transmit antennas with CRS used in the test. The antenna transmission modes are specified in clause 7.1 in TS 36.213.

A.3.2.2.3 OCNG TDD pattern 3: outer resource blocks allocation in 1.4 MHz

Table A.3.2.2.3-1: OP.3 TDD: OCNG TDD Pattern 3 for 5 ms downlink-to-uplink switch-point periodicity

| Allocation n_{PRB} | Relative power level γ_{PRB} [dB] | | | | PDSCH Data |
|-------------------------|--|---|---|--|------------|
| | Subframe (Note 1) | | | | |
| | 0 | 5 | 3, 4, 8, 9 and 6 (as normal subframe) <small>Note 3</small> | 1 and 6 (as special subframe) <small>Note 3</small> | |
| 0 – 1 | 0 | 0 | 0 | 0 | Note 2 |
| 4 – 5 | 0 | 0 | 0 | 0 | |

Note 1: The allocation of any PDSCH with or without SIB1 applies only to the subframes not configured as PRS subframes.

Note 2: These physical resource blocks are assigned to an arbitrary number of virtual UEs with one PDSCH per virtual UE; the data transmitted over the OCNG PDSCHs shall be uncorrelated pseudo random data, which is QPSK modulated. The parameter γ_{PRB} is used to scale the power of PDSCH.

Note 3: Subframes available for DL transmission depends on the Uplink-Downlink configuration defined in Table 4.2-2 in TS 36.211 [16].

Note 4: If two or more transmit antennas with CRS are used in the test, the OCNG shall be transmitted to the virtual users by all the transmit antennas with CRS and according to the antenna transmission mode 2. The parameter γ_{PRB} applies to each antenna port separately, so the transmit power is equal between all the transmit antennas with CRS used in the test. The antenna transmission modes are specified in clause 7.1 in TS 36.213.

A.3.2.2.4 OCNG TDD pattern 4: full bandwidth allocation in 1.4 MHz

Table A.3.2.2.4-1: OP.4 TDD: OCNG TDD Pattern 4 for 5 ms downlink-to-uplink switch-point periodicity

| Allocation n_{PRB} | Relative power level γ_{PRB} [dB] | | | | PDSCH Data |
|-------------------------|--|---|--|--|------------|
| | Subframe (Note 1) | | | | |
| | 0 | 5 | 3, 4, 8, 9 and 6 (as normal subframe) <small>Note 3</small> | 1 and 6 (as special subframe) <small>Note 3</small> | |
| 0 – 5 | 0 | 0 | 0 | 0 | Note 2 |

Note 1: The allocation of any PDSCH with or without SIB1 applies only to the subframes not configured as PRS subframes.

Note 2: These physical resource blocks are assigned to an arbitrary number of virtual UEs with one PDSCH per virtual UE; the data transmitted over the OCNG PDSCHs shall be uncorrelated pseudo random data, which is QPSK modulated. The parameter γ_{PRB} is used to scale the power of PDSCH.

Note 3: Subframes available for DL transmission depends on the Uplink-Downlink configuration in Table 4.2-2 in TS 36.211 [16].

Note 4: If two or more transmit antennas with CRS are used in the test, the OCNG shall be transmitted to the virtual users by all the transmit antennas with CRS and according to the antenna transmission mode 2. The parameter γ_{PRB} applies to each antenna port separately, so the transmit power is equal between all the transmit antennas with CRS used in the test. The antenna transmission modes are specified in clause 7.1 in TS 36.213.

A.3.2.2.5 OCNG TDD pattern 5: outer resource blocks allocation in 10 MHz for MBSFN ABS

Table A.3.2.2.5-1: OP.5 TDD: OCNG TDD Pattern 5 for 5ms downlink-to-uplink switch-point periodicity

| Allocation n_{PRB} | Relative power level γ_{PRB} [dB] | | | | PDSCH Data |
|-------------------------|--|---|---|--|------------|
| | Subframe (Note 1) | | | | |
| | 0 | 5 | 3, 4, 8, 9 and 6 (as normal subframe) <small>Note 3</small> | 1 and 6 (as special subframe) <small>Note 3</small> | |
| 0 – 12 | 0 | 0 | 0 | Table A.3.2.2.5-2 | Note 2 |
| 37 – 49 | 0 | 0 | 0 | | |

Note 1: PDSCH allocation does not apply to subframes configured as PRS subframes.

Note 2: These physical resource blocks are assigned to an arbitrary number of virtual UEs with one PDSCH per virtual UE; the data transmitted over the OCNG PDSCHs shall be uncorrelated pseudo random data, which is QPSK modulated. The parameter γ_{PRB} is used to scale the power of PDSCH.

Note 3: Subframes available for DL transmission depends on the Uplink-Downlink configuration defined in Table 4.2-2 in TS 36.211 [16]. Any of the subframes 3, 4, 8 and 9 configured as MBSFN ABS in a test shall not contain any PMCH data and shall contain CRS only in the first symbol of the first time slot. The subframe(s) configured as MBSFN ABS depend upon the MBSFN ABS pattern used in the test.

Note 4: If two or more transmit antennas with CRS are used in the test, the OCNG shall be transmitted to the virtual users by all the transmit antennas with CRS and according to the antenna transmission mode 2. The parameter γ_{PRB} applies to each antenna port separately, so the transmit power is equal between all the transmit antennas with CRS used in the test. The antenna transmission modes are specified in clause 7.1 in TS 36.213.

Table A.3.2.2.5-2: OP.5 TDD: OCNG TDD Pattern 5 for special subframe configuration with 5ms downlink-to-uplink switch-point periodicity

| Allocation n_{PRB} | Relative power level γ_{PRB} [dB] | | | | | | | | | | | | | | | | | |
|-------------------------|--|---|---|---|---|---|---|---|---|---|---|---|---|---|---|---|---|---|
| | Special subframe configuration | | | | | | | | | | | | | | | | | |
| | 0 | | 1 | | 2 | | 3 | | 4 | | 5 | | 6 | | 7 | | 8 | |
| | Control region OFDM symbols | | | | | | | | | | | | | | | | | |
| | 1 | 2 | 1 | 2 | 1 | 2 | 1 | 2 | 1 | 2 | 1 | 2 | 1 | 2 | 1 | 2 | 1 | 2 |
| 0 – 12 | 0 | | 0 | | 0 | | 0 | | 0 | | 0 | | 0 | | 0 | | 0 | |
| 37 – 49 | 0 | | 0 | | 0 | | 0 | | 0 | | 0 | | 0 | | 0 | | 0 | |

Note 1: Special subframe configurations are defined in Table 4.2-1 in TS 36.211 [16].

A.3.2.2.6 OCNG TDD pattern 6: full bandwidth allocation in 10 MHz for MBSFN ABS

Table A.3.2.2.6-1: OP.6 TDD: OCNG TDD Pattern 6 for 5ms downlink-to-uplink switch-point periodicity

| Allocation n_{PRB} | Relative power level γ_{PRB} [dB] | | | | PDSCH Data |
|-------------------------|--|---|---|---|------------|
| | Subframe (Note 1) | | | | |
| | 0 | 5 | 3, 4, 8, 9 and 6 (as normal subframe) ^{Note 3} | 1 and 6 (as special subframe) ^{Note 3} | |
| 0 – 49 | 0 | 0 | 0 | 0 | Note 2 |

Note 1: PDSCH allocation does not apply to subframes configured as PRS subframes.
 Note 2: These physical resource blocks are assigned to an arbitrary number of virtual UEs with one PDSCH per virtual UE; the data transmitted over the OCNG PDSCHs shall be uncorrelated pseudo random data, which is QPSK modulated. The parameter γ_{PRB} is used to scale the power of PDSCH.
 Note 3: Subframes available for DL transmission depends on the Uplink-Downlink configuration in Table 4.2-2 in TS 36.211 [16]. Any of the subframes 3, 4, 8 and 9 configured as MBSFN ABS in a test shall not contain any PMCH data and shall contain CRS only in the first symbol of the first time slot. The subframe(s) configured as MBSFN ABS depend upon the MBSFN ABS pattern used in the test.
 Note 4: If two or more transmit antennas with CRS are used in the test, the OCNG shall be transmitted to the virtual users by all the transmit antennas with CRS and according to the antenna transmission mode 2. The parameter γ_{PRB} applies to each antenna port separately, so the transmit power is equal between all the transmit antennas with CRS used in the test. The antenna transmission modes are specified in clause 7.1 in TS 36.213.

A.3.2.2.7 OCNG TDD pattern 7: outer resource blocks allocation in 20 MHz

Table A.3.2.2.7-1: OP.7 TDD: OCNG TDD Pattern 7 for 5ms downlink-to-uplink switch-point periodicity

| Allocation n_{PRB} | Relative power level γ_{PRB} [dB] | | | | PDSCH Data |
|-------------------------|--|---|---|---|------------|
| | Subframe (Note 1) | | | | |
| | 0 | 5 | 3, 4, 8, 9 and 6 (as normal subframe) ^{Note 3} | 1 and 6 (as special subframe) ^{Note 3} | |
| 0 – 37 | 0 | 0 | 0 | Table A.3.2.2.7-2 | Note 2 |
| 62 – 99 | 0 | 0 | 0 | | |

| | |
|---------|---|
| Note 1: | The allocation of any PDSCH with or without SIB1 applies only to the subframes not configured as PRS subframes. |
| Note 2: | These physical resource blocks are assigned to an arbitrary number of virtual UEs with one PDSCH per virtual UE; the data transmitted over the OCNG PDSCHs shall be uncorrelated pseudo random data, which is QPSK modulated. The parameter γ_{PRB} is used to scale the power of PDSCH. |
| Note 3: | Subframes available for DL transmission depends on the Uplink-Downlink configuration defined in Table 4.2-2 in 3GPP TS 36.211 [16]. |
| Note 4: | If two or more transmit antennas with CRS are used in the test, the OCNG shall be transmitted to the virtual users by all the transmit antennas with CRS and according to the antenna transmission mode 2. The parameter γ_{PRB} applies to each antenna port separately, so the transmit power is equal between all the transmit antennas with CRS used in the test. The antenna transmission modes are specified in section 7.1 in 3GPP TS 36.213. |

Table A.3.2.2.7-2: OP.7 TDD: OCNG TDD Pattern 7 for special subframe configuration with 5ms downlink-to-uplink switch-point periodicity

| Allocation n_{PRB} | CP length | Relative power level γ_{PRB} [dB] | | | | | | | | | | | | | | | | | |
|-------------------------|-----------|--|---|---|---|---|---|---|---|---|---|---|---|---|---|---|---|---|---|
| | | Special subframe configuration | | | | | | | | | | | | | | | | | |
| | | 0 | | 1 | | 2 | | 3 | | 4 | | 5 | | 6 | | 7 | | 8 | |
| | | Control region OFDM symbols | | | | | | | | | | | | | | | | | |
| | | 1 | 2 | 1 | 2 | 1 | 2 | 1 | 2 | 1 | 2 | 1 | 2 | 1 | 2 | 1 | 2 | 1 | 2 |
| 0 – 37 | N | 0 | 0 | 0 | 0 | 0 | 0 | 0 | 0 | 0 | 0 | 0 | 0 | 0 | 0 | 0 | 0 | 0 | 0 |
| 62 – 99 | N | 0 | 0 | 0 | 0 | 0 | 0 | 0 | 0 | 0 | 0 | 0 | 0 | 0 | 0 | 0 | 0 | 0 | 0 |

Note 1: Special subframe configurations are defined in Table 4.2-1 in TS 36.211 [16].

A.3.2.2.8 OCNG TDD pattern 8: full bandwidth allocation in 20 MHz

Table A.3.2.2.8-1: OP.8 TDD: OCNG TDD Pattern 8 for 5ms downlink-to-uplink switch-point periodicity

| Allocation n_{PRB} | Relative power level γ_{PRB} [dB] | | | | PDSCH Data |
|-------------------------|--|---|---|---|------------|
| | Subframe (Note 1) | | | | |
| | 0 | 5 | 3, 4, 8, 9 and 6 (as normal subframe) ^{Note 3} | 1 and 6 (as special subframe) ^{Note 3} | |
| 0 – 99 | 0 | 0 | 0 | 0 | Note 2 |

Note 1: The allocation of any PDSCH with or without SIB1 applies only to the subframes not configured as PRS subframes

Note 2: These physical resource blocks are assigned to an arbitrary number of virtual UEs with one PDSCH per virtual UE; the data transmitted over the OCNG PDSCHs shall be uncorrelated pseudo random data, which is QPSK modulated. The parameter γ_{PRB} is used to scale the power of PDSCH.

Note 3: Subframes available for DL transmission depends on the Uplink-Downlink configuration in Table 4.2-2 in 3GPP TS 36.211 [16].

Note 4: If two or more transmit antennas with CRS are used in the test, the OCNG shall be transmitted to the virtual users by all the transmit antennas with CRS and according to the antenna transmission mode 2. The parameter γ_{PRB} applies to each antenna port separately, so the transmit power is equal between all the transmit antennas with CRS used in the test. The antenna transmission modes are specified in section 7.1 in 3GPP TS 36.213.

A.3.2.2.9 OCNG TDD pattern 9: outer resource blocks allocation in 5 MHz

Table A.3.2.2.9-1: OP.9 TDD: OCNG TDD Pattern 9 for 5ms downlink-to-uplink switch-point periodicity

| Allocation | Relative power level γ_{PRB} [dB] | PDSCH |
|------------|--|-------|
|------------|--|-------|

| n_{PRB} | Subframe (Note 1) | | | | Data |
|---|-------------------|---|--|---|--------|
| | 0 | 5 | 3, 4, 8, 9 and 6 (as normal subframe) ^{Note 3} | 1 and 6 (as special subframe) ^{Note 3} | |
| 0 – 6 | 0 | 0 | 0 | Table A.3.2.2.9-2 | Note 2 |
| 18 – 24 | 0 | 0 | 0 | | |
| <p>Note 1: The allocation of any PDSCH with or without SIB1 applies only to the subframes not configured as PRS subframes.</p> <p>Note 2: These physical resource blocks are assigned to an arbitrary number of virtual UEs with one PDSCH per virtual UE; the data transmitted over the OCNB PDSCHs shall be uncorrelated pseudo random data, which is QPSK modulated. The parameter γ_{PRB} is used to scale the power of PDSCH.</p> <p>Note 3: Subframes available for DL transmission depends on the Uplink-Downlink configuration defined in Table 4.2-2 in 3GPP TS 36.211 [16].</p> <p>Note 4: If two or more transmit antennas with CRS are used in the test, the OCNB shall be transmitted to the virtual users by all the transmit antennas with CRS and according to the antenna transmission mode 2. The parameter γ_{PRB} applies to each antenna port separately, so the transmit power is equal between all the transmit antennas with CRS used in the test. The antenna transmission modes are specified in section 7.1 in 3GPP TS 36.213.</p> | | | | | |

Table A.3.2.2.9-2: OP.9 TDD: OCNB TDD Pattern 9 for special subframe configuration with 5ms downlink-to-uplink switch-point periodicity

| Allocation n_{PRB} | CP length | Relative power level γ_{PRB} [dB] | | | | | | | | | | | | | | | | | |
|-------------------------|-----------|--|---|---|---|---|---|---|---|---|---|---|---|---|---|---|---|---|---|
| | | Special subframe configuration | | | | | | | | | | | | | | | | | |
| | | 0 | | 1 | | 2 | | 3 | | 4 | | 5 | | 6 | | 7 | | 8 | |
| | | Control region OFDM symbols | | | | | | | | | | | | | | | | | |
| | | 1 | 2 | 1 | 2 | 1 | 2 | 1 | 2 | 1 | 2 | 1 | 2 | 1 | 2 | 1 | 2 | 1 | 2 |
| 0 – 6 | N | 0 | 0 | 0 | 0 | 0 | 0 | 0 | 0 | 0 | 0 | 0 | 0 | 0 | 0 | 0 | 0 | 0 | 0 |
| 18 – 24 | N | 0 | 0 | 0 | 0 | 0 | 0 | 0 | 0 | 0 | 0 | 0 | 0 | 0 | 0 | 0 | 0 | 0 | 0 |

Note 1: Special subframe configurations are defined in Table 4.2-1 in TS 36.211 [16].

A.3.2.2.10 OCNB TDD pattern 10: full bandwidth allocation in 5 MHz

Table A.3.2.2.10-1: OP.10 TDD: OCNB TDD Pattern 10 for 5ms downlink-to-uplink switch-point periodicity

| Allocation n_{PRB} | Relative power level γ_{PRB} [dB] | | | | PDSCH Data | |
|--|--|---|---|---|---|--------|
| | Subframe (Note 1) | | | | | |
| | | 0 | 5 | 3, 4, 8, 9 and 6 (as normal subframe) ^{Note 3} | 1 and 6 (as special subframe) ^{Note 3} | |
| 0 – 24 | | 0 | 0 | 0 | 0 | Note 2 |
| <p>Note 1: The allocation of any PDSCH with or without SIB1 applies only to the subframes not configured as PRS subframes.</p> <p>Note 2: These physical resource blocks are assigned to an arbitrary number of virtual UEs with one PDSCH per virtual UE; the data transmitted over the OCNB PDSCHs shall be uncorrelated pseudo random data, which is QPSK modulated. The parameter γ_{PRB} is used to scale the power of PDSCH.</p> <p>Note 3: Subframes available for DL transmission depends on the Uplink-Downlink configuration in Table 4.2-2 in 3GPP TS 36.211 [16].</p> <p>Note 4: If two or more transmit antennas with CRS are used in the test, the OCNB shall be transmitted to the virtual users by all the transmit antennas with CRS and according to the antenna</p> | | | | | | |

transmission mode 2. The parameter γ_{PRB} applies to each antenna port separately, so the transmit power is equal between all the transmit antennas with CRS used in the test. The antenna transmission modes are specified in section 7.1 in 3GPP TS 36.213.

A.3.2.2.11 OCNG TDD pattern 11: Generic resource blocks allocation (without MBSFN)

Table A.3.2.2.11-1: OP.11 TDD: OCNG TDD Pattern 11

| OCNG Pattern Name | Bandwidth (MHz) | Allocation n_{PRB} | Relative power level γ_{PRB} [dB] | | | | PDSCH Data |
|-------------------|-----------------|--------------------------------|--|---|---|---|------------|
| | | | Subframe | | | | |
| | | | 0 | 5 | 3, 4, 8, 9 and 6 (as normal subframe) <small>Note 5</small> | 1 and 6 (as special subframe) <small>Note 5</small> | |
| OP.11 TDD | 10 | 0 – 49 <small>Note 1,2</small> | 0 | 0 | 0 | 0 | Note 3 |
| | | | | | | | |

Note 1: The OCNG pattern is used only for a serving cell of the UE under test.

Note 2: The OCNG allocation applied to all downlink physical resource blocks (PRBs) except the REs that are allocated for the PDSCH for the UE under test.

Note 3: OCNG PRBs are assigned to an arbitrary number of virtual UEs with one PDSCH per virtual UE; the data transmitted over the OCNG PDSCHs shall be uncorrelated pseudo random data, which is QPSK modulated. The parameter γ_{PRB} is used to scale the power of PDSCH.

Note 4: If two or more transmit antennas with CRS are used in the test, the PDSCH part of OCNG shall be transmitted to the virtual users by all the transmit antennas with CRS and according to the antenna transmission mode 2. The parameter γ_{PRB} applies to each antenna port separately, so the transmit power of the PDSCH part of OCNG is equal between all the transmit antennas with CRS used in the test. The antenna transmission modes are specified in clause 7.1 in TS 36.213.

Note 5: Subframes available for DL transmission depends on the Uplink-Downlink configuration in Table 4.2-2 in TS 36.211 [16].

A.3.2.3 OCNG Patterns for Narrowband IoT

The following Narrowband OCNG patterns (NOCNG) are used for modelling allocations to UEs not under test in a Narrowband IoT cell. Depending on scenario, allocations may be for UEs of category NB1 only, or for UEs of category NB1 as well as of other categories. The former is applicable to guard-band and stand-alone deployments of Narrowband IoT, whereas the latter is applicable to in-band deployment. In order to allow different power levels for the LTE cell and the Narrowband IoT cell, a distinction is made between OCNG and NOCNG where the latter is used for category NB1 UEs and the former is used for other UE categories.

OCNG in the LTE cell is expressed by parameters OCNG_RA and OCNG_RB which together with a relative power level (γ) specifies the PDSCH-to-RS EPRE ratio in OFDM symbols with and without LTE cell-specific reference symbols, respectively. The relative power, which is used for modelling boosting per virtual LTE UE allocation, is expressed by:

$$\gamma_i = PDSCH_i_RA / OCNG_RA = PDSCH_i_RB / OCNG_RB,$$

where γ_i denotes the relative power level of the i :th virtual LTE UE.

Moreover in each test case NOCNG is expressed by parameters NOCNG_RA and NOCNG_RB which together with a relative power level (γ) specifies the <channel>-to-RS EPRE ratio in OFDM symbols with and without Narrowband reference symbols (NB-RS), respectively. The relative power, which is used for modelling boosting per virtual UE category NB1 allocation, is expressed by:

$$\gamma_k = \langle channel \rangle_k_RA / NOCNG_RA = \langle channel \rangle_k_RB / NOCNG_RB,$$

where γ_k denotes the relative power level of the k :th virtual NB-IoT UE, and channel may be either of NPDCCH and NPDSCH.

The parameter settings of OCNG_RA, OCNG_RB, NOCNG_RA, NOCNG_RB and the set of relative power levels γ are chosen such that when also taking allocations to the UE category NB1 under test into account, as given by a NPDCCH and NPDSCH reference channels, a transmitted power spectral density that is constant on an OFDM symbol basis is targeted.

A.3.2.3.1 Narrowband IoT OCNG FDD pattern 1: In-band NB-IoT in 10 MHz EUTRAN cell

Table A.3.2.3.1-1: NOP.1 FDD: OCNG FDD Pattern 1

| Allocation n_{PRB} | Relative power level γ_{PRB} [dB] | | | PDSCH Data | NPDCCH and NPDSCH Data |
|---|--|------------|----------|------------|------------------------|
| | Subframe | | | | |
| | 0, 4 | 5, 9 | 1-3, 6-8 | | |
| $0 - (nCell[1]RB - 1)$ (Note 5) | 0 | 0 | 0 | Note 1 | N/A |
| $nCell[1]RB$ (Note 5) | 0 (Note 3) | 0 (Note 3) | N/A | N/A | Note 2 |
| | N/A | N/A | 0 | Note 1 | N/A |
| $(nCell[1]RB + 1) - (nCell[...]RB - 1)$ (Note 5) | 0 | 0 | 0 | Note 1 | N/A |
| $nCell[...]RB$ (Note 5) | 0 (Note 3) | 0 (Note 3) | N/A | N/A | Note 2 |
| | N/A | N/A | 0 | Note 1 | N/A |
| $(nCell[...]RB + 1) - (nCell[N]RB - 1)$ (Note 5) | 0 | 0 | 0 | Note 1 | N/A |
| $nCell[N]RB$ (Note 5) | 0 (Note 3) | 0 (Note 3) | N/A | N/A | Note 2 |
| | N/A | N/A | 0 | Note 1 | N/A |
| $(nCell[N]RB + 1) - 49$ (Note 5) | 0 | 0 | 0 | Note 1 | N/A |
| <p>Note 1: These physical resource blocks are assigned to an arbitrary number of virtual UEs with one PDSCH per virtual UE; the data transmitted over the OCNG PDSCHs shall be uncorrelated QPSK modulated pseudo random data. The parameter γ_{PRB} is used to scale the power of PDSCH. If two or more transmit antennas with CRS are used in the test, the PDSCH part of OCNG shall be transmitted to the virtual users by all the transmit antennas with CRS and according to the antenna transmission mode 2. The parameter γ_{PRB} applies to each antenna port separately, so the transmit power of the PDSCH part of OCNG is equal between all the transmit antennas with CRS used in the test. The antenna transmission modes are specified in clause 7.1 in TS 36.213.</p> <p>Note 2: This physical resource block is assigned to a virtual UE for transmission of NPDCCH or NPDSCH; the data transmitted over the NOCNG NPDCCH or NPDSCH shall be uncorrelated QPSK modulated pseudo random data. The parameter γ_{PRB} is used to scale the power of NPDCCH and NPDSCH. If two transmit antennas with NBRS are used in the test, the NPDCCH and NPDSCH parts of NOCNG shall be transmitted to the virtual users by both transmit antennas with NBRS and according to the antenna transmission mode 2. The parameter γ_{PRB} applies to each antenna port separately, so the transmit power of the NPDCCH and NPDSCH parts of NOCNG is equal between both the transmit antennas with NBRS used in the test. The antenna transmission modes are specified in clause 7.1 in TS 36.213.</p> <p>Note 3: Value of γ_{PRB} is applicable to PRBs not used for transmission of NPSS, NSSS, and NPBCH in anchor cells.</p> <p>Note 4: SI transmissions, and NPDCCH and NPDSCH for the UE under test, have precedence over OCNG and NOCNG.</p> <p>Note 5: $nCell[k]RB$ is the index of the RB used for allocation of the NB-IoT cell k with $k = \{1, \dots, N\}$ with N the total number of the NB-IoT cells belonging to the same LTE donor cell as specified in the individual tests.</p> <p>N/A: Not Applicable</p> | | | | | |

A.3.2.3.2 Narrowband IoT OCNG FDD pattern 2: guard band NB-IoT in 10 MHz EUTRAN cell

Table A.3.2.3.2-1: NOP.2 FDD: OCNG FDD Pattern 2

| Allocation n_{PRB} | Relative power level γ_{PRB} [dB] | | | PDSCH Data | NPDCCH and NPDSCH Data |
|--|--|------------|----------|------------|------------------------|
| | Subframe | | | | |
| | 0, 4 | 5, 9 | 1-3, 6-8 | | |
| 0 – 49 | 0 | 0 | 0 | Note 1 | N/A |
| 50 | 0 (Note 3) | 0 (Note 3) | 0 | N/A | Note 2 |
| <p>Note 1: These physical resource blocks are assigned to an arbitrary number of virtual UEs with one PDSCH per virtual UE; the data transmitted over the OCNG PDSCHs shall be uncorrelated QPSK modulated pseudo random data. The parameter γ_{PRB} is used to scale the power of PDSCH. If two or more transmit antennas with CRS are used in the test, the PDSCH part of OCNG shall be transmitted to the virtual users by all the transmit antennas with CRS and according to the antenna transmission mode 2. The parameter γ_{PRB} applies to each antenna port separately, so the transmit power of the PDSCH part of OCNG is equal between all the transmit antennas with CRS used in the test. The antenna transmission modes are specified in clause 7.1 in TS 36.213.</p> <p>Note 2: This physical resource block is assigned to a virtual UE for transmission of NPDCCH or NPDSCH; the data transmitted over the NOCNG NPDCCH or NPDSCH shall be uncorrelated QPSK modulated pseudo random data. The parameter γ_{PRB} is used to scale the power of NPDCCH and NPDSCH. If two transmit antennas with NBRS are used in the test, the NPDCCH and NPDSCH parts of NOCNG shall be transmitted to the virtual users by both transmit antennas with NBRS and according to the antenna transmission mode 2. The parameter γ_{PRB} applies to each antenna port separately, so the transmit power of the NPDCCH and NPDSCH parts of NOCNG is equal between both the transmit antennas with NBRS used in the test. The antenna transmission modes are specified in clause 7.1 in TS 36.213.</p> <p>Note 3: Value of γ_{PRB} is applicable to PRBs not used for transmission of NPSS, NSSS and PBCH in anchor cell ($n_{PRB} = 50$).</p> <p>Note 4: SI transmissions, and NPDCCH and NPDSCH for the UE under test, have precedence over OCNG and NOCNG.</p> <p>N/A: Not Applicable</p> | | | | | |

A.3.2.3.3 Narrowband IoT OCNG FDD pattern 3: standalone NB-IoT

Table A.3.2.3.3-1: NOP.3 FDD: OCNG FDD Pattern 3

| Allocation n_{PRB} | Relative power level γ_{PRB} [dB] | | | NPDCCH and NPDSCH Data |
|--|--|------------|----------|------------------------|
| | Subframe | | | |
| | 0, 4 | 5, 9 | 1-3, 6-8 | |
| 0 | 0 (Note 2) | 0 (Note 2) | 0 | Note 1 |
| <p>Note 1: This physical resource block is assigned to a virtual UE for transmission of NPDCCH or NPDSCH; the data transmitted over the NOCNG NPDCCH or NPDSCH shall be uncorrelated QPSK modulated pseudo random data. The parameter γ_{PRB} is used to scale the power of NPDCCH and NPDSCH. If two transmit antennas with NBRS are used in the test, the NPDCCH and NPDSCH parts of NOCNG shall be transmitted to the virtual users by both transmit antennas with NBRS and according to the antenna transmission mode 2. The parameter γ_{PRB} applies to each antenna port separately, so the transmit power of the NPDCCH and NPDSCH parts of NOCNG is equal</p> | | | | |

between both the transmit antennas with NBRs used in the test. The antenna transmission modes are specified in clause 7.1 in TS 36.213.

Note 2: Value of γ_{PRB} is applicable to PRBs not used for transmission of NPSS, NSSS and NPBCH in anchor cell ($n_{PRB} = 0$).

Note 3: SI transmissions, and NPDCCH and NPDSCH for the UE under test, have precedence over NOCNG.

A.3.3 Reference DRX Configurations

Table A.3.3-1: Reference DRX Configurations

| Parameter | Value | | Comments |
|--------------------------|--|-----------|--------------------------------------|
| Reference configuration | DRX_S | DRX_L | As defined in 4.8.2.1.5 in TS 36.508 |
| onDurationTimer | psf2 | psf6 | |
| drx-InactivityTimer | psf100 | psf1920 | |
| drx-RetransmissionTimer | psf16 | psf16 | |
| longDRX-CycleStartOffset | sf40, 0 | sf1280, 0 | |
| shortDRX | disabled | disabled | |
| Note: | For further information see clause 6.3.2 in TS 36.331. | | |

A.3.4 ABS Transmission Configurations

A.3.4.1 Non-MBSFN ABS Transmission Configurations

A.3.4.1.1 Non-MBSFN ABS Transmission, 1x2 antenna with PBCH

Table A.3.4.1.1-1: Transmission configuration with non-MBSFN ABS, 1x2 with PBCH

| Physical Channels and Signals | Parameters | EPRE, [dB] | |
|--|------------|------------|----------|
| | | Non-ABS | ABS |
| PBCH | PBCH_RA | 0 | 0 |
| | PBCH_RB | 0 | 0 |
| PSS | PSS_RA | 0 | 0 |
| SSS | SSS_RA | 0 | 0 |
| PCFICH | PCFICH_RB | 0 | 0 Note 1 |
| PHICH | PHICH_RA | 0 | -Inf |
| | PHICH_RB | 0 | -Inf |
| PDCCH | PDCCH_RA | 0 | 0 Note 1 |
| | PDCCH_RB | 0 | 0 Note 1 |
| PDSCH | PDSCH_RA | 0 | 0 Note 1 |
| | PDSCH_RB | 0 | 0 Note 1 |
| OCNG | OCNG_RA | 0 | -Inf |
| | OCNG_RB | 0 | -Inf |
| NOTE 1: Only used for SIB1, otherwise EPRE is -Inf | | | |
| NOTE 2: 1x2 antenna configuration is assumed | | | |

A.3.4.1.2 Non-MBSFN ABS Transmission, 2x2 antenna without PBCH

Table A.3.4.1.2-1: Transmission configuration #1 with non-MBSFN ABS, 2x2 without PBCH

| Physical Channels and Signals | Parameters | EPRE, [dB] | |
|-------------------------------|------------|------------|------|
| | | Non-ABS | ABS |
| PBCH | PBCH_RA | -3 | -Inf |
| | PBCH_RB | -3 | -Inf |

| | | | |
|--|-----------|----|------|
| PSS | PSS_RA | -3 | -3 |
| SSS | SSS_RA | -3 | -3 |
| PCFICH | PCFICH_RB | 1 | -Inf |
| PHICH | PHICH_RA | -3 | -Inf |
| | PHICH_RB | -3 | -Inf |
| PDCCH | PDCCH_RA | 1 | -Inf |
| | PDCCH_RB | 1 | -Inf |
| PDSCH | PDSCH_RA | -3 | -Inf |
| | PDSCH_RB | -3 | -Inf |
| OCNG | OCNG_RA | -3 | -Inf |
| | OCNG_RB | -3 | -Inf |
| NOTE: 2x2 antenna configuration is assumed | | | |

Table A.3.4.1.2-2: Transmission configuration #2 with non-MBSFN ABS, 2x2 without PBCH

| Physical Channels and Signals | Parameters | EPRE, [dB] | |
|--|------------|------------|------|
| | | Non-ABS | ABS |
| PBCH | PBCH_RA | -3 | -Inf |
| | PBCH_RB | -3 | -Inf |
| PSS | PSS_RA | -3 | -3 |
| SSS | SSS_RA | -3 | -3 |
| PCFICH | PCFICH_RB | 1 | -Inf |
| PHICH | PHICH_RA | -3 | -Inf |
| | PHICH_RB | -3 | -Inf |
| PDCCH | PDCCH_RA | -3 | -Inf |
| | PDCCH_RB | -3 | -Inf |
| PDSCH | PDSCH_RA | -3 | -Inf |
| | PDSCH_RB | -3 | -Inf |
| OCNG | OCNG_RA | -3 | -Inf |
| | OCNG_RB | -3 | -Inf |
| NOTE: 2x2 antenna configuration is assumed | | | |

A.3.4.2 MBSFN ABS Transmission Configurations

A.3.4.2.1 MBSFN ABS Transmission, 1x2 antenna

Table A.3.4.2.1-1: Transmission configuration with MBSFN ABS, 1x2

| Physical Channels and Signals | Parameters | EPRE, [dB] | |
|--|------------|------------|------|
| | | Non-ABS | ABS |
| PBCH | PBCH_RA | 0 | N/A |
| | PBCH_RB | 0 | N/A |
| PSS | PSS_RA | 0 | N/A |
| SSS | SSS_RA | 0 | N/A |
| PCFICH | PCFICH_RB | 0 | -Inf |
| PHICH | PHICH_RA | 0 | -Inf |
| | PHICH_RB | 0 | -Inf |
| PDCCH | PDCCH_RA | 0 | -Inf |
| | PDCCH_RB | 0 | -Inf |
| PDSCH | PDSCH_RA | 0 | -Inf |
| | PDSCH_RB | 0 | -Inf |
| PMCH | PMCH_RA | 0 | -Inf |
| | PMCH_RB | 0 | -Inf |
| OCNG | OCNG_RA | 0 | -Inf |
| | OCNG_RB | 0 | -Inf |
| NOTE: 1x2 antenna configuration is assumed | | | |

A.3.4.2.2 MBSFN ABS Transmission, 2x2 antenna

Table A.3.4.2.2-1: Transmission configuration #1 with MBSFN ABS, 2x2

| Physical Channels and Signals | Parameters | EPRE, [dB] | |
|--|------------|------------|------|
| | | Non-ABS | ABS |
| PBCH | PBCH_RA | -3 | N/A |
| | PBCH_RB | -3 | N/A |
| PSS | PSS_RA | -3 | N/A |
| SSS | SSS_RA | -3 | N/A |
| PCFICH | PCFICH_RB | 1 | -Inf |
| PHICH | PHICH_RA | -3 | -Inf |
| | PHICH_RB | -3 | -Inf |
| PDCCH | PDCCH_RA | 1 | -Inf |
| | PDCCH_RB | 1 | -Inf |
| PDSCH | PDSCH_RA | -3 | -Inf |
| | PDSCH_RB | -3 | -Inf |
| PMCH | PMCH_RA | -3 | -Inf |
| | PMCH_RB | -3 | -Inf |
| OCNG | OCNG_RA | -3 | -Inf |
| | OCNG_RB | -3 | -Inf |
| NOTE: 2x2 antenna configuration is assumed | | | |

Table A.3.4.2.2-2: Transmission configuration # 2 with MBSFN ABS, 2x2

| Physical Channels and Signals | Parameters | EPRE, [dB] | |
|--|------------|------------|------|
| | | Non-ABS | ABS |
| PBCH | PBCH_RA | -3 | N/A |
| | PBCH_RB | -3 | N/A |
| PSS | PSS_RA | -3 | N/A |
| SSS | SSS_RA | -3 | N/A |
| PCFICH | PCFICH_RB | 1 | -Inf |
| PHICH | PHICH_RA | -3 | -Inf |
| | PHICH_RB | -3 | -Inf |
| PDCCH | PDCCH_RA | -3 | -Inf |
| | PDCCH_RB | -3 | -Inf |
| PDSCH | PDSCH_RA | -3 | -Inf |
| | PDSCH_RB | -3 | -Inf |
| PMCH | PMCH_RA | -3 | -Inf |
| | PMCH_RB | -3 | -Inf |
| OCNG | OCNG_RA | -3 | -Inf |
| | OCNG_RB | -3 | -Inf |
| NOTE: 2x2 antenna configuration is assumed | | | |

A.3.5 Impact of Reference Sensitivity Degradation with Carrier Aggregation on Test Cases

A.3.5.1 Impact of Reference Sensitivity Degradation due to Insertion Loss

For a UE supporting inter-band carrier aggregation configuration with uplink in one E-UTRA band, if there is a relaxation of receiver sensitivity $\Delta R_{IB,c} > 0$ dB as defined in TS 36.101 [5], 7.3.1-1A, there is no adjustment of test parameters in the tests specified in TS 36.133 when $\Delta R_{IB,c} \leq 1$ dB.

A.3.6 Carrier Aggregation Test Cases with Different Channel Bandwidth Combinations

A.3.6.1 Introduction

In Annex A carrier aggregation test cases may be defined with different channel bandwidth combinations to verify the same RRM requirement.

If multiple carrier aggregation test cases with different channel bandwidth combinations are defined to verify the same RRM requirement that is channel bandwidth independent, then the UE needs to be tested only with one bandwidth combination out of the bandwidth combination sets supported by that UE.

A.3.7 Test Cases with Different Channel Bandwidths

A.3.7.1 Introduction

This clause defines a principle which is applicable to test cases verifying RRM requirements for single carrier operation.

A.3.7.2 Principle of testing

Test cases defined for 5MHz channel bandwidth that reference this clause are applicable to UEs that support only Band 31.

A.3.8 Antenna Configuration

Unless otherwise specified, E-UTRA FDD or E-UTRA TDD cells in all RRM Test cases in AWGN propagation condition are configured with Antenna Configuration 1x2.

A.3.8.1 Antenna connection for 4 Rx capable UEs

A.3.8.1.1 Introduction

All tests in sections A.4 to A.9 are specified for UEs supporting either category 0 (1RX) or 2RX. In this section, the antenna connection method for applying 2RX tests to UEs supporting 4RX antenna ports is specified. No tests are currently specified in section A.4-A.9 which are applicable only to 4RX antenna ports, so 4RX capable UEs are always tested by reusing tests which were originally specified for 2RX UEs.

A.3.8.1.2 Principle of testing

A.3.8.1.2.1 Single carrier tests

For 4RX capable UEs supporting at least one 2RX band, the, all single carrier tests specified in section A.4 to A.8 shall be tested on any band where 2RX is supported with the antenna connection specified in A.8.3.1.2.3. For single carrier tests specified in section A.9, all tests shall be tested with the antenna connection specified in A.3.8.1.2.3 for bands where 2RX is supported, and the antenna connection specified in A.3.8.1.2.4 for bands where 4RX is supported.

For 4RX capable UEs which do not support any 2RX band, all tests specified in sections A.4 to A.9 shall be tested using the antenna connection specified in section A.3.8.1.2.4. For radio link monitoring tests, the SNR levels are modified according to table A.3.8.1.2.1-1 and table A.3.8.1.2.1-2.

Table A.3.8.1.2.1-1 Modified parameters for RLM out of sync testing with 4 RX antenna connection

| Test case | SNR during T3 (dB) | | | |
|-----------|--------------------|--------|--------|--------|
| | Test 1 | Test 2 | Test 3 | Test 4 |
| A.7.3.1 | -17 | -17 | -15 | -15.7 |

| | | | | |
|--|--------|-------|-------|-------|
| A.7.3.3 | -16.6 | -16.7 | -14.8 | -15.4 |
| A.7.3.5 | -15.7 | -17 | N/A | N/A |
| A.7.3.7 | -15.4 | -16.6 | N/A | N/A |
| A.7.3.9 (cell 1) | Note 1 | N/A | N/A | N/A |
| A.7.3.10 (cell 1) | Note 1 | N/A | N/A | N/A |
| A.7.3.13 (cell 1) | Note 1 | N/A | N/A | N/A |
| A.7.3.14 (cell 1) | Note 1 | N/A | N/A | N/A |
| A.7.3.17 (cell 1) | Note 1 | N/A | N/A | N/A |
| A.7.3.18 (cell 1) | Note 1 | N/A | N/A | N/A |
| A.7.3.23 | -15.7 | N/A | N/A | N/A |
| Note 1: For 4Rx capable UEs without any 2Rx supported RF bands,this test can be skipped. | | | | |

Table A.3.8.1.2.1-2 Modified parameters for RLM in sync single carrier testing with 4 RX antenna connection

| Test case | SNR during T3 (dB) | | SNR during T4 (dB) | |
|--|--------------------|--------|--------------------|--------|
| | Test 1 | Test 2 | Test 1 | Test 2 |
| A.7.3.2 | -14 | -15.7 | -9.9 | -10.8 |
| A.7.3.4 | -14.8 | -15.4 | -9.9 | -10.8 |
| A.7.3.6 | -17 | N/A | -12.2 | N/A |
| A.7.3.8 | -16.6 | N/A | -12.6 | N/A |
| A.7.3.11 (cell 1) | Note 1 | N/A | Note 1 | N/A |
| A.7.3.12 (cell 1) | Note 1 | N/A | Note 1 | N/A |
| A.7.3.15 (cell 1) | Note 1 | N/A | Note 1 | N/A |
| A.7.3.16 (cell 1) | Note 1 | N/A | Note 1 | N/A |
| A.7.3.19 (cell 1) | Note 1 | N/A | Note 1 | N/A |
| A.7.3.20 (cell 1) | Note 1 | N/A | Note 1 | N/A |
| A.7.3.21 (cell 1) | Note 1 | N/A | Note 1 | N/A |
| A.7.3.22 (cell 1) | Note 1 | N/A | Note 1 | N/A |
| A.7.3.24 | -15.7 | N/A | -10.8 | N/A |
| A.7.3.25 | -15.7 | N/A | -10.8 | N/A |
| Note 1: For 4Rx capable UEs without any 2Rx supported RF bands,this test can be skipped. | | | | |

A.3.8.1.2.2 Carrier aggregation and Dual connectivity tests

All carrier aggregation and dual connectivity tests are performed using the antenna connection in section A.3.8.1.2.3 for the PCell antenna connection if the PCell is on a band where 2RX is supported or the antenna connection in A.3.8.1.2.4 for the PCell antenna connection if the PCell is on a band where 4RX is supported.

All carrier aggregation and dual connectivity tests are performed using the antenna connection in section A.3.8.1.2.3 for the SCell or PSCell antenna connection if an SCell or PSCell is on band where 2RX is supported or the testing procedure in A.3.8.1.2.4 for the SCell or PSCell antenna connection if an SCell or PSCell is on a band where 4RX is supported.

For dual connectivity radio link monitoring tests with the PSCell on a band where 4RX is supported, the PSCell SNR levels are modified according to table A.3.8.1.2.2 -1 and table A.3.8.1.2.2 -2.

Table A.3.8.1.2.1-1 Modified parameters for dual connectivity RLM out of sync testing with 4 RX antenna connection

| Test case | SNR during T3 (dB) |
|-------------------|---|
| A.7.3.38 (cell 2) | -15.7 (5MHz) -15.7 (10MHz) -16.3 (20 MHz) |
| A.7.3.39 (cell 2) | -15.7 (5MHz) -15.7 (10MHz) -16.3 (20 MHz) |
| A.7.3.40 (cell 2) | -15.4 (5MHz) -15.4 (10MHz) -16.1 (20MHz) |

Table A.3.8.1.2.1-1 Modified parameters for RLM out of sync testing with 4 RX antenna connection

| Test case | SNR during T3 (dB) | SNR during T4 (dB) |
|-------------------|---|--|
| A.7.3.41 (cell 2) | -15.7 (5 Mhz) -17.0 (10 Mhz) -17.0 (20 Mhz) | -10.8 (5MHz) -12.2 (10MHz) -12.2 (20 MHz) |
| A.7.3.42 (cell 2) | -15.7 (5 Mhz) -17.0 (10 Mhz) -17.0 (20 Mhz) | -10.8 (5MHz) -12.2 (10MHz) -12.2 (20 MHz) |
| A.7.3.43 (cell 2) | -16.6 (5MHz) -16.6 (10 MHz) -16.6 (20 MHz) | -12.6 (5MHz) -12.6 (10 MHz) -12.6 (20 MHz) |

A.3.8.1.2.3 Antenna connection for bands where 2RX is supported

For bands where 2RX is supported, it is left to the UE declaration and AP configuration to decide which 2 of the 4 Rx ports are connected with data source from system simulator. The remaining 2 Rx ports shall be connected with zero input. No test parameters or requirements are modified.

A.3.8.1.2.4 Antenna connection for bands where 4RX is supported

For bands where 4RX is supported, all 4 Rx are connected with data source from system simulator. The system simulator shall provide independent noise and fading (low correlation) for each antenna port. Except for the modifications to radio link monitoring thresholds described in sections A.3.8.1.2.1 and A.3.8.1.2.2, no test parameters or requirements are modified.

A.3.9 Carrier Aggregation Test Cases with Different Duplex Modes

A.3.9.1 Introduction

This clause defines a principle which is applicable to test cases verifying RRM requirements for carrier aggregation.

A.3.9.2 Principle of testing

In Annex A carrier aggregation test cases may be defined for different duplex modes or combination of duplex modes (E-UTRA FDD, E-UTRA TDD and E-UTRA TDD-FDD) to verify the same RRM requirement.

If multiple carrier aggregation test cases are defined for different duplex modes (E-UTRA FDD or E-UTRA TDD) or for combination of duplex modes (E-UTRA TDD-FDD) to verify the same RRM requirement which is independent of the duplex mode and is identical for different duplex modes or combination of duplex modes, then from UE the performance point of view the test coverage can be considered fulfilled by executing only the corresponding test case(s) with one of the duplex modes supported by the UE.

A.3.10 Carrier Aggregation Test Cases with Different CA Configurations

A.3.10.1 Introduction

This clause defines a principle which is applicable to test cases verifying RRM requirements for carrier aggregation.

A.3.10.2 Principle of testing

In Annex A carrier aggregation test cases may be defined for two CCs as well as for more than two CCs to verify the same RRM requirement.

If multiple carrier aggregation test cases are defined for two CCs as well as for more than two CCs to verify the same RRM requirement, then from the UE performance point of view the test coverage can be considered fulfilled by executing only the test cases with the maximum number of CCs supported by the UE.

Editor's note: whether it is sufficient to test for any one of the band combinations supported by the UE is FFS.

A.3.11 Test Cases for Synchronous and Asynchronous Dual Connectivity

A.3.11.1 Introduction

This clause defines a principle which is applicable to test cases verifying RRM requirements for dual connectivity (DC) operation in synchronous and asynchronous scenarios.

A.3.11.2 Principle of Testing

In Annex A test cases may be defined in both synchronous DC and asynchronous DC scenarios to verify the same RRM requirement.

If test cases are defined in both synchronous and asynchronous DC scenarios to verify the same RRM requirement then the UE capable of both synchronous and asynchronous DC operations needs to be tested with one of the tests in either synchronous or asynchronous DC scenarios.

A.3.12 Proximity-based Services

A.3.12.1 Introduction

This clause also defines the principle and the reference configurations that are applicable to test cases verifying RRM core requirements for ProSe Direct Discovery and ProSe Direct Communication.

A.3.12.2 Reference DRX configurations for ProSe tests

Table A.3.12.2-1: Reference DRX Configurations

| Parameter | Value |
|--------------------------|--|
| Reference configuration | DRX_P1 |
| onDurationTimer | psf1 |
| drx-InactivityTimer | psf1 |
| drx-RetransmissionTimer | psf1 |
| longDRX-CycleStartOffset | sf320, 0 |
| shortDRX | Disabled |
| Note: | For further information see clause 6.3.2 in TS 36.331. |

A.3.12.3 Test Cases with Different Channel Bandwidths

A.3.12.3.1 Introduction

This clause defines a principle which is applicable to test cases verifying ProSe RRM requirements with different channel bandwidths.

A.3.12.3.2 Principle of testing

Some ProSe test cases are defined for different channel bandwidths to verify the same RRM requirement.

If test cases with different channel bandwidth are defined to verify the same RRM requirement then the UE is required to pass the test cases only with one of the channel bandwidths.

A.3.12.4 Reference resource pool configurations for ProSe Direct Discovery

Table A.3.12.4-1: ProSe Direct Discovery configuration for E-UTRA FDD (Configuration #1)

| Information Element | | | | Value |
|--|----------------------------|----------------------------------|----------------------|--|
| <i>discRxPool</i> | <i>cp-Len</i> | | | Normal |
| | <i>discPeriod</i> | | | rf32 |
| | <i>numRetx</i> | | | 0 |
| | <i>numRepetition</i> | | | 1 |
| | <i>tf-ResourceConfig</i> | <i>prb-Num</i> | | 12 |
| | | <i>prb-Start</i> | | 0 |
| | | <i>prb-End</i> | | 23 |
| | | <i>offsetIndicator</i> | | 160 |
| | | <i>subframeBitmap</i> | | 11000000 00000000 00000000 00000000 00000000 |
| | <i>txParameters</i> | | | not present |
| | <i>rxParameters</i> | | | not present |
| <i>discTxPoolCommon/ discTxPoolDedicated</i> | <i>cp-Len</i> | | | Normal |
| | <i>discPeriod</i> | | | rf32 |
| | <i>numRetx</i> | | | 0 |
| | <i>numRepetition</i> | | | 1 |
| | <i>tf-ResourceConfig</i> | <i>prb-Num</i> | | 2 |
| | | <i>prb-Start</i> | | 3 |
| | | <i>prb-End</i> | | 5 |
| | | <i>offsetIndicator</i> | | 160 |
| | | <i>subframeBitmap</i> | | 10000000 00000000 00000000 00000000 00000000 |
| | <i>txParameters</i> | <i>txParametersGeneral</i> | <i>alpha</i> | al0 |
| | | | <i>p0</i> | 31 |
| | | <i>ue-SelectedResourceConfig</i> | <i>poolSelection</i> | random |
| | | | <i>txProbability</i> | p100 |
| | <i>rxParameters</i> | | | not present |
| <i>discTxPowerInfo</i> | <i>discMaxTxPower</i> | | | 23 |
| <i>SL-SyncConfig</i> | <i>syncCP-Len</i> | | | Normal |
| | <i>syncOffsetIndicator</i> | | | 35 (155 mod 40) |
| | <i>slssid</i> | | | 30 |
| | <i>txParameters</i> | <i>txParametersGeneral</i> | <i>alpha</i> | al0 |
| | | | <i>p0</i> | 31 |
| | | <i>syncTxThreshIC</i> | | 0 (-infinity) |
| | <i>rxParamsNCell</i> | | | not present |
| <i>discInterFreqList</i> | | | | not present |

Table A.3.12.4-2: ProSe Direct Discovery configuration for E-UTRA FDD (Configuration #2)

| Information Element | | | | Value |
|---------------------|-------------------|--|--|--------|
| <i>discRxPool</i> | <i>cp-Len</i> | | | Normal |
| | <i>discPeriod</i> | | | rf32 |
| | <i>numRetx</i> | | | 0 |

| | | | |
|--|----------------------------|------------------------|--|
| | <i>numRepetition</i> | | 1 |
| | <i>tf-ResourceConfig</i> | <i>prb-Num</i> | 12 |
| | | <i>prb-Start</i> | 0 |
| | | <i>prb-End</i> | 23 |
| | | <i>offsetIndicator</i> | 160 |
| | | <i>subframeBitmap</i> | 11000000 00000000 00000000 00000000 00000000 |
| | <i>txParameters</i> | | not present |
| | <i>rxParameters</i> | <i>tdd-Config</i> | not present |
| | | <i>syncConfigIndex</i> | 0 |
| <i>discTxPoolCommon/ discTxPoolDedicated</i> | | | not present |
| <i>discTxPowerInfo</i> | <i>discMaxTxPower</i> | | 23 |
| <i>SL-SyncConfig</i> | <i>syncCP-Len</i> | | Normal |
| | <i>syncOffsetIndicator</i> | | 20 (140 mod 40) |
| | <i>slssid</i> | | 30 |
| | <i>txParameters</i> | | not present |
| | <i>rxParamsNCell</i> | <i>physCellId</i> | 1 |
| | | <i>discSyncWindow</i> | w1 |
| <i>discInterFreqLis</i> | | | not present |

Table A.3.12.4-3: ProSe Direct Discovery configuration for E-UTRA TDD Config 0 (Configuration #3)

| Information Element | | | | Value |
|--|--------------------------|----------------------------------|----------------------|--|
| <i>discRxPool</i> | <i>cp-Len</i> | | | Normal |
| | <i>discPeriod</i> | | | rf32 |
| | <i>numRetx</i> | | | 0 |
| | <i>numRepetition</i> | | | 1 |
| | <i>tf-ResourceConfig</i> | <i>prb-Num</i> | | 12 |
| | | <i>prb-Start</i> | | 0 |
| | | <i>prb-End</i> | | 23 |
| | | <i>offsetIndicator</i> | | 163 |
| | | <i>subframeBitmap</i> | | 11000000 00000000 00000000 00000000 00000000 00 |
| | <i>txParameters</i> | | | not present |
| | <i>rxParameters</i> | | | not present |
| <i>discTxPoolCommon/ discTxPoolDedicated</i> | <i>cp-Len</i> | | | Normal |
| | <i>discPeriod</i> | | | rf32 |
| | <i>numRetx</i> | | | 0 |
| | <i>numRepetition</i> | | | 1 |
| | <i>tf-ResourceConfig</i> | <i>prb-Num</i> | | 2 |
| | | <i>prb-Start</i> | | 3 |
| | | <i>prb-End</i> | | 5 |
| | | <i>offsetIndicator</i> | | 163 |
| | | <i>subframeBitmap</i> | | 10000000 00000000 00000000 00000000 00000000 00 |
| | <i>txParameters</i> | <i>txParametersGeneral</i> | <i>alpha</i> | al0 |
| | | | <i>p0</i> | 31 |
| | | <i>ue-SelectedResourceConfig</i> | <i>poolSelection</i> | random |
| | | | <i>txProbability</i> | p100 |
| | <i>rxParameters</i> | | | not present |

| | | | | |
|--------------------------|----------------------------|----------------------------|--------------|-----------------|
| <i>discTxPowerInfo</i> | <i>discMaxTxPower</i> | | | 23 |
| <i>SL-SyncConfig</i> | <i>syncCP-Len</i> | | | Normal |
| | <i>syncOffsetIndicator</i> | | | 38 (158 mod 40) |
| | <i>slssid</i> | | | 30 |
| | <i>txParameters</i> | <i>txParametersGeneral</i> | <i>alpha</i> | al0 |
| | | | <i>p0</i> | 31 |
| | | <i>syncTxThreshIC</i> | | 0 (-infinity) |
| | <i>rxParamsNCell</i> | | | not present |
| <i>discInterFreqList</i> | | | | not present |

Table A.3.12.4-4: ProSe Direct Discovery configuration for E-UTRA FDD for PS discovery (Configuration #4)

| Information Element | | | | Value |
|--------------------------|--|--------------------------|--------------------------|--|
| <i>discConfig</i> | | | | not present |
| <i>discInterFreqList</i> | | | | not present |
| <i>discConfig-v1310</i> | | | | not present |
| <i>discConfigPS</i> | <i>discRxPoolPS</i> | <i>cp-Len</i> | | Normal |
| | | <i>discPeriod-v1310</i> | | rf4 |
| | | <i>numRetx</i> | | 0 |
| | | <i>numRepetition</i> | | 1 |
| | | <i>tf-ResourceConfig</i> | <i>prb-Num</i> | 12 |
| | | | <i>prb-Start</i> | 0 |
| | | | <i>prb-End</i> | 23 |
| | | | <i>offsetIndicator</i> | 20 |
| | | | <i>subframeBitmap</i> | 11000000 00000000 00000000 00000000 00000000 |
| | | <i>txParameters</i> | | not present |
| | | <i>rxParameters</i> | <i>tdd-Config</i> | not present |
| | | | <i>syncConfigIndex</i> | 0 |
| | <i>discTxPoolPS-Common/ discTxPoolPS-Dedicated</i> | | | not present |
| <i>discConfigRelay</i> | <i>relayUE-Config</i> | <i>threshHigh</i> | | not present |
| | | <i>threshLow</i> | | not present |
| | | <i>hystMax</i> | | not present |
| | | <i>hystMin</i> | | not present |
| | <i>remoteUE-Config</i> | <i>threshHigh</i> | | 0 (-130dBm) |
| | | <i>hystMax</i> | | dB0 |
| | | <i>reselectionInfoIC</i> | <i>q-RxLevMin</i> | (-94dBm) |
| | | | <i>filterCoefficient</i> | fc0 |
| | | | <i>minHyst</i> | dB3 |

Table A.3.12.4-5: ProSe Direct Discovery configuration for E-UTRA FDD for inter-frequency discovery (Configuration #5)

| Information Element | | | | Value |
|--------------------------------|---------------------------------|--------------------------|--|-------------|
| <i>discConfig</i> | | | | not present |
| <i>discInterFreqList</i> | <i>carrierFreq</i> | | | Note 1 |
| | <i>plmn-IdentityList</i> | | | not present |
| <i>discConfig-v1310</i> | | | | |
| <i>discInterFreqList-v1310</i> | | | | |
| <i>discResourcesNonPS</i> | <i>discRxResourcesInterFreq</i> | <i>cp-Len</i> | | Normal |
| | | <i>discPeriod</i> | | rf32 |
| | | <i>numRetx</i> | | 0 |
| | | <i>numRepetition</i> | | 1 |
| | | <i>tf-ResourceConfig</i> | | |

| | | | |
|--|---------------------------------|-----------------------------------|--|
| | | <i>prb-Num</i> | 12 |
| | | <i>prb-Start</i> | 0 |
| | | <i>prb-End</i> | 23 |
| | | <i>offsetIndicator</i> | 160 |
| | | <i>subframeBitmap</i> | 11000000 00000000 00000000 00000000 00000000 |
| | | <i>txParameters</i> | not present |
| | | <i>rxParameters</i> | not present |
| | | <i>rxParamsAddNeighFreq</i> | |
| | | <i>physCellId</i> | Note 1 |
| | <i>discTxResourcesInterFreq</i> | <i>discTxPoolCommon</i> | |
| | | <i>cp-Len</i> | Normal |
| | | <i>discPeriod</i> | rf32 |
| | | <i>numRetx</i> | 0 |
| | | <i>numRepetition</i> | 1 |
| | | <i>tf-ResourceConfig</i> | |
| | | <i>prb-Num</i> | 2 |
| | | <i>prb-Start</i> | 3 |
| | | <i>prb-End</i> | 5 |
| | | <i>offsetIndicator</i> | 160 |
| | | <i>subframeBitmap</i> | 10000000 00000000 00000000 00000000 00000000 |
| | | <i>txParameters</i> | |
| | | <i>txParametersGeneral</i> | |
| | | <i>alpha</i> | al0 |
| | | <i>p0</i> | 31 |
| | | <i>ue-SelectedResourceConfig</i> | |
| | | <i>poolSelection</i> | |
| | | <i>txProbability</i> | p100 |
| | | <i>rxParameters</i> | not present |
| | | <i>rxParamsAddNeighFreq</i> | not present |
| | | <i>txParamsAddNeighFreq</i> | |
| | | <i>physCellId</i> | Note 1 |
| | | <i>p-Max</i> | 23 |
| | | <i>tdd-Config</i> | not present |
| | | <i>tdd-Config-v1130</i> | not present |
| | | <i>freqInfo</i> | |
| | | <i>ul-CarrierFreq</i> | Note 1 |
| | | <i>ul-Bandwidth</i> | n25 |
| | | <i>additionalSpectrumEmission</i> | NS_01 |
| | | <i>referenceSignalPower</i> | Note 2 |
| | | <i>syncConfigIndex</i> | not present |
| | <i>discResourcesPS</i> | | not present |
| | <i>discConfigOther</i> | <i>txPowerInfo</i> | <i>discMaxTxPower</i> 23 |
| | | <i>refCarrierCommon</i> | not present |
| | | <i>discSyncConfig</i> | not present |
| | | <i>discCellSelectionInfo</i> | <i>q-RxLevMin</i> -70 (-140dBm) |
| | | <i>q-RxLevMinOffset</i> | not present |
| | | <i>q-Hyst</i> | dB0 |
| | | <i>q-RxLevMinReselection</i> | -70 (-140dBm) |
| | | <i>t-ReselectionEUTRA</i> | 0 |
| | <i>gapRequestsAllowedCommon</i> | | True |
| | <i>discConfigRelay</i> | | not present |
| | <i>discConfigPS</i> | | not present |
| NOTE 1: As specified in the test | | | |
| NOTE 2: As configured by the test system | | | |

A.3.12.5 Reference resource pool configurations for ProSe Direct Communication

Table A.3.12.5-1: ProSe Direct Communication configuration for E-UTRA FDD (Configuration #1)

| Information Element | | | | Value (5MHz) | Value (10MHz) |
|--|-------------------------------|-------------------------|-------------|--|---------------|
| <i>commRxPool</i> | <i>sc-CP-Len</i> | | | Normal | |
| | <i>sc-Period</i> | | | sf40 | |
| | <i>sc-TF-ResourceConfig</i> | <i>prb-Num</i> | | 12 | 25 |
| | | <i>prb-Start</i> | | 0 | 0 |
| | | <i>prb-End</i> | | 23 | 49 |
| | | <i>offsetIndicator</i> | | 0 | |
| | | <i>subframeBitmap</i> | | 00011000 00000000 00000000 00000000 00000000 | |
| | <i>data-CP-Len</i> | | | Normal | |
| | <i>dataHoppingConfig</i> | <i>hoppingParameter</i> | | 0 | |
| | | <i>numSubbands</i> | | ns1 | |
| <i>rb-Offset</i> | | | 0 | | |
| <i>ue-SelectedResourceConfig</i> | <i>data-TF-ResourceConfig</i> | <i>prb-Num</i> | 12 | 25 | |
| | | <i>prb-Start</i> | 0 | 0 | |
| | | <i>prb-End</i> | | 23 | 49 |
| | | <i>offsetIndicator</i> | | 0 | |
| | | <i>subframeBitmap</i> | | 00000000 11111111 11111111 11111111 11111111 | |
| | <i>trpt-Subset-r12</i> | | 001 | | |
| | <i>rxParametersNCell</i> | | not present | | |
| | <i>txParameters</i> | | not present | | |
| <i>commTxPoolNormalCommon/ commTxPoolNormalDedicated</i> | <i>sc-CP-Len</i> | | | Normal | |
| | <i>sc-Period</i> | | | sf40 | |
| | <i>sc-TF-ResourceConfig</i> | <i>prb-Num</i> | | 12 | 25 |
| | | <i>prb-Start</i> | | 0 | 0 |
| | | <i>prb-End</i> | | 24 | 49 |
| | | <i>offsetIndicator</i> | | 0 | |
| | | <i>subframeBitmap</i> | | 00011000 00000000 00000000 00000000 00000000 | |
| | <i>data-CP-Len</i> | | | Normal | |
| | <i>dataHoppingConfig</i> | <i>hoppingParameter</i> | | 0 | |
| | | <i>numSubbands</i> | | ns1 | |
| <i>rb-Offset</i> | | | 0 | | |
| <i>ue-SelectedResourceConfig</i> | <i>data-TF-ResourceConfig</i> | <i>prb-Num</i> | 12 | 25 | |
| | | <i>prb-Start</i> | 0 | 0 | |
| | | <i>prb-End</i> | | 23 | 49 |
| | | <i>offsetIndicator</i> | | 0 | |
| | | <i>subframeBitmap</i> | | 00000000 11111111 11111111 11111111 11111111 | |
| | <i>trpt-Subset-r12</i> | | 001 | | |
| | <i>rxParametersNCell</i> | | not present | | |

| | | | | |
|----------------------|----------------------------|----------------------------|--------------|---------------|
| | <i>txParameters</i> | <i>sc-TxParameters</i> | <i>alpha</i> | al0 |
| | | | <i>p0</i> | 31 |
| | | <i>dataTxParameters</i> | <i>alpha</i> | al0 |
| | | | <i>p0</i> | 31 |
| <i>SL-SyncConfig</i> | <i>syncCP-Len</i> | | | Normal |
| | <i>syncOffsetIndicator</i> | | | 2 |
| | <i>sIssid</i> | | | 30 |
| | <i>txParameters</i> | <i>txParametersGeneral</i> | <i>alpha</i> | al0 |
| | | | <i>p0</i> | 31 |
| | | <i>syncTxThreshIC</i> | | 0 (-infinity) |
| | <i>rxParamsNCell</i> | | | not present |

Table A.3.12.5-2: ProSe Direct Communication pre-configuration for E-UTRAN FDD for out-of-network coverage operation (Configuration #2)

| Information Element | | | Value (5MHz) | Value (10MHz) | |
|----------------------------------|-------------------------------|-------------------------|------------------------|--|----|
| <i>preconfigSync</i> | <i>syncCP-Len-r12</i> | | Normal | | |
| | <i>syncOffsetIndicator1</i> | | 2 | | |
| | <i>syncOffsetIndicator2</i> | | 1 | | |
| | <i>syncTxParameters</i> | | 31 | | |
| | <i>syncTxThreshOoC</i> | | 0 (-110dBm / 15kHz) | | |
| | <i>filterCoefficient</i> | | fc0 | | |
| | <i>syncRefMinHyst</i> | | dB0 | | |
| | <i>syncRefDiffHyst</i> | | dB0 | | |
| <i>preconfigComm</i> | <i>sc-CP-Len</i> | | Normal | | |
| | <i>sc-Period</i> | | sf40 | | |
| | <i>sc-TF-ResourceConfig</i> | <i>prb-Num</i> | | 12 | 25 |
| | | <i>prb-Start</i> | | 0 | 0 |
| | | <i>prb-End</i> | | 23 | 49 |
| | | <i>offsetIndicator</i> | | 0 | |
| | | <i>subframeBitmap</i> | | 00011000 00000000 00000000 00000000 00000000 | |
| | <i>data-CP-Len</i> | | Normal | | |
| | <i>dataHoppingConfig</i> | <i>hoppingParameter</i> | | 0 | |
| | | <i>numSubbands</i> | | ns1 | |
| <i>rb-Offset</i> | | | 0 | | |
| <i>ue-SelectedResourceConfig</i> | <i>data-TF-ResourceConfig</i> | <i>prb-Num</i> | 12 | 25 | |
| | | <i>prb-Start</i> | 0 | 0 | |
| | | <i>prb-End</i> | 23 | 49 | |
| | | <i>offsetIndicator</i> | 0 | | |
| | | <i>subframeBitmap</i> | | 00000000 11111111 11111111 11111111 11111111 | |
| | <i>trpt-Subset-r12</i> | | 001 | | |

A.3.12.6 Reference Measurement Channels for ProSe Direct Discovery

A.3.12.6.1 FDD

Table A.3.12.6-1: PSDCH Reference Measurement Channels for FDD

| Parameter | Unit | Value |
|-------------------|------|---------|
| Reference channel | | D.1 FDD |

| | | |
|--|------|------|
| Channel bandwidth | MHz | 5 |
| Allocated resource blocks | | 2 |
| Subcarriers per resource block | | 12 |
| Allocated subframes per Discovery period | | 1 |
| DFT-OFDM Symbols per subframe (see note) | | 11 |
| Modulation | | QPSK |
| Information Bit Payload | | 232 |
| Transport block CRC | Bits | 24 |
| Maximum number of HARQ transmissions | | 1 |
| Binary Channel Bits (see note) | Bits | 528 |
| NOTE1: PSDCH transmissions are rate-matched for 12 DFT-OFDM symbols per subframe, and the last symbol shall be punctured as per TS 36.211. | | |

A.3.12.7 Reference measurement channels for ProSe Direct Communication

A.3.12.7.1 FDD

Table A.3.12.7-1: PSCCH Reference Measurement Channels for FDD

| Parameter | | Unit | Value | |
|---|-------------------------------------|------|---|----------|
| Reference channel | | | CC.1 FDD | CC.2 FDD |
| Channel bandwidth | | MHz | 5 | 10 |
| Allocated resource blocks | | | 1 | 1 |
| Subcarriers per resource block | | | 12 | 12 |
| DFT-OFDM Symbols per subframe (see Note 1) | | | 11 | 11 |
| Modulation | | | QPSK | QPSK |
| Information Bit Payload | | Bits | 41 | 43 |
| Information bits | Frequency hopping flag | | 0 | |
| | RB assignment | | Set as per PSSCH RB allocation specific in the test | |
| | Time resource pattern (I_{TRP}) | | 0 (Note 2) | |
| | Modulation and coding scheme | | Set as the PSSCH MCS specified in the test | |
| | Timing advance indication | | 0 | |
| | Group destination ID | | As set by higher layers | |
| Transport block CRC | | Bits | 16 | 16 |
| Maximum number of HARQ transmissions | | | 2 | 2 |
| Binary Channel Bits (see Note 1) | | Bits | 264 | 264 |
| NOTE1: PSCCH transmissions are rate-matched for 12 DFT-OFDM symbols per subframe, and the last symbol shall be punctured as per TS 36.211. | | | | |
| NOTE 2: For $N_{TRP} = 8$ (FDD) and $trpt-Subset = 001$, $I_{TRP} = 0$ corresponds to a time repetition pattern of (1,0,0,0,0,0,0,0) as per TS 36.213. | | | | |

Table A.3.12.7-1: PSSCH Reference Measurement Channels for FDD

| Parameter | | Unit | Value | |
|---|--|------|----------|----------|
| Reference channel | | | CD.1 FDD | CD.2 FDD |
| Channel bandwidth | | MHz | 5 | 10 |
| Allocated resource blocks | | | 2 | 3 |
| Subcarriers per resource block | | | 12 | 12 |
| DFT-OFDM Symbols per subframe (see Note 1) | | | 11 | 11 |
| Modulation | | | QPSK | QPSK |
| Target Code Rate | | | 1/3 | 1/3 |
| Information Bit Payload | | | 176 | 256 |
| Transport block CRC | | Bits | 24 | 24 |
| Maximum number of HARQ transmissions | | | 3 | 3 |
| Binary Channel Bits (see note) | | Bits | 528 | 1056 |
| NOTE1: PSDCH transmissions are rate-matched for 12 DFT-OFDM symbols per | | | | |

| |
|--|
| subframe, and the last symbol shall be punctured as per TS 36.211. |
|--|

A.3.12.8 ProSe Receive Traffic Generator

This clause defines the configuration for active Sidelink UEs used to generate receive traffic in ProSe RRM tests.

A.3.12.8.1 ProSe Direct Communication Receive Traffic Generator for FDD

Table A.3.12.8.1-1: Active Sidelink UE configuration for ProSe Direct Communication

| Configuration | | | PCP.1.FDD |
|---|---------------------------------|-----------|---|
| Channel BW | | MHz | 5 or 10 |
| Number of Active Sidelink UEs per sc-period | | | 5 MHz: 12 10 MHz: 16 |
| Active Sidelink UEs | PSCCH RMC (defined in A.3.12.7) | | 5 MHz: CC.1 FDD 10 MHz: CC.2 FDD |
| | PSCCH resource allocation | | 5MHz: [2i:2i], for Sidelink UE i=0,...,11 10MHz:[3i:3i], for Sidelink UE i = 0, ..., 15 |
| | PSSCH RMC (defined in A.3.12.7) | | 5 MHz: CD.1 FDD 10 MHz: CD.2 FDD |
| | PSSCH resource allocation | | Non-overlapping RBs 5MHz: [2i:2i+1], for Sidelink UE i = 0, ..., 11 10MHz:[3i:3i+2], for Sidelink UE i = 0, ..., 15 |
| | RSRP | dBm/15kHz | -98 |

A.3.12.8.2 ProSe Direct Discovery Receive Traffic Generator for FDD

Table A.3.12.8.2-1: Active Sidelink UE configuration for ProSe Direct Discovery

| Configuration | | | PDP.1.FDD | PDP.2.FDD |
|--|---------------------------|-----------|-----------------------------------|--|
| Channel BW | | MHz | 5 | |
| Number of Active Sidelink UEs per Discovery subframe | | | 12 | |
| Active Sidelink UEs | Sidelink UE Transmissions | | PSDCH (RMC D.1 FDD) | PSDCH (RMC D.1 FDD) + SLSS on synchronization subframe |
| | Resource allocation | | Non overlapping RBs in a subframe | |
| | RSRP | dBm/15kHz | -95 | |

A.3.13 Time Offset between Cells

A.3.13.1 Introduction

In Annex A in some test cases a parameter called, ‘time offset between cells’ is used. The meaning of this parameter is defined in this clause.

A.3.13.2 Definition

Unless explicitly stated otherwise, the time offset between cells for a pair of cells is defined as the difference between radio frame start timings of the pair of cells.

A.3.14 Carrier Aggregation under operation with Frame Structure 3 Test Cases with Different Duplex Modes

A.3.14.1 Introduction

This clause defines a principle which is applicable to test cases verifying RRM requirements for carrier aggregation with at least one Scell under operation with Frame Structure 3.

A.3.14.2 Principle of testing

In Annex A, tests for carrier aggregation with at least one Scell under operation with frame structure 3 are specified with both an FDD and a TDD PCell to verify the same RRM requirement. If both types of tests are relevant to a UE considering supported CA bands, the test coverage can be considered fulfilled by executing either the tests with FDD PCell or the tests with TDD PCell and the UE is not required to pass both tests.

A.3.15 Dual connectivity test cases with different combination of duplex mode

A.3.15.1 Introduction

This clause defines a principle which is applicable to test cases verifying RRM requirements for dual connectivity (DC) operation with different combination of duplex modes.

A.3.15.2 Principle of testing

If multiple dual connectivity test cases are defined for different combination of duplex modes (E-UTRA FDD-FDD, E-UTRA TDD-TDD and E-UTRA TDD-FDD) to verify the same RRM requirement which is independent of the combination of duplex modes and is identical for different combination of duplex modes, then from UE the performance point of view the test coverage can be considered fulfilled by executing only the corresponding test case(s) with one of the combination of duplex modes supported by the UE.

A.3.16 Reference PRACH Configurations

Table A.3.16-1: PRACH configuration parameters

| Parameter | Value | | | Comments |
|----------------------------------|------------|-----------------|----------------------|--|
| Reference configuration | PRACH_2CE | PRACH_3CE | PRACH_4CE | |
| Rsrp-ThresholdsPRACH | {-99} dBm | {-107, -99} dBm | {-107, -99, -92} dBm | As defined in TS36.331 |
| CE level0: | Configured | Configured | Configured | Up to 4 CE levels, each corresponding to a PRACH configuration |
| Prach Configuration Index: | 4 | 4 | 4 | See TS 36.211 section 5.7.1 |
| numRepetitionPerPreambleAttempt: | 1 | 1 | 1 | Number of PRACH repetitions per attempt for each CE level, See TS 36.211 |
| prach-HoppingConfig: | off | off | off | Coverage level specific frequency hopping configuration for PRACH |
| CE level1: | Configured | Configured | Configured | Up to 4 CE levels, each corresponding to a PRACH configuration |
| Prach Configuration Index: | 4 | 4 | 4 | see TS 36.211 section 5.7.1 |
| numRepetitionPerPreambleAttempt: | 128 | 64 | 32 | Number of PRACH repetitions per attempt for each CE level, See TS 36.211 |
| prach-HoppingConfig: | off | off | off | Coverage level specific |

| | | | | |
|----------------------------------|----------------|----------------|------------|--|
| | | | | frequency hopping configuration for PRACH |
| CE level2: | Not Configured | Configured | Configured | Up to 4 CE levels, each corresponding to a PRACH configuration |
| Prach Configuration Index: | - | 4 | 4 | see TS 36.211 section 5.7.1 |
| numRepetitionPerPreambleAttempt: | - | 128 | 64 | Number of PRACH repetitions per attempt for each CE level, See TS 36.211 |
| prach-HoppingConfig: | - | off | off | Coverage level specific frequency hopping configuration for PRACH |
| CE level3: | Not Configured | Not Configured | Configured | Up to 4 CE levels, each corresponding to a PRACH configuration |
| Prach Configuration Index: | - | - | 4 | see TS 36.211 section 5.7.1 |
| numRepetitionPerPreambleAttempt: | - | - | 128 | Number of PRACH repetitions per attempt for each CE level, See TS 36.211 |
| prach-HoppingConfig: | - | - | off | Coverage level specific frequency hopping configuration for PRACH |

A.3.17 Listen before talk model

A.3.17.1 Introduction

In some RRM test cases for FS3, a listen before talk (LBT) model is specified. The intention of the LBT model is to emulate using test equipment the behaviour of an FS3 eNB which performs channel measurement to check that the channel is clear prior to performing downlink transmission.

A.3.17.2 Definition

Prior to each DMTC window, the test equipment shall determine whether to transmit a discovery reference signal (DRS) during the DMTC window with probability $P=0.75$. In many cases the test requirement depends on the number of configured discovery signal occasions which are not available during the test, so the test equipment shall track how many DRS are not transmitted during the test period. If the test equipment determines that it shall transmit a DRS, then the timing of the DRS transmission within the DMTC window is randomly selected from the set of possible DRS transmission signal timings, such that there is an equal probability of any valid DRS timing.

For non DRS downlink transmission bursts, if transmission occurred in the previous subframe, transmission is muted for a duration of one subframe. Additionally, if the start time of the candidate transmission burst is within 8 subframes of the start of the DMTC window, transmission is not performed. Otherwise

The length of the transmission burst in subframes is defined as N . The burst transmission format is determined according to the steps below:

1. Select N randomly from a given set of the number of subframes $S1=\{1,3,5,8\}$ with equal probability as the total length of burst transmission format.
2. A uniform random variable from 0 to 1 is generated. If the random variable is less than $P=0.75$, a burst of N fully occupied subframes is transmitted. Otherwise, the burst transmission is muted and the muting duration is the same as the number N of subframes for determined burst format.

A.3.18 Reference NPRACH Configurations

Table A.3.18-1 defines the reference NB-IoT PRACH configurations for a NB-IoT RRM test case where the UE is required to transmit NPRACH during the testing procedure, but the testing purpose of the RRM test case does not include testing NPRACH performance.

Table A.3.18-1: NPRACH.R-1: Reference NPRACH Configuration

| Field | Value | | | Comment |
|---|----------------|----------------|----------------|---|
| Parameters not per NPRACH coverage level | | | | |
| rsrp-ThresholdsPrach | {rsrp1, rsrp2} | | | The values of NPRACH RSRP thresholds for will be set according the requirement of individual test cases |
| nprach-CP-Length | us66dot7 | | | NPRACH format 0 |
| Parameters per NPRACH coverage Level | | | | |
| CE Level | Level 0 | Level 1 | Level 2 | Valid values as defined in TS 36.331 |
| nprach-Periodicity | ms40 | ms40 | ms40 | {ms40, ms80, ms160, ms240, ms320, ms640, ms1280, ms2560} |
| nprach-StartTime | ms8 | ms8 | ms8 | {ms8, ms16, ms32, ms64, ms128, ms256, ms512, ms1024} |
| nprach-SubcarrierOffset | n0 | n0 | n0 | {n0, n12, n24, n36, n2, n18, n34} |
| nprach-NumSubcarriers | n12 | n12 | n12 | {n12, n24, n36, n48} |
| nprach-SubcarrierMSG3-RangeStart | {one} | {one} | {one} | {zero, oneThird, twoThird, one} |
| maxNumPreambleAttemptCE | n3 | n5 | n7 | {n3, n4, n5, n6, n7, n8, n10} |
| numRepetitionsPerPreambleAttempt | n1 | n8 | n32 | {n1, n2, n4, n8, n16, n32, n64, n128} |
| npdcch-NumRepetitions-RA | r1 | r8 | r32 | {r1, r2, r4, r8, r16, r32, r64, r128, r256, r512, r1024, r2048} |
| npdcch-StartSF-CSS-RA | v8 | v2 | v2 | {v1dot5, v2, v4, v8, v16, v32, v48, v64} |
| npdcch-Offset-RA | zero | zero | zero | {zero, oneEighth, oneFourth, threeEighth} |

A.3.19 Dual connectivity test cases with different bandwidth combinations

A.3.19.1 Introduction

This clause defines a principle which is applicable to test cases verifying RRM requirements for dual connectivity (DC) operation with different bandwidth combinations.

A.3.19.2 Principle of testing

If multiple dual connectivity test cases with different channel bandwidth combinations are defined to verify the same RRM requirement that is channel bandwidth independent, then the UE needs to be tested only with one bandwidth combination out of the bandwidth combination sets supported by that UE.

A.3.20 Category M1 UE Test Cases

A.3.20.1 Introduction

This clause defines a principle which is applicable to test cases verifying RRM requirements for Category M1 UE in both CEModeA and CEModeB.

A.3.20.2 Principle of Cat-M1 UE Testing

In Annex A Cat-M1 UE test cases may be defined for both CEModeA and CEModeB to verify the same type of RRM requirement.

If test cases are defined in both CEModeA and CEModeB in order to verify the same type of RRM requirement then the UE capable of CEModeB needs to be tested for the corresponding test(s) defined in CEModeA and/or in CEModeB according to the applicability rules defined in Table A.3.20.2-1.

The UE which is not capable of CEModeB shall be tested for all CEModeA test cases defined in Annex A.

In test cases defined for CEModeB, test equipment shall transmit PBCH with 5 repetitions as specified in section 6.6.4 of [16].

Table A.3.20.2-1: Test case applicability rules for category M1 UE in CEModeA and CEModeB

| Type of Test Cases | Coverage mode(s) Applicable for Testing | |
|--|---|---------|
| | CEModeA | CEModeB |
| A.4 E-UTRAN RRC IDLE State: Intra-frequency Cell Re-Selection Tests for Category M1 UE | X | X |
| A.5 E-UTRAN RRC CONNECTED Mode Mobility: E-UTRAN Intra-frequency Handover Tests for Category M1 UE | X | |
| A.5 RRC Connection Control: E-UTRAN Intra-frequency RRC Re-Establishment Tests for Category M1 UE | | X |
| A.6 E-UTRAN Contention Based Random Access Tests for Cat-M1 UE | | X |
| A.7 Timing and Signalling Characteristics: E-UTRAN UE Transmit Timing Accuracy Tests for Category M1 UE | | X |
| A.7 Timing and Signalling Characteristics: E-UTRAN Timing Advance Adjustment Accuracy Tests for Cat-M1 UE | | X |
| A.7.3 Radio Link Monitoring: E-UTRAN Radio Link Monitoring Tests for Category M1 UE | X | |
| A.8 Measurements Procedures: E-UTRAN Intra-frequency Event Triggered Reporting under Fading Propagation Conditions Tests for Category M1 UE | X | X |
| A.8 Measurements Procedures: E-UTRAN Intra-frequency Identification of a New CGI of E-UTRA cell using Autonomous Gaps Tests for Category M1 UE | N/A | X |
| A.9 Measurement Performance Requirements: RSRP Intra-Frequency Measurement Accuracy Tests for Category M1 UE | X | X |

A.4 E-UTRAN RRC_IDLE state

A.4.2 Cell Re-Selection

A.4.2.1 E-UTRAN FDD – FDD Intra frequency case

A.4.2.1.1 Test Purpose and Environment

This test is to verify the requirement for the FDD-FDD intra frequency cell reselection requirements specified in clause 4.2.2.3.

The test scenario comprises of 1 E-UTRA FDD carrier and 2 cells as given in tables A.4.2.1.1-1 and A.4.2.1.1-2. The test consists of three successive time periods, with time duration of T1, T2 and T3 respectively. Only Cell 1 is already identified by the UE prior to the start of the test, i.e. Cell 2 is not identified by the UE prior to the start of the test. Cell 1 and Cell 2 belong to different tracking areas. Furthermore, UE has not registered with network for the tracking area containing Cell 2.

Table A.4.2.1.1-1: General test parameters for FDD intra frequency cell reselection test case

| Parameter | | Unit | Value | Comment |
|---|-----------------|------|----------|---|
| Initial condition | Active cell | | Cell1 | |
| | Neighbour cells | | Cell2 | |
| T2 end condition | Active cell | | Cell2 | |
| | Neighbour cells | | Cell1 | |
| Final condition | Visited cell | | Cell1 | |
| E-UTRA RF Channel Number | | | 1 | Only one FDD carrier frequency is used. |
| Channel Bandwidth (BW_{channel}) | | MHz | 10 | |
| Time offset between cells | | | 3 ms | Asynchronous cells |
| Access Barring Information | | - | Not Sent | No additional delays in random access procedure. |
| PRACH configuration | | | 4 | As specified in table 5.7.1-2 in TS 36.211 |
| DRX cycle length | | s | 1.28 | The value shall be used for all cells in the test. |
| T1 | | s | >7 | During T1, Cell 2 shall be powered off, and during the off time the physical cell identity shall be changed, The intention is to ensure that Cell 2 has not been detected by the UE prior to the start of period T2 |
| T2 | | s | 40 | T2 need to be defined so that cell re-selection reaction time is taken into account. |
| T3 | | s | 15 | T3 need to be defined so that cell re-selection reaction time is taken into account. |

Table A.4.2.1.1-2: Cell specific test parameters for FDD intra frequency cell reselection test case in AWGN

| Parameter | Unit | Cell 1 | | | Cell 2 | | |
|---|------------|----------|-------|------|-----------|------|-------|
| | | T1 | T2 | T3 | T1 | T2 | T3 |
| E-UTRA RF Channel Number | | 1 | | | 1 | | |
| $BW_{channel}$ | MHz | 10 | | | 10 | | |
| OCNG Patterns defined in A.3.2.1.2 (OP.2 FDD) | | OP.2 FDD | | | OP.2 FDD | | |
| PBCH_RA | dB | 0 | | | 0 | | |
| PBCH_RB | | | | | | | |
| PSS_RA | | | | | | | |
| SSS_RA | | | | | | | |
| PCFICH_RB | | | | | | | |
| PHICH_RA | | | | | | | |
| PHICH_RB | | | | | | | |
| PDCCH_RA | | | | | | | |
| PDCCH_RB | | | | | | | |
| PDSCH_RA | | | | | | | |
| PDSCH_RB | | | | | | | |
| OCNG_RA ^{Note 1} | | | | | | | |
| OCNG_RB ^{Note 1} | | | | | | | |
| Qrxlevmin | | | | | | | |
| Pcompensation | dB | 0 | 0 | 0 | 0 | 0 | 0 |
| Qhysts | dB | 0 | 0 | 0 | 0 | 0 | 0 |
| Qoffset _{s,n} | dB | 0 | 0 | 0 | 0 | 0 | 0 |
| Cell_selection_and_reselection_quality_measurement | | RSRP | | | RSRP | | |
| \hat{E}_s / I_{ot} | dB | 16 | -3.11 | 2.79 | -infinity | 2.79 | -3.11 |
| N_{oc} ^{Note2} | dBm/15 kHz | -98 | | | | | |
| \hat{E}_s / N_{oc} | dB | 16 | 13 | 16 | -infinity | 16 | 13 |
| RSRP ^{Note3} | dBm/15 kHz | -82 | -85 | -82 | -infinity | -82 | -85 |
| Treselection | s | 0 | 0 | 0 | 0 | 0 | 0 |
| Sintrasearch | dB | Not sent | | | Not sent | | |
| Propagation Condition | | AWGN | | | | | |
| <p>Note 1: OCNG shall be used such that both cells are fully allocated and a constant total transmitted power spectral density is achieved for all OFDM symbols.</p> <p>Note 2: Interference from other cells and noise sources not specified in the test is assumed to be constant over subcarriers and time and shall be modelled as AWGN of appropriate power for N_{oc} to be fulfilled.</p> <p>Note 3: RSRP levels have been derived from other parameters for information purposes. They are not settable parameters themselves.</p> | | | | | | | |

A.4.2.1.2 Test Requirements

The cell reselection delay to a newly detectable cell is defined as the time from the beginning of time period T2, to the moment when the UE camps on Cell 2, and starts to send preambles on the PRACH for sending the RRC CONNECTION REQUEST message to perform a Tracking Area Update procedure on Cell 2.

The cell re-selection delay to a newly detectable cell shall be less than 34 s.

The cell reselection delay to an already detected cell is defined as the time from the beginning of time period T3, to the moment when the UE camps on Cell 1, and starts to send preambles on the PRACH for sending the RRC CONNECTION REQUEST message to perform a Tracking Area Update procedure on Cell 1.

The cell re-selection delay to an already detected cell shall be less than 8 s.

The rate of correct cell reselections observed during repeated tests shall be at least 90%.

NOTE: The cell re-selection delay to a newly detectable cell can be expressed as: $T_{\text{detect,EUTRAN_Intra}} + T_{\text{SI}}$, and to an already detected cell can be expressed as: $T_{\text{evaluateFDD,intra}} + T_{\text{SI}}$,

Where:

$T_{\text{detect,EUTRAN_Intra}}$ See Table 4.2.2.3-1 in clause 4.2.2.3

$T_{\text{evaluateFDD,intra}}$ See Table 4.2.2.3-1 in clause 4.2.2.3

T_{SI} Maximum repetition period of relevant system info blocks that needs to be received by the UE to camp on a cell; 1280 ms is assumed in this test case.

This gives a total of 33.28 s, allow 34 s for the cell re-selection delay to a newly detectable cell and 7.68 s, allow 8 s for the cell re-selection delay to an already detected cell in the test case.

A.4.2.2 E-UTRAN TDD – TDD Intra frequency case

A.4.2.2.1 Test Purpose and Environment

This test is to verify the requirement for the TDD-TDD intra frequency cell reselection requirements specified in clause 4.2.2.3.

The test scenario comprises of 1 E-UTRA TDD carrier and 2 cells as given in tables A.4.2.2.1-1 and A.4.2.2.1-2. The test consists of three successive time periods, with time duration of T1, T2, and T3 respectively. Only cell 1 is already identified by the UE prior to the start of the test. Cell 1 and cell 2 belong to different tracking areas. Furthermore, UE has not registered with network for the tracking area containing cell 2.

Table A.4.2.2.1-1: General test parameters for TDD intra frequency cell re-selection test case

| Parameter | | Unit | Value | Comment |
|---|-----------------|---------------|----------|---|
| Initial condition | Active cell | | Cell1 | |
| | Neighbour cells | | Cell2 | |
| T2 end condition | Active cell | | Cell2 | |
| | Neighbour cells | | Cell1 | |
| Final condition | Visited cell | | Cell1 | |
| E-UTRA RF Channel Number | | | 1 | Only one TDD carrier frequency is used. |
| Channel Bandwidth (BW_{channel}) | | MHz | 10 | |
| Time offset between cells | | μs | 3 | Synchronous cells |
| Access Barring Information | | - | Not Sent | No additional delays in random access procedure. |
| Special subframe configuration | | | 6 | As specified in table 4.2-1 in TS 36.211 |
| Uplink-downlink configuration | | | 1 | As specified in table 4.2-2 in TS 36.211 |
| PRACH configuration index | | | 53 | As specified in table 5.7.1-3 in TS 36.211 |
| DRX cycle length | | s | 1.28 | The value shall be used for all cells in the test. |
| T1 | | s | >7 | During T1, Cell 2 shall be powered off, and during the off time the physical cell identity shall be changed, The intention is to ensure that Cell 2 has not been detected by the UE prior to the start of period T2 |
| T2 | | s | 40 | T2 need to be defined so that cell re-selection reaction time is taken into account. |
| T3 | | s | 15 | T3 need to be defined so that cell re-selection reaction time is taken into account. |

Table A.4.2.2.1-2: Cell specific test parameters for TDD intra frequency cell re-selection test case in AWGN

| Parameter | Unit | Cell 1 | | | Cell 2 | | |
|-----------|------|--------|----|----|--------|----|----|
| | | T1 | T2 | T3 | T1 | T2 | T3 |
| | | | | | | | |

| | | | | | | | |
|--|--|----------|-------|------|-----------|------|-------|
| E-UTRA RF Channel Number | | 1 | | | 1 | | |
| BW _{channel} | MHz | 10 | | | 10 | | |
| OCNG Pattern defined in A.3.2.2.2 (OP.2 TDD) | | OP.2 TDD | | | OP.2 TDD | | |
| PBCH_RA | dB | 0 | | | 0 | | |
| PBCH_RB | | | | | | | |
| PSS_RA | | | | | | | |
| SSS_RA | | | | | | | |
| PCFICH_RB | | | | | | | |
| PHICH_RA | | | | | | | |
| PHICH_RB | | | | | | | |
| PDCCH_RA | | | | | | | |
| PDCCH_RB | | | | | | | |
| PDSCH_RA | | | | | | | |
| PDSCH_RB | | | | | | | |
| OCNG_RA ^{Note 1} | | | | | | | |
| OCNG_RB ^{Note 1} | | | | | | | |
| Qrxlevmin | dBm | -140 | | | -140 | | |
| Pcompensation | dB | 0 | | | 0 | | |
| Qhyst _s | dB | 0 | | | 0 | | |
| Qoffset _{s, n} | dB | 0 | | | 0 | | |
| Cell_selection_and_reselection_quality_measurement | | RSRP | | | RSRP | | |
| \hat{E}_s / I_{ot} | dB | 16 | -3.11 | 2.79 | -infinity | 2.79 | -3.11 |
| N_{oc} ^{Note2} | dBm/15 kHz | -98 | | | | | |
| \hat{E}_s / N_{oc} | dB | 16 | 13 | 16 | -infinity | 16 | 13 |
| RSRP ^{Note3} | dBm/15 kHz | -82 | -85 | -82 | -infinity | -82 | -85 |
| Treselection | s | 0 | 0 | 0 | 0 | 0 | 0 |
| Sintrasearch | dB | Not sent | | | Not sent | | |
| Propagation Condition | | AWGN | | | | | |
| Note 1: | OCNG shall be used such that both cells are fully allocated and a constant total transmitted power spectral density is achieved for all OFDM symbols. | | | | | | |
| Note 2: | Interference from other cells and noise sources not specified in the test is assumed to be constant over subcarriers and time and shall be modelled as AWGN of appropriate power for N_{oc} to be fulfilled. | | | | | | |
| Note 3: | RSRP levels have been derived from other parameters for information purposes. They are not settable parameters themselves. | | | | | | |

A.4.2.2.2 Test Requirements

The cell reselection delay to a newly detectable cell is defined as the time from the beginning of time period T2, to the moment when the UE camps on Cell 2, and starts to send preambles on the PRACH for sending the RRC CONNECTION REQUEST message to perform a Tracking Area Update procedure on Cell 2.

The cell re-selection delay to a newly detectable cell shall be less than 34 s.

The cell reselection delay to an already detected cell is defined as the time from the beginning of time period T3, to the moment when the UE camps on cell 1, and starts to send preambles on the PRACH for sending the RRC CONNECTION REQUEST message to perform a Tracking Area Update procedure on cell 1.

The cell re-selection delay shall be less than 8 s.

The rate of correct cell reselections observed during repeated tests shall be at least 90%.

NOTE: The cell re-selection delay to a newly detectable cell can be expressed as: $T_{\text{detect, E-UTRAN_Intra}} + T_{\text{SI-EUTRA}}$, and to an already detected cell can be expressed as: $T_{\text{evaluate, E-UTRAN_intra}} + T_{\text{SI-EUTRA}}$,

Where:

$T_{\text{detect,EUTRAN_Intra}}$ See Table 4.2.2.3-1 in clause 4.2.2.3

$T_{\text{evaluate,E-UTRAN_intra}}$ See Table 4.2.2.3-1 in clause 4.2.2.3

$T_{\text{SI-EUTRA}}$ Maximum repetition period of relevant system info blocks that needs to be received by the UE to camp on a cell; 1280 ms is assumed in this test case.

This gives a total of 33.28 s, allow 34 s for the cell re-selection delay to a newly detectable cell and 7.68 s, allow 8 s for the cell re-selection delay to an already detected cell in the test case.

A.4.2.3 E-UTRAN FDD – FDD Inter frequency case

A.4.2.3.1 Test Purpose and Environment

This test is to verify the requirement for the FDD-FDD inter-frequency cell reselection requirements specified in clause 4.2.2.4.

The test scenario comprises of 2 E-UTRA FDD cells on 2 different carriers as given in tables A.4.2.3.1-1 and A.4.2.3.1-2. The test consists of three successive time periods, with time duration of T1, T2 and T3 respectively. Both cell 1 and cell 2 are already identified by the UE prior to the start of the test. Cell 1 and cell 2 belong to different tracking areas and cell 2 is of higher priority than cell 1. Furthermore, UE has not registered with network for the tracking area containing cell 2.

Table A.4.2.3.1-1: General test parameters for FDD-FDD inter frequency cell re-selection test case

| Parameter | | Unit | Value | Comment |
|----------------------------|----------------|------|----------|--|
| Initial condition | Active cell | | Cell2 | UE shall be forced to cell 2 in the initialisation phase, so that reselection to cell 1 occurs during the first T1 phase |
| T1 end condition | Active cell | | Cell1 | UE shall perform reselection to cell 1 during T1 |
| | Neighbour cell | | Cell2 | |
| Final condition | Active cell | | Cell2 | UE shall perform reselection to cell 2 during T3 |
| E-UTRA RF Channel Number | | | 1, 2 | Two FDD carrier frequencies are used. |
| Time offset between cells | | | 3 ms | Asynchronous cells |
| PRACH configuration | | | 4 | As specified in table 5.7.1-2 in TS 36.211 |
| Access Barring Information | | - | Not Sent | No additional delays in random access procedure. |
| DRX cycle length | | s | 1.28 | The value shall be used for all cells in the test. |
| T1 | | s | 15 | T1 need to be defined so that cell re-selection reaction time is taken into account. |
| T2 | | s | >7 | During T2, cell 2 shall be powered off, and during the off time the physical cell identity shall be changed, The intention is to ensure that cell 2 has not been detected by the UE prior to the start of period T3. |
| T3 | | s | 75 | T3 need to be defined so that cell re-selection reaction time is taken into account. |

Table A.4.2.3.1-2: Cell specific test parameters for FDD-FDD inter-frequency cell reselection test case in AWGN

| Parameter | Unit | Cell 1 | | | Cell 2 | | |
|---|------|----------|----|----|----------|----|----|
| | | T1 | T2 | T3 | T1 | T2 | T3 |
| E-UTRA RF Channel number | | 1 | | | 2 | | |
| BW _{channel} | MHz | 10 | | | 10 | | |
| OCNG Patterns defined in A.3.2.1.2 (OP.2 FDD) | | OP.2 FDD | | | OP.2 FDD | | |
| PBCH_RA | dB | | | | | | |

| | | | | | | | |
|--|------------|------|-----|-----|----------|-----------|-----|
| PBCH_RB | dB | | | | | | |
| PSS_RA | dB | | | | | | |
| SSS_RA | dB | | | | | | |
| PCFICH_RB | dB | | | | | | |
| PHICH_RA | dB | | | | | | |
| PHICH_RB | dB | 0 | | | 0 | | |
| PDCCH_RA | dB | | | | | | |
| PDCCH_RB | dB | | | | | | |
| PDSCH_RA | dB | | | | | | |
| PDSCH_RB | dB | | | | | | |
| OCNG_RA ^{Note 1} | dB | | | | | | |
| OCNG_RB ^{Note 1} | dB | | | | | | |
| Qrxlevmin | dBm | -140 | | | -140 | | |
| N_{oc} ^{Note 2} | dBm/15 kHz | -98 | | | | | |
| RSRP ^{Note 3} | dBm/15 KHz | -84 | -84 | -84 | -102 | -infinity | -86 |
| \hat{E}_s / I_{ot} | dB | 14 | 14 | 14 | -4 | -infinity | 12 |
| \hat{E}_s / N_{oc} | dB | 14 | 14 | 14 | -4 | -infinity | 12 |
| Treselection ^{NEUTRAN} | s | 0 | | | 0 | | |
| Snonintrasearch | dB | 50 | | | Not sent | | |
| Thresh _{x, high} | dB | 48 | | | 48 | | |
| Thresh _{servng, low} | dB | 44 | | | 44 | | |
| Thresh _{x, low} | dB | 50 | | | 50 | | |
| Propagation Condition | | AWGN | | | | | |
| Note 1: OCNG shall be used such that both cells are fully allocated and a constant total transmitted power spectral density is achieved for all OFDM symbols. | | | | | | | |
| Note 2: Interference from other cells and noise sources not specified in the test is assumed to be constant over subcarriers and time and shall be modelled as AWGN of appropriate power for N_{oc} to be fulfilled. | | | | | | | |
| Note 3: RSRP levels have been derived from other parameters for information purposes. They are not settable parameters themselves. | | | | | | | |

A.4.2.3.2 Test Requirements

The cell reselection delay to higher priority is defined as the time from the beginning of time period T3, to the moment when the UE camps on cell 2, and starts to send preambles on the PRACH for sending the RRC CONNECTION REQUEST message to perform a Tracking Area Update procedure on Cell 2.

The cell re-selection delay to higher priority shall be less than 68 s.

The cell reselection delay to lower priority is defined as the time from the beginning of time period T1, to the moment when the UE camps on cell 1, and starts to send preambles on the PRACH for sending the RRC CONNECTION REQUEST message to perform a Tracking Area Update procedure on cell 1.

The cell re-selection delay to lower priority shall be less than 8 s.

The rate of correct cell reselections observed during repeated tests shall be at least 90%.

NOTE: The cell re-selection delay to higher priority cell can be expressed as: $T_{\text{higher_priority_search}} + T_{\text{evaluateFDD,inter}} + T_{\text{SI}}$, and to lower priority cell can be expressed as: $T_{\text{evaluateFDD,inter}} + T_{\text{SI}}$,

Where:

$T_{\text{higher_priority_search}}$ See clause 4.2.2

$T_{\text{evaluateFDD,inter}}$ See Table 4.2.2.4-1 in clause 4.2.2.4

T_{SI} Maximum repetition period of relevant system info blocks that needs to be received by the UE to camp on a cell; 1280 ms is assumed in this test case.

This gives a total of 67.68 s for higher priority cell search and 7.68 s for lower priority cell search, allow 68 s for higher priority cell and 8 s for lower priority cell in the test case.

A.4.2.4 E-UTRAN FDD – TDD Inter frequency case

A.4.2.4.1 Test Purpose and Environment

This test is to verify the requirement for the FDD-TDD inter-frequency cell reselection requirements specified in clause 4.2.2.4.

The test scenario comprises of 1 E-UTRA FDD cell and 1 E-UTRA TDD cell as given in tables A.4.2.4.1-1 and A.4.2.4.1-2. The test consists of three successive time periods, with time duration of T1, T2 and T3 respectively. Both cell 1 and cell 2 are already identified by the UE prior to the start of the test. Cell 1 and cell 2 belong to different tracking areas and cell 2 is of higher priority than cell 1. Furthermore, UE has not registered with network for the tracking area containing cell 2.

Table A.4.2.4.1-1: General test parameters for FDD-TDD inter frequency cell re-selection test case

| Parameter | | Unit | Value | Comment |
|---------------------------------------|----------------|------|----------|--|
| Initial condition | Active cell | | Cell2 | UE shall be forced to cell 2 in the initialisation phase, so that reselection to cell 1 occurs during the first T1 phase |
| T1 end condition | Active cell | | Cell1 | UE shall perform reselection to cell 1 during T1 |
| | Neighbour cell | | Cell2 | |
| Final condition | Active cell | | Cell2 | UE shall perform reselection to cell 2 during T3 |
| Cell 1 E-UTRA RF Channel Number | | | 1 | One FDD carrier frequency is used. And Cell 1 is on RF channel number 1. |
| Cell 2 E-UTRA RF Channel Number | | | 2 | One TDD carrier frequencies is used. And Cell 2 is on RF channel number 2. |
| Time offset between cells | | | 3 ms | Asynchronous cells |
| E-UTRA FDD PRACH configuration | | | 4 | As specified in table 5.7.1-2 in TS 36.211 |
| E-UTRA TDD PRACH configuration | | | 53 | As specified in table 5.7.1-3 in TS 36.211 |
| Special subframe configuration | | | 6 | As specified in table 4.2-1 in TS 36.211 |
| Uplink-downlink configuration | | | 1 | As specified in table 4.2-2 in TS 36.211 |
| E-UTRA FDD Access Barring Information | | - | Not Sent | No additional delays in random access procedure. |
| E-UTRA TDD Access Barring Information | | - | Not Sent | No additional delays in random access procedure. |
| DRX cycle length | | s | 1.28 | The value shall be used for all cells in the test. |
| T1 | | s | 15 | T1 need to be defined so that cell re-selection reaction time is taken into account. |
| T2 | | s | >7 | During T2, cell 2 shall be powered off, and during the off time the physical cell identity shall be changed, The intention is to ensure that cell 2 has not been detected by the UE prior to the start of period T3. |
| T3 | | s | 75 | T3 need to be defined so that cell re-selection reaction time is taken into account. |

Table A.4.2.4.1-2: Cell specific test parameters for FDD-TDD inter-frequency cell reselection test case in AWGN

| Parameter | Unit | Cell 1 | | | Cell 2 | | |
|--|------|----------|----|----|----------|----|----|
| | | T1 | T2 | T3 | T1 | T2 | T3 |
| E-UTRA RF Channel number | | 1 | | | 2 | | |
| BW _{channel} | MHz | 10 | | | 10 | | |
| OCNG Patterns defined in A.3.2.1.2 (OP.2 FDD) and A.3.2.2.2 (OP.2 TDD) | | OP.2 FDD | | | OP.2 TDD | | |

| | | | | | | | |
|--------------------------------|--|------|-----|-----|----------|-----------|-----|
| PBCH_RA | dB | | | | | | |
| PBCH_RB | dB | | | | | | |
| PSS_RA | dB | | | | | | |
| SSS_RA | dB | | | | | | |
| PCFICH_RB | dB | | | | | | |
| PHICH_RA | dB | | | | | | |
| PHICH_RB | dB | 0 | | | 0 | | |
| PDCCH_RA | dB | | | | | | |
| PDCCH_RB | dB | | | | | | |
| PDSCH_RA | dB | | | | | | |
| PDSCH_RB | dB | | | | | | |
| OCNG_RA ^{Note 1} | dB | | | | | | |
| OCNG_RB ^{Note 1} | dB | | | | | | |
| Qrxlevmin | dBm | -140 | | | -140 | | |
| N_{oc} ^{Note 2} | dBm/15 kHz | -98 | | | | | |
| RSRP ^{Note 3} | dBm/15 KHz | -84 | -84 | -84 | -102 | -infinity | -86 |
| \hat{E}_s / I_{ot} | dB | 14 | 14 | 14 | -4 | -infinity | 12 |
| \hat{E}_s / N_{oc} | dB | 14 | 14 | 14 | -4 | -infinity | 12 |
| Treselection ^{EUTRAN} | s | 0 | | | 0 | | |
| Snonintrasearch | dB | 50 | | | Not sent | | |
| Thresh _{x, high} | dB | 48 | | | 48 | | |
| Thresh _{serv, low} | dB | 44 | | | 44 | | |
| Thresh _{x, low} | dB | 50 | | | 50 | | |
| Propagation Condition | | AWGN | | | | | |
| Note 1: | OCNG shall be used such that both cells are fully allocated and a constant total transmitted power spectral density is achieved for all OFDM symbols. | | | | | | |
| Note 2: | Interference from other cells and noise sources not specified in the test is assumed to be constant over subcarriers and time and shall be modelled as AWGN of appropriate power for N_{oc} to be fulfilled. | | | | | | |
| Note 3: | RSRP levels have been derived from other parameters for information purposes. They are not settable parameters themselves. | | | | | | |

A.4.2.4.2 Test Requirements

The cell reselection delay to higher priority is defined as the time from the beginning of time period T3, to the moment when the UE camps on cell 2, and starts to send preambles on the PRACH for sending the RRC CONNECTION REQUEST message to perform a Tracking Area Update procedure on cell 2.

The cell re-selection delay to higher priority shall be less than 68 s.

The cell reselection delay to lower priority is defined as the time from the beginning of time period T1, to the moment when the UE camps on cell 1, and starts to send preambles on the PRACH for sending the RRC CONNECTION REQUEST message to perform a Tracking Area Update procedure on cell 1.

The cell re-selection delay to lower priority shall be less than 8 s.

The rate of correct cell reselections observed during repeated tests shall be at least 90%.

NOTE: The cell re-selection delay to higher priority cell can be expressed as: $T_{\text{higher_priority_search}} + T_{\text{evaluate,E-UTRAN_inter}} + T_{\text{SI-EUTRA}}$, and to lower priority cell can be expressed as: $T_{\text{evaluate,E-UTRAN_inter}} + T_{\text{SI-EUTRA}}$,

Where:

$T_{\text{higher_priority_search}}$ See clause 4.2.2

$T_{\text{evaluate,E-UTRAN_inter}}$ See Table 4.2.2.4-1 in clause 4.2.2.4

$T_{\text{SI-EUTRA}}$ Maximum repetition period of relevant system info blocks that needs to be received by the UE to camp on a cell; 1280 ms is assumed in this test case.

This gives a total of 67.68 s for higher priority cell search and 7.68 s for lower priority cell search, allow 68 s for higher priority cell and 8 s for lower priority cell in the test case.

A.4.2.5 E-UTRAN TDD – FDD Inter frequency case

A.4.2.5.1 Test Purpose and Environment

This test is to verify the requirement for the TDD-FDD inter-frequency cell reselection requirements specified in clause 4.2.2.4.

The test scenario comprises of 1 E-UTRA TDD cell and 1 E-UTRA FDD cell as given in tables A.4.2.5.1-1 and A.4.2.5.1-2. The test consists of three successive time periods, with time duration of T1, T2 and T3 respectively. Both cell 1 and cell 2 are already identified by the UE prior to the start of the test. Cell 1 and cell 2 belong to different tracking areas and cell 2 is of higher priority than cell 1. Furthermore, UE has not registered with network for the tracking area containing cell 2.

Table A.4.2.5.1-1: General test parameters for TDD-FDD inter frequency cell re-selection test case

| Parameter | | Unit | Value | Comment |
|---------------------------------------|----------------|------|----------|--|
| Initial condition | Active cell | | Cell2 | UE shall be forced to cell 2 in the initialisation phase, so that reselection to cell 1 occurs during the first T1 phase |
| T1 end condition | Active cell | | Cell1 | UE shall perform reselection to cell 1 during T1 |
| | Neighbour cell | | Cell2 | |
| Final condition | Active cell | | Cell2 | UE shall perform reselection to cell 2 during T3 |
| Cell 1 E-UTRA RF Channel Number | | | 1 | One TDD carrier frequency is used. And Cell 1 is on RF channel number 1. |
| Cell 2 E-UTRA RF Channel Number | | | 2 | One FDD carrier frequencies is used. And Cell 2 is on RF channel number 2. |
| Time offset between cells | | | 3 ms | Asynchronous cells |
| E-UTRA TDD PRACH configuration | | | 53 | As specified in table 5.7.1-3 in TS 36.211 |
| Special subframe configuration | | | 6 | As specified in table 4.2-1 in TS 36.211 |
| Uplink-downlink configuration | | | 1 | As specified in table 4.2-2 in TS 36.211 |
| E-UTRA FDD PRACH configuration | | | 4 | As specified in table 5.7.1-2 in TS 36.211 |
| E-UTRA FDD Access Barring Information | | - | Not Sent | No additional delays in random access procedure. |
| E-UTRA TDD Access Barring Information | | - | Not Sent | No additional delays in random access procedure. |
| DRX cycle length | | s | 1.28 | The value shall be used for all cells in the test. |
| T1 | | s | 15 | T1 need to be defined so that cell re-selection reaction time is taken into account. |
| T2 | | s | >7 | During T2, cell 2 shall be powered off, and during the off time the physical cell identity shall be changed, The intention is to ensure that cell 2 has not been detected by the UE prior to the start of period T3. |
| T3 | | s | 75 | T3 need to be defined so that cell re-selection reaction time is taken into account. |

Table A.4.2.5.1-2: Cell specific test parameters for TDD-FDD inter-frequency cell reselection test case in AWGN

| Parameter | Unit | Cell 1 | | | Cell 2 | | |
|--|------|----------|----|----|----------|----|----|
| | | T1 | T2 | T3 | T1 | T2 | T3 |
| E-UTRA RF Channel number | | 1 | | | 2 | | |
| BW _{channel} | MHz | 10 | | | 10 | | |
| OCNG Patterns defined in A.3.2.1.2 (OP.2 FDD) and A.3.2.2.2 (OP.2 TDD) | | OP.2 TDD | | | OP.2 FDD | | |
| PBCH_RA | dB | | | | | | |
| PBCH_RB | dB | | | | | | |
| PSS_RA | dB | | | | | | |

| | | | | | | | |
|---|------------|------|-----|-----|----------|-----------|-----|
| SSS_RA | dB | | | | | | |
| PCFICH_RB | dB | | | | | | |
| PHICH_RA | dB | | | | | | |
| PHICH_RB | dB | 0 | | | 0 | | |
| PDCCH_RA | dB | | | | | | |
| PDCCH_RB | dB | | | | | | |
| PDSCH_RA | dB | | | | | | |
| PDSCH_RB | dB | | | | | | |
| OCNG_RA ^{Note 1} | dB | | | | | | |
| OCNG_RB ^{Note 1} | dB | | | | | | |
| Qrxlevmin | dBm | -140 | | | -140 | | |
| N_{oc} ^{Note 2} | dBm/15 kHz | -98 | | | | | |
| RSRP ^{Note 3} | dBm/15 KHz | -84 | -84 | -84 | -102 | -infinity | -86 |
| \hat{E}_s / I_{ot} | dB | 14 | 14 | 14 | -4 | -infinity | 12 |
| \hat{E}_s / N_{oc} | dB | 14 | 14 | 14 | -4 | -infinity | 12 |
| Treselection ^{EUTRAN} | s | 0 | | | 0 | | |
| Snonintrasearch | dB | 50 | | | Not sent | | |
| Thresh _{x, high} | dB | 48 | | | 48 | | |
| Thresh _{servicing, low} | dB | 44 | | | 44 | | |
| Thresh _{x, low} | dB | 50 | | | 50 | | |
| Propagation Condition | | AWGN | | | | | |
| <p>Note 1: OCNG shall be used such that both cells are fully allocated and a constant total transmitted power spectral density is achieved for all OFDM symbols.</p> <p>Note 2: Interference from other cells and noise sources not specified in the test is assumed to be constant over subcarriers and time and shall be modelled as AWGN of appropriate power for N_{oc} to be fulfilled.</p> <p>Note 3: RSRP levels have been derived from other parameters for information purposes. They are not settable parameters themselves.</p> | | | | | | | |

A.4.2.5.2 Test Requirements

The cell reselection delay to higher priority is defined as the time from the beginning of time period T3, to the moment when the UE camps on cell 2, and starts to send preambles on the PRACH for sending the RRC CONNECTION REQUEST message to perform a Tracking Area Update procedure on cell 2.

The cell re-selection delay to higher priority shall be less than 68 s.

The cell reselection delay to lower priority is defined as the time from the beginning of time period T1, to the moment when the UE camps on cell 1, and starts to send preambles on the PRACH for sending the RRC CONNECTION REQUEST message to perform a Tracking Area Update procedure on cell 1.

The cell re-selection delay to lower priority shall be less than 8 s.

The rate of correct cell reselections observed during repeated tests shall be at least 90%.

NOTE: The cell re-selection delay to higher priority cell can be expressed as: $T_{\text{higher_priority_search}} + T_{\text{evaluate,E-UTRAN_inter}} + T_{\text{SI-EUTRA}}$, and to lower priority cell can be expressed as: $T_{\text{evaluate,E-UTRAN_inter}} + T_{\text{SI-EUTRA}}$,

Where:

$T_{\text{higher_priority_search}}$ See clause 4.2.2

$T_{\text{evaluate,E-UTRAN_inter}}$ See Table 4.2.2.4-1 in clause 4.2.2.4

$T_{\text{SI-EUTRA}}$ Maximum repetition period of relevant system info blocks that needs to be received by the UE to camp on a cell; 1280 ms is assumed in this test case.

This gives a total of 67.68 s for higher priority cell search and 7.68 s for lower priority cell search, allow 68 s for higher priority cell and 8 s for lower priority cell in the test case.

A.4.2.6 E-UTRAN TDD – TDD: Inter frequency case

A.4.2.6.1 Test Purpose and Environment

This test is to verify the requirement for the TDD-TDD inter-frequency cell reselection requirements specified in clause 4.2.2.4.

The test scenario comprises of 2 E-UTRA TDD cells on 2 different carriers as given in tables A.4.2.6.1-1 and A.4.2.6.1-2. The test consists of three successive time periods, with time duration of T1, T2, and T2 respectively. Both cell 1 and cell 2 are already identified by the UE prior to the start of the test. Cell 1 and cell 2 belong to different tracking areas and cell 2 is of higher priority than cell 1. Furthermore, UE has not registered with network for the tracking area containing cell 2.

Table A.4.2.6.1-1: General test parameters for TDD-TDD inter frequency cell reselection test case

| Parameter | | Unit | Value | Comment |
|--------------------------------|----------------|------|-----------|--|
| Initial condition | Active cell | | Cell2 | UE shall be forced to cell 2 in the initialisation phase, so that reselection to cell 1 occurs during the first T1 phase |
| T1 end condition | Active cells | | Cell1 | UE shall perform reselection to cell 1 during T1 |
| | Neighbour cell | | Cell2 | |
| Final condition | Active cell | | Cell2 | UE shall perform reselection to cell 2 during T3 |
| E-UTRA RF Channel Number | | | 1, 2 | Two TDD carrier frequencies are used. |
| Time offset between cells | | | 3 μ s | Synchronous cells |
| Access Barring Information | | - | Not Sent | No additional delays in random access procedure. |
| Special subframe configuration | | | 6 | As specified in table 4.2-1 in TS 36.211 |
| Uplink-downlink configuration | | | 1 | As specified in table 4.2-2 in TS 36.211 |
| PRACH configuration index | | | 53 | As specified in table 5.7.1-3 in TS 36.211 |
| DRX cycle length | | s | 1,28 | The value shall be used for all cells in the test. |
| T1 | | s | 15 | T1 need to be defined so that cell re-selection reaction time is taken into account. |
| T2 | | s | >7 | During T2, cell 2 shall be powered off, and during the off time the physical cell identity shall be changed, The intention is to ensure that cell 2 has not been detected by the UE prior to the start of period T3. |
| T3 | | s | 75 | T3 need to be defined so that cell re-selection reaction time is taken into account. |

Table A.4.2.6.1-2: Cell specific test parameters for TDD-TDD inter-frequency cell reselection test case in AWGN

| Parameter | Unit | Cell 1 | | | Cell 2 | | |
|--|------|----------|----|----|----------|----|----|
| | | T1 | T2 | T3 | T1 | T2 | T3 |
| E-UTRA RF Channel number | | 1 | | | 2 | | |
| BW _{channel} | MHz | 10 | | | 10 | | |
| OCNG Pattern defined in A.3.2.2.2 (OP.2 TDD) | | OP.2 TDD | | | OP.2 TDD | | |
| PBCH_RA | dB | 0 | | | 0 | | |
| PBCH_RB | dB | | | | | | |
| PSS_RA | dB | | | | | | |
| SSS_RA | dB | | | | | | |
| PCFICH_RB | dB | | | | | | |
| PHICH_RA | dB | | | | | | |
| PHICH_RB | dB | | | | | | |
| PDCCH_RA | dB | | | | | | |
| PDCCH_RB | dB | | | | | | |
| PDSCH_RA | dB | | | | | | |
| PDSCH_RB | dB | | | | | | |

| | | | | | | | |
|--------------------------------|--|------|-----|-----|----------|-----------|-----|
| OCNG_RA ^{Note 1} | dB | | | | | | |
| OCNG_RB ^{Note 1} | dB | | | | | | |
| Qrxlevmin | dBm | -140 | | | -140 | | |
| N_{oc} ^{Note 2} | dBm/15 kHz | -98 | | | | | |
| RSRP ^{Note 3} | dBm/15 KHz | -84 | -84 | -84 | -102 | -infinity | -86 |
| \hat{E}_s / I_{ot} | dB | 14 | 14 | 14 | -4 | -infinity | 12 |
| \hat{E}_s / N_{oc} | dB | 14 | 14 | 14 | -4 | -infinity | 12 |
| Treselection ^{EUTRAN} | S | 0 | | | 0 | | |
| Snoninrasearch | dB | 50 | | | Not sent | | |
| Thresh _{x, high} | dB | 48 | | | 48 | | |
| Thresh _{serv, low} | dB | 44 | | | 44 | | |
| Thresh _{x, low} | dB | 50 | | | 50 | | |
| Propagation Condition | | AWGN | | | | | |
| Note 1: | OCNG shall be used such that both cells are fully allocated and a constant total transmitted power spectral density is achieved for all OFDM symbols. | | | | | | |
| Note 2: | Interference from other cells and noise sources not specified in the test is assumed to be constant over subcarriers and time and shall be modelled as AWGN of appropriate power for N_{oc} to be fulfilled. | | | | | | |
| Note 3: | RSRP levels have been derived from other parameters for information purposes. They are not settable parameters themselves. | | | | | | |

A.4.2.6.2 Test Requirements

The cell reselection delay to higher priority is defined as the time from the beginning of time period T3, to the moment when the UE camps on cell 2, and starts to send preambles on the PRACH for sending the RRC CONNECTION REQUEST message to perform a Tracking Area Update procedure on cell 2.

The cell re-selection delay to higher priority shall be less than 68 s.

The cell reselection delay to lower priority is defined as the time from the beginning of time period T1, to the moment when the UE camps on cell 1, and starts to send preambles on the PRACH for sending the RRC CONNECTION REQUEST message to perform a Tracking Area Update procedure on cell 1.

The cell re-selection delay to lower priority shall be less than 8 s.

The rate of correct cell reselections observed during repeated tests shall be at least 90%.

NOTE: The cell re-selection delay to higher priority cell can be expressed as: $T_{\text{higher_priority_search}} + T_{\text{evaluate,E-UTRAN_inter}} + T_{\text{SI-EUTRA}}$, and to lower priority cell can be expressed as: $T_{\text{evaluate,E-UTRAN_inter}} + T_{\text{SI-EUTRA}}$,

Where:

$T_{\text{higher_priority_search}}$ See clause 4.2.2

$T_{\text{evaluate,E-UTRAN_inter}}$ See Table 4.2.2.4-1 in clause 4.2.2.4

$T_{\text{SI-EUTRA}}$ Maximum repetition period of relevant system info blocks that needs to be received by the UE to camp on a cell; 1280 ms is assumed in this test case.

This gives a total of 67.68 s for higher priority cell search and 7.68 s for lower priority cell search, allow 68 s for higher priority cell and 8 s for lower priority cell in the test case.

A.4.2.7 E-UTRAN FDD – FDD Inter frequency case in the existence of non-allowed CSG cell

A.4.2.7.1 Test Purpose and Environment

This test is to verify the requirement for the FDD-FDD inter-frequency cell reselection requirements specified in clause 4.2.2.4 when there is the interference from non-allowed CSG cell and the layers have equal priority.

The test scenario comprises of 2 E-UTRA FDD cells on 2 different carriers and 1 non-allowed E-UTRA FDD CSG cell as given in tables A.4.2.7.1-1 and A.4.2.7.1-2. The test consists of three successive time periods, with time duration of T1, T2 and T3 respectively. Cell 1 is already identified by the UE prior to the start of the test. Cell 1 and cell 2 belong to different tracking areas and cell 3 is a non-allowed CSG cell. Furthermore, UE has not registered with network for the tracking area containing cell 2.

Table A.4.2.7.1-1: General test parameters for FDD-FDD inter frequency cell re-selection test case with non-allowed CSG cell

| Parameter | | Unit | Value | Comment |
|----------------------------|-------------|------|----------|--|
| Initial condition | Active cell | | Cell1 | UE shall be forced to cell 1 in the initialisation phase |
| Final condition | Active cell | | Cell2 | UE shall perform reselection to cell 2 during T2 |
| E-UTRA RF Channel Number | | | 1, 2 | Two FDD carrier frequencies are used. |
| Time offset between cells | | | 3 ms | Asynchronous cells |
| PRACH configuration | | | 4 | As specified in table 5.7.1-2 in TS 36.211 |
| Access Barring Information | | - | Not Sent | No additional delays in random access procedure. |
| DRX cycle length | | s | 1.28 | The value shall be used for all cells in the test. |
| T1 | | s | 15 | T1 need to be defined so that the non-allowed CSG cell is identified. |
| T2 | | s | 40 | T2 need to be defined so that cell re-selection reaction time is taken into account. |
| T3 | | s | 15 | T3 need to be defined so that whether cell re-selection would not occur is insured. |

Table A.4.2.7.1-2: Cell specific test parameters for FDD-FDD inter frequency cell re-selection test case with non-allowed CSG cell

| Parameter | Unit | Cell 1 | | | Cell 2 | | | Cell 3(Non-allowed CSG cell) | | |
|---|------------|----------|-------|-------|-----------|-----|-----|------------------------------|-------|-------|
| | | T1 | T2 | T3 | T1 | T2 | T3 | T1 | T2 | T3 |
| E-UTRA RF Channel Number | | 1 | | | 2 | | | 1 | | |
| BW _{channel} | MHz | 10 | | | 10 | | | 10 | | |
| OCNG Patterns defined in A.3.2.1.2 (OP.2 FDD) | | OP.2 FDD | | | OP.2 FDD | | | OP.2 FDD | | |
| PBCH_RA | dB | 0 | | | 0 | | | 0 | | |
| PBCH_RB | dB | | | | | | | | | |
| PSS_RA | dB | | | | | | | | | |
| SSS_RA | dB | | | | | | | | | |
| PCFICH_RB | dB | | | | | | | | | |
| PHICH_RA | dB | | | | | | | | | |
| PHICH_RB | dB | | | | | | | | | |
| PDCCH_RA | dB | | | | | | | | | |
| PDCCH_RB | dB | | | | | | | | | |
| PDSCH_RA | dB | | | | | | | | | |
| PDSCH_RB | dB | | | | | | | | | |
| OCNG_RA ^{Note 1} | dB | | | | | | | | | |
| OCNG_RB ^{Note 1} | dB | | | | | | | | | |
| Qrxlevmin | dBm | -140 | | | -140 | | | -140 | | |
| Qqualmin | dB | | | | -20 | | | | | |
| N_{oc} ^{Note 2} | dBm/15 kHz | | | | -98 | | | | | |
| RSRP ^{Note 3} | dBm/15 kHz | -90 | -90 | -85 | -Infinity | -85 | -90 | -90 | -85 | -60 |
| RSRQ ^{Note 3} | dB | -14.1 | -17.1 | -35.8 | | | | -14.1 | -12.1 | -10.8 |

| | | | | | | | | | | |
|-----------------------|--|-------|-------|-----|-----------|----|---|----------|------|------|
| \hat{E}_s / I_{ot} | dB | -0.64 | -5.21 | -25 | -Infinity | 13 | 8 | -0.64 | 4.36 | 24.8 |
| \hat{E}_s / N_{oc} | dB | 8 | 8 | 13 | -Infinity | 13 | 8 | 8 | 13 | 38 |
| Treselection | s | 0 | | | 0 | | | 0 | | |
| Snoninrasearch | dB | -10 | | | Not sent | | | Not sent | | |
| Propagation Condition | | AWGN | | | | | | | | |
| Note 1: | OCNG shall be used such that both cells are fully allocated and a constant total transmitted power spectral density is achieved for all OFDM symbols. | | | | | | | | | |
| Note 2: | Interference from other cells and noise sources not specified in the test is assumed to be constant over subcarriers and time and shall be modelled as AWGN of appropriate power for N_{oc} to be fulfilled. | | | | | | | | | |
| Note 3: | RSRP and RSRQ levels have been derived from other parameters for information purposes. They are not settable parameters themselves. | | | | | | | | | |

A.4.2.7.2 Test Requirements

The cell reselection delay to a newly detectable cell is defined as the time from the beginning of time period T2, to the moment when the UE camps on Cell 2, and starts to send preambles on the PRACH for sending the RRC CONNECTION REQUEST message to perform a Tracking Area Update procedure on Cell 2.

The cell re-selection delay to a newly detectable cell shall be less than 34 s.

The rate of correct cell reselections observed during repeated tests shall be at least 90%.

The probability of reselection from Cell 2 to Cell 1 during T3 observed during testing shall be less than 10%.

NOTE: The cell re-selection delay to a newly detectable cell can be expressed as: $T_{\text{detect,EUTRAN_Inter}} + T_{\text{SI}}$,

Where:

$T_{\text{detect,EUTRAN_Inter}}$ See Table 4.2.2.4-1 in clause 4.2.2.4

T_{SI} Maximum repetition period of relevant system info blocks that needs to be received by the UE to camp on a cell; 1280 ms is assumed in this test case.

This gives a total of 33.28 s, allow 34 s for the cell re-selection delay to a newly detectable cell in the test case.

A.4.2.8 E-UTRAN TDD – TDD Inter frequency case in the existence of non-allowed CSG cell

A.4.2.8.1 Test Purpose and Environment

This test is to verify the requirement for the TDD-TDD inter-frequency cell reselection requirements specified in clause 4.2.2.4 when there is the interference from non-allowed CSG cell and the layers have equal priority.

The test scenario comprises of 2 E-UTRA TDD cells on 2 different carriers and 1 non-allowed E-UTRA TDD CSG cell as given in tables A.4.2.8.1-1 and A.4.2.8.1-2. The test consists of three successive time periods, with time duration of T1, T2 and T3 respectively. Cell 1 is already identified by the UE prior to the start of the test. Cell 1 and cell 2 belong to different tracking areas and cell 3 is a non-allowed CSG cell. Furthermore, UE has not registered with network for the tracking area containing cell 2.

Table A.4.2.8.1-1: General test parameters for TDD-TDD inter frequency cell re-selection test case with non-allowed CSG cell

| Parameter | Unit | Value | Comment |
|-------------------|-------------|-------|--|
| Initial condition | Active cell | Cell1 | UE shall be forced to cell 1 in the initialisation phase |

| | | | | |
|--------------------------------|---------------|--|----------|--|
| Final condition | Active cell | | Cell2 | UE shall perform reselection to cell 2 during T2 |
| E-UTRA RF Channel Number | | | 1, 2 | Two TDD carrier frequencies are used. |
| Time offset between cells | μs | | 3 | Synchronous cells |
| Uplink-downlink configuration | | | 1 | As specified in table 4.2-2 in TS 36.211 |
| Special subframe configuration | | | 6 | As specified in table 4.2-1 in TS 36.211 |
| PRACH configuration | | | 53 | As specified in table 5.7.1-3 in TS 36.211 |
| Access Barring Information | - | | Not Sent | No additional delays in random access procedure. |
| DRX cycle length | s | | 1.28 | The value shall be used for all cells in the test. |
| T1 | s | | 15 | T1 need to be defined so that the non-allowed CSG cell is identified. |
| T2 | s | | 40 | T2 need to be defined so that cell re-selection reaction time is taken into account. |
| T3 | s | | 15 | T3 need to be defined so that whether cell re-selection would not occur is insured. |

Table A.4.2.8.1-2: Cell specific test parameters for TDD-TDD inter frequency cell re-selection test case with non-allowed CSG cell

| Parameter | Unit | Cell 1 | | | Cell 2 | | | Cell 3 (Non-allowed CSG cell) | | |
|--|--|----------|-------|-------|-----------|-----|-----|----------------------------------|-------|-------|
| | | T1 | T2 | T3 | T1 | T2 | T3 | T1 | T2 | T3 |
| E-UTRA RF Channel Number | | 1 | | | 2 | | | 1 | | |
| BW_{channel} | MHz | 10 | | | 10 | | | 10 | | |
| OCNG Pattern defined in A.3.2.2.2 (OP.2 TDD) | | OP.2 TDD | | | OP.2 TDD | | | OP.2 TDD | | |
| PBCH_RA | dB | 0 | | | 0 | | | 0 | | |
| PBCH_RB | dB | | | | | | | | | |
| PSS_RA | dB | | | | | | | | | |
| SSS_RA | dB | | | | | | | | | |
| PCFICH_RB | dB | | | | | | | | | |
| PHICH_RA | dB | | | | | | | | | |
| PHICH_RB | dB | | | | | | | | | |
| PDCCH_RA | dB | | | | | | | | | |
| PDCCH_RB | dB | | | | | | | | | |
| PDSCH_RA | dB | | | | | | | | | |
| PDSCH_RB | dB | | | | | | | | | |
| OCNG_RA ^{Note 1} | dB | -140 | | | -140 | | | -140 | | |
| OCNG_RB ^{Note 1} | dB | | | | | | | | | |
| Qrxlevmin | dBm | -140 | | | -140 | | | -140 | | |
| Qualmin | dB | | | | -20 | | | | | |
| N_{oc} ^{Note 2} | dBm/ 15kHz | | | | -98 | | | | | |
| RSRP ^{Note 3} | dBm/ 15kHz | -90 | -90 | -85 | -Infinity | -85 | -90 | -90 | -85 | -60 |
| RSRQ ^{Note 3} | dB | -14.1 | -17.1 | -35.8 | | | | -14.1 | -12.1 | -10.8 |
| \hat{E}_s / I_{ot} | dB | -0.64 | -5.21 | -25 | -Infinity | 13 | 8 | -0.64 | 4.36 | 24.8 |
| \hat{E}_s / N_{oc} | dB | 8 | 8 | 13 | -Infinity | 13 | 8 | 8 | 13 | 38 |
| Treselection | S | 0 | | | 0 | | | 0 | | |
| Snonintrasearch | dB | -10 | | | Not sent | | | Not sent | | |
| Propagation Condition | | AWGN | | | | | | | | |
| Note 1: | OCNG shall be used such that both cells are fully allocated and a constant total transmitted power spectral density is achieved for all OFDM symbols. | | | | | | | | | |
| Note 2: | Interference from other cells and noise sources not specified in the test is assumed to be constant over subcarriers and time and shall be modelled as AWGN of appropriate power for N_{oc} to be fulfilled. | | | | | | | | | |
| Note 3: | RSRP and RSRQ levels have been derived from other parameters for information purposes. They are not settable parameters themselves. | | | | | | | | | |

A.4.2.8.2 Test Requirements

The cell reselection delay to a newly detectable cell is defined as the time from the beginning of time period T2, to the moment when the UE camps on Cell 2, and starts to send preambles on the PRACH for sending the RRC CONNECTION REQUEST message to perform a Tracking Area Update procedure on Cell 2.

The cell re-selection delay to a newly detectable cell shall be less than 34 s.

The rate of correct cell reselections observed during repeated tests shall be at least 90%.

The probability of reselection from Cell 2 to Cell 1 during T3 observed during testing shall be less than 10%.

NOTE: The cell re-selection delay to a newly detectable cell can be expressed as: $T_{\text{detect,EUTRAN_Inter}} + T_{\text{SI}}$,

Where:

$T_{\text{detect,EUTRAN_Inter}}$ See Table 4.2.2.4-1 in clause 4.2.2.4

T_{SI} Maximum repetition period of relevant system info blocks that needs to be received by the UE to camp on a cell; 1280 ms is assumed in this test case.

This gives a total of 33.28 s, allow 34 s for the cell re-selection delay to a newly detectable cell in the test case.

A.4.2.9 E-UTRAN FDD – FDD Intra frequency case for 5MHz bandwidth

A.4.2.9.1 Test Purpose and Environment

The purpose of this test case is the same as for the test defined in subclause A.4.2.1.1.

The parameters of this test are the same as defined in Subclause A.4.2.1.1 except that the values of the parameters in the Table A.4.2.9.1-1 will replace the values of the corresponding parameters in A.4.2.1.1-1, and the values of the parameters in the Table A.4.2.9.1-2 will replace the values of the corresponding parameters in A.4.2.1.1-2.

Table A.4.2.9.1-1: General test parameters for FDD intra frequency cell reselection test case for 5MHz bandwidth

| Parameter | Unit | Value | Comment |
|--|------|-------|---------|
| Channel Bandwidth (BW_{channel}) | MHz | 5 | |
| Note 1: See Table A.4.2.1.1-1 for the other parameters. | | | |
| Note 2: This is according to the principle defined in section A.3.7.2. | | | |

Table A.4.2.9.1-2: Cell specific test parameters for FDD intra frequency cell reselection test case in AWGN for 5MHz

| Parameter | Unit | Cell 1 | | | Cell 2 | | |
|---|------|-----------|----|----|-----------|----|----|
| | | T1 | T2 | T3 | T1 | T2 | T3 |
| BW_{channel} | MHz | 5 | | | 5 | | |
| OCNG Patterns defined in A.3.2.1.16 (OP.16 FDD) | | OP.16 FDD | | | OP.16 FDD | | |
| Note 1: OCNG shall be used such that both cells are fully allocated and a constant total transmitted power spectral density is achieved for all OFDM symbols. | | | | | | | |
| Note 2: See Table A.4.2.1.1-2 for the other parameters. | | | | | | | |

A.4.2.9.2 Test Requirements

The test requirements defined in section A.4.2.1.2 shall apply to this test case.

A.4.2.10 E-UTRAN FDD – FDD reselection using an increased number of carriers

A.4.2.10.1 Test Purpose and Environment

This test is to verify the requirement for the FDD-FDD inter-frequency cell reselection requirements for increased UE carrier monitoring specified in clause 4.2.2.4.

The test scenario comprises of indicating 8 E-UTRA FDD interfrequency cells on 8 different carriers in the neighbour list of cell 1 as given in tables A.4.2.10.1-1 and A.4.2.10.1-2. Each repetition of the test consists of five successive time periods, with time duration of T0, T1, T2, T3 and T4 respectively. In the initialisation phase and at the start of each repetition of T0, the test equipment provides signals for cell 1 (serving cell), and selects frequencies for cells 2, 3 and 4 which are chosen from the 8 interfrequency layers which are configured in the UE neighbour cell list as described in general and cell specific parameters. The neighbour lists of cells 2, 3 and 4 shall include the frequency of cell 1 in the normal performance group as well as the other frequencies configured to the UE in the test.

Cell 1, 2, 3 and 4 are identified by the UE during time phase T0. Cell 1, cell 2, cell 3 and cell 4 all belong to different tracking areas. Furthermore, UE has not registered with network for the tracking area containing cell 2, 3 or 4. Cells 1, 2, 3 and 4 all have equal absolute priority.

Table A.4.2.10.1-1: General test parameters for FDD-FDD inter frequency cell re-selection test case

| Parameter | | Unit | Value | Comment |
|--|----------------|------|--|---|
| T0 | Active cell | | Cell1 | T0 is repeated on each repetition of the test. In T0 the test equipment selects frequencies for cell 2, 3, 4 and then time is allowed for the UE to identify the neighbour cells. See cell specific parameters for detailed settings. |
| T1 start condition | Active cell | | Cell 1 | |
| T1 end condition | Active cell | | Cell 2 | UE shall perform reselection to cell 2 during T1 |
| | Neighbour cell | | Cell 1, cell 3, cell 4 | |
| T2 end condition | Active cell | | Cell 3 | UE shall perform reselection to cell 3 during T2 |
| | Neighbour cell | | Cell 1, cell 2, cell 4 | |
| T3 end condition | Active cell | | Cell 4 | UE shall perform reselection to cell 4 during T3 |
| | Neighbour cell | | Cell 1, cell 2, cell 3 | |
| T4 end condition | Active cell | | Cell 1 | UE shall perform reselection to cell 1 during T4 |
| | Neighbour cell | | Cell 2, cell 3, cell 4 | |
| UE configured E-UTRA RF Channel Number | | | 1, 2,3,4,5,6,7,8,9 | Serving cell and eight xDD carrier frequencies are used in the UE neighbour cell list. Frequencies 5,6,7,8 and 9 are indicated to have reduced performance |
| Test equipment configuration | | | Cell 1 uses UTRA RF channel number 1 Cells 2,3,4 are randomly selected to use different frequencies selected from frequencies 2,3,4,5,6,7,8,9 | |
| PRACH configuration | | | 4 | As specified in table 5.7.1-2 in TS 36.211 [16] |
| Access Barring Information | | - | Not Sent | No additional delays in random access procedure. |
| DRX cycle length | | s | 1.28 | The value shall be used for all cells in the test. |
| T0 | | s | (Test equipment frequency selection and configuration time) + 960 | T0 is defined so that the Test equipment selects frequencies and configures the cells, then the UE cell detection time is taken into account. |

| | | | |
|----|---|-----|--|
| T1 | s | 25 | T1 need to be defined so that cell re-selection reaction time is taken into account. |
| T2 | s | 200 | T2 need to be defined so that cell re-selection reaction time is taken into account |
| T3 | s | 200 | T3 need to be defined so that cell re-selection reaction time is taken into account. |
| T4 | s | 25 | T4 need to be defined so that cell re-selection reaction time is taken into account |

Table A.4.2.10.1-2: Cell specific test parameters for FDD-FDD inter-frequency cell reselection test case in AWGN

| Parameter | Unit | Cell 1 | | | | | Cell 2 | | | | | Cell 3 | | | | | Cell 4 | | | | |
|--|------------|---|-----|-----|-----|-----|--|-----|-----|-----|-----|---|-----|-----|----|----|---|-----|-----|----|----|
| | | T0 | T1 | T2 | T3 | T4 | T0 | T1 | T2 | T3 | T4 | T0 | T1 | T2 | T3 | T4 | T0 | T1 | T2 | T3 | T4 |
| E-UTRA RF Channel number | | 1 | | | | | Randomly selected from 2,3,4 such that cell 2 is in the normal performance group | | | | | Randomly selected from 5,6,7,8,9 such that cell 3 is in the reduced performance group | | | | | Randomly selected from 5,6,7,8,9 such that cell 4 is in the reduced performance group | | | | |
| BW _{channel} | MHz | 5MHz: N _{RB} = 25 10MHz: N _{RB} = 50 | | | | | 5MHz: N _{RB} = 25 10MHz: N _{RB} = 50 | | | | | 5MHz: N _{RB} = 25 10MHz: N _{RB} = 50 | | | | | 5MHz: N _{RB} = 25 10MHz: N _{RB} = 50 | | | | |
| OCNG patterns | | OP.16 FDD (5MHz) OP.2 FDD (10MHz) | | | | | OP.16 FDD (5MHz) OP.2 FDD (10MHz) | | | | | OP.16 FDD (5MHz) OP.2 FDD (10MHz) | | | | | OP.16 FDD (5MHz) OP.2 FDD (10MHz) | | | | |
| PBCH_RA | dB | 0 | | | | | 0 | | | | | 0 | | | | | 0 | | | | |
| PBCH_RB | dB | | | | | | | | | | | | | | | | | | | | |
| PSS_RA | dB | | | | | | | | | | | | | | | | | | | | |
| SSS_RA | dB | | | | | | | | | | | | | | | | | | | | |
| PCFICH_RB | dB | | | | | | | | | | | | | | | | | | | | |
| PHICH_RA | dB | | | | | | | | | | | | | | | | | | | | |
| PHICH_RB | dB | | | | | | | | | | | | | | | | | | | | |
| PDCCH_RA | dB | | | | | | | | | | | | | | | | | | | | |
| PDCCH_RB | dB | | | | | | | | | | | | | | | | | | | | |
| PDSCH_RA | dB | | | | | | | | | | | | | | | | | | | | |
| PDSCH_RB | dB | | | | | | | | | | | | | | | | | | | | |
| OCNG_RA ^{Note 1} | dB | | | | | | | | | | | | | | | | | | | | |
| OCNG_RB ^{Note 1} | dB | | | | | | | | | | | | | | | | | | | | |
| Qrxlevmin | dBm | -140 | | | | | -140 | | | | | -140 | | | | | -140 | | | | |
| N _{oc} ^{Note 2} | dBm/15 kHz | -98 | | | | | -98 | | | | | -98 | | | | | -98 | | | | |
| \hat{E}_s / N_{oc} | dB | 14 | 8 | 8 | 8 | 14 | 8 | 14 | 8 | 8 | 8 | 8 | 8 | 14 | 8 | 8 | 8 | 8 | 8 | 14 | 8 |
| \hat{E}_s / I_{ot} | dB | 14 | 8 | 8 | 8 | 14 | 8 | 14 | 8 | 8 | 8 | 8 | 8 | 14 | 8 | 8 | 8 | 8 | 8 | 14 | 8 |
| RSRP ^{Note 3} | dBm/15 kHz | -84 | -90 | -90 | -90 | -84 | -90 | -84 | -90 | -90 | -90 | -90 | -90 | -84 | - | - | -90 | -90 | -90 | - | - |
| Treselection _{NEUTRAN} | s | 0 | | | | | 0 | | | | | 0 | | | | | 0 | | | | |
| Snonintrasearch | dB | 62 | | | | | 62 | | | | | 62 | | | | | 62 | | | | |
| Propagation Condition | | AWGN | | | | | AWGN | | | | | AWGN | | | | | AWGN | | | | |
| Antenna Configuration | | 1x2 | | | | | 1x2 | | | | | 1x2 | | | | | 1x2 | | | | |
| Timing offset to Cell 1 | | - | | | | | 3ms | | | | | 3ms | | | | | 3ms | | | | |
| <p>Note 1: OCNG shall be used such that both cells are fully allocated and a constant total transmitted power spectral density is achieved for all OFDM symbols.</p> <p>Note 2: Interference from other cells and noise sources not specified in the test is assumed to be constant over subcarriers and time and shall be modelled as AWGN of appropriate power for to be fulfilled.</p> <p>Note 3: Es/lot and RSRP levels have been derived from other parameters for information purposes. They are not settable parameters themselves.</p> | | | | | | | | | | | | | | | | | | | | | |

A.4.2.10.2 Test Requirements

The cell reselection delay is defined as the time from the beginning of a relevant time period, to the moment when the UE camps on the target cell, and starts to send preambles on the PRACH for sending the RRC CONNECTION REQUEST message to perform a Tracking Area Update procedure on the target cell.

The reselection delays shall meet the requirements in table A.4.2.10.2-1.

Table A.4.2.10.2-1 : Reselection delay requirements

| Time phase | Target cell | Requirement for reselection delay (seconds) |
|------------|------------------------------------|---|
| T1 | Cell 2 (normal performance group) | 20.5 |
| T2 | Cell 3 (reduced performance group) | 193.3 |
| T3 | Cell 4 (reduced performance group) | 193.3 |
| T4 | Cell 1 (normal performance group) | 20.5 |

NOTE: The cell re-selection delay to a normal performance group cell can be expressed as: $K_{\text{carrier,normal}} * T_{\text{evaluate,E-UTRAN_Inter}} + T_{\text{SI}}$, and to a reduced performance group cell can be expressed as: $6 * K_{\text{carrier,reduced}} * T_{\text{evaluate,E-UTRAN_Inter}} + T_{\text{SI}}$.

This gives a total of 20.48 s for normal performance group reselection and 193.28 s for reduced performance group reselection, allow 20.5 s for normal performance group and 193.3 s for reduced performance group in the test case. At least 90% of reselections to the reduced performance group shall be within the required time, and at least 90% of reselections to the normal performance group shall be within the required time, with a successful reselection counted if it is within the required time regardless of the carrier frequencies involved.

A.4.2.11 E-UTRAN TDD – TDD reselection using an increased number of carriers

A.4.2.11.1 Test Purpose and Environment

This test is to verify the requirement for the TDD-TDD inter-frequency cell reselection requirements for increased UE carrier monitoring specified in clause 4.2.2.4.

The test scenario comprises of indicating 8 E-UTRA TDD interfrequency cells on 8 different carriers in the neighbour list of cell 1 as given in tables A.4.2.11.1-1 and A.4.2.11.1-2. Each repetition of the test consists of five successive time periods, with time duration of T0, T1, T2, T3 and T4 respectively. In the initialisation phase and at the start of each repetition of T0, the test equipment provides signals for cell 1 (serving cell), and selects frequencies for cells 2, 3 and 4 which are chosen from the 8 interfrequency layers which are configured in the UE neighbour cell list as described in general and cell specific parameters. The neighbour lists of cells 2, 3 and 4 shall include the frequency of cell 1 in the normal performance group as well as the other frequencies configured to the UE in the test.

Cell 1, 2, 3 and 4 are identified by the UE during time phase T0. Cell 1, cell 2, cell 3 and cell 4 all belong to different tracking areas. Furthermore, UE has not registered with network for the tracking area containing cell 2, 3 or 4. Cells 1, 2, 3 and 4 all have equal absolute priority.

Table A.4.2.11.1-1: General test parameters for TDD-TDD inter frequency cell re-selection test case

| Parameter | Unit | Value | Comment |
|--------------------|----------------|------------------------|---|
| T0 | Active cell | Cell1 | T0 is repeated on each repetition of the test. In T0 the test equipment selects frequencies for cell 2,3,4 and then time is allowed for the UE to identify the neighbour cells. See cell specific parameters for detailed settings. |
| T1 start condition | Active cell | Cell 1 | |
| T1 end condition | Active cell | Cell 2 | UE shall perform reselection to cell 2 during T1 |
| | Neighbour cell | Cell 1, cell 3, cell 4 | |
| T2 end condition | Active cell | Cell 3 | UE shall perform reselection to cell 3 during T2 |

| | | | | |
|--|----------------|---|--|--|
| | Neighbour cell | | Cell 1, cell 2, cell 4 | |
| T3 end condition | Active cell | | Cell4 | UE shall perform reselection to cell 4 during T3 |
| | Neighbour cell | | Cell 1, cell 2, cell 3 | |
| T4 end condition | Active cell | | Cell1 | UE shall perform reselection to cell 1 during T4 |
| | Neighbour cell | | Cell 2, cell 3, cell 4 | |
| UE configured E-UTRA RF Channel Number | | | 1, 2,3,4,5,6,7,8,9 | Serving cell and eight xDD carrier frequencies are used in the UE neighbour cell list. Frequencies 5,6,7,8 and 9 are indicated to have reduced performance |
| Test equipment configuration | | | Cell 1 uses UTRA RF channel number 1 Cells 2,3,4 are randomly selected to use different frequencies selected from frequencies 2,3,4,5,6,7,8,9 | |
| PRACH configuration | | | 4 | As specified in table 5.7.1-2 in TS 36.211 [16] |
| Access Barring Information | | - | Not Sent | No additional delays in random access procedure. |
| DRX cycle length | | s | 1.28 | The value shall be used for all cells in the test. |
| T0 | | s | (Test equipment frequency selection and configuration time) + 960 | T0 is defined so that the Test equipment selects frequencies and configures the cells, then the UE cell detection time is taken into account. |
| T1 | | s | 25 | T1 need to be defined so that cell reselection reaction time is taken into account. |
| T2 | | s | 200 | T2 need to be defined so that cell reselection reaction time is taken into account |
| T3 | | s | 200 | T3 need to be defined so that cell reselection reaction time is taken into account. |
| T4 | | s | 25 | T4 need to be defined so that cell reselection reaction time is taken into account |

Table A.4.2.11.1-2: Cell specific test parameters for TDD-TDD inter-frequency cell reselection test case in AWGN

| Parameter | Unit | Cell 1 | | | | | Cell 2 | | | | | Cell 3 | | | | | Cell 4 | | | | | |
|--|------------|---|-----|-----|-----|-----|--|-----|-----|-----|-----|---|-----|-----|-----|-----|---|-----|-----|-----|-----|-----|
| | | T0 | T1 | T2 | T3 | T4 | T0 | T1 | T2 | T3 | T4 | T0 | T1 | T2 | T3 | T4 | T0 | T1 | T2 | T3 | T4 | |
| E-UTRA RF Channel number | | 1 | | | | | Randomly selected from 2,3,4 such that cell 2 is in the normal performance group | | | | | Randomly selected from 5,6,7,8,9 such that cell 3 is in the reduced performance group | | | | | Randomly selected from 5,6,7,8,9 such that cell 4 is in the reduced performance group | | | | | |
| BW _{channel} | MHz | 5MHz: N _{RB} = 25 10MHz: N _{RB} = 50 | | | | | 5MHz: N _{RB} = 25 10MHz: N _{RB} = 50 | | | | | 5MHz: N _{RB} = 25 10MHz: N _{RB} = 50 | | | | | 5MHz: N _{RB} = 25 10MHz: N _{RB} = 50 | | | | | |
| OCNG Patterns | | 5MHz: OP.10 TDD 10MHz: OP.2 TDD | | | | | 5MHz: OP.10 TDD 10MHz: OP.2 TDD | | | | | 5MHz: OP.10 TDD 10MHz: OP.2 TDD | | | | | 5MHz: OP.10 TDD 10MHz: OP.2 TDD | | | | | |
| PBCH_RA | dB | 0 | | | | | 0 | | | | | 0 | | | | | 0 | | | | | |
| PBCH_RB | dB | | | | | | | | | | | | | | | | | | | | | |
| PSS_RA | dB | | | | | | | | | | | | | | | | | | | | | |
| SSS_RA | dB | | | | | | | | | | | | | | | | | | | | | |
| PCFICH_RB | dB | | | | | | | | | | | | | | | | | | | | | |
| PHICH_RA | dB | | | | | | | | | | | | | | | | | | | | | |
| PHICH_RB | dB | | | | | | | | | | | | | | | | | | | | | |
| PDCCH_RA | dB | | | | | | | | | | | | | | | | | | | | | |
| PDCCH_RB | dB | | | | | | | | | | | | | | | | | | | | | |
| PDSCH_RA | dB | | | | | | | | | | | | | | | | | | | | | |
| PDSCH_RB | dB | | | | | | | | | | | | | | | | | | | | | |
| OCNG_RA ^{Note 1} | dB | | | | | | | | | | | | | | | | | | | | | |
| OCNG_RB ^{Note 1} | dB | | | | | | | | | | | | | | | | | | | | | |
| Qrxlevmin | dBm | -140 | | | | | -140 | | | | | -140 | | | | | -140 | | | | | |
| N _{oc} ^{Note 2} | dBm/15 kHz | -98 | | | | | -98 | | | | | -98 | | | | | -98 | | | | | |
| \hat{E}_s / N_{oc} | dB | 14 | 8 | 8 | 8 | 14 | 8 | 14 | 8 | 8 | 8 | 8 | 8 | 14 | 8 | 8 | 8 | 8 | 8 | 8 | 14 | 8 |
| \hat{E}_s / I_{tot} | dB | 14 | 8 | 8 | 8 | 14 | 8 | 14 | 8 | 8 | 8 | 8 | 8 | 14 | 8 | 8 | 8 | 8 | 8 | 8 | 14 | 8 |
| RSRP ^{Note 3} | dBm/15 kHz | -84 | -90 | -90 | -90 | -84 | -90 | -84 | -90 | -90 | -90 | -90 | -90 | -90 | -84 | -90 | -90 | -90 | -90 | -90 | -84 | -90 |
| Treselection ^{NEUTRAN} | s | 0 | | | | | 0 | | | | | 0 | | | | | 0 | | | | | |
| Snonintrasearch | dB | 62 | | | | | 62 | | | | | 62 | | | | | 62 | | | | | |
| Propagation Condition | | AWGN | | | | | AWGN | | | | | AWGN | | | | | AWGN | | | | | |
| Antenna Configuration | | 1x2 | | | | | 1x2 | | | | | 1x2 | | | | | 1x2 | | | | | |
| Timing offset to Cell 1 | | - | | | | | 3ms | | | | | 3ms | | | | | 3ms | | | | | |
| <p>Note 1: OCNG shall be used such that both cells are fully allocated and a constant total transmitted power spectral density is achieved for all OFDM symbols.</p> <p>Note 2: Interference from other cells and noise sources not specified in the test is assumed to be constant over subcarriers and time and shall be modelled as AWGN of appropriate power for to be fulfilled.</p> <p>Note 3: Es/lot and RSRP levels have been derived from other parameters for information purposes. They are not settable parameters themselves.</p> | | | | | | | | | | | | | | | | | | | | | | |

A.4.2.11.2 Test Requirements

The cell reselection delay is defined as the time from the beginning of a relevant time period, to the moment when the UE camps on the target cell, and starts to send preambles on the PRACH for sending the RRC CONNECTION REQUEST message to perform a Tracking Area Update procedure on the target cell.

The reselection delays shall meet the requirements in table A.4.2.11.2-1

Table A.4.2.11.2-1 : Reselection delay requirements

| Time phase | Target cell | Requirement for reselection delay (seconds) |
|------------|------------------------------------|---|
| T1 | Cell 2 (normal performance group) | 20.5 |
| T2 | Cell 3 (reduced performance group) | 193.3 |
| T3 | Cell 4 (reduced performance group) | 193.3 |
| T4 | Cell 1 (normal performance group) | 20.5 |

NOTE: The cell re-selection delay to a normal performance group cell can be expressed as: $K_{\text{carrier,normal}} * T_{\text{evaluate,E-UTRAN_Inter}} + T_{\text{SI}}$, and to a reduced performance group cell can be expressed as: $6 * K_{\text{carrier,reduced}} * T_{\text{evaluate,E-UTRAN_Inter}} + T_{\text{SI}}$.

This gives a total of 20.48 s for normal performance group reselection and 193.28 s for reduced performance group reselection, allow 20.5 s for normal performance group and 193.3 s for reduced performance group in the test case. At least 90% of reselections to the reduced performance group shall be within the required time, and at least 90% of reselections to the normal performance group shall be within the required time, with a successful reselection counted if it is within the required time regardless of the carrier frequencies involved.

A.4.2.12 E-UTRAN FDD – FDD Intra frequency case for Cat-M1 UE in normal coverage

A.4.2.12.1 Test Purpose and Environment

This test is to verify the requirement for the FDD-FDD intra frequency cell reselection requirements for category M1 UE in normal coverage specified in clause 4.2.2.3.

The test scenario comprises of 1 E-UTRA FDD carrier and 2 cells as given in tables A.4.2.12.1-1 and A.4.2.12.1-2. The test consists of three successive time periods, with time duration of T1, T2 and T3 respectively. Only Cell 1 is already identified by the UE prior to the start of the test, i.e. Cell 2 is not identified by the UE prior to the start of the test. Cell 1 and Cell 2 belong to different tracking areas. Furthermore, UE has not registered with network for the tracking area containing Cell 2.

Table A.4.2.12.1-1: General test parameters for FDD intra frequency cell reselection test case for Cat-M1 UE in normal coverage

| Parameter | Unit | Value | Comment |
|----------------------------|-----------------|-----------|--|
| Initial condition | Active cell | Cell1 | |
| | Neighbour cells | Cell2 | |
| T2 end condition | Active cell | Cell2 | |
| | Neighbour cells | Cell1 | |
| Final condition | Visited cell | Cell1 | |
| E-UTRA RF Channel Number | | 1 | Only one FDD carrier frequency is used. |
| Access Barring Information | - | Not Sent | No additional delays in random access procedure. |
| PRACH Configuration | | PRACH_2CE | Refer to A.3.16 |
| DRX cycle length | s | 1.28 | The value shall be used for all cells in the test. |

| | | | |
|----|---|----|---|
| T1 | s | >7 | During T1, Cell 2 shall be powered off, and during the off time the physical cell identity shall be changed, The intention is to ensure that Cell 2 has not been detected by the UE prior to the start of period T2 |
| T2 | s | 40 | T2 need to be defined so that cell re-selection reaction time is taken into account. |
| T3 | s | 15 | T3 need to be defined so that cell re-selection reaction time is taken into account. |

Table A.4.2.12.1-2: Cell specific test parameters for FDD intra frequency cell reselection test case for Cat-M1 UE in normal coverage

| Parameter | Unit | Cell 1 | | | Cell 2 | | |
|---|------------|----------|-------|------|-----------|------|-------|
| | | T1 | T2 | T3 | T1 | T2 | T3 |
| E-UTRA RF Channel Number | | 1 | | | | | |
| $BW_{channel}$ | MHz | 10 | | | | | |
| OCNG Patterns | | OP.6 FDD | | | OP.6 FDD | | |
| PBCH_RA | dB | -3 | | | -3 | | |
| PBCH_RB | dB | | | | | | |
| PSS_RA | dB | | | | | | |
| SSS_RA | dB | | | | | | |
| MPDCCH_RA | dB | | | | | | |
| MPDCCH_RB | dB | | | | | | |
| PDSCH_RA | dB | | | | | | |
| PDSCH_RB | dB | | | | | | |
| OCNG_RA ^{Note 1} | dB | | | | | | |
| OCNG_RB ^{Note 1} | dB | | | | | | |
| Qrxlevmin | dBm | -140 | -140 | -140 | -140 | -140 | -140 |
| Pcompensation | dB | 0 | 0 | 0 | 0 | 0 | 0 |
| Qhysts | dB | 0 | 0 | 0 | 0 | 0 | 0 |
| Qoffset _{s, n} | dB | 0 | 0 | 0 | 0 | 0 | 0 |
| Cell_selection_and_reselection_quality_measurement | | RSRP | | | RSRP | | |
| N_{oc} ^{Note2} | dBm/15 kHz | -98 | | | | | |
| \hat{E}_s / N_{oc} | dB | 16 | 12 | 16 | -infinity | 16 | 12 |
| \hat{E}_s / I_{ot} | dB | 16 | -4.11 | 3.73 | -infinity | 3.73 | -4.11 |
| RSRP ^{Note3} | dBm/15 kHz | -82 | -86 | -82 | -infinity | -82 | -86 |
| Treselection | s | 0 | 0 | 0 | 0 | 0 | 0 |
| Sintrasearch | dB | Not sent | | | Not sent | | |
| Propagation Condition | | AWGN | | | AWGN | | |
| Antenna Configuration | | 2x1 | | | 2x1 | | |
| Timing offset to Cell 1 | ms | - | | | 3 | | |
| <p>Note 1: OCNG shall be used such that both cells are fully allocated and a constant total transmitted power spectral density is achieved for all OFDM symbols.</p> <p>Note 2: Interference from other cells and noise sources not specified in the test is assumed to be constant over subcarriers and time and shall be modelled as AWGN of appropriate power for N_{oc} to be fulfilled.</p> <p>Note 3: RSRP levels have been derived from other parameters for information purposes. They are not settable parameters themselves.</p> | | | | | | | |

A.4.2.12.2 Test Requirements

The cell reselection delay to a newly detectable cell is defined as the time from the beginning of time period T2, to the moment when the UE camps on Cell 2, and starts to send preambles on the PRACH for sending the RRC CONNECTION REQUEST message to perform a Tracking Area Update procedure on Cell 2.

The cell re-selection delay to a newly detectable cell shall be less than 34 s.

The cell reselection delay to an already detected cell is defined as the time from the beginning of time period T3, to the moment when the UE camps on Cell 1, and starts to send preambles on the PRACH for sending the RRC CONNECTION REQUEST message to perform a Tracking Area Update procedure on Cell 1.

The cell re-selection delay to an already detected cell shall be less than 8 s.

The rate of correct cell reselections observed during repeated tests shall be at least 90%.

NOTE: The cell re-selection delay to a newly detectable cell can be expressed as: $T_{detect,EUTRAN_Intra} + T_{SI-EUTRA-M1-NC}$, and to an already detected cell can be expressed as: $T_{evaluate,EUTRAN_Intra} + T_{SI-EUTRA-M1-NC}$.

Where:

$T_{\text{detect,EUTRAN_Intra}}$ See Table 4.2.2.3-1 in clause 4.2.2.3

$T_{\text{evaluate,EUTRAN_Intra}}$ See Table 4.2.2.3-1 in clause 4.2.2.3

$T_{\text{SI-EUTRA-M1-NC}}$ Maximum repetition period of relevant system info blocks that needs to be received by the UE to camp on a cell; 1280 ms is assumed in this test case.

This gives a total of 33.28 s, allow 34 s for the cell re-selection delay to a newly detectable cell and 7.68 s, allow 8 s for the cell re-selection delay to an already detected cell in the test case.

A.4.2.13 E-UTRAN HD – FDD Intra frequency case for Cat-M1 UE in normal coverage

A.4.2.13.1 Test Purpose and Environment

This test is to verify the requirement for the HD-FDD intra frequency cell reselection requirements for Cat-M1 UE specified in clause 4.2.2.3.

The test scenario comprises of 1 E-UTRA carrier and 2 cells as given in tables A.4.2.13.1-1 and A.4.2.13.1-2. The test consists of three successive time periods, with time duration of T1, T2 and T3 respectively. Only Cell 1 is already identified by the UE prior to the start of the test, i.e. Cell 2 is not identified by the UE prior to the start of the test. Cell 1 and Cell 2 belong to different tracking areas. Furthermore, UE has not registered with network for the tracking area containing Cell 2.

Table A.4.2.13.1-1: General test parameters for HD-FDD intra frequency cell reselection test case for Cat-M1 UE in normal coverage

| | Parameter | Unit | Value | Comment |
|----------------------------|-----------------|------|-----------|---|
| Initial condition | Active cell | | Cell1 | |
| | Neighbour cells | | Cell2 | |
| T2 end condition | Active cell | | Cell2 | |
| | Neighbour cells | | Cell1 | |
| Final condition | Visited cell | | Cell1 | |
| E-UTRA RF Channel Number | | | 1 | Only one carrier frequency is used. |
| Access Barring Information | | - | Not Sent | No additional delays in random access procedure. |
| PRACH Configuration | | | PRACH_2CE | Refer to A.3.16 |
| DRX cycle length | | s | 1.28 | The value shall be used for all cells in the test. |
| T1 | | s | >7 | During T1, Cell 2 shall be powered off, and during the off time the physical cell identity shall be changed, The intention is to ensure that Cell 2 has not been detected by the UE prior to the start of period T2 |
| T2 | | s | 40 | T2 need to be defined so that cell re-selection reaction time is taken into account. |
| T3 | | s | 15 | T3 need to be defined so that cell re-selection reaction time is taken into account. |

Table A.4.2.13.1-2: Cell specific test parameters for HD-FDD intra frequency cell reselection test case for Cat-M1 UE in normal coverage

| Parameter | Unit | Cell 1 | | | Cell 2 | | |
|---|------------|----------|-------|------|-----------|------|-------|
| | | T1 | T2 | T3 | T1 | T2 | T3 |
| E-UTRA RF Channel Number | | 1 | | | | | |
| $BW_{channel}$ | MHz | 10 | | | | | |
| OCNG Patterns | | OP.6 FDD | | | OP.6 FDD | | |
| PBCH_RA | dB | -3 | | | -3 | | |
| PBCH_RB | dB | | | | | | |
| PSS_RA | dB | | | | | | |
| SSS_RA | dB | | | | | | |
| MPDCCH_RA | dB | | | | | | |
| MPDCCH_RB | dB | | | | | | |
| PDSCH_RA | dB | | | | | | |
| PDSCH_RB | dB | | | | | | |
| OCNG_RA ^{Note 1} | dB | | | | | | |
| OCNG_RB ^{Note 1} | dB | | | | | | |
| Qrxlevmin | dBm | -140 | -140 | -140 | -140 | -140 | -140 |
| Pcompensation | dB | 0 | 0 | 0 | 0 | 0 | 0 |
| Qhysts | dB | 0 | 0 | 0 | 0 | 0 | 0 |
| Qoffset _{s, n} | dB | 0 | 0 | 0 | 0 | 0 | 0 |
| Cell_selection_and_reselection_quality_measurement | | RSRP | | | RSRP | | |
| N_{oc} ^{Note2} | dBm/15 kHz | -98 | | | | | |
| \hat{E}_s / N_{oc} | dB | 16 | 12 | 16 | -infinity | 16 | 12 |
| \hat{E}_s / I_{ot} | dB | 16 | -4.11 | 3.73 | -infinity | 3.73 | -4.11 |
| RSRP ^{Note3} | dBm/15 kHz | -82 | -86 | -82 | -infinity | -82 | -86 |
| Treselection | s | 0 | 0 | 0 | 0 | 0 | 0 |
| Sintrasearch | dB | Not sent | | | Not sent | | |
| Propagation Condition | | AWGN | | | AWGN | | |
| Antenna Configuration | | 2x1 | | | 2x1 | | |
| Timing offset to Cell 1 | ms | - | | | 3 | | |
| <p>Note 1: OCNG shall be used such that both cells are fully allocated and a constant total transmitted power spectral density is achieved for all OFDM symbols.</p> <p>Note 2: Interference from other cells and noise sources not specified in the test is assumed to be constant over subcarriers and time and shall be modelled as AWGN of appropriate power for N_{oc} to be fulfilled.</p> <p>Note 3: RSRP levels have been derived from other parameters for information purposes. They are not settable parameters themselves.</p> | | | | | | | |

A.4.2.13.2 Test Requirements

The cell reselection delay to a newly detectable cell is defined as the time from the beginning of time period T2, to the moment when the UE camps on Cell 2, and starts to send preambles on the PRACH for sending the RRC CONNECTION REQUEST message to perform a Tracking Area Update procedure on Cell 2.

The cell re-selection delay to a newly detectable cell shall be less than 34 s.

The cell reselection delay to an already detected cell is defined as the time from the beginning of time period T3, to the moment when the UE camps on Cell 1, and starts to send preambles on the PRACH for sending the RRC CONNECTION REQUEST message to perform a Tracking Area Update procedure on Cell 1.

The cell re-selection delay to an already detected cell shall be less than 8 s.

The rate of correct cell reselections observed during repeated tests shall be at least 90%.

NOTE: The cell re-selection delay to a newly detectable cell can be expressed as: $T_{detect,EUTRAN_Intra} + T_{SI-EUTRA-M1-NC}$, and to an already detected cell can be expressed as: $T_{evaluate,EUTRAN_Intra} + T_{SI-EUTRA-M1-NC}$.

Where:

$T_{\text{detect,EUTRAN_Intra}}$ See Table 4.2.2.3-1 in clause 4.2.2.3

$T_{\text{evaluate,EUTRAN_Intra}}$ See Table 4.2.2.3-1 in clause 4.2.2.3

$T_{\text{SI-EUTRA-M1-NC}}$ Maximum repetition period of relevant system info blocks that needs to be received by the UE to camp on a cell; 1280 ms is assumed in this test case.

This gives a total of 33.28 s, allow 34 s for the cell re-selection delay to a newly detectable cell and 7.68 s, allow 8 s for the cell re-selection delay to an already detected cell in the test case.

A.4.2.14 E-UTRAN TDD – TDD Intra frequency case for Cat-M1 UE in normal coverage

A.4.2.14.1 Test Purpose and Environment

This test is to verify the requirement for the TDD intra frequency cell reselection requirements for Cat-M1 UE specified in clause 4.2.2.3.

The test scenario comprises of 1 E-UTRA TDD carrier and 2 cells as given in tables A.4.2.14.1-1 and A.4.2.14.1-2. The test consists of three successive time periods, with time duration of T1, T2, and T3 respectively. Only cell 1 is already identified by the UE prior to the start of the test. Cell 1 and cell 2 belong to different tracking areas. Furthermore, UE has not registered with network for the tracking area containing cell 2.

Table A.4.2.14.1-1: General test parameters for TDD intra frequency cell re-selection test case for Cat-M1 UE

| Parameter | | Unit | Value | Comment |
|--------------------------------|-----------------|------|-----------|---|
| Initial condition | Active cell | | Cell1 | |
| | Neighbour cells | | Cell2 | |
| T2 end condition | Active cell | | Cell2 | |
| | Neighbour cells | | Cell1 | |
| Final condition | Visited cell | | Cell1 | |
| E-UTRA RF Channel Number | | | 1 | Only one TDD carrier frequency is used. |
| Access Barring Information | | - | Not Sent | No additional delays in random access procedure. |
| Special subframe configuration | | | 6 | As specified in table 4.2-1 in TS 36.211 |
| Uplink-downlink configuration | | | 1 | As specified in table 4.2-2 in TS 36.211 |
| PRACH Configuration | | | PRACH_2CE | Refer to A.3.16 |
| DRX cycle length | | s | 1.28 | The value shall be used for all cells in the test. |
| T1 | | s | >7 | During T1, Cell 2 shall be powered off, and during the off time the physical cell identity shall be changed, The intention is to ensure that Cell 2 has not been detected by the UE prior to the start of period T2 |
| T2 | | s | 40 | T2 need to be defined so that cell re-selection reaction time is taken into account. |
| T3 | | s | 15 | T3 need to be defined so that cell re-selection reaction time is taken into account. |

Table A.4.2.14.1-2: Cell specific test parameters for TDD intra frequency cell re-selection test case for Cat-M1 UE in AWGN in normal coverage

| Parameter | Unit | Cell 1 | | | Cell 2 | | |
|--------------------------|------|----------|----|----|----------|----|----|
| | | T1 | T2 | T3 | T1 | T2 | T3 |
| E-UTRA RF Channel Number | | 1 | | | | | |
| BW _{channel} | MHz | 10 | | | | | |
| OCNG Patterns | | OP.2 TDD | | | OP.2 TDD | | |
| PBCH_RA | dB | -3 | | | -3 | | |

| | | | | | | | |
|---|------------|----------|-------|------|-----------|------|-------|
| PBCH_RB | dB | | | | | | |
| PSS_RA | dB | | | | | | |
| SSS_RA | dB | | | | | | |
| MPDCCH_RA | dB | | | | | | |
| MPDCCH_RB | dB | | | | | | |
| PDSCH_RA | dB | | | | | | |
| PDSCH_RB | dB | | | | | | |
| OCNG_RA ^{Note 1} | dB | | | | | | |
| OCNG_RB ^{Note 1} | dB | | | | | | |
| Qrxlevmin | dBm | -140 | -140 | -140 | -140 | -140 | -140 |
| Pcompensation | dB | 0 | 0 | 0 | 0 | 0 | 0 |
| Qhysts | dB | 0 | 0 | 0 | 0 | 0 | 0 |
| Qoffset _{s, n} | dB | 0 | 0 | 0 | 0 | 0 | 0 |
| Cell_selection_and_reselection_quality_measurement | | RSRP | | | RSRP | | |
| N_{oc} ^{Note2} | dBm/15 kHz | -98 | | | | | |
| \hat{E}_s / N_{oc} | dB | 16 | 12 | 16 | -infinity | 16 | 12 |
| \hat{E}_s / I_{ot} | dB | 16 | -4.11 | 3.73 | -infinity | 3.73 | -4.11 |
| RSRP ^{Note3} | dBm/15 kHz | -82 | -86 | -82 | -infinity | -82 | -86 |
| Treselection | s | 0 | 0 | 0 | 0 | 0 | 0 |
| Sintrasearch | dB | Not sent | | | Not sent | | |
| Propagation Condition | | AWGN | | | AWGN | | |
| Antenna Configuration | | 2x1 | | | 2x1 | | |
| Timing offset to Cell 1 | μ s | - | | | 3 | | |
| <p>Note 1: OCNG shall be used such that both cells are fully allocated and a constant total transmitted power spectral density is achieved for all OFDM symbols.</p> <p>Note 2: Interference from other cells and noise sources not specified in the test is assumed to be constant over subcarriers and time and shall be modelled as AWGN of appropriate power for N_{oc} to be fulfilled.</p> <p>Note 3: RSRP levels have been derived from other parameters for information purposes. They are not settable parameters themselves.</p> | | | | | | | |

A.4.2.14.2 Test Requirements

The cell reselection delay to a newly detectable cell is defined as the time from the beginning of time period T2, to the moment when the UE camps on Cell 2, and starts to send preambles on the PRACH for sending the RRC CONNECTION REQUEST message to perform a Tracking Area Update procedure on Cell 2.

The cell re-selection delay to a newly detectable cell shall be less than 34 s.

The cell reselection delay to an already detected cell is defined as the time from the beginning of time period T3, to the moment when the UE camps on cell 1, and starts to send preambles on the PRACH for sending the RRC CONNECTION REQUEST message to perform a Tracking Area Update procedure on cell 1.

The cell re-selection delay shall be less than 8 s.

The rate of correct cell reselections observed during repeated tests shall be at least 90%.

NOTE: The cell re-selection delay to a newly detectable cell can be expressed as: $T_{\text{detect, E-UTRAN_intra}} + T_{\text{SI-EUTRA-MI-NC}}$, and to an already detected cell can be expressed as: $T_{\text{evaluate, E-UTRAN_intra}} + T_{\text{SI-EUTRA-MI-NC}}$,

Where:

$T_{\text{detect, E-UTRAN_intra}}$ See Table 4.2.2.3-1 in clause 4.2.2.3

$T_{\text{evaluate, E-UTRAN_intra}}$ See Table 4.2.2.3-1 in clause 4.2.2.3

$T_{\text{SI-EUTRA-MI-NC}}$ Maximum repetition period of relevant system info blocks that needs to be received by the UE to camp on a cell; 1280 ms is assumed in this test case.

This gives a total of 33.28 s, allow 34 s for the cell re-selection delay to a newly detectable cell and 7.68 s, allow 8 s for the cell re-selection delay to an already detected cell in the test case.

A.4.2.15 E-UTRAN FDD – FDD Intra frequency case for Cat-M1 UE in enhanced coverage

A.4.2.15.1 Test Purpose and Environment

This test is to verify the requirement for the FDD-FDD intra frequency cell reselection requirements for category M1 UE in enhanced coverage specified in clause 4.2.2.11.

The test scenario comprises of 1 E-UTRA FDD carrier and 2 cells as given in tables A.4.2.15.1-1 and A.4.2.15.1-2. The test consists of three successive time periods, with time duration of T1, T2 and T3 respectively. Only Cell 1 is already identified by the UE prior to the start of the test, i.e. Cell 2 is not identified by the UE prior to the start of the test. Cell 1 and Cell 2 belong to different tracking areas. Furthermore, UE has not registered with network for the tracking area containing Cell 2.

Table A.4.2.15.1-1: General test parameters for FDD intra frequency cell reselection test case for Cat-M1 UE in enhanced coverage

| Parameter | | Unit | Value | Comment |
|----------------------------|-----------------|------|-----------|---|
| Initial condition | Active cell | | Cell1 | |
| | Neighbour cells | | Cell2 | |
| T2 end condition | Active cell | | Cell2 | |
| | Neighbour cells | | Cell1 | |
| Final condition | Visited cell | | Cell1 | |
| E-UTRA RF Channel Number | | | 1 | Only one FDD carrier frequency is used. |
| Access Barring Information | | - | Not Sent | No additional delays in random access procedure. |
| PRACH Parameters | | | PRACH_4CE | Refer to A.3.16 |
| DRX cycle length | | s | 0.64 | The value shall be used for all cells in the test. |
| T1 | | s | >7 | During T1, Cell 2 shall be powered off, and during the off time the physical cell identity shall be changed, The intention is to ensure that Cell 2 has not been detected by the UE prior to the start of period T2 |
| T2 | | s | ≤340 | T2 need to be defined so that cell re-selection reaction time is taken into account. |
| T3 | | s | 20 | T3 need to be defined so that cell re-selection reaction time is taken into account. |

Table A.4.2.15.1-2: Cell specific test parameters for FDD intra frequency cell reselection test case for Cat-M1 UE in enhanced coverage

| Parameter | Unit | Cell 1 | | | Cell 2 | | |
|---|------------|----------|--------|-------|-----------|-------|--------|
| | | T1 | T2 | T3 | T1 | T2 | T3 |
| E-UTRA RF Channel Number | | 1 | | | | | |
| BW _{channel} | MHz | 10 | | | | | |
| OCNG Patterns | | OP.6 FDD | | | OP.6 FDD | | |
| PBCH_RA | dB | -3 | | | -3 | | |
| PBCH_RB | dB | | | | | | |
| PSS_RA | dB | | | | | | |
| SSS_RA | dB | | | | | | |
| MPDCCH_RA | dB | | | | | | |
| MPDCCH_PB | dB | | | | | | |
| PDSCH_RA | dB | | | | | | |
| PDSCH_RB | dB | | | | | | |
| OCNG_RA ^{Note 1} | dB | | | | | | |
| OCNG_RB ^{Note 1} | dB | | | | | | |
| Qrxlevmin | dBm | -140 | -140 | -140 | -140 | -140 | -140 |
| Pcompensation | dB | 0 | 0 | 0 | 0 | 0 | 0 |
| Qhysts | dB | 0 | 0 | 0 | 0 | 0 | 0 |
| Qoffset _{s, n} | dB | 0 | 0 | 0 | 0 | 0 | 0 |
| Cell_selection_and_reselection_quality_measurement | | RSRP | | | RSRP | | |
| N_{oc} ^{Note2} | dBm/15 kHz | -98 | | | | | |
| \hat{E}_s / N_{oc} | dB | -7 | -12 | -7 | -infinity | -7 | -12 |
| \hat{E}_s / I_{ot} | dB | -7 | -12.79 | -7.27 | -infinity | -7.27 | -12.79 |
| RSRP ^{Note3} | dBm/15 kHz | -105 | -110 | -105 | -infinity | -105 | -110 |
| Treselection | s | 0 | 0 | 0 | 0 | 0 | 0 |
| Sintrasearch | dB | Not sent | | | Not sent | | |
| Propagation Condition | | AWGN | | | AWGN | | |
| Antenna Configuration | | 2x1 | | | 2x1 | | |
| Timing offset to Cell 1 | ms | - | | | 3 | | |
| <p>Note 1: OCNG shall be used such that both cells are fully allocated and a constant total transmitted power spectral density is achieved for all OFDM symbols.</p> <p>Note 2: Interference from other cells and noise sources not specified in the test is assumed to be constant over subcarriers and time and shall be modelled as AWGN of appropriate power for N_{oc} to be fulfilled.</p> <p>Note 3: RSRP levels have been derived from other parameters for information purposes. They are not settable parameters themselves.</p> | | | | | | | |

A.4.2.15.2 Test Requirements

The cell reselection delay to a newly detectable cell is defined as the time from the beginning of time period T2, to the moment when the UE camps on Cell 2, and starts to send preambles on the PRACH for sending the RRC CONNECTION REQUEST message to perform a Tracking Area Update procedure on Cell 2.

The cell re-selection delay to a newly detectable cell shall be less than 338 s.

The cell reselection delay to an already detected cell is defined as the time from the beginning of time period T3, to the moment when the UE camps on Cell 1, and starts to send preambles on the PRACH for sending the RRC CONNECTION REQUEST message to perform a Tracking Area Update procedure on Cell 1.

The cell re-selection delay to an already detected cell shall be less than 18 s.

The rate of correct cell reselections observed during repeated tests shall be at least 90%.

NOTE: The cell re-selection delay to a newly detectable cell can be expressed as: $T_{\text{detect,EUTRAN_Intra}} + T_{\text{SI}}$, and to an already detected cell can be expressed as: $T_{\text{evaluate,EUTRAN_Intra}} + T_{\text{SI}}$,

Where:

$T_{\text{detect,EUTRAN_Intra}}$ See Table 4.2.2.11-1 in clause 4.2.2.11

$T_{\text{evaluate,EUTRAN_Intra}}$ See Table 4.2.2.11-1 in clause 4.2.2.11

T_{SI} Maximum repetition period of relevant system info blocks that needs to be received by the UE to camp on a cell; 6400 ms is assumed in this test case.

This gives a total of 337.36 s, allow 338 s for the cell re-selection delay to a newly detectable cell and 17.36 s, allow 18 s for the cell re-selection delay to an already detected cell in the test case.

A.4.2.16 E-UTRAN HD – FDD Intra frequency case for Cat-M1 UE in enhanced coverage

A.4.2.16.1 Test Purpose and Environment

This test is to verify the requirement for the HD-FDD intra frequency cell reselection requirements for Cat-M1 UE specified in clause 4.2.2.11.

The test scenario comprises of 1 E-UTRA carrier and 2 cells as given in tables A.4.2.16.1-1 and A.4.2.16.1-2. The test consists of three successive time periods, with time duration of T1, T2 and T3 respectively. Only Cell 1 is already identified by the UE prior to the start of the test, i.e. Cell 2 is not identified by the UE prior to the start of the test. Cell 1 and Cell 2 belong to different tracking areas. Furthermore, UE has not registered with network for the tracking area containing Cell 2.

Table A.4.2.16.1-1: General test parameters for HD-FDD intra frequency cell reselection test case for Cat-M1 UE in enhanced coverage

| | Parameter | Unit | Value | Comment |
|----------------------------|-----------------|------|-----------|---|
| Initial condition | Active cell | | Cell1 | |
| | Neighbour cells | | Cell2 | |
| T2 end condition | Active cell | | Cell2 | |
| | Neighbour cells | | Cell1 | |
| Final condition | Visited cell | | Cell1 | |
| E-UTRA RF Channel Number | | | 1 | Only one carrier frequency is used. |
| Access Barring Information | | - | Not Sent | No additional delays in random access procedure. |
| PRACH Parameters | | | PRACH_4CE | Refer to A.3.16 |
| DRX cycle length | | s | 0.64 | The value shall be used for all cells in the test. |
| T1 | | s | >7 | During T1, Cell 2 shall be powered off, and during the off time the physical cell identity shall be changed, The intention is to ensure that Cell 2 has not been detected by the UE prior to the start of period T2 |
| T2 | | s | ≤340 | T2 need to be defined so that cell re-selection reaction time is taken into account. |
| T3 | | s | ≤20 | T3 need to be defined so that cell re-selection reaction time is taken into account. |

Table A.4.2.16.1-2: Cell specific test parameters for HD-FDD intra frequency cell reselection test case for Cat-M1 UE in enhanced coverage

| Parameter | Unit | Cell 1 | | | Cell 2 | | |
|---|------------|----------|--------|-------|-----------|-------|--------|
| | | T1 | T2 | T3 | T1 | T2 | T3 |
| E-UTRA RF Channel Number | | 1 | | | | | |
| $BW_{channel}$ | MHz | 10 | | | | | |
| OCNG Patterns | | OP.6 FDD | | | OP.6 FDD | | |
| PBCH_RA | dB | -3 | | | -3 | | |
| PBCH_RB | dB | | | | | | |
| PSS_RA | dB | | | | | | |
| SSS_RA | dB | | | | | | |
| MPDCCH_RA | dB | | | | | | |
| MPDCCH_PB | dB | | | | | | |
| PDSCH_RA | dB | | | | | | |
| PDSCH_RB | dB | | | | | | |
| OCNG_RA ^{Note 1} | dB | | | | | | |
| OCNG_RB ^{Note 1} | dB | | | | | | |
| Qrxlevmin | dBm | -140 | -140 | -140 | -140 | -140 | -140 |
| Pcompensation | dB | 0 | 0 | 0 | 0 | 0 | 0 |
| Qhysts | dB | 0 | 0 | 0 | 0 | 0 | 0 |
| Qoffset _{s, n} | dB | 0 | 0 | 0 | 0 | 0 | 0 |
| Cell_selection_and_reselection_quality_measurement | | RSRP | | | RSRP | | |
| N_{oc} ^{Note2} | dBm/15 kHz | -98 | | | | | |
| \hat{E}_s / N_{oc} | dB | -7 | -12 | -7 | -infinity | -7 | -12 |
| \hat{E}_s / I_{ot} | dB | -7 | -12.79 | -7.27 | -infinity | -7.27 | -12.79 |
| RSRP ^{Note3} | dBm/15 kHz | -105 | -110 | -105 | -infinity | -105 | -110 |
| Treselection | s | 0 | 0 | 0 | 0 | 0 | 0 |
| Sintrasearch | dB | Not sent | | | Not sent | | |
| Propagation Condition | | AWGN | | | AWGN | | |
| Antenna Configuration | | 2x1 | | | 2x1 | | |
| Timing offset to Cell 1 | ms | - | | | 3 | | |
| <p>Note 1: OCNG shall be used such that both cells are fully allocated and a constant total transmitted power spectral density is achieved for all OFDM symbols.</p> <p>Note 2: Interference from other cells and noise sources not specified in the test is assumed to be constant over subcarriers and time and shall be modelled as AWGN of appropriate power for N_{oc} to be fulfilled.</p> <p>Note 3: RSRP levels have been derived from other parameters for information purposes. They are not settable parameters themselves.</p> | | | | | | | |

A.4.2.16.2 Test Requirements

The cell reselection delay to a newly detectable cell is defined as the time from the beginning of time period T2, to the moment when the UE camps on Cell 2, and starts to send preambles on the PRACH for sending the RRC CONNECTION REQUEST message to perform a Tracking Area Update procedure on Cell 2.

The cell re-selection delay to a newly detectable cell shall be less than 338 s.

The cell reselection delay to an already detected cell is defined as the time from the beginning of time period T3, to the moment when the UE camps on Cell 1, and starts to send preambles on the PRACH for sending the RRC CONNECTION REQUEST message to perform a Tracking Area Update procedure on Cell 1.

The cell re-selection delay to an already detected cell shall be less than 18 s.

The rate of correct cell reselections observed during repeated tests shall be at least 90%.

NOTE: The cell re-selection delay to a newly detectable cell can be expressed as: $T_{detect,EUTRAN_Intra} + T_{SI}$, and to an already detected cell can be expressed as: $T_{evaluate,EUTRAN_Intra} + T_{SI}$,

Where:

$T_{\text{detect,EUTRAN_Intra}}$ See Table 4.2.2.11-1 in clause 4.2.2.11

$T_{\text{evaluate,EUTRAN_Intra}}$ See Table 4.2.2.11-1 in clause 4.2.2.11

T_{SI} Maximum repetition period of relevant system info blocks that needs to be received by the UE to camp on a cell; 6400 ms is assumed in this test case.

This gives a total of 337.36 s, allow 338 s for the cell re-selection delay to a newly detectable cell and 17.36 s, allow 18 s for the cell re-selection delay to an already detected cell in the test case.

A.4.2.17 E-UTRAN TDD – TDD Intra frequency case for Cat-M1 UE in enhanced coverage

A.4.2.17.1 Test Purpose and Environment

This test is to verify the requirement for the TDD intra frequency cell reselection requirements for Cat-M1 UE specified in clause 4.2.2.11.

The test scenario comprises of 1 E-UTRA TDD carrier and 2 cells as given in tables A.4.2.17.1-1 and A.4.2.17.1-2. The test consists of three successive time periods, with time duration of T1, T2, and T3 respectively. Only cell 1 is already identified by the UE prior to the start of the test. Cell 1 and cell 2 belong to different tracking areas. Furthermore, UE has not registered with network for the tracking area containing cell 2.

Table A.4.2.17.1-1: General test parameters for TDD intra frequency cell re-selection test case for Cat-M1 UE

| Parameter | | Unit | Value | Comment |
|--------------------------------|-----------------|------|-----------|---|
| Initial condition | Active cell | | Cell1 | |
| | Neighbour cells | | Cell2 | |
| T2 end condition | Active cell | | Cell2 | |
| | Neighbour cells | | Cell1 | |
| Final condition | Visited cell | | Cell1 | |
| E-UTRA RF Channel Number | | | 1 | Only one TDD carrier frequency is used. |
| Access Barring Information | | - | Not Sent | No additional delays in random access procedure. |
| Special subframe configuration | | | 6 | As specified in table 4.2-1 in TS 36.211 |
| Uplink-downlink configuration | | | 1 | As specified in table 4.2-2 in TS 36.211 |
| PRACH Parameters | | | PRACH_4CE | Refer to A.3.16 |
| DRX cycle length | | s | 0.64 | The value shall be used for all cells in the test. |
| T1 | | s | >7 | During T1, Cell 2 shall be powered off, and during the off time the physical cell identity shall be changed, The intention is to ensure that Cell 2 has not been detected by the UE prior to the start of period T2 |
| T2 | | s | ≤340 | T2 need to be defined so that cell re-selection reaction time is taken into account. |
| T3 | | s | ≤20 | T3 need to be defined so that cell re-selection reaction time is taken into account. |

Table A.4.2.17.1-2: Cell specific test parameters for TDD intra frequency cell re-selection test case for Cat-M1 UE in AWGN in enhanced coverage

| Parameter | Unit | Cell 1 | | | Cell 2 | | |
|--------------------------|------|----------|----|----|----------|----|----|
| | | T1 | T2 | T3 | T1 | T2 | T3 |
| E-UTRA RF Channel Number | | 1 | | | | | |
| BW _{channel} | MHz | 10 | | | | | |
| OCNG Patterns | | OP.2 TDD | | | OP.2 TDD | | |
| PBCH_RA | dB | -3 | | | -3 | | |

| | | | | | | | |
|--|------------|----------|--------|-------|-----------|-------|--------|
| PBCH_RB | dB | | | | | | |
| PSS_RA | dB | | | | | | |
| SSS_RA | dB | | | | | | |
| MPDCCH_RA | dB | | | | | | |
| MPDCCH_PB | dB | | | | | | |
| PDSCH_RA | dB | | | | | | |
| PDSCH_RB | dB | | | | | | |
| OCNG_RA ^{Note 1} | dB | | | | | | |
| OCNG_RB ^{Note 1} | dB | | | | | | |
| Qrxlevmin | dBm | -140 | -140 | -140 | -140 | -140 | -140 |
| Pcompensation | dB | 0 | 0 | 0 | 0 | 0 | 0 |
| Qhysts | dB | 0 | 0 | 0 | 0 | 0 | 0 |
| Qoffset _{s, n} | dB | 0 | 0 | 0 | 0 | 0 | 0 |
| Cell_selection_and_reselection_quality_measurement | | RSRP | | | RSRP | | |
| N_{oc} ^{Note2} | dBm/15 kHz | -98 | | | | | |
| \hat{E}_s / N_{oc} | dB | -7 | -12 | -7 | -infinity | -7 | -12 |
| \hat{E}_s / I_{ot} | dB | -7 | -12.79 | -7.27 | -infinity | -7.27 | -12.79 |
| RSRP ^{Note3} | dBm/15 kHz | -105 | -110 | -105 | -infinity | -105 | -110 |
| Treselection | s | 0 | 0 | 0 | 0 | 0 | 0 |
| Sintrasearch | dB | Not sent | | | Not sent | | |
| Propagation Condition | | AWGN | | | AWGN | | |
| Antenna Configuration | | 2x1 | | | 2x1 | | |
| Timing offset to Cell 1 | μ s | - | | | 3 | | |
| Note 1: OCNG shall be used such that both cells are fully allocated and a constant total transmitted power spectral density is achieved for all OFDM symbols. | | | | | | | |
| Note 2: Interference from other cells and noise sources not specified in the test is assumed to be constant over subcarriers and time and shall be modelled as AWGN of appropriate power for N_{oc} to be fulfilled. | | | | | | | |
| Note 3: RSRP levels have been derived from other parameters for information purposes. They are not settable parameters themselves. | | | | | | | |

A.4.2.17.2 Test Requirements

The cell reselection delay to a newly detectable cell is defined as the time from the beginning of time period T2, to the moment when the UE camps on Cell 2, and starts to send preambles on the PRACH for sending the RRC CONNECTION REQUEST message to perform a Tracking Area Update procedure on Cell 2.

The cell re-selection delay to a newly detectable cell shall be less than 338 s.

The cell reselection delay to an already detected cell is defined as the time from the beginning of time period T3, to the moment when the UE camps on Cell 1, and starts to send preambles on the PRACH for sending the RRC CONNECTION REQUEST message to perform a Tracking Area Update procedure on Cell 1.

The cell re-selection delay to an already detected cell shall be less than 18 s.

The rate of correct cell reselections observed during repeated tests shall be at least 90%.

NOTE: The cell re-selection delay to a newly detectable cell can be expressed as: $T_{\text{detect,EUTRAN_Intra}} + T_{\text{SI}}$, and to an already detected cell can be expressed as: $T_{\text{evaluate,EUTRAN_Intra}} + T_{\text{SI}}$,

Where:

$T_{\text{detect,EUTRAN_Intra}}$ See Table 4.2.2.11-1 in clause 4.2.2.11

$T_{\text{evaluate,EUTRAN_Intra}}$ See Table 4.2.2.11-1 in clause 4.2.2.11

T_{SI} Maximum repetition period of relevant system info blocks that needs to be received by the UE to camp on a cell; 6400 ms is assumed in this test case.

This gives a total of 337.36 s, allow 338 s for the cell re-selection delay to a newly detectable cell and 17.36 s, allow 18 s for the cell re-selection delay to an already detected cell in the test case.

A.4.2.18 HD – FDD Intra frequency case for UE Category NB1 In-Band mode in normal coverage

A.4.2.18.1 Test Purpose and Environment

This test is to verify the requirement for the HD-FDD intra frequency cell reselection requirements for Cat-NB1 UE specified in clause 4.6.2.2.

The test scenario comprises of 1 E-UTRA carrier with two ecells of different cell ID and one NB-IoT carrier with 2 ncells of different physical cell ID, as given in tables A.4.2.18.1-1, A.4.2.18.1-2 and A.4.2.18.1-3. The test consists of three successive time periods, with time duration of T1, T2 and T3 respectively. Only nCell1 is already identified by the UE prior to the start of the test, i.e. nCell 2 is not identified. nCell 1 and nCell 2 belong to different tracking areas. Furthermore, UE has not registered with network for the tracking area containing nCell 2.

Table A.4.2.18.1-1: General test parameters for HD-FDD intra frequency cell reselection test case for Cat-NB1 UE in normal coverage

| Parameter | | Unit | Value | Comment |
|----------------------------|-----------------|------|------------------------|---|
| NB-IOT operational mode | | | In-band | |
| Initial condition | Active cell | | nCell1 | |
| | Neighbour cells | | eCell1, eCell2, nCell2 | |
| T2 end condition | Active cell | | nCell2 | |
| | Neighbour cells | | eCell1, eCell2, nCell1 | |
| Final condition | Visited cell | | nCell1 | |
| E-UTRA RF Channel Number | | | 1 | One carrier frequency is used for eCell1 and eCell2. |
| Access Barring Information | | - | Not Sent | No additional delays in random access procedure. |
| NPRACH Configuration | | | NPRACH.R-1 | Refer to A.3.18 |
| DRX cycle length | | s | 1.28 | The value shall be used for all cells in the test. |
| T1 | | s | >7 | During T1, nCell2 shall be powered off, and during the off time the physical cell identity shall be changed. The intention is to ensure that nCell2 has not been detected by the UE prior to the start of period T2 |
| T2 | | s | 60 | T2 is defined so that cell re-selection time is taken into account. Once the UE has reselected to nCell2 (within T2) T3 starts |
| T3 | | s | 15 | T3 is defined so that cell re-selection time is taken into account. |

Table A.4.2.18.1-2: nCell 1, nCell 2 specific test parameters for HD-FDD intra frequency cell reselection test case for Cat-NB1 UE in normal coverage

| Parameter | Unit | nCell 1 | | | nCell 2 | | |
|---------------------------|------|------------|----|----|------------|----|----|
| | | T1 | T2 | T3 | T1 | T2 | T3 |
| BW _{channel} | kHz | 180 | | | 180 | | |
| PRB location within eCell | - | eCell1: 30 | | | eCell2: 30 | | |
| NPBCH_RA | dB | -3 | | | -3 | | |
| NPBCH_RB | dB | | | | | | |
| NPSS_RA | dB | | | | | | |
| NSSS_RA | dB | | | | | | |
| NPDCCH_RA | dB | | | | | | |
| NPDCCH_RB | dB | | | | | | |
| NPDSCH_RA | dB | | | | | | |
| NPDSCH_RB | dB | | | | | | |

| | | | | | | | |
|--|------------|---------------------------------|-------|------|-----------|------|-------|
| NOCNG_RA ^{Note 1} | dB | | | | | | |
| NOCNG_RB ^{Note 1} | dB | | | | | | |
| Qrxlevmin | dBm | -140 | -140 | -140 | -140 | -140 | -140 |
| Pcompensation | dB | 0 | 0 | 0 | 0 | 0 | 0 |
| Qhysts | dB | 0 | 0 | 0 | 0 | 0 | 0 |
| Qoffset _{s,n} | dB | 0 | 0 | 0 | 0 | 0 | 0 |
| Cell_selection_and_reselection_quality_measurement | | NRSRP | | | NRSRP | | |
| N_{oc} | dBm/15 kHz | Specified in Table A.4.2.18.1-3 | | | | | |
| \hat{E}_s/N_{oc} | dB | 17 | 13 | 17 | -infinity | 17 | 13 |
| \hat{E}_s/I_{ot} ^{Note2} | dB | 17 | -4.09 | 3.79 | -infinity | 3.79 | -4.09 |
| NRSRP ^{Note2} | dBm/15 kHz | -81 | -85 | -81 | -infinity | -81 | -85 |
| Treselection | s | 0 | 0 | 0 | 0 | 0 | 0 |
| Propagation Condition | | AWGN | | | AWGN | | |
| Antenna Configuration | | 2x1 | | | 2x1 | | |
| Timing offset to nCell 1 | ms | - | | | 3 | | |
| <p>Note 1: NOCNG shall be used such that both cells are fully allocated and a constant total transmitted power spectral density is achieved for all OFDM symbols.</p> <p>Note 2: E_s/I_{ot} and NRSRP levels have been derived from other parameters for information purposes. They are not settable parameters themselves.</p> | | | | | | | |

Table A.4.2.18.1-3: eCell 1 and eCell2 specific test parameters for HD-FDD intra frequency cell reselection test case for Cat-NB1 UE in normal coverage

| Parameter | Unit | eCell 1 | | | eCell 2 | | |
|--|------------|-----------|------|------|-----------|------|------|
| | | T1 | T2 | T3 | T1 | T2 | T3 |
| BW _{channel} | MHz | 10 | | | 10 | | |
| NOCNG Pattern defined in clause D.3 | - | NOP.1 FDD | | | NOP.1 FDD | | |
| PBCH_RA | dB | -3 | | | -3 | | |
| PBCH_RB | dB | | | | | | |
| PSS_RA | dB | | | | | | |
| SSS_RA | dB | | | | | | |
| PDCCH_RA | dB | | | | | | |
| PDCCH_RB | dB | | | | | | |
| PDSCH_RA | dB | | | | | | |
| PDSCH_RB | dB | | | | | | |
| OCNG_RA ^{Note 1} | dB | | | | | | |
| OCNG_RB ^{Note 1} | dB | | | | | | |
| Qrxlevmin | dBm | -140 | -140 | -140 | -140 | -140 | -140 |
| Pcompensation | dB | 0 | 0 | 0 | 0 | 0 | 0 |
| Qhysts | dB | 0 | 0 | 0 | 0 | 0 | 0 |
| Qoffset _{s,n} | dB | 0 | 0 | 0 | 0 | 0 | 0 |
| N_{oc} ^{Note2} | dBm/15 kHz | -98 | | | -98 | | |
| \hat{E}_s/N_{oc} ^{Note2} | dBm | 3 | 3 | 3 | 3 | 3 | 3 |
| Treselection | s | 0 | 0 | 0 | 0 | 0 | 0 |
| Propagation Condition | | AWGN | | | AWGN | | |
| Antenna Configuration | | 2x1 | | | 2x1 | | |
| Timing offset to eCell 1 | ms | - | | | 3 | | |
| <p>Note 1: OCNG shall be used such that the Cell is fully allocated and a constant total transmitted power spectral density is achieved for all OFDM symbols.</p> <p>Note 2: Interference from other cells and noise sources not specified in the test is assumed to be constant over subcarriers and time and shall be modelled as AWGN of appropriate power N_{oc}.</p> <p>Note 3: Void</p> | | | | | | | |

A.4.2.18.2 Test Requirements

The cell reselection delay to a newly detectable cell is defined as the time from the beginning of time period T2, to the moment when the UE camps on nCell 2, and starts to send preambles on the PRACH for sending the RRC CONNECTION REQUEST message to perform a Tracking Area Update procedure on nCell 2.

The cell re-selection delay to a newly detectable cell shall be less than 59.32 s.

The cell reselection delay to an already detected cell is defined as the time from the beginning of time period T3, to the moment when the UE camps on nCell 1, and starts to send preambles on the PRACH for sending the RRC CONNECTION REQUEST message to perform a Tracking Area Update procedure on nCell 1.

The cell re-selection delay to an already detected cell shall be less than 14.82 s.

The rate of correct cell reselections observed during repeated tests shall be at least 90%.

NOTE: The cell re-selection delay to a newly detectable cell can be expressed as: $T_{\text{detect,NB_Intra_NB-IoT-NC}} + T_{\text{SI}}$, and to an already detected cell can be expressed as: $T_{\text{evaluate, NB_intra_NB-IoT-NC}} + T_{\text{SI}}$,

Where:

$T_{\text{detect,NB_Intra_NB-IoT-NC}}$ See Table 4.6.2.2-1 in clause 4.6.2.2

$T_{\text{evaluate, NB_intra_NB-IoT-NC}}$ See Table 4.6.2.2-1 in clause 4.6.2.2

T_{SI} Maximum repetition period of relevant system info blocks that needs to be received by the UE to camp on a cell; 8.32 s is assumed in this test case.

This gives a total of 59.32 s, allow 60 s for the cell re-selection delay to a newly detectable cell and 14.82 s, allow 15s for the cell re-selection delay to an already detected cell in the test case.

A.4.2.19 HD – FDD Intra frequency case for UE Category NB1 In-Band mode in enhanced coverage

A.4.2.19.1 Test Purpose and Environment

This test is to verify the requirement for the HD-FDD intra frequency cell reselection requirements for Cat-NB1 UE specified in clause 4.6.2.4.

The test scenario comprises of 1 E-UTRA carrier and a total of 4 cells as given in tables A.4.2.19.1-1, A.4.2.19.1-2 and A.4.2.19.1-3. The test consists of three successive time periods, with time duration of T1, T2 and T3 respectively. Only nCell1 is already identified by the UE prior to the start of the test, i.e. nCell 2 is not identified. nCell 1 and nCell 2 belong to different tracking areas. Furthermore, UE has not registered with network for the tracking area containing nCell 2.

Table A.4.2.19.1-1: General test parameters for HD-FDD intra frequency cell reselection test case for Cat-NB1 UE in enhanced coverage

| Parameter | Unit | Value | Comment |
|----------------------------|-----------------|------------------------|--|
| NB-IOT operational mode | | In-band | |
| Initial condition | Active cell | nCell1 | |
| | Neighbour cells | eCell1, eCell2, nCell2 | |
| T2 end condition | Active cell | nCell2 | |
| | Neighbour cells | eCell1, eCell2, nCell1 | |
| Final condition | Visited cell | nCell1 | |
| E-UTRA RF Channel Number | | 1 | One carrier frequency is used for eCell1 and eCell2. |
| Access Barring Information | - | Not Sent | No additional delays in random access procedure. |
| NPRACH Configuration | | NPRACH.R-1 | Refer to A.3.18 |
| DRX cycle length | s | 1.28 | The value shall be used for all cells in the test. |

| | | | |
|----|---|----|---|
| T1 | s | >7 | During T1, nCell2 shall be powered off, and during the off time the physical cell identity shall be changed. The intention is to ensure that nCell2 has not been detected by the UE prior to the start of period T2 |
| T2 | s | 67 | T2 is defined so that cell re-selection time is taken into account. Once the UE has reselected to nCell2 (within T2) T3 starts |
| T3 | s | 22 | T3 is defined so that cell re-selection time is taken into account. |

Table A.4.2.19.1-2: nCell 1, nCell 2 specific test parameters for HD-FDD intra frequency cell reselection test case for Cat-NB1 UE in enhanced coverage

| | | nCell 1 | | | nCell 2 | | |
|--|------------|---------------------------------|--------|-------|------------|-------|--------|
| | | T1 | T2 | T3 | T1 | T2 | T3 |
| BW _{channel} | kHz | 180 | | | 180 | | |
| PRB location within eCell | - | eCell1: 30 | | | eCell2: 30 | | |
| NPBCH_RA | dB | -3 | | | -3 | | |
| NPBCH_RB | dB | | | | | | |
| NPSS_RA | dB | | | | | | |
| NSSS_RA | dB | | | | | | |
| NPDCCH_RA | dB | | | | | | |
| NPDCCH_RB | dB | | | | | | |
| NPDSCH_RA | dB | | | | | | |
| NPDSCH_RB | dB | | | | | | |
| NOCNG_RA ^{Note 1} | dB | | | | | | |
| NOCNG_RB ^{Note 1} | dB | | | | | | |
| Qrxlevmin | dBm | -156 | -156 | -156 | -156 | -156 | -156 |
| Pcompensation | dB | 0 | 0 | 0 | 0 | 0 | 0 |
| Qhysts | dB | 0 | 0 | 0 | 0 | 0 | 0 |
| Qoffsets _{s,n} | dB | 0 | 0 | 0 | 0 | 0 | 0 |
| Cell_selection_and_reselection_quality_measurement | | NRSRP | | | NRSRP | | |
| N _{oc} | dBm/15 kHz | Specified in Table A.4.2.19.1-3 | | | | | |
| \hat{E}_s / N_{oc} | dB | -9 | -9 | -0.7 | -infinity | -0.7 | -9 |
| \hat{E}_s / I_{ot} ^{Note2} | dB | -9 | -11.67 | -1.21 | -infinity | -1.21 | -11.67 |
| NRSRP ^{Note2} | dBm/15 kHz | -107 | -107 | -98.7 | -infinity | -98.7 | -107 |
| Treselection | s | 0 | 0 | 0 | 0 | 0 | 0 |
| Propagation Condition | | AWGN | | | AWGN | | |
| Antenna Configuration | | 2x1 | | | 2x1 | | |
| Timing offset to nCell 1 | ms | - | | | 3 | | |
| Note 1: NOCNG shall be used such that both cells are fully allocated and a constant total transmitted power spectral density is achieved for all OFDM symbols. Note 2: Es/Iot and NRSRP levels have been derived from other parameters for information purposes. They are not settable parameters themselves. | | | | | | | |

Table A.4.2.19.1-3: eCell 1 and eCell 2 specific test parameters for HD-FDD intra frequency cell reselection test case for Cat-NB1 UE in enhanced coverage

| Parameter | Unit | eCell 1 | | | eCell 2 | | |
|-----------------------|------|-------------|----|----|---------|----|----|
| | | T1 | T2 | T3 | T1 | T2 | T3 |
| BW _{channel} | MHz | 10 | | | 10 | | |
| OCNG Pattern | - | NOP.1 FDD** | | | ** | | |
| PBCH_RA | dB | -3 | | | -3 | | |
| PBCH_RB | dB | | | | | | |
| PSS_RA | dB | | | | | | |
| SSS_RA | dB | | | | | | |
| PDCCH_RA | dB | | | | | | |
| PDCCH_RB | dB | | | | | | |

| | | | | | | | |
|--|------------|------|------|------|------|------|------|
| PDSCH_RA | dB | | | | | | |
| PDSCH_RB | dB | | | | | | |
| OCNG_RA ^{Note 1} | dB | | | | | | |
| OCNG_RB ^{Note 1} | dB | | | | | | |
| Qrxlevmin | dBm | -140 | -140 | -140 | -140 | -140 | -140 |
| Pcompensation | dB | 0 | 0 | 0 | 0 | 0 | 0 |
| Qhyst _s | dB | 0 | 0 | 0 | 0 | 0 | 0 |
| Qoffset _{s,n} | dB | 0 | 0 | 0 | 0 | 0 | 0 |
| N_{oc} ^{Note2} | dBm/15 kHz | -98 | | | -98 | | |
| \hat{E}_s / N_{oc} ^{Note2} | dBm | 3 | 3 | 3 | 3 | 3 | 3 |
| Treselection | s | 0 | 0 | 0 | 0 | 0 | 0 |
| Propagation Condition | | AWGN | | | AWGN | | |
| Antenna Configuration | | 2x1 | | | 2x1 | | |
| Timing offset to eCell 1 | ms | - | | | 3 | | |
| <p>Note 1: OCNG shall be used such that the Cell is fully allocated and a constant total transmitted power spectral density is achieved for all OFDM symbols.</p> <p>Note 2: Interference from other cells and noise sources not specified in the test is assumed to be constant over subcarriers and time and shall be modelled as AWGN of appropriate power N_{oc}.</p> <p>Note 3: Void</p> | | | | | | | |

A.4.2.19.2 Test Requirements

The cell reselection delay to a newly detectable cell is defined as the time from the beginning of time period T2, to the moment when the UE camps on nCell 2, and starts to send preambles on the PRACH for sending the RRC CONNECTION REQUEST message to perform a Tracking Area Update procedure on nCell 2.

The cell re-selection delay to a newly detectable cell shall be less than 66.32 s.

The cell reselection delay to an already detected cell is defined as the time from the beginning of time period T3, to the moment when the UE camps on nCell 1, and starts to send preambles on the PRACH for sending the RRC CONNECTION REQUEST message to perform a Tracking Area Update procedure on nCell 1.

The cell re-selection delay to an already detected cell shall be less than 21.12 s.

The rate of correct cell reselections observed during repeated tests shall be at least 90%.

NOTE: The cell re-selection delay to a newly detectable cell can be expressed as: $T_{\text{detect,NB_intra_NB-IoT-EC}} + T_{\text{SI}}$, and to an already detected cell can be expressed as: $T_{\text{evaluate, NB_intra_NB-IoT-EC}} + T_{\text{SI}}$,

Where:

$T_{\text{detect,NB_intra_NB-IoT-EC}}$ See Table 4.6.2.4-1 in clause 4.6.2.4

$T_{\text{evaluate, NB_intra_NB-IoT-EC}}$ See Table 4.6.2.4-1 in clause 4.6.2.4

T_{SI} Maximum repetition period of relevant system info blocks that needs to be received by the UE to camp on a cell; 8.32s is assumed in this test case.

This gives a total of 66.32s, allow 67 s for the cell re-selection delay to a newly detectable cell and 21.12s, allow 22 s for the cell re-selection delay to an already detected cell in the test case.

A.4.2.20 Void

A.4.2.21 Void

A.4.2.22 Void

A.4.2.23 Void

A.4.2.24 HD – FDD Inter frequency case for UE Category NB1 In-Band mode in enhanced coverage

A.4.2.24.1 Test Purpose and Environment

This test is to verify the requirement for the HD-FDD inter frequency cell reselection requirements for Cat-NB1 UE specified in clause 4.6.2.6.

The test scenario comprises of 1 E-UTRA carrier and a total of 3 cells as given in tables A.4.2.24.1-1, A.4.2.24.1-2 and A.4.2.24.1-3. The test consists of four successive time periods, with time duration of T0, T1, T2 and T3 respectively. Only nCell1 is already identified by the UE prior to the start of the test, i.e. nCell 2 is not identified. nCell 1 and nCell 2 belong to different tracking areas. Furthermore, UE has not registered with network for the tracking area containing nCell 2.

Table A.4.2.24.1-1: General test parameters for HD-FDD inter frequency cell reselection test case for Cat-NB1 UE in enhanced coverage

| Parameter | | Unit | Value | Comment |
|----------------------------|-----------------|------|----------------|---|
| NB-IOT operational mode | | | In-band | |
| Initial condition | Active cell | | nCell1 | |
| | Neighbour cells | | eCell1, nCell2 | |
| T2 end condition | Active cell | | nCell2 | |
| | Neighbour cells | | eCell1, nCell1 | |
| Final condition | Visited cell | | nCell1 | |
| E-UTRA RF Channel Number | | | 1 | One carrier frequency is used for eCell. |
| Access Barring Information | | - | Not Sent | No additional delays in random access procedure. |
| PRACH Configuration | | | 1 | Refer to A.3.16 |
| DRX cycle length | | s | 1.28 | The value shall be used for all cells in the test. |
| T0 | | s | 5 | During T0, UE decodes SIB3-NB and SIB5-NB to acquire the inter-frequency carrier information. |
| T1 | | s | >7 | During T1, nCell2 shall be powered off, and during the off time the physical cell identity shall be changed. The intention is to ensure that nCell2 has not been detected by the UE prior to the start of period T2 |
| T2 | | s | 67 | T2 is defined so that cell re-selection time is taken into account. |
| T3 | | s | 22 | T3 is defined so that cell re-selection time is taken into account. |

Table A.4.2.24.1-2: nCell 1, nCell 2 specific test parameters for HD-FDD inter frequency cell reselection test case for Cat-NB1 UE in enhanced coverage

| | | nCell 1 | | | | nCell 2 | | | |
|-----------------------|-----|---------|----|----|----|---------|----|----|----|
| | | T0 | T1 | T2 | T3 | T0 | T1 | T2 | T3 |
| BW _{channel} | kHz | 180 | | | | 180 | | | |

| | | | | | | | | | |
|--|------------|---------------------------------|------|------|--------|-----------|-----------|--------|------|
| PRB location within eCell | - | 30 | | | | 35 | | | |
| NPBCH_RA | dB | -3 | | | | -3 | | | |
| NPBCH_RB | dB | | | | | | | | |
| NPSS_RA | dB | | | | | | | | |
| NSSS_RA | dB | | | | | | | | |
| NPDCCH_RA | dB | | | | | | | | |
| NPDCCH_RB | dB | | | | | | | | |
| NPDSCH_RA | dB | | | | | | | | |
| NPDSCH_RB | dB | | | | | | | | |
| NOCNG_RA ^{Note 1} | dB | | | | | | | | |
| NOCNG_RB ^{Note 1} | dB | | | | | | | | |
| Qrxlevmin | dBm | -140 | | | | -140 | | | |
| Pcompensation | dB | 0 | | | | 0 | | | |
| Qhysts | dB | 0 | | | | 0 | | | |
| Qoffsets _{s,n} | dB | 0 | | | | 0 | | | |
| Cell_selection_and_reselection_quality_measurement | | NRSRP | | | | NRSRP | | | |
| N_{oc} | dBm/15 kHz | Specified in Table A.4.2.24.1-3 | | | | | | | |
| \hat{E}_s/N_{oc} | dB | 10 | -12 | -12 | -2.7 | -infinity | -infinity | -2.7 | -12 |
| \hat{E}_s/I_{ot} ^{Note2} | dB | 10 | -12 | -12 | -2.7 | -infinity | -infinity | -2.7 | -12 |
| NRSRP ^{Note2} | dBm/15 kHz | -88 | -110 | -110 | -100.7 | -infinity | -infinity | -100.7 | -110 |
| Treselection | s | 0 | | | | 0 | | | |
| Propagation Condition | | AWGN | | | | AWGN | | | |
| Antenna Configuration | | 2x1 | | | | 2x1 | | | |
| Timing offset to nCell 1 | ms | 0 | | | | | | | |
| <p>Note 1: NOCNG shall be used such that both cells are fully allocated and a constant total transmitted power spectral density is achieved for all OFDM symbols.</p> <p>Note 2: E_s/I_{ot} and NRSRP levels have been derived from other parameters for information purposes. They are not settable parameters themselves.</p> | | | | | | | | | |

Table A.4.2.24.1-3: eCell 1 specific test parameters for HD-FDD inter frequency cell reselection test case for Cat-NB1 UE in enhanced coverage

| | | eCell 1 | | | |
|---------------------------|------------|-----------|----|----|----|
| | | T0 | T1 | T2 | T3 |
| BW _{channel} | MHz | 10 | | | |
| OCNG Pattern | - | NOP.1 FDD | | | |
| PBCH_RA | dB | -3 | | | |
| PBCH_RB | dB | | | | |
| PSS_RA | dB | | | | |
| SSS_RA | dB | | | | |
| PDCCH_RA | dB | | | | |
| PDCCH_RB | dB | | | | |
| PDSCH_RA | dB | | | | |
| PDSCH_RB | dB | | | | |
| OCNG_RA ^{Note 1} | dB | | | | |
| OCNG_RB ^{Note 1} | dB | | | | |
| Qrxlevmin | dBm | -140 | | | |
| Pcompensation | dB | 0 | | | |
| Qhysts | dB | 0 | | | |
| Qoffsets _{s,n} | dB | 0 | | | |
| N_{oc} | dBm/15 kHz | -98 | | | |
| \hat{E}_s/N_{oc} | dB | 3 | 3 | 3 | 3 |
| Treselection | s | 0 | | | |
| Propagation Condition | | AWGN | | | |
| Antenna Configuration | | 2x1 | | | |

Note 1: OCNG shall be used such that the eCell is fully allocated and a constant total transmitted power spectral density is achieved for all OFDM symbols.

Note 2: Interference from other cells and noise sources not specified in the test is assumed to be constant over subcarriers and time and shall be modelled as AWGN of appropriate power N_{oc} .

A.4.2.24.2 Test Requirements

The cell reselection delay to a newly detectable cell is defined as the time from the beginning of time period T2, to the moment when the UE camps on nCell 2, and starts to send preambles on the PRACH for sending the RRC CONNECTION REQUEST message to perform a Tracking Area Update procedure on nCell 2.

The cell re-selection delay to a newly detectable cell shall be less than 66.32 s.

The cell reselection delay to an already detected cell is defined as the time from the beginning of time period T3, to the moment when the UE camps on nCell 1, and starts to send preambles on the PRACH for sending the RRC CONNECTION REQUEST message to perform a Tracking Area Update procedure on nCell 1.

The cell re-selection delay to an already detected cell shall be less than 21.12 s.

The rate of correct cell reselections observed during repeated tests shall be at least 90%.

NOTE: The cell re-selection delay to a newly detectable cell can be expressed as: $T_{\text{detect,NB_Inter_EC}} + T_{\text{SI}}$, and to an already detected cell can be expressed as: $T_{\text{evaluate, NB_Inter_EC}} + T_{\text{SI}}$.

Where:

| | |
|--------------------------------------|--|
| $T_{\text{detect,NB_Inter_EC}}$ | See Table 4.6.2.6-1 in clause 4.6.2.6 |
| $T_{\text{evaluate, NB_Inter_EC}}$ | See Table 4.6.2.6-1 in clause 4.6.2.6 |
| T_{SI} | Maximum repetition period of relevant system info blocks that needs to be received by the UE to camp on a cell; 8.32 s is assumed in this test case. |

This gives a total of 66.32 s, allow 67 s for the cell re-selection delay to a newly detectable cell and 21.12s, allow 22s for the cell re-selection delay to an already detected cell in the test case.

A.4.3 E-UTRAN to UTRAN Cell Re-Selection

A.4.3.1 E-UTRAN FDD – UTRAN FDD:

A.4.3.1.1 EUTRA FDD-UTRA FDD cell reselection: UTRA FDD is of higher priority

A.4.3.1.1.1 Test Purpose and Environment

This test is to verify the requirement for the E-UTRA FDD- UTRA FDD inter-RAT cell reselection requirements specified in clause 4.2.2.5 when the UTRA cell is of higher priority.

The test scenario comprises of one E-UTRA FDD and one UTRA FDD cells as given in tables A.4.3.1.1.1-1, A.4.3.1.1.1-2 and A.4.3.1.1.1-3. The test consists of three successive time periods, with time duration of T1, T2 and T3 respectively. E-UTRA cell 1 is already identified by the UE prior to the start of the test. Cell 2 is of higher priority than cell 1.

Table A.4.3.1.1.1-1: General test parameters for E-UTRA FDD- higher priority UTRA FDD inter RAT cell re-selection test case

| | Parameter | Unit | Value | Comment |
|-------------------|-------------|------|--------|---|
| Initial condition | Active cell | | Cell 1 | UE is on cell 1 in the initialisation phase, so that reselection to cell 2 occurs during T2 |
| T2 end | Active cell | | Cell 2 | UE shall perform reselection to cell 2 during T2 |

| | | | | |
|-----------------------------------|----------------|--|----------|---|
| condition | Neighbour cell | | Cell 1 | |
| T3 end condition | Active cell | | Cell 1 | UE shall perform reselection to cell 1 during T3 |
| | Neighbour cell | | Cell 2 | |
| E-UTRA PRACH configuration | | | 4 | As specified in table 5.7.1-2 in TS 36.211 |
| E-UTRA Access Barring Information | - | | Not Sent | No additional delays in random access procedure. |
| DRX cycle length | s | | 1.28 | The value shall be used for all cells in the test. |
| T1 | s | | >20 | During T1, cell 2 shall be powered off, and during the off time the primary scrambling code shall be changed. The intention is to ensure that cell 2 has not been detected by the UE prior to the start of period T2. |
| T2 | s | | 85 | T2 needs to be defined so that cell re-selection reaction time is taken into account. |
| T3 | s | | 25 | T3 need to be defined so that cell re-selection reaction time is taken into account. |

Table A.4.3.1.1-2: Cell specific test parameters for cell 1(E-UTRA)

| Parameter | Unit | Cell 1 | | |
|--|------------|----------|-----|-----|
| | | T1 | T2 | T3 |
| E-UTRA RF Channel number | | 1 | | |
| $BW_{channel}$ | MHz | 10 | | |
| OCNG Patterns defined in A.3.2.1.2 (OP.2 FDD) | | OP.2 FDD | | |
| PBCH_RA | dB | 0 | | |
| PBCH_RB | dB | | | |
| PSS_RA | dB | | | |
| SSS_RA | dB | | | |
| PCFICH_RB | dB | | | |
| PHICH_RA | dB | | | |
| PHICH_RB | dB | | | |
| PDCCH_RA | dB | | | |
| PDCCH_RB | dB | | | |
| PDSCH_RA | dB | | | |
| PDSCH_RB | dB | | | |
| OCNG_RA ^{Note 1} | dB | | | |
| OCNG_RB ^{Note 1} | dB | | | |
| Qqualmin for UTRA neighbour cell | dB | -20 | | |
| Qrxlevmin for UTRA neighbour cell | dBm | -115 | | |
| Qrxlevmin | dBm | -140 | | |
| N_{oc} | dBm/15 kHz | -98 | | |
| RSRP | dBm/15 KHz | -84 | -84 | -84 |
| \hat{E}_s / I_{ot} | dB | 14 | 14 | 14 |
| \hat{E}_s / N_{oc} | dB | 14 | 14 | 14 |
| Treselection _{EUTRAN} | S | 0 | | |
| Snoninrasearch | dB | 50 | | |
| Thresh _{x, high} (Note 2) | dB | 40 | | |
| Propagation Condition | | AWGN | | |
| <p>Note 1: OCNG shall be used such that both cells are fully allocated and a constant total transmitted power spectral density is achieved for all OFDM symbols.</p> <p>Note 2: This refers to the value of Thresh_{x, high} which is included in E-UTRA system information, and is a threshold for the UTRA target cell</p> | | | | |

Table A.4.3.1.1.1-3: Cell specific test parameters for cell 2(UTRA)

| Parameter | Unit | Cell 2 (UTRA) | | |
|--|--------------|---------------|--------|--------|
| | | T1 | T2 | T3 |
| UTRA RF Channel Number | | Channel 2 | | |
| CPICH_Ec/lor | dB | -10 | | |
| PCCPCH_Ec/lor | dB | -12 | | |
| SCH_Ec/lor | dB | -12 | | |
| PICH_Ec/lor | dB | -15 | | |
| OCNS_Ec/lor | dB | -0.941 | | |
| \hat{I}_{or}/I_{oc} | dB | -Infinity | 11 | -5 |
| I_{oc} | dBm/3,84 MHz | -70 | | |
| CPICH_Ec/lo | dB | -Infinity | -10.33 | -16.19 |
| CPICH_RSCP | dBm | -Infinity | -69 | -85 |
| Propagation Condition | | AWGN | | |
| Qqualmin | dB | -20 | | |
| Qrxlevmin | dBm | -115 | | |
| QrxlevminEUTRA | dBm | -140 | | |
| UE_TXPWR_MAX_RACH | dBm | 21 | | |
| Treselection | s | 0 | | |
| Sprioritysearch1 | dB | 62 | | |
| Sprioritysearch2 | dB | 0 | | |
| Thresh _{serv, low} | dB | 36 | | |
| Thresh _{x, low} (Note 1) | dB | 50 | | |
| Note 1 : his refers to the value of Thresh _{x, low} which is included in UTRA system information, and is a threshold for the E-UTRA target cell | | | | |

A.4.3.1.1.2 Test Requirements

The cell reselection delay to higher priority is defined as the time from the beginning of time period T2, to the moment when the UE camps on cell 2, and starts to send preambles on the PRACH for sending the RRC CONNECTION REQUEST message on cell 2.

The cell re-selection delay to higher priority shall be less than 81 s.

The rate of correct cell reselections observed during repeated tests shall be at least 90%.

NOTE: The cell re-selection delay to higher priority cell can be expressed as: $T_{\text{higher_priority_search}} + T_{\text{evaluateUTRA_FDD}} + T_{\text{SL-UTRA}}$

Where:

$T_{\text{higher_priority_search}}$ See clause 4.2.2; 60s is assumed in this test case

$T_{\text{evaluateUTRA-FDD}}$ See Table 4.2.2.5.1-1

$T_{\text{SL-UTRA}}$ Maximum repetition period of relevant system info blocks that needs to be received by the UE to camp on a cell; 1280 ms is assumed in this test case.

This gives a total of 80.48 s for higher priority cell search, allow 81 s for higher priority cell reselection in the test case.

A.4.3.1.2 EUTRA FDD-UTRA FDD cell reselection: UTRA FDD is of lower priority

A.4.3.1.2.1 Test Purpose and Environment

This test is to verify the requirement for the EUTRA FDD- UTRA FDD inter-RAT cell reselection requirements specified in clause 4.2.2.5.1 when the UTRA cell is of lower priority.

The test scenario comprises of one UTRA FDD and one E-UTRA FDD cells as given in tables A.4.3.1.2.1-1, A.4.3.1.2.1-2 and A.4.3.1.2.1-3. The test consists of two successive time periods, with time duration of T1 and T2

respectively. Both E-UTRA cell 1 and UTRA cell 2 are already identified by the UE prior to the start of the test. Cell 2 is of lower priority than cell 1.

Table A.4.3.1.2.1-1: General test parameters for EUTRA FDD- lower priority UTRA FDD inter RAT cell re-selection test case

| | Parameter | Unit | Value | Comment |
|-----------------------------------|----------------|------|----------|--|
| Initial condition | Active cell | | Cell1 | E-UTRAN cell |
| T1 end condition | Active cells | | Cell1 | UE shall perform reselection to cell 1 during T1 for subsequent iterations of the test |
| | Neighbour cell | | Cell2 | |
| T2 end condition | Active cell | | Cell2 | UE shall perform reselection to cell 2 during T2 |
| | Neighbour cell | | Cell1 | |
| E-UTRA PRACH configuration | | | 4 | As specified in table 5.7.1-2 in TS 36.211 |
| E_UTRA Access Barring Information | | - | Not Sent | No additional delays in random access procedure. |
| DRX cycle length | | s | 1.28 | The value shall be used for all cells in the test. |
| T1 | | s | 85 | T1 need to be defined so that cell re-selection reaction time is taken into account. |
| T2 | | s | 25 | T2 need to be defined so that cell re-selection reaction time is taken into account. |

Table A.4.3.1.2.1-2: Cell specific test parameters for cell 1 (E-UTRA)

| Parameter | Unit | Cell 1 | |
|---|------------|----------|------|
| | | T1 | T2 |
| E-UTRA RF Channel number | | 1 | |
| $BW_{channel}$ | MHz | 10 | |
| OCNG Patterns defined in A.3.2.1.2 (OP.2 FDD) | | OP.2 FDD | |
| PBCH_RA | dB | 0 | |
| PBCH_RB | dB | | |
| PSS_RA | dB | | |
| SSS_RA | dB | | |
| PCFICH_RB | dB | | |
| PHICH_RA | dB | | |
| PHICH_RB | dB | | |
| PDCCH_RA | dB | | |
| PDCCH_RB | dB | | |
| PDSCH_RA | dB | | |
| PDSCH_RB | dB | | |
| OCNG_RA ^{Note 1} | dB | | |
| OCNG_RB ^{Note 1} | dB | | |
| Qqualmin for UTRA neighbour cell | dB | -20 | |
| Qrxlevmin for UTRA neighbour cell | dBm | -115 | |
| Qrxlevmin | dBm | -140 | |
| N_{oc} | dBm/15 kHz | -98 | |
| RSRP | dBm/15 KHz | -86 | -102 |
| \hat{E}_s / I_{ot} | dB | 12 | -4 |
| \hat{E}_s / N_{oc} | dB | 12 | -4 |
| Treselection _{EUTRAN} | s | 0 | |
| Snonintrasearch | dB | Not sent | |
| Thresh _{serv, low} | dB | 44 | |
| Thresh _{x, low} (Note 2) | dB | 42 | |
| Propagation Condition | | AWGN | |

| | |
|---------|---|
| Note 1: | OCNG shall be used such that both cells are fully allocated and a constant total transmitted power spectral density is achieved for all OFDM symbols. |
| Note 2: | This refers to the value of $\text{Thresh}_{x, \text{low}}$ which is included in E-UTRA system information, and is a threshold for the UTRA target cell |

Table A.4.3.1.2.1-3: Cell specific test parameters for cell 2 (UTRA)

| Parameter | Unit | Cell 2 (UTRA) | |
|---|--------------|---------------|--------|
| | | T1 | T2 |
| UTRA RF Channel Number | | Channel 2 | |
| CPICH_Ec/lor | dB | -10 | |
| PCCPCH_Ec/lor | dB | -12 | |
| SCH_Ec/lor | dB | -12 | |
| PICH_Ec/lor | dB | -15 | |
| OCNS_Ec/lor | dB | -0.941 | |
| \hat{I}_{or}/I_{oc} | dB | 13 | 13 |
| I_{oc} | dBm/3,84 MHz | -70 | |
| CPICH_Ec/lo | dB | -10.21 | -10.21 |
| CPICH_RSCP | dBm | -67 | -67 |
| Propagation Condition | | AWGN | |
| Qqualmin | dB | -20 | |
| Qrxlevmin | dBm | -115 | |
| QrxlevminEUTRA | dBm | -140 | |
| UE_TXPWR_MAX_RACH | dBm | 21 | |
| Treselection | s | 0 | |
| Sprioritysearch1 | dB | 42 | |
| Sprioritysearch2 | dB | 0 | |
| $\text{Thresh}_{x, \text{high}}$ (Note 1) | dB | 48 | |
| Note 1 : This refers to the value of $\text{Thresh}_{x, \text{high}}$ which is included in UTRA system information, and is a threshold for the E-UTRA target cell | | | |

A.4.3.1.2.2 Test Requirements

The cell reselection delay to lower priority is defined as the time from the beginning of time period T2, to the moment when the UE camps on cell 2, and starts to send preambles on the PRACH for sending the RRC CONNECTION REQUEST message on cell 2.

The cell re-selection delay to lower priority shall be less than 21 s.

The rate of correct cell reselections observed during repeated tests shall be at least 90%.

NOTE: The cell re-selection delay to lower priority cell can be expressed as: $T_{\text{evaluateUTRA-FDD}} + T_{\text{SI-UTRA}}$

Where:

$T_{\text{evaluateUTRA-FDD}}$ See Table 4.2.2.5.1-1

$T_{\text{SI-UTRA}}$ Maximum repetition period of relevant system info blocks that needs to be received by the UE to camp on a cell; 1280 ms is assumed in this test case.

This gives a total of 20.48 s for lower priority cell reselection, allow 21 s.

A.4.3.1.3 EUTRA FDD-UTRA FDD cell reselection in fading propagation conditions: UTRA FDD is of lower priority

A.4.3.1.3.1 Test Purpose and Environment

This test is to verify the requirement for the EUTRA FDD- UTRA FDD inter-RAT cell reselection requirements specified in clause 4.2.2.5.1 when the UTRA cell is of lower priority, and to verify the robustness of the UE measurement filtering in a fading environment. The E-UTRA cell is in fading propagation conditions and the UTRA cell is in AWGN propagation conditions.

The test scenario comprises of one UTRA FDD and one E-UTRA FDD cells as given in tables A.4.3.1.3.1-1, A.4.3.1.3.1-2 and A.4.3.1.3.1-3. The test consists of four successive time periods, with time duration of T1 T2, T3 and T4 respectively. Both E-UTRA cell 1 and UTRA cell 2 are already identified by the UE prior to the start of the test. Cell 2 is of lower priority than cell 1.

Table A.4.3.1.3.1-1: General test parameters for EUTRA FDD- lower priority UTRA FDD inter RAT cell re-selection test case

| | Parameter | Unit | Value | Comment |
|-----------------------------------|----------------|------|----------|--|
| Initial condition | Active cell | | Cell1 | E-UTRAN cell |
| T1 end condition | Active cells | | Cell1 | UE shall perform reselection to cell 1 during T1 for subsequent iterations of the test |
| | Neighbour cell | | Cell2 | |
| T3 end condition | Active cell | | Cell2 | UE shall perform reselection to cell 2 during T3 |
| | Neighbour cell | | Cell1 | |
| E-UTRA PRACH configuration | | | 4 | As specified in table 5.7.1-2 in TS 36.211 |
| E_UTRA Access Barring Information | | - | Not Sent | No additional delays in random access procedure. |
| DRX cycle length | | s | 1.28 | The value shall be used for all cells in the test. |
| T1 | | s | <85 | T1 need to be defined so that cell re-selection reaction time is taken into account. T1 is terminated when the UE starts to send preambles to cell 1 |
| T2 | | s | 64 | The start of T2 is defined as the time when the UE starts to send PRACH preambles to cell 1 |
| T3 | | s | <25 | T3 need to be defined so that cell re-selection reaction time is taken into account. T3 is terminated when the UE starts to send preambles to cell 2 |
| T4 | | s | 64 | The start of T4 is defined as the time when the UE starts to send PRACH preambles to cell 2 |

Table A.4.3.1.3.1-2: Cell specific test parameters for cell 1 (E-UTRA)

| Parameter | Unit | Cell 1 | | | |
|---|------|----------|----|----|----|
| | | T1 | T2 | T3 | T4 |
| E-UTRA RF Channel number | | 1 | | | |
| BW _{channel} | MHz | 10 | | | |
| Correlation Matrix and Antenna Configuration | | 1x2 Low | | | |
| OCNG Patterns defined in A.3.2.1.2 (OP.2 FDD) | | OP.2 FDD | | | |
| PSS_RA | dB | 0 | | | |
| SSS_RA | dB | 0 | | | |
| PCFICH_RB | dB | 0 | | | |
| PHICH_RA | dB | 0 | | | |
| PHICH_RB | dB | 0 | | | |
| PDCCH_RA | dB | 0 | | | |
| PDCCH_RB | dB | 0 | | | |
| PDSCH_RA | dB | 0 | | | |
| PDSCH_RB | dB | 0 | | | |

| | | | | | |
|---|------------|----------|-----|------|------|
| OCNG_RA ^{Note 1} | dB | 0 | | | |
| OCNG_RB ^{Note 1} | dB | 0 | | | |
| Qqualmin for UTRA neighbour cell | dB | -20 | | | |
| Qrxlevmin for UTRA neighbour cell | dBm | -115 | | | |
| Qrxlevmin | dBm | -140 | | | |
| N_{oc} | dBm/15 kHz | -104 | | | |
| RSRP | dBm/15 KHz | -82 | -82 | -107 | -107 |
| \hat{E}_s/I_{ot} | dB | 22 | 22 | -3 | -3 |
| \hat{E}_s/N_{oc} | dB | 22 | 22 | -3 | -3 |
| Treselection ^{EUTRAN} | s | 0 | | | |
| Snonintrasearch | dB | Not sent | | | |
| Thresh _{serv, low} | dB | 44 | | | |
| Thresh _{x, low} (Note 2) | dB | 42 | | | |
| Propagation Condition | | ETU70 | | | |
| Note 1: OCNG shall be used such that both cells are fully allocated and a constant total transmitted power spectral density is achieved for all OFDM symbols. | | | | | |
| Note 2: This refers to the value of Thresh _{x, low} which is included in E-UTRA system information, and is a threshold for the UTRA target cell. | | | | | |

Table A.4.3.1.3.1-3: Cell specific test parameters for cell 2 (UTRA)

| Parameter | Unit | Cell 2 (UTRA) | | | |
|---|--------------|---------------|--------|--------|--------|
| | | T1 | T2 | T3 | T4 |
| UTRA RF Channel Number | | Channel 2 | | | |
| CPICH_Ec/lor | dB | -10 | | | |
| PCCPCH_Ec/lor | dB | -12 | | | |
| SCH_Ec/lor | dB | -12 | | | |
| PICH_Ec/lor | dB | -15 | | | |
| OCNS_Ec/lor | dB | -0.941 | | | |
| \hat{I}_{or}/I_{oc} | dB | 13 | 13 | 13 | 13 |
| I_{oc} | dBm/3,84 MHz | -70 | | | |
| CPICH_Ec/lo | dB | -10.21 | -10.21 | -10.21 | -10.21 |
| CPICH_RSCP | dBm | -67 | -67 | -67 | -67 |
| Propagation Condition | | AWGN | | | |
| Qqualmin | dB | -20 | | | |
| Qrxlevmin | dBm | -115 | | | |
| QrxlevminEUTRA | dBm | -140 | | | |
| UE_TXPWR_MAX_RACH | dBm | 21 | | | |
| Treselection | s | 0 | | | |
| Sprioritysearch1 | dB | 42 | | | |
| Sprioritysearch2 | dB | 0 | | | |
| Thresh _{x, high} (Note 1) | dB | 44 | | | |
| Note 1: This refers to the value of Thresh _{x, high} which is included in UTRA system information, and is a threshold for the E-UTRA target cell | | | | | |

A.4.3.1.3.2 Test Requirements

The probability of reselection from cell 1 to cell 2 during T2 observed during testing shall be less than 10%

The probability of reselection from cell 2 to cell 1 during T4 observed during testing shall be less than 10%

The cell reselection delay to lower priority is defined as the time from the beginning of time period T3, to the moment when the UE camps on cell 2, and starts to send preambles on the PRACH for sending the RRC CONNECTION REQUEST message on cell 2. In order to evaluate reselection delay, the system simulator first needs to verify that the UE is camped on cell 1 at the start of T3

The cell re-selection delay to lower priority shall be less than 21 s.

The rate of correct cell reselections observed during repeated tests shall be at least 90%.

NOTE: The cell re-selection delay to lower priority cell can be expressed as: $T_{\text{evaluateUTRA_FDD}} + T_{\text{SI-UTRA}}$

Where:

$T_{\text{evaluateUTRA-FDD}}$ See Table 4.2.2.5.1-1

$T_{\text{SI-UTRA}}$ Maximum repetition period of relevant system info blocks that needs to be received by the UE to camp on a cell; 1280 ms is assumed in this test case.

This gives a total of 20.48 s for lower priority cell reselection, allow 21 s.

A.4.3.1.4 EUTRA FDD-UTRA FDD cell reselection: UTRA FDD is of lower priority for 5MHz bandwidth

A.4.3.1.4.1 Test Purpose and Environment

The purpose of this test case is the same as for the test defined in subclause A.4.3.1.2.1

The parameters of this test are the same as defined in Subclause A.4.3.1.2.1 except that the values of the parameters in the Table A.4.3.1.4.1-2 will replace the values of the corresponding parameters in A.4.3.1.2.1-2.

This is according to the principle defined in section A.3.7.2.

Table A.4.3.1.4.1-2: Cell specific test parameters for cell 1 (E-UTRA) for 5MHz bandwidth

| Parameter | Unit | Cell 1 | |
|---|------|-----------|----|
| | | T1 | T2 |
| BW_{channel} | MHz | 5 | |
| OCNG Patterns defined in A.3.2.1.16 (OP.16 FDD) | | OP.16 FDD | |
| Note 1: See Table A.4.3.1.2.1-2 for the other parameters. | | | |

A.4.3.1.4.2 Test Requirements

The test requirements defined in section A.4.3.1.2.1 shall apply to this test case.

A.4.3.1.5 Idle mode FDD to UTRA FDD interRAT reselection

A.4.3.1.5.1 Test Purpose and Environment

This test is to verify the requirement for the E-UTRA FDD-UTRA FDD inter-RAT cell reselection requirements for increased UE carrier monitoring specified in clause 4.2.2.4.

The test scenario comprises of indicating 8 UTRA FDD interfrequency cells on 6 different carriers in the neighbour list of cell 1 as given in table A.4.3.1.5-1 and cells 2 and 3 as given in table A.4.3.1.5-2. Each repetition of the test consists of five successive time periods, with time duration of T0, T1, T2, T3 and T4 respectively. In the initialisation phase and at the start of each repetition of T0, the test equipment provides signals for cell 1 (serving cell), and selects frequencies for cells 2 and 3 which are chosen from the 6 inter-RAT layers which are configured in the UE neighbour cell list as described in general and cell specific parameters. The neighbour lists of cells 2 and 3 shall include the frequency of cell 1 in the normal performance group and shall exclude the other frequencies configured to the UE in the test.

Cell 1, 2 and 3 are identified by the UE during time period T0. Cell 1, cell 2 and cell 3 all belong to different tracking areas. Furthermore, UE has not registered with network for the tracking area containing cell 2 or 3. Cells 2 and 3 all have lower absolute priority than cell 1.

Table A.4.3.1.5-1: General test parameters for E-UTRAN FDD- UTRAN FDD inter frequency cell re-selection test case

| Parameter | | Unit | Value | Comment |
|--|----------------|------|--|--|
| T0 | Active cell | | Cell 1 | T0 is repeated on each repetition of the test. In T0 the test equipment selects frequencies for cell 2 and 3, and then time is allowed for the UE to identify the neighbour cells. See cell specific parameters for detailed settings. |
| T1 start condition | Active cell | | Cell 1 | |
| T1 end condition | Active cell | | Cell 2 | UE shall perform reselection to cell 2 during T1 |
| | Neighbour cell | | Cell 1, cell 3 | |
| T2 end condition | Active cell | | Cell 1 | UE shall perform reselection to cell 1 during T2 |
| | Neighbour cell | | Cell 2, cell 3 | |
| T3 end condition | Active cell | | Cell 3 | UE shall perform reselection to cell 3 during T3 |
| | Neighbour cell | | Cell 1, cell 2 | |
| T4 end condition | Active cell | | Cell 1 | UE shall perform reselection to cell 1 during T4 |
| | Neighbour cell | | Cell 2, cell 3 | |
| UE configured E-UTRA RF Channel Number | | | 1 | Serving cell and six UTRA FDD carrier frequencies are used in the UE neighbour cell list. Frequencies 5,6 and 7 are indicated to have reduced performance |
| UE configured UTRA RF Channel Number | | | 2,3,4,5,6,7 | |
| Test equipment configuration | | | Cell 1 uses E-UTRA RF channel number 1 Cells 2,3,4 are randomly selected to use different frequencies selected from frequencies 2,3,4,5,6,7 | |
| PRACH configuration | | | 4 | As specified in table 5.7.1-2 in TS 36.211 |
| Access Barring Information | | - | Not Sent | No additional delays in random access procedure. |
| DRX cycle length | | s | 1.28 | The value shall be used for all cells in the test. |
| T0 | | s | (test equipment frequency selection and configuration time) + 960 | Initialisation time need to be defined so that cell detection time is taken into account. |
| T1 | | s | 60 | T1 need to be defined so that cell re-selection reaction time is taken into account. |
| T2 | | s | 25 | T2 need to be defined so that cell re-selection reaction time is taken into account |
| T3 | | s | 350 | T3 need to be defined so that cell re-selection reaction time is taken into account. |
| T4 | | s | 25 | T4 need to be defined so that cell re-selection reaction time is taken into account |

Table A.4.3.1.5-2: Cell specific test parameters for E-UTRAN FDD- UTRAN FDD inter-RAT cell reselection test case in AWGN cell 1 (E-UTRAN)

| Parameter | Unit | Cell 1 | | | | |
|---|-------------------------------------|---|--------|--------|--------|--------|
| | | T0 | T1 | T2 | T3 | T4 |
| E-UTRA RF Channel number | | 1 | | | | |
| BW _{channel} | MHz | 5MHz: N _{RB} = 25 10MHz: N _{RB} = 50 | | | | |
| l _o | dBm/4.5MHz(25RB) dBm/9MHz (50RB) | -59.06 | -71.77 | -59.06 | -71.77 | -59.06 |
| | | -56.05 | -68.76 | -56.05 | -68.76 | -56.05 |
| PDSCH parameters: DL Reference Measurement Channel | | OP.16 FDD (5MHz) OP.2 FDD (10MHz) | | | | |
| PBCH RA | dB | 0 | | | | |
| PBCH RB | dB | | | | | |
| PSS RA | dB | | | | | |
| SSS RA | dB | | | | | |
| PCFICH RB | dB | | | | | |
| PHICH RA | dB | | | | | |
| PHICH RB | dB | | | | | |
| PDCCH RA | dB | | | | | |
| PDCCH RB | dB | | | | | |
| PDSCH RA | dB | | | | | |
| PDSCH RB | dB | | | | | |
| OCNG_RA ^{Note 1} | dB | | | | | |
| OCNG_RB ^{Note 1} | dB | | | | | |
| Qrxlevmin | dBm | -140 | | | | |
| N _{oc} ^{Note 2} | dBm | -98 | | | | |
| RSRP ^{Note 3} | dBm | -84 | -102 | -84 | -102 | -84 |
| \hat{E}_s / I_{ot} | dB | 14 | -4 | 14 | -4 | 14 |
| \hat{E}_s / N_{oc} | dB | 14 | -4 | 14 | -4 | 1 |
| T _{reselectionEUTRAN} | s | 0 | | | | |
| S _{nonintra} search | dB | 62 | | | | |
| Thresh _{serv, low} | dB | 44 | | | | |
| Thresh _{x, low} (Note 4) | dB | 40 | | | | |
| Propagation Condition | | AWGN | | | | |
| <p>Note 1: OCNG shall be used such that the cell is fully allocated and a constant total transmitted power spectral density is achieved for all OFDM symbols.</p> <p>Note 2: Interference from other cells and noise sources not specified in the test is assumed to be constant over subcarriers and time and shall be modelled as AWGN of appropriate power for to be fulfilled.</p> <p>Note 3: RSRP levels have been derived from other parameters for information purposes. They are not settable parameters themselves.</p> <p>Note 4: This refers to the value of Thresh_{x, low} which is included in E-UTRA system information, and is a threshold for the UTRA target cell</p> | | | | | | |

Table A.4.3.1.5-3: Cell specific test parameters for cells 2 and 3 (UTRA)

| Parameter | Unit | Cell 2 | | | | | Cell 3 | | | | |
|-------------------------|------|--|-----|-----|----|-----|---|----|-----|-----|-----|
| | | T0 | T1 | T2 | T3 | T4 | T0 | T1 | T2 | T3 | T4 |
| UTRA RF Channel Number | | Randomly selected from 1, 2, 3 such that cell 2 is in the normal performance group | | | | | Randomly selected from 4, 5, 6 such that cell 3 is in the reduced performance group | | | | |
| CPICH_Ec/lor | dB | -10 | | | | | -10 | | | | |
| PCCPCH_Ec/lor | dB | -12 | | | | | -12 | | | | |
| SCH_Ec/lor | dB | -12 | | | | | -12 | | | | |
| PICH_Ec/lor | dB | -15 | | | | | -15 | | | | |
| OCNS_Ec/lor | dB | -0.941 | | | | | 0.941 | | | | |
| \hat{I}_{or} / I_{oc} | dB | +11 | +11 | +11 | -5 | +11 | +11 | -5 | +11 | +11 | +11 |

| I_{oc} | dBm/3,84 MHz | -70 | | | | | -70 | | | | |
|--|--------------|------------|------------|------------|------------|------------|------------|------------|------------|------------|------------|
| CPICH_Ec/Io | dB | -10.3 3 | -10.3 3 | -10.3 3 | -16.1 9 | -10.3 3 | -10.3 3 | -16.1 9 | -10.3 3 | -10.3 3 | -10.3 3 |
| CPICH_RSCP | dBm | -69 | -69 | -69 | -85 | -69 | -69 | -85 | -69 | -69 | -69 |
| Propagation Condition | | AWGN | | | | | AWGN | | | | |
| Qqualmin | dB | -20 | | | | | -20 | | | | |
| Qrxlevmin | dBm | -115 | | | | | -115 | | | | |
| QrxlevminEUTRA | dBm | -140 | | | | | -140 | | | | |
| UE_TXPWR_MAX_RACH | dBm | 21 | | | | | 21 | | | | |
| Treselection | s | 0 | | | | | 0 | | | | |
| Sprioritysearch1 | dB | 40 | | | | | 40 | | | | |
| Sprioritysearch2 | dB | 0 | | | | | 0 | | | | |
| Thresh _{x,high} (Note 1) | dB | 50 | | | | | 50 | | | | |
| Note 1: This refers to the value of Thresh _{x,high} which is included in UTRA system information, and is a threshold for the E-UTRA target cell | | | | | | | | | | | |

A.4.3.1.5.2 Test Requirements

The cell reselection delay is defined as the time from the beginning of a relevant time period, to the moment when the UE camps on the target cell, and starts to send preambles on the PRACH for sending the RRC CONNECTION REQUEST message to perform a Tracking Area Update procedure on the target cell.

The reselection delays shall meet the requirements in table A.4.3.1.5.2-1

Table A.4.3.1.5.2-1

| Time phase | Target cell | Requirement for reselection delay (seconds) |
|------------|------------------------------------|---|
| T0 | Cell 1 | |
| T1 | Cell 2 (normal performance group) | 59 |
| T2 | Cell 1 (normal performance group) | 21 |
| T3 | Cell 3 (reduced performance group) | 347 |
| T4 | Cell 1 (normal performance group) | 21 |

NOTE: The cell re-selection delay to a normal performance group cell can be expressed as: $(N_{UTRA_carrier,normal}) * T_{evaluateUTRA_FDD} + T_{SI-UTRA}$ and to a reduced performance group cell can be expressed as: $6 * N_{UTRA_carrier,reduced} * T_{evaluateUTRA_FDD} + T_{SI-UTRA}$.

Where:

$T_{evaluateUTRA-FDD}$ See Table 4.2.2.5.1-1

$T_{SI-UTRA}$ Maximum repetition period of relevant system info blocks that needs to be received by the UE to camp on a cell; 1280 ms is assumed in this test case.

This gives a total of 58.88 s for normal performance group reselection, allow 21 s, and gives a total of 346.88 s for reduced performance group reselection, allow 347 s for reduced performance group in the test case. For reselections back to cell 1 since only one frequency is configured, the requirement is $T_{evaluate,E-UTRAN} + T_{SI} = 20.48$ s, allow 21 s.

A.4.3.2 E-UTRAN FDD – UTRAN TDD:

A.4.3.2.1 Test Purpose and Environment

A.4.3.2.1.1 Void

A.4.3.2.1.2 1.28Mcps TDD option

This test is to verify the requirement for the E-UTRA FDD to UTRA TDD inter-RAT cell reselection requirements specified in clause 4.2.2.5.2 when the UTRA cell is of lower priority.

This test scenario comprised of 1 E-UTRA FDD serving cell (Cell 1), and 1 UTRA TDD cell (Cell 2) to be re-selected. Test parameters are given in table A.4.3.2.1.2-1, A.4.3.2.1.2-2, and A.4.3.2.1.2-3. The test consists of two successive time periods, with time duration of T1 and T2 respectively. Cell 2 is of lower priority than cell 1.

The ranking of the cells shall be made according to the cell reselection criteria specified in TS36.304.

Table A.4.3.2.1.2-1: General test parameters for E-UTRA FDD to UTRA (1.28 Mcps TDD OPTION) Cell Re-selection

| Parameter | | Unit | Value | Comment |
|----------------------------|----------------|------|----------|--|
| Initial condition | Active cell | | Cell1 | E-UTRAN cell |
| T1 end condition | Active cell | | Cell1 | UE shall perform reselection to cell 1 during T1 for subsequent iterations of the test |
| | Neighbour cell | | Cell2 | 1.28 Mcps TDD OPTION cell |
| T2 end condition | Active cell | | Cell2 | UE shall perform reselection to cell 2 during T2 |
| | Neighbour cell | | Cell1 | E-UTRA FDD cell |
| CP length of cell 1 | | | normal | |
| E-UTRA PRACH configuration | | | 4 | As specified in table 5.7.1-2 in TS 36.211 |
| Time offset between cells | | | 3 ms | Asynchronous cells |
| Access Barring Information | | - | Not sent | No additional delays in random access procedure. |
| Treselection | | s | 0 | |
| DRX cycle length | | s | 1,28 | |
| HCS | | | Not used | |
| T1 | | s | 85 | T1 need to be defined so that cell re-selection reaction time is taken into account. |
| T2 | | s | 25 | |

Table A.4.3.2.1.2-2: Cell specific test parameters for cell re-selection E-UTRA FDD to UTRA TDD test case (cell 1)

| Parameter | Unit | Cell 1 | |
|----------------------------------|-----------|-------------|------|
| | | T1 | T2 |
| E-UTRA RF Channel Number | | 1 | |
| $BW_{channel}$ | MHz | 10 | |
| PBCH_RA | dB | 0 | 0 |
| PBCH_RB | dB | | |
| PSS_RA | dB | | |
| SSS_RA | dB | | |
| PCFICH_RB | dB | | |
| PHICH_RA | dB | | |
| PHICH_RB | dB | | |
| PDCCH_RA | dB | | |
| PDCCH_RB | dB | | |
| PDSCH_RA | dB | | |
| PDSCH_RB | dB | | |
| OCNG_RA ^{Note1} | dB | | |
| OCNG_RB ^{Note1} | dB | | |
| Qrxlevmin | dBm/15kHz | | |
| N_{oc} | dBm/15kHz | -98 | |
| RSRP | dBm/15kHz | -87 | -101 |
| \hat{E}_s/I_{ot} | dB | 11 | -3 |
| $S_{noninrasearch}$ | dB | Not sent | |
| Thresh _{serving, low} | dB | 46 (-94dBm) | |
| Thresh _{x, low} (Note2) | dB | 24 (-79dBm) | |
| Propagation Condition | | AWGN | |

| |
|--|
| Note 1: OCNG shall be used such that cell is fully allocated and a constant total transmitted power spectral density is achieved for all OFDM symbols. |
| Note2: This refers to the value of $\text{Thresh}_{x, \text{low}}$ which is included in E-UTRA system information, and is a threshold for the UTRA TDD target cell |

Table A.4.3.2.1.2-3: Cell specific test parameters for cell re-selection E-UTRA FDD to UTRA TDD test case (cell 2)

| Parameter | Unit | Cell 2 (UTRA) | | | |
|--|--------------|---------------|-----|-------|------|
| | | 0 | | DwPTS | |
| Timeslot Number | | T1 | T2 | T1 | T2 |
| UTRA RF Channel Number (Note1) | | Channel 2 | | | |
| PCCPCH_Ec/Ior | dB | -3 | -3 | | |
| DwPCH_Ec/Ior | dB | | | 0 | 0 |
| OCNS_Ec/Ior | dB | -3 | -3 | | |
| \hat{I}_{or}/I_{oc} | dB | 11 | 11 | 11 | 11 |
| I_{oc} | dBm/1.28 MHz | -80 | | | |
| PCCPCH RSCP | dBm | -72 | -72 | n.a. | n.a. |
| Propagation Condition | | AWGN | | | |
| Qrxlevmin | dBm | -103 | | | |
| Qoffset1 _{s,n} | dB | C1, C2: 0 | | | |
| Qhyst1 _s | dB | 0 | | | |
| Thresh _{x, high} (Note2) | dB | 46 (-94dBm) | | | |
| Note1: In the case of multi-frequency cell, the UTRA RF Channel Number is the primary frequency's channel number. | | | | | |
| Note2: This refers to the value of Thresh _{x, high} which is included in UTRA system information, and is a threshold for the E-UTRA target cell | | | | | |

A.4.3.2.1.3 Void

A.4.3.2.2 Test Requirements

A.4.3.2.2.1 1.28Mcps TDD option

The cell reselection delay to lower priority is defined as the time from the beginning of time period T2, to the moment when the UE camps on cell 2, and starts to send the SYNCH-UL sequence in the UpPTS for sending the RRC CONNECTION REQUEST message on cell 2.

The cell re-selection delay to lower priority shall be less than 21 s.

The rate of correct cell reselections observed during repeated tests shall be at least 90%.

NOTE: The cell re-selection delay to lower priority cell can be expressed as: $T_{\text{evaluateUTRA_TDD}} + T_{\text{SI-UTRA}}$

Where:

$T_{\text{evaluateUTRA_TDD}}$ 19.2s, See table table 4.2.2.5.2-1

$T_{\text{SI-UTRA}}$ Maximum repetition period of relevant system info blocks that needs to be received by the UE to camp on a cell; 1280 ms is assumed in this test case.

This gives a total of 20.48 s, allow 21 s for lower priority cell reselection in the test case.

A.4.3.2.2.3 Void

A.4.3.2A E-UTRA FDD to UTRA TDD cell re-selection for IncMon

A.4.3.2A.1 Test Purpose and Environment

This test is to verify the requirement for the E-UTRA FDD to UTRA TDD inter-RAT cell reselection requirements for increased UE carrier monitoring specified in clause 4.2.2.4. UTRA TDD cells are of lower priority than E-UTRA serving cell.

The test scenario comprises of indicating 7 UTRA TDD inter-RAT cells on 7 different carriers in the neighbour list of cell 1 as given in tables A.4.3.2A.1-1, A.4.3.2A.1-2 and A.4.3.2A.1-3. Each repetition of the test consists of five successive time periods, with time duration of T0, T1, T2, T3, and T4 respectively. In the initialisation phase and at the start of each repetition of T0, the test equipment provides signals for cell 1 (E-UTRA serving cell), and selects frequencies for cells 2 and 3 which are chosen from the 7 inter-RAT layers which are configured in the UE neighbour cell list as described in general and cell specific parameters. The neighbour lists of cells 2 and 3 shall include the frequency of cell 1 in the normal performance group and shall exclude the other UTRA TDD frequencies configured to the UE in the test.

Cell 1, 2 and 3 are identified by the UE during time phase T0. Cell 1, cell 2 and cell 3 belong to different tracking areas. Furthermore, UE has not registered with network for the tracking area containing cell 2 or 3.

Table A.4.3.2A.1-1: General test parameters for E-UTRA FDD to UTRA TDD inter-RAT cell re-selection test case

| Parameter | Unit | Value | Comment |
|--------------------------------------|----------------|---|---|
| T0 | Active cell | Cell1 | T0 is repeated on each repetition of the test. In T0 the test equipment selects frequencies for cell 2, 3 and then time is allowed for the UE to identify the neighbour cells. See cell specific parameters for detailed settings. |
| T1 start condition | Active cell | Cell 1 | |
| T1 end condition | Active cell | Cell2 | UE shall perform reselection to cell 2 during T1 |
| | Neighbour cell | Cell1 | |
| T2 end condition | Active cell | Cell1 | UE shall perform reselection to cell 1 during T2 |
| T3 end condition | Active cell | Cell3 | UE shall perform reselection to cell 3 during T3 |
| | Neighbour cell | Cell1 | |
| T4 end condition | Active cell | Cell1 | UE shall perform reselection to cell 1 in T4 so that next repetition of test can start from T0 |
| UE configured UTRA RF Channel Number | | 1, 2, 3, 4, 5, 6, 7 | Seven UTRA TDD carrier frequencies are used in the UE neighbour cell list. Frequencies 4, 5, 6, and 7 are indicated to have reduced performance |
| Test equipment configuration | | Cell 1, 2, 3 | Cell 1 uses E-UTRA RF channel number 1 Cells 2 is randomly selected to use different frequencies selected from UTRA frequencies 1, 2, 3. Cells 3 is randomly selected to use different frequencies selected from UTRA frequencies 4, 5, 6, 7. |
| CP length of cell 1 | | normal | |
| PRACH configuration | | 4 | As specified in table 5.7.1-2 in TS 36.211 [16] |
| Access Barring Information | - | Not Sent | No additional delays in random access procedure. |
| T _{reselection} | s | 0 | |
| HCS | | Not used | |
| DRX cycle length | s | 1.28 | The value shall be used for all cells in the test. |
| T0 | s | (Test equipment frequency selection and configuration time) + 960 | T0 is defined so that the Test equipment selects frequencies and configures the cells, then the UE cell detection time is taken into account. |
| T1 | s | 60 | T1 need to be defined so that cell re-selection reaction time is taken into account. |
| T2 | s | 25 | T2 need to be defined so that cell re-selection reaction time is taken into account |

| | | | |
|----|---|-----|--|
| T3 | s | 500 | T3 need to be defined so that cell re-selection reaction time is taken into account. |
| T4 | s | 25 | T4 need to be defined so that cell re-selection reaction time is taken into account |

Table A.4.3.2A.1-2: E-UTRA Cell specific test parameters for E-UTRA FDD to UTRA TDD inter-RAT cell reselection test case in AWGN

| Parameter | Unit | Cell 1 | | | | |
|---|-----------|---|------|-----|------|-----|
| | | T0 | T1 | T2 | T3 | T4 |
| E-UTRA RF Channel number | | 1 | | | | |
| BW _{channel} | MHz | 5MHz: N _{RB} = 25 10MHz: N _{RB} = 50 | | | | |
| OCNG Patterns | | 5MHz: OP.16 FDD 10MHz: OP.2 FDD | | | | |
| PBCH_RA | dB | 0 | | | | |
| PBCH_RB | dB | | | | | |
| PSS_RA | dB | | | | | |
| SSS_RA | dB | | | | | |
| PCFICH_RB | dB | | | | | |
| PHICH_RA | dB | | | | | |
| PHICH_RB | dB | | | | | |
| PDCCH_RA | dB | | | | | |
| PDCCH_RB | dB | | | | | |
| PDSCH_RA | dB | | | | | |
| PDSCH_RB | dB | | | | | |
| OCNG_RA ^{NOTE 1} | dB | | | | | |
| OCNG_RB ^{NOTE 1} | dB | | | | | |
| N _{oc} ^{NOTE 2} | dBm/15kHz | | | | | |
| \hat{E}_s / N_{oc} | dB | 11 | -3 | 11 | -3 | 11 |
| \hat{E}_s / I_{ot} ^{NOTE 3} | dB | 11 | -3 | 11 | -3 | 11 |
| RSRP ^{NOTE 3} | dBm/15kHz | -87 | -101 | -87 | -101 | -87 |
| Q _{rxlevmin} | dBm/15kHz | -140 | | | | |
| S _{nonintrasearch} | dB | Not sent | | | | |
| Thresh _{serv, low} | dB | 46 (-94dBm) | | | | |
| Thresh _{x, low} ^{NOTE 4} | dB | 24 (-79dBm) | | | | |
| Propagation Condition | | AWGN | | | | |
| Antenna Configuration | | 1x2 | | | | |
| NOTE 1: OCNG shall be used such that both cells are fully allocated and a constant total transmitted power spectral density is achieved for all OFDM symbols. | | | | | | |
| NOTE 2: Interference from other cells and noise sources not specified in the test is assumed to be constant over subcarriers and time and shall be modelled as AWGN of appropriate power for to be fulfilled. | | | | | | |
| NOTE 3: E _s /I _{ot} and RSRP levels have been derived from other parameters for information purposes. They are not settable parameters themselves. | | | | | | |
| NOTE 4: This refers to the value of Thresh _{x, low} which is included in E-UTRA system information, and is a threshold for the UTRA TDD target cell. | | | | | | |

Table A.4.3.2A.1-3: UTRA TDD Cell specific test parameters for E-UTRA FDD to UTRA TDD inter-RAT cell reselection test case in AWGN

| Parameter | Unit | Cell 2 (UTRA TDD) | | | | | | | | | |
|--|------|--|----|----|----|----|-------|----|----|----|----|
| | | 0 | | | | | DwPTS | | | | |
| Timeslot Number | | T0 | T1 | T2 | T3 | T4 | T0 | T1 | T2 | T3 | T4 |
| UTRA RF Channel Number ^{NOTE 1} | | Randomly selected from 1, 2, 3 such that cell 2 is in the normal performance group | | | | | | | | | |
| PCCPCH_Ec/Ior | dB | -3 | | | | | | | | | |
| DwPCH_Ec/Ior | dB | | | | | | 0 | | | | |
| OCNS_Ec/Ior | dB | -3 | | | | | | | | | |

| | | | | | | | | | | | |
|--|------------------|-------------|-----|-----|-----|-----|------|----|----|----|----|
| I_{oc} | dBm/ 1.28 MHz | -80 | | | | | | | | | |
| \hat{I}_{or}/I_{oc} | dB | -3 | 11 | -3 | -3 | -3 | -3 | 11 | -3 | -3 | -3 |
| PCCPCH RSCP | dBm | -86 | -72 | -86 | -86 | -86 | n.a. | | | | |
| Propagation Condition | | AWGN | | | | | | | | | |
| $Q_{rxlevmin}$ | dBm | -103 | | | | | | | | | |
| $Q_{offset1_{s,n}}$ | dB | C1, C2: 0 | | | | | | | | | |
| Q_{hyst1_s} | dB | 0 | | | | | | | | | |
| $S_{prioritysearch1}$ | dB | 24 (-79dBm) | | | | | | | | | |
| $S_{prioritysearch2}$ | dB | 0 | | | | | | | | | |
| $Thresh_{x, high}$ ^{NOTE 2} | dB | 46 (-94dBm) | | | | | | | | | |
| $S_{searchE-UTRA}$ | dB | Not send | | | | | | | | | |
| Time offset to cell1 | ms | 3 | | | | | | | | | |
| NOTE 1: In the case of multi-frequency cell, the UTRA RF Channel Number is the primary frequency's channel number. | | | | | | | | | | | |
| NOTE 2: This refers to the value of $Thresh_{x, high}$ which is included in UTRA system information, and is a threshold for the E-UTRA target cell | | | | | | | | | | | |

Table A.4.3.2A.1-4:

| Parameter | Unit | Cell 3 (UTRA TDD) | | | | | | | | | |
|--|------------------|--|-----|-----|-----|-----|-------|----|----|----|----|
| | | 0 | | | | | DwPTS | | | | |
| Timeslot Number | | T0 | T1 | T2 | T3 | T4 | T0 | T1 | T2 | T3 | T4 |
| UTRA RF Channel Number ^{NOTE 1} | | Randomly selected from 4, 5, 6, 7 such that cell 3 is in the reduced performance group | | | | | | | | | |
| PCCPCH_Ec/Ior | dB | -3 | | | | | | | | | |
| DwPCH_Ec/Ior | dB | | | | | | 0 | | | | |
| OCNS_Ec/Ior | dB | -3 | | | | | | | | | |
| I_{oc} | dBm/ 1.28 MHz | -80 | | | | | | | | | |
| \hat{I}_{or}/I_{oc} | dB | -3 | -3 | -3 | 11 | -3 | -3 | -3 | -3 | 11 | -3 |
| PCCPCH RSCP | dBm | -86 | -86 | -86 | -72 | -86 | n.a. | | | | |
| Propagation Condition | | AWGN | | | | | | | | | |
| $Q_{rxlevmin}$ | dBm | -103 | | | | | | | | | |
| $Q_{offset1_{s,n}}$ | dB | C1, C2: 0 | | | | | | | | | |
| Q_{hyst1_s} | dB | 0 | | | | | | | | | |
| $S_{prioritysearch1}$ | dB | 24 (-79dBm) | | | | | | | | | |
| $S_{prioritysearch2}$ | dB | 0 | | | | | | | | | |
| $Thresh_{x, high}$ ^{NOTE 2} | dB | 46 (-94dBm) | | | | | | | | | |
| $S_{searchE-UTRA}$ | dB | Not send | | | | | | | | | |
| Time offset to cell1 | ms | 3 | | | | | | | | | |
| Time offset to cell2 | µs | 3 | | | | | | | | | |
| NOTE 1: In the case of multi-frequency cell, the UTRA RF Channel Number is the primary frequency's channel number. | | | | | | | | | | | |
| NOTE 2: This refers to the value of $Thresh_{x, high}$ which is included in UTRA system information, and is a threshold for the E-UTRA target cell | | | | | | | | | | | |

A.4.3.2A.2 Test Requirements

The cell reselection delay is defined as the time from the beginning of a relevant time period, to the moment when the UE camps on the target cell, and starts to send the SYNCH-UL sequence in the UpPTS on cell 2, 3 for sending the RRC CONNECTION REQUEST message to perform a Tracking Area Update procedure on the target cell.

The reselection delays shall meet the requirements in table A.4.3.2A.2-1

Table A.4.3.2A.2-1: Test requirements for E-UTRA FDD to UTRA TDD inter-RAT cell reselection

| Time phase | Target cell | Requirement for reselection delay (seconds) |
|------------|-----------------------------------|---|
| T1 | Cell 2 (normal performance group) | 58.9 |

| | | |
|----|------------------------------------|-------|
| T3 | Cell 3 (reduced performance group) | 462.1 |
|----|------------------------------------|-------|

The rate of correct cell reselections observed during repeated tests shall be at least 90%, with a successful reselection counted if it is within the required time regardless of the carrier frequencies involved. At least 90% of reselections to the reduced performance group shall be within the required time, and at least 90% of reselections to the normal performance group shall be within the required time.

NOTE: The cell re-selection delay to a normal performance group cell can be expressed as: $N_{\text{UTRA_carrier_TDD,normal}} * T_{\text{evaluateUTRA_TDD}} + T_{\text{SI_UTRA}}$, and to a reduced performance group cell can be expressed as: $6 * N_{\text{UTRA_carrier_TDD,reduced}} * T_{\text{evaluateUTRA_TDD}} + T_{\text{SI_UTRA}}$,

Where:

$T_{\text{evaluateUTRA_TDD}}$ 19.2s, See Table 4.2.2.5.2-1

$T_{\text{SI_UTRA}}$ Maximum repetition period of relevant system info blocks that needs to be received by the UE to camp on a cell; 1280 ms is assumed in this test case.

This gives a total of $3 * 19.2 + 1.28 = 58.88$ s for normal performance group reselection and $6 * 4 * 19.2 + 1.28 = 462.08$ s for reduced performance group reselection, allow 58.9s for normal performance group and 462.1s for reduced performance group in the test case.

Since only one E-UTRA frequency is configured and signal level of UTRA cell is lower than threshold of $S_{\text{prioritysearch}}$, the UE shall select back to cell 1 (E-UTRA cell) within $K_{\text{carrier}} * T_{\text{evaluateEUTRA}} + T_{\text{SI}} = 19.2 + 1.28 = 20.48$ s.

A.4.3.3 E-UTRAN TDD – UTRAN FDD:

A.4.3.3.1 Test Purpose and Environment

This test is to verify the requirement for the EUTRA TDD- UTRA FDD inter-RAT cell reselection requirements specified in clause 4.2.2.5.1 when the UTRA cell is of lower priority.

The test scenario comprises of one UTRA FDD and one E-UTRA TDD cells as given in tables A.4.3.3.1-1, A.4.3.3.1-2 and A.4.3.3.1-3. The test consists of two successive time periods, with time duration of T1 and T2 respectively. Both E-UTRA cell 1 and UTRA cell 2 are already identified by the UE prior to the start of the test. Cell 2 is of lower priority than cell 1.

Table A.4.3.3.1-1: General test parameters for EUTRA TDD- lower priority UTRA FDD inter RAT cell reselection test case

| | Parameter | Unit | Value | Comment |
|--|----------------|------|----------|--|
| Initial condition | Active cell | | Cell1 | E-UTRAN cell |
| T1 end condition | Active cells | | Cell1 | UE shall perform reselection to cell 1 during T1 for subsequent iterations of the test |
| | Neighbour cell | | Cell2 | |
| T2 end condition | Active cell | | Cell2 | UE shall perform reselection to cell 2 during T2 |
| | Neighbour cell | | Cell1 | |
| E-UTRA PRACH configuration | | | 53 | As specified in table 5.7.1-3 in TS 36.211 |
| Uplink-downlink configuration of cell 1 | | | 1 | As specified in table 4.2.2 in TS 36.211 |
| Special subframe configuration of cell 1 | | | 6 | As specified in table 4.2.1 in TS 36.211 |
| E_UTRA Access Barring Information | | - | Not Sent | No additional delays in random access procedure. |
| DRX cycle length | | s | 1.28 | The value shall be used for all cells in the test. |
| T1 | | s | 85 | T1 need to be defined so that cell re-selection reaction time is taken into account. |
| T2 | | s | 25 | T2 need to be defined so that cell re-selection reaction time is taken into account. |

Table A.4.3.3.1-2: Cell specific test parameters for cell 1(E-UTRA)

| Parameter | Unit | Cell 1 | |
|---|------------|----------|------|
| | | T1 | T2 |
| E-UTRA RF Channel number | | 1 | |
| $BW_{channel}$ | MHz | 10 | |
| OCNG Patterns defined in A.3.2.2.2 (OP.2 TDD) | | OP.2 TDD | |
| PBCH_RA | dB | 0 | |
| PBCH_RB | dB | | |
| PSS_RA | dB | | |
| SSS_RA | dB | | |
| PCFICH_RB | dB | | |
| PHICH_RA | dB | | |
| PHICH_RB | dB | | |
| PDCCH_RA | dB | | |
| PDCCH_RB | dB | | |
| PDSCH_RA | dB | | |
| PDSCH_RB | dB | | |
| OCNG_RA ^{NOTE 1} | dB | | |
| OCNG_RB ^{NOTE 1} | dB | | |
| Qqualmin for UTRA neighbour cell | dB | | |
| Qrxlevmin for UTRA neighbour cell | dBm | -115 | |
| Qrxlevmin | dBm | -140 | |
| N_{oc} | dBm/15 kHz | -98 | |
| RSRP | dBm/15 KHz | -86 | -102 |
| \hat{E}_s / I_{ot} | dB | 12 | -4 |
| \hat{E}_s / N_{oc} | dB | 12 | -4 |
| Treselection ^{NEUTRAN} | s | 0 | |
| Snonintrasearch | dB | Not sent | |
| Thresh ^{serv, low} | dB | 44 | |
| Thresh _{x, low} (NOTE 2) | dB | 42 | |
| Propagation Condition | | AWGN | |
| NOTE 1: OCNG shall be used such that both cells are fully allocated and a constant total transmitted power spectral density is achieved for all OFDM symbols. | | | |
| NOTE 2: This refers to the value of Thresh _{x, low} which is included in E-UTRA system information, and is a threshold for the UTRA target cell | | | |

Table A.4.3.3.1-3: Cell specific test parameters for cell 2 (UTRA)

| Parameter | Unit | Cell 2 (UTRA) | |
|-------------------------|--------------|---------------|--------|
| | | T1 | T2 |
| UTRA RF Channel Number | | Channel 2 | |
| CPICH_Ec/lor | dB | -10 | |
| PCCPCH_Ec/lor | dB | -12 | |
| SCH_Ec/lor | dB | -12 | |
| PICH_Ec/lor | dB | -15 | |
| OCNS_Ec/lor | dB | -0.941 | |
| \hat{I}_{or} / I_{oc} | dB | 13 | 13 |
| I_{oc} | dBm/3,84 MHz | -70 | |
| CPICH_Ec/lo | dB | -10.21 | -10.21 |
| CPICH_RSCP | dBm | -67 | -67 |
| Propagation Condition | | AWGN | |
| Qqualmin | dB | -20 | |

| | | |
|--|-----|------|
| Qrxlevmin | dBm | -115 |
| QrxlevminEUTRA | dBm | -140 |
| UE_TXPWR_MAX_RACH | dBm | 21 |
| Treselection | s | 0 |
| Sprioritysearch1 | dB | 42 |
| Sprioritysearch2 | dB | 0 |
| Thresh _{x, high} (NOTE 1) | dB | 48 |
| NOTE 1 : This refers to the value of Thresh _{x, high} which is included in UTRA system information, and is a threshold for the E-UTRA target cell | | |

A.4.3.3.2 Test Requirements

The cell reselection delay to lower priority is defined as the time from the beginning of time period T2, to the moment when the UE camps on cell 2, and starts to send preambles on the PRACH for sending the RRC CONNECTION REQUEST message on cell 2.

The cell re-selection delay to lower priority shall be less than 21 s.

The rate of correct cell reselections observed during repeated tests shall be at least 90%.

NOTE: The cell re-selection delay to lower priority cell can be expressed as: $T_{\text{evaluateUTRA_FDD}} + T_{\text{SI-UTRA}}$

Where:

$T_{\text{evaluateUTRA-FDD}}$ See Table 4.2.2.5.1-1

$T_{\text{SI-UTRA}}$ Maximum repetition period of relevant system info blocks that needs to be received by the UE to camp on a cell; 1280 ms is assumed in this test case.

This gives a total of 20.48 s for lower priority cell reselection, allow 21 s.

A.4.3.3A Idle mode TDD to UTRA FDD interRAT reselection

A.4.3.3A.1 Test Purpose and Environment

This test is to verify the requirement for the E-UTRA TDD-UTRA FDD inter-RAT cell reselection requirements for increased UE carrier monitoring specified in clause 4.2.2.4.

The test scenario comprises of indicating 8 UTRA FDD interfrequency cells on 6 different carriers in the neighbour list of cell 1 as given in table A.4.3.3A.1-2 and table A.4.3.3A.1-3 and cells 2 and 3 as given in table A.4.3.3A.1-4. Each repetition of the test consists of five successive time periods, with time duration of T0, T1, T2, T3 and T4 respectively. In the initialisation phase and at the start of each repetition of T0, the test equipment provides signals for cell 1 (serving cell), and selects frequencies for cells 2 and 3 which are chosen from the 6 inter-RAT layers which are configured in the UE neighbour cell list as described in general and cell specific parameters. The neighbour lists of cells 2 and 3 shall include the frequency of cell 1 in the normal performance group and shall exclude the other frequencies configured to the UE in the test.

Cell 1, 2 and 3 4 are identified by the UE during time period T0. Cell 1, cell 2 and cell 3 belong to different tracking areas. Furthermore, UE has not registered with network for the tracking area containing cell 2 or 3. Cells 1, 2 and 3 4 all have lower absolute priority than cell 1.

Table A.4.3.3A.1-1: General test parameters for E-UTRAN TDD- UTRAN FDD inter frequency cell reselection test case

| Parameter | Unit | Value | Comment |
|--------------------|-------------|--------|--|
| T0 | Active cell | Cell 1 | T0 is repeated on each repetition of the test. In T0 the test equipment selects frequencies for cell 2, 3 and then time is allowed for the UE to identify the neighbour cells. See cell specific parameters for detailed settings. |
| T1 start condition | Active cell | Cell 1 | |

| | | | | |
|--|----------------|---|--|---|
| T1 end condition | Active cell | | Cell 2 | UE shall perform reselection to cell 2 during T1 |
| | Neighbour cell | | Cell 1, cell 3 | |
| T2 end condition | Active cell | | Cell 1 | UE shall perform reselection to cell 1 during T2 |
| | Neighbour cell | | Cell 2, cell 3 | |
| T3 end condition | Active cell | | Cell 3 | UE shall perform reselection to cell 3 during T3 |
| | Neighbour cell | | Cell 1, cell 2 | |
| T4 end condition | Active cell | | Cell 1 | UE shall perform reselection to cell 1 during T4 |
| | Neighbour cell | | Cell 2, cell 3 | |
| UE configured E-UTRA RF Channel Number | | | 1 | Serving cell and six UTRA FDD carrier frequencies are used in the UE neighbour cell list. Frequencies 5,6 and 7 are indicated to have reduced performance |
| UE configured UTRA RF Channel Number | | | 2,3,4,5,6,7 | |
| Test equipment configuration | | | Cell 1 uses E-UTRA RF channel number 1 Cells 2,3,4 are randomly selected to use different frequencies selected from frequencies 2,3,4,5,6,7 | |
| PRACH configuration | | | 4 | As specified in table 5.7.1-2 in TS 36.211 |
| Access Barring Information | | - | Not Sent | No additional delays in random access procedure. |
| DRX cycle length | | s | 1.28 | The value shall be used for all cells in the test. |
| T0 | | s | (test equipment frequency selection and configuration time) + 960 | Initialisation time need to be defined so that cell detection time is taken into account. |
| T1 | | s | 60 | T1 need to be defined so that cell reselection reaction time is taken into account. |
| T2 | | s | 25 | T2 need to be defined so that cell reselection reaction time is taken into account |
| T3 | | s | 350 | T3 need to be defined so that cell reselection reaction time is taken into account. |
| T4 | | s | 25 | T4 need to be defined so that cell reselection reaction time is taken into account |

Table A.4.3.3A.1-2: General test parameters for EUTRA TDD- UTRA FDD inter RAT cell re-selection test case

| Parameter | Unit | Value | Comment |
|--|------|-------|--|
| Uplink-downlink configuration of cell 1 | | 1 | As specified in table 4.2.2 in TS 36.211 |
| Special subframe configuration of cell 1 | | 6 | As specified in table 4.2.1 in TS 36.211 |

Table A.4.3.3A.1-3: Cell specific test parameters for E-UTRAN TDD- UTRAN FDD inter-RAT cell reselection test case in AWGN cell 1 (E-UTRAN)

| Parameter | Unit | Cell 1 | | | | |
|--|-------------------------------------|---|--------|--------|--------|--------|
| | | T0 | T1 | T2 | T3 | T4 |
| E-UTRA RF Channel number | | 1 | | | | |
| BW _{channel} | MHz | 5MHz: N _{RB} = 25 10MHz: N _{RB} = 50 | | | | |
| Io | dBm/4.5MHz(25RB) dBm/9MHz (50RB) | -59.06 | -71.77 | -59.06 | -71.77 | -59.06 |
| | | -56.05 | -68.76 | -56.05 | -68.76 | -56.05 |
| PDSCH parameters: DL Reference Measurement Channel | | OP.10 TDD(5MHz) OP.2 TDD (10MHz) | | | | |
| PBCH RA | dB | 0 | | | | |
| PBCH RB | dB | | | | | |
| PSS RA | dB | | | | | |
| SSS RA | dB | | | | | |
| PCFICH RB | dB | | | | | |
| PHICH RA | dB | | | | | |
| PHICH RB | dB | | | | | |
| PDCCH RA | dB | | | | | |
| PDCCH RB | dB | | | | | |
| PDSCH RA | dB | | | | | |
| PDSCH RB | dB | | | | | |
| OCNG_RA ^{Note 1} | dB | | | | | |
| OCNG_RB ^{Note 1} | dB | | | | | |
| Qrxlevmin | dBm | -140 | | | | |
| N _{oc} ^{Note 2} | dBm | -98 | | | | |
| RSRP ^{Note 3} | dBm | -84 | -102 | -84 | -102 | -84 |
| \hat{E}_s/I_{ot} | dB | 14 | -4 | 14 | -4 | 14 |
| \hat{E}_s/N_{oc} | dB | 14 | -4 | 14 | -4 | 14 |
| Treselection _{EUTRAN} | s | 0 | | | | |
| Snonintrasearch | dB | 62 | | | | |
| Thresh _{serv, low} | dB | 44 | | | | |
| Thresh _{x, low} (Note 4) | dB | 40 | | | | |
| Propagation Condition | | AWGN | | | | |
| <p>Note 1: OCNG shall be used such that the cell is fully allocated and a constant total transmitted power spectral density is achieved for all OFDM symbols.</p> <p>Note 2: Interference from other cells and noise sources not specified in the test is assumed to be constant over subcarriers and time and shall be modelled as AWGN of appropriate power for to be fulfilled.</p> <p>Note 3: RSRP levels have been derived from other parameters for information purposes. They are not settable parameters themselves.</p> <p>Note 4: This refers to the value of Thresh_{x, low} which is included in E-UTRA system information, and is a threshold for the UTRA target cell.</p> | | | | | | |

Table A.4.3.3A.1-4: Cell specific test parameters for cells 2 and 3 (UTRA)

| Parameter | Unit | Cell 2 | | | | | Cell 3 | | | | |
|------------------------|------|--|-----|-----|----|-----|---|----|-----|-----|-----|
| | | T0 | T1 | T2 | T3 | T4 | T0 | T1 | T2 | T3 | T4 |
| UTRA RF Channel Number | | Randomly selected from 1, 2, 3 such that cell 2 is in the normal performance group | | | | | Randomly selected from 4, 5, 6 such that cell 3 is in the reduced performance group | | | | |
| CPICH_Ec/lor | dB | -10 | | | | | -10 | | | | |
| PCCPCH_Ec/lor | dB | -12 | | | | | -12 | | | | |
| SCH_Ec/lor | dB | -12 | | | | | -12 | | | | |
| PICH_Ec/lor | dB | -15 | | | | | -15 | | | | |
| OCNS_Ec/lor | dB | -0.941 | | | | | 0.941 | | | | |
| \hat{I}_{or}/I_{oc} | dB | +11 | +11 | +11 | -5 | +11 | +11 | -5 | +11 | +11 | +11 |

| I_{oc} | dBm/3,84 MHz | -70 | | | | | -70 | | | | |
|--|--------------|------------|------------|------------|------------|------------|------------|------------|------------|------------|------------|
| CPICH_Ec/Io | dB | -10.3 3 | -10.3 3 | -10.3 3 | -16.1 9 | -10.3 3 | -10.3 3 | -16.1 9 | -10.3 6 | -10.3 3 | -10.3 3 |
| CPICH_RSCP | dBm | -69 | -69 | -69 | -85 | -69 | -69 | -85 | -69 | -69 | -69 |
| Propagation Condition | | AWGN | | | | | AWGN | | | | |
| Qqualmin | dB | -20 | | | | | -20 | | | | |
| Qrxlevmin | dBm | -115 | | | | | -115 | | | | |
| QrxlevminEUTRA | dBm | -140 | | | | | -140 | | | | |
| UE_TXPWR_MAX_RACH | dBm | 21 | | | | | 21 | | | | |
| Treselection | s | 0 | | | | | 0 | | | | |
| Sprioritysearch1 | dB | 40 | | | | | 40 | | | | |
| Sprioritysearch2 | dB | 0 | | | | | 0 | | | | |
| Thresh _{x,high} (Note 1) | dB | 50 | | | | | 50 | | | | |
| Note 1: This refers to the value of Thresh _{x,high} which is included in UTRA system information, and is a threshold for the E-UTRA target cell | | | | | | | | | | | |

A.4.3.3A.2 Test Requirements

The cell reselection delay is defined as the time from the beginning of a relevant time period, to the moment when the UE camps on the target cell, and starts to send preambles on the PRACH for sending the RRC CONNECTION REQUEST message to perform a Tracking Area Update procedure on the target cell.

The reselection delays shall meet the requirements in table A.4.3.1.5-1

Table A.4.3.3A.2-1

| Time phase | Target cell | Requirement for reselection delay (seconds) |
|------------|------------------------------------|---|
| T0 | Cell 1 | |
| T1 | Cell 2 (normal performance group) | 59 |
| T2 | Cell 1 (normal performance group) | 21 |
| T3 | Cell 3 (reduced performance group) | 347 |
| T4 | Cell 1 (normal performance group) | 21 |

NOTE: The cell re-selection delay to a normal performance group cell can be expressed as: $(N_{UTRA_carrier,normal}) * T_{evaluateUTRA_FDD} + T_{SI-UTRA}$ and to a reduced performance group cell can be expressed as: $6 * N_{UTRA_carrier,reduced} * T_{evaluateUTRA_FDD} + T_{SI-UTRA}$.

Where:

$T_{evaluateUTRA-FDD}$ See Table 4.2.2.5.1-1

$T_{SI-UTRA}$ Maximum repetition period of relevant system info blocks that needs to be received by the UE to camp on a cell; 1280 ms is assumed in this test case.

This gives a total of 58.88 s for normal performance group reselection, allow 59 s, and gives a total of 346.88 s for reduced performance group reselection, allow 347 s for reduced performance group in the test case. For reselections back to cell 1 since only one frequency is configured, the requirement is $T_{evaluate,E-UTRAN} + T_{SI} = 20.48$ s, allow 21 s.

A.4.3.4 E-UTRAN TDD – UTRAN TDD:

A.4.3.4.1 E-UTRA to UTRA TDD cell re-selection: UTRA is of higher priority

A.4.3.4.1.1 Test Purpose and Environment

A.4.3.4.1.1.1 Void

A.4.3.4.1.1.2 1.28 Mcps TDD option

This test is to verify the requirement for the E-UTRA TDD to UTRA TDD inter-RAT cell re-selection requirements specified in clause 4.2.2.5 when the UTRA cell is of higher priority.

This test scenario comprised of 1 E-UTRA TDD serving cell, and 1 UTRA TDD cell to be re-selected. Test parameters are given in table A.4.3.4.1.1.2-1, A.4.3.4.1.1.2-2, and A.4.3.4.1.1.2-3. The test consists of three successive time periods, with time duration of T1, T2 and T3 respectively. E-UTRA cell 1 is already identified by the UE prior to the start of the test. Cell 2 is of higher priority than cell 1.

The ranking of the cells shall be made according to the cell reselection criteria specified in TS36.304.

Table A.4.3.4.1.1.2-1: General test parameters for E-UTRAN to UTRAN (1.28 Mcps TDD OPTION) Cell Re-selection

| Parameter | | Unit | Value | Comment |
|--|----------------|------|----------|---|
| Initial condition | Active cell | | Cell 1 | UE is on cell 1 in the initialisation phase, so that reselection to cell 2 occurs during T2 |
| T2 end condition | Active cell | | Cell 2 | UE shall perform reselection to cell 2 during T2 |
| | Neighbour cell | | Cell 1 | |
| T3 end condition | Active cell | | Cell 1 | UE shall perform reselection to cell 1 during T3 |
| | Neighbour cell | | Cell 2 | |
| Uplink-downlink configuration of cell 1 | | | 1 | As specified in table 4.2.2 in TS 36.211 |
| Special subframe configuration of cell 1 | | | 6 | As specified in table 4.2.1 in TS 36.211 |
| PRACH configuration of cell 1 | | | 53 | As specified in table 4.7.1-3 in TS 36.211 |
| CP length of cell 1 | | | Normal | |
| Time offset between cells | | | 3 ms | Asynchronous cells |
| Access Barring Information | | - | Not sent | No additional delays in random access procedure. |
| T _{reselection} | | s | 0 | |
| DRX cycle length | | s | 1,28 | |
| HCS | | | Not used | |
| T1 | | s | >20 | During T1, cell 2 shall be powered off, and during the off time the primary scrambling code shall be changed, The intention is to ensure that cell 2 has not been detected by the UE prior to the start of period T2. |
| T2 | | s | 85 | T2 needs to be defined so that cell re-selection reaction time is taken into account. |
| T3 | | s | 25 | T3 needs to be defined so that cell re-selection reaction time is taken into account. |

Table A.4.3.4.1.1.2-2: Cell specific test parameters for cell re-selection E-UTRA TDD to UTRA TDD test case (cell 1)

| Parameter | Unit | Cell 1 | | |
|--------------------------|------|--------|----|----|
| | | T1 | T2 | T3 |
| E-UTRA RF Channel Number | | 1 | | |

| | | | | |
|---|-----------|------------|-----|-----|
| $BW_{channel}$ | MHz | 10 | | |
| PBCH_RA | dB | 0 | 0 | 0 |
| PBCH_RB | dB | | | |
| PSS_RA | dB | | | |
| SSS_RA | dB | | | |
| PCFICH_RB | dB | | | |
| PHICH_RA | dB | | | |
| PHICH_RB | dB | | | |
| PDCCH_RA | dB | | | |
| PDCCH_RB | dB | | | |
| PDSCH_RA | dB | | | |
| PDSCH_RB | dB | | | |
| OCNG_RA ^{NOTE 1} | dB | | | |
| OCNG_RB ^{NOTE 1} | dB | | | |
| $Q_{rxlevmin}$ | dBm/15kHz | | | |
| N_{oc} | dBm/15kHz | -98 | | |
| RSRP | dBm/15kHz | -87 | -87 | -87 |
| \hat{E}_s / I_{ot} | dB | 11 | 11 | 11 |
| Thresh _{x, high} (NOTE 2) | dB | 24(-79dBm) | | |
| S _{nonintrasearch} | dB | 46 | | |
| Propagation Condition | | AWGN | | |
| NOTE 1: OCNG shall be used such that cell is fully allocated and a constant total transmitted power spectral density is achieved for all OFDM symbols. | | | | |
| NOTE 2: This refers to the value of Thresh _{x, high} which is included in E-UTRA system information, and is a threshold for the UTRA target cell | | | | |

Table A.4.3.4.1.1.2-3: Cell specific test parameters for cell re-selection E-UTRA TDD to UTRA TDD test case (cell 2)

| Parameter | Unit | Cell 2 (UTRA) | | | | | |
|--|--------------|---------------|-----|-----|-------|----|----|
| | | 0 | | | DwPTS | | |
| Timeslot Number | | T1 | T2 | T3 | T1 | T2 | T3 |
| UTRA RF Channel Number (NOTE 1) | | Channel 2 | | | | | |
| PCCPCH_Ec/Ior | dB | -3 | -3 | -3 | | | |
| DwPCH_Ec/Ior | dB | | | | 0 | 0 | 0 |
| OCNS_Ec/Ior | dB | -3 | -3 | -3 | | | |
| \hat{I}_{or} / I_{oc} | dB | -inf | 11 | -3 | -inf | 11 | -3 |
| I_{oc} | dBm/1.28 MHz | -80 | | | | | |
| PCCPCH RSCP | dBm | -inf | -72 | -86 | n.a. | | |
| Propagation Condition | | AWGN | | | | | |
| $Q_{rxlevmin}$ | dBm | -103 | | | | | |
| Qoffset1 _{s,n} | dB | C1, C2: 0 | | | | | |
| Qhyst1 _s | dB | 0 | | | | | |
| S _{nonintrasearch} | dB | Not sent | | | | | |
| Thresh _{serving, low} | dB | 24 (-79dBm) | | | | | |
| Thresh _{x, low} (NOTE 2) | dB | 46 (-94dBm) | | | | | |
| NOTE 1: In the case of multi-frequency cell, the UTRA RF Channel Number is the primary frequency's channel number. | | | | | | | |
| NOTE 2: This refers to the value of Thresh _{x, low} which is included in UTRA system information, and is a threshold for the E-UTRA target cell | | | | | | | |

A.4.3.4.1.1.3 Void

A.4.3.4.1.2 Test Requirements

A.4.3.4.1.2.1 Void

A.4.3.4.1.2.2 1.28 Mcps TDD option

The cell reselection delay to higher priority is defined as the time from the beginning of time period T2, to the moment when the UE camps on cell 2, and starts to send the SYNCH-UL sequence in the UpPTS for sending the RRC CONNECTION REQUEST message on cell 2.

The cell re-selection delay to higher priority shall be less than 81 s.

The rate of correct cell reselections observed during repeated tests shall be at least 90%.

NOTE: The cell re-selection delay to higher priority cell can be expressed as: $T_{\text{higher_priority_search}} + T_{\text{evaluateUTRA_TDD}} + T_{\text{SL_UTRA}}$,

Where:

$T_{\text{higher_priority_search}}$ 60s, See clause 4.2.2

$T_{\text{evaluateUTRA_TDD}}$ 19.2s, See Table 4.2.2.5.2-1

$T_{\text{SL_UTRA}}$ Maximum repetition period of relevant system info blocks that needs to be received by the UE to camp on a cell; 1280 ms is assumed in this test case.

This gives a total of 80.48 s, allow 81 s for higher priority cell reselection in the test case.

A.4.3.4.1.2.3 Void

A.4.3.4.2 E-UTRA to UTRA TDD cell re-selection: UTRA is of lower priority

A.4.3.4.2.1 Test Purpose and Environment

A.4.3.4.2.1.1 Void

A.4.3.4.2.1.2 1.28 Mcps TDD option

This test is to verify the requirement for the E-UTRA TDD to UTRA TDD inter-RAT cell re-selection requirements specified in clause 4.2.2.5 when the UTRA cell is of lower priority.

This test scenario comprised of 1 E-UTRA TDD serving cell (Cell 1), and 1 UTRA TDD cell (Cell 2) to be re-selected. Test parameters are given in table A.4.3.4.2.1.2-1, A.4.3.4.2.1.2-2, and A.4.3.4.2.1.2-3. The test consists of two successive time periods, with time duration of T1 and T2 respectively. Cell 2 is of lower priority than cell 1.

The ranking of the cells shall be made according to the cell reselection criteria specified in TS36.304.

Table A.4.3.4.2.1.2-1: General test parameters for E-UTRAN to UTRAN (1.28 Mcps TDD OPTION) Cell Re-selection

| Parameter | | Unit | Value | Comment |
|---|----------------|------|--------|--|
| Initial condition | Active cell | | Cell 1 | E-UTRAN cell |
| T1 end condition | Active cell | | Cell1 | UE shall perform reselection to cell 1 during T1 for subsequent iterations of the test |
| | Neighbour cell | | Cell2 | 1.28 Mcps TDD OPTION cell |
| T2 end condition | Active cell | | Cell2 | UE shall perform reselection to cell 2 during T2 |
| | Neighbour cell | | Cell1 | E-UTRA TDD cell |
| Uplink-downlink configuration of cell 1 | | | 1 | As specified in table 4.2.2 in TS 36.211 |
| Special subframe configuration | | | 6 | As specified in table 4.2.1 in TS 36.211 |

| | | | |
|-------------------------------|---|----------|--|
| of cell 1 | | | |
| PRACH configuration of cell 1 | | 53 | As specified in table 4.7.1-3 in TS 36.211 |
| CP length of cell 1 | | Normal | |
| Time offset between cells | | 3 ms | Asynchronous cells |
| Access Barring Information | - | Not sent | No additional delays in random access procedure. |
| Treselection | s | 0 | |
| DRX cycle length | s | 1,28 | |
| HCS | | Not used | |
| T1 | s | 85 | |
| T2 | s | 25 | |

Table A.4.3.4.2.1.2-2: Cell specific test parameters for cell re-selection E-UTRA TDD to UTRA TDD test case (cell 1)

| Parameter | Unit | Cell 1 | |
|--|-----------|-------------|------|
| | | T1 | T2 |
| E-UTRA RF Channel Number | | 1 | |
| BW _{channel} | MHz | 10 | |
| PBCH_RA | dB | 0 | 0 |
| PBCH_RB | dB | | |
| PSS_RA | dB | | |
| SSS_RA | dB | | |
| PCFICH_RB | dB | | |
| PHICH_RA | dB | | |
| PHICH_RB | dB | | |
| PDCCH_RA | dB | | |
| PDCCH_RB | dB | | |
| PDSCH_RA | dB | | |
| PDSCH_RB | dB | | |
| OCNG_RA ^{Note1} | dB | | |
| OCNG_RB ^{Note1} | dB | | |
| Qrxlevmin | dBm/15kHz | -140 | -140 |
| N _{oc} | dBm/15kHz | -98 | |
| RSRP | dBm/15kHz | -87 | -101 |
| \hat{E}_s/I_{ot} | dB | 11 | -3 |
| S _{nonintra} search | dB | Not sent | |
| Thresh _{serving, low} | dB | 46 (-94dBm) | |
| Thresh _{x, low} (Note2) | dB | 24 (-79dBm) | |
| Propagation Condition | | AWGN | |
| Note1: OCNG shall be used such that cell is fully allocated and a constant total transmitted power spectral density is achieved for all OFDM symbols. Note2: This refers to the value of Thresh _{x, low} which is included in E-UTRA system information, and is a threshold for the UTRA target cell | | | |

Table A.4.3.4.2.1.2-3: Cell specific test parameters for cell re-selection E-UTRA TDD to UTRA TDD test case (cell 2)

| Parameter | Unit | Cell 2 (UTRA) | | | |
|--------------------------------|------|---------------|----|-------|----|
| | | 0 | | DwPTS | |
| Timeslot Number | | T1 | T2 | T1 | T2 |
| UTRA RF Channel Number (Note1) | | Channel 2 | | | |
| PCCPCH_Ec/I _{or} | dB | -3 | -3 | | |
| DwPCH_Ec/I _{or} | dB | | | 0 | 0 |
| OCNS_Ec/I _{or} | dB | -3 | -3 | | |
| \hat{I}_{or}/I_{oc} | dB | 11 | 11 | 11 | 11 |

| | | | | | |
|----------------------------------|--|-------------|-----|------|------|
| I_{oc} | dBm/1.28 MHz | -80 | | | |
| PCCPCH RSCP | dBm | -72 | -72 | n.a. | n.a. |
| Propagation Condition | | AWGN | | | |
| Qrxlevmin | dBm | -103 | | | |
| Qoffset1 _{s,n} | dB | C1, C2: 0 | | | |
| Qhyst1 _s | dB | 0 | | | |
| Thresh _{x,high} (Note2) | dB | 46 (-94dBm) | | | |
| Note1: | In the case of multi-frequency cell, the UTRA RF Channel Number is the primary frequency's channel number. | | | | |
| Note2: | This refers to the value of Thresh _{x,high} which is included in UTRA system information, and is a threshold for the E-UTRA target cell | | | | |

A.4.3.4.2.1.3 Void

A.4.3.4.2.2 Test Requirements

A.4.3.4.2.2.1 Void

A.4.3.4.2.2.2 1.28 Mpcs TDD option

The cell reselection delay to lower priority is defined as the time from the beginning of time period T2, to the moment when the UE camps on cell 2, and starts to send the SYNCH-UL sequence in the UpPTS for sending the RRC CONNECTION REQUEST message on cell 2.

The cell re-selection delay to lower priority shall be less than 21 s.

The rate of correct cell reselections observed during repeated tests shall be at least 90%.

NOTE: The cell re-selection delay to lower priority cell can be expressed as: $T_{\text{evaluateUTRA_TDD}} + T_{\text{SL_UTRA}}$,

Where:

$T_{\text{evaluateUTRA_TDD}}$ 19.2s, See Table 4.2.2.5.2-1

$T_{\text{SL_UTRA}}$ Maximum repetition period of relevant system info blocks that needs to be received by the UE to camp on a cell; 1280 ms is assumed in this test case.

This gives a total of 20.48 s, allow 21 s for lower priority cell reselection in the test case.

A.4.3.4.2.2.3 Void

A.4.3.4.3 EUTRA TDD-UTRA TDD cell reselection in fading propagation conditions: UTRA TDD is of lower priority

A.4.3.4.3.1 Test Purpose and Environment

This test is to verify the requirement for the EUTRA TDD- UTRA TDD inter-RAT cell reselection requirements specified in clause 4.2.2.5.2 when the UTRA cell is of lower priority, and to verify the robustness of the UE measurement filtering in a fading environment. The E-UTRA cell is in fading propagation conditions and the UTRA cell is in AWGN propagation conditions.

The test scenario comprises of one UTRA TDD and one E-UTRA TDD cells as given in tables A.4.3.4.3.1-1, A.4.3.4.3.1-2 and A.4.3.4.3.1-3. The test consists of four successive time periods, with time duration of T1 T2, T3 and T4 respectively. Both E-UTRA cell 1 and UTRA cell 2 are already identified by the UE prior to the start of the test. Cell 2 is of lower priority than cell 1.

Table A.4.3.4.3.1-1: General test parameters for EUTRA TDD- lower priority UTRA TDD inter RAT cell re-selection test case

| Parameter | | Unit | Value | Comment |
|--|----------------|------|----------|--|
| Initial condition | Active cell | | Cell1 | E-UTRAN cell |
| T1 end condition | Active cells | | Cell1 | UE shall perform reselection to cell 1 during T1 for subsequent iterations of the test |
| | Neighbour cell | | Cell2 | |
| T3 end condition | Active cell | | Cell2 | UE shall perform reselection to cell 2 during T3 |
| | Neighbour cell | | Cell1 | |
| E-UTRA PRACH configuration | | | 53 | As specified in table 5.7.1-3 in TS 36.211 |
| Uplink-downlink configuration of cell 1 | | | 1 | As specified in table 4.2.2 in TS 36.211 |
| Special subframe configuration of cell 1 | | | 6 | As specified in table 4.2.1 in TS 36.211 |
| E_UTRA Access Barring Information | | - | Not Sent | No additional delays in random access procedure. |
| DRX cycle length | | s | 1.28 | The value shall be used for all cells in the test. |
| T1 | | s | <85 | T1 need to be defined so that cell re-selection reaction time is taken into account. T1 is terminated when the UE starts to send preambles to cell 1 |
| T2 | | s | 64 | The start of T2 is defined as the time when the UE starts to send PRACH preambles to cell 1 |
| T3 | | s | <25 | T3 need to be defined so that cell re-selection reaction time is taken into account. T3 is terminated when the UE starts to send PRACH preambles to cell 2 |
| T4 | | s | 64 | The start of T4 is defined as the time when the UE starts to send PRACH preambles to cell 2 |

Table A.4.3.4.3.1-2: Cell specific test parameters for cell 1 (E-UTRA)

| Parameter | Unit | Cell 1 | | | |
|---|------------|----------|-----|------|------|
| | | T1 | T2 | T3 | T4 |
| E-UTRA RF Channel number | | 1 | | | |
| BW _{channel} | MHz | 10 | | | |
| Correlation Matrix and Antenna Configuration | | 1x2 Low | | | |
| OCNG Patterns defined in A.3.2.2.2 (OP.2 TDD) | | OP.2 TDD | | | |
| PSS_RA | dB | 0 | | | |
| SSS_RA | dB | | | | |
| PCFICH_RB | dB | | | | |
| PHICH_RA | dB | | | | |
| PHICH_RB | dB | | | | |
| PDCCH_RA | dB | | | | |
| PDCCH_RB | dB | | | | |
| PDSCH_RA | dB | | | | |
| PDSCH_RB | dB | | | | |
| OCNG_RA ^{Note 1} | dB | | | | |
| OCNG_RB ^{Note 1} | dB | | | | |
| Qrxlevmin for UTRA neighbour cell | dBm | -103 | | | |
| Qrxlevmin | dBm | -140 | | | |
| N _{oc} | dBm/15 kHz | -104 | | | |
| RSRP | dBm/15 KHz | -82 | -82 | -107 | -107 |
| \hat{E}_s/I_{ot} | dB | 22 | 22 | -3 | -3 |
| \hat{E}_s/N_{oc} | dB | 22 | 22 | -3 | -3 |
| TreselectionEUTRAN | s | 0 | | | |

| | | |
|---|----|----------|
| Snointrasearch | dB | Not sent |
| Thresh _{-serving, low} | dB | 44 |
| Thresh _{x, low} (Note 2) | dB | 24 |
| Propagation Condition | | ETU70 |
| Note 1: OCNG shall be used such that both cells are fully allocated and a constant total transmitted power spectral density is achieved for all OFDM symbols. | | |
| Note 2: This refers to the value of Thresh _{x, low} which is included in E-UTRA system information, and is a threshold for the UTRA target cell. | | |

Table A.4.3.4.3.1-3: Cell specific test parameters for cell 2 (UTRA)

| Parameter | Unit | Cell 2 (UTRA) | | | | | | | |
|--|--------------|---------------|-----|-----|-----|-------|------|------|------|
| | | 0 | | | | DwPTS | | | |
| Timeslot Number | | T1 | T2 | T3 | T4 | T1 | T2 | T3 | T4 |
| UTRA RF Channel Number (Note1) | | Channel 2 | | | | | | | |
| PCCPCH_Ec/lor | dB | -3 | | | | | | | |
| DwPCH_Ec/lor | dB | | | | | 0 | | | |
| OCNS_Ec/lor | dB | -3 | | | | | | | |
| \hat{I}_{or}/I_{oc} | dB | 13 | 13 | 13 | 13 | 13 | 13 | 13 | 13 |
| I_{oc} | dBm/1.28 MHz | -80 | | | | | | | |
| PCCPCH RSCP | dBm | -70 | -70 | -70 | -70 | n.a. | n.a. | n.a. | n.a. |
| Propagation Condition | | AWGN | | | | | | | |
| Qrxlevmin | dBm | -103 | | | | | | | |
| Qrxlevmin _{EUTRA} | dBm | -140 | | | | | | | |
| UE_TXPWR_MAX_RACH | dBm | 21 | | | | | | | |
| Treselection | s | 0 | | | | | | | |
| Thresh _{x, high} (Note2) | dB | 44 | | | | | | | |
| Note1: In the case of multi-frequency cell, the UTRA RF Channel Number is the primary frequency's channel number. | | | | | | | | | |
| Note2: This refers to the value of Thresh _{x, high} which is included in UTRA system information, and is a threshold for the E-UTRA target cell | | | | | | | | | |

A.4.3.4.3.2 Test Requirements

The probability of reselection from cell 1 to cell 2 during T2 observed during testing shall be less than 10%

The probability of reselection from cell 2 to cell 1 during T4 observed during testing shall be less than 10%

The cell reselection delay to lower priority is defined as the time from the beginning of time period T3, to the moment when the UE camps on cell 2, and starts to send the SYNCH-UL sequene in the U_pPTS for sending the RRC CONNECTION REQUEST message on cell 2. In order to evaluate reselection delay, the system simulator first needs to verify that the UE is camped on cell 1 at the start of T3

The cell re-selection delay to lower priority shall be less than 21 s.

The rate of correct cell reselections observed during repeated tests shall be at least 90%.

NOTE: The cell re-selection delay to lower priority cell can be expressed as: $T_{\text{evaluateUTRA_TDD}} + T_{\text{SL-UTRA}}$

Where:

$T_{\text{evaluateUTRA_TDD}}$ 19.2s, See Table 4.2.2.5.2-1

$T_{\text{SL-UTRA}}$ Maximum repetition period of relevant system info blocks that needs to be received by the UE to camp on a cell; 1280 ms is assumed in this test case.

This gives a total of 20.48 s for lower priority cell reselection, allow 21 s.

A.4.3.4.4 E-UTRA TDD to UTRA TDD cell re-selection for IncMon

A.4.3.4.4.1 Test Purpose and Environment

This test is to verify the requirement for the E-UTRA TDD to UTRA TDD inter-RAT cell reselection requirements for increased UE carrier monitoring specified in clause 4.2.2.4. UTRA TDD cells are of lower priority than E-UTRA serving cell.

The test scenario comprises of indicating 7 UTRA TDD inter-RAT cells on 7 different carriers in the neighbour list of cell 1 as given in tables A.4.3.4.4.1-1, A.4.3.4.4.1-2 and A.4.3.4.4.1-3. Each repetition of the test consists of five successive time periods, with time duration of T0, T1, T2, T3, and T4 respectively. In the initialisation phase and at the start of each repetition of T0, the test equipment provides signals for cell 1 (E-UTRA serving cell), and selects frequencies for cells 2 and 3 which are chosen from the 7 inter-RAT layers which are configured in the UE neighbour cell list as described in general and cell specific parameters. The neighbour lists of cells 2 and 3 shall include the frequency of cell 1 in the normal performance group and shall exclude the other UTRA TDD frequencies configured to the UE in the test.

Cell 1, 2, and 3 are identified by the UE during time phase T0. Cell 1, cell 2, and cell 3 belong to different tracking areas. Furthermore, UE has not registered with network for the tracking area containing cell 2 or 3.

Table A.4.3.4.4.1-1: General test parameters for E-UTRA TDD to UTRA TDD inter-RAT cell re-selection test case

| Parameter | | Unit | Value | Comment |
|--|----------------|------|---|---|
| T0 | Active cell | | Cell1 | T0 is repeated on each repetition of the test. In T0 the test equipment selects frequencies for cell 2, 3 and then time is allowed for the UE to identify the neighbour cells. See cell specific parameters for detailed settings. |
| T1 start condition | Active cell | | Cell 1 | |
| T1 end condition | Active cell | | Cell2 | UE shall perform reselection to cell 2 during T1 |
| | Neighbour cell | | Cell1 | |
| T2 end condition | Active cell | | Cell1 | UE shall perform reselection to cell 1 during T2 |
| T3 end condition | Active cell | | Cell3 | UE shall perform reselection to cell 3 during T3 |
| | Neighbour cell | | Cell1 | |
| T4 end condition | Active cell | | Cell1 | UE shall perform reselection to cell 1 in T4 so that next repetition of test can start from T0 |
| UE configured UTRA RF Channel Number | | | 1, 2, 3, 4, 5, 6, 7 | Seven UTRA TDD carrier frequencies are used in the UE neighbour cell list. Frequencies 4, 5, 6, and 7 are indicated to have reduced performance |
| Test equipment configuration | | | Cell 1, 2, 3 | Cell 1 uses E-UTRA RF channel number 1 Cells 2 is randomly selected to use different frequencies selected from UTRA frequencies 1, 2, 3. Cells 3 is randomly selected to use different frequencies selected from UTRA frequencies 4, 5, 6, 7. |
| Uplink-downlink configuration of cell 1 | | | 1 | As specified in table 4.2.2 in TS 36.211 [16] |
| Special subframe configuration of cell 1 | | | 6 | As specified in table 4.2.1 in TS 36.211 [16] |
| CP length of cell 1 | | | normal | |
| PRACH configuration | | | 53 | As specified in table 5.7.1-3 in TS 36.211 [16] |
| Access Barring Information | | - | Not Sent | No additional delays in random access procedure. |
| T _{reselection} | | s | 0 | |
| HCS | | | Not used | |
| DRX cycle length | | s | 1.28 | The value shall be used for all cells in the test. |
| T0 | | s | (Test equipment frequency selection and configuration time) + 960 | T0 is defined so that the Test equipment selects frequencies and configures the cells, then the UE cell detection time is taken into account. |
| T1 | | s | 60 | T1 need to be defined so that cell re-selection reaction time is taken into account. |

| | | | |
|----|---|-----|--|
| T2 | s | 25 | T2 need to be defined so that cell re-selection reaction time is taken into account |
| T3 | s | 500 | T3 need to be defined so that cell re-selection reaction time is taken into account. |
| T4 | s | 25 | T4 need to be defined so that cell re-selection reaction time is taken into account |

Table A.4.3.4.4.1-2: E-UTRA Cell specific test parameters for E-UTRA TDD to UTRA TDD inter-RAT cell reselection test case in AWGN

| Parameter | Unit | Cell 1 | | | | |
|---|-----------|---|------|-----|------|-----|
| | | T0 | T1 | T2 | T3 | T4 |
| E-UTRA RF Channel number | | 1 | | | | |
| BW _{channel} | MHz | 5MHz: N _{RB} = 25 10MHz: N _{RB} = 50 | | | | |
| OCNG Patterns | | 5MHz: OP.10 TDD 10MHz: OP.2 TDD | | | | |
| PBCH_RA | dB | 0 | | | | |
| PBCH_RB | dB | | | | | |
| PSS_RA | dB | | | | | |
| SSS_RA | dB | | | | | |
| PCFICH_RB | dB | | | | | |
| PHICH_RA | dB | | | | | |
| PHICH_RB | dB | | | | | |
| PDCCH_RA | dB | | | | | |
| PDCCH_RB | dB | | | | | |
| PDSCH_RA | dB | | | | | |
| PDSCH_RB | dB | | | | | |
| OCNG_RA ^{Note 1} | dB | | | | | |
| OCNG_RB ^{Note 1} | dB | | | | | |
| N_{oc} ^{Note 2} | dBm/15kHz | | | | | |
| \hat{E}_s / N_{oc} | dB | 11 | -3 | 11 | -3 | 11 |
| \hat{E}_s / I_{ot} ^{Note 3} | dB | 11 | -3 | 11 | -3 | 11 |
| RSRP ^{Note 3} | dBm/15kHz | -87 | -101 | -87 | -101 | -87 |
| Q _{rxlevmin} | dBm/15kHz | -140 | | | | |
| S _{noninrasearch} | dB | Not sent | | | | |
| Thresh _{servin, low} | dB | 46 (-94dBm) | | | | |
| Thresh _{x, low} ^{Note 4} | dB | 24 (-79dBm) | | | | |
| Propagation Condition | | AWGN | | | | |
| Antenna Configuration | | 1x2 | | | | |
| Note 1: OCNG shall be used such that both cells are fully allocated and a constant total transmitted power spectral density is achieved for all OFDM symbols. Note 2: Interference from other cells and noise sources not specified in the test is assumed to be constant over subcarriers and time and shall be modelled as AWGN of appropriate power for to be fulfilled. Note 3: E _s /I _{ot} and RSRP levels have been derived from other parameters for information purposes. They are not settable parameters themselves. Note 4: This refers to the value of Thresh _{x, low} which is included in E-UTRA system information, and is a threshold for the UTRA TDD target cell. | | | | | | |

Table A.4.3.4.4.1-3: UTRA TDD Cell specific test parameters for E-UTRA TDD to UTRA TDD inter-RAT cell reselection test case in AWGN

| Parameter | Unit | Cell 2 (UTRA TDD) | | | | | | | | | |
|---|------|--|----|----|----|----|-------|----|----|----|----|
| | | 0 | | | | | DwPTS | | | | |
| Timeslot Number | | T0 | T1 | T2 | T3 | T4 | T0 | T1 | T2 | T3 | T4 |
| UTRA RF Channel Number ^{Note1} | | Randomly selected from 1, 2, 3 such that cell 2 is in the normal performance group | | | | | | | | | |
| PCCPCH_Ec/Ior | dB | -3 | | | | | | | | | |
| DwPCH_Ec/Ior | dB | | | | | | 0 | | | | |

| | | | | | | | | | | | |
|------------------------------------|---|-------------|-----|-----|-----|-----|------|----|----|----|----|
| OCNS_Ec/lor | dB | -3 | | | | | | | | | |
| I_{oc} | dBm/ 1.28 MHz | -80 | | | | | | | | | |
| \hat{I}_{or}/I_{oc} | dB | -3 | 11 | -3 | -3 | -3 | -3 | 11 | -3 | -3 | -3 |
| PCCPCH RSCP | dBm | -86 | -72 | -86 | -86 | -86 | n.a. | | | | |
| Propagation Condition | | AWGN | | | | | | | | | |
| $Q_{rxlevmin}$ | dBm | -103 | | | | | | | | | |
| $Q_{offset1_{s,n}}$ | dB | C1, C2: 0 | | | | | | | | | |
| Q_{hyst1_s} | dB | 0 | | | | | | | | | |
| $S_{prioritysearch1}$ | dB | 24 (-79dBm) | | | | | | | | | |
| $S_{prioritysearch2}$ | dB | 0 | | | | | | | | | |
| $Thresh_{x, low}$ ^{Note2} | dB | 46 (-94dBm) | | | | | | | | | |
| $S_{searchE-UTRA}$ | dB | Not send | | | | | | | | | |
| Time offset to cell1 | ms | 3 | | | | | | | | | |
| Note1: | In the case of multi-frequency cell, the UTRA RF Channel Number is the primary frequency's channel number. | | | | | | | | | | |
| Note2: | This refers to the value of $Thresh_{x, low}$ which is included in UTRA system information, and is a threshold for the E-UTRA target cell | | | | | | | | | | |

Table A.4.3.4.4.1-4:

| Parameter | Unit | Cell 3 (UTRA TDD) | | | | | | | | | |
|---|--|--|-----|-----|-----|-----|-------|----|----|----|----|
| | | 0 | | | | | DwPTS | | | | |
| Timeslot Number | | T0 | T1 | T2 | T3 | T4 | T0 | T1 | T2 | T3 | T4 |
| UTRA RF Channel Number ^{Note1} | | Randomly selected from 4, 5, 6, 7 such that cell 3 is in the reduced performance group | | | | | | | | | |
| PCCPCH_Ec/lor | dB | -3 | | | | | | | | | |
| DwPCH_Ec/lor | dB | | | | | | 0 | | | | |
| OCNS_Ec/lor | dB | -3 | | | | | | | | | |
| I_{oc} | dBm/ 1.28 MHz | -80 | | | | | | | | | |
| \hat{I}_{or}/I_{oc} | dB | -3 | -3 | -3 | 11 | -3 | -3 | -3 | -3 | 11 | -3 |
| PCCPCH RSCP | dBm | -86 | -86 | -86 | -72 | -86 | n.a. | | | | |
| Propagation Condition | | AWGN | | | | | | | | | |
| $Q_{rxlevmin}$ | dBm | -103 | | | | | | | | | |
| $Q_{offset1_{s,n}}$ | dB | C1, C2: 0 | | | | | | | | | |
| Q_{hyst1_s} | dB | 0 | | | | | | | | | |
| $S_{prioritysearch1}$ | dB | 24 (-79dBm) | | | | | | | | | |
| $S_{prioritysearch2}$ | dB | 0 | | | | | | | | | |
| $Thresh_{x, high}$ ^{Note2} | dB | 46 (-94dBm) | | | | | | | | | |
| $S_{searchE-UTRA}$ | dB | Not send | | | | | | | | | |
| Time offset to cell1 | ms | 3 | | | | | | | | | |
| Time offset to cell2 | µs | 3 | | | | | | | | | |
| Note1: | In the case of multi-frequency cell, the UTRA RF Channel Number is the primary frequency's channel number. | | | | | | | | | | |
| Note2: | This refers to the value of $Thresh_{x, high}$ which is included in UTRA system information, and is a threshold for the E-UTRA target cell | | | | | | | | | | |

A.4.3.4.4.2 Test Requirements

The cell reselection delay is defined as the time from the beginning of a relevant time period, to the moment when the UE camps on the target cell, and starts to send the SYNCH-UL sequence in the UpPTS on cell 2, 3 for sending the RRC CONNECTION REQUEST message to perform a Tracking Area Update procedure on the target cell.

The reselection delays shall meet the requirements in table A.4.3.4.4.2-1

Table A.4.3.4.4.2-1: Test requirements for E-UTRA TDD to UTRA TDD inter-RAT cell reselection

| Time phase | Target cell | Requirement for reselection delay (seconds) |
|------------|-------------|---|
|------------|-------------|---|

| | | |
|----|------------------------------------|-------|
| T1 | Cell 2 (normal performance group) | 58.9 |
| T3 | Cell 3 (reduced performance group) | 462.1 |

The rate of correct cell reselections observed during repeated tests shall be at least 90%, with a successful reselection counted if it is within the required time regardless of the carrier frequencies involved. At least 90% of reselections to the reduced performance group shall be within the required time, and at least 90% of reselections to the normal performance group shall be within the required time.

NOTE: The cell re-selection delay to a normal performance group cell can be expressed as: $N_{\text{UTRA_carrier_TDD,normal}} * T_{\text{evaluateUTRA_TDD}} + T_{\text{SI_UTRA}}$, and to a reduced performance group cell can be expressed as: $6 * N_{\text{UTRA_carrier_TDD,reduced}} * T_{\text{evaluateUTRA_TDD}} + T_{\text{SI_UTRA}}$.

Where:

$T_{\text{evaluateUTRA_TDD}}$ 19.2s, See Table 4.2.2.5.2-1

$T_{\text{SI_UTRA}}$ Maximum repetition period of relevant system info blocks that needs to be received by the UE to camp on a cell; 1280 ms is assumed in this test case.

This gives a total of $3 * 19.2 + 1.28 = 58.88$ s for normal performance group reselection and $6 * 4 * 19.2 + 1.28 = 462.08$ s for reduced performance group reselection, allow 58.9s for normal performance group and 462.1s for reduced performance group in the test case.

Since only one E-UTRA frequency is configured and signal level of UTRA cell is lower than threshold of $S_{\text{prioritysearch}}$, the UE shall select back to cell 1 (E-UTRA cell) within $K_{\text{carrier}} * T_{\text{evaluateEUTRA}} + T_{\text{SI}} = 19.2 + 1.28 = 20.48$ s, allow 21 s.

A.4.4 E-UTRAN to GSM Cell Re-Selection

A.4.4.1 E-UTRAN FDD – GSM:

A.4.4.1.1 Test Purpose and Environment

This test is to verify the requirement for the E-UTRAN FDD to GSM cell re-selection delay reported in clause 4.2.2.5.

This scenario implies the presence of 1 E-UTRAN serving cell, and 1 GSM cell to be re-selected. The UE is requested to monitor neighbouring cells on 1 E-UTRA carrier and 12 GSM cells. Test parameters are given in Table, A.4.4.1-1, A.4.4.1-2, A.4.4.1-3. E-UTRA FDD cell (Cell 1) and GSM cell (cell 2) shall belong to different Location Areas. The test comprises two successive time periods, T1 and T2. During initialization before the start of the test, the UE is camped on cell 1. By the end of T1, the UE has identified BSIC on the GSM BCCH carrier of cell 2 but the signal levels do not meet the reselection criterion during T1. At the start of T2, the signal levels change such that cell 2 satisfies reselection criterion. The GSM layer is configured at a lower priority than the serving E-UTRA FDD layer.

Table A.4.4.1-1: General test parameters for E-UTRA FDD GSM cell re-selection test case

| Parameter | Unit | Value | Comment |
|----------------------------|----------------|----------|--|
| Initial condition | Active cell | Cell1 | UE shall be forced to cell 1 in the initialisation phase and shall be able to detect and monitor the 4 strongest GSM BCCH carriers in T1 . Cell 1 is an E-UTRA FDD cell. |
| Final condition | Neighbour cell | Cell2 | UE shall perform reselection to cell 2 during T2. Cell 2 is a GSM cell. |
| E-UTRA RF Channel Number | | 1 | 1 E-UTRA FDD carrier frequency |
| GSM ARFCN | | 1 | 12 GSM BCCH carriers are used |
| PRACH configuration | | 4 | As specified in table 5.7.1-2 in TS 36.211 |
| Access Barring Information | - | Not Sent | No additional delays in random access procedure. |
| CP length of cell 1 | | Normal | |
| DRX cycle length | s | 1.28 | The value shall be used for all cells in the test. |
| T1 | s | 35 | T1 need to be defined so that cell re-selection reaction time is taken into account. |

| | | | |
|---------------------|---|------|---|
| T2 | s | 35 | T2 need to be defined so that the higher layer search periodicity and cell re-selection reaction time are taken into account. |
| Propagation channel | | AWGN | |

Table A.4.4.1-2: Cell-specific test parameters for Cell 1 – E-UTRA FDD cell

| Parameter | Unit | Cell 1 | |
|---|------------|----------|------|
| | | T1 | T2 |
| E-UTRA RF Channel number | | 1 | |
| BW_{channel} | MHz | 10 | |
| OCNG Patterns defined in A.3.2.1.2 (OP.2 FDD) | | OP.2 FDD | |
| PBCH_RA | dB | 0 | |
| PBCH_RB | dB | | |
| PSS_RA | dB | | |
| SSS_RA | dB | | |
| PCFICH_RB | dB | | |
| PHICH_RA | dB | | |
| PHICH_RB | dB | | |
| PDCCH_RA | dB | | |
| PDCCH_RB | dB | | |
| PDSCH_RA | dB | | |
| PDSCH_RB | dB | | |
| OCNG_RA ^{Note 1} | dB | | |
| OCNG_RB ^{Note 1} | dB | | |
| Qrxlevmin | dBm | | |
| N_{oc} | dBm/15 kHz | -98 | |
| RSRP | dBm/15 KHz | -89 | -102 |
| \hat{E}_s/I_{ot} | dB | 9 | -4 |
| \hat{E}_s/N_{oc} | dB | 9 | -4 |
| $T_{\text{reselectionEUTRAN}}$ | s | 0 | |
| $S_{\text{nonintra search}}$ | dB | Not sent | |
| Thresh _{serv, low} | dB | 44 | |
| Thresh _{x, low} (Note 2) | dB | 24 | |
| Note 1: OCNG shall be used such that both cells are fully allocated and a constant total transmitted power spectral density is achieved for all OFDM symbols. | | | |
| Note 2: This refers to Thresh _{x, low} which is included in E-UTRA system information, and is a threshold for GSM target cell. | | | |

Table A.4.4.1-3: Cell-specific test parameters for Cell 2 – GSM cell

| Parameter | Unit | Cell 2 (GSM) | |
|----------------------------|------|--------------|-----|
| | | T1 | T2 |
| Absolute RF Channel Number | | ARFCN 1 | |
| RXLEV | dBm | -90 | -75 |
| RXLEV_ACCESS_MIN | dBm | -105 | |
| MS_TXPWR_MAX_CCH | dBm | 24 | |

A.4.4.1.2 Test Requirements

The cell re-selection delay is defined as the time from the beginning of time period T2, to the moment when the UE camps on Cell 2, and starts to send the RR Channel Request message for location update to Cell 2.

The cell re-selection delay shall be less than $26\text{ s} + T_{\text{BCCH}}$, where T_{BCCH} is the maximum time allowed to read BCCH data from GSM cell [8].

The rate of correct cell reselections observed during repeated tests shall be at least 90%.

NOTE: The cell re-selection delay can be expressed as: $4 * T_{\text{measureGSM}} + T_{\text{BCCH}}$, where:

$T_{\text{measureGSM}}$ See Table 4.2.2.5.3-1 in clause 4.2.2.5.3.

T_{BCCH} Maximum time allowed to read BCCH data from GSM cell [8].
According to [8], the maximum time allowed to read the BCCH data, when being synchronized to a BCCH carrier, is 1.9 s.

This gives a total of $25.6\text{ s} + T_{\text{BCCH}}$, allow $26\text{ s} + T_{\text{BCCH}}$ in the test case.

A.4.4.2 E-UTRAN TDD – GSM:

A.4.4.2.1 Test Purpose and Environment

This test is to verify the requirement for the E-UTRAN TDD to GSM cell re-selection delay reported in clause 4.2.2.5.

This scenario implies the presence of 1 E-UTRAN serving cell, and 1 GSM cell to be re-selected. The UE is requested to monitor neighbouring cells on 1 E-UTRA carrier and 12 GSM cells. Test parameters are given in Table, A.4.4.2-1, A.4.4.2-2, A.4.4.2-3. E-UTRA TDD cell (Cell 1) and GSM cell (cell 2) shall belong to different Location Areas. The test comprises two successive time periods, T1 and T2. During initialization before the start of the test, the UE is camped on cell 1. By the end of T1, the UE has identified BSIC on the GSM BCCH carrier of cell 2 but the signal levels do not meet the reselection criterion during T1. At the start of T2, the signal levels change such that cell 2 satisfies reselection criterion. The GSM layer is configured at a lower priority than the serving E-UTRA TDD layer.

Table A.4.4.2-1: General test parameters for E-UTRA TDD GSM cell re-selection test case

| Parameter | | Unit | Value | Comment |
|---|----------------|------|----------|---|
| Initial condition | Active cell | | Cell1 | UE shall be forced to cell 1 in the initialisation phase and shall be able to detect and monitor the 4 strongest GSM BCCH carriers in T1. Cell 1 is an E-UTRA TDD cell. |
| Final condition | Neighbour cell | | Cell2 | UE shall perform reselection to cell 2 during T2. Cell 2 is a GSM cell. |
| E-UTRA RF Channel Number | | | 1 | 1 E-UTRA TDD carrier frequency |
| GSM ARFCN | | | 1 | 12 GSM BCCH carriers are used |
| Uplink-downlink configuration of cell 1 | | | 1 | As specified in table 4.2.2 in TS 36.211 |
| Special subframe configuration for cell 1 | | | 6 | As specified in table 4.2.1 in TS 36.211 |
| PRACH configuration for cell 1 | | | 53 | As specified in table 5.7.1-3 in TS 36.211 |
| CP length of cell 1 | | | Normal | |
| Access Barring Information | | - | Not Sent | No additional delays in random access procedure. |
| DRX cycle length | | s | 1.28 | The value shall be used for all cells in the test. |
| T1 | | s | 35 | T1 need to be defined so that cell re-selection reaction time is taken into account. |
| T2 | | s | 35 | T2 need to be defined so that the higher layer search periodicity and cell re-selection reaction time are taken into account. |
| Propagation channel | | | AWGN | |

Table A.4.4.2-2: Cell-specific test parameters for Cell 1 – E-UTRA TDD cell

| Parameter | Unit | Cell 1 | |
|--------------------------|------|--------|----|
| | | T1 | T2 |
| E-UTRA RF Channel number | | 1 | |
| BW_{channel} | MHz | 10 | |

| OCNG Patterns defined in A.3.2.2.2 (OP.2 TDD) | | OP.2 TDD | |
|---|------------|----------|------|
| PBCH_RA | dB | 0 | |
| PBCH_RB | dB | | |
| PSS_RA | dB | | |
| SSS_RA | dB | | |
| PCFICH_RB | dB | | |
| PHICH_RA | dB | | |
| PHICH_RB | dB | | |
| PDCCH_RA | dB | | |
| PDCCH_RB | dB | | |
| PDSCH_RA | dB | | |
| PDSCH_RB | dB | | |
| OCNG_RA ^{Note 1} | dB | | |
| OCNG_RB ^{Note 1} | dB | | |
| Qrxlevmin | dBm | | |
| N_{oc} | dBm/15 kHz | -98 | |
| RSRP | dBm/15 KHz | -89 | -102 |
| \hat{E}_s/I_{ot} | dB | 9 | -4 |
| \hat{E}_s/N_{oc} | dB | 9 | -4 |
| T _{reselectionEUTRAN} | s | 0 | |
| S _{nonintrasearch} | dB | Not sent | |
| Thresh _{serving, low} | dB | 44 | |
| Thresh _{x, low} (Note 2) | dB | 24 | |
| Note 1: OCNG shall be used such that both cells are fully allocated and a constant total transmitted power spectral density is achieved for all OFDM symbols. | | | |
| Note 2: This refers to Thresh _{x, low} which is included in E-UTRA system information, and is a threshold for GSM target cell. | | | |

Table A.4.4.2-3: Cell-specific test parameters for Cell 2 – GSM cell

| Parameter | Unit | Cell 2 (GSM) | |
|----------------------------|------|--------------|-----|
| | | T1 | T2 |
| Absolute RF Channel Number | | ARFCN 1 | |
| RXLEV | dBm | -90 | -75 |
| RXLEV_ACCESS_MIN | dBm | -105 | |
| MS_TXPWR_MAX_CCH | dBm | 24 | |

A.4.4.2.2 Test Requirements

The cell re-selection delay is defined as the time from the beginning of time period T2, to the moment when the UE camps on Cell 2, and starts to send the RR Channel Request message for location update to Cell 2.

The cell re-selection delay shall be less than $26\text{ s} + T_{\text{BCCH}}$, where T_{BCCH} is the maximum time allowed to read BCCH data from GSM cell [8].

The rate of correct cell reselections observed during repeated tests shall be at least 90%.

NOTE: The cell re-selection delay can be expressed as: $4 * T_{\text{measureGSM}} + T_{\text{BCCH}}$, where:

$T_{\text{measureGSM}}$ See Table 4.2.2.5.3-1 in clause 4.2.2.5.3.

T_{BCCH} Maximum time allowed to read BCCH data from GSM cell [8].
According to [8], the maximum time allowed to read the BCCH data, when being synchronized to a BCCH carrier, is 1.9 s.

This gives a total of $25.6\text{ s} + T_{\text{BCCH}}$, allow $26\text{ s} + T_{\text{BCCH}}$ in the test case.

A.4.5 E-UTRAN to HRPD Cell Re-Selection

A.4.5.1 E-UTRAN FDD – HRPD

A.4.5.1.1 E-UTRAN FDD – HRPD Cell Reselection: HRPD is of Lower Priority

A.4.5.1.1.1 Test Purpose and Environment

This test is to verify the requirement for the E-UTRAN FDD- HRPD inter-RAT cell reselection requirements specified in clause 4.2.2.5.4 when the HRPD cell is of lower priority.

The test scenario comprises of one HRPD and one E-UTRAN FDD cells as given in tables A.4.5.1.1.1-1, A.4.5.1.1.1-2 and A.4.5.1.1.1-3.

The test consists of two successive time periods, with time duration of T1 and T2 respectively. Both E-UTRAN FDD cell 1 and HRPD cell 2 are already identified by the UE prior to the start of the test. At T1 the UE is camped on to cell 1. Cell 2 is of lower priority than cell 1. Cell 1 and cell 2 shall belong to different tracking areas.

Table A.4.5.1.1.1-1: General Test Parameters for E-UTRAN FDD - lower priority HRPD Cell Re-selection

| Parameter | | Unit | Value | Comment |
|---|----------------|------|----------|--|
| Initial condition | Active cell | | Cell 1 | E-UTRAN FDD cell |
| | Neighbour cell | | Cell 2 | HRPD cell |
| Final condition | Active cell | | Cell 2 | HRPD cell is selecting during T2 |
| DRX cycle length | | s | 1.28 | |
| E-UTRA FDD RF Channel Number | | | 1 | Only one FDD carrier frequency is used. |
| E-UTRA FDD Channel Bandwidth ($BW_{channel}$) | | MHz | 10 | |
| HRPD RF Channel Number | | | 1 | Only one HRPD carrier frequency is used. |
| E-UTRA FDD PRACH configuration | | | 4 | As specified in table 5.7.1-2 in TS 36.211 |
| E_UTRA FDD Access Barring Information | | - | Not Sent | No additional delays in random access procedure. |
| T1 | | s | 30 | |
| T2 | | s | 30 | |

Table A.4.5.1.1.1-2: Cell Specific Test Parameters for E-UTRAN FDD (Cell # 1)

| Parameter | Unit | Cell 1 | |
|---|------------|----------|------|
| | | T1 | T2 |
| E-UTRA RF Channel number | | 1 | |
| $BW_{channel}$ | MHz | 10 | |
| OCNG Patterns defined in A.3.2.1.2 (OP.2 FDD) | | OP.2 FDD | |
| PBCH_RA | dB | 0 | |
| PBCH_RB | dB | | |
| PSS_RA | dB | | |
| SSS_RA | dB | | |
| PCFICH_RB | dB | | |
| PHICH_RA | dB | | |
| PHICH_RB | dB | | |
| PDCCH_RA | dB | | |
| PDCCH_RB | dB | | |
| PDSCH_RA | dB | | |
| PDSCH_RB | dB | | |
| OCNG_RA ^{Note 1} | dB | | |
| OCNG_RB ^{Note 1} | dB | | |
| N_{oc} | dBm/15 kHz | -98 | |
| RSRP | dBm/15 KHz | -89 | -102 |
| \hat{E}_s / I_{ot} | dB | 9 | -4 |
| \hat{E}_s / N_{oc} | dB | 9 | -4 |
| Treselection _{EUTRAN} | S | 0 | |
| Snonintrasearch | dB | Not sent | |
| cellReselectionPriority | - | 1 | |
| Qrxlevmin | dBm | -140 | |
| Qrxlevminoffset | dB | 0 | |
| Pcompensation | dB | 0 | |
| $S_{ServingCell}$ | dB | 51 | 38 |
| Thresh _{serv, low} | dB | 44 | |
| Propagation Condition | | AWGN | |
| Note 1: OCNG shall be used such that both cells are fully allocated and a constant total transmitted power spectral density is achieved for all OFDM symbols. | | | |

Table A.4.5.1.1.1-3: Cell Specific Test Parameters for HRPD (cell # 2)

| Parameter | Unit | Cell 2 | |
|---|-----------------|--------|----|
| | | T1 | T2 |
| HRPD RF Channel Number | | 1 | |
| $\frac{\text{Control } E_b}{N_t}$ (38.4 kbps) | dB | 21 | |
| $\frac{\text{Control } E_b}{N_t}$ (76.8 kbps) | dB | 18 | |
| \hat{I}_{or}/I_{oc} | dB | 0 | 0 |
| I_{oc} | dBm/ 1.2288 MHz | -55 | |
| CDMA2000 HRPD Pilot Strength | dB | -3 | -3 |
| Propagation Condition | | AWGN | |
| $S_{\text{nonServingCell},x}$ | | -6 | |
| Treselection | s | 0 | |
| hrpd-CellReselectionPriority | - | 0 | |
| Thresh _{x, low} | | -14 | |

A.4.5.1.1.2 Test Requirements

The cell reselection delay to lower priority is defined as the time from the beginning of time period T2, to the moment when the UE camps on cell 2 and starts to send access probe preambles on the Access Channel on cell 2.

The cell re-selection delay to the lower priority cell 2 shall be less than 21 s.

The rate of correct cell reselections observed during repeated tests shall be at least 90%.

NOTE: The cell re-selection delay to lower priority cell can be expressed as: $T_{\text{evaluateHRPD}} + T_{\text{SI-HRPD}}$

Where:

$T_{\text{evaluateHRPD}}$ See Table 4.2.2.5.4-1

$T_{\text{SI-HRPD}}$ Maximum repetition period of relevant system information blocks that need to be received by the UE to camp on cell 2; 1704 ms is assumed in this test case.

This gives a total of 20.904 s for the lower priority cell reselection, allow 21 s in the test case.

A.4.5.2 E-UTRAN TDD – HRPD

A.4.5.2.1 E-UTRAN TDD – HRPD Cell Reselection: HRPD is of Lower Priority

A.4.5.2.1.1 Test Purpose and Environment

This test is to verify the requirement for the E-UTRAN TDD- HRPD inter-RAT cell reselection requirements specified in clause 4.2.2.5.4 when the HRPD cell is of lower priority.

The test scenario comprises of one HRPD and one E-UTRAN TDD cells as given in tables A.4.5.2.1.1-1, A.4.5.2.1.1-2 and A.4.5.2.1.1-3.

The test consists of two successive time periods, with time duration of T1 and T2 respectively. Both E-UTRAN TDD cell 1 and HRPD cell 2 are already identified by the UE prior to the start of the test. At T1 the UE is camped on to cell 1. Cell 2 is of lower priority than cell 1. Cell 1 and cell 2 shall belong to different tracking areas.

Table A.4.5.2.1.1-1: General Test Parameters for E-UTRAN TDD - lower priority HRPD Cell Re-selection

| | Parameter | Unit | Value | Comment |
|--|------------------|-------------|--------------|--|
| Initial condition | Active cell | | Cell 1 | E-UTRAN TDD cell |
| | Neighbour cell | | Cell 2 | HRPD cell |
| Final condition | Active cell | | Cell 2 | HRPD cell is selecting during T2 |
| Uplink-downlink configuration of cell 1 | | | 1 | As specified in table 4.2.2 in TS 36.211 |
| Special subframe configuration of cell 1 | | | 6 | As specified in table 4.2.1 in TS 36.211 |
| CP length of cell 1 | | | Normal | |
| DRX cycle length | | s | 1.28 | |
| E-UTRA TDD RF Channel Number | | | 1 | Only one TDD carrier frequency is used. |
| E-UTRA TDD Channel Bandwidth (BWchannel) | | MHz | 10 | |
| HRPD RF Channel Number | | | 1 | Only one HRPD carrier frequency is used. |
| E-UTRA TDD PRACH configuration of cell 1 | | | 53 | As specified in table 4.7.1-3 in TS 36.211 |
| E_UTRA TDD Access Barring Information | | - | Not Sent | No additional delays in random access procedure. |
| T1 | | s | 30 | |
| T2 | | s | 30 | |

Table A.4.5.2.1.1-2: Cell Specific Test Parameters for E-UTRAN TDD (Cell # 1)

| Parameter | Unit | Cell 1 | |
|---|------------|----------|------|
| | | T1 | T2 |
| E-UTRA RF Channel number | | 1 | |
| $BW_{channel}$ | MHz | 10 | |
| OCNG Patterns defined in A.3.2.2.2 (OP.2 TDD) | | OP.2 TDD | |
| PBCH_RA | dB | 0 | |
| PBCH_RB | dB | | |
| PSS_RA | dB | | |
| SSS_RA | dB | | |
| PCFICH_RB | dB | | |
| PHICH_RA | dB | | |
| PHICH_RB | dB | | |
| PDCCH_RA | dB | | |
| PDCCH_RB | dB | | |
| PDSCH_RA | dB | | |
| PDSCH_RB | dB | | |
| OCNG_RA ^{Note 1} | dB | | |
| OCNG_RB ^{Note 1} | dB | | |
| N_{oc} | dBm/15 kHz | -98 | |
| RSRP | dBm/15 KHz | -89 | -102 |
| \hat{E}_s / I_{ot} | dB | 9 | -4 |
| \hat{E}_s / N_{oc} | dB | 9 | -4 |
| Treselection _{EUTRAN} | S | 0 | |
| Snonintrasearch | dB | Not sent | |
| cellReselectionPriority | - | 1 | |
| Qrxlevmin | dBm | -140 | |
| Qrxlevminoffset | dB | 0 | |
| Pcompensation | dB | 0 | |
| $S_{ServingCell}$ | dB | 51 | 38 |
| Thresh _{serv, low} | dB | 44 | |
| Propagation Condition | | AWGN | |
| Note 1: OCNG shall be used such that both cells are fully allocated and a constant total transmitted power spectral density is achieved for all OFDM symbols. | | | |

Table A.4.5.2.1.1-3: Cell Specific Test Parameters for HRPD (cell # 2)

| Parameter | Unit | Cell 2 | |
|---|-----------------|--------|----|
| | | T1 | T2 |
| HRPD RF Channel Number | | 1 | |
| $\frac{\text{Control } E_b}{N_t}$ (38.4 kbps) | dB | 21 | |
| $\frac{\text{Control } E_b}{N_t}$ (76.8 kbps) | dB | 18 | |
| \hat{I}_{or}/I_{oc} | dB | 0 | 0 |
| I_{oc} | dBm/ 1.2288 MHz | -55 | |
| CDMA2000 HRPD Pilot Strength | dB | -3 | -3 |
| Propagation Condition | | AWGN | |
| $S_{\text{nonServingCell},x}$ | | -6 | |
| Treselection | s | 0 | |
| hrpd-CellReselectionPriority | - | 0 | |
| Thresh _{x, low} | | -14 | |

A.4.5.2.1.2 Test Requirements

The cell reselection delay to lower priority is defined as the time from the beginning of time period T2, to the moment when the UE camps on cell 2 and starts to send access probe preambles on the Access Channel on cell 2.

The cell re-selection delay to the lower priority cell 2 shall be less than 21 s.

The rate of correct cell reselections observed during repeated tests shall be at least 90%.

NOTE: The cell re-selection delay to lower priority cell can be expressed as: $T_{\text{evaluateHRPD}} + T_{\text{SI-HRPD}}$

Where:

$T_{\text{evaluateHRPD}}$ See Table 4.2.2.5.4-1

$T_{\text{SI-HRPD}}$ Maximum repetition period of relevant system information blocks that need to be received by the UE to camp on cell 2; 1704 ms is assumed in this test case.

This gives a total of 20.904 s for the lower priority cell reselection, allow 21 s in the test case.

A.4.6 E-UTRAN to cdma2000 1X Cell Re-Selection

A.4.6.1 E-UTRAN FDD – cdma2000 1X

A.4.6.1.1 E-UTRAN FDD – cdma2000 1X Cell Reselection: cdma2000 1X is of Lower Priority

A.4.6.1.1.1 Test Purpose and Environment

This test is to verify the requirement for the E-UTRAN FDD- cdma2000 1X inter-RAT cell reselection requirements specified in clause 4.2.2.5.5 when the cdma2000 1X cell is of lower priority.

The test scenario comprises of one cdma2000 1X and one E-UTRAN FDD cells as given in tables A.4.6.1.1.1-1, A.4.6.1.1.1-2 and A.4.6.1.1.1-3.

The test consists of two successive time periods, with time duration of T1 and T2 respectively. Both E-UTRAN FDD cell 1 and cdma2000 1X cell 2 are already identified by the UE prior to the start of the test. At T1 the UE is camped on to cell 1. Cell 2 is of lower priority than cell 1. Cell 1 and cell 2 shall belong to different tracking areas.

Table A.4.6.1.1.1-1: General Test Parameters for E-UTRAN FDD - lower priority cdma2000 1X Cell Re-selection

| Parameter | | Unit | Value | Comment |
|--|----------------|------|----------|--|
| Initial condition | Active cell | | Cell 1 | E-UTRAN FDD cell |
| | Neighbour cell | | Cell 2 | cdma2000 1X cell |
| Final condition | Active cell | | Cell 2 | cdma2000 1X cell is selecting during T2 |
| DRX cycle length | | s | 1.28 | |
| E-UTRA FDD RF Channel Number | | | 1 | Only one FDD carrier frequency is used. |
| E-UTRA FDD Channel Bandwidth (BW_{channel}) | | MHz | 10 | |
| cdma2000 1X RF Channel Number | | | 1 | Only one cdma2000 1X carrier frequency is used. |
| E-UTRA FDD PRACH configuration | | | 4 | As specified in table 5.7.1-2 in TS 36.211 |
| E-UTRA FDD Access Barring Information | | - | Not Sent | No additional delays in random access procedure. |
| T1 | | s | 30 | |
| T2 | | s | 30 | |

Table A.4.6.1.1.1-2: Cell Specific Test Parameters for E-UTRAN FDD (Cell # 1)

| Parameter | Unit | Cell 1 | |
|---|------------|----------|------|
| | | T1 | T2 |
| E-UTRA RF Channel number | | 1 | |
| BW _{channel} | MHz | 10 | |
| OCNG Patterns defined in A.3.2.1.2 (OP.2 FDD) | | OP.2 FDD | |
| PBCH_RA | dB | 0 | |
| PBCH_RB | dB | | |
| PSS_RA | dB | | |
| SSS_RA | dB | | |
| PCFICH_RB | dB | | |
| PHICH_RA | dB | | |
| PHICH_RB | dB | | |
| PDCCH_RA | dB | | |
| PDCCH_RB | dB | | |
| PDSCH_RA | dB | | |
| PDSCH_RB | dB | | |
| OCNG_RA ^{Note 1} | dB | | |
| OCNG_RB ^{Note 1} | dB | | |
| N_{oc} ^{Note 2} | dBm/15 kHz | -98 | |
| RSRP ^{Note 3} | dBm/15 KHz | -89 | -102 |
| \hat{E}_s / I_{ot} | dB | 9 | -4 |
| \hat{E}_s / N_{oc} | dB | 9 | -4 |
| Treselection _{EUTRAN} | S | 0 | |
| Snonintrasearch | dB | Not sent | |
| cellReselectionPriority | - | 1 | |
| Qrxlevmin | dBm | -140 | |
| Qrxlevminoffset | dB | 0 | |
| Pcompensation | dB | 0 | |
| S _{ServingCell} | dB | 51 | 38 |
| Thresh _{serv, low} | dB | 44 | |
| Propagation Condition | | AWGN | |
| <p>Note 1: OCNG shall be used such that both cells are fully allocated and a constant total transmitted power spectral density is achieved for all OFDM symbols.</p> <p>Note 2: Interference from other cells and noise sources not specified in the test is assumed to be constant over subcarriers and time and shall be modelled as AWGN of appropriate power for N_{oc} to be fulfilled.</p> <p>Note 3: RSRP levels have been derived from other parameters for information purposes. They are not settable parameters themselves.</p> | | | |

Table A.4.6.1.1-3: Cell Specific Test Parameters for cdma2000 1X (cell # 2)

| Parameter | Unit | Cell 2 | |
|--|-----------------|--------|-----|
| | | T1 | T2 |
| cdma2000 1X RF Channel Number | | 1 | |
| $\frac{\text{Pilot } E_c}{I_{or}}$ | dB | -7 | |
| $\frac{\text{Sync } E_c}{I_{or}}$ | dB | -16 | |
| $\frac{\text{Paging } E_c}{I_{or}}$ (4.8 kbps) | dB | -12 | |
| \hat{I}_{or}/I_{oc} | dB | 0 | 0 |
| I_{oc} | dBm/ 1.2288 MHz | -55 | |
| CDMA2000 1xRTT Pilot Strength | dB | -10 | -10 |
| Propagation Condition | | AWGN | |
| $S_{nonServingCell,x}$ | | -20 | |
| Treselection | s | 0 | |
| oneXRTT-CellReselectionPriority | - | 0 | |
| Thresh _{x, low} | | -28 | |

A.4.6.1.1.2 Test Requirements

The cell reselection delay to lower priority is defined as the time from the beginning of time period T2, to the moment when the UE camps on cell 2 and starts to send access probe preambles on the Access Channel on cell 2.

The cell re-selection delay to the lower priority cell 2 shall be less than 21 s.

The rate of correct cell reselections observed during repeated tests shall be at least 90%.

NOTE: The cell re-selection delay to lower priority cell can be expressed as: $T_{\text{evaluatecdma2000 1X}} + T_{\text{SI-cdma2000 1X}}$

Where:

$T_{\text{evaluatecdma2000 1X}}$ See Table 4.2.2.5.5-1

$T_{\text{SI-cdma2000 1X}}$ Maximum repetition period of relevant system information blocks that need to be received by the UE to camp on cell 2; 1280 ms is assumed in this test case.

This gives a total of 20.48 s for the lower priority cell reselection, allow 21 s in the test case.

A.4.6.2 E-UTRAN TDD – cdma2000 1X

A.4.6.2.1 E-UTRAN TDD –cdma2000 1X Cell Reselection: cdma2000 1X is of Lower Priority

A.4.6.2.1.1 Test Purpose and Environment

This test is to verify the requirement for the E-UTRAN TDD- cdma2000 1X inter-RAT cell reselection requirements specified in clause 4.2.2.5.5 when the cdma2000 1X cell is of lower priority.

The test scenario comprises of one cdma2000 1X and one E-UTRAN TDD cells as given in tables A.4.6.2.1.1-1, A.4.6.2.1.1-2 and A.4.6.2.1.1-3.

The test consists of two successive time periods, with time duration of T1 and T2 respectively. Both E-UTRAN TDD cell 1 and cdma2000 1X cell 2 are already identified by the UE prior to the start of the test. At T1 the UE is camped on to cell 1. Cell 2 is of lower priority than cell 1. Cell 1 and cell 2 shall belong to different tracking areas.

Table A.4.6.2.1.1-1: General Test Parameters for E-UTRAN TDD - lower priority cdma2000 1X Cell Re-selection

| Parameter | | Unit | Value | Comment |
|--|----------------|------|----------|--|
| Initial condition | Active cell | | Cell 1 | E-UTRAN TDD cell |
| | Neighbour cell | | Cell 2 | cdma2000 1X cell |
| Final condition | Active cell | | Cell 2 | cdma2000 1X cell is selecting during T2 |
| DRX cycle length | | s | 1.28 | |
| E-UTRA TDD RF Channel Number | | | 1 | Only one TDD carrier frequency is used. |
| E-UTRA TDD Channel Bandwidth (BW_{channel}) | | MHz | 10 | |
| cdma2000 1X RF Channel Number | | | 1 | Only one cdma2000 1X carrier frequency is used. |
| E-UTRA TDD PRACH configuration | | | 53 | As specified in table 5.7.1-3 in TS 36.211 |
| Uplink-downlink configuration of cell 1 | | | 1 | As specified in table 4.2.2 in TS 36.211 |
| Special subframe configuration of cell 1 | | | 6 | As specified in table 4.2.1 in TS 36.211 |
| E_UTRA TDD Access Barring Information | | - | Not Sent | No additional delays in random access procedure. |
| T1 | | s | 30 | |
| T2 | | s | 30 | |

Table A.4.6.2.1.1-2: Cell Specific Test Parameters for E-UTRAN TDD (Cell # 1)

| Parameter | Unit | Cell 1 | |
|---|------------|----------|------|
| | | T1 | T2 |
| E-UTRA RF Channel number | | 1 | |
| BW _{channel} | MHz | 10 | |
| OCNG Patterns defined in A.3.2.2.2 (OP.2 TDD) | | OP.2 TDD | |
| PBCH_RA | dB | 0 | |
| PBCH_RB | dB | | |
| PSS_RA | dB | | |
| SSS_RA | dB | | |
| PCFICH_RB | dB | | |
| PHICH_RA | dB | | |
| PHICH_RB | dB | | |
| PDCCH_RA | dB | | |
| PDCCH_RB | dB | | |
| PDSCH_RA | dB | | |
| PDSCH_RB | dB | | |
| OCNG_RA ^{Note 1} | dB | | |
| OCNG_RB ^{Note 1} | dB | | |
| N_{oc} ^{Note 2} | dBm/15 kHz | -98 | |
| RSRP ^{Note 3} | dBm/15 KHz | -89 | -102 |
| \hat{E}_s / I_{ot} | dB | 9 | -4 |
| \hat{E}_s / N_{oc} | dB | 9 | -4 |
| Treselection _{EUTRAN} | S | 0 | |
| Snonintrasearch | dB | Not sent | |
| cellReselectionPriority | - | 1 | |
| Qrxlevmin | dBm | -140 | |
| Qrxlevminoffset | dB | 0 | |
| Pcompensation | dB | 0 | |
| S _{ServingCell} | dB | 51 | 38 |
| Thresh _{serv,low} | dB | 44 | |
| Propagation Condition | | AWGN | |
| <p>Note 1: CNG shall be used such that both cells are fully allocated and a constant total transmitted power spectral density is achieved for all OFDM symbols.</p> <p>Note 2: Interference from other cells and noise sources not specified in the test is assumed to be constant over subcarriers and time and shall be modelled as AWGN of appropriate power for N_{oc} to be fulfilled.</p> <p>Note 3: SRP levels have been derived from other parameters for information purposes. They are not settable parameters themselves.</p> | | | |

Table A.4.6.2.1.1-3: Cell Specific Test Parameters for cdma2000 1X (cell # 2)

| Parameter | Unit | Cell 2 | |
|--|-----------------|--------|-----|
| | | T1 | T2 |
| cdma2000 1X RF Channel Number | | 1 | |
| $\frac{\text{Pilot } E_c}{I_{or}}$ | dB | -7 | |
| $\frac{\text{Sync } E_c}{I_{or}}$ | dB | -16 | |
| $\frac{\text{Paging } E_c}{I_{or}}$ (4.8 kbps) | dB | -12 | |
| \hat{I}_{or}/I_{oc} | dB | 0 | 0 |
| I_{oc} | dBm/ 1.2288 MHz | -55 | |
| CDMA2000 1xRTT Pilot Strength | dB | -10 | -10 |
| Propagation Condition | | AWGN | |
| $S_{nonServingCell,x}$ | | -20 | |
| Treselection | s | 0 | |
| oneXRTT-CellReselectionPriority | - | 0 | |
| Thresh _{x, low} | | -28 | |

A.4.6.2.1.2 Test Requirements

The cell reselection delay to lower priority is defined as the time from the beginning of time period T2, to the moment when the UE camps on cell 2 and starts to send access probe preambles on the Access Channel on cell 2.

The cell re-selection delay to the lower priority cell 2 shall be less than 21 s.

The rate of correct cell reselections observed during repeated tests shall be at least 90%.

NOTE: The cell re-selection delay to lower priority cell can be expressed as: $T_{\text{evaluatecdma2000 1X}} + T_{\text{SI-cdma2000 1X}}$

Where:

$T_{\text{evaluatecdma2000 1X}}$ See Table 4.2.2.5.5-1

$T_{\text{SI-cdma2000 1X}}$ Maximum repetition period of relevant system information blocks that need to be received by the UE to camp on cell 2; 1280 ms is assumed in this test case.

This gives a total of 20.48 s for the lower priority cell reselection, allow 21 s in the test case.

A.5 E-UTRAN RRC CONNECTED Mode Mobility

A.5.1 E-UTRAN Handover

A.5.1.1 E-UTRAN FDD - FDD Intra frequency handover

A.5.1.1.1 Test Purpose and Environment

This test is to verify the requirement for the FDD-FDD intra frequency handover requirements specified in clause 5.1.2.1.

The test scenario comprises of 1 E-UTRA FDD carrier and 2 cells as given in tables A.5.1.1.1-1 and A.5.1.1.1-2. The test consists of three successive time periods, with time durations of T1, T2 and T3 respectively. At the start of time duration T1, the UE may not have any timing information of cell 2.

E-UTRAN shall send a RRC message implying handover to cell 2. The RRC message implying handover shall be sent to the UE during period T2, after the UE has reported Event A3. T3 is defined as the end of the last TTI containing the RRC message implying handover.

Table A.5.1.1.1-1: General test parameters for E-UTRAN FDD-FDD intra frequency handover test case

| Parameter | | Unit | Value | Comment |
|---|-------------------|------|--|--|
| PDSCH parameters | | | DL Reference Measurement Channel R.0 FDD | As specified in clause A.3.1.1.1 |
| PCFICH/PDCCH/PHICH parameters | | | DL Reference Measurement Channel R.6 FDD | As specified in clause A.3.1.2.1 |
| Initial conditions | Active cell | | Cell 1 | |
| | Neighbouring cell | | Cell 2 | |
| Final condition | Active cell | | Cell 2 | |
| E-UTRA RF Channel Number | | | 1 | Only one FDD carrier frequency is used. |
| Channel Bandwidth (BW_{channel}) | | MHz | 10 | |
| A3-Offset | | dB | 0 | |
| Hysteresis | | dB | 0 | |
| Time To Trigger | | s | 0 | |
| Filter coefficient | | | 0 | L3 filtering is not used |
| DRX | | | | OFF |
| CP length | | | Normal | |
| Access Barring Information | | - | Not Sent | No additional delays in random access procedure. |
| PRACH configuration | | | 4 | As specified in table 5.7.1-2 in TS 36.211 |
| Time offset between cells | | | 3 ms | Asynchronous cells |
| T1 | | s | 5 | |
| T2 | | s | ≤ 5 | |
| T3 | | s | 1 | |

Table A.5.1.1.1-2: Cell specific test parameters for E-UTRAN FDD-FDD intra frequency handover test case

| Parameter | Unit | Cell 1 | | | Cell 2 | | |
|--|------------|----------|----------|----------|------------|----------|----------|
| | | T1 | T2 | T3 | T1 | T2 | T3 |
| E-UTRA RF Channel Number | | 1 | | | 1 | | |
| BW_{channel} | MHz | 10 | | | 10 | | |
| OCNG Patterns defined in A.3.2.1.1 (OP.1 FDD) and in A.3.2.1.2 (OP.2 FDD) | | OP.1 FDD | OP.1 FDD | OP.2 FDD | OP.2 FDD | OP.2 FDD | OP.1 FDD |
| PBCH_RA | dB | 0 | | | 0 | | |
| PBCH_RB | dB | | | | | | |
| PSS_RA | dB | | | | | | |
| SSS_RA | dB | | | | | | |
| PCFICH_RB | dB | | | | | | |
| PHICH_RA | dB | | | | | | |
| PHICH_RB | dB | | | | | | |
| PDCCH_RA | dB | | | | | | |
| PDCCH_RB | dB | | | | | | |
| PDSCH_RA | dB | | | | | | |
| PDSCH_RB | dB | | | | | | |
| OCNG_RA ^{Note 1} | dB | | | | | | |
| OCNG_RB ^{Note 1} | dB | | | | | | |
| $\hat{E}_s / I_{\text{ot}}$ | dB | 8 | -3.3 | -3.3 | -Infinity | 2.36 | 2.36 |
| N_{oc} ^{Note 2} | dBm/15 KHz | -98 | | | | | |
| $\hat{E}_s / N_{\text{oc}}$ | dB | 8 | 8 | 8 | - Infinity | 11 | 11 |
| RSRP ^{Note 3} | dBm/15 KHz | -90 | -90 | -90 | - Infinity | -87 | -87 |
| Propagation Condition | | AWGN | | | | | |
| <p>Note 1: OCNG shall be used such that both cells are fully allocated and a constant total transmitted power spectral density is achieved for all OFDM symbols.</p> <p>Note 2: Interference from other cells and noise sources not specified in the test is assumed to be constant over subcarriers and time and shall be modelled as AWGN of appropriate power for N_{oc} to be fulfilled.</p> <p>Note 3: RSRP levels have been derived from other parameters for information purposes. They are not settable parameters themselves.</p> | | | | | | | |

A.5.1.1.2 Test Requirements

The UE shall start to transmit the PRACH to Cell 2 less than 50 ms from the beginning of time period T3.

The rate of correct handovers observed during repeated tests shall be at least 90%.

NOTE: The handover delay can be expressed as: RRC procedure delay + $T_{\text{interrupt}}$, where:

RRC procedure delay = 15 ms and is specified in clause 11.2 in TS 36.331 [2].

$T_{\text{interrupt}}$ = 35 ms in the test; $T_{\text{interrupt}}$ is defined in clause 5.1.2.1.2.

This gives a total of 50 ms.

A.5.1.2 E-UTRAN TDD - TDD Intra frequency handover

A.5.1.2.1 Test Purpose and Environment

This test is to verify the requirement for the TDD-TDD intra frequency handover requirements specified in clause 5.2.2.4.

The test scenario comprises of 1 E-UTRA TDD carrier and 2 cells as given in tables A.5.1.2.1-1 and A.5.1.2.1-2. The test consists of three successive time periods, with time durations of T1, T2 and T3 respectively. At the start of time duration T1, the UE may not have any timing information of cell 2.

E-UTRAN shall send a RRC message implying handover to cell 2. The RRC message implying handover shall be sent to the UE during period T2, after the UE has reported Event A3. T3 is defined as the end of the last TTI containing the RRC message implying handover.

Table A.5.1.2.1-1: General test parameters for E-UTRAN TDD-TDD Intra frequency handover test case

| Parameter | | Unit | Value | Comment |
|--------------------------------------|-------------------|------|--|--|
| PDSCH parameters | | | DL Reference Measurement Channel R.0 TDD | As specified in clause A.3.1.1.2 |
| PCFICH/PDCCHPHICH parameters | | | DL Reference Measurement Channel R.6 TDD | As specified in clause A.3.1.2.2 |
| Initial conditions | Active cell | | Cell 1 | |
| | Neighbouring cell | | Cell 2 | |
| Final condition | Active cell | | Cell 2 | |
| E-UTRA RF Channel Number | | | 1 | Only one TDD carrier frequency is used. |
| Channel Bandwidth ($BW_{channel}$) | | MHz | 10 | |
| A3-Offset | | dB | 0 | |
| Hysteresis | | dB | 0 | |
| Time To Trigger | | s | 0 | |
| Filter coefficient | | | 0 | L3 filtering is not used |
| DRX | | | | OFF |
| CP length | | | Normal | |
| Access Barring Information | | - | Not Sent | No additional delays in random access procedure. |
| Special subframe configuration | | | 6 | As specified in table 4.2-1 in TS 36.211 |
| Uplink-downlink configuration | | | 1 | As specified in table 4.2-2 in TS 36.211 |
| PRACH configuration index | | | 53 | As specified in table 5.7.1-3 in TS 36.211 |
| Time offset between cells | | | 3 μ s | Synchronous cells |
| T1 | | s | 5 | |
| T2 | | s | ≤ 5 | |
| T3 | | s | 1 | |

Table A.5.1.2.1-2: Cell specific test parameters for E-UTRAN TDD-TDD Intra frequency handover test case

| Parameter | Unit | Cell 1 | | | Cell 2 | | |
|---|------------|----------|----------|----------|-----------|----------|----------|
| | | T1 | T2 | T3 | T1 | T2 | T3 |
| E-UTRA RF Channel Number | | 1 | | | 1 | | |
| $BW_{channel}$ | MHz | 10 | | | 10 | | |
| OCNG Patterns defined in A.3.2.2.1 (OP.1 TDD) and in A.3.2.2.2 (OP.2 TDD) | | OP.1 TDD | OP.1 TDD | OP.2 TDD | OP.2 TDD | OP.2 TDD | OP.1 TDD |
| PBCH_RA | dB | 0 | | | 0 | | |
| PBCH_RB | dB | | | | | | |
| PSS_RA | dB | | | | | | |
| SSS_RA | dB | | | | | | |
| PCFICH_RB | dB | | | | | | |
| PHICH_RA | dB | | | | | | |
| PHICH_RB | dB | | | | | | |
| PDCCH_RA | dB | | | | | | |
| PDCCH_RB | dB | | | | | | |
| PDSCH_RA | dB | | | | | | |
| PDSCH_RB | dB | | | | | | |
| OCNG_RA ^{Note 1} | dB | | | | | | |
| OCNG_RB ^{Note 1} | dB | | | | | | |
| \hat{E}_s / I_{ot} | dB | | | | | | |
| N_{oc} ^{Note 2} | dBm/15 KHz | -98 | | | | | |
| \hat{E}_s / N_{oc} | dB | 8 | 8 | 8 | -Infinity | 11 | 11 |
| RSRP ^{Note 3} | dBm/15 KHz | -90 | -90 | -90 | -Infinity | -87 | -87 |
| Propagation Condition | | AWGN | | | | | |
| <p>Note 1: OCNG shall be used such that both cells are fully allocated and a constant total transmitted power spectral density is achieved for all OFDM symbols.</p> <p>Note 2: Interference from other cells and noise sources not specified in the test is assumed to be constant over subcarriers and time and shall be modelled as AWGN of appropriate power for N_{oc} to be fulfilled.</p> <p>Note 3: RSRP levels have been derived from other parameters for information purposes. They are not settable parameters themselves.</p> | | | | | | | |

A.5.1.2.2 Test Requirements

The UE shall start to transmit the PRACH to Cell 2 less than 50 ms from the beginning of time period T3.

The rate of correct handovers observed during repeated tests shall be at least 90%.

NOTE: The handover delay can be expressed as: RRC procedure delay + $T_{interrupt}$, where:

RRC procedure delay = 15 ms and is specified in clause 11.2 in TS 36.331 [2].

$T_{interrupt}$ = 35 ms in the test; $T_{interrupt}$ is defined in clause 5.2.2.4.2.

This gives a total of 50 ms.

A.5.1.3 E-UTRAN FDD – FDD Inter frequency handover

A.5.1.3.1 Test Purpose and Environment

This test is to verify the requirement for the FDD-FDD inter-frequency handover requirements specified in clause 5.1.2.1.

The test scenario comprises of two E-UTRA FDD carriers and one cell on each carrier as given in tables A.5.1.3.1-1 and A.5.1.3.1-2. PDCCHs indicating new transmissions shall be sent continuously to ensure that the UE would not enter

the DRX state. The test consists of three successive time periods, with time durations of T1, T2 and T3 respectively. At the start of time duration T1, the UE does not have any timing information of cell 2. Starting T2, cell 2 becomes detectable and the UE is expected to detect and send a measurement report. Gap pattern configuration with id #0 as specified in Table 8.1.2.1-1 is configured before T2 begins to enable inter-frequency monitoring.

A RRC message implying handover shall be sent to the UE during period T2, after the UE has reported Event A3. The start of T3 is the instant when the last TTI containing the RRC message implying handover is sent to the UE.

Table A.5.1.3.1-1: General test parameters for E-UTRAN FDD-FDD Inter frequency handover test case

| Parameter | | Unit | Value | Comment |
|--------------------------------------|-------------------|------|--|--|
| PDSCH parameters | | | DL Reference Measurement Channel R.0 FDD | As specified in clause A.3.1.1.1 |
| PCFICH/PDCCH/PHICH parameters | | | DL Reference Measurement Channel R.6 FDD | As specified in clause A.3.1.2.1 |
| Initial conditions | Active cell | | Cell 1 | Cell 1 is on RF channel number 1 |
| | Neighbouring cell | | Cell 2 | Cell 2 is on RF channel number 2 |
| Final condition | Active cell | | Cell 2 | |
| E-UTRA RF channel number | | | 1, 2 | Two FDD carriers are used |
| Channel Bandwidth ($BW_{channel}$) | | MHz | 10 | |
| A3-Offset | | dB | -4 | |
| Hysteresis | | dB | 0 | |
| TimeToTrigger | | s | 0 | |
| Filter coefficient | | | 0 | L3 filtering is not used |
| DRX | | | DRX_L | As specified in clause A.3.3 |
| PRACH configuration | | | 4 | As specified in table 5.7.1-2 in TS 36.211 |
| Access Barring Information | | - | Not sent | No additional delays in random access procedure |
| Time offset between cells | | | 3 ms | Asynchronous cells |
| Gap pattern configuration Id | | | 0 | As specified in Table 8.1.2.1-1 started before T2 starts |
| T1 | | s | 5 | |
| T2 | | s | ≤ 5 | |
| T3 | | s | 1 | |

Table A.5.1.3.1-2: Cell specific test parameters for E-UTRAN FDD-FDD Inter frequency handover test case

| Parameter | Unit | Cell 1 | | | Cell 2 | | |
|---|--|----------|----------|----------|-----------|----------|----------|
| | | T1 | T2 | T3 | T1 | T2 | T3 |
| E-UTRA RF Channel number | | 1 | | | 2 | | |
| $BW_{channel}$ | MHz | 10 | | | 10 | | |
| OCNG Patterns defined in A.3.2.1.1 (OP.1 FDD) and in A.3.2.1.2 (OP.2 FDD) | | OP.1 FDD | OP.1 FDD | OP.2 FDD | OP.2 FDD | OP.2 FDD | OP.1 FDD |
| PBCH_RA | dB | 0 | | | 0 | | |
| PBCH_RB | dB | | | | | | |
| PSS_RA | dB | | | | | | |
| SSS_RA | dB | | | | | | |
| PCFICH_RB | dB | | | | | | |
| PHICH_RA | dB | | | | | | |
| PHICH_RB | dB | | | | | | |
| PDCCH_RA | dB | | | | | | |
| PDCCH_RB | dB | | | | | | |
| PDSCH_RA | dB | | | | | | |
| PDSCH_RB | dB | | | | | | |
| OCNG_RA ^{Note 1} | dB | | | | | | |
| OCNG_RB ^{Note 1} | dB | | | | | | |
| \hat{E}_s / I_{ot} | dB | | | | | | |
| N_{oc} ^{Note 2} | dBm/15 kHz | -98 | | | | | |
| \hat{E}_s / N_{oc} | dB | 4 | 4 | 4 | -Infinity | 7 | 7 |
| RSRP ^{Note 3} | dBm/15 KHz | -94 | -94 | -94 | -Infinity | -91 | -91 |
| Propagation Condition | | AWGN | | | | | |
| Note 1: | OCNG shall be used such that both cells are fully allocated and a constant total transmitted power spectral density is achieved for all OFDM symbols. | | | | | | |
| Note 2: | Interference from other cells and noise sources not specified in the test is assumed to be constant over subcarriers and time and shall be modelled as AWGN of appropriate power for N_{oc} to be fulfilled. | | | | | | |
| Note 3: | RSRP levels have been derived from other parameters for information purposes. They are not settable parameters themselves. | | | | | | |

A.5.1.3.2 Test Requirements

The UE shall start to transmit the PRACH to Cell 2 less than 50 ms from the beginning of time period T3.

The rate of correct handovers observed during repeated tests shall be at least 90%.

NOTE: The handover delay can be expressed as: RRC procedure delay + $T_{interrupt}$, where:

RRC procedure delay = 15 ms and is specified in clause 11.2 in TS 36.331 [2].

$T_{interrupt}$ = 35 ms in the test; $T_{interrupt}$ is defined in clause 5.1.2.1.2.

This gives a total of 50 ms.

A.5.1.4 E-UTRAN TDD – TDD Inter frequency handover

A.5.1.4.1 Test Purpose and Environment

This test is to verify the requirement for the TDD-TDD inter frequency handover requirements specified in clause 5.2.2.4.

The test scenario comprises of two E-UTRA TDD carriers and one cell on each carrier as given in tables Table A.5.1.4.1-1 and Table A.5.1.4.1-2. PDCCHs indicating new transmissions shall be sent continuously to ensure that the

UE would not enter the DRX state. The test consists of three successive time periods, with time durations of T1, T2 and T3 respectively. At the start of time duration T1, the UE may not have any timing information of cell 2.

E-UTRAN shall send a RRC message implying handover to cell 2. The RRC message implying handover shall be sent to the UE during period T2, after the UE has reported Event A3.

Table A.5.1.4.1-1: General test parameters for E-UTRAN TDD-TDD Inter frequency handover test case

| Parameter | | Unit | Value | Comment |
|--------------------------------------|----------------|------|--|--|
| PDSCH parameters | | | DL Reference Measurement Channel R.0 TDD | As specified in clause A.3.1.1.2 |
| PCFICH/PDCCH/PHICH parameters | | | DL Reference Measurement Channel R.6 TDD | As specified in clause A.3.1.2.2 |
| Gap Pattern Id | | | 1 | As specified in TS 36.133 clause 8.1.2.1. |
| Initial conditions | Active cell | | Cell 1 | |
| | Neighbour cell | | Cell 2 | |
| Final conditions | Active cell | | Cell 2 | |
| E-UTRA RF channel number | | | 1, 2 | Two TDD carriers are used |
| Channel Bandwidth ($BW_{channel}$) | | MHz | 10 | |
| A3-Offset | | dB | -4 | |
| Hysteresis | | dB | 0 | |
| Time to Trigger | | ms | 0 | |
| Filter coefficient | | | 0 | |
| DRX | | | DRX_L | As specified in clause A.3.3 |
| CP length | | | Normal | |
| Access Barring Information | | - | Not Sent | No additional delays in random access procedure. |
| Special subframe configuration | | | 6 | As specified in table 4.2-1 in TS 36.211 |
| Uplink-downlink configuration | | | 1 | As specified in table 4.2-2 in TS 36.211 |
| PRACH configuration | | | 53 | As specified in table 5.7.1-3 in TS 36.211 |
| Time offset between cells | | | 3 μ s | Synchronous cells |
| T1 | | s | 5 | |
| T2 | | s | ≤ 5 | |
| T3 | | s | 1 | |

Table A.5.1.4.1-2: Cell specific test parameters for E-UTRAN TDD-TDD Inter frequency handover test case

| Parameter | Unit | Cell 1 | | | Cell 2 | | |
|---|------------|----------|----------|----------|-----------|----------|----------|
| | | T1 | T2 | T3 | T1 | T2 | T3 |
| E-UTRA RF Channel number | | 1 | | | 2 | | |
| $BW_{channel}$ | MHz | 10 | | | 10 | | |
| OCNG Patterns defined in A.3.2.1.1 (OP.1 FDD) and in A.3.2.1.2 (OP.2 FDD) | | OP.1 FDD | OP.1 FDD | OP.2 FDD | OP.2 FDD | OP.2 FDD | OP.1 FDD |
| PBCH_RA | dB | 0 | | | 0 | | |
| PBCH_RB | dB | | | | | | |
| PSS_RA | dB | | | | | | |
| SSS_RA | dB | | | | | | |
| PCFICH_RB | dB | | | | | | |
| PHICH_RA | dB | | | | | | |
| PHICH_RB | dB | | | | | | |
| PDCCH_RA | dB | | | | | | |
| PDCCH_RB | dB | | | | | | |
| PDSCH_RA | dB | | | | | | |
| PDSCH_RB | dB | | | | | | |
| OCNG_RA ^{Note 1} | dB | | | | | | |
| OCNG_RB ^{Note 1} | dB | | | | | | |
| \hat{E}_s / I_{oc} | dB | | | | | | |
| N_{oc} ^{Note 2} | dBm/15 kHz | -98 | | | | | |
| \hat{E}_s / N_{oc} | dB | 4 | 4 | 4 | -Infinity | 7 | 7 |
| RSRP ^{Note 3} | dBm/15 KHz | -94 | -94 | -94 | -infinity | -91 | -91 |
| Propagation Condition | | AWGN | | | | | |
| <p>Note 1: OCNG shall be used such that both cells are fully allocated and a constant total transmitted power spectral density is achieved for all OFDM symbols.</p> <p>Note 2: Interference from other cells and noise sources not specified in the test is assumed to be constant over subcarriers and time and shall be modelled as AWGN of appropriate power for N_{oc} to be fulfilled.</p> <p>Note 3: RSRP levels have been derived from other parameters for information purposes. They are not settable parameters themselves.</p> | | | | | | | |

A.5.1.4.2 Test Requirements

The UE shall start to transmit the PRACH to Cell 2 less than 50 ms from the beginning of time period T3.

The rate of correct handovers observed during repeated tests shall be at least 90%.

NOTE: The handover delay can be expressed as: RRC procedure delay + $T_{interrupt}$, where:

RRC procedure delay = 15 ms and is specified in clause 11.2 in TS 36.331 [2].

$T_{interrupt}$ = 35 ms in the test; $T_{interrupt}$ is defined in clause 5.2.2.4.2.

This gives a total of 50 ms.

A.5.1.5 E-UTRAN FDD – FDD Inter frequency handover: unknown target cell

A.5.1.5.1 Test Purpose and Environment

This test is to verify the FDD-FDD inter-frequency handover requirements for the case when the target cell is unknown as specified in clause 5.1.2.1.

The test scenario comprises of two E-UTRA FDD carriers and one cell on each carrier as given in tables A.5.1.5.1-1 and A.5.1.5.1-2. No gap patterns are configured in the test case. The test consists of two successive time periods, with time durations of T1 and T2 respectively. At the start of time duration T1, the UE does not have any timing information of cell 2. Starting T2, cell 2 becomes detectable and the UE is expected to detect and start to transmit the PRACH to Cell 2.

A RRC message implying handover shall be sent to the UE during period T1. The start of T2 is the instant when the last TTI containing the RRC message implying handover is sent to the UE.

Table A.5.1.5.1-1: General test parameters for the E-UTRAN FDD-FDD Inter frequency handover test case when the target cell is unknown

| Parameter | | Unit | Value | Comment |
|---|-------------------|------|--|---|
| PDSCH parameters | | | DL Reference Measurement Channel R.0 FDD | As specified in clause A.3.1.1.1 |
| PCFICH/PDCCH/PHICH parameters | | | DL Reference Measurement Channel R.6 FDD | As specified in clause A.3.1.2.1 |
| Initial conditions | Active cell | | Cell 1 | Cell 1 is on RF channel number 1 |
| | Neighbouring cell | | Cell 2 | Cell 2 is on RF channel number 2 |
| Final condition | Active cell | | Cell 2 | |
| E-UTRA RF channel number | | | 1, 2 | Two FDD carriers are used |
| Channel Bandwidth (BW_{channel}) | | MHz | 10 | |
| DRX | | | OFF | Non-DRX test |
| PRACH configuration | | | 4 | As specified in table 5.7.1-2 in TS 36.211 |
| Access Barring Information | | - | Not sent | No additional delays in random access procedure |
| Time offset between cells | | | 3 ms | Asynchronous cells |
| T1 | | s | ≤ 5 | |
| T2 | | s | 1 | |

Table A.5.1.5.1-2: Cell specific test parameters for the E-UTRAN FDD-FDD Inter frequency handover test case when the target cell is unknown

| Parameter | Unit | Cell 1 | | Cell 2 | |
|---|------------|----------|----------|-----------|----------|
| | | T1 | T2 | T1 | T2 |
| E-UTRA RF Channel number | | 1 | | 2 | |
| $BW_{channel}$ | MHz | 10 | | 10 | |
| OCNG Patterns defined in A.3.2.1.1 (OP.1 FDD) and in A.3.2.1.2 (OP.2 FDD) | | OP.1 FDD | OP.2 FDD | OP.2 FDD | OP.1 FDD |
| PBCH_RA | dB | 0 | | 0 | |
| PBCH_RB | | | | | |
| PSS_RA | | | | | |
| SSS_RA | | | | | |
| PCFICH_RB | | | | | |
| PHICH_RA | | | | | |
| PHICH_RB | | | | | |
| PDCCH_RA | | | | | |
| PDCCH_RB | | | | | |
| PDSCH_RA | | | | | |
| PDSCH_RB | | | | | |
| OCNG_RA ^{Note 1} | | | | | |
| OCNG_RB ^{Note 1} | | | | | |
| \hat{E}_s / I_{ot} | | | | | |
| N_{oc} ^{Note 2} | dBm/15 kHz | -98 | | | |
| \hat{E}_s / N_{oc} | dB | 4 | 4 | -Infinity | 7 |
| RSRP ^{Note 3} | dBm/15 KHz | -94 | -94 | -Infinity | -91 |
| Propagation Condition | | AWGN | | | |
| <p>Note 1: OCNG shall be used such that both cells are fully allocated and a constant total transmitted power spectral density is achieved for all OFDM symbols.</p> <p>Note 2: Interference from other cells and noise sources not specified in the test is assumed to be constant over subcarriers and time and shall be modelled as AWGN of appropriate power for N_{oc} to be fulfilled.</p> <p>Note 3: RSRP levels have been derived from other parameters for information purposes. They are not settable parameters themselves.</p> | | | | | |

A.5.1.5.2 Test Requirements

The UE shall start to transmit the PRACH to Cell 2 less than 130 ms from the beginning of time period T2.

The rate of correct handovers observed during repeated tests shall be at least 90%.

NOTE: The handover delay can be expressed as: RRC procedure delay + $T_{interrupt}$, where:

RRC procedure delay = 15 ms, which is specified in clause 11.2 in TS 36.331 [2].

$T_{interrupt}$ = 115 ms in the test. See clause 5.1.2.1.2

This gives a total of 130 ms.

A.5.1.6 E-UTRAN TDD – TDD Inter frequency handover; unknown Target Cell

A.5.1.6.1 Test Purpose and Environment

This test is to verify the TDD-TDD inter-frequency handover requirements for the case when the target cell is unknown as specified in clause 5.2.2.4.

The test scenario comprises of two E-UTRA TDD carriers and one cell on each carrier as given in tables A.5.1.6.1-1 and A.5.1.6.1-2. No gap patterns are configured in the test case. The test consists of two successive time periods, with time durations of T1, T2 respectively. At the start of time duration T1, the UE does not have any timing information of cell 2. Starting T2, cell 2 becomes detectable and the UE receives a RRC handover command from the network. The start of T2 is the instant when the last TTI containing the RRC message implying handover is sent to the UE.

Table A.5.1.6.1-1: General test parameters for the E-UTRAN TDD-TDD Inter-Frequency handover test case when the target cell is unknown

| Parameter | | Unit | Value | Comment |
|--------------------------------|-------------------|------|--|---|
| PDSCH parameters | | | DL Reference Measurement Channel R.0 TDD | As specified in clause A.3.1.1.2 |
| PCFICH/PDCCH/PHICH parameters | | | DL Reference Measurement Channel R.6 TDD | As specified in clause A.3.1.2.2 |
| Initial conditions | Active cell | | Cell 1 | Cell 1 is on RF channel number 1 |
| | Neighbouring cell | | Cell 2 | Cell 2 is on RF channel number 2 |
| Final condition | Active cell | | Cell 2 | |
| E-UTRA RF channel number | | | 1, 2 | Two TDD carriers |
| DRX | | | OFF | Non-DRX test |
| Access Barring Information | | - | Not sent | No additional delays in random access procedure |
| Special subframe configuration | | | 6 | As specified in table 4.2-1 in TS 36.211 |
| Uplink-downlink configuration | | | 1 | As specified in table 4.2-2 in TS 36.211 |
| PRACH configuration | | | 53 | As specified in table 5.7.1-3 in TS 36.211 |
| Time offset between cells | | | 3 μ s | Synchronous cells |
| Gap pattern configuration | | | - | No gap pattern configured |
| T1 | | s | ≤ 5 | |
| T2 | | s | 1 | |

Table A.5.1.6.1-2: Cell specific test parameters for the E-UTRAN TDD-TDD Inter frequency handover test case when the target cell is unknown

| Parameter | Unit | Cell 1 | | Cell 2 | |
|--|------------|----------|----------|-----------|----------|
| | | T1 | T2 | T1 | T2 |
| E-UTRA RF Channel Number | | 1 | | 2 | |
| BW _{channel} | MHz | 10 | | 10 | |
| OCNG Patterns defined in A.3.2.2.1 (OP.1 TDD) and in A.3.2.2.2 (OP.2 TDD) | | OP.1 TDD | OP.2 TDD | OP.2 TDD | OP.1 TDD |
| PBCH_RA | dB | 0 | | 0 | |
| PBCH_RB | dB | | | | |
| PSS_RA | dB | | | | |
| SSS_RA | dB | | | | |
| PCFICH_RB | dB | | | | |
| PHICH_RA | dB | | | | |
| PHICH_RB | dB | | | | |
| PDCCH_RA | dB | | | | |
| PDCCH_RB | dB | | | | |
| PDSCH_RA | dB | | | | |
| PDSCH_RB | dB | | | | |
| OCNG_RA ^{Note 1} | dB | | | | |
| OCNG_RB ^{Note 1} | dB | | | | |
| N_{oc} ^{Note 3} | dBm/15 kHz | -98 | | | |
| RSRP ^{Note 4} | dBm/15 kHz | -94 | -94 | -Infinity | -93 |
| \hat{E}_s / I_{ot} | dB | 4 | 4 | -Infinity | 5 |
| SCH_RP ^{Note 4} | dBm/15 kHz | -94 | -94 | -Infinity | -93 |
| \hat{E}_s / N_{oc} | dB | 4 | 4 | -Infinity | 5 |
| Propagation Condition | | AWGN | | | |
| <p>Note 1: OCNG shall be used such that both cells are fully allocated and a constant total transmitted power spectral density is achieved for all OFDM symbols.</p> <p>Note 2: The resources for uplink transmission are assigned to the UE prior to the start of time period T2.</p> <p>Note 3: Interference from other cells and noise sources not specified in the test is assumed to be constant over subcarriers and time and shall be modelled as AWGN of appropriate power for N_{oc} to be fulfilled.</p> <p>Note 4: RSRP and SCH_RP levels have been derived from other parameters for information purposes. They are not settable parameters themselves.</p> | | | | | |

A.5.1.6.2 Test Requirements

The UE shall start to transmit the PRACH to Cell 2 less than 130 ms from the beginning of time period T2.

The rate of correct handovers observed during repeated tests shall be at least 90%.

NOTE: The handover delay can be expressed as: RRC procedure delay + $T_{interrupt}$, where:

RRC procedure delay = 15 ms, which is specified in clause 11.2 in TS 36.331 [2].

$T_{interrupt}$ = 115 ms in the test. See clause 5.2.2.4.2

This gives a total of 130 ms.

A.5.1.7 E-UTRAN FDD – TDD Inter frequency handover

A.5.1.7.1 Test Purpose and Environment

This test is to verify the requirement for the FDD-TDD inter frequency handover requirements specified in clause 5.2.2.2.

The test scenario comprises of one E-UTRA FDD cell and one E-UTRA TDD cell as given in tables Table A.5.1.7.1-1 , Table A.5.1.7.1-2 and Table A.5.1.7.1-3. PDCCHs indicating new transmissions shall be sent continuously to ensure that the UE would not enter the DRX state. The test consists of three successive time periods, with time durations of T1, T2 and T3 respectively. At the start of time duration T1, the UE does not have any timing information of cell 2.

E-UTRAN shall send a RRC message implying handover to cell 2. The RRC message implying handover shall be sent to the UE during period T2, after the UE has reported Event A3.

Table A.5.1.7.1-1: General test parameters for E-UTRAN FDD-TDD Inter frequency handover test case

| Parameter | | Unit | Value | Comment |
|---------------------------------------|----------------|------|--|---|
| Cell 1 PDSCH parameters | | | DL Reference Measurement Channel R.0 FDD | As specified in clause A.3.1.1.1 |
| Cell 1 PCFICH/PDCCH/PHICH parameters | | | DL Reference Measurement Channel R.6 FDD | As specified in clause A.3.1.2.1 |
| Cell 2 PDSCH parameters | | | DL Reference Measurement Channel R.0 TDD | As specified in clause A.3.1.1.2 |
| Cell 2 PCFICH/PDCCH/PHICH parameters | | | DL Reference Measurement Channel R.6 TDD | As specified in clause A.3.1.2.2 |
| Gap Pattern Id | | | 0 | As specified in TS 36.133 clause 8.1.2.1. |
| Initial conditions | Active cell | | Cell 1 | |
| | Neighbour cell | | Cell 2 | |
| Final conditions | Active cell | | Cell 2 | |
| Cell 1 E-UTRA RF channel number | | | 1 | One FDD carrier is used |
| Cell 2 E-UTRA RF channel number | | | 2 | One TDD carrier is used |
| Channel Bandwidth ($BW_{channel}$) | | MHz | 10 | |
| A3-Offset | | dB | -4 | |
| Hysteresis | | dB | 0 | |
| Time to Trigger | | ms | 0 | |
| Filter coefficient | | | 0 | |
| DRX | | | DRX_L | As specified in clause A.3.3 |
| CP length | | | Normal | |
| E-UTRA TDD Access Barring Information | | - | Not Sent | No additional delays in random access procedure. |
| Special subframe configuration | | | 6 | As specified in table 4.2-1 in TS 36.211. Applicable to cell 2. |
| Uplink-downlink configuration | | | 1 | As specified in table 4.2-2 in TS 36.211. Applicable to cell 2 |
| E-UTRA TDD PRACH configuration | | | 53 | As specified in table 5.7.1-3 in TS 36.211 |
| Time offset between cells | | | 3 ms | Asynchronous cells |
| T1 | | s | 5 | |
| T2 | | s | ≤5 | |
| T3 | | s | 1 | |

Table A.5.1.7.1-2: Cell specific test parameters for E-UTRAN FDD (cell #1) in E-UTRAN FDD-TDD Inter frequency handover test case

| Parameter | Unit | Cell 1 | | |
|---|------|----------|----------|----------|
| | | T1 | T2 | T3 |
| E-UTRA RF Channel number | | 1 | | |
| $BW_{channel}$ | MHz | 10 | | |
| OCNG Patterns defined in A.3.2.1.1 (OP.1 FDD) and in A.3.2.1.2 (OP.2 FDD) | | OP.1 FDD | OP.1 FDD | OP.2 FDD |
| PBCH_RA | dB | 0 | | |
| PBCH_RB | dB | | | |
| PSS_RA | dB | | | |
| SSS_RA | dB | | | |
| PCFICH_RB | dB | | | |
| PHICH_RA | dB | | | |
| PHICH_RB | dB | | | |

| | | | | |
|--|------------|-----|-----|-----|
| PDCCH_RA | dB | | | |
| PDCCH_RB | dB | | | |
| PDSCH_RA | dB | | | |
| PDSCH_RB | dB | | | |
| OCNG_RA ^{Note 1} | dB | | | |
| OCNG_RB ^{Note 1} | dB | | | |
| \hat{E}_s / I_{ot} | dB | 4 | 4 | 4 |
| N_{oc} ^{Note 2} | dBm/15 kHz | -98 | | |
| \hat{E}_s / N_{oc} | dB | 4 | 4 | 4 |
| RSRP ^{Note 3} | dBm/15 KHz | -94 | -94 | -94 |
| Propagation Condition | AWGN | | | |
| <p>Note 1: OCNG shall be used such that both cells are fully allocated and a constant total transmitted power spectral density is achieved for all OFDM symbols.</p> <p>Note 2: Interference from other cells and noise sources not specified in the test is assumed to be constant over subcarriers and time and shall be modelled as AWGN of appropriate power for N_{oc} to be fulfilled.</p> <p>Note 3: RSRP levels have been derived from other parameters for information purposes. They are not settable parameter themselves.</p> | | | | |

Table A.5.1.7.1-3: Cell specific test parameters for E-UTRAN TDD (cell #2) in E-UTRAN FDD-TDD Inter frequency handover test case

| Parameter | Unit | Cell 2 | | | | | |
|--|------------|-----------|----------|----------|-----|-----|--|
| | | T1 | T2 | T3 | | | |
| E-UTRA RF Channel number | | 2 | | | | | |
| BW _{channel} | MHz | 10 | | | | | |
| OCNG Patterns defined in A.3.2.2.1 (OP.1 TDD) and in A.3.2.2.2 (OP.2 TDD) | | OP.2 TDD | OP.2 TDD | OP.1 TDD | | | |
| PBCH_RA | dB | 0 | | | | | |
| PBCH_RB | dB | | | | | | |
| PSS_RA | dB | | | | | | |
| SSS_RA | dB | | | | | | |
| PCFICH_RB | dB | | | | | | |
| PHICH_RA | dB | | | | | | |
| PHICH_RB | dB | | | | | | |
| PDCCH_RA | dB | | | | | | |
| PDCCH_RB | dB | | | | | | |
| PDSCH_RA | dB | | | | | | |
| PDSCH_RB | dB | | | | | | |
| OCNG_RA ^{Note 1} | dB | -Infinity | | | | | |
| OCNG_RB ^{Note 1} | dB | | | | | | |
| \hat{E}_s / I_{ot} | dB | | | | 7 | 7 | |
| N_{oc} ^{Note 2} | dBm/15 kHz | | | | -98 | | |
| \hat{E}_s / N_{oc} | dB | | | | 7 | 7 | |
| RSRP ^{Note 3} | dBm/15 KHz | | | | -91 | -91 | |
| Propagation Condition | AWGN | | | | | | |
| <p>Note 1: OCNG shall be used such that both cells are fully allocated and a constant total transmitted power spectral density is achieved for all OFDM symbols.</p> <p>Note 2: Interference from other cells and noise sources not specified in the test is assumed to be constant over subcarriers and time and shall be modelled as AWGN of appropriate power for N_{oc} to be fulfilled.</p> <p>Note 3: RSRP levels have been derived from other parameters for information purposes. They are not settable parameter themselves.</p> | | | | | | | |

A.5.1.7.2 Test Requirements

The UE shall start to transmit the PRACH to Cell 2 less than 50 ms from the beginning of time period T3.

The rate of correct handovers observed during repeated tests shall be at least 90%.

NOTE: The handover delay can be expressed as: RRC procedure delay + $T_{\text{interrupt}}$, where:

RRC procedure delay = 15 ms and is specified in clause 11.2 in TS 36.331 [2].

$T_{\text{interrupt}}$ = 35 ms in the test; $T_{\text{interrupt}}$ is defined in clause 5.2.2.4.2.

This gives a total of 50 ms.

A.5.1.8 E-UTRAN TDD – FDD Inter frequency handover

A.5.1.8.1 Test Purpose and Environment

This test is to verify the requirement for the TDD-FDD inter-frequency handover requirements specified in clause 5.2.2.3.

The test scenario comprises of one E-UTRA TDD cell and one E-UTRA FDD cell as given in tables Table A.5.1.8.1-1, Table A.5.1.8.1-2 and Table A.5.1.8.1-3. PDCCHs indicating new transmissions should be sent continuously to ensure that the UE would not enter the DRX state. The test consists of three successive time periods, with time durations of T1, T2 and T3 respectively. At the start of time duration T1, the UE does not have any timing information of cell 2. Starting T2, cell 2 becomes detectable and the UE is expected to detect and send a measurement report. Gap pattern configuration with id #0 as specified in Table 8.1.2.1-1 is configured before T2 begins to enable inter-frequency monitoring.

A RRC message implying handover shall be sent to the UE during period T2, after the UE has reported Event A3. The start of T3 is the instant when the last TTI containing the RRC message implying handover is sent to the UE.

Table A.5.1.8.1-1: General test parameters for E-UTRAN TDD-FDD Inter frequency handover test case

| Parameter | | Unit | Value | Comment |
|---|-------------------|------|--|--|
| Cell 1 PDSCH parameters | | | DL Reference Measurement Channel R.0 TDD | As specified in clause A.3.1.1.2 |
| Cell 1 PCFICH/PDCCH/PHICH parameters | | | DL Reference Measurement Channel R.6 TDD | As specified in clause A.3.1.2.2 |
| Cell 2 PDSCH parameters | | | DL Reference Measurement Channel R.0 FDD | As specified in clause A.3.1.1.1 |
| Cell 2 PCFICH/PDCCH/PHICH parameters | | | DL Reference Measurement Channel R.6 FDD | As specified in clause A.3.1.2.1 |
| Initial conditions | Active cell | | Cell 1 | Cell 1 is on RF channel number 1 |
| | Neighbouring cell | | Cell 2 | Cell 2 is on RF channel number 2 |
| Final condition | Active cell | | Cell 2 | |
| Cell 1 E-UTRA RF channel number | | | 1 | One TDD carrier is used |
| Cell 2 E-UTRA RF channel number | | | 2 | One FDD carrier is used |
| Channel Bandwidth (BW_{channel}) | | MHz | 10 | |
| A3-Offset | | dB | -4 | |
| Hysteresis | | dB | 0 | |
| TimeToTrigger | | s | 0 | |
| Filter coefficient | | | 0 | L3 filtering is not used |
| DRX | | | DRX_L | As specified in clause A.3.3 |
| E-UTRA FDD PRACH configuration | | | 4 | As specified in table 5.7.1-2 in TS 36.211 |
| E-UTRA FDD Access Barring Information | | - | Not sent | No additional delays in random access procedure |
| Time offset between cells | | | 3 ms | Asynchronous cells |
| Gap pattern configuration Id | | | 0 | As specified in Table 8.1.2.1-1 started before T2 starts |
| T1 | | s | 5 | |
| T2 | | s | ≤5 | |
| T3 | | s | 1 | |

Table A.5.1.8.1-2: Cell specific test parameters for E-UTRAN TDD (cell #1) in E-UTRAN TDD-FDD Inter frequency handover test case

| Parameter | Unit | Cell 1 | | |
|--|------------|----------|----------|----------|
| | | T1 | T2 | T3 |
| E-UTRA RF Channel number | | 1 | | |
| BW _{channel} | MHz | 10 | | |
| OCNG Patterns defined in A.3.2.2.1 (OP.1 TDD) and in A.3.2.2.2 (OP.2 TDD) | | OP.1 TDD | OP.1 TDD | OP.2 TDD |
| PBCH_RA | dB | 0 | | |
| PBCH_RB | | | | |
| PSS_RA | | | | |
| SSS_RA | | | | |
| PCFICH_RB | | | | |
| PHICH_RA | | | | |
| PHICH_RB | | | | |
| PDCCH_RA | | | | |
| PDCCH_RB | | | | |
| PDSCH_RA | | | | |
| PDSCH_RB | | | | |
| OCNG_RA ^{Note 1} | | | | |
| OCNG_RB ^{Note 1} | | | | |
| \hat{E}_s / I_{ot} | | | | |
| N_{oc} ^{Note 2} | dBm/15 kHz | -98 | | |
| \hat{E}_s / N_{oc} | dB | 4 | 4 | 4 |
| RSRP ^{Note 3} | dBm/15 KHz | -94 | -94 | -94 |
| Propagation Condition | AWGN | | | |
| <p>Note 1: OCNG shall be used such that both cells are fully allocated and a constant total transmitted power spectral density is achieved for all OFDM symbols.</p> <p>Note 2: Interference from other cells and noise sources not specified in the test is assumed to be constant over subcarriers and time and shall be modelled as AWGN of appropriate power for N_{oc} to be fulfilled.</p> <p>Note 3: RSRP levels have been derived from other parameters for information purposes. They are not settable parameter themselves.</p> | | | | |

Table A.5.1.8.1-3: Cell specific test parameters for E-UTRAN FDD (cell #2) in E-UTRAN TDD-FDD Inter frequency handover test case

| Parameter | Unit | Cell 2 | | |
|---|------|----------|----------|----------|
| | | T1 | T2 | T3 |
| E-UTRA RF Channel number | | 2 | | |
| BW _{channel} | MHz | 10 | | |
| OCNG Patterns defined in A.3.2.1.1 (OP.1 FDD) and in A.3.2.1.2 (OP.2 FDD) | | OP.2 FDD | OP.2 FDD | OP.1 FDD |
| PBCH_RA | dB | 0 | | |
| PBCH_RB | | | | |
| PSS_RA | | | | |
| SSS_RA | | | | |
| PCFICH_RB | | | | |
| PHICH_RA | | | | |
| PHICH_RB | | | | |
| PDCCH_RA | | | | |
| PDCCH_RB | | | | |
| PDSCH_RA | | | | |
| PDSCH_RB | | | | |
| OCNG_RA ^{Note 1} | | | | |
| OCNG_RB ^{Note 1} | | | | |
| \hat{E}_s / I_{ot} | | | | |

| | | | | |
|--|------------|-----------|-----|-----|
| N_{oc} <small>Note 2</small> | dBm/15 kHz | -98 | | |
| \hat{E}_s/N_{oc} | dB | -Infinity | 7 | 7 |
| RSRP <small>Note 3</small> | dBm/15 KHz | -Infinity | -91 | -91 |
| Propagation Condition | AWGN | | | |
| <p>Note 1: OCNG shall be used such that both cells are fully allocated and a constant total transmitted power spectral density is achieved for all OFDM symbols.</p> <p>Note 2: Interference from other cells and noise sources not specified in the test is assumed to be constant over subcarriers and time and shall be modelled as AWGN of appropriate power for N_{oc} to be fulfilled.</p> <p>Note 3: RSRP levels have been derived from other parameters for information purposes. They are not settable parameter themselves.</p> | | | | |

A.5.1.8.2 Test Requirements

The UE shall start to transmit the PRACH to Cell 2 less than 50 ms from the beginning of time period T3.

The rate of correct handovers observed during repeated tests shall be at least 90%.

NOTE: The handover delay can be expressed as: RRC procedure delay + $T_{interrupt}$, where:

RRC procedure delay = 15 ms and is specified in clause 11.2 in TS 36.331 [2].

$T_{interrupt}$ = 35 ms in the test; $T_{interrupt}$ is defined in clause 5.1.2.1.2.

This gives a total of 50 ms.

A.5.1.9 E-UTRAN FDD - FDD Intra frequency handover for 5MHz bandwidth

A.5.1.9.1 Test Purpose and Environment

The purpose of this test case is the same as for the test defined in subclause A.5.1.1. The test parameters are the same except those described in the following section. The listed parameter values in Tables A.5.1.9.1-1 and A.5.1.9.1-2 will replace the values of corresponding parameters in Tables A.5.1.1.1-1 and A.5.1.1.1-2.

Table A.5.1.9.1-1: General test parameters for E-UTRAN FDD-FDD intra frequency handover test case, 5MHz

| Parameter | Unit | Value | Comment |
|--|------|---|----------------------------------|
| PDSCH parameters | | DL Reference Measurement Channel R.5 FDD | As specified in clause A.3.1.1.1 |
| PCFICH/PDCCH/PHICH parameters | | DL Reference Measurement Channel R.11 FDD | As specified in clause A.3.1.2.1 |
| Channel Bandwidth ($BW_{channel}$) | MHz | 5 | |
| Note 1: See Table A.5.1.1.1-1 for other general test parameters. | | | |
| Note 2: This test is performed according to the principle defined in section A.3.7.2 | | | |

Table A.5.1.9.1-2: Cell specific test parameters for E-UTRAN FDD-FDD intra frequency handover test case, 5MHz

| Parameter | Unit | Cell 1 | | | Cell 2 | | |
|---|------|-----------|-----------|-----------|-----------|-----------|-----------|
| | | T1 | T2 | T3 | T1 | T2 | T3 |
| $BW_{channel}$ | MHz | 5 | | | 5 | | |
| OCNG Patterns defined in A.3.2.1.15 (OP.15 FDD) and in A.3.2.1.16 (OP.16 FDD) | | OP.15 FDD | OP.15 FDD | OP.16 FDD | OP.16 FDD | OP.16 FDD | OP.15 FDD |
| Note 1: See Table A.5.1.1.1-2 for other cell-specific test parameters. | | | | | | | |

A.5.1.9.2 Test Requirements

The requirements defined in section A.5.1.1.2 shall apply to this test case.

A.5.1.10 E-UTRAN FDD - FDD Intra frequency handover for UE category 0

A.5.1.10.1 Test Purpose and Environment

This test is to verify the requirement for the FDD-FDD intra frequency handover requirements specified in clause 5.1.2.1.

The test scenario comprises of 1 E-UTRA FDD carrier and 2 cells as given in tables A.5.1.10.1-1 and A.5.1.10.1-2. The test consists of three successive time periods, with time durations of T1, T2 and T3 respectively. At the start of time duration T1, the UE may not have any timing information of cell 2.

E-UTRAN shall send a RRC message implying handover to cell 2. The RRC message implying handover shall be sent to the UE during period T2, after the UE has reported Event A3. T3 is defined as the end of the last TTI containing the RRC message implying handover.

Table A.5.1.10.1-1: General test parameters for E-UTRAN FDD-FDD intra frequency handover test case

| Parameter | | Unit | Value | Comment |
|---|-------------------|------|---|--|
| PDSCH parameters | | | DL Reference Measurement Channel R.13 FDD | As specified in clause A.3.1.1.3 |
| PCFICH/PDCCH/PHICH parameters | | | DL Reference Measurement Channel R.6 FDD | As specified in clause A.3.1.2.1 |
| Initial conditions | Active cell | | Cell 1 | |
| | Neighbouring cell | | Cell 2 | |
| Final condition | Active cell | | Cell 2 | |
| E-UTRA RF Channel Number | | | 1 | Only one FDD carrier frequency is used. |
| Channel Bandwidth (BW_{channel}) | | MHz | 10 | |
| A3-Offset | | dB | 0 | |
| Hysteresis | | dB | 0 | |
| Time To Trigger | | s | 0 | |
| Filter coefficient | | | 0 | L3 filtering is not used |
| DRX | | | | OFF |
| CP length | | | Normal | |
| Access Barring Information | | - | Not Sent | No additional delays in random access procedure. |
| PRACH configuration | | | 4 | As specified in table 5.7.1-2 in TS 36.211 |
| Time offset between cells | | | 3 ms | Asynchronous cells |
| T1 | | s | 5 | |
| T2 | | s | ≤5 | |
| T3 | | s | 1 | |

Table A.5.1.10.1-2: Cell specific test parameters for E-UTRAN FDD-FDD intra frequency handover test case

| Parameter | Unit | Cell 1 | | | Cell 2 | | |
|---|------|----------|----------|----------|----------|----------|----------|
| | | T1 | T2 | T3 | T1 | T2 | T3 |
| E-UTRA RF Channel Number | | 1 | | | 1 | | |
| BW_{channel} | MHz | 10 | | | 10 | | |
| OCNG Patterns defined in A.3.2.1.1 (OP.1 FDD) and in A.3.2.1.2 (OP.2 FDD) | | OP.1 FDD | OP.1 FDD | OP.2 FDD | OP.2 FDD | OP.2 FDD | OP.1 FDD |
| PBCH_RA | dB | | | | | | |
| PBCH_RB | dB | | | | | | |
| PSS_RA | dB | | | | | | |

| | | | | | | | |
|---|------------|------|-----|-----|------------|-----|-----|
| SSS_RA | dB | 0 | | | 0 | | |
| PCFICH_RB | dB | | | | | | |
| PHICH_RA | dB | | | | | | |
| PHICH_RB | dB | | | | | | |
| PDCCH_RA | dB | | | | | | |
| PDCCH_RB | dB | | | | | | |
| PDSCH_RA | dB | | | | | | |
| PDSCH_RB | dB | | | | | | |
| OCNG_RA ^{Note 1} | dB | | | | | | |
| OCNG_RB ^{Note 1} | dB | | | | | | |
| \hat{E}_s / I_{ot} | dB | | | | | | |
| N_{oc} ^{Note 2} | dBm/15 KHz | -98 | | | | | |
| \hat{E}_s / N_{oc} | dB | 8 | 8 | 8 | - Infinity | 11 | 11 |
| RSRP ^{Note 3} | dBm/15 KHz | -90 | -90 | -90 | - Infinity | -87 | -87 |
| Propagation Condition | | AWGN | | | | | |
| <p>Note 1: OCNG shall be used such that both cells are fully allocated and a constant total transmitted power spectral density is achieved for all OFDM symbols.</p> <p>Note 2: Interference from other cells and noise sources not specified in the test is assumed to be constant over subcarriers and time and shall be modelled as AWGN of appropriate power for N_{oc} to be fulfilled.</p> <p>Note 3: RSRP levels have been derived from other parameters for information purposes. They are not settable parameters themselves.</p> | | | | | | | |

A.5.1.10.2 Test Requirements

The UE shall start to transmit the PRACH to Cell 2 less than 50 ms from the beginning of time period T3.

The rate of correct handovers observed during repeated tests shall be at least 90%.

NOTE: The handover delay can be expressed as: RRC procedure delay + $T_{interrupt}$, where:

$$\text{RRC procedure delay} = 15 \text{ ms and is specified in clause 11.2 in TS 36.331 [2].}$$

$$T_{interrupt} = 35 \text{ ms in the test; } T_{interrupt} \text{ is defined in clause 5.1.2.1.2.}$$

This gives a total of 50 ms.

A.5.1.11 E-UTRAN HD - FDD Intra frequency handover for UE category 0

A.5.1.11.1 Test Purpose and Environment

This test is to verify the requirement for the HD-FDD intra frequency handover requirements specified in clause 5.2.2.5.

The test scenario comprises of 1 E-UTRA FDD carrier and 2 cells as given in tables A.5.1.11.1-1 and A.5.1.11.1-2. The test consists of three successive time periods, with time durations of T1, T2 and T3 respectively. At the start of time duration T1, the UE may not have any timing information of cell 2.

E-UTRAN shall send a RRC message implying handover to cell 2. The RRC message implying handover shall be sent to the UE during period T2, after the UE has reported Event A3. T3 is defined as the end of the last TTI containing the RRC message implying handover.

Table A.5.1.11.1-1: General test parameters for E-UTRAN HD-FDD intra frequency handover test case

| Parameter | Unit | Value | Comment |
|-------------------------------|-------------------|---|----------------------------------|
| PDSCH parameters | | DL Reference Measurement Channel R.1 HD-FDD | As specified in clause A.3.1.1.4 |
| PCFICH/PDCCH/PHICH parameters | | DL Reference Measurement Channel R.3 HD-FDD | As specified in clause A.3.1.2.3 |
| Initial conditions | Active cell | Cell 1 | |
| | Neighbouring cell | Cell 2 | |
| Final condition | Active cell | Cell 2 | |

| | | | |
|---|-----|----------|--|
| E-UTRA RF Channel Number | | 1 | Only one FDD carrier frequency is used. |
| Channel Bandwidth (BW_{channel}) | MHz | 10 | |
| A3-Offset | dB | 0 | |
| Hysteresis | dB | 0 | |
| Time To Trigger | s | 0 | |
| Filter coefficient | | 0 | L3 filtering is not used |
| DRX | | | OFF |
| CP length | | Normal | |
| Access Barring Information | - | Not Sent | No additional delays in random access procedure. |
| PRACH configuration | | 4 | As specified in table 5.7.1-2 in TS 36.211 |
| Time offset between cells | | 3 ms | Asynchronous cells |
| T1 | s | 5 | |
| T2 | s | ≤ 5 | |
| T3 | s | 1 | |

Table A.5.1.11.1-2: Cell specific test parameters for E-UTRAN FDD-FDD intra frequency handover test case

| Parameter | Unit | Cell 1 | | | Cell 2 | | |
|--|------------|----------|----------|----------|------------|----------|----------|
| | | T1 | T2 | T3 | T1 | T2 | T3 |
| E-UTRA RF Channel Number | | 1 | | | 1 | | |
| BW_{channel} | MHz | 10 | | | 10 | | |
| OCNG Patterns defined in A.3.2.1.1 (OP.1 FDD) and in A.3.2.1.2 (OP.2 FDD) | | OP.1 FDD | OP.1 FDD | OP.2 FDD | OP.2 FDD | OP.2 FDD | OP.1 FDD |
| PBCH_RA | dB | 0 | | | 0 | | |
| PBCH_RB | dB | | | | | | |
| PSS_RA | dB | | | | | | |
| SSS_RA | dB | | | | | | |
| PCFICH_RB | dB | | | | | | |
| PHICH_RA | dB | | | | | | |
| PHICH_RB | dB | | | | | | |
| PDCCH_RA | dB | | | | | | |
| PDCCH_RB | dB | | | | | | |
| PDSCH_RA | dB | | | | | | |
| PDSCH_RB | dB | | | | | | |
| OCNG_RA ^{Note 1} | dB | | | | | | |
| OCNG_RB ^{Note 1} | dB | | | | | | |
| $\hat{E}_s / I_{\text{ot}}$ | dB | | | | | | |
| N_{oc} ^{Note 2} | dBm/15 KHz | -98 | | | | | |
| $\hat{E}_s / N_{\text{oc}}$ | dB | 8 | 8 | 8 | - Infinity | 11 | 11 |
| RSRP ^{Note 3} | dBm/15 KHz | -90 | -90 | -90 | - Infinity | -87 | -87 |
| Propagation Condition | | AWGN | | | | | |
| <p>Note 1: OCNG shall be used such that both cells are fully allocated and a constant total transmitted power spectral density is achieved for all OFDM symbols.</p> <p>Note 2: Interference from other cells and noise sources not specified in the test is assumed to be constant over subcarriers and time and shall be modelled as AWGN of appropriate power for N_{oc} to be fulfilled.</p> <p>Note 3: RSRP levels have been derived from other parameters for information purposes. They are not settable parameters themselves.</p> | | | | | | | |

A.5.1.11.2 Test Requirements

The UE shall start to transmit the PRACH to Cell 2 less than 50 ms from the beginning of time period T3.

The rate of correct handovers observed during repeated tests shall be at least 90%.

NOTE: The handover delay can be expressed as: RRC procedure delay + $T_{\text{interrupt}}$, where:

RRC procedure delay = 15 ms and is specified in clause 11.2 in TS 36.331 [2].

$T_{\text{interrupt}}$ = 35 ms in the test; $T_{\text{interrupt}}$ is defined in clause 5.2.2.5.2.

This gives a total of 50 ms.

A.5.1.12 E-UTRAN TDD - TDD Intra frequency handover for UE category 0

A.5.1.12.1 Test Purpose and Environment

This test is to verify the requirement for the TDD-TDD intra frequency handover requirements specified in clause 5.2.2.4.

The test scenario comprises of 1 E-UTRA TDD carrier and 2 cells as given in tables A.5.1.12.1-1 and A.5.1.12.1-2. The test consists of three successive time periods, with time durations of T1, T2 and T3 respectively. At the start of time duration T1, the UE may not have any timing information of cell 2.

E-UTRAN shall send a RRC message implying handover to cell 2. The RRC message implying handover shall be sent to the UE during period T2, after the UE has reported Event A3. T3 is defined as the end of the last TTI containing the RRC message implying handover.

Table A.5.1.12.1-1: General test parameters for E-UTRAN TDD-TDD Intra frequency handover test case

| Parameter | | Unit | Value | Comment |
|---|-------------------|------|---|--|
| PDSCH parameters | | | DL Reference Measurement Channel R.12 TDD | As specified in clause A.3.1.1.5 |
| PCFICH/PDCCHPHICH parameters | | | DL Reference Measurement Channel R.6 TDD | As specified in clause A.3.1.2.2 |
| Initial conditions | Active cell | | Cell 1 | |
| | Neighbouring cell | | Cell 2 | |
| Final condition | Active cell | | Cell 2 | |
| E-UTRA RF Channel Number | | | 1 | Only one TDD carrier frequency is used. |
| Channel Bandwidth (BW_{channel}) | | MHz | 10 | |
| A3-Offset | | dB | 0 | |
| Hysteresis | | dB | 0 | |
| Time To Trigger | | s | 0 | |
| Filter coefficient | | | 0 | L3 filtering is not used |
| DRX | | | | OFF |
| CP length | | | Normal | |
| Access Barring Information | | - | Not Sent | No additional delays in random access procedure. |
| Special subframe configuration | | | 6 | As specified in table 4.2-1 in TS 36.211 |
| Uplink-downlink configuration | | | 1 | As specified in table 4.2-2 in TS 36.211 |
| PRACH configuration index | | | 53 | As specified in table 5.7.1-3 in TS 36.211 |
| Time offset between cells | | | 3 μ s | Synchronous cells |
| T1 | | s | 5 | |
| T2 | | s | ≤ 5 | |
| T3 | | s | 1 | |

Table A.5.1.12.1-2: Cell specific test parameters for E-UTRAN TDD-TDD Intra frequency handover test case

| Parameter | Unit | Cell 1 | | | Cell 2 | | |
|--------------------------|------|--------|----|----|--------|----|----|
| | | T1 | T2 | T3 | T1 | T2 | T3 |
| E-UTRA RF Channel Number | | 1 | | | 1 | | |
| BW_{channel} | MHz | 10 | | | 10 | | |

| OCNG Patterns defined in A.3.2.2.1 (OP.1 TDD) and in A.3.2.2.2 (OP.2 TDD) | | OP.1 TDD | OP.1 TDD | OP.2 TDD | OP.2 TDD | OP.2 TDD | OP.1 TDD |
|---|------------|----------|----------|----------|-----------|----------|----------|
| PBCH_RA | dB | 0 | | | 0 | | |
| PBCH_RB | dB | | | | | | |
| PSS_RA | dB | | | | | | |
| SSS_RA | dB | | | | | | |
| PCFICH_RB | dB | | | | | | |
| PHICH_RA | dB | | | | | | |
| PHICH_RB | dB | | | | | | |
| PDCCH_RA | dB | | | | | | |
| PDCCH_RB | dB | | | | | | |
| PDSCH_RA | dB | | | | | | |
| PDSCH_RB | dB | | | | | | |
| OCNG_RA ^{Note 1} | dB | | | | | | |
| OCNG_RB ^{Note 1} | dB | | | | | | |
| \hat{E}_s/I_{ot} | dB | 8 | -3.3 | -3.3 | -Infinity | 2.36 | 2.36 |
| N_{oc} ^{Note 2} | dBm/15 KHz | -98 | | | | | |
| \hat{E}_s/N_{oc} | dB | 8 | 8 | 8 | -Infinity | 11 | 11 |
| RSRP ^{Note 3} | dBm/15 KHz | -90 | -90 | -90 | -Infinity | -87 | -87 |
| Propagation Condition | | AWGN | | | | | |
| <p>Note 1: OCNG shall be used such that both cells are fully allocated and a constant total transmitted power spectral density is achieved for all OFDM symbols.</p> <p>Note 2: Interference from other cells and noise sources not specified in the test is assumed to be constant over subcarriers and time and shall be modelled as AWGN of appropriate power for N_{oc} to be fulfilled.</p> <p>Note 3: RSRP levels have been derived from other parameters for information purposes. They are not settable parameters themselves.</p> | | | | | | | |

A.5.1.12.2 Test Requirements

The UE shall start to transmit the PRACH to Cell 2 less than 50 ms from the beginning of time period T3.

The rate of correct handovers observed during repeated tests shall be at least 90%.

NOTE: The handover delay can be expressed as: RRC procedure delay + $T_{interrupt}$, where:

RRC procedure delay = 15 ms and is specified in clause 11.2 in TS 36.331 [2].

$T_{interrupt}$ = 35 ms in the test; $T_{interrupt}$ is defined in clause 5.2.2.4.2.

This gives a total of 50 ms.

A.5.1.13 E-UTRAN FDD-FDD Intra frequency handover for Cat-M1 UEs in CEModeA

A.5.1.13.1 Test Purpose and Environment

This test is to verify the requirement for the FDD-FDD intra frequency handover requirements specified in clause 5.5.2.1.

The test scenario comprises of one E-UTRA FDD carrier and two cells as given in tables A.5.1.13.1-1 and A.5.1.13.1-2. The test consists of three successive time periods, with time durations of T1, T2 and T3 respectively. At the start of time duration T1, the UE may not have any timing information of Cell 2.

E-UTRAN shall send a RRC message implying handover to Cell 2. The RRC message implying handover shall be sent to the UE during period T2, after the UE has reported Event A3. T3 is defined as the end of the last TTI containing the RRC message implying handover.

During the test, UE is configured with measurement gap for cell search, because the narrowband of the PDSCH Reference Measurement Channel does not overlap with the centre 6 PRBs of the carrier bandwidth.

Table A.5.1.13.1-1: General test parameters for E-UTRAN FDD-FDD intra frequency handover for Cat-M1 UEs in CEModeA test case

| Parameter | | Unit | Value | Comment |
|----------------------------|-------------------|------|-----------|--|
| Initial conditions | Active cell | | Cell 1 | |
| | Neighbouring cell | | Cell 2 | |
| Final condition | Active cell | | Cell 2 | |
| E-UTRA RF Channel Number | | | 1 | Only one FDD carrier frequency is used. |
| A3-Offset | | dB | 0 | |
| Hysteresis | | dB | 0 | |
| Time To Trigger | | s | 0 | |
| Filter coefficient | | | 0 | L3 filtering is not used |
| DRX | | | | OFF |
| CP length | | | Normal | |
| Access Barring Information | | - | Not Sent | No additional delays in random access procedure. |
| PRACH configuration | | | PRACH_4CE | As specified in A.3.16 |
| PRACH initial CE level | | | 0 | Specified in the handover message |
| T1 | | s | 5 | |
| T2 | | s | ≤5 | |
| T3 | | s | 1 | |
| Gap pattern ID | | | 1 | |

Table A.5.1.13.1-2: Cell specific test parameters for E-UTRAN FDD-FDD intra frequency handover for Cat-M1 UEs in CEModeA test case

| Parameter | Unit | Cell 1 | | | Cell 2 | | | | |
|--|------------|-----------|-----------|----------|----------|----------|-----------|-----|----|
| | | T1 | T2 | T3 | T1 | T2 | T3 | | |
| E-UTRA RF Channel Number | | 1 | | | | | | | |
| BW _{channel} | MHz | 10 | | | | | | | |
| PDSCH Reference Channel in clause A.3.1.4.1 | | R.21 FDD | R.21 FDD | - | - | - | R.21 FDD | | |
| MPDCCH Reference Channel in clause A.3.1.3.1 | | R.17 FDD | | | R.17 FDD | | | | |
| PCFICH/PDCCH/PHICH Reference Channel in clause A.3.1.2.1 | | R.7 FDD | | | R.7 FDD | | | | |
| OCNG Patterns in clause A.3.2.1 | | OP.21 FDD | OP.21 FDD | OP.6 FDD | OP.6 FDD | OP.6 FDD | OP.21 FDD | | |
| PBCH_RA | dB | | | | | | | | |
| PBCH_RB | dB | | | | | | | | |
| PSS_RA | dB | | | | | | | | |
| SSS_RA | dB | | | | | | | | |
| PCFICH_RB | dB | | | | | | | | |
| PHICH_RA | dB | | | | | | | | |
| PHICH_RB | dB | | | | | | | | |
| PDCCH_RA | dB | | | | | | | -3 | -3 |
| PDCCH_RB | dB | | | | | | | -3 | -3 |
| MPDCCH_RA | dB | | | | | | | -3 | -3 |
| MPDCCH_RB | dB | | | | | | | -3 | -3 |
| PDSCH_RA | dB | | | | | | | -3 | -3 |
| PDSCH_RB | dB | | | | | | | -3 | -3 |
| OCNG_RA ^{Note 1} | dB | | | | | | | -3 | -3 |
| OCNG_RB ^{Note 1} | dB | | | | | | | -3 | -3 |
| N_{oc} ^{Note 2} | dBm/15 KHz | | | | | | | -98 | |

| | | | | | | | |
|--|------------|--------|--------|--------|---------------------------------|------|------|
| \hat{E}_s / N_{oc} | dB | 8 | 8 | 8 | -Infinity | 12 | 12 |
| \hat{E}_s / I_{ot} <small>Note 3</small> | dB | 8 | -4.27 | -4.27 | -Infinity | 3.36 | 3.36 |
| RSRP <small>Note 3</small> | dBm/15 KHz | -90 | -90 | -90 | -Infinity | -86 | -86 |
| I_o <small>Note 3</small> | dBm/9MHz | -61.58 | -56.57 | -56.57 | Specified in columns for Cell 1 | | |
| Propagation Condition | | AWGN | | | AWGN | | |
| Antenna Configuration | | 2x1 | | | 2x1 | | |
| Timing offset to Cell 1 Asynchronous cells | ms | - | | | 3 | | |
| <p>Note 1: OCNG shall be used such that both cells are fully allocated and a constant total transmitted power spectral density is achieved for all OFDM symbols.</p> <p>Note 2: Interference from other cells and noise sources not specified in the test is assumed to be constant over subcarriers and time and shall be modelled as AWGN of appropriate power for N_{oc} to be fulfilled.</p> <p>Note 3: E_s/I_{ot}, RSRP and I_o level has been derived from other parameters for information purpose. They are not settable parameters themselves.</p> | | | | | | | |

A.5.1.13.2 Test Requirements

The UE shall finish the transmission of all repetitions of the PRACH to Cell 2 less than 170 ms from the beginning of time period T3.

The rate of correct handovers observed during repeated tests shall be at least 90%.

NOTE: The handover delay can be expressed as: RRC procedure delay + $T_{interrupt}$, where:

RRC procedure delay = 15 ms and is specified in clause 11.2 in TS 36.331 [2].

$T_{interrupt}$ = 120 + 35 ms in the test; $T_{interrupt}$ is defined in clause 5.5.2.1.2.

This gives a total of 170 ms.

A.5.1.14 E-UTRAN HD-FDD Intra frequency handover for Cat-M1 UEs in CEModeA

A.5.1.14.1 Test Purpose and Environment

This test is to verify the requirement for the HD-FDD intra frequency handover requirements specified in clause 5.5.2.2.

The test scenario comprises of 1 E-UTRA FDD carrier and 2 cells as given in tables A.5.1.14.1-1 and A.5.1.14.1-2. The test consists of three successive time periods, with time durations of T1, T2 and T3 respectively. At the start of time duration T1, the UE may not have any timing information of Cell 2.

E-UTRAN shall send a RRC message implying handover to Cell 2. The RRC message implying handover shall be sent to the UE during period T2, after the UE has reported Event A3. T3 is defined as the end of the last TTI containing the RRC message implying handover.

During the test, UE is configured with measurement gap for cell search, because the narrowband of the PDSCH Reference Measurement Channel does not overlap with the centre 6 PRBs of the carrier bandwidth.

Table A.5.1.14.1-1: General test parameters for E-UTRAN HD-FDD intra frequency handover for Cat-M1 UEs in CEModeA test case

| Parameter | Unit | Value | Comment |
|--------------------------|-------------------|--------|---|
| Initial conditions | Active cell | Cell 1 | |
| | Neighbouring cell | Cell 2 | |
| Final condition | Active cell | Cell 2 | |
| E-UTRA RF Channel Number | | 1 | Only one FDD carrier frequency is used. |

| | | | |
|----------------------------|----|-----------|--|
| A3-Offset | dB | 0 | |
| Hysteresis | dB | 0 | |
| Time To Trigger | s | 0 | |
| Filter coefficient | | 0 | L3 filtering is not used |
| DRX | | | OFF |
| CP length | | Normal | |
| Access Barring Information | - | Not Sent | No additional delays in random access procedure. |
| PRACH configuration | | PRACH_4CE | As specified in A.3.16 |
| PRACH initial CE level | | 0 | Specified in the handover message |
| T1 | s | 5 | |
| T2 | s | ≤5 | |
| T3 | s | 1 | |
| Gap pattern ID | | 1 | |

Table A.5.1.14.1-2: Cell specific test parameters for E-UTRAN HD-FDD intra frequency handover for Cat-M1 UEs in CEModeA test case

| Parameter | Unit | Cell 1 | | | Cell 2 | | |
|--|------------|-------------|-------------|----------|---------------------------------|----------|-------------|
| | | T1 | T2 | T3 | T1 | T2 | T3 |
| E-UTRA RF Channel Number | | 1 | | | | | |
| $BW_{channel}$ | MHz | 10 | | | | | |
| PDSCH Reference Channel in clause A.3.1.4.2 | | R.11 HD-FDD | R.11 HD-FDD | - | - | - | R.11 HD-FDD |
| MPDCCH Reference Channel in clause A.3.1.3.2 | | R.7 HD-FDD | | | R.7 HD-FDD | | |
| PCFICH/PDCCH/PHICH Reference Channel in clause A.3.1.2.3 | | R.4 HD-FDD | | | R.4 HD-FDD | | |
| OCNG Patterns in clause A.3.2.1 | | OP.21 FDD | OP.21 FDD | OP.6 FDD | OP.6 FDD | OP.6 FDD | OP.21 FDD |
| PBCH_RA | dB | -3 | | | -3 | | |
| PBCH_RB | dB | | | | | | |
| PSS_RA | dB | | | | | | |
| SSS_RA | dB | | | | | | |
| PCFICH_RB | dB | | | | | | |
| PHICH_RA | dB | | | | | | |
| PHICH_RB | dB | | | | | | |
| PDCCH_RA | dB | | | | | | |
| PDCCH_RB | dB | | | | | | |
| MPDCCH_RA | dB | | | | | | |
| MPDCCH_RB | dB | | | | | | |
| PDSCH_RA | dB | | | | | | |
| PDSCH_RB | dB | | | | | | |
| OCNG_RA ^{Note 1} | dB | | | | | | |
| OCNG_RB ^{Note 1} | dB | | | | | | |
| N_{oc} ^{Note 2} | dBm/15 KHz | -98 | | | | | |
| \hat{E}_s / N_{oc} ^{Note 3} | dB | 8 | 8 | 8 | -Infinity | 12 | 12 |
| \hat{E}_s / I_{ot} | dB | 8 | -4.27 | -4.27 | -Infinity | 3.36 | 3.36 |
| RSRP ^{Note 3} | dBm/15 KHz | -90 | -90 | -90 | -Infinity | -86 | -86 |
| I_0 ^{Note 3} | dBm/9MHz | -61.58 | -56.57 | -56.57 | Specified in columns for Cell 1 | | |
| Propagation Condition | | AWGN | | | AWGN | | |
| Antenna Configuration | | 2x1 | | | 2x1 | | |
| Timing offset to Cell 1 Asynchronous cells | ms | - | | | 3 | | |

| | |
|---------|--|
| Note 1: | OCNG shall be used such that both cells are fully allocated and a constant total transmitted power spectral density is achieved for all OFDM symbols. |
| Note 2: | Interference from other cells and noise sources not specified in the test is assumed to be constant over subcarriers and time and shall be modelled as AWGN of appropriate power for N_{oc} to be fulfilled. |
| Note 3: | Es/lot, RSRP and Io level has been derived from other parameters for information purpose. They are not settable parameters themselves |

A.5.1.14.2 Test Requirements

The UE shall finish the transmission of all the repetitions of the PRACH to Cell 2 less than 170 ms from the beginning of time period T3.

The rate of correct handovers observed during repeated tests shall be at least 90%.

NOTE: The handover delay can be expressed as: RRC procedure delay + $T_{interrupt}$, where:

RRC procedure delay = 15 ms and is specified in clause 11.2 in TS 36.331 [2].

$T_{interrupt} = 120 + 35$ ms in the test; $T_{interrupt}$ is defined in clause 5.5.2.1.2.

This gives a total of 170 ms.

A.5.1.15 E-UTRAN TDD Intra frequency handover for Cat-M1 UEs in CEModeA

A.5.1.15.1 Test Purpose and Environment

This test is to verify the requirement for the TDD intra frequency handover requirements specified in clause 5.5.2.3.

The test scenario comprises of 1 E-UTRA TDD carrier and 2 cells as given in tables A.5.1.15.1-1 and A.5.1.15.1-2. The test consists of three successive time periods, with time durations of T1, T2 and T3 respectively. At the start of time duration T1, the UE may not have any timing information of Cell 2.

E-UTRAN shall send a RRC message implying handover to Cell 2. The RRC message implying handover shall be sent to the UE during period T2, after the UE has reported Event A3. T3 is defined as the end of the last TTI containing the RRC message implying handover.

During the test, UE is configured with measurement gap for cell search, because the narrowband of the PDSCH Reference Measurement Channel does not overlap with the centre 6 PRBs of the carrier bandwidth.

Table A.5.1.15.1-1: General test parameters for E-UTRAN TDD Intra frequency handover for Cat-M1 UEs in CEModeA test case

| Parameter | Unit | Value | Comment |
|--------------------------------|-------------------|-----------|--|
| Initial conditions | Active cell | Cell 1 | |
| | Neighbouring cell | Cell 2 | |
| Final condition | Active cell | Cell 2 | |
| E-UTRA RF Channel Number | | 1 | Only one TDD carrier frequency is used. |
| A3-Offset | dB | 0 | |
| Hysteresis | dB | 0 | |
| Time To Trigger | s | 0 | |
| Filter coefficient | | 0 | L3 filtering is not used |
| DRX | | | OFF |
| CP length | | Normal | |
| Access Barring Information | - | Not Sent | No additional delays in random access procedure. |
| Special subframe configuration | | 6 | As specified in table 4.2-1 in TS 36.211 |
| Uplink-downlink configuration | | 1 | As specified in table 4.2-2 in TS 36.211 |
| PRACH configuration index | | PRACH_4CE | As specified in A.3.16 |

| | | | |
|------------------------|---|----|-----------------------------------|
| PRACH initial CE level | | 0 | Specified in the handover message |
| T1 | s | 5 | |
| T2 | s | ≤5 | |
| T3 | s | 1 | |
| Gap pattern ID | | 1 | |

Table A.5.1.15.1-2: Cell specific test parameters for E-UTRAN TDD Intra frequency handover for Cat-M1 UEs in CEModeA test case

| Parameter | Unit | Cell 1 | | | Cell 2 | | |
|---|------------|-----------|-----------|----------|---------------------------------|----------|-----------|
| | | T1 | T2 | T3 | T1 | T2 | T3 |
| E-UTRA RF Channel Number | | 1 | | | | | |
| BW _{channel} | MHz | 10 | | | | | |
| PDSCH Reference Channel in clause A.3.1.4.3 | | R.17 TDD | R.17 TDD | - | - | - | R.17 TDD |
| MPDCCH Reference Channel in clause A.3.1.3.3 | | R.15 TDD | | | R.15 TDD | | |
| PCFICH/PDCCH/PHICH Reference Channel in clause A.3.1.2.2 | | R.7 TDD | | | R.7 TDD | | |
| OCNG Patterns in clause A.3.2.2 | | OP.11 TDD | OP.11 TDD | OP.2 TDD | OP.2 TDD | OP.2 TDD | OP.11 TDD |
| PBCH_RA | dB | -3 | | | -3 | | |
| PBCH_RB | dB | | | | | | |
| PSS_RA | dB | | | | | | |
| SSS_RA | dB | | | | | | |
| PCFICH_RB | dB | | | | | | |
| PHICH_RA | dB | | | | | | |
| PHICH_RB | dB | | | | | | |
| PDCCH_RA | dB | | | | | | |
| PDCCH_RB | dB | | | | | | |
| MPDCCH_RA | dB | | | | | | |
| MPDCCH_RB | dB | | | | | | |
| PDSCH_RA | dB | | | | | | |
| PDSCH_RB | dB | | | | | | |
| OCNG_RA ^{Note 1} | dB | | | | | | |
| OCNG_RB ^{Note 1} | dB | | | | | | |
| N_{oc} ^{Note 2} | dBm/15 KHz | -98 | | | | | |
| \hat{E}_s / N_{oc} | dB | 8 | 8 | 8 | -Infinity | 12 | 12 |
| \hat{E}_s / I_{ot} ^{Note 3} | dB | 8 | -4.27 | -4.27 | -Infinity | 3.36 | 3.36 |
| RSRP ^{Note 3} | dBm/15 KHz | -90 | -90 | -90 | -Infinity | -86 | -86 |
| I_o ^{Note 3} | dBm/9MHz | -61.58 | -56.57 | -56.57 | Specified in columns for Cell 1 | | |
| Propagation Condition | | AWGN | | | AWGN | | |
| Antenna Configuration | | 2x1 | | | 2x1 | | |
| Timing offset to Cell 1 Synchronous cells | μs | - | | | 3 | | |
| <p>Note 1: OCNG shall be used such that both cells are fully allocated and a constant total transmitted power spectral density is achieved for all OFDM symbols.</p> <p>Note 2: Interference from other cells and noise sources not specified in the test is assumed to be constant over subcarriers and time and shall be modelled as AWGN of appropriate power for N_{oc} to be fulfilled.</p> <p>Note 3: E_s/I_{ot}, RSRP and I_o level has been derived from other parameters for information purpose. They are not settable parameters themselves</p> | | | | | | | |

A.5.1.15.2 Test Requirements

The UE shall finish the transmission of all the repetitions of the PRACH to Cell 2 less than 170 ms from the beginning of time period T3.

The rate of correct handovers observed during repeated tests shall be at least 90%.

NOTE: The handover delay can be expressed as: RRC procedure delay + $T_{\text{interrupt}}$, where:

RRC procedure delay = 15 ms and is specified in clause 11.2 in TS 36.331 [2].

$T_{\text{interrupt}} = 120 + 35$ ms in the test; $T_{\text{interrupt}}$ is defined in clause 5.5.2.3.2.

This gives a total of 170 ms.

A.5.1.16 E-UTRAN FDD-FDD Intra frequency handover for Cat-M1 UEs in CEModeB

A.5.1.16.1 Test Purpose and Environment

This test is to verify the requirement for the FDD-FDD intra frequency handover requirements specified in clause 5.6.2.1.

The test scenario comprises of one E-UTRA FDD carrier and two cells as given in tables A.5.1.16.1-1 and A.5.1.16.1-2. The test consists of three successive time periods, with time durations of T1, T2 and T3 respectively. At the start of time duration T1, the UE may not have any timing information of Cell 2.

During period T2, the UE should report Event A3, and afterwards E-UTRAN shall send a RRC message to the UE implying handover to Cell 2. T3 is defined as the end of the last TTI containing the RRC message from UE implying handover.

During the test, the UE is configured with measurement gap for cell search, because the narrowband of the PDSCH Reference Measurement Channel does not overlap with the centre 6 PRBs of the carrier bandwidth.

Table A.5.1.16.1-1: General test parameters for E-UTRAN FDD-FDD intra frequency handover for Cat-M1 UEs in CEModeB test case

| Parameter | | Unit | Value | Comment |
|----------------------------|-------------------|------|-----------|--|
| Initial conditions | Active cell | | Cell 1 | |
| | Neighbouring cell | | Cell 2 | |
| Final condition | Active cell | | Cell 2 | |
| E-UTRA RF Channel Number | | | 1 | Only one FDD carrier frequency is used. |
| A3-Offset | | dB | 0 | |
| Hysteresis | | dB | 0 | |
| Time To Trigger | | s | 0 | |
| Filter coefficient | | | 0 | L3 filtering is not used |
| DRX | | | | OFF |
| CP length | | | Normal | |
| Access Barring Information | | - | Not Sent | No additional delays in random access procedure. |
| PRACH configuration | | | PRACH_4CE | As specified in A.3.16 |
| PRACH initial CE level | | | 0 | Specified in handover message |
| T1 | | s | 5 | |
| T2 | | s | ≤5 | |
| T3 | | s | 5 | |
| Gap pattern ID | | | 1 | |

Table A.5.1.16.1-2: Cell specific test parameters for E-UTRAN FDD-FDD intra frequency handover for Cat-M1 UEs in CEModeB test case

| Parameter | Unit | Cell 1 | | | Cell 2 | | |
|-----------|------|--------|----|----|--------|----|----|
| | | T1 | T2 | T3 | T1 | T2 | T3 |
| | | | | | | | |

| | | | | | | | |
|--|------------|-----------|-----------|----------|---------------------------------|----------|-----------|
| E-UTRA RF Channel Number | | 1 | | | | | |
| BW _{channel} | MHz | 10 | | | | | |
| PDSCH Reference Channel in A.3.1.4.4 | | R.23 FDD | R.23 FDD | - | - | - | R.23 FDD |
| MPDCCH Reference Channel in A.3.1.3.4 | | R.19 FDD | | | R.19 FDD | | |
| PCFICH/PDCCH/PHICH Reference Channel in clause A.3.1.2.1 | | R.7 FDD | | | R.7 FDD | | |
| OCNG Patterns in clause A.3.2.1 | | OP.21 FDD | OP.21 FDD | OP.6 FDD | OP.6 FDD | OP.6 FDD | OP.21 FDD |
| PBCH_RA | dB | -3 | | | | | |
| PBCH_RB | dB | | | | | | |
| PSS_RA | dB | | | | | | |
| SSS_RA | dB | | | | | | |
| PCFICH_RB | dB | | | | | | |
| PHICH_RA | dB | | | | | | |
| PHICH_RB | dB | | | | | | |
| PDCCH_RA | dB | | | | | | |
| PDCCH_RB | dB | | | | | | |
| MPDCCH_RA | dB | | | | | | |
| MPDCCH_RB | dB | | | | | | |
| PDSCH_RA | dB | | | | | | |
| PDSCH_RB | dB | | | | | | |
| OCNG_RA ^{Note 1} | dB | | | | | | |
| OCNG_RB ^{Note 1} | dB | | | | | | |
| N_{oc} ^{Note 2} | dBm/15 KHz | | | | | | |
| \hat{E}_s / N_{oc} | dB | -12 | -12 | -12 | -Infinity | -7 | -7 |
| \hat{E}_s / I_{ot} ^{Note 3} | dB | -12 | -12.79 | -12.79 | -Infinity | -7.27 | -7.27 |
| RSRP ^{Note 3} | dBm/15 KHz | -110 | -110 | -110 | -Infinity | -105 | -105 |
| I_o ^{Note 3} | dBm/9MHz | -69.95 | -69.21 | -69.21 | Specified in columns for Cell 1 | | |
| Propagation Condition | | AWGN | | | AWGN | | |
| Antenna Configuration | | 2x1 | | | 2x1 | | |
| Timing offset to Cell 1 Asynchronous cells | ms | - | | | 3 | | |
| <p>Note 1: OCNG shall be used such that both cells are fully allocated and a constant total transmitted power spectral density is achieved for all OFDM symbols.</p> <p>Note 2: Interference from other cells and noise sources not specified in the test is assumed to be constant over subcarriers and time and shall be modelled as AWGN of appropriate power for N_{oc} to be fulfilled.</p> <p>Note 3: E_s/I_{ot}, RSRP and I_o level has been derived from other parameters for information purpose. They are not settable parameters themselves.</p> | | | | | | | |

A.5.1.16.2 Test Requirements

The UE shall finish transmission of all repetitions of the PRACH to Cell 2 less than 2610ms from the beginning of time period T3.

The rate of correct handovers observed during repeated tests shall be at least 90%.

NOTE: The handover delay can be expressed as: RRC procedure delay + $T_{interrupt}$, where:

$$\text{RRC procedure delay} = 15 \text{ ms and is specified in clause 11.2 in TS 36.331 [2].}$$

$$T_{interrupt} = 2560\text{ms} + 35\text{ms} = 2595\text{ms is defined in clause 5.6.2.1.2.}$$

This gives a total of 2610ms.

A.5.1.17 E-UTRAN HD-FDD Intra frequency handover for Cat-M1 UEs in CEModeB

A.5.1.17.1 Test Purpose and Environment

This test is to verify the requirement for the HD-FDD intra frequency handover requirements specified in clause 5.6.2.2.

The test scenario comprises of one E-UTRA FDD carrier and two cells as given in tables A.5.1.17.1-1 and A.5.1.17.1-2. The test consists of three successive time periods, with time durations of T1, T2 and T3 respectively. At the start of time duration T1, the UE may not have any timing information of Cell 2.

During period T2, the UE should report Event A3, and afterwards E-UTRAN shall send a RRC message to the UE implying handover to Cell 2. During T3 is defined as the end of the last TTI containing the RRC message from UE implying handover.

During the test, UE is configured with measurement gap for cell search, because the narrowband of the PDSCH Reference Measurement Channel does not overlap with the centre 6 PRBs of the carrier bandwidth.

Table A.5.1.17.1-1: General test parameters for E-UTRAN HD-FDD intra frequency handover for Cat-M1 UEs in CEModeB test case

| Parameter | | Unit | Value | Comment |
|----------------------------|-------------------|------|-----------|--|
| Initial conditions | Active cell | | Cell 1 | |
| | Neighbouring cell | | Cell 2 | |
| Final condition | Active cell | | Cell 2 | |
| A3-Offset | | dB | 0 | |
| Hysteresis | | dB | 0 | |
| Time To Trigger | | s | 0 | |
| Filter coefficient | | | 0 | L3 filtering is not used |
| DRX | | | | OFF |
| CP length | | | Normal | |
| Access Barring Information | | - | Not Sent | No additional delays in random access procedure. |
| PRACH configuration | | | PRACH_4CE | As specified in clause A.3.16 |
| PRACH initial CE level | | | 0 | Specified in handover message |
| T1 | | s | 5 | |
| T2 | | s | ≤5 | |
| T3 | | s | 5 | |
| Gap pattern ID | | | 1 | |

Table A.5.1.17.1-2: Cell specific test parameters for E-UTRAN HD-FDD intra frequency handover for Cat-M1 UEs in CEModeA test case

| Parameter | Unit | Cell 1 | | | Cell 2 | | |
|--|------|-------------|-------------|----------|------------|----------|-------------|
| | | T1 | T2 | T3 | T1 | T2 | T3 |
| E-UTRA RF Channel Number | | 1 | | | | | |
| BW _{channel} | MHz | 10 | | | | | |
| PDSCH Reference Channel in clause A.3.1.4.5 | | R.13 HD-FDD | R.13 HD-FDD | - | - | - | R.13 HD-FDD |
| MPDCCH Reference Channel in clause A.3.1.3.5 | | R.9 HD-FDD | | | R.9 HD-FDD | | |
| PCFICH/PDCCH/PHICH Reference Channel in clause A.3.1.2.3 | | R.4 HD-FDD | | | R.4 HD-FDD | | |
| OCNG Patterns in clause A.3.2.1 | | OP.21 FDD | OP.21 FDD | OP.6 FDD | OP.6 FDD | OP.6 FDD | OP.21 FDD |
| PBCH_RA | dB | | | | | | |
| PBCH_RB | dB | | | | | | |
| PSS_RA | dB | | | | | | |
| SSS_RA | dB | | | | | | |

| | | | | | | | |
|--|------------|--------|--------|--------|---------------------------------|-------|-------|
| PCFICH_RB | dB | -3 | | | -3 | | |
| PHICH_RA | dB | | | | | | |
| PHICH_RB | dB | | | | | | |
| PDCCH_RA | dB | | | | | | |
| PDCCH_RB | dB | | | | | | |
| MPDCCH_RA | dB | | | | | | |
| MPDCCH_RB | dB | | | | | | |
| PDSCH_RA | dB | | | | | | |
| PDSCH_RB | dB | | | | | | |
| OCNG_RA ^{Note 1} | dB | | | | | | |
| OCNG_RB ^{Note 1} | dB | | | | | | |
| N_{oc} ^{Note 2} | dBm/15 KHz | | | | | | |
| \hat{E}_s / N_{oc} ^{Note 3} | dB | -12 | -12 | -12 | -Infinity | -7 | -7 |
| \hat{E}_s / I_{ot} | dB | -12 | -12.79 | -12.79 | -Infinity | -7.27 | -7.27 |
| RSRP ^{Note 3} | dBm/15 KHz | -110 | -110 | -110 | -Infinity | -105 | -105 |
| I_o ^{Note 3} | dBm/9MHz | -69.95 | -69.21 | -69.21 | Specified in columns for Cell 1 | | |
| Propagation Condition | | AWGN | | | AWGN | | |
| Antenna Configuration | | 2x1 | | | 2x1 | | |
| Timing offset to Cell 1 Asynchronous cells | ms | - | | | 3 | | |
| Note 1: OCNG shall be used such that both cells are fully allocated and a constant total transmitted power spectral density is achieved for all OFDM symbols. | | | | | | | |
| Note 2: Interference from other cells and noise sources not specified in the test is assumed to be constant over subcarriers and time and shall be modelled as AWGN of appropriate power for N_{oc} to be fulfilled. | | | | | | | |
| Note 3: E_s/I_{ot} , RSRP and I_o level has been derived from other parameters for information purpose. They are not settable parameters themselves. | | | | | | | |

A.5.1.17.2 Test Requirements

The UE shall finish the transmission of all repetitions of the PRACH to Cell 2 less than 2610 ms from the beginning of time period T3.

The rate of correct handovers observed during repeated tests shall be at least 90%.

NOTE: The handover delay can be expressed as: RRC procedure delay + $T_{interrupt}$, where:

RRC procedure delay = 15 ms and is specified in clause 11.2 in TS 36.331 [2].

$T_{interrupt} = 2560\text{ms} + 35\text{ms} = 2595\text{ms}$ is defined in clause 5.6.2.1.2.

This gives a total of 2610ms.

A.5.1.18 E-UTRAN TDD Intra frequency handover for Cat-M1 UEs in CEModeB

A.5.1.18.1 Test Purpose and Environment

This test is to verify the requirement for the TDD-TDD intra frequency handover requirements specified in clause 5.6.2.3.

The test scenario comprises of one E-UTRA TDD carrier and two cells as given in tables A.5.1.18.1-1 and A.5.1.18.1-2. The test consists of three successive time periods, with time durations of T1, T2 and T3 respectively. At the start of time duration T1, the UE may not have any timing information of Cell 2.

During period T2, the UE should report Event A3, and afterwards E-UTRAN shall send a RRC message to the UE implying handover to Cell 2. During T3 is defined as the end of the last TTI containing the RRC message from UE implying handover.

During the test, the UE is configured with measurement gap for cell search, because the narrowband of the PDSCH Reference Measurement Channel does not overlap with the centre 6 PRBs of the carrier bandwidth.

Table A.5.1.18.1-1: General test parameters for E-UTRAN TDD Intra frequency handover for Cat-M1 UEs in CEModeB test case

| Parameter | Unit | Value | Comment |
|--------------------------------|-------------------|-----------|--|
| Initial conditions | Active cell | Cell 1 | |
| | Neighbouring cell | Cell 2 | |
| Final condition | Active cell | Cell 2 | |
| A3-Offset | dB | 0 | |
| Hysteresis | dB | 0 | |
| Time To Trigger | s | 0 | |
| Filter coefficient | | 0 | L3 filtering is not used |
| DRX | | | OFF |
| CP length | | Normal | |
| Access Barring Information | - | Not Sent | No additional delays in random access procedure. |
| Special subframe configuration | | 6 | As specified in table 4.2-1 in TS 36.211 |
| Uplink-downlink configuration | | 1 | As specified in table 4.2-2 in TS 36.211 |
| PRACH configuration | | PRACH_4CE | As specified in clause A.3.16 |
| PRACH initial CE level | | 0 | Specified in handover message |
| T1 | s | 5 | |
| T2 | s | ≤5 | |
| T3 | s | 5 | |
| Gap pattern ID | | 1 | |

Table A.5.1.18.1-2: Cell specific test parameters for E-UTRAN TDD Intra frequency handover test case

| Parameter | Unit | Cell 1 | | | Cell 2 | | |
|--|------------|-----------|-----------|----------|----------|----------|-----------|
| | | T1 | T2 | T3 | T1 | T2 | T3 |
| E-UTRA RF Channel Number | | 1 | | | 1 | | |
| BW _{channel} | MHz | 10 | | | 10 | | |
| PDSCH Reference Channel in clause A.3.1.4.6 | | R.19 TDD | R.19 TDD | - | - | - | R.19 TDD |
| MPDCCH Reference Channel in clause A.3.1.3.6 | | R.17 TDD | | | R.17 TDD | | |
| PCFICH/PDCCH/PHICH Reference Channel in clause A.3.1.2.2 | | R.7 TDD | | | R.7 TDD | | |
| OCNG Patterns in clause A.3.2.2 | | OP.11 TDD | OP.11 TDD | OP.2 TDD | OP.2 TDD | OP.2 TDD | OP.11 TDD |
| PBCH_RA | dB | -3 | | | -3 | | |
| PBCH_RB | dB | | | | | | |
| PSS_RA | dB | | | | | | |
| SSS_RA | dB | | | | | | |
| PCFICH_RB | dB | | | | | | |
| PHICH_RA | dB | | | | | | |
| PHICH_RB | dB | | | | | | |
| PDCCH_RA | dB | | | | | | |
| PDCCH_RB | dB | | | | | | |
| MPDCCH_RA | dB | | | | | | |
| MPDCCH_RB | dB | | | | | | |
| PDSCH_RA | dB | | | | | | |
| PDSCH_RB | dB | | | | | | |
| OCNG_RA ^{Note 1} | dB | | | | | | |
| OCNG_RB ^{Note 1} | dB | | | | | | |
| N_{oc} ^{Note 2} | dBm/15 KHz | | | | | | |

| | | | | | | | |
|--|------------|--------|--------|--------|---------------------------------|-------|-------|
| \hat{E}_s / N_{oc} | dB | -12 | -12 | -12 | -Infinity | -7 | -7 |
| \hat{E}_s / I_{ot} <small>Note 3</small> | dB | -12 | -12.79 | -12.79 | -Infinity | -7.27 | -7.27 |
| RSRP <small>Note 3</small> | dBm/15 KHz | -110 | -110 | -110 | -Infinity | -105 | -105 |
| I_o <small>Note 3</small> | dBm/9MHz | -69.95 | -69.21 | -69.21 | Specified in columns for Cell 1 | | |
| Propagation Condition | | AWGN | | | AWGN | | |
| Antenna Configuration | | 2x1 | | | 2x1 | | |
| Timing offset to Cell 1 Synchronous cells | μ s | - | | | 3 | | |
| <p>Note 1: OCNG shall be used such that both cells are fully allocated and a constant total transmitted power spectral density is achieved for all OFDM symbols.</p> <p>Note 2: Interference from other cells and noise sources not specified in the test is assumed to be constant over subcarriers and time and shall be modelled as AWGN of appropriate power for N_{oc} to be fulfilled.</p> <p>Note 3: E_s/I_{ot}, RSRP and I_o level has been derived from other parameters for information purpose. They are not settable parameters themselves.</p> | | | | | | | |

A.5.1.18.2 Test Requirements

The UE shall finish the transmission of all repetitions of the PRACH to Cell 2 less than 2610 ms from the beginning of time period T3.

The rate of correct handovers observed during repeated tests shall be at least 90%.

NOTE: The handover delay can be expressed as: RRC procedure delay + $T_{interrupt}$, where:

RRC procedure delay = 15 ms and is specified in clause 11.2 in TS 36.331 [2].

$T_{interrupt} = 2560\text{ms} + 35\text{ms} = 2595\text{ms}$ is defined in clause 5.6.2.1.2.

This gives a total of 2610 ms.

A.5.2 E-UTRAN Handover to other RATs

A.5.2.1 E-UTRAN FDD – UTRAN FDD Handover

A.5.2.1.1 Test Purpose and Environment

This test is to verify the requirement for the E-UTRAN FDD to UTRAN FDD handover requirements specified in clause 5.3.1.

The test parameters are given in Tables A.5.2.1.1-1, A.5.2.1.1-2 and A.5.2.1.1-3. The test consists of three successive time periods, with time durations of T1, T2 and T3 respectively. At the start of time duration T1, the UE does not have any timing information of Cell 2. Starting T2, Cell 2 becomes detectable and the UE is expected to detect and send a measurement report. Gap pattern configuration with id #0 as specified in Table 8.1.2.1-1 is configured before T2 begins to enable inter-RAT frequency monitoring.

A RRC message implying handover shall be sent to the UE during period T2, after the UE has reported Event B2. The start of T3 is the instant when the last TTI containing the RRC message implying handover is sent to the UE. The handover message shall contain cell 2 as the target cell.

Table A.5.2.1.1-1: General test parameters for E-UTRAN FDD to UTRAN FDD handover test case

| Parameter | | Unit | Value | Comment |
|-------------------------------|-------------------|------|--|----------------------------------|
| PDSCH parameters | | | DL Reference Measurement Channel R.0 FDD | As specified in clause A.3.1.1.1 |
| PCFICH/PDCCH/PHICH parameters | | | DL Reference Measurement Channel R.6 FDD | As specified in clause A.3.1.2.1 |
| Initial conditions | Active cell | | Cell 1 | E-UTRAN cell |
| | Neighbouring cell | | Cell 2 | UTRAN cell |

| Final condition | Active cell | | Cell 2 | UTRAN cell |
|---|-------------|-----|-------------|---|
| Channel Bandwidth ($BW_{channel}$) | | MHz | 10 | |
| Gap Pattern Id | | | 0 | As specified in Table 8.1.2.1-1 started before T2 starts |
| E-UTRAN FDD measurement quantity | | | RSRP | |
| Inter-RAT (UTRAN FDD) measurement quantity | | | CPICH Ec/N0 | |
| b2-Threshold1 | | dBm | -90 | Absolute E-UTRAN RSRP threshold for event B2 |
| b2-Threshold2-UTRA | | dB | -18 | Absolute UTRAN CPICH Ec/Io threshold for event B2 |
| Hysteresis | | dB | 0 | |
| TimeToTrigger | | s | 0 | |
| Filter coefficient | | | 0 | L3 filtering is not used |
| DRX | | | OFF | Non-DRX test |
| Access Barring Information | | - | Not sent | No additional delays in random access procedure |
| E-UTRA RF Channel Number | | | 1 | One E-UTRA FDD carrier frequency is used. |
| E-UTRA Channel Bandwidth ($BW_{channel}$) | | MHz | 10 | |
| UTRA RF Channel Number | | | 1 | One UTRA FDD carrier frequency is used. |
| Monitored UTRA FDD cell list size | | | 12 | UTRA cells on UTRA RF channel 1 provided in the cell before T2. |
| Post-verification period | | | False | |
| T1 | | s | 5 | |
| T2 | | s | ≤ 5 | |
| T3 | | s | 1 | |

Table A.5.2.1.1-2: Cell specific test parameters for E-UTRAN FDD to UTRAN FDD handover test case (cell 1)

| Parameter | Unit | Cell 1 (E-UTRA) | | |
|---|------------|-----------------|----------|----------|
| | | T1 | T2 | T3 |
| E-UTRA RF Channel number | | 1 | | |
| $BW_{channel}$ | MHz | 10 | | |
| OCNG Patterns defined in A.3.2.1.1 (OP.1 FDD) and in A.3.2.1.2 (OP.2 FDD) | | OP.1 FDD | OP.1 FDD | OP.2 FDD |
| PBCH_RA | dB | 0 | | |
| PBCH_RB | dB | | | |
| PSS_RA | dB | | | |
| SSS_RA | dB | | | |
| PCFICH_RB | dB | | | |
| PHICH_RA | dB | | | |
| PHICH_RB | dB | | | |
| PDCCH_RA | dB | | | |
| PDCCH_RB | dB | | | |
| PDSCH_RA | dB | | | |
| PDSCH_RB | dB | | | |
| OCNG_RA ^{Note 1} | dB | | | |
| OCNG_RB ^{Note 1} | dB | | | |
| \hat{E}_s / I_{ot} | dB | 0 | 0 | 0 |
| N_{oc} | dBm/15 kHz | -98 | | |
| \hat{E}_s / N_{oc} | dB | 0 | 0 | 0 |
| RSRP ^{Note 2} | dBm/15 KHz | -98 | -98 | -98 |
| I_o ^{Note 2} | dBm/9 MHz | -67.21 | -67.21 | -67.21 |
| Propagation Condition | | AWGN | | |
| Note 1: OCNG shall be used such that both cells are fully allocated and a constant total transmitted power spectral density is achieved for all OFDM symbols. | | | | |
| Note 2: RSRP and I_o levels have been derived from other parameters for information purposes. They are not settable parameters themselves. | | | | |

Table A.5.2.1.1-3: Cell specific test parameters for E-UTRAN FDD to UTRAN FDD handover test case (cell 2)

| Parameter | Unit | Cell 2 (UTRA) | | |
|--|--------------|---------------|-------|--------|
| | | T1 | T2 | T3 |
| CPICH_Ec/lor | dB | -10 | | |
| PCCPCH_Ec/lor | dB | -12 | | |
| SCH_Ec/lor | dB | -12 | | |
| PICH_Ec/lor | dB | -15 | | |
| DCH_Ec/lor | dB | N/A | N/A | Note 1 |
| OCNS_Ec/lor | dB | -0.941 | 0.941 | Note 2 |
| \hat{I}_{or} / I_{oc} | dB | -infinity | -1.8 | -1.8 |
| I_{oc} | dBm/3,84 MHz | -70 | -70 | -70 |
| CPICH_Ec/lo | dB | -infinity | -14 | -14 |
| Propagation Condition | | AWGN | | |
| Note 1: The DPCH level is controlled by the power control loop | | | | |
| Note 2: The power of the OCNS channel that is added shall make the total power from the cell to be equal to I_{or} . | | | | |

A.5.2.1.2 Test Requirements

The UE shall start to transmit the UL DPCCCH to Cell 2 less than 190 ms from the beginning of time period T3.

The rate of correct handovers observed during repeated tests shall be at least 90%.

NOTE: The handover delay can be expressed as: RRC procedure delay + $T_{\text{interrupt}}$, where:

RRC procedure delay = 50 ms, which is specified in clause 5.3.1.1.1.

$T_{\text{interrupt}}$ = 140 ms in the test; $T_{\text{interrupt}}$ is defined in clause 5.3.1.1.2.

This gives a total of 190 ms.

A.5.2.2 E-UTRAN TDD - UTRAN FDD Handover

A.5.2.2.1 Test Purpose and Environment

This test is to verify the E-UTRAN TDD – UTRAN FDD handover requirements specified in clause 5.3.1.

The test scenario comprises of one E-UTRAN TDD cell and one UTRAN FDD cell as given in the tables A.5.2.2.1-1, A5.2.2.1-2 and A.5.2.2.1-3. The test consists of three successive time periods, with time duration of T1, T2 and T3 respectively. At start of time duration T1, the UE does not have any timing information of cell 2. Gap pattern configuration with id #0 as specified in Table 8.1.2.1-1 is configured before the start of T2 to enable the monitoring of UTRAN FDD. A neighbouring cell list, including the UTRAN cell (cell2), shall be sent to the UE before T2 starts. During the time T2 cell 2 becomes detectable and the UE is expected to detect and send the measurement report. A RRC message implying handover shall be sent to the UE during T2, after the UE has reported event B2. The start of T3 is the instant when the last TTI containing the RRC message implying handover is sent to the UE. The handover message shall contain cell 2 as the target cell.

Table A.5.2.2.1-1: General test parameters for E-UTRAN TDD-UTRAN FDD handover

| Parameter | | Unit | Value | Comment |
|---|----------------|------|--|--|
| PDSCH parameters (E-UTRAN TDD) | | | DL Reference Measurement Channel R.0 TDD | As specified in clause A.3.1.1.2 |
| PCFICH/PDCCH/PHICH parameters (E-UTRAN TDD) | | | DL Reference Measurement Channel R.6 TDD | As specified in clause A.3.1.2.2 |
| Initial conditions | Active cell | | Cell 1 | Cell 1 is on E-UTRA RF channel number 1. |
| | Neighbour cell | | Cell 2 | Cell 2 is on UTRA RF channel number 1. |
| Final conditions | Active cell | | Cell 2 | |
| Special subframe configuration | | | 6 | As specified in table 4.2-1 in TS 36.211. Applicable to cell 1. |
| Uplink-downlink configuration | | | 1 | As specified in table 4.2-2 in TS 36.211. Applicable to cell 1 |
| E-UTRAN TDD measurement quantity | | | RSRP | |
| Inter-RAT (UTRA FDD) measurement quantity | | | CPICH Ec/Io | |
| b2-Threshold1 | | dBm | -90 | Absolute E-UTRAN RSRP threshold for event B2 |
| b2-Threshold2-UTRA | | dB | -18 | UTRAN FDD CPICH Ec/Io threshold for event B2 |
| Hysteresis | | dB | 0 | |
| DRX | | | OFF | No DRX configured. |
| Time to Trigger | | ms | 0 | |
| Filter coefficient | | | 0 | |
| CP length | | | Normal | Applicable to cell 1 |
| Gap pattern configuration Id | | | 0 | As specified in Table 8.1.2.1-1; to start before T2 starts |
| E-UTRA RF Channel Number | | | 1 | One E-UTRA TDD carrier frequency is used. |
| E-UTRA Channel Bandwidth (BW _{channel}) | | MHz | 10 | |
| UTRA RF Channel Number | | | 1 | One UTRA FDD carrier frequency is used. |
| Monitored UTRA FDD cell list size | | | 12 | UTRA cells on UTRA RF channel 1 provided in the cell list before T2. |

| | | | |
|--------------------------|---|-------|--------------------------------|
| Post-verification period | | False | Post verification is not used. |
| T1 | s | 5 | |
| T2 | s | ≤5 | |
| T3 | s | 1 | |

Table A.5.2.2.1-2: Cell specific test parameters for E-UTRAN TDD (cell 1) for handover to UTRAN FDD (cell # 2)

| Parameter | Unit | Cell 1 (E-UTRAN) | | |
|--|------------|------------------|--------|----------|
| | | T1 | T2 | T3 |
| E-UTRA RF Channel Number | | 1 | | |
| $BW_{channel}$ | MHz | 10 | | |
| OCNG Pattern defined in A.3.2.2.1 (OP.1 TDD) and in A.3.2.2.2 (OP.2 TDD) | | OP.1 TDD | | OP.2 TDD |
| PBCH_RA | dB | 0 | | |
| PBCH_RB | | | | |
| PSS_RA | | | | |
| SSS_RA | | | | |
| PCFICH_RB | | | | |
| PHICH_RA | | | | |
| PHICH_RB | | | | |
| PDCCH_RA | | | | |
| PDCCH_RB | | | | |
| PDSCH_RA | | | | |
| PDSCH_RB | | | | |
| OCNG_RA ^{Note 1} | | | | |
| OCNG_RB ^{Note 1} | | | | |
| RSRP | dBm/15 kHz | -98 | -98 | -98 |
| \hat{E}_s/I_{ot} | dB | 0 | 0 | 0 |
| \hat{E}_s/N_{oc} | dB | 0 | 0 | 0 |
| N_{oc} | dBm/15 kHz | -98 | | |
| I_o ^{Note 2} | dBm/9 MHz | -67.21 | -67.21 | -67.21 |
| Propagation Condition | | AWGN | | |
| Note 1: OCNG shall be used such that the cell is fully allocated and a constant total transmitted power spectral density is achieved for all OFDM symbols. | | | | |
| Note 2: RSRP and I_o levels have been derived from other parameters for information purposes. They are not settable parameters themselves. | | | | |

Table A.5.2.2.1-3: Cell specific test parameters for UTRAN FDD (cell # 2) for handover from E-UTRAN TDD cell (cell #1)

| Parameter | Unit | Cell 1 (UTRA) | | |
|---------------------------|--------------|---------------|--------|--------|
| | | T1 | T2 | T3 |
| CPICH_Ec/I _{or} | dB | -10 | | |
| PCCPCH_Ec/I _{or} | dB | -12 | | |
| SCH_Ec/I _{or} | dB | -12 | | |
| PICH_Ec/I _{or} | dB | -15 | | |
| DPCH_Ec/I _{or} | dB | N/A | N/A | Note 1 |
| OCNS | dB | -0.941 | -0.941 | Note 2 |
| \hat{I}_{or}/I_{oc} | dB | -infinity | -1.8 | -1.8 |
| I_{oc} | dBm/3.84 MHz | -70 | | |
| CPICH_Ec/I _o | dB | -infinity | -14 | -14 |

| | | |
|-----------------------|--|------|
| Propagation Condition | | AWGN |
| Note 1: | The DPCH level is controlled by the power control loop | |
| Note 2: | The power of the OCNS channel that is added shall make the total power from the cell to be equal to I_{or} . | |

A.5.2.2.2 Test Requirements

The UE shall start to transmit the UL DPCH to Cell 2 less than 190 ms from the beginning of time period T3.

The rate of correct handovers observed during repeated tests shall be at least 90%.

NOTE: The handover delay can be expressed as: RRC procedure delay + $T_{interrupt}$, where:

RRC procedure delay = 50 ms, which is specified in clause 5.1.1.1.1.

$T_{interrupt}$ = 140 ms in the test; $T_{interrupt}$ is defined in clause 5.3.1.1.2.

This gives a total of 190 ms.

A.5.2.3 E-UTRAN FDD- GSM Handover

A.5.2.3.1 Test Purpose and Environment

This test is to verify the requirement for the E-UTRAN to GSM cell handover delay specified in clause 5.3.3.

The test parameters are given in Table A.5.2.3.1 -1, A.5.2.3.1 -2 and A.5.2.3.1 -3 below. In the measurement control information it is indicated to the UE that event-triggered reporting with Event B1 shall be used. The test consists of three successive time periods, with time duration of T1, T2 and T3 respectively. At the start of time duration T1, the UE may not have any timing information of cell 2.

The RRC message implying handover to cell 2 shall be sent to the UE during period T2, after the UE has reported Event B1. The start of T3 is defined as the end of last E-UTRAN TTI containing the RRC message implying handover.

The requirements are also applicable for a UE not requiring measurement gap, in which case no measurement gap pattern should be sent for the parameters specified in Table A.5.2.3.1-1.

Table A.5.2.3.1 -1: General test parameters for E-UTRAN FDD-GSM handover

| Parameter | | Unit | Value | Comment |
|--------------------------------|----------------|------|--|---|
| PDSCH parameters | | | DL Reference Measurement Channel R.0 FDD | As specified in clause A.3.1.1.1 |
| PCFICH/PDCCH/PHICH parameters | | | DL Reference Measurement Channel R.6 FDD | As specified in clause A.3.1.2.1 |
| Gap Pattern Id | | | 1 | As specified in TS 36.133 section 8.1.2.1. |
| Initial conditions | Active cell | | Cell 1 | |
| | Neighbour cell | | Cell 2 | |
| Final conditions | Active cell | | Cell 2 | |
| Inter-RAT measurement quantity | | | GSM Carrier RSSI | |
| Threshold other system | | dBm | -80 | Absolute GSM carrier RSSI threshold for event B1. |
| Hysteresis | | dB | 0 | |
| Time to Trigger | | ms | 0 | |
| Filter coefficient | | | 0 | L3 filtering is not used |
| DRX | | | | OFF |
| T1 | | s | 20 | |
| T2 | | s | 7 | |
| T3 | | s | 1 | |

Table A. A.5.2.3.1 - 2: Cell Specific Parameters for Handover from E- UTRAN FDD to GSM cell case (cell 1)

| Parameter | Unit | Cell 1 | |
|---|----------------|------------|----------|
| | | T1, T2 | T3 |
| BW_{channel} | MHz | 10 | |
| OCNG Patterns defined in A.3.2.1.1 (OP.1 FDD) and in A.3.2.1.2 (OP.2 FDD) | | OP.1 FDD | OP.2 FDD |
| PBCH_RA | dB | 0 | |
| PBCH_RB | dB | | |
| PSS_RA | dB | | |
| SSS_RA | dB | | |
| PCFICH_RB | dB | | |
| PHICH_RA | dB | | |
| PHICH_RB | dB | | |
| PDCCH_RA | dB | | |
| PDCCH_RB | dB | | |
| PDSCH_RA | dB | | |
| PDSCH_RB | dB | | |
| OCNG_RA ^{Note1} | dB | | |
| OCNG_RB ^{Note1} | dB | | |
| $\hat{E}_s / I_{\text{ot}}$ | dB | | |
| N_{oc} ^{Note 2} | dBm/15 kHz | -98 (AWGN) | |
| $\hat{E}_s / N_{\text{oc}}$ | dB | 4 | |
| RSRP ^{Note 3} | dBm/15kHz z | -94 | |
| Propagation Condition | | AWGN | |
| <p>Note 1: OCNG shall be used such that cell 1 is fully allocated and a constant total transmitted power spectral density is achieved for all OFDM symbols.</p> <p>Note 2: Interference from other cells and noise sources not specified in the test is assumed to be constant over subcarriers and time and shall be modelled as AWGN of appropriate power for N_{oc} to be fulfilled.</p> <p>Note 3: RSRP levels have been derived from other parameters for information purposes. They are not settable parameters themselves.</p> | | | |

Table A.5.2.3.1 - 3: Cell Specific Parameters for Handover from E-UTRAN FDD to GSM cell case (cell 2)

| Parameter | Unit | Cell 2 (GSM) | |
|----------------------------|------|--------------|--------|
| | | T1 | T2, T3 |
| Absolute RF Channel Number | | ARFCN 1 | |
| RXLEV | dBm | -85 | -75 |

A.5.2.3.2 Test Requirements

The UE shall begin to send access bursts on the new DCCH of the target cell less than 100 ms from the beginning of time period T3.

The rate of correct handovers observed during repeated tests shall be at least 90%.

NOTE: The test requirement in this test case is expressed as:

$$T_{\text{Handover delay}} = 90 \text{ ms (Table 5.3.3.2.1-1)} + T_{\text{offset}} + T_{\text{UL}}$$

T_{offset} : Equal to 4.65 ms, GSM timing uncertainty between the time from when the UE is ready to transmit until the start of the next timeslot in GSM 26 multiframe structure

T_{UL} : Equal to 4.65 ms, the time the UE has to wait in case the next timeslot is an idle frame or a SACCH frame.

This gives a total of 99.3 ms, allow 100 ms in the test case.

A.5.2.4 E-UTRAN TDD - UTRAN TDD Handover

A.5.2.4.1 Test Purpose and Environment

A.5.2.4.1.1 Void

A.5.2.4.1.2 1.28 Mcps TDD option

This test is to verify the requirement for E-UTRAN TDD to UTRAN TDD handover requirements specified in clause 5.3.2.

The test scenario comprises of 1 E-UTRA TDD cell and 1 UTRA TDD cell as given in tables Table A.5.2.4.1.2-1, Table A.5.2.4.1.2-2, and Table A.5.2.4.1.2-3. Gap pattern configuration #0 as defined in table 8.1.2.1-1 is provided.

The test consists of three successive time periods, with time durations of T1, T2 and T3 respectively.

E-UTRAN shall send a RRC message implying handover to UE. The RRC message implying handover shall be sent to the UE during period T2, after the UE has reported Event B2. The end of the last TTI containing handover message is begin of T3 duration.

Table A.5.2.4.1.2-1: General test parameters for E-UTRA TDD to UTRA(1.28 Mcps TDD OPTION) handover test case

| Parameter | | Unit | Value | Comment |
|--|----------------|------|--|---|
| PDSCH parameters | | | DL Reference Measurement Channel R.0 TDD | As specified in clause A.3.1.1.2 |
| PCFICH/PDCCH/PHICH parameters | | | DL Reference Measurement Channel R.6 TDD | As specified in clause A.3.1.2.2 |
| Initial conditions | Active cell | | Cell 1 | E-UTRA TDD cell |
| | Neighbour cell | | Cell 2 | UTRA 1.28Mcps TDD Cell |
| Final conditions | Active cell | | Cell 2 | |
| Gap Pattern Id | | | 0 | As specified in TS 36.133 clause 8.1.2.1. |
| Uplink-downlink configuration of cell 1 | | | 1 | As specified in table 4.2.2 in TS 36.211 |
| Special subframe configuration of cell 1 | | | 6 | As specified in table 4.2.1 in TS 36.211 |
| CP length of cell 1 | | | Normal | |
| Time offset between cells | | | 3 ms | Asynchronous cells |
| Access Barring Information | | | Not Sent | No additional delays in random access procedure. |
| Assigned Sub-Channel Number | | | 1 | No additional delays in random access procedure due to ASC. |
| Hysteresis | | dB | 0 | |
| Time To Trigger | | s | 0 | |
| Filter coefficient | | | 0 | L3 filtering is not used |
| DRX | | | OFF | |
| Ofn | | dB | 0 | |
| Thresh1 | | dBm | -93 | E-UTRA event B2 threshold |
| Thresh2 | | dBm | -80 | UTRA event B2 threshold |
| T1 | | s | 5 | |
| T2 | | s | ≤10 | |
| T3 | | s | 1 | |

Table A.5.2.4.1.2-2: Cell specific test parameters for E-UTRA TDD to UTRA TDD handover test case (cell 1)

| Parameter | Unit | Cell 1 | | |
|---|------------|----------|--------|----------|
| | | T1 | T2 | T3 |
| E-UTRA RF Channel Number | | 1 | | |
| $BW_{channel}$ | MHz | 10 | | |
| OCNG Pattern defined in A.3.2.2.1 (OP.1 TDD) and in A.3.2.1.2 (OP.2 TDD) | | OP.1 TDD | | OP.2 TDD |
| PBCH_RA | dB | 0 | 0 | 0 |
| PBCH_RB | dB | | | |
| PSS_RA | dB | | | |
| SSS_RA | dB | | | |
| PCFICH_RB | dB | | | |
| PHICH_RA | dB | | | |
| PHICH_RB | dB | | | |
| PDCCH_RA | dB | | | |
| PDCCH_RB | dB | | | |
| PDSCH_RA | dB | | | |
| PDSCH_RB | dB | | | |
| OCNG_RA ^{Note 1} | dB | | | |
| OCNG_RB ^{Note 1} | dB | | | |
| \hat{E}_s / I_{ot} | dB | 13 | -3 | -3 |
| \hat{E}_s / N_{oc} | dB | 13 | -3 | -3 |
| N_{oc} | dBm/15kHz | -98 | | |
| RSRP ^{Note 2} | dBm/15kHz | -85 | -101 | -101 |
| SCH_RP ^{Note 2} | dBm/15 kHz | -85 | -101 | -101 |
| I_o ^{Note 2} | dBm/9MHz | -57.01 | -68.45 | -68.45 |
| Propagation Condition | | AWGN | | |
| <p>Note 1: OCNG shall be used such that cell is fully allocated and a constant total transmitted power spectral density is achieved for all OFDM symbols.</p> <p>Note 2: RSRP, SCH_RP and I_o levels have been derived from other parameters for information purposes. They are not settable parameters themselves</p> | | | | |

Table A.5.2.4.1.2-3: Cell specific test parameters for cell search E-UTRA to UTRA case (cell 2)

| Parameter | Unit | Cell 2 (UTRA) | | | | | |
|---|--------------|---------------|--------|--------|-------|----|----|
| | | 0 | | | DwPTS | | |
| Timeslot Number | | T1 | T2 | T3 | T1 | T2 | T3 |
| UTRA RF Channel Number ^{Note 21} | | Channel 2 | | | | | |
| PCCPCH_Ec/I _{or} | dB | -3 | | | | | |
| DwPCH_Ec/I _{or} | dB | | | | 0 | | |
| OCNS_Ec/I _{or} | dB | -3 | | | | | |
| \hat{I}_{or} / I_{oc} | dB | -3 | 11 | 11 | -3 | 11 | 11 |
| I_{oc} | dBm/1.28 MHz | -80 | | | | | |
| PCCPCH RSCP ^{Note 2} | dBm | -86 | -72 | -72 | n.a. | | |
| I_o ^{Note 2} | dBm/1.28 MHz | -78.24 | -68.67 | -68.67 | | | |
| Propagation Condition | | AWGN | | | | | |
| <p>Note 1: In the case of multi-frequency cell, the UTRA RF Channel Number is the primary frequency's channel number.</p> <p>Note 2: PCCPCH_RSCP and I_o levels have been derived from other parameters for information purposes. They are not settable parameters themselves.</p> | | | | | | | |

A.5.2.4.1.3 Void

A.5.2.4.2 Test Requirements

A.5.2.4.2.1 Void

A.5.2.4.2.2 1.28 Mcps TDD option

The UE shall start to transmit the SYNCH-UL sequence in the UpPTS to Cell 2 less than 120 ms from the beginning of time period T3.

The rate of correct handovers observed during repeated tests shall be at least 90%.

NOTE: The handover delay can be expressed as: RRC procedure delay + $T_{\text{interrupt}}$, where:

RRC procedure delay = 50 ms, which is specified in clause 5.3.2.2.1.

$T_{\text{interrupt}}$ is defined in clause 5.3.2.2.2. $T_{\text{interrupt}} = 70$ ms in the test as following:

$$T_{\text{interrupt1}} = T_{\text{offset}} + T_{\text{UL}} + 30 * F_{\text{SFN}} + 20 \text{ ms}$$

$$T_{\text{offset}} = 10 \text{ ms}; T_{\text{UL}} = 10 \text{ ms}; \text{ and } F_{\text{SFN}} = 1 \text{ for UE decoding SFN.}$$

This gives a total of 120 ms.

A.5.2.4.2.3 Void

A.5.2.5 E-UTRAN FDD – UTRAN TDD Handover

A.5.2.5.1 Test Purpose and Environment

A.5.2.5.1.1 Void

A.5.2.5.1.2 1.28 Mcps TDD option

This test is to verify the requirement for the E-UTRAN FDD to UTRAN TDD handover requirements specified in clause 5.3.2.

The test scenario comprises of two cells, E-UTRA TDD cell1 and UTRA TDD cell2. The test consists of three successive time periods, with time durations of T1, T2 and T3 respectively. At the start of time duration T1, the UE does not have any timing information of Cell 2. Starting T2, Cell 2 becomes detectable and the UE is expected to detect and send a measurement report. Gap pattern configuration with id #1 as specified in Table 8.1.2.1-1 is configured before T2 begins to enable inter-RAT frequency monitoring. The test parameters are given in Tables A.5.2.5.1-1, A.5.2.5.1-2 and A.5.2.5.1-3.

A RRC message implying handover shall be sent to the UE during period T2, after the UE has reported Event B2. The start of T3 is the instant when the last TTI containing the RRC message implying handover is sent to the UE. The handover message shall contain cell 2 as the target cell.

Table A.5.2.5.1.2-1: General test parameters for E-UTRA FDD to UTRA (1.28 Mcps TDD option) handover test case

| Parameter | Unit | Value | Comment |
|-------------------------------|------|--|----------------------------------|
| PDSCH parameters | | DL Reference Measurement Channel R.0 FDD | As specified in clause A.3.1.1.1 |
| PCFICH/PDCCH/PHICH parameters | | DL Reference Measurement Channel R.6 | As specified in clause A.3.1.2.1 |

| | | | | |
|----------------------------------|----------------|--|----------|---|
| | | | FDD | |
| Initial conditions | Active cell | | Cell 1 | E-UTRA FDD cell |
| | Neighbour cell | | Cell 2 | UTRA 1.28Mcps TDD Cell |
| Final conditions | Active cell | | Cell 2 | |
| Gap Pattern Id | | | 1 | As specified in TS 36.133 clause 8.1.2.1. |
| E-UTRAN FDD measurement quantity | | | RSRP | |
| UTRAN TDD measurement quantity | | | RSCP | |
| CP length of cell 1 | | | Normal | |
| Access Barring Information | | | Not Sent | No additional delays in random access procedure. |
| Assigned Sub-Channel Number | | | 1 | No additional delays in random access procedure due to ASC. |
| Hysteresis | dB | | 0 | |
| Time To Trigger | s | | 0 | |
| Filter coefficient | | | 0 | L3 filtering is not used |
| DRX | | | OFF | |
| Ofn | dB | | 0 | |
| Thresh1 | dBm | | -93 | Absolute E-UTRAN RSRP threshold for event B2 |
| Thresh2 | dBm | | -80S | Absolute UTRAN RSCP threshold for event B2 |
| T1 | s | | 5 | |
| T2 | s | | ≤ 10 | |
| T3 | s | | 1 | |

Table A.5.2.5.1.2-2: Cell specific test parameters for E-UTRAN FDD to UTRAN (1.28 Mcps TDD option) handover test case (cell 1)

| Parameter | Unit | Cell 1 (E-UTRA) | | |
|---|------------|-----------------|----------|----------|
| | | T1 | T2 | T3 |
| E-UTRA RF Channel number | | 1 | | |
| BW _{channel} | MHz | 10 | | |
| OCNG Patterns defined in A.3.2.1.1 (OP.1 FDD) and in A.3.2.1.2 (OP.2 FDD) | | OP.1 FDD | OP.1 FDD | OP.2 FDD |
| PBCH_RA | dB | 0 | | |
| PBCH_RB | dB | | | |
| PSS_RA | dB | | | |
| SSS_RA | dB | | | |
| PCFICH_RB | dB | | | |
| PHICH_RA | dB | | | |
| PHICH_RB | dB | | | |
| PDCCH_RA | dB | | | |
| PDCCH_RB | dB | | | |
| PDSCH_RA | dB | | | |
| PDSCH_RB | dB | | | |
| OCNG_RA ^{Note 1} | dB | | | |
| OCNG_RB ^{Note 1} | dB | | | |
| \hat{E}_s / N_{oc} | dB | | | |
| N_{oc} | dBm/15 kHz | -98 | | |
| \hat{E}_s / I_{ot} | dB | 13 | -3 | -3 |
| RSRP ^{Note 2} | dBm/15 KHz | -85 | -101 | -101 |
| I_o ^{Note 2} | dBm/9MHz | -57.01 | -68.45 | -68.45 |
| Propagation Condition | | AWGN | | |
| Note 1: OCNG shall be used such that both cells are fully allocated and a constant total transmitted power spectral density is achieved for all OFDM symbols. | | | | |
| Note 2: RSRP and I_o levels have been derived from other parameters for information purposes. They are not settable parameters themselves | | | | |

Table A.5.2.5.1.2-3: Cell specific test parameters for E-UTRAN FDD to UTRAN (1.28 Mcps TDD option) handover test case (cell 2)

| Parameter | Unit | Cell 2 (UTRA) | | | | | |
|---|---|---------------|--------|--------|-------|----|----|
| | | 0 | | | DwPTS | | |
| Timeslot Number | | T1 | T2 | T3 | T1 | T2 | T3 |
| UTRA RF Channel Number <small>Note 21</small> | | Channel 2 | | | | | |
| PCCPCH_Ec/I _{or} | dB | -3 | | | | | |
| DwPCH_Ec/I _{or} | dB | | | | 0 | | |
| OCNS_Ec/I _{or} | dB | -3 | | | | | |
| \hat{I}_{or}/I_{oc} | dB | -3 | 11 | 11 | -3 | 11 | 11 |
| I_{oc} | dBm/1.28 MHz | -80 | | | | | |
| PCCPCH RSCP <small>Note 2</small> | dBm | -86 | -72 | -72 | n.a. | | |
| I_o <small>Note 2</small> | dBm/1.28 MHz | -78.24 | -68.67 | -68.67 | | | |
| Propagation Condition | | AWGN | | | | | |
| Note 1: | In the case of multi-frequency cell, the UTRA RF Channel Number is the primary frequency's channel number. | | | | | | |
| Note 2: | PCCPCH_RSCP and I_o levels have been derived from other parameters for information purposes. They are not settable parameters themselves. | | | | | | |

A.5.2.5.1.3 Void

A.5.2.5.2 Test Requirements

A.5.2.5.2.1 Void

A.5.2.5.2.2 1.28 Mcps TDD option

The UE shall start to transmit the SYNCH-UL sequence in the UpPTS to Cell 2 less than 120 ms from the beginning of time period T3.

The rate of correct handovers observed during repeated tests shall be at least 90%.

NOTE: The handover delay can be expressed as: RRC procedure delay + $T_{interrupt}$, where:

RRC procedure delay = 50 ms, which is specified in clause 5.3.2.2.1.

$T_{interrupt}$ is defined in clause 5.3.2.2.2. $T_{interrupt} = 70$ ms in the test as following:

$$T_{interrupt1} = T_{offset} + T_{UL} + 30 * F_{SFN} + 20 \text{ ms}$$

$$T_{offset} = 10 \text{ ms}; T_{UL} = 10 \text{ ms}; \text{ and } F_{SFN} = 1 \text{ for UE decoding SFN.}$$

This gives a total of 120 ms.

A.5.2.5.2.3 Void

A.5.2.6 E-UTRAN TDD - GSM Handover

A.5.2.6.1 Test Purpose and Environment

This test is to verify the requirement for the E-UTRAN to GSM cell handover delay specified in clause 5.3.3.

The test parameters are given in Table A.5.2.6.1-1, A.5.2.6.1-2 and A.5.2.6.1-3 below. In the measurement control information it is indicated to the UE that event-triggered reporting with Event B1 shall be used. The test consists of

three successive time periods, with time duration of T1, T2 and T3 respectively. At the start of time duration T1, the UE may not have any timing information of cell 2.

The RRC message implying handover to cell 2 shall be sent to the UE during period T2, after the UE has reported Event B1. The start of T3 is defined as the end of last E-UTRAN TTI containing the RRC message implying handover.

The requirements are also applicable for a UE not requiring measurement gap, in which case no measurement gap pattern should be sent for the parameters specified in Table A.5.2.6.1-1.

Table A.5.2.6.1-1: General test parameters for E-UTRAN TDD toGSM neighbours handover test case in AWGN propagation condition

| Parameter | | Unit | Value | Comment |
|---|----------------|------|--|---|
| PDSCH parameters | | | DL Reference Measurement Channel R.0 TDD | As specified in clause A.3.1.1.2 |
| PCFICH/PDCCH/PHICH parameters | | | DL Reference Measurement Channel R.6 TDD | As specified in clause A.3.1.2.2 |
| Gap Pattern Id | | | 1 | As specified in TS 36.133 clause 8.1.2.1. |
| Initial conditions | Active cell | | Cell 1 | |
| | Neighbour cell | | Cell 2 | |
| Final conditions | Active cell | | Cell 2 | |
| Uplink-downlink configuration of cell 1 | | | 1 | As specified in table 4.2.2 in TS 36.211 |
| Special subframe configuration of cell 1 | | | 6 | As specified in table 4.2.1 in TS 36.211 |
| CP length of cell 1 | | | Normal | |
| Inter-RAT measurement quantity | | | GSM Carrier RSSI | |
| E-UTRA RF Channel Number | | | 1 | E-UTRA RF Channel Number |
| E-UTRA Channel Bandwidth (BW _{channel}) | | MHz | 10 | E-UTRA Channel Bandwidth (BW _{channel}) |
| Threshold other system | | dBm | -80 | Absolute GSM carrier RSSI threshold for event B1. |
| Hysteresis | | dB | 0 | |
| Time to Trigger | | ms | 0 | |
| Filter coefficient | | | 0 | L3 filtering is not used |
| DRX | | | OFF | |
| T1 | | s | 20 | |
| T2 | | s | 7 | |
| T3 | | s | 1 | |

Table A.5.2.6.1-2: Cell Specific Parameters for Handover E- UTRAN TDD to GSM handover test case

| Parameter | Unit | Cell 1 | |
|---|------|----------|----------|
| | | T1, T2 | T3 |
| E-UTRA RF Channel Number | | 1 | |
| BW _{channel} | MHz | 10 | |
| OCNG Patterns defined in A.3.2.2.1 (OP.1 TDD) and in A.3.2.2.2 (OP.2 TDD) | | OP.1 TDD | OP.2 TDD |
| PBCH_RA | dB | 0 | |
| PBCH_RB | dB | | |
| PSS_RA | dB | | |
| SSS_RA | dB | | |
| PCFICH_RB | dB | | |
| PHICH_RA | dB | | |
| PHICH_RB | dB | | |
| PDCCH_RA | dB | | |
| PDCCH_RB | dB | | |
| PDSCH_RA | dB | | |
| PDSCH_RB | dB | | |
| OCNG_RA ^{Note1} | dB | | |
| OCNG_RB ^{Note1} | dB | | |

| | | |
|--|------------|------------|
| \hat{E}_s / N_{oc} | dB | 4 |
| N_{oc} Note 2 | dBm/15 kHz | -98 (AWGN) |
| \hat{E}_s / I_{ot} | dB | 4 |
| RSRP Note 3 | dBm/15kHz | -94 |
| Propagation Condition | | AWGN |
| NOTE 1: OCNG shall be used such that cell 1 is fully allocated and a constant total transmitted power spectral density is achieved for all OFDM symbols. | | |
| NOTE 2: Interference from other cells and noise sources not specified in the test is assumed to be constant over subcarriers and time and shall be modelled as AWGN of appropriate power for N_{oc} to be fulfilled. | | |
| NOTE 3: RSRP levels have been derived from other parameters for information purposes. They are not settable parameters themselves. | | |

Table A.5.2.6.1-3: Cell Specific Parameters for Handover E-UTRAN to GSM cell case (cell 2)

| Parameter | Unit | Cell 2 (GSM) | |
|----------------------------|------|--------------|--------|
| | | T1 | T2, T3 |
| Absolute RF Channel Number | | ARFCN 1 | |
| RXLEV | dBm | -85 | -75 |

A.5.2.6.2 Test Requirements

The UE shall begin to send access bursts on the new DCCH of the target cell less than 100 ms from the beginning of time period T3.

The rate of correct handovers observed during repeated tests shall be at least 90%.

NOTE: The test requirement in this test case is expressed as:

$$T_{\text{Handover delay}} = 90 \text{ ms (Table 5.3.3.2.1-1)} + T_{\text{offset}} + T_{\text{UL}}$$

T_{offset} : Equal to 4.65 ms, GSM timing uncertainty between the time from when the UE is ready to transmit until the start of the next timeslot in GSM 26 multiframe structure

T_{UL} : Equal to 4.65 ms, the time the UE has to wait in case the next timeslot is an idle frame or a SACCH frame.

This gives a total of 99.3 ms, allow 100 ms in the test case.

A.5.2.7 E-UTRAN FDD – UTRAN FDD Handover; Unknown Target Cell

A.5.2.7.1 Test Purpose and Environment

This test is to verify the requirement for the E-UTRAN FDD to UTRAN FDD handover requirements for the case when the target cell is unknown as specified in clause 5.3.1.

The test parameters are given in Tables A.5.2.7.1-1, A.5.2.7.1-2 and A.5.2.7.1-3. The test consists of two successive time periods, with time durations of T1, T2. At the start of time duration T1, the UE does not have any timing information of Cell 2. Starting T2, cell 2 becomes detectable and the UE receives a RRC handover command from the network. The start of T2 is the instant when the last TTI containing the RRC message implying handover is sent to the UE. No Gap pattern configuration shall be used.

Table A.5.2.7.1-1: General test parameters for E-UTRAN FDD to UTRAN FDD handover test case

| Parameter | Unit | Value | Comment |
|------------------|------|--|----------------------------------|
| PDSCH parameters | | DL Reference Measurement Channel R.0 FDD | As specified in clause A.3.1.1.1 |

| | | | | |
|---|-------------------|-----|--|---|
| PCFICH/PDCCH/PHICH parameters | | | DL Reference Measurement Channel R.6 FDD | As specified in clause A.3.1.2.1 |
| Initial conditions | Active cell | | Cell 1 | E-UTRAN cell |
| | Neighbouring cell | | Cell 2 | UTRAN cell |
| Final condition | Active cell | | Cell 2 | UTRAN cell |
| Channel Bandwidth ($BW_{channel}$) | | MHz | 10 | |
| E-UTRAN FDD measurement quantity | | | RSRP | |
| Inter-RAT (UTRAN FDD) measurement quantity | | | CPICH E_c/N_0 | |
| DRX | | | OFF | Non-DRX test |
| Access Barring Information | | - | Not sent | No additional delays in random access procedure |
| E-UTRA RF Channel Number | | | 1 | One E-UTRA FDD carrier frequency is used. |
| E-UTRA Channel Bandwidth ($BW_{channel}$) | | MHz | 10 | |
| UTRA RF Channel Number | | | 1 | One UTRA FDD carrier frequency is used. |
| Monitored UTRA FDD cell list size | | | 12 | UTRA cells on UTRA RF channel 1 provided in the cell before T2. |
| Post-verification period | | | False | |
| T1 | | s | ≤ 5 | |
| T2 | | s | 1 | |

Table A.5.2.7.1-2: Cell specific test parameters for E-UTRAN FDD to UTRAN FDD handover test case (cell 1)

| Parameter | Unit | Cell 1 (E-UTRA) | |
|---|------------|-----------------|----------|
| | | T1 | T2 |
| E-UTRA RF Channel number | | 1 | |
| $BW_{channel}$ | MHz | 10 | |
| OCNG Patterns defined in A.3.2.1.1 (OP.1 FDD) and in A.3.2.1.2 (OP.2 FDD) | | OP.1 FDD | OP.2 FDD |
| PBCH_RA | dB | 0 | |
| PBCH_RB | dB | | |
| PSS_RA | dB | | |
| SSS_RA | dB | | |
| PCFICH_RB | dB | | |
| PHICH_RA | dB | | |
| PHICH_RB | dB | | |
| PDCCH_RA | dB | | |
| PDCCH_RB | dB | | |
| PDSCH_RA | dB | | |
| PDSCH_RB | dB | | |
| OCNG_RA ^{Note 1} | dB | | |
| OCNG_RB ^{Note 1} | dB | | |
| \hat{E}_s/I_{ot} | dB | 0 | 0 |
| N_{oc} ^{Note 2} | dBm/15 kHz | -98 | |
| \hat{E}_s/N_{oc} | dB | 0 | 0 |
| RSRP ^{Note 3} | dBm/15 KHz | -98 | -98 |
| Propagation Condition | | AWGN | |
| <p>Note 1: OCNG shall be used such that both cells are fully allocated and a constant total transmitted power spectral density is achieved for all OFDM symbols.</p> <p>Note 2: Interference from other cells and noise sources not specified in the test is assumed to be constant over subcarriers and time and shall be modelled as AWGN of appropriate power for N_{oc} to be fulfilled.</p> <p>Note 3: RSRP levels have been derived from other parameters for information purposes. They are not settable parameters themselves.</p> | | | |

Table A.5.2.7.1-3: Cell specific test parameters for E-UTRAN FDD to UTRAN FDD handover test case (cell 2)

| Parameter | Unit | Cell 2 (UTRA) | |
|---|--------------|---------------|------|
| | | T1 | T2 |
| CPICH_Ec/lor | dB | -10 | |
| PCCPCH_Ec/lor | dB | -12 | |
| SCH_Ec/lor | dB | -12 | |
| PICH_Ec/lor | dB | -15 | |
| DCH_Ec/lor | dB | Note 1 | |
| OCNS_Ec/lor | dB | Note 2 | |
| \hat{I}_{or}/I_{oc} | dB | -infinity | -1.8 |
| I_{oc} | dBm/3,84 MHz | -70 | -70 |
| CPICH_Ec/lo | dB | -infinity | -14 |
| Propagation Condition | | AWGN | |
| <p>Note 1: The DPCH level is controlled by the power control loop</p> <p>Note 2: The power of the OCNS channel that is added shall make the total power from the cell to be equal to I_{or}.</p> | | | |

A.5.2.7.2 Test Requirements

The UE shall start to transmit the UL DPCCCH to Cell 2 less than 290 ms from the beginning of time period T2.

The rate of correct handovers observed during repeated tests shall be at least 90%.

NOTE: The handover delay can be expressed as: RRC procedure delay + $T_{interrupt}$, where:

RRC procedure delay is 50ms. See clause 5.3.1.1.1.

$T_{interrupt}$ is 240ms. See clause 5.3.1.1.2.

This gives a total of 290ms in the test case.

A.5.2.8 E-UTRAN FDD - GSM Handover; Unknown Target Cell

A.5.2.8.1 Test Purpose and Environment

This test is to verify the E-UTRAN FDD to GSM handover requirements for the case when the target GSM cell is unknown as specified in clause 5.3.3.

The test parameters are given in Table A.5.2.8.1-1, A.5.2.8.1-2 and A.5.2.8.1-3 below. The test consists of two successive time periods, with time duration of T1, T2 respectively. At the start of time duration T1, the UE will not have any timing information of cell 2. Starting T2, cell 2 becomes detectable and the UE receives a RRC handover command from the network. The start of T2 is the instant when the last TTI containing the RRC message implying handover is sent to the UE. No Gap pattern configuration shall be used.

Table A.5.2.8.1-1: General test parameters for E-UTRAN FDD to GSM handover test case; unknown target cell

| Parameter | | Unit | Value | Comment |
|-------------------------------|----------------|------|--|--|
| PDSCH parameters | | | DL Reference Measurement Channel R.0 FDD | As specified in clause A.3.1.1.1 |
| PCFICH/PDCCH/PHICH parameters | | | DL Reference Measurement Channel R.6 FDD | As specified in clause A.3.1.2.1 |
| Gap Pattern Id | | | None | No measurement gaps shall be provided. |
| Initial conditions | Active cell | | Cell 1 | |
| | Neighbour cell | | Cell 2 | |
| Final conditions | Active cell | | Cell 2 | |
| DRX | | | OFF | No DRX configured |
| T1 | | s | 7 | |
| T2 | | s | 1 | |

Table A.5.2.8.1 - 2: Cell specific parameters for cell # 1 in E-UTRAN FDD to GSM handover test case; unknown target cell

| Parameter | Unit | Cell 1 | |
|--|------------|----------|----------|
| | | T1 | T2 |
| BW _{channel} | MHz | 10 | |
| OCNG Patterns defined in A.3.2.1.1 (OP.1 FDD) and in A.3.2.1.2 (OP.2 FDD) | | OP.1 FDD | OP.2 FDD |
| PBCH_RA | dB | 0 | |
| PBCH_RB | dB | | |
| PSS_RA | dB | | |
| SSS_RA | dB | | |
| PCFICH_RB | dB | | |
| PHICH_RA | dB | | |
| PHICH_RB | dB | | |
| PDCCH_RA | dB | | |
| PDCCH_RB | dB | | |
| PDSCH_RA | dB | | |
| PDSCH_RB | dB | | |
| OCNG_RA ^{Note1} | dB | | |
| OCNG_RB ^{Note1} | dB | | |
| \hat{E}_s / I_{ot} | dB | | |
| N_{oc} ^{Note 2} | dBm/15 kHz | -98 | |
| \hat{E}_s / N_{oc} | dB | 4 | |
| RSRP ^{Note 3} | dBm/15 kHz | -94 | |
| Propagation Condition | | AWGN | |
| Note 1: OCNG shall be used such that cell 1 is fully allocated and a constant total transmitted power spectral density is achieved for all OFDM symbols. Note 2: Interference from other cells and noise sources not specified in the test is assumed to be constant over subcarriers and time and shall be modelled as AWGN of appropriate power for N_{oc} to be fulfilled. Note 3: RSRP levels have been derived from other parameters for information purposes. They are not settable parameters themselves. | | | |

Table A.5.2.8.1-3: Cell specific parameters for cell # 2 in E-UTRAN FDD to GSM handover test case; unknown target cell

| Parameter | Unit | Cell 2 (GSM) | |
|----------------------------|------|--------------|-----|
| | | T1 | T2 |
| Absolute RF Channel Number | | ARFCN 1 | |
| RXLEV | dBm | -Infinity | -75 |

A.5.2.8.2 Test Requirements

The UE shall begin to send access bursts on the new DCCH of the target cell less than 200 ms from the beginning of time period T2.

The rate of correct handovers observed during repeated tests shall be at least 90%.

NOTE: The test requirement in this test case is expressed as:

$$T_{\text{Handover delay}} = 190 \text{ ms (Table 5.3.3.2.1-1)} + T_{\text{offset}} + T_{\text{UL}}$$

T_{offset} : Equal to 4.65 ms is the GSM timing uncertainty from the time when the UE is ready to transmit until the start of the next timeslot in GSM 26 multiframe structure

T_{UL} : Equal to 4.65 ms is the time the UE has to wait in case the next timeslot is an idle frame or a SACCH frame.

This gives a total of 199.3 ms, allow 200 ms in the test case.

A.5.2.9 E-UTRAN TDD - GSM Handover; Unknown Target Cell

A.5.2.9.1 Test Purpose and Environment

This test is to verify the E-UTRAN TDD to GSM handover requirements for the case when the target GSM cell is unknown as specified in clause 5.3.3.

The test parameters are given in Table A.5.2.9.1 -1, A.5.2.9.1 -2 and A.5.2.9.1 -3 below. The test consists of two successive time periods, with time duration of T1, T2 respectively. At the start of time duration T1, the UE will not have any timing information of cell 2. Starting T2, cell 2 becomes detectable and the UE receives a RRC handover command from the network. The start of T2 is the instant when the last TTI containing the RRC message implying handover is sent to the UE. No Gap pattern configuration shall be used.

Table A.5.2.9.1-1: General test parameters for E-UTRAN TDD to GSM handover test case; unknown target cell

| Parameter | | Unit | Value | Comment |
|--------------------------------|----------------|------|--|--|
| PDSCH parameters | | | DL Reference Measurement Channel R.0 TDD | As specified in clause A.3.1.1.2 |
| PCFICH/PDCCH/PHICH parameters | | | DL Reference Measurement Channel R.6 TDD | As specified in clause A.3.1.2.2 |
| Gap Pattern Id | | | None | No measurement gaps shall be provided. |
| Initial conditions | Active cell | | Cell 1 | |
| | Neighbour cell | | Cell 2 | |
| Final conditions | Active cell | | Cell 2 | |
| DRX | | | OFF | No DRX configured |
| Special subframe configuration | | | 6 | As specified in table 4.2-1 in TS 36.211 |
| Uplink-downlink configuration | | | 1 | As specified in table 4.2-2 in TS 36.211 |
| T1 | | s | 7 | |
| T2 | | s | 1 | |

Table A.5.2.9.1 - 2: Cell specific parameters for cell # 1 in E-UTRAN TDD to GSM handover test case; unknown target cell

| Parameter | Unit | Cell 1 | |
|--|------------|----------|----------|
| | | T1 | T2 |
| BW _{channel} | MHz | 10 | |
| OCNG Patterns defined in A.3.2.2.1 (OP.1 TDD) and in A.3.2.2.2 (OP.2 TDD) | | OP.1 TDD | OP.2 TDD |
| PBCH_RA | dB | 0 | |
| PBCH_RB | dB | | |
| PSS_RA | dB | | |
| SSS_RA | dB | | |
| PCFICH_RB | dB | | |
| PHICH_RA | dB | | |
| PHICH_RB | dB | | |
| PDCCH_RA | dB | | |
| PDCCH_RB | dB | | |
| PDSCH_RA | dB | | |
| PDSCH_RB | dB | | |
| OCNG_RA ^{Note1} | dB | | |
| OCNG_RB ^{Note1} | dB | | |
| \hat{E}_s / I_{ot} | dB | | |
| N_{oc} ^{Note 2} | dBm/15 kHz | -98 | |
| \hat{E}_s / N_{oc} | dB | 4 | |
| RSRP ^{Note 3} | dBm/15 kHz | -94 | |
| Propagation Condition | | AWGN | |
| Note 1: OCNG shall be used such that cell 1 is fully allocated and a constant total transmitted power spectral density is achieved for all OFDM symbols. Note 2: Interference from other cells and noise sources not specified in the test is assumed to be constant over subcarriers and time and shall be modelled as AWGN of appropriate power for N_{oc} to be fulfilled. Note 3: RSRP levels have been derived from other parameters for information purposes. They are not settable parameters themselves. | | | |

Table A.5.2.9.1 - 3: Cell specific parameters for cell # 2 in E-UTRAN TDD to GSM handover test case; unknown target cell

| Parameter | Unit | Cell 2 (GSM) | |
|----------------------------|------|--------------|-----|
| | | T1 | T2 |
| Absolute RF Channel Number | | ARFCN 1 | |
| RXLEV | dBm | -Infinity | -75 |

A.5.2.9.2 Test Requirements

The UE shall begin to send access bursts on the new DCCH of the target cell less than 200 ms from the beginning of time period T2.

The rate of correct handovers observed during repeated tests shall be at least 90%.

NOTE: The test requirement in this test case is expressed as:

$$T_{\text{Handover delay}} = 190 \text{ ms (Table 5.3.3.2.1-1)} + T_{\text{offset}} + T_{\text{UL}}$$

T_{offset} : Equal to 4.65 ms is the GSM timing uncertainty from the time when the UE is ready to transmit until the start of the next timeslot in GSM 26 multiframe structure

T_{UL} : Equal to 4.65 ms is the time the UE has to wait in case the next timeslot is an idle frame or a SACCH frame.

This gives a total of 199.3 ms, allow 200 ms in the test case.

A.5.2.10 E-UTRAN TDD to UTRAN TDD handover: unknown target cell

A.5.2.10.1 Test Purpose and Environment

This test is to verify the requirement for E-UTRAN TDD to UTRAN TDD handover requirements specified in clause 5.3.2 when the target UTRAN TDD cell is unknown.

The test scenario comprises of 1 E-UTRAN TDD cell and 1 UTRAN TDD cell as given in tables A.5.2.10.1-1, A.5.2.10.1-2, and A.5.2.10.1-3. No gap pattern is configured in the test case.

The test consists of two successive time periods, with time durations of T1 and T2 respectively. During time duration T1, a RRC message implying handover to UTRA 1.28Mcps TDD cell shall be sent to the UE. The end of the last TTI containing handover message is the beginning of T2 duration.

Table A.5.2.10.1-1: General test parameters for E-UTRAN TDD to unknown UTRAN TDD cell handover test case

| Parameter | | Unit | Value | Comment |
|--|----------------|------|--|--|
| PDSCH parameters | | | DL Reference Measurement Channel R.0 TDD | As specified in clause A.3.1.1.2 |
| PCFICH/PDCCH/PHICH parameters | | | DL Reference Measurement Channel R.6 TDD | As specified in clause A.3.1.2.2 |
| Initial conditions | Active cell | | Cell 1 | E-UTRAN TDD cell |
| | Neighbour cell | | Cell 2 | UTRA 1.28Mcps TDD cell |
| Final conditions | Active cell | | Cell 2 | UTRA 1.28Mcps TDD cell |
| CP length of cell 1 | | | Normal | |
| Uplink-downlink configuration of cell 1 | | | 1 | As specified in table 4.2.2 in TS 36.211 |
| Special subframe configuration of cell 1 | | | 6 | As specified in table 4.2.1 in TS 36.211 |
| Time offset between cells | | | 3 ms | Asynchronous cells |
| Access Barring Information | | | Not Sent | No additional delays in random access procedure. |
| Assigned Sub-Channel Number | | | 1 | No additional delays in random access procedure due to ASC. |
| TimeToTrigger | | s | 0 | |
| Filter coefficient | | | 0 | L3 filtering is not used |
| DRX | | | OFF | |
| T1 | | s | 5 | During T1, cell 2 shall be powered off, and during the off time the physical layer cell identity shall be changed. |
| T2 | | s | 1 | |

Table A.5.2.10.1-2: Cell specific test parameters for E-UTRAN TDD to unknown UTRAN TDD cell handover test case (cell 1)

| Parameter | Unit | Cell 1 | |
|--------------------------|------|--------|----|
| | | T1 | T2 |
| E-UTRA RF Channel Number | | 1 | |
| BWchannel | MHz | 10 | |

| | | | |
|---|------------|----------|----------|
| OCNG Patterns defined in TS36.133 A.3.2.2.1 (OP.1 TDD) and in A.3.2.2.2 (OP.2 TDD) | | OP.1 TDD | OP.2 TDD |
| PBCH_RA | dB | 0 | 0 |
| PBCH_RB | dB | | |
| PSS_RA | dB | | |
| SSS_RA | dB | | |
| PCFICH_RB | dB | | |
| PHICH_RA | dB | | |
| PHICH_RB | dB | | |
| PDCCH_RA | dB | | |
| PDCCH_RB | dB | | |
| PDSCH_RA | dB | | |
| PDSCH_RB | dB | | |
| OCNG_RANote 1 | dB | | |
| OCNG_RBNote 1 | dB | | |
| \hat{E}_s / I_{ot} | dB | 3 | 3 |
| \hat{E}_s / N_{oc} | dB | 3 | 3 |
| N_{oc} | dBm/15kHz | -98 | |
| RSRP | dBm/15kHz | -95 | -95 |
| SCH_RP | dBm/15 kHz | -95 | -95 |
| Propagation Condition | | AWGN | |
| Note 1: OCNG shall be used such that cell is fully allocated and a constant total transmitted power spectral density is achieved for all OFDM symbols. Note 2: RSRP and SCH_RP levels have been derived from other parameters for information purposes. They are not settable parameters themselves. | | | |

Table A.5.2.10.1-3: Cell specific test parameters for E-UTRAN TDD to unknown UTRAN TDD cell test case (cell 2)

| Parameter | Unit | Cell 2 (UTRA) | | | |
|--|--------------|---------------|-----|-----------|----|
| | | 0 | | DwPTS | |
| Timeslot Number | | T1 | T2 | T1 | T2 |
| UTRA RF Channel Number ^{Note1} | | Channel 2 | | | |
| PCCPCH_Ec/lor | dB | -3 | | | |
| DwPCH_Ec/lor | dB | | | 0 | |
| OCNS_Ec/lor | dB | -3 | | | |
| \hat{I}_{or} / I_{oc} | dB | -infinity | 13 | -infinity | 13 |
| I_{oc} | dBm/1.28 MHz | -80 | | | |
| PCCPCH RSCP | dBm | -infinity | -70 | n.a. | |
| Propagation Condition | | AWGN | | | |
| Note1: In the case of multi-frequency cell, the UTRA RF Channel Number is the primary frequency's channel number. Note2: P-CCPCH RSCP levels have been derived from other parameters for information purposes. They are not settable parameters themselves. | | | | | |

A.5.2.10.2 Test Requirements

The UE shall start to transmit the SYNCH-UL sequence in the UpPTS to Cell 2 less than 280 ms from the beginning of time period T2.

The rate of correct handovers observed during repeated tests shall be at least 90%.

NOTE: The handover delay can be expressed as: RRC procedure delay + Tinterrupt, where:

RRC procedure delay = 50 ms, which is specified in clause 5.3.2.2.1.

$T_{\text{interrupt}}$ is defined in clause 5.3.2.2.2. $T_{\text{interrupt}} = 230$ ms in the test as following:

$$T_{\text{interrupt1}} = T_{\text{offset}} + T_{\text{UL}} + 30 * F_{\text{SFN}} + 180 \text{ ms}$$

$$T_{\text{offset}} = 10 \text{ ms}; T_{\text{UL}} = 10 \text{ ms}; \text{ and } F_{\text{SFN}} = 1 \text{ for UE decoding SFN.}$$

This gives a total of 280 ms.

A.5.2.10A E-UTRAN FDD – UTRAN FDD Multicarrier Handover with two target cells

A.5.2.10A.1 Test Purpose and Environment

This test is to verify the requirement for the E-UTRAN FDD to UTRAN FDD handover requirements specified in clause 5.3.1 in a 2 cell multicarrier configuration. It is applicable to UEs that support DC-HSDPA, DB-DC-HSDPA and which do not support 3C-HSDPA or 4C-HSDPA.

The test parameters are given in Tables A.5.2.10A.1-1, A.5.2.10A.1-2 and A.5.2.10A.1-3. The test consists of three successive time periods, with time durations of T1, T2 and T3 respectively. At the start of time duration T1, the UE does not have any timing information of Cell 2. Starting T2, Cell 2 and cell 3 become detectable and the UE is expected to detect and send a measurement report. Gap pattern configuration with id #0 as specified in Table 8.1.2.1-1 is configured before T2 begins to enable inter-RAT frequency monitoring.

A RRC message implying handover to cell 2 and cell 3 shall be sent to the UE during period T2, after the UE has reported Event B2. The start of T3 is the instant when the last TTI containing the RRC message implying handover is sent to the UE. The handover message shall contain cell 2 as the target Primary Serving HS-DSCH cell and cell 3 as the target Secondary Serving HS-DSCH cell.

Table A.5.2.10A.1-1: General test parameters for E-UTRAN FDD to UTRAN FDD handover test case

| Parameter | | Unit | Value | Comment |
|--|-------------------|------|--|--|
| PDSCH parameters | | | DL Reference Measurement Channel R.0 FDD | As specified in clause A.3.1.1.1 |
| PCFICH/PDCCH/PHICH parameters | | | DL Reference Measurement Channel R.6 FDD | As specified in clause A.3.1.2.1 |
| Initial conditions | Active cell | | Cell 1 | E-UTRAN cell |
| | Neighbouring cell | | Cell 2 | UTRAN cell |
| Final condition | Active cell | | Cell 2 and cell 3 | UTRAN cell |
| Channel Bandwidth (BW_{channel}) | | MHz | 10 | |
| Gap Pattern Id | | | 0 | As specified in Table 8.1.2.1-1 started before T2 starts |
| E-UTRAN FDD measurement quantity | | | RSRP | |
| Inter-RAT (UTRAN FDD) measurement quantity | | | CPICH Ec/Io | |
| b2-Threshold1 | | dBm | -90 | Absolute E-UTRAN RSRP threshold for event B2 |
| b2-Threshold2-UTRA | | dB | -18 | Absolute UTRAN CPICH Ec/Io threshold for event B2 |
| Hysteresis | | dB | 0 | |
| TimeToTrigger | | s | 0 | |
| Filter coefficient | | | 0 | L3 filtering is not used |
| DRX | | | OFF | Non-DRX test |
| Access Barring Information | | - | Not sent | No additional delays in random access procedure |
| E-UTRA RF Channel Number | | | 1 | One E-UTRA FDD carrier frequency is used. |
| E-UTRA Channel Bandwidth (BW_{channel}) | | MHz | 10 | |
| UTRA RF Channel Number | | | 1 | One UTRA FDD carrier frequency is used. |

| | | | |
|-----------------------------------|---|-------|---|
| Monitored UTRA FDD cell list size | | 12 | UTRA cells on UTRA RF channel 1 provided in the cell before T2. |
| Post-verification period | | False | |
| T1 | s | 5 | |
| T2 | s | ≤5 | |
| T3 | s | 1 | |

Table A.5.2.10A.1-2: Cell specific test parameters for E-UTRAN FDD to UTRAN FDD handover test case (cell 1)

| Parameter | Unit | Cell 1 (E-UTRA) | | |
|---|------------|-----------------|----------|----------|
| | | T1 | T2 | T3 |
| E-UTRA RF Channel number | | 1 | | |
| $BW_{channel}$ | MHz | 10 | | |
| OCNG Patterns defined in A.3.2.1.1 (OP.1 FDD) and in A.3.2.1.2 (OP.2 FDD) | | OP.1 FDD | OP.1 FDD | OP.2 FDD |
| PBCH_RA | dB | 0 | | |
| PBCH_RB | | | | |
| PSS_RA | | | | |
| SSS_RA | | | | |
| PCFICH_RB | | | | |
| PHICH_RA | | | | |
| PHICH_RB | | | | |
| PDCCH_RA | | | | |
| PDCCH_RB | | | | |
| PDSCH_RA | | | | |
| PDSCH_RB | | | | |
| OCNG_RA ^{Note 1} | | | | |
| OCNG_RB ^{Note 1} | | | | |
| \hat{E}_s / I_{ot} | | | | |
| N_{oc} | dBm/15 kHz | -98 | | |
| \hat{E}_s / N_{oc} | dB | 0 | 0 | 0 |
| RSRP ^{Note 2} | dBm/15 KHz | -98 | -98 | -98 |
| I_o ^{Note 2} | dBm/9 MHz | -67.21 | -67.21 | -67.21 |
| Propagation Condition | | AWGN | | |
| Note 1: OCNG shall be used such that both cells are fully allocated and a constant total transmitted power spectral density is achieved for all OFDM symbols. Note 2: RSRP and I_o levels have been derived from other parameters for information purposes. They are not settable parameters themselves. | | | | |

Table A.5.2.10A.1-3: Cell specific test parameters for E-UTRAN FDD to UTRAN FDD multi carrier handover test case (cell 2 and cell 3)

| | | Cell 2 | | | Cell 3 | | |
|-------------------------|----|------------------------------|------|------|--------------------------------|------|------|
| | | T1 | T2 | T3 | T1 | T2 | T3 |
| UTRA RF Channel Number | | Channel 1 | | | Channel 2 | | |
| Cell type | | Primary Serving HS-DSCH Cell | | | Secondary Serving HS-DSCH Cell | | |
| CPICH_Ec/Ior | dB | -10 | | | -10 | | |
| PCCPCH_Ec/Ior | dB | -12 | | | -12 | | |
| SCH_Ec/Ior | dB | -12 | | | -12 | | |
| PICH_Ec/Ior | dB | -15 | | | -15 | | |
| HS-SCCH_Ec/Ior | dB | -13 | | | -13 | | |
| HS-DPDCH_Ec/Ior | dB | -10 | | | -10 | | |
| DPCH_Ec/Ior | dB | Note 1 | | | N/A | | |
| OCNS | | Note 2 | | | -2.02 | | |
| \hat{I}_{or} / I_{oc} | dB | -Inf | -1.8 | -1.8 | -Inf | -1.8 | -1.8 |

| | | | |
|-----------------------|--|------|------|
| I_{oc} | dBm/3.84 MHz | -70 | |
| Propagation Condition | | AWGN | AWGN |
| Note 1: | The DPCH level is controlled by the power control loop | | |
| Note 2: | The power of the OCNS channel that is added shall make the total power from the cell to be equal to I_{or} | | |
| Note 3: | The UE shall be scheduled continuously with HS-DSCH data during T3 using both cell 2 and cell 3 | | |

A.5.2.10A.2 Test Requirements

The UE shall start to transmit the UL DPCCH to Cell 2 less than 210 ms from the beginning of time period T3.

The rate of correct handovers observed during repeated tests shall be at least 90%.

NOTE: The handover delay can be expressed as: RRC procedure delay + $T_{interrupt}$, where:

RRC procedure delay = 50 ms, which is specified in clause 5.3.1.1.1.

$T_{interrupt}$ = 160 ms in the test; $T_{interrupt}$ is defined in clause 5.3.1.1.2.

This gives a total of 210 ms.

A.5.2.10B E-UTRAN TDD – UTRAN FDD Multicarrier Handover with two target cells

A.5.2.10B.1 Test Purpose and Environment

This test is to verify the requirement for the E-UTRAN TDD to UTRAN FDD handover requirements specified in clause 5.3.1 in a 2 cell multicarrier configuration. It is applicable to UEs that support DC-HSDPA, DB-DC-HSDPA and which do not support 3C-HSDPA or 4C-HSDPA.

The test parameters are given in Tables A.5.2.10B.1-1, A.5.2.10B.1-2 and A.5.2.10B.1-3. The test consists of three successive time periods, with time durations of T1, T2 and T3 respectively. At the start of time duration T1, the UE does not have any timing information of Cell 2. Starting T2, Cell 2 and cell 3 become detectable and the UE is expected to detect and send a measurement report. Gap pattern configuration with id #0 as specified in Table 8.1.2.1-1 is configured before T2 begins to enable inter-RAT frequency monitoring.

A RRC message implying handover to cell 2 and cell 3 shall be sent to the UE during period T2, after the UE has reported Event B2. The start of T3 is the instant when the last TTI containing the RRC message implying handover is sent to the UE. The handover message shall contain cell 2 as the target Primary Serving HS-DSCH cell and cell 3 as the target Secondary Serving HS-DSCH cell.

Table A.5.2.10B.1-1: General test parameters for E-UTRAN TDD to UTRAN FDD handover test case

| Parameter | | Unit | Value | Comment |
|---|----------------|------|--|---|
| PDSCH parameters (E-UTRAN TDD) | | | DL Reference Measurement Channel R.0 TDD | As specified in clause A.3.1.1.2 |
| PCFICH/PDCCH/PHICH parameters (E-UTRAN TDD) | | | DL Reference Measurement Channel R.6 TDD | As specified in clause A.3.1.2.2 |
| Initial conditions | Active cell | | Cell 1 | Cell 1 is on E-UTRA RF channel number 1. |
| | Neighbour cell | | Cell 2 | Cell 2 is on UTRA RF channel number 1. |
| Final conditions | Active cell | | Cell 2 and cell 3 | |
| Special subframe configuration | | | 6 | As specified in table 4.2-1 in TS 36.211. Applicable to cell 1. |
| Uplink-downlink configuration | | | 1 | As specified in table 4.2-2 in TS 36.211. Applicable to cell 1 |
| E-UTRAN TDD measurement quantity | | | RSRP | |
| Inter-RAT (UTRA FDD) measurement quantity | | | CPICH E_c/I_0 | |

| | | | |
|---|-----|--------|--|
| b2-Threshold1 | dBm | -90 | Absolute E-UTRAN RSRP threshold for event B2 |
| b2-Threshold2-UTRA | dB | -18 | UTRAN FDD CPICH Ec/Io threshold for event B2 |
| Hysteresis | dB | 0 | |
| DRX | | OFF | No DRX configured. |
| Time to Trigger | ms | 0 | |
| Filter coefficient | | 0 | |
| CP length | | Normal | Applicable to cell 1 |
| Gap pattern configuration Id | | 0 | As specified in Table 8.1.2.1-1; to start before T2 starts |
| E-UTRA RF Channel Number | | 1 | One E-UTRA TDD carrier frequency is used. |
| E-UTRA Channel Bandwidth (BW _{channel}) | MHz | 10 | |
| UTRA RF Channel Number | | 1 | One UTRA FDD carrier frequency is used. |
| Monitored UTRA FDD cell list size | | 12 | UTRA cells on UTRA RF channel 1 provided in the cell list before T2. |
| Post-verification period | | False | Post verification is not used. |
| T1 | s | 5 | |
| T2 | s | ≤5 | |
| T3 | s | 1 | |

Table A.5.2.10B.1-2: Cell specific test parameters for E-UTRAN TDD to UTRAN FDD handover test case (cell 1)

| Parameter | Unit | Cell 1 (E-UTRAN) | | |
|--|------------|------------------|--------|----------|
| | | T1 | T2 | T3 |
| E-UTRA RF Channel Number | | 1 | | |
| BW _{channel} | MHz | 10 | | |
| OCNG Pattern defined in A.3.2.2.1 (OP.1 TDD) and in A.3.2.2.2 (OP.2 TDD) | | OP.1 TDD | | OP.2 TDD |
| PBCH_RA | dB | 0 | | |
| PBCH_RB | | | | |
| PSS_RA | | | | |
| SSS_RA | | | | |
| PCFICH_RB | | | | |
| PHICH_RA | | | | |
| PHICH_RB | | | | |
| PDCCH_RA | | | | |
| PDCCH_RB | | | | |
| PDSCH_RA | | | | |
| PDSCH_RB | | | | |
| OCNG_RA ^{Note 1} | | | | |
| OCNG_RB ^{Note 1} | | | | |
| RSRP | | | | |
| \hat{E}_s / I_{ot} | dB | 0 | 0 | 0 |
| \hat{E}_s / N_{oc} | dB | 0 | 0 | 0 |
| N_{oc} | dBm/15 kHz | -98 | | |
| I_o ^{Note 2} | dBm/9 MHz | -67.21 | -67.21 | -67.21 |
| Propagation Condition | | AWGN | | |
| <p>Note 1: OCNG shall be used such that the cell is fully allocated and a constant total transmitted power spectral density is achieved for all OFDM symbols.</p> <p>Note 2: RSRP and I_o levels have been derived from other parameters for information purposes. They are not settable parameters themselves.</p> | | | | |

Table A.5.2.10B.1-3: Cell specific test parameters for E-UTRAN TDD to UTRAN FDD multi carrier handover test case (cell 2 and cell 3)

| | | Cell 2 | | | Cell 3 | | |
|--|--------------|------------------------------|------|------|--------------------------------|------|------|
| | | T1 | T2 | T3 | T1 | T2 | T3 |
| UTRA RF Channel Number | | Channel 1 | | | Channel 2 | | |
| Cell type | | Primary Serving HS-DSCH Cell | | | Secondary Serving HS-DSCH Cell | | |
| CPICH_Ec/I _{or} | dB | -10 | | | -10 | | |
| PCCPCH_Ec/I _{or} | dB | -12 | | | -12 | | |
| SCH_Ec/I _{or} | dB | -12 | | | -12 | | |
| PICH_Ec/I _{or} | dB | -15 | | | -15 | | |
| HS-SCCH_Ec/I _{or} | dB | -13 | | | -13 | | |
| HS-DPDCCH_Ec/I _{or} | dB | -10 | | | -10 | | |
| DPCH_Ec/I _{or} | dB | Note 1 | | | N/A | | |
| OCNS | | Note 2 | | | -2.02 | | |
| \hat{I}_{or}/I_{oc} | dB | -Inf | -1.8 | -1.8 | -Inf | -1.8 | -1.8 |
| I_{oc} | dBm/3.84 MHz | -70 | | | | | |
| Propagation Condition | | AWGN | | | AWGN | | |
| Note 1: The DPCH level is controlled by the power control loop Note 2: The power of the OCNS channel that is added shall make the total power from the cell to be equal to I _{or} Note 3: The UE shall be scheduled continuously with HS-DSCH data during T3 using both cell 2 and cell 3 | | | | | | | |

A.5.2.10B.2 Test Requirements

The UE shall start to transmit the UL DPCCCH to Cell 2 less than 210 ms from the beginning of time period T3.

The rate of correct handovers observed during repeated tests shall be at least 90%.

NOTE: The handover delay can be expressed as: RRC procedure delay + T_{interrupt}, where:

RRC procedure delay = 50 ms, which is specified in clause 5.3.1.1.1.

T_{interrupt} = 160 ms in the test; T_{interrupt} is defined in clause 5.3.1.1.2.

This gives a total of 210 ms.

A.5.2.11 E-UTRAN FDD – UTRAN FDD Handover for 5MHz Bandwidth

A.5.2.11.1 Test Purpose and Environment

The purpose of this test case is the same as for the test defined in subclause A.5.2.1.1.

The parameters of this test are the same as defined in Subclause A.5.2.1.1 except that the values of the parameters in the Table A.5.2.11.1-1 will replace the values of the corresponding parameters in A.5.2.1.1-1, and the values of the parameters in the Table A.5.2.11.1-2 will replace the values of the corresponding parameters in A.5.2.1.1-2.

Table A.5.2.11.1-1: General test parameters for E-UTRAN FDD to UTRAN FDD handover test case for 5MHz bandwidth

| Parameter | Unit | Value | Comment |
|---|------|---|----------------------------------|
| PDSCH parameters | | DL Reference Measurement Channel R.5 FDD | As specified in clause A.3.1.1.1 |
| PCFICH/PDCCH/PHICH parameters | | DL Reference Measurement Channel R.11 FDD | As specified in clause A.3.1.2.1 |
| E-UTRA Channel Bandwidth (BW _{channel}) | MHz | 5 | |
| Note 1: See Table A.5.2.1.1-1 for other general test parameters. | | | |
| Note 2: This test is according to the principle defined in section A.3.7.2. | | | |

Table A.5.2.11.1-2: Cell specific test parameters for E-UTRAN FDD to UTRAN FDD handover test case (cell 1)

| Parameter | Unit | Cell 1 (E-UTRA) | | |
|---|---|-----------------|-----------|-----------|
| | | T1 | T2 | T3 |
| $BW_{channel}$ | MHz | 5 | | |
| OCNG Patterns defined in A.3.2.1.15 (OP.15 FDD) and in A.3.2.1.16 (OP.16 FDD) | | OP.15 FDD | OP.15 FDD | OP.16 FDD |
| I_0 ^{Note 2} | dBm/4.5 MHz | -70.22 | -70.22 | -70.22 |
| Note 1: | OCNG shall be used such that both cells are fully allocated and a constant total transmitted power spectral density is achieved for all OFDM symbols. | | | |
| Note 2: | RSRP and I_0 levels have been derived from other parameters for information purposes. They are not settable parameters themselves. | | | |
| Note 3: | See Table A.5.2.1.1-2 for other cell specific test parameters. | | | |

A.5.2.11.2 Test Requirements

The test requirements defined in section A.5.2.1.2 shall apply to this test case.

A.5.3 E-UTRAN Handover to Non-3GPP RATs

A.5.3.1 E-UTRAN FDD – HRPD Handover

A.5.3.1.1 Test Purpose and Environment

This test is to verify the requirement for the E-UTRAN FDD to HRPD handover requirements specified in clause 5.4.1.

The test parameters are given in Tables A.5.3.1.1-1, A.5.3.1.1-2 and A.5.3.1.1-3. The test consists of three successive time periods, with time durations of T1, T2 and T3 respectively. At the start of time duration T1, the UE does not have any timing information of Cell 2. Starting T2, Cell 2 becomes detectable and the UE is expected to detect and send a measurement report. Gap pattern configuration with id #0 as specified in Table 8.1.2.1-1 is configured before T2 begins to enable inter-RAT frequency monitoring.

A RRC message implying handover shall be sent to the UE during period T2, after the UE has reported Event B2. The start of T3 is the instant when the last TTI containing the RRC message implying handover is sent to the UE. The handover message shall contain cell 2 as the target cell.

Table A.5.3.1.1-1: General test parameters for E-UTRAN FDD to HRPD handover test case

| Parameter | | Unit | Value | Comment |
|---------------------------------------|-------------------|------|--|--|
| PDSCH parameters | | | DL Reference Measurement Channel R.0 FDD | As specified in clause A.3.1.1.1 |
| PCFICH/PDCCH/PHICH parameters | | | DL Reference Measurement Channel R.6 FDD | As specified in clause A.3.1.2.1 |
| Initial conditions | Active cell | | Cell 1 | E-UTRAN FDD cell |
| | Neighbouring cell | | Cell 2 | HRPD cell |
| Final condition | Active cell | | Cell 2 | HRPD cell |
| Channel Bandwidth ($BW_{channel}$) | | MHz | 10 | |
| Gap Pattern Id | | | 0 | As specified in Table 8.1.2.1-1 started before T2 starts |
| E-UTRAN FDD measurement quantity | | | RSRP | |
| Inter-RAT (HRPD) measurement quantity | | | CDMA2000 HRPD Pilot Strength | |
| b2-Threshold1 | | dBm | -90 | Absolute E-UTRAN RSRP threshold for event B2 |
| b2-Threshold2-CDMA2000 | | dB | -7 | Absolute 'CDMA2000 HRPD Pilot Strength' threshold for event B2 |
| Hysteresis | | dB | 0 | |
| TimeToTrigger | | s | 0 | |

| | | | |
|--------------------------------------|-----|-----------------|--|
| Filter coefficient | | 0 | L3 filtering is not used |
| DRX | | OFF | Non-DRX test |
| Access Barring Information | - | Not sent | No additional delays in random access procedure |
| E-UTRA RF Channel Number | | 1 | One E-UTRA FDD carrier frequency is used. |
| E-UTRA Channel Bandwidth (BWchannel) | MHz | 10 | |
| HRPD RF Channel Number | | 1 | One HRPD carrier frequency is used. |
| HRPD neighbour cell list size | | 8 | HRPD cells on HRPD RF channel 1 provided in the cell list before T2. |
| cdma2000-SearchWindowSize | | 8 (60 PN chips) | Search window size as defined in clause 6.3.5 in TS 36.331 |
| T1 | s | 5 | |
| T2 | s | ≤10 | |
| T3 | s | 1 | |

Table A.5.3.1.1-2: Cell specific test parameters for E-UTRAN FDD cell#1 for handover to HRPD cell # 2

| Parameter | Unit | Cell 1 (E-UTRA) | | |
|---|------------|-----------------|-----|----------|
| | | T1 | T2 | T3 |
| E-UTRA RF Channel number | | 1 | | |
| BW_{channel} | MHz | 10 | | |
| OCNG Patterns defined in A.3.2.1.1 (OP.1 FDD) and in A.3.2.1.2 (OP.2 FDD) | | OP.1 FDD | | OP.2 FDD |
| PBCH_RA | dB | 0 | | |
| PBCH_RB | dB | | | |
| PSS_RA | dB | | | |
| SSS_RA | dB | | | |
| PCFICH_RB | dB | | | |
| PHICH_RA | dB | | | |
| PHICH_RB | dB | | | |
| PDCCH_RA | dB | | | |
| PDCCH_RB | dB | | | |
| PDSCH_RA | dB | | | |
| PDSCH_RB | dB | | | |
| OCNG_RA ^{Note 1} | dB | | | |
| OCNG_RB ^{Note 1} | dB | | | |
| N_{oc} ^{Note 2} | dBm/15 kHz | | | |
| RSRP ^{Note 3} | dBm/15 KHz | -98 | -98 | -98 |
| \hat{E}_s / N_{oc} | dB | 0 | 0 | 0 |
| \hat{E}_s / I_{ot} | dB | 0 | 0 | 0 |
| Propagation Condition | | AWGN | | |
| <p>Note 1: OCNG shall be used such that both cells are fully allocated and a constant total transmitted power spectral density is achieved for all OFDM symbols.</p> <p>Note 2: Interference from other cells and noise sources not specified in the test is assumed to be constant over subcarriers and time and shall be modelled as AWGN of appropriate power for N_{oc} to be fulfilled.</p> <p>Note 3: RSRP levels have been derived from other parameters for information purposes. They are not settable parameters themselves.</p> | | | | |

Table A.5.3.1.1-3: Cell specific test parameters for HRPD (cell # 2) for handover from E-UTRAN FDD cell (cell #1)

| Parameter | Unit | Cell 2 (HRPD) | | |
|---|----------------|---------------|----|----|
| | | T1 | T2 | T3 |
| $\frac{\text{Control } E_b}{N_t}$ (38.4 kbps) | dB | 21 | | |
| $\frac{\text{Control } E_b}{N_t}$ (76.8 kbps) | dB | 18 | | |
| \hat{I}_{or}/I_{oc} | dB | -infinity | 0 | 0 |
| I_{oc} | dBm/1.2288 MHz | -55 | | |
| CDMA2000 HRPD Pilot Strength | dB | -infinity | -3 | -3 |
| Propagation Condition | | AWGN | | |

A.5.3.1.2 Test Requirements

The UE shall start transmission of the reverse control channel in HRPD to Cell 2 less than 127 ms from the beginning of time period T3.

The rate of correct handovers observed during repeated tests shall be at least 90%.

NOTE: The handover delay can be expressed as: RRC procedure delay + $T_{\text{interrupt}}$, where:

RRC procedure delay = 50 ms, which is specified in clause 5.4.1.1.1.

$T_{\text{interrupt}}$ = 76.66 ms in the test; $T_{\text{interrupt}}$ is defined in clause 5.4.1.1.2.

This gives a total of 126.66 ms, allow 127 ms in the test.

A.5.3.2 E-UTRAN FDD – cdma2000 1X Handover

A.5.3.2.1 Test Purpose and Environment

This test is to verify the requirement for the E-UTRAN FDD to cdma2000 1X handover requirements specified in clause 5.4.2.

The test parameters are given in Tables A.5.3.2.1-1, A.5.3.2.1-2 and A.5.3.2.1-3. The test consists of three successive time periods, with time durations of T1, T2 and T3 respectively. At the start of time duration T1, the UE does not have any timing information of Cell 2. Starting T2, Cell 2 becomes detectable and the UE is expected to detect and send a measurement report. Gap pattern configuration with id #0 as specified in Table 8.1.2.1-1 is configured before T2 begins to enable inter-RAT frequency monitoring.

A RRC message implying handover shall be sent to the UE during period T2, after the UE has reported Event B2. The start of T3 is the instant when the last TTI containing the RRC message implying handover is sent to the UE. The handover message shall contain cell 2 as the target cell.

Table A.5.3.2.1-1: General test parameters for E-UTRAN FDD to cdma2000 1X handover test case

| Parameter | | Unit | Value | Comment |
|---|-------------------|------|--|--|
| PDSCH parameters | | | DL Reference Measurement Channel R.0 FDD | As specified in clause A.3.1.1.1 |
| PCFICH/PDCCH/PHICH parameters | | | DL Reference Measurement Channel R.6 FDD | As specified in clause A.3.1.2.1 |
| Initial conditions | Active cell | | Cell 1 | E-UTRAN FDD cell |
| | Neighbouring cell | | Cell 2 | cdma2000 1X cell |
| Final condition | Active cell | | Cell 2 | cdma2000 1X cell |
| Channel Bandwidth (BW_{channel}) | | MHz | 10 | |
| Gap Pattern Id | | | 0 | As specified in Table 8.1.2.1-1 started before T2 starts |

| E-UTRAN FDD measurement quantity | | RSRP | |
|--|-----|-------------------------------|--|
| Inter-RAT (cdma2000 1X) measurement quantity | | CDMA2000 1xRTT Pilot Strength | |
| b2-Threshold1 | dBm | -90 | Absolute E-UTRAN RSRP threshold for event B2 |
| b2-Threshold2-CDMA2000 | dB | -14 | Absolute 'CDMA2000 1xRTT Pilot Strength' threshold for event B2 |
| Hysteresis | dB | 0 | |
| TimeToTrigger | s | 0 | |
| Filter coefficient | | 0 | L3 filtering is not used |
| DRX | | OFF | Non-DRX test |
| Access Barring Information | - | Not sent | No additional delays in random access procedure |
| E-UTRA RF Channel Number | | 1 | One E-UTRA FDD carrier frequency is used. |
| E-UTRA Channel Bandwidth (BWchannel) | MHz | 10 | |
| cdma2000 1X RF Channel Number | | 1 | One HRPD carrier frequency is used. |
| cdma2000 1X neighbour cell list size | | 8 | cdma2000 1X cells on cdma2000 1X RF channel 1 provided in the cell list before T2. |
| cdma2000-SearchWindowSize | | 8 (60 PN chips) | Search window size as defined in clause 6.3.5 in TS 36.331 |
| T1 | s | 5 | |
| T2 | s | ≤10 | |
| T3 | s | 1 | |

Table A.5.3.2.1-2: Cell specific test parameters for E-UTRAN FDD cell#1 for handover to cdma2000 1X cell # 2

| Parameter | Unit | Cell 1 (E-UTRA) | | |
|---|------------|-----------------|-----|----------|
| | | T1 | T2 | T3 |
| E-UTRA RF Channel number | | 1 | | |
| $BW_{channel}$ | MHz | 10 | | |
| OCNG Patterns defined in A.3.2.1.1 (OP.1 FDD) and in A.3.2.1.2 (OP.2 FDD) | | OP.1 FDD | | OP.2 FDD |
| PBCH_RA | dB | 0 | | |
| PBCH_RB | dB | | | |
| PSS_RA | dB | | | |
| SSS_RA | dB | | | |
| PCFICH_RB | dB | | | |
| PHICH_RA | dB | | | |
| PHICH_RB | dB | | | |
| PDCCH_RA | dB | | | |
| PDCCH_RB | dB | | | |
| PDSCH_RA | dB | | | |
| PDSCH_RB | dB | | | |
| OCNG_RA ^{Note 1} | dB | | | |
| OCNG_RB ^{Note 1} | dB | | | |
| N_{oc} ^{Note 2} | dBm/15 kHz | | | |
| RSRP ^{Note 3} | dBm/15 KHz | -98 | -98 | -98 |
| \hat{E}_s / N_{oc} | dB | 0 | 0 | 0 |
| \hat{E}_s / I_{ot} | dB | 0 | 0 | 0 |
| Propagation Condition | | AWGN | | |
| <p>Note 1: OCNG shall be used such that both cells are fully allocated and a constant total transmitted power spectral density is achieved for all OFDM symbols.</p> <p>Note 2: Interference from other cells and noise sources not specified in the test is assumed to be constant over subcarriers and time and shall be modelled as AWGN of appropriate power for N_{oc} to be fulfilled.</p> <p>Note 3: RSRP levels have been derived from other parameters for information purposes. They are not settable parameters themselves.</p> | | | | |

Table A.5.3.2.1-3: Cell specific test parameters for cdma2000 1X (cell # 2) for handover from E-UTRAN FDD cell (cell #1)

| Parameter | Unit | Cell 2 (cdma2000 1X) | | |
|--|----------------|----------------------|-----|-----|
| | | T1 | T2 | T3 |
| $\frac{\text{Pilot } E_c}{I_{or}}$ | dB | -7 | | |
| $\frac{\text{Sync } E_c}{I_{or}}$ | dB | -16 | | |
| $\frac{\text{Paging } E_c}{I_{or}}$ (4.8 kbps) | dB | -12 | | |
| \hat{I}_{or}/I_{oc} | dB | -infinity | 0 | 0 |
| I_{oc} | dBm/1.2288 MHz | -55 | | |
| CDMA2000 1xRTT Pilot Strength | dB | -infinity | -10 | -10 |
| Propagation Condition | | AWGN | | |

A.5.3.2.2 Test Requirements

The UE shall start transmission of the reverse control channel in cdma2000 1X to Cell 2 less than 300 ms from the beginning of time period T3.

NOTE: The handover delay can be expressed as: RRC procedure delay + $T_{\text{interrupt}}$, where:

RRC procedure delay = 130 ms, which is specified in clause 5.4.2.1.1.

$T_{\text{interrupt}}$ = 170 ms in the test; $T_{\text{interrupt}}$ is defined in clause 5.4.2.1.2.

This gives a total of 300 ms.

A.5.3.3 E-UTRAN FDD – HRPD Handover; Unknown Target Cell

A.5.3.3.1 Test Purpose and Environment

This test is to verify the requirement for the E-UTRAN FDD to HRPD handover requirements for the case when the target HRPD cell is unknown as specified in clause 5.4.1.

The test parameters are given in Tables A.5.3.3.1-1, A.5.3.3.1-2 and A.5.3.3.1-3. The test consists of two successive time periods, with time durations of T1 and T2 respectively. At the start of time duration T1, the UE does not have any timing information of cell 2. During time period T1, message containing Information Element *systemTimeInfo* as defined in clause 6.3.1 of TS 36.331 [2] shall be sent by the System Simulator (SS). No gap patterns are configured in the test case. No HRPD neighbour cell list shall be provided to the UE.

A RRC message implying handover to the unknown HRPD cell shall be sent to the UE towards the end of the time period T1. The start of T2 is the instant when the last TTI containing the RRC message implying handover is sent to the UE. The handover message shall contain cell 2 as the target cell.

Table A.5.3.3.1-1: General test parameters for E-UTRAN FDD to HRPD handover test case; unknown target HRPD cell

| Parameter | Unit | Value | Comment |
|---|-------------------|--|----------------------------------|
| PDSCH parameters | | DL Reference Measurement Channel R.0 FDD | As specified in clause A.3.1.1.1 |
| PCFICH/PDCCH/PHICH parameters | | DL Reference Measurement Channel R.6 FDD | As specified in clause A.3.1.2.1 |
| Initial conditions | Active cell | Cell 1 | E-UTRAN FDD cell |
| | Neighbouring cell | Cell 2 | HRPD cell |
| Final condition | Active cell | Cell 2 | HRPD cell |
| Channel Bandwidth (BW_{channel}) | MHz | 10 | |

| | | | |
|--------------------------------------|-----|-----------------|--|
| DRX | | OFF | Non-DRX test |
| Access Barring Information | - | Not sent | No additional delays in random access procedure |
| E-UTRA RF Channel Number | | 1 | One E-UTRA FDD carrier frequency is used. |
| E-UTRA Channel Bandwidth (BWchannel) | MHz | 10 | |
| HRPD RF Channel Number | | 1 | One HRPD carrier frequency is used. |
| cdma2000-SearchWindowSize | | 8 (60 PN chips) | Search window size as defined in clause 6.3.5 in TS 36.331 |
| T1 | s | ≤5 | |
| T2 | s | 1 | |

Table A.5.3.3.1-2: Cell specific test parameters for E-UTRAN FDD cell#1 for handover to unknown HRPD cell # 2

| Parameter | Unit | Cell 1 (E-UTRAN FDD) | |
|---|------------|----------------------|-----|
| | | T1 | T2 |
| E-UTRA RF Channel number | | 1 | |
| $BW_{channel}$ | MHz | 10 | |
| OCNG Patterns defined in A.3.2.1.1 (OP.1 FDD) | | OP.1 FDD | |
| PBCH_RA | dB | 0 | |
| PBCH_RB | dB | | |
| PSS_RA | dB | | |
| SSS_RA | dB | | |
| PCFICH_RB | dB | | |
| PHICH_RA | dB | | |
| PHICH_RB | dB | | |
| PDCCH_RA | dB | | |
| PDCCH_RB | dB | | |
| PDSCH_RA | dB | | |
| PDSCH_RB | dB | | |
| OCNG_RA ^{Note 1} | dB | | |
| OCNG_RB ^{Note 1} | dB | | |
| N_{oc} ^{Note 2} | dBm/15 kHz | -98 | |
| RSRP ^{Note 3} | dBm/15 kHz | -98 | -98 |
| \hat{E}_s / N_{oc} | dB | 0 | 0 |
| \hat{E}_s / I_{ot} | dB | 0 | 0 |
| Propagation Condition | | AWGN | |
| <p>Note 1: OCNG shall be used such that both cells are fully allocated and a constant total transmitted power spectral density is achieved for all OFDM symbols.</p> <p>Note 2: Interference from other cells and noise sources not specified in the test is assumed to be constant over subcarriers and time and shall be modelled as AWGN of appropriate power for N_{oc} to be fulfilled.</p> <p>Note 3: RSRP levels have been derived from other parameters for information purposes. They are not settable parameters themselves.</p> | | | |

Table A.5.3.3.1-3: Cell specific test parameters for unknown HRPD (cell # 2) for handover from E-UTRAN FDD cell (cell #1)

| Parameter | Unit | Cell 2 (HRPD) | |
|---------------------------------------|-----------------|---------------|----|
| | | T1 | T2 |
| Control $\frac{E_b}{N_t}$ (38.4 kbps) | dB | 21 | |
| Control $\frac{E_b}{N_t}$ (76.8 kbps) | dB | 18 | |
| \hat{I}_{or} / I_{oc} | dB | -infinity | 0 |
| I_{oc} | dBm/1.22 88 MHz | -55 | |
| CDMA2000 HRPD Pilot Strength | dB | -infinity | -3 |
| Propagation Condition | | AWGN | |

A.5.3.3.2 Test Requirements

The UE shall start transmission of the reverse control channel in HRPD to Cell 2 less than 127 ms from the beginning of time period T2.

The rate of correct handovers observed during repeated tests shall be at least 90%.

NOTE: The handover delay is expressed as: RRC procedure delay + $T_{\text{interrupt}}$, where:

$T_{\text{interrupt}}$ also includes time to detect HRPD cell; see clause 5.4.1.1.2

This gives a total of 126.66 ms, allow 127 ms in the test case.

A.5.3.4 E-UTRAN FDD – cdma2000 1X Handover; Unknown Target cell

A.5.3.4.1 Test Purpose and Environment

This test is to verify the requirement for the E-UTRAN FDD to cdma2000 1X handover requirements for the case when the target cdma2000 1X cell is unknown as specified in clause 5.4.2.

The test parameters are given in Tables A.5.3.4.1-1, A.5.3.4.1-2 and A.5.3.4.1-3. The test consists of two successive time periods, with time durations of T1 and T2 respectively. At the start of time duration T1, the UE does not have any timing information of cell 2. During time period T1, message containing Information Element *systemTimeInfo* as defined in clause 6.3.1 of TS 36.331 [2] shall be sent by the System Simulator (SS). No gap patterns are configured in the test case. No cdma2000 1X neighbour cell list shall be provided to the UE.

A RRC message implying handover to the unknown cdma2000 1X cell shall be sent to the UE towards the end of the time period T1. The start of T2 is the instant when the last TTI containing the RRC message implying handover is sent to the UE. The handover message shall contain cell 2 as the target cell.

Table A.5.3.2.1-1: General test parameters for E-UTRAN FDD to cdma2000 1X handover test case; unknown target cdma2000 1X cell

| Parameter | | Unit | Value | Comment |
|--|-------------------|------|--|--|
| PDSCH parameters | | | DL Reference Measurement Channel R.0 FDD | As specified in clause A.3.1.1.1 |
| PCFICH/PDCCH/PHICH parameters | | | DL Reference Measurement Channel R.6 FDD | As specified in clause A.3.1.2.1 |
| Initial conditions | Active cell | | Cell 1 | E-UTRAN FDD cell |
| | Neighbouring cell | | Cell 2 | cdma2000 1X cell |
| Final condition | Active cell | | Cell 2 | cdma2000 1X cell |
| Channel Bandwidth (BW_{channel}) | | MHz | 10 | |
| DRX | | | OFF | Non-DRX test |
| Access Barring Information | | - | Not sent | No additional delays in random access procedure |
| E-UTRA RF Channel Number | | | 1 | One E-UTRA FDD carrier frequency is used. |
| E-UTRA Channel Bandwidth (BW_{channel}) | | MHz | 10 | |
| cdma2000 1X RF Channel Number | | | 1 | One HRPD carrier frequency is used. |
| cdma2000-SearchWindowSize | | | 8 (60 PN chips) | Search window size as defined in clause 6.3.5 in TS 36.331 |
| T1 | | s | ≤ 5 | |
| T2 | | s | 1 | |

Table A.5.3.2.1-2: Cell specific test parameters for E-UTRAN FDD cell#1 for handover to unknown cdma2000 1X cell # 2

| Parameter | Unit | Cell 1 (E-UTRAN FDD) | |
|---|------|----------------------|----|
| | | T1 | T2 |
| E-UTRA RF Channel number | | 1 | |
| BW_{channel} | MHz | 10 | |
| OCNG Patterns defined in A.3.2.1.1 (OP.1 FDD) | | OP.1 FDD | |
| PBCH_RA | dB | 0 | |
| PBCH_RB | dB | | |
| PSS_RA | dB | | |

| | | | |
|--|------------|------|-----|
| SSS_RA | dB | | |
| PCFICH_RB | dB | | |
| PHICH_RA | dB | | |
| PHICH_RB | dB | | |
| PDCCH_RA | dB | | |
| PDCCH_RB | dB | | |
| PDSCH_RA | dB | | |
| PDSCH_RB | dB | | |
| OCNG_RA ^{Note 1} | dB | | |
| OCNG_RB ^{Note 1} | dB | | |
| N_{oc} ^{Note 2} | dBm/15 kHz | -98 | |
| RSRP ^{Note 3} | dBm/15 kHz | -98 | -98 |
| \hat{E}_s / N_{oc} | dB | 0 | 0 |
| \hat{E}_s / I_{ot} | dB | 0 | 0 |
| Propagation Condition | | AWGN | |
| Note 1: OCNG shall be used such that both cells are fully allocated and a constant total transmitted power spectral density is achieved for all OFDM symbols. | | | |
| Note 2: Interference from other cells and noise sources not specified in the test is assumed to be constant over subcarriers and time and shall be modelled as AWGN of appropriate power for N_{oc} to be fulfilled. | | | |
| Note 3: RSRP levels have been derived from other parameters for information purposes. They are not settable parameters themselves. | | | |

Table A.5.3.2.1-3: Cell specific test parameters for unknown cdma2000 1X (cell # 2) for handover from E-UTRAN FDD cell (cell #1)

| Parameter | Unit | Cell 2 (cdma2000 1X) | |
|--|-----------------|----------------------|-----|
| | | T1 | T2 |
| $\frac{\text{Pilot } E_c}{I_{or}}$ | dB | -7 | |
| $\frac{\text{Sync } E_c}{I_{or}}$ | dB | -16 | |
| $\frac{\text{Paging } E_c}{I_{or}}$ (4.8 kbps) | dB | -12 | |
| \hat{I}_{or} / I_{oc} | dB | -infinity | 0 |
| I_{oc} | dBm/1.22 88 MHz | -55 | |
| CDMA2000 1xRTT Pilot Strength | dB | -infinity | -10 |
| Propagation Condition | | AWGN | |

A.5.3.4.2 Test Requirements

The UE shall start transmission of the reverse control channel in cdma2000 1X to Cell 2 less than 300 ms from the beginning of time period T2.

The rate of correct handovers observed during repeated tests shall be at least 90%.

NOTE: The handover delay is expressed as: RRC procedure delay + $T_{interrupt}$, where:

$T_{interrupt}$ also includes time to detect cdma2000 1X cell; see clause 5.4.2.1.2

This gives a total of 300 ms.

A.5.3.5 E-UTRAN TDD – HRPD Handover

A.5.3.5.1 Test Purpose and Environment

This test is to verify the requirement for the E-UTRAN TDD to HRPD handover requirements specified in clause 5.4.1.

The test parameters are given in Tables A.5.3.5.1-1, A.5.3.5.1-2 and A.5.3.5.1-3. The test consists of three successive time periods, with time durations of T1, T2 and T3 respectively. At the start of time duration T1, the UE does not have any timing information of Cell 2. Starting T2, Cell 2 becomes detectable and the UE is expected to detect and send a measurement report. Gap pattern configuration with id #0 as specified in Table 8.1.2.1-1 is configured before T2 begins to enable inter-RAT frequency monitoring.

A RRC message implying handover shall be sent to the UE during period T2, after the UE has reported Event B2. The start of T3 is the instant when the last TTI containing the RRC message implying handover is sent to the UE. The handover message shall contain cell 2 as the target cell.

Table A.5.3.5.1-1: General test parameters for E-UTRAN TDD to HRPD handover test case

| Parameter | | Unit | Value | Comment |
|---|-------------------|------|--|--|
| PDSCH parameters | | | DL Reference Measurement Channel R.0 TDD | As specified in clause A.3.1.1.2 |
| PCFICH/PDCCH/PHICH parameters | | | DL Reference Measurement Channel R.6 TDD | As specified in clause A.3.1.2.2 |
| Initial conditions | Active cell | | Cell 1 | E-UTRAN TDD cell |
| | Neighbouring cell | | Cell 2 | HRPD cell |
| Final condition | Active cell | | Cell 2 | HRPD cell |
| Channel Bandwidth (BW _{channel}) | | MHz | 10 | |
| Gap Pattern Id | | | 0 | As specified in Table 8.1.2.1-1 started before T2 starts |
| E-UTRAN TDD measurement quantity | | | RSRP | |
| Inter-RAT (HRPD) measurement quantity | | | CDMA2000 HRPD Pilot Strength | |
| b2-Threshold1 | | dBm | -90 | Absolute E-UTRAN RSRP threshold for event B2 |
| b2-Threshold2-CDMA2000 | | dB | -7 | Absolute 'CDMA2000 HRPD Pilot Strength' threshold for event B2 |
| Hysteresis | | dB | 0 | |
| TimeToTrigger | | s | 0 | |
| Filter coefficient | | | 0 | L3 filtering is not used |
| DRX | | | OFF | Non-DRX test |
| Access Barring Information | | - | Not sent | No additional delays in random access procedure |
| E-UTRA RF Channel Number | | | 1 | One E-UTRA TDD carrier frequency is used. |
| E-UTRA Channel Bandwidth (BW _{channel}) | | MHz | 10 | |
| Uplink-downlink configuration of cell 1 | | | 1 | As specified in table 4.2.2 in TS 36.211 |
| Special subframe configuration of cell 1 | | | 6 | As specified in table 4.2.1 in TS 36.211 |
| HRPD RF Channel Number | | | 1 | One HRPD carrier frequency is used. |
| HRPD neighbour cell list size | | | 8 | HRPD cells on HRPD RF channel 1 provided in the cell list before T2. |
| cdma2000-SearchWindowSize | | | 8 (60 PN chips) | Search window size as defined in clause 6.3.5 in TS 36.331 |
| T1 | | s | 5 | |
| T2 | | s | ≤10 | |
| T3 | | s | 1 | |

Table A.5.3.5.1-2: Cell specific test parameters for E-UTRAN TDD cell#1 for handover to HRPD cell # 2

| Parameter | Unit | Cell 1 (E-UTRA) |
|-----------|------|-----------------|
|-----------|------|-----------------|

| | | T1 | T2 | T3 |
|---|------------|----------|-----|----------|
| E-UTRA RF Channel number | | 1 | | |
| BW _{channel} | MHz | 10 | | |
| OCNG Patterns defined in TS36.133 A.3.2.2.1 (OP.1 TDD) and in A.3.2.2.2 (OP.2 TDD) | | OP.1 TDD | | OP.2 TDD |
| PBCH_RA | dB | 0 | | |
| PBCH_RB | dB | | | |
| PSS_RA | dB | | | |
| SSS_RA | dB | | | |
| PCFICH_RB | dB | | | |
| PHICH_RA | dB | | | |
| PHICH_RB | dB | | | |
| PDCCH_RA | dB | | | |
| PDCCH_RB | dB | | | |
| PDSCH_RA | dB | | | |
| PDSCH_RB | dB | | | |
| OCNG_RA ^{Note 1} | dB | | | |
| OCNG_RB ^{Note 1} | dB | | | |
| N_{oc} ^{Note 2} | dBm/15 kHz | | | |
| RSRP ^{Note 3} | dBm/15 KHz | -98 | -98 | -98 |
| \hat{E}_s / N_{oc} | dB | 0 | 0 | 0 |
| \hat{E}_s / I_{ot} | dB | 0 | 0 | 0 |
| Propagation Condition | | AWGN | | |
| Note 1: OCNG shall be used such that both cells are fully allocated and a constant total transmitted power spectral density is achieved for all OFDM symbols. Note 2: Interference from other cells and noise sources not specified in the test is assumed to be constant over subcarriers and time and shall be modelled as AWGN of appropriate power for N_{oc} to be fulfilled. Note 3: RSRP levels have been derived from other parameters for information purposes. They are not settable parameters themselves. | | | | |

Table A.5.3.5.1-3: Cell specific test parameters for HRPD (cell # 2) for handover from E-UTRAN TDD cell (cell #1)

| Parameter | Unit | Cell 2 (HRPD) | | |
|---|----------------|---------------|----|----|
| | | T1 | T2 | T3 |
| $\frac{\text{Control } E_b}{N_t}$ (38.4 kbps) | dB | 21 | | |
| $\frac{\text{Control } E_b}{N_t}$ (76.8 kbps) | dB | 18 | | |
| \hat{I}_{or} / I_{oc} | dB | -infinity | 0 | 0 |
| I_{oc} | dBm/1.2288 MHz | -55 | | |
| CDMA2000 HRPD Pilot Strength | dB | -infinity | -3 | -3 |
| Propagation Condition | | AWGN | | |

A.5.3.5.2 Test Requirements

The UE shall start transmission of the reverse control channel in HRPD to Cell 2 less than 127 ms from the beginning of time period T3.

The rate of correct handovers observed during repeated tests shall be at least 90%.

NOTE: The handover delay can be expressed as: RRC procedure delay + $T_{\text{interrupt}}$, where:

RRC procedure delay = 50 ms, which is specified in clause 5.4.1.1.1.

$T_{\text{interrupt}} = 76.66$ ms in the test; $T_{\text{interrupt}}$ is defined in clause 5.4.1.1.2.

This gives a total of 126.66 ms, allow 127 ms in the test.

A.5.3.6 E-UTRAN TDD – cdma2000 1X Handover

A.5.3.6.1 Test Purpose and Environment

This test is to verify the requirement for the E-UTRAN TDD to cdma2000 1X handover requirements specified in clause 5.4.2.

The test parameters are given in Tables A.5.3.6.1-1, A.5.3.6.1-2 and A.5.3.6.1-3. The test consists of three successive time periods, with time durations of T1, T2 and T3 respectively. At the start of time duration T1, the UE does not have any timing information of Cell 2. Starting T2, Cell 2 becomes detectable and the UE is expected to detect and send a measurement report. Gap pattern configuration with id #0 as specified in Table 8.1.2.1-1 is configured before T2 begins to enable inter-RAT frequency monitoring.

A RRC message implying handover shall be sent to the UE during period T2, after the UE has reported Event B2. The start of T3 is the instant when the last TTI containing the RRC message implying handover is sent to the UE. The handover message shall contain cell 2 as the target cell.

Table A.5.3.6.1-1: General test parameters for E-UTRAN TDD to cdma2000 1X handover test case

| Parameter | | Unit | Value | Comment |
|--|-------------------|------|--|--|
| PDSCH parameters | | | DL Reference Measurement Channel R.0 TDD | As specified in clause A.3.1.1.2 |
| PCFICH/PDCCH/PHICH parameters | | | DL Reference Measurement Channel R.6 TDD | As specified in clause A.3.1.2.2 |
| Initial conditions | Active cell | | Cell 1 | E-UTRAN TDD cell |
| | Neighbouring cell | | Cell 2 | cdma2000 1X cell |
| Final condition | Active cell | | Cell 2 | cdma2000 1X cell |
| Channel Bandwidth (BW_{channel}) | | MHz | 10 | |
| Gap Pattern Id | | | 0 | As specified in Table 8.1.2.1-1 started before T2 starts |
| E-UTRAN TDD measurement quantity | | | RSRP | |
| Inter-RAT (cdma2000 1X) measurement quantity | | | CDMA2000 1xRTT Pilot Strength | |
| b2-Threshold1 | | dBm | -90 | Absolute E-UTRAN RSRP threshold for event B2 |
| b2-Threshold2-CDMA2000 | | dB | -14 | Absolute 'CDMA2000 1xRTT Pilot Strength' threshold for event B2 |
| Hysteresis | | dB | 0 | |
| TimeToTrigger | | S | 0 | |
| Filter coefficient | | | 0 | L3 filtering is not used |
| DRX | | | OFF | Non-DRX test |
| Access Barring Information | | - | Not sent | No additional delays in random access procedure |
| E-UTRA RF Channel Number | | | 1 | One E-UTRA TDD carrier frequency is used. |
| E-UTRA Channel Bandwidth (BW_{channel}) | | MHz | 10 | |
| cdma2000 1X RF Channel Number | | | 1 | One cdma2000 1X carrier frequency is used. |
| cdma2000 1X neighbour cell list size | | | 8 | cdma2000 1X cells on cdma2000 1X RF channel 1 provided in the cell list before T2. |
| cdma2000-SearchWindowSize | | | 8 (60 PN chips) | Search window size as defined in clause 6.3.5 in TS 36.331 |
| T1 | | S | 5 | |
| T2 | | S | ≤ 10 | |
| T3 | | S | 1 | |

Table A.5.3.6.1-2: Cell specific test parameters for E-UTRAN TDD cell#1 for handover to cdma2000 1X cell # 2

| Parameter | Unit | Cell 1 (E-UTRA) | | |
|---|------------|-----------------|-----|----------|
| | | T1 | T2 | T3 |
| E-UTRA RF Channel number | | 1 | | |
| $BW_{channel}$ | MHz | 10 | | |
| OCNG Patterns defined in A.3.2.2.1 (OP.1 TDD) and in A.3.2.2.2 (OP.2 TDD) | | OP.1 TDD | | OP.2 TDD |
| PBCH_RA | dB | 0 | | |
| PBCH_RB | dB | | | |
| PSS_RA | dB | | | |
| SSS_RA | dB | | | |
| PCFICH_RB | dB | | | |
| PHICH_RA | dB | | | |
| PHICH_RB | dB | | | |
| PDCCH_RA | dB | | | |
| PDCCH_RB | dB | | | |
| PDSCH_RA | dB | | | |
| PDSCH_RB | dB | | | |
| OCNG_RA ^{Note 1} | dB | | | |
| OCNG_RB ^{Note 1} | dB | | | |
| N_{oc} ^{Note 2} | dBm/15 kHz | | | |
| RSRP ^{Note 3} | dBm/15 KHz | -98 | -98 | -98 |
| \hat{E}_s / N_{oc} | dB | 0 | 0 | 0 |
| \hat{E}_s / I_{ot} | dB | 0 | 0 | 0 |
| Propagation Condition | | AWGN | | |
| Note 1: OCNG shall be used such that both cells are fully allocated and a constant total transmitted power spectral density is achieved for all OFDM symbols. Note 2: Interference from other cells and noise sources not specified in the test is assumed to be constant over subcarriers and time and shall be modelled as AWGN of appropriate power for N_{oc} to be fulfilled. Note 3: RSRP levels have been derived from other parameters for information purposes. They are not settable parameters themselves. | | | | |

Table A.5.3.6.1-3: Cell specific test parameters for cdma2000 1X (cell # 2) for handover from E-UTRAN TDD cell (cell #1)

| Parameter | Unit | Cell 2 (cdma2000 1X) | | |
|--|----------------|----------------------|-----|-----|
| | | T1 | T2 | T3 |
| $\frac{Pilot E_c}{I_{or}}$ | dB | -7 | | |
| $\frac{Sync E_c}{I_{or}}$ | dB | -16 | | |
| $\frac{Paging E_c}{I_{or}}$ (4.8 kbps) | dB | -12 | | |
| \hat{I}_{or} / I_{oc} | dB | -infinity | 0 | 0 |
| I_{oc} | dBm/1.2288 MHz | -55 | | |
| CDMA2000 1xRTT Pilot Strength | dB | -infinity | -10 | -10 |
| Propagation Condition | | AWGN | | |

A.5.3.6.2 Test Requirements

The UE shall start transmission of the reverse control channel in cdma2000 1X to Cell 2 less than 300 ms from the beginning of time period T3.

NOTE: The handover delay can be expressed as: RRC procedure delay + $T_{\text{interrupt}}$, where:

RRC procedure delay = 130 ms, which is specified in clause 5.4.2.1.1.

$T_{\text{interrupt}}$ = 170 ms in the test; $T_{\text{interrupt}}$ is defined in clause 5.4.2.1.2.

This gives a total of 300 ms.

A.6 RRC Connection Control

A.6.1 RRC Re-establishment

A.6.1.1 E-UTRAN FDD Intra-frequency RRC Re-establishment

A.6.1.1.1 Test Purpose and Environment

The purpose is to verify that the E-UTRA FDD intra-frequency RRC re-establishment delay is within the specified limits. These tests will verify the requirements in clause 6.1.2.

The test parameters are given in table A.6.1.1.1-1 and table A.6.1.1.2 below. The test consists of 3 successive time periods, with time duration of T1, T2 and T3 respectively. At the start of time period T2, cell 1, which is the active cell, is deactivated. The time period T3 starts after the occurrence of the radio link failure.

Table A.6.1.1.1-1: General test parameters for E-UTRAN FDD intra-frequency RRC Re-establishment test case

| Parameter | | Unit | Value | Comment |
|---|-------------------|------|--|---|
| PDSCH parameters | | | DL Reference Measurement Channel R.0 FDD | As specified in clause A.3.1.1.1 |
| PCFICH/PDCCH/PHICH parameters | | | DL Reference Measurement Channel R.6 FDD | As specified in clause A.3.1.2.1 |
| Initial conditions | Active cell | | Cell 1 | |
| | Neighbouring cell | | Cell 2 | |
| Final condition | Active cell | | Cell 2 | |
| E-UTRA RF Channel Number | | | 1 | Only one FDD carrier frequency is used. |
| Channel Bandwidth (BW_{channel}) | | MHz | 10 | |
| N310 | | - | 1 | Maximum consecutive out-of-sync indications from lower layers |
| N311 | | - | 1 | Minimum consecutive in-sync indications from lower layers |
| T310 | | ms | 0 | Radio link failure timer; T310 is disabled |
| T311 | | ms | 3000 | RRC re-establishment timer |
| DRX | | | OFF | |
| CP length | | | Normal | |
| Access Barring Information | | - | Not Sent | No additional delays in random access procedure. |
| PRACH configuration index | | | 4 | As specified in table 5.7.1-2 in TS 36.211 |
| Time offset between cells | | ms | 3 | Asynchronous cells |
| T1 | | s | 5 | |
| T2 | | ms | 200 | |
| T3 | | s | 3 | |

Table A.6.1.1.1-2: Cell specific test parameters for E-UTRAN FDD intra-frequency RRC Re-establishment test case

| Parameter | Unit | Cell 1 | | | Cell 2 | | |
|---|------------|----------|-----------|-----------|----------|----------|----------|
| | | T1 | T2 | T3 | T1 | T2 | T3 |
| E-UTRA RF Channel Number | | 1 | | | 1 | | |
| BW _{channel} | MHz | 10 | | | 10 | | |
| OCNG Patterns defined in A.3.2.1.1 (OP.1 FDD) and in A.3.2.1.2 (OP.2 FDD) | | OP.1 FDD | OP.1 FDD | OP.2 FDD | OP.2 FDD | OP.2 FDD | OP.1 FDD |
| PBCH_RA | dB | 0 | | | 0 | | |
| PBCH_RB | dB | | | | | | |
| PSS_RA | dB | | | | | | |
| SSS_RA | dB | | | | | | |
| PCFICH_RB | dB | | | | | | |
| PHICH_RA | dB | | | | | | |
| PHICH_RB | dB | | | | | | |
| PDCCH_RA | dB | | | | | | |
| PDCCH_RB | dB | | | | | | |
| PDSCH_RA | dB | | | | | | |
| PDSCH_RB | dB | | | | | | |
| OCNG_RA ^{Note 1} | dB | | | | | | |
| OCNG_RB ^{Note 1} | dB | | | | | | |
| \hat{E}_s/I_{ot} | dB | | | | | | |
| N_{oc} ^{Note 2} | dBm/15 KHz | -98 | | | | | |
| \hat{E}_s/N_{oc} | dB | 7 | -Infinity | -Infinity | 4 | 4 | 4 |
| RSRP ^{Note 3} | dBm/15 KHz | -91 | -Infinity | -Infinity | -94 | -94 | -94 |
| Propagation Condition | | AWGN | | | | | |
| <p>Note 1: OCNG shall be used such that both cells are fully allocated and a constant total transmitted power spectral density is achieved for all OFDM symbols.</p> <p>Note 2: Interference from other cells and noise sources not specified in the test is assumed to be constant over subcarriers and time and shall be modelled as AWGN of appropriate power for N_{oc} to be fulfilled.</p> <p>Note 3: RSRP levels have been derived from other parameters for information purposes. They are not settable parameters themselves.</p> | | | | | | | |

A.6.1.1.2 Test Requirements

The RRC re-establishment delay is defined as the time from the start of time period T3, to the moment when the UE starts to send PRACH preambles to cell 2 for sending the *RRCConnectionReestablishmentRequest* message to cell 2.

The RRC re-establishment delay to a known E-UTRA FDD intra frequency cell shall be less than 1.5 s.

The rate of correct RRC re-establishments observed during repeated tests shall be at least 90%.

NOTE: The RRC re-establishment delay in the test is derived from the following expression:

$$T_{\text{re-establish_delay}} = T_{\text{UL_grant}} + T_{\text{UE_re-establish_delay}}$$

Where:

$T_{\text{UL_grant}}$ = It is the time required to acquire and process uplink grant from the target cell. The PRACH reception at the system simulator is used as a trigger for the completion of the test; hence $T_{\text{UL_grant}}$ is not used.

$$T_{\text{UE_re-establish_delay}} = 50 \text{ ms} + N_{\text{freq}} * T_{\text{search}} + T_{\text{SI}} + T_{\text{PRACH}}$$

$$N_{\text{freq}} = 1$$

$$T_{\text{search}} = 100 \text{ ms}$$

$T_{SI} = 1280$ ms; it is the time required for receiving all the relevant system information as defined in TS 36.331 for the target E-UTRAN FDD cell.

$T_{PRACH} = 15$ ms; it is the additional delay caused by the random access procedure.

This gives a total of 1445 ms, allow 1.5 s in the test case.

A.6.1.2 E-UTRAN FDD Inter-frequency RRC Re-establishment

A.6.1.2.1 Test Purpose and Environment

The purpose is to verify that the E-UTRA FDD inter-frequency RRC re-establishment delay is within the specified limits. These tests will verify the requirements in clause 6.1.2.

The test parameters are given in table A.6.1.1.2-1 and table A.6.1.1.2-2 below. The test consists of 3 successive time periods, with time duration of T1, T2 and T3 respectively. At the start of time period T2, cell 1, which is the active cell, is deactivated. The time period T3 starts after the occurrence of radio link failure. At the start of time period T3, cell 2, which is the neighbour cell, is activated.

Table A.6.1.2.1-1: General test parameters for E-UTRAN FDD inter-frequency RRC Re-establishment test case

| Parameter | | Unit | Value | Comment |
|--|-------------------|------|--|--|
| PDSCH parameters | | | DL Reference Measurement Channel R.0 FDD | As specified in clause A.3.1.1.1 |
| PCFICH/PDCCH/PHICH parameters | | | DL Reference Measurement Channel R.6 FDD | As specified in clause A.3.1.2.1 |
| Initial conditions | Active cell | | Cell 1 | |
| | Neighbouring cell | | Cell 2 | |
| Final condition | Active cell | | Cell 2 | |
| E-UTRA RF Channel Number (cell 1) | | | 1 | |
| E-UTRA RF Channel Number (cell 2) | | | 2 | |
| E-UTRA FDD inter-frequency carrier list size | | | 1 | 2 E-UTRA FDD carrier frequencies in total: 1 intra-frequency and 1 inter-frequency |
| Channel Bandwidth ($BW_{channel}$) | | MHz | 10 | |
| N310 | | - | 1 | Maximum consecutive out-of-sync indications from lower layers |
| N311 | | - | 1 | Minimum consecutive in-sync indications from lower layers |
| T310 | | ms | 0 | Radio link failure timer; T310 is disabled |
| T311 | | ms | 5000 | RRC re-establishment timer |
| DRX | | | OFF | |
| CP length | | | Normal | |
| Access Barring Information | | - | Not Sent | No additional delays in random access procedure. |
| PRACH configuration index | | | 4 | As specified in table 5.7.1-2 in TS 36.211 |
| Time offset between cells | | ms | 3 | Asynchronous cells |
| T1 | | s | 5 | |
| T2 | | ms | 200 | |
| T3 | | s | 5 | |

Table A.6.1.2.1-2: Cell specific test parameters for E-UTRAN FDD inter-frequency RRC Re-establishment test case

| Parameter | Unit | Cell 1 | | | Cell 2 | | |
|--------------------------|------|--------|----|----|--------|----|----|
| | | T1 | T2 | T3 | T1 | T2 | T3 |
| E-UTRA RF Channel Number | | 1 | | | 2 | | |
| $BW_{channel}$ | MHz | 10 | | | 10 | | |

| OCNG Patterns defined in A.3.2.1.1 (OP.1 FDD) and in A.3.2.1.2 (OP.2 FDD) | | OP.1 FDD | OP.1 FDD | OP.2 FDD | OP.2 FDD | OP.2 FDD | OP.1 FDD |
|---|------------|----------|-----------|-----------|-----------|-----------|----------|
| PBCH_RA | dB | 0 | | | 0 | | |
| PBCH_RB | dB | | | | | | |
| PSS_RA | dB | | | | | | |
| SSS_RA | dB | | | | | | |
| PCFICH_RB | dB | | | | | | |
| PHICH_RA | dB | | | | | | |
| PHICH_RB | dB | | | | | | |
| PDCCH_RA | dB | | | | | | |
| PDCCH_RB | dB | | | | | | |
| PDSCH_RA | dB | | | | | | |
| PDSCH_RB | dB | | | | | | |
| OCNG_RA ^{Note 1} | dB | | | | | | |
| OCNG_RB ^{Note 1} | dB | | | | | | |
| \hat{E}_s / I_{ot} | dB | 4 | -Infinity | -Infinity | -Infinity | -Infinity | 7 |
| N_{oc} ^{Note 2} | dBm/15 KHz | -98 | | | | | |
| \hat{E}_s / N_{oc} | dB | 4 | -Infinity | -Infinity | -Infinity | -Infinity | 7 |
| RSRP ^{Note 3} | dBm/15 KHz | -94 | -Infinity | -Infinity | -Infinity | -Infinity | -91 |
| Propagation Condition | | AWGN | | | | | |
| <p>Note 1: OCNG shall be used such that both cells are fully allocated and a constant total transmitted power spectral density is achieved for all OFDM symbols.</p> <p>Note 2: Interference from other cells and noise sources not specified in the test is assumed to be constant over subcarriers and time and shall be modelled as AWGN of appropriate power for N_{oc} to be fulfilled.</p> <p>Note 3: RSRP levels have been derived from other parameters for information purposes. They are not settable parameters themselves.</p> | | | | | | | |

A.6.1.2.2 Test Requirements

The RRC re-establishment delay is defined as the time from the start of time period T3, to the moment when the UE starts to send PRACH preambles to cell 2 for sending the *RRCConnectionReestablishmentRequest* message to cell 2.

The RRC re-establishment delay to an unknown E-UTRA FDD inter frequency cell shall be less than 3 s.

The rate of correct RRC re-establishments observed during repeated tests shall be at least 90%.

NOTE: The RRC re-establishment delay in the test is derived from the following expression:

$$T_{\text{re-establish_delay}} = T_{\text{UL_grant}} + T_{\text{UE_re-establish_delay}}$$

Where:

$T_{\text{UL_grant}}$ = It is the time required to acquire and process uplink grant from the target cell. The PRACH reception at the system simulator is used as a trigger for the completion of the test; hence $T_{\text{UL_grant}}$ is not used.

$$T_{\text{UE_re-establish_delay}} = 50 \text{ ms} + N_{\text{freq}} * T_{\text{search}} + T_{\text{SI}} + T_{\text{PRACH}}$$

$$N_{\text{freq}} = 2$$

$$T_{\text{search}} = 800 \text{ ms}$$

$T_{\text{SI}} = 1280 \text{ ms}$; it is the time required for receiving all the relevant system information as defined in TS 36.331 for the target E-UTRAN FDD cell.

$T_{\text{PRACH}} = 15 \text{ ms}$; it is the additional delay caused by the random access procedure.

This gives a total of 2945 ms, allow 3 s in the test case.

A.6.1.3 E-UTRAN TDD Intra-frequency RRC Re-establishment

A.6.1.3.1 Test Purpose and Environment

The purpose is to verify that the E-UTRA TDD intra-frequency RRC re-establishment delay is within the specified limits. These tests will verify the requirements in clause 6.1.2.

The test parameters are given in table A.6.1.3.1-1 and table A.6.1.3.1-2 below. The test consists of 3 successive time periods, with time duration of T1, T2 and T3 respectively. At the start of time period T2, cell 1, which is the active cell, is deactivated. The time period T3 starts after the occurrence of the radio link failure.

Table A.6.1.3.1-1: General test parameters for E-UTRAN TDD intra-frequency RRC Re-establishment test case

| Parameter | | Unit | Value | Comment |
|---|-------------------|---------------|--|---|
| PDSCH parameters | | | DL Reference Measurement Channel R.0 TDD | As specified in clause A.3.1.1.2 |
| PCFICH/PDCCH/PHICH parameters | | | DL Reference Measurement Channel R.6 TDD | As specified in clause A.3.1.2.2 |
| Initial conditions | Active cell | | Cell 1 | |
| | Neighbouring cell | | Cell 2 | |
| Final condition | Active cell | | Cell 2 | |
| E-UTRA RF Channel Number | | | 1 | Only one TDD carrier frequency is used. |
| Channel Bandwidth (BW_{channel}) | | MHz | 10 | |
| N310 | | - | 1 | Maximum consecutive out-of-sync indications from lower layers |
| N311 | | - | 1 | Minimum consecutive in-sync indications from lower layers |
| T310 | | ms | 0 | Radio link failure timer; T310 is disabled |
| T311 | | ms | 3000 | RRC re-establishment timer |
| DRX | | | OFF | |
| CP length | | | Normal | |
| Access Barring Information | | - | Not Sent | No additional delays in random access procedure. |
| Special subframe configuration | | | 6 | As specified in table 4.2-1 in TS 36.211 |
| Uplink-downlink configuration | | | 1 | As specified in table 4.2-2 in TS 36.211 |
| PRACH configuration index | | | 53 | As specified in table 5.7.1-3 in TS 36.211 |
| Time offset between cells | | μs | 3 | Synchronous cells |
| T1 | | s | 5 | |
| T2 | | ms | 200 | |
| T3 | | s | 3 | |

Table A.6.1.3.1-2: Cell specific test parameters for E-UTRAN TDD intra-frequency RRC Re-establishment test case

| Parameter | Unit | Cell 1 | | | Cell 2 | | |
|---|------|----------|----------|----------|----------|----------|----------|
| | | T1 | T2 | T3 | T1 | T2 | T3 |
| E-UTRA RF Channel Number | | 1 | | | 1 | | |
| BW_{channel} | MHz | 10 | | | 10 | | |
| OCNG Patterns defined in A.3.2.2.1 (OP.1 TDD) and in A.3.2.2.2 (OP.2 TDD) | | OP.1 TDD | OP.1 TDD | OP.2 TDD | OP.2 TDD | OP.2 TDD | OP.1 TDD |
| PBCH_RA | dB | | | | | | |
| PBCH_RB | dB | | | | | | |
| PSS_RA | dB | | | | | | |
| SSS_RA | dB | | | | | | |
| PCFICH_RB | dB | | | | | | |

| | | | | | | | |
|---|------------|------|-----------|-----------|-------|-----|-----|
| PHICH_RA | dB | 0 | | | 0 | | |
| PHICH_RB | dB | | | | | | |
| PDCCH_RA | dB | | | | | | |
| PDCCH_RB | dB | | | | | | |
| PDSCH_RA | dB | | | | | | |
| PDSCH_RB | dB | | | | | | |
| OCNG_RA ^{Note 1} | dB | | | | | | |
| OCNG_RB ^{Note 1} | dB | | | | | | |
| \hat{E}_s/I_{ot} | dB | 1.54 | -Infinity | -Infinity | -3.79 | 4 | 4 |
| N_{oc} ^{Note 2} | dBm/15 KHz | -98 | | | | | |
| \hat{E}_s/N_{oc} | dB | 7 | -Infinity | -Infinity | 4 | 4 | 4 |
| RSRP ^{Note 3} | dBm/15 KHz | -91 | -Infinity | -Infinity | -94 | -94 | -94 |
| Propagation Condition | | AWGN | | | | | |
| <p>Note 1: OCNG shall be used such that both cells are fully allocated and a constant total transmitted power spectral density is achieved for all OFDM symbols.</p> <p>Note 2: Interference from other cells and noise sources not specified in the test is assumed to be constant over subcarriers and time and shall be modelled as AWGN of appropriate power for N_{oc} to be fulfilled.</p> <p>Note 3: RSRP levels have been derived from other parameters for information purposes. They are not settable parameters themselves.</p> | | | | | | | |

A.6.1.3.2 Test Requirements

The RRC re-establishment delay is defined as the time from the start of time period T3, to the moment when the UE starts to send PRACH preambles to cell 2 for sending the *RRCConnectionReestablishmentRequest* message to cell 2.

The RRC re-establishment delay to a known E-UTRA TDD intra frequency cell shall be less than 1.5 s.

The rate of correct RRC re-establishments observed during repeated tests shall be at least 90%.

NOTE: The RRC re-establishment delay in the test is derived from the following expression:

$$T_{\text{re-establish_delay}} = T_{\text{UL_grant}} + T_{\text{UE_re-establish_delay}}$$

Where:

$T_{\text{UL_grant}}$ = It is the time required to acquire and process uplink grant from the target cell. The PRACH reception at the system simulator is used as a trigger for the completion of the test; hence $T_{\text{UL_grant}}$ is not used.

$$T_{\text{UE_re-establish_delay}} = 50 \text{ ms} + N_{\text{freq}} * T_{\text{search}} + T_{\text{SI}} + T_{\text{PRACH}}$$

$$N_{\text{freq}} = 1$$

$$T_{\text{search}} = 100 \text{ ms}$$

$T_{\text{SI}} = 1280 \text{ ms}$; it is the time required for receiving all the relevant system information as defined in TS 36.331 for the target E-UTRAN TDD cell.

$T_{\text{PRACH}} = 15 \text{ ms}$; it is the additional delay caused by the random access procedure.

This gives a total of 1445 ms, allow 1.5 s in the test case.

A.6.1.4 E-UTRAN TDD Inter-frequency RRC Re-establishment

A.6.1.4.1 Test Purpose and Environment

The purpose is to verify that the E-UTRA TDD inter-frequency RRC re-establishment delay is within the specified limits. These tests will verify the requirements in clause 6.1.2.

The test parameters are given in table A.6.1.4.1-1 and table A.6.1.4.1-2 below. The test consists of 3 successive time periods, with time duration of T1, T2 and T3 respectively. At the start of time period T2, cell 1, which is the active cell,

is deactivated. The time period T3 starts after the occurrence of radio link failure. At the start of time period T3, cell 2, which is the neighbour cell, is activated.

Table A.6.1.4.1-1: General test parameters for E-UTRAN TDD inter-frequency RRC Re-establishment test case

| Parameter | | Unit | Value | Comment |
|--|-------------------|---------|--|--|
| PDSCH parameters | | | DL Reference Measurement Channel R.0 TDD | As specified in clause A.3.1.1.2 |
| PCFICH/PDCCH/PHICH parameters | | | DL Reference Measurement Channel R.6 TDD | As specified in clause A.3.1.2.2 |
| Initial conditions | Active cell | | Cell 1 | |
| | Neighbouring cell | | Cell 2 | |
| Final condition | Active cell | | Cell 2 | |
| E-UTRA RF Channel Number (cell 1) | | | 1 | |
| E-UTRA RF Channel Number (cell 2) | | | 2 | |
| E-UTRA TDD inter-frequency carrier list size | | | 1 | 2 E-UTRA TDD carrier frequencies in total: 1 intra-frequency and 1 inter-frequency |
| Channel Bandwidth ($BW_{channel}$) | | MHz | 10 | |
| N310 | | - | 1 | Maximum consecutive out-of-sync indications from lower layers |
| N311 | | - | 1 | Minimum consecutive in-sync indications from lower layers |
| T310 | | ms | 0 | Radio link failure timer; T310 is disabled |
| T311 | | ms | 5000 | RRC re-establishment timer |
| DRX | | | OFF | |
| CP length | | | Normal | |
| Access Barring Information | | - | Not Sent | No additional delays in random access procedure. |
| Special subframe configuration | | | 6 | As specified in table 4.2-1 in TS 36.211 |
| Uplink-downlink configuration | | | 1 | As specified in table 4.2-2 in TS 36.211 |
| PRACH configuration index | | | 53 | As specified in table 5.7.1-3 in TS 36.211 |
| Time offset between cells | | μ s | 3 | Synchronous cells |
| T1 | | s | 5 | |
| T2 | | ms | 200 | |
| T3 | | s | 5 | |

Table A.6.1.4.1-2: Cell specific test parameters for E-UTRAN TDD inter-frequency RRC Re-establishment test case

| Parameter | Unit | Cell 1 | | | Cell 2 | | |
|---|------|----------|----------|----------|----------|----------|----------|
| | | T1 | T2 | T3 | T1 | T2 | T3 |
| E-UTRA RF Channel Number | | 1 | | | 2 | | |
| $BW_{channel}$ | MHz | 10 | | | 10 | | |
| OCNG Patterns defined in A.3.2.2.1 (OP.1 TDD) and in A.3.2.2.2 (OP.2 TDD) | | OP.1 TDD | OP.1 TDD | OP.2 TDD | OP.2 TDD | OP.2 TDD | OP.1 TDD |
| PBCH_RA | dB | 0 | | | 0 | | |
| PBCH_RB | dB | | | | | | |
| PSS_RA | dB | | | | | | |
| SSS_RA | dB | | | | | | |
| PCFICH_RB | dB | | | | | | |
| PHICH_RA | dB | | | | | | |
| PHICH_RB | dB | | | | | | |
| PDCCH_RA | dB | | | | | | |
| PDCCH_RB | dB | | | | | | |
| PDSCH_RA | dB | | | | | | |
| PDSCH_RB | dB | | | | | | |

| | | | | | | | |
|---|------------|-----|-----------|-----------|-----------|-----------|-----|
| OCNG_RA ^{Note 1} | dB | | | | | | |
| OCNG_RB ^{Note 1} | dB | | | | | | |
| \hat{E}_s / I_{ot} | dB | 4 | -Infinity | -Infinity | -Infinity | -Infinity | 7 |
| N_{oc} ^{Note 2} | dBm/15 KHz | -98 | | | | | |
| \hat{E}_s / N_{oc} | dB | 4 | -Infinity | -Infinity | -Infinity | -Infinity | 7 |
| RSRP ^{Note 3} | dBm/15 KHz | -94 | -Infinity | -Infinity | -Infinity | -Infinity | -91 |
| Propagation Condition | AWGN | | | | | | |
| <p>Note 1: OCNG shall be used such that both cells are fully allocated and a constant total transmitted power spectral density is achieved for all OFDM symbols.</p> <p>Note 2: Interference from other cells and noise sources not specified in the test is assumed to be constant over subcarriers and time and shall be modelled as AWGN of appropriate power for N_{oc} to be fulfilled.</p> <p>Note 3: RSRP levels have been derived from other parameters for information purposes. They are not settable parameters themselves.</p> | | | | | | | |

A.6.1.4.2 Test Requirements

The RRC re-establishment delay is defined as the time from the start of time period T3, to the moment when the UE starts to send PRACH preambles to cell 2 for sending the *RRCConnectionReestablishmentRequest* message to cell 2.

The RRC re-establishment delay to an unknown E-UTRA TDD inter frequency cell shall be less than 3 s.

The rate of correct RRC re-establishments observed during repeated tests shall be at least 90%.

NOTE: The RRC re-establishment delay in the test is derived from the following expression:

$$T_{\text{re-establish_delay}} = T_{\text{UL_grant}} + T_{\text{UE_re-establish_delay}}$$

Where:

$T_{\text{UL_grant}}$ = It is the time required to acquire and process uplink grant from the target cell. The PRACH reception at the system simulator is used as a trigger for the completion of the test; hence $T_{\text{UL_grant}}$ is not used.

$$T_{\text{UE_re-establish_delay}} = 50 \text{ ms} + N_{\text{freq}} * T_{\text{search}} + T_{\text{SI}} + T_{\text{PRACH}}$$

$$N_{\text{freq}} = 2$$

$$T_{\text{search}} = 800 \text{ ms}$$

$T_{\text{SI}} = 1280 \text{ ms}$; it is the time required for receiving all the relevant system information as defined in TS 36.331 for the target E-UTRAN TDD cell.

$T_{\text{PRACH}} = 15 \text{ ms}$; it is the additional delay caused by the random access procedure.

This gives a total of 2945 ms, allow 3 s in the test case.

A.6.1.5 E-UTRAN FDD Intra-frequency RRC Re-establishment for 5MHz bandwidth

A.6.1.5.1 Test Purpose and Environment

The purpose of this test case is the same as for the test defined in subclause A.6.1.1.1.

The parameters of this test are the same as defined in Subclause A.6.1.1.1 except that the values of the parameters in the Table A.6.1.5.1-1 will replace the values of the corresponding parameters in A.6.1.1.1-1, and the values of the parameters in the Table A.6.1.5.1-2 will replace the values of the corresponding parameters in A.6.1.1.1-2.

Table A.6.1.5.1-1: General test parameters for E-UTRAN FDD intra-frequency RRC Re-establishment test case for 5MHz bandwidth

| Parameter | Unit | Value | Comment |
|---|------|---|----------------------------------|
| PDSCH parameters | | DL Reference Measurement Channel R.5 FDD | As specified in clause A.3.1.1.1 |
| PCFICH/PDCCH/PHICH parameters | | DL Reference Measurement Channel R.11 FDD | As specified in clause A.3.1.2.1 |
| Channel Bandwidth ($BW_{channel}$) | MHz | 5 | |
| Note 1: See Table A.6.1.1.1-1 for the other parameters. | | | |
| Note 2: This test is according to the principle defined in section A.3.7.2. | | | |

Table A.6.1.5.1-2: Cell specific test parameters for E-UTRAN FDD intra-frequency RRC Re-establishment test case for 5MHz bandwidth

| Parameter | Unit | Cell 1 | | | Cell 2 | | |
|---|------|-----------|-----------|-----------|-----------|-----------|-----------|
| | | T1 | T2 | T3 | T1 | T2 | T3 |
| $BW_{channel}$ | MHz | 5 | | | 5 | | |
| OCNG Patterns defined in A.3.2.1.15 (OP.15 FDD) and A.3.2.1.16 (OP.16 FDD) | | OP.15 FDD | OP.15 FDD | OP.16 FDD | OP.16 FDD | OP.16 FDD | OP.15 FDD |
| Note 1: OCNG shall be used such that both cells are fully allocated and a constant total transmitted power spectral density is achieved for all OFDM symbols. | | | | | | | |
| Note 2: See Table A.6.1.5.1-2 for the other parameters. | | | | | | | |

A.6.1.5.2 Test Requirements

The test requirements defined in section A.6.1.1.2 shall apply to this test case.

A.6.1.6 E-UTRAN FD-FDD Intra-frequency RRC Re-establishment for UE category 0

A.6.1.6.1 Test Purpose and Environment

The purpose is to verify that the E-UTRA FDD intra-frequency RRC re-establishment delay is within the specified limits. These tests will verify the requirements in clause 6.1.2.

The test parameters are given in table A.6.1.6.1-1 and table A.6.1.6.1-2 below. The test consists of 3 successive time periods, with time duration of T1, T2 and T3 respectively. At the start of time period T2, cell 1, which is the active cell, is deactivated. The time period T3 starts after the occurrence of the radio link failure.

Table A.6.1.6.1-1: General test parameters for E-UTRAN FDD intra-frequency RRC Re-establishment test case

| Parameter | Unit | Value | Comment |
|--------------------------------------|-------------------|---|---|
| PDSCH parameters | | DL Reference Measurement Channel R.13 FDD | As specified in clause A.3.1.1.3 |
| PCFICH/PDCCH/PHICH parameters | | DL Reference Measurement Channel R.6 FDD | As specified in clause A.3.1.2.1 |
| Initial conditions | Active cell | Cell 1 | |
| | Neighbouring cell | Cell 2 | |
| Final condition | Active cell | Cell 2 | |
| E-UTRA RF Channel Number | | 1 | Only one FDD carrier frequency is used. |
| Channel Bandwidth ($BW_{channel}$) | MHz | 10 | |
| N310 | - | 1 | Maximum consecutive out-of-sync indications from lower layers |
| N311 | - | 1 | Minimum consecutive in-sync indications from lower layers |

| | | | |
|----------------------------|----|----------|--|
| T310 | ms | 0 | Radio link failure timer; T310 is disabled |
| T311 | ms | 3000 | RRC re-establishment timer |
| DRX | | OFF | |
| CP length | | Normal | |
| Access Barring Information | - | Not Sent | No additional delays in random access procedure. |
| PRACH configuration index | | 4 | As specified in table 5.7.1-2 in TS 36.211 |
| Time offset between cells | ms | 3 | Asynchronous cells |
| T1 | s | 5 | |
| T2 | ms | 200 | |
| T3 | s | 3 | |

Table A.6.1.6.1-2: Cell specific test parameters for E-UTRAN FDD intra-frequency RRC Re-establishment test case

| Parameter | Unit | Cell 1 | | | Cell 2 | | |
|---|------------|----------|-----------|-----------|----------|----------|----------|
| | | T1 | T2 | T3 | T1 | T2 | T3 |
| E-UTRA RF Channel Number | | 1 | | | 1 | | |
| $BW_{channel}$ | MHz | 10 | | | 10 | | |
| OCNG Patterns defined in A.3.2.1.1 (OP.1 FDD) and in A.3.2.1.2 (OP.2 FDD) | | OP.1 FDD | OP.1 FDD | OP.2 FDD | OP.2 FDD | OP.2 FDD | OP.1 FDD |
| PBCH_RA | dB | 0 | | | 0 | | |
| PBCH_RB | dB | | | | | | |
| PSS_RA | dB | | | | | | |
| SSS_RA | dB | | | | | | |
| PCFICH_RB | dB | | | | | | |
| PHICH_RA | dB | | | | | | |
| PHICH_RB | dB | | | | | | |
| PDCCH_RA | dB | | | | | | |
| PDCCH_RB | dB | | | | | | |
| PDSCH_RA | dB | | | | | | |
| PDSCH_RB | dB | | | | | | |
| OCNG_RA ^{Note 1} | dB | | | | | | |
| OCNG_RB ^{Note 1} | dB | | | | | | |
| \hat{E}_s / I_{ot} | dB | | | | | | |
| N_{oc} ^{Note 2} | dBm/15 KHz | -98 | | | | | |
| \hat{E}_s / N_{oc} | dB | 7 | -Infinity | -Infinity | 4 | 4 | 4 |
| RSRP ^{Note 3} | dBm/15 KHz | -91 | -Infinity | -Infinity | -94 | -94 | -94 |
| Propagation Condition | | AWGN | | | | | |
| <p>Note 1: OCNG shall be used such that both cells are fully allocated and a constant total transmitted power spectral density is achieved for all OFDM symbols.</p> <p>Note 2: Interference from other cells and noise sources not specified in the test is assumed to be constant over subcarriers and time and shall be modelled as AWGN of appropriate power for N_{oc} to be fulfilled.</p> <p>Note 3: RSRP levels have been derived from other parameters for information purposes. They are not settable parameters themselves.</p> | | | | | | | |

A.6.1.6.2 Test Requirements

The RRC re-establishment delay is defined as the time from the start of time period T3, to the moment when the UE starts to send PRACH preambles to cell 2 for sending the *RRCConnectionReestablishmentRequest* message to cell 2.

The RRC re-establishment delay to a known E-UTRA FDD intra frequency cell shall be less than 1.5 s.

The rate of correct RRC re-establishments observed during repeated tests shall be at least 90%.

NOTE: The RRC re-establishment delay in the test is derived from the following expression:

$$T_{\text{re-establish_delay}} = T_{\text{UL_grant}} + T_{\text{UE_re-establish_delay}}$$

Where:

$T_{\text{UL_grant}}$ = It is the time required to acquire and process uplink grant from the target cell. The PRACH reception at the system simulator is used as a trigger for the completion of the test; hence $T_{\text{UL_grant}}$ is not used.

$$T_{\text{UE_re-establish_delay}} = 50 \text{ ms} + N_{\text{freq}} * T_{\text{search}} + T_{\text{SI}} + T_{\text{PRACH}}$$

$$N_{\text{freq}} = 1$$

$$T_{\text{search}} = 100 \text{ ms}$$

$T_{\text{SI}} = 1280 \text{ ms}$; it is the time required for receiving all the relevant system information as defined in TS 36.331 for the target E-UTRAN FDD cell.

$T_{\text{PRACH}} = 15 \text{ ms}$; it is the additional delay caused by the random access procedure.

This gives a total of 1445 ms, allow 1.5 s in the test case.

A.6.1.7 E-UTRAN HD-FDD Intra-frequency RRC Re-establishment for UE category 0

A.6.1.7.1 Test Purpose and Environment

The purpose is to verify that the E-UTRA FDD intra-frequency RRC re-establishment delay is within the specified limits. These tests will verify the requirements in clause 6.1.2.

The test parameters are given in table A.6.1.7.1-1 and table A.6.1.7.1-2 below. The test consists of 3 successive time periods, with time duration of T1, T2 and T3 respectively. At the start of time period T2, cell 1, which is the active cell, is deactivated. The time period T3 starts after the occurrence of the radio link failure.

Table A.6.1.7.1-1: General test parameters for E-UTRAN HD-FDD intra-frequency RRC Re-establishment test case

| Parameter | | Unit | Value | Comment |
|---|-------------------|------|---|---|
| PDSCH parameters | | | DL Reference Measurement Channel R.1 HD-FDD | As specified in clause A.3.1.1.4 |
| PCFICH/PDCCH/PHICH parameters | | | DL Reference Measurement Channel R.3 HD-FDD | As specified in clause A.3.1.2.3 |
| Initial conditions | Active cell | | Cell 1 | |
| | Neighbouring cell | | Cell 2 | |
| Final condition | Active cell | | Cell 2 | |
| E-UTRA RF Channel Number | | | 1 | Only one FDD carrier frequency is used. |
| Channel Bandwidth (BW_{channel}) | | MHz | 10 | |
| N310 | | - | 1 | Maximum consecutive out-of-sync indications from lower layers |
| N311 | | - | 1 | Minimum consecutive in-sync indications from lower layers |
| T310 | | ms | 0 | Radio link failure timer; T310 is disabled |
| T311 | | ms | 3000 | RRC re-establishment timer |
| DRX | | | OFF | |
| CP length | | | Normal | |
| Access Barring Information | | - | Not Sent | No additional delays in random access procedure. |
| PRACH configuration index | | | 4 | As specified in table 5.7.1-2 in TS 36.211 |
| Time offset between cells | | ms | 3 | Asynchronous cells |
| T1 | | s | 5 | |
| T2 | | ms | 200 | |
| T3 | | s | 3 | |

Table A.6.1.7.1-2: Cell specific test parameters for E-UTRAN HD-FDD intra-frequency RRC Re-establishment test case

| Parameter | Unit | Cell 1 | | | Cell 2 | | |
|---|------------|----------|-----------|-----------|----------|----------|----------|
| | | T1 | T2 | T3 | T1 | T2 | T3 |
| E-UTRA RF Channel Number | | 1 | | | 1 | | |
| BW _{channel} | MHz | 10 | | | 10 | | |
| OCNG Patterns defined in A.3.2.1.1 (OP.1 FDD) and in A.3.2.1.2 (OP.2 FDD) | | OP.1 FDD | OP.1 FDD | OP.2 FDD | OP.2 FDD | OP.2 FDD | OP.1 FDD |
| PBCH_RA | dB | 0 | | | 0 | | |
| PBCH_RB | dB | | | | | | |
| PSS_RA | dB | | | | | | |
| SSS_RA | dB | | | | | | |
| PCFICH_RB | dB | | | | | | |
| PHICH_RA | dB | | | | | | |
| PHICH_RB | dB | | | | | | |
| PDCCH_RA | dB | | | | | | |
| PDCCH_RB | dB | | | | | | |
| PDSCH_RA | dB | | | | | | |
| PDSCH_RB | dB | | | | | | |
| OCNG_RA ^{Note 1} | dB | | | | | | |
| OCNG_RB ^{Note 1} | dB | | | | | | |
| \hat{E}_s/I_{ot} | dB | | | | | | |
| N_{oc} ^{Note 2} | dBm/15 KHz | -98 | | | | | |
| \hat{E}_s/N_{oc} | dB | 7 | -Infinity | -Infinity | 4 | 4 | 4 |
| RSRP ^{Note 3} | dBm/15 KHz | -91 | -Infinity | -Infinity | -94 | -94 | -94 |
| Propagation Condition | | AWGN | | | | | |
| <p>Note 1: OCNG shall be used such that both cells are fully allocated and a constant total transmitted power spectral density is achieved for all OFDM symbols.</p> <p>Note 2: Interference from other cells and noise sources not specified in the test is assumed to be constant over subcarriers and time and shall be modelled as AWGN of appropriate power for N_{oc} to be fulfilled.</p> <p>Note 3: RSRP levels have been derived from other parameters for information purposes. They are not settable parameters themselves.</p> | | | | | | | |

A.6.1.7.2 Test Requirements

The RRC re-establishment delay is defined as the time from the start of time period T3, to the moment when the UE starts to send PRACH preambles to cell 2 for sending the *RRCConnectionReestablishmentRequest* message to cell 2.

The RRC re-establishment delay to a known E-UTRA FDD intra frequency cell shall be less than 1.5 s.

The rate of correct RRC re-establishments observed during repeated tests shall be at least 90%.

NOTE: The RRC re-establishment delay in the test is derived from the following expression:

$$T_{\text{re-establish_delay}} = T_{\text{UL_grant}} + T_{\text{UE_re-establish_delay}}$$

Where:

$T_{\text{UL_grant}}$ = It is the time required to acquire and process uplink grant from the target cell. The PRACH reception at the system simulator is used as a trigger for the completion of the test; hence $T_{\text{UL_grant}}$ is not used.

$$T_{\text{UE_re-establish_delay}} = 50 \text{ ms} + N_{\text{freq}} * T_{\text{search}} + T_{\text{SI}} + T_{\text{PRACH}}$$

$$N_{\text{freq}} = 1$$

$$T_{\text{search}} = 100 \text{ ms}$$

$T_{SI} = 1280$ ms; it is the time required for receiving all the relevant system information as defined in TS 36.331 for the target E-UTRAN FDD cell.

$T_{PRACH} = 15$ ms; it is the additional delay caused by the random access procedure.

This gives a total of 1445 ms, allow 1.5 s in the test case.

A.6.1.8 E-UTRAN TDD Intra-frequency RRC Re-establishment for UE category 0

A.6.1.8.1 Test Purpose and Environment

The purpose is to verify that the E-UTRA TDD intra-frequency RRC re-establishment delay is within the specified limits. These tests will verify the requirements in clause 6.1.2.

The test parameters are given in table A.6.1.8.1-1 and table A.6.1.8.1-2 below. The test consists of 3 successive time periods, with time duration of T1, T2 and T3 respectively. At the start of time period T2, cell 1, which is the active cell, is deactivated. The time period T3 starts after the occurrence of the radio link failure.

Table A.6.1.8.1-1: General test parameters for E-UTRAN TDD intra-frequency RRC Re-establishment test case

| Parameter | | Unit | Value | Comment |
|--------------------------------------|-------------------|---------|---|---|
| PDSCH parameters | | | DL Reference Measurement Channel R.12 TDD | As specified in clause A.3.1.1.5 |
| PCFICH/PDCCH/PHICH parameters | | | DL Reference Measurement Channel R.6 TDD | As specified in clause A.3.1.2.2 |
| Initial conditions | Active cell | | Cell 1 | |
| | Neighbouring cell | | Cell 2 | |
| Final condition | Active cell | | Cell 2 | |
| E-UTRA RF Channel Number | | | 1 | Only one TDD carrier frequency is used. |
| Channel Bandwidth ($BW_{channel}$) | | MHz | 10 | |
| N310 | | - | 1 | Maximum consecutive out-of-sync indications from lower layers |
| N311 | | - | 1 | Minimum consecutive in-sync indications from lower layers |
| T310 | | ms | 0 | Radio link failure timer; T310 is disabled |
| T311 | | ms | 3000 | RRC re-establishment timer |
| DRX | | | OFF | |
| CP length | | | Normal | |
| Access Barring Information | | - | Not Sent | No additional delays in random access procedure. |
| Special subframe configuration | | | 6 | As specified in table 4.2-1 in TS 36.211 |
| Uplink-downlink configuration | | | 1 | As specified in table 4.2-2 in TS 36.211 |
| PRACH configuration index | | | 53 | As specified in table 5.7.1-3 in TS 36.211 |
| Time offset between cells | | μ s | 3 | Synchronous cells |
| T1 | | s | 5 | |
| T2 | | ms | 200 | |
| T3 | | s | 3 | |

Table A.6.1.8.1-2: Cell specific test parameters for E-UTRAN TDD intra-frequency RRC Re-establishment test case

| Parameter | Unit | Cell 1 | | | Cell 2 | | |
|--------------------------|------|--------|----|----|--------|----|----|
| | | T1 | T2 | T3 | T1 | T2 | T3 |
| E-UTRA RF Channel Number | | 1 | | | 1 | | |
| $BW_{channel}$ | MHz | 10 | | | 10 | | |

| OCNG Patterns defined in A.3.2.2.1 (OP.1 TDD) and in A.3.2.2.2 (OP.2 TDD) | | OP.1 TDD | OP.1 TDD | OP.2 TDD | OP.2 TDD | OP.2 TDD | OP.1 TDD |
|---|------------|----------|-----------|-----------|----------|----------|----------|
| PBCH_RA | dB | 0 | | | 0 | | |
| PBCH_RB | dB | | | | | | |
| PSS_RA | dB | | | | | | |
| SSS_RA | dB | | | | | | |
| PCFICH_RB | dB | | | | | | |
| PHICH_RA | dB | | | | | | |
| PHICH_RB | dB | | | | | | |
| PDCCH_RA | dB | | | | | | |
| PDCCH_RB | dB | | | | | | |
| PDSCH_RA | dB | | | | | | |
| PDSCH_RB | dB | | | | | | |
| OCNG_RA ^{Note 1} | dB | | | | | | |
| OCNG_RB ^{Note 1} | dB | | | | | | |
| \hat{E}_s / I_{ot} | dB | 1.54 | -Infinity | -Infinity | -3.79 | 4 | 4 |
| N_{oc} ^{Note 2} | dBm/15 KHz | -98 | | | | | |
| \hat{E}_s / N_{oc} | dB | 7 | -Infinity | -Infinity | 4 | 4 | 4 |
| RSRP ^{Note 3} | dBm/15 KHz | -91 | -Infinity | -Infinity | -94 | -94 | -94 |
| Propagation Condition | | AWGN | | | | | |
| <p>Note 1: OCNG shall be used such that both cells are fully allocated and a constant total transmitted power spectral density is achieved for all OFDM symbols.</p> <p>Note 2: Interference from other cells and noise sources not specified in the test is assumed to be constant over subcarriers and time and shall be modelled as AWGN of appropriate power for N_{oc} to be fulfilled.</p> <p>Note 3: RSRP levels have been derived from other parameters for information purposes. They are not settable parameters themselves.</p> | | | | | | | |

A.6.1.8.2 Test Requirements

The RRC re-establishment delay is defined as the time from the start of time period T3, to the moment when the UE starts to send PRACH preambles to cell 2 for sending the *RRCConnectionReestablishmentRequest* message to cell 2.

The RRC re-establishment delay to a known E-UTRA TDD intra frequency cell shall be less than 1.5 s.

The rate of correct RRC re-establishments observed during repeated tests shall be at least 90%.

NOTE: The RRC re-establishment delay in the test is derived from the following expression:

$$T_{\text{re-establish_delay}} = T_{\text{UL_grant}} + T_{\text{UE_re-establish_delay}}$$

Where:

$T_{\text{UL_grant}}$ = It is the time required to acquire and process uplink grant from the target cell. The PRACH reception at the system simulator is used as a trigger for the completion of the test; hence $T_{\text{UL_grant}}$ is not used.

$$T_{\text{UE_re-establish_delay}} = 50 \text{ ms} + N_{\text{freq}} * T_{\text{search}} + T_{\text{SI}} + T_{\text{PRACH}}$$

$$N_{\text{freq}} = 1$$

$$T_{\text{search}} = 100 \text{ ms}$$

$T_{\text{SI}} = 1280 \text{ ms}$; it is the time required for receiving all the relevant system information as defined in TS 36.331 for the target E-UTRAN TDD cell.

$T_{\text{PRACH}} = 15 \text{ ms}$; it is the additional delay caused by the random access procedure.

This gives a total of 1445 ms, allow 1.5 s in the test case.

A.6.1.9 E-UTRAN FD-FDD Intra-frequency RRC Re-establishment for Cat-M1 UE in CEModeA

A.6.1.9.1 Test Purpose and Environment

The purpose is to verify that the E-UTRA FDD intra-frequency RRC re-establishment delay is within the specified limits. These tests will verify the requirements in clause 6.7.2.

The test parameters are given in table A.6.1.9.1-1 and table A.6.1.9.1-2 below. The test consists of 3 successive time periods, with time duration of T1, T2 and T3 respectively. At the start of time period T2, cell 1, which is the active cell, is deactivated. The time period T3 starts after the occurrence of the radio link failure.

Table A.6.1.9.1-1: General test parameters for E-UTRAN FDD intra-frequency RRC Re-establishment test case

| Parameter | Unit | Value | Comment |
|--------------------------------------|-------------------|-----------|---|
| Initial conditions | Active cell | Cell 1 | |
| | Neighbouring cell | Cell 2 | |
| Final condition | Active cell | Cell 2 | |
| E-UTRA RF Channel Number | | 1 | Only one FDD carrier frequency is used. |
| Channel Bandwidth ($BW_{channel}$) | MHz | 10 | |
| PRACH Configuration | | PRACH_2CE | As specified in A.3.16 |
| N310 | - | 1 | Maximum consecutive out-of-sync indications from lower layers |
| N311 | - | 1 | Minimum consecutive in-sync indications from lower layers |
| T310 | ms | 0 | Radio link failure timer; T310 is disabled |
| T311 | ms | 3000 | RRC re-establishment timer |
| DRX | | OFF | |
| CP length | | Normal | |
| Access Barring Information | - | Not Sent | No additional delays in random access procedure. |
| PRACH configuration index | | 4 | As specified in table 5.7.1-2 in TS 36.211 |
| Time offset between cells | ms | 3 | Asynchronous cells |
| T1 | s | 5 | |
| T2 | ms | 400 | |
| T3 | s | 3 | |

Table A.6.1.9.1-2: Cell specific test parameters for E-UTRAN FDD intra-frequency RRC Re-establishment test case

| Parameter | Unit | Cell 1 | | | Cell 2 | | |
|--|------|-----------|-----------|----------|----------|----------|-----------|
| | | T1 | T2 | T3 | T1 | T2 | T3 |
| E-UTRA RF Channel Number | | 1 | | | 1 | | |
| $BW_{channel}$ | MHz | 10 | | | 10 | | |
| PDSCH Reference Channel in clause A.3.1.4.1 | | R.21 FDD | R.21 FDD | - | - | - | R.21 FDD |
| MPDCCH Reference Channel in clause A.3.1.3.1 | | R.17 FDD | | | R.17 FDD | | |
| OCNG Patterns in clause A.3.2.1 | | OP.21 FDD | OP.21 FDD | OP.6 FDD | OP.6 FDD | OP.6 FDD | OP.21 FDD |
| PBCH_RA | dB | | | | | | |
| PBCH_RB | dB | | | | | | |
| PSS_RA | dB | | | | | | |
| SSS_RA | dB | | | | | | |
| MPDCCH_RA | dB | | | | | | |
| MPDCCH_RB | dB | | | | | | |
| PDSCH_RA | dB | | | | | | |

| | | | | | | | |
|--|------------|------|-----------|-----------|-------|-----|-----|
| PDSCH_RB | dB | -3 | | | -3 | | |
| OCNG_RA ^{Note 1} | dB | | | | | | |
| OCNG_RB ^{Note 1} | dB | | | | | | |
| \hat{E}_s/I_{ot} | dB | 1.54 | -Infinity | -Infinity | -3.79 | 4 | 4 |
| N_{oc} ^{Note 2} | dBm/15 KHz | -98 | | | | | |
| \hat{E}_s/N_{oc} | dB | 7 | -Infinity | -Infinity | 4 | 4 | 4 |
| RSRP ^{Note 3} | dBm/15 KHz | -91 | -Infinity | -Infinity | -94 | -94 | -94 |
| Propagation Condition | | AWGN | | | AWGN | | |
| Antenna Configuration | | 2x1 | | | 2x1 | | |
| <p>Note 1: OCNG shall be used such that both cells are fully allocated and a constant total transmitted power spectral density is achieved for all OFDM symbols.</p> <p>Note 2: Interference from other cells and noise sources not specified in the test is assumed to be constant over subcarriers and time and shall be modelled as AWGN of appropriate power for N_{oc} to be fulfilled.</p> <p>Note 3: Es/Iot and RSRP levels have been derived from other parameters for information purposes. They are not settable parameters themselves.</p> | | | | | | | |

A.6.1.9.2 Test Requirements

The RRC re-establishment delay is defined as the time from the start of time period T3, to the moment when the UE starts to send PRACH preambles to cell 2 for sending the *RRCConnectionReestablishmentRequest* message to cell 2.

The RRC re-establishment delay to a known E-UTRA FDD intra frequency cell shall be less than 1.5 s.

The rate of correct RRC re-establishments observed during repeated tests shall be at least 90%.

NOTE: The RRC re-establishment delay in the test is derived from the following expression:

$$T_{\text{re-establish_delay}} = T_{\text{UL_grant}} + T_{\text{UE_re-establish_delay}}$$

Where:

$T_{\text{UL_grant}}$ = It is the time required to acquire and process uplink grant from the target cell. The PRACH reception at the system simulator is used as a trigger for the completion of the test; hence $T_{\text{UL_grant}}$ is not used.

$$T_{\text{UE_re-establish_delay}} = 50 \text{ ms} + N_{\text{freq}} * T_{\text{search}} + T_{\text{SI-EUTRA-M1-CEModeA}} + T_{\text{PRACH}}$$

$$N_{\text{freq}} = 1$$

$$T_{\text{search}} = 0 \text{ ms}$$

$T_{\text{SI-EUTRA-M1-CEModeA}} = 1280 \text{ ms}$; it is the time required for receiving all the relevant system information as defined in TS 36.331 for the target E-UTRAN FDD cell.

$T_{\text{PRACH}} = 15 \text{ ms}$; it is the additional delay caused by the random access procedure.

This gives a total of 1345 ms, allow 1.5 s in the test case.

A.6.1.10 E-UTRAN HD-FDD Intra-frequency RRC Re-establishment for Cat-M1 UE in CEModeA

A.6.1.10.1 Test Purpose and Environment

The purpose is to verify that the E-UTRA FDD intra-frequency RRC re-establishment delay is within the specified limits. These tests will verify the requirements in clause 6.7.2.

The test parameters are given in table A.6.1.10.1-1 and table A.6.1.10.1-2 below. The test consists of 3 successive time periods, with time duration of T1, T2 and T3 respectively. At the start of time period T2, cell 1, which is the active cell, is deactivated. The time period T3 starts after the occurrence of the radio link failure.

Table A.6.1.10.1-1: General test parameters for E-UTRAN HD-FDD intra-frequency RRC Re-establishment test case

| Parameter | | Unit | Value | Comment |
|--------------------------------------|-------------------|------|-----------|---|
| Initial conditions | Active cell | | Cell 1 | |
| | Neighbouring cell | | Cell 2 | |
| Final condition | Active cell | | Cell 2 | |
| E-UTRA RF Channel Number | | | 1 | Only one FDD carrier frequency is used. |
| Channel Bandwidth ($BW_{channel}$) | | MHz | 10 | |
| PRACH Configuration | | | PRACH_2CE | As specified in A.3.16 |
| N310 | | - | 1 | Maximum consecutive out-of-sync indications from lower layers |
| N311 | | - | 1 | Minimum consecutive in-sync indications from lower layers |
| T310 | | ms | 0 | Radio link failure timer; T310 is disabled |
| T311 | | ms | 3000 | RRC re-establishment timer |
| DRX | | | OFF | |
| CP length | | | Normal | |
| Access Barring Information | | - | Not Sent | No additional delays in random access procedure. |
| PRACH configuration index | | | 4 | As specified in table 5.7.1-2 in TS 36.211 |
| Time offset between cells | | ms | 3 | Asynchronous cells |
| T1 | | s | 5 | |
| T2 | | ms | 400 | |
| T3 | | s | 3 | |

Table A.6.1.10.1-2: Cell specific test parameters for E-UTRAN HD-FDD intra-frequency RRC Re-establishment test case

| Parameter | Unit | Cell 1 | | | Cell 2 | | |
|--|------------|-------------|-------------|-----------|------------|----------|-------------|
| | | T1 | T2 | T3 | T1 | T2 | T3 |
| E-UTRA RF Channel Number | | 1 | | | 1 | | |
| $BW_{channel}$ | MHz | 10 | | | 10 | | |
| PDSCH Reference Channel in clause A.3.1.4.2 | | R.11 HD-FDD | R.11 HD-FDD | - | - | - | R.11 HD-FDD |
| MPDCCH Reference Channel in clause A.3.1.3.2 | | R.7 HD-FDD | | | R.7 HD-FDD | | |
| OCNG Patterns in clause A.3.2.1 | | OP.21 FDD | OP.21 FDD | OP.6 FDD | OP.6 FDD | OP.6 FDD | OP.21 FDD |
| PBCH_RA | dB | -3 | | | -3 | | |
| PBCH_RB | dB | | | | | | |
| PSS_RA | dB | | | | | | |
| SSS_RA | dB | | | | | | |
| MPDCCH_RA | dB | | | | | | |
| MPDCCH_RB | dB | | | | | | |
| PDSCH_RA | dB | | | | | | |
| PDSCH_RB | dB | | | | | | |
| OCNG_RA ^{Note 1} | dB | | | | | | |
| OCNG_RB ^{Note 1} | dB | | | | | | |
| \hat{E}_s/I_{ot} | dB | 1.54 | -Infinity | -Infinity | -3.79 | 4 | 4 |
| N_{oc} ^{Note 2} | dBm/15 KHz | -98 | | | | | |
| \hat{E}_s/N_{oc} | dB | 7 | -Infinity | -Infinity | 4 | 4 | 4 |
| RSRP ^{Note 3} | dBm/15 KHz | -91 | -Infinity | -Infinity | -94 | -94 | -94 |
| Propagation Condition | | AWGN | | | AWGN | | |
| Antenna Configuration | | 2x1 | | | 2x1 | | |

| | |
|---------|--|
| Note 1: | OCNG shall be used such that both cells are fully allocated and a constant total transmitted power spectral density is achieved for all OFDM symbols. |
| Note 2: | Interference from other cells and noise sources not specified in the test is assumed to be constant over subcarriers and time and shall be modelled as AWGN of appropriate power for N_{oc} to be fulfilled. |
| Note 3: | Es/lot and RSRP levels have been derived from other parameters for information purposes. They are not settable parameters themselves. |

A.6.1.10.2 Test Requirements

The RRC re-establishment delay is defined as the time from the start of time period T3, to the moment when the UE starts to send PRACH preambles to cell 2 for sending the *RRCConnectionReestablishmentRequest* message to cell 2.

The RRC re-establishment delay to a known E-UTRA FDD intra frequency cell shall be less than 1.5 s.

The rate of correct RRC re-establishments observed during repeated tests shall be at least 90%.

NOTE: The RRC re-establishment delay in the test is derived from the following expression:

$$T_{\text{re-establish_delay}} = T_{\text{UL_grant}} + T_{\text{UE_re-establish_delay}}$$

Where:

$T_{\text{UL_grant}}$ = It is the time required to acquire and process uplink grant from the target cell. The PRACH reception at the system simulator is used as a trigger for the completion of the test; hence $T_{\text{UL_grant}}$ is not used.

$$T_{\text{UE_re-establish_delay}} = 50 \text{ ms} + N_{\text{freq}} * T_{\text{search}} + T_{\text{SI-EUTRA-MI-CEModeA}} + T_{\text{PRACH}}$$

$$N_{\text{freq}} = 1$$

$$T_{\text{search}} = 0 \text{ ms}$$

$T_{\text{SI-EUTRA-MI-CEModeA}} = 1280 \text{ ms}$; it is the time required for receiving all the relevant system information as defined in TS 36.331 for the target E-UTRAN FDD cell.

$T_{\text{PRACH}} = 15 \text{ ms}$; it is the additional delay caused by the random access procedure.

This gives a total of 1345 ms, allow 1.5 s in the test case.

A.6.1.11 E-UTRAN TDD Intra-frequency RRC Re-establishment for Cat-M1 UE in CEModeA

A.6.1.11.1 Test Purpose and Environment

The purpose is to verify that the E-UTRA TDD intra-frequency RRC re-establishment delay is within the specified limits. These tests will verify the requirements in clause 6.7.2.

The test parameters are given in table A.6.1.11.1-1 and table A.6.1.11.1-2 below. The test consists of 3 successive time periods, with time duration of T1, T2 and T3 respectively. At the start of time period T2, cell 1, which is the active cell, is deactivated. The time period T3 starts after the occurrence of the radio link failure.

Table A.6.1.11.1-1: General test parameters for E-UTRAN TDD intra-frequency RRC Re-establishment test case

| Parameter | Unit | Value | Comment |
|---|-------------------|-----------|---|
| Initial conditions | Active cell | Cell 1 | |
| | Neighbouring cell | Cell 2 | |
| Final condition | Active cell | Cell 2 | |
| E-UTRA RF Channel Number | | 1 | Only one TDD carrier frequency is used. |
| Channel Bandwidth (BW_{channel}) | MHz | 10 | |
| PRACH Configuration | | PRACH_2CE | As specified in A.3.16 |
| N310 | - | 1 | Maximum consecutive out-of-sync indications from lower layers |

| | | | |
|--------------------------------|---------|----------|---|
| N311 | - | 1 | Minimum consecutive in-sync indications from lower layers |
| T310 | ms | 0 | Radio link failure timer; T310 is disabled |
| T311 | ms | 3000 | RRC re-establishment timer |
| DRX | | OFF | |
| CP length | | Normal | |
| Access Barring Information | - | Not Sent | No additional delays in random access procedure. |
| Special subframe configuration | | 6 | As specified in table 4.2-1 in TS 36.211 |
| Uplink-downlink configuration | | 1 | As specified in table 4.2-2 in TS 36.211 |
| PRACH configuration index | | 53 | As specified in table 5.7.1-3 in TS 36.211 |
| Time offset between cells | μ s | 3 | Synchronous cells |
| T1 | s | 5 | |
| T2 | ms | 400 | |
| T3 | s | 3 | |

Table A.6.1.11.1-2: Cell specific test parameters for E-UTRAN TDD intra-frequency RRC Re-establishment test case

| Parameter | Unit | Cell 1 | | | Cell 2 | | |
|---|------------|-----------|-----------|-----------|----------|----------|-----------|
| | | T1 | T2 | T3 | T1 | T2 | T3 |
| E-UTRA RF Channel Number | | 1 | | | 1 | | |
| BW _{channel} | MHz | 10 | | | 10 | | |
| PDSCH Reference Channel in clause A.3.1.4.3 | | R.17 TDD | R.17 TDD | - | - | - | R.17 TDD |
| MPDCCH Reference Channel in clause A.3.1.3.3 | | R.15 TDD | | | R.15 TDD | | |
| OCNG Patterns in clause A.3.2.2 | | OP.11 TDD | OP.11 TDD | OP.2 TDD | OP.2 TDD | OP.2 TDD | OP.11 TDD |
| PBCH_RA | dB | -3 | | | -3 | | |
| PBCH_RB | dB | | | | | | |
| PSS_RA | dB | | | | | | |
| SSS_RA | dB | | | | | | |
| MPDCCH_RA | dB | | | | | | |
| MPDCCH_RB | dB | | | | | | |
| PDSCH_RA | dB | | | | | | |
| PDSCH_RB | dB | | | | | | |
| OCNG_RA ^{Note 1} | dB | | | | | | |
| OCNG_RB ^{Note 1} | dB | | | | | | |
| \hat{E}_s/I_{ot} | dB | 1.54 | -Infinity | -Infinity | -3.79 | 4 | 4 |
| N_{oc} ^{Note 2} | dBm/15 KHz | -98 | | | | | |
| \hat{E}_s/N_{oc} | dB | 7 | -Infinity | -Infinity | 4 | 4 | 4 |
| RSRP ^{Note 3} | dBm/15 KHz | -91 | -Infinity | -Infinity | -94 | -94 | -94 |
| Propagation Condition | | AWGN | | | AWGN | | |
| Antenna Configuration | | 2x1 | | | 2x1 | | |
| <p>Note 1: OCNG shall be used such that both cells are fully allocated and a constant total transmitted power spectral density is achieved for all OFDM symbols.</p> <p>Note 2: Interference from other cells and noise sources not specified in the test is assumed to be constant over subcarriers and time and shall be modelled as AWGN of appropriate power for N_{oc} to be fulfilled.</p> <p>Note 3: E_s/I_{ot} and RSRP levels have been derived from other parameters for information purposes. They are not settable parameters themselves.</p> | | | | | | | |

A.6.1.11.2 Test Requirements

The RRC re-establishment delay is defined as the time from the start of time period T3, to the moment when the UE starts to send PRACH preambles to cell 2 for sending the *RRCConnectionReestablishmentRequest* message to cell 2.

The RRC re-establishment delay to a known E-UTRA TDD intra frequency cell shall be less than 1.5 s.

The rate of correct RRC re-establishments observed during repeated tests shall be at least 90%.

NOTE: The RRC re-establishment delay in the test is derived from the following expression:

$$T_{\text{re-establish_delay}} = T_{\text{UL_grant}} + T_{\text{UE_re-establish_delay}}$$

Where:

$T_{\text{UL_grant}}$ = It is the time required to acquire and process uplink grant from the target cell. The PRACH reception at the system simulator is used as a trigger for the completion of the test; hence $T_{\text{UL_grant}}$ is not used.

$$T_{\text{UE_re-establish_delay}} = 50 \text{ ms} + N_{\text{freq}} * T_{\text{search}} + T_{\text{SI-EUTRA-M1-CEModeA}} + T_{\text{PRACH}}$$

$$N_{\text{freq}} = 1$$

$$T_{\text{search}} = 0 \text{ ms}$$

$T_{\text{SI-EUTRA-M1-CEModeA}} = 1280 \text{ ms}$; it is the time required for receiving all the relevant system information as defined in TS 36.331 for the target E-UTRAN TDD cell.

$T_{\text{PRACH}} = 15 \text{ ms}$; it is the additional delay caused by the random access procedure.

This gives a total of 1345 ms, allow 1.5 s in the test case.

A.6.1.12 E-UTRAN FD-FDD Intra-frequency RRC Re-establishment for Cat-M1 UE in CEModeB

A.6.1.12.1 Test Purpose and Environment

The purpose is to verify that the E-UTRA FDD intra-frequency RRC re-establishment delay is within the specified limits. These tests will verify the requirements in clause 6.7.2.

The test parameters are given in table A.6.1.12.1-1 and table A.6.1.12.1-2 below. The test consists of 4 successive time periods, with time duration of T1, T2, T3 and T4 respectively. During T1, both cell 1 and cell 2 are in CEModeB. At the start of time period T3, cell 1, which is the active cell, is deactivated. The time period T4 starts after the occurrence of the radio link failure.

Table A.6.1.12.1-1: General test parameters for E-UTRAN FDD intra-frequency RRC Re-establishment test case

| Parameter | | Unit | Value | Comment |
|---|-------------------|------|-----------|---|
| Initial conditions | Active cell | | Cell 1 | |
| | Neighbouring cell | | Cell 2 | |
| Final condition | Active cell | | Cell 2 | |
| E-UTRA RF Channel Number | | | 1 | Only one FDD carrier frequency is used. |
| Channel Bandwidth (BW_{channel}) | | MHz | 10 | |
| PRACH Configuration | | | PRACH_3CE | As specified in A.3.16 |
| N310 | | - | 1 | Maximum consecutive out-of-sync indications from lower layers |
| N311 | | - | 1 | Minimum consecutive in-sync indications from lower layers |
| T310 | | ms | 0 | Radio link failure timer; T310 is disabled |
| T311 | | ms | 3000 | RRC re-establishment timer |
| DRX | | | OFF | |
| CP length | | | Normal | |

| | | | |
|----------------------------|----|----------|--|
| Access Barring Information | - | Not Sent | No additional delays in random access procedure. |
| PRACH configuration index | | 4 | As specified in table 5.7.1-2 in TS 36.211 |
| Time offset between cells | ms | 3 | Asynchronous cells |
| T1 | s | 5 | |
| T2 | s | 5 | |
| T3 | ms | 4000 | |
| T4 | s | 9 | |

Table A.6.1.12.1-2: Cell specific test parameters for E-UTRAN FDD intra-frequency RRC Re-establishment test case

| Parameter | Unit | Cell 1 | | | | Cell 2 | | | |
|---|------------|-----------|-----------|-----------|-----------|----------|----------|----------|-----------|
| | | T1 | T2 | T3 | T4 | T1 | T2 | T3 | T4 |
| E-UTRA RF Channel Number | | 1 | | | | 1 | | | |
| BW _{channel} | MHz | 10 | | | | 10 | | | |
| PDSCH Reference Channel in clause A.3.1.4.4 | | R.23 FDD | R.23 FDD | R.23 FDD | - | - | - | - | R.23 FDD |
| MPDCCH Reference Channel in clause A.3.1.3.4 | | R.19 FDD | | | | R.19 FDD | | | |
| OCNG Patterns in clause A.3.2.1 | | OP.21 FDD | OP.21 FDD | OP.21 FDD | OP.6 FDD | OP.6 FDD | OP.6 FDD | OP.6 FDD | OP.21 FDD |
| PBCH_RA | dB | -3 | | | | -3 | | | |
| PBCH_RB | dB | | | | | | | | |
| PSS_RA | dB | | | | | | | | |
| SSS_RA | dB | | | | | | | | |
| MPDCCH_RA | dB | | | | | | | | |
| MPDCCH_RB | dB | | | | | | | | |
| PDSCH_RA | dB | | | | | | | | |
| PDSCH_RB | dB | | | | | | | | |
| OCNG_RA ^{Note 1} | dB | | | | | | | | |
| OCNG_RB ^{Note 1} | dB | | | | | | | | |
| \hat{E}_s/I_{ot} | dB | 1.54 | -15.27 | -Infinity | -Infinity | -3.79 | -12.14 | -12 | -12 |
| N_{oc} ^{Note 2} | dBm/15 KHz | -98 | | | | | | | |
| \hat{E}_s/N_{oc} | dB | 7 | -15 | -Infinity | -Infinity | 4 | -12 | -12 | -12 |
| RSRP ^{Note 3} | dBm/15 KHz | -91 | -113 | -Infinity | -Infinity | -94 | -110 | -110 | -110 |
| Propagation Condition | | AWGN | | | | AWGN | | | |
| Antenna Configuration | | 2x1 | | | | 2x1 | | | |
| <p>Note 1: OCNG shall be used such that both cells are fully allocated and a constant total transmitted power spectral density is achieved for all OFDM symbols.</p> <p>Note 2: Interference from other cells and noise sources not specified in the test is assumed to be constant over subcarriers and time and shall be modelled as AWGN of appropriate power for N_{oc} to be fulfilled.</p> <p>Note 3: E_s/I_{ot} and RSRP levels have been derived from other parameters for information purposes. They are not settable parameters themselves.</p> | | | | | | | | | |

A.6.1.12.2 Test Requirements

The RRC re-establishment delay is defined as the time from the start of time period T4, to the moment when the UE starts to send PRACH preambles to cell 2 for sending the *RRConnectionReestablishmentRequest* message to cell 2.

The RRC re-establishment delay to a known E-UTRA FDD intra frequency cell shall be less than 7 s.

The rate of correct RRC re-establishments observed during repeated tests shall be at least 90%.

NOTE: The RRC re-establishment delay in the test is derived from the following expression:

$$T_{\text{re-establish_delay}} = T_{\text{UL_grant}} + T_{\text{UE_re-establish_delay}}$$

Where:

$T_{\text{UL_grant}}$ = It is the time required to acquire and process uplink grant from the target cell. The PRACH reception at the system simulator is used as a trigger for the completion of the test; hence $T_{\text{UL_grant}}$ is not used.

$$T_{\text{UE_re-establish_delay}} = 50 \text{ ms} + N_{\text{freq}} * T_{\text{search}} + T_{\text{SI-EUTRA-M1-CEModeB}} + T_{\text{PRACH}}$$

$$N_{\text{freq}} = 1$$

$$T_{\text{search}} = 0 \text{ ms}$$

$T_{\text{SI-EUTRA-M1-CEModeB}} = 6400 \text{ ms}$; it is the time required for receiving all the relevant system information as defined in TS 36.331 for the target E-UTRAN FDD cell.

$T_{\text{PRACH}} = 15 \text{ ms}$; it is the additional delay caused by the random access procedure.

This gives a total of 6465 ms, allow 7 s in the test case.

A.6.1.13 E-UTRAN HD-FDD Intra-frequency RRC Re-establishment for Cat-M1 UE in CEModeB

A.6.1.13.1 Test Purpose and Environment

The purpose is to verify that the E-UTRA FDD intra-frequency RRC re-establishment delay is within the specified limits. These tests will verify the requirements in clause 6.7.2.

The test parameters are given in table A.6.1.13.1-1 and table A.6.1.13.1-2 below. The test consists of 4 successive time periods, with time duration of T1, T2, T3 and T4 respectively. During T1, both cell 1 and cell 2 are in CEModeB. At the start of time period T3, cell 1, which is the active cell, is deactivated. The time period T4 starts after the occurrence of the radio link failure.

Table A.6.1.13.1-1: General test parameters for E-UTRAN HD-FDD intra-frequency RRC Re-establishment test case

| Parameter | | Unit | Value | Comment |
|---|-------------------|------|-----------|---|
| Initial conditions | Active cell | | Cell 1 | |
| | Neighbouring cell | | Cell 2 | |
| Final condition | Active cell | | Cell 2 | |
| E-UTRA RF Channel Number | | | 1 | Only one FDD carrier frequency is used. |
| Channel Bandwidth (BW_{channel}) | | MHz | 10 | |
| PRACH Configuration | | | PRACH_3CE | As specified in A.3.16 |
| N310 | | - | 1 | Maximum consecutive out-of-sync indications from lower layers |
| N311 | | - | 1 | Minimum consecutive in-sync indications from lower layers |
| T310 | | ms | 0 | Radio link failure timer; T310 is disabled |
| T311 | | ms | 3000 | RRC re-establishment timer |
| DRX | | | OFF | |
| CP length | | | Normal | |
| Access Barring Information | | - | Not Sent | No additional delays in random access procedure. |
| PRACH configuration index | | | 4 | As specified in table 5.7.1-2 in TS 36.211 |
| Time offset between cells | | ms | 3 | Asynchronous cells |
| T1 | | s | 5 | |
| T2 | | s | 5 | |
| T3 | | ms | 4000 | |
| T4 | | s | 9 | |

Table A.6.1.13.1-2: Cell specific test parameters for E-UTRAN HD-FDD intra-frequency RRC Re-establishment test case

| Parameter | Unit | Cell 1 | | | | Cell 2 | | | |
|--|------------|-------------|-------------|-------------|-----------|------------|----------|----------|-------------|
| | | T1 | T2 | T3 | T4 | T1 | T2 | T3 | T4 |
| E-UTRA RF Channel Number | | 1 | | | | 1 | | | |
| BW _{channel} | MHz | 10 | | | | 10 | | | |
| PDSCH Reference Channel in clause A.3.1.4.5 | | R.13 HD-FDD | R.13 HD-FDD | R.13 HD-FDD | - | - | - | - | R.13 HD-FDD |
| MPDCCH Reference Channel in clause A.3.1.3.5 | | R.9 HD-FDD | | | | R.9 HD-FDD | | | |
| OCNG Patterns in clause A.3.2.1 | | OP.21 FDD | OP.21 FDD | OP.21 FDD | OP.6 FDD | OP.6 FDD | OP.6 FDD | OP.6 FDD | OP.21 FDD |
| PBCH_RA | dB | -3 | | | | -3 | | | |
| PBCH_RB | dB | | | | | | | | |
| PSS_RA | dB | | | | | | | | |
| SSS_RA | dB | | | | | | | | |
| MPDCCH_RA | dB | | | | | | | | |
| MPDCCH_RB | dB | | | | | | | | |
| PDSCH_RA | dB | | | | | | | | |
| PDSCH_RB | dB | | | | | | | | |
| OCNG_RA ^{Note 1} | dB | | | | | | | | |
| OCNG_RB ^{Note 1} | dB | | | | | | | | |
| \hat{E}_s / I_{ot} | dB | 1.54 | -15.27 | -Infinity | -Infinity | -3.79 | -12.14 | -12 | -12 |
| N_{oc} ^{Note 2} | dBm/15 KHz | -98 | | | | | | | |
| \hat{E}_s / N_{oc} | dB | 7 | -15 | -Infinity | -Infinity | 4 | -12 | -12 | -12 |
| RSRP ^{Note 3} | dBm/15 KHz | -91 | -113 | -Infinity | -Infinity | -94 | -110 | -110 | -110 |
| Propagation Condition | | AWGN | | | | AWGN | | | |
| Antenna Configuration | | 2x1 | | | | 2x1 | | | |
| <p>Note 1: OCNG shall be used such that both cells are fully allocated and a constant total transmitted power spectral density is achieved for all OFDM symbols.</p> <p>Note 2: Interference from other cells and noise sources not specified in the test is assumed to be constant over subcarriers and time and shall be modelled as AWGN of appropriate power for N_{oc} to be fulfilled.</p> <p>Note 3: Es/lot and RSRP levels have been derived from other parameters for information purposes. They are not settable parameters themselves.</p> | | | | | | | | | |

A.6.1.13.2 Test Requirements

The RRC re-establishment delay is defined as the time from the start of time period T4, to the moment when the UE starts to send PRACH preambles to cell 2 for sending the *RRConnectionReestablishmentRequest* message to cell 2.

The RRC re-establishment delay to a known E-UTRA FDD intra frequency cell shall be less than 7 s.

The rate of correct RRC re-establishments observed during repeated tests shall be at least 90%.

NOTE: The RRC re-establishment delay in the test is derived from the following expression:

$$T_{\text{re-establish_delay}} = T_{\text{UL_grant}} + T_{\text{UE_re-establish_delay}}$$

Where:

$T_{\text{UL_grant}}$ = It is the time required to acquire and process uplink grant from the target cell. The PRACH reception at the system simulator is used as a trigger for the completion of the test; hence $T_{\text{UL_grant}}$ is not used.

$$T_{UE_re-establish_delay} = 50 \text{ ms} + N_{freq} * T_{search} + T_{SI-EUTRA-M1-CEModeB} + T_{PRACH}$$

$$N_{freq} = 1$$

$$T_{search} = 0 \text{ ms}$$

$T_{SI-EUTRA-M1-CEModeB} = 6400 \text{ ms}$; it is the time required for receiving all the relevant system information as defined in TS 36.331 for the target E-UTRAN FDD cell.

$T_{PRACH} = 15 \text{ ms}$; it is the additional delay caused by the random access procedure.

This gives a total of 6465 ms, allow 7 s in the test case.

A.6.1.14 E-UTRAN TDD Intra-frequency RRC Re-establishment for Cat-M1 UE in CEModeB

A.6.1.14.1 Test Purpose and Environment

The purpose is to verify that the E-UTRA TDD intra-frequency RRC re-establishment delay is within the specified limits. These tests will verify the requirements in clause 6.7.2.

The test parameters are given in table A.6.1.14.1-1 and table A.6.1.14.1-2 below. The test consists of 4 successive time periods, with time duration of T1, T2, T3 and T4 respectively. During T1, both cell 1 and cell 2 are in CEModeB. At the start of time period T3, cell 1, which is the active cell, is deactivated. The time period T4 starts after the occurrence of the radio link failure.

Table A.6.1.14.1-1: General test parameters for E-UTRAN TDD intra-frequency RRC Re-establishment test case

| Parameter | | Unit | Value | Comment |
|--------------------------------------|-------------------|---------------|-----------|---|
| Initial conditions | Active cell | | Cell 1 | |
| | Neighbouring cell | | Cell 2 | |
| Final condition | Active cell | | Cell 2 | |
| E-UTRA RF Channel Number | | | 1 | Only one TDD carrier frequency is used. |
| Channel Bandwidth ($BW_{channel}$) | | MHz | 10 | |
| PRACH Configuration | | | PRACH_3CE | As specified in A.3.16 |
| N310 | | - | 1 | Maximum consecutive out-of-sync indications from lower layers |
| N311 | | - | 1 | Minimum consecutive in-sync indications from lower layers |
| T310 | | ms | 0 | Radio link failure timer; T310 is disabled |
| T311 | | ms | 3000 | RRC re-establishment timer |
| DRX | | | OFF | |
| CP length | | | Normal | |
| Access Barring Information | | - | Not Sent | No additional delays in random access procedure. |
| Special subframe configuration | | | 6 | As specified in table 4.2-1 in TS 36.211 |
| Uplink-downlink configuration | | | 1 | As specified in table 4.2-2 in TS 36.211 |
| PRACH configuration index | | | 53 | As specified in table 5.7.1-3 in TS 36.211 |
| Time offset between cells | | μs | 3 | Synchronous cells |
| T1 | | s | 5 | |
| T2 | | s | 5 | |
| T3 | | ms | 4000 | |
| T4 | | s | 9 | |

Table A.6.1.14.1-2: Cell specific test parameters for E-UTRAN TDD intra-frequency RRC Re-establishment test case

| Parameter | Unit | Cell 1 | | | | Cell 2 | | | |
|---|------------|-----------|-----------|-----------|-----------|----------|----------|----------|-----------|
| | | T1 | T2 | T3 | T4 | T1 | T2 | T3 | T4 |
| E-UTRA RF Channel Number | | 1 | | | | 1 | | | |
| BW _{channel} | MHz | 10 | | | | 10 | | | |
| PDSCH Reference Channel in clause A.3.1.4.6 | | R.19 TDD | R.19 TDD | R.19 TDD | - | - | - | - | R.19 TDD |
| MPDCCH Reference Channel in clause A.3.1.3.6 | | R.17 TDD | | | | R.17 TDD | | | |
| OCNG Patterns in clause A.3.2.2 | | OP.11 TDD | OP.11 TDD | OP.11 TDD | OP.2 TDD | OP.2 TDD | OP.2 TDD | OP.2 TDD | OP.11 TDD |
| PBCH_RA | dB | -3 | | | | -3 | | | |
| PBCH_RB | dB | | | | | | | | |
| PSS_RA | dB | | | | | | | | |
| SSS_RA | dB | | | | | | | | |
| MPDCCH_RA | dB | | | | | | | | |
| MPDCCH_RB | dB | | | | | | | | |
| PDSCH_RA | dB | | | | | | | | |
| PDSCH_RB | dB | | | | | | | | |
| OCNG_RA ^{Note 1} | dB | | | | | | | | |
| OCNG_RB ^{Note 1} | dB | | | | | | | | |
| \hat{E}_s/I_{ot} | dB | 1.54 | -15.27 | -Infinity | -Infinity | -3.79 | -12.14 | -12 | -12 |
| N_{oc} ^{Note 2} | dBm/15 KHz | -98 | | | | | | | |
| \hat{E}_s/N_{oc} | dB | 7 | -15 | -Infinity | -Infinity | 4 | -12 | -12 | -12 |
| RSRP ^{Note 3} | dBm/15 KHz | -91 | -113 | -Infinity | -Infinity | -94 | -110 | -110 | -110 |
| Propagation Condition | | AWGN | | | | AWGN | | | |
| Antenna Configuration | | 2x1 | | | | 2x1 | | | |
| <p>Note 1: OCNG shall be used such that both cells are fully allocated and a constant total transmitted power spectral density is achieved for all OFDM symbols.</p> <p>Note 2: Interference from other cells and noise sources not specified in the test is assumed to be constant over subcarriers and time and shall be modelled as AWGN of appropriate power for N_{oc} to be fulfilled.</p> <p>Note 3: E_s/I_{ot} and RSRP levels have been derived from other parameters for information purposes. They are not settable parameters themselves.</p> | | | | | | | | | |

A.6.1.14.2 Test Requirements

The RRC re-establishment delay is defined as the time from the start of time period T3, to the moment when the UE starts to send PRACH preambles to cell 2 for sending the *RRConnectionReestablishmentRequest* message to cell 2.

The RRC re-establishment delay to a known E-UTRA TDD intra frequency cell shall be less than 7 s.

The rate of correct RRC re-establishments observed during repeated tests shall be at least 90%.

NOTE: The RRC re-establishment delay in the test is derived from the following expression:

$$T_{\text{re-establish_delay}} = T_{\text{UL_grant}} + T_{\text{UE_re-establish_delay}}$$

Where:

$T_{\text{UL_grant}}$ = It is the time required to acquire and process uplink grant from the target cell. The PRACH reception at the system simulator is used as a trigger for the completion of the test; hence $T_{\text{UL_grant}}$ is not used.

$$T_{\text{UE_re-establish_delay}} = 50 \text{ ms} + N_{\text{freq}} * T_{\text{search}} + T_{\text{SLEUTRA-M1-CEModeB}} + T_{\text{PRACH}}$$

$$N_{\text{freq}} = 1$$

$$T_{\text{search}} = 0 \text{ ms}$$

$T_{SI-EUTRA-MI-CEModeB} = 6400$ ms; it is the time required for receiving all the relevant system information as defined in TS 36.331 for the target E-UTRAN TDD cell.

$T_{PRACH} = 15$ ms; it is the additional delay caused by the random access procedure.

This gives a total of 6465 ms, allow 7 s in the test case.

A.6.1.15 HD-FDD Intra-frequency RRC Re-establishment for UE category NB1 in In-Band mode under enhanced coverage

A.6.1.15.1 Test Purpose and Environment

The purpose is to verify that the NB-IoT FDD intra-frequency RRC re-establishment delay is within the specified limits. These tests will verify the requirements for Cat-NB1 UE in clause 6.5.

The test parameters are given in table A.6.1.15.1-1 and table A.6.1.15.1-2 below. nCell1 and nCell2 are NB-IoT cells with different physical cell ID on the same frequency carrier. The test consists of 3 successive time periods, with time duration of T1, T2 and T3 respectively. At the start of time period T2, cell 1, which is the active cell, is deactivated. The time period T3 starts after the occurrence of the radio link failure.

Table A.6.1.15.1-1: General test parameters for HD-FDD Intra-frequency RRC Re-establishment for UE category NB1 in In-Band mode under enhanced coverage

| Parameter | | Unit | Value | Comment |
|----------------------------|-----------------|------|------------------------|---|
| NB-IOT operational mode | | | In-band | |
| Initial condition | Active cell | | nCell1 | |
| | Neighbour cells | | eCell1, eCell2, nCell2 | |
| Final condition | Active cell | | nCell2 | |
| E-UTRA RF Channel Number | | | 1 | One carrier frequency is used for eCell1 and eCell2. |
| Access Barring Information | | - | Not Sent | No additional delays in random access procedure. |
| NPRACH Configuration | | | NPRACH.R-1 | Refer to A.3.18 |
| NPDCCH repetition level | | | 16 | NPDCCH R_{max} |
| N310 | | - | 1 | Maximum consecutive out-of-sync indications from lower layers |
| N311 | | - | 1 | Minimum consecutive in-sync indications from lower layers |
| T310 | | ms | 0 | Radio link failure timer; T310 is disabled |
| T311-v13xy | | ms | 60000 | RRC re-establishment timer |
| DRX | | | OFF | |
| T1 | | s | 5 | |
| T2 | | ms | 400 | |
| T3 | | s | 60 | |

Table A.6.1.15.1-2: nCell 1, nCell 2 specific test parameters for HD-FDD Intra-frequency RRC Re-establishment for UE category NB1 in In-Band mode under enhanced coverage

| | | nCell 1 | | | nCell 2 | | |
|---------------------------|-----|-------------|----|----|-------------|----|----|
| | | T1 | T2 | T3 | T1 | T2 | T3 |
| $BW_{channel}$ | kHz | 200 | | | 200 | | |
| PRB location within eCell | - | 30 | | | 30 | | |
| NPDSCH parameters | | R.14 HD-FDD | | | R.14 HD-FDD | | |
| NPDCCH parameters | | R.26 HD-FDD | | | R.26 HD-FDD | | |
| NOCNG Patterns | - | NOP.1 FDD | | | NOP.1 FDD | | |
| NPBCH_RA | dB | 0 | | | 0 | | |
| NPBCH_RB | dB | | | | | | |
| NPSS_RA | dB | | | | | | |
| NSSS_RA | dB | | | | | | |
| NPDCCH_RA | dB | | | | | | |

| | | | | | | | |
|--|------------|---------------------------------|-----------|-----------|-----------|--------|--------|
| NPDCCH_RB | dB | | | | | | |
| NPDSCH_RA | dB | | | | | | |
| NPDSCH_RB | dB | | | | | | |
| NOCNG_RA ^{Note 1} | dB | | | | | | |
| NOCNG_RB ^{Note 1} | dB | | | | | | |
| N_{oc} | dBm/15 kHz | Specified in Table A.6.1.15.1-3 | | | | | |
| \hat{E}_s / N_{oc} | dB | 7 | -Infinity | -Infinity | -Infinity | -12.6 | -12.6 |
| \hat{E}_s / I_{ot} ^{Note2} | dB | 7 | -Infinity | -Infinity | -Infinity | -12.6 | -12.6 |
| NRSRP ^{Note2} | dBm/15 kHz | -91 | -Infinity | -Infinity | -Infinity | -110.6 | -110.6 |
| Propagation Condition | | AWGN | | | AWGN | | |
| Antenna Configuration | | 1x1 | | | 1x1 | | |
| Timing offset to nCell 1 | ms | - | | | 3 | | |
| Note 1: NOCNG shall be used such that both cells are fully allocated and a constant total transmitted power spectral density is achieved for all OFDM symbols. | | | | | | | |
| Note 2: E_s/I_{ot} and NRSRP levels have been derived from other parameters for information purposes. They are not settable parameters themselves. | | | | | | | |

Table A.6.1.15.1-3: eCell 1 and eCell 2 specific test parameters for HD-FDD Intra-frequency RRC Re-establishment for UE category NB1 in In-Band mode under enhanced coverage

| Parameter | Unit | eCell 1 | | | eCell 2 | | |
|---|------------|---------|-------|-------|---------|-------|-------|
| | | T1 | T2 | T3 | T1 | T2 | T3 |
| $BW_{channel}$ | MHz | 10 | | | 10 | | |
| PBCH_RA | dB | | | | | | |
| PBCH_RB | dB | | | | | | |
| PSS_RA | dB | | | | | | |
| SSS_RA | dB | | | | | | |
| PDCCH_RA | dB | 0 | | | 0 | | |
| PDCCH_RB | dB | | | | | | |
| PCFICH_RB | dB | | | | | | |
| OCNG_RA ^{Note 1} | dB | | | | | | |
| OCNG_RB ^{Note 1} | dB | | | | | | |
| Qrxlevmin | dBm | -140 | -140 | -140 | -140 | -140 | -140 |
| Pcompensation | dB | 0 | 0 | 0 | 0 | 0 | 0 |
| Qhyst _s | dB | 0 | 0 | 0 | 0 | 0 | 0 |
| Qoffset _{s,n} | dB | 0 | 0 | 0 | 0 | 0 | 0 |
| N_{oc} ^{Note2} | dBm/15 kHz | -98 | | | -98 | | |
| \hat{E}_s / N_{oc} | dBm | -12.6 | -12.6 | -12.6 | -12.6 | -12.6 | -12.6 |
| Propagation Condition | | AWGN | | | AWGN | | |
| Antenna Configuration | | 1x1 | | | 1x1 | | |
| Timing offset to eCell 1 | ms | - | | | 3 | | |
| Note 1: OCNG shall be used such that the eCell is fully allocated and a constant total transmitted power spectral density is achieved for all OFDM symbols. | | | | | | | |
| Note 2: Interference from other cells and noise sources not specified in the test is assumed to be constant over subcarriers and time and shall be modelled as AWGN of appropriate power N_{oc} . | | | | | | | |
| Note 3: E_s/I_{ot} and RSRP levels have been derived from other parameters for information purposes. They are not settable parameters themselves. | | | | | | | |

A.6.1.15.2 Test Requirements

The RRC re-establishment delay is defined as the time from the start of time period T3, to the moment when the UE starts to send NPRACH preambles to cell 2 for sending the *RRConnectionReestablishmentRequest* message to cell 2.

The RRC re-establishment delay to an unknown NB-IoT FDD intra frequency cell shall be less than 58 s.

The rate of correct RRC re-establishments observed during repeated tests shall be at least 90%.

NOTE: The RRC re-establishment delay in the test is derived from the following expression:

$$T_{\text{re-establish_delay}} = T_{\text{UL_grant}} + T_{\text{UE-re-establish_delay_NB-IoT}}$$

Where:

$T_{\text{UL_grant}}$ = It is the time required to acquire and process uplink grant from the target cell. The NPRACH reception at the system simulator is used as a trigger for the completion of the test; hence $T_{\text{UL_grant}}$ is not used.

$$T_{\text{UE-re-establish_delay_NB-IoT}} = 100 \text{ ms} + N_{\text{NB-IoT-freq}} * T_{\text{search_NB-IoT}} + T_{\text{SI_NB-IoT}} + T_{\text{PRACH_NB-IoT}}$$

$$N_{\text{NB-IoT-freq}} = 1$$

$$T_{\text{search_NB-IoT}} = 14800 \text{ ms}$$

$T_{\text{SI_NB-IoT}} = 41560 \text{ ms}$; it is the time required for receiving all the relevant system information as defined in TS 36.331 for the target NB-IoT FDD cell.

$T_{\text{PRACH_NB-IoT}} = 1280 \text{ ms}$; it is the additional delay caused by the random access procedure.

A.6.1.16 HD-FDD Inter-frequency RRC Re-establishment for UE category NB1 in In-Band mode under normal coverage

A.6.1.16.1 Test Purpose and Environment

The purpose is to verify that the NB-IoT FDD inter-frequency RRC re-establishment delay is within the specified limits. These tests will verify the requirements for Cat-NB1 UE in clause 6.5.

The test parameters are given in table A.6.1.16.1-1 and table A.6.1.16.1-2 below. nCell1 and nCell2 are NB-IoT cells on different frequency carriers. The test consists of 3 successive time periods, with time duration of T1, T2 and T3 respectively. At the start of time period T2, cell 1, which is the active cell, is deactivated. The time period T3 starts after the occurrence of the radio link failure. During T1, the UE shall be indicated with the carrier frequency of nCell 2 to ensure that the UE has the context of the carrier frequency of nCell 2.

Table A.6.1.16.1-1: General test parameters for HD-FDD Inter-frequency RRC Re-establishment for UE category NB1 in In-Band mode under normal coverage

| Parameter | | Unit | Value | Comment |
|----------------------------|-----------------|------|----------------|---|
| NB-IOT operational mode | | | In-band | |
| Initial condition | Active cell | | nCell1 | |
| | Neighbour cells | | eCell1, nCell2 | |
| Final condition | Active cell | | nCell2 | |
| E-UTRA RF Channel Number | | | 1 | One carrier frequency is used for eCell. |
| Access Barring Information | | - | Not Sent | No additional delays in random access procedure. |
| NPRACH Configuration | | | NPRACH.R-1 | Refer to A.3.18 |
| NPDCCH repetition level | | | 16 | NPDCCH R_{max} |
| N310 | | - | 1 | Maximum consecutive out-of-sync indications from lower layers |
| N311 | | - | 1 | Minimum consecutive in-sync indications from lower layers |
| T310 | | ms | 0 | Radio link failure timer; T310 is disabled |
| T311 | | ms | 15000 | RRC re-establishment timer |
| DRX | | | OFF | |
| T1 | | s | 5 | |
| T2 | | ms | 400 | |
| T3 | | s | 15 | |

Table A.6.1.16.1-2: nCell 1, nCell 2 specific test parameters for HD-FDD Inter-frequency RRC Re-establishment for UE category NB1 in In-Band mode under normal coverage

| | | nCell 1 | | | nCell 2 | | |
|--|------------|---------------------------------|-----------|-----------|-------------|-----|-----|
| | | T1 | T2 | T3 | T1 | T2 | T3 |
| BW _{channel} | kHz | 200 | | | 200 | | |
| PRB location within eCell | - | 30 | | | 35 | | |
| NPDSCH parameters | | R.14 HD-FDD | | | R.14 HD-FDD | | |
| NPDCCH parameters | | R.26 HD-FDD | | | R.26 HD-FDD | | |
| NOCNG Patterns | - | NOP.1 FDD | | | NOP.1 FDD | | |
| NPBCH_RA | dB | 0 | | | 0 | | |
| NPBCH_RB | dB | | | | | | |
| NPSS_RA | dB | | | | | | |
| NSSS_RA | dB | | | | | | |
| NPDCCH_RA | dB | | | | | | |
| NPDCCH_RB | dB | | | | | | |
| NPDSCH_RA | dB | | | | | | |
| NPDSCH_RB | dB | | | | | | |
| NOCNG_RA ^{Note 1} | dB | | | | | | |
| NOCNG_RB ^{Note 1} | dB | | | | | | |
| N_{oc} | dBm/15 kHz | Specified in Table A.6.1.16.1-3 | | | | | |
| \hat{E}_s/N_{oc} | dB | 7 | -Infinity | -Infinity | -Infinity | 4 | 4 |
| \hat{E}_s/I_{ot} ^{Note2} | dB | 7 | -Infinity | -Infinity | -Infinity | 4 | 4 |
| NRSRP ^{Note2} | dBm/15 kHz | -91 | -Infinity | -Infinity | -Infinity | -94 | -94 |
| Propagation Condition | | AWGN | | | AWGN | | |
| Antenna Configuration | | 1x1 | | | 1x1 | | |
| Timing offset to nCell 1 | ms | - | | | 3 | | |
| Note 1: NOCNG shall be used such that both cells are fully allocated and a constant total transmitted power spectral density is achieved for all OFDM symbols. Note 2: Es/Iot and NRSRP levels have been derived from other parameters for information purposes. They are not settable parameters themselves. | | | | | | | |

Table A.6.1.16.1-3: eCell 1 specific test parameters for HD-FDD Inter-frequency RRC Re-establishment for UE category NB1 in In-Band mode under normal coverage

| | | eCell 1 | | |
|-------------------------------------|------------|---------|-----|-----|
| | | T1 | T2 | T3 |
| BW _{channel} | MHz | 10 | | |
| PBCH_RA | dB | 0 | | |
| PBCH_RB | dB | | | |
| PSS_RA | dB | | | |
| SSS_RA | dB | | | |
| PCFICH_RB | dB | | | |
| PDCCH_RA | dB | | | |
| PDCCH_RB | dB | | | |
| OCNG_RA ^{Note 1} | dB | | | |
| OCNG_RB ^{Note 1} | dB | | | |
| N_{oc} | dBm/15 kHz | | | |
| \hat{E}_s/N_{oc} | dB | 4 | 4 | 4 |
| \hat{E}_s/I_{ot} ^{Note2} | dB | 4 | 4 | 4 |
| RSRP ^{Note2} | dBm/15 kHz | -94 | -94 | -94 |
| Propagation Condition | | AWGN | | |
| Antenna Configuration | | 1x1 | | |

| | |
|---------|---|
| Note 1: | OCNG shall be used such that the eCell is fully allocated and a constant total transmitted power spectral density is achieved for all OFDM symbols. |
| Note 2: | Interference from other cells and noise sources not specified in the test is assumed to be constant over subcarriers and time and shall be modelled as AWGN of appropriate power N_{oc} . |
| Note 3: | Es/lot and RSRP levels have been derived from other parameters for information purposes. They are not settable parameters themselves. |

A.6.1.16.2 Test Requirements

The RRC re-establishment delay is defined as the time from the start of time period T3, to the moment when the UE starts to send NPRACH preambles to cell 2 for sending the *RRCConectionReestablishmentRequest* message to cell 2.

The RRC re-establishment delay to an unknown NB-IoT FDD inter frequency cell shall be less than 12 s.

The rate of correct RRC re-establishments observed during repeated tests shall be at least 90%.

NOTE: The RRC re-establishment delay in the test is derived from the following expression:

$$T_{\text{re-establish_delay}} = T_{\text{UL_grant}} + T_{\text{UE-re-establish_delay_NB-IoT}}$$

Where:

$T_{\text{UL_grant}}$ = It is the time required to acquire and process uplink grant from the target cell. The NPRACH reception at the system simulator is used as a trigger for the completion of the test; hence $T_{\text{UL_grant}}$ is not used.

$$T_{\text{UE-re-establish_delay_NB-IoT}} = 100 \text{ ms} + N_{\text{NB-IoT-freq}} * T_{\text{search_NB-IoT}} + T_{\text{SI_NB-IoT}} + T_{\text{PRACH_NB-IoT}}$$

$$N_{\text{NB-IoT-freq}} = 2$$

$$T_{\text{search_NB-IoT}} = 1400 \text{ ms}$$

$T_{\text{SI_NB-IoT}} = 8320 \text{ ms}$; it is the time required for receiving all the relevant system information as defined in TS 36.331 for the target NB-IoT FDD cell.

$T_{\text{PRACH_NB-IoT}} = 80 \text{ ms}$; it is the additional delay caused by the random access procedure.

A.6.2 Random Access

A.6.2.1 E-UTRAN FDD – Contention Based Random Access Test

A.6.2.1.1 Test Purpose and Environment

The purpose of this test is to verify that the behavior of the random access procedure is according to the requirements and that the PRACH power settings and timing are within specified limits. This test will verify the requirements in Clause 6.2.2 and Clause 7.1.2 in an AWGN model.

For this test a single cell is used. The test parameters are given in tables A.6.2.1.1-1 and A.6.2.1.1-2.

Table A.6.2.1.1-1: General test parameters for FDD contention based random access test

| Parameter | Unit | Value | Comments |
|------------------------------------|------|--|----------------------------|
| E-UTRA RF Channel Number | | 1 | |
| BW _{channel} | MHz | 10 | |
| OCNG Pattern ^{Note 1} | | OP.1/2 FDD ^{Note 1} | As defined in A.3.2.1.1/2. |
| PDSCH parameters ^{Note 4} | | DL Reference Measurement Channel R.0 FDD ^{Note 4} | As defined in A.3.1.1.1. |
| PCFICH/PDCCH/PHICH | | DL Reference Measurement | As defined in A.3.1.2.1. |

| parameters | | Channel R.6 FDD | |
|--|------------|-----------------|---|
| PBCH_RA | dB | | |
| PBCH_RB | dB | | |
| PSS_RA | dB | | |
| SSS_RA | dB | | |
| PCFICH_RB | dB | | |
| PHICH_RA | dB | | |
| PHICH_RB | dB | 0 | |
| PDCCH_RA | dB | | |
| PDCCH_RB | dB | | |
| PDSCH_RA | dB | | |
| PDSCH_RB | dB | | |
| OCNG_RA ^{Note 1} | dB | | |
| OCNG_RB ^{Note 1} | dB | | |
| \hat{E}_s/I_{ot} | dB | 3 | |
| N_{oc} | dBm/15 KHz | -98 | |
| \hat{E}_s/N_{oc} | dB | 3 | |
| I_o ^{Note 2} | dBm/9 MHz | -65.5 | |
| RSRP ^{Note 3} | dBm/15 KHz | -95 | |
| referenceSignalPower | dBm/15 KHz | -5 | As defined in clause 6.3.2 in TS 36.331. |
| Configured UE transmitted power (P_{CMAX}) | dBm | 23 | As defined in clause 6.2.5 in TS 36.101. |
| PRACH Configuration Index | - | 4 | As defined in table 5.7.1-2 in TS 36.211. |
| Backoff Parameter Index | - | 2 | As defined in table 7.2-1 in TS 36.321. |
| Propagation Condition | - | AWGN | |
| <p>Note 1: OCNG shall be used such that the cell is fully allocated and a constant total transmitted power spectral density is achieved for all OFDM symbols. The OCNG pattern is chosen during the test according to the presence of a DL reference measurement channel.</p> <p>Note 2: I_o level has been derived from other parameters for information purpose. It is not a settable parameter.</p> <p>Note 3: RSRP level has been derived from other parameters for information purposes. It is not a settable parameter.</p> <p>Note 4: The DL PDSCH reference measurement channel is used in the test only when a downlink transmission dedicated to the UE under test is required.</p> | | | |

Table A.6.2.1.1-2: RACH-Configuration parameters for FDD contention based random access test

| Field | Value | Comment |
|--|---------|---------------|
| powerRampingStep | dB2 | |
| preambleInitialReceivedTargetPower | dBm-120 | |
| preambleTransMax | n6 | |
| ra-ResponseWindowSize | sf10 | 10 sub-frames |
| mac-ContentionResolutionTimer | sf48 | 48 sub-frames |
| maxHARQ-Msg3Tx | 4 | |
| Note: For further information see Clause 6.3.2 in TS 36.331. | | |

A.6.2.1.2 Test Requirements

Contention based random access is triggered by *not* explicitly assigning a random access preamble via dedicated signalling in the downlink.

A.6.2.1.2.1 Random Access Response Reception

To test the UE behavior specified in Subclause 6.2.2.1.1 the System Simulator shall transmit a Random Access Response containing a Random Access Preamble identifier corresponding to the transmitted Random Access Preamble

after 5 preambles have been received by the System Simulator. In response to the first 4 preambles, the System Simulator shall transmit a Random Access Response *not* corresponding to the transmitted Random Access Preamble.

The UE may stop monitoring for Random Access Response(s) and shall transmit the msg3 if the Random Access Response contains a Random Access Preamble identifier corresponding to the transmitted Random Access Preamble.

The UE shall re-select a preamble and transmit with the calculated PRACH transmission power when the backoff time expires if all received Random Access Responses contain Random Access Preamble identifiers that do not match the transmitted Random Access Preamble.

In addition, the power applied to all preambles shall be in accordance with what is specified in Subclause 6.2.2. The power of the first preamble shall be -30 dBm. The power of the first preamble shall be -30 dBm with an accuracy specified in clause 6.3.5.1.1 of TS 36.101 [5]. The relative power applied to additional preambles shall have an accuracy specified in clause 6.3.5.2.1 of TS 36.101 [5].

The transmit timing of all PRACH transmissions shall be within the accuracy specified in Subclause 7.1.2.

A.6.2.1.2.2 No Random Access Response Reception

To test the UE behavior specified in subclause 6.2.2.1.2 the System Simulator shall transmit a Random Access Response containing a Random Access Preamble identifier corresponding to the transmitted Random Access Preamble after 5 preambles have been received by the System Simulator. The System Simulator shall *not* respond to the first 4 preambles.

The UE shall re-select a preamble and transmit with the calculated PRACH transmission power when the backoff time expires if no Random Access Response is received within the RA Response window.

In addition, the power applied to all preambles shall be in accordance with what is specified in Subclause 6.2.2. The power of the first preamble shall be -30 dBm with an accuracy specified in clause 6.3.5.1.1 of TS 36.101 [5]. The relative power applied to additional preambles shall have an accuracy specified in clause 6.3.5.2.1 of TS 36.101 [5].

The transmit timing of all PRACH transmissions shall be within the accuracy specified in Subclause 7.1.2.

A.6.2.1.2.3 Receiving a NACK on msg3

To test the UE behavior specified in subclause 6.2.2.1.3 the System Simulator shall NACK *all* UE msg3 following a successful Random Access Response.

The UE shall re-transmit the msg3 upon the reception of a NACK on msg3 until the maximum number of HARQ re-transmissions is reached.

A.6.2.1.2.4 Reception of an Incorrect Message over Temporary C-RNTI

To test the UE behavior specified in Subclause 6.2.2.1.5 the System Simulator shall send a message addressed to the temporary C-RNTI with a UE Contention Resolution Identity included in the MAC control element *not* matching the CCCH SDU transmitted in msg3 uplink message.

The UE shall re-select a preamble and transmit with the calculated PRACH transmission power when the backoff time expires unless the received message includes a UE Contention Resolution Identity MAC control element and the UE Contention Resolution Identity included in the MAC control element matches the CCCH SDU transmitted in the uplink message.

A.6.2.1.2.5 Reception of a Correct Message over Temporary C-RNTI

To test the UE behavior specified in Subclause 6.2.2.1.5 the System Simulator shall send a message addressed to the temporary C-RNTI with a UE Contention Resolution Identity included in the MAC control element matching the CCCH SDU transmitted in the msg3 uplink message.

The UE shall send ACK if the Contention Resolution is successful.

A.6.2.1.2.6 Contention Resolution Timer expiry

To test the UE behavior specified in Subclause 6.2.2.1.6 the System Simulator shall *not* send a response to a msg3.

The UE shall re-select a preamble and transmit with the calculated PRACH transmission power when the backoff time expires if the Contention Resolution Timer expires.

A.6.2.2 E-UTRAN FDD – Non-Contention Based Random Access Test

A.6.2.2.1 Test Purpose and Environment

The purpose of this test is to verify that the behavior of the random access procedure is according to the requirements and that the PRACH power settings and timing are within specified limits. This test will verify the requirements in Clause 6.2.2 and Clause 7.1.2 in an AWGN model.

For this test a single cell is used. The test parameters are given in tables A.6.2.2.1-1 and A.6.2.2.1-2.

Table A.6.2.2.1-1: General test parameters for FDD non-contention based random access test

| Parameter | Unit | Value | Comments | |
|--|------------|--|---|--|
| E-UTRA RF Channel Number | | 1 | | |
| BW_{channel} | MHz | 10 | | |
| OCNG Pattern | | OP.1 FDD | As defined in A.3.2.1.1. | |
| PDSCH parameters | | DL Reference Measurement Channel R.0 FDD | As defined in A.3.1.1.1. | |
| PCFICH/PDCCH/PHICH parameters | | DL Reference Measurement Channel R.6 FDD | As defined in A.3.1.2.1. | |
| PBCH_RA | dB | 0 | | |
| PBCH_RB | dB | | | |
| PSS_RA | dB | | | |
| SSS_RA | dB | | | |
| PCFICH_RB | dB | | | |
| PHICH_RA | dB | | | |
| PHICH_RB | dB | | | |
| PDCCH_RA | dB | | | |
| PDCCH_RB | dB | | | |
| PDSCH_RA | dB | | | |
| PDSCH_RB | dB | | | |
| OCNG_RA ^{Note 1} | dB | | | |
| OCNG_RB ^{Note 1} | dB | | | |
| $\hat{E}_s / I_{\text{ot}}$ | dB | | 3 | |
| N_{oc} | dBm/15 KHz | | -98 | |
| $\hat{E}_s / N_{\text{oc}}$ | dB | 3 | | |
| I_0 ^{Note 2} | dBm/9 MHz | -65.5 | | |
| RSRP ^{Note 3} | dBm/15 KHz | -95 | | |
| referenceSignalPower | dBm/15 KHz | -5 | As defined in clause 6.3.2 in TS 36.331. | |
| Configured UE transmitted power (P_{CMAX}) | dBm | 23 | As defined in clause 6.2.5 in TS 36.101. | |
| PRACH Configuration Index | - | 4 | As defined in table 5.7.1-2 in TS 36.211. | |
| Backoff Parameter Index | - | 2 | As defined in table 7.2-1 in TS 36.321. | |
| Propagation Condition | - | AWGN | | |
| Note 1: OCNG shall be used such that the cell is fully allocated and a constant total transmitted power spectral density is achieved for all OFDM symbols. Note 2: I_0 level has been derived from other parameters for information purpose. It is not a settable parameter. Note 3: RSRP level has been derived from other parameters for information purposes. It is not a settable parameter. | | | | |

Table A.6.2.2.1-2: RACH-Configuration parameters for FDD non-contention based random access test

| Field | Value | Comment |
|--|---------|---------------|
| powerRampingStep | dB2 | |
| preambleInitialReceivedTargetPower | dBm-120 | |
| preambleTransMax | n6 | |
| ra-ResponseWindowSize | sf10 | 10 sub-frames |
| Note: For further information see Clause 6.3.2 in TS 36.331. | | |

A.6.2.2.2 Test Requirements

Non-Contention based random access is triggered by explicitly assigning a random access preamble via dedicated signalling in the downlink.

A.6.2.2.2.1 Random Access Response Reception

To test the UE behavior specified in Subclause 6.2.2.2.1 the System Simulator shall transmit a Random Access Response containing a Random Access Preamble identifier corresponding to the transmitted Random Access Preamble after 5 preambles have been received by the System Simulator. In response to the first 4 preambles, the System Simulator shall transmit a Random Access Response *not* corresponding to the transmitted Random Access Preamble.

The UE may stop monitoring for Random Access Response(s) if the Random Access Response contains a Random Access Preamble identifier corresponding to the transmitted Random Access Preamble.

The UE shall re-transmit the preamble with the calculated PRACH transmission power if all received Random Access Responses contain Random Access Preamble identifiers that do not match the transmitted Random Access Preamble.

In addition, the power applied to all preambles shall be in accordance with what is specified in Subclause 6.2.2. The power of the first preamble shall be -30 dBm with an accuracy specified in clause 6.3.5.1.1 of TS 36.101 [5]. The relative power applied to additional preambles shall have an accuracy specified in clause 6.3.5.2.1 of TS 36.101 [5].

The transmit timing of all PRACH transmissions shall be within the accuracy specified in Subclause 7.1.2.

A.6.2.2.2.2 No Random Access Response Reception

To test the UE behavior specified in subclause 6.2.2.2.2 the System Simulator shall transmit a Random Access Response containing a Random Access Preamble identifier corresponding to the transmitted Random Access Preamble after 5 preambles have been received by the System Simulator. The System Simulator shall *not* respond to the first 4 preambles.

The UE shall re-transmit the preamble with the calculated PRACH transmission power.

In addition, the power applied to all preambles shall be in accordance with what is specified in Subclause 6.2.2. The power of the first preamble shall be -30 dBm with an accuracy specified in clause 6.3.5.1.1 of TS 36.101 [5]. The relative power applied to additional preambles shall have an accuracy specified in clause 6.3.5.2.1 of TS 36.101 [5].

The transmit timing of all PRACH transmissions shall be within the accuracy specified in Subclause 7.1.2.

A.6.2.3 E-UTRAN TDD – Contention Based Random Access Test

A.6.2.3.1 Test Purpose and Environment

The purpose of this test is to verify that the behavior of the random access procedure is according to the requirements and that the PRACH power settings and timing are within specified limits. This test will verify the requirements in Clause 6.2.2 and Clause 7.1.2 in an AWGN model.

For this test a single cell is used. The test parameters are given in tables A.6.2.3.1-1 and A.6.2.3.1-2.

Table A.6.2.3.1-1: General test parameters for TDD contention based random access test

| Parameter | Unit | Value | Comments |
|--|------------|--|---|
| E-UTRA RF Channel Number | - | 1 | |
| BW_{channel} | MHz | 10 | |
| OCNG Pattern ^{Note 1} | - | OP.1/2 TDD ^{Note 1} | As defined in A.3.2.2.1/2. |
| PDSCH parameters ^{Note 4} | - | DL Reference Measurement Channel R.0 TDD ^{Note 4} | As defined in A.3.1.1.2. |
| PCFICH/PDCCH/PHICH parameters | - | DL Reference Measurement Channel R.6 TDD | As defined in A.3.1.2.2. |
| Special subframe configuration | - | 6 | As specified in table 4.2-1 in TS 36.211. |
| Uplink-downlink configuration | - | 1 | As specified in table 4.2-2 in TS 36.211. |
| PBCH_RA | dB | 0 | |
| PBCH_RB | dB | | |
| PSS_RA | dB | | |
| SSS_RA | dB | | |
| PCFICH_RB | dB | | |
| PHICH_RA | dB | | |
| PHICH_RB | dB | | |
| PDCCH_RA | dB | | |
| PDCCH_RB | dB | | |
| PDSCH_RA | dB | | |
| PDSCH_RB | dB | | |
| OCNG_RA ^{Note 1} | dB | | |
| OCNG_RB ^{Note 1} | dB | | |
| $\hat{E}_s / I_{\text{ot}}$ | dB | | 3 |
| N_{oc} | dBm/15 KHz | -98 | |
| $\hat{E}_s / N_{\text{oc}}$ | dB | 3 | |
| I_0 ^{Note 2} | dBm/9 MHz | -65.5 | |
| RSRP ^{Note 3} | dBm/15 KHz | -95 | |
| referenceSignalPower | dBm/15 KHz | -5 | As defined in clause 6.3.2 in TS 36.331. |
| Configured UE transmitted power (P_{CMAX}) | dBm | 23 | As defined in clause 6.2.5 in TS 36.101. |
| PRACH Configuration Index | - | 53 | As defined in table 5.7.1-3 in TS 36.211. |
| Backoff Parameter Index | - | 2 | As defined in table 7.2-1 in TS 36.321. |
| Propagation Condition | - | AWGN | |
| <p>Note 1: OCNG shall be used such that the cell is fully allocated and a constant total transmitted power spectral density is achieved for all OFDM symbols. The OCNG pattern is chosen during the test according to the presence of a DL reference measurement channel.</p> <p>Note 2: I_0 level has been derived from other parameters for information purpose. It is not a settable parameter.</p> <p>Note 3: RSRP level has been derived from other parameters for information purposes. It is not a settable parameter.</p> <p>Note 4: The DL PDSCH reference measurement channel is used in the test only when a downlink transmission dedicated to the UE under test is required.</p> | | | |

Table A.6.2.3.1-2: RACH-Configuration parameters for TDD contention based random access test

| Field | Value | Comment |
|------------------------------------|---------|---------------|
| numberOfRA-Preambles | n52 | |
| sizeOfRA-PreamblesGroupA | n52 | No group B. |
| powerRampingStep | dB2 | |
| preambleInitialReceivedTargetPower | dBm-120 | |
| preambleTransMax | n6 | |
| ra-ResponseWindowSize | sf10 | 10 sub-frames |
| mac-ContentionResolutionTimer | sf48 | 48 sub-frames |

| | | |
|--|---|--|
| maxHARQ-Msg3Tx | 4 | |
| Note: For further information see Clause 6.3.2 in TS 36.331. | | |

A.6.2.3.2 Test Requirements

Contention based random access is triggered by *not* explicitly assigning a random access preamble via dedicated signalling in the downlink.

A.6.2.3.2.1 Random Access Response Reception

To test the UE behavior specified in Subclause 6.2.2.1.1 the System Simulator shall transmit a Random Access Response containing a Random Access Preamble identifier corresponding to the transmitted Random Access Preamble after 5 preambles have been received by the System Simulator. In response to the first 4 preambles, the System Simulator shall transmit a Random Access Response *not* corresponding to the transmitted Random Access Preamble.

The UE may stop monitoring for Random Access Response(s) and shall transmit the msg3 if the Random Access Response contains a Random Access Preamble identifier corresponding to the transmitted Random Access Preamble.

The UE shall re-select a preamble and transmit with the calculated PRACH transmission power when the backoff time expires if all received Random Access Responses contain Random Access Preamble identifiers that do not match the transmitted Random Access Preamble.

In addition, the power applied to all preambles shall be in accordance with what is specified in Subclause 6.2.2. The power of the first preamble shall be -22 dBm with an accuracy specified in clause 6.3.5.1.1 of TS 36.101 [5]. The relative power applied to additional preambles shall have an accuracy specified in clause 6.3.5.2.1 of TS 36.101 [5].

The transmit timing of all PRACH transmissions shall be within the accuracy specified in Subclause 7.1.2.

A.6.2.3.2.2 No Random Access Response reception

To test the UE behavior specified in Subclause 6.2.2.1.2 the System Simulator shall transmit a Random Access Response containing a Random Access Preamble identifier corresponding to the transmitted Random Access Preamble after 5 preambles have been received by the System Simulator. The System Simulator shall *not* respond to the first 4 preambles.

The UE shall re-select a preamble and transmit with the calculated PRACH transmission power when the backoff time expires if no Random Access Response is received within the RA Response window.

In addition, the power applied to all preambles shall be in accordance with what is specified in Subclause 6.2.2. The power of the first preamble shall be -22 dBm with an accuracy specified in clause 6.3.5.1.1 of TS 36.101 [5]. The relative power applied to additional preambles shall have an accuracy specified in clause 6.3.5.2.1 of TS 36.101 [5].

The transmit timing of all PRACH transmissions shall be within the accuracy specified in Subclause 7.1.2.

A.6.2.3.2.3 Receiving a NACK on msg3

To test the UE behavior specified in Subclause 6.2.2.1.3 the System Simulator shall NACK *all* UE msg3 following a successful Random Access Response.

The UE shall re-transmit the msg3 upon the reception of a NACK on msg3 until the maximum number of HARQ re-transmissions is reached.

A.6.2.3.2.4 Reception of an Incorrect Message over Temporary C-RNTI

To test the UE behavior specified in Subclause 6.2.2.1.5 the System Simulator shall send a message addressed to the temporary C-RNTI with a UE Contention Resolution Identity included in the MAC control element *not* matching the CCCH SDU transmitted in msg3 uplink message.

The UE shall re-select a preamble and transmit with the calculated PRACH transmission power when the backoff time expires unless the received message includes a UE Contention Resolution Identity MAC control element and the UE Contention Resolution Identity included in the MAC control element matches the CCCH SDU transmitted in the uplink message.

A.6.2.3.2.5 Reception of a Correct Message over Temporary C-RNTI

To test the UE behavior specified in Subclause 6.2.2.1.5 the System Simulator shall send a message addressed to the temporary C-RNTI with a UE Contention Resolution Identity included in the MAC control element matching the CCCH SDU transmitted in the msg3 uplink message.

The UE shall send ACK if the Contention Resolution is successful.

A.6.2.3.2.6 Contention Resolution Timer expiry

To test the UE behavior specified in Subclause 6.2.2.1.6 the System Simulator shall *not* send a response to a msg3.

The UE shall re-select a preamble and transmit with the calculated PRACH transmission power when the backoff time expires if the Contention Resolution Timer expires.

A.6.2.4 E-UTRAN TDD – Non-Contention Based Random Access Test

A.6.2.4.1 Test Purpose and Environment

The purpose of this test is to verify that the behavior of the random access procedure is according to the requirements and that the PRACH power settings and timing are within specified limits. This test will verify the requirements in Clause 6.2.2 and Clause 7.1.2 in an AWGN model.

For this test a single cell is used. The test parameters are given in tables A.6.2.4.1-1 and A.6.2.4.1-2.

Table A.6.2.4.1-1: General test parameters for TDD non-contention based random access test

| Parameter | Unit | Value | Comments | |
|--------------------------------|------------|--|---|--|
| E-UTRA RF Channel Number | - | 1 | | |
| BW _{channel} | MHz | 10 | | |
| OCNG Pattern | - | OP.1 TDD | As defined in A.3.2.2.1. | |
| PDSCH parameters | - | DL Reference Measurement Channel R.0 TDD | As defined in A.3.1.1.2. | |
| PCFICH/PDCCH/PHICH parameters | - | DL Reference Measurement Channel R.6 TDD | As defined in A.3.1.2.2. | |
| Special subframe configuration | - | 6 | As specified in table 4.2-1 in TS 36.211. | |
| Uplink-downlink configuration | - | 1 | As specified in table 4.2-2 in TS 36.211. | |
| PBCH_RA | dB | 0 | | |
| PBCH_RB | dB | | | |
| PSS_RA | dB | | | |
| SSS_RA | dB | | | |
| PCFICH_RB | dB | | | |
| PHICH_RA | dB | | | |
| PHICH_RB | dB | | | |
| PDCCH_RA | dB | | | |
| PDCCH_RB | dB | | | |
| PDSCH_RA | dB | | | |
| PDSCH_RB | dB | | | |
| OCNG_RA ^{Note 1} | dB | | | |
| OCNG_RB ^{Note 1} | dB | | | |
| \hat{E}_s/I_{ot} | dB | | 3 | |
| N_{oc} | dBm/15 KHz | | -98 | |
| \hat{E}_s/N_{oc} | dB | | 3 | |
| I_o ^{Note 2} | dBm/9 MHz | -65.5 | | |
| RSRP ^{Note 3} | dBm/15 KHz | -95 | | |
| referenceSignalPower | dBm/15 KHz | -5 | As defined in clause 6.3.2 in TS 36.331. | |
| Configured UE transmitted | dBm | 23 | As defined in clause 6.2.5 in TS 36.101. | |

| | | | |
|--|---|------|---|
| power (P_{CMAX}) | | | |
| PRACH Configuration Index | - | 53 | As defined in table 5.7.1-3 in TS 36.211. |
| Backoff Parameter Index | - | 2 | As defined in table 7.2-1 in TS 36.321. |
| Propagation Condition | - | AWGN | |
| <p>Note 1: OCNG shall be used such that the cell is fully allocated and a constant total transmitted power spectral density is achieved for all OFDM symbols.</p> <p>Note 2: lo level has been derived from other parameters for information purpose. It is not a settable parameter.</p> <p>Note 3: RSRP level has been derived from other parameters for information purposes. It is not a settable parameter.</p> | | | |

Table A.6.2.4.1-2: RACH-Configuration parameters for TDD non-contention based random access test

| Field | Value | Comment |
|--|---------|---------------|
| powerRampingStep | dB2 | |
| preambleInitialReceivedTargetPower | dBm-120 | |
| preambleTransMax | n6 | |
| ra-ResponseWindowSize | sf10 | 10 sub-frames |
| Note: For further information see Clause 6.3.2 in TS 36.331. | | |

A.6.2.4.2 Test Requirements

Non-Contention based random access is triggered by explicitly assigning a random access preamble via dedicated signalling in the downlink.

A.6.2.4.2.1 Random Access Response Reception

To test the UE behavior specified in Subclause 6.2.2.2.1 the System Simulator shall transmit a Random Access Response containing a Random Access Preamble identifier corresponding to the transmitted Random Access Preamble after 5 preambles have been received by the System Simulator. In response to the first 4 preambles, the System Simulator shall transmit a Random Access Response *not* corresponding to the transmitted Random Access Preamble.

The UE may stop monitoring for Random Access Response(s) if the Random Access Response contains a Random Access Preamble identifier corresponding to the transmitted Random Access Preamble.

The UE shall re-transmit the preamble with the calculated PRACH transmission power if all received Random Access Responses contain Random Access Preamble identifiers that do not match the transmitted Random Access Preamble.

In addition, the power applied to all preambles shall be in accordance with what is specified in Subclause 6.2.2. The power of the first preamble shall be -22 dBm with an accuracy specified in clause 6.3.5.1.1 of TS 36.101 [5]. The relative power applied to additional preambles shall have an accuracy specified in clause 6.3.5.2.1 of TS 36.101 [5].

The transmit timing of all PRACH transmissions shall be within the accuracy specified in Subclause 7.1.2.

A.6.2.4.2.2 No Random Access Response Reception

To test the UE behavior specified in Subclause 6.2.2.2.2 the System Simulator shall transmit a Random Access Response containing a Random Access Preamble identifier corresponding to the transmitted Random Access Preamble after 5 preambles have been received by the System Simulator. The System Simulator shall *not* respond to the first 4 preambles.

The UE shall re-transmit the preamble with the calculated PRACH transmission power.

In addition, the power applied to all preambles shall be in accordance with what is specified in Subclause 6.2.2. The power of the first preamble shall be -22 dBm with an accuracy specified in clause 6.3.5.1.1 of TS 36.101 [5]. The relative power applied to additional preambles shall have an accuracy specified in clause 6.3.5.2.1 of TS 36.101 [5].

The transmit timing of all PRACH transmissions shall be within the accuracy specified in Subclause 7.1.2.

A.6.2.5 E-UTRAN FDD – Contention Based Random Access Test for 5MHz bandwidth

A.6.2.5.1 Test Purpose and Environment

The purpose of this test case is the same as for the test defined in subclause A.6.2.1.1.

The parameters of this test are the same as defined in Subclause A.6.2.1.1 except that the values of the parameters in the Table A.6.2.5.1-1 will replace the values of the corresponding parameters in A.6.2.1.1-1

Table A.6.2.5.1-1: General test parameters for FDD contention based random access test for 5MHz bandwidth

| Parameter | Unit | Value | Comments |
|------------------------------------|--|--|------------------------------|
| BW _{channel} | MHz | 5 | |
| OCNG Pattern ^{Note 1} | | OP.15/16 FDD ^{Note 1} | As defined in A.3.2.1.15/16. |
| PDSCH parameters ^{Note 2} | | DL Reference Measurement Channel R.5 FDD ^{Note 2} | As defined in A.3.1.1.1. |
| PCFICH/PDCCH/PHICH parameters | | DL Reference Measurement Channel R.11 FDD | As defined in A.3.1.2.1. |
| I _o ^{Note 2} | dBm/4.5 MHz | -68.5 | |
| Note 1: | OCNG shall be used such that the cell is fully allocated and a constant total transmitted power spectral density is achieved for all OFDM symbols. The OCNG pattern is chosen during the test according to the presence of a DL reference measurement channel. | | |
| Note 2: | The DL PDSCH reference measurement channel is used in the test only when a downlink transmission dedicated to the UE under test is required. | | |
| Note 3: | See Table A.6.2.1.1-1 for the other parameters. | | |
| Note 4: | This test is according to the principle defined in section A.3.7.2. | | |

A.6.2.5.2 Test Requirements

The test requirements defined in section A.6.2.1.2 shall apply to this test case.

A.6.2.6 E-UTRAN FDD – Non-contention Based Random Access Test for 5MHz bandwidth

A.6.2.6.1 Test Purpose and Environment

The purpose of this test case is the same as for the test defined in subclause A.6.2.2.1.

The parameters of this test are the same as defined in Subclause A.6.2.2.1 except that the values of the parameters in the Table A.6.2.6.1-1 will replace the values of the corresponding parameters in A.6.2.2.1-1

Table A.6.2.6.1-1: General test parameters for FDD non-contention based random access test for 5MHz bandwidth

| Parameter | Unit | Value | Comments |
|------------------------------------|--|--|---------------------------|
| BW _{channel} | MHz | 5 | |
| OCNG Pattern ^{Note 1} | | OP.15 FDD ^{Note 1} | As defined in A.3.2.1.15. |
| PDSCH parameters ^{Note 2} | | DL Reference Measurement Channel R.5 FDD ^{Note 2} | As defined in A.3.1.1.1. |
| PCFICH/PDCCH/PHICH parameters | | DL Reference Measurement Channel R.11 FDD | As defined in A.3.1.2.1. |
| I _o ^{Note 2} | dBm/4.5 MHz | -68.5 | |
| Note 1: | OCNG shall be used such that the cell is fully allocated and a constant total transmitted power spectral density is achieved for all OFDM symbols. | | |
| Note 2: | I _o level has been derived from other parameters for information purpose. It is not a settable parameter | | |

Note 3: See Table A.6.2.2.1-1 for the other parameters.
 Note 4: This test is according to the principle defined in section A.3.7.2.

A.6.2.6.2 Test Requirements

The test requirements defined in section A.6.2.2.2 shall apply to this test case.

A.6.2.7 E-UTRAN FDD – Non-Contention Based Random Access Test For SCell

A.6.2.7.1 Test Purpose and Environment

The purpose of this test is to verify that the behavior of the random access procedure, for the SCell, is according to the requirements and that the PRACH power settings and timing, for the SCell, are within specified limits. This test will verify the requirements in Clause 6.2.2 and Clause 7.1.2 in an AWGN model.

For this test two cells are used. Cell 1 is PCell and Cell 2 is SCell. PCell and SCell are different timing advance group. Cell 1 is in the primary Timing Advance Group (pTAG) and Cell 2 is in the secondary Timing Advance Group (sTAG). The purpose of the PCell is to allow the SCell to be configured and to handle the Random Access Response which takes place on PCell. The test parameters are given in tables A.6.2.7.1-1 and A.6.2.7.1-2.

Table A.6.2.7.1-1: General test parameters for FDD non-contention based random access test

| Parameter | Unit | Cell 1 | Cell 2 | Comments |
|-------------------------------|------------|--|--|---|
| E-UTRA RF Channel Number | | 1 | 2 | |
| BW _{channel} | MHz | 10 | 10 | |
| Active PCell | | Cell 1 | | Primary cell of RF channel number 1. |
| Active SCell | | | Cell 2 | Secondary cell of RF channel number 2. |
| TAG configuration | | pTAG | sTAG | pTAG+sTAG configures Cell 1 and Cell 2 to separate TAGs |
| OCNG Pattern | | OP.1 FDD | OP.1 FDD | As defined in A.3.2.1.11. |
| PDSCH parameters | | DL Reference Measurement Channel R.0 FDD | DL Reference Measurement Channel R.0 FDD | As defined in A.3.1.1.1. |
| PCFICH/PDCCH/PHICH parameters | | DL Reference Measurement Channel R.6 FDD | DL Reference Measurement Channel R.6 FDD | As defined in A.3.1.2.1. |
| PBCH_RA | dB | | | |
| PBCH_RB | dB | | | |
| PSS_RA | dB | | | |
| SSS_RA | dB | | | |
| PCFICH_RB | dB | | | |
| PHICH_RA | dB | | | |
| PHICH_RB | dB | 0 | 0 | |
| PDCCH_RA | dB | | | |
| PDCCH_RB | dB | | | |
| PDSCH_RA | dB | | | |
| PDSCH_RB | dB | | | |
| OCNG_RA ^{Note 1} | dB | | | |
| OCNG_RB ^{Note 1} | dB | | | |
| \hat{E}_s/I_{ot} | dB | 3 | 3 | |
| N_{oc} | dBm/15 KHz | -98 | -98 | |

| | | | | |
|--|------------|-------|-------|---|
| \hat{E}_s / N_{oc} | dB | 3 | 3 | |
| I_o ^{Note 2} | dBm/9 MHz | -65.5 | -65.5 | |
| RSRP ^{Note 3} | dBm/15 KHz | -95 | -95 | |
| referenceSignalPower | dBm/15 KHz | -5 | -5 | As defined in clause 6.3.2 in TS 36.331. |
| Configured UE transmitted power ($P_{CMAX,c}$) | dBm | 23 | 23 | As defined in clause 6.2.5 in TS 36.101. |
| PRACH Configuration Index | - | 4 | 4 | As defined in table 5.7.1-2 in TS 36.211. |
| Backoff Parameter Index | - | 2 | 2 | As defined in table 7.2-1 in TS 36.321. |
| Propagation Condition | - | AWGN | AWGN | |
| Note 1: OCNG shall be used such that the cell is fully allocated and a constant total transmitted power spectral density is achieved for all OFDM symbols. | | | | |
| Note 2: I_o level has been derived from other parameters for information purpose. It is not a settable parameter. | | | | |
| Note 3: RSRP level has been derived from other parameters for information purposes. It is not a settable parameter. | | | | |

Table A.6.2.7.1-2: RACH-Configuration parameters for FDD non-contention based random access test

| Field | Value | Comment |
|--|---------|---------------|
| powerRampingStep | dB2 | |
| preambleInitialReceivedTargetPower | dBm-120 | |
| preambleTransMax | n6 | |
| ra-ResponseWindowSize | sf10 | 10 sub-frames |
| Note: For further information see Clause 6.3.2 in TS 36.331. | | |

A.6.2.7.2 Test Requirements

Non-Contention based random access is triggered by explicitly assigning a random access preamble via dedicated signalling in the downlink.

A.6.2.7.2.1 Random Access Response Reception

To test the UE behavior specified in Subclause 6.2.2.2.1 the System Simulator shall transmit, on Cell 1, the PCell, a Random Access Response containing a Random Access Preamble identifier corresponding to the transmitted Random Access Preamble after 5 preambles have been received by the System Simulator, on Cell 2. In response to the first 4 preambles, the System Simulator shall transmit a Random Access Response *not* corresponding to the transmitted Random Access Preamble.

The UE may stop monitoring for Random Access Response(s) if the Random Access Response contains a Random Access Preamble identifier corresponding to the transmitted Random Access Preamble.

The UE shall re-transmit the preamble with the calculated PRACH transmission power if all received Random Access Responses contain Random Access Preamble identifiers that do not match the transmitted Random Access Preamble.

In addition, the power applied to all preambles shall be in accordance with what is specified in Subclause 6.2.2. The power of the first preamble shall be -30 dBm with an accuracy specified in clause 6.3.5.1.1 of TS 36.101 [5]. The relative power applied to additional preambles shall have an accuracy specified in clause 6.3.5.2.1 of TS 36.101 [5].

The transmit timing of all PRACH transmissions shall be within the accuracy specified in Subclause 7.1.2.

A.6.2.7.2.2 No Random Access Response Reception

To test the UE behavior specified in subclause 6.2.2.2.2 the System Simulator shall transmit, on Cell 1, the PCell, a Random Access Response containing a Random Access Preamble identifier corresponding to the transmitted Random Access Preamble after 5 preambles have been received by the System Simulator on Cell 2. The System Simulator shall *not* respond to the first 4 preambles.

The UE shall re-transmit the preamble with the calculated PRACH transmission power.

In addition, the power applied to all preambles shall be in accordance with what is specified in Subclause 6.2.2. The power of the first preamble shall be -30 dBm with an accuracy specified in clause 6.3.5.1.1 of TS 36.101 [5]. The relative power applied to additional preambles shall have an accuracy specified in clause 6.3.5.2.1 of TS 36.101 [5].

The transmit timing of all PRACH transmissions shall be within the accuracy specified in Subclause 7.1.2.

A.6.2.7.2.3 Stop Preamble transmission if maximum number of preamble transmission counter has been reached

To test the UE behavior specified in Subclause 6.2.2 the System Simulator shall transmit, in response to the first 6 preambles, a Random Access Response *not* corresponding to the transmitted Random Access Preamble on Cell 1, the PCell. The UE shall stop transmitting preambles after 6 preambles.

The UE shall re-transmit the preamble with the calculated PRACH transmission power.

In addition, the power applied to all preambles shall be in accordance with what is specified in Subclause 6.2.2. The power of the first preamble shall be -30 dBm with an accuracy specified in clause 6.3.5.1.1 of TS 36.101 [5]. The relative power applied to additional preambles shall have an accuracy specified in clause 6.3.5.2.1 of TS 36.101 [5].

The transmit timing of all PRACH transmissions shall be within the accuracy specified in Subclause 7.1.2.

A.6.2.8 E-UTRAN TDD – Non-Contention Based Random Access Test For SCell

A.6.2.8.1 Test Purpose and Environment

This test is applicable for UE supporting the optional capability of Multiple Timing Advance.

The purpose of this test is to verify that the behavior of the random access procedure, for the SCell, is according to the requirements and that the PRACH power settings and timing, for the SCell, are within specified limits. This test will verify the requirements in Clause 6.2.2 and Clause 7.1.2 in an AWGN model.

For this test two cells are used. Cell 1 is PCell and Cell 2 is SCell. PCell and SCell are different timing advance group. Cell 1 is in the primary Timing Advance Group (pTAG) and Cell 2 is in the secondary Timing Advance Group (sTAG). The purpose of the PCell is to allow the SCell to be configured and to handle the Random Access Response which takes place on PCell. The test parameters are given in tables A.6.2.8.1-1 and A.6.2.8.1-2.

Table A.6.2.8.1-1: General test parameters for TDD non-contention based random access test

| Parameter | Unit | Cell 1 | Cell 2 | Comments |
|--------------------------------|------|--|--|---|
| E-UTRA RF Channel Number | - | 1 | 1 | |
| BW _{channel} | MHz | 10 | 10 | |
| Active PCell | | Cell 1 | | Primary cell of RF channel number 1. |
| Active SCell | | | Cell 2 | Secondary cell of RF channel number 2. |
| TAG configuration | | pTAG | sTAG | pTAG+sTAG configures Cell 1 and Cell 2 to separate TAGs |
| OCNG Pattern | - | OP.1 TDD | OP.1 TDD | As defined in A.3.2.2.1. |
| PDSCH parameters | - | DL Reference Measurement Channel R.0 TDD | DL Reference Measurement Channel R.0 TDD | As defined in A.3.1.1.2. |
| PCFICH/PDCCH/PHICH parameters | - | DL Reference Measurement Channel R.6 TDD | DL Reference Measurement Channel R.6 TDD | As defined in A.3.1.2.2. |
| Special subframe configuration | - | 6 | 6 | As specified in table 4.2-1 in TS 36.211. |
| Uplink-downlink configuration | - | 1 | 1 | As specified in table 4.2-2 in TS 36.211. |
| PBCH_RA | dB | | | |

| | | | | |
|--|------------|-------|-------|---|
| PBCH_RB | dB | | | |
| PSS_RA | dB | | | |
| SSS_RA | dB | | | |
| PCFICH_RB | dB | | | |
| PHICH_RA | dB | | | |
| PHICH_RB | dB | 0 | 0 | |
| PDCCH_RA | dB | | | |
| PDCCH_RB | dB | | | |
| PDSCH_RA | dB | | | |
| PDSCH_RB | dB | | | |
| OCNG_RA ^{Note 1} | dB | | | |
| OCNG_RB ^{Note 1} | dB | | | |
| \hat{E}_s / I_{ot} | dB | 3 | 3 | |
| N_{oc} | dBm/15 KHz | -98 | -98 | |
| \hat{E}_s / N_{oc} | dB | 3 | 3 | |
| I_o ^{Note 2} | dBm/9 MHz | -65.5 | -65.5 | |
| RSRP ^{Note 3} | dBm/15 KHz | -95 | -95 | |
| referenceSignalPower | dBm/15 KHz | -5 | -5 | As defined in clause 6.3.2 in TS 36.331. |
| Configured UE transmitted power ($P_{CMAX,c}$) | dBm | 23 | 23 | As defined in clause 6.2.5 in TS 36.101. |
| PRACH Configuration Index | - | 53 | 53 | As defined in table 5.7.1-3 in TS 36.211. |
| Backoff Parameter Index | - | 2 | 2 | As defined in table 7.2-1 in TS 36.321. |
| Propagation Condition | - | AWGN | AWGN | |
| Note 1: OCNG shall be used such that the cell is fully allocated and a constant total transmitted power spectral density is achieved for all OFDM symbols. | | | | |
| Note 2: I_o level has been derived from other parameters for information purpose. It is not a settable parameter. | | | | |
| Note 3: RSRP level has been derived from other parameters for information purposes. It is not a settable parameter. | | | | |

Table A.6.2.8.1-2: RACH-Configuration parameters for TDD non-contention based random access test

| Field | Value | Comment |
|--|---------|---------------|
| powerRampingStep | dB2 | |
| preambleInitialReceivedTargetPower | dBm-120 | |
| preambleTransMax | n6 | |
| ra-ResponseWindowSize | sf10 | 10 sub-frames |
| Note: For further information see Clause 6.3.2 in TS 36.331. | | |

A.6.2.8.2 Test Requirements

Non-Contention based random access is triggered by explicitly assigning a random access preamble via dedicated signalling in the downlink.

A.6.2.8.2.1 Random Access Response Reception

To test the UE behavior specified in Subclause 6.2.2.2.1 the System Simulator shall transmit, on Cell 1, the PCell, a Random Access Response containing a Random Access Preamble identifier corresponding to the transmitted Random Access Preamble after 5 preambles have been received by the System Simulator, on Cell 2. In response to the first 4 preambles, the System Simulator shall transmit a Random Access Response *not* corresponding to the transmitted Random Access Preamble.

The UE may stop monitoring for Random Access Response(s) if the Random Access Response contains a Random Access Preamble identifier corresponding to the transmitted Random Access Preamble.

The UE shall re-transmit the preamble with the calculated PRACH transmission power if all received Random Access Responses contain Random Access Preamble identifiers that do not match the transmitted Random Access Preamble.

In addition, the power applied to all preambles shall be in accordance with what is specified in Subclause 6.2.2. The power of the first preamble shall be -22 dBm with an accuracy specified in clause 6.3.5.1.1 of TS 36.101 [5]. The relative power applied to additional preambles shall have an accuracy specified in clause 6.3.5.2.1 of TS 36.101 [5].

The transmit timing of all PRACH transmissions shall be within the accuracy specified in Subclause 7.1.2.

A.6.2.8.2.2 No Random Access Response Reception

To test the UE behavior specified in Subclause 6.2.2.2 the System Simulator shall transmit, on Cell 1, the PCell, a Random Access Response containing a Random Access Preamble identifier corresponding to the transmitted Random Access Preamble after 5 preambles have been received by the System Simulator, on Cell 2. The System Simulator shall *not* respond to the first 4 preambles.

The UE shall re-transmit the preamble with the calculated PRACH transmission power.

In addition, the power applied to all preambles shall be in accordance with what is specified in Subclause 6.2.2. The power of the first preamble shall be -22 dBm with an accuracy specified in clause 6.3.5.1.1 of TS 36.101 [5]. The relative power applied to additional preambles shall have an accuracy specified in clause 6.3.5.2.1 of TS 36.101 [5].

The transmit timing of all PRACH transmissions shall be within the accuracy specified in Subclause 7.1.2.

A.6.2.8.2.3 Stop Preamble transmission if maximum number of preamble transmission counter has been reached

To test the UE behavior specified in Subclause 6.2.2 the System Simulator shall transmit, in response to the first 6 preambles, a Random Access Response *not* corresponding to the transmitted Random Access Preamble on Cell 1, the PCell. The UE shall stop transmitting preambles after 6 preambles.

The UE shall re-transmit the preamble with the calculated PRACH transmission power.

In addition, the power applied to all preambles shall be in accordance with what is specified in Subclause 6.2.2. The power of the first preamble shall be -22 dBm with an accuracy specified in clause 6.3.5.1.1 of TS 36.101 [5]. The relative power applied to additional preambles shall have an accuracy specified in clause 6.3.5.2.1 of TS 36.101 [5].

The transmit timing of all PRACH transmissions shall be within the accuracy specified in Subclause 7.1.2.

A.6.2.9 3DL/3UL TDD CA Non-Contention Based Random Access Test for 2 SCells

A.6.2.9.1 Test Purpose and Environment

This test is applicable for UE supporting the optional capability of Multiple Timing Advance.

The purpose of this test is to verify that the behavior of the random access procedure, for the two SCells, is according to the requirements and that the PRACH power settings and timing, for the SCell, are within specified limits. This test will verify the requirements in Clause 6.2.2 and Clause 7.1.2 in an AWGN model.

For this test three cells are used. Cell 1 is PCell, Cell 2 is SCell1 and Cell 3 is SCell2. Cell 1 and Cell 2/Cell 3 belong to different timing advance groups. Cell 1 is in the primary Timing Advance Group (pTAG). Cell 2 and Cell3 are in the same secondary Timing Advance Group (sTAG). The purpose of the Cell 1 is to allow Cell 2 and Cell 3 to be configured and to handle the Random Access Response which takes place on Cell 1. The test parameters are given in tables A.6.2.9.1-1 and A.6.2.9.1-2.

Table A.6.2.9.1-1: General test parameters for 3DL/3UL TDD CA non-contention based random access test

| Parameter | Unit | Cell 1 | Cell 2 | Cell 3 | Comments |
|--------------------------|------|---|---|---|----------|
| E-UTRA RF Channel Number | - | 1 | 2 | 3 | |
| BW _{channel} | - | 5MHz: N _{RB,c} = 25 10MHz: N _{RB,c} = 50 20MHz: N _{RB,c} = | 5MHz: N _{RB,c} = 25 10MHz: N _{RB,c} = 50 20MHz: N _{RB,c} = | 5MHz: N _{RB,c} = 25 10MHz: N _{RB,c} = 50 20MHz: N _{RB,c} = | |

| | | | | | |
|--|-------------------------------|--|--|--|---|
| TAG configuration | - | 100 pTAG | 100 sTAG | 100 sTAG | Cell 2 and Cell 3 are in the same sTAG |
| PDSCH parameters: DL Reference Measurement Channel | - | 5MHz: R.4 TDD 10MHz: R.0 TDD 20MHz: R.3 TDD | 5MHz: R.4 TDD 10MHz: R.0 TDD 20MHz: R.3 TDD | 5MHz: R.4 TDD 10MHz: R.0 TDD 20MHz: R.3 TDD | As defined in A.3.1.1.2. |
| PCFICH/PDCCH/PHICH parameters: DL Reference Measurement Channel | - | 5MHz: R.11 TDD 10MHz: R.6 TDD 20MHz: R.10 TDD | 5MHz: R.11 TDD 10MHz: R.6 TDD 20MHz: R.10 TDD | 5MHz: R.11 TDD 10MHz: R.6 TDD 20MHz: R.10 TDD | As defined in A.3.1.2.2. |
| OCNG Patterns | - | 5MHz: OP.9 TDD 10MHz: OP.1 TDD 20MHz: OP.7 TDD | 5MHz: OP.9 TDD 10MHz: OP.1 TDD 20MHz: OP.7 TDD | 5MHz: OP.9 TDD 10MHz: OP.1 TDD 20MHz: OP.7 TDD | As defined in A.3.2.2. |
| Special subframe configuration | - | 6 | 6 | 6 | As specified in table 4.2-1 in TS 36.211. |
| Uplink-downlink configuration | - | 1 | 1 | 1 | As specified in table 4.2-2 in TS 36.211. |
| PBCH_RA | dB | 0 | 0 | 0 | |
| PBCH_RB | dB | | | | |
| PSS_RA | dB | | | | |
| SSS_RA | dB | | | | |
| PCFICH_RB | dB | | | | |
| PHICH_RA | dB | | | | |
| PHICH_RB | dB | | | | |
| PDCCH_RA | dB | | | | |
| PDCCH_RB | dB | | | | |
| PDSCH_RA | dB | | | | |
| PDSCH_RB | dB | | | | |
| OCNG_RA ^{Note 1} | dB | | | | |
| OCNG_RB ^{Note 1} | dB | | | | |
| \hat{E}_s / I_{ot} | dB | 3 | 3 | 3 | |
| N_{oc} | dBm/15 KHz | -98 | -98 | -98 | |
| \hat{E}_s / N_{oc} | dB | 3 | 3 | 3 | |
| I_o ^{Note 2} | dBm/ BW _{channel} | -65.5+10log ($N_{RB,c}/50$) | -65.5+10log ($N_{RB,c}/50$) | -65.5+10log ($N_{RB,c}/50$) | |
| RSRP ^{Note 3} | dBm/15 KHz | -95 | -95 | -95 | |
| referenceSignalPower | dBm/15 KHz | -5 | -5 | -5 | As defined in clause 6.3.2 in TS 36.331. |
| Configured UE transmitted power ($P_{CMAX,c}$) | dBm | 23 | 23 | 23 | As defined in clause 6.2.5 in TS 36.101. |
| PRACH Configuration Index | - | 53 | 53 | 53 | As defined in table 5.7.1-3 in TS 36.211. |
| Backoff Parameter Index | - | 2 | 2 | 2 | As defined in table 7.2-1 in TS 36.321. |
| Propagation Condition | - | AWGN | AWGN | AWGN | |
| Antenna Configuration | | 1x2 | 1x2 | 1x2 | |
| Timing offset to Cell 1 | μs | - | 0 | 0 | |
| Time alignment error relative to cell 1 ^{Note 4} | μs | - | ≤ TAE | ≤ TAE | |
| Time alignment error relative to cell 2 ^{Note 4} | μs | - | - | ≤ TAE | |

| | |
|---------|--|
| Note 1: | OCNG shall be used such that the cell is fully allocated and a constant total transmitted power spectral density is achieved for all OFDM symbols. |
| Note 2: | lo level has been derived from other parameters for information purpose. It is not a settable parameter. |
| Note 3: | RSRP level has been derived from other parameters for information purposes. It is not a settable parameter. |
| Note 4: | The time alignment error (TAE) between two cells specified in TS36.104 [30] clause 6.5.3.1 (value depends upon the type of carrier aggregation). |
| Note 5: | This test verifies the RRM requirement which is independent of channel bandwidth and is performed according to the principle defined in section A.3.6.1. |

Table A.6.2.9.1-2: RACH-Configuration parameters for cell2 and cell3 for 3DL/3UL TDD CA non-contention based random access test

| Field | Value | Comment |
|--|---------|---------------|
| powerRampingStep | dB2 | |
| preambleInitialReceivedTargetPower | dBm-120 | |
| preambleTransMax | n6 | |
| ra-ResponseWindowSize | sf10 | 10 sub-frames |
| Note 1: For further information see Clause 6.3.2 in TS 36.331. | | |

A.6.2.9.2 Test Requirements

Non-Contention based random access is triggered by explicitly assigning a random access preamble via dedicated signalling in the downlink.

A.6.2.9.2.1 Random Access Response Reception

A.6.2.9.2.1.1 Test Requirements for Cell 2

To test the UE behavior specified in Subclause 6.2.2.2.1 the System Simulator shall transmit, on cell 1 a Random Access Response containing a Random Access Preamble identifier corresponding to the transmitted Random Access Preamble after 5 preambles have been received by the System Simulator, on cell 2. In response to the first 4 preambles, the System Simulator shall transmit a Random Access Response *not* corresponding to the transmitted Random Access Preamble.

The UE may stop monitoring for Random Access Response(s) if the Random Access Response contains a Random Access Preamble identifier corresponding to the transmitted Random Access Preamble.

The UE shall re-transmit the preamble with the calculated PRACH transmission power if all received Random Access Responses contain Random Access Preamble identifiers that do not match the transmitted Random Access Preamble.

In addition, the power applied to all preambles shall be in accordance with what is specified in Subclause 6.2.2. The power of the first preamble shall be -22 dBm with an accuracy specified in clause 6.3.5.1.1 of TS 36.101 [5]. The relative power applied to additional preambles shall have an accuracy specified in clause 6.3.5.2.1 of TS 36.101 [5].

The transmit timing of all PRACH transmissions on cell 2 shall be within the accuracy specified in Subclause 7.1.2.

A.6.2.9.2.1.2 Test Requirements for Cell 3

To test the UE behavior specified in Subclause 6.2.2.2.1 the System Simulator shall transmit, on cell 1 a Random Access Response containing a Random Access Preamble identifier corresponding to the transmitted Random Access Preamble after 5 preambles have been received by the System Simulator, on cell 3. In response to the first 4 preambles, the System Simulator shall transmit a Random Access Response *not* corresponding to the transmitted Random Access Preamble.

The UE may stop monitoring for Random Access Response(s) if the Random Access Response contains a Random Access Preamble identifier corresponding to the transmitted Random Access Preamble.

The UE shall re-transmit the preamble with the calculated PRACH transmission power if all received Random Access Responses contain Random Access Preamble identifiers that do not match the transmitted Random Access Preamble.

In addition, the power applied to all preambles shall be in accordance with what is specified in Subclause 6.2.2. The power of the first preamble shall be -22 dBm with an accuracy specified in clause 6.3.5.1.1 of TS 36.101 [5]. The relative power applied to additional preambles shall have an accuracy specified in clause 6.3.5.2.1 of TS 36.101 [5].

The transmit timing of all PRACH transmissions on cell 3 shall be within the accuracy specified in Subclause 7.1.2.

A.6.2.9.2.2 No Random Access Response Reception

A.6.2.9.2.2.1 Test Requirements for Cell 2

To test the UE behavior specified in Subclause 6.2.2.2 the System Simulator shall transmit, on cell 1, a Random Access Response containing a Random Access Preamble identifier corresponding to the transmitted Random Access Preamble after 5 preambles have been received by the System Simulator, on cell 2. The System Simulator shall *not* respond to the first 4 preambles.

The UE shall re-transmit the preamble with the calculated PRACH transmission power on cell 2.

In addition, the power applied to all preambles shall be in accordance with what is specified in Subclause 6.2.2. The power of the first preamble shall be -22 dBm with an accuracy specified in clause 6.3.5.1.1 of TS 36.101 [5]. The relative power applied to additional preambles shall have an accuracy specified in clause 6.3.5.2.1 of TS 36.101 [5].

The transmit timing of all PRACH transmissions on cell 2 shall be within the accuracy specified in Subclause 7.1.2.

A.6.2.9.2.2.2 Test Requirements for Cell 3

To test the UE behavior specified in Subclause 6.2.2.2 the System Simulator shall transmit, on cell 1, a Random Access Response containing a Random Access Preamble identifier corresponding to the transmitted Random Access Preamble after 5 preambles have been received by the System Simulator, on cell 3. The System Simulator shall *not* respond to the first 4 preambles.

The UE shall re-transmit the preamble with the calculated PRACH transmission power on cell 3.

In addition, the power applied to all preambles shall be in accordance with what is specified in Subclause 6.2.2. The power of the first preamble shall be -22 dBm with an accuracy specified in clause 6.3.5.1.1 of TS 36.101 [5]. The relative power applied to additional preambles shall have an accuracy specified in clause 6.3.5.2.1 of TS 36.101 [5].

The transmit timing of all PRACH transmissions on cell 3 shall be within the accuracy specified in Subclause 7.1.2.

A.6.2.9.2.3 Stop Preamble transmission if maximum number of preamble transmission counter has been reached

A.6.2.9.2.3.1 Test Requirements for Cell 2

To test the UE behavior specified in Subclause 6.2.2 the System Simulator shall transmit, in response to the first 6 preambles, a Random Access Response *not* corresponding to the transmitted Random Access Preamble on cell 1. The UE shall stop transmitting preambles after 6 preambles.

The UE shall re-transmit the preamble with the calculated PRACH transmission power on cell 2.

In addition, the power applied to all preambles shall be in accordance with what is specified in Subclause 6.2.2. The power of the first preamble shall be -22 dBm with an accuracy specified in clause 6.3.5.1.1 of TS 36.101 [5]. The relative power applied to additional preambles shall have an accuracy specified in clause 6.3.5.2.1 of TS 36.101 [5].

The transmit timing of all PRACH transmissions on cell 2 shall be within the accuracy specified in Subclause 7.1.2.

A.6.2.9.2.3.2 Test Requirements for Cell 3

To test the UE behavior specified in Subclause 6.2.2 the System Simulator shall transmit, in response to the first 6 preambles, a Random Access Response *not* corresponding to the transmitted Random Access Preamble on cell 1. The UE shall stop transmitting preambles after 6 preambles.

The UE shall re-transmit the preamble with the calculated PRACH transmission power on cell 3.

In addition, the power applied to all preambles shall be in accordance with what is specified in Subclause 6.2.2. The power of the first preamble shall be -22 dBm with an accuracy specified in clause 6.3.5.1.1 of TS 36.101 [5]. The relative power applied to additional preambles shall have an accuracy specified in clause 6.3.5.2.1 of TS 36.101 [5].

The transmit timing of all PRACH transmissions on cell 3 shall be within the accuracy specified in Subclause 7.1.2.

A.6.2.10 E-UTRAN FDD Contention Based Random Access Test for Cat-M1 UEs in Normal Coverage

A.6.2.10.1 Test Purpose and Environment

The purpose of this test is to verify whether the behavior of the random access procedure of a Cat-M1 UE in Normal Coverage is according to the requirements, whether the PRACH power settings and timing are within specified limits, and whether the UE determines properly the enhanced coverage level based on the RSRP measurement and the configured criterion in RSRP-ThresholdsPrach [2]. This test will verify the requirements in Clause 6.2.2, Clause 6.2.3 and Clause 7.24.2 in an AWGN model.

For this test a single cell is used. The test parameters are given in tables A.6.2.10.1-1 and A.6.2.10.1-2.

Table A.6.2.10.1-1: General test parameters for FDD contention based random access test

| Parameter | Unit | Value | Comments |
|--|------------|--|---------------------------|
| E-UTRA RF Channel Number | | 1 | |
| BW _{channel} | MHz | 10 | |
| OCNG Pattern ^{Note 1} | | OP.21 FDD | As defined in A.3.2.1.21. |
| PDSCH parameters ^{Note 2} | | R.20 FDD | As defined in A.3.1.4.1 |
| MPDCCH parameters ^{Note 2} | | R.16 FDD | As defined in A.3.1.3.1 |
| PCFICH/PDCCH/PHICH parameters | | DL Reference Measurement Channel R.6 FDD | As defined in A.3.1.2.1 |
| PBCH_RA | dB | 0 | |
| PBCH_RB | dB | | |
| PSS_RA | dB | | |
| SSS_RA | dB | | |
| PCFICH_RB | dB | | |
| PHICH_RA | dB | | |
| PHICH_RB | dB | | |
| PDCCH_RA | dB | | |
| PDCCH_RB | dB | | |
| MPDCCH_RA | dB | | |
| MPDCCH_RB | dB | | |
| PDSCH_RA | dB | | |
| PDSCH_RB | dB | | |
| OCNG_RA ^{Note 1} | dB | | |
| OCNG_RB ^{Note 1} | dB | | |
| N_{oc} | dBm/15 KHz | | -103 |
| \hat{E}_s/N_{oc} | dB | 3 | |
| \hat{E}_s/I_{ot} ^{Note 3} | dB | 3 | |
| RSRP ^{Note 3} | dBm/15 KHz | -100 | |
| I_o ^{Note 3} | dBm/9 MHz | -70.45 | |
| Propagation Condition | - | AWGN | |
| <p>Note 1: OCNG shall be used such that the cell is fully allocated and a constant total transmitted power spectral density is achieved for all OFDM symbols. The OCNG pattern is chosen during the test according to the presence of a DL reference measurement channel.</p> <p>Note 2: The PDSCH and MPDCCH reference measurement channels are used in</p> | | | |

the test only when a downlink transmission dedicated to the UE under test is required.

Note 3: Es/lot, RSRP and lo level has been derived from other parameters for information purpose. They are not settable parameters themselves.

Table A.6.2.10.1-2: RACH-Configuration parameters for FDD contention based random access test

| Field | Value | | | | Comment |
|--|----------------|----------------|----------------|----------------|---------|
| Parameters not per CE Levels | | | | | |
| powerRampingStep | dB2 | | | | |
| preambleInitialReceivedTargetPower | dBm-120 | | | | |
| preambleTransMax | n6 | | | | |
| maxHARQ-Msg3Tx | 4 | | | | |
| rar-HoppingConfig | Off | | | | |
| Parameters per CE Levels | | | | | |
| CE Level | Level 0 | Level 1 | Level 2 | Level 3 | |
| ra-ResponseWindowSize (per CE) | sf20 | sf80 | sf180 | sf320 | |
| mac-ContentionResolutionTimer (per CE) | sf80 | sf120 | sf200 | sf480 | |
| PreambleMappingInfo {firstPreamble, lastPreamble} | {0, 9} | {10,19} | {20,29} | {30,39} | |
| Note: For further information see Clause 6.3.2 in TS 36.331. | | | | | |

Table A.6.2.10.1-3: PRACH-Configuration parameters for FDD contention based random access test

| Field | Value | | | | Comment |
|--|--|----------------|----------------|----------------|--|
| Parameters not per CE Levels | | | | | |
| rsrp-ThresholdsPrach | {24, 27, 33} | | | | Corresponding to {-116, -113, -107} dBm as defined in Section 9.1.21.5 |
| mpdcch-startSF-CSS-RA | v1 | | | | |
| referenceSignalPower | -5 dBm/15 KHz | | | | As defined in clause 6.3.2 in TS 36.331. |
| maxHARQ-Msg3Tx | 4 | | | | As defined in table 5.7.1-2 in TS 36.211 |
| Backoff Parameter Index | 2 | | | | As defined in table 7.2-1 in TS 36.321 |
| Configured UE transmitted power (P_{CMAX}) | Maximum value allowed by the applicable UE power class | | | | As defined in clause 6.2.5 in TS 36.101 |
| Parameters per PRACH CE Levels | | | | | |
| CE Level | Level 0 | Level 1 | Level 2 | Level 3 | |
| prach-ConfigIndex | 4 | 4 | 4 | 4 | As defined in table 5.7.1-2 in TS 36.211 |
| prach-FreqOffset | 0 | 0 | 0 | 0 | |
| prach-StartingSubframe | sf2 | sf4 | sf16 | sf64 | |
| maxNumPreambleAttempt | n3 | n5 | n7 | n10 | |
| numRepetitionPerPreambleAttempt | n1 | n4 | n16 | n64 | |
| mpdcch-NarrowbandsToMonitor | 2 | 2 | 2 | 2 | |
| mpdcch-NumRepetition-RA | r8 | r8 | r128 | r128 | |
| prach-HoppingConfig | Off | Off | Off | Off | |
| Note 1: See Clause 6.3.2 in TS 36.331 for further information on the parameters in this table. | | | | | |

A.6.2.10.2 Test Requirements

Contention based random access is triggered by *not* explicitly assigning a random access preamble via dedicated signalling in the downlink.

A.6.2.10.2.1 Random Access Response Reception

To test the UE behavior specified in Subclause 6.2.2, the System Simulator shall transmit a Random Access Response containing a Random Access Preamble identifier corresponding to the transmitted Random Access Preamble after 5 preamble transmission attempts (the preamble may be transmitted multiple times in each attempt) have been received by the System Simulator. In response to the first 4 preamble transmission attempts, the System Simulator shall transmit a Random Access Response *not* corresponding to the transmitted Random Access Preamble.

The UE may stop monitoring for Random Access Response(s) and shall transmit the msg3 if the Random Access Response contains a Random Access Preamble identifier corresponding to the transmitted Random Access Preamble.

The UE shall re-select a preamble and transmit with the calculated PRACH transmission power when the backoff time expires if all received Random Access Responses contain Random Access Preamble identifiers that do not match the transmitted Random Access Preamble.

In addition, the power applied to all preambles shall be in accordance with what is specified in Subclause 6.2.2. The power of the first preamble shall be -25 dBm with an accuracy specified in clause 6.3.5.1.1 of TS 36.101 [5]. The relative power applied to additional preambles shall have an accuracy specified in clause 6.3.5.2.1 of TS 36.101 [5].

The transmit timing of all PRACH transmissions shall be within the accuracy specified in Subclause 7.24.2.

A.6.2.10.2.2 No Random Access Response Reception

To test the UE behavior specified in subclause 6.2.2.1.2, the System Simulator shall transmit a Random Access Response containing a Random Access Preamble identifier corresponding to the transmitted Random Access Preamble after 5 preamble transmission attempts have been received by the System Simulator. The System Simulator shall *not* respond to the first 4 preamble transmission attempts.

The UE shall re-select a preamble and transmit with the calculated PRACH transmission power when the backoff time expires if no Random Access Response is received within the RA Response window.

In addition, the power applied to all preambles shall be in accordance with what is specified in Subclause 6.2.2. The power of the first preamble shall be -25 dBm with an accuracy specified in clause 6.3.5.1.1 of TS 36.101 [5]. The relative power applied to additional preambles shall have an accuracy specified in clause 6.3.5.2.1 of TS 36.101 [5].

The transmit timing of all PRACH transmissions shall be within the accuracy specified in Subclause 7.24.2.

A.6.2.10.2.3 Receiving a NACK on msg3

To test the UE behavior specified in subclause 6.2.2.1.3, the System Simulator shall NACK *all* UE msg3 following a successful Random Access Response.

The UE shall re-transmit the msg3 upon the reception of a NACK on msg3 until the maximum number of HARQ re-transmissions is reached.

A.6.2.10.2.4 Reception of an Incorrect Message over Temporary C-RNTI

To test the UE behavior specified in Subclause 6.2.2.1.5, the System Simulator shall send a message addressed to the temporary C-RNTI with a UE Contention Resolution Identity included in the MAC control element *not* matching the CCCH SDU transmitted in msg3 uplink message.

The UE shall re-select a preamble and transmit with the calculated PRACH transmission power when the backoff time expires unless the received message includes a UE Contention Resolution Identity MAC control element and the UE Contention Resolution Identity included in the MAC control element matches the CCCH SDU transmitted in the uplink message.

A.6.2.10.2.5 Reception of a Correct Message over Temporary C-RNTI

To test the UE behavior specified in Subclause 6.2.2.1.5, the System Simulator shall send a message addressed to the temporary C-RNTI with a UE Contention Resolution Identity included in the MAC control element matching the CCCH SDU transmitted in the msg3 uplink message.

The UE shall send ACK if the Contention Resolution is successful.

A.6.2.10.2.6 Contention Resolution Timer expiry

To test the UE behavior specified in Subclause 6.2.2.1.6, the System Simulator shall *not* send a response to a msg3.

The UE shall re-select a preamble and transmit with the calculated PRACH transmission power when the backoff time expires if the Contention Resolution Timer expires.

A.6.2.10.2.7 PRACH Resource Selection

The UE shall select PRACH resources and transmits or re- transmits PRACH preambles using the PRACH resources and PRACH configuration corresponding to the coverage enhancement level 0.

Note: The PRACH Resource Selection requirement is already assumed for testing the other PRACH requirements.

A.6.2.11 E-UTRAN HD-FDD Contention Based Random Access Test for Cat-M1 UEs in Normal Coverage

A.6.2.11.1 Test Purpose and Environment

The purpose of this test is to verify whether the behavior of the random access procedure of a Cat-M1 UE in Normal Coverage is according to the requirements, whether the PRACH power settings and timing are within specified limits, and whether the UE determines properly the enhanced coverage level based on the RSRP measurement and the configured criterion in RSRP-ThresholdsPrach [2]. This test will verify the requirements in Clause 6.2.2, Clause 6.2.3 and Clause 7.24.2 in an AWGN model.

For this test a single cell is used. The test parameters are given in tables A.6.2.11.1-1 and A.6.2.11.1-2.

Table A.6.2.11.1-1: General test parameters for HD-FDD contention based random access test

| Parameter | Unit | Value | Comments |
|--------------------------------------|------------|---|---------------------------|
| E-UTRA RF Channel Number | | 1 | |
| BW _{channel} | MHz | 10 | |
| OCNG Pattern ^{Note 1} | | OP.21 FDD | As defined in A.3.2.1.21. |
| PDSCH parameters ^{Note 2} | | R.10 HD-FDD | As defined in A.3.1.4.2 |
| MPDCCH parameters ^{Note 2} | | R.6 HD-FDD | As defined in A.3.1.3.2 |
| PCFICH/PDCCH/PHICH parameters | | DL Reference Measurement Channel R.3 HD-FDD | As defined in A.3.1.2.3 |
| PBCH_RA | dB | 0 | |
| PBCH_RB | dB | | |
| PSS_RA | dB | | |
| SSS_RA | dB | | |
| PCFICH_RB | dB | | |
| PHICH_RA | dB | | |
| PHICH_RB | dB | | |
| PDCCH_RA | dB | | |
| PDCCH_RB | dB | | |
| MPDCCH_RA | dB | | |
| MPDCCH_RB | dB | | |
| PDSCH_RA | dB | | |
| PDSCH_RB | dB | | |
| OCNG_RA ^{Note 1} | dB | | |
| OCNG_RB ^{Note 1} | dB | | |
| N_{oc} | dBm/15 KHz | | -103 |
| \hat{E}_s/N_{oc} | dB | 3 | |
| \hat{E}_s/I_{ot} ^{Note 3} | dB | 3 | |

| | | | |
|---|------------|--------|--|
| RSRP ^{Note 3} | dBm/15 KHz | -100 | |
| Io ^{Note 3} | dBm/9 MHz | -70.45 | |
| Propagation Condition | - | AWGN | |
| <p>Note 1: OCNG shall be used such that the cell is fully allocated and a constant total transmitted power spectral density is achieved for all OFDM symbols. The OCNG pattern is chosen during the test according to the presence of a DL reference measurement channel.</p> <p>Note 2: The PDSCH and MPDCCH reference measurement channels are used in the test only when a downlink transmission dedicated to the UE under test is required.</p> <p>Note 3: Es/Iot, RSRP and Io level has been derived from other parameters for information purpose. They are not settable parameters themselves.</p> | | | |

Table A.6.2.11.1-2: RACH-Configuration parameters for HD-FDD contention based random access test

| Field | Value | | | | Comment |
|--|----------------|----------------|----------------|----------------|---------|
| Parameters not per CE Levels | | | | | |
| powerRampingStep | dB2 | | | | |
| preambleInitialReceivedTargetPower | dBm-120 | | | | |
| preambleTransMax | n6 | | | | |
| maxHARQ-Msg3Tx | 4 | | | | |
| rar-HoppingConfig | Off | | | | |
| Parameters per CE Levels | | | | | |
| CE Level | Level 0 | Level 1 | Level 2 | Level 3 | |
| ra-ResponseWindowSize (per CE) | sf20 | sf80 | sf180 | sf320 | |
| mac-ContentionResolutionTimer (per CE) | sf80 | sf120 | sf200 | sf480 | |
| PreambleMappingInfo {firstPreamble, lastPreamble} | {0, 9} | {10,19} | {20,29} | {30,39} | |
| Note: For further information see Clause 6.3.2 in TS 36.331. | | | | | |

Table A.6.2.11.1-3: PRACH-Configuration parameters for HD-FDD contention based random access test

| Field | Value | | | | Comment |
|--|--|----------------|----------------|----------------|--|
| Parameters not per CE Levels | | | | | |
| rsrp-ThresholdsPrach | {24, 27, 33} | | | | Corresponding to {-116, -113, -107} dBm as defined in Section 9.1.21.5 |
| mpdcch-startSF-CSS-RA | v1 | | | | |
| referenceSignalPower | -5 dBm/15 KHz | | | | As defined in clause 6.3.2 in TS 36.331. |
| maxHARQ-Msg3Tx | 4 | | | | As defined in table 5.7.1-2 in TS 36.211 |
| Backoff Parameter Index | 2 | | | | As defined in table 7.2-1 in TS 36.321 |
| Configured UE transmitted power (P_{CMAX}) | Maximum value allowed by the applicable UE power class | | | | As defined in clause 6.2.5 in TS 36.101 |
| Parameters per PRACH CE Levels | | | | | |
| CE Level | Level 0 | Level 1 | Level 2 | Level 3 | |
| prach-ConfigIndex | 4 | 4 | 4 | 4 | As defined in table 5.7.1-2 in TS 36.211 |
| prach-FreqOffset | 0 | 0 | 0 | 0 | |
| prach-StartingSubframe | sf2 | sf4 | sf16 | sf64 | |
| maxNumPreambleAttempt | n3 | n5 | n7 | n10 | |
| numRepetitionPerPreambleAttempt | n1 | n4 | n16 | n64 | |
| mpdcch-NarrowbandsToMonitor | 2 | 2 | 2 | 2 | |
| mpdcch-NumRepetition-RA | r8 | r8 | r128 | r128 | |
| prach-HoppingConfig | Off | Off | Off | Off | |
| Note 1: See Clause 6.3.2 in TS 36.331 for further information on the parameters in this table. | | | | | |

A.6.2.11.2 Test Requirements

Contention based random access is triggered by *not* explicitly assigning a random access preamble via dedicated signalling in the downlink.

A.6.2.11.2.1 Random Access Response Reception

To test the UE behavior specified in Subclause 6.2.2, the System Simulator shall transmit a Random Access Response containing a Random Access Preamble identifier corresponding to the transmitted Random Access Preamble after 5 preamble transmission attempts (the preamble may be transmitted multiple times in each attempt) have been received by the System Simulator. In response to the first 4 preamble transmission attempts, the System Simulator shall transmit a Random Access Response *not* corresponding to the transmitted Random Access Preamble.

The UE may stop monitoring for Random Access Response(s) and shall transmit the msg3 if the Random Access Response contains a Random Access Preamble identifier corresponding to the transmitted Random Access Preamble.

The UE shall re-select a preamble and transmit with the calculated PRACH transmission power when the backoff time expires if all received Random Access Responses contain Random Access Preamble identifiers that do not match the transmitted Random Access Preamble.

In addition, the power applied to all preambles shall be in accordance with what is specified in Subclause 6.2.2. The power of the first preamble shall be -25 dBm with an accuracy specified in clause 6.3.5.1.1 of TS 36.101 [5]. The relative power applied to additional preambles shall have an accuracy specified in clause 6.3.5.2.1 of TS 36.101 [5].

The transmit timing of all PRACH transmissions shall be within the accuracy specified in Subclause 7.24.2.

A.6.2.11.2.2 No Random Access Response Reception

To test the UE behavior specified in subclause 6.2.2.1.2, the System Simulator shall transmit a Random Access Response containing a Random Access Preamble identifier corresponding to the transmitted Random Access Preamble after 5 preamble transmission attempts have been received by the System Simulator. The System Simulator shall *not* respond to the first 4 preamble transmission attempts.

The UE shall re-select a preamble and transmit with the calculated PRACH transmission power when the backoff time expires if no Random Access Response is received within the RA Response window.

In addition, the power applied to all preambles shall be in accordance with what is specified in Subclause 6.2.2. The power of the first preamble shall be -25 dBm with an accuracy specified in clause 6.3.5.1.1 of TS 36.101 [5]. The relative power applied to additional preambles shall have an accuracy specified in clause 6.3.5.2.1 of TS 36.101 [5].

The transmit timing of all PRACH transmissions shall be within the accuracy specified in Subclause 7.24.2.

A.6.2.11.2.3 Receiving a NACK on msg3

To test the UE behavior specified in subclause 6.2.2.1.3, the System Simulator shall NACK *all* UE msg3 following a successful Random Access Response.

The UE shall re-transmit the msg3 upon the reception of a NACK on msg3 until the maximum number of HARQ re-transmissions is reached.

A.6.2.11.2.4 Reception of an Incorrect Message over Temporary C-RNTI

To test the UE behavior specified in Subclause 6.2.2.1.5, the System Simulator shall send a message addressed to the temporary C-RNTI with a UE Contention Resolution Identity included in the MAC control element *not* matching the CCCH SDU transmitted in msg3 uplink message.

The UE shall re-select a preamble and transmit with the calculated PRACH transmission power when the backoff time expires unless the received message includes a UE Contention Resolution Identity MAC control element and the UE Contention Resolution Identity included in the MAC control element matches the CCCH SDU transmitted in the uplink message.

A.6.2.11.2.5 Reception of a Correct Message over Temporary C-RNTI

To test the UE behavior specified in Subclause 6.2.2.1.5, the System Simulator shall send a message addressed to the temporary C-RNTI with a UE Contention Resolution Identity included in the MAC control element matching the CCCH SDU transmitted in the msg3 uplink message.

The UE shall send ACK if the Contention Resolution is successful.

A.6.2.11.2.6 Contention Resolution Timer expiry

To test the UE behavior specified in Subclause 6.2.2.1.6, the System Simulator shall *not* send a response to a msg3.

The UE shall re-select a preamble and transmit with the calculated PRACH transmission power when the backoff time expires if the Contention Resolution Timer expires.

A.6.2.11.2.7 PRACH Resource Selection

The UE shall select PRACH resources and transmits or re- transmits PRACH preambles using the PRACH resources and PRACH configuration corresponding to the coverage enhancement level 0.

Note: The PRACH Resource Selection requirement is already assumed for testing the other PRACH requirements.

A.6.2.12 E-UTRAN TDD Contention Based Random Access Test for Cat-M1 UEs in Normal Coverage

A.6.2.12.1 Test Purpose and Environment

The purpose of this test is to verify whether the behavior of the random access procedure of a Cat-M1 UE in Normal Coverage is according to the requirements, whether the PRACH power settings and timing are within specified limits, and whether the UE determines properly the enhanced coverage level based on the RSRP measurement and the configured criterion in RSRP-ThresholdsPrach [2]. This test will verify the requirements in Clause 6.2.2, Clause 6.2.3 and Clause 7.24.2 in an AWGN model.

For this test a single cell is used. The test parameters are given in tables A.6.2.12.1-1 and A.6.2.12.1-2.

Table A.6.2.12.1-1: General test parameters for TDD contention based random access test

| Parameter | Unit | Value | Comments |
|-------------------------------------|------|--|---|
| E-UTRA RF Channel Number | | 1 | |
| BW _{channel} | MHz | 10 | |
| OCNG Pattern ^{Note 1} | | OP.11 TDD | As defined in A.3.2.2.11. |
| PDSCH parameters ^{Note 2} | | R.16 TDD | As defined in A.3.1.4.3 |
| MPDCCH parameters ^{Note 2} | | R.14 TDD | As defined in A.3.1.3.3 |
| PCFICH/PDCCH/PHICH parameters | | DL Reference Measurement Channel R.6 TDD | As defined in A.3.1.2.2 |
| Special subframe configuration | - | 6 | As specified in table 4.2-1 in TS 36.211. |
| Uplink-downlink configuration | - | 1 | As specified in table 4.2-2 in TS 36.211. |
| PBCH_RA | dB | 0 | |
| PBCH_RB | dB | | |
| PSS_RA | dB | | |
| SSS_RA | dB | | |
| PCFICH_RB | dB | | |
| PHICH_RA | dB | | |
| PHICH_RB | dB | | |

| | | | |
|--|------------|--------|--|
| PDCCH_RA | dB | | |
| PDCCH_RB | dB | | |
| MPDCCH_RA | dB | | |
| MPDCCH_RB | dB | | |
| PDSCH_RA | dB | | |
| PDSCH_RB | dB | | |
| OCNG_RA ^{Note 1} | dB | | |
| OCNG_RB ^{Note 1} | dB | | |
| N_{oc} | dBm/15 KHz | -103 | |
| \hat{E}_s/N_{oc} | dB | 3 | |
| \hat{E}_s/I_{ot} ^{Note 3} | dB | 3 | |
| RSRP ^{Note 3} | dBm/15 KHz | -100 | |
| I_o ^{Note 3} | dBm/9 MHz | -70.45 | |
| Propagation Condition | - | AWGN | |
| <p>Note 1: OCNG shall be used such that the cell is fully allocated and a constant total transmitted power spectral density is achieved for all OFDM symbols. The OCNG pattern is chosen during the test according to the presence of a DL reference measurement channel.</p> <p>Note 2: The PDSCH and MPDCCH reference measurement channels are used in the test only when a downlink transmission dedicated to the UE under test is required.</p> <p>Note 3: E_s/I_{ot}, RSRP and I_o level has been derived from other parameters for information purpose. They are not settable parameters themselves.</p> | | | |

Table A.6.2.12.1-2: RACH-Configuration parameters for TDD contention based random access test

| Field | Value | | | | Comment |
|--|----------------|----------------|----------------|----------------|-------------|
| Parameters not per CE Levels | | | | | |
| numberOfRA-Preambles | n52 | | | | |
| sizeOfRA-PreamblesGroupA | n52 | | | | No group B. |
| powerRampingStep | dB2 | | | | |
| preambleInitialReceivedTargetPower | dBm-120 | | | | |
| preambleTransMax | n6 | | | | |
| maxHARQ-Msg3Tx | 4 | | | | |
| rar-HoppingConfig | Off | | | | |
| Parameters per CE Levels | | | | | |
| CE Level | Level 0 | Level 1 | Level 2 | Level 3 | |
| ra-ResponseWindowSize (per CE) | sf20 | sf80 | sf180 | sf320 | |
| mac-ContentionResolutionTimer (per CE) | sf80 | sf120 | sf200 | sf480 | |
| PreambleMappingInfo {firstPreamble, lastPreamble} | {0, 9} | {10,19} | {20,29} | {30,39} | |
| Note 1: For further information see Clause 6.3.2 in TS 36.331. | | | | | |

Table A.6.2.12.1-3: PRACH-Configuration parameters for TDD contention based random access test

| Field | Value | | Comment |
|--|--|--|--|
| Parameters not per CE Levels | | | |
| rsrp-ThresholdsPrach | {24, 27, 33} | | Corresponding to {-116, -113, -107} dBm as defined in Section 9.1.21.5 |
| mpdcch-startSF-CSS-RA | v1 | | |
| referenceSignalPower | -5 dBm/15 KHz | | As defined in clause 6.3.2 in TS 36.331. |
| maxHARQ-Msg3Tx | 4 | | As defined in table 5.7.1-2 in TS 36.211 |
| Backoff Parameter Index | 2 | | As defined in table 7.2-1 in TS 36.321 |
| Configured UE transmitted power (P_{CMAX}) | Maximum value allowed by the applicable UE power class | | As defined in clause 6.2.5 in TS 36.101 |

| Parameters per PRACH CE Levels | | | | | |
|--|---------|---------|---------|---------|--|
| CE Level | Level 0 | Level 1 | Level 2 | Level 3 | |
| prach-ConfigIndex | 4 | 4 | 4 | 4 | As defined in table 5.7.1-2 in TS 36.211 |
| prach-FreqOffset | 0 | 0 | 0 | 0 | |
| prach-StartingSubframe | sf2 | sf4 | sf16 | sf64 | |
| maxNumPreambleAttempt | n3 | n5 | n7 | n10 | |
| numRepetitionPerPreambleAttempt | n1 | n4 | n16 | n64 | |
| mpdcch-NarrowbandsToMonitor | 2 | 2 | 2 | 2 | |
| mpdcch-NumRepetition-RA | r8 | r8 | r128 | r128 | |
| prach-HoppingConfig | Off | Off | Off | Off | |
| Note 1: See Clause 6.3.2 in TS 36.331 for further information on the parameters in this table. | | | | | |

A.6.2.12.2 Test Requirements

Contention based random access is triggered by *not* explicitly assigning a random access preamble via dedicated signalling in the downlink.

A.6.2.12.2.1 Random Access Response Reception

To test the UE behavior specified in Subclause 6.2.2, the System Simulator shall transmit a Random Access Response containing a Random Access Preamble identifier corresponding to the transmitted Random Access Preamble after 5 preamble transmission attempts (the preamble may be transmitted multiple times in each attempt) have been received by the System Simulator. In response to the first 4 preamble transmission attempts, the System Simulator shall transmit a Random Access Response *not* corresponding to the transmitted Random Access Preamble.

The UE may stop monitoring for Random Access Response(s) and shall transmit the msg3 if the Random Access Response contains a Random Access Preamble identifier corresponding to the transmitted Random Access Preamble.

The UE shall re-select a preamble and transmit with the calculated PRACH transmission power when the backoff time expires if all received Random Access Responses contain Random Access Preamble identifiers that do not match the transmitted Random Access Preamble.

In addition, the power applied to all preambles shall be in accordance with what is specified in Subclause 6.2.2. The power of the first preamble shall be -25 dBm with an accuracy specified in clause 6.3.5.1.1 of TS 36.101 [5]. The relative power applied to additional preambles shall have an accuracy specified in clause 6.3.5.2.1 of TS 36.101 [5].

The transmit timing of all PRACH transmissions shall be within the accuracy specified in Subclause 7.24.2.

A.6.2.12.2.2 No Random Access Response Reception

To test the UE behavior specified in subclause 6.2.2.1.2, the System Simulator shall transmit a Random Access Response containing a Random Access Preamble identifier corresponding to the transmitted Random Access Preamble after 5 preamble transmission attempts have been received by the System Simulator. The System Simulator shall *not* respond to the first 4 preamble transmission attempts.

The UE shall re-select a preamble and transmit with the calculated PRACH transmission power when the backoff time expires if no Random Access Response is received within the RA Response window.

In addition, the power applied to all preambles shall be in accordance with what is specified in Subclause 6.2.2. The power of the first preamble shall be -25 dBm with an accuracy specified in clause 6.3.5.1.1 of TS 36.101 [5]. The relative power applied to additional preambles shall have an accuracy specified in clause 6.3.5.2.1 of TS 36.101 [5].

The transmit timing of all PRACH transmissions shall be within the accuracy specified in Subclause 7.24.2.

A.6.2.12.2.3 Receiving a NACK on msg3

To test the UE behavior specified in subclause 6.2.2.1.3, the System Simulator shall NACK *all* UE msg3 following a successful Random Access Response.

The UE shall re-transmit the msg3 upon the reception of a NACK on msg3 until the maximum number of HARQ re-transmissions is reached.

A.6.2.12.2.4 Reception of an Incorrect Message over Temporary C-RNTI

To test the UE behavior specified in Subclause 6.2.2.1.5, the System Simulator shall send a message addressed to the temporary C-RNTI with a UE Contention Resolution Identity included in the MAC control element *not* matching the CCCH SDU transmitted in msg3 uplink message.

The UE shall re-select a preamble and transmit with the calculated PRACH transmission power when the backoff time expires unless the received message includes a UE Contention Resolution Identity MAC control element and the UE Contention Resolution Identity included in the MAC control element matches the CCCH SDU transmitted in the uplink message.

A.6.2.12.2.5 Reception of a Correct Message over Temporary C-RNTI

To test the UE behavior specified in Subclause 6.2.2.1.5, the System Simulator shall send a message addressed to the temporary C-RNTI with a UE Contention Resolution Identity included in the MAC control element matching the CCCH SDU transmitted in the msg3 uplink message.

The UE shall send ACK if the Contention Resolution is successful.

A.6.2.12.2.6 Contention Resolution Timer expiry

To test the UE behavior specified in Subclause 6.2.2.1.6, the System Simulator shall *not* send a response to a msg3.

The UE shall re-select a preamble and transmit with the calculated PRACH transmission power when the backoff time expires if the Contention Resolution Timer expires.

A.6.2.12.2.7 PRACH Resource Selection

The UE shall select PRACH resources and transmits or re-transmits PRACH preambles using the PRACH resources and PRACH configuration corresponding to the coverage enhancement level 0.

Note: The PRACH Resource Selection requirement is already assumed for testing the other PRACH requirements.

A.6.2.13 E-UTRAN FDD Contention Based Random Access Test for Cat-M1 UEs in Enhanced Coverage

A.6.2.13.1 Test Purpose and Environment

The purpose of this test is to verify whether the behavior of the random access procedure of a Cat-M1 UE in Enhanced Coverage is according to the requirements, whether the PRACH power settings and timing are within specified limits, and whether the UE determines properly the enhanced coverage level based on the RSRP measurement and the configured criterion in RSRP-ThresholdsPrach [2]. This test will verify the requirements in Clause 6.2.2, Clause 6.2.3 and Clause 7.24.2 in an AWGN model.

For this test a single cell is used. The test parameters are given in tables A.6.2.13.1-1 and A.6.2.13.1-2.

Table A.6.2.13.1-1: General test parameters for FDD contention based random access test

| Parameter | Unit | Value | Comments |
|-------------------------------------|------|--------------------------|---------------------------|
| E-UTRA RF Channel Number | | 1 | |
| BW _{channel} | MHz | 10 | |
| OCNG Pattern ^{Note 1} | | OP.21 FDD | As defined in A.3.2.1.21. |
| PDSCH parameters ^{Note 2} | | R.22 FDD | As defined in A.3.1.4.4 |
| MPDCCH parameters ^{Note 2} | | R.18 FDD | As defined in A.3.1.3.4 |
| PCFICH/PDCCH/PHICH parameters | | DL Reference Measurement | As defined in A.3.1.2.1 |

| | | Channel R.6 FDD | |
|--|------------|--------------------|-----|
| PBCH_RA | dB | 0 | |
| PBCH_RB | dB | | |
| PSS_RA | dB | | |
| SSS_RA | dB | | |
| PCFICH_RB | dB | | |
| PHICH_RA | dB | | |
| PHICH_RB | dB | | |
| PDCCH_RA | dB | | |
| PDCCH_RB | dB | | |
| MPDCCH_RA | dB | | |
| MPDCCH_RB | dB | | |
| PDSCH_RA | dB | | |
| PDSCH_RB | dB | | |
| OCNG_RA ^{Note 1} | dB | | |
| OCNG_RB ^{Note 1} | dB | | |
| N_{oc} | dBm/15 KHz | | -98 |
| \hat{E}_s / N_{oc} | dB | -12 | |
| \hat{E}_s / I_{ot} ^{Note 3} | dB | -12 | |
| RSRP ^{Note 3} | dBm/15 KHz | -110 | |
| I_o ^{Note 3} | dBm/9 MHz | -70 | |
| Propagation Condition | - | AWGN | |
| <p>Note 1: OCNG shall be used such that the cell is fully allocated and a constant total transmitted power spectral density is achieved for all OFDM symbols. The OCNG pattern is chosen during the test according to the presence of a DL reference measurement channel.</p> <p>Note 2: The PDSCH and MPDCCH reference measurement channels are used in the test only when a downlink transmission dedicated to the UE under test is required.</p> <p>Note 3: E_s/I_{ot}, RSRP and I_o level has been derived from other parameters for information purpose. They are not settable parameters themselves.</p> | | | |

Table A.6.2.13.1-2: RACH-Configuration parameters for FDD contention based random access test

| Field | Value | | | | Comment |
|--|----------------|----------------|----------------|----------------|---------|
| Parameters not per CE Levels | | | | | |
| powerRampingStep | dB2 | | | | |
| preambleInitialReceivedTargetPower | dBm-120 | | | | |
| preambleTransMax | n6 | | | | |
| maxHARQ-Msg3Tx | 4 | | | | |
| rar-HoppingConfig | Off | | | | |
| Parameters per CE Levels | | | | | |
| CE Level | Level 0 | Level 1 | Level 2 | Level 3 | |
| ra-ResponseWindowSize (per CE) | sf20 | sf80 | sf180 | sf320 | |
| mac-ContentionResolutionTimer (per CE) | sf80 | sf120 | sf200 | sf480 | |
| PreambleMappingInfo {firstPreamble, lastPreamble} | {0, 9} | {10, 19} | {20, 29} | {30, 39} | |
| Note: For further information see Clause 6.3.2 in TS 36.331. | | | | | |

Table A.6.2.13.1-3: PRACH-Configuration parameters for FDD contention based random access test

| Field | Value | Comment |
|-------------------------------------|---------------|---|
| Parameters not per CE Levels | | |
| rsrp-ThresholdsPrach | {23,37,47} | Corresponding to {-117, -103, -93} dBm as defined in Section 9.1.21.5 |
| mpdcch-startSF-CSS-RA | v1 | |
| referenceSignalPower | -5 dBm/15 KHz | As defined in clause 6.3.2 in TS 36.331. |

| maxHARQ-Msg3Tx | 4 | | | | As defined in table 5.7.1-2 in TS 36.211 |
|--|--|---------|---------|---------|--|
| Backoff Parameter Index | 2 | | | | As defined in table 7.2-1 in TS 36.321 |
| Configured UE transmitted power (P_{CMAX}) | Maximum value allowed by the applicable UE power class | | | | As defined in clause 6.2.5 in TS 36.101 |
| Parameters per PRACH CE Levels | | | | | |
| CE Level | Level 0 | Level 1 | Level 2 | Level 3 | |
| prach-ConfigIndex | 4 | 4 | 4 | 4 | As defined in table 5.7.1-2 in TS 36.211 |
| prach-FreqOffset | 0 | 0 | 0 | 0 | |
| prach-StartingSubframe | sf2 | sf4 | sf16 | sf64 | |
| maxNumPreambleAttempt | n3 | n5 | n7 | n10 | |
| numRepetitionPerPreambleAttempt | n1 | n4 | n16 | n64 | |
| mpdcch-NarrowbandsToMonitor | 2 | 2 | 2 | 2 | |
| mpdcch-NumRepetition-RA | r8 | r8 | r128 | r128 | |
| prach-HoppingConfig | Off | Off | Off | Off | |
| Note 1: See Clause 6.3.2 in TS 36.331 for further information on the parameters in this table. | | | | | |

A.6.2.13.2 Test Requirements

Contention based random access is triggered by *not* explicitly assigning a random access preamble via dedicated signalling in the downlink.

A.6.2.13.2.1 Random Access Response Reception

To test the UE behavior specified in Subclause 6.2.2, the System Simulator shall transmit a Random Access Response containing a Random Access Preamble identifier corresponding to the transmitted Random Access Preamble after 5 preamble transmission attempts (the preamble may be transmitted multiple times in each attempt) have been received by the System Simulator. In response to the first 4 preamble transmission attempts, the System Simulator shall transmit a Random Access Response *not* corresponding to the transmitted Random Access Preamble.

The UE may stop monitoring for Random Access Response(s) and shall transmit the msg3 if the Random Access Response contains a Random Access Preamble identifier corresponding to the transmitted Random Access Preamble.

The UE shall re-select a preamble and transmit with the calculated PRACH transmission power when the backoff time expires if all received Random Access Responses contain Random Access Preamble identifiers that do not match the transmitted Random Access Preamble.

In addition, the power applied to all preambles shall be in accordance with what is specified in Subclause 6.2.2. The power of the first preamble shall be -27 dBm. The power of the first preamble shall be -27 dBm with an accuracy specified in clause 6.3.5.1.1 of TS 36.101 [5]. The relative power applied to additional preambles shall have an accuracy specified in clause 6.3.5.2.1 of TS 36.101 [5].

The transmit timing of all PRACH transmissions shall be within the accuracy specified in Subclause 7.24.2.

A.6.2.13.2.2 No Random Access Response Reception

To test the UE behavior specified in subclause 6.2.2.1.2, the System Simulator shall transmit a Random Access Response containing a Random Access Preamble identifier corresponding to the transmitted Random Access Preamble after 5 preamble transmission attempts have been received by the System Simulator. The System Simulator shall *not* respond to the first 4 preamble transmission attempts.

The UE shall re-select a preamble and transmit with the calculated PRACH transmission power when the backoff time expires if no Random Access Response is received within the RA Response window.

In addition, the power applied to all preambles shall be in accordance with what is specified in Subclause 6.2.2. The power of the first preamble shall be -27 dBm with an accuracy specified in clause 6.3.5.1.1 of TS 36.101 [5]. The relative power applied to additional preambles shall have an accuracy specified in clause 6.3.5.2.1 of TS 36.101 [5].

The transmit timing of all PRACH transmissions shall be within the accuracy specified in Subclause 7.24.2.

A.6.2.13.2.3 Receiving a NACK on msg3

To test the UE behavior specified in subclause 6.2.2.1.3, the System Simulator shall NACK *all* UE msg3 following a successful Random Access Response.

The UE shall re-transmit the msg3 upon the reception of a NACK on msg3 until the maximum number of HARQ re-transmissions is reached.

A.6.2.13.2.4 Reception of an Incorrect Message over Temporary C-RNTI

To test the UE behavior specified in Subclause 6.2.2.1.5, the System Simulator shall send a message addressed to the temporary C-RNTI with a UE Contention Resolution Identity included in the MAC control element *not* matching the CCCH SDU transmitted in msg3 uplink message.

The UE shall re-select a preamble and transmit with the calculated PRACH transmission power when the backoff time expires unless the received message includes a UE Contention Resolution Identity MAC control element and the UE Contention Resolution Identity included in the MAC control element matches the CCCH SDU transmitted in the uplink message.

A.6.2.13.2.5 Reception of a Correct Message over Temporary C-RNTI

To test the UE behavior specified in Subclause 6.2.2.1.5, the System Simulator shall send a message addressed to the temporary C-RNTI with a UE Contention Resolution Identity included in the MAC control element matching the CCCH SDU transmitted in the msg3 uplink message.

The UE shall send ACK if the Contention Resolution is successful.

A.6.2.13.2.6 Contention Resolution Timer expiry

To test the UE behavior specified in Subclause 6.2.2.1.6, the System Simulator shall *not* send a response to a msg3.

The UE shall re-select a preamble and transmit with the calculated PRACH transmission power when the backoff time expires if the Contention Resolution Timer expires.

A.6.2.13.2.7 PRACH Resource Selection

The UE shall select PRACH resources and transmits or re-transmits PRACH preambles using the PRACH resources and PRACH configuration corresponding to the coverage enhancement level 2.

Note: The PRACH Resource Selection requirement is already assumed for testing the other PRACH requirements.

A.6.2.14 E-UTRAN HD-FDD Contention Based Random Access Test for Cat-M1 UEs in Enhanced Coverage

A.6.2.14.1 Test Purpose and Environment

The purpose of this test is to verify whether the behavior of the random access procedure of a Cat-M1 UE in Enhanced Coverage is according to the requirements, whether the PRACH power settings and timing are within specified limits, and whether the UE determines properly the enhanced coverage level based on the RSRP measurement and the configured criterion in RSRP-ThresholdsPrach [2]. This test will verify the requirements in Clause 6.2.2, Clause 6.2.3 and Clause 7.24.2 in an AWGN model.

For this test a single cell is used. The test parameters are given in tables A.6.2.14.1-1 and A.6.2.14.1-2.

Table A.6.2.14.1-1: General test parameters for HD-FDD contention based random access test

| Parameter | Unit | Value | Comments |
|--------------------------|------|-------|----------|
| E-UTRA RF Channel Number | | 1 | |
| BW _{channel} | MHz | 10 | |

| | | | |
|--|------------|---|---------------------------|
| OCNG Pattern ^{Note 1} | | OP.21 FDD | As defined in A.3.2.1.21. |
| PDSCH parameters ^{Note 2} | | R.12 HD-FDD | As defined in A.3.1.4.5 |
| MPDCCH parameters ^{Note 2} | | R.8 HD-FDD | As defined in A.3.1.3.5 |
| PCFICH/PDCCH/PHICH parameters | | DL Reference Measurement Channel R.3 HD-FDD | As defined in A.3.1.2.3 |
| PBCH_RA | dB | 0 | |
| PBCH_RB | dB | | |
| PSS_RA | dB | | |
| SSS_RA | dB | | |
| PCFICH_RB | dB | | |
| PHICH_RA | dB | | |
| PHICH_RB | dB | | |
| PDCCH_RA | dB | | |
| PDCCH_RB | dB | | |
| MPDCCH_RA | dB | | |
| MPDCCH_RB | dB | | |
| PDSCH_RA | dB | | |
| PDSCH_RB | dB | | |
| OCNG_RA ^{Note 1} | dB | | |
| OCNG_RB ^{Note 1} | dB | | |
| N_{oc} | dBm/15 KHz | | -98 |
| \hat{E}_s / N_{oc} | dB | -12 | |
| \hat{E}_s / I_{ot} ^{Note 3} | dB | -12 | |
| RSRP ^{Note 3} | dBm/15 KHz | -110 | |
| I_o ^{Note 3} | dBm/9 MHz | -70 | |
| Propagation Condition | - | AWGN | |
| <p>Note 1: OCNG shall be used such that the cell is fully allocated and a constant total transmitted power spectral density is achieved for all OFDM symbols. The OCNG pattern is chosen during the test according to the presence of a DL reference measurement channel.</p> <p>Note 2: The PDSCH and MPDCCH reference measurement channels are used in the test only when a downlink transmission dedicated to the UE under test is required.</p> <p>Note 3: E_s/I_{ot}, RSRP and I_o level has been derived from other parameters for information purpose. They are not settable parameters themselves.</p> | | | |

Table A.6.2.14.1-2: RACH-Configuration parameters for HD-FDD contention based random access test

| Field | Value | | | | Comment |
|--|----------------|----------------|----------------|----------------|---------|
| Parameters not per CE Levels | | | | | |
| powerRampingStep | dB2 | | | | |
| preambleInitialReceivedTargetPower | dBm-120 | | | | |
| preambleTransMax | n6 | | | | |
| maxHARQ-Msg3Tx | 4 | | | | |
| rar-HoppingConfig | Off | | | | |
| Parameters per CE Levels | | | | | |
| CE Level | Level 0 | Level 1 | Level 2 | Level 3 | |
| ra-ResponseWindowSize (per CE) | sf20 | sf80 | sf180 | sf320 | |
| mac-ContentionResolutionTimer (per CE) | sf80 | sf120 | sf200 | sf480 | |
| PreambleMappingInfo {firstPreamble, lastPreamble} | {0, 9} | {10, 19} | {20, 29} | {30, 39} | |
| Note: For further information see Clause 6.3.2 in TS 36.331. | | | | | |

Table A.6.2.14.1-3: PRACH-Configuration parameters for HD-FDD contention based random access test

| Field | Value | | | | Comment |
|--|--|----------------|----------------|----------------|---|
| Parameters not per CE Levels | | | | | |
| rsrp-ThresholdsPrach | {23,37,47} | | | | Corresponding {117, -103, -93} dBm as defined in Section 9.1.21.5 |
| mpdcch-startSF-CSS-RA | v1 | | | | |
| referenceSignalPower | -5 dBm/15 KHz | | | | As defined in clause 6.3.2 in TS 36.331. |
| maxHARQ-Msg3Tx | 4 | | | | As defined in table 5.7.1-2 in TS 36.211 |
| Backoff Parameter Index | 2 | | | | As defined in table 7.2-1 in TS 36.321 |
| Configured UE transmitted power (P_{CMAX}) | Maximum value allowed by the applicable UE power class | | | | As defined in clause 6.2.5 in TS 36.101 |
| Parameters per PRACH CE Levels | | | | | |
| CE Level | Level 0 | Level 1 | Level 2 | Level 3 | |
| prach-ConfigIndex | 4 | 4 | 4 | 4 | As defined in table 5.7.1-2 in TS 36.211 |
| prach-FreqOffset | 0 | 0 | 0 | 0 | |
| prach-StartingSubframe | sf2 | sf4 | sf16 | sf64 | |
| maxNumPreambleAttempt | n3 | n5 | n7 | n10 | |
| numRepetitionPerPreambleAttempt | n1 | n4 | n16 | n64 | |
| mpdcch-NarrowbandsToMonitor | 2 | 2 | 2 | 2 | |
| mpdcch-NumRepetition-RA | r8 | r8 | r128 | r128 | |
| prach-HoppingConfig | Off | Off | Off | Off | |
| Note 1: See Clause 6.3.2 in TS 36.331 for further information on the parameters in this table. | | | | | |

A.6.2.14.2 Test Requirements

Contention based random access is triggered by *not* explicitly assigning a random access preamble via dedicated signalling in the downlink.

A.6.2.14.2.1 Random Access Response Reception

To test the UE behavior specified in Subclause 6.2.2, the System Simulator shall transmit a Random Access Response containing a Random Access Preamble identifier corresponding to the transmitted Random Access Preamble after 5 preamble transmission attempts (the preamble may be transmitted multiple times in each attempt) have been received by the System Simulator. In response to the first 4 preamble transmission attempts, the System Simulator shall transmit a Random Access Response *not* corresponding to the transmitted Random Access Preamble.

The UE may stop monitoring for Random Access Response(s) and shall transmit the msg3 if the Random Access Response contains a Random Access Preamble identifier corresponding to the transmitted Random Access Preamble.

The UE shall re-select a preamble and transmit with the calculated PRACH transmission power when the backoff time expires if all received Random Access Responses contain Random Access Preamble identifiers that do not match the transmitted Random Access Preamble.

In addition, the power applied to all preambles shall be in accordance with what is specified in Subclause 6.2.2. The power of the first preamble shall be -27 dBm. The power of the first preamble shall be -27 dBm with an accuracy specified in clause 6.3.5.1.1 of TS 36.101 [5]. The relative power applied to additional preambles shall have an accuracy specified in clause 6.3.5.2.1 of TS 36.101 [5].

The transmit timing of all PRACH transmissions shall be within the accuracy specified in Subclause 7.24.2.

A.6.2.14.2.2 No Random Access Response Reception

To test the UE behavior specified in subclause 6.2.2.1.2, the System Simulator shall transmit a Random Access Response containing a Random Access Preamble identifier corresponding to the transmitted Random Access Preamble after 5 preamble transmission attempts have been received by the System Simulator. The System Simulator shall *not* respond to the first 4 preamble transmission attempts.

The UE shall re-select a preamble and transmit with the calculated PRACH transmission power when the backoff time expires if no Random Access Response is received within the RA Response window.

In addition, the power applied to all preambles shall be in accordance with what is specified in Subclause 6.2.2. The power of the first preamble shall be -27 dBm with an accuracy specified in clause 6.3.5.1.1 of TS 36.101 [5]. The relative power applied to additional preambles shall have an accuracy specified in clause 6.3.5.2.1 of TS 36.101 [5].

The transmit timing of all PRACH transmissions shall be within the accuracy specified in Subclause 7.24.2.

A.6.2.14.2.3 Receiving a NACK on msg3

To test the UE behavior specified in subclause 6.2.2.1.3, the System Simulator shall NACK *all* UE msg3 following a successful Random Access Response.

The UE shall re-transmit the msg3 upon the reception of a NACK on msg3 until the maximum number of HARQ re-transmissions is reached.

A.6.2.14.2.4 Reception of an Incorrect Message over Temporary C-RNTI

To test the UE behavior specified in Subclause 6.2.2.1.5, the System Simulator shall send a message addressed to the temporary C-RNTI with a UE Contention Resolution Identity included in the MAC control element *not* matching the CCCH SDU transmitted in msg3 uplink message.

The UE shall re-select a preamble and transmit with the calculated PRACH transmission power when the backoff time expires unless the received message includes a UE Contention Resolution Identity MAC control element and the UE Contention Resolution Identity included in the MAC control element matches the CCCH SDU transmitted in the uplink message.

A.6.2.14.2.5 Reception of a Correct Message over Temporary C-RNTI

To test the UE behavior specified in Subclause 6.2.2.1.5, the System Simulator shall send a message addressed to the temporary C-RNTI with a UE Contention Resolution Identity included in the MAC control element matching the CCCH SDU transmitted in the msg3 uplink message.

The UE shall send ACK if the Contention Resolution is successful.

A.6.2.14.2.6 Contention Resolution Timer expiry

To test the UE behavior specified in Subclause 6.2.2.1.6, the System Simulator shall *not* send a response to a msg3.

The UE shall re-select a preamble and transmit with the calculated PRACH transmission power when the backoff time expires if the Contention Resolution Timer expires.

A.6.2.14.2.7 PRACH Resource Selection

The UE shall select PRACH resources and transmits or re-transmits PRACH preambles using the PRACH resources and PRACH configuration corresponding to the coverage enhancement level 2.

Note: The PRACH Resource Selection requirement is already assumed for testing the other PRACH requirements.

A.6.2.15 E-UTRAN TDD Contention Based Random Access Test for Cat-M1 UEs in Enhanced Coverage

A.6.2.15.1 Test Purpose and Environment

The purpose of this test is to verify whether the behavior of the random access procedure of a Cat-M1 UE in Enhanced Coverage is according to the requirements, whether the PRACH power settings and timing are within specified limits, and whether the UE determines properly the enhanced coverage level based on the RSRP measurement and the configured criterion in RSRP-ThresholdsPrach [2]. This test will verify the requirements in Clause 6.2.2, Clause 6.2.3 and Clause 7.24.2 in an AWGN model.

For this test a single cell is used. The test parameters are given in tables A.6.2.15.1-1 and A.6.2.15.1-2.

Table A.6.2.15.1-1: General test parameters for TDD contention based random access test

| Parameter | Unit | Value | Comments |
|---|------------|--|---|
| E-UTRA RF Channel Number | | 1 | |
| BW _{channel} | MHz | 10 | |
| OCNG Pattern ^{Note 1} | | OP.11 TDD | As defined in A.3.2.2.11. |
| PDSCH parameters ^{Note 2} | | R.18 TDD | As defined in A.3.1.4.6 |
| MPDCCH parameters ^{Note 2} | | R.16 TDD | As defined in A.3.1.3.6 |
| PCFICH/PDCCH/PHICH parameters | | DL Reference Measurement Channel R.6 TDD | As defined in A.3.1.2.2 |
| Special subframe configuration | - | 6 | As specified in table 4.2-1 in TS 36.211. |
| Uplink-downlink configuration | - | 1 | As specified in table 4.2-2 in TS 36.211. |
| PBCH_RA | dB | 0 | |
| PBCH_RB | dB | | |
| PSS_RA | dB | | |
| SSS_RA | dB | | |
| PCFICH_RB | dB | | |
| PHICH_RA | dB | | |
| PHICH_RB | dB | | |
| PDCCH_RA | dB | | |
| PDCCH_RB | dB | | |
| MPDCCH_RA | dB | | |
| MPDCCH_RB | dB | | |
| PDSCH_RA | dB | | |
| PDSCH_RB | dB | | |
| OCNG_RA ^{Note 1} | dB | | |
| OCNG_RB ^{Note 1} | dB | | |
| N_{oc} | dBm/15 KHz | | -98 |
| \hat{E}_s/N_{oc} | dB | -12 | |
| \hat{E}_s/I_{ot} ^{Note 3} | dB | -12 | |
| RSRP ^{Note 3} | dBm/15 KHz | -110 | |
| I_o ^{Note 3} | dBm/9 MHz | -70 | |
| Propagation Condition | - | AWGN | |
| <p>Note 1: OCNG shall be used such that the cell is fully allocated and a constant total transmitted power spectral density is achieved for all OFDM symbols. The OCNG pattern is chosen during the test according to the presence of a DL reference measurement channel.</p> <p>Note 2: The PDSCH and MPDCCH reference measurement channels are used in the test only when a downlink transmission dedicated to the UE under test is required.</p> | | | |

| |
|--|
| Note 3: Es/lot, RSRP and Io level has been derived from other parameters for information purpose. They are not settable parameters themselves. |
|--|

Table A.6.2.15.1-2: RACH-Configuration parameters for TDD contention based random access test

| Field | Value | | | | Comment |
|--|----------------|----------------|----------------|----------------|-------------|
| Parameters not per CE Levels | | | | | |
| numberOfRA-Preambles | n52 | | | | |
| sizeOfRA-PreamblesGroupA | n52 | | | | No group B. |
| powerRampingStep | dB2 | | | | |
| preambleInitialReceivedTargetPower | dBm-120 | | | | |
| preambleTransMax | n6 | | | | |
| maxHARQ-Msg3Tx | 4 | | | | |
| rar-HoppingConfig | Off | | | | |
| Parameters per CE Levels | | | | | |
| CE Level | Level 0 | Level 1 | Level 2 | Level 3 | |
| ra-ResponseWindowSize (per CE) | sf20 | sf80 | sf180 | sf320 | |
| mac-ContentionResolutionTimer (per CE) | sf80 | sf120 | sf200 | sf480 | |
| PreambleMappingInfo {firstPreamble, lastPreamble} | {0, 9} | {10,19} | {20,29} | {30,39} | |
| Note: For further information see Clause 6.3.2 in TS 36.331. | | | | | |

Table A.6.2.15.1-3: PRACH-Configuration parameters for TDD contention based random access test

| Field | Value | | | | Comment |
|--|--|----------------|----------------|----------------|---|
| Parameters not per CE Levels | | | | | |
| rsrp-ThresholdsPrach | {23,37,47} | | | | Corresponding to {-117, -103, -93} dBm as defined in Section 9.1.21.5 |
| mpdcch-startSF-CSS-RA | v1 | | | | |
| referenceSignalPower | -5 dBm/15 KHz | | | | As defined in clause 6.3.2 in TS 36.331. |
| maxHARQ-Msg3Tx | 4 | | | | As defined in table 5.7.1-2 in TS 36.211 |
| Backoff Parameter Index | 2 | | | | As defined in table 7.2-1 in TS 36.321 |
| Configured UE transmitted power (P_{CMAX}) | Maximum value allowed by the applicable UE power class | | | | As defined in clause 6.2.5 in TS 36.101 |
| Parameters per PRACH CE Levels | | | | | |
| CE Level | Level 0 | Level 1 | Level 2 | Level 3 | |
| prach-ConfigIndex | 4 | 4 | 4 | 4 | As defined in table 5.7.1-2 in TS 36.211 |
| prach-FreqOffset | 0 | 0 | 0 | 0 | |
| prach-StartingSubframe | sf2 | sf4 | sf16 | sf64 | |
| maxNumPreambleAttempt | n3 | n5 | n7 | n10 | |
| numRepetitionPerPreambleAttempt | n1 | n4 | n16 | n64 | |
| mpdcch-NarrowbandsToMonitor | 2 | 2 | 2 | 2 | |
| mpdcch-NumRepetition-RA | r8 | r8 | r128 | r128 | |
| prach-HoppingConfig | Off | Off | Off | Off | |
| Note 1: See Clause 6.3.2 in TS 36.331 for further information on the parameters in this table. | | | | | |

A.6.2.15.2 Test Requirements

Contention based random access is triggered by *not* explicitly assigning a random access preamble via dedicated signalling in the downlink.

A.6.2.15.2.1 Random Access Response Reception

To test the UE behavior specified in Subclause 6.2.2, the System Simulator shall transmit a Random Access Response containing a Random Access Preamble identifier corresponding to the transmitted Random Access Preamble after 5 preamble transmission attempts (the preamble may be transmitted multiple times in each attempt) have been received by the System Simulator. In response to the first 4 preamble transmission attempts, the System Simulator shall transmit a Random Access Response *not* corresponding to the transmitted Random Access Preamble.

The UE may stop monitoring for Random Access Response(s) and shall transmit the msg3 if the Random Access Response contains a Random Access Preamble identifier corresponding to the transmitted Random Access Preamble.

The UE shall re-select a preamble and transmit with the calculated PRACH transmission power when the backoff time expires if all received Random Access Responses contain Random Access Preamble identifiers that do not match the transmitted Random Access Preamble.

In addition, the power applied to all preambles shall be in accordance with what is specified in Subclause 6.2.2. The power of the first preamble shall be -27 dBm with an accuracy specified in clause 6.3.5.1.1 of TS 36.101 [5]. The relative power applied to additional preambles shall have an accuracy specified in clause 6.3.5.2.1 of TS 36.101 [5].

The transmit timing of all PRACH transmissions shall be within the accuracy specified in Subclause 7.24.2.

A.6.2.15.2.2 No Random Access Response Reception

To test the UE behavior specified in subclause 6.2.2.1.2, the System Simulator shall transmit a Random Access Response containing a Random Access Preamble identifier corresponding to the transmitted Random Access Preamble after 5 preamble transmission attempts have been received by the System Simulator. The System Simulator shall *not* respond to the first 4 preamble transmission attempts.

The UE shall re-select a preamble and transmit with the calculated PRACH transmission power when the backoff time expires if no Random Access Response is received within the RA Response window.

In addition, the power applied to all preambles shall be in accordance with what is specified in Subclause 6.2.2. The power of the first preamble shall be -27 dBm with an accuracy specified in clause 6.3.5.1.1 of TS 36.101 [5]. The relative power applied to additional preambles shall have an accuracy specified in clause 6.3.5.2.1 of TS 36.101 [5].

The transmit timing of all PRACH transmissions shall be within the accuracy specified in Subclause 7.24.2.

A.6.2.15.2.3 Receiving a NACK on msg3

To test the UE behavior specified in subclause 6.2.2.1.3, the System Simulator shall NACK *all* UE msg3 following a successful Random Access Response.

The UE shall re-transmit the msg3 upon the reception of a NACK on msg3 until the maximum number of HARQ re-transmissions is reached.

A.6.2.15.2.4 Reception of an Incorrect Message over Temporary C-RNTI

To test the UE behavior specified in Subclause 6.2.2.1.5, the System Simulator shall send a message addressed to the temporary C-RNTI with a UE Contention Resolution Identity included in the MAC control element *not* matching the CCCH SDU transmitted in msg3 uplink message.

The UE shall re-select a preamble and transmit with the calculated PRACH transmission power when the backoff time expires unless the received message includes a UE Contention Resolution Identity MAC control element and the UE Contention Resolution Identity included in the MAC control element matches the CCCH SDU transmitted in the uplink message.

A.6.2.15.2.5 Reception of a Correct Message over Temporary C-RNTI

To test the UE behavior specified in Subclause 6.2.2.1.5, the System Simulator shall send a message addressed to the temporary C-RNTI with a UE Contention Resolution Identity included in the MAC control element matching the CCCH SDU transmitted in the msg3 uplink message.

The UE shall send ACK if the Contention Resolution is successful.

A.6.2.15.2.6 Contention Resolution Timer expiry

To test the UE behavior specified in Subclause 6.2.2.1.6, the System Simulator shall *not* send a response to a msg3.

The UE shall re-select a preamble and transmit with the calculated PRACH transmission power when the backoff time expires if the Contention Resolution Timer expires.

A.6.2.15.2.7 PRACH Resource Selection

The UE shall select PRACH resources and transmits or re- transmits PRACH preambles using the PRACH resources and PRACH configuration corresponding to the coverage enhancement level 2.

Note: The PRACH Resource Selection requirement is already assumed for testing the other PRACH requirements.

A.6.2.16 Contention Based Random Access Test for UE category NB1 UEs In-band mode in normal coverage

A.6.2.16.1 Test Purpose and Environment

The purpose of this test is to verify whether the behavior of the random access procedure of a category NB1 UE in Normal Coverage is according to the requirements, whether the NPRACH power settings and timing are within specified limits, and whether the UE determines properly the enhanced coverage level based on the NRSRP measurement and the configured criterion in NRSRP-ThresholdsPrach [2]. This test will verify the requirements in Clause 6.6.2, Clause 6.6.3 and Clause 7.20.2 in an AWGN model.

For this test a single NB-IoT cell and a single LTE cell are used. The test parameters are given in tables A.6.2.16.1-1, A.6.2.16.1-2 and A.6.2.16.1-4.

Table A.6.2.16.1-1: nCell specific test parameters for HD-FDD contention based random access test for UE category NB1 In-Band mode in Normal Coverage

| Parameter | Unit | Value | Comments |
|--------------------------------------|-------------|---------------------------------|-------------------------|
| NB-IOT operational mode | | In-band | |
| BW_{channel} | kHz | 200 | |
| PRB location within eCell | - | 30 | |
| NPDSCH parameters ^{Note 2} | | R.15 HD-FDD | As defined in A.3.1.5.1 |
| NPDCCH parameters ^{Note 2} | | R.27 HD-FDD | As defined in A.3.1.6.1 |
| NPBCH_RA | dB | -3 | |
| NPBCH_RB | dB | | |
| NPSS_RA | dB | | |
| NSSS_RA | dB | | |
| NPDCCH_RA | dB | | |
| NPDCCH_RB | dB | | |
| NPDSCH_RA | dB | | |
| NPDSCH_RB | dB | | |
| NOCNG_RA ^{Note 1} | dB | | |
| NOCNG_RB ^{Note 1} | dB | | |
| DRX | | OFF | |
| N_{oc} | dBm/15 kHz | Specified in Table A.6.2.16.1-2 | |
| \hat{E}_s/N_{oc} | dB | 3 | |
| \hat{E}_s/I_{ot} ^{Note 3} | dB | 3 | |
| NRSRP ^{Note 3} | dBm/15 kHz | -95 | |
| I_o ^{Note 3} | dBm/180 kHz | -82.45 | |
| Propagation Condition | - | AWGN | |
| Antenna Configuration | | 2x1 | |

| | |
|---------|---|
| Note 1: | NOCNG shall be used such that the cell is fully allocated and a constant total transmitted power spectral density is achieved for all OFDM symbols. The OCNG pattern is chosen during the test according to the presence of a DL reference measurement channel. |
| Note 2: | The NPDSCH and NPDCCH reference measurement channels are used in the test only when a downlink transmission dedicated to the UE under test is required. |
| Note 3: | Es/lot, NRSRP and Io level has been derived from other parameters for information purpose. They are not settable parameters themselves. |

Table A.6.2.16.1-2: eCell specific test parameters for HD-FDD contention based random access test for UE category NB1 In-Band mode in Normal Coverage

| Parameter | Unit | Value |
|---|------------|-----------|
| E-UTRA RF Channel Number | | 1 |
| BW _{channel} | MHz | 10 |
| NOCNG Pattern ^{Note 1} | - | NOP.1 FDD |
| PBCH_RA | dB | -3 |
| PBCH_RB | dB | |
| PSS_RA | dB | |
| SSS_RA | dB | |
| PCFICH_RB | dB | |
| PHICH_RA | dB | |
| PHICH_RB | dB | |
| PDCCH_RA | dB | |
| PDCCH_RB | dB | |
| PDSCH_RA | dB | |
| PDSCH_RB | dB | |
| OCNG_RA ^{Note 1} | dB | |
| OCNG_RB ^{Note 1} | dB | |
| N_{oc} | dBm/15 kHz | |
| \hat{E}_s / N_{oc} | dB | 3 |
| Propagation Condition | - | AWGN |
| Antenna Configuration | - | 2x1 |
| Note 1: OCNG shall be used such that the eCell is fully allocated and a constant total transmitted power spectral density is achieved for all OFDM symbols. | | |

Table A.6.2.16.1-3: Void

Table A.6.2.16.1-4: NPRACH-Configuration parameters for HD-FDD contention based random access test for UE category NB1 In-Band mode in Normal Coverage

| Field | Value | Comment |
|--|--|---|
| Parameters not per NPRACH resource | | |
| RSRP-ThresholdsNPRACH-InfoList | {24, 39} | Corresponding to {-116, -101} dBm as defined in Table 9.1.4-1 |
| nprach-CP-Length | us66dot7 | |
| nrs-Power | -5 dBm/15 kHz | As defined in clause 6.7.3 in TS 36.331. |
| Backoff Parameter Index | 1 | As defined in table 7.2-2 in TS 36.321 |
| Configured UE transmitted power (P_{CMAX}) | 23 dBm for power class 3, 20 dBm for power class 5 | As defined in clause 6.2.5F in TS 36.101 |
| powerRampingStep | dB2 | |
| preambleInitialReceivedTargetPower | dBm-112 | |
| preambleTransMax-CE | n6 | |

| Parameters per NPRACH Resource | | | |
|---|----------------|----------------|----------------|
| <i>NPRACH Resource</i> | <i>Level 0</i> | <i>Level 1</i> | <i>Level 2</i> |
| nprach-Periodicity | ms40 | ms240 | ms1280 |
| nprach-StartTime | ms8 | ms64 | ms512 |
| nprach-SubcarrierOffset | n0 | n0 | n0 |
| nprach-NumSubcarriers | n12 | n12 | n12 |
| nprach-SubcarrierMSG3-RangeStart | zero | zero | zero |
| maxNumPreambleAttemptCE | n3 | n6 | n10 |
| numRepetitionsPerPreambleAttempt | n2 | n8 | n64 |
| npdcch-NumRepetitions-RA | r4 | r16 | r128 |
| npdcch-StartSF-CSS-RA | v1dot5 | v1dot5 | v1dot5 |
| npdcch-Offset-RA | zero | zero | Zero |
| nprach-NumCBRA-StartSubcarriers | n8 | n8 | n8 |
| ra-ResponseWindowSize (per NPRACH Resource) | pp2 | pp2 | pp2 |
| mac-ContentionResolutionTimer (per NPRACH Resource) | pp8 | pp8 | pp8 |
| Note 1: See Clause 6.7. 3 in TS 36.331 for further information on the parameters in this table. | | | |

A.6.2.16.2 Test Requirements

Contention based random access is triggered by *not* explicitly assigning a random access preamble via dedicated signalling in the downlink.

A.6.2.16.2.1 Random Access Response Reception

To test the UE behavior specified in Subclause 6.6.2, the System Simulator shall transmit a Random Access Response containing a Random Access Preamble identifier corresponding to the transmitted Random Access Preamble after 3 preamble transmission attempts (the preamble may be transmitted multiple times in each attempt) have been received by the System Simulator. In response to the first 2 preamble transmission attempts, the System Simulator shall transmit a Random Access Response *not* corresponding to the transmitted Random Access Preamble.

The UE may stop monitoring for Random Access Response(s) and shall transmit the msg3 if the Random Access Response contains a Random Access Preamble identifier corresponding to the transmitted Random Access Preamble.

The UE shall re-select a preamble and transmit with the calculated NPRACH transmission power when the backoff time expires if all received Random Access Responses contain Random Access Preamble identifiers that do not match the transmitted Random Access Preamble.

In addition, the power applied to all preambles shall be in accordance with what is specified in Subclause 6.6.2. The power of the first preamble shall be -25 dBm with an accuracy specified in clause 6.3.5F.1.1 of TS 36.101 [5]. The relative power applied to additional preambles shall have an accuracy specified in clause 6.3.5F.2 of TS 36.101 [5].

The transmit timing of all NPRACH transmissions shall be within the accuracy specified in Subclause 7.20.2.

A.6.2.16.2.2 No Random Access Response Reception

To test the UE behavior specified in subclause 6.6.2.2, the System Simulator shall transmit a Random Access Response containing a Random Access Preamble identifier corresponding to the transmitted Random Access Preamble after 3 preamble transmission attempts have been received by the System Simulator. The System Simulator shall *not* respond to the first 2 preamble transmission attempts.

The UE shall re-select a preamble and transmit with the calculated NPRACH transmission power when the backoff time expires if no Random Access Response is received within the RA Response window.

In addition, the power applied to all preambles shall be in accordance with what is specified in Subclause 6.6.2. The power of the first preamble shall be -25 dBm with an accuracy specified in clause 6.3.5F.1.1 of TS 36.101 [5]. The relative power applied to additional preambles shall have an accuracy specified in clause 6.3.5F.2 of TS 36.101 [5].

The transmit timing of all NPRACH transmissions shall be within the accuracy specified in Subclause 7.20.2.

A.6.2.16.2.3 Receiving a NACK on msg3

To test the UE behavior specified in subclause 6.6.2.3, the System Simulator shall NACK *all* UE msg3 following a successful Random Access Response.

The UE shall re-transmit the msg3 upon the reception of a NACK on msg3 until the maximum number of re-transmissions defined by *maxNumPreambleAttemptCE* in the table A.6.2.16.1-4 is reached.

A.6.2.16.2.4 Reception of an Incorrect Message over Temporary C-RNTI

To test the UE behavior specified in Subclause 6.6.2.4, the System Simulator shall send a message addressed to the temporary C-RNTI with a UE Contention Resolution Identity included in the MAC control element *not* matching the CCCH SDU transmitted in msg3 uplink message.

The UE shall re-select a preamble and transmit with the calculated NPRACH transmission power when the backoff time expires unless the received message includes a UE Contention Resolution Identity MAC control element and the UE Contention Resolution Identity included in the MAC control element matches the CCCH SDU transmitted in the uplink message.

A.6.2.16.2.5 Reception of a Correct Message over Temporary C-RNTI

To test the UE behavior specified in Subclause 6.6.2.4, the System Simulator shall send a message addressed to the temporary C-RNTI with a UE Contention Resolution Identity included in the MAC control element matching the CCCH SDU transmitted in the msg3 uplink message.

The UE shall send ACK if the Contention Resolution is successful.

A.6.2.16.2.6 Contention Resolution Timer expiry

To test the UE behavior specified in Subclause 6.6.2.5, the System Simulator shall *not* send a response to a msg3.

The UE shall re-select a preamble and transmit with the calculated NPRACH transmission power when the backoff time expires if the Contention Resolution Timer expires.

A.6.2.16.2.7 NPRACH Resource Selection

The UE shall select NPRACH resources and transmits or re-transmits NPRACH preambles using the NPRACH resources and NPRACH configuration corresponding to the coverage enhancement level 0. The rate of correct coverage enhancement level selection during repeated tests shall be at least 90%.

Note: Correct coverage enhancement level selection is a prerequisite for testing the other NPRACH requirements.

A.6.2.17 Contention Based Random Access Test for UE category NB1 UEs In-band mode in Enhanced Coverage

A.6.2.17.1 Test Purpose and Environment

The purpose of this test is to verify whether the behavior of the random access procedure of a category NB1 UE in Enhanced Coverage is according to the requirements, whether the NPRACH power settings and timing are within specified limits, and whether the UE determines properly the enhanced coverage level based on the NRSRP measurement and the configured criterion in NRSRP-ThresholdsPrach [2]. This test will verify the requirements in Clause 6.6.2, Clause 6.6.3 and Clause 7.20.2 in an AWGN model.

For this test a single NB-IoT cell and a single LTE cell are used. The test parameters are given in tables A.6.2.17.1-1, A.6.2.17.1-2 and A.6.2.17.1-4.

Table A.6.2.17.1-1: nCell specific test parameters for HD-FDD contention based random access test for UE category NB1 In-Band mode in Enhanced Coverage

| Parameter | Unit | Value | Comments |
|---|-------------|---------------------------------|-------------------------|
| NB-IOT operational mode | | In-band | |
| BW_{channel} | kHz | 200 | |
| PRB location within eCell | - | 30 | |
| NPDSCH parameters ^{Note 2} | | R.15 HD-FDD | As defined in A.3.1.5.1 |
| NPDCCH parameters ^{Note 2} | | R.27 HD-FDD | As defined in A.3.1.6.1 |
| NPBCH_RA | dB | -3 | |
| NPBCH_RB | dB | | |
| NPSS_RA | dB | | |
| NSSS_RA | dB | | |
| NPDCCH_RA | dB | | |
| NPDCCH_RB | dB | | |
| NPDSCH_RA | dB | | |
| NPDSCH_RB | dB | | |
| NOCNG_RA ^{Note 1} | dB | | |
| NOCNG_RB ^{Note 1} | dB | | |
| DRX | | OFF | |
| N_{oc} | dBm/15 kHz | Specified in Table A.6.2.17.1-2 | |
| \hat{E}_s / N_{oc} | dB | -12.5 | |
| \hat{E}_s / I_{ot} ^{Note 3} | dB | -12.5 | |
| NRSRP ^{Note 3} | dBm/15 kHz | -110.5 | |
| I_o ^{Note 3} | dBm/180 kHz | -86.97 | |
| Propagation Condition | - | AWGN | |
| Antenna Configuration | | 2x1 | |
| <p>Note 1: NOCNG shall be used such that the cell is fully allocated and a constant total transmitted power spectral density is achieved for all OFDM symbols. The OCNG pattern is chosen during the test according to the presence of a DL reference measurement channel.</p> <p>Note 2: The NPDSCH and NPDCCH reference measurement channels are used in the test only when a downlink transmission dedicated to the UE under test is required.</p> <p>Note 3: E_s/I_{ot}, NRSRP and I_o level has been derived from other parameters for information purpose. They are not settable parameters themselves.</p> | | | |

Table A.6.2.17.1-2: eCell specific test parameters for HD-FDD contention based random access test for UE category NB1 In-Band mode in Enhanced Coverage

| Parameter | Unit | Value |
|---------------------------------|------|-----------|
| E-UTRA RF Channel Number | | 1 |
| BW_{channel} | MHz | 10 |
| NOCNG Pattern ^{Note 1} | - | NOP.1 FDD |
| PBCH_RA | dB | -3 |
| PBCH_RB | dB | |
| PSS_RA | dB | |
| SSS_RA | dB | |
| PCFICH_RB | dB | |
| PHICH_RA | dB | |
| PHICH_RB | dB | |
| PDCCH_RA | dB | |
| PDCCH_RB | dB | |
| PDSCH_RA | dB | |
| PDSCH_RB | dB | |
| OCNG_RA ^{Note 1} | dB | |
| OCNG_RB ^{Note 1} | dB | |

| | | |
|--|------------|------|
| N_{oc} | dBm/15 kHz | -98 |
| \hat{E}_s/N_{oc} | dB | 3 |
| Propagation Condition | - | AWGN |
| Antenna Configuration | - | 2x1 |
| Note 1: OCNG shall be used such that the cell is fully allocated and a constant total transmitted power spectral density is achieved for all OFDM symbols. | | |

Table A.6.2.17.1-3: Void

Table A.6.2.17.1-4: NPRACH-Configuration parameters for HD-FDD contention based random access test for UE category NB1 In-Band mode in Enhanced Coverage

| Field | Value | | | Comment |
|--|---|----------------|----------------|---|
| Parameters not per NPRACH resource | | | | |
| RSRP-ThresholdsNPRACH-InfoList | {19, 40} | | | Corresponding to {-121, -100} dBm as defined in Table 9.1.4-1 |
| nprach-CP-Length | us266dot7 | | | |
| nrs-Power | -5 dBm/15 kHz | | | As defined in clause 6.7.3 in TS 36.331. |
| Backoff Parameter Index | 1 | | | As defined in table 7.2-2 in TS 36.321 |
| Configured UE transmitted power (P_{CMAX}) | 23 dBm for power class 3, 20 dBm for power class 5 | | | As defined in clause 6.2.5F in TS 36.101 |
| powerRampingStep | dB2 | | | |
| preambleInitialReceivedTargetPower | dBm-120 | | | |
| preambleTransMax-CE | n6 | | | |
| Parameters per NPRACH Resource | | | | |
| NPRACH Resource | Level 0 | Level 1 | Level 2 | |
| nprach-Periodicity | ms40 | ms240 | ms1280 | |
| nprach-StartTime | ms8 | ms64 | ms512 | |
| nprach-SubcarrierOffset | n0 | n0 | n0 | |
| nprach-NumSubcarriers | n12 | n12 | n12 | |
| nprach-SubcarrierMSG3-RangeStart | zero | zero | zero | |
| maxNumPreambleAttemptCE | n3 | n6 | n10 | |
| numRepetitionsPerPreambleAttempt | n2 | n8 | n64 | |
| npdcch-NumRepetitions-RA | r4 | r16 | r128 | |
| npdcch-StartSF-CSS-RA | v1dot5 | v1dot5 | v1dot5 | |
| npdcch-Offset-RA | zero | zero | Zero | |
| nprach-NumCBRA-StartSubcarriers | n8 | n8 | n8 | |
| ra-ResponseWindowSize (per NPRACH Resource) | pp2 | pp2 | pp2 | |
| mac-ContentionResolutionTimer (per NPRACH Resource) | pp8 | pp8 | pp8 | |
| Note 1: See Clause 6.7.3 in TS 36.331 for further information on the parameters in this table. | | | | |

A.6.2.17.2 Test Requirements

Contention based random access is triggered by *not* explicitly assigning a random access preamble via dedicated signalling in the downlink.

A.6.2.17.2.1 Random Access Response Reception

To test the UE behavior specified in Subclause 6.6.2, the System Simulator shall transmit a Random Access Response containing a Random Access Preamble identifier corresponding to the transmitted Random Access Preamble after 5 preamble transmission attempts (the preamble may be transmitted multiple times in each attempt) have been received by the System Simulator. In response to the first 4 preamble transmission attempts, the System Simulator shall transmit a Random Access Response *not* corresponding to the transmitted Random Access Preamble.

The UE may stop monitoring for Random Access Response(s) and shall transmit the msg3 if the Random Access Response contains a Random Access Preamble identifier corresponding to the transmitted Random Access Preamble.

The UE shall re-select a preamble and transmit with the calculated NPRACH transmission power when the backoff time expires if all received Random Access Responses contain Random Access Preamble identifiers that do not match the transmitted Random Access Preamble.

In addition, the power applied to all preambles shall be in accordance with what is specified in Subclause 6.6.2. The power of the first preamble shall be 23 dBm for power class 3 and 20 dBm for power class 5 with an accuracy specified in clause 6.3.5F.1.1 of TS 36.101 [5].

The transmit timing of all NPRACH transmissions shall be within the accuracy specified in Subclause 7.20.2.

A.6.2.17.2.2 No Random Access Response Reception

To test the UE behavior specified in subclause 6.6.2.2, the System Simulator shall transmit a Random Access Response containing a Random Access Preamble identifier corresponding to the transmitted Random Access Preamble after 5 preamble transmission attempts have been received by the System Simulator. The System Simulator shall *not* respond to the first 4 preamble transmission attempts.

The UE shall re-select a preamble and transmit with the calculated NPRACH transmission power when the backoff time expires if no Random Access Response is received within the RA Response window.

In addition, the power applied to all preambles shall be in accordance with what is specified in Subclause 6.6.2. The power of the first preamble shall be 23 dBm for power class 3 and 20 dBm for power class 5 with an accuracy specified in clause 6.3.5F.1.1 of TS 36.101 [5].

The transmit timing of all NPRACH transmissions shall be within the accuracy specified in Subclause 7.20.2.

A.6.2.17.2.3 Receiving a NACK on msg3

To test the UE behavior specified in subclause 6.6.2.3, the System Simulator shall NACK *all* UE msg3 following a successful Random Access Response.

The UE shall re-transmit the msg3 upon the reception of a NACK on msg3 until the maximum number of re-transmissions defined by *maxNumPreambleAttemptCE* in the table A.6.2.17.1-4 is reached.

A.6.2.17.2.4 Reception of an Incorrect Message over Temporary C-RNTI

To test the UE behavior specified in Subclause 6.6.2.4, the System Simulator shall send a message addressed to the temporary C-RNTI with a UE Contention Resolution Identity included in the MAC control element *not* matching the CCCH SDU transmitted in msg3 uplink message.

The UE shall re-select a preamble and transmit with the calculated NPRACH transmission power when the backoff time expires unless the received message includes a UE Contention Resolution Identity MAC control element and the UE Contention Resolution Identity included in the MAC control element matches the CCCH SDU transmitted in the uplink message.

A.6.2.17.2.5 Reception of a Correct Message over Temporary C-RNTI

To test the UE behavior specified in Subclause 6.6.2.4, the System Simulator shall send a message addressed to the temporary C-RNTI with a UE Contention Resolution Identity included in the MAC control element matching the CCCH SDU transmitted in the msg3 uplink message.

The UE shall send ACK if the Contention Resolution is successful.

A.6.2.17.2.6 Contention Resolution Timer expiry

To test the UE behavior specified in Subclause 6.6.2.5, the System Simulator shall *not* send a response to a msg3.

The UE shall re-select a preamble and transmit with the calculated NPRACH transmission power when the backoff time expires if the Contention Resolution Timer expires.

A.6.2.17.2.7 NPRACH Resource Selection

The UE shall select NPRACH resources and transmits or re-transmits NPRACH preambles using the NPRACH resources and NPRACH configuration corresponding to the coverage enhancement level 1. The rate of correct coverage enhancement level selection during repeated tests shall be at least 90%.

Note: Correct coverage enhancement level selection is a prerequisite for testing the other NPRACH requirements.

A.6.3 RRC Connection Release with Redirection

A.6.3.1 Redirection from E-UTRAN FDD to UTRAN FDD

A.6.3.1.1 Test Purpose and Environment

The purpose of this test is to verify that the UE makes correct performing the RRC connection release with redirection to the target UTRAN FDD cell. This test will partly verify the RRC connection release with redirection to UTRAN FDD cell requirements in clause 6.3.2.1.

The test parameters are given in Tables A.6.3.1.1-1, A.6.3.1.1-2 and A.6.3.1.1-3 below. The test consists of two successive time periods, with time duration of T1, and T2 respectively. The “*RRCCConnectionRelease*” message containing the relevant system information of Cell 2 shall be sent to the UE during period T1 and the start of T2 is the instant when the last TTI containing the RRC message is sent to the UE. Prior to time duration T2, the UE shall not have any timing information of Cell 2. Cell 2 is powered up at the beginning of the T2.

Table A.6.3.1.1-1: General test parameters for RRC Connection Release with Redirection from E-UTRAN FDD to UTRAN FDD under AWGN propagation conditions

| Parameter | Unit | Value | Comment |
|---|------|--|---|
| PDSCH parameters (E-UTRAN FDD) | | DL Reference Measurement Channel R.0 FDD | As specified in clause A.3.1.1.1. |
| PCFICH/PDCCH/PHICH parameters (E-UTRAN FDD) | | DL Reference Measurement Channel R.6 FDD | As specified in clause A.3.1.2.1. |
| Active cell | | Cell 1 | Cell 1 is on E-UTRA RF channel number 1. |
| Neighbour cell | | Cell 2 | Cell 2 is on UTRA RF channel number 1. |
| CP length | | Normal | Applicable to cell 1 |
| E-UTRA RF Channel Number | | 1 | One E-UTRA FDD carrier frequency is used. |
| E-UTRA Channel Bandwidth ($BW_{channel}$) | MHz | 10 | |
| UTRA RF Channel Number | | 1 | One UTRA FDD carrier frequency is used. |
| Inter-RAT (UTRA FDD) measurement quantity | | CPICH E_c/I_0 | |
| Filter coefficient | | 0 | L3 filtering is not used. |
| DRX | | OFF | |
| UTRA FDD cell list size | | 16 | UTRA cells on UTRA RF channel 1 provided in the “ <i>RRCCConnectionRelease</i> ” message from the E-UTRAN |
| T1 | s | ≤ 5 | |
| T2 | s | 1 | |

Table A.6.3.1.1-2: Cell specific test parameters for cell #1 E-UTRAN FDD to UTRAN FDD RRC release with redirection under AWGN propagation conditions

| Parameter | Unit | Cell 1 | |
|--|------------|----------|-----|
| | | T1 | T2 |
| E-UTRA RF Channel Number | | 1 | |
| BW_{channel} | MHz | 10 | |
| OCNG Pattern defined in A.3.2.1.1 (OP.1 FDD) | | OP.1 FDD | |
| PBCH_RA | dB | 0 | |
| PBCH_RB | dB | | |
| PSS_RA | dB | | |
| SSS_RA | dB | | |
| PCFICH_RB | dB | | |
| PHICH_RA | dB | | |
| PHICH_RB | dB | | |
| PDCCH_RA | dB | | |
| PDCCH_RB | dB | | |
| PDSCH_RA | dB | | |
| PDSCH_RB | dB | | |
| OCNG_RA ^{Note 1} | dB | | |
| OCNG_RB ^{Note 1} | dB | | |
| \hat{E}_s/I_{ot} | dB | | |
| N_{oc} ^{Note 3} | dBm/15 kHz | -98 | |
| \hat{E}_s/N_{oc} | dB | 4 | 4 |
| RSRP ^{Note 4} | dBm/15 kHz | -94 | -94 |
| SCH_RP | dBm/15 kHz | -94 | -94 |
| Propagation Condition | | AWGN | |
| <p>Note 1: OCNG shall be used such that the cell is fully allocated and a constant total transmitted power spectral density is achieved for all OFDM symbols.</p> <p>Note 2: The resources for uplink transmission are assigned to the UE prior to the start of time period T2.</p> <p>Note 3: Interference from other cells and noise sources not specified in the test is assumed to be constant over subcarriers and time and shall be modelled as AWGN of appropriate power for N_{oc} to be fulfilled.</p> <p>Note 4: RSRP levels have been derived from other parameters for information purposes. They are not settable parameters themselves.</p> | | | |

Table A.6.3.1.1-3: Cell specific test parameters for cell #2 E-UTRAN FDD to UTRAN FDD RRC release with redirection under AWGN propagation conditions

| Parameter | Unit | Cell 2 | |
|---|--------------|-----------|------|
| | | T1 | T1 |
| UTRA RF Channel Number | | 1 | |
| CPICH_Ec/I _{or} | dB | -10 | |
| PCCPCH_Ec/I _{or} | dB | -12 | |
| SCH_Ec/I _{or} | dB | -12 | |
| PICH_Ec/I _{or} | dB | -15 | |
| DPCH_Ec/I _{or} | dB | N/A | |
| OCNS | | -0.941 | |
| \hat{I}_{or}/I_{oc} | dB | $-\infty$ | 0.02 |
| I_{oc} | dBm/3.84 MHz | -70 | |
| CPICH_Ec/I _o ^{Note 3} | dB | $-\infty$ | -13 |
| Propagation Condition | | AWGN | |
| <p>Note 1: The DPCH level is controlled by the power control loop.</p> <p>Note 2: The power of the OCNS channel that is added shall make the total power from the cell to be equal to I_{or}.</p> <p>Note 3: This gives an SCH Ec/I_o of -15dB</p> | | | |

A.6.3.1.2 Test Requirements

The UE shall start to transmit random access to Cell 2 less than 650 ms from the beginning of time period T2.

The rate of correct RRC connection release redirection to UTRAN FDD observed during repeated tests shall be at least 90%.

NOTE: The Re-establishment delay in this case can be expressed as

$$T_{\text{connection_release_redirect_UTRA FDD}} = T_{\text{RRC_procedure_delay}} + T_{\text{identify-UTRA FDD}} + T_{\text{SI-UTRA FDD}} + T_{\text{RA}}$$

where

$$T_{\text{RRC_procedure_delay}} = 110 \text{ ms}$$

$$T_{\text{identify-UTRA FDD}} = 500 \text{ ms}$$

$T_{\text{SI-UTRA FDD}}$ = the time required for acquiring all the relevant system information of the target UTRA FDD cell. This time depends upon whether the UE is provided with the relevant system information of the target UTRA FDD cell or not by the E-UTRAN before the RRC connection is released. 0 ms is assumed in this test case.

T_{RA} = The additional delay caused by the random access procedure. 40 ms is assumed in this test case.

This gives a total of 650 ms.

A.6.3.2 Redirection from E-UTRAN TDD to UTRAN FDD

A.6.3.2.1 Test Purpose and Environment

The purpose of this test is to verify that the UE makes correct performing the RRC connection release with redirection to the target UTRAN FDD cell. This test will partly verify the RRC connection release with redirection to UTRAN FDD cell requirements in clause 6.3.2.1.

The test parameters are given in Tables A.6.3.2.1-1, A.6.3.2.1-2 and A.6.3.2.1-3 below. The test consists of two successive time periods, with time duration of T1, and T2 respectively. The “*RRCConnectionRelease*” message containing the relevant system information of Cell 2 shall be sent to the UE during period T1 and the start of T2 is the instant when the last TTI containing the RRC message is sent to the UE. Prior to time duration T2, the UE shall not have any timing information of cell 2. Cell 2 is powered up at the beginning of the T2,

Table A.6.3.2.1-1: General test parameters for RRC Connection Release with Redirection from E-UTRAN TDD to UTRAN FDD under AWGN propagation conditions

| Parameter | Unit | Value | Comment |
|--|------|--|--|
| PDSCH parameters (E-UTRAN TDD) | | DL Reference Measurement Channel R.0 TDD | As specified in clause A.3.1.1.2. |
| PCFICH/PDCCH/PHICH parameters (E-UTRAN TDD) | | DL Reference Measurement Channel R.6 TDD | As specified in clause A.3.1.2.2. |
| Active cell | | Cell 1 | Cell 1 is on E-UTRA RF channel number 1. |
| Neighbour cell | | Cell 2 | Cell 2 is on UTRA RF channel number 1. |
| CP length | | Normal | Applicable to cell 1 |
| E-UTRA RF Channel Number | | 1 | One E-UTRA TDD carrier frequency is used. |
| E-UTRA Channel Bandwidth (BW_{channel}) | MHz | 10 | |
| Special subframe configuration | | 6 | As specified in table 4.2-1 in TS 36.211 |
| Uplink-downlink configuration | | 1 | As specified in table 4.2-2 in TS 36.211 |
| UTRA RF Channel Number | | 1 | One UTRA FDD carrier frequency is used. |
| Inter-RAT (UTRA FDD) measurement quantity | | CPICH Ec/Io | |
| Filter coefficient | | 0 | L3 filtering is not used. |
| DRX | | OFF | |
| UTRA FDD cell list size | | 16 | UTRA cells on UTRA RF channel 1 provided in the “ <i>RRCConnectionRelease</i> ” message from the E-UTRAN |
| T1 | s | ≤5 | |

| | | | |
|----|---|---|--|
| T2 | s | 1 | |
|----|---|---|--|

Table A.6.3.2.1-2: Cell specific test parameters for cell #1 E-UTRAN TDD to UTRAN FDD RRC release with redirection under AWGN propagation conditions

| Parameter | Unit | Cell 1 | |
|--|------------|----------|-----|
| | | T1 | T2 |
| E-UTRA RF Channel Number | | 1 | |
| BW _{channel} | MHz | 10 | |
| OCNG Pattern defined in A.3.2.2.1 (OP.1 TDD) | | OP.1 TDD | |
| PBCH_RA | dB | 0 | |
| PBCH_RB | dB | | |
| PSS_RA | dB | | |
| SSS_RA | dB | | |
| PCFICH_RB | dB | | |
| PHICH_RA | dB | | |
| PHICH_RB | dB | | |
| PDCCH_RA | dB | | |
| PDCCH_RB | dB | | |
| PDSCH_RA | dB | | |
| PDSCH_RB | dB | | |
| OCNG_RA ^{Note 1} | dB | | |
| OCNG_RB ^{Note 1} | dB | | |
| \hat{E}_s/I_{ot} | dB | | |
| N_{oc} ^{Note 3} | dBm/15 kHz | -98 | |
| \hat{E}_s/N_{oc} | dB | 4 | 4 |
| RSRP ^{Note 4} | dBm/15 kHz | -94 | -94 |
| SCH_RP | dBm/15 kHz | -94 | -94 |
| Propagation Condition | | AWGN | |
| <p>Note 1: OCNG shall be used such that the cell is fully allocated and a constant total transmitted power spectral density is achieved for all OFDM symbols.</p> <p>Note 2: The resources for uplink transmission are assigned to the UE prior to the start of time period T2.</p> <p>Note 3: Interference from other cells and noise sources not specified in the test is assumed to be constant over subcarriers and time and shall be modelled as AWGN of appropriate power for N_{oc} to be fulfilled.</p> <p>Note 4: RSRP levels have been derived from other parameters for information purposes. They are not settable parameters themselves.</p> | | | |

Table A.6.3.2.1-3: Cell specific test parameters for cell #2 E-UTRAN TDD to UTRAN FDD RRC release with redirection under AWGN propagation conditions

| Parameter | Unit | Cell 2 | |
|-------------------------------|--------------|-----------|------|
| | | T1 | T2 |
| UTRA RF Channel Number | | 1 | |
| CPICH_Ec/Ior | dB | -10 | |
| PCCPCH_Ec/Ior | dB | -12 | |
| SCH_Ec/Ior | dB | -12 | |
| PICH_Ec/Ior | dB | -15 | |
| DPCH_Ec/Ior | dB | N/A | |
| OCNS | | -0.941 | |
| \hat{I}_{or}/I_{oc} | dB | $-\infty$ | 0.02 |
| I_{oc} | dBm/3.84 MHz | -70 | |
| CPICH_Ec/Io ^{Note 3} | dB | $-\infty$ | -13 |
| Propagation Condition | | AWGN | |

| | |
|---------|--|
| Note 1: | The DPCH level is controlled by the power control loop. |
| Note 2: | The power of the OCNS channel that is added shall make the total power from the cell to be equal to I_{or} . |
| Note 3: | This gives an SCH Ec/Io of -15dB |

A.6.3.2.2 Test Requirements

The UE shall start to transmit random access to Cell 2 less than 650 ms from the beginning of time period T2.

The rate of correct RRC connection release redirection to UTRA FDD observed during repeated tests shall be at least 90%.

NOTE: The Re-establishment delay in this case can be expressed as

$$T_{\text{connection_release_redirect_UTRA FDD}} = T_{\text{RRC_procedure_delay}} + T_{\text{identify-UTRA FDD}} + T_{\text{SI-UTRA FDD}} + T_{\text{RA}}$$

where

$$T_{\text{RRC_procedure_delay}} = 110 \text{ ms}$$

$$T_{\text{identify-UTRA FDD}} = 500 \text{ ms}$$

$T_{\text{SI-UTRA FDD}}$ = the time required for acquiring all the relevant system information of the target UTRA FDD cell. This time depends upon whether the UE is provided with the relevant system information of the target UTRA FDD cell or not by the E-UTRAN before the RRC connection is released. 0 ms is assumed in this test case.

T_{RA} = The additional delay caused by the random access procedure. 40 ms is assumed in this test case.

This gives a total of 650 ms.

A.6.3.3 Redirection from E-UTRAN FDD to GERAN when System Information is provided

A.6.3.3.1 Test Purpose and Environment

The purpose of this test is to verify that the UE performs the RRC connection release with redirection from the E-UTRA FDD to the target GERAN cell within $T_{\text{connection_release_redirect_GERAN}}$. This test will partly verify the RRC connection release with redirection to GERAN requirements in clause 6.3.2.2.

The test parameters are given in Tables A.6.3.3.1-1, A.6.3.3.1-2 and A.6.3.3.1-3 below. No measurement gaps are configured. The test consists of two successive time periods, with time duration of T1, and T2 respectively. During time duration T1, the UE shall not have any timing information of cell 2. The start of T2 is the instant when the last TTI containing the RRC message, "RRCConnectionRelease", is received by the UE from cell 1. The "RRCConnectionRelease" message shall contain all the relevant system information of cell 2.

Table A.6.3.3.1-1: General test parameters for RRC connection release with redirection from E-UTRAN FDD to GERAN in AWGN

| Parameter | Unit | Value | Comment |
|---|------|--|---|
| PDSCH parameters (E-UTRAN FDD) | | DL Reference Measurement Channel R.0 FDD | As specified in clause A.3.1.1.1. |
| PCFICH/PDCCH/PHICH parameters (E-UTRAN FDD) | | DL Reference Measurement Channel R.6 FDD | As specified in clause A.3.1.2.1. |
| Active cell | | Cell 1 | Cell 1 is on E-UTRA RF channel number 1. |
| Neighbour cell | | Cell 2 | Cell 2 is on Absolute RF Channel Number 1 (GSM cell) |
| CP length | | Normal | Applicable to cell 1 |
| E-UTRA RF Channel Number | | 1 | One E-UTRA FDD carrier frequency is used. |
| E-UTRA Channel Bandwidth (BW _{channel}) | MHz | 10 | |
| DRX | | OFF | |
| Monitored GSM cell list size | | 6 GSM neighbour including ARFCN 1 | GSM cells are provided in the "RRCConnectionRelease" message. |

| | | | |
|----|---|---|--|
| T1 | s | 5 | |
| T2 | s | 2 | |

Table A.6.3.3.1-2: Cell specific test parameters for E-UTRA FDD cell (cell #1) for RRC connection release with redirection from E-UTRAN FDD to GERAN in AWGN

| Parameter | Unit | Cell 1 | |
|--|--|----------|-----|
| | | T1 | T2 |
| E-UTRA RF Channel Number | | 1 | |
| BWchannel | MHz | 10 | |
| OCNG Pattern defined in A.3.2.1.1 (OP.1 FDD) | | OP.1 FDD | |
| PBCH_RA | dB | 0 | |
| PBCH_RB | dB | | |
| PSS_RA | dB | | |
| SSS_RA | dB | | |
| PCFICH_RB | dB | | |
| PHICH_RA | dB | | |
| PHICH_RB | dB | | |
| PDCCH_RA | dB | | |
| PDCCH_RB | dB | | |
| PDSCH_RA | dB | | |
| PDSCH_RB | dB | | |
| OCNG_RANote 1 | dB | | |
| OCNG_RBNote 1 | dB | | |
| \hat{E}_s / I_{ot} | dB | | |
| \hat{E}_s / N_{oc} | dB | 4 | 4 |
| N_{oc} | dBm/15 kHz | -98 | |
| RSRP | dBm/15 kHz | -94 | -94 |
| SCH_RP | dBm/15 kHz | -94 | -94 |
| Propagation Condition | | AWGN | |
| Note 1: | OCNG shall be used such that the cell is fully allocated and a constant total transmitted power spectral density is achieved for all OFDM symbols. | | |
| Note 2: | Interference from other cells and noise sources not specified in the test is assumed to be constant over subcarriers and time and shall be modelled as AWGN of appropriate power for N_{oc} to be fulfilled. | | |
| Note 3: | RSRP levels have been derived from other parameters for information purposes. They are not settable parameters themselves. | | |

Table A.6.3.3.1-3: Cell specific test parameters for GERAN cell (cell #2) for RRC connection release with redirection from E-UTRAN FDD to GERAN in AWGN

| Parameter | Unit | Cell 2 | |
|----------------------------|------|-----------|-------|
| | | T1 | T2 |
| Absolute RF Channel Number | | ARFNC 1 | |
| RXLEV | dBm | -Infinity | -75 |
| GSM BSIC | | N/A | Valid |

A.6.3.3.2 Test Requirements

The UE shall begin to send access bursts on RACH of the target GERAN cell (cell #2) less than 1120 ms from the beginning of time period T2.

The rate of correct “RRC connection release with redirection to GERAN” observed during repeated tests shall be at least 90%.

NOTE: The test requirement in this test case is expressed as:

$$T_{\text{connection_release_redirect_GERAN}} = T_{\text{RRC_procedure_delay}} + T_{\text{identify_GERAN}} + T_{\text{SI_GERAN}} + T_{\text{RA}}$$

$T_{\text{RRC_procedure_delay}} = 110$ ms, which is the time for processing the received message “*RRCConnectionRelease*”.

$T_{\text{identify-GERAN}} = 1000$ ms, which is the time for identifying the target GERAN cell.

$T_{\text{SI-GERAN}} = 0$; UE does not have to read the system information of the GERAN cell since all relevant SI is provided to the UE in the “*RRCConnectionRelease*” message.

$T_{\text{RA}} = 10$ ms, which is about 2 GSM frames (2×4.65 ms) to account for the GSM timing uncertainty.

A.6.3.4 Redirection from E-UTRAN TDD to GERAN when System Information is provided

A.6.3.4.1 Test Purpose and Environment

The purpose of this test is to verify that the UE performs the RRC connection release with redirection from the E-UTRA TDD to the target GERAN cell within $T_{\text{connection_release_redirect_GERAN}}$. This test will partly verify the RRC connection release with redirection to GERAN requirements in clause 6.3.2.2.

The test parameters are given in Tables A.6.3.4.1-1, A.6.3.4.1-2 and A.6.3.4.1-3 below. No measurement gaps are configured. The test consists of two successive time periods, with time duration of T1, and T2 respectively. During time duration T1, the UE shall not have any timing information of cell 2. The start of T2 is the instant when the last TTI containing the RRC message, “*RRCConnectionRelease*”, is received by the UE from cell 1. The “*RRCConnectionRelease*” message shall contain all the relevant system information of cell 2.

Table A.6.3.4.1-1: General test parameters for RRC connection release with redirection from E-UTRAN TDD to GERAN in AWGN

| Parameter | Unit | Value | Comment |
|--|------|--|--|
| PDSCH parameters (E-UTRAN TDD) | | DL Reference Measurement Channel R.0 TDD | As specified in clause A.3.1.1.2. |
| PCFICH/PDCCH/PHICH parameters (E-UTRAN TDD) | | DL Reference Measurement Channel R.6 TDD | As specified in clause A.3.1.2.2. |
| Active | | Cell 1 | Cell 1 is on E-UTRA RF channel number 1. |
| Neighbour cell | | Cell 2 | Cell 2 is on Absolute RF Channel Number 1 (GSM cell) |
| CP length | | Normal | Applicable to cell 1 |
| Special subframe configuration | | 6 | As specified in table 4.2.1 in TS 36.211. The same configuration applies to all cells. |
| Uplink-downlink configuration | | 1 | |
| E-UTRA RF Channel Number | | 1 | One E-UTRA TDD carrier frequency is used. |
| E-UTRA Channel Bandwidth (BW_{channel}) | MHz | 10 | |
| DRX | | OFF | |
| Monitored GSM cell list size | | 6 GSM neighbour including ARFCN 1 | GSM cells provided in the “ <i>RRCConnectionRelease</i> ” message. |
| T1 | s | 5 | |
| T2 | s | 2 | |

Table A.6.3.4.1-2: Cell specific test parameters for E-UTRA TDD cell (cell #1) for RRC connection release with redirection from E-UTRAN TDD to GERAN in AWGN

| Parameter | Unit | Cell 1 | |
|--|------|----------|----|
| | | T1 | T2 |
| E-UTRA RF Channel Number | | 1 | |
| BW_{channel} | MHz | 10 | |
| OCNG Pattern defined in A.3.2.2.1 (OP.1 TDD) | | OP.1 TDD | |
| PBCH_RA | dB | | |
| PBCH_RB | dB | | |
| PSS_RA | dB | | |
| SSS_RA | dB | | |
| PCFICH_RB | dB | | |

| | | | |
|--|------------|------|-----|
| PHICH_RA | dB | 0 | |
| PHICH_RB | dB | | |
| PDCCH_RA | dB | | |
| PDCCH_RB | dB | | |
| PDSCH_RA | dB | | |
| PDSCH_RB | dB | | |
| OCNG_RA ^{Note 1} | dB | | |
| OCNG_RB ^{Note 1} | dB | | |
| \hat{E}_s/I_{ot} | dB | 4 | 4 |
| \hat{E}_s/N_{oc} | dB | 4 | 4 |
| N_{oc} | dBm/15 kHz | -98 | |
| RSRP | dBm/15 kHz | -94 | -94 |
| SCH_RP | dBm/15 kHz | -94 | -94 |
| Propagation Condition | | AWGN | |
| Note 1: OCNG shall be used such that the cell is fully allocated and a constant total transmitted power spectral density is achieved for all OFDM symbols. | | | |
| Note 2: Interference from other cells and noise sources not specified in the test is assumed to be constant over subcarriers and time and shall be modelled as AWGN of appropriate power for N_{oc} to be fulfilled. | | | |
| Note 3: RSRP levels have been derived from other parameters for information purposes. They are not settable parameters themselves. | | | |

Table A.6.3.4.1-3: Cell specific test parameters for GERAN cell (cell #2) for RRC connection release with redirection from E-UTRAN TDD to GERAN in AWGN

| Parameter | Unit | Cell 2 | |
|----------------------------|------|-----------|-------|
| | | T1 | T2 |
| Absolute RF Channel Number | | ARFNC 1 | |
| RXLEV | dBm | -Infinity | -75 |
| GSM BSIC | | N/A | Valid |

A.6.3.4.2 Test Requirements

The UE shall begin to send access bursts on RACH of the target GERAN cell (cell #2) less than 1120 ms from the beginning of time period T2.

The rate of correct “RRC connection release with redirection to GERAN” observed during repeated tests shall be at least 90%.

NOTE: The test requirement in this test case is expressed as:

$$T_{\text{connection_release_redirect_GERAN}} = T_{\text{RRC_procedure_delay}} + T_{\text{identify-GERAN}} + T_{\text{SI-GERAN}} + T_{\text{RA}}$$

$T_{\text{RRC_procedure_delay}} = 110$ ms, which is the time for processing the received message “*RRCConnectionRelease*”.

$T_{\text{identify-GERAN}} = 1000$ ms, which is the time for identifying the target GERAN cell.

A.6.3.5 E-UTRA TDD RRC connection release redirection to UTRA TDD

A.6.3.5.1 Test Purpose and Environment

The purpose of this test is to verify that the UE performs the RRC connection release with redirection from the E-UTRA TDD to the target UTRA TDD cell within $T_{\text{connection_release_redirect_UTRA TDD}}$. This test will partly verify the RRC connection release with redirection to UTRA TDD requirements in clause 6.3.2.3.

The test parameters are given in table A.6.3.5.1-1, table A.6.3.5.1-2, and table A.6.3.5.1-3. No measurement gaps are configured. The test consists of two successive time periods, with time duration of T1, and T2 respectively. During time duration T1, the UE shall not have any timing information of cell 2. The “*RRCConnectionRelease*” message containing the relevant system information of Cell 2 shall be sent to the UE during period T1 and the start of T2 is the instant when

the last TTI containing the RRC message, “*RRCConnectionRelease*”, is received by the UE from cell 1. The “*RRCConnectionRelease*” message shall contain all the relevant system information of Cell 2.

Table A.6.3.5.1-1: General test parameters for E-UTRA TDD RRC connection release redirection to UTRA TDD

| Parameter | Unit | Value | Comment |
|---|------|--|--|
| PDSCH parameters (E-UTRAN TDD) | | DL Reference Measurement Channel R.0 TDD | As specified in clause A.3.1.1.2. |
| PCFICH/PDCCH/PHICH parameters (E-UTRAN TDD) | | DL Reference Measurement Channel R.6 TDD | As specified in clause A.3.1.2.2. |
| Active cell | | Cell 1 | Cell 1 is on E-UTRA RF channel number 1. |
| Neighbour cell | | Cell 2 | Cell 2 is on UTRA RF channel number 1. |
| Time offset between cells | ms | 3 | Asynchronous cells |
| E-UTRA RF Channel Number | | 1 | One E-UTRA TDD carrier frequency is used. |
| E-UTRA Channel Bandwidth ($BW_{channel}$) | MHz | 10 | |
| CP length | | Normal | Applicable to cell 1 |
| Special subframe configuration of cell 1 | | 6 | As specified in table 4.2.1 in TS 36.211 |
| Uplink-downlink configuration of cell 1 | | 1 | As specified in table 4.2-2 in TS 36.211 |
| UTRA RF Channel Number | | 1 | One UTRA TDD carrier frequency is used. |
| UTRA RF Channel Number | | 1 | One UTRA TDD carrier frequency is used. |
| Filter coefficient | | 0 | L3 filtering is not used. |
| DRX | | OFF | |
| Monitored UTRA TDD cell list size | | 16 | UTRA cells on UTRA RF channel 1 provided in the “ <i>RRCConnectionRelease</i> ” message from the E-UTRAN |
| T1 | s | 5 | |
| T2 | s | 1 | |

Table A.6.3.5.1-2: Cell specific test parameters for cell 1 in E-UTRA TDD RRC connection release redirection to UTRA TDD test

| Parameter | Unit | Cell 1 | |
|--|------------|----------|-----|
| | | T1 | T2 |
| E-UTRA RF Channel Number | | 1 | |
| $BW_{channel}$ | MHz | 10 | |
| OCNG Pattern defined in A.3.2.2.1 (OP.1 TDD) | | OP.1 TDD | |
| PBCH_RA | dB | 0 | |
| PBCH_RB | dB | | |
| PSS_RA | dB | | |
| SSS_RA | dB | | |
| PCFICH_RB | dB | | |
| PHICH_RA | dB | | |
| PHICH_RB | dB | | |
| PDCCH_RA | dB | | |
| PDCCH_RB | dB | | |
| PDSCH_RA | dB | | |
| PDSCH_RB | dB | | |
| OCNG_RA ^{Note 1} | dB | | |
| OCNG_RB ^{Note 1} | dB | | |
| \hat{E}_s / I_{ot} | dB | | |
| N_{oc} ^{Note 3} | dBm/15 kHz | -98 | |
| \hat{E}_s / N_{oc} | dB | 4 | 4 |
| RSRP ^{Note 4} | dBm/15 kHz | -94 | -94 |

| | | | |
|-----------------------|--|------|-----|
| SCH_RP | dBm/15 kHz | -94 | -94 |
| Propagation Condition | | AWGN | |
| Note 1: | OCNG shall be used such that the cell is fully allocated and a constant total transmitted power spectral density is achieved for all OFDM symbols. | | |
| Note 2: | The resources for uplink transmission are assigned to the UE prior to the start of time period T2. | | |
| Note 3: | Interference from other cells and noise sources not specified in the test is assumed to be constant over subcarriers and time and shall be modelled as AWGN of appropriate power for N_{oc} to be fulfilled. | | |
| Note 4: | RSRP levels have been derived from other parameters for information purposes. They are not settable parameters themselves. | | |

Table A.6.3.5.1-3: Cell specific test parameters for cell 2 in E-UTRA TDD RRC connection release redirection to UTRA TDD test

| Parameter | Unit | Cell 2 (UTRA TDD) | | | |
|---|--|-------------------|--------|-------|-------|
| | | 0 | | DwPTS | |
| Timeslot Number | | T1 | T2 | T1 | T2 |
| UTRA RF Channel Number ^{Note1} | | Channel 1 | | | |
| PCCPCH_Ec/I _{or} | dB | -4.77 | -4.77 | | |
| DwPCH_Ec/I _{or} | dB | | | 0 | 0 |
| OCNS_Ec/I _{or} ^{Note2} | dB | -1.76 | -1.76 | | |
| \hat{I}_{or}/I_{oc} | dB | -inf | 8 | -inf | 8 |
| I_{oc} | dBm/1.28 MHz | -80 | | | |
| PCCPCH RSCP ^{Note3} | dBm | -inf | -76.77 | n.a. | n.a. |
| PCCPCH_Ec/I _o ^{Note3} | dB | -inf | -5.41 | n.a. | n.a. |
| DwPCH_Ec/I _o ^{Note3} | dB | n.a. | n.a. | -inf | -0.64 |
| Propagation Condition | | AWGN | | | |
| Note 1: | In the case of multi-frequency cell, the UTRA RF Channel Number is the primary frequency's channel number. | | | | |
| Note 2: | The power of the OCNS channel that is added shall make the total power from the cell to be equal to I_{or} . | | | | |
| Note 3: | P-CCPCH RSRP, PCCPCH_Ec/I _o and DwPCH_Ec/I _o levels have been derived from other parameters for information purposes. They are not settable parameters themselves. | | | | |

A.6.3.5.2 Test Requirements

The UE shall start to transmit the SYNCH-UL sequence in the UpPTS to Cell 2 less than 650 ms from the beginning of time period T2.

The rate of correct RRC connection release redirection to UTRA TDD observed during repeated tests shall be at least 90%.

NOTE: The time delay can be expressed as: $T_{RRC_procedure_delay} + T_{identify-UTRA\ TDD} + T_{SI-UTRA\ TDD} + T_{RA}$, where:

$T_{RRC_procedure_delay} = 110$ ms, which is specified in clause 6.3.2.3.

$T_{identify-UTRA\ TDD} = 500$ ms; which is defined in clause 6.3.2.3.

$T_{SI-UTRA\ TDD} = 0$ ms, UE does not have to read the system information of the UTRAN TDD since all relevant SI is provided to the UE in the "RRCConnectionRelease" message.

$T_{RA} = 40$ ms. This is the additional delay caused by the random access procedure

It gives a total delay of 650 ms.

A.6.3.6 E-UTRA FDD RRC connection release redirection to UTRA TDD

A.6.3.6.1 Test Purpose and Environment

The purpose of this test is to verify that the UE performs the RRC connection release with redirection from the E-UTRA FDD to the target UTRA TDD cell within $T_{\text{connection_release_redirect_UTRA TDD}}$. This test will partly verify the RRC connection release with redirection to UTRA TDD requirements in clause 6.3.2.3.

The test parameters are given in table A.6.3.6.1-1, table A.6.3.6.1-2, and table A.6.3.6.1-3. No measurement gaps are configured. The test consists of two successive time periods, with time duration of T1, and T2 respectively. During time duration T1, the UE shall not have any timing information of cell 2. The “*RRCConnectionRelease*” message containing the relevant system information of Cell 2 shall be sent to the UE during period T1 and the start of T2 is the instant when the last TTI containing the RRC message, “*RRCConnectionRelease*”, is received by the UE from cell 1. The “*RRCConnectionRelease*” message shall contain all the relevant system information of Cell 2.

Table A.6.3.6.1-1: General test parameters for E-UTRA FDD RRC connection release redirection to UTRA TDD

| Parameter | Unit | Value | Comment |
|--|------|--|--|
| PDSCH parameters (E-UTRAN FDD) | | DL Reference Measurement Channel R.0 FDD | As specified in clause A.3.1.1.1. |
| PCFICH/PDCCH/PHICH parameters (E-UTRAN FDD) | | DL Reference Measurement Channel R.6 FDD | As specified in clause A.3.1.2.1. |
| Active cell | | Cell 1 | Cell 1 is on E-UTRA RF channel number 1. |
| Neighbour cell | | Cell 2 | Cell 2 is on UTRA RF channel number 1. |
| CP length | | Normal | Applicable to cell 1 |
| Time offset between cells | ms | 3 | Asynchronous cells |
| E-UTRA RF Channel Number | | 1 | One E-UTRA FDD carrier frequency is used. |
| E-UTRA Channel Bandwidth (BW_{channel}) | MHz | 10 | |
| Filter coefficient | | 0 | L3 filtering is not used. |
| DRX | | OFF | |
| Monitored UTRA TDD cell list size | | 16 | UTRA cells on UTRA RF channel 1 provided in the “ <i>RRCConnectionRelease</i> ” message from the E-UTRAN |
| T1 | s | 5 | |
| T2 | s | 1 | |

Table A.6.3.6.1-2: Cell specific test parameters for cell 1 in E-UTRA FDD RRC connection release redirection to UTRA TDD test

| Parameter | Unit | Cell 1 | |
|---|------|----------|----|
| | | T1 | T2 |
| E-UTRA RF Channel Number | | 1 | |
| BW_{channel} | MHz | 10 | |
| OCNG Patterns defined in A.3.2.1.1 (OP.1 FDD) | | OP.1 FDD | |
| PBCH_RA | dB | 0 | |
| PBCH_RB | dB | | |
| PSS_RA | dB | | |
| SSS_RA | dB | | |
| PCFICH_RB | dB | | |
| PHICH_RA | dB | | |
| PHICH_RB | dB | | |
| PDCCH_RA | dB | | |
| PDCCH_RB | dB | | |
| PDSCH_RA | dB | | |
| PDSCH_RB | dB | | |
| OCNG_RA ^{Note 1} | dB | | |
| OCNG_RB ^{Note 1} | dB | | |

| | | | |
|---|------------|------|-----|
| \hat{E}_s / I_{ot} | dB | 4 | 4 |
| N_{oc} ^{Note 3} | dBm/15 kHz | -98 | |
| \hat{E}_s / N_{oc} | dB | 4 | 4 |
| RSRP ^{Note 4} | dBm/15 kHz | -94 | -94 |
| SCH_RP | dBm/15 kHz | -94 | -94 |
| Propagation Condition | | AWGN | |
| <p>Note 1: OCNG shall be used such that both cells are fully allocated and a constant total transmitted power spectral density is achieved for all OFDM symbols.</p> <p>Note 2: The resources for uplink transmission are assigned to the UE prior to the start of time period T2.</p> <p>Note 3: Interference from other cells and noise sources not specified in the test is assumed to be constant over subcarriers and time and shall be modelled as AWGN of appropriate power for N_{oc} to be fulfilled.</p> <p>Note 4: RSRP levels have been derived from other parameters for information purposes. They are not settable parameters themselves.</p> | | | |

Table A.6.3.6.1-3: Cell specific test parameters for cell 2 in E-UTRA FDD RRC connection release redirection to UTRA TDD test

| Parameter | Unit | Cell 2 (UTRA TDD) | | | |
|---|--------------|-------------------|--------|-------|-------|
| | | 0 | | DwPTS | |
| Timeslot Number | | T1 | T2 | T1 | T2 |
| UTRA RF Channel Number ^{Note1} | | Channel 1 | | | |
| PCCPCH_Ec/I _{or} | dB | -4.77 | -4.77 | | |
| DwPCH_Ec/I _{or} | dB | | | 0 | 0 |
| OCNS_Ec/I _{or} ^{Note2} | dB | -1.76 | -1.76 | | |
| \hat{I}_{or} / I_{oc} | dB | -inf | 8 | -inf | 8 |
| I_{oc} | dBm/1.28 MHz | -80 | | | |
| PCCPCH RSCP ^{Note3} | dBm | -inf | -76.77 | n.a. | n.a. |
| PCCPCH_Ec/I _o ^{Note3} | dB | -inf | -5.41 | n.a. | n.a. |
| DwPCH_Ec/I _o ^{Note3} | dB | n.a. | n.a. | -inf | -0.64 |
| Propagation Condition | | AWGN | | | |
| <p>Note 1: In the case of multi-frequency cell, the UTRA RF Channel Number is the primary frequency's channel number.</p> <p>Note 2: The power of the OCNS channel that is added shall make the total power from the cell to be equal to I_{or}.</p> <p>Note 3: P-CCPCH RSRP, PCCPCH_Ec/I_o and DwPCH_Ec/I_o levels have been derived from other parameters for information purposes. They are not settable parameters themselves.</p> | | | | | |

A. 6.3.6.2 Test Requirements

The UE shall start to transmit the SYNCH-UL sequence in the UpPTS to Cell 2 less than 650 ms from the beginning of time period T2.

The rate of correct RRC connection release redirection to UTRA TDD observed during repeated tests shall be at least 90%.

NOTE: The time delay can be expressed as: $T_{RRC_procedure_delay} + T_{identify-UTRA\ TDD} + T_{SI-UTRA\ TDD} + T_{RA}$, where:

$T_{RRC_procedure_delay} = 110$ ms, which is specified in clause 6.3.2.3.

$T_{identify-UTRA\ TDD} = 500$ ms; which is defined in clause 6.3.2.3.

$T_{SI-UTRA\ TDD} = 0$ ms, UE does not have to read the system information of the UTRAN TDD since all relevant SI is provided to the UE in the "RRCConnectionRelease" message.

$T_{RA} = 40$ ms. This is the additional delay caused by the random access procedure.

This gives a total delay of 650 ms.

A.6.3.7 E-UTRA TDD RRC connection release redirection to UTRA TDD without SI provided

A.6.3.7.1 Test Purpose and Environment

The purpose of this test is to verify that the UE performs the RRC connection release with redirection from the E-UTRA TDD to the target UTRA TDD cell within $T_{\text{connection_release_redirect_UTRA TDD}}$. This test will partly verify the RRC connection release with redirection to UTRA TDD requirements in clause 6.3.2.3.

The test parameters are given in table A.6.3.7.1-1, table A.6.3.7.1-2, and table A.6.3.7.1-3. No measurement gaps are configured. The test consists of two successive time periods, with time duration of T1, and T2 respectively. During time duration T1, the UE shall not have any timing information of cell 2. The “*RRCConnectionRelease*” message not containing the relevant system information of Cell 2 shall be sent to the UE during period T1 and the start of T2 is the instant when the last TTI containing the RRC message, “*RRCConnectionRelease*”, is received by the UE from Cell 1.

Table A.6.3.7.1-1: General test parameters for E-UTRA TDD RRC connection release redirection to UTRA TDD without SI provided

| Parameter | Unit | Value | Comment |
|--|------|--|--|
| PDSCH parameters (E-UTRAN TDD) | | DL Reference Measurement Channel R.0 TDD | As specified in clause A.3.1.1.2. |
| PCFICH/PDCCH/PHICH parameters (E-UTRAN TDD) | | DL Reference Measurement Channel R.6 TDD | As specified in clause A.3.1.2.2. |
| Active cell | | Cell 1 | Cell 1 is on E-UTRA RF channel number 1. |
| Neighbour cell | | Cell 2 | Cell 2 is on UTRA RF channel number 1. |
| Time offset between cells | ms | 3 | Asynchronous cells |
| E-UTRA RF Channel Number | | 1 | One E-UTRA TDD carrier frequency is used. |
| E-UTRA Channel Bandwidth (BW_{channel}) | MHz | 10 | |
| CP length | | Normal | Applicable to cell 1 |
| Uplink-downlink configuration of cell 1 | | 1 | As specified in table 4.2.2 in TS 36.211 |
| Special subframe configuration of cell 1 | | 6 | As specified in table 4.2.1 in TS 36.211 |
| UTRA RF Channel Number | | 1 | One UTRA TDD carrier frequency is used. |
| Filter coefficient | | 0 | L3 filtering is not used. |
| DRX | | OFF | |
| Monitored UTRA TDD cell list size | | none | No explicit neighbour list is provided to the UE |
| T1 | s | 5 | |
| T2 | s | 2 | |

Table A.6.3.7.1-2: Cell specific test parameters for cell 1 in E-UTRA TDD RRC connection release redirection to UTRA TDD test without SI provided

| Parameter | Unit | Cell 1 | |
|--|------|----------|----|
| | | T1 | T2 |
| E-UTRA RF Channel Number | | 1 | |
| BW_{channel} | MHz | 10 | |
| OCNG Pattern defined in A.3.2.2.1 (OP.1 TDD) | | OP.1 TDD | |
| PBCH_RA | dB | 0 | |
| PBCH_RB | dB | | |
| PSS_RA | dB | | |
| SSS_RA | dB | | |
| PCFICH_RB | dB | | |
| PHICH_RA | dB | | |
| PHICH_RB | dB | | |
| PDCCH_RA | dB | | |
| PDCCH_RB | dB | | |

| | | | |
|---|------------|------|-----|
| PDSCH_RA | dB | | |
| PDSCH_RB | dB | | |
| OCNG_RA ^{Note 1} | dB | | |
| OCNG_RB ^{Note 1} | dB | | |
| \hat{E}_s/I_{ot} | dB | 4 | 4 |
| N_{oc} ^{Note 3} | dBm/15 kHz | -98 | |
| \hat{E}_s/N_{oc} | dB | 4 | 4 |
| RSRP ^{Note 4} | dBm/15 kHz | -94 | -94 |
| SCH_RP | dBm/15 kHz | -94 | -94 |
| Propagation Condition | | AWGN | |
| <p>Note 1: OCNG shall be used such that both cells are fully allocated and a constant total transmitted power spectral density is achieved for all OFDM symbols.</p> <p>Note 2: The resources for uplink transmission are assigned to the UE prior to the start of time period T2.</p> <p>Note 3: Interference from other cells and noise sources not specified in the test is assumed to be constant over subcarriers and time and shall be modelled as AWGN of appropriate power for N_{oc} to be fulfilled.</p> <p>Note 4: RSRP levels have been derived from other parameters for information purposes. They are not settable parameters themselves.</p> | | | |

Table A.6.3.7.1-3: Cell specific test parameters for cell 2 in E-UTRA TDD RRC connection release redirection to UTRA TDD test without SI provided

| Parameter | Unit | Cell 2 (UTRA TDD) | | | |
|---|--------------|-------------------|--------|-------|-------|
| | | 0 | | DwPTS | |
| Timeslot Number | | T1 | T2 | T1 | T2 |
| UTRA RF Channel Number ^{Note1} | | Channel 1 | | | |
| PCCPCH_Ec/I _{or} | dB | -4.77 | -4.77 | | |
| DwPCH_Ec/I _{or} | dB | | | 0 | 0 |
| OCNS_Ec/I _{or} ^{Note2} | dB | -1.76 | -1.76 | | |
| \hat{I}_{or}/I_{oc} | dB | -inf | 8 | -inf | 8 |
| I_{oc} | dBm/1.28 MHz | -80 | | | |
| PCCPCH RSCP ^{Note3} | dBm | -inf | -76.77 | n.a. | n.a. |
| PCCPCH_Ec/I _o ^{Note3} | dB | -inf | -5.41 | n.a. | n.a. |
| DwPCH_Ec/I _o ^{Note3} | dB | n.a. | n.a. | -inf | -0.64 |
| Propagation Condition | | AWGN | | | |
| <p>Note 1: In the case of multi-frequency cell, the UTRA RF Channel Number is the primary frequency's channel number.</p> <p>Note 2: The power of the OCNS channel that is added shall make the total power from the cell to be equal to I_{or}.</p> <p>Note 3: P-CCPCH RSRP, PCCPCH_Ec/I_o and DwPCH_Ec/I_o levels have been derived from other parameters for information purposes. They are not settable parameters themselves.</p> | | | | | |

A.6.3.7.2 Test Requirements

The UE shall start to transmit the SYNCH-UL sequence in the UpPTS to Cell 2 less than 1930 ms from the beginning of time period T2.

The rate of correct RRC connection release redirection to UTRA TDD observed during repeated tests shall be at least 90%.

NOTE: The time delay can be expressed as: $T_{RRC_procedure_delay} + T_{identify-UTRA\ TDD} + T_{SI-UTRA\ TDD} + T_{RA}$, where:

$T_{RRC_procedure_delay} = 110$ ms, which is specified in clause 6.3.2.3.

$T_{identify-UTRA\ TDD} = 500$ ms; which is defined in clause 6.3.2.3.

$T_{SI-UTRA\ TDD}$: Maximum repetition period of relevant system info blocks that need to be received by the UE during RRC connection release redirection to UTRA TDD cell. 1280 ms is assumed in this test case.

$T_{RA} = 40\text{ms}$, this is the additional delay caused by the random access procedure.

This gives a total delay of 1930 ms.

A.6.3.8 E-UTRA FDD RRC connection release redirection to UTRA TDD without SI provided

A.6.3.8.1 Test Purpose and Environment

The purpose of this test is to verify that the UE performs the RRC connection release with redirection from the E-UTRA FDD to the target UTRA TDD cell within $T_{\text{connection_release_redirect_UTRA\ TDD}}$. This test will partly verify the RRC connection release with redirection to UTRA TDD requirements in clause 6.3.2.3.

The test parameters are given in table A.6.3.8.1-1, table A.6.3.8.1-2, and table A.6.3.8.1-3. No measurement gaps are configured. The test consists of two successive time periods, with time duration of T1, and T2 respectively. During time duration T1, the UE shall not have any timing information of cell 2. The “*RRCConnectionRelease*” message not containing the relevant system information of Cell 2 shall be sent to the UE during period T1 and the start of T2 is the instant when the last TTI containing the RRC message, “*RRCConnectionRelease*”, is received by the UE from Cell 1.

Table A.6.3.8.1-1: General test parameters for E-UTRA FDD RRC connection release redirection to UTRA TDD without SI provided

| Parameter | Unit | Value | Comment |
|--|------|--|--|
| PDSCH parameters (E-UTRAN FDD) | | DL Reference Measurement Channel R.0 FDD | As specified in clause A.3.1.1.1. |
| PCFICH/PDCCH/PHICH parameters (E-UTRAN FDD) | | DL Reference Measurement Channel R.6 FDD | As specified in clause A.3.1.2.1. |
| Active cell | | Cell 1 | Cell 1 is on E-UTRA RF channel number 1. |
| Neighbour cell | | Cell 2 | Cell 2 is on UTRA RF channel number 1. |
| Time offset between cells | ms | 3 | Asynchronous cells |
| E-UTRA RF Channel Number | | 1 | One E-UTRA TDD carrier frequency is used. |
| E-UTRA Channel Bandwidth (BW_{channel}) | MHz | 10 | |
| CP length | | Normal | Applicable to cell 1 |
| UTRA RF Channel Number | | 1 | One UTRA TDD carrier frequency is used. |
| Filter coefficient | | 0 | L3 filtering is not used. |
| DRX | | OFF | |
| Monitored UTRA TDD cell list size | | none | No explicit neighbour list is provided to the UE |
| T1 | S | 5 | |
| T2 | S | 2 | |

Table A.6.3.8.1-2: Cell specific test parameters for cell 1 in E-UTRA FDD RRC connection release redirection to UTRA TDD test without SI provided

| Parameter | Unit | Cell 1 | |
|---|------|----------|----|
| | | T1 | T2 |
| E-UTRA RF Channel Number | | 1 | |
| BW_{channel} | MHz | 10 | |
| OCNG Patterns defined in A.3.2.1.1 (OP.1 FDD) | | OP.1 FDD | |
| PBCH_RA | dB | | |
| PBCH_RB | dB | | |
| PSS_RA | dB | | |
| SSS_RA | dB | | |
| PCFICH_RB | dB | | |

| | | | |
|---|------------|------|-----|
| PHICH_RA | dB | 0 | |
| PHICH_RB | dB | | |
| PDCCH_RA | dB | | |
| PDCCH_RB | dB | | |
| PDSCH_RA | dB | | |
| PDSCH_RB | dB | | |
| OCNG_RA ^{Note 1} | dB | | |
| OCNG_RB ^{Note 1} | dB | | |
| \hat{E}_s/I_{ot} | dB | 4 | 4 |
| N_{oc} ^{Note 3} | dBm/15 kHz | -98 | |
| \hat{E}_s/N_{oc} | dB | 4 | 4 |
| RSRP ^{Note 4} | dBm/15 kHz | -94 | -94 |
| SCH_RP | dBm/15 kHz | -94 | -94 |
| Propagation Condition | | AWGN | |
| <p>Note 1: OCNG shall be used such that both cells are fully allocated and a constant total transmitted power spectral density is achieved for all OFDM symbols.</p> <p>Note 2: The resources for uplink transmission are assigned to the UE prior to the start of time period T2.</p> <p>Note 3: Interference from other cells and noise sources not specified in the test is assumed to be constant over subcarriers and time and shall be modelled as AWGN of appropriate power for N_{oc} to be fulfilled.</p> <p>Note 4: RSRP levels have been derived from other parameters for information purposes. They are not settable parameters themselves.</p> | | | |

Table A.6.3.8.1-3: Cell specific test parameters for cell 2 in E-UTRA FDD RRC connection release redirection to UTRA TDD test without SI provided

| Parameter | Unit | Cell 2 (UTRA TDD) | | | |
|---|--------------|-------------------|--------|-------|-------|
| | | 0 | | DwPTS | |
| Timeslot Number | | T1 | T2 | T1 | T2 |
| UTRA RF Channel Number ^{Note1} | | Channel 1 | | | |
| PCCPCH_Ec/Ior | dB | -4.77 | -4.77 | | |
| DwPCH_Ec/Ior | dB | | | 0 | 0 |
| OCNS_Ec/Ior ^{Note2} | dB | -1.76 | -1.76 | | |
| \hat{I}_{or}/I_{oc} | dB | -inf | 8 | -inf | 8 |
| I_{oc} | dBm/1.28 MHz | -80 | | | |
| PCCPCH RSCP ^{Note3} | dBm | -inf | -76.77 | n.a. | n.a. |
| PCCPCH_Ec/Io ^{Note3} | dB | -inf | -5.41 | n.a. | n.a. |
| DwPCH_Ec/Io ^{Note3} | dB | n.a. | n.a. | -inf | -0.64 |
| Propagation Condition | | AWGN | | | |
| <p>Note 1: In the case of multi-frequency cell, the UTRA RF Channel Number is the primary frequency's channel number.</p> <p>Note 2: The power of the OCNS channel that is added shall make the total power from the cell to be equal to I_{or}.</p> <p>Note 3: P-CCPCH RSRP, PCCPCH_Ec/Io and DwPCH_Ec/Io levels have been derived from other parameters for information purposes. They are not settable parameters themselves.</p> | | | | | |

A.6.3.8.2 Test Requirements

The UE shall start to transmit the SYNCH-UL sequence in the UpPTS to Cell 2 less than 1930 ms from the beginning of time period T2.

The rate of correct RRC connection release redirection to UTRA TDD observed during repeated tests shall be at least 90%.

NOTE: The time delay can be expressed as: $T_{RRC_procedure_delay} + T_{identify-UTRA\ TDD} + T_{SI-UTRA\ TDD} + T_{RA}$, where:

$T_{RRC_procedure_delay} = 110$ ms, which is specified in clause 6.3.2.3.

$T_{\text{identify-UTRA TDD}} = 500$ ms; which is defined in clause 6.3.2.3.

$T_{\text{SI-UTRA TDD}}$: Maximum repetition period of relevant system info blocks that need to be received by the UE during RRC connection release redirection to UTRA TDD cell. 1280 ms is assumed in this test case.

$T_{\text{RA}} = 40$ ms, this is the additional delay caused by the random access procedure.

This gives a total delay of 1930 ms.

A.6.3.9 Redirection from E-UTRAN FDD to UTRAN FDD without System Information

A.6.3.9.1 Test Purpose and Environment

The purpose of this test is to verify that the UE makes correct performing the RRC connection release with redirection to the target UTRAN FDD cell. This test will partly verify the RRC connection release with redirection to UTRAN FDD cell requirements in clause 6.3.2.1.

The test parameters are given in Tables A.6.3.9.1-1, A.6.3.9.1-2 and A.6.3.9.1-3 below. The test consists of two successive time periods, with time duration of T1, and T2 respectively. The “*RRCConnectionRelease*” message not containing any system information of Cell 2 shall be sent to the UE during period T1. The start of T2 is the instant when the last TTI containing the RRC message is sent to the UE. Prior to time duration T2, the UE shall not have any timing information of Cell 2. Cell 2 is powered up at the beginning of the T2.

Table A.6.3.9.1-1: General test parameters for RRC Connection Release with Redirection from E-UTRAN FDD to UTRAN FDD under AWGN propagation conditions

| Parameter | Unit | Value | Comment |
|--|------|--|--|
| PDSCH parameters (E-UTRAN FDD) | | DL Reference Measurement Channel R.0 FDD | As specified in clause A.3.1.1.1. |
| PCFICH/PDCCH/PHICH parameters (E-UTRAN FDD) | | DL Reference Measurement Channel R.6 FDD | As specified in clause A.3.1.2.1. |
| Active cell | | Cell 1 | Cell 1 is on E-UTRA RF channel number 1. |
| Neighbour cell | | Cell 2 | Cell 2 is on UTRA RF channel number 1. |
| CP length | | Normal | Applicable to cell 1 |
| E-UTRA RF Channel Number | | 1 | One E-UTRA FDD carrier frequency is used. |
| E-UTRA Channel Bandwidth (BW_{channel}) | MHz | 10 | |
| UTRA RF Channel Number | | 1 | One UTRA FDD carrier frequency is used. |
| Inter-RAT (UTRA FDD) measurement quantity | | CPICH Ec/Io | |
| Filter coefficient | | 0 | L3 filtering is not used. |
| DRX | | OFF | |
| UTRA FDD cell list size | | None | No explicit neighbour list is provided to the UE |
| T1 | s | ≤ 5 | |
| T2 | s | 2 | |

Table A.6.3.9.1-2: Cell specific test parameters for cell #1 E-UTRAN FDD to UTRAN FDD RRC release with redirection under AWGN propagation conditions

| Parameter | Unit | Cell 1 | |
|--|------|----------|----|
| | | T1 | T2 |
| E-UTRA RF Channel Number | | 1 | |
| BW_{channel} | MHz | 10 | |
| OCNG Pattern defined in A.3.2.1.1 (OP.1 FDD) | | OP.1 FDD | |
| PBCH_RA | dB | | |
| PBCH_RB | dB | | |
| PSS_RA | dB | | |
| SSS_RA | dB | | |
| PCFICH_RB | dB | | |
| PHICH_RA | dB | | |

| | | | |
|--|------------|------|-----|
| PHICH_RB | dB | 0 | |
| PDCCH_RA | dB | | |
| PDCCH_RB | dB | | |
| PDSCH_RA | dB | | |
| PDSCH_RB | dB | | |
| OCNG_RA ^{Note 1} | dB | | |
| OCNG_RB ^{Note 1} | dB | | |
| \hat{E}_s/I_{ot} | dB | 4 | 4 |
| N_{oc} ^{Note 3} | dBm/15 kHz | -98 | |
| \hat{E}_s/N_{oc} | dB | 4 | 4 |
| RSRP ^{Note 4} | dBm/15 kHz | -94 | -94 |
| SCH_RP | dBm/15 kHz | -94 | -94 |
| Propagation Condition | | AWGN | |
| <p>Note 1: OCNG shall be used such that the cell is fully allocated and a constant total transmitted power spectral density is achieved for all OFDM symbols.</p> <p>Note 2: The resources for uplink transmission are assigned to the UE prior to the start of time period T2.</p> <p>Note 3: Interference from other cells and noise sources not specified in the test is assumed to be constant over subcarriers and time and shall be modelled as AWGN of appropriate power for N_{oc} to be fulfilled.</p> <p>Note 4: RSRP levels have been derived from other parameters for information purposes. They are not settable parameters themselves.</p> | | | |

Table A.6.3.9.1-3: Cell specific test parameters for cell #2 E-UTRAN FDD to UTRAN FDD RRC release with redirection under AWGN propagation conditions

| Parameter | Unit | Cell 2 | |
|--|--------------|-----------|------|
| | | T1 | T1 |
| UTRA RF Channel Number | | 1 | |
| CPICH_Ec/Ior | dB | -10 | |
| PCCPCH_Ec/Ior | dB | -12 | |
| SCH_Ec/Ior | dB | -12 | |
| PICH_Ec/Ior | dB | -15 | |
| DPCH_Ec/Ior | dB | N/A | |
| OCNS | | -0.941 | |
| \hat{I}_{or}/I_{oc} | dB | $-\infty$ | 0.02 |
| I_{oc} | dBm/3.84 MHz | -70 | |
| CPICH_Ec/Io ^{Note 3} | dB | $-\infty$ | -13 |
| Propagation Condition | | AWGN | |
| <p>Note 1: The DPCH level is controlled by the power control loop.</p> <p>Note 2: The power of the OCNS channel that is added shall make the total power from the cell to be equal to I_{or}.</p> <p>Note 3: This gives an SCH Ec/Io of -15dB</p> | | | |

A.6.3.9.2 Test Requirements

The UE shall start to send random access to the target UTRA FDD cell (Cell 2) less than 1930 ms from the beginning of time period T2.

The rate of correct "RRC connection release with redirection to UTRAN" observed during repeated tests shall be at least 90%.

NOTE: The test requirement in this case can be expressed as

$$T_{\text{connection_release_redirect_UTRA FDD}} = T_{\text{RRC_procedure_delay}} + T_{\text{identify-UTRA FDD}} + T_{\text{SI-UTRA FDD}} + T_{\text{RA}}$$

where

$$T_{\text{RRC_procedure_delay}} = 110 \text{ ms}$$

$$T_{\text{identify-UTRA FDD}} = 500 \text{ ms}$$

$T_{\text{SI-UTRA FDD}}$ = the time required for acquiring all the relevant system information of the target UTRA FDD cell. This time depends upon whether the UE is provided with the relevant system information of the target UTRA FDD cell or not by the E-UTRAN before the RRC connection is released. Since no SI is provided, 1280 ms is assumed in this test case.

T_{RA} = The additional delay caused by the random access procedure. 40 ms is assumed in this test case.

This gives a total of 1930 ms.

A.6.3.10 Redirection from E-UTRAN FDD to GERAN when System Information is not provided

A.6.3.10.1 Test Purpose and Environment

The purpose of this test is to verify that the UE performs the RRC connection release with redirection from the E-UTRA FDD to the target GERAN cell within $T_{\text{connection_release_redirect_GERAN}}$. This test will partly verify the RRC connection release with redirection to GERAN requirements in clause 6.3.2.2.

The test parameters are given in Tables A.6.3.10.1-1, A.6.3.10.1-2 and A.6.3.10.1-3 below. No measurement gaps are configured. The test consists of two successive time periods, with time duration of T1, and T2 respectively. During time duration T1, the UE shall not have any timing information of cell 2. The start of T2 is the instant when the last TTI containing the RRC message, “*RRConnectionRelease*”, is received by the UE from cell 1. The “*RRConnectionRelease*” message shall not contain any system information of cell 2.

Table A.6.3.10.1-1: General test parameters for RRC connection release with redirection from E-UTRAN FDD to GERAN in AWGN

| Parameter | Unit | Value | Comment |
|--|------|--|---|
| PDSCH parameters (E-UTRAN FDD) | | DL Reference Measurement Channel R.0 FDD | As specified in clause A.3.1.1.1. |
| PCFICH/PDCCH/PHICH parameters (E-UTRAN FDD) | | DL Reference Measurement Channel R.6 FDD | As specified in clause A.3.1.2.1. |
| Active cell | | Cell 1 | Cell 1 is on E-UTRA RF channel number 1. |
| Neighbour cell | | Cell 2 | Cell 2 is on Absolute RF Channel Number 1 (GSM cell) |
| CP length | | Normal | Applicable to cell 1 |
| E-UTRA RF Channel Number | | 1 | One E-UTRA FDD carrier frequency is used. |
| E-UTRA Channel Bandwidth (BW_{channel}) | MHz | 10 | |
| DRX | | OFF | |
| Monitored GSM cell list size | | 6 GSM neighbour including ARFCN 1 | Only the list of GERAN carrier frequencies is provided in the “ <i>RRConnectionRelease</i> ” message. |
| T1 | s | ≤5 | |
| T2 | s | 4 | |

Table A.6.3.10.1-2: Cell specific test parameters for E-UTRA FDD cell (cell #1) for RRC connection release with redirection from E-UTRAN FDD to GERAN in AWGN

| Parameter | Unit | Cell 1 | |
|--|------|----------|----|
| | | T1 | T2 |
| E-UTRA RF Channel Number | | 1 | |
| BW_{channel} | MHz | 10 | |
| OCNG Pattern defined in A.3.2.1.1 (OP.1 FDD) | | OP.1 FDD | |
| PBCH_RA | dB | | |
| PBCH_RB | dB | | |
| PSS_RA | dB | | |
| SSS_RA | dB | | |
| PCFICH_RB | dB | | |

| | | | |
|--|------------|------|-----|
| PHICH_RA | dB | 0 | |
| PHICH_RB | dB | | |
| PDCCH_RA | dB | | |
| PDCCH_RB | dB | | |
| PDSCH_RA | dB | | |
| PDSCH_RB | dB | | |
| OCNG_RA ^{Note 1} | dB | | |
| OCNG_RB ^{Note 1} | dB | | |
| \hat{E}_s / I_{ot} | dB | 4 | 4 |
| \hat{E}_s / N_{oc} | dB | 4 | 4 |
| N_{oc} | dBm/15 kHz | -98 | |
| RSRP | dBm/15 kHz | -94 | -94 |
| SCH_RP | dBm/15 kHz | -94 | -94 |
| Propagation Condition | | AWGN | |
| <p>Note 1: OCNG shall be used such that the cell is fully allocated and a constant total transmitted power spectral density is achieved for all OFDM symbols.</p> <p>Note 2: Interference from other cells and noise sources not specified in the test is assumed to be constant over subcarriers and time and shall be modelled as AWGN of appropriate power for N_{oc} to be fulfilled.</p> <p>Note 3: RSRP levels have been derived from other parameters for information purposes. They are not settable parameters themselves.</p> | | | |

Table A.6.3.10.1-3: Cell specific test parameters for GERAN cell (cell #2) for RRC connection release with redirection from E-UTRAN FDD to GERAN in AWGN

| Parameter | Unit | Cell 2 | |
|----------------------------|------|-----------|-------|
| | | T1 | T2 |
| Absolute RF Channel Number | | ARFNC 1 | |
| RXLEV | dBm | -Infinity | -75 |
| GSM BSIC | | N/A | Valid |

A.6.3.10.2 Test Requirements

The UE shall begin to send access bursts on RACH of the target GERAN cell (cell #2) less than 3020 ms from the beginning of time period T2.

The rate of correct “RRC connection release with redirection to GERAN” observed during repeated tests shall be at least 90%.

NOTE: The test requirement in this test case is expressed as:

$$T_{\text{connection_release_redirect_GERAN}} = T_{\text{RRC_procedure_delay}} + T_{\text{identify-GERAN}} + T_{\text{SI-GERAN}} + T_{\text{RA}}$$

$T_{\text{RRC_procedure_delay}} = 110$ ms, which is the time for processing the received message “*RRCCONNECTIONRELEASE*”.

$T_{\text{identify-GERAN}} = 1000$ ms, which is the time for identifying the target GERAN cell.

$T_{\text{SI-GERAN}} = 1900$ ms, which is the maximum time allowed to read BCCH data from the target GERAN cell.

$T_{\text{RA}} = 10$ ms, which is about 2 GSM frames (2×4.65 ms) to account for the GSM timing uncertainty.

A.6.3.11 Redirection from E-UTRAN TDD to GERAN when System Information is not provided

A.6.3.11.1 Test Purpose and Environment

The purpose of this test is to verify that the UE performs the RRC connection release with redirection from the E-UTRA TDD to the target GERAN cell within $T_{\text{connection_release_redirect_GERAN}}$. This test will partly verify the RRC connection release with redirection to GERAN requirements in clause 6.3.2.2.

The test parameters are given in Tables A.6.3.11.1-1, A.6.3.11.1-2 and A.6.3.11.1-3 below. No measurement gaps are configured. The test consists of two successive time periods, with time duration of T1, and T2 respectively. During time duration T1, the UE shall not have any timing information of cell 2. The start of T2 is the instant when the last TTI containing the RRC message, “*RRCConnectionRelease*”, is received by the UE from cell 1. The “*RRCConnectionRelease*” message shall not contain any system information of cell 2.

Table A.6.3.11.1-1: General test parameters for RRC connection release with redirection from E-UTRAN TDD to GERAN in AWGN

| Parameter | Unit | Value | Comment |
|--|------|--|--|
| PDSCH parameters (E-UTRAN TDD) | | DL Reference Measurement Channel R.0 TDD | As specified in clause A.3.1.1.2. |
| PCFICH/PDCCH/PHICH parameters (E-UTRAN TDD) | | DL Reference Measurement Channel R.6 TDD | As specified in clause A.3.1.2.2. |
| Active | | Cell 1 | Cell 1 is on E-UTRA RF channel number 1. |
| Neighbour cell | | Cell 2 | Cell 2 is on Absolute RF Channel Number 1 (GSM cell) |
| CP length | | Normal | Applicable to cell 1 |
| Special subframe configuration | | 6 | As specified in table 4.2.1 in TS 36.211. The same configuration applies to all cells. |
| Uplink-downlink configuration | | 1 | |
| E-UTRA RF Channel Number | | 1 | One E-UTRA TDD carrier frequency is used. |
| E-UTRA Channel Bandwidth (BW_{channel}) | MHz | 10 | |
| DRX | | OFF | |
| Monitored GSM cell list size | | 6 GSM neighbour including ARFCN 1 | Only the list of GERAN carrier frequencies is provided in the “ <i>RRCConnectionRelease</i> ” message. |
| T1 | s | ≤5 | |
| T2 | s | 4 | |

Table A.6.3.11.1-2: Cell specific test parameters for E-UTRA TDD cell (cell #1) for RRC connection release with redirection from E-UTRAN TDD to GERAN in AWGN

| Parameter | Unit | Cell 1 | |
|--|------|----------|----|
| | | T1 | T2 |
| E-UTRA RF Channel Number | | 1 | |
| BW_{channel} | MHz | 10 | |
| OCNG Pattern defined in A.3.2.2.1 (OP.1 TDD) | | OP.1 TDD | |
| PBCH_RA | dB | 0 | |
| PBCH_RB | dB | | |
| PSS_RA | dB | | |
| SSS_RA | dB | | |
| PCFICH_RB | dB | | |
| PHICH_RA | dB | | |
| PHICH_RB | dB | | |
| PDCCH_RA | dB | | |
| PDCCH_RB | dB | | |
| PDSCH_RA | dB | | |
| PDSCH_RB | dB | | |
| OCNG_RA ^{Note 1} | dB | | |
| OCNG_RB ^{Note 1} | dB | | |

| | | | |
|-----------------------|--|------|-----|
| \hat{E}_s / I_{ot} | dB | 4 | 4 |
| \hat{E}_s / N_{oc} | dB | 4 | 4 |
| N_{oc} | dBm/15 kHz | -98 | |
| RSRP | dBm/15 kHz | -94 | -94 |
| SCH_RP | dBm/15 kHz | -94 | -94 |
| Propagation Condition | | AWGN | |
| Note 1: | OCNG shall be used such that the cell is fully allocated and a constant total transmitted power spectral density is achieved for all OFDM symbols. | | |
| Note 2: | Interference from other cells and noise sources not specified in the test is assumed to be constant over subcarriers and time and shall be modelled as AWGN of appropriate power for N_{oc} to be fulfilled. | | |
| Note 3: | RSRP levels have been derived from other parameters for information purposes. They are not settable parameters themselves. | | |

Table A.6.3.11.1-3: Cell specific test parameters for GERAN cell (cell #2) for RRC connection release with redirection from E-UTRAN TDD to GERAN in AWGN

| Parameter | Unit | Cell 2 | |
|----------------------------|------|-----------|-------|
| | | T1 | T2 |
| Absolute RF Channel Number | | ARFNC 1 | |
| RXLEV | dBm | -Infinity | -75 |
| GSM BSIC | | N/A | Valid |

A.6.3.11.2 Test Requirements

The UE shall begin to send access bursts on RACH of the target GERAN cell (cell #2) less than 3020 ms from the beginning of time period T2.

The rate of correct “RRC connection release with redirection to GERAN” observed during repeated tests shall be at least 90%.

NOTE: The test requirement in this test case is expressed as:

$$T_{\text{connection_release_redirect_GERAN}} = T_{\text{RRC_procedure_delay}} + T_{\text{identify-GERAN}} + T_{\text{SI-GERAN}} + T_{\text{RA}}$$

$T_{\text{RRC_procedure_delay}} = 110$ ms, which is the time for processing the received message “*RRCConnectionRelease*”.

$T_{\text{identify-GERAN}} = 1000$ ms, which is the time for identifying the target GERAN cell.

$T_{\text{SI-GERAN}} = 1900$ ms, which is the maximum time allowed to read BCCH data from the target GERAN cell.

$T_{\text{RA}} = 10$ ms, which is about 2 GSM frames ($2 \cdot 4.65$ ms) to account for the GSM timing uncertainty.

A.6.3.12 E-UTRAN TDD RRC connection release redirection to UTRAN FDD without SI provided

A.6.3.12.1 Test Purpose and Environment

The purpose of this test is to verify that the UE performs the RRC connection release with redirection from the E-UTRAN TDD to the target UTRAN FDD cell within $T_{\text{connection_release_redirect_UTRAN FDD}}$. This test will partly verify the RRC connection release with redirection to UTRAN FDD requirements in clause 6.3.2.1.

The test parameters are given in table A.6.3.12.1-1, table A.6.3.12.1-2, and table A.6.3.12.1-3. The test consists of two successive time periods, with time duration of T1, and T2 respectively. During time duration T1, the UE shall not have any timing information of cell 2. The “*RRCConnectionRelease*” message not containing any system information of Cell 2 shall be sent to the UE during period T1. The start of T2 is the instant when the last TTI containing the RRC message, “*RRCConnectionRelease*”, is received by the UE from Cell 1.

Table A.6.3.12.1-1: General test parameters for E-UTRAN TDD RRC connection release redirection to UTRAN FDD without SI provided

| Parameter | Unit | Value | Comment |
|---|------|--|--|
| PDSCH parameters (E-UTRAN TDD) | | DL Reference Measurement Channel R.0 TDD | As specified in clause A.3.1.1.2. |
| PCFICH/PDCCH/PHICH parameters (E-UTRAN TDD) | | DL Reference Measurement Channel R.6 TDD | As specified in clause A.3.1.2.2. |
| Active cell | | Cell 1 | Cell 1 is on E-UTRAN RF channel number 1. |
| Neighbour cell | | Cell 2 | Cell 2 is on UTRAN RF channel number 1. |
| E-UTRAN RF Channel Number | | 1 | One E-UTRAN TDD carrier frequency is used. |
| E-UTRAN Channel Bandwidth (BW_{channel}) | MHz | 10 | |
| Uplink-downlink configuration of cell 1 | | 1 | As specified in table 4.2.2 in TS 36.211 |
| Special subframe configuration of cell 1 | | 6 | As specified in table 4.2.1 in TS 36.211 |
| CP length | | Normal | Applicable to cell 1 |
| UTRAN RF Channel Number | | 1 | One UTRAN TDD carrier frequency is used. |
| Filter coefficient | | 0 | L3 filtering is not used. |
| DRX | | OFF | |
| Monitored UTRAN FDD cell list size | | None | No explicit neighbour list is provided to the UE |
| T1 | s | ≤ 5 | |
| T2 | s | 2 | |

Table A.6.3.12.1-2: Cell specific test parameters for cell 1 in E-UTRAN TDD RRC connection release redirection to UTRAN FDD test without SI provided

| Parameter | Unit | Cell 1 | |
|--|------------|----------|-----|
| | | T1 | T2 |
| E-UTRAN RF Channel Number | | 1 | |
| BW_{channel} | MHz | 10 | |
| OCNG Pattern defined in A.3.2.2.1 (OP.1 TDD) | | OP.1 TDD | |
| PBCH_RA | dB | 0 | |
| PBCH_RB | dB | | |
| PSS_RA | dB | | |
| SSS_RA | dB | | |
| PCFICH_RB | dB | | |
| PHICH_RA | dB | | |
| PHICH_RB | dB | | |
| PDCCH_RA | dB | | |
| PDCCH_RB | dB | | |
| PDSCH_RA | dB | | |
| PDSCH_RB | dB | | |
| OCNG_RA ^{Note 1} | dB | | |
| OCNG_RB ^{Note 1} | dB | | |
| $\hat{E}_s / I_{\text{ot}}$ | dB | | |
| N_{oc} ^{Note 3} | dBm/15 kHz | -98 | |
| $\hat{E}_s / N_{\text{oc}}$ | dB | 4 | 4 |
| RSRP ^{Note 4} | dBm/15 kHz | -94 | -94 |
| SCH_RP | dBm/15 kHz | -94 | -94 |
| Propagation Condition | | AWGN | |

| | |
|---------|--|
| Note 1: | OCNG shall be used such that the cell is fully allocated and a constant total transmitted power spectral density is achieved for all OFDM symbols. |
| Note 2: | The resources for uplink transmission are assigned to the UE prior to the start of time period T2. |
| Note 3: | Interference from other cells and noise sources not specified in the test is assumed to be constant over subcarriers and time and shall be modelled as AWGN of appropriate power for N_{oc} to be fulfilled. |
| Note 4: | RSRP levels have been derived from other parameters for information purposes. They are not settable parameters themselves. |

Table A.6.3.12.1-3: Cell specific test parameters for cell 2 in E-UTRAN TDD RRC connection release redirection to UTRAN FDD test without SI provided

| Parameter | Unit | Cell 2 | |
|--------------------------------|--|-----------|------|
| | | T1 | T1 |
| UTRAN RF Channel Number | | 1 | |
| CPICH_Ec/lor | dB | -10 | |
| PCCPCH_Ec/lor | dB | -12 | |
| SCH_Ec/lor | dB | -12 | |
| PICH_Ec/lor | dB | -15 | |
| DPCH_Ec/lor | dB | N/A | |
| OCNS | | -0.941 | |
| \hat{I}_{or}/I_{oc} | dB | $-\infty$ | 0.02 |
| I_{oc} | dBm/3.84 MHz | -70 | |
| CPICH_Ec/lor ^{Note 3} | dB | $-\infty$ | -13 |
| Propagation Condition | | AWGN | |
| Note 1: | The DPCH level is controlled by the power control loop. | | |
| Note 2: | The power of the OCNS channel that is added shall make the total power from the cell to be equal to I_{or} . | | |
| Note 3: | This gives an SCH Ec/lor of -15dB | | |

A.6.3.12.2 Test Requirements

The UE shall start to send random access to the target UTRAN FDD cell (Cell 2) less than 1930 ms from the beginning of time period T2.

The rate of correct RRC connection release redirection to UTRAN FDD observed during repeated tests shall be at least 90%.

NOTE: The time delay can be expressed as: $T_{RRC_procedure_delay} + T_{identify-UTRAN\ FDD} + T_{SI-UTRAN\ FDD} + T_{RA}$, where:

$T_{RRC_procedure_delay} = 110$ ms, which is specified in clause 6.3.2.1.

$T_{identify-UTRAN\ FDD} = 500$ ms; which is defined in clause 6.3.2.1.

$T_{SI-UTRAN\ FDD}$: Maximum repetition period of relevant system info blocks that need to be received by the UE during RRC connection release redirection to UTRAN FDD cell. 1280 ms is assumed in this test case.

$T_{RA} = 40$ ms, this is the additional delay caused by the random access procedure.

This gives a total delay of 1930 ms.

A.7 Timing and Signalling Characteristics

A.7.1 UE Transmit Timing

A.7.1.1 E-UTRAN FDD – UE Transmit Timing Accuracy Tests

A.7.1.1.1 Test Purpose and Environment

The purpose of this test is to verify that the UE is capable of following the frame timing change of the connected eNode B and that the UE initial transmit timing accuracy, maximum amount of timing change in one adjustment, minimum and maximum adjustment rate are within the specified limits. This test will verify the requirements in clause 7.1.2.

For this test a single cell is used. Table A.7.1.1.1-1 defines the strength of the transmitted signals and the propagation condition. The transmit timing is verified by the UE transmitting SRS using the configuration defined in Table A.7.1.1.1-2.

Table A.7.1.1.1-1: Test Parameters for UE Transmit Timing Accuracy Tests for E-UTRAN FDD

| Parameter | Unit | Value | | | |
|--|--------------|----------|---------------------|----------|----------------------|
| | | Test 1 | Test 2 | Test 3 | Test 4 |
| E-UTRA RF Channel Number | | 1 | 1 | 1 | 1 |
| Channel Bandwidth (BW_{channel}) | MHz | 10 | 10 | 1.4 | 10 |
| DRX cycle | ms | N/A | 80 ^{Note5} | N/A | 640 ^{Note5} |
| PDCCH/PCFICH/PHICH Reference measurement channel ^{Note1} | | R.6 FDD | R.6 FDD | R.8 FDD | R.6 FDD |
| OCNG Pattern ^{Note2} | | OP.2 FDD | OP.2 FDD | OP.4 FDD | OP.2 FDD |
| PBCH_RA | dB | 0 | 0 | 0 | 0 |
| PBCH_RB | | | | | |
| PSS_RA | | | | | |
| SSS_RA | | | | | |
| PCFICH_RB | | | | | |
| PHICH_RA | | | | | |
| PHICH_RB | | | | | |
| PDCCH_RA | | | | | |
| PDCCH_RB | | | | | |
| OCNG_RA ^{Note3} | | | | | |
| OCNG_RB ^{Note3} | | | | | |
| N_{oc} | dBm/15 kHz | -98 | -98 | -98 | -98 |
| \hat{E}_s/I_{ot} | dB | 3 | 3 | 3 | 3 |
| \hat{E}_s/N_{oc} | dB | 3 | 3 | 3 | 3 |
| I_o ^{Note4} | dBm/9 MHz | -65.5 | -65.5 | N/A | -65.5 |
| | dBm/1.08 MHz | N/A | N/A | -74.7 | N/A |
| Propagation condition | - | AWGN | AWGN | AWGN | AWGN |
| <p>Note 1: For the reference measurement channels, see clause A.3.1.</p> <p>Note 2: For the OCNG pattern, see clause A.3.2.</p> <p>Note 3: OCNG shall be used such that both cells are fully allocated and a constant total transmitted power spectral density is achieved for all OFDM symbols.</p> <p>Note 4: I_o level has been derived from other parameters for information purpose. It is not a settable parameter.</p> <p>Note 5: DRX related parameters are defined in Table A.7.1.1.1-3.</p> | | | | | |

Table A.7.1.1.1-2: Sounding Reference Symbol Configuration to be used in UE Transmit Timing Accuracy Tests for E-UTRAN FDD

| Field | Value | | | | Comment |
|------------------------------------|--------|--------|--------|--------|--|
| | Test 1 | Test 2 | Test 3 | Test 4 | |
| srsBandwidthConfiguration | bw5 | bw5 | bw7 | bw5 | |
| srsSubframeConfiguration | sc1 | sc3 | sc1 | sc3 | |
| ackNackSrsSimultaneousTransmission | FALSE | FALSE | FALSE | FALSE | |
| srsMaxUpPTS | N/A | N/A | N/A | N/A | Not applicable for FDD |
| srsBandwidth | 0 | 0 | 0 | 0 | No hopping |
| srsHoppingBandwidth | hbw0 | hbw0 | hbw0 | hbw0 | |
| frequencyDomainPosition | 0 | 0 | 0 | 0 | |
| duration | TRUE | TRUE | TRUE | TRUE | Indefinite duration |
| Srs-ConfigurationIndex | 0 | 77 | 0 | 317 | SRS periodicity of 2ms, 80 ms and 320ms for Test 1, 2 and 4, respectively. |
| transmissionComb | 0 | 0 | 0 | 0 | |
| cyclicShift | cs0 | cs0 | cs0 | cs0 | No cyclic shift |
| SRS-AntennaPort | an1 | | | | Number of antenna ports used for SRS transmission |

Note: For further information see clause 6.3.2 in TS 36.331.

Table A.7.1.1.1-3: drx-Configuration to be used in UE Transmit Timing Accuracy Test 2 and Test 4 for E-UTRAN FDD

| Field | Value | | Comment |
|--------------------------|---------|---------|---------|
| | Test 2 | Test 4 | |
| onDurationTimer | psf1 | psf1 | |
| drx-InactivityTimer | psf1 | psf1 | |
| drx-RetransmissionTimer | psf1 | psf1 | |
| longDRX-CycleStartOffset | sf80 | sf640 | |
| shortDRX | disable | disable | |

Note: For further information see clause 6.3.2 in TS 36.331.

A.7.1.1.2 Test Requirements

For parameters specified in Tables A.7.1.1.1-1 and A.7.1.1.1-2, the initial transmit timing accuracy, the maximum amount of timing change in one adjustment, the minimum and the maximum adjustment rate shall be within the limits defined in clause 7.1.2.

The following sequence of events shall be used to verify that the requirements are met.

For the 10MHz channel bandwidth, the test sequence shall be carried out in RRC_CONNECTED for both non-DRX (for Test1) and DRX with a cycle length of 80 ms or a cycle length of 640 ms (Tests 2 and 4, respectively):

- After a connection is set up with the cell, the test system shall verify that the UE transmit timing offset is within $N_{TA} \times T_S \pm 12 \times T_S$ with respect to the first detected path (in time) of the corresponding downlink frame of cell 1.
- The test system adjusts the downlink transmit timing for the cell by $+64 \times T_S$ (for Test 1 and Test 2) or $+32 \times T_S$ (for Test 4) compared to that in (a).
- The test system shall verify that for Test 1 the adjustment step size and the adjustment rate shall be according to the requirements in clause 7.1.2 until the UE transmit timing offset is within $N_{TA} \times T_S \pm 12 \times T_S$ with respect to the first detected path (in time) of the corresponding downlink frame of cell 1. Skip this step for Test 2 and Test 4.

- d) The test system shall verify that the UE transmit timing offset stays within $N_{TA} \times T_S \pm 12 \times T_S$ with respect to the first detected path (in time) of the corresponding downlink frame of cell 1. For test 2 and test 4 the UE transmit timing offset shall be verified for the first transmission in the DRX cycle immediately after DL timing adjustment.

For the 1.4MHz channel bandwidth, the test sequence shall be carried out in RRC_CONNECTED for non-DRX (Test 3):

- a) After a connection is set up with the cell, the test system shall verify that the UE transmit timing offset is within $N_{TA} \times T_S \pm 24 \times T_S$ with respect to the first detected path (in time) of the corresponding downlink frame of cell 1.
- b) The test system adjusts the downlink transmit timing for the cell by $+128 \times T_S$ (approximately $+4\mu s$) compared to that in (a).
- c) The test system shall verify that the adjustment step size and the adjustment rate shall be according to the requirements in clause 7.1.2 until the UE transmit timing offset is within $N_{TA} \times T_S \pm 24 \times T_S$ with respect to the first detected path (in time) of the corresponding downlink frame of cell 1.
- d) The test system shall verify that the UE transmit timing offset stays within $N_{TA} \times T_S \pm 24 \times T_S$ with respect to the first detected path (in time) of the corresponding downlink frame of cell 1.

A.7.1.2 E-UTRAN TDD - UE Transmit Timing Accuracy Tests

A.7.1.2.1 Test Purpose and Environment

The purpose of this test is to verify that the UE is capable of following the frame timing change of the connected eNode B and that the UE initial transmit timing accuracy, maximum amount of timing change in one adjustment, minimum and maximum adjustment rate are within the specified limits. This test will verify the requirements in clause 7.1.2.

For this test a single cell is used. Table A.7.1.2.1-1 defines the strength of the transmitted signals and the propagation condition. The transmit timing is verified by the UE transmitting SRS using the configuration defined in Table A.7.1.2.1-2.

Table A.7.1.2.1-1: Test Parameters for UE Transmit Timing Accuracy Tests for E-UTRAN TDD

| Parameter | Unit | Value | | | |
|---|------|----------|---------------------|----------|----------------------|
| | | Test 1 | Test 2 | Test 3 | Test 4 |
| E-UTRA RF Channel Number | | 1 | 1 | 1 | 1 |
| Channel Bandwidth ($BW_{channel}$) | MHz | 10 | 10 | 1.4 | 10 |
| Special subframe configuration ^{Note1} | | 6 | 6 | 6 | 6 |
| Uplink-downlink configuration ^{Note2} | | 1 | 1 | 1 | 1 |
| DRX cycle | ms | N/A | 80 ^{Note7} | N/A | 640 ^{Note7} |
| PDCCH/PCFICH/PHICH Reference measurement channel ^{Note3} | | R.6 TDD | R.6 TDD | R.8 TDD | R.6 TDD |
| OCNG Pattern ^{Note4} | | OP.2 TDD | OP.2 TDD | OP.4 TDD | OP.2 TDD |
| PBCH_RA | dB | 0 | 0 | 0 | 0 |
| PBCH_RB | | | | | |
| PSS_RA | | | | | |
| SSS_RA | | | | | |
| PCFICH_RB | | | | | |
| PHICH_RA | | | | | |
| PHICH_RB | | | | | |
| PDCCH_RA | | | | | |
| PDCCH_RB | | | | | |
| OCNG_RA ^{Note5} | | | | | |
| OCNG_RB ^{Note5} | | | | | |
| N_{oc} | | | | | |
| \hat{E}_s / I_{ot} | dB | 3 | 3 | 3 | 3 |

| | | | | | |
|---|--------------|-------|-------|-------|-------|
| \hat{E}_s/N_{oc} | dB | 3 | 3 | 3 | 3 |
| I_0 ^{Note6} | dBm/9 MHz | -65.5 | -65.5 | N/A | -65.5 |
| | dBm/1.08 MHz | N/A | N/A | -74.7 | N/A |
| Propagation condition | - | AWGN | AWGN | AWGN | AWGN |
| <p>Note 1: For the special subframe configuration see table 4.2-1 in TS 36.211.</p> <p>Note 2: For the uplink-downlink configuration see table 4.2-2 in TS 36.211.</p> <p>Note 3: For the reference measurement channels, see clause A.3.1.</p> <p>Note 4: For the OCNG pattern, see clause A.3.2.</p> <p>Note 5: OCNG shall be used such that both cells are fully allocated and a constant total transmitted power spectral density is achieved for all OFDM symbols.</p> <p>Note 6: I_0 level has been derived from other parameters for information purpose. It is not a settable parameter.</p> <p>Note 7: DRX related parameters are defined in Table A.7.1.2.1-3.</p> | | | | | |

Table A.7.1.2.1-2: Sounding Reference Symbol Configuration to be used in UE Transmit Timing Accuracy Tests for E-UTRAN TDD

| Field | Value | | | | Comment |
|--|--------|--------|--------|--------|---|
| | Test 1 | Test 2 | Test 3 | Test 4 | |
| srsBandwidthConfiguration | bw5 | bw5 | bw7 | bw5 | |
| srsSubframeConfiguration | sc3 | sc3 | sc3 | sc3 | Once every 5 subframes |
| ackNackSrsSimultaneousTransmission | FALSE | FALSE | FALSE | FALSE | |
| srsMaxUpPTS | FALSE | FALSE | FALSE | FALSE | |
| srsBandwidth | 0 | 0 | 0 | 0 | No hopping |
| srsHoppingBandwidth | hbw0 | hbw0 | hbw0 | hbw0 | |
| frequencyDomainPosition | 0 | 0 | 0 | 0 | |
| duration | TRUE | TRUE | TRUE | TRUE | Indefinite duration |
| Srs-ConfigurationIndex | 15 | 85 | 15 | 325 | SRS periodicity of 10, 80, 10 and 320 ms for Test 1, 2, 3 and 4 respectively. |
| transmissionComb | 0 | 0 | 0 | 0 | |
| cyclicShift | cs0 | cs0 | cs0 | cs0 | No cyclic shift |
| SRS-AntennaPort | an1 | | | | Number of antenna ports used for SRS transmission |
| Note: For further information see clause 6.3.2 in TS 36.331. | | | | | |

Table A.7.1.2.1-3: DRX Configuration to be used in UE Transmit Timing Accuracy Test 2 and Test 4 for E-UTRAN TDD

| Field | Value | | Comment |
|--|---------|---------|---------|
| | Test 2 | Test 4 | |
| onDurationTimer | psf1 | psf1 | |
| drx-InactivityTimer | psf1 | psf1 | |
| drx-RetransmissionTimer | psf1 | psf1 | |
| longDRX-CycleStartOffset | sf80 | Sf640 | |
| shortDRX | disable | disable | |
| Note: For further information see clause 6.3.2 in TS 36.331. | | | |

A.7.1.2.2 Test Requirements

For parameters specified in Tables A.7.1.2.1-1 and A.7.1.2.1-2, the initial transmit timing accuracy, the maximum amount of timing change in one adjustment, the minimum and the maximum adjustment rate shall be within the limits defined in clause 7.1.2.

The following sequence of events shall be used to verify that the requirements are met.

For the 10MHz channel bandwidth, the test sequence shall be carried out in RRC_CONNECTED for both non-DRX (for Test1) and DRX with a cycle length of 80 ms or a cycle length of 640 ms (Tests 2 and 4, respectively):

- a) After a connection is set up with the cell, the test system shall verify that the UE transmit timing offset is within $(N_{TA} + 624) \times T_S \pm 12 \times T_S$ with respect to the first detected path (in time) of the corresponding downlink frame of cell 1.
- b) The test system adjusts the downlink transmit timing for the cell by $+64 \times T_S$ (for Test 1 and Test 2) or $+32 \times T_S$ (for Test 4) compared to that in (a).
- c) The test system shall verify that for test 1 the adjustment step size and the adjustment rate shall be according to the requirements in clause 7.1.2 until the UE transmit timing offset is within $(N_{TA} + 624) \times T_S \pm 12 \times T_S$ with respect to the first detected path (in time) of the corresponding downlink frame of cell 1. Skip this step for test 2 and test 4.
- d) The test system shall verify that the UE transmit timing offset stays within $(N_{TA} + 624) \times T_S \pm 12 \times T_S$ with respect to the first detected path (in time) of the corresponding downlink frame of cell 1. For test 2 and test 4 the UE transmit timing offset shall be verified for the first transmission in the DRX cycle immediately after DL timing adjustment.

For the 1.4MHz channel bandwidth, the test sequence shall be carried out in RRC_CONNECTED for non-DRX (Test 3):

- a) After a connection is set up with the cell, the test system shall verify that the UE transmit timing offset is within $(N_{TA} + 624) \times T_S \pm 24 \times T_S$ with respect to the first detected path (in time) of the corresponding downlink frame of cell 1.
- b) The test system adjusts the downlink transmit timing for the cell by $+128 \times T_S$ (approximately $+4\mu s$) compared to that in (a).
- c) The test system shall verify that the adjustment step size and the adjustment rate shall be according to the requirements in clause 7.1.2 until the UE transmit timing offset is within $(N_{TA} + 624) \times T_S \pm 24 \times T_S$ with respect to the first detected path (in time) of the corresponding downlink frame of cell 1.
- d) The test system shall verify that the UE transmit timing offset stays within $(N_{TA} + 624) \times T_S \pm 24 \times T_S$ with respect to the first detected path (in time) of the corresponding downlink frame of cell 1.

A.7.1.3 E-UTRAN FDD – UE Transmit Timing Accuracy Tests for SCell

A.7.1.3.1 Test Purpose and Environment

The purpose of this test is to verify that the UE is capable of following the frame timing change of the connected eNode B and that the UE initial transmit timing accuracy, maximum amount of timing change in one adjustment, minimum and maximum adjustment rate are within the specified limits. This test will verify the requirements in clause 7.1.2.

For this test two cells are used. Cell 1 is PCell and Cell 2 is SCell. Both PCell and SCell are in the primary Timing Advance Group (pTAG). Table A.7.1.3.1-1 defines the strength of the transmitted signals and the propagation condition. The transmit timing is verified by the UE transmitting SRS using the configuration defined in Table A.7.1.3.1-2.

Table A.7.1.3.1-1: General test Parameters for UE Transmit Timing Accuracy Tests for E-UTRAN FDD

| Parameter | Unit | Cell 1 | | | Cell 2 | | |
|--------------------------------------|------|--------|--------|--------|--------|--------|--------|
| | | Test 1 | Test 2 | Test 3 | Test 1 | Test 2 | Test 3 |
| E-UTRA RF Channel Number | | 1 | 1 | 1 | 2 | 2 | 2 |
| Channel Bandwidth ($BW_{channel}$) | MHz | 20 | 20 | 20 | 20 | 20 | 20 |
| Active PCell | | Cell 1 | Cell 1 | Cell 1 | | | |
| Active SCell | | | | | Cell 2 | Cell 2 | Cell 2 |

| TAG configuration | | pTAG | pTAG | pTAG | pTAG | pTAG | pTAG |
|--|------------|-----------|---------------------|----------------------|-----------|---------------------|----------------------|
| DRX cycle | ms | N/A | 80 ^{Note5} | 640 ^{Note5} | N/A | 80 ^{Note5} | 640 ^{Note5} |
| PDCCH/PCFICH/PHICH Reference measurement channel ^{Note1} | | R.10 FDD | R.10 FDD | R.10 FDD | R.10 FDD | R.10 FDD | R.10 FDD |
| OCNG Pattern ^{Note2} | | OP.12 FDD | OP.12 FDD | OP.12 FDD | OP.12 FDD | OP.12 FDD | OP.12 FDD |
| PBCH_RA | dB | 0 | 0 | 0 | 0 | 0 | 0 |
| PBCH_RB | | | | | | | |
| PSS_RA | | | | | | | |
| SSS_RA | | | | | | | |
| PCFICH_RB | | | | | | | |
| PHICH_RA | | | | | | | |
| PHICH_RB | | | | | | | |
| PDCCH_RA | | | | | | | |
| PDCCH_RB | | | | | | | |
| OCNG_RA ^{Note3} | | | | | | | |
| OCNG_RB ^{Note3} | | | | | | | |
| N_{oc} | dBm/15 kHz | -98 | -98 | -98 | -98 | -98 | -98 |
| \hat{E}_s/I_{ot} | dB | 3 | 3 | 3 | 3 | 3 | 3 |
| \hat{E}_s/N_{oc} | dB | 3 | 3 | 3 | 3 | 3 | 3 |
| I_o ^{Note4} | dBm/18 MHz | -62.5 | -62.5 | -62.5 | -62.5 | -62.5 | -62.5 |
| Propagation condition | - | AWGN | AWGN | AWGN | AWGN | AWGN | AWGN |
| Note 1: For the reference measurement channels, see clause A.3.1. Note 2: For the OCNG pattern, see clause A.3.2. Note 3: OCNG shall be used such that both cells are fully allocated and a constant total transmitted power spectral density is achieved for all OFDM symbols. Note 4: I_o level has been derived from other parameters for information purpose. It is not a settable parameter. Note 5: DRX related parameters are defined in Table A.7.1.3.1-3. | | | | | | | |

Table A.7.1.3.1-2: Sounding Reference Symbol Configuration to be used in UE Transmit Timing Accuracy Tests for E-UTRAN FDD

| Field | Cell 1 | | | Cell 2 | | | Comment |
|--|--------|--------|--------|--------|--------|--------|--|
| | Test 1 | Test 2 | Test 3 | Test 1 | Test 2 | Test 3 | |
| srsBandwidthConfiguration | bw5 | bw5 | bw5 | bw5 | bw5 | bw5 | |
| srsSubframeConfiguration | sc1 | sc3 | sc3 | sc1 | sc3 | sc3 | |
| ackNackSrsSimultaneousTransmission | FALSE | FALSE | FALSE | FALSE | FALSE | FALSE | |
| srsMaxUpPTS | N/A | N/A | N/A | N/A | N/A | N/A | Not applicable for FDD |
| srsBandwidth | 0 | 0 | 0 | 0 | 0 | 0 | No hopping |
| srsHoppingBandwidth | hbw0 | hbw0 | hbw0 | hbw0 | hbw0 | hbw0 | |
| frequencyDomainPosition | 0 | 0 | 0 | 0 | 0 | 0 | |
| duration | TRUE | TRUE | TRUE | TRUE | TRUE | TRUE | Indefinite duration |
| Srs-ConfigurationIndex | 0 | 77 | 317 | 0 | 77 | 317 | SRS periodicity of 2ms, 80 ms and 320ms for Test 1, 2 and 3, respectively. |
| transmissionComb | 0 | 0 | 0 | 0 | 0 | 0 | |
| cyclicShift | cs0 | cs0 | cs0 | cs0 | cs0 | cs0 | No cyclic shift |
| srsAntennaPort | an1 | an1 | an1 | an1 | an1 | an1 | Number of SRS antenna ports |
| NOTE: For further information see clause 6.3.2 in TS 36.331. | | | | | | | |

Table A.7.1.3.1-3: drx-Configuration to be used in UE Transmit Timing Accuracy Test 2 and Test 3 for E-UTRAN FDD

| Field | Test 2 | | Test 3 | | Comment |
|--------------------------|--|---------|---------|---------|---------|
| | Cell 1 | Cell 2 | Cell 1 | Cell 2 | |
| onDurationTimer | psf1 | psf1 | psf1 | psf1 | |
| drx-InactivityTimer | psf1 | psf1 | psf1 | psf1 | |
| drx-RetransmissionTimer | psf1 | psf1 | psf1 | psf1 | |
| longDRX-CycleStartOffset | sf80 | sf80 | Sf640 | Sf640 | |
| shortDRX | disable | disable | disable | Disable | |
| NOTE: | For further information see clause 6.3.2 in TS 36.331. | | | | |

A.7.1.3.2 Test Requirements

For parameters specified in Tables A.7.1.3.1-1, and A.7.1.3.1-2 the initial transmit timing accuracy, the maximum amount of timing change in one adjustment, the minimum and the maximum adjustment rate shall be within the limits defined in clause 7.1.2.

The following sequence of events shall be used to verify that the requirements are met.

The test sequence shall be carried out in RRC_CONNECTED for both non-DRX (for Test 1) and DRX with a cycle length of 80 ms or a cycle length of 640 mss(Test 2 and 3, respectively):

- After the SCell (Cell 2) is activated, the test system shall verify that the UE transmit timing offsets of both PCell and SCell are within $N_{TA} \times T_S \pm 12 \times T_S$ with respect to the first detected path (in time) of the corresponding downlink frame of PCell (Cell 1).
- The test system adjusts the downlink transmit timing for the PCell (Cell 1) by $+64 \times T_S$ (for Test 1 and Test 2) or $+32 \times T_S$ (for Test 3) compared to that in (a).
- The test system shall verify that for Test 1 the adjustment step size and the adjustment rate shall be according to the requirements in clause 7.1.2 until the UE transmit timing offsets of both PCell and SCell are within $N_{TA} \times T_S \pm 12 \times T_S$ with respect to the first detected path (in time) of the corresponding downlink frame of PCell (Cell 1). Skip this step for Test 2 and Test 3.
- The test system shall verify that the UE transmit timing offsets of both PCell and SCell stay within $N_{TA} \times T_S \pm 12 \times T_S$ with respect to the first detected path (in time) of the corresponding downlink frame of PCell (Cell 1). For test 2 and test 3 the UE transmit timing offset shall be verified for the first transmission in the DRX cycle immediately after DL timing adjustment.

A.7.1.4 E-UTRAN TDD - UE Transmit Timing Accuracy Tests for SCell

A.7.1.4.1 Test Purpose and Environment

The purpose of this test is to verify that the UE is capable of following the frame timing change of the connected eNode B and that the UE initial transmit timing accuracy, maximum amount of timing change in one adjustment, minimum and maximum adjustment rate are within the specified limits. This test will verify the requirements in clause 7.1.2.

For this test two cells are used. Cell 1 is PCell and Cell 2 is SCell. Both PCell and SCell are in the primary Timing Advance Group (pTAG). Table A.7.1.4.1-1 defines the strength of the transmitted signals and the propagation condition. The transmit timing is verified by the UE transmitting SRS using the configuration defined in Table A.7.1.4.1-2.

Table A.7.1.4.1-1: Test Parameters for UE Transmit Timing Accuracy Tests for E-UTRAN TDD

| Parameter | Unit | Cell 1 | | | Cell 2 | | |
|--|------|--------|--------|--------|--------|--------|--------|
| | | Test 1 | Test 2 | Test 3 | Test 1 | Test 2 | Test 3 |
| E-UTRA RF Channel Number | | 1 | 1 | 1 | 2 | 2 | 2 |
| Channel Bandwidth (BW _{channel}) | MHz | 20 | 20 | 20 | 20 | 20 | 20 |
| E-UTRA RF Channel Number | | 1 | 1 | 1 | 2 | 2 | 2 |
| Active PCell | | Cell 1 | Cell 1 | Cell 1 | | | |

| | | | | | | | |
|---|------------|----------|---------------------|----------------------|----------|---------------------|----------------------|
| Active SCell | | | | | Cell 2 | Cell 2 | Cell 2 |
| TAG configuration | | pTAG | pTAG | pTAG | pTAG | pTAG | pTAG |
| Special subframe configuration ^{Note1} | | 6 | 6 | 6 | 6 | 6 | 6 |
| Uplink-downlink configuration ^{Note2} | | 1 | 1 | 1 | 1 | 1 | 1 |
| DRX cycle | ms | OFF | 80 ^{Note7} | 640 ^{Note7} | OFF | 80 ^{Note7} | 640 ^{Note7} |
| PDCCH/PCFICH/PHICH Reference measurement channel ^{Note3} | | R.10 TDD | R.10 TDD | R.10 TDD | R.10 TDD | R.10 TDD | R.10 TDD |
| OCNG Pattern ^{Note4} | | OP.8 TDD | OP.8 TDD | OP.8 TDD | OP.8 TDD | OP.8 TDD | OP.8 TDD |
| PBCH_RA | dB | 0 | 0 | 0 | 0 | 0 | 0 |
| PBCH_RB | | | | | | | |
| PSS_RA | | | | | | | |
| SSS_RA | | | | | | | |
| PCFICH_RB | | | | | | | |
| PHICH_RA | | | | | | | |
| PHICH_RB | | 0 | 0 | 0 | 0 | 0 | 0 |
| PDCCH_RA | | | | | | | |
| PDCCH_RB | | | | | | | |
| OCNG_RA ^{Note5} | | | | | | | |
| OCNG_RB ^{Note5} | | | | | | | |
| N_{oc} | dBm/15 kHz | -98 | -98 | -98 | -98 | -98 | -98 |
| \hat{E}_s/I_{ot} | dB | 3 | 3 | 3 | 3 | 3 | 3 |
| \hat{E}_s/N_{oc} | dB | 3 | 3 | 3 | 3 | 3 | 3 |
| I_0 ^{Note6} | dBm/18 MHz | -62.5 | -62.5 | -62.5 | -62.5 | -62.5 | -62.5 |
| Propagation condition | - | AWGN | AWGN | AWGN | AWGN | AWGN | AWGN |
| <p>Note 1: For the special subframe configuration see table 4.2-1 in TS 36.211.</p> <p>Note 2: For the uplink-downlink configuration see table 4.2-2 in TS 36.211.</p> <p>Note 3: For the reference measurement channels, see clause A.3.1.</p> <p>Note 4: For the OCNG pattern, see clause A.3.2.</p> <p>Note 5: OCNG shall be used such that both cells are fully allocated and a constant total transmitted power spectral density is achieved for all OFDM symbols.</p> <p>Note 6: I_0 level has been derived from other parameters for information purpose. It is not a settable parameter.</p> <p>Note 7: DRX related parameters are defined in Table A.7.1.4.1-3.</p> | | | | | | | |

Table A.7.1.4.1-2: Sounding Reference Symbol Configuration to be used in UE Transmit Timing Accuracy Tests for E-UTRAN TDD

| Field | Cell 1 | | | Cell 2 | | | Comment |
|-------------------------------------|--------|--------|--------|--------|--------|--------|---|
| | Test 1 | Test 2 | Test 3 | Test 1 | Test 2 | Test 3 | |
| srsBandwidthConfiguration | bw5 | bw5 | bw5 | bw5 | bw5 | bw5 | |
| srsSubframeConfiguration | sc3 | sc3 | sc3 | sc3 | sc3 | sc3 | Once every 5 subframes |
| ackNackSrsSimultaneous Transmission | FALSE | FALSE | FALSE | FALSE | FALSE | FALSE | |
| srsMaxUpPTS | FALSE | FALSE | FALSE | FALSE | FALSE | FALSE | |
| srsBandwidth | 0 | 0 | 0 | 0 | 0 | 0 | No hopping |
| srsHoppingBandwidth | hbw0 | hbw0 | hbw0 | hbw0 | hbw0 | hbw0 | |
| frequencyDomainPosition | 0 | 0 | 0 | 0 | 0 | 0 | |
| duration | TRUE | TRUE | TRUE | TRUE | TRUE | TRUE | Indefinite duration |
| Srs-ConfigurationIndex | 15 | 85 | 325 | 15 | 85 | 325 | SRS periodicity of 10, 80 ms and 320ms for Test 1, 2 and 3, respectively. |
| transmissionComb | 0 | 0 | 0 | 0 | 0 | 0 | |
| cyclicShift | cs0 | cs0 | cs0 | cs0 | cs0 | cs0 | No cyclic shift |

| | | | | | | | |
|--|-----|-----|-----|-----|-----|-----|-----------------------------|
| srsAntennaPort | an1 | an1 | an1 | an1 | an1 | an1 | Number of SRS antenna ports |
| Note: For further information see clause 6.3.2 in TS 36.331. | | | | | | | |

Table A.7.1.4.1-3: DRX Configuration to be used in UE Transmit Timing Accuracy Test 2 and Test 3 for E-UTRAN TDD

| Field | Test 2 | | Test 3 | | Comment |
|--|---------|---------|---------|---------|---------|
| | Cell 1 | Cell 2 | Cell 1 | Cell 2 | |
| onDurationTimer | psf1 | psf1 | psf1 | psf1 | |
| drx-InactivityTimer | psf1 | psf1 | psf1 | psf1 | |
| drx-RetransmissionTimer | psf1 | psf1 | psf1 | psf1 | |
| longDRX-CycleStartOffset | sf80 | sf80 | Sf640 | Sf640 | |
| shortDRX | disable | disable | disable | disable | |
| Note: For further information see clause 6.3.2 in TS 36.331. | | | | | |

A.7.1.4.2 Test Requirements

For parameters specified in Tables A.7.1.4.1-1 and A.7.1.4.1-2, the initial transmit timing accuracy, the maximum amount of timing change in one adjustment, the minimum and the maximum adjustment rate shall be within the limits defined in clause 7.1.2.

The following sequence of events shall be used to verify that the requirements are met.

The test sequence shall be carried out in RRC_CONNECTED for both non-DRX (for Test 1) and DRX with a cycle length of 80 ms or a cycle length of 640 ms (Test 2 and 3, respectively):

- After the SCell (Cell 2) is activated, the test system shall verify that the UE transmit timing offsets of both PCell and SCell are within $(N_{TA} + 624) \times T_S \pm 12 \times T_S$ with respect to the first detected path (in time) of the corresponding downlink frame of PCell (Cell 1).
- The test system adjusts the downlink transmit timing for the PCell (Cell 1) by $+64 \times T_S$ (for Test 1 and Test 2) or $+32 \times T_S$ (for Test 3) compared to that in (a).
- The test system shall verify that for test 1 the adjustment step size and the adjustment rate shall be according to the requirements in clause 7.1.2 until the UE transmit timing offsets of both PCell and SCell are within $(N_{TA} + 624) \times T_S \pm 12 \times T_S$ with respect to the first detected path (in time) of the corresponding downlink frame of PCell (Cell 1). Skip this step for test 2 and test 3.
- The test system shall verify that the UE transmit timing offsets of both PCell and SCell stay within $(N_{TA} + 624) \times T_S \pm 12 \times T_S$ with respect to the first detected path (in time) of the corresponding downlink frame of PCell (Cell 1). For test 2 and test 3 the UE transmit timing offset shall be verified for the first transmission in the DRX cycle immediately after DL timing adjustment.

A.7.1.4A E-UTRAN TDD - UE Transmit Timing Accuracy Tests for SCell for 20 MHz + 10 MHz

A.7.1.4A.1 Test Purpose and Environment

The purpose of this test case is the same as for the test defined in subclause A.7.1.4.1.

The parameters of this test are the same as defined in Subclause A.7.1.4.1 except that the values of the parameters in the Table A.7.1.4A.1-1 will replace the values of the corresponding parameters in A.7.1.4.1-1. Parameters used for the sounding reference symbol configuration and DRX configuration are unchanged from table A.7.1.4.1-2 and table A.7.1.4.1-3.

Table A.7.1.4A.1-1: Test Parameters for UE Transmit Timing Accuracy Tests for E-UTRAN TDD for 20 MHz +10 MHz

| Parameter | Unit | Cell 1 | Cell 2 |
|-----------|------|--------|--------|
|-----------|------|--------|--------|

| | | Test 1 | Test 2 | Test 3 | Test 1 | Test 2 | Test 3 |
|---|------------|----------|----------|----------|----------|----------|----------|
| Channel Bandwidth (BW_{channel}) | MHz | 20 | 20 | 20 | 10 | 10 | 10 |
| PDCCH/PCFICH/PHICH Reference measurement channel ^{Note3} | | R.10 TDD | R.10 TDD | R.10 TDD | R.6 TDD | R.6 TDD | R.6 TDD |
| OCNG Pattern ^{Note4} | | OP.8 TDD | OP.8 TDD | OP.8 TDD | OP.2 TDD | OP.2 TDD | OP.2 TDD |
| I_0 ^{Note6} | dBm/18 MHz | -62.5 | -62.5 | -62.5 | N/A | N/A | N/A |
| | dBm/9 MHz | N/A | N/A | N/A | -65.5 | -65.5 | -65.5 |

A.7.1.4A.2 Test Requirements

The test requirements defined in section A.7.1.4.2 shall apply to this test case.

A.7.1.5 E-UTRAN FDD – UE Transmit Timing Accuracy Tests for 5MHz Bandwidth

A.7.1.5.1 Test Purpose and Environment

The purpose of this test case is the same as for the test defined in subclause A.7.1.1.1.

The parameters of this test are the same as defined in Subclause A.7.1.1.1 except that the values of the parameters in Test 1 in the Table A.7.1.5.1-1 will replace the values of the corresponding parameters in A.7.1.1.1-1. Only Test 1 is defined for the 5MHz bandwidth.

Table A.7.1.5.1-1: Test Parameters for UE Transmit Timing Accuracy Tests for E-UTRAN FDD for 5MHz bandwidth

| Parameter | Unit | Value |
|--|-------------|-----------|
| | | Test 1 |
| Channel Bandwidth (BW_{channel}) | MHz | 5 |
| PDCCH/PCFICH/PHICH Reference measurement channel ^{Note1} | | R.11 FDD |
| OCNG Pattern ^{Note2} | | OP.16 FDD |
| I_0 ^{Note4} | dBm/4.5 MHz | -68.5 |
| Note 1: For the reference measurement channels, see clause A.3.1. Note 2: For the OCNG pattern, see clause A.3.2. Note 3: See Table A.7.1.1.1-1 for the other parameters. Note 4: This test is according to the principle defined in section A.3.7.2. | | |

A.7.1.5.2 Test Requirements

The test requirements defined in section A.7.1.1.2 shall apply to this test case.

A.7.1.6 E-UTRAN FDD – UE Transmit Timing Accuracy Tests for SCell in sTAG

A.7.1.6.1 Test Purpose and Environment

The purpose of this test is to verify that the UE is capable of following the frame timing change of the connected eNode B and that the UE initial transmit timing accuracy, maximum amount of timing change in one adjustment, minimum and maximum adjustment rate are within the specified limits for SCell in sTAG. This test will verify the requirements in clause 7.1.2.

For this test two cells are used. Cell 1 is PCell and Cell 2 is SCell. PCell is in the Primary Timing Advance Group (pTAG) and SCell is in the secondary Timing Advance Group (sTAG). Table A.7.1.6.1-1 defines the strength of the transmitted signals and the propagation condition. The transmit timing for SCell in sTAG is verified by the UE transmitting SRS using the configuration defined in Table A.7.1.6.1-2.

Table A.7.1.6.1-1: General test Parameters for UE Transmit Timing Accuracy Tests for SCell in sTAG for E-UTRAN FDD

| Parameter | Unit | Cell 1 | | Cell 2 | |
|--|------------|----------|---------------------|----------|---------------------|
| | | Test 1 | Test 2 | Test 1 | Test 2 |
| E-UTRA RF Channel Number | | 1 | 1 | 2 | 2 |
| Channel Bandwidth (BW _{channel}) | MHz | 10 | 10 | 10 | 10 |
| Active PCell | | Cell 1 | Cell 1 | | |
| Active SCell | | | | Cell 2 | Cell 2 |
| TAG configuration | | pTAG | pTAG | sTAG | sTAG |
| DRX cycle | ms | OFF | 80 ^{Note5} | OFF | 80 ^{Note5} |
| PDCCH/PCFICH/PHICH Reference measurement channel ^{Note1} | | R.6 FDD | R.6 FDD | R.6 FDD | R.6 FDD |
| OCNG Pattern ^{Note2} | | OP.2 FDD | OP.2 FDD | OP.2 FDD | OP.2 FDD |
| PBCH_RA | dB | 0 | 0 | 0 | 0 |
| PBCH_RB | | | | | |
| PSS_RA | | | | | |
| SSS_RA | | | | | |
| PCFICH_RB | | | | | |
| PHICH_RA | | | | | |
| PHICH_RB | | | | | |
| PDCCH_RA | | | | | |
| PDCCH_RB | | | | | |
| OCNG_RA ^{Note3} | | | | | |
| OCNG_RB ^{Note3} | | | | | |
| N_{oc} | dBm/15 kHz | -98 | -98 | -98 | -98 |
| \hat{E}_s/I_{ot} | dB | 3 | 3 | 3 | 3 |
| \hat{E}_s/N_{oc} | dB | 3 | 3 | 3 | 3 |
| I_0 ^{Note4} | dBm/9 MHz | -65.5 | -65.5 | -65.5 | -65.5 |
| Propagation condition | - | AWGN | AWGN | AWGN | AWGN |
| <p>Note 1: For the reference measurement channels, see clause A.3.1.</p> <p>Note 2: For the OCNG pattern, see clause A.3.2.</p> <p>Note 3: OCNG shall be used such that both cells are fully allocated and a constant total transmitted power spectral density is achieved for all OFDM symbols.</p> <p>Note 4: I_0 level has been derived from other parameters for information purpose. It is not a settable parameter.</p> <p>Note 5: DRX related parameters are defined in Table A.7.1.6.1-3.</p> | | | | | |

Table A.7.1.6.1-2: Sounding Reference Symbol Configuration to be used in UE Transmit Timing Accuracy Tests for SCell in sTAG for E-UTRAN FDD

| Field | Cell 1 | | Cell 2 | | Comment |
|------------------------------------|--------|--------|--------|--------|------------------------|
| | Test 1 | Test 2 | Test 1 | Test 2 | |
| srsBandwidthConfiguration | bw5 | bw5 | bw5 | bw5 | |
| srsSubframeConfiguration | sc3 | sc3 | sc3 | sc3 | Once every 5 subframes |
| ackNackSrsSimultaneousTransmission | FALSE | FALSE | FALSE | FALSE | |
| srsMaxUpPTS | FALSE | FALSE | FALSE | FALSE | |
| srsBandwidth | 0 | 0 | 0 | 0 | No hopping |
| srsHoppingBandwidth | hbw0 | hbw0 | hbw0 | hbw0 | |

| | | | | | |
|--|------|------|------|------|---|
| frequencyDomainPosition | 0 | 0 | 0 | 0 | |
| duration | TRUE | TRUE | TRUE | TRUE | Indefinite duration |
| Srs-ConfigurationIndex | 15 | 85 | 15 | 85 | SRS periodicity of 10 and 80 ms for Test 1 and 2, respectively. |
| transmissionComb | 0 | 0 | 0 | 0 | |
| cyclicShift | cs0 | cs0 | cs0 | cs0 | No cyclic shift |
| srsAntennaPort | an1 | an1 | an1 | an1 | Number of SRS antenna ports |
| Note: For further information see clause 6.3.2 in TS 36.331. | | | | | |

Table A.7.1.6.1-3: drx-Configuration to be used in Test 2 of UE Transmit Timing Accuracy for SCell in sTAG for E-UTRAN FDD

| Field | Cell 1 | Cell 2 | Comment |
|--|---------|---------|---------|
| onDurationTimer | psf1 | psf1 | |
| drx-InactivityTimer | psf1 | psf1 | |
| drx-RetransmissionTimer | psf1 | psf1 | |
| longDRX-CycleStartOffset | sf80 | sf80 | |
| shortDRX | disable | disable | |
| Note: For further information see clause 6.3.2 in TS 36.331. | | | |

A.7.1.6.2 Test Requirements

For parameters specified in Tables A.7.1.6.1-1, and A.7.1.6.1-2 the initial transmit timing accuracy, the maximum amount of timing change in one adjustment, the minimum and the maximum adjustment rate for SCell in sTAG shall be within the limits defined in clause 7.1.2.

The following sequence of events shall be used to verify that the requirements are met.

For Test1 and Test2, the test sequence shall be carried out in RRC_CONNECTED for both non-DRX and DRX with a cycle length of 80 ms:

- After the SCell (Cell 2) is activated, the test system shall verify that the UE transmit timing offsets for SCell in sTAG are within $N_{TA} \times T_S \pm 12 \times T_S$ with respect to the first detected path (in time) of the corresponding downlink frame of the activated SCell.
- The test system adjusts the downlink transmit timing for the activated SCell (Cell 2) by $+64 \times T_S$ (approximately $+2\mu s$) compared to that in (a).
- The test system shall verify that for Test 1 the adjustment step size and the adjustment rate for SCell in sTAG shall be according to the requirements in clause 7.1.2 until the UE transmit timing offsets of SCell within $N_{TA} \times T_S \pm 12 \times T_S$ with respect to the first detected path (in time) of the corresponding downlink frame of the activated SCell (Cell 2). Skip this step for Test 2.
- The test system shall verify that the UE transmit timing offsets of the SCell in sTAG stay within $N_{TA} \times T_S \pm 12 \times T_S$ with respect to the first detected path (in time) of the corresponding downlink frame of the activated SCell (Cell 2).

A.7.1.7 E-UTRAN TDD - UE Transmit Timing Accuracy Tests for SCell in sTAG

A.7.1.7.1 Test Purpose and Environment

The purpose of this test is to verify that the UE is capable of following the frame timing change of the connected eNode B and that the UE initial transmit timing accuracy, maximum amount of timing change in one adjustment, minimum and maximum adjustment rate are within the specified limits for SCell in sTAG. This test will verify the requirements in clause 7.1.2.

For this test two cells are used. Cell 1 is PCell and Cell 2 is SCell. PCell is in the Primary Timing Advance Group (pTAG) and SCell is in the secondary Timing Advance Group (sTAG). Table A.7.1.7.1-1 defines the strength of the transmitted signals and the propagation condition. The transmit timing for SCell in sTAG is verified by the UE transmitting SRS using the configuration defined in Table A.7.1.7.1-2.

Table A.7.1.7.1-1: Test Parameters for UE Transmit Timing Accuracy Tests for SCell in sTAG for E-UTRAN TDD

| Parameter | Unit | Cell 1 | | Cell 2 | | | | | | |
|---|-----------|----------|---------------------|----------|---------------------|------------|-----|-----|-----|-----|
| | | Test 1 | Test 2 | Test 1 | Test 2 | | | | | |
| E-UTRA RF Channel Number | | 1 | 1 | 2 | 2 | | | | | |
| Channel Bandwidth (BW _{channel}) | MHz | 10 | 10 | 10 | 10 | | | | | |
| E-UTRA RF Channel Number | | 1 | 1 | 2 | 2 | | | | | |
| Active PCell | | Cell 1 | Cell 1 | | | | | | | |
| Active SCell | | | | Cell 2 | Cell 2 | | | | | |
| TAG configuration | | pTAG | pTAG | sTAG | sTAG | | | | | |
| Special subframe configuration ^{Note1} | | 6 | 6 | 6 | 6 | | | | | |
| Uplink-downlink configuration ^{Note2} | | 1 | 1 | 1 | 1 | | | | | |
| DRX cycle | ms | OFF | 80 ^{Note7} | OFF | 80 ^{Note7} | | | | | |
| PDCCH/PCFICH/PHICH Reference measurement channel ^{Note3} | | R.6 TDD | R.6 TDD | R.6 TDD | R.6 TDD | | | | | |
| OCNG Pattern ^{Note4} | | OP.2 TDD | OP.2 TDD | OP.2 TDD | OP.2 TDD | | | | | |
| PBCH_RA | dB | 0 | 0 | 0 | 0 | | | | | |
| PBCH_RB | | | | | | | | | | |
| PSS_RA | | | | | | | | | | |
| SSS_RA | | | | | | | | | | |
| PCFICH_RB | | | | | | | | | | |
| PHICH_RA | | | | | | | | | | |
| PHICH_RB | | | | | | | | | | |
| PDCCH_RA | | | | | | | | | | |
| PDCCH_RB | | | | | | | | | | |
| OCNG_RA ^{Note5} | | | | | | | | | | |
| OCNG_RB ^{Note5} | | | | | | | | | | |
| N_{oc} | | | | | | dBm/15 kHz | -98 | -98 | -98 | -98 |
| \hat{E}_s/I_{ot} | | | | | | dB | 3 | 3 | 3 | 3 |
| \hat{E}_s/N_{oc} | dB | 3 | 3 | 3 | 3 | | | | | |
| l_0 ^{Note6} | dBm/9 MHz | --65.5 | --65.5 | --65.5 | --65.5 | | | | | |
| Propagation condition | - | AWGN | AWGN | AWGN | AWGN | | | | | |
| Note 1: For the special subframe configuration see table 4.2-1 in TS 36.211. Note 2: For the uplink-downlink configuration see table 4.2-2 in TS 36.211. Note 3: For the reference measurement channels, see clause A.3.1. Note 4: For the OCNG pattern, see clause A.3.2. Note 5: OCNG shall be used such that both cells are fully allocated and a constant total transmitted power spectral density is achieved for all OFDM symbols. Note 6: l_0 level has been derived from other parameters for information purpose. It is not a settable parameter. Note 7: DRX related parameters are defined in Table A.7.1.7.1-3. | | | | | | | | | | |

Table A.7.1.7.1-2: Sounding Reference Symbol Configuration to be used in UE Transmit Timing Accuracy Tests for SCell in sTAG for E-UTRAN TDD

| Field | Cell 1 | | Cell 2 | | Comment |
|---------------------------|--------|--------|--------|--------|------------------------|
| | Test 1 | Test 2 | Test 1 | Test 2 | |
| srsBandwidthConfiguration | bw5 | bw5 | bw5 | bw5 | |
| srsSubframeConfiguration | sc3 | sc3 | sc3 | sc3 | Once every 5 subframes |

| | | | | | |
|--|-------|-------|-------|-------|---|
| ackNackSrsSimultaneous Transmission | FALSE | FALSE | FALSE | FALSE | |
| srsMaxUpPTS | FALSE | FALSE | FALSE | FALSE | |
| srsBandwidth | 0 | 0 | 0 | 0 | No hopping |
| srsHoppingBandwidth | hbw0 | hbw0 | hbw0 | hbw0 | |
| frequencyDomainPosition | 0 | 0 | 0 | 0 | |
| duration | TRUE | TRUE | TRUE | TRUE | Indefinite duration |
| Srs-ConfigurationIndex | 15 | 85 | 15 | 85 | SRS periodicity of 10 and 80 ms for Test 1 and 2, respectively. |
| transmissionComb | 0 | 0 | 0 | 0 | |
| cyclicShift | cs0 | cs0 | cs0 | cs0 | No cyclic shift |
| srsAntennaPort | an1 | an1 | an1 | an1 | Number of SRS antenna ports |
| Note: For further information see clause 6.3.2 in TS 36.331. | | | | | |

Table A.7.1.7.1-3: DRX Configuration to be used in Test 2 of UE Transmit Timing Accuracy for SCell in sTAG for E-UTRAN TDD

| Field | Cell 1 | Cell 2 | Comment |
|--|---------|---------|---------|
| onDurationTimer | psf1 | psf1 | |
| drx-InactivityTimer | psf1 | psf1 | |
| drx-RetransmissionTimer | psf1 | psf1 | |
| longDRX-CycleStartOffset | sf80 | sf80 | |
| shortDRX | disable | disable | |
| Note: For further information see clause 6.3.2 in TS 36.331. | | | |

A.7.1.7.2 Test Requirements

For parameters specified in Tables A.7.1.7.1-1 and A.7.1.7.1-2, the initial transmit timing accuracy, the maximum amount of timing change in one adjustment, the minimum and the maximum adjustment rate for SCell in sTAG shall be within the limits defined in clause 7.1.2.

The following sequence of events shall be used to verify that the requirements are met.

For Test 1 and Test 2, the test sequence shall be carried out in RRC_CONNECTED for both non-DRX and DRX with a cycle length of 80 ms:

- After the SCell (Cell 2) is activated, the test system shall verify that the UE transmit timing offsets for SCell in sTAG are within $(N_{TA} + 624) \times T_S \pm 12 \times T_S$ with respect to the first detected path (in time) of the corresponding downlink frame of the activated SCell (Cell 2).
- The test system adjusts the downlink transmit timing for the activated SCell (Cell 2) by $+64 \times T_S$ (approximately $+2\mu\text{s}$) compared to that in (a).
- The test system shall verify that for test 1 the adjustment step size and the adjustment rate for SCell in sTAG shall be according to the requirements in clause 7.1.2 until the UE transmit timing offsets of SCell are within $(N_{TA} + 624) \times T_S \pm 12 \times T_S$ with respect to the first detected path (in time) of the corresponding downlink frame of the activated SCell (Cell 2). Skip this step for test 2.
- The test system shall verify that the UE transmit timing offsets of the SCell in sTAG stay within $(N_{TA} + 624) \times T_S \pm 12 \times T_S$ with respect to the first detected path (in time) of the corresponding downlink frame of the activated SCell (Cell 2).

A.7.1.7A E-UTRAN TDD - UE Transmit Timing Accuracy Tests for SCell in sTAG for 20MHz +20MHz

A.7.1.7A.1 Test Purpose and Environment

The purpose of this test case is the same as for the test defined in subclause A.7.1.7. The test parameters are the same except those described in the following section. The listed parameter values in Tables A.7.1.7B.1-1 will replace the values of corresponding parameters in Tables A.7.1.7.1-1.

Table A.7.1.7A.1-1: Test Parameters for UE Transmit Timing Accuracy Tests for SCell in sTAG for E-UTRAN TDD with 20MHz +20MHz bandwidth

| Parameter | Unit | Cell 1 | | Cell 2 | |
|---|------------|----------|----------|----------|----------|
| | | Test 1 | Test 2 | Test 1 | Test 2 |
| E-UTRA RF Channel Number | | 1 | 1 | 2 | 2 |
| Channel Bandwidth ($BW_{channel}$) | MHz | 20 | 20 | 20 | 20 |
| PDCCH/PCFICH/PHICH Reference measurement channel defined in A.3.1.2.2 | | R.10 TDD | R.10 TDD | R.10 TDD | R.10 TDD |
| OCNG Pattern defined in A.3.2.2 | | OP.8 TDD | OP.8 TDD | OP.8 TDD | OP.8 TDD |
| I_{oNote1} | dBm/18 MHz | -62.5 | -62.5 | -62.5 | -62.5 |

Note 1: I_o level has been derived from other parameters for information purpose. It is not a settable parameter.

A.7.1.7A.2 Test Requirements

The test requirements defined in section A.7.1.7.2 shall apply to these test cases.

A.7.1.7B E-UTRAN TDD - UE Transmit Timing Accuracy Tests for SCell in sTAG for 20MHz +10MHz

A.7.1.7B.1 Test Purpose and Environment

The purpose of this test case is the same as for the test defined in subclause A.7.1.7. The test parameters are the same except those described in the following section. The listed parameter values in Tables A.7.1.7B.1-1 will replace the values of corresponding parameters in Tables A.7.1.7.1-1.

Table A.7.1.7B.1-1: Test Parameters for UE Transmit Timing Accuracy Tests for SCell in sTAG for E-UTRAN TDD with 20MHz +10MHz bandwidth

| Parameter | Unit | Cell 1 | | Cell 2 | |
|---|------------|----------|----------|----------|----------|
| | | Test 1 | Test 2 | Test 1 | Test 2 |
| E-UTRA RF Channel Number | | 1 | 1 | 2 | 2 |
| Channel Bandwidth ($BW_{channel}$) | MHz | 20 | 20 | 10 | 10 |
| PDCCH/PCFICH/PHICH Reference measurement channel defined in A.3.1.2.2 | | R.10 TDD | R.10 TDD | R.6 TDD | R.6 TDD |
| OCNG Pattern defined in A.3.2.2 | | OP.8 TDD | OP.8 TDD | OP.2 TDD | OP.2 TDD |
| I_{oNote1} | dBm/18 MHz | -62.5 | -62.5 | - | - |
| | dBm/9 MHz | - | - | -65.5 | -65.5 |

Note 1: I_o level has been derived from other parameters for information purpose. It is not a settable parameter.

A.7.1.7B.2 Test Requirements

The test requirements defined in section A.7.1.7.2 shall apply to these test cases.

A.7.1.8 Void

A.7.1.9 Void

A.7.1.10 E-UTRAN FDD – UE Transmit Timing Accuracy Tests for Cat-M1 UE in CEModeA

A.7.1.10.1 Test Purpose and Environment

The purpose of this test is to verify that the Cat-M1 UE in CEModeA is capable of following the frame timing change of the connected eNode B and that the UE initial transmit timing accuracy, maximum amount of timing change in one adjustment, minimum and maximum adjustment rate are within the specified limits. This test will verify the requirements in clause 7.24.2.

For this test a single cell is used. Table A.7.1.10.1-1 defines the strength of the transmitted signals and the propagation condition. The transmit timing is verified by the UE transmitting SRS using the configuration defined in Table A.7.1.10.1-2.

Table A.7.1.10.1-1: Test Parameters for UE Transmit Timing Accuracy Tests for E-UTRAN FDD Cat-M1 UE under CEModeA

| Parameter | Unit | Value | | |
|---|--------------|----------------------------------|---------------------|----------------------|
| | | Test 1 | Test 2 | Test 3 |
| E-UTRA RF Channel Number | | 1 | 1 | 1 |
| Channel Bandwidth (BW_{channel}) | MHz | 10 | 10 | 10 |
| DRX cycle | ms | N/A | 80 ^{Note5} | 640 ^{Note5} |
| PRACH Configuration | | PRACH_4CE As specified in A.3.16 | | |
| MPDCCH Reference measurement channel ^{Note1} | | R.16 FDD | R.16 FDD | R.16 FDD |
| OCNG Pattern ^{Note2} | | OP.21 FDD | OP.21 FDD | OP.21 FDD |
| PBCH_RA | dB | 0 | 0 | 0 |
| PBCH_RB | | | | |
| PSS_RA | | | | |
| SSS_RA | | | | |
| PHICH_RA | | | | |
| PHICH_RB | | | | |
| MPDCCH_RA | | | | |
| MPDCCH_RB | | | | |
| OCNG_RA ^{Note3} | | | | |
| OCNG_RB ^{Note3} | | | | |
| N_{oc} | dBm/15 kHz | -98 | -98 | -98 |
| \hat{E}_s / I_{ot} | dB | 3 | 3 | 3 |
| \hat{E}_s / N_{oc} | dB | 3 | 3 | 3 |
| I_o ^{Note4} | dBm/9 MHz | -65.5 | -65.5 | -65.5 |
| | dBm/1.08 MHz | N/A | N/A | N/A |
| Propagation condition | - | AWGN | AWGN | AWGN |
| Note 1: For the reference measurement channels, see clause A.3.1. Note 2: For the OCNG pattern, see clause A.3.2. Note 3: OCNG shall be used such that both cells are fully allocated and a constant total transmitted power spectral density is achieved for all OFDM symbols. Note 4: I_o level has been derived from other parameters for information purpose. It is not a settable parameter. Note 5: DRX related parameters are defined in Table A.7.1.10.1-3. | | | | |

Table A.7.1.10.1-2: Sounding Reference Symbol Configuration to be used in UE Transmit Timing Accuracy Tests for E-UTRAN FDD Cat-M1 UE under CEModeA

| Field | Value | | | Comment |
|--|--------|--------|--------|--|
| | Test 1 | Test 2 | Test 3 | |
| srsBandwidthConfiguration | bw5 | bw5 | bw5 | |
| srsSubframeConfiguration | sc1 | sc3 | sc3 | |
| ackNackSrsSimultaneousTransmission | FALSE | FALSE | FALSE | |
| srsMaxUpPTS | N/A | N/A | N/A | Not applicable for FDD |
| srsBandwidth | 0 | 0 | 0 | No hopping |
| srsHoppingBandwidth | hbw0 | hbw0 | hbw0 | |
| frequencyDomainPosition | 0 | 0 | 0 | |
| duration | TRUE | TRUE | TRUE | Indefinite duration |
| Srs-ConfigurationIndex | 0 | 77 | 317 | SRS periodicity of 2ms, 80 ms and 320ms for Test 1, 2 and 4, respectively. |
| transmissionComb | 0 | 0 | 0 | |
| cyclicShift | cs0 | cs0 | cs0 | No cyclic shift |
| SRS-AntennaPort | an1 | | | Number of antenna ports used for SRS transmission |
| Note 1: For further information see clause 6.3.2 in TS 36.331. | | | | |

Table A.7.1.10.1-3: drx-Configuration to be used in UE Transmit Timing Accuracy Test 2 and Test 3 for E-UTRAN FDD Cat-M1 UE under CEModeA

| Field | Value | | Comment |
|--|---------|---------|---------|
| | Test 2 | Test 3 | |
| onDurationTimer | psf1 | psf1 | |
| drx-InactivityTimer | psf1 | psf1 | |
| drx-RetransmissionTimer | psf1 | psf1 | |
| longDRX-CycleStartOffset | sf80 | sf640 | |
| shortDRX | disable | disable | |
| Note 1: For further information see clause 6.3.2 in TS 36.331. | | | |

A.7.1.10.2 Test Requirements

For parameters specified in Tables A.7.1.10.1-1 and A.7.1.10.1-2, the initial transmit timing accuracy, the maximum amount of timing change in one adjustment, the minimum and the maximum adjustment rate shall be within the limits defined in clause 7.24.2.

The following sequence of events shall be used to verify that the requirements are met.

For the 10MHz channel bandwidth, the test sequence shall be carried out in RRC_CONNECTED for both non-DRX (for Test1) and DRX with a cycle length of 80 ms or a cycle length of 640 ms (Tests 2 and 4, respectively):

- After a connection is set up with the cell, the test system shall verify that the UE transmit timing offset is within $N_{TA} \times T_S \pm 24 \times T_S$ with respect to the first detected path (in time) of the corresponding downlink frame of cell 1.
- The test system adjusts the downlink transmit timing for the cell by $+64 \times T_S$ (for Test 1 and Test 2) or $+32 \times T_S$ (for Test 3) compared to that in (a).
- The test system shall verify that for Test 1 the adjustment step size and the adjustment rate shall be according to the requirements in clause 7.24.2 until the UE transmit timing offset is within $N_{TA} \times T_S \pm 24 \times T_S$ with respect to the first detected path (in time) of the corresponding downlink frame of cell 1. Skip this step for Test 2 and Test 3.
- The test system shall verify that the UE transmit timing offset stays within $N_{TA} \times T_S \pm 24 \times T_S$ with respect to the first detected path (in time) of the corresponding downlink frame of cell 1. For test 2 and test 3 the UE transmit timing offset shall be verified for the first transmission in the DRX cycle immediately after DL timing adjustment.

A.7.1.11 E-UTRAN HD-FDD – UE Transmit Timing Accuracy Tests for Cat-M1 UE in CEModeA

A.7.1.11.1 Test Purpose and Environment

The purpose of this test is to verify that the Cat-M1 UE in CEModeA is capable of following the frame timing change of the connected eNode B and that the UE initial transmit timing accuracy, maximum amount of timing change in one adjustment, minimum and maximum adjustment rate are within the specified limits. This test will verify the requirements in clause 7.24.2.

For this test a single cell is used. Table A.7.1.11.1-1 defines the strength of the transmitted signals and the propagation condition. The transmit timing is verified by the UE transmitting SRS using the configuration defined in Table A.7.1.11.1-2.

Table A.7.1.11.1-1: Test Parameters for UE Transmit Timing Accuracy Tests for E-UTRAN HD-FDD Cat-M1 UE under CEModeA

| Parameter | Unit | Value | | |
|---|--------------|----------------------------------|---------------------|----------------------|
| | | Test 1 | Test 2 | Test 3 |
| E-UTRA RF Channel Number | | 1 | 1 | 1 |
| Channel Bandwidth ($BW_{channel}$) | MHz | 10 | 10 | 10 |
| DRX cycle | ms | N/A | 80 ^{Note5} | 640 ^{Note5} |
| PRACH configuration | | PRACH_4CE As specified in A.3.16 | | |
| MPDCCH Reference measurement channel ^{Note1} | | R.6 HD-FDD | R.6 HD-FDD | R.6 HD-FDD |
| OCNG Pattern ^{Note2} | | OP.21 FDD | OP.21 FDD | OP.21 FDD |
| PBCH_RA | dB | 0 | 0 | 0 |
| PBCH_RB | | | | |
| PSS_RA | | | | |
| SSS_RA | | | | |
| PHICH_RA | | | | |
| PHICH_RB | | | | |
| MPDCCH_RA | | | | |
| MPDCCH_RB | | | | |
| OCNG_RA ^{Note3} | | | | |
| OCNG_RB ^{Note3} | | | | |
| N_{oc} | dBm/15 kHz | -98 | -98 | -98 |
| \hat{E}_s / I_{ot} | dB | 3 | 3 | 3 |
| \hat{E}_s / N_{oc} | dB | 3 | 3 | 3 |
| I_o ^{Note4} | dBm/9 MHz | -65.5 | -65.5 | -65.5 |
| | dBm/1.08 MHz | N/A | N/A | N/A |
| Propagation condition | - | AWGN | AWGN | AWGN |
| Note 1: For the reference measurement channels, see clause A.3.1. | | | | |
| Note 2: For the OCNG pattern, see clause A.3.2. | | | | |
| Note 3: OCNG shall be used such that both cells are fully allocated and a constant total transmitted power spectral density is achieved for all OFDM symbols. | | | | |
| Note 4: I_o level has been derived from other parameters for information purpose. It is not a settable parameter. | | | | |
| Note 5: DRX related parameters are defined in Table A.7.1.11.1-3. | | | | |

Table A.7.1.11.1-2: Sounding Reference Symbol Configuration to be used in UE Transmit Timing Accuracy Tests for E-UTRAN HD-FDD Cat-M1 UE under CEModeA

| Field | Value | | | Comment |
|------------------------------------|--------|--------|--------|------------------------|
| | Test 1 | Test 2 | Test 3 | |
| srsBandwidthConfiguration | bw5 | bw5 | bw5 | |
| srsSubframeConfiguration | sc1 | sc3 | sc3 | |
| ackNackSrsSimultaneousTransmission | FALSE | FALSE | FALSE | |
| srsMaxUpPTS | N/A | N/A | N/A | Not applicable for FDD |

| | | | | |
|--|------|------|------|--|
| srsBandwidth | 0 | 0 | 0 | No hopping |
| srsHoppingBandwidth | hbw0 | hbw0 | hbw0 | |
| frequencyDomainPosition | 0 | 0 | 0 | |
| duration | TRUE | TRUE | TRUE | Indefinite duration |
| Srs-ConfigurationIndex | 7 | 77 | 317 | SRS periodicity of 10ms, 80ms and 320ms for Test 1, 2 and 3, respectively. |
| transmissionComb | 0 | 0 | 0 | |
| cyclicShift | cs0 | cs0 | cs0 | No cyclic shift |
| SRS-AntennaPort | an1 | | | Number of antenna ports used for SRS transmission |
| Note 1: For further information see clause 6.3.2 in TS 36.331. | | | | |

Table A.7.1.11.1-3: drx-Configuration to be used in UE Transmit Timing Accuracy Test 2 and Test 3 for E-UTRAN HD-FDD Cat-M1 UE under CEModeA

| Field | Value | | Comment |
|--|---------|---------|---------|
| | Test 2 | Test 3 | |
| onDurationTimer | psf1 | psf1 | |
| drx-InactivityTimer | psf1 | psf1 | |
| drx-RetransmissionTimer | psf1 | psf1 | |
| longDRX-CycleStartOffset | sf80 | sf640 | |
| shortDRX | disable | disable | |
| Note 1: For further information see clause 6.3.2 in TS 36.331. | | | |

A.7.1.11.2 Test Requirements

For parameters specified in Tables A.7.1.11.1-1 and A.7.1.11.1-2, the initial transmit timing accuracy, the maximum amount of timing change in one adjustment, the minimum and the maximum adjustment rate shall be within the limits defined in clause 7.24.2.

The following sequence of events shall be used to verify that the requirements are met.

For the 10MHz channel bandwidth, the test sequence shall be carried out in RRC_CONNECTED for both non-DRX (for Test1) and DRX with a cycle length of 80 ms or a cycle length of 640 ms (Tests 2 and 4, respectively):

- After a connection is set up with the cell, the test system shall verify that the UE transmit timing offset is within $N_{TA} \times T_S \pm 24 \times T_S$ with respect to the first detected path (in time) of the corresponding downlink frame of cell 1.
- The test system adjusts the downlink transmit timing for the cell by $+64 \times T_S$ (for Test 1 and Test 2) or $+32 \times T_S$ (for Test 3) compared to that in (a).
- The test system shall verify that for Test 1 the adjustment step size and the adjustment rate shall be according to the requirements in clause 7.24.2 until the UE transmit timing offset is within $N_{TA} \times T_S \pm 24 \times T_S$ with respect to the first detected path (in time) of the corresponding downlink frame of cell 1. Skip this step for Test 2 and Test 3.
- The test system shall verify that the UE transmit timing offset stays within $N_{TA} \times T_S \pm 24 \times T_S$ with respect to the first detected path (in time) of the corresponding downlink frame of cell 1. For test 2 and test 3 the UE transmit timing offset shall be verified for the first transmission in the DRX cycle immediately after DL timing adjustment.

A.7.1.12 E-UTRAN TDD - UE Transmit Timing Accuracy Tests for Cat-M1 UE in CEModeA

A.7.1.12.1 Test Purpose and Environment

The purpose of this test is to verify that the UE is capable of following the frame timing change of the connected eNode B and that the UE initial transmit timing accuracy, maximum amount of timing change in one adjustment, minimum and maximum adjustment rate are within the specified limits. This test will verify the requirements in clause 7.24.2.

For this test a single cell is used. Table A.7.1.12.1-1 defines the strength of the transmitted signals and the propagation condition. The transmit timing is verified by the UE transmitting SRS using the configuration defined in Table A.7.1.12.1-2.

Table A.7.1.12.1-1: Test Parameters for UE Transmit Timing Accuracy Tests for E-UTRAN TDD Cat-M1 UE under CEModeA

| Parameter | Unit | Value | | |
|--|--------------|--|---------------------|----------------------|
| | | Test 1 | Test 2 | Test 3 |
| E-UTRA RF Channel Number | | 1 | 1 | 1 |
| Channel Bandwidth (BW_{channel}) | MHz | 10 | 10 | 10 |
| Special subframe configuration ^{Note1} | | 6 | 6 | 6 |
| Uplink-downlink configuration ^{Note2} | | 1 | 1 | 1 |
| DRX cycle | ms | N/A | 80 ^{Note7} | 640 ^{Note7} |
| PRACH configuration | | PRACH ₄ CE As specified in A.3.16 | | |
| MPDCCH Reference measurement channel ^{Note3} | | R.14 TDD | R.14 TDD | R.14 TDD |
| OCNG Pattern ^{Note4} | | OP.11 TDD | OP.11 TDD | OP.11 TDD |
| PBCH_RA | dB | 0 | 0 | 0 |
| PBCH_RB | | | | |
| PSS_RA | | | | |
| SSS_RA | | | | |
| PHICH_RA | | | | |
| PHICH_RB | | 0 | 0 | 0 |
| MPDCCH_RA | | | | |
| MPDCCH_RB | | | | |
| OCNG_RA ^{Note5} | | | | |
| OCNG_RB ^{Note5} | | | | |
| N_{oc} | dBm/15 kHz | -98 | -98 | -98 |
| \hat{E}_s / I_{ot} | dB | 3 | 3 | 3 |
| \hat{E}_s / N_{oc} | dB | 3 | 3 | 3 |
| I_0 ^{Note6} | dBm/9 MHz | -65.5 | -65.5 | -65.5 |
| | dBm/1.08 MHz | N/A | N/A | N/A |
| Propagation condition | - | AWGN | AWGN | AWGN |
| Note 1: For the special subframe configuration see table 4.2-1 in TS 36.211. Note 2: For the uplink-downlink configuration see table 4.2-2 in TS 36.211. Note 3: For the reference measurement channels, see clause A.3.1. Note 4: For the OCNG pattern, see clause A.3.2. Note 5: OCNG shall be used such that both cells are fully allocated and a constant total transmitted power spectral density is achieved for all OFDM symbols. Note 6: I_0 level has been derived from other parameters for information purpose. It is not a settable parameter. Note 7: DRX related parameters are defined in Table A.7.1.12.1-3. | | | | |

Table A.7.1.12.1-2: Sounding Reference Symbol Configuration to be used in UE Transmit Timing Accuracy Tests for E-UTRAN TDD Cat-M1 UE under CEModeA

| Field | Values | | | Comment |
|------------------------------------|--------|--------|--------|---|
| | Test 1 | Test 2 | Test 3 | |
| srsBandwidthConfiguration | bw5 | bw5 | Bw5 | |
| srsSubframeConfiguration | sc3 | sc3 | sc3 | Once every 5 subframes |
| ackNackSrsSimultaneousTransmission | FALSE | FALSE | FALSE | |
| srsMaxUpPTS | FALSE | FALSE | FALSE | |
| srsBandwidth | 0 | 0 | 0 | No hopping |
| srsHoppingBandwidth | hbw0 | hbw0 | hbw0 | |
| frequencyDomainPosition | 0 | 0 | 0 | |
| Duration | TRUE | TRUE | TRUE | Indefinite duration |
| Srs-ConfigurationIndex | 15 | 85 | 325 | SRS periodicity of 10, 80, 10 and 320 ms for Test 1, 2, 3 and 4 respectively. |
| transmissionComb | 0 | 0 | 0 | |

| | | | | |
|-----------------|-----|-----|-----|---|
| cyclicShift | cs0 | cs0 | cs0 | No cyclic shift |
| SRS-AntennaPort | an1 | | | Number of antenna ports used for SRS transmission |

Table A.7.1.12.1-3: DRX Configuration to be used in UE Transmit Timing Accuracy Test 2 and Test 3 for E-UTRAN TDD Cat-M1 UE under CEModeA

| Field | Value | | Comment |
|--------------------------|--|---------|---------|
| | Test 2 | Test 3 | |
| onDurationTimer | psf1 | psf1 | |
| drx-InactivityTimer | psf1 | psf1 | |
| drx-RetransmissionTimer | psf1 | psf1 | |
| longDRX-CycleStartOffset | sf80 | Sf640 | |
| shortDRX | disable | disable | |
| Note: | For further information see clause 6.3.2 in TS 36.331. | | |

A.7.1.12.2 Test Requirements

For parameters specified in Tables A.7.1.12.1-1 and A.7.1.12.1-2, the initial transmit timing accuracy, the maximum amount of timing change in one adjustment, the minimum and the maximum adjustment rate shall be within the limits defined in clause 7.24.2.

The following sequence of events shall be used to verify that the requirements are met.

For the 10MHz channel bandwidth, the test sequence shall be carried out in RRC_CONNECTED for both non-DRX (for Test1) and DRX with a cycle length of 80 ms or a cycle length of 640 ms (Tests 2 and 4, respectively):

- After a connection is set up with the cell, the test system shall verify that the UE transmit timing offset is within $(N_{TA} + 624) \times T_S \pm 24 \times T_S$ with respect to the first detected path (in time) of the corresponding downlink frame of cell 1.
- The test system adjusts the downlink transmit timing for the cell by $+64 \times T_S$ (for Test 1 and Test 2) or $+32 \times T_S$ (for Test 3) compared to that in (a).
- The test system shall verify that for test 1 the adjustment step size and the adjustment rate shall be according to the requirements in clause 7.24.2 until the UE transmit timing offset is within $(N_{TA} + 624) \times T_S \pm 24 \times T_S$ with respect to the first detected path (in time) of the corresponding downlink frame of cell 1. Skip this step for test 2 and test 3.
- The test system shall verify that the UE transmit timing offset stays within $(N_{TA} + 624) \times T_S \pm 24 \times T_S$ with respect to the first detected path (in time) of the corresponding downlink frame of cell 1. For test 2 and test 3 the UE transmit timing offset shall be verified for the first transmission in the DRX cycle immediately after DL timing adjustment.

A.7.1.13 3DL/3UL TDD CA UE Transmit Timing Accuracy Tests for 2 SCells

A.7.1.13.1 Test Purpose and Environment

The purpose of this test is to verify that the UE is capable of following the frame timing change of the connected eNode B and that the UE initial transmit timing accuracy, maximum amount of timing change in one adjustment, minimum and maximum adjustment rate are within the specified limits for SCell in sTAG. This test will verify the requirements in clause 7.1.2.

For this test three cells are used. Cell 1 is PCell, Cell 2 is SCell1 and Cell 3 is SCell2. PCell is in the Primary Timing Advance Group (pTAG) and SCell1 and SCell2 are in the secondary Timing Advance Group (sTAG). Table A.7.1.13.1-1 defines the strength of the transmitted signals and the propagation condition. The transmit timing for SCell1 and SCell2 in sTAG is verified by the UE transmitting SRS using the configuration defined in Table A.7.1.13.1-2.

Table A.7.1.13.1-1: Test Parameters for UE Transmit Timing Accuracy Tests for SCell1 and SCell2 in sTAG for 3DL/3UL TDD CAE-UTRAN TDD

| Parameter | Unit | Cell 1 | | Cell 2 | | Cell 3 | |
|--|--------------|--------------------------------|--------------------------------|--------------------------------|--------------------------------|--------------------------------|--------------------------------|
| | | Test 1 | Test 2 | Test 1 | Test 2 | Test 1 | Test 2 |
| E-UTRA RF Channel Number | | 1 | 1 | 2 | 2 | 3 | 3 |
| Channel Bandwidth (BW _{channel}) | MHz | 5, 10, 20 | 5, 10, 20 | 5, 10, 20 | 5, 10, 20 | 5, 10, 20 | 5, 10, 20 |
| Active PCell | | Cell 1 | Cell 1 | | | | |
| Active SCell | | | | Cell 2 | Cell 2 | Cell 3 | Cell 3 |
| TAG configuration | | pTAG | pTAG | sTAG | sTAG | sTAG | sTAG |
| Special subframe configuration ^{Note1} | | 6 | 6 | 6 | 6 | 6 | 6 |
| Uplink-downlink configuration ^{Note2} | | 1 | 1 | 1 | 1 | 1 | 1 |
| DRX cycle | ms | OFF | 80 ^{Note7} | OFF | 80 ^{Note7} | OFF | 80 ^{Note7} |
| PDCCH/PCFICH/PHICH Reference measurement channel ^{Note3} | | R.11 TDD , R.6 TDD, R.10 TDD | R.11 TDD , R.6 TDD, R.10 TDD | R.11 TDD , R.6 TDD, R.10 TDD | R.11 TDD , R.6 TDD, R.10 TDD | R.11 TDD , R.6 TDD, R.10 TDD | R.11 TDD , R.6 TDD, R.10 TDD |
| OCNG Pattern ^{Note4} | | OP.10 TDD , OP.2 TDD, OP.8 TDD | OP.10 TDD , OP.2 TDD, OP.8 TDD | OP.10 TDD , OP.2 TDD, OP.8 TDD | OP.10 TDD , OP.2 TDD, OP.8 TDD | OP.10 TDD , OP.2 TDD, OP.8 TDD | OP.10 TDD , OP.2 TDD, OP.8 TDD |
| PBCH_RA | dB | 0 | 0 | 0 | 0 | 0 | 0 |
| PBCH_RB | | | | | | | |
| PSS_RA | | | | | | | |
| SSS_RA | | | | | | | |
| PCFICH_RB | | | | | | | |
| PHICH_RA | | | | | | | |
| PHICH_RB | | | | | | | |
| PDCCH_RA | | | | | | | |
| PDCCH_RB | | | | | | | |
| OCNG_RA ^{Note5} | | | | | | | |
| OCNG_RB ^{Note5} | | | | | | | |
| N_{oc} | | | | | | | |
| \hat{E}_s / I_{ot} | dB | 3 | 3 | 3 | 3 | 3 | 3 |
| \hat{E}_s / N_{oc} | dB | 3 | 3 | 3 | 3 | 3 | 3 |
| I_o ^{Note6} | dBm/ 4.5 MHz | -68.5 | -68.5 | -68.5 | -68.5 | -68.5 | -68.5 |
| | dBm/ 9 MHz | --65.5 | --65.5 | --65.5 | --65.5 | --65.5 | --65.5 |
| | dBm/ 18MHz | -62.4 | -62.4 | -62.4 | -62.4 | -62.4 | -62.4 |
| Timing offset to Cell 1 | μs | - | - | 0 | 0 | 0 | 0 |
| Time alignment error relative to cell 1 ^{Note 8} | μs | - | - | ≤ TAE | ≤ TAE | ≤ TAE | ≤ TAE |
| Propagation condition | - | AWGN | AWGN | AWGN | AWGN | AWGN | AWGN |
| <p>Note 1: For the special subframe configuration see table 4.2-1 in TS 36.211.</p> <p>Note 2: For the uplink-downlink configuration see table 4.2-2 in TS 36.211.</p> <p>Note 3: For the reference measurement channels, see clause A.3.1.</p> <p>Note 4: For the OCNG pattern, see clause A.3.2.</p> <p>Note 5: OCNG shall be used such that both cells are fully allocated and a constant total transmitted power spectral density is achieved for all OFDM symbols.</p> <p>Note 6: I_o level has been derived from other parameters for information purpose. It is not a settable parameter.</p> <p>Note 7: DRX related parameters are defined in Table A.7.1.x.1-3.</p> <p>Note 8: Time alignment error (TAE) as specified in TS 36.104 [30] clause 6.5.3.1. The TAE value depends upon the type of carrier aggregation.</p> | | | | | | | |

Table A.7.1.13.1-2: Sounding Reference Symbol Configuration to be used in UE Transmit Timing Accuracy Tests for SCell1 and SCell2 in sTAG for 3DL/3UL TDD CA

| Field | Cell 1 | | Cell 2 | | Cell 3 | | Comment |
|--|--------|--------|--------|--------|--------|--------|---|
| | Test 1 | Test 2 | Test 1 | Test 2 | Test 1 | Test 2 | |
| srsBandwidthConfiguration | bw5 | bw5 | bw5 | bw5 | bw5 | bw5 | |
| srsSubframeConfiguration | sc3 | sc3 | sc3 | sc3 | sc3 | sc3 | Once every 5 subframes |
| ackNackSrsSimultaneousTransmission | FALSE | FALSE | FALSE | FALSE | FALSE | FALSE | |
| srsMaxUpPTS | FALSE | FALSE | FALSE | FALSE | FALSE | FALSE | |
| srsBandwidth | 0 | 0 | 0 | 0 | 0 | 0 | No hopping |
| srsHoppingBandwidth | hbw0 | hbw0 | hbw0 | hbw0 | hbw0 | hbw0 | |
| frequencyDomainPosition | 0 | 0 | 0 | 0 | 0 | 0 | |
| duration | TRUE | TRUE | TRUE | TRUE | TRUE | TRUE | Indefinite duration |
| Srs-ConfigurationIndex | 15 | 85 | 15 | 85 | 15 | 85 | SRS periodicity of 10 and 80 ms for Test 1 and 2, respectively. |
| transmissionComb | 0 | 0 | 0 | 0 | 0 | 0 | |
| cyclicShift | cs0 | cs0 | cs0 | cs0 | cs0 | cs0 | No cyclic shift |
| srsAntennaPort | an1 | an1 | an1 | an1 | an1 | an1 | Number of SRS antenna ports |
| Note 1: For further information see clause 6.3.2 in TS 36.331. | | | | | | | |

Table A.7.1.13.1-3: DRX Configuration to be used in Test 2 of UE Transmit Timing Accuracy for SCell1 and SCell2 in sTAG for 3DL/3UL TDD CA

| Field | Cell 1 | Cell 2 | Cell 3 | Comment |
|--|---------|---------|---------|---------|
| onDurationTimer | psf1 | psf1 | psf1 | |
| drx-InactivityTimer | psf1 | psf1 | psf1 | |
| drx-RetransmissionTimer | psf1 | psf1 | psf1 | |
| longDRX-CycleStartOffset | sf80 | sf80 | sf80 | |
| shortDRX | disable | disable | Disable | |
| Note 1: For further information see clause 6.3.2 in TS 36.331. | | | | |

A.7.1.13.2 Test Requirements

For parameters specified in Tables A.7.1.13.1-1, 7.1.8.1-2 and A.7.1.13.1-3, the initial transmit timing accuracy, the maximum amount of timing change in one adjustment, the minimum and the maximum adjustment rate for SCell1 and SCell2 in sTAG shall be within the limits defined in clause 7.1.2.

The following sequence of events shall be used to verify that the requirements are met.

For Test 1 and Test 2, the test sequence shall be carried out in RRC_CONNECTED for both non-DRX and DRX with a cycle length of 80 ms:

- After the SCell1 (Cell 2) and SCell2 (Cell3) are activated, the test system shall verify that the UE transmit timing offsets for SCell1 and SCell2 in sTAG are within $(N_{TA} + 624) \times T_{S \pm} \pm 12 \times T_S$ with respect to the first detected path (in time) of the corresponding downlink frame of the activated SCell1 (Cell 2) or SCell2 (Cell3).
- The test system adjusts the downlink transmit timing for the activated SCell1 (Cell 2) and SCell2 (Cell3) by $+64 \times T_S$ (approximately $+2\mu s$) compared to that in (a).
- The test system shall verify that for test 1 the adjustment step size and the adjustment rate for SCell1 and SCell2 in sTAG shall be according to the requirements in clause 7.1.2 until the UE transmit timing offsets of SCell1 and SCell2 are within $(N_{TA} + 624) \times T_{S \pm} \pm 12 \times T_S$ with respect to the first detected path (in time) of the corresponding downlink frame of the activated SCell1 (Cell 2) or SCell2 (Cell3). Skip this step for test 2.
- The test system shall verify that the UE transmit timing offsets of the SCell1 and SCell2 in sTAG stay within $(N_{TA} + 624) \times T_{S \pm} \pm 12 \times T_S$ with respect to the first detected path (in time) of the corresponding downlink frame of the activated SCell1 (Cell 2) or SCell2 (Cell3).

A.7.1.14 E-UTRAN FDD – UE Transmit Timing Accuracy Tests for Cat-M1 UE in CEModeB

A.7.1.14.1 Test Purpose and Environment

The purpose of this test is to verify that the Cat-M1 UE in CEModeB is capable of following the frame timing change of the connected eNode B and that the UE initial transmit timing accuracy, maximum amount of timing change in one adjustment, minimum and maximum adjustment rate are within the specified limits. This test will verify the requirements in clause 7.24.2.

As specified in Clause 7.24.2 the UE adjusts its uplink timing at the end of of repetition period when configured with repetitions. By measuring the reception of the PUSCH, the transmit timing accuracy can be measured and the requirements can be verified. For this test a single cell is used. Table A.7.1.14.1-1 defines the strength of the transmitted signals and the propagation condition.

Table A.7.1.14.1-1: Test Parameters for UE Transmit Timing Accuracy Tests for E-UTRAN FDD Cat-M1 UE under CEModeB

| Parameter | Unit | Value | | |
|---|--------------|-----------|---------------------|----------------------|
| | | Test 1 | Test 2 | Test 3 |
| E-UTRA RF Channel Number | | 1 | 1 | 1 |
| Channel Bandwidth (BW _{channel}) | MHz | 10 | 10 | 10 |
| DRX cycle | ms | N/A | 80 ^{Note5} | 640 ^{Note5} |
| MPDCCH Reference measurement channel ^{Note1} | | R.18 FDD | R.18 FDD | R.18 FDD |
| OCNG Pattern ^{Note2} | | OP.21 FDD | OP.21 FDD | OP.21 FDD |
| Number of repetitions | MPDCCH | 128 | | |
| | PUSCH | 32 | | |
| PBCH_RA | dB | 0 | 0 | 0 |
| PBCH_RB | | | | |
| PSS_RA | | | | |
| SSS_RA | | | | |
| PHICH_RA | | | | |
| PHICH_RB | | | | |
| MPDCCH_RA | | | | |
| MPDCCH_RB | | | | |
| OCNG_RA ^{Note3} | | | | |
| OCNG_RB ^{Note3} | | | | |
| N_{oc} | | | | |
| \hat{E}_s / I_{ot} | dB | -12 | -12 | -12 |
| \hat{E}_s / N_{oc} | dB | -12 | -12 | -12 |
| I_o ^{Note4} | dBm/9 MHz | -86.4 | -86.4 | -86.4 |
| | dBm/1.08 MHz | N/A | N/A | N/A |
| Propagation condition | - | AWGN | AWGN | AWGN |
| Note 1: For the reference measurement channels, see clause A.3.1. | | | | |
| Note 2: For the OCNG pattern, see clause A.3.2. | | | | |
| Note 3: OCNG shall be used such that both cells are fully allocated and a constant total transmitted power spectral density is achieved for all OFDM symbols. | | | | |
| Note 4: I_o level has been derived from other parameters for information purpose. It is not a settable parameter. | | | | |
| Note 5: DRX related parameters are defined in Table A.7.1.14.1-2. | | | | |

Table A.7.1.14.1-2: drx-Configuration to be used in UE Transmit Timing Accuracy Test 2 and Test 3 for E-UTRAN FDD Cat-M1 UE under CEModeB

| Field | Value | | Comment |
|-------|--------|--------|---------|
| | Test 2 | Test 3 | |

| | | | |
|--|---------|---------|--|
| onDurationTimer | psf1 | psf1 | |
| drx-InactivityTimer | psf1 | psf1 | |
| drx-RetransmissionTimer | psf1 | psf1 | |
| longDRX-CycleStartOffset | sf80 | sf640 | |
| shortDRX | disable | disable | |
| Note: For further information see clause 6.3.2 in TS 36.331. | | | |

A.7.1.14.2 Test Requirements

For parameters specified in Tables A.7.1.14.1-1 and A.7.1.14.1-2, the initial transmit timing accuracy, the maximum amount of timing change in one adjustment, the minimum and the maximum adjustment rate shall be within the limits defined in clause 7.24.2. The UE shall not adjust the the transmission timing autonomously during an ongoing repetition period. Adjustments can only be done at the end of a last subframe in a repetition period.

The following sequence of events shall be used to verify that the requirements are met.

For the 10MHz channel bandwidth, the test sequence shall be carried out in RRC_CONNECTED for both non-DRX (for Test1) and DRX with a cycle length of 80 ms or a cycle length of 640 ms (Tests 2 and 3, respectively):

- After a connection is set up with the cell, the test system shall verify that the UE transmit timing offset is within $N_{TA} \times T_S \pm 48 \times T_S$ with respect to the first detected path (in time) of the corresponding downlink frame of cell 1.
- The test system adjusts the downlink transmit timing for the cell by $+64 \times T_S$ (for Test 1 and Test 2) or $+32 \times T_S$ (for Test 3) compared to that in (a).
- The test system shall verify that for Test 1 the adjustment step size and the adjustment rate shall be according to the requirements in clause 7.24.2 until the UE transmit timing offset is within $N_{TA} \times T_S \pm 48 \times T_S$ with respect to the first detected path (in time) of the corresponding downlink frame of cell 1. Skip this step for Test 2 and Test 3.
- The test system shall verify that the UE transmit timing offset stays within $N_{TA} \times T_S \pm 48 \times T_S$ with respect to the first detected path (in time) of the corresponding downlink frame of cell 1. For test 2 and test 3 the UE transmit timing offset shall be verified for the first transmission in the DRX cycle immediately after DL timing adjustment.

A.7.1.15 E-UTRAN HD-FDD – UE Transmit Timing Accuracy Tests for Cat-M1 UE in CEModeB

A.7.1.15.1 Test Purpose and Environment

The purpose of this test is to verify that the Cat-M1 UE in CEModeB is capable of following the frame timing change of the connected eNode B and that the UE initial transmit timing accuracy, maximum amount of timing change in one adjustment, minimum and maximum adjustment rate are within the specified limits. This test will verify the requirements in clause 7.24.2.

As specified in Clause 7.24.2 the UE adjusts its uplink timing at the end of of repetition period when configured with repetitions. By measuring the reception of the PUSCH, the transmit timing accuracy can be measured and the requirements can be verified. For this test a single cell is used. Table A.7.1.15.1-1 defines the strength of the transmitted signals and the propagation condition.

Table A.7.1.15.1-1: Test Parameters for UE Transmit Timing Accuracy Tests for E-UTRAN HD-FDD Cat-M1 UE under CEModeB

| Parameter | Unit | Value | | |
|---|------|------------|---------------------|----------------------|
| | | Test 1 | Test 2 | Test 3 |
| E-UTRA RF Channel Number | | 1 | 1 | 1 |
| Channel Bandwidth ($BW_{channel}$) | MHz | 10 | 10 | 10 |
| DRX cycle | ms | N/A | 80 ^{Note5} | 640 ^{Note5} |
| MPDCCH Reference measurement channel ^{Note1} | | R.6 HD-FDD | R.6 HD-FDD | R. 6 HD-FDD |

| OCNG Pattern ^{Note2} | | | OP.21 FDD | OP.21 FDD | OP.21 FDD |
|---|--------|--------------|-----------|-----------|-----------|
| Number of repetitions | MPDDCH | | 128 | | |
| | PUSCH | | 32 | | |
| PBCH_RA | | dB | 0 | 0 | 0 |
| PBCH_RB | | | | | |
| PSS_RA | | | | | |
| SSS_RA | | | | | |
| PHICH_RA | | | | | |
| PHICH_RB | | | | | |
| MPDCCH_RA | | | | | |
| MPDCCH_RB | | | | | |
| OCNG_RA ^{Note3} | | | | | |
| OCNG_RB ^{Note3} | | | | | |
| N_{oc} | | dBm/15 kHz | -98 | -98 | -98 |
| \hat{E}_s / I_{ot} | | dB | -12 | -12 | -12 |
| \hat{E}_s / N_{oc} | | dB | -12 | -12 | -12 |
| I_o ^{Note4} | | dBm/9 MHz | -86.4 | -86.4 | -86.4 |
| | | dBm/1.08 MHz | N/A | N/A | N/A |
| Propagation condition | | - | AWGN | AWGN | AWGN |
| Note 1: For the reference measurement channels, see clause A.3.1. | | | | | |
| Note 2: For the OCNG pattern, see clause A.3.2. | | | | | |
| Note 3: OCNG shall be used such that both cells are fully allocated and a constant total transmitted power spectral density is achieved for all OFDM symbols. | | | | | |
| Note 4: I_o level has been derived from other parameters for information purpose. It is not a settable parameter. | | | | | |
| Note 5: DRX related parameters are defined in Table A.7.1.15.1-2. | | | | | |

Table A.7.1.15.1-3: drx-Configuration to be used in UE Transmit Timing Accuracy Test 2 and Test 3 for E-UTRAN HD-FDD Cat-M1 UE under CEModeB

| Field | Value | | Comment |
|--|---------|---------|---------|
| | Test 2 | Test 3 | |
| onDurationTimer | psf1 | psf1 | |
| drx-InactivityTimer | psf1 | psf1 | |
| drx-RetransmissionTimer | psf1 | psf1 | |
| longDRX-CycleStartOffset | sf80 | sf640 | |
| shortDRX | disable | disable | |
| Note: For further information see clause 6.3.2 in TS 36.331. | | | |

A.7.1.15.2 Test Requirements

For parameters specified in Tables A.7.1.15.1-1 and A.7.1.15.1-2, the initial transmit timing accuracy, the maximum amount of timing change in one adjustment, the minimum and the maximum adjustment rate shall be within the limits defined in clause 7.24.2. The UE shall not adjust the the transmission timing autonomously during an ongoing repetition period. Adjustments can only be done at the end of a last subframe in a repetition period.

The following sequence of events shall be used to verify that the requirements are met.

For the 10MHz channel bandwidth, the test sequence shall be carried out in RRC_CONNECTED for both non-DRX (for Test1) and DRX with a cycle length of 80 ms or a cycle length of 640 ms (Tests 2 and 3, respectively):

- After a connection is set up with the cell, the test system shall verify that the UE transmit timing offset is within $N_{TA} \times T_S \pm 48 \times T_S$ with respect to the first detected path (in time) of the corresponding downlink frame of cell 1.
- The test system adjusts the downlink transmit timing for the cell by $+64 \times T_S$ (for Test 1 and Test 2) or $+32 \times T_S$ (for Test 3) compared to that in (a).
- The test system shall verify that for Test 1 the adjustment step size and the adjustment rate shall be according to the requirements in clause 7.24.2 until the UE transmit timing offset is within $N_{TA} \times T_S \pm 48 \times T_S$ with respect to

the first detected path (in time) of the corresponding downlink frame of cell 1. Skip this step for Test 2 and Test 3.

- d) The test system shall verify that the UE transmit timing offset stays within $N_{TA} \times T_S \pm 48 \times T_S$ with respect to the first detected path (in time) of the corresponding downlink frame of cell 1. For test 2 and test 3 the UE transmit timing offset shall be verified for the first transmission in the DRX cycle immediately after DL timing adjustment.

A.7.1.16 E-UTRAN TDD - UE Transmit Timing Accuracy Tests for Cat-M1 UE in CEModeB

A.7.1.16.1 Test Purpose and Environment

The purpose of this test is to verify that the Cat-M1 UE in CEModeB is capable of following the frame timing change of the connected eNode B and that the UE initial transmit timing accuracy, maximum amount of timing change in one adjustment, minimum and maximum adjustment rate are within the specified limits. This test will verify the requirements in clause 7.24.2.

As specified in Clause 7.24.2 the UE adjusts its uplink timing at the end of of repetition period when configured with repetitions. By measuring the reception of the PUSCH, the transmit timing accuracy can be measured and the requirements can be verified. For this test a single cell is used. Table A.7.1.16.1-1 defines the strength of the transmitted signals and the propagation condition.

Table A.7.1.16.1-1: Test Parameters for UE Transmit Timing Accuracy Tests for E-UTRAN TDD Cat-M1 UE under CEModeB

| Parameter | | Unit | Value | | |
|---|--------|--------------|-----------|---------------------|----------------------|
| | | | Test 1 | Test 2 | Test 3 |
| E-UTRA RF Channel Number | | | 1 | 1 | 1 |
| Channel Bandwidth ($BW_{channel}$) | | MHz | 10 | 10 | 10 |
| Special subframe configuration ^{Note1} | | | 6 | 6 | 6 |
| Uplink-downlink configuration ^{Note2} | | | 1 | 1 | 1 |
| DRX cycle | | ms | N/A | 80 ^{Note7} | 640 ^{Note7} |
| MPDCCH Reference measurement channel ^{Note3} | | | R.14 TDD | R.14 TDD | R.14 TDD |
| OCNG Pattern ^{Note4} | | | OP.11 TDD | OP.11 TDD | OP.11 TDD |
| PBCH_RA | | dB | 0 | 0 | 0 |
| Number of repetitions | MPDCCH | | 128 | | |
| | PUSCH | | 32 | | |
| PBCH_RB | | | 0 | 0 | 0 |
| PSS_RA | | | | | |
| SSS_RA | | | | | |
| PHICH_RA | | | | | |
| PHICH_RB | | | | | |
| MPDCCH_RA | | | | | |
| MPDCCH_RB | | | | | |
| OCNG_RA ^{Note5} | | | | | |
| OCNG_RB ^{Note5} | | | | | |
| N_{oc} | | dBm/15 kHz | | | |
| \hat{E}_s / I_{ot} | | dB | -12 | -12 | -12 |
| \hat{E}_s / N_{oc} | | dB | -12 | -12 | -12 |
| I_o ^{Note6} | | dBm/9 MHz | -86.4 | -86.4 | -86.4 |
| | | dBm/1.08 MHz | N/A | N/A | N/A |
| Propagation condition | | - | AWGN | AWGN | AWGN |
| Note 1: For the special subframe configuration see table 4.2-1 in TS 36.211. | | | | | |
| Note 2: For the uplink-downlink configuration see table 4.2-2 in TS 36.211. | | | | | |
| Note 3: For the reference measurement channels, see clause A.3.1. | | | | | |
| Note 4: For the OCNG pattern, see clause A.3.2. | | | | | |
| Note 5: OCNG shall be used such that both cells are fully allocated and a constant total transmitted power spectral | | | | | |

density is achieved for all OFDM symbols.

Note 6: Io level has been derived from other parameters for information purpose. It is not a settable parameter.

Note 7: DRX related parameters are defined in Table A.7.1.16.1-2.

Table A.7.1.16.1-2: DRX Configuration to be used in UE Transmit Timing Accuracy Test 2 and Test 3 for E-UTRAN TDD Cat-M1 UE under CEModeB

| Field | Value | | Comment |
|--------------------------|--|---------|---------|
| | Test 2 | Test 3 | |
| onDurationTimer | psf1 | psf1 | |
| drx-InactivityTimer | psf1 | psf1 | |
| drx-RetransmissionTimer | psf1 | psf1 | |
| longDRX-CycleStartOffset | sf80 | Sf640 | |
| shortDRX | disable | disable | |
| Note: | For further information see clause 6.3.2 in TS 36.331. | | |

A.7.1.16.2 Test Requirements

For parameters specified in Tables A.7.1.16.1-1 and A.7.1.16.1-2, the initial transmit timing accuracy, the maximum amount of timing change in one adjustment, the minimum and the maximum adjustment rate shall be within the limits defined in clause 7.24.2. The UE shall not adjust the the transmission timing autonomously during an ongoing repetition period. Adjustments can only be done at the end of a last subframe in a repetition period.

The following sequence of events shall be used to verify that the requirements are met.

For the 10MHz channel bandwidth, the test sequence shall be carried out in RRC_CONNECTED for both non-DRX (for Test1) and DRX with a cycle length of 80 ms or a cycle length of 640 ms (Tests 2 and 3, respectively):

- After a connection is set up with the cell, the test system shall verify that the UE transmit timing offset is within $N_{TA} \times T_S \pm 48 \times T_S$ with respect to the first detected path (in time) of the corresponding downlink frame of cell 1.
- The test system adjusts the downlink transmit timing for the cell by $+64 \times T_S$ (for Test 1 and Test 2) or $+32 \times T_S$ (for Test 3) compared to that in (a).
- The test system shall verify that for Test 1 the adjustment step size and the adjustment rate shall be according to the requirements in clause 7.24.2 until the UE transmit timing offset is within $N_{TA} \times T_S \pm 48 \times T_S$ with respect to the first detected path (in time) of the corresponding downlink frame of cell 1. Skip this step for Test 2 and Test 3.
- The test system shall verify that the UE transmit timing offset stays within $N_{TA} \times T_S \pm 48 \times T_S$ with respect to the first detected path (in time) of the corresponding downlink frame of cell 1. For test 2 and test 3 the UE transmit timing offset shall be verified for the first transmission in the DRX cycle immediately after DL timing adjustment.

A.7.1.17 E-UTRAN HD-FDD – UE Transmit Timing Accuracy Tests for Category NB1 UE In-Band mode under normal coverage

A.7.1.17.1 Test Purpose and Environment

The purpose of this test is to verify that the Category NB1 UE under normal coverage is capable of following the frame timing change of the connected eNode B and that the UE initial transmit timing accuracy, maximum amount of timing change in one adjustment, minimum and maximum adjustment rate are within the specified limits. This test will verify the requirements in clause 7.20.

For this test a single NB-IoT cell and a single LTE cell are used. Test parameters are given in Table A.7.1.17.1-1, Table A.7.1.17.1-2, and Table A.7.1.17.1-3. The transmit timing is verified by the UE transmitting NPUSCH.

Table A.7.1.17.1-1: General Test Parameters for UE Transmit Timing Accuracy Tests for E-UTRAN HD-FDD Category NB1 UE in In-Band mode under normal coverage

| Parameter | Unit | Value |
|--|------|------------------------|
| | | Test 1 |
| NB-IoT Operation mode | | In-band |
| DRX | | OFF |
| NPRACH configuration | | As specified in A.3.18 |
| NPDCCH repetition level | | 1 |
| npdcch-StartSF-USS ^{Note 1} | | v8 |
| npdcch-NumRepetitions-r13 ^{Note 1} | | r1 |
| NPUSCH repetition level | | 1 |
| Note 1: For further information see clause 6.7.3.2 in TS 36.331 [2]. | | |

Table A.7.1.17.1-2: nCell specific Test Parameters for UE Transmit Timing Accuracy Tests for E-UTRAN HD-FDD Category NB1 UE in In-Band mode under normal coverage

| Parameter | Unit | Value |
|---|------------|---------------------------------|
| | | Test 1 |
| RF Channel Number | | 1 |
| $BW_{channel}$ | kHz | 200 |
| PRB location within eCell | | 30 |
| NPDSCH parameter | | R.15 HD-FDD |
| NPDCCH parameter | | R.29 HD-FDD |
| NPBCH_RA | dB | -3 |
| NPBCH_RB | | |
| NPSS_RA | | |
| NSSS_RA | | |
| NPDCCH_RA | | |
| NPDCCH_RB | | |
| NPDSCH_RA | | |
| NPDSCH_RB | | |
| NOCNG_RA ^{Note1} | | |
| NOCNG_RB ^{Note1} | | |
| N_{oc} | dBm/15 kHz | Specified in Table A.7.1.17.1-3 |
| \hat{E}_s/I_{ot} | dB | 4 |
| \hat{E}_s/N_{oc} | dB | 4 |
| Antenna Configuration | | 2x1 |
| Propagation condition | - | AWGN |
| Note 1: NOCNG shall be used such that the cell is fully allocated and a constant total transmitted power spectral density is achieved for all OFDM symbols. | | |

Table A.7.1.17.1-3: eCell specific Test Parameters for UE Transmit Timing Accuracy Tests for E-UTRAN HD-FDD Category NB1 UE in In-Band mode under normal coverage

| Parameter | Unit | Value |
|--------------------------|------|-----------|
| | | Test 1 |
| E-UTRA RF Channel Number | | 1 |
| $BW_{channel}$ | MHz | 10 |
| NOCNG Pattern | - | NOP.1 FDD |
| PBCH_RA | dB | -3 |
| PBCH_RB | | |
| PSS_RA | | |
| SSS_RA | | |
| PCFICH_RB | | |
| PHICH_RA | | |
| PHICH_RB | | |
| PDCCH_RA | | |

| | | |
|--|------------|------|
| PDCCH_RB | | |
| OCNG_RA ^{Note1} | | |
| OCNG_RB ^{Note1} | | |
| N_{oc} | dBm/15 kHz | -98 |
| \hat{E}_s/N_{oc} | dB | 4 |
| Antenna configuration | | 2x1 |
| Propagation condition | - | AWGN |
| Note 1: OCNG shall be used such that the cell is fully allocated and a constant total transmitted power spectral density is achieved for all OFDM symbols. | | |

A.7.1.17.2 Test Requirements

For parameters specified in Tables A.7.1.17.1-1, A.7.1.17.1-2, and A.7.1.17.1-3, the initial transmit timing accuracy, the maximum amount of timing change in one adjustment, the minimum and the maximum adjustment rate shall be within the limits defined in clause 7.20.2.

The following sequence of events shall be used to verify that the requirements are met.

The test sequence shall be carried out in RRC_CONNECTED:

- a) After a connection is set up with the cell, the test system sends NPDCCH including uplink grant for NPUSCH transmission and the test system shall measure the UE transmit timing offset ($n \times T_s$) and verify that it is within T_e . ($n \times T_s \leq N_{TA} \times T_s \pm 80 \times T_s$) with respect to the first detected path (in time) of the corresponding downlink frame of NB-IoT cell 1.
- b) Using the value of n measured in a), the test system adjusts the downlink transmit timing for the cell:
 - if $n < 0$, by $+(144 - |n|) \times T_s$ compared to that in (a).
 - if $n \geq 0$, by $-(144 - |n|) \times T_s$ compared to that in (a).

The timing adjustment is performed monotonically in multiple steps of $|\Delta T| \leq 9 \times T_s$ per 256 ms (ΔT is to be defined in the test procedure) until the above required total timing change is achieved, during which no grant is transmitted for the UE.

- c) Immediately after (b), the test system sends NPDCCH including uplink grant for NPUSCH transmission and immediately after receiving NPUSCH the test system repeatedly sends NPDCCH including uplink grant for NPUSCH transmission until the UE transmit timing offset is within $N_{TA} \times T_s \pm 80 \times T_s$ with respect to the first detected path (in time) of the corresponding downlink frame of cell 1. The test system shall verify that the difference in timing between the first NPUSCH transmission in step c) and the NPUSCH transmission in step a) shall be not greater than the maximum amount of the magnitude of the timing change in one adjustment requirement in clause 7.20.2. Using the first NPUSCH transmission in step c) and subsequent NPUSCH transmissions, the test system shall verify that the adjustment step size and the adjustment rate shall be according to the requirements in clause 7.20.2 until the UE transmit timing offset is within $N_{TA} \times T_s \pm 80 \times T_s$ with respect to the first detected path (in time) of the corresponding downlink frame of cell 1.
- d) The test system the test system sends NPDCCH including uplink grant for NPUSCH transmission and shall verify that the UE transmit timing offset stays within $N_{TA} \times T_s \pm 80 \times T_s$ with respect to the first detected path (in time) of the corresponding downlink frame of NB-IoT cell 1.

A.7.1.18 E-UTRAN HD-FDD – UE Transmit Timing Accuracy Tests for Category NB1 UE In-band mode under enhanced coverage

A.7.1.18.1 Test Purpose and Environment

The purpose of this test is to verify that the Category NB1 UE under enhanced coverage is capable of following the frame timing change of the connected eNode B, that the UE initial transmit timing accuracy is within the specified

limits and that the UE shall not adjust the uplink transmission timing autonomously during an ongoing repetition period other than at initial transmission. This test will verify the requirements in clause 7.20.

For this test a single NB-IoT cell and a single LTE cell are used. Test parameters are given in Table A.7.1.18.1-1, Table A.7.1.18.1-2, Table A.7.1.18.1-3, and Table A.7.1.18.1-4. The transmit timing is verified by the UE transmitting NPUSCH.

Table A.7.1.18.1-1: General Test Parameters for UE Transmit Timing Accuracy Tests for E-UTRAN HD-FDD Category NB1 UE in In-Band mode under enhanced coverage

| Parameter | Unit | Value | |
|--|------|------------------------|--------------|
| | | Test 1 | Test 2 |
| NB-IoT Operation mode | | In-band | In-band |
| DRX | | OFF | ON |
| NPRACH configuration | | As specified in A.3.18 | |
| NPDCCH repetition level | | 32 | 32 |
| npdcch-StartSF-USS ^{Note 2} | | v2 | v2 |
| npdcch-NumRepetitions-r13 ^{Note 2} | | r32 | r32 |
| NPUSCH resource units | | 1 | 1 |
| NPUSCH repetition level | | 128 | 128 |
| NPUSCH subcarrier spacing | kHz | 15 | 15 |
| NPUSCH number of subcarriers | | 1 | 1 |
| NPUSCH modulation | | $\pi/4$ QPSK | $\pi/4$ QPSK |
| NPUSCH Transport block size | Bits | 40 | 40 |
| Note 1: DRX related parameters are defined in Table A.7.1.18.1-4. | | | |
| Note 2: For further information see clause 6.7.3.2 in TS 36.331 [2]. | | | |

Table A.7.1.18.1-2: nCell specific Test Parameters for UE Transmit Timing Accuracy Tests for E-UTRAN HD-FDD Category NB1 UE in In-Band mode under enhanced coverage

| Parameter | Unit | Value | |
|---|------------|---------------------------------|---------------------------------|
| | | Test 1 | Test 2 |
| RF Channel Number | | 1 | 1 |
| $BW_{channel}$ | kHz | 200 | 200 |
| PRB location within eCell | | 30 | 30 |
| NPDSCH parameter | | R.17 HD-FDD | R.17 HD-FDD |
| NPDCCH parameter | | R.29 HD-FDD | R.29 HD-FDD |
| NPBCH_RA | dB | -3 | -3 |
| NPBCH_RB | | | |
| NPSS_RA | | | |
| NSSS_RA | | | |
| NPDCCH_RA | | | |
| NPDCCH_RB | | | |
| NPDSCH_RA | | | |
| NPDSCH_RB | | | |
| NOCNG_RA ^{Note1} | | | |
| NOCNG_RB ^{Note1} | | | |
| N_{oc} | dBm/15 kHz | Specified in Table A.7.1.18.1-3 | Specified in Table A.7.1.18.1-3 |
| \hat{E}_s/I_{ot} | dB | -11 | -11 |
| \hat{E}_s/N_{oc} | dB | -11 | -11 |
| Antenna Configuration | | 2x1 | 2x1 |
| Propagation condition | - | AWGN | AWGN |
| Note 1: NOCNG shall be used such that the cell is fully allocated and a constant total transmitted power spectral density is achieved for all OFDM symbols. | | | |

Table A.7.1.18.1-3: eCell specific Test Parameters for UE Transmit Timing Accuracy Tests for E-UTRAN HD-FDD Category NB1 UE in In-Band mode under enhanced coverage

| Parameter | Unit | Value |
|-----------|------|-------|
|-----------|------|-------|

| | | Test 1 | Test 2 |
|--|------------|-----------|-----------|
| E-UTRA RF Channel Number | | 1 | 1 |
| BW _{channel} | MHz | 10 | 10 |
| PRB location within eCell | | 30 | 30 |
| NOCNG pattern | | NOP.1 FDD | NOP.1 FDD |
| PBCH_RA | dB | -3 | -3 |
| PBCH_RB | | | |
| PSS_RA | | | |
| SSS_RA | | | |
| PCFICH_RB | | | |
| PHICH_RA | | | |
| PHICH_RB | | | |
| PDCCH_RA | | | |
| PDCCH_RB | | | |
| OCNG_RA ^{Note1} | | | |
| OCNG_RB ^{Note1} | | | |
| N_{oc} | dBm/15 kHz | -98 | -98 |
| \hat{E}_s/N_{oc} | dB | -11 | -11 |
| Antenna Configuration | | 2x1 | 2x1 |
| Propagation condition | - | AWGN | AWGN |
| Note 1: OCNG shall be used such that the cell is fully allocated and a constant total transmitted power spectral density is achieved for all OFDM symbols. | | | |

Table A.7.1.18.1-4: drx-Configuration to be used in UE Transmit Timing Accuracy Test 2 for E-UTRAN HD-FDD Category NB1 UE In-band mode under enhanced coverage

| Field | Value | Comment |
|--|---------|---------|
| | Test 2 | |
| onDurationTimer | pp1 | |
| drx-InactivityTimer | pp0 | |
| drx-RetransmissionTimer | pp0 | |
| longDRX-CycleStartOffset | sf2048 | |
| shortDRX | disable | |
| Note 1: For further information see clause 6.7.3 in TS 36.331 [2]. | | |

A.7.1.18.2 Test Requirements

For parameters specified in Tables A.7.1.18.1-1, Tables A.7.1.18.1-2, Tables A.7.1.18.1-3 and Tables A.7.1.18.1-4, the initial transmit timing accuracy shall be within the limits defined in clause 7.20.2 and the UE shall not adjust the uplink transmission timing autonomously during an ongoing repetition period other than at initial transmission.

The following sequence of events shall be used to verify that the requirements are met.

The test sequence shall be carried out in RRC_CONNECTED for both non-DRX (for Test1) and DRX with a cycle length of 2048 ms (Test 2):

- a) After a connection is set up with the cell, the test system sends NPDCCH including uplink grant for NPUSCH transmission and the test system shall measure the UE transmit timing offset ($n \times T_s$) and verify that it is within T_e ($n \times T_s \leq N_{TA} \times T_s \pm 80 \times T_s$) with respect to the first detected path (in time) of the corresponding downlink frame of NB-IoT cell 1.
- b) The test system sends NPDCCH including uplink grant for NPUSCH transmission. After 16ms from the initial NPUSCH transmission, the test system adjusts the downlink transmit timing for the cell, using the value of n measured in a),
 - if $n < 0$, by $+(144 - |n|) \times T_s$ compared to that in (a).
 - if $n \geq 0$, by $-(144 - |n|) \times T_s$ compared to that in (a).

The timing adjustment is performed monotonically in multiple steps of $|\Delta T| \leq 9 \times T_S$ per 256 ms (ΔT is to be defined in the test procedure) until the above required total timing change is achieved, during which no grant is transmitted for the UE.

- c) For test 2, the test system sends NPDCCH including uplink grant for NPUSCH transmission and shall verify that the UE transmit timing offset stays within $N_{TA} \times T_S \pm 80 \times T_S$ with respect to the first detected path (in time) of the corresponding downlink frame of NB-IoT cell 1. The UE transmit timing offset shall be verified for the first transmission in the DRX cycle immediately after DL timing adjustment.

A.7.2 UE Timing Advance

A.7.2.1 E-UTRAN FDD – UE Timing Advance Adjustment Accuracy Test

A.7.2.1.1 Test Purpose and Environment

The purpose of the test is to verify E-UTRAN FDD Timing Advance adjustment accuracy requirements, defined in clause 7.3.2.2, in an AWGN model.

The test parameters are given in tables A.7.2.1.1-1, A.7.2.1.1-2, and A.7.2.1.1-3. The test consists of two successive time periods, with time duration of T1 and T2 respectively. In each time period, timing advance commands are sent to the UE and Sounding Reference Signals (SRS), as specified in table A.7.2.1.1-3, are sent from the UE and received by the test equipment. By measuring the reception of the SRS, the transmit timing, and hence the timing advance adjustment accuracy, can be measured.

During time period T1, the test equipment shall send one message with a Timing Advance Command MAC Control Element, as specified in Clause 6.1.3.5 in TS 36.321. The Timing Advance Command value shall be set to 31, which according to Clause 4.2.3 in TS 36.213 results in zero adjustment of the Timing Advance. In this way, a reference value for the timing advance used by the UE is established.

During time period T2, the test equipment shall send a sequence of messages with Timing Advance Command MAC Control Elements, with Timing Advance Command value specified in table A.7.2.1.1-2. This value shall result in changes of the timing advance used by the UE, and the accuracy of the change shall then be measured, using the SRS sent from the UE.

As specified in Clause 7.3.2.1, the UE adjusts its uplink timing at sub-frame $n+6$ for a timing advance command received in sub-frame n . This delay must be taken into account when measuring the timing advance adjustment accuracy, via the SRS sent from the UE.

The UE Time Alignment Timer, described in Clause 5.2 in TS 36.321, shall be configured so that it does not expire in the duration of the test.

Table A.7.2.1.1-1: General Test Parameters for E-UTRAN FDD Timing Advance Accuracy Test

| Parameter | Unit | Value | Comment |
|--|------|---|--|
| PDSCH parameters | | DL Reference Measurement Channel R.0 FDD | As specified in clause A.3.1.1.1 |
| PCFICH/PDCCH/PHICH parameters | | DL Reference Measurement Channel R.6 FDD | As specified in clause A.3.1.2.1 |
| Timing Advance Command (T_A) value during T1 | | 31 | $N_{TA} = 0$ for the purpose of establishing a reference value from which the timing advance adjustment accuracy can be measured during T2 |
| Timing Advance Command (T_A) value during T2 | | 39 | $N_{TA} = 128$ |
| DRX | | OFF | |
| T1 | s | 5 | |
| T2 | s | 5 | |

Table A.7.2.1.1-2: Cell specific Test Parameters for E-UTRAN FDD Timing Advance Accuracy Test

| Parameter | Unit | Value |
|-----------|------|-------|
|-----------|------|-------|

| | | T1 | T2 |
|---|------------|----------|----|
| E-UTRA RF Channel Number | | 1 | |
| BW _{channel} | MHz | 10 | |
| OCNG Patterns defined in A.3.2.1.1 (OP.1 FDD) | | OP.1 FDD | |
| PBCH_RA | dB | 0 | |
| PBCH_RB | dB | | |
| PSS_RA | dB | | |
| SSS_RA | dB | | |
| PCFICH_RB | dB | | |
| PHICH_RA | dB | | |
| PHICH_RB | dB | | |
| PDCCH_RA | dB | | |
| PDCCH_RB | dB | | |
| PDSCH_RA | dB | | |
| PDSCH_RB | dB | | |
| OCNG_RA ^{Note1} | dB | | |
| OCNG_RB ^{Note1} | dB | | |
| Timing Advance Command (T_A) | | 31 | 39 |
| \hat{E}_s / I_{ot} | dB | 3 | |
| N_{oc} | dBm/15 KHz | -98 | |
| \hat{E}_s / N_{oc} | dB | 3 | |
| I_o ^{Note2} | dBm/9 MHz | -65.5 | |
| Propagation Condition | | AWGN | |
| Note 1: OCNG shall be used such that both cells are fully allocated and a constant total transmitted power spectral density is achieved for all OFDM symbols. | | | |
| Note 2: I_o level has been derived from other parameters for information purpose. It is not a settable parameter. | | | |

Table A.7.2.1.1-3: Sounding Reference Symbol Configuration for E-UTRAN FDD Transmit Timing Accuracy Test

| Field | Value | Comment |
|--|-------|---|
| srsBandwidthConfiguration | bw5 | |
| srsSubframeConfiguration | sc3 | Once every 5 subframes |
| ackNackSrsSimultaneousTransmission | FALSE | |
| srsMaxUpPTS | N/A | Not applicable for E-UTRAN FDD |
| srsBandwidth | 0 | No hopping |
| srsHoppingBandwidth | hbw0 | |
| frequencyDomainPosition | 0 | |
| Duration | TRUE | Indefinite duration |
| Srs-ConfigurationIndex | 7 | SRS periodicity of 10. |
| transmissionComb | 0 | |
| cyclicShift | cs0 | No cyclic shift |
| SRS-AntennaPort | an1 | Number of antenna ports used for SRS transmission |
| Note: For further information see clause 6.3.2 in TS 36.331. | | |

A.7.2.1.2 Test Requirements

The UE shall apply the signalled Timing Advance value to the transmission timing at the designated activation time i.e. 6 sub frames after the reception of the timing advance command.

The Timing Advance adjustment accuracy shall be within the limits specified in clause 7.3.2.2.

The rate of correct Timing Advance adjustments observed during repeated tests shall be at least 90%.

A.7.2.2 E-UTRAN TDD – UE Timing Advance Adjustment Accuracy Test

A.7.2.2.1 Test Purpose and Environment

The purpose of the test is to verify E-UTRAN TDD Timing Advance adjustment accuracy requirements, defined in clause 7.3.2.2, in an AWGN model.

The test parameters are given in tables A.7.2.2.1-1, A.7.2.2.1-2, and A.7.2.2.1-3. The test consists of two successive time periods, with time duration of T1 and T2 respectively. In each time period, timing advance commands are sent to the UE and Sounding Reference Signals (SRS), as specified in table A.7.2.2.1-3, are sent from the UE and received by the test equipment. By measuring the reception of the SRS, the transmit timing, and hence the timing advance adjustment accuracy, can be measured.

During time period T1, the test equipment shall send one message with a Timing Advance Command MAC Control Element, as specified in Clause 6.1.3.5 in TS 36.321. The Timing Advance Command value shall be set to 31, which according to Clause 4.2.3 in TS 36.213 results in zero adjustment of the Timing Advance. In this way, a reference value for the timing advance used by the UE is established.

During time period T2, the test equipment shall send a sequence of messages with Timing Advance Command MAC Control Elements, with Timing Advance Command value specified in table A.7.2.1.1-2. This value shall result in changes of the timing advance used by the UE, and the accuracy of the change shall then be measured, using the SRS sent from the UE.

As specified in Clause 7.3.2.1, the UE adjusts its uplink timing at sub-frame $n+6$ for a timing advance command received in sub-frame n . This delay must be taken into account when measuring the timing advance adjustment accuracy, via the SRS sent from the UE.

The UE Time Alignment Timer, described in Clause 5.2 in TS 36.321, shall be configured so that it does not expire in the duration of the test.

Table A.7.2.2.1-1: General Test Parameters for E-UTRAN TDD Timing Advance Accuracy Test

| Parameter | Unit | Value | Comment |
|--|------|--|--|
| PDSCH parameters | | DL Reference Measurement Channel R.0 TDD | As specified in clause A.3.1.1.2 |
| PCFICH/PDCCH/PHICH parameters | | DL Reference Measurement Channel R.6 TDD | As specified in clause A.3.1.2.2 |
| Timing Advance Command (T_A) value during T1 | | 31 | $N_{TA} = 0$ for the purpose of establishing a reference value from which the timing advance adjustment accuracy can be measured during T2 |
| Timing Advance Command (T_A) value during T2 | | 39 | $N_{TA} = 128$ |
| DRX | | OFF | |
| T1 | s | 5 | |
| T2 | s | 5 | |

Table A.7.2.2.1-2: Cell specific Test Parameters for E-UTRAN TDD Timing Advance Accuracy Test

| Parameter | Unit | Value | |
|---|------|----------|----|
| | | T1 | T2 |
| E-UTRA RF Channel Number | | 1 | |
| BW _{channel} | MHz | 10 | |
| Special subframe configuration ^{Note1} | | 6 | |
| Uplink-downlink configuration ^{Note2} | | 1 | |
| OCNG Patterns defined in A.3.2.2.1 (OP.1 TDD) | | OP.1 TDD | |
| PBCH_RA | dB | | |
| PBCH_RB | dB | | |
| PSS_RA | dB | | |
| SSS_RA | dB | | |
| PCFICH_RB | dB | | |
| PHICH_RA | dB | | |

| | | | |
|---|------------|----------|----|
| PHICH_RB | dB | 0 | |
| PDCCH_RA | dB | | |
| PDCCH_RB | dB | | |
| PDSCH_RA | dB | | |
| PDSCH_RB | dB | | |
| OCNG_RA ^{Note3} | dB | | |
| OCNG_RB ^{Note3} | dB | | |
| Timing Advance Command (T_A) | | 31 | 39 |
| \hat{E}_s / I_{ot} | dB | 3 | |
| N_{oc} | dBm/15 KHz | -98 | |
| \hat{E}_s / N_{oc} | dB | 3 | |
| I_o ^{Note4} | dBm/9 MHz | -65.5 | |
| Propagation Condition | | AWGN | |
| <p>Note 1: For the special subframe configuration see table 4.2-1 in TS 36.211.</p> <p>Note 2: For the uplink-downlink configuration see table 4.2-2 in TS 36.211.</p> <p>Note 3: OCNG shall be used such that both cells are fully allocated and a constant total transmitted power spectral density is achieved for all OFDM symbols.</p> <p>Note 4: I_o level has been derived from other parameters for information purpose. It is not a settable parameter.</p> | | | |

Table A.7.2.2.1-3: Sounding Reference Symbol Configuration for E-UTRAN TDD Transmit Timing Accuracy Test

| Field | Value | Comment |
|--|-------|---|
| srsBandwidthConfiguration | bw5 | |
| srsSubframeConfiguration | sc3 | Once every 5 subframes |
| ackNackSrsSimultaneousTransmission | FALSE | |
| srsMaxUpPTS | N/A | |
| srsBandwidth | bw0 | No hopping |
| srsHoppingBandwidth | hbw0 | |
| frequencyDomainPosition | 0 | |
| Duration | TRUE | Indefinite duration |
| Srs-ConfigurationIndex | 15 | SRS periodicity of 10ms. |
| transmissionComb | 0 | |
| cyclicShift | cs0 | No cyclic shift |
| SRS-AntennaPort | an1 | Number of antenna ports used for SRS transmission |
| Note: For further information see clause 6.3.2 in TS 36.331. | | |

A.7.2.2.2 Test Requirements

The UE shall apply the signalled Timing Advance value to the transmission timing at the designated activation time i.e. 6 sub frames after the reception of the timing advance command.

The Timing Advance adjustment accuracy shall be within the limits specified in clause 7.3.2.2.

The rate of correct Timing Advance adjustments observed during repeated tests shall be at least 90%.

A.7.2.3 E-UTRAN FDD – UE Timing Advance Adjustment Accuracy Test for 5MHz

A.7.2.3.1 Test Purpose and Environment

The purpose of this test case is the same as for the test defined in subclause A.7.2.1.1.

The parameters of this test are the same as defined in Subclause A.7.2.1.1 except that the values of the parameters in the Table A.7.2.3.1-1 will replace the values of the corresponding parameters in A.7.2.1.1-1, table A.7.2.3.1-2 will replace the values of the corresponding parameters in A.7.2.1.1-2. Parameters used for the sounding reference symbol configuration are unchanged from table A.7.2.1.1-3.

Table A.7.2.3.1-1: General Test Parameters for E-UTRAN FDD Timing Advance Accuracy Test for 5MHz bandwidth

| Parameter | Unit | Value | Comment |
|--|------|--|----------------------------------|
| PDSCH parameters | | DL Reference Measurement Channel R.5 FDD | As specified in clause A.3.1.1.1 |
| PCFICH/PDCCH/PHICH parameters | | DL Reference Measurement Channel R.11 FDD | As specified in clause A.3.1.2.1 |
| Note 1: For the reference measurement channels, see clause A.3.1. | | | |
| Note 2: See Table A.7.2.1.1-1 for the other parameters. | | | |
| Note 3: This test is according to the principle defined in section A.3.7.2 | | | |

Table A.7.2.3.1-2: Cell specific Test Parameters for E-UTRAN FDD Timing Advance Accuracy Test for 5MHz bandwidth

| Parameter | Unit | Value | |
|---|-------------|-------|-----------|
| | | T1 | T2 |
| BW _{channel} | MHz | | 5 |
| OCNG Patterns defined in A.3.2.1.15 (OP.15 FDD) | | | OP.15 FDD |
| I _o ^{Note2} | dBm/4.5 MHz | | -68.5 |
| Note 1: For the reference measurement channels, see clause A.3.2. | | | |
| Note 2: See Table A.7.2.1.1-2 for the other parameters. | | | |

A.7.2.3.2 Test Requirements

The test requirements defined in section A.7.2.1.2 shall apply to this test case.

A.7.2.4 E-UTRAN FDD – UE Timing Advance Adjustment Accuracy Test for SCell in sTAG

A.7.2.4.1 Test Purpose and Environment

The purpose of the test is to verify E-UTRAN FDD Timing Advance adjustment accuracy requirements, defined in clause 7.3.2.2, in an AWGN model.

The test parameters are given in tables A.7.2.4.1-1, A.7.2.4.1-2, and A.7.2.4.1-3. For this test two cells are used. Cell 1 is PCell and Cell 2 is SCell. PCell is in the primary Timing Advance Group (pTAG) and SCell is in the secondary Timing Advance Group (sTAG). The test consists of two successive time periods, with time duration of T1 and T2 respectively. In each time period, timing advance commands for sTAG are sent to the UE and Sounding Reference Signals (SRS), as specified in table A.7.2.4.1-3, are sent from the UE and received by the test equipment. By measuring the reception of the SRS, the transmit timing, and hence the timing advance adjustment accuracy, can be measured for SCell in sTAG.

During time period T1, the test equipment shall send one message with a Timing Advance Command MAC Control Element for sTAG, as specified in Clause 6.1.3.5 in TS 36.321. The Timing Advance Command value shall be set to 31, which according to Clause 4.2.3 in TS 36.213 results in zero adjustment of the Timing Advance. In this way, a reference value for the timing advance for sTAG used by the UE is established.

During time period T2, the test equipment shall send a sequence of messages with Timing Advance Command MAC Control Elements for sTAG, with Timing Advance Command value specified in table A.7.2.4.1-2. This value shall result in changes of the timing advance for sTAG used by the UE, and the accuracy of the change shall then be measured, using the SRS sent from the UE.

As specified in Clause 7.3.2.1, the UE adjusts its uplink timing at sub-frame n+6 for a timing advance command received in sub-frame n. This delay must be taken into account when measuring the timing advance adjustment accuracy, via the SRS sent from the UE.

The UE Time Alignment Timer, described in Clause 5.2 in TS 36.321, shall be configured so that it does not expire in the duration of the test.

Table A.7.2.4.1-1: General Test Parameters for E-UTRAN FDD Timing Advance Accuracy Test for SCell in sTAG

| Parameter | Unit | Value | Comment |
|--|------|---|--|
| PDSCH parameters | | DL Reference Measurement Channel R.0 FDD | As specified in clause A.3.1.1.1 |
| PCFICH/PDCCH/PHICH parameters | | DL Reference Measurement Channel R.6 FDD | As specified in clause A.3.1.2.1 |
| Timing Advance Command (T_A) value during T1 | | 31 | $N_{TA} = 0$ for the purpose of establishing a reference value from which the timing advance adjustment accuracy can be measured during T2 |
| Timing Advance Command (T_A) value during T2 | | 39 | $N_{TA} = 128$ |
| DRX | | OFF | |
| T1 | s | 5 | |
| T2 | s | 5 | |

Table A.7.2.4.1-2: Cell specific Test Parameters for E-UTRAN FDD Timing Advance Accuracy Test for SCell in sTAG

| Parameter | Unit | Value | | | |
|---|------------|----------|-------|----------|-------|
| | | Cell1 | | Cell2 | |
| | | T1 | T2 | T1 | T2 |
| E-UTRA RF Channel Number | | 1 | | 2 | |
| $BW_{channel}$ | MHz | 10 | | 10 | |
| Active PCell | | Cell1 | Cell1 | | |
| Active SCell | | | | Cell2 | Cell2 |
| TAG configuration | | pTAG | pTAG | sTAG | sTAG |
| OCNG Patterns defined in A.3.2.1.1 (OP.1 FDD) | | OP.1 FDD | | OP.1 FDD | |
| PBCH_RA | dB | | | | |
| PBCH_RB | dB | | | | |
| PSS_RA | dB | | | | |
| SSS_RA | dB | | | | |
| PCFICH_RB | dB | | | | |
| PHICH_RA | dB | | | | |
| PHICH_RB | dB | | | | |
| PDCCH_RA | dB | 0 | | 0 | |
| PDCCH_RB | dB | | | | |
| PDSCH_RA | dB | | | | |
| PDSCH_RB | dB | | | | |
| OCNG_RA ^{Note1} | dB | | | | |
| OCNG_RB ^{Note1} | dB | | | | |
| Timing Advance Command (T_A) | | / | / | 31 | 39 |
| \hat{E}_s / I_{ot} | dB | 3 | | 3 | |
| N_{oc} | dBm/15 KHz | -98 | | -98 | |
| \hat{E}_s / N_{oc} | dB | 3 | | 3 | |
| I_o ^{Note2} | dBm/9 MHz | -65.5 | | -65.5 | |
| Propagation Condition | | AWGN | | AWGN | |

| | |
|---------|---|
| Note 1: | OCNG shall be used such that both cells are fully allocated and a constant total transmitted power spectral density is achieved for all OFDM symbols. |
| Note 2: | lo level has been derived from other parameters for information purpose. It is not a settable parameter. |

Table A.7.2.4.1-3: Sounding Reference Symbol Configuration for E-UTRAN FDD Transmit Timing Accuracy Test for SCell in sTAG

| Field | Value | Comment |
|--|-------|---|
| srsBandwidthConfiguration | bw5 | |
| srsSubframeConfiguration | sc3 | Once every 5 subframes |
| ackNackSrsSimultaneousTransmission | FALSE | |
| srsMaxUpPTS | N/A | Not applicable for E-UTRAN FDD |
| srsBandwidth | 0 | No hopping |
| srsHoppingBandwidth | hbw0 | |
| frequencyDomainPosition | 0 | |
| Duration | TRUE | Indefinite duration |
| Srs-ConfigurationIndex | 7 | SRS periodicity of 10. |
| transmissionComb | 0 | |
| cyclicShift | cs0 | No cyclic shift |
| SRS-AntennaPort | an1 | Number of antenna ports used for SRS transmission |
| Note: For further information see clause 6.3.2 in TS 36.331. | | |

A.7.2.4.2 Test Requirements

The UE shall apply the signalled Timing Advance value for SCell in sTAG to the transmission timing at the designated activation time i.e. 6 sub frames after the reception of the timing advance command.

The Timing Advance adjustment accuracy for SCell in STAG shall be within the limits specified in clause 7.3.2.2.

The rate of correct Timing Advance adjustments observed during repeated tests shall be at least 90%.

A.7.2.5 E-UTRAN TDD – UE Timing Advance Adjustment Accuracy Test for SCell in sTAG

A.7.2.5.1 Test Purpose and Environment

The purpose of the test is to verify E-UTRAN TDD Timing Advance adjustment accuracy requirements, defined in clause 7.3.2.2, in an AWGN model.

The test parameters are given in tables A.7.2.5.1-1, A.7.2.5.1-2, and A.7.2.5.1-3. For this test two cells are used. Cell 1 is PCell and Cell 2 is SCell. PCell is in the primary Timing Advance Group (pTAG) and SCell is in the secondary Timing Advance Group (sTAG). The test consists of two successive time periods, with time duration of T1 and T2 respectively. In each time period, timing advance commands for sTAG are sent to the UE and Sounding Reference Signals (SRS), as specified in table A.7.2.5.1-3, are sent from the UE and received by the test equipment, but only for SCell. By measuring the reception of the SRS, the transmit timing, and hence the timing advance adjustment accuracy, can be measured for SCell in sTAG.

During time period T1, the test equipment shall send one message with a Timing Advance Command MAC Control Element for sTAG, as specified in Clause 6.1.3.5 in TS 36.321. The Timing Advance Command value shall be set to 31, which according to Clause 4.2.3 in TS 36.213 results in zero adjustment of the Timing Advance. In this way, a reference value for the timing advance used by the UE is established.

During time period T2, the test equipment shall send a sequence of messages with Timing Advance Command MAC Control Elements for sTAG, with Timing Advance Command value specified in table A.7.2.5.1-2. This value shall result in changes of the timing advance on SCell used by the UE, and the accuracy of the change shall then be measured, using the SRS sent from the UE.

As specified in Clause 7.3.2.1, the UE adjusts its uplink timing at sub-frame n+6 for a timing advance command received in sub-frame n. This delay must be taken into account when measuring the timing advance adjustment accuracy, via the SRS sent from the UE.

The UE Time Alignment Timer, described in Clause 5.2 in TS 36.321, shall be configured so that it does not expire in the duration of the test.

Table A.7.2.5.1-1: General Test Parameters for E-UTRAN TDD Timing Advance Accuracy Test for SCell in sTAG

| Parameter | Unit | Value | Comment |
|--|------|--|--|
| PDSCH parameters | | DL Reference Measurement Channel R.0 TDD | As specified in clause A.3.1.1.2 |
| PCFICH/PDCCH/PHICH parameters | | DL Reference Measurement Channel R.6 TDD | As specified in clause A.3.1.2.2 |
| Timing Advance Command (T_A) value during T1 | | 31 | $N_{TA} = 0$ for the purpose of establishing a reference value from which the timing advance adjustment accuracy can be measured during T2 |
| Timing Advance Command (T_A) value during T2 | | 39 | $N_{TA} = 128$ |
| DRX | | OFF | |
| T1 | s | 5 | |
| T2 | s | 5 | |

Table A.7.2.5.1-2: Cell specific Test Parameters for E-UTRAN TDD Timing Advance Accuracy Test for SCell in sTAG

| Parameter | Unit | Value | | | |
|---|------------|----------|----|----------|----|
| | | Cell 1 | | Cell 2 | |
| | | T1 | T2 | T1 | T2 |
| E-UTRA RF Channel Number | | 1 | | 2 | |
| $BW_{channel}$ | MHz | 10 | | 10 | |
| Active PCell | | Cell1 | | | |
| Active SCell | | | | Cell2 | |
| TAG configuration | | pTAG | | sTAG | |
| Special subframe configuration ^{Note1} | | 6 | | 6 | |
| Uplink-downlink configuration ^{Note2} | | 1 | | 1 | |
| OCNG Patterns defined in A.3.2.2.1 (OP.1 TDD) | | OP.1 TDD | | OP.1 TDD | |
| PBCH_RA | dB | 0 | | 0 | |
| PBCH_RB | dB | | | | |
| PSS_RA | dB | | | | |
| SSS_RA | dB | | | | |
| PCFICH_RB | dB | | | | |
| PHICH_RA | dB | | | | |
| PHICH_RB | dB | | | | |
| PDCCH_RA | dB | | | | |
| PDCCH_RB | dB | | | | |
| PDSCH_RA | dB | | | | |
| PDSCH_RB | dB | | | | |
| OCNG_RA ^{Note3} | dB | | | | |
| OCNG_RB ^{Note3} | dB | | | | |
| Timing Advance Command (T_A) | | | | | |
| \hat{E}_s / I_{ot} | dB | 3 | | 3 | |
| N_{oc} | dBm/15 KHz | -98 | | -98 | |
| \hat{E}_s / N_{oc} | dB | 3 | | 3 | |
| I_0 ^{Note4} | dBm/9 MHz | -65.5 | | -65.5 | |
| Propagation Condition | | AWGN | | AWGN | |

| | |
|---------|---|
| Note 1: | For the special subframe configuration see table 4.2-1 in TS 36.211. |
| Note 2: | For the uplink-downlink configuration see table 4.2-2 in TS 36.211. |
| Note 3: | OCNG shall be used such that both cells are fully allocated and a constant total transmitted power spectral density is achieved for all OFDM symbols. |
| Note 4: | lo level has been derived from other parameters for information purpose. It is not a settable parameter. |

Table A.7.2.5.1-3: Sounding Reference Symbol Configuration for E-UTRAN TDD Transmit Timing Accuracy Test for SCell in sTAG

| Field | Value | Comment |
|------------------------------------|--|---|
| srsBandwidthConfiguration | bw5 | |
| srsSubframeConfiguration | sc3 | Once every 5 subframes |
| ackNackSrsSimultaneousTransmission | FALSE | |
| srsMaxUpPTS | N/A | |
| srsBandwidth | bw0 | No hopping |
| srsHoppingBandwidth | hbw0 | |
| frequencyDomainPosition | 0 | |
| Duration | TRUE | Indefinite duration |
| Srs-ConfigurationIndex | 15 | SRS periodicity of 10ms. |
| transmissionComb | 0 | |
| cyclicShift | cs0 | No cyclic shift |
| SRS-AntennaPort | an1 | Number of antenna ports used for SRS transmission |
| Note: | For further information see clause 6.3.2 in TS 36.331. | |

A.7.2.5.2 Test Requirements

The UE shall apply the signalled Timing Advance value for SCell in sTAG to the transmission timing at the designated activation time i.e. 6 sub frames after the reception of the timing advance command.

The Timing Advance adjustment accuracy for SCell in sTAG shall be within the limits specified in clause 7.3.2.2.

The rate of correct Timing Advance adjustments observed during repeated tests shall be at least 90%.

A.7.2.5A E-UTRAN TDD – UE Timing Advance Adjustment Accuracy Test for SCell in sTAG for 20 MHz +20 MHz

A.7.2.5A.1 Test Purpose and Environment

The purpose of this test case is the same as for the test defined in subclause A.7.2.5.1.

The parameters of this test are the same as defined in Subclause A.7.2.5.1 except that the values of the parameters in the Table A.7.2.5A.1-1 will replace the values of the corresponding parameters in A.7.2.5.1-1, table A.7.2.5A.1-2 will replace the values of the corresponding parameters in A.7.2.5.1-2. Parameters used for the sounding reference symbol configuration are unchanged from table A.7.2.5.1-3.

Table A.7.2.5A.1-1: General Test Parameters for E-UTRAN TDD Timing Advance Accuracy Test for SCell in sTAG for 20 MHz +20 MHz

| Parameter | Unit | Value | Comment |
|-------------------------------|------|---|----------------------------------|
| PDSCH parameters | | DL Reference Measurement Channel R.3 TDD | As specified in clause A.3.1.1.2 |
| PCFICH/PDCCH/PHICH parameters | | DL Reference Measurement Channel R.10 TDD | As specified in clause A.3.1.2.2 |

Table A.7.2.5A.1-2: Cell specific Test Parameters for E-UTRAN TDD Timing Advance Accuracy Test for SCell in sTAG for 20 MHz +20 MHz

| Parameter | Unit | Value | | | |
|----------------------------------|------------|----------|----|----------|----|
| | | Cell 1 | | Cell 2 | |
| | | T1 | T2 | T1 | T2 |
| $BW_{channel}$ | MHz | 20 | | 20 | |
| OCNG Patterns defined in A.3.2.2 | | OP.7 TDD | | OP.7 TDD | |
| I_0^{Note4} | dBm/18 MHz | -62.5 | | -62.5 | |

A.7.2.5A.2 Test Requirements

The test requirements defined in section A.7.2.5.2 shall apply to this test case.

A.7.2.5B E-UTRAN TDD – UE Timing Advance Adjustment Accuracy Test for SCell in sTAG for 20 MHz +10 MHz

A.7.2.5B.1 Test Purpose and Environment

The purpose of this test case is the same as for the test defined in subclause A.7.2.5.1.

The parameters of this test are the same as defined in Subclause A.7.2.5.1 except that the values of the parameters in the Table A.7.2.5B.1-1 will replace the values of the corresponding parameters in A.7.2.5.1-1, table A.7.2.5B.1-2 will replace the values of the corresponding parameters in A.7.2.5.1-2. Parameters used for the sounding reference symbol configuration are unchanged from table A.7.2.5.1-3.

Table A.7.2.5B.1-1: General Test Parameters for E-UTRAN TDD Timing Advance Accuracy Test for SCell in sTAG for 20 MHz +10 MHz

| Parameter | Unit | Value | Comment |
|-------------------------------|------|---|----------------------------------|
| PDSCH parameters | | For Cell 1: DL Reference Measurement Channel R.3 TDD For Cell 2: DL Reference Measurement Channel R.0 TDD | As specified in clause A.3.1.1.2 |
| PCFICH/PDCCH/PHICH parameters | | For Cell 1: DL Reference Measurement Channel R.10 TDD For Cell 2: DL Reference Measurement Channel R.6 TDD | As specified in clause A.3.1.2.2 |

Table A.7.2.5B.1-2: Cell specific Test Parameters for E-UTRAN TDD Timing Advance Accuracy Test for SCell in sTAG for 20 MHz +10 MHz

| Parameter | Unit | Value | | | |
|----------------------------------|------------|----------|----|----------|----|
| | | Cell 1 | | Cell 2 | |
| | | T1 | T2 | T1 | T2 |
| $BW_{channel}$ | MHz | 20 | | 10 | |
| OCNG Patterns defined in A.3.2.2 | | OP.7 TDD | | OP.1 TDD | |
| I_0^{Note4} | dBm/18 MHz | -62.5 | | N/A | |
| | dBm/9 MHz | N/A | | -65.5 | |

A.7.2.5B.2 Test Requirements

The test requirements defined in section A.7.2.5.2 shall apply to this test case.

A.7.2.6 E-UTRAN FDD Timing Advance Adjustment Accuracy Test for Cat-M1 UE in CEModeA

A.7.2.6.1 Test Purpose and Environment

The purpose of the test is to verify E-UTRAN FDD Timing Advance adjustment accuracy requirements for Cat-M1 UE configured with CEModeA, defined in clause 7.3.2.2, in an AWGN model.

The test parameters are given in tables A.7.2.6.1-1, A.7.2.6.1-2, and A.7.2.6.1-3. The test consists of two successive time periods, with time duration of T1 and T2 respectively. In each time period, timing advance commands are sent to the UE and Sounding Reference Signals (SRS), as specified in table A.7.2.1.1-3, are sent from the UE and received by the test equipment. By measuring the reception of the SRS, the transmit timing, and hence the timing advance adjustment accuracy, can be measured.

During time period T1, the test equipment shall send one message with a Timing Advance Command MAC Control Element, as specified in Clause 6.1.3.5 in TS 36.321. The Timing Advance Command value shall be set to 31, which according to Clause 4.2.3 in TS 36.213 results in zero adjustment of the Timing Advance. In this way, a reference value for the timing advance used by the UE is established.

During time period T2, the test equipment shall send a sequence of messages with Timing Advance Command MAC Control Elements, with Timing Advance Command value specified in table A.7.2.6.1-2. This value shall result in changes of the timing advance used by the UE, and the accuracy of the change shall then be measured, using the SRS sent from the UE.

As specified in Clause 7.3.2.1, the UE adjusts its uplink timing at sub-frame n+6 for a timing advance command received in sub-frame n. This delay must be taken into account when measuring the timing advance adjustment accuracy, via the SRS sent from the UE.

The UE Time Alignment Timer, described in Clause 5.2 in TS 36.321, shall be configured so that it does not expire in the duration of the test.

Table A.7.2.6.1-1: General Test Parameters for E-UTRAN FDD Timing Advance Accuracy Test for Cat-M1 UE in CEModeA

| Parameter | Unit | Value | Comment |
|--|------|----------|--|
| PDSCH parameters: DL Reference Measurement Channel | | R.20 FDD | As specified in clause A.3.1.4.1 |
| MPDCCH parameters: DL Reference Measurement Channel | | R.16 FDD | As specified in clause A.3.1.3.1 |
| Timing Advance Command (T_A) value during T1 | | 31 | $N_{TA} = 0$ for the purpose of establishing a reference value from which the timing advance adjustment accuracy can be measured during T2 |
| Timing Advance Command (T_A) value during T2 | | 39 | $N_{TA} = 128$ |
| DRX | | OFF | |
| T1 | s | 5 | |
| T2 | s | 5 | |

Table A.7.2.6.1-2: Cell specific Test Parameters for E-UTRAN FDD UE Timing Advance Accuracy Test for Cat-M1 UE in CEModeA

| Parameter | Unit | Value | |
|---|------|----------|----|
| | | T1 | T2 |
| E-UTRA RF Channel Number | | 1 | |
| $BW_{channel}$ | MHz | 10 | |
| PDSCH parameters: DL Reference Measurement Channel | | R.20 FDD | |

| | | | |
|--|------------|-----------|----|
| MPDCCH parameters: DL Reference Measurement Channel | | R.16 FDD | |
| OCNG Patterns defined in A.3.2.1.21 | | OP.21 FDD | |
| PBCH_RA | dB | 0 | |
| PBCH_RB | dB | | |
| PSS_RA | dB | | |
| SSS_RA | dB | | |
| PCFICH_RB | dB | | |
| PHICH_RA | dB | | |
| PHICH_RB | dB | | |
| MPDCCH_RA | dB | | |
| MPDCCH_RB | dB | | |
| PDCCH_RA | dB | | |
| PDCCH_RB | dB | | |
| PDSCH_RA | dB | | |
| PDSCH_RB | dB | | |
| OCNG_RA ^{Note1} | dB | | |
| OCNG_RB ^{Note1} | dB | | |
| Timing Advance Command (T_A) | | 31 | 39 |
| \hat{E}_s / I_{ot} | dB | 3 | |
| N_{oc} | dBm/15 KHz | -98 | |
| \hat{E}_s / N_{oc} | dB | 3 | |
| I_o ^{Note2} | dBm/9 MHz | -65.5 | |
| Propagation Condition | | AWGN | |
| <p>Note 1: OCNG shall be used such that cells is fully allocated and a constant total transmitted power spectral density is achieved for all OFDM symbols.</p> <p>Note 2: I_o level has been derived from other parameters for information purpose. It is not a settable parameter.</p> | | | |

Table A.7.2.6.1-3: Sounding Reference Symbol Configuration for E-UTRAN FDD UE Transmit Timing Accuracy Test for Cat-M1 UE in CEModeA

| Field | Value | Comment |
|--|-------|---|
| srsBandwidthConfiguration | Bw5 | |
| srsSubframeConfiguration | sc3 | Once every 5 subframes |
| ackNackSrsSimultaneousTransmission | FALSE | |
| srsMaxUpPTS | N/A | Not applicable for E-UTRAN FDD |
| srsBandwidth | 0 | No hopping |
| srsHoppingBandwidth | hbw0 | |
| frequencyDomainPosition | 0 | |
| Duration | TRUE | Indefinite duration |
| Srs-ConfigurationIndex | 17 | SRS periodicity of 20. |
| transmissionComb | 0 | |
| cyclicShift | cs0 | No cyclic shift |
| SRS-AntennaPort | an1 | Number of antenna ports used for SRS transmission |
| Note 1: For further information see clause 6.3.2 in TS 36.331. | | |

A.7.2.6.2 Test Requirements

The UE shall apply the signalled Timing Advance value to the transmission timing at the designated activation time i.e. 6 sub frames after the reception of the timing advance command.

The Timing Advance adjustment accuracy shall be within the limits specified in clause 7.3.2.2.

The rate of correct Timing Advance adjustments observed during repeated tests shall be at least 90%.

A.7.2.7 E-UTRAN HD-FDD UE Timing Advance Adjustment Accuracy Test for Cat-M1 UE in CEModeA

A.7.2.7.1 Test Purpose and Environment

The purpose of the test is to verify E-UTRAN HD-FDD Timing Advance adjustment accuracy requirements for Cat-M1 UE configured with CEModeA, defined in clause 7.3.2.2, in an AWGN model.

The test parameters are given in tables A.7.2.7.1-1, A.7.2.7.1-2, and A.7.2.7.1-3. The test consists of two successive time periods, with time duration of T1 and T2 respectively. In each time period, timing advance commands are sent to the UE and Sounding Reference Signals (SRS), as specified in table A.7.2.7.1-3, are sent from the UE and received by the test equipment. By measuring the reception of the SRS, the transmit timing, and hence the timing advance adjustment accuracy, can be measured.

During time period T1, the test equipment shall send one message with a Timing Advance Command MAC Control Element, as specified in Clause 6.1.3.5 in TS 36.321. The Timing Advance Command value shall be set to 31, which according to Clause 4.2.3 in TS 36.213 results in zero adjustment of the Timing Advance. In this way, a reference value for the timing advance used by the UE is established.

During time period T2, the test equipment shall send a sequence of messages with Timing Advance Command MAC Control Elements, with Timing Advance Command value specified in table A.7.2.7.1-2. This value shall result in changes of the timing advance used by the UE, and the accuracy of the change shall then be measured, using the SRS sent from the UE.

As specified in Clause 7.3.2.1, the UE adjusts its uplink timing at sub-frame n+6 for a timing advance command received in sub-frame n. This delay must be taken into account when measuring the timing advance adjustment accuracy, via the SRS sent from the UE.

The UE Time Alignment Timer, described in Clause 5.2 in TS 36.321, shall be configured so that it does not expire in the duration of the test.

Table A.7.2.7.1-1: General Test Parameters for E-UTRAN HD-FDD Timing Advance Accuracy Test for Cat-M1 UE in CEModeA

| Parameter | Unit | Value | Comment |
|--|------|-------------|--|
| PDSCH parameters: DL Reference Measurement Channel | | R.10 HD-FDD | As specified in clause A.3.1.4.2 |
| MPDCCH parameters: DL Reference Measurement Channel | | R.6 HD-FDD | As specified in clause A.3.1.3.2 |
| Timing Advance Command (T_A) value during T1 | | 31 | $N_{TA} = 0$ for the purpose of establishing a reference value from which the timing advance adjustment accuracy can be measured during T2 |
| Timing Advance Command (T_A) value during T2 | | 39 | $N_{TA} = 128$ |
| DRX | | OFF | |
| T1 | s | 5 | |
| T2 | s | 5 | |

Table A.7.2.7.1-2: Cell specific Test Parameters for E-UTRAN HD-FDD Timing Advance Accuracy Test for Cat-M1 UE in CEModeA

| Parameter | Unit | Value | |
|---|------|-------------|----|
| | | T1 | T2 |
| E-UTRA RF Channel Number | | 1 | |
| $BW_{channel}$ | MHz | 10 | |
| PDSCH parameters: DL Reference Measurement Channel | | R.10 HD-FDD | |

| | | | |
|---|------------|------------|----|
| MPDCCH parameters: DL Reference Measurement Channel | | R.6 HD-FDD | |
| OCNG Patterns defined in A.3.2.1.21 | | OP.21 FDD | |
| PBCH_RA | dB | 0 | |
| PBCH_RB | dB | | |
| PSS_RA | dB | | |
| SSS_RA | dB | | |
| PCFICH_RB | dB | | |
| PHICH_RA | dB | | |
| PHICH_RB | dB | | |
| MPDCCH_RA | dB | | |
| MPDCCH_RB | dB | | |
| PDCCH_RA | dB | | |
| PDCCH_RB | dB | | |
| PDSCH_RA | dB | | |
| PDSCH_RB | dB | | |
| OCNG_RA ^{Note1} | dB | | |
| OCNG_RB ^{Note1} | dB | | |
| Timing Advance Command (T_A) | | 31 | 39 |
| \hat{E}_s / I_{ot} | dB | 3 | |
| N_{oc} | dBm/15 KHz | -98 | |
| \hat{E}_s / N_{oc} | dB | 3 | |
| I_o ^{Note2} | dBm/9 MHz | -65.5 | |
| Propagation Condition | | AWGN | |
| Note 1: OCNG shall be used such that both cells are fully allocated and a constant total transmitted power spectral density is achieved for all OFDM symbols. | | | |
| Note 2: I_o level has been derived from other parameters for information purpose. It is not a settable parameter. | | | |

Table A.7.2.7.1-3: Sounding Reference Symbol Configuration for E-UTRAN HD-FDD Transmit Timing Accuracy Test for Cat-M1 UE in CEModeA

| Field | Value | Comment |
|--|-------|---|
| srsBandwidthConfiguration | Bw5 | |
| srsSubframeConfiguration | sc3 | Once every 5 subframes |
| ackNackSrsSimultaneousTransmission | FALSE | |
| srsMaxUpPTS | N/A | |
| srsBandwidth | 0 | No hopping |
| srsHoppingBandwidth | hbw0 | |
| frequencyDomainPosition | 0 | |
| Duration | TRUE | Indefinite duration |
| Srs-ConfigurationIndex | 17 | SRS periodicity of 20. |
| transmissionComb | 0 | |
| cyclicShift | cs0 | No cyclic shift |
| SRS-AntennaPort | an1 | Number of antenna ports used for SRS transmission |
| Note 1: For further information see clause 6.3.2 in TS 36.331. | | |

A.7.2.7.2 Test Requirements

The UE shall apply the signalled Timing Advance value to the transmission timing at the designated activation time i.e. 6 sub frames after the reception of the timing advance command.

The Timing Advance adjustment accuracy shall be within the limits specified in clause 7.3.2.2.

The rate of correct Timing Advance adjustments observed during repeated tests shall be at least 90%.

A.7.2.8 E-UTRAN TDD Timing Advance Adjustment Accuracy Test for Cat-M1 UE in CEModeA

A.7.2.8.1 Test Purpose and Environment

The purpose of the test is to verify E-UTRAN TDD Timing Advance adjustment accuracy requirements for Cat-M1 UE configured with CEModeA, defined in clause 7.3.2.2, in an AWGN model.

The test parameters are given in tables A.7.2.8.1-1, A.7.2.8.1-2, and A.7.2.8-3. The test consists of two successive time periods, with time duration of T1 and T2 respectively. In each time period, timing advance commands are sent to the UE and Sounding Reference Signals (SRS), as specified in table A.7.2.8.1-3, are sent from the UE and received by the test equipment. By measuring the reception of the SRS, the transmit timing, and hence the timing advance adjustment accuracy, can be measured.

During time period T1, the test equipment shall send one message with a Timing Advance Command MAC Control Element, as specified in Clause 6.1.3.5 in TS 36.321. The Timing Advance Command value shall be set to 31, which according to Clause 4.2.3 in TS 36.213 results in zero adjustment of the Timing Advance. In this way, a reference value for the timing advance used by the UE is established.

During time period T2, the test equipment shall send a sequence of messages with Timing Advance Command MAC Control Elements, with Timing Advance Command value specified in table A.7.2.8.1-2. This value shall result in changes of the timing advance used by the UE, and the accuracy of the change shall then be measured, using the SRS sent from the UE.

As specified in Clause 7.3.2.1, the UE adjusts its uplink timing at sub-frame n+6 for a timing advance command received in sub-frame n. This delay must be taken into account when measuring the timing advance adjustment accuracy, via the SRS sent from the UE.

The UE Time Alignment Timer, described in Clause 5.2 in TS 36.321, shall be configured so that it does not expire in the duration of the test.

Table A.7.2.8.1-1: General Test Parameters for E-UTRAN TDD Timing Advance Accuracy Test for Cat-M1 UE in CEModeA

| Parameter | Unit | Value | Comment |
|--|------|----------|--|
| PDSCH parameters: DL Reference Measurement Channel | | R.16 TDD | As specified in clause A.3.1.4.3 |
| MPDCCH parameters: DL Reference Measurement Channel | | R.14 TDD | As specified in clause A.3.1.3.3 |
| Timing Advance Command (T_A) value during T1 | | 31 | $N_{TA} = 0$ for the purpose of establishing a reference value from which the timing advance adjustment accuracy can be measured during T2 |
| Timing Advance Command (T_A) value during T2 | | 39 | $N_{TA} = 128$ |
| DRX | | OFF | |
| T1 | s | 5 | |
| T2 | s | 5 | |

Table A.7.2.8.1-2: Cell specific Test Parameters for E-UTRAN TDD Timing Advance Accuracy Test for Cat-M1 UE in CEModeA

| Parameter | Unit | Value | |
|---|------|----------|----|
| | | T1 | T2 |
| E-UTRA RF Channel Number | | 1 | |
| $BW_{channel}$ | MHz | 10 | |
| PDSCH parameters: DL Reference Measurement Channel | | R.16 TDD | |

| | | | |
|---|------------|-----------|----|
| MPDCCH parameters: DL Reference Measurement Channel | | R.14 TDD | |
| Special subframe configuration ^{Note1} | | 6 | |
| Uplink-downlink configuration ^{Note2} | | 1 | |
| OCNG Patterns defined in A.3.2.2.11 | | OP.11 TDD | |
| PBCH_RA | dB | 0 | |
| PBCH_RB | dB | | |
| PSS_RA | dB | | |
| SSS_RA | dB | | |
| PCFICH_RB | dB | | |
| PHICH_RA | dB | | |
| PHICH_RB | dB | | |
| MPDCCH_RA | dB | | |
| MPDCCH_RB | dB | | |
| PDCCH_RA | dB | | |
| PDCCH_RB | dB | | |
| PDSCH_RA | dB | | |
| PDSCH_RB | dB | | |
| OCNG_RA ^{Note3} | dB | | |
| OCNG_RB ^{Note3} | dB | | |
| Timing Advance Command (T_A) | | 31 | 39 |
| \hat{E}_s / I_{ot} | dB | 3 | |
| N_{oc} | dBm/15 KHz | -98 | |
| \hat{E}_s / N_{oc} | dB | 3 | |
| I_o ^{Note4} | dBm/9 MHz | -65.5 | |
| Propagation Condition | | AWGN | |
| <p>Note 1: For the special subframe configuration see table 4.2-1 in TS 36.211.</p> <p>Note 2: For the uplink-downlink configuration see table 4.2-2 in TS 36.211.</p> <p>Note 3: OCNG shall be used such that both cells are fully allocated and a constant total transmitted power spectral density is achieved for all OFDM symbols.</p> <p>Note 4: I_o level has been derived from other parameters for information purpose. It is not a settable parameter.</p> | | | |

Table A.7.2.8.1-3: Sounding Reference Symbol Configuration for E-UTRAN TDD Transmit Timing Accuracy Test for Cat-M1 UE in CEModeA

| Field | Value | Comment |
|--|-------|---|
| srsBandwidthConfiguration | Bw5 | |
| srsSubframeConfiguration | sc3 | Once every 5 subframes |
| ackNackSrsSimultaneousTransmission | FALSE | |
| srsMaxUpPTS | N/A | |
| srsBandwidth | bw0 | No hopping |
| srsHoppingBandwidth | hbw0 | |
| frequencyDomainPosition | 0 | |
| Duration | TRUE | Indefinite duration |
| Srs-ConfigurationIndex | 15 | SRS periodicity of 10ms. |
| transmissionComb | 0 | |
| cyclicShift | cs0 | No cyclic shift |
| SRS-AntennaPort | an1 | Number of antenna ports used for SRS transmission |
| Note 1: For further information see clause 6.3.2 in TS 36.331. | | |

A.7.2.8.2 Test Requirements

The UE shall apply the signalled Timing Advance value to the transmission timing at the designated activation time i.e. 6 sub frames after the reception of the timing advance command.

The Timing Advance adjustment accuracy shall be within the limits specified in clause 7.3.2.2.

The rate of correct Timing Advance adjustments observed during repeated tests shall be at least 90%.

A.7.2.9 Void

A.7.2.10 Void

A.7.2.11 Void

A.7.2.9 HD-FDD UE Timing Advance Adjustment Accuracy Test for UE Category NB1 in Standalone Mode under Enhance Coverage

A.7.2.9.1 Test Purpose and Environment

The purpose of the test is to verify E-UTRAN Timing Advance adjustment accuracy requirements for UE category NB1 in enhanced coverage, defined in clause 7.22.2.2, in an AWGN model.

The test parameters are given in tables A.7.2.9.1-1 and A.7.2.9.1-2. The test consists of two successive time periods, with time duration of T1 and T2 respectively. In each time period, timing advance commands are sent to the UE and the UE is scheduled in every uplink subframe to transmit NPUSCH, which is received by the test equipment. By measuring the reception of the NPUSCH, the transmit timing, and hence the timing advance adjustment accuracy, can be measured.

During time period T1, the test equipment shall send one message with a Timing Advance Command MAC Control Element, as specified in Clause 6.1.3.5 in TS 36.321. The Timing Advance Command value shall be set to 31, which according to Clause 16.1.2 in TS 36.213 results in zero adjustment of the Timing Advance. In this way, a reference value for the timing advance used by the UE is established.

During time period T2, the test equipment shall send a sequence of messages with Timing Advance Command MAC Control Elements, with Timing Advance Command value specified in table A.7.2.9.1-2. This value shall result in changes of the timing advance used by the UE, and the accuracy of the change shall then be measured, using the NPUSCH sent from the UE.

As specified in Clause 7.22.2.1, the UE adjusts its uplink timing at sub-frame $n+12$ for a timing advance command received in sub-frame n , where sub-frame n refers to the last subframe in the repetition period in which the MAC control element containing timing advance command was received. In addition, the UE shall not apply a TA command during an uplink repetition period. The timing advance adjustment accuracy is verified via the uplink transmission of NPUSCH carrying ACK/NACK response to the NPDSCH carrying TA command. k_0 in ACK/NACK resource filed in DCI is set as 13.

The UE Time Alignment Timer, described in Clause 5.2 in TS 36.321, shall be configured so that it does not expire in the duration of the test.

Table A.7.2.9.1-1: General Test Parameters for E-UTRAN Timing Advance Accuracy Test for UE Category NB1 in Standalone Mode under Enhanced Coverage

| Parameter | Unit | Value | Comment |
|--|--------|------------|--|
| NB-IoT operational mode | | Standalone | |
| CP Length | | Normal | |
| Timing Advance Command (T_A) value during T1 | | 31 | $N_{TA} = 0$ for the purpose of establishing a reference value from which the timing advance adjustment accuracy can be measured during T2 |
| Timing Advance Command (T_A) value during T2 | | 39 | $N_{TA} = 128$ |
| Number of repetitions | NPDCCH | 128 | |
| | NPDSCH | 128 | |
| | NPUSCH | 32 | |
| DRX | | OFF | |

| | | | |
|----|---|---|--|
| T1 | s | 5 | |
| T2 | s | 5 | |

Table A.7.2.7.1-2: Cell specific Test Parameters for E-UTRAN Timing Advance Accuracy Test for UE Category NB1 in Standalone Mode under Enhanced Coverage

| Parameter | Unit | Value | |
|--|--------------|-------------|----|
| | | T1 | T2 |
| E-UTRA RF Channel Number | | 1 | |
| BW _{channel} | KHz | 200 | |
| NPDSCH parameters: DL Reference Measurement Channel defined in A.3.1.5.3 | | R.18 HD-FDD | |
| NPDCCH parameters: DL Reference Measurement Channel defined in A.3.1.6.3 | | R.30 HD-FDD | |
| NOCNG Patterns defined in A.3.2.3.3 | | NOP.3 FDD | |
| NPBCH_RA | dB | 0 | |
| NPBCH_RB | dB | | |
| NPSS_RA | dB | | |
| NSSS_RA | dB | | |
| NPDCCH_RA | dB | | |
| NPDCCH_RB | dB | | |
| NPDSCH_RA | dB | | |
| NPDSCH_RB | dB | | |
| NOCNG_RA ^{Note1} | dB | | |
| NOCNG_RB ^{Note1} | dB | | |
| Timing Advance Command (T_A) | | 31 | 39 |
| \hat{E}_s / I_{ot} | dB | -12 | |
| N_{oc} | dBm/15 KHz | -88 | |
| \hat{E}_s / N_{oc} | dB | -12 | |
| I_o ^{Note2} | dBm/ 180 KHz | -76.9 | |
| Antenna Configuration | | 1x1 | |
| Propagation Condition | | AWGN | |
| Note 1: OCNG shall be used such that the cell is fully allocated and a constant total transmitted power spectral density is achieved for all OFDM symbols. | | | |
| Note 2: I_o level has been derived from other parameters for information purpose. It is not a settable parameter. | | | |

A.7.2.9.2 Test Requirements

The UE shall apply the signalled Timing Advance value to the transmission timing at subframe $n+12$, where subframe n is the last subframe in the repetition period of NPDSCH in which the timing advance command is received by the UE.

The Timing Advance adjustment accuracy shall be within the limits specified in clause 7.22.2.2.

The rate of correct Timing Advance adjustments observed during repeated tests shall be at least 90%.

A.7.2.10 E-UTRAN FDD UE Timing Advance Adjustment Accuracy Test in CEModeB

A.7.2.10.1 Test Purpose and Environment

The purpose of the test is to verify E-UTRAN FDD Timing Advance adjustment accuracy requirements for Cat-M1 UE configured with CEModeB, defined in clause 7.3.2.2, in an AWGN model.

The test parameters are given in tables A.7.2.10.1-1 and A.7.2.10.1-2. The test consists of two successive time periods, with time duration of T1 and T2 respectively. In each time period, timing advance commands are sent to the UE and

PUSCH are sent from the UE and received by the test equipment. By measuring the reception of the PUSCH, the transmit timing, and hence the timing advance adjustment accuracy, can be measured.

During time period T1, the test equipment shall send one message with a Timing Advance Command MAC Control Element, as specified in Clause 6.1.3.5 in TS 36.321. The Timing Advance Command value shall be set to 31, which according to Clause 4.2.3 in TS 36.213 results in zero adjustment of the Timing Advance. In this way, a reference value for the timing advance used by the UE is established.

During time period T2, the test equipment shall send a sequence of messages with Timing Advance Command MAC Control Elements, with Timing Advance Command value specified in table A.7.2.10.1-2. This value shall result in changes of the timing advance used by the UE, and the accuracy of the change shall then be measured, using PUSCH sent from the UE.

As specified in Clause 7.3.2.1, the UE adjusts its uplink timing at sub-frame n+6 for a timing advance command received in sub-frame n. This delay must be taken into account when measuring the timing advance adjustment accuracy, via PUSCH sent from the UE.

The UE Time Alignment Timer, described in Clause 5.2 in TS 36.321, shall be configured so that it does not expire in the duration of the test.

Table A.7.2.10.1-1: General Test Parameters for E-UTRAN FDD UE Timing Advance Adjustment Accuracy Test in CEModeB

| Parameter | Unit | Value | Comment |
|--|------|-------|--|
| Timing Advance Command (T_A) value during T1 | | 31 | $N_{TA} = 0$ for the purpose of establishing a reference value from which the timing advance adjustment accuracy can be measured during T2 |
| Timing Advance Command (T_A) value during T2 | | 39 | $N_{TA} = 128$ |
| DRX | | OFF | |
| T1 | s | 5 | |
| T2 | s | 5 | |
| Number of repetitions of MPDCCH | | 128 | |
| Number of repetitions of PUSCH | | 32 | |

Table A.7.2.10.1-2: Cell specific Test Parameters for E-UTRAN FDD UE Timing Advance Adjustment Accuracy Test in CEModeB

| Parameter | Unit | Value | | | |
|--|------------|-----------|----|-----|----|
| | | T1 | T2 | | |
| E-UTRA RF Channel Number | | 1 | | | |
| $BW_{channel}$ | MHz | 10 | | | |
| PDSCH Reference Measurement Channel in clause A.3.1.4.4 | | R.22 FDD | | | |
| MPDCCH Reference Measurement Channel in clause A.3.1.3.4 | | R.18 FDD | | | |
| OCNG Patterns defined in A.3.2.1.21 | | OP.21 FDD | | | |
| PBCH_RA | dB | 0 | | | |
| PBCH_RB | dB | | | | |
| PSS_RA | dB | | | | |
| SSS_RA | dB | | | | |
| PHICH_RA | dB | | | | |
| PHICH_RB | dB | | | | |
| MPDCCH_RA | dB | | | | |
| MPDCCH_RB | dB | | | | |
| PDSCH_RA | dB | | | | |
| PDSCH_RB | dB | | | | |
| OCNG_RA ^{Note1} | dB | | | | |
| OCNG_RB ^{Note1} | dB | | | | |
| Timing Advance Command (T_A) | | | | 31 | 39 |
| N_{oc} | dBm/15 KHz | | | -98 | |
| \hat{E}_s / N_{oc} | dB | -12 | | | |

| | | |
|---|------------|--------|
| \hat{E}_s / I_{ot} ^{Note2} | dB | -12 |
| RSRP ^{Note2} | dBm/15 KHz | -110 |
| I_o ^{Note2} | dBm/9 MHz | -69.95 |
| Propagation Condition | | AWGN |
| Antenna Configuration | | 1x1 |
| Note 1: OCNG shall be used such that cells is fully allocated and a constant total transmitted power spectral density is achieved for all OFDM symbols. | | |
| Note 2: \hat{E}_s / I_{ot} , RSRP, I_o level has been derived from other parameters for information purpose. It is not a settable parameter. | | |

A.7.2.10.2 Test Requirements

The UE shall apply the signalled Timing Advance value to the transmission timing at the designated activation time i.e. 6 subframes after the reception of the timing advance command.

The Timing Advance adjustment accuracy shall be within the limits specified in clause 7.3.2.2.

The rate of correct Timing Advance adjustments observed during repeated tests shall be at least 90%.

When a repetition period is configured on the uplink, the UE shall not adjust the uplink transmission timing autonomously during an ongoing repetition period for which $R > 1$.

A.7.2.11 E-UTRAN HD-FDD UE Timing Advance Adjustment Accuracy Test in CEModeB

A.7.2.11.1 Test Purpose and Environment

The purpose of the test is to verify E-UTRAN HD-FDD Timing Advance adjustment accuracy requirements for Cat-M1 UE configured with CEModeB, defined in clause 7.3.2.2, in an AWGN model.

The test parameters are given in tables A.7.2.11.1-1 and A.7.2.11.1-2. The test consists of two successive time periods, with time duration of T1 and T2 respectively. In each time period, timing advance commands are sent to the UE and PUSCH are sent from the UE and received by the test equipment. By measuring the reception of the PUSCH, the transmit timing, and hence the timing advance adjustment accuracy, can be measured.

During time period T1, the test equipment shall send one message with a Timing Advance Command MAC Control Element, as specified in Clause 6.1.3.5 in TS 36.321. The Timing Advance Command value shall be set to 31, which according to Clause 4.2.3 in TS 36.213 results in zero adjustment of the Timing Advance. In this way, a reference value for the timing advance used by the UE is established.

During time period T2, the test equipment shall send a sequence of messages with Timing Advance Command MAC Control Elements, with Timing Advance Command value specified in table A.7.2.11.1-2. This value shall result in changes of the timing advance used by the UE, and the accuracy of the change shall then be measured, using PUSCH sent from the UE.

As specified in Clause 7.3.2.1, the UE adjusts its uplink timing at sub-frame $n+6$ for a timing advance command received in sub-frame n . This delay must be taken into account when measuring the timing advance adjustment accuracy, via PUSCH sent from the UE.

The UE Time Alignment Timer, described in Clause 5.2 in TS 36.321, shall be configured so that it does not expire in the duration of the test.

Table A.7.2.11.1-1: General Test Parameters for E-UTRAN HD-FDD UE Timing Advance Adjustment Accuracy Test in CEModeB

| Parameter | Unit | Value | Comment |
|--|------|-------|--|
| Timing Advance Command (T_A) value during T1 | | 31 | $N_{TA} = 0$ for the purpose of establishing a reference value from which the timing advance adjustment accuracy can be measured during T2 |

| | | | |
|--|---|-----|----------------|
| Timing Advance Command (T_A) value during T2 | | 39 | $N_{TA} = 128$ |
| DRX | | OFF | |
| T1 | s | 5 | |
| T2 | s | 5 | |
| Number of repetitions of MPDCCH | | 128 | |
| Number of repetitions of PUSCH | | 32 | |

Table A.7.2.11.1-2: Cell specific Test Parameters for E-UTRAN HD-FDD UE Timing Advance Adjustment Accuracy Test in CEModeB

| Parameter | Unit | Value | |
|---|------------|-------------|----|
| | | T1 | T2 |
| E-UTRA RF Channel Number | | 1 | |
| $BW_{channel}$ | MHz | 10 | |
| PDSCH Reference Measurement Channel in clause A.3.1.4.5 | | R.12 HD-FDD | |
| MPDCCH Reference Measurement Channel in clause A.3.1.3.5 | | R.8 HD-FDD | |
| OCNG Patterns defined in A.3.2.1.21 | | OP.21 FDD | |
| PBCH_RA | dB | 0 | |
| PBCH_RB | dB | | |
| PSS_RA | dB | | |
| SSS_RA | dB | | |
| PHICH_RA | dB | | |
| PHICH_RB | dB | | |
| PDCCH_RA | dB | | |
| PDCCH_RB | dB | | |
| PDSCH_RA | dB | | |
| PDSCH_RB | dB | | |
| OCNG_RA ^{Note1} | dB | | |
| OCNG_RB ^{Note1} | dB | | |
| Timing Advance Command (T_A) | | 31 | 39 |
| N_{oc} | dBm/15 KHz | -98 | |
| \hat{E}_s / N_{oc} | dB | -12 | |
| \hat{E}_s / I_{ot} ^{Note2} | dB | -12 | |
| RSRP ^{Note2} | dBm/15 KHz | -110 | |
| I_o ^{Note2} | dBm/9 MHz | -69.95 | |
| Propagation Condition | | AWGN | |
| Antenna Configuration | | 1x1 | |
| Note 1: OCNG shall be used such that both cells are fully allocated and a constant total transmitted power spectral density is achieved for all OFDM symbols. | | | |
| Note 2: \hat{E}_s / I_{ot} , RSRP, I_o level has been derived from other parameters for information purpose. It is not a settable parameter. | | | |

A.7.2.11.2 Test Requirements

The UE shall apply the signalled Timing Advance value to the transmission timing at the designated activation time i.e. 6 sub frames after the reception of the timing advance command.

The Timing Advance adjustment accuracy shall be within the limits specified in clause 7.3.2.2.

The rate of correct Timing Advance adjustments observed during repeated tests shall be at least 90%.

When a repetition period is configured on the uplink, the UE shall not adjust the uplink transmission timing autonomously during an ongoing repetition period for which $R > 1$.

A.7.2.12 E-UTRAN TDD UE Timing Advance Adjustment Accuracy Test in CEModeB

A.7.2.12.1 Test Purpose and Environment

The purpose of the test is to verify E-UTRAN TDD Timing Advance adjustment accuracy requirements for Cat-M1 UE configured with CEModeB, defined in clause 7.3.2.2, in an AWGN model.

The test parameters are given in tables A.7.2.12.1-1 and A.7.2.12.1-2. The test consists of two successive time periods, with time duration of T1 and T2 respectively. In each time period, timing advance commands are sent to the UE and PUSCH are sent from the UE and received by the test equipment. By measuring the reception of the PUSCH, the transmit timing, and hence the timing advance adjustment accuracy, can be measured.

During time period T1, the test equipment shall send one message with a Timing Advance Command MAC Control Element, as specified in Clause 6.1.3.5 in TS 36.321. The Timing Advance Command value shall be set to 31, which according to Clause 4.2.3 in TS 36.213 results in zero adjustment of the Timing Advance. In this way, a reference value for the timing advance used by the UE is established.

During time period T2, the test equipment shall send a sequence of messages with Timing Advance Command MAC Control Elements, with Timing Advance Command value specified in table A.7.2.12.1-2. This value shall result in changes of the timing advance used by the UE, and the accuracy of the change shall then be measured, using PUSCH sent from the UE.

As specified in Clause 7.3.2.1, the UE adjusts its uplink timing at sub-frame $n+6$ for a timing advance command received in sub-frame n . This delay must be taken into account when measuring the timing advance adjustment accuracy, via PUSCH sent from the UE.

The UE Time Alignment Timer, described in Clause 5.2 in TS 36.321, shall be configured so that it does not expire in the duration of the test.

Table A.7.2.12.1-1: General Test Parameters for E-UTRAN TDD UE Timing Advance Adjustment Accuracy Test in CEModeB

| Parameter | Unit | Value | Comment |
|--|------|-------|--|
| Timing Advance Command (T_A) value during T1 | | 31 | $N_{TA} = 0$ for the purpose of establishing a reference value from which the timing advance adjustment accuracy can be measured during T2 |
| Timing Advance Command (T_A) value during T2 | | 39 | $N_{TA} = 128$ |
| DRX | | OFF | |
| T1 | s | 5 | |
| T2 | s | 5 | |
| Number of repetitions of MPDCCH | | 128 | |
| Number of repetitions of PUSCH | | 32 | |

Table A.7.2.12.1-2: Cell specific Test Parameters for E-UTRAN TDD UE Timing Advance Adjustment Accuracy Test in CEModeB

| Parameter | Unit | Value | |
|--|------|-------|-----------|
| | | T1 | T2 |
| E-UTRA RF Channel Number | | | 1 |
| $BW_{channel}$ | MHz | | 10 |
| PDSCH Reference Measurement Channel in clause A.3.1.4.6 | | | R.18 TDD |
| MPDCCH Reference Measurement Channel in clause A.3.1.3.6 | | | R.16 TDD |
| Special subframe configuration ^{Note1} | | | 6 |
| Uplink-downlink configuration ^{Note2} | | | 1 |
| OCNG Patterns defined in A.3.2.2.11 | | | OP.11 TDD |
| PBCH_RA | dB | | 0 |
| PBCH_RB | dB | | |
| PSS_RA | dB | | |
| SSS_RA | dB | | |

| | | | |
|--|------------|----|--------|
| PHICH_RA | dB | | |
| PHICH_RB | dB | | |
| PDCCH_RA | dB | | |
| PDCCH_RB | dB | | |
| PDSCH_RA | dB | | |
| PDSCH_RB | dB | | |
| OCNG_RA ^{Note3} | dB | | |
| OCNG_RB ^{Note3} | dB | | |
| Timing Advance Command (T_A) | | 31 | 39 |
| N_{oc} | dBm/15 KHz | | -98 |
| \hat{E}_s/N_{oc} | dB | | -12 |
| \hat{E}_s/I_{ot} ^{Note4} | dB | | -12 |
| RSRP ^{Note4} | dBm/15 KHz | | -110 |
| I_o ^{Note4} | dBm/9 MHz | | -69.95 |
| Propagation Condition | | | AWGN |
| Antenna Configuration | | | 1x1 |
| <p>Note 1: For the special subframe configuration see table 4.2-1 in TS 36.211.</p> <p>Note 2: For the uplink-downlink configuration see table 4.2-2 in TS 36.211.</p> <p>Note 3: OCNG shall be used such that both cells are fully allocated and a constant total transmitted power spectral density is achieved for all OFDM symbols.</p> <p>Note 4: \hat{E}_s/I_{ot}, RSRP, I_o level has been derived from other parameters for information purpose. It is not a settable parameter.</p> | | | |

A.7.2.12.2 Test Requirements

The UE shall apply the signalled Timing Advance value to the transmission timing at the designated activation time i.e. 6 sub frames after the reception of the timing advance command.

The Timing Advance adjustment accuracy shall be within the limits specified in clause 7.3.2.2.

The rate of correct Timing Advance adjustments observed during repeated tests shall be at least 90%.

When a repetition period is configured on the uplink, the UE shall not adjust the uplink transmission timing autonomously during an ongoing repetition period for which $R > 1$.

A.7.3 Radio Link Monitoring

In the following section, any uplink signal transmitted by the UE is used for detecting the In-/Out-of-Sync state of the UE. In terms of measurement, the uplink signal is verified on the basis of the UE output power:

For intra-band contiguous carrier aggregation, transmit OFF power is measured as the mean power per component carrier.

For UE with multiple transmit antennas, transmit OFF power is measured as the mean power at each transmit connector.

- UE output power higher than Transmit OFF power -50 dBm (as defined in TS 36.101 [5]) means uplink signal
- UE output power equal to or less than Transmit OFF power -50 dBm (as defined in TS 36.101 [5]) means no uplink signal.

A.7.3.1 E-UTRAN FDD Radio Link Monitoring Test for Out-of-sync

A.7.3.1.1 Test Purpose and Environment

The purpose of this test is to verify that the UE properly detects the out of sync and in sync for the purpose of monitoring downlink radio link quality of the PCell. This test will partly verify the E-UTRAN FDD radio link monitoring requirements in clause 7.6.

The test parameters are given in Tables A.7.3.1.1-1, A.7.3.1.1-2 and A.7.3.1.1-3 below. There is one cell (cell 1), which is the active cell, in the test. The test consists of three successive time periods, with time duration of T1, T2 and T3 respectively. Figure A.7.3.1.1-1 shows the variation of the downlink SNR in the active cell to emulate out-of-sync and in-sync states. Prior to the start of the time duration T1, the UE shall be fully synchronized to cell 1. The UE shall be configured for periodic CQI reporting in PUCCH 1-0 mode with a reporting periodicity of 2 ms.

Table A.7.3.1.1-1: General test parameters for E-UTRAN FDD out-of-sync testing

| Parameter | | Unit | Value | | | | Comment |
|--|---------------------------------|------|----------------|----------------|----------------|----------------|--|
| | | | Test 1 | Test 2 | Test 3 | Test 4 | |
| PCFICH/PDCCH/PHICH parameters | | | R.6 FDD | R.7 FDD | R.6 FDD | R.7 FDD | As specified in section A.3.1.2.1. None of the PDCCH are intended for the UE under test |
| OCNG parameters | | | OP.2 FDD | OP.2 FDD | OP.2 FDD | OP.2 FDD | As specified in section A.3.2.1.2. |
| Active cell | | | Cell 1 | Cell 1 | Cell 1 | Cell 1 | Cell 1 is on E-UTRA RF channel number 1 |
| CP length | | | Normal | Normal | Normal | Normal | |
| E-UTRA RF Channel Number | | | 1 | 1 | 1 | 1 | One E-UTRA FDD carrier frequency is used. |
| E-UTRA Channel Bandwidth (BW _{channel}) | | MHz | 10 | 10 | 10 | 10 | |
| Correlation Matrix and Antenna Configuration | | | 1x2 | 2x2 | 1x2 Low | 2x2 Low | Correlation Matrix and Antenna Configuration are defined in TS 36.101 [5] Annex B.2.3.2 |
| Out of sync transmission parameters (Note 1) | DCI format | | 1A | 1A | 1A | 1A | As defined in section 5.3.3.1.3 in TS 36.212 |
| | Number of Control OFDM symbols | | 2 | 2 | 2 | 2 | Out of sync threshold Q _{out} and the corresponding hypothetical PDCCH/PCFICH transmission parameters are as specified in section 7.6.1 and Table 7.6.1-1 respectively. |
| | Aggregation level | CCE | 8 | 8 | 8 | 8 | |
| | ρ _A , ρ _B | | 0 | -3 | 0 | -3 | |
| | Ratio of PDCCH to RS EPRE | dB | 4 | 1 | 4 | 1 | |
| | Ratio of PCFICH to RS EPRE | dB | 4 | 1 | 4 | 1 | |
| DRX | | | OFF | OFF | OFF | OFF | |
| Layer 3 filtering | | | <i>Enabled</i> | <i>Enabled</i> | <i>Enabled</i> | <i>Enabled</i> | <i>Counters: N310 = 1; N311 = 1</i> |
| T310 timer | | ms | 0 | 0 | 0 | 0 | <i>T310 is disabled</i> |
| T311 timer | | ms | 1000 | 1000 | 1000 | 1000 | T311 is enabled |
| Periodic CQI reporting mode | | | PUCCH 1-0 | PUCCH 1-0 | PUCCH 1-0 | PUCCH 1-0 | As defined in table 7.2.2-1 in TS 36.213. |
| CQI reporting periodicity | | ms | 2 | 2 | 2 | 2 | Minimum CQI reporting periodicity |
| Propagation channel | | | AWGN | AWGN | ETU 70 Hz | ETU 70 Hz | . |
| T1 | | s | 1 | 1 | 1 | 1 | |
| T2 | | s | 0.4 | 0.4 | 0.4 | 0.4 | |
| T3 | | s | 0.5 | 0.5 | 0.5 | 0.5 | |
| Note 1: PDCCH/PCFICH corresponding to the out of sync transmission parameters need not be included in the Reference Measurement Channel. | | | | | | | |

Table A.7.3.1.1-2: Cell specific test parameters for E-UTRAN FDD (cell # 1) for out-of-sync radio link monitoring tests # 1 and # 2

| Parameter | Unit | Test 1 | | | Test 2 | | |
|-----------|------|--------|----|----|--------|----|----|
| | | T1 | T2 | T3 | T1 | T2 | T3 |
| | | | | | | | |

| | | | | | | | |
|---------------------------------------|--|----------|------|-------|----------|------|-------|
| E-UTRA RF Channel Number | | 1 | | | 1 | | |
| BW _{channel} | MHz | 10 | | | 10 | | |
| Antenna Configuration | | 1x2 | | | 2x2 | | |
| OCNG Pattern defined in A.3.2.1 (FDD) | | OP.2 FDD | | | OP.2 FDD | | |
| ρ_A, ρ_B | | 0 | | | -3 | | |
| PCFICH_RB | dB | 4 | | | 1 | | |
| PDCCH_RA | dB | 4 | | | 1 | | |
| PDCCH_RB | dB | 4 | | | 1 | | |
| PBCH_RA | dB | 0 | | | -3 | | |
| PBCH_RB | dB | | | | | | |
| PSS_RA | dB | | | | | | |
| SSS_RA | dB | | | | | | |
| PHICH_RA | dB | | | | | | |
| PHICH_RB | dB | | | | | | |
| PDSCH_RA | dB | | | | | | |
| PDSCH_RB | dB | | | | | | |
| OCNG_RA ^{Note 1} | dB | | | | | | |
| OCNG_RB ^{Note 1} | dB | | | | | | |
| SNR ^{Note 6,7} | dB | -4.7 | -9.5 | -13.5 | -4.7 | -9.5 | -13.5 |
| N_{oc} | dBm/15 kHz | -98 | | | -98 | | |
| Propagation condition | | AWGN | | | AWGN | | |
| Note 1: | OCNG shall be used such that the resources in cell # 1 are fully allocated and a constant total transmitted power spectral density is achieved for all OFDM symbols. | | | | | | |
| Note 2: | The uplink resources for CQI reporting are assigned to the UE prior to the start of time period T1. | | | | | | |
| Note 3: | The timers and layer 3 filtering related parameters are configured prior to the start of time period T1. | | | | | | |
| Note 4: | The signal contains PDCCH for UEs other than the device under test as part of OCNG. | | | | | | |
| Note 5: | SNR levels correspond to the signal to noise ratio over the cell-specific reference signal REs. | | | | | | |
| Note 6: | The SNR in time periods T1, T2 and T3 is denoted as SNR1, SNR2 and SNR3 respectively in figure A.7.3.1.1-1. | | | | | | |
| Note 7: | The SNR values are specified for testing a UE which supports 2RX on at least one band. For testing of a UE which supports 4RX on all bands, the SNR during T3 is modified as specified in section A.3.8.1. | | | | | | |

Table A.7.3.1.1-3: Cell specific test parameters for E-UTRAN FDD (cell # 1) for out-of-sync radio link monitoring tests # 3 and # 4

| Parameter | Unit | Test 3 | | | Test 4 | | |
|---|------------|-----------|------|-------|-----------|------|-------|
| | | T1 | T2 | T3 | T1 | T2 | T3 |
| E-UTRA RF Channel Number | | 1 | | | 1 | | |
| $BW_{channel}$ | MHz | 10 | | | 10 | | |
| Correlation Matrix and Antenna Configuration | | 1x2 Low | | | 2x2 Low | | |
| OCNG Pattern defined in A.3.2.1 (FDD) | | OP.2 FDD | | | OP.2 FDD | | |
| P_A, P_B | | 0 | | | -3 | | |
| PCFICH_RB | dB | 4 | | | 1 | | |
| PDCCH_RA | dB | 4 | | | 1 | | |
| PDCCH_RB | dB | 4 | | | 1 | | |
| PBCH_RA | dB | 0 | | | -3 | | |
| PBCH_RB | dB | | | | | | |
| PSS_RA | dB | | | | | | |
| SSS_RA | dB | | | | | | |
| PHICH_RA | dB | | | | | | |
| PHICH_RB | dB | | | | | | |
| PDSCH_RA | dB | | | | | | |
| PDSCH_RB | dB | | | | | | |
| OCNG_RA ^{Note 1} | dB | | | | | | |
| OCNG_RB ^{Note 1} | dB | | | | | | |
| SNR ^{Note 6,7} | dB | -1.4 | -5.5 | -11.5 | -2.3 | -6.2 | -12.2 |
| N_{oc} | dBm/15 kHz | -98 | | | -98 | | |
| Propagation condition | | ETU 70 Hz | | | ETU 70 Hz | | |
| Note 1: OCNG shall be used such that the resources in cell # 1 are fully allocated and a constant total transmitted power spectral density is achieved for all OFDM symbols. Note 2: The uplink resources for CQI reporting are assigned to the UE prior to the start of time period T1. Note 3: The timers and layer 3 filtering related parameters are configured prior to the start of time period T1. Note 4: The signal contains PDCCH for UEs other than the device under test as part of OCNG. Note 5: SNR levels correspond to the signal to noise ratio over the cell-specific reference REs. Note 6: The SNR in time periods T1, T2 and T3 is denoted as SNR1, SNR2 and SNR3 respectively in figure A.7.3.1.1-1. Note 7: The SNR values are specified for testing a UE which supports 2RX on at least one band. For testing of a UE which supports 4RX on all bands, the SNR during T3 is modified as specified in section A.3.8.1. | | | | | | | |

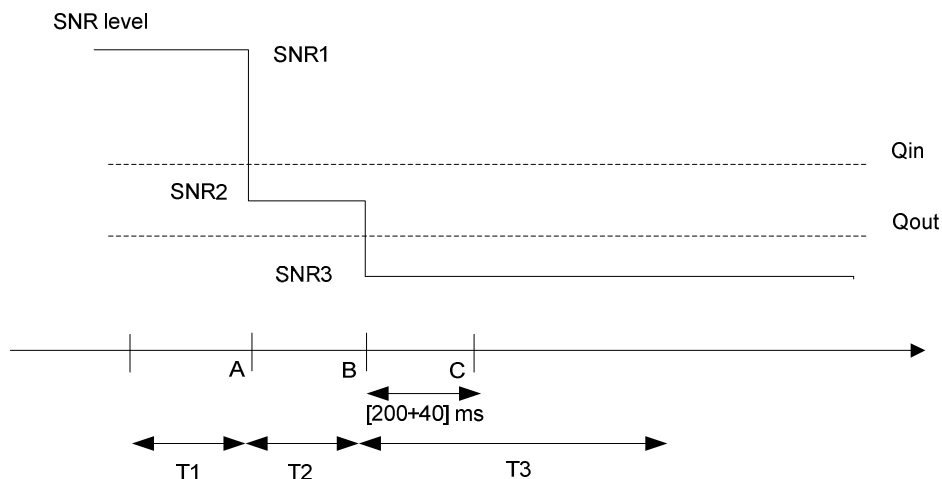

Figure A.7.3.1.1-1 SNR variation for out-of-sync testing

A.7.3.1.2 Test Requirements

The UE behaviour in each test during time durations T1, T2 and T3 shall be as follows:

During the period from time point A to time point B the UE shall transmit uplink signal at least in all subframes configured for CQI transmission according to the configured CQI reporting mode (PUCCH 1-0).

The UE shall stop transmitting uplink signal no later than time point C (240 ms after the start of time duration T3).

The rate of correct events observed during repeated tests shall be at least 90%.

A.7.3.2 E-UTRAN FDD Radio Link Monitoring Test for In-sync

A.7.3.2.1 Test Purpose and Environment

The purpose of this test is to verify that the UE properly detects the out of sync and in sync for the purpose of monitoring downlink radio link quality of the PCell. This test will partly verify the E-UTRAN FDD radio link monitoring requirements in clause 7.6.

The test parameters are given in Tables A.7.3.2.1-1 and A.7.3.2.1-2 below. There is one cell (cell 1), which is the active cell, in the test. The test consists of five successive time periods, with time duration of T1, T2, T3, T4 and T5 respectively. Figure A.7.3.2.1-1 shows the variation of the downlink SNR in the active cell to emulate out-of-sync and in-sync states. Prior to the start of the time duration T1, the UE shall be fully synchronized to cell 1. The UE shall be configured for periodic CQI reporting in PUCCH 1-0 mode with a reporting periodicity of 2 ms.

Table A.7.3.2.1-1: General test parameters for E-UTRAN FDD in-sync testing

| Parameter | | Unit | Value | | Comment |
|--|--------------------------------|------|----------|----------|--|
| | | | Test 1 | Test 2 | |
| PCFICH/PDCCH/PHICH parameters | | | R.6 FDD | R.7 FDD | As specified in clause A.3.1.2.1. None of the PDCCH are intended for the UE under test |
| OCNG parameters | | | OP.2 FDD | OP.2 FDD | As specified in clause A.3.2.1.2. |
| Active cell | | | Cell 1 | Cell 1 | Cell 1 is on E-UTRA RF channel number 1 |
| CP length | | | Normal | Normal | |
| E-UTRA RF Channel Number | | | 1 | 1 | One E-UTRA FDD carrier frequency is used. |
| E-UTRA Channel Bandwidth ($BW_{channel}$) | | MHz | 10 | 10 | |
| Correlation Matrix and Antenna Configuration | | | 1x2 Low | 2x2 Low | Correlation Matrix and Antenna Configuration are defined in TS 36.101 [5] Annex B.2.3.2 |
| In sync transmission parameters (Note 1) | DCI format | | 1C | 1C | As defined in clause 5.3.3.1.4 in TS 36.212 |
| | Number of Control OFDM symbols | | 2 | 2 | In sync threshold Q_{in} and the corresponding hypothetical PDCCH/PCFICH transmission parameters |
| | Aggregation level | CCE | 4 | 4 | |

| | | | | | |
|--|--------------------------------|-----|-----------|-----------|--|
| | ρ_A, ρ_B | | 0 | -3 | are as specified in clause and Table 7.6.1-2 respectively. |
| | Ratio of PDCCH to RS EPRE | | 0 | -3 | |
| | Ratio of PCFICH to RS EPRE | | 4 | 1 | |
| Out of sync transmission parameters (Note 1) | DCI format | | 1A | 1A | As defined in clause 5.3.3.1.3 in TS 36.212 |
| | Number of Control OFDM symbols | | 2 | 2 | Out of sync threshold Q_{out} and the corresponding hypothetical PDCCH/PCFICH transmission parameters are as specified in clause 7.6.1 and Table 7.6.1-1 respectively. |
| | Aggregation level | CCE | 8 | 8 | |
| | ρ_A, ρ_B | | 0 | -3 | |
| | Ratio of PDCCH to RS EPRE | dB | 4 | 1 | |
| | Ratio of PCFICH to RS EPRE | dB | 4 | 1 | |
| DRX | | | OFF | OFF | |
| Layer 3 filtering | | | Enabled | Enabled | Counters: N310 = 1; N311 = 1 |
| T310 timer | | ms | 2000 | 2000 | T310 is enabled |
| T311 timer | | ms | 1000 | 1000 | T311 is enabled |
| Periodic CQI reporting mode | | | PUCCH 1-0 | PUCCH 1-0 | As defined in table 7.2.2-1 in TS 36.213. |
| CQI reporting periodicity | | ms | 2 | 2 | Minimum CQI reporting periodicity |
| Propagation channel | | | ETU 70 Hz | ETU 70 Hz | |
| T1 | | s | 0.5 | 0.5 | |
| T2 | | s | 0.4 | 0.4 | |
| T3 | | s | 1.46 | 1.46 | |
| T4 | | s | 0.4 | 0.4 | |
| T5 | | s | 1 | 1 | |
| Note 1: PDCCH/PCFICH corresponding to the in-sync and out of sync transmission parameters need not be included in the Reference Measurement Channel. | | | | | |

Table A.7.3.2.1-2: Cell specific test parameters for E-UTRAN FDD (cell # 1) for in-sync radio link monitoring tests # 1 and # 2

| Parameter | Unit | Test 1 | | | | | Test 2 | | | | |
|--|------|---------|----|----|----|----|---------|----|----|----|----|
| | | T1 | T2 | T3 | T4 | T5 | T1 | T2 | T3 | T4 | T5 |
| E-UTRA RF Channel Number | | 1 | | | | | 1 | | | | |
| BW _{channel} | MHz | 10 | | | | | 10 | | | | |
| Correlation Matrix and Antenna Configuration | | 1x2 Low | | | | | 2x2 Low | | | | |

| OCNG Pattern defined in A.3.2.1 (FDD) | | OP.2 FDD | | | | | OP.2 FDD | | | | |
|--|------------|------------------|------|-------|------|------|-----------|------|-------|------|------|
| | | ρ_A, ρ_B | | 0 | | | | | -3 | | |
| PCFICH_RB | dB | 4 | | | | | 1 | | | | |
| PDCCH_RA | dB | 0 | | | | | -3 | | | | |
| PDCCH_RB | dB | 0 | | | | | -3 | | | | |
| PBCH_RA | dB | 0 | | | | | -3 | | | | |
| PBCH_RB | dB | | | | | | | | | | |
| PSS_RA | dB | | | | | | | | | | |
| SSS_RA | dB | | | | | | | | | | |
| PHICH_RA | dB | | | | | | | | | | |
| PHICH_RB | dB | | | | | | | | | | |
| PDSCH_RA | dB | | | | | | | | | | |
| PDSCH_RB | dB | | | | | | | | | | |
| OCNG_RA ^{Note 1} | dB | | | | | | | | | | |
| OCNG_RB ^{Note 1} | dB | | | | | | | | | | |
| SNR ^{Note 6,7} | dB | -1.4 | -5.5 | -11.5 | -6.4 | -1.4 | -2.3 | -6.2 | -12.2 | -7.3 | -2.3 |
| N_{oc} | dBm/15 kHz | -98 | | | | | -98 | | | | |
| Propagation condition | | ETU 70 Hz | | | | | ETU 70 Hz | | | | |
| <p>Note 1: OCNG shall be used such that the resources in cell # 1 are fully allocated and a constant total transmitted power spectral density is achieved for all OFDM symbols.</p> <p>Note 2: The uplink resources for CQI reporting are assigned to the UE prior to the start of time period T1.</p> <p>Note 3: The timers and layer 3 filtering related parameters are configured prior to the start of time period T1.</p> <p>Note 4: The signal contains PDCCH for UEs other than the device under test as part of OCNG.</p> <p>Note 5: SNR levels correspond to the signal to noise ratio over the cell-specific reference signal REs.</p> <p>Note 6: The SNR in time periods T1, T2, T3, T4 and T5 is denoted as SNR1, SNR2, SNR3, SNR4 and SNR5 respectively in figure A.7.3.2.1-1.</p> <p>Note 7: The SNR values are specified for testing a UE which supports 2RX on at least one band. For testing of a UE which supports 4RX on all bands, the SNR during T3 and T4 is modified as specified in section A.3.8.1.</p> | | | | | | | | | | | |

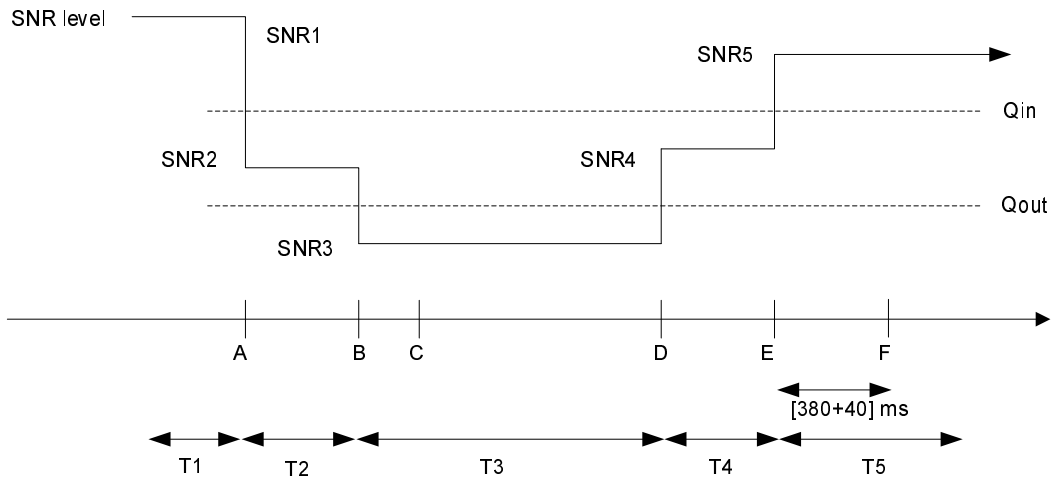

Figure A.7.3.2.1-1 SNR variation for in-sync testing

A.7.3.2.2 Test Requirements

The UE behaviour in each test during time durations T1, T2, T3, T4 and T5 shall be as follows:

During the period from time point A to time point F (420 ms after the start of time duration T5) the UE shall transmit uplink signal at least in all subframes configured for CQI transmission according to the configured CQI reporting mode (PUCCH 1-0).

The rate of correct events observed during repeated tests shall be at least 90%.

A.7.3.3 E-UTRAN TDD Radio Link Monitoring Test for Out-of-sync

A.7.3.3.1 Test Purpose and Environment

The purpose of this test is to verify that the UE properly detects the out of sync and in sync for the purpose of monitoring downlink radio link quality of the PCell. This test will partly verify the E-UTRAN TDD radio link monitoring requirements in clause 7.6.

The test parameters are given in Tables A.7.3.3.1-1, A.7.3.3.1-2 and A.7.3.3.1-3 below. There is one cell (cell 1), which is the active cell, in the test. The test consists of three successive time periods, with time duration of T1, T2 and T3 respectively. Figure A.7.3.3.1-1 shows the variation of the downlink SNR in the active cell to emulate out-of-sync and in-sync states. Prior to the start of the time duration T1, the UE shall be fully synchronized to cell 1. The UE shall be configured for periodic CQI reporting in PUCCH 1-0 mode with a reporting periodicity of 1 ms.

Table A.7.3.3.1-1: General test parameters for E-UTRAN TDD out-of-sync testing

| Parameter | | Unit | Value | | | | Comment |
|--|--------------------------------|------|----------------|----------------|----------------|----------------|---|
| | | | Test 1 | Test 2 | Test 3 | Test 4 | |
| PCFICH/PDCCH/PHICH parameters | | | R.6 TDD | R.7 TDD | R.6 TDD | R.7 TDD | As specified in clause A.3.1.2.2. None of the PDCCH are intended for the UE under test |
| OCNG parameters | | | OP.2 TDD | OP.2 TDD | OP.2 TDD | OP.2 TDD | As specified in clause A.3.2.2.2. |
| Active cell | | | Cell 1 | Cell 1 | Cell 1 | Cell 1 | Cell 1 is on E-UTRA RF channel number 1 |
| CP length | | | Normal | Normal | Normal | Normal | |
| E-UTRA RF Channel Number | | | 1 | 1 | 1 | 1 | One E-UTRA TDD carrier frequency is used. |
| E-UTRA Channel Bandwidth (BW_{channel}) | | MHz | 10 | 10 | 10 | 10 | |
| Correlation Matrix and Antenna Configuration | | | 1x2 | 2x2 | 1x2 Low | 2x2 Low | Correlation Matrix and Antenna Configuration are defined in TS 36.101 [5] Annex B.2.3.2 |
| Out of sync transmission parameters (Note 1) | DCI format | | 1A | 1A | 1A | 1A | As defined in clause 5.3.3.1.3 in TS 36.212 |
| | Number of Control OFDM symbols | | 2 | 2 | 2 | 2 | Out of sync threshold Q_{out} and the corresponding hypothetical PDCCH/PCFICH transmission parameters are as specified in clause 7.6.1 and Table 7.6.1-1 respectively. |
| | Aggregation level | CCE | 8 | 8 | 8 | 8 | |
| | ρ_A, ρ_B | | 0 | -3 | 0 | -3 | |
| | Ratio of PDCCH to RS EPRE | dB | 4 | 1 | 4 | 1 | |
| Ratio of PCFICH to RS EPRE | dB | 4 | 1 | 4 | 1 | | |
| DRX | | | OFF | OFF | OFF | OFF | |
| Layer 3 filtering | | | <i>Enabled</i> | <i>Enabled</i> | <i>Enabled</i> | <i>Enabled</i> | <i>Counters:</i> $N_{310} = 1; N_{311} = 1$ |
| T310 timer | | ms | 0 | 0 | 0 | 0 | <i>T310 is disabled</i> |
| T311 timer | | ms | 1000 | 1000 | 1000 | 1000 | T311 is enabled |
| Periodic CQI reporting mode | | | PUCCH 1-0 | PUCCH 1-0 | PUCCH 1-0 | PUCCH 1-0 | As defined in table 7.2.2-1 in TS 36.213. |
| CQI reporting periodicity | | ms | 1 | 1 | 1 | 1 | Minimum CQI reporting periodicity |
| Propagation channel | | | AWGN | AWGN | ETU 70 Hz | ETU 70 Hz | . |
| T1 | | s | 1 | 1 | 1 | 1 | |
| T2 | | s | 0.4 | 0.4 | 0.4 | 0.4 | |
| T3 | | s | 0.5 | 0.5 | 0.5 | 0.5 | |

Note 1: PDCCH/PCFICH corresponding to the out of sync transmission parameters need not be included in the Reference Measurement Channel.

Table A.7.3.3.1-2: Cell specific test parameters for E-UTRAN TDD (cell # 1) for out-of-sync radio link monitoring tests # 1 and # 2

| Parameter | Unit | Test 1 | | | Test 2 | | |
|--|------------|----------|------|-------|----------|------|-------|
| | | T1 | T2 | T3 | T1 | T2 | T3 |
| E-UTRA RF Channel Number | | 1 | | | 1 | | |
| BW _{channel} | MHz | 10 | | | 10 | | |
| Antenna Configuration | | 1x2 | | | 2x2 | | |
| Special subframe configuration ^{Note1} | | 6 | | | 6 | | |
| Uplink-downlink configuration ^{Note2} | | 1 | | | 1 | | |
| OCNG Pattern defined in A.3.2.2 (TDD) | | OP.2 TDD | | | OP.2 TDD | | |
| P_A, P_B | | 0 | | | -3 | | |
| PCFICH_RB | dB | 4 | | | 1 | | |
| PDCCH_RA | dB | 4 | | | 1 | | |
| PDCCH_RB | dB | 4 | | | 1 | | |
| PBCH_RA | dB | 0 | | | -3 | | |
| PBCH_RB | dB | | | | | | |
| PSS_RA | dB | | | | | | |
| SSS_RA | dB | | | | | | |
| PHICH_RA | dB | | | | | | |
| PHICH_RB | dB | | | | | | |
| PDSCH_RA | dB | | | | | | |
| PDSCH_RB | dB | | | | | | |
| OCNG_RA ^{Note 3} | dB | | | | | | |
| OCNG_RB ^{Note 3} | dB | | | | | | |
| SNR ^{Note 8,9} | dB | -5.1 | -9.1 | -13.1 | -5.2 | -9.2 | -13.2 |
| N_{oc} | dBm/15 kHz | -98 | | | -98 | | |
| Propagation condition | | AWGN | | | AWGN | | |
| <p>Note 1: For the special subframe configuration see table 4.2-1 in TS 36.211.</p> <p>Note 2: For the uplink-downlink configuration see table 4.2-2 in TS 36.211.</p> <p>Note 3: OCNG shall be used such that the resources in cell # 1 are fully allocated and a constant total transmitted power spectral density is achieved for all OFDM symbols.</p> <p>Note 4: The uplink resources for CQI reporting are assigned to the UE prior to the start of time period T1.</p> <p>Note 5: The timers and layer 3 filtering related parameters are configured prior to the start of time period T1.</p> <p>Note 6: The signal contains PDCCH for UEs other than the device under test as part of OCNG.</p> <p>Note 7: SNR levels correspond to the signal to noise ratio over the cell-specific reference signal REs.</p> <p>Note 8: The SNR in time periods T1, T2 and T3 is denoted as SNR1, SNR2 and SNR3 respectively in figure A.7.3.3.1-1.</p> <p>Note 9: The SNR values are specified for testing a UE which supports 2RX on at least one band. For testing of a UE which supports 4RX on all bands, the SNR during T3 is modified as specified in section A.3.8.1.</p> | | | | | | | |

Table A.7.3.3.1-3: Cell specific test parameters for E-UTRAN TDD (cell # 1) for out-of-sync radio link monitoring tests # 3 and # 4

| Parameter | Unit | Test 3 | | | Test 4 | | |
|--------------------------|------|--------|----|----|--------|----|----|
| | | T1 | T2 | T3 | T1 | T2 | T3 |
| E-UTRA RF Channel Number | | 1 | | | 1 | | |
| BW _{channel} | MHz | 10 | | | 10 | | |

| | | | | | | | |
|---|------------|-----------------|------|-------|-----------------|------|-------|
| Correlation Matrix and Antenna Configuration | | 1x2 Low | | | 2x2 Low | | |
| Special subframe configuration ^{Note1} | | 6 | | | 6 | | |
| Uplink-downlink configuration ^{Note2} | | 1 | | | 1 | | |
| OCNG Pattern defined in A.3.2.2 (TDD) | | OP.2 TDD | | | OP.2 TDD | | |
| P_{A, P_B} | | 0 | | | -3 | | |
| PCFICH_RB | dB | 4 | | | 1 | | |
| PDCCH_RA | dB | 4 | | | 1 | | |
| PDCCH_RB | dB | 4 | | | 1 | | |
| PBCH_RA | dB | 0 | | | -3 | | |
| PBCH_RB | dB | | | | | | |
| PSS_RA | dB | | | | | | |
| SSS_RA | dB | | | | | | |
| PHICH_RA | dB | | | | | | |
| PHICH_RB | dB | | | | | | |
| PDSCH_RA | dB | | | | | | |
| PDSCH_RB | dB | | | | | | |
| OCNG_RA ^{Note 3} | dB | | | | | | |
| OCNG_RB ^{Note 3} | dB | | | | | | |
| SNR ^{Note 8} | dB | -1.4 | -5.3 | -11.3 | -2.3 | -5.9 | -11.9 |
| N_{oc} | dBm/15 kHz | -98 | | | -98 | | |
| Propagation condition | | ETU 70 Hz | | | ETU 70 Hz | | |
| <p>Note 1: For the special subframe configuration see table 4.2-1 in TS 36.211.</p> <p>Note 2: For the uplink-downlink configuration see table 4.2-2 in TS 36.211.</p> <p>Note 3: OCNG shall be used such that the resources in cell # 1 are fully allocated and a constant total transmitted power spectral density is achieved for all OFDM symbols.</p> <p>Note 4: The uplink resources for CQI reporting are assigned to the UE prior to the start of time period T1.</p> <p>Note 5: The timers and layer 3 filtering related parameters are configured prior to the start of time period T1.</p> <p>Note 6: The signal contains PDCCH for UEs other than the device under test as part of OCNG.</p> <p>Note 7: SNR levels correspond to the signal to noise ratio over the cell-specific reference REs.</p> <p>Note 8: The SNR in time periods T1, T2 and T3 is denoted as SNR1, SNR2 and SNR3 respectively in figure A.7.3.3.1-1.</p> | | | | | | | |

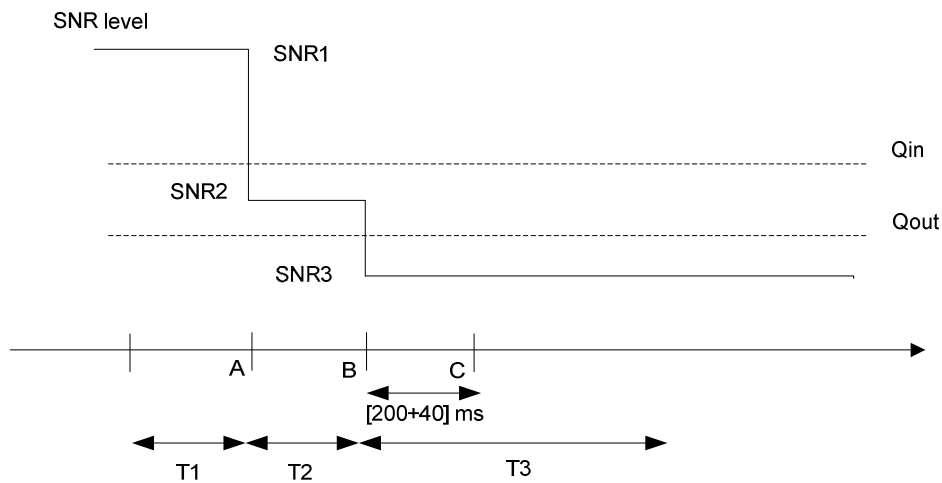

Figure A.7.3.3.1-1. SNR variation for out-of-sync testing

A.7.3.3.2 Test Requirements

The UE behaviour in each test during time durations T1, T2 and T3 shall be as follows:

During the period from time point A to time point B the UE shall transmit uplink signal at least in all uplink subframes configured for CQI transmission according to the configured CQI reporting mode (PUCCH 1-0).

The UE shall stop transmitting uplink signal no later than time point C (240 ms after the start of the time duration T3).

The rate of correct events observed during repeated tests shall be at least 90%.

A.7.3.4 E-UTRAN TDD Radio Link Monitoring Test for In-sync

A.7.3.4.1 Test Purpose and Environment

The purpose of this test is to verify that the UE properly detects the out of sync and in sync for the purpose of monitoring downlink radio link quality of the PCell. This test will partly verify the E-UTRAN TDD radio link monitoring requirements in clause 7.6.

The test parameters are given in Tables A.7.3.4.1-1 and A.7.3.4.1-2 below. There is one cell (cell 1), which is the active cell, in the test. The test consists of five successive time periods, with time duration of T1, T2, T3, T4 and T5 respectively. Figure A.7.3.4.1-1 shows the variation of the downlink SNR in the active cell to emulate out-of-sync and in-sync states. Prior to the start of the time duration T1, the UE shall be fully synchronized to cell 1. The UE shall be configured for periodic CQI reporting in PUCCH 1-0 mode with a reporting periodicity of 1 ms.

Table A.7.3.4.1-1: General test parameters for E-UTRAN TDD in-sync testing

| Parameter | | Unit | Value | | Comment |
|---|--------------------------------|------|----------|----------|--|
| | | | Test 1 | Test 2 | |
| PCFICH/PDCCH/PHICH parameters | | | R.6 TDD | R.7 TDD | As specified in clause A.3.1.2.2. None of the PDCCH are intended for the UE under test |
| OCNG parameters | | | OP.2 TDD | OP.2 TDD | As specified in clause A.3.2.2.2. |
| Active cell | | | Cell 1 | Cell 1 | Cell 1 is on E-UTRA RF channel number 1 |
| CP length | | | Normal | Normal | |
| E-UTRA RF Channel Number | | | 1 | 1 | One E-UTRA FDD carrier frequency is used. |
| E-UTRA Channel Bandwidth (BW _{channel}) | | MHz | 10 | 10 | |
| Correlation Matrix and Antenna Configuration | | | 1x2 Low | 2x2 Low | Correlation Matrix and Antenna Configuration are defined in TS 36.101 [5] Annex B.2.3.2 |
| In sync transmission parameters (Note 1) | DCI format | | 1C | 1C | As defined in clause 5.3.3.1.4 in TS 36.212 |
| | Number of Control OFDM symbols | | 2 | 2 | In sync threshold Q _{in} and the corresponding hypothetical PDCCH/PCFICH transmission parameters are as specified in clause and Table 7.6.1-2 |
| | Aggregation level | CCE | 4 | 4 | |
| | ρ_A, ρ_B | | 0 | -3 | |

| | | | | | |
|--|--------------------------------|-----|-----------|-----------|--|
| | Ratio of PDCCH to RS EPRE | | 0 | -3 | respectively. |
| | Ratio of PCFICH to RS EPRE | | 4 | 1 | |
| Out of sync transmission parameters (Note 1) | DCI format | | 1A | 1A | As defined in clause 5.3.3.1.3 in TS 36.212 |
| | Number of Control OFDM symbols | | 2 | 2 | Out of sync threshold Q_{out} and the corresponding hypothetical PDCCH/PCFICH transmission parameters are as specified in clause 7.6.1 and Table 7.6.1-1 respectively. |
| | Aggregation level | CCE | 8 | 8 | |
| | ρ_A, ρ_B | | 0 | -3 | |
| | Ratio of PDCCH to RS EPRE | dB | 4 | 1 | |
| | Ratio of PCFICH to RS EPRE | dB | 4 | 1 | |
| DRX | | | OFF | OFF | |
| Layer 3 filtering | | | Enabled | Enabled | Counters: N310 = 1; N311 = 1 |
| T310 timer | | ms | 2000 | 2000 | T310 is enabled |
| T311 timer | | ms | 1000 | 1000 | T311 is enabled |
| Periodic CQI reporting mode | | | PUCCH 1-0 | PUCCH 1-0 | As defined in table 7.2.2-1 in TS 36.213. |
| CQI reporting periodicity | | ms | 1 | 1 | Minimum CQI reporting periodicity |
| Propagation channel | | | ETU 70 Hz | ETU 70 Hz | |
| T1 | | s | 0.5 | 0.5 | |
| T2 | | s | 0.4 | 0.4 | |
| T3 | | s | 1.46 | 1.46 | |
| T4 | | s | 0.4 | 0.4 | |
| T5 | | s | 1 | 1 | |
| Note 1: PDCCH/PCFICH corresponding to the in-sync and out of sync transmission parameters need not be included in the Reference Measurement Channel. | | | | | |

Table A.7.3.4.1-2: Cell specific test parameters for E-UTRAN TDD (cell # 1) for in-sync radio link monitoring tests # 1 and # 2

| Parameter | Unit | Test 1 | | | | | Test 2 | | | | |
|---|------|---------|----|----|----|----|---------|----|----|----|----|
| | | T1 | T2 | T3 | T4 | T5 | T1 | T2 | T3 | T4 | T5 |
| E-UTRA RF Channel Number | | 1 | | | | | 1 | | | | |
| BW _{channel} | MHz | 10 | | | | | 10 | | | | |
| Correlation Matrix and Antenna Configuration | | 1x2 Low | | | | | 2x2 Low | | | | |
| Special subframe configuration ^{Note1} | | 6 | | | | | 6 | | | | |

| | | | | | | | | | | | |
|---|------------|-----------|------|-------|------|------|-----------|------|-------|------|------|
| Uplink-downlink configuration ^{Note 2} | | 1 | | | | | 1 | | | | |
| OCNG Pattern defined in A.3.2.2 (TDD) | | OP.2 TDD | | | | | OP.2 TDD | | | | |
| ρ_A, ρ_B | | 0 | | | | | -3 | | | | |
| PCFICH_RB | dB | 4 | | | | | 1 | | | | |
| PDCCH_RA | dB | 0 | | | | | -3 | | | | |
| PDCCH_RB | dB | 0 | | | | | -3 | | | | |
| PBCH_RA | dB | 0 | | | | | -3 | | | | |
| PBCH_RB | dB | | | | | | | | | | |
| PSS_RA | dB | | | | | | | | | | |
| SSS_RA | dB | | | | | | | | | | |
| PHICH_RA | dB | | | | | | | | | | |
| PHICH_RB | dB | | | | | | | | | | |
| PDSCH_RA | dB | | | | | | | | | | |
| PDSCH_RB | dB | | | | | | | | | | |
| OCNG_RA ^{Note 3} | dB | | | | | | | | | | |
| OCNG_RB ^{Note 3} | dB | | | | | | | | | | |
| SNR ^{Note 8,9} | dB | -1.4 | -5.3 | -11.3 | -6.4 | -1.4 | -2.3 | -5.9 | -11.9 | -7.3 | -2.3 |
| N_{oc} | dBm/15 kHz | -98 | | | | | -98 | | | | |
| Propagation condition | | ETU 70 Hz | | | | | ETU 70 Hz | | | | |
| <p>Note 1: For the special subframe configuration see table 4.2-1 in TS 36.211.</p> <p>Note 2: For the uplink-downlink configuration see table 4.2-2 in TS 36.211.</p> <p>Note 3: OCNG shall be used such that the resources in cell # 1 are fully allocated and a constant total transmitted power spectral density is achieved for all OFDM symbols.</p> <p>Note 4: The uplink resources for CQI reporting are assigned to the UE prior to the start of time period T1.</p> <p>Note 5: The timers and layer 3 filtering related parameters are configured prior to the start of time period T1.</p> <p>Note 6: The signal contains PDCCH for UEs other than the device under test as part of OCNG.</p> <p>Note 7: SNR levels correspond to the signal to noise ratio over the cell-specific reference signal REs.</p> <p>Note 8: The SNR in time periods T1, T2, T3, T4 and T5 is denoted as SNR1, SNR2, SNR3, SNR4 and SNR5 respectively in figure A.7.3.4.1-1.</p> <p>Note 9: The SNR values are specified for testing a UE which supports 2RX on at least one band. For testing of a UE which supports 4RX on all bands, the SNR during T3 and T4 is modified as specified in section A.3.8.1.</p> | | | | | | | | | | | |

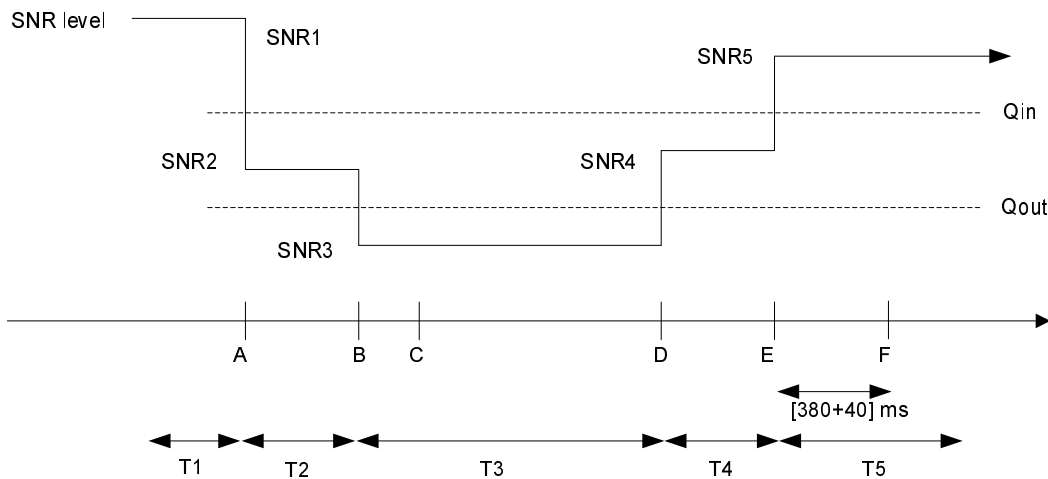

Figure A.7.3.4.1-1. SNR variation for in-sync testing

A.7.3.4.2 Test Requirements

The UE behaviour in each test during time durations T1, T2, T3, T4 and T5 shall be as follows:

During the period from time point A to time point F (420 ms after the start of time duration T5) the UE shall transmit uplink signal at least in all uplink subframes configured for CQI transmission according to the configured CQI mode (PUCCH 1-0).

The rate of correct events observed during repeated tests shall be at least 90%.

A.7.3.5 E-UTRAN FDD Radio Link Monitoring Test for Out-of-sync in DRX

A.7.3.5.1 Test Purpose and Environment

The purpose of this test is to verify that the UE properly detects the out of sync and in sync for the purpose of monitoring downlink radio link quality of the PCell when DRX is used. This test will partly verify the E-UTRAN FDD radio link monitoring requirements in clause 7.6.

The test parameters are given in Tables A.7.3.5.1-1, A.7.3.5.1-2, A.7.3.5.1-3 and A.7.3.5.1-4. There is one cell (cell 1), which is the active cell, in the test. The test consists of three successive time periods, with time duration of T1, T2 and T3 respectively. Figure A.7.3.5.1-1 shows the variation of the downlink SNR in the active cell to emulate out-of-sync and in-sync states. Prior to the start of the time duration T1, the UE shall be fully synchronized to cell 1. The UE shall be configured for periodic CQI reporting in PUCCH 1-0 mode with a reporting periodicity of 2 ms. In the test, DRX configuration is enabled and DRX inactivity timer has already been expired, i.e. UE tries to decode PDCCH and to send periodic CQI during the period when On-duration timer is running. Time alignment timers shall be set to “infinity” so that UL timing alignment is maintained during the test.

Table A.7.3.5.1-1: General test parameters for E-UTRAN FDD out-of-sync tests in DRX

| Parameter | | Unit | Value | | Comment |
|--|--------------------------------|------|-----------|-----------|--|
| | | | Test 1 | Test 2 | |
| PCFICH/PDCCH/PHICH parameters | | | R.7 FDD | R.6 FDD | As specified in clause A.3.1.2.1. None of the PDCCH are intended for the UE under test |
| OCNG parameters | | | OP.2 FDD | OP.2 FDD | As specified in clause A.3.2.1.2. |
| Active cell | | | Cell 1 | Cell 1 | Cell 1 is on E-UTRA RF channel number 1 |
| CP length | | | Normal | Normal | |
| E-UTRA RF Channel Number | | | 1 | 1 | One E-UTRA FDD carrier frequency is used. |
| E-UTRA Channel Bandwidth (BW _{channel}) | | MHz | 10 | 10 | |
| Correlation Matrix and Antenna Configuration | | | 2x2 Low | 1x2 | Correlation Matrix and Antenna Configuration are defined in TS 36.101 [5] Annex B.2.3.2 |
| Out of sync transmission parameters (Note 1) | DCI format | | 1A | 1A | As defined in clause 5.3.3.1.3 in TS 36.212 |
| | Number of Control OFDM symbols | | 2 | 2 | Out of sync threshold Q_{out} and the corresponding hypothetical PDCCH/PCFICH transmission parameters are as specified in clause 7.6.1 and Table 7.6.1-1 respectively. |
| | Aggregation level | CCE | 8 | 8 | |
| | ρ_A, ρ_B | | -3 | 0 | |
| | Ratio of PDCCH to RS EPRE | dB | 1 | 4 | |
| Ratio of PCFICH to RS EPRE | dB | 1 | 4 | | |
| DRX cycle | | ms | 40 | 1280 | See Table A.7.3.5.1-3 |
| Layer 3 filtering | | | Enabled | Enabled | Counters: $N_{310} = 1; N_{311} = 1$ |
| T310 timer | | ms | 0 | 0 | T310 is disabled |
| T311 timer | | ms | 1000 | 1000 | T311 is enabled |
| Periodic CQI reporting mode | | | PUCCH 1-0 | PUCCH 1-0 | As defined in table 7.2.2-1 in TS 36.213. |
| CQI reporting periodicity | | ms | 2 | 2 | Minimum CQI reporting periodicity |
| Propagation channel | | | ETU 70 Hz | AWGN | . |
| T1 | | s | 4 | 32 | |
| T2 | | s | 1.6 | 12.8 | |
| T3 | | s | 1.8 | 13 | |
| Note 1: PDCCH/PCFICH corresponding to the out of sync transmission parameters need not be included in the Reference Measurement Channel. | | | | | |

Table A.7.3.5.1-2: Cell specific test parameters for E-UTRAN FDD (cell # 1) for out-of-sync radio link monitoring tests # 1 and # 2 in DRX

| Parameter | Unit | Test 1 | | | Test 2 | | |
|--|------|---------|----|----|--------|----|----|
| | | T1 | T2 | T3 | T1 | T2 | T3 |
| E-UTRA RF Channel Number | | 1 | | | 1 | | |
| BW _{channel} | MHz | 10 | | | 10 | | |
| Correlation Matrix and Antenna Configuration | | 2x2 Low | | | 1x2 | | |

| | | | | | | | |
|---|------------|-----------|------|-------|----------|------|-------|
| OCNG Pattern defined in A.3.2.1 (FDD) | | OP.2 FDD | | | OP.2 FDD | | |
| ρ_A, ρ_B | | -3 | | | 0 | | |
| PCFICH_RB | dB | 1 | | | 4 | | |
| PDCCH_RA | dB | 1 | | | 4 | | |
| PDCCH_RB | dB | 1 | | | 4 | | |
| PBCH_RA | dB | -3 | | | 0 | | |
| PBCH_RB | dB | | | | | | |
| PSS_RA | dB | | | | | | |
| SSS_RA | dB | | | | | | |
| PHICH_RA | dB | | | | | | |
| PHICH_RB | dB | | | | | | |
| PDSCH_RA | dB | | | | | | |
| PDSCH_RB | dB | | | | | | |
| OCNG_RA ^{Note1} | dB | | | | | | |
| OCNG_RB ^{Note1} | dB | | | | | | |
| SNR ^{Note 6,7} | dB | -2.3 | -6.2 | -12.2 | -4.7 | -9.5 | -13.5 |
| N_{oc} | dBm/15 kHz | -98 | | | -98 | | |
| Propagation condition | | ETU 70 Hz | | | AWGN | | |
| <p>Note 1: OCNG shall be used such that the resources in cell # 1 are fully allocated and a constant total transmitted power spectral density is achieved for all OFDM symbols.</p> <p>Note 2: The uplink resources for CQI reporting are assigned to the UE prior to the start of time period T1.</p> <p>Note 3: The timers and layer 3 filtering related parameters are configured prior to the start of time period T1.</p> <p>Note 4: The signal contains PDCCH for UEs other than the device under test as part of OCNG.</p> <p>Note 5: SNR levels correspond to the signal to noise ratio over the cell-specific reference signal REs.</p> <p>Note 6: The SNR in time periods T1, T2 and T3 is denoted as SNR1, SNR2 and SNR3 respectively in figure A.7.3.5.1-1.</p> <p>Note 7: The SNR values are specified for testing a UE which supports 2RX on at least one band. For testing of a UE which supports 4RX on all bands, the SNR during T3 is modified as specified in section A.3.8.1.</p> | | | | | | | |

Table A.7.3.5.1-3: DRX-Configuration for E-UTRAN FDD out-of-sync tests

| Field | Test1 | Test2 | Comment |
|--------------------------|---------|---------|---|
| | Value | Value | |
| onDurationTimer | psf2 | psf2 | As specified in clause 6.3.2 in TS 36.331 |
| drx-InactivityTimer | psf1 | psf1 | |
| drx-RetransmissionTimer | psf1 | psf1 | |
| longDRX-CycleStartOffset | sf40 | sf1280 | |
| shortDRX | disable | disable | |

Table A.7.3.5.1-4: TimeAlignmentTimer -Configuration for E-UTRAN FDD out-of-sync testing

| Field | Test1 | Test2 | Comment |
|--------------------|----------|----------|--|
| | Value | Value | |
| TimeAlignmentTimer | infinity | infinity | As specified in clause 6.3.2 in TS 36.331 |
| sr-ConfigIndex | 0 | 0 | For further information see clause 6.3.2 in TS 36.331 and section 10.1 in TS 36.213. |

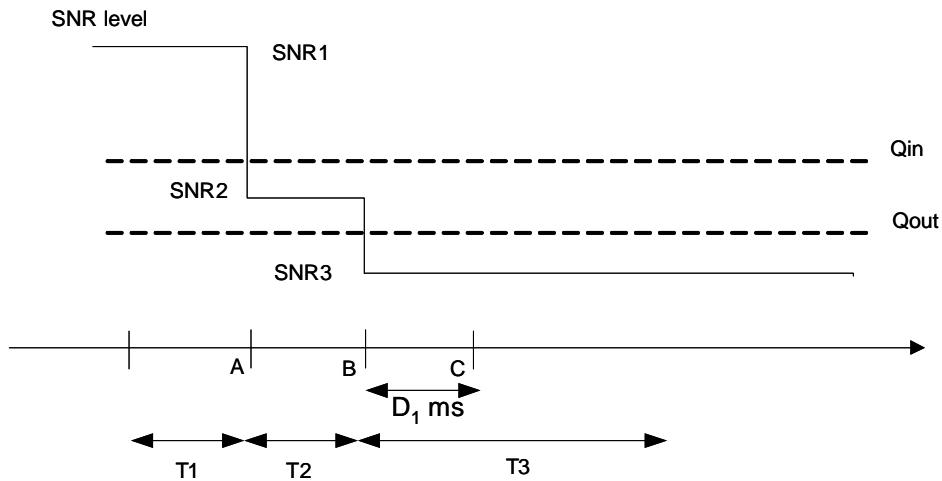

Figure A.7.3.5.1-1 SNR variation for out-of-sync testing in DRX

A.7.3.5.2 Test Requirements

The UE behaviour in each test during time durations T1, T2 and T3 shall be as follows:

In test 1 and test 2 during the period from time point A to time point B the UE shall transmit uplink signal at least once every DRX cycle, in the On-duration part of the cycle in the subframe according to the configured CQI reporting mode (PUCCH 1-0).

In test 1 the UE shall stop transmitting uplink signal no later than time point C (duration $D_1 = 900$ ms after the start of time duration T3).

In test 2 the UE shall stop transmitting uplink signal no later than time point C (duration $D_1 = 6500$ ms after the start of time duration T3).

The rate of correct events observed during repeated tests shall be at least 90%.

A.7.3.6 E-UTRAN FDD Radio Link Monitoring Test for In-sync in DRX

A.7.3.6.1 Test Purpose and Environment

The purpose of this test is to verify that the UE properly detects the out of sync and in sync for the purpose of monitoring downlink radio link quality of the PCell when DRX is used. This test will partly verify the E-UTRAN FDD radio link monitoring requirements in clause 7.6.

The test parameters are given in Tables A.7.3.6.1-1, A.7.3.6.1-2, A.7.3.6.1-3 and A.7.3.6.1-4. There is one cell (cell 1), which is the active cell, in the test. The test consists of five successive time periods, with time duration of T1, T2, T3, T4 and T5 respectively. Figure A.7.3.6.1-1 shows the variation of the downlink SNR in the active cell to emulate out-of-sync and in-sync states. Prior to the start of the time duration T1, the UE shall be fully synchronized to cell 1. The UE shall be configured for periodic CQI reporting in PUCCH 1-0 mode with a reporting periodicity of 2 ms. In the test, DRX configuration is enabled and DRX inactivity timer has already been expired, i.e. UE tries to decode PDCCH and to send periodic CQI during the period when On-duration timer is running. Time alignment timers shall be set to “infinity” so that UL timing alignment is maintained during the test.

Table A.7.3.6.1-1: General test parameters for E-UTRAN FDD in-sync test in DRX

| Parameter | | Unit | Value | Comment |
|---|--------------------------------|----------------|---|---|
| PCFICH/PDCCH/PHICH parameters | | | R.6 FDD | As specified in clause A.3.1.2.1. None of the PDCCH are intended for the UE under test |
| OCNG parameters | | | OP.2 FDD | As specified in clause A.3.2.1.2. |
| Active cell | | | Cell 1 | Cell 1 is on E-UTRA RF channel number 1 |
| CP length | | | Normal | |
| E-UTRA RF Channel Number | | | 1 | One E-UTRA FDD carrier frequency is used. |
| E-UTRA Channel Bandwidth (BW _{channel}) | | MHz | 10 | |
| Antenna Configuration | | | 1x2 | |
| In sync transmission parameters (Note 1) | DCI format | | 1C | As defined in clause 5.3.3.1.4 in TS 36.212 |
| | Number of Control OFDM symbols | | 2 | In sync threshold Q _{in} and the corresponding hypothetical PDCCH/PCFICH transmission parameters are as specified in clause and Table 7.6.1-2 respectively. |
| | Aggregation level | CC E | 4 | |
| | ρ_A, ρ_B | | 0 | |
| | Ratio of PDCCH to RS EPRE | | 0 | |
| | Ratio of PCFICH to RS EPRE | | 4 | |
| Out of sync transmission parameters (Note 1) | DCI format | | 1A | |
| Out of sync transmission parameters (Note 1) | Number of Control OFDM symbols | | 2 | Out of sync threshold Q _{out} and the corresponding hypothetical PDCCH/PCFICH transmission parameters are as specified in clause 7.6.1 and Table 7.6.1-1 respectively. |
| | Aggregation level | CC E | 8 | |
| | ρ_A, ρ_B | | 0 | |
| | Ratio of PDCCH to RS EPRE | dB | 4 | |
| | Ratio of PCFICH to RS EPRE | dB | 4 | |
| | DRX cycle | ms | 40 | |
| Layer 3 filtering | | <i>Enabled</i> | <i>Counters:</i> <i>N310 = 1; N311 = 1</i> | |
| T310 timer | ms | 2000 | <i>T310 is enabled</i> | |
| T311 timer | ms | 1000 | T311 is enabled | |

| | | | |
|--|----|-----------|---|
| Periodic CQI reporting mode | | PUCCH 1-0 | As defined in table 7.2.2-1 in TS 36.213. |
| CQI reporting periodicity | ms | 2 | Minimum CQI reporting periodicity |
| Propagation channel | | AWGN | |
| T1 | s | 4 | |
| T2 | s | 1.6 | |
| T3 | s | 1.46 | |
| T4 | s | 0.4 | |
| T5 | s | 4 | |
| Note 1: PDCCH/PCFICH corresponding to the in-sync and out of sync transmission parameters need not be included in the Reference Measurement Channel. | | | |

Table A.7.3.6.1-2: Cell specific test parameters for E-UTRAN FDD (cell # 1) for in-sync radio link monitoring test # 1 in DRX

| Parameter | Unit | Test 1 | | | | |
|---|------------|----------|------|-------|------|------|
| | | T1 | T2 | T3 | T4 | T5 |
| E-UTRA RF Channel Number | | 1 | | | | |
| BW _{channel} | MHz | 10 | | | | |
| Antenna Configuration | | 1x2 | | | | |
| OCNG Pattern defined in A.3.2.1 (FDD) | | OP.2 FDD | | | | |
| ρ_A, ρ_B | | 0 | | | | |
| PCFICH_RB | dB | 4 | | | | |
| PDCCH_RA | dB | 0 | | | | |
| PDCCH_RB | dB | 0 | | | | |
| PBCH_RA | dB | 0 | | | | |
| PBCH_RB | dB | | | | | |
| PSS_RA | dB | | | | | |
| SSS_RA | dB | | | | | |
| PHICH_RA | dB | | | | | |
| PHICH_RB | dB | | | | | |
| PDSCH_RA | dB | | | | | |
| PDSCH_RB | dB | | | | | |
| OCNG_RA ^{Note1} | dB | | | | | |
| OCNG_RB ^{Note1} | dB | | | | | |
| SNR ^{Note 6,7} | dB | -4.7 | -9.5 | -13.5 | -8.7 | -4.7 |
| N_{oc} | dBm/15 kHz | -98 | | | | |
| Propagation condition | | AWGN | | | | |
| Note 1: OCNG shall be used such that the resources in cell # 1 are fully allocated and a constant total transmitted power spectral density is achieved for all OFDM symbols. Note 2: The uplink resources for CQI reporting are assigned to the UE prior to the start of time period T1. Note 3: The timers and layer 3 filtering related parameters are configured prior to the start of time period T1. Note 4: The signal contains PDCCH for UEs other than the device under test as part of OCNG. Note 5: SNR levels correspond to the signal to noise ratio over the cell-specific reference signal REs. Note 6: The SNR in time periods T1, T2, T3, T4 and T5 is denoted as SNR1, SNR2, SNR3, SNR4 and SNR5 respectively in figure A.7.3.6.1-1. Note 7: The SNR values are specified for testing a UE which supports 2RX on at least one band. For testing of a UE which supports 4RX on all bands, the SNR during T3 and T4 is modified as specified in section A.3.8.1. | | | | | | |

Table A.7.3.6.1-3: DRX-Configuration for E-UTRAN FDD out-of-sync tests

| Field | Value | Comment |
|--------------------------|---------|---|
| onDurationTimer | psf2 | As specified in clause 6.3.2 in TS 36.331 |
| drx-InactivityTimer | psf1 | |
| drx-RetransmissionTimer | psf1 | |
| longDRX-CycleStartOffset | sf40 | |
| shortDRX | disable | |

Table A.7.3.6.1-4: TimeAlignmentTimer -Configuration for E-UTRAN FDD out-of-sync testing

| Field | Value | Comment |
|--------------------|----------|--|
| TimeAlignmentTimer | infinity | As specified in clause 6.3.2 in TS 36.331 |
| sr-ConfigIndex | 0 | For further information see clause 6.3.2 in TS 36.331 and section 10.1 in TS 36.213. |

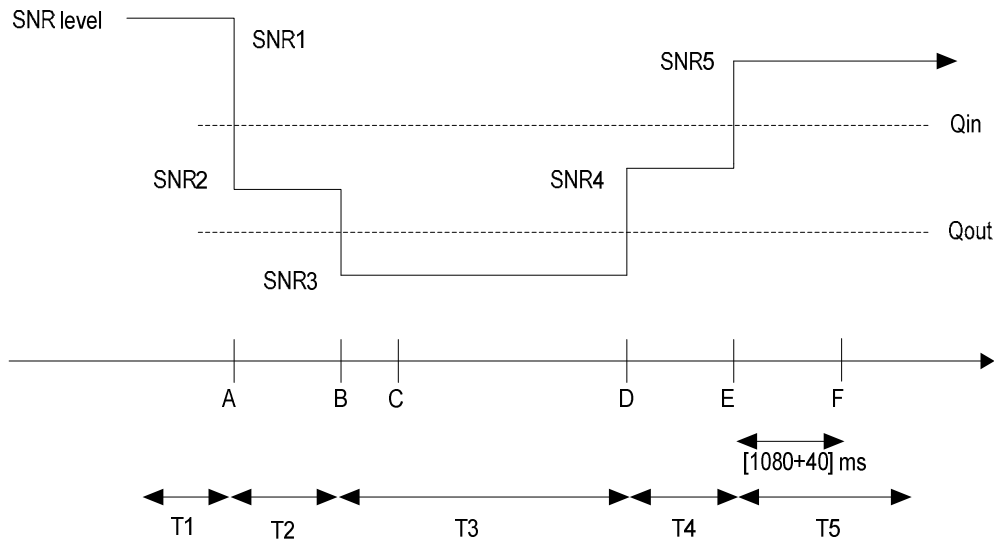
**Figure A.7.3.6.1-1 SNR variation for in-sync testing in DRX**

A.7.3.6.2 Test Requirements

The UE behaviour in each test during time durations T1, T2, T3, T4 and T5 shall be as follows:

During the period from time point A to time point F (1120 ms after the start of time duration T5) the UE shall transmit uplink signal at least once every DRX cycle, in the On-duration part of the cycle in the subframe according to the configured CQI reporting mode (PUCCH 1-0).

The rate of correct events observed during repeated tests shall be at least 90%.

A.7.3.7 E-UTRAN TDD Radio Link Monitoring Test for Out-of-sync in DRX

A.7.3.7.1 Test Purpose and Environment

The purpose of this test is to verify that the UE properly detects the out of sync and in sync for the purpose of monitoring downlink radio link quality of the PCell when DRX is used. This test will partly verify the E-UTRAN TDD radio link monitoring requirements in clause 7.6.

The test parameters are given in Tables A.7.3.7.1-1, A.7.3.7.1-2, A.7.3.7.1-3 and A.7.3.7.1-4. There is one cell (cell 1), which is the active cell, in the test. The test consists of three successive time periods, with time duration of T1, T2 and T3 respectively. Figure A.7.3.7.1-1 shows the variation of the downlink SNR in the active cell to emulate out-of-sync and in-sync states. Prior to the start of the time duration T1, the UE shall be fully synchronized to cell 1. The UE shall be configured for periodic CQI reporting in PUCCH 1-0 mode with a reporting periodicity of 1 ms. In the test, DRX configuration is enabled and DRX inactivity timer has already been expired, i.e. UE tries to decode PDCCH and to send periodic CQI during the period when On-duration timer is running. Time alignment timers shall be set to “infinity” so that UL timing alignment is maintained during the test.

Table A.7.3.7.1-1: General test parameters for E-UTRAN TDD out-of-sync tests in DRX

| Parameter | | Unit | Value | | Comment |
|--|---------------------------------|------|-----------|-----------|---|
| | | | Test 1 | Test 2 | |
| PCFICH/PDCCH/PHICH parameters | | | R.7 TDD | R.6 TDD | As specified in clause A.3.1.2.2. None of the PDCCH are intended for the UE under test |
| OCNG parameters | | | OP.2 TDD | OP.2 TDD | As specified in clause A.3.2.2.2. |
| Active cell | | | Cell 1 | Cell 1 | Cell 1 is on E-UTRA RF channel number 1 |
| CP length | | | Normal | Normal | |
| E-UTRA RF Channel Number | | | 1 | 1 | One E-UTRA TDD carrier frequency is used. |
| E-UTRA Channel Bandwidth (BW _{channel}) | | MHz | 10 | 10 | |
| Correlation Matrix and Antenna Configuration | | | 2x2 Low | 1x2 | Correlation Matrix and Antenna Configuration are defined in TS 36.101 [5] Annex B.2.3.2 |
| Out of sync transmission parameters (Note 1) | DCI format | | 1A | 1A | As defined in clause 5.3.3.1.3 in TS 36.212 |
| | Number of Control OFDM symbols | | 2 | 2 | Out of sync threshold Q _{out} and the corresponding hypothetical PDCCH/PCFICH transmission parameters are as specified in clause 7.6.1 and Table 7.6.1-1 respectively. |
| | Aggregation level | CCE | 8 | 8 | |
| | ρ _A , ρ _B | | -3 | 0 | |
| | Ratio of PDCCH to RS EPRE | dB | 1 | 4 | |
| Ratio of PCFICH to RS EPRE | dB | 1 | 4 | | |
| DRX cycle | | ms | 40 | 1280 | See Table A.7.3.7.1-3 |
| Layer 3 filtering | | | Enabled | Enabled | Counters: N310 = 1; N311 = 1 |
| T310 timer | | ms | 0 | 0 | T310 is disabled |
| T311 timer | | ms | 1000 | 1000 | T311 is enabled |
| Periodic CQI reporting mode | | | PUCCH 1-0 | PUCCH 1-0 | As defined in table 7.2.2-1 in TS 36.213. |
| CQI reporting periodicity | | ms | 1 | 1 | Minimum CQI reporting periodicity |
| Propagation channel | | | ETU 70 Hz | AWGN | . |
| T1 | | s | 4 | 32 | |
| T2 | | s | 1.6 | 12.8 | |
| T3 | | s | 1.8 | 13 | |
| Note 1: PDCCH/PCFICH corresponding to the out of sync transmission parameters need not be included in the Reference Measurement Channel. | | | | | |

Table A.7.3.7.1-2: Cell specific test parameters for E-UTRAN TDD (cell # 1) for out-of-sync radio link monitoring tests # 1 and # 2 in DRX

| Parameter | Unit | Test 1 | | | Test 2 | | |
|--|------|---------|----|----|--------|----|----|
| | | T1 | T2 | T3 | T1 | T2 | T3 |
| E-UTRA RF Channel Number | | 1 | | | 1 | | |
| BW _{channel} | MHz | 10 | | | 10 | | |
| Correlation Matrix and Antenna Configuration | | 2x2 Low | | | 1x2 | | |

| | | | | | | | |
|--|------------|-----------|------|-------|----------|------|-------|
| Special subframe configuration ^{Note1} | | 6 | | | 6 | | |
| Uplink-downlink configuration ^{Note2} | | 1 | | | 1 | | |
| OCNG Pattern defined in A.3.2.2 (TDD) | | OP.2 TDD | | | OP.2 TDD | | |
| ρ_A, ρ_B | | -3 | | | 0 | | |
| PCFICH_RB | dB | 1 | | | 4 | | |
| PDCCH_RA | dB | 1 | | | 4 | | |
| PDCCH_RB | dB | 1 | | | 4 | | |
| PBCH_RA | dB | -3 | | | 0 | | |
| PBCH_RB | dB | | | | | | |
| PSS_RA | dB | | | | | | |
| SSS_RA | dB | | | | | | |
| PHICH_RA | dB | | | | | | |
| PHICH_RB | dB | | | | | | |
| PDSCH_RA | dB | | | | | | |
| PDSCH_RB | dB | | | | | | |
| OCNG_RA ^{Note3} | dB | | | | | | |
| OCNG_RB ^{Note3} | dB | | | | | | |
| SNR ^{Note 8,9} | dB | -2.3 | -5.9 | -11.9 | -5.1 | -9.1 | -13.1 |
| N_{oc} | dBm/15 kHz | -98 | | | -98 | | |
| Propagation condition | | ETU 70 Hz | | | AWGN | | |
| <p>Note 1: For the special subframe configuration see table 4.2-1 in TS 36.211.</p> <p>Note 2: For the uplink-downlink configuration see table 4.2-2 in TS 36.211.</p> <p>Note 3: OCNG shall be used such that the resources in cell # 1 are fully allocated and a constant total transmitted power spectral density is achieved for all OFDM symbols.</p> <p>Note 4: The uplink resources for CQI reporting are assigned to the UE prior to the start of time period T1.</p> <p>Note 5: The timers and layer 3 filtering related parameters are configured prior to the start of time period T1.</p> <p>Note 6: The signal contains PDCCH for UEs other than the device under test as part of OCNG.</p> <p>Note 7: SNR levels correspond to the signal to noise ratio over the cell-specific reference signal REs.</p> <p>Note 8: The SNR in time periods T1, T2 and T3 is denoted as SNR1, SNR2 and SNR3 respectively in figure A.7.3.7.1-1.</p> <p>Note 9: The SNR values are specified for testing a UE which supports 2RX on at least one band. For testing of a UE which supports 4RX on all bands, the SNR during T3 is modified as specified in section A.3.8.1.</p> | | | | | | | |

Table A.7.3.7.1-3: DRX-Configuration for E-UTRAN TDD out-of-sync tests

| Field | Test1 | Test2 | Comment |
|--------------------------|---------|---------|---|
| | Value | Value | |
| onDurationTimer | psf2 | psf2 | As specified in clause 6.3.2 in TS 36.331 |
| drx-InactivityTimer | psf1 | psf1 | |
| drx-RetransmissionTimer | psf1 | psf1 | |
| longDRX-CycleStartOffset | sf40 | sf1280 | |
| shortDRX | disable | disable | |

Table A.7.3.7.1-4: TimeAlignmentTimer -Configuration for E-UTRAN TDD out-of-sync testing

| Field | Test1 | Test2 | Comment |
|--------------------|----------|----------|--|
| | Value | Value | |
| TimeAlignmentTimer | infinity | infinity | As specified in clause 6.3.2 in TS 36.331 |
| sr-ConfigIndex | 2 | 2 | For further information see clause 6.3.2 in TS 36.331 and section 10.1 in TS 36.213. |

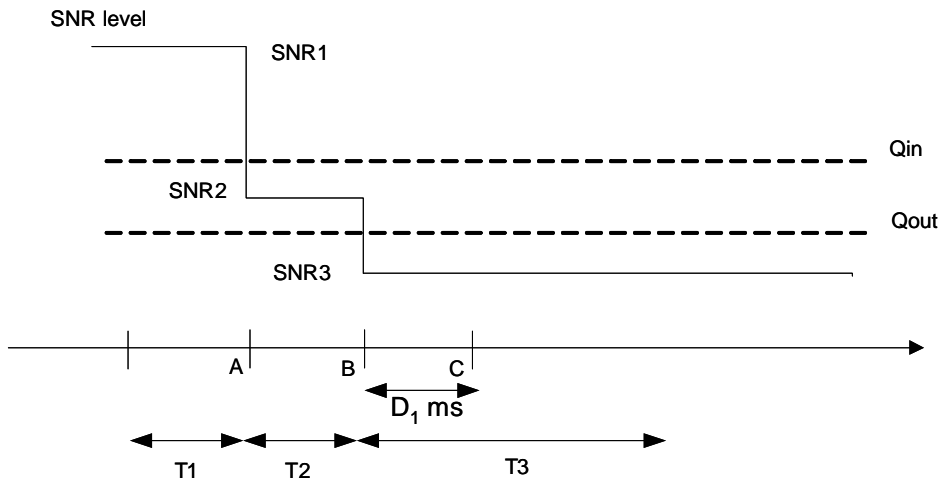

Figure A.7.3.7.1-1 SNR variation for out-of-sync testing in DRX

A.7.3.7.2 Test Requirements

The UE behaviour in each test during time durations T1, T2 and T3 shall be as follows:

In test 1 and test 2 during the period from time point A to time point B the UE shall transmit uplink signal at least once every DRX cycle, in the On-duration part of the cycle in the uplink subframe according to the configured CQI reporting mode (PUCCH 1-0).

In test 1 the UE shall stop transmitting uplink signal no later than time point C ($D_1 = 900$ ms after the start of time duration T3).

In test 2 the UE shall stop transmitting uplink signal no later than time point C (duration $D_1 = 6500$ ms after the start of time duration T3).

The rate of correct events observed during repeated tests shall be at least 90%.

A.7.3.8 E-UTRAN TDD Radio Link Monitoring Test for In-sync in DRX

A.7.3.8.1 Test Purpose and Environment

The purpose of this test is to verify that the UE properly detects the out of sync and in sync for the purpose of monitoring downlink radio link quality of the PCell when DRX is used. This test will partly verify the E-UTRAN TDD radio link monitoring requirements in clause 7.6.

The test parameters are given in Tables A.7.3.8.1-1, A.7.3.8.1-2, A.7.3.8.1-3 and A.7.3.8.1-4. There is one cell (cell 1), which is the active cell, in the test. The test consists of five successive time periods, with time duration of T1, T2, T3, T4 and T5 respectively. Figure A.7.3.8.1-1 shows the variation of the downlink SNR in the active cell to emulate out-of-sync and in-sync states. Prior to the start of the time duration T1, the UE shall be fully synchronized to cell 1. The UE shall be configured for periodic CQI reporting in PUCCH 1-0 mode with a reporting periodicity of 1 ms. In the test, DRX configuration is enabled and DRX inactivity timer has already been expired, i.e. UE tries to decode PDCCH and to send periodic CQI during the period when On-duration timer is running. Time alignment timers shall be set to “infinity” so that UL timing alignment is maintained during the test.

Table A.7.3.8.1-1: General test parameters for E-UTRAN TDD in-sync test in DRX

| Parameter | Unit | Value | Comment |
|-------------------------------|------|----------|--|
| PCFICH/PDCCH/PHICH parameters | | R.6 TDD | As specified in clause A.3.1.2.2. None of the PDCCH are intended for the UE under test |
| OCNG parameters | | OP.2 TDD | As specified in clause A.3.2.2.2. |

| | | | | |
|--|--------------------------------|-----|----------------|--|
| Active cell | | | Cell 1 | Cell 1 is on E-UTRA RF channel number 1 |
| CP length | | | Normal | |
| E-UTRA RF Channel Number | | | 1 | One E-UTRA TDD carrier frequency is used. |
| E-UTRA Channel Bandwidth ($BW_{channel}$) | | MHz | 10 | |
| Antenna Configuration | | | 1x2 | |
| In sync transmission parameters (Note 1) | DCI format | | 1C | As defined in clause 5.3.3.1.4 in TS 36.212 |
| | Number of Control OFDM symbols | | 2 | In sync threshold Q_{in} and the corresponding hypothetical PDCCH/PCFICH transmission parameters are as specified in clause and Table 7.6.1-2 respectively. |
| | Aggregation level | CCE | 4 | |
| | ρ_A, ρ_B | | 0 | |
| | Ratio of PDCCH to RS EPRE | | 0 | |
| | Ratio of PCFICH to RS EPRE | | 4 | |
| Out of sync transmission parameters (Note 1) | DCI format | | 1A | |
| Out of sync transmission parameters (Note 1) | Number of Control OFDM symbols | | 2 | Out of sync threshold Q_{out} and the corresponding hypothetical PDCCH/PCFICH transmission parameters are as specified in clause 7.6.1 and Table 7.6.1-1 respectively. |
| | Aggregation level | CCE | 8 | |
| | ρ_A, ρ_B | | 0 | |
| | Ratio of PDCCH to RS EPRE | dB | 4 | |
| | Ratio of PCFICH to RS EPRE | dB | 4 | |
| | DRX cycle | ms | | |
| Layer 3 filtering | | | <i>Enabled</i> | <i>Counters:</i> $N_{310} = 1; N_{311} = 1$ |
| T310 timer | ms | | 2000 | <i>T310 is enabled</i> |
| T311 timer | ms | | 1000 | <i>T311 is enabled</i> |
| Periodic CQI reporting mode | | | PUCCH 1-0 | As defined in table 7.2.2-1 in TS 36.213. |
| CQI reporting periodicity | ms | | 1 | Minimum CQI reporting periodicity |
| Propagation channel | | | AWGN | |
| T1 | s | | 4 | |
| T2 | s | | 1.6 | |
| T3 | s | | 1.46 | |
| T4 | s | | 0.4 | |
| T5 | s | | 4 | |
| Note 1: PDCCH/PCFICH corresponding to the in-sync and out of sync transmission parameters need not be included in the Reference Measurement Channel. | | | | |

Table A.7.3.8.1-2: Cell specific test parameters for E-UTRAN TDD (cell # 1) for in-sync radio link monitoring test # 1 in DRX

| Parameter | Unit | Test 1 | | | | |
|---|------|--------|----|----|----|----|
| | | T1 | T2 | T3 | T4 | T5 |
| E-UTRA RF Channel Number | | 1 | | | | |
| $BW_{channel}$ | MHz | 10 | | | | |
| Antenna Configuration | | 1x2 | | | | |
| Special subframe configuration ^{Note1} | | 6 | | | | |
| Uplink-downlink configuration ^{Note2} | | 1 | | | | |

| | | | | | | |
|---|------------|----------|------|-------|------|------|
| OCNG Pattern defined in A.3.2.2 (TDD) | | OP.2 TDD | | | | |
| ρ_A, ρ_B | | 0 | | | | |
| PCFICH_RB | dB | 4 | | | | |
| PDCCH_RA | dB | 0 | | | | |
| PDCCH_RB | dB | 0 | | | | |
| PBCH_RA | dB | 0 | | | | |
| PBCH_RB | dB | | | | | |
| PSS_RA | dB | | | | | |
| SSS_RA | dB | | | | | |
| PHICH_RA | dB | | | | | |
| PHICH_RB | dB | | | | | |
| PDSCH_RA | dB | | | | | |
| PDSCH_RB | dB | | | | | |
| OCNG_RA ^{Note3} | dB | | | | | |
| OCNG_RB ^{Note3} | dB | | | | | |
| SNR ^{Note 8,9} | dB | -5.1 | -9.1 | -13.1 | -9.1 | -5.1 |
| N_{oc} | dBm/15 kHz | -98 | | | | |
| Propagation condition | | AWGN | | | | |
| <p>Note 1: For the special subframe configuration see table 4.2-1 in TS 36.211.</p> <p>Note 2: For the uplink-downlink configuration see table 4.2-2 in TS 36.211.</p> <p>Note 3: OCNG shall be used such that the resources in cell # 1 are fully allocated and a constant total transmitted power spectral density is achieved for all OFDM symbols.</p> <p>Note 4: The uplink resources for CQI reporting are assigned to the UE prior to the start of time period T1.</p> <p>Note 5: The timers and layer 3 filtering related parameters are configured prior to the start of time period T1.</p> <p>Note 6: The signal contains PDCCH for UEs other than the device under test as part of OCNG.</p> <p>Note 7: SNR levels correspond to the signal to noise ratio over the cell-specific reference signal REs.</p> <p>Note 8: The SNR in time periods T1, T2, T3, T4 and T5 is denoted as SNR1, SNR2, SNR3, SNR4 and SNR5 respectively in figure A.7.3.8.1-1.</p> <p>Note 9: The SNR values are specified for testing a UE which supports 2RX on at least one band. For testing of a UE which supports 4RX on all bands, the SNR during T3 and T4 is modified as specified in section A.3.8.1.</p> | | | | | | |

Table A.7.3.8.1-3: DRX-Configuration for E-UTRAN TDD out-of-sync tests

| Field | Value | Comment |
|--------------------------|---------|---|
| onDurationTimer | psf2 | As specified in clause 6.3.2 in TS 36.331 |
| drx-InactivityTimer | psf1 | |
| drx-RetransmissionTimer | psf1 | |
| longDRX-CycleStartOffset | sf40 | |
| shortDRX | disable | |

Table A.7.3.8.1-4: TimeAlignmentTimer -Configuration for E-UTRAN TDD out-of-sync testing

| Field | Value | Comment |
|--------------------|----------|--|
| TimeAlignmentTimer | infinity | As specified in clause 6.3.2 in TS 36.331 |
| sr-ConfigIndex | 2 | For further information see clause 6.3.2 in TS 36.331 and section 10.1 in TS 36.213. |

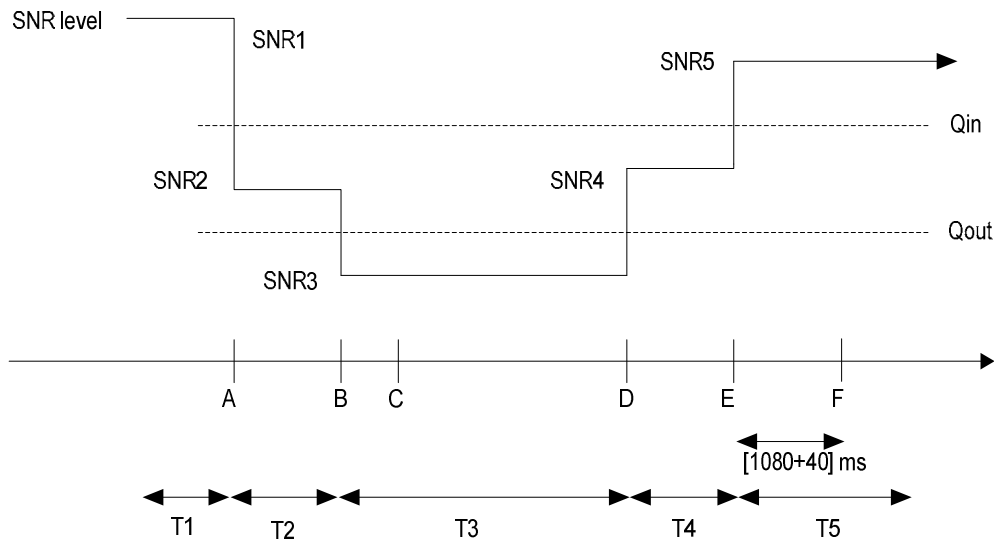

Figure A.7.3.8.1-1 SNR variation for in-sync testing in DRX

A.7.3.8.2 Test Requirements

The UE behaviour in each test during time durations T1, T2, T3, T4 and T5 shall be as follows:

During the period from time point A to time point F (1120 ms after the start of time duration T5) the UE shall transmit uplink signal at least once every DRX cycle, in the On-duration part of the cycle in the uplink subframe according to the configured CQI reporting mode (PUCCH 1-0).

The rate of correct events observed during repeated tests shall be at least 90%.

A.7.3.9 E-UTRAN FDD Radio Link Monitoring Test for Out-of-sync under Time Domain Measurement Resource Restriction and Non-MBSFN ABS

A.7.3.9.1 Test Purpose and Environment

The purpose of this test is to verify that the UE properly detects the out of sync and in sync for the purpose of monitoring downlink radio link quality of the serving cell under time domain measurement resource restriction when CRS assistance information is not provided. This test will partly verify the E-UTRAN FDD radio link monitoring requirements in clause 7.6.

The test parameters are given in Tables A.7.3.9.1-1 and A.7.3.9.1-2 below. The test consists of three successive time periods, with time duration of T1, T2 and T3 respectively. Figure A.7.3.9.1-1 shows the variation of the downlink SNR in the active cell to emulate out-of-sync and in-sync states. Prior to the start of the time duration T1, the UE shall be fully synchronized to cell 1. The UE shall be configured for periodic CQI reporting in PUCCH 1-0 mode with a reporting periodicity of 2 ms.

Non-MBSFN ABS pattern is configured in the aggressor Cell 2 in this test. The UE is configured by higher layers with a time domain measurement restriction pattern for performing serving cell measurements. The patterns shall be configured prior to the start of T1.

Table A.7.3.9.1-1: General test parameters for E-UTRAN FDD out-of-sync testing under time domain measurement resource restriction with non-MBSFN ABS

| Parameter | Unit | Value | Comment |
|-----------|------|-------|---------|
|-----------|------|-------|---------|

| | | | | |
|---|--------------------------------|-----|--|---|
| PCFICH/PDCCH/PHICH parameters | | | R.9.FDD | As specified in clause A.3.1.2.1. None of the PDCCH are intended for the UE under test |
| OCNG parameters | | | OP.6 FDD | As specified in clause A.3.2.1.6. |
| Serving cell (PCell) | | | Cell 1 | Cell 1 is on E-UTRA RF channel number 1 |
| Neighbor cell | | | Cell 2 | Aggressor cell on E-UTRA RF channel number 1 |
| Neighbor cell ABS configuration | | | Non-MBSFN ABS | As defined in Table A.3.4.1.2-1 |
| CP length | | | Normal | |
| E-UTRA RF Channel Number | | | 1 | One E-UTRA FDD carrier frequency is used. |
| E-UTRA Channel Bandwidth ($BW_{channel}$) | | MHz | 10 | |
| Correlation Matrix and Antenna Configuration | | | 2x2 Low | Correlation Matrix and Antenna Configuration are defined in TS 36.101 [5] Annex B.2.3.2 |
| Out of sync transmission parameters (Note 1) | DCI format | | 1A | As defined in clause 5.3.3.1.3 in TS 36.212 |
| | Number of Control OFDM symbols | | 3 | Out of sync threshold Q_{out} and the corresponding hypothetical PDCCH/PCFICH transmission parameters are as specified in clause 7.6.1 and Table 7.6.1-1 respectively. |
| | Aggregation level | CCE | 8 | |
| | ρ_A, ρ_B | | -3 | |
| | Ratio of PDCCH to RS EPRE | dB | 1 | |
| Ratio of PCFICH to RS EPRE | dB | 1 | | |
| DRX | | | OFF | |
| Layer 3 filtering | | | Enabled | Counters:: N310 = 1; N311 = 1 |
| T310 timer | | ms | 0 | T310 is disabled |
| T311 timer | | ms | 1000 | T311 is enabled |
| Periodic CQI reporting mode | | | PUCCH 1-0 | As defined in table 7.2.2-1 in TS 36.213. |
| CQI reporting periodicity | | ms | 2 | Minimum CQI reporting periodicity |
| Time offset between cells | | | 3 μ s | Synchronous cells |
| T1 | | s | 1 | |
| T2 | | s | 0.4 | |
| T3 | | s | 0.5 | |
| Physical cell ID PCI | | | $(PCI_{cell1} - PCI_{cell2}) \bmod 3 \neq 0$ | Cell IDs are chosen such that CRS from cells 1 and 2 do not overlap in frequency |
| ABS pattern | | | '10000000100000001000000000001000000010000000' | FDD ABS Pattern Info IE, as defined in TS 36.423 [28], clause 9.2.54. Configured in Cell 2. The first/leftmost bit corresponds to the PCell subframe #0 of the radio frame satisfying $SFN \bmod x = 0$, where x is the size of the bit string (40) divided by 10. No MBSFN subframes are configured in the ABS subframes. |
| Time domain measurement resource restriction pattern | | | '10000000100000001000000000001000000010000000' | Time domain measurement resource restriction pattern for serving cell measurement signalled to the UE in message measSubframePatternPCell-r10 as defined in TS 36.331, clause 6.3.2. |
| Note 1: PDCCH/PCFICH corresponding to the out of sync transmission parameters need not be included in the Reference Measurement Channel | | | | |

Table A.7.3.9.1-2: Cell specific test parameters for E-UTRAN FDD for out-of-sync radio link monitoring under time domain measurement resource restriction with non-MBSFN ABS

| Parameter | Unit | Cell 1 | | | Cell 2 | | |
|--------------------------|------|--------|----|----|--------|----|----|
| | | T1 | T2 | T3 | T1 | T2 | T3 |
| E-UTRA RF Channel Number | | 1 | | | 1 | | |

| | | | | | |
|--|------------|-----------|------|-------|---|
| $BW_{channel}$ | MHz | 10 | | | 10 |
| Correlation Matrix and Antenna Configuration | | 2x2 Low | | | 2x2 Low |
| OCNG Pattern defined in A.3.2.1.6 (FDD) | | OP.6 FDD | | | OP.6 FDD |
| ρ_A, ρ_B | | -3 | | | -3 |
| PCFICH_RB | dB | 1 | | | Non-ABS and ABS subframe channel powers defined in Table A.3.4.1.2-1. |
| PDCCH_RA | dB | 1 | | | |
| PDCCH_RB | dB | 1 | | | |
| PBCH_RA | dB | -3 | | | |
| PBCH_RB | dB | | | | |
| PSS_RA | dB | | | | |
| SSS_RA | dB | | | | |
| PHICH_RA | dB | | | | |
| PHICH_RB | dB | | | | |
| PDSCH_RA | dB | | | | |
| PDSCH_RB | dB | | | | |
| OCNG_RA ^{Note1} | dB | | | | |
| OCNG_RB ^{Note1} | dB | | | | |
| SNR ^{Note 6,7} | dB | -1.3 | -5.4 | -12.4 | 5 |
| N_{oc} | dBm/15 kHz | -98 | | | -98 |
| Propagation condition | | ETU 30 Hz | | | ETU 30 Hz |
| <p>Note 1: OCNG shall be used such that the resources in cell # 1 are fully allocated and a constant total transmitted power spectral density is achieved for all OFDM symbols.</p> <p>Note 2: The uplink resources for CQI reporting are assigned to the UE prior to the start of time period T1.</p> <p>Note 3: The timers and layer 3 filtering related parameters are configured prior to the start of time period T1.</p> <p>Note 4: The signal contains PDCCH for UEs other than the device under test as part of OCNG.</p> <p>Note 5: SNR levels correspond to the signal quality, signal-to-interference-plus-noise ratio, on the CRS REs.</p> <p>Note 6: The SNR in the restricted measurement subframes during time periods T1, T2 and T3 is denoted as SNR1, SNR2 and SNR3 respectively in figure A.7.3. 9.1-1.</p> <p>Note 7: The SNR values are specified for testing a UE which supports 2RX on at least one band. For testing of a UE which supports 4RX on all bands, the SNR during T3 is modified as specified in section A.3.8.1.</p> | | | | | |

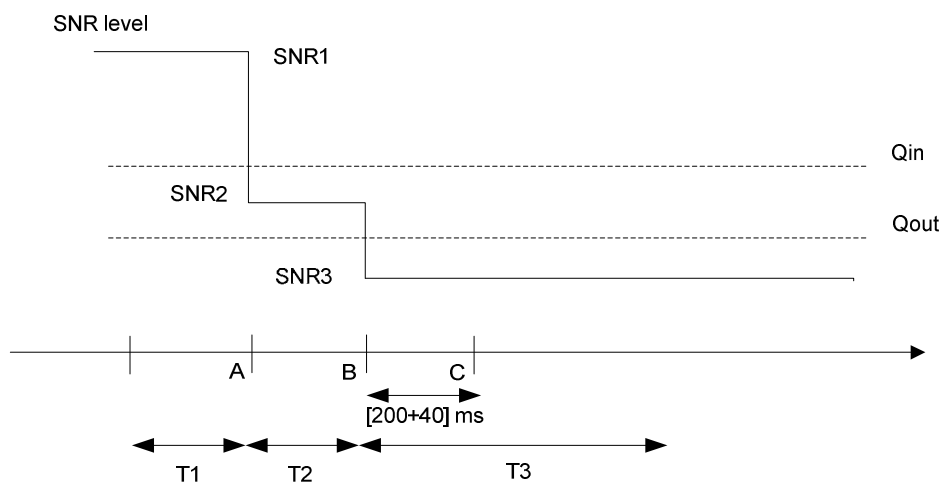

Figure A.7.3.9.1-1 SNR variation for out-of-sync testing

A.7.3.9.2 Test Requirements

The UE behaviour in each test during time durations T1, T2 and T3 shall be as follows:

During the period from time point A to time point B the UE shall transmit uplink signal at least in all subframes configured for CQI transmission according to the configured CQI reporting mode (PUCCH 1-0).

The UE shall stop transmitting uplink signal no later than time point C (240 ms after the start of time duration T3).

The rate of correct events observed during repeated tests shall be at least 90%.

A.7.3.10 E-UTRAN TDD Radio Link Monitoring Test for Out-of-sync under Time Domain Measurement Resource Restriction with Non-MBSFN ABS

A.7.3.10.1 Test Purpose and Environment

The purpose of this test is to verify that the UE properly detects the out of sync and in sync for the purpose of monitoring downlink radio link quality of the serving cell under time domain measurement resource restriction when CRS assistance information is not provided. This test will partly verify the E-UTRAN TDD radio link monitoring requirements in clause 7.6.

The test parameters are given in Tables A.7.3.10.1-1 and A.7.3.10.1-2 below. There are two cells, cell 1 is the serving cell and cell 2 is the neighbor aggressor cell. The test consists of three successive time periods, with time duration of T1, T2 and T3 respectively. Figure A.7.3.10.1-1 shows the variation of the downlink SNR in the active cell to emulate out-of-sync and in-sync states. Prior to the start of the time duration T1, the UE shall be fully synchronized to cell 1. The UE shall be configured for periodic CQI reporting in PUCCH 1-0 mode with a reporting periodicity of 1 ms.

Non-MBSFN ABS pattern is configured in Cell 2 in this test. The UE is configured by higher layers with a time domain measurement restriction pattern for performing serving cell measurements. The patterns shall be configured prior to the start of T1.

Table A.7.3.10.1-1: General test parameters for E-UTRAN TDD out-of-sync testing under time domain measurement resource restriction with non-MBSFN ABS

| Parameter | | Unit | Value | Comment |
|---|--------------------------------|------|---------------|--|
| PCFICH/PDCCH/PHICH parameters | | | R.9 TDD | As specified in clause A.3.1.2.2. None of the PDCCH are intended for the UE under test |
| OCNG parameters | | | OP.2 TDD | As specified in clause A.3.2.2.2. |
| Serving cell | | | Cell 1 | Cell 1 is on E-UTRA RF channel number 1 |
| Neighbor cell | | | Cell 2 | Cell 2 is the aggressor cell on E-UTRA RF channel number 1 |
| Neighbor cell ABS configuration | | | Non-MBSFN ABS | As defined in Table A.3.4.1.2-1 |
| CP length | | | Normal | |
| E-UTRA RF Channel Number | | | 1 | One E-UTRA TDD carrier frequency is used. |
| E-UTRA Channel Bandwidth (BW _{channel}) | | MHz | 10 | |
| Correlation Matrix and Antenna Configuration | | | 2x2 Low | Correlation Matrix and Antenna Configuration are defined in TS 36.101 [5] Annex B.2.3.2 |
| Out of sync transmission parameters (Note 1) | DCI format | | 1A | As defined in clause 5.3.3.1.3 in TS 36.212 |
| | Number of Control OFDM symbols | | 3 | Out of sync threshold Q_{out} and the corresponding hypothetical PDCCH/PCFICH transmission parameters are as specified in clause 7.6.1 and Table 7.6.1-1 respectively. |
| | Aggregation level | CCE | 8 | |
| | ρ_A, ρ_B | | -3 | |
| | Ratio of PDCCH to RS EPRE | dB | 1 | |
| Ratio of PCFICH to RS | dB | 1 | | |

| | | | | |
|--|------|--|--|---|
| | EPRE | | | |
| Physical cell ID PCI | | | $(PCI_{cell1} - PCI_{cell2}) \bmod 3 \neq 0$ | Cell IDs are chosen such that CRS from cells 1 and 2 do not overlap in frequency. |
| ABS pattern | | | 10000000001000000000 | TDD ABS Pattern Info IE is configured in Cell 2 as defined in clause 9.2.54 in TS 36.423 [28]. The first/leftmost bit corresponds to the subframe #0 of the radio frame satisfying $SFN \bmod x = 0$, where x is the size of the bit string (20) divided by 10. No MBSFN subframes are configured in the ABS subframes. |
| Time domain measurement resource restriction pattern | | | 10000000001000000000 | MeasSubframePattern IE is configured in UE for serving cell measurement as defined in clause 6.3.6 in TS 36.331. |
| DRX | | | OFF | |
| Layer 3 filtering | | | Enabled | Counters: N310 = 1; N311 = 1 |
| T310 timer | ms | | 0 | T310 is disabled |
| T311 timer | ms | | 1000 | T311 is enabled |
| Periodic CQI reporting mode | | | PUCCH 1-0 | As defined in table 7.2.2-1 in TS 36.213. |
| CQI reporting periodicity | ms | | 1 | Minimum CQI reporting periodicity |
| Time offset between cells | μs | | 3 | |
| Propagation channel | | | ETU30 | |
| T1 | s | | 1 | |
| T2 | s | | 0.4 | |
| T3 | s | | 0.5 | |
| Note 1: PDCCH/PCFICH corresponding to the out of sync transmission parameters need not be included in the Reference Measurement Channel. | | | | |

Table A.7.3.10.1-2: Cell specific test parameters for E-UTRAN TDD for out-of-sync radio link monitoring under time domain measurement resource restriction with non-MBSFN ABS

| Parameter | Unit | Cell 1 | | | Cell 2 | | |
|---|------|----------|------|-------|---|----|----|
| | | T1 | T2 | T3 | T1 | T2 | T3 |
| E-UTRA RF Channel Number | | 1 | | | 1 | | |
| BW _{channel} | MHz | 10 | | | 10 | | |
| Correlation Matrix and Antenna Configuration | | 2x2 Low | | | 2x2 Low | | |
| Special subframe configuration ^{Note1} | | 6 | | | 6 | | |
| Uplink-downlink configuration ^{Note2} | | 1 | | | 1 | | |
| OCNG Pattern defined in A.3.2.2 (TDD) | | OP.2 TDD | | | OP.2 TDD | | |
| P_A, P_B | | -3 | | | -3 | | |
| PCFICH_RB | dB | 1 | | | Non-ABS and ABS subframe channel powers defined in Table A.3.4.1.2-1. | | |
| PDCCH_RA | dB | 1 | | | | | |
| PDCCH_RB | dB | 1 | | | | | |
| PBCH_RA | dB | -3 | | | | | |
| PBCH_RB | dB | | | | | | |
| PSS_RA | dB | | | | | | |
| SSS_RA | dB | | | | | | |
| PHICH_RA | dB | | | | | | |
| PHICH_RB | dB | | | | | | |
| PDSCH_RA | dB | | | | | | |
| PDSCH_RB | dB | | | | | | |
| OCNG_RA ^{Note 3} | dB | -1.3 | | | 5 | | |
| OCNG_RB ^{Note 3} | dB | | | | | | |
| SNR ^{Note 8,9} | dB | -1.3 | -5.4 | -12.4 | | | |

| | | | |
|-----------------------|--|-------|-------|
| N_{oc} | dBm/15 kHz | -98 | -98 |
| Propagation condition | | ETU30 | ETU30 |
| Note 1: | For the special subframe configuration see table 4.2-1 in TS 36.211. | | |
| Note 2: | For the uplink-downlink configuration see table 4.2-2 in TS 36.211. | | |
| Note 3: | OCNG shall be used such that the resources in cell # 1 are fully allocated and a constant total transmitted power spectral density is achieved for all OFDM symbols. | | |
| Note 4: | The uplink resources for CQI reporting are assigned to the UE prior to the start of time period T1. | | |
| Note 5: | The timers and layer 3 filtering related parameters are configured prior to the start of time period T1. | | |
| Note 6: | The signal contains PDCCH for UEs other than the device under test as part of OCNG. | | |
| Note 7: | SNR levels correspond to the signal to noise ratio over the cell-specific reference signal REs. | | |
| Note 8: | The SNR in time periods T1, T2 and T3 of active cell is denoted as SNR1, SNR2 and SNR3 respectively in figure A.7.3.10.1-1. | | |
| Note 9: | The SNR values are specified for testing a UE which supports 2RX on at least one band. For testing of a UE which supports 4RX on all bands, the SNR during T3 is modified as specified in section A.3.8.1. | | |

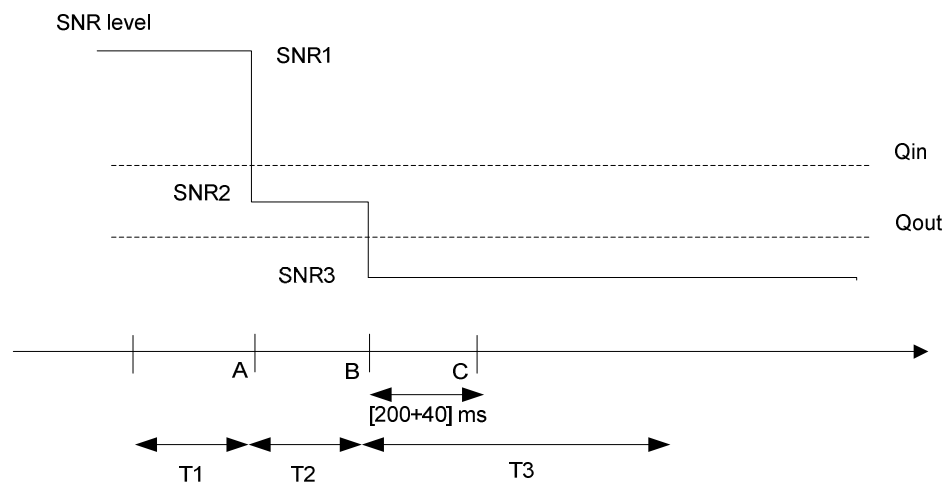

Figure A.7.3.10.1-1 SNR variation in active cell for out-of-sync testing under time domain measurement resource restriction with non-MBSFN ABS

A.7.3.10.2 Test Requirements

The UE behaviour in each test during time durations T1, T2 and T3 shall be as follows:

During the period from time point A to time point B the UE shall transmit uplink signal at least in all uplink subframes configured for CQI transmission according to the configured CQI reporting mode (PUCCH 1-0).

The UE shall stop transmitting uplink signal no later than time point C (240 ms after the start of the time duration T3).

The rate of correct events observed during repeated tests shall be at least 90%.

A.7.3.11 E-UTRAN FDD Radio Link Monitoring Test for In-sync for Non-MBSFN ABS

A.7.3.11.1 Test Purpose and Environment

The purpose of this test is to verify that the UE properly detects the out of sync and in sync for the purpose of monitoring downlink radio link quality of the serving cell under time domain measurement resource restriction when CRS assistance information is not provided. This test will partly verify the E-UTRAN FDD radio link monitoring requirements in clause 7.6.

The test parameters are given in Tables A.7.3.11.1-1 and A.7.3.11.1-2 below. There are two cells in the test: Cell 1 is the Active cell and Cell 2 is the Neighbor cell. The test consists of five successive time periods, with time duration of T1, T2, T3, T4 and T5 respectively. Figure A.7.3.11.1-1 shows the variation of the downlink SNR in the active cell to emulate out-of-sync and in-sync states. Prior to the start of the time duration T1, the UE shall be fully synchronized to cell 1. The UE shall be configured for periodic CQI reporting in PUCCH 1-0 mode with a reporting periodicity of 2 ms.

Non-MBSFN ABS pattern is configured in Cell 2 in this test. The UE is configured by higher layers with a time domain measurement restriction pattern for performing serving cell measurements. The patterns shall be configured prior to the start of T1.

Table A.7.3.11.1-1: General test parameters for E-UTRAN FDD in-sync testing under time domain measurement resource restriction

| Parameter | | Unit | Value | Comment |
|--|--------------------------------|------|---------------|--|
| PCFICH/PDCCH/PHICH parameters | | | R.9 FDD | As specified in clause A.3.1.2.1. None of the PDCCH are intended for the UE under test |
| OCNG parameters | | | OP.6 FDD | As specified in clause A.3.2.1.6. |
| Active cell | | | Cell 1 | Cell 1 is on E-UTRA RF channel number 1 |
| Neighbor cell | | | Cell 2 | Cell 2 is on E-UTRA RF channel number 1; Cell 2 generates interference over restricted resources. |
| Neighbor cell ABS configuration | | | Non-MBSFN ABS | As defined in Table A.3.4.1.2-2 |
| CP length | | | Normal | |
| E-UTRA RF Channel Number | | | 1 | One E-UTRA FDD carrier frequency is used. |
| E-UTRA Channel Bandwidth (BWchannel) | | MHz | 10 | |
| Correlation Matrix and Antenna Configuration | | | 2x2 Low | Correlation Matrix and Antenna Configuration are defined in TS 36.101 [5] Annex B.2.3.2 |
| In sync transmission parameters for the active cell (Note 1) | DCI format | | 1C | As defined in clause 5.3.3.1.4 in TS 36.212 |
| | Number of Control OFDM symbols | | 3 | In sync threshold Q_{in} and the corresponding hypothetical PDCCH/PCFICH transmission parameters are as specified in clause and Table 7.6.1-2 respectively. |
| | Aggregation level | CC E | 4 | |
| | ρ_A, ρ_B | | -3 | |
| | Ratio of PDCCH to RS EPRE | dB | -3 | |
| | Ratio of PCFICH to RS EPRE | dB | 1 | |
| Out of sync transmission parameters for active cell (Note 1) | DCI format | | 1A | |
| Out of sync transmission parameters for active cell (Note 1) | Number of Control OFDM symbols | | 3 | Out of sync threshold Q_{out} and the corresponding hypothetical PDCCH/PCFICH transmission parameters are as specified in clause 7.6.1 and Table 7.6.1-1 respectively. |
| | Aggregation level | CC E | 8 | |
| | ρ_A, ρ_B | | -3 | |
| | Ratio of PDCCH to RS EPRE | dB | 1 | |
| | Ratio of PCFICH to RS EPRE | dB | 1 | |
| | DRX | | | |
| Layer 3 filtering | | | Enabled | Counters: |

| | | | |
|--|----|--|---|
| | | | N310 = 1; N311 = 1 |
| T310 timer | ms | 2000 | T310 is enabled |
| T311 timer | ms | 1000 | T311 is enabled |
| Periodic CQI reporting mode | | PUCCH 1-0 | As defined in table 7.2.2-1 in TS 36.213. |
| CQI reporting periodicity | ms | 2 | Minimum CQI reporting periodicity |
| Time offset between cells | μs | 3 | |
| Propagation channel | | ETU30 | |
| T1 | s | 0.5 | |
| T2 | s | 0.4 | |
| T3 | s | 1.46 | |
| T4 | s | 0.4 | |
| T5 | s | 1 | |
| Physical cell ID PCI | | $(PCI_{cell1} - PCI_{cell2}) \bmod 3 \neq 0$ | Cell IDs are chosen such that CRS from cells 1 and 2 do not overlap in frequency |
| ABS pattern | | '100000001 000000010 000000100 000001000 0000' | FDD ABS Pattern Info IE, as defined in TS 36.423 [28], clause 9.2.54. Configured in Cell 2. The first/leftmost bit corresponds to the PCell subframe #0 of the radio frame satisfying $SFN \bmod x = 0$, where x is the size of the bit string (40) divided by 10. No MBSFN subframes are configured in the ABS subframes. |
| Time domain measurement resource restriction pattern | | '100000001 000000010 000000100 000001000 0000' | Time domain measurement resource restriction pattern for serving cell measurement signalled to the UE in message measSubframePatternPCell-r10 as defined in TS 36.331, clause 6.3.2. |
| Note 1: PDCCH/PCFICH corresponding to the in-sync and out of sync transmission parameters need not be included in the Reference Measurement Channel. | | | |

Table A.7.3.11.1-2: Cell specific test parameters for E-UTRAN FDD for in-sync radio link monitoring under time domain measurement resource restriction

| Parameter | Unit | Cell 1 | | | | | Cell 2 | | | | |
|--|------|----------|----|----|----|----|---|----|----|----|----|
| | | T1 | T2 | T3 | T4 | T5 | T1 | T2 | T3 | T4 | T5 |
| E-UTRA RF Channel Number | | 1 | | | | | 1 | | | | |
| BW _{channel} | MHz | 10 | | | | | 10 | | | | |
| Correlation Matrix and Antenna Configuration | | 2x2 Low | | | | | 2x2 Low | | | | |
| PCFICH/PDCCH/PHICH parameters | | R.9 FDD | | | | | R.9 FDD | | | | |
| Number of Control OFDM symbols | | 3 | | | | | 3 | | | | |
| OCNG Pattern defined in A.3.2.1.6 (FDD) | | OP.6 FDD | | | | | OP.6 FDD | | | | |
| P_A, P_B | | -3 | | | | | -3 | | | | |
| PCFICH_RB | dB | 1 | | | | | Non-ABS and ABS subframe channel powers defined in Table A.3.4.1.2-2. | | | | |
| PDCCH_RA | dB | -3 | | | | | | | | | |
| PDCCH_RB | dB | -3 | | | | | | | | | |
| PBCH_RA | dB | | | | | | | | | | |
| PBCH_RB | dB | | | | | | | | | | |
| PSS_RA | dB | | | | | | | | | | |
| SSS_RA | dB | | | | | | | | | | |

| | | | | | | | |
|--|------------|-------|------|-------|------|------|-------|
| PHICH_RA | dB | -3 | | | | | |
| PHICH_RB | dB | | | | | | |
| PDSCH_RA | dB | | | | | | |
| PDSCH_RB | dB | | | | | | |
| OCNG_RA ^{Note 1} | dB | | | | | | |
| OCNG_RB ^{Note 1} | dB | | | | | | |
| SNR ^{Note 6,7} | dB | -1.3 | -5.4 | -12.4 | -7.3 | -1.3 | 5 |
| N_{oc} | dBm/15 kHz | -98 | | | | | -98 |
| Propagation condition | | ETU30 | | | | | ETU30 |
| <p>Note 1: OCNG shall be used such that the resources in cell # 1 are fully allocated and a constant total transmitted power spectral density is achieved for all OFDM symbols.</p> <p>Note 2: The uplink resources for CQI reporting are assigned to the UE prior to the start of time period T1.</p> <p>Note 3: The timers and layer 3 filtering related parameters are configured prior to the start of time period T1.</p> <p>Note 4: The signal contains PDCCH for UEs other than the device under test as part of OCNG.</p> <p>Note 5: SNR levels correspond to the signal to noise ratio over the cell-specific reference signal REs.</p> <p>Note 6: The SNR in time periods T1, T2, T3, T4 and T5 of the active cell is denoted as SNR1, SNR2, SNR3, SNR4 and SNR5 respectively in figure A.7.3.11.1-1.</p> <p>Note 7: The SNR values are specified for testing a UE which supports 2RX on at least one band. For testing of a UE which supports 4RX on all bands, the SNR during T3 and T4 is modified as specified in section A.3.8.1.</p> | | | | | | | |

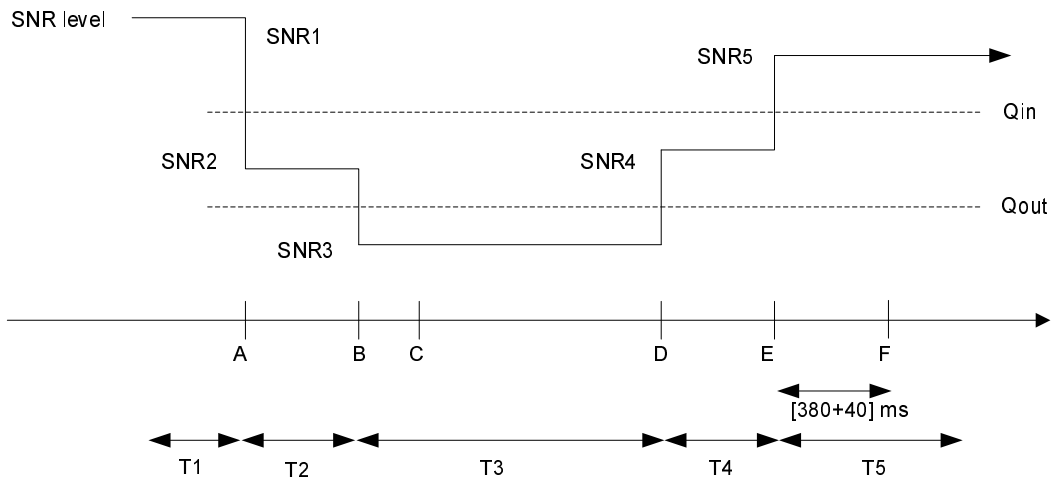

Figure A.7.3.11.1-1 SNR variation in the active cell for in-sync testing under time domain measurement resource restriction

A.7.3.11.2 Test Requirements

The UE behaviour in each test during time durations T1, T2, T3, T4 and T5 shall be as follows:

During the period from time point A to time point F (420 ms after the start of time duration T5) the UE shall transmit uplink signal at least in all subframes configured for CQI transmission according to the configured CQI reporting mode (PUCCH 1-0).

The rate of correct events observed during repeated tests shall be at least 90%.

A.7.3.12 E-UTRAN TDD Radio Link Monitoring Test for In-sync for Non-MBSFN ABS

A.7.3.12.1 Test Purpose and Environment

The purpose of this test is to verify that the UE properly detects the out of sync and in sync for the purpose of monitoring downlink radio link quality of the serving cell under time domain measurement resource restriction when

CRS assistance information is not provided. This test will partly verify the E-UTRAN TDD radio link monitoring requirements in clause 7.6.

The test parameters are given in Tables A.7.3.12.1-1 and A.7.3.12.1-2 below. There are two cells in the test: Cell 1 is the Active cell and Cell 2 is the Neighbor cell. The test consists of five successive time periods, with time duration of T1, T2, T3, T4 and T5 respectively. Figure A.7.3.12.1-1 shows the variation of the downlink SNR in the active cell to emulate out-of-sync and in-sync states. Prior to the start of the time duration T1, the UE shall be fully synchronized to cell 1. The UE shall be configured for periodic CQI reporting in PUCCH 1-0 mode with a reporting periodicity of 1 ms.

Non-MBSFN ABS pattern is configured in the aggressor Cell 2 in this test. The UE is configured by higher layers with a time domain measurement restriction pattern for performing serving cell measurements. The patterns shall be configured prior to the start of T1.

Table A.7.3.12.1-1: General test parameters for E-UTRAN TDD in-sync testing under time domain measurement resource restriction

| Parameter | | Unit | Value | Comment |
|--|--------------------------------|------|---------------|--|
| PCFICH/PDCCH/PHICH parameters | | | R.9 TDD | As specified in clause A.3.1.2.2. None of the PDCCH are intended for the UE under test |
| OCNG parameters | | | OP.2 TDD | As specified in clause A.3.2.2.2. |
| Active cell | | | Cell 1 | Cell 1 is on E-UTRA RF channel number 1 |
| Neighbor cell | | | Cell 2 | Cell 2 is on E-UTRA RF channel number 1; Cell 2 generates interference over restricted resources. |
| Neighbor cell ABS configuration | | | Non-MBSFN ABS | As defined in Table A.3.4.1.2-2 |
| CP length | | | Normal | |
| E-UTRA RF Channel Number | | | 1 | One E-UTRA TDD carrier frequency is used. |
| E-UTRA Channel Bandwidth (BW/channel) | | MHz | 10 | |
| Correlation Matrix and Antenna Configuration | | | 2x2 Low | Correlation Matrix and Antenna Configuration are defined in TS 36.101 [5] Annex B.2.3.2 |
| In sync transmission parameters for the active cell (Note 1) | DCI format | | 1C | As defined in clause 5.3.3.1.4 in TS 36.212 |
| | Number of Control OFDM symbols | | 3 | In sync threshold Q_{in} and the corresponding hypothetical PDCCH/PCFICH transmission parameters are as specified in clause and Table 7.6.1-2 respectively. |
| | Aggregation level | CC E | 4 | |
| | ρ_A, ρ_B | | -3 | |
| | Ratio of PDCCH to RS EPRE | dB | -3 | |
| | Ratio of PCFICH to RS EPRE | dB | 1 | |
| Out of sync transmission parameters for active cell (Note 1) | DCI format | | 1A | |
| Out of sync transmission parameters for active cell (Note 1) | Number of Control OFDM symbols | | 3 | Out of sync threshold Q_{out} and the corresponding hypothetical PDCCH/PCFICH transmission parameters are as specified in clause 7.6.1 and Table 7.6.1-1 respectively. |
| | Aggregation level | CC E | 8 | |
| | ρ_A, ρ_B | | -3 | |
| | Ratio of PDCCH to RS EPRE | dB | 1 | |

| | | | | |
|--|----------------------------|----|--|---|
| | Ratio of PCFICH to RS EPRE | dB | 1 | |
| DRX | | | OFF | |
| Layer 3 filtering | | | Enabled | Counters: N310 = 1; N311 = 1 |
| T310 timer | ms | | 2000 | T310 is enabled |
| T311 timer | ms | | 1000 | T311 is enabled |
| Periodic CQI reporting mode | | | PUCCH 1-0 | As defined in table 7.2.2-1 in TS 36.213. |
| CQI reporting periodicity | ms | | 1 | Minimum CQI reporting periodicity |
| Time offset between cells | μ s | | 3 | |
| Propagation channel | | | ETU30 | |
| T1 | s | | 0.5 | |
| T2 | s | | 0.4 | |
| T3 | s | | 1.46 | |
| T4 | s | | 0.4 | |
| T5 | s | | 1 | |
| Physical cell ID PCI | | | $(PCI_{cell1} - PCI_{cell2}) \bmod 3 \neq 0$ | Cell IDs are chosen such that CRS from cells 1 and 2 do not overlap in frequency |
| ABS pattern | | | 1000000000 1000000000 | TDD ABS Pattern Info IE, as defined in TS 36.423 [28], clause 9.2.54. Configured in Cell 2. The first/leftmost bit corresponds to the subframe #0 of the radio frame satisfying $SFN \bmod x = 0$, where x is the size of the bit string (20) divided by 10. No MBSFN subframes are configured in the ABS subframes. |
| Time domain measurement resource restriction pattern | | | 1000000000 1000000000 | Time domain measurement resource restriction pattern for serving cell measurement signalled to the UE in message <code>measSubframePatternPCell-r10</code> as defined in TS 36.331, clause 6.3.2. Configured in Cell 1. |
| Note 1: PDCCH/PCFICH corresponding to the in-sync and out of sync transmission parameters need not be included in the Reference Measurement Channel. | | | | |

Table A.7.3.12.1-2: Cell specific test parameters for E-UTRAN TDD for in-sync radio link monitoring under time domain measurement resource restriction

| Parameter | Unit | Cell 1 | | | | | Cell 2 | | | | |
|---|------|---------|----|----|----|----|---------|----|----|----|----|
| | | T1 | T2 | T3 | T4 | T5 | T1 | T2 | T3 | T4 | T5 |
| E-UTRA RF Channel Number | | 1 | | | | | 1 | | | | |
| $BW_{channel}$ | MHz | 10 | | | | | 10 | | | | |
| Correlation Matrix and Antenna Configuration | | 2x2 Low | | | | | 2x2 Low | | | | |
| Special subframe configuration ^{Note1} | | 6 | | | | | 6 | | | | |
| Uplink-downlink configuration ^{Note2} | | 1 | | | | | 1 | | | | |
| PCFICH/PDCCH/PHI CH parameters | | R.9 TDD | | | | | R.9 TDD | | | | |

| | | | | | | | |
|---|------------|----------|------|-------|------|------|---|
| Number of Control OFDM symbols | | 3 | | | | | 3 |
| OCNG Pattern defined in A.3.2.2 (TDD) | | OP.2 TDD | | | | | OP.2 TDD |
| ρ_A, ρ_B | | -3 | | | | | -3 |
| PCFICH_RB | dB | 1 | | | | | Non-ABS and ABS subframe channel powers defined in Table A.3.4.1.2-2. |
| PDCCH_RA | dB | -3 | | | | | |
| PDCCH_RB | dB | -3 | | | | | |
| PBCH_RA | dB | -3 | | | | | |
| PBCH_RB | dB | | | | | | |
| PSS_RA | dB | | | | | | |
| SSS_RA | dB | | | | | | |
| PHICH_RA | dB | | | | | | |
| PHICH_RB | dB | | | | | | |
| PDSCH_RA | dB | | | | | | |
| PDSCH_RB | dB | | | | | | |
| OCNG_RA ^{Note 3} | dB | | | | | | |
| OCNG_RB ^{Note 3} | dB | | | | | | |
| SNR ^{Note 8,9} | dB | -1.3 | -5.4 | -12.4 | -7.3 | -1.3 | |
| N_{oc} | dBm/15 kHz | -98 | | | | | -98 |
| Propagation condition | | ETU30 | | | | | ETU30 |
| <p>Note 1: For the special subframe configuration see table 4.2-1 in TS 36.211.</p> <p>Note 2: For the uplink-downlink configuration see table 4.2-2 in TS 36.211.</p> <p>Note 3: OCNG shall be used such that the resources in cell # 1 are fully allocated and a constant total transmitted power spectral density is achieved for all OFDM symbols.</p> <p>Note 4: The uplink resources for CQI reporting are assigned to the UE prior to the start of time period T1.</p> <p>Note 5: The timers and layer 3 filtering related parameters are configured prior to the start of time period T1.</p> <p>Note 6: The signal contains PDCCH for UEs other than the device under test as part of OCNG.</p> <p>Note 7: SNR levels correspond to the signal to noise ratio over the cell-specific reference signal REs.</p> <p>Note 8: The SNR in time periods T1, T2, T3, T4 and T5 of active cell is denoted as SNR1, SNR2, SNR3, SNR4 and SNR5 respectively in figure A.7.3.12.1-1.</p> <p>Note 9: The SNR values are specified for testing a UE which supports 2RX on at least one band. For testing of a UE which supports 4RX on all bands, the SNR during T3 and T4 is modified as specified in section A.3.8.1.</p> | | | | | | | |

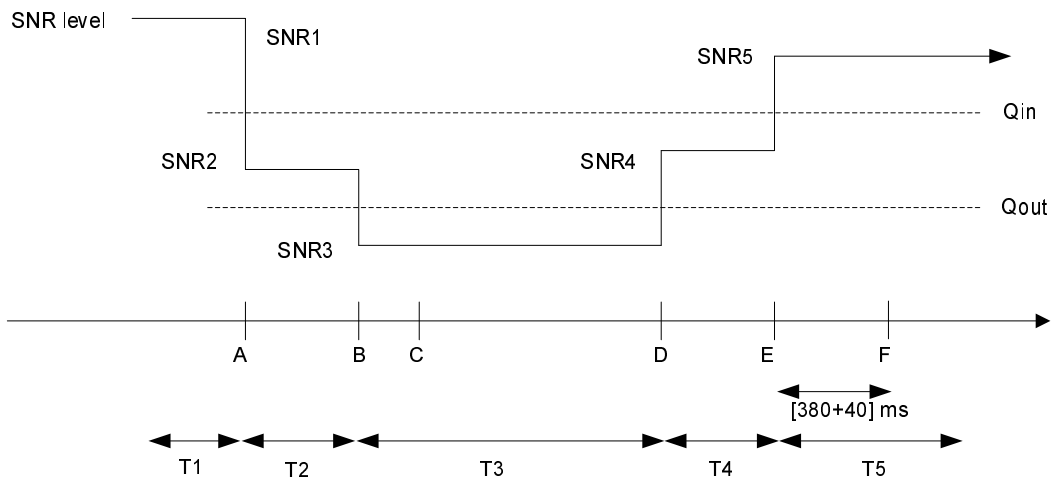

Figure A.7.3.12.1-1 SNR variation in active cell for in-sync testing under time domain measurement resource restriction

A.7.3.12.2 Test Requirements

The UE behaviour in each test during time durations T1, T2, T3, T4 and T5 shall be as follows:

During the period from time point A to time point F (420 ms after the start of time duration T5) the UE shall transmit uplink signal at least in all uplink subframes configured for CQI transmission according to the configured CQI mode (PUCCH 1-0).

The rate of correct events observed during repeated tests shall be at least 90%.

A.7.3.13 E-UTRAN FDD Radio Link Monitoring Test for Out-of-sync under Time Domain Measurement Resource Restriction with MBSFN ABS

A.7.3.13.1 Test Purpose and Environment

The purpose of this test is to verify that the UE properly detects the out of sync and in sync for the purpose of monitoring downlink radio link quality of the serving cell under time domain measurement resource restriction when CRS assistance information is not provided. This test will partly verify the E-UTRAN FDD radio link monitoring requirements in clause 7.6.

The test parameters are given in Tables A.7.3.13.1-1 and A.7.3.13.1-2 below. The test consists of three successive time periods, with time duration of T1, T2 and T3 respectively. Figure A.7.3.13.1-1 shows the variation of the downlink SNR in the active cell to emulate out-of-sync and in-sync states. Prior to the start of the time duration T1, the UE shall be fully synchronized to Cell 1. The UE shall be configured for periodic CQI reporting in PUCCH 1-0 mode with a reporting periodicity of 2 ms.

MBSFN ABS pattern is configured in the aggressor Cell 2 in this test. The UE is configured by higher layers with a time domain measurement restriction pattern for performing serving cell measurements. The patterns shall be configured prior to the start of T1.

Table A.7.3.13.1-1: General test parameters for E-UTRAN FDD out-of-sync testing under time domain measurement resource restriction with MBSFN ABS

| Parameter | Unit | Value | Comment | |
|--|--------------------------------|--|--|----|
| PCFICH/PDCCH/PHICH parameters | | R.9.FDD | As specified in clause A.3.1.2.1. None of the PDCCH are intended for the UE under test | |
| OCNG parameters | | OP.6 FDD for the serving cell (Cell 1) OP.9 FDD for the neighbour cell (Cell 2) | As specified in clause A.3.2.1.6 and A.3.2.1.9 respectively | |
| Serving cell (PCell) | | Cell 1 | Cell 1 is on E-UTRA RF channel number 1 | |
| Neighbor cell | | Cell 2 | Aggressor cell on E-UTRA RF channel number 1 | |
| Neighbor cell ABS configuration | | MBSFN ABS | As defined in Table A.3.4.2.2-1 | |
| CP length | | Normal | | |
| E-UTRA RF Channel Number | | 1 | One E-UTRA FDD carrier frequency is used. | |
| E-UTRA Channel Bandwidth ($BW_{channel}$) | MHz | 10 | | |
| Correlation Matrix and Antenna Configuration | | 2x2 Low | Correlation Matrix and Antenna Configuration are defined in TS 36.101 [5] Annex B.2.3.2 | |
| Out of sync transmission parameters (Note 1) | DCI format | 1A | As defined in clause 5.3.3.1.3 in TS 36.212 | |
| | Number of Control OFDM symbols | 3 | Out of sync threshold Q_{out} and the corresponding hypothetical PDCCH/PCFICH transmission parameters are as specified in clause 7.6.1 and Table 7.6.1-1 respectively. | |
| | Aggregation level | CCE | | 8 |
| | ρ_A, ρ_B | | | -3 |
| | Ratio of PDCCH to RS EPRE | dB | | 1 |
| Ratio of PCFICH to RS EPRE | dB | 1 | | |
| DRX | | OFF | | |

| | | | |
|---|----|--|--|
| Layer 3 filtering | | Enabled | Counters:: N310 = 1; N311 = 1 |
| T310 timer | ms | 0 | T310 is disabled |
| T311 timer | ms | 1000 | T311 is enabled |
| Periodic CQI reporting mode | | PUCCH 1-0 | As defined in table 7.2.2-1 in TS 36.213. |
| CQI reporting periodicity | ms | 2 | Minimum CQI reporting periodicity |
| Time offset between cells | | 3 μs | Synchronous cells |
| T1 | s | 1 | |
| T2 | s | 0.4 | |
| T3 | s | 0.5 | |
| Physical cell ID PCI | | $(PCI_{cell1} - PCI_{cell2}) \bmod 3 = 0$, PCI_{cell1} not equal to PCI_{cell2} | Cell IDs are chosen such that CRS from cells 1 and 2 overlap in frequency |
| ABS pattern | | '01000000100000001000000001000000100000001000000' | FDD ABS Pattern Info IE, as defined in TS 36.423 [28], clause 9.2.54. Configured in Cell 2. The first/leftmost bit corresponds to the PCell subframe #0 of the radio frame satisfying $SFN \bmod x = 0$, where x is the size of the bit string (40) divided by 10. MBSFN subframes are configured in the ABS subframes. |
| Time domain measurement resource restriction pattern | | '01000000100000001000000001000000100000001000000' | Time domain measurement resource restriction pattern for serving cell measurement signalled to the UE in message measSubframePattern-Serv-r10 as defined in TS 36.331, clause 6.3.2. |
| Note 1: PDCCH/PCFICH corresponding to the out of sync transmission parameters need not be included in the Reference Measurement Channel | | | |

Table A.7.3.13.1-2: Cell specific test parameters for E-UTRAN FDD for out-of-sync radio link monitoring under time domain measurement resource restriction with MBSFN ABS

| Parameter | Unit | Cell 1 | | | Cell 2 | | |
|--|------------|-----------|------|-------|---|----|----|
| | | T1 | T2 | T3 | T1 | T2 | T3 |
| E-UTRA RF Channel Number | | 1 | | | 1 | | |
| BW _{channel} | MHz | 10 | | | 10 | | |
| Correlation Matrix and Antenna Configuration | | 2x2 Low | | | 2x2 Low | | |
| OCNG Pattern defined in A.3.2.1 (FDD) | | OP.6 FDD | | | OP.9 FDD | | |
| ρ _A , ρ _B | | -3 | | | -3 | | |
| PCFICH_RB | dB | 1 | | | Non-ABS and ABS subframe channel powers defined in Table A.3.4.2.2-1. | | |
| PDCCH_RA | dB | 1 | | | | | |
| PDCCH_RB | dB | 1 | | | | | |
| PBCH_RA | dB | -3 | | | | | |
| PBCH_RB | dB | | | | | | |
| PSS_RA | dB | | | | | | |
| SSS_RA | dB | | | | | | |
| PHICH_RA | dB | | | | | | |
| PHICH_RB | dB | | | | | | |
| PDSCH_RA | dB | | | | | | |
| PDSCH_RB | dB | | | | | | |
| OCNG_RA ^{Note1} | dB | -1.3 | | | 5 | | |
| OCNG_RB ^{Note1} | dB | | | | | | |
| SNR ^{Note 6,7} | dB | -1.3 | -5.4 | -12.4 | | | |
| N _{oc} | dBm/15 kHz | -98 | | | -98 | | |
| Propagation condition | | ETU 30 Hz | | | ETU 30 Hz | | |

- Note 1: OCNG shall be used such that the resources in cell # 1 are fully allocated and a constant total transmitted power spectral density is achieved for all OFDM symbols.
- Note 2: The uplink resources for CQI reporting are assigned to the UE prior to the start of time period T1.
- Note 3: The timers and layer 3 filtering related parameters are configured prior to the start of time period T1.
- Note 4: The signal contains PDCCH for UEs other than the device under test as part of OCNG.
- Note 5: SNR levels correspond to the signal quality, signal-to-interference-plus-noise ratio, on the CRS REs.
- Note 6: The SNR in the restricted measurement subframes during time periods T1, T2 and T3 is denoted as SNR1, SNR2 and SNR3 respectively in figure A.7.3.13.1-1.
- Note 7: The SNR values are specified for testing a UE which supports 2RX on at least one band. For testing of a UE which supports 4RX on all bands, the SNR during T3 is modified as specified in section A.3.8.1.

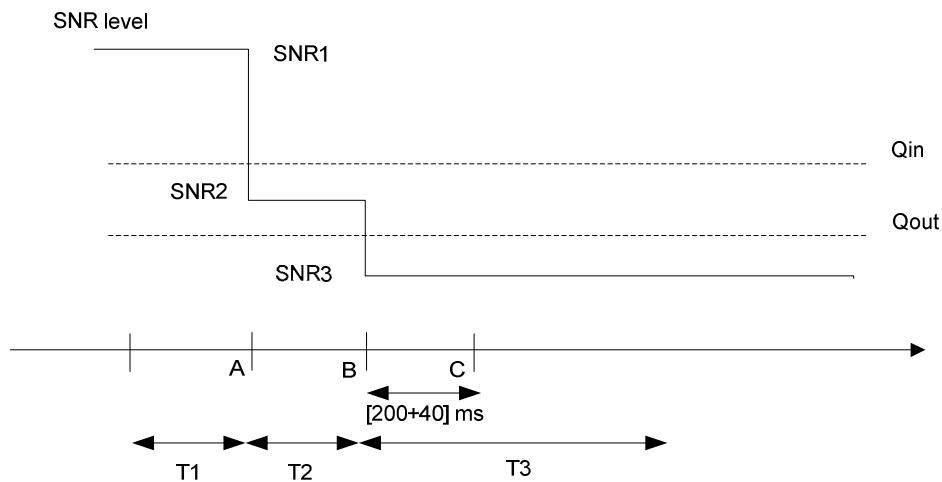

Figure A.7.3.13.1-1 SNR variation for out-of-sync testing

A.7.3.13.2 Test Requirements

The UE behaviour in each test during time durations T1, T2 and T3 shall be as follows:

During the period from time point A to time point B the UE shall transmit uplink signal at least in all subframes configured for CQI transmission according to the configured CQI reporting mode (PUCCH 1-0).

The UE shall stop transmitting uplink signal no later than time point C (240 ms after the start of time duration T3).

The rate of correct events observed during repeated tests shall be at least 90%.

A.7.3.14 E-UTRAN TDD Radio Link Monitoring Test for Out-of-sync under Time Domain Measurement Resource Restriction with MBSFN ABS

A.7.3.14.1 Test Purpose and Environment

The purpose of this test is to verify that the UE properly detects the out of sync and in sync for the purpose of monitoring downlink radio link quality of the serving cell under time domain measurement resource restriction when CRS assistance information is not provided. This test will partly verify the E-UTRAN TDD radio link monitoring requirements in clause 7.6.

The test parameters are given in Tables A.7.3.14.1-1 and A.7.3.14.1-2 below. The test consists of three successive time periods, with time duration of T1, T2 and T3 respectively. Figure A.7.3.14.1-1 shows the variation of the downlink SNR in the active cell to emulate out-of-sync and in-sync states. Prior to the start of the time duration T1, the UE shall be fully synchronized to Cell 1. The UE shall be configured for periodic CQI reporting in PUCCH 1-0 mode with a reporting periodicity of 2 ms.

MBSFN ABS pattern is configured in the aggressor Cell 2 in this test. The UE is configured by higher layers with a time domain measurement restriction pattern for performing serving cell measurements. The patterns shall be configured prior to the start of T1.

Table A.7.3.14.1-1: General test parameters for E-UTRAN TDD out-of-sync testing under time domain measurement resource restriction with MBSFN ABS

| Parameter | | Unit | Value | Comment |
|--|--------------------------------|------|--|---|
| PCFICH/PDCCH/PHICH parameters | | | R.9.TDD | As specified in clause A.3.1.2.1. None of the PDCCH are intended for the UE under test |
| OCNG parameters | | | OP.2 TDD for the serving cell (Cell 1) OP.6 TDD for the neighbour cell (Cell 2) | As specified in clause A.3.2.2.2 and A.3.2.2.6 respectively |
| Serving cell (PCell) | | | Cell 1 | Cell 1 is on E-UTRA RF channel number 1 |
| Neighbor cell | | | Cell 2 | Aggressor cell on E-UTRA RF channel number 1 |
| Neighbor cell ABS configuration | | | MBSFN ABS | As defined in Table A.3.4.2.2-1 |
| CP length | | | Normal | |
| E-UTRA RF Channel Number | | | 1 | One E-UTRA FDD carrier frequency is used. |
| E-UTRA Channel Bandwidth ($BW_{channel}$) | | MHz | 10 | |
| Correlation Matrix and Antenna Configuration | | | 2x2 Low | Correlation Matrix and Antenna Configuration are defined in TS 36.101 [5] Annex B.2.3.2 |
| Out of sync transmission parameters (Note 1) | DCI format | | 1A | As defined in clause 5.3.3.1.3 in TS 36.212 |
| | Number of Control OFDM symbols | | 3 | Out of sync threshold Q_{out} and the corresponding hypothetical PDCCH/PCFICH transmission parameters are as specified in clause 7.6.1 and Table 7.6.1-1 respectively. |
| | Aggregation level | CCE | 8 | |
| | ρ_A, ρ_B | | -3 | |
| | Ratio of PDCCH to RS EPRE | dB | 1 | |
| Ratio of PCFICH to RS EPRE | dB | 1 | | |
| DRX | | | OFF | |
| Layer 3 filtering | | | Enabled | Counters:: N310 = 1; N311 = 1 |
| T310 timer | | ms | 0 | T310 is disabled |
| T311 timer | | ms | 1000 | T311 is enabled |
| Periodic CQI reporting mode | | | PUCCH 1-0 | As defined in table 7.2.2-1 in TS 36.213. |
| CQI reporting periodicity | | ms | 1 | Minimum CQI reporting periodicity |
| Time offset between cells | | | 3 μ s | Synchronous cells |
| T1 | | s | 1 | |
| T2 | | s | 0.4 | |
| T3 | | s | 0.5 | |
| Physical cell ID PCI | | | $(PCI_{cell1} - PCI_{cell2}) \bmod 3 = 0$, PCI_{cell1} not equal to PCI_{cell2} | Cell IDs are chosen such that CRS from cells 1 and 2 overlap in frequency |
| ABS pattern | | | '00001000000000100000' | MBSFN ABS. TDD ABS Pattern Info IE, as defined in TS 36.423 [28], clause 9.2.54. Configured in Cell 2. The first/leftmost bit corresponds to the PCell subframe #0 of the radio frame satisfying $SFN \bmod x = 0$, where x is the size of the bit string (20) divided by 10. All ABS subframes are MBSFN subframes. |

| | | | |
|---|--|------------------------|---|
| Time domain measurement resource restriction pattern | | '00001000000000100000' | Time-domain measurement resource restriction pattern for serving cell measurements signalled to the UE in message measSubframePattern-Serv-r10 as defined in TS 36.331, clause 6.3.2. |
| Note 1: PDCCH/PCFICH corresponding to the out of sync transmission parameters need not be included in the Reference Measurement Channel | | | |

Table A.7.3.14.1-2: Cell specific test parameters for E-UTRAN TDD for out-of-sync radio link monitoring under time domain measurement resource restriction with MBSFN ABS

| Parameter | Unit | Cell 1 | | | Cell 2 | | |
|--|------------|-----------|------|-------|---|----|----|
| | | T1 | T2 | T3 | T1 | T2 | T3 |
| E-UTRA RF Channel Number | | 1 | | | 1 | | |
| BW _{channel} | MHz | 10 | | | 10 | | |
| Special subframe configuration ^{Note1} | | 6 | | | 6 | | |
| Uplink-downlink configuration ^{Note2} | | 1 | | | 1 | | |
| Correlation Matrix and Antenna Configuration | | 2x2 Low | | | 2x2 Low | | |
| OCNG Pattern defined in A.3.2.2 (TDD) | | OP.2 TDD | | | OP.6 TDD | | |
| ρ_A, ρ_B | | -3 | | | -3 | | |
| PCFICH_RB | dB | 1 | | | Non-ABS and ABS subframe channel powers defined in Table A.3.4.2.2-1. | | |
| PDCCH_RA | dB | 1 | | | | | |
| PDCCH_RB | dB | 1 | | | | | |
| PBCH_RA | dB | -3 | | | | | |
| PBCH_RB | dB | | | | | | |
| PSS_RA | dB | | | | | | |
| SSS_RA | dB | | | | | | |
| PHICH_RA | dB | | | | | | |
| PHICH_RB | dB | | | | | | |
| PDSCH_RA | dB | | | | | | |
| PDSCH_RB | dB | | | | | | |
| OCNG_RA ^{Note3} | dB | | | | | | |
| OCNG_RB ^{Note3} | dB | | | | | | |
| SNR ^{Note 7,8,9} | dB | -1.3 | -5.4 | -12.4 | 5 | | |
| N_{oc} | dBm/15 kHz | -98 | | | -98 | | |
| Propagation condition | | ETU 30 Hz | | | ETU 30 Hz | | |
| <p>Note 1: For the special subframe configuration see table 4.2-1 in TS 36.211.</p> <p>Note 2: For the uplink-downlink subframe configuration see table 4.2-2 in TS 36.211.</p> <p>Note 3: OCNG shall be used such that the resources in cell # 1 are fully allocated and a constant total transmitted power spectral density is achieved for all OFDM symbols.</p> <p>Note 4: The uplink resources for CQI reporting are assigned to the UE prior to the start of time period T1.</p> <p>Note 5: The timers and layer 3 filtering related parameters are configured prior to the start of time period T1.</p> <p>Note 6: The signal contains PDCCH for UEs other than the device under test as part of OCNG.</p> <p>Note 7: SNR levels correspond to the signal quality, signal-to-interference-plus-noise ratio, on the CRS REs.</p> <p>Note 8: The SNR in the restricted measurement subframes during time periods T1, T2 and T3 is denoted as SNR1, SNR2 and SNR3 respectively in Figure A.7.3.14.1-1.</p> <p>Note 9: The SNR values are specified for testing a UE which supports 2RX on at least one band. For testing of a UE which supports 4RX on all bands, the SNR during T3 is modified as specified in section A.3.8.1.</p> | | | | | | | |

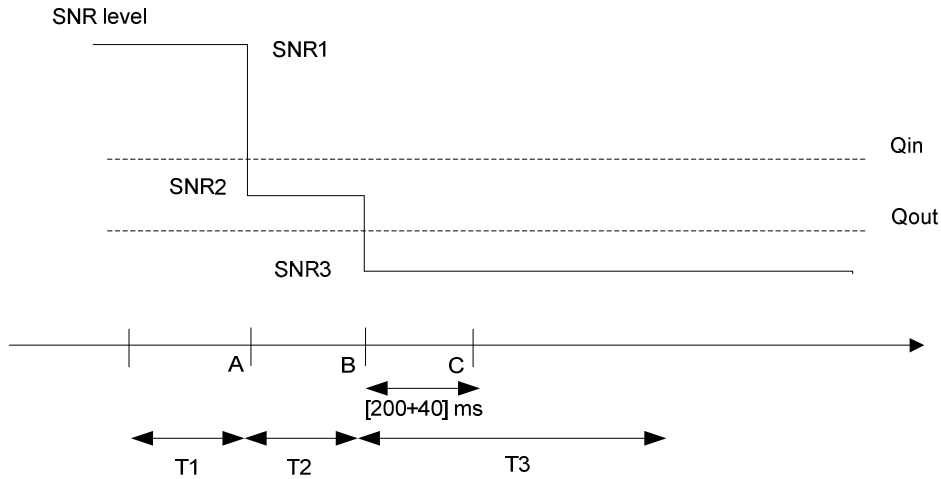

Figure A.7.3.14.1-1 SNR variation for out-of-sync testing

A.7.3.14.2 Test Requirements

The UE behaviour in each test during time durations T1, T2 and T3 shall be as follows:

During the period from time point A to time point B the UE shall transmit uplink signal at least in all subframes configured for CQI transmission according to the configured CQI reporting mode (PUCCH 1-0).

The UE shall stop transmitting uplink signal no later than time point C (240 ms after the start of time duration T3).

The rate of correct events observed during repeated tests shall be at least 90%.

A.7.3.15 E-UTRAN FDD Radio Link Monitoring Test for In-sync under Time Domain Measurement Resource Restriction with MBSFN ABS

A.7.3.15.1 Test Purpose and Environment

The purpose of this test is to verify that the UE properly detects the out of sync and in sync for the purpose of monitoring downlink radio link quality of the serving cell under time domain measurement resource restriction when CRS assistance information is not provided. This test will partly verify the E-UTRAN FDD radio link monitoring requirements in clause 7.6.

The test parameters are given in Tables A.7.3.15.1-1 and A.7.3.15.1-2 below. There are two cells, cell 1 is the serving cell and cell 2 is the neighbour aggressor cell. The test consists of five successive time periods, with time duration of T1, T2, T3, T4 and T5 respectively. Figure A.7.3.15.1-1 shows the variation of the downlink SNR in the active cell to emulate out-of-sync and in-sync states. Prior to the start of the time duration T1, the UE shall be fully synchronized to cell 1. The UE shall be configured for periodic CQI reporting in PUCCH 1-0 mode with a reporting periodicity of 2 ms.

MBSFN ABS pattern is configured in Cell 2 in this test. The UE is configured by higher layers with a time domain measurement restriction pattern for performing serving cell measurements. The patterns shall be configured prior to the start of T1.

Table A.7.3.15.1-1: General test parameters for E-UTRAN FDD in-sync testing under time domain measurement resource restriction with MBSFN ABS

| Parameter | Unit | Value | Comment |
|-------------------------------|------|---------|--|
| PCFICH/PDCCH/PHICH parameters | | R.9 FDD | As specified in clause A.3.1.2.1. None of the PDCCH are intended for the UE under test |
| Serving cell | | Cell 1 | Cell 1 is on E-UTRA RF channel number 1 |
| Neighbour cell | | Cell 2 | Cell 2 is the aggressor cell on E-UTRA RF channel number 1 |

| | | | | |
|--|--------------------------------|-----|--|---|
| Neighbour cell ABS configuration | | | MBSFN ABS | As defined in Table A.3.4.2.2-2 |
| OCNG parameters for Cell 1 | | | OP.6 FDD | As specified in clause A.3.2.1.6. |
| OCNG parameters for Cell 2 | | | OP.9 FDD | As specified in clause A.3.2.1.9. |
| CP length | | | Normal | |
| Neighbor cell ABS configuration | | | MBSFN ABS | |
| E-UTRA RF Channel Number | | | 1 | One E-UTRA FDD carrier frequency is used. |
| E-UTRA Channel Bandwidth (BWchannel) | | MHz | 10 | |
| Correlation Matrix and Antenna Configuration | | | 2x2 Low | Correlation Matrix and Antenna Configuration are defined in TS 36.101 [5] Annex B.2.3.2 |
| In sync transmission parameters (Note 1) | DCI format | | 1C | As defined in clause 5.3.3.1.4 in TS 36.212 |
| | Number of Control OFDM symbols | | 3 | In sync threshold Q_{in} and the corresponding hypothetical PDCCH/PCFICH transmission parameters are as specified in clause and Table 7.6.1-2 respectively. |
| | Aggregation level | CCE | 4 | |
| | ρ_A, ρ_B | | -3 | |
| | Ratio of PDCCH to RS EPRE | dB | -3 | |
| | Ratio of PCFICH to RS EPRE | dB | 1 | |
| Out of sync transmission parameters (Note 1) | DCI format | | 1A | As defined in clause 5.3.3.1.3 in TS 36.212 |
| | Number of Control OFDM symbols | | 3 | Out of sync threshold Q_{out} and the corresponding hypothetical PDCCH/PCFICH transmission parameters are as specified in clause 7.6.1 and Table 7.6.1-1 respectively. |
| | Aggregation level | CCE | 8 | |
| | ρ_A, ρ_B | | -3 | |
| | Ratio of PDCCH to RS EPRE | dB | 1 | |
| | Ratio of PCFICH to RS EPRE | dB | 1 | |
| Physical cell ID PCI | | | $(PCI_{cell1} - PCI_{cell2}) \bmod 3 = 0$, PCI_{cell1} not equal to PCI_{cell2} | Cell IDs are chosen such that CRS from cells 1 and 2 overlap in frequency. |
| ABS pattern | | | 010000001000000010000 0000010000001000000 | FDD ABS Pattern Info IE is configured in Cell 2 as defined in clause 9.2.54 in TS 36.423 [28]. The first/leftmost bit corresponds to the subframe #0 of the radio frame satisfying $SFN \bmod x = 0$, where x is the size of the bit string (40) divided by 10. All ABS subframes are MBSFN subframes. |
| Time domain measurement resource restriction pattern | | | 010000001000000010000 0000010000001000000 | MeasSubframePattern IE is configured in UE for serving cell measurement as defined in clause 6.3.6 in TS 36.331. |
| DRX | | | OFF | |
| Layer 3 filtering | | | Enabled | Counters: $N_{310} = 1$; $N_{311} = 1$ |
| T310 timer | | ms | 2000 | T310 is enabled |
| T311 timer | | ms | 1000 | T311 is enabled |
| Periodic CQI reporting mode | | | PUCCH 1-0 | As defined in table 7.2.2-1 in TS 36.213. |
| CQI reporting periodicity | | ms | 2 | Minimum CQI reporting periodicity |

| | | | |
|--|---------|-------|--|
| Time offset between cells | μ s | 3 | |
| Propagation channel | | ETU30 | |
| T1 | s | 0.5 | |
| T2 | s | 0.4 | |
| T3 | s | 1.46 | |
| T4 | s | 0.4 | |
| T5 | s | 1 | |
| Note 1: PDCCH/PCFICH corresponding to the in-sync and out of sync transmission parameters need not be included in the Reference Measurement Channel. | | | |

Table A.7.3.15.1-2: Cell specific test parameters for E-UTRAN FDD for in-sync radio link monitoring under time domain measurement resource restriction with MBSFN ABS

| Parameter | Unit | Cell 1 | | | | | Cell 2 | | | | |
|--|------------|----------|------|-------|------|------|---|----|----|----|----|
| | | T1 | T2 | T3 | T4 | T5 | T1 | T2 | T3 | T4 | T5 |
| E-UTRA RF Channel Number | | 1 | | | | | 1 | | | | |
| BW _{channel} | MHz | 10 | | | | | 10 | | | | |
| Correlation Matrix and Antenna Configuration | | 2x2 Low | | | | | 2x2 Low | | | | |
| OCNG Pattern defined in A.3.2.1 (FDD) | | OP.6 FDD | | | | | OP.9 FDD | | | | |
| ρ_A, ρ_B | | -3 | | | | | -3 | | | | |
| PCFICH_RA | dB | 1 | | | | | Non-ABS and ABS subframe channel powers defined in Table A.3.4.2.2-2. | | | | |
| PDCCH_RA | dB | -3 | | | | | | | | | |
| PDCCH_RB | dB | -3 | | | | | | | | | |
| PBCH_RA | dB | -3 | | | | | | | | | |
| PBCH_RB | dB | | | | | | | | | | |
| PSS_RA | dB | | | | | | | | | | |
| SSS_RA | dB | | | | | | | | | | |
| PHICH_RA | dB | | | | | | | | | | |
| PHICH_RB | dB | | | | | | | | | | |
| PDSCH_RA | dB | | | | | | | | | | |
| PDSCH_RB | dB | | | | | | | | | | |
| OCNG_RA ^{Note 1} | dB | -1.3 | | | | | 5 | | | | |
| OCNG_RB ^{Note 1} | dB | | | | | | | | | | |
| SNR ^{Note 6,7} | dB | -1.3 | -5.4 | -12.4 | -7.3 | -1.3 | | | | | |
| N_{oc} | dBm/15 kHz | -98 | | | | | -98 | | | | |
| Propagation condition | | ETU30 | | | | | ETU30 | | | | |
| <p>Note 1: OCNG shall be used such that the resources in Cell 1 are fully allocated and a constant total transmitted power spectral density is achieved for all OFDM symbols.</p> <p>Note 2: The uplink resources for CQI reporting are assigned to the UE prior to the start of time period T1.</p> <p>Note 3: The timers and layer 3 filtering related parameters are configured prior to the start of time period T1.</p> <p>Note 4: The signal contains PDCCH for UEs other than the device under test as part of OCNG.</p> <p>Note 5: SNR levels correspond to the signal to noise ratio over the cell-specific reference signal REs.</p> <p>Note 6: The SNR in time periods T1, T2, T3, T4 and T5 of the active cell is denoted as SNR1, SNR2, SNR3, SNR4 and SNR5 respectively in figure A.7.3.15.1-1.</p> <p>Note 7: The SNR values are specified for testing a UE which supports 2RX on at least one band. For testing of a UE which supports 4RX on all bands, the SNR during T3 and T4 is modified as specified in section A.3.8.1.</p> | | | | | | | | | | | |

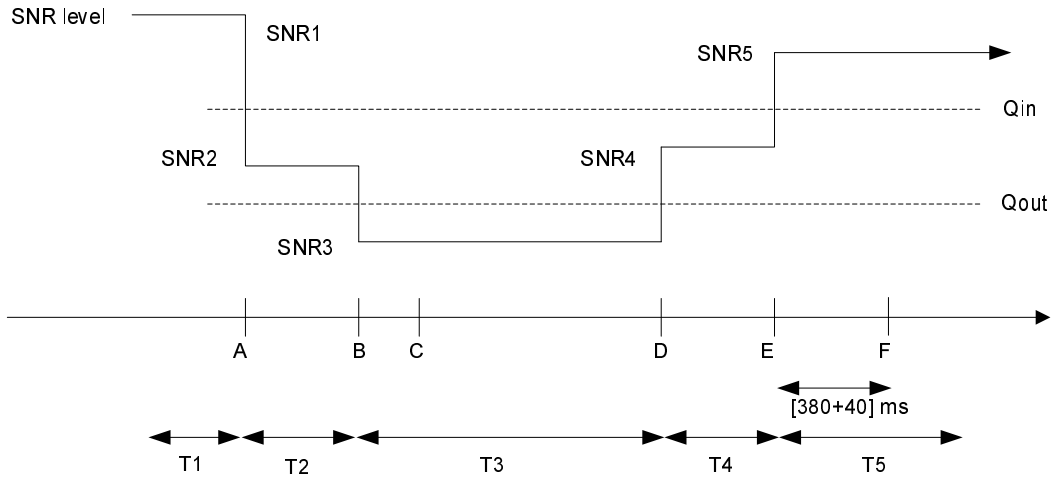

Figure A.7.3.15.1-1 SNR variation in the active cell for in-sync testing under time domain measurement resource restriction with MBSFN ABS

A.7.3.15.2 Test Requirements

The UE behaviour in each test during time durations T1, T2, T3, T4 and T5 shall be as follows:

During the period from time point A to time point F (420 ms after the start of time duration T5) the UE shall transmit uplink signal at least in all subframes configured for CQI transmission according to the configured CQI reporting mode (PUCCH 1-0).

The rate of correct events observed during repeated tests shall be at least 90%.

A.7.3.16 E-UTRAN TDD Radio Link Monitoring Test for In-sync under Time Domain Measurement Resource Restriction with MBSFN ABS

A.7.3.16.1 Test Purpose and Environment

The purpose of this test is to verify that the UE properly detects the out of sync and in sync for the purpose of monitoring downlink radio link quality of the serving cell under time domain measurement resource restriction when CRS assistance information is not provided. This test will partly verify the E-UTRAN TDD radio link monitoring requirements in clause 7.6.

The test parameters are given in Tables A.7.3.16.1-1 and A.7.3.16.1-2 below. There are two cells, cell 1 is the serving cell and cell 2 is the neighbour aggressor cell. The test consists of five successive time periods, with time duration of T1, T2, T3, T4 and T5 respectively. Figure A.7.3.15.1-1 shows the variation of the downlink SNR in the active cell to emulate out-of-sync and in-sync states. Prior to the start of the time duration T1, the UE shall be fully synchronized to cell 1. The UE shall be configured for periodic CQI reporting in PUCCH 1-0 mode with a reporting periodicity of 1 ms.

MBSFN ABS pattern is configured in Cell 2 in this test. The UE is configured by higher layers with a time domain measurement restriction pattern for performing serving cell measurements. The patterns shall be configured prior to the start of T1.

Table A.7.3.16.1-1: General test parameters for E-UTRAN TDD in-sync testing under time domain measurement resource restriction with MBSFN ABS

| Parameter | Unit | Value | Comment |
|-------------------------------|------|---------|--|
| PCFICH/PDCCH/PHICH parameters | | R.9 TDD | As specified in clause A.3.1.2.2. None of the PDCCH are intended for the UE under test |
| Serving cell | | Cell 1 | Cell 1 is on E-UTRA RF channel number 1 |
| Neighbour cell | | Cell 2 | Cell 2 is the aggressor cell on E- |

| | | | | |
|--|--------------------------------|---|---|--|
| | | | UTRA RF channel number 1 | |
| Neighbour cell ABS configuration | | MBSFN ABS | As defined in Table A.3.4.2.2-2 | |
| OCNG parameters for Cell 1 | | OP.2 TDD | As specified in clause A.3.2.2.2. | |
| OCNG parameters for Cell 2 | | OP.6 TDD | As specified in clause A.3.2.2.6. | |
| CP length | | Normal | | |
| Neighbor cell ABS configuration | | MBSFN ABS | | |
| E-UTRA RF Channel Number | | 1 | One E-UTRA TDD carrier frequency is used. | |
| E-UTRA Channel Bandwidth (BWchannel) | MHz | 10 | | |
| Correlation Matrix and Antenna Configuration | | 2x2 Low | Correlation Matrix and Antenna Configuration are defined in TS 36.101 [5] Annex B.2.3.2 | |
| In sync transmission parameters (Note 1) | DCI format | | 1C | As defined in clause 5.3.3.1.4 in TS 36.212 |
| | Number of Control OFDM symbols | | 3 | In sync threshold Q_{in} and the corresponding hypothetical PDCCH/PCFICH transmission parameters are as specified in clause and Table 7.6.1-2 respectively. |
| | Aggregation level | CCE | 4 | |
| | ρ_A, ρ_B | | -3 | |
| | Ratio of PDCCH to RS EPRE | dB | -3 | |
| | Ratio of PCFICH to RS EPRE | dB | 1 | |
| Out of sync transmission parameters (Note 1) | DCI format | | 1A | As defined in clause 5.3.3.1.3 in TS 36.212 |
| | Number of Control OFDM symbols | | 3 | Out of sync threshold Q_{out} and the corresponding hypothetical PDCCH/PCFICH transmission parameters are as specified in clause 7.6.1 and Table 7.6.1-1 respectively. |
| | Aggregation level | CCE | 8 | |
| | ρ_A, ρ_B | | -3 | |
| | Ratio of PDCCH to RS EPRE | dB | 1 | |
| | Ratio of PCFICH to RS EPRE | dB | 1 | |
| Physical cell ID PCI | | $(PCI_{cell1} - PCI_{cell2}) \bmod 3 = 0, PCI_{cell1}$ not equal to PCI_{cell2} | Cell IDs are chosen such that CRS from cells 1 and 2 overlap in frequency. | |
| ABS pattern | | 00001000000000100000 | TDD ABS Pattern Info IE is configured in Cell 2 as defined in clause 9.2.54 in TS 36.423 [28]. The first/leftmost bit corresponds to the subframe #0 of the radio frame satisfying $SFN \bmod x = 0$, where x is the size of the bit string (20) divided by 10. All ABS subframes are MBSFN subframes. | |
| Time domain measurement resource restriction pattern | | 00001000000000100000 | MeasSubframePattern IE is configured in UE for serving cell measurement as defined in clause 6.3.6 in TS 36.331. | |
| DRX | | OFF | | |
| Layer 3 filtering | | Enabled | Counters: $N_{310} = 1; N_{311} = 1$ | |
| T310 timer | ms | 2000 | T310 is enabled | |
| T311 timer | ms | 1000 | T311 is enabled | |
| Periodic CQI reporting mode | | PUCCH 1-0 | As defined in table 7.2.2-1 in TS 36.213. | |

| | | | |
|--|----|-------|-----------------------------------|
| CQI reporting periodicity | ms | 1 | Minimum CQI reporting periodicity |
| Time offset between cells | μs | 3 | |
| Propagation channel | | ETU30 | |
| T1 | s | 0.5 | |
| T2 | s | 0.4 | |
| T3 | s | 1.46 | |
| T4 | s | 0.4 | |
| T5 | s | 1 | |
| Note 1: PDCCH/PCFICH corresponding to the in-sync and out of sync transmission parameters need not be included in the Reference Measurement Channel. | | | |

Table A.7.3.16.1-2: Cell specific test parameters for E-UTRAN TDD for in-sync radio link monitoring under time domain measurement resource restriction with MBSFN ABS

| Parameter | Unit | Cell 1 | | | | | Cell 2 | | | | |
|---|------------|----------|------|-------|------|------|---|----|----|----|----|
| | | T1 | T2 | T3 | T4 | T5 | T1 | T2 | T3 | T4 | T5 |
| E-UTRA RF Channel Number | | 1 | | | | | 1 | | | | |
| BW _{channel} | MHz | 10 | | | | | 10 | | | | |
| Correlation Matrix and Antenna Configuration | | 2x2 Low | | | | | 2x2 Low | | | | |
| Special subframe configuration ^{Note1} | | 6 | | | | | 6 | | | | |
| Uplink-downlink configuration ^{Note2} | | 1 | | | | | 1 | | | | |
| OCNG Pattern defined in A.3.2.2 (TDD) | | OP.2 TDD | | | | | OP.6 TDD | | | | |
| P_A, P_B | | -3 | | | | | -3 | | | | |
| PCFICH_RB | dB | 1 | | | | | Non-ABS and ABS subframe channel powers defined in Table A.3.4.2.2-2. | | | | |
| PDCCH_RA | dB | -3 | | | | | | | | | |
| PDCCH_RB | dB | -3 | | | | | | | | | |
| PBCH_RA | dB | -3 | | | | | | | | | |
| PBCH_RB | dB | | | | | | | | | | |
| PSS_RA | dB | | | | | | | | | | |
| SSS_RA | dB | | | | | | | | | | |
| PHICH_RA | dB | | | | | | | | | | |
| PHICH_RB | dB | | | | | | | | | | |
| PDSCH_RA | dB | | | | | | | | | | |
| PDSCH_RB | dB | | | | | | | | | | |
| OCNG_RA ^{Note 1} | dB | -1.3 | | | | | 5 | | | | |
| OCNG_RB ^{Note 1} | dB | | | | | | | | | | |
| SNR ^{Note 8,9} | dB | -1.3 | -5.4 | -12.4 | -7.3 | -1.3 | | | | | |
| N_{oc} | dBm/15 kHz | -98 | | | | | -98 | | | | |
| Propagation condition | | ETU30 | | | | | ETU30 | | | | |
| <p>Note 1: For the special subframe configuration see table 4.2-1 in TS 36.211.</p> <p>Note 2: For the uplink-downlink configuration see table 4.2-2 in TS 36.211.</p> <p>Note 3: OCNG shall be used such that the resources in Cell 1 are fully allocated and a constant total transmitted power spectral density is achieved for all OFDM symbols.</p> <p>Note 4: The uplink resources for CQI reporting are assigned to the UE prior to the start of time period T1.</p> <p>Note 5: The timers and layer 3 filtering related parameters are configured prior to the start of time period T1.</p> <p>Note 6: The signal contains PDCCH for UEs other than the device under test as part of OCNG.</p> <p>Note 7: SNR levels correspond to the signal to noise ratio over the cell-specific reference signal REs.</p> <p>Note 8: The SNR in time periods T1, T2, T3, T4 and T5 of the active cell is denoted as SNR1, SNR2, SNR3, SNR4 and SNR5 respectively in figure A.7.3.16.1-1.</p> <p>Note 9: The SNR values are specified for testing a UE which supports 2RX on at least one band. For testing of a UE which supports 4RX on all bands, the SNR during T3 and T4 is modified as specified in section A.3.8.1.</p> | | | | | | | | | | | |

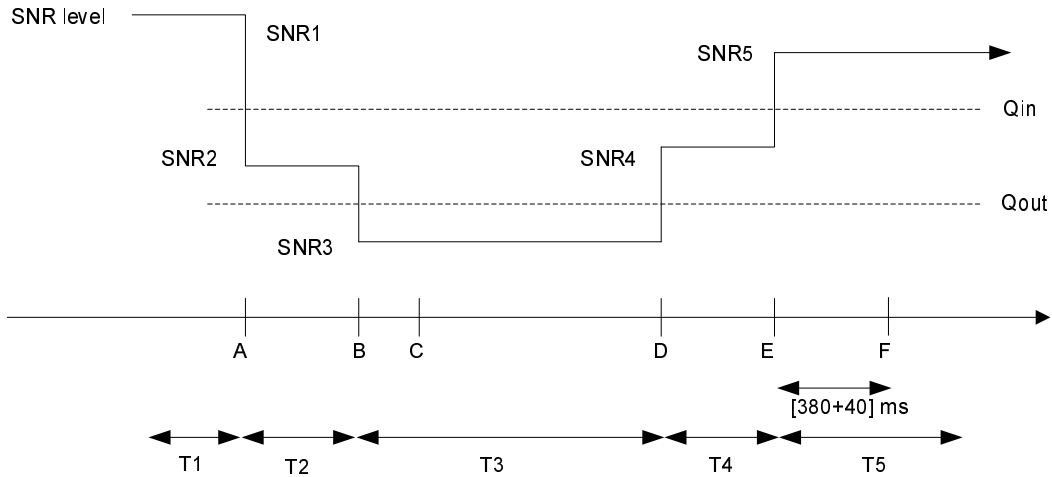

Figure A.7.3.16.1-1 SNR variation in the active cell for in-sync testing under time domain measurement resource restriction with MBSFN ABS

A.7.3.16.2 Test Requirements

The UE behaviour in each test during time durations T1, T2, T3, T4 and T5 shall be as follows:

During the period from time point A to time point F (420 ms after the start of time duration T5) the UE shall transmit uplink signal at least in all subframes configured for CQI transmission according to the configured CQI reporting mode (PUCCH 1-0).

The rate of correct events observed during repeated tests shall be at least 90%.

A.7.3.17 E-UTRAN FDD Radio Link Monitoring Test for Out-of-sync under Time Domain Measurement Resource Restriction with CRS Assistance Information and Non-MBSFN ABS

A.7.3.17.1 Test Purpose and Environment

The purpose of this test is to verify that the UE properly detects the out of sync and in sync for the purpose of monitoring downlink radio link quality of the PCell under time domain measurement resource restriction with CRS assistance information. This test will partly verify the E-UTRAN FDD radio link monitoring requirements in clause 7.6.

The test parameters are given in Tables A.7.3.17.1-1 and A.7.3.17.1-2 below. There are three active cells in the test: Cell 1 is the PCell cell and Cell 2 and 3 are the neighbour cells. The test consists of three successive time periods, with time duration of T1, T2 and T3 respectively. Figure A.7.3.17.1-1 shows the variation of the downlink SNR in the active cell to emulate out-of-sync and in-sync states. Prior to the start of the time duration T1, the UE shall be fully synchronized to cell 1. The UE shall be configured for periodic CQI reporting in PUCCH 1-0 mode with a reporting periodicity of 2 ms.

Non-MBSFN ABS pattern is configured in both Cell 2 and Cell 3 in this test. The UE is configured by higher layers with a time domain measurement restriction pattern for performing Pcell measurements. The UE is also provided via higher layers with the CRS assistance information for Cell 2 and Cell 3, which shall be valid during T1, T2 and T3 in this test. The non-MBSFN ABS pattern, the time domain measurement resource restriction pattern and the CRS assistance information shall be configured prior to the start of T1.

Table A.7.3.17.1-1: General test parameters for E-UTRAN FDD out-of-sync testing under time domain measurement resource restriction with CRS Assistance Information and Non-MBSFN ABS

| Parameter | Unit | Value | Comment |
|-------------------------------|------|---------|--|
| PCFICH/PDCCH/PHICH parameters | | R.7 FDD | As specified in clause A.3.1.2.1. None of the PDCCH are intended for the UE under test |

| | | | | |
|--|--------------------------------|---------|---|---|
| OCNG parameters | | | OP.6 FDD | As specified in section A.3.2.1.6. |
| PCell | | | Cell 1 | Cell 1 is on E-UTRA RF channel number 1 |
| Neighbor cells | | | Cell 2 and Cell 3 | Both of aggressor cells on E-UTRA RF channel number 1 |
| Neighbor cell ABS configuration | | | Non-MBSFN ABS | As defined in Table A.3.4.1.2-1 |
| CP length | | | Normal | |
| E-UTRA RF Channel Number | | | 1 | One E-UTRA FDD carrier frequency is used. |
| E-UTRA Channel Bandwidth ($BW_{channel}$) | | MHz | 10 | |
| Correlation Matrix and Antenna Configuration | | | 2x2 Low | Correlation Matrix and Antenna Configuration are defined in TS 36.101 [5] Annex B.2.3.2 |
| Out of sync transmission parameters (Note 1) | DCI format | | 1A | As defined in clause 5.3.3.1.3 in TS 36.212 |
| | Number of Control OFDM symbols | | 2 | Out of sync threshold Q_{out} and the corresponding hypothetical PDCCH/PCFICH transmission parameters are as specified in clause 7.6.1 and Table 7.6.1-1 respectively. |
| | Aggregation level | CCE | 8 | |
| | ρ_A, ρ_B | | -3 | |
| | Ratio of PDCCH to RS EPRE | dB | 1 | |
| Ratio of PCFICH to RS EPRE | dB | 1 | | |
| DRX | | | OFF | |
| Layer 3 filtering | | | Enabled | Counters:: N310 = 1; N311 = 1 |
| T310 timer | | ms | 0 | T310 is disabled |
| T311 timer | | ms | 1000 | T311 is enabled |
| Periodic CQI reporting mode | | | PUCCH 1-0 | As defined in table 7.2.2-1 in TS 36.213. |
| CQI reporting periodicity | | ms | 2 | Minimum CQI reporting periodicity |
| Time offset between cells | | μ s | Cell 2 time offset with respect to Cell 1: 3 Cell 3 time offset with respect to Cell 1: 2 | Three synchronous cells |
| Frequency shift between cells | | Hz | Cell 2 frequency shift with respect to Cell 1: 300 Cell 3 frequency shift with respect to Cell 1: -100 | |
| T1 | | s | 1 | |
| T2 | | s | 0.4 | |
| T3 | | s | 0.5 | |
| Physical cell IDs | | | $(PCI_{cell1} - PCI_{cell2}) \bmod 3 = 0$ $(PCI_{cell1} - PCI_{cell3}) \bmod 3 \neq 0$ PCI_{cell1} not equal to PCI_{cell2} | Cell PCIs are selected so that all conditions are met |
| ABS pattern | | | '10000000100000001000000010000000000010000000100000000' | FDD ABS Pattern Info IE, as defined in TS 36.423 [28], clause 9.2.54. The first/leftmost bit corresponds to the PCell subframe #0 of the radio frame satisfying $SFN \bmod x = 0$, where x is the size of the bit string (40) divided by 10. No MBSFN subframes are configured in the ABS subframes. Configured in both Cell 2 and Cell 3 prior to the start of T1. |
| Time domain measurement resource restriction pattern | | | '10000000100000001000000010000000000010000000100000000' | Time domain measurement resource restriction pattern for serving cell measurement signalled to the UE in message measSubframePatternPCell-r10 as defined in TS 36.331, clause 6.3.2. |
| CRS assistance information | physCellId | | see PCI conditions above | The CRS assistance information is provided for Cell 2 and Cell 3 in <i>CRS-AssistanceInfo</i> . It includes a single <i>MBSFN-SubframeConfig</i> |
| | antennaPort sCount | | an2 | |

| | | | | |
|---|--------------------------|--|---------------------|--|
| | mbsfn-SubframeConfigList | | oneFrame = '000000' | element with subframe allocation oneFrame='000000' |
| Note 1: PDCCH/PCFICH corresponding to the out of sync transmission parameters need not be included in the Reference Measurement Channel | | | | |

Table A.7.3.17.1-2: Cell specific test parameters for E-UTRAN FDD for out-of-sync radio link monitoring under time domain measurement resource restriction with CRS Assistance Information and Non-MBSFN ABS

| Parameter | Unit | Cell 1 | | | Cell 2 | Cell 3 |
|--|------------|-----------|------|-------|---|---|
| | | T1 | T2 | T3 | T1-T3 | T1-T3 |
| E-UTRA RF Channel Number | | 1 | | | 1 | 1 |
| BW _{channel} | MHz | 10 | | | 10 | 10 |
| Correlation Matrix and Antenna Configuration | | 2x2 Low | | | 2x2 Low | 2x2 Low |
| OCNG Pattern defined in A.3.2.1.6 (FDD) | | OP.6 FDD | | | OP.6 FDD | OP.6 FDD |
| ρ_A, ρ_B | | -3 | | | -3 | -3 |
| PCFICH_RB | dB | 1 | | | Non-ABS and ABS subframe channel powers defined in Table A.3.4.1.2-1. | Non-ABS and ABS subframe channel powers defined in Table A.3.4.1.2-1. |
| PDCCH_RA | dB | 1 | | | | |
| PDCCH_RB | dB | 1 | | | | |
| PBCH_RA | dB | -3 | | | | |
| PBCH_RB | dB | | | | | |
| PSS_RA | dB | | | | | |
| SSS_RA | dB | | | | | |
| PHICH_RA | dB | | | | | |
| PHICH_RB | dB | | | | | |
| PDSCH_RA | dB | | | | | |
| PDSCH_RB | dB | | | | | |
| OCNG_RA ^{Note1} | dB | | | | | |
| OCNG_RB ^{Note1} | dB | | | | | |
| SNR ^{Note 6,7} | dB | -1.5 | -5.2 | -13.7 | | |
| N_{oc} | dBm/15 kHz | -98 | | | -98 | -98 |
| Propagation condition | | ETU 30 Hz | | | ETU 30 Hz | ETU 30 Hz |
| <p>Note 1: OCNG shall be used such that the resources in cell # 1 are fully allocated and a constant total transmitted power spectral density is achieved for all OFDM symbols.</p> <p>Note 2: The uplink resources for CQI reporting are assigned to the UE prior to the start of time period T1.</p> <p>Note 3: The timers and layer 3 filtering related parameters are configured prior to the start of time period T1.</p> <p>Note 4: The signal contains PDCCH for UEs other than the device under test as part of OCNG.</p> <p>Note 5: SNR levels correspond to the signal quality, signal-to-interference-plus-noise ratio, on the CRS REs.</p> <p>Note 6: The SNR in the restricted measurement subframes during time periods T1, T2 and T3 is denoted as SNR1, SNR2 and SNR3 respectively in figure A.7.3.17.1-1.</p> <p>Note 7: The SNR values are specified for testing a UE which supports 2RX on at least one band. For testing of a UE which supports 4RX on all bands, the SNR during T3 is modified as specified in section A.3.8.1.</p> | | | | | | |

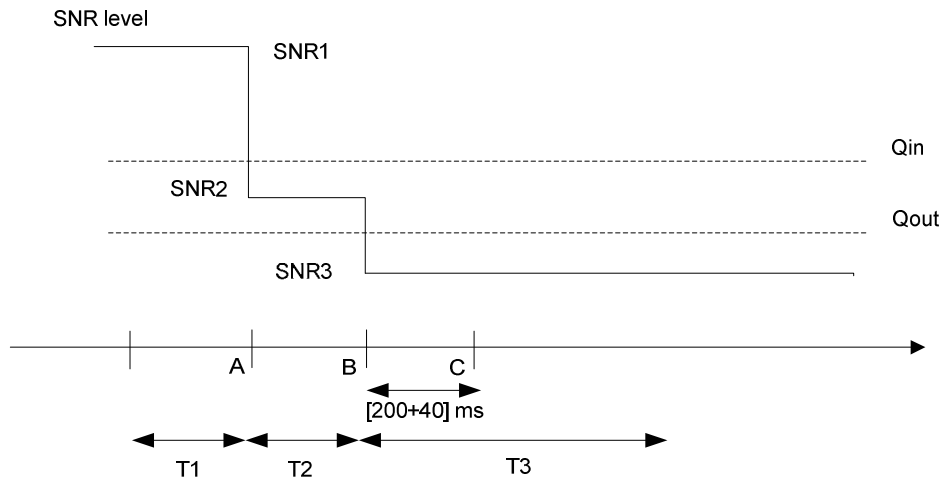

Figure A.7.3.17.1-1 SNR variation for out-of-sync testing

A.7.3.17.2 Test Requirements

The UE behaviour in each test during time durations T1, T2 and T3 shall be as follows:

During the period from time point A to time point B the UE shall transmit uplink signal at least in all subframes configured for CQI transmission according to the configured CQI reporting mode (PUCCH 1-0).

The UE shall stop transmitting uplink signal no later than time point C (240 ms after the start of time duration T3).

The rate of correct events observed during repeated tests shall be at least 90%.

A.7.3.18 E-UTRAN TDD Radio Link Monitoring Test for Out-of-sync under Time Domain Measurement Resource Restriction with CRS Assistance Information and Non-MBSFN ABS

A.7.3.18.1 Test Purpose and Environment

The purpose of this test is to verify that the UE properly detects the out of sync and in sync for the purpose of monitoring downlink radio link quality of the serving cell under time domain measurement resource restriction with CRS assistance information. This test will partly verify the E-UTRAN TDD radio link monitoring requirements in clause 7.6.

The test parameters are given in Tables A.7.3.18.1-1 and A.7.3.18.1-2 below. There are three active cells in the test: Cell 1 is the PCell cell and Cell 2 and 3 are the neighbour cells. The test consists of three successive time periods, with time duration of T1, T2 and T3 respectively. Figure A.7.3.18.1-1 shows the variation of the downlink SNR in the active cell to emulate out-of-sync and in-sync states. Prior to the start of the time duration T1, the UE shall be fully synchronized to cell 1. The UE shall be configured for periodic CQI reporting in PUCCH 1-0 mode with a reporting periodicity of 2 ms.

Non-MBSFN ABS pattern is configured in both Cell 2 and Cell 3 in this test. The UE is configured by higher layers with a time domain measurement restriction pattern for performing Pcell measurements. The UE is also provided via higher layers with the CRS assistance information for Cell 2 and Cell 3, which shall be valid during T1, T2 and T3 in this test. The non-MBSFN ABS pattern, the time domain measurement resource restriction pattern and the CRS assistance information shall be configured prior to the start of T1.

Table A.7.3.18.1-1: General test parameters for E-UTRAN TDD out-of-sync testing under time domain measurement resource restriction with CRS Assistance Information and Non-MBSFN ABS

| Parameter | Unit | Value | Comment |
|-----------|------|-------|---------|
|-----------|------|-------|---------|

| | | | | |
|--|--------------------------------|---------|---|---|
| PCFICH/PDCCH/PHICH parameters | | | R.7.TDD | As specified in clause A.3.1.2.2. None of the PDCCH are intended for the UE under test |
| OCNG parameters | | | OP.2 TDD | As specified in clause A.3.2.2.2 |
| PCell | | | Cell 1 | Cell 1 is on E-UTRA RF channel number 1 |
| Neighbor cells | | | Cell 2 and Cell 3 | Both of aggressor cells on E-UTRA RF channel number 1 |
| Neighbor cell ABS configuration | | | Non-MBSFN ABS | As defined in Table A.3.4.1.2-1 |
| CP length | | | Normal | |
| E-UTRA RF Channel Number | | | 1 | One E-UTRA TDD carrier frequency is used. |
| E-UTRA Channel Bandwidth ($BW_{channel}$) | | MHz | 10 | |
| Correlation Matrix and Antenna Configuration | | | 2x2 Low | Correlation Matrix and Antenna Configuration are defined in TS 36.101 [5] Annex B.2.3.2 |
| Out of sync transmission parameters (Note 1) | DCI format | | 1A | As defined in clause 5.3.3.1.3 in TS 36.212 |
| | Number of Control OFDM symbols | | 2 | Out of sync threshold Q_{out} and the corresponding hypothetical PDCCH/PCFICH transmission parameters are as specified in clause 7.6.1 and Table 7.6.1-1 respectively. |
| | Aggregation level | CCE | 8 | |
| | ρ_A, ρ_B | | -3 | |
| | Ratio of PDCCH to RS EPRE | dB | 1 | |
| | Ratio of PCFICH to RS EPRE | dB | 1 | |
| DRX | | | OFF | |
| Layer 3 filtering | | | Enabled | Counters:: N310 = 1; N311 = 1 |
| T310 timer | | ms | 0 | T310 is disabled |
| T311 timer | | ms | 1000 | T311 is enabled |
| Periodic CQI reporting mode | | | PUCCH 1-0 | As defined in table 7.2.2-1 in TS 36.213. |
| CQI reporting periodicity | | ms | 1 | Minimum CQI reporting periodicity |
| Time offset between cells | | μ s | Cell 2 time offset with respect to Cell 1: 3 Cell 3 time offset with respect to Cell 1: 2 | Three synchronous cells |
| Frequency shift between cells | | Hz | Cell 2 frequency shift with respect to Cell 1: 300 Cell 3 frequency shift with respect to Cell 1: -100 | |
| T1 | | s | 1 | |
| T2 | | s | 0.4 | |
| T3 | | s | 0.5 | |
| Physical cell IDs | | | $(PCI_{cell1} - PCI_{cell2}) \bmod 3 = 0$ $(PCI_{cell1} - PCI_{cell3}) \bmod 3 \neq 0$ PCI_{cell1} not equal to PCI_{cell2} | Cell PCIs are selected so that all conditions are met |
| ABS pattern | | | '00001000000000100000' | TDD ABS Pattern Info IE, as defined in TS 36.423 [28], clause 9.2.54. The first/leftmost bit corresponds to the PCell subframe #0 of the radio frame satisfying $SFN \bmod x = 0$, where x is the size of the bit string (20) divided by 10. No MBSFN subframes are configured in the ABS subframes. Configured in both Cell 2 and Cell 3 prior to the start of T1. |
| Time domain measurement resource restriction pattern | | | '00001000000000100000' | Time domain measurement resource restriction pattern for serving cell measurement signalled to the UE in message measSubframePatternPCell-r10 as defined in TS 36.331, clause 6.3.2. |

| | | | | |
|---|--------------------------|--|----------------------------|---|
| CRS assistance information | physCellId | | see PCI conditions above | The CRS assistance information is provided for Cell 2 only in <i>CRS-AssistanceInfo</i> . It includes a single <i>MBSFN-SubframeConfig</i> element with subframe allocation <i>oneFrame</i> ='000000' |
| | antennaPort | | an2 | |
| | sCount | | | |
| | mbsfn-SubframeConfigList | | <i>oneFrame</i> = '000000' | |
| Note 1: PDCCH/PCFICH corresponding to the out of sync transmission parameters need not be included in the Reference Measurement Channel | | | | |

Table A.7.3.18.1-2: Cell specific test parameters for E-UTRAN TDD for out-of-sync radio link monitoring under time domain measurement resource restriction with CRS Assistance Information and Non-MBSFN ABS

| Parameter | Unit | Cell 1 | | | Cell 2 | Cell 3 |
|--|------------|-----------|------|-------|---|---|
| | | T1 | T2 | T3 | T1-T3 | T1-T3 |
| E-UTRA RF Channel Number | | 1 | | | 1 | 1 |
| BW _{channel} | MHz | 10 | | | 10 | 10 |
| Special subframe configuration ^{Note1} | | 6 | | | 6 | 6 |
| Uplink-downlink configuration ^{Note2} | | 1 | | | 1 | 1 |
| Correlation Matrix and Antenna Configuration | | 2x2 Low | | | 2x2 Low | 2x2 Low |
| OCNG Pattern defined in A.3.2.2.2 (TDD) | | OP.2 TDD | | | OP.2 TDD | OP.2 TDD |
| ρ_A, ρ_B | | -3 | | | -3 | -3 |
| PCFICH_RA | dB | 1 | | | Non-ABS and ABS subframe channel powers defined in Table A.3.4.1.2-1. | Non-ABS and ABS subframe channel powers defined in Table A.3.4.1.2-1. |
| PDCCH_RA | dB | 1 | | | | |
| PDCCH_RB | dB | 1 | | | | |
| PBCH_RA | dB | -3 | | | | |
| PBCH_RB | dB | | | | | |
| PSS_RA | dB | | | | | |
| SSS_RA | dB | | | | | |
| PHICH_RA | dB | | | | | |
| PHICH_RB | dB | | | | | |
| PDSCH_RA | dB | | | | | |
| PDSCH_RB | dB | | | | | |
| OCNG_RA ^{Note1} | dB | | | | | |
| OCNG_RB ^{Note1} | dB | | | | | |
| SNR ^{Note 6,9} | dB | -1.5 | -5.2 | -13.7 | | |
| N_{oc} | dBm/15 kHz | -98 | | | -98 | -98 |
| Propagation condition | | ETU 30 Hz | | | ETU 30 Hz | ETU 30 Hz |
| <p>Note 1: For the special subframe configuration see table 4.2-1 in TS 36.211.</p> <p>Note 2: For the uplink-downlink subframe configuration see table 4.2-2 in TS 36.211.</p> <p>Note 3: OCNG shall be used such that the resources in cell # 1 are fully allocated and a constant total transmitted power spectral density is achieved for all OFDM symbols.</p> <p>Note 4: The uplink resources for CQI reporting are assigned to the UE prior to the start of time period T1.</p> <p>Note 5: The timers and layer 3 filtering related parameters are configured prior to the start of time period T1.</p> <p>Note 6: The signal contains PDCCH for UEs other than the device under test as part of OCNG.</p> <p>Note 7: SNR levels correspond to the signal quality, signal-to-interference-plus-noise ratio, on the CRS REs.</p> <p>Note 8: The SNR in the restricted measurement subframes during time periods T1, T2 and T3 is denoted as SNR1, SNR2 and SNR3 respectively in Figure A.7.3.18.1-1.</p> <p>Note 9: The SNR values are specified for testing a UE which supports 2RX on at least one band. For testing of a UE which supports 4RX on all bands, the SNR during T3 is modified as specified in section A.3.8.1.</p> | | | | | | |

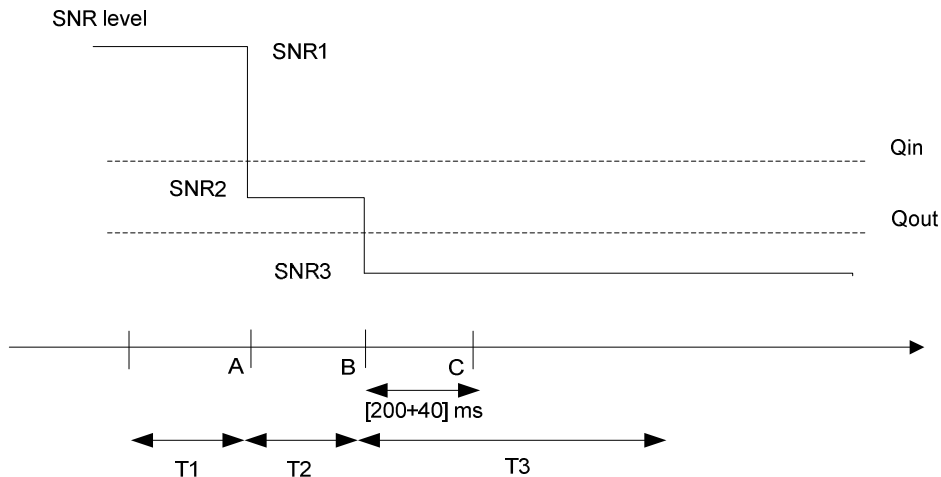

Figure A.7.3.18.1-1 SNR variation for out-of-sync testing

A.7.3.18.2 Test Requirements

The UE behaviour in each test during time durations T1, T2 and T3 shall be as follows:

During the period from time point A to time point B the UE shall transmit uplink signal at least in all subframes configured for CQI transmission according to the configured CQI reporting mode (PUCCH 1-0).

The UE shall stop transmitting uplink signal no later than time point C (240 ms after the start of time duration T3).

The rate of correct events observed during repeated tests shall be at least 90%.

A.7.3.19 E-UTRAN FDD Radio Link Monitoring Test for In-sync under Time Domain Measurement Resource Restriction with CRS assistance information and Non-MBSFN ABS

A.7.3.19.1 Test Purpose and Environment

The purpose of this test is to verify that the UE properly detects the out of sync and in sync for the purpose of monitoring downlink radio link quality of the PCell under time domain measurement resource restriction with CRS assistance information. This test will partly verify the E-UTRAN FDD radio link monitoring requirements in section 7.6.

The test parameters are given in Tables A.7.3.19.1-1 and A.7.3.19.1-2 below. There are three active cells in the test: Cell 1 is the PCell cell and Cell 2 and 3 are the neighbour cells. The test consists of five successive time periods, with time duration of T1, T2, T3, T4 and T5 respectively. Figure A.7.3.19.1-1 shows the variation of the downlink SNR in the active cell to emulate out-of-sync and in-sync states. Prior to the start of the time duration T1, the UE shall be fully synchronized to cell 1. The UE shall be configured for periodic CQI reporting in PUCCH 1-0 mode with a reporting periodicity of 2 ms.

Non-MBSFN ABS pattern is configured in both Cell 2 and Cell 3 in this test. The UE is configured by higher layers with a time domain measurement restriction pattern for performing PCell measurements. The UE is also provided via higher layers with the CRS assistance information for Cell 2 and Cell 3, which shall be valid during T1, T2, T3, T4 and T5 in this test. The Non-MBSFN ABS pattern, the time domain measurement resource restriction pattern and the CRS assistance information shall be configured prior to the start of T1.

Table A.7.3.19.1-1: General test parameters for E-UTRAN FDD in-sync radio link monitoring test

| Parameter | Unit | Value | | | Comment |
|--------------------|------|---------|---------|---------|-------------------------|
| | | Test 1 | | | |
| | | Cell 1 | Cell 2 | Cell 3 | |
| PCFICH/PDCCH/PHICH | | R.9 FDD | R.9 FDD | R.9 FDD | As specified in section |

| | | | | | | |
|--|--------------------------|------------|--|--|--|--|
| parameters | | | | | | A.3.1.2.1. None of the PDCCH are intended for the UE under test |
| OCNG parameters | | | OP.6 FDD | OP.6 FDD | OP.6 FDD | As specified in section A.3.2.1.6. |
| Active cell | | | PCell | Neighbor Cell | Neighbor Cell | Cell 1, Cell 2 and Cell 3 are on E-UTRA RF channel number 1 |
| CP length | | | Normal | Normal | Normal | |
| E-UTRA RF Channel Number | | | 1 | 1 | 1 | One E-UTRA FDD carrier frequency is used. |
| E-UTRA Channel Bandwidth ($BW_{channel}$) | | MHz | 10 | 10 | 10 | |
| Correlation Matrix and Antenna Configuration | | | 2x2 Low | 2x2 Low | 2x2 Low | Correlation Matrix and Antenna Configuration are defined in TS 36.101 [5] Annex B.2.3.2 |
| Neighbor Cell ABS configuration | | | N/A | Non-MBSFN ABS | | As defined in Table A.3.4.1.2-2 |
| ABS Pattern | | | N/A | '100000001 0000000100 0 0000100000 0010000000 ' | '100000001 0000000100 0 0000100000 0010000000 ' | FDD ABS Pattern Info IE, as defined in TS 36.423 [28], clause 9.2.54. The first/leftmost bit corresponds to the Pcell subframe #0 of the radio frame satisfying SFN mod $x = 0$, where x is the size of the bit string (40) divided by 10. No MBSFN subframes are configured in the ABS subframes. Configured in both Cell 2 and Cell 3 prior to the start of T1. |
| Time domain measurement resource restriction pattern | | | '100000001 0000000100 0000010000 0001000000 0' | N/A | N/A | Time domain measurement resource restriction pattern for serving cell measurement signalled to the UE in message measSubframePatternPCell-r10 as defined in TS 36.331, clause 6.3.2. |
| CRS assistant information | physCellId | | N/A | see PCI conditions below | see PCI conditions below | The CRS assistance information is provided for Cell 2 and Cell 3 in CRS-AssistanceInfo. It includes a single MBSFN-SubframeConfig element with subframe allocation oneFrame='000000' |
| | antennaPortsCount | | | an2 | an2 | |
| | mbsfn-SubframeConfigList | | | oneFrame = '000000' | oneFrame = '000000' | |
| Time offset between cells (With respect to Cell 1) | | us | 0 | 3 | 2 | |
| Frequency shift between cells (With respect to Cell 1) | | Hz | 0 | 300 | -100 | |
| Physical Cell ID | | | PCI_{cell1} | $(PCI_{cell1} - PCI_{cell2}) \bmod 3 = 0$, PCI_{cell1} not equal to PCI_{cell2} | $(PCI_{cell1} - PCI_{cell3}) \bmod 3 \neq 0$ | Cell PCIs are selected so that all conditions are met |
| In sync transmission parameters (Note 1) | | DCI format | 1C | 1C | 1C | |
| In sync | Number of Control OFDM | | 3 | 3 | 3 | As defined in section 5.3.3.1.4 in TS 36.212 |

| | | | | | | |
|--|--------------------------------|-----------|---------|---|--------------------------------------|---|
| transmission parameters (Note 1) | symbols | | | | | In sync threshold Q_{in} and the corresponding hypothetical PDCCH/PCFICH transmission parameters are as specified in section and Table 7.6.1-2 respectively. |
| | Aggregation level | CCE | 4 | 4 | 4 | |
| | ρ_A, ρ_B | | -3 | -3 | -3 | |
| | Ratio of PDCCH to RS EPRE | | -3 | Non-ABS and ABS subframe channel powers defined in Table A.3.4.1.2-2. | | |
| Ratio of PCFICH to RS EPRE | | 1 | | | | |
| Out of sync transmission parameters (Note 1) | DCI format | | 1A | 1A | 1A | |
| | Number of Control OFDM symbols | | 3 | 3 | 3 | As defined in section 5.3.3.1.3 in TS 36.212 |
| | Aggregation level | CCE | 8 | 8 | 8 | Out of sync threshold Q_{out} and the corresponding hypothetical PDCCH/PCFICH transmission parameters are as specified in section 7.6.1 and Table 7.6.1-1 respectively. |
| | ρ_A, ρ_B | | -3 | -3 | -3 | |
| | Ratio of PDCCH to RS EPRE | dB | 1 | Non-ABS and ABS subframe channel powers defined in Table A.3.4.1.2-2. | | |
| | Ratio of PCFICH to RS EPRE | dB | 1 | | | |
| DRX | | OFF | OFF | OFF | | |
| Layer 3 filtering | | Enabled | Disable | Disable | Counters: $N_{310} = 1; N_{311} = 1$ | |
| T310 timer | ms | 2000 | N/A | | | T310 is enabled |
| T311 timer | ms | 1000 | | | | T311 is enabled |
| Periodic CQI reporting mode | | PUCCH 1-0 | | | | As defined in table 7.2.2-1 in TS 36.213. |
| CQI reporting periodicity | ms | 2 | | | | Minimum CQI reporting periodicity |
| T1 | s | 0.5 | N/A | | | |
| T2 | s | 0.4 | | | | |
| T3 | s | 1.46 | | | | |
| T4 | s | 0.4 | | | | |
| T5 | s | 1 | | | | |
| Note 1: PDCCH/PCFICH corresponding to the in-sync and out of sync transmission parameters need not be included in the Reference Measurement Channel. | | | | | | |

Table A.7.3.19.1-2: Cell specific test parameters for E-UTRAN FDD in-sync radio link monitoring test

| Parameter | Unit | Test 1 | | | | | | |
|--|------|----------|----|----|----|----|---|----------|
| | | Cell1 | | | | | Cell2 | Cell3 |
| | | T1 | T2 | T3 | T4 | T5 | T1-T5 | T1-T5 |
| E-UTRA RF Channel Number | | 1 | | | | | 1 | 1 |
| $BW_{channel}$ | MHz | 10 | | | | | 10 | 10 |
| Correlation Matrix and Antenna Configuration | | 2x2 Low | | | | | 2x2 Low | 2x2 Low |
| PCFICH/PDCCH/PHICH parameters | | R.9 FDD | | | | | R.9 FDD | R.9 FDD |
| OCNG Pattern defined in A.3.2.1 (FDD) | | OP.6 FDD | | | | | OP.6 FDD | OP.6 FDD |
| ρ_A, ρ_B | | -3 | | | | | -3 | -3 |
| PCFICH_RB | dB | 1 | | | | | Non-ABS and ABS subframe channel powers defined in Table A.3.4.1.2-2. | |
| PDCCH_RA | dB | | | | | | | |
| PDCCH_RB | dB | | | | | | | |
| PBCH_RA | dB | | | | | | | |
| PBCH_RB | dB | | | | | | | |
| PSS_RA | dB | -3 | | | | | | |

| | | | | | | | | |
|---------------------------|------------|--------|------|-------|------|------|--------|--------|
| SSS_RA | dB | | | | | | | |
| PHICH_RA | dB | | | | | | | |
| PHICH_RB | dB | | | | | | | |
| PDSCH_RA | dB | | | | | | | |
| PDSCH_RB | dB | | | | | | | |
| OCNG_RA ^{Note 1} | dB | | | | | | | |
| OCNG_RB ^{Note 1} | dB | | | | | | | |
| SNR ^{Note 6,7} | dB | -1.5 | -5.2 | -13.7 | -8.6 | -1.5 | 4 | 2 |
| N_{oc} | dBm/15 kHz | -98 | | | | | -98 | -98 |
| Propagation condition | Hz | ETU 30 | | | | | ETU 30 | ETU 30 |

Note 1: OCNG shall be used such that the resources in cell 1 are fully allocated and a constant total transmitted power spectral density is achieved for all OFDM symbols.

Note 2: The uplink resources for CQI reporting are assigned to the UE prior to the start of time period T1.

Note 3: The timers and layer 3 filtering related parameters are configured prior to the start of time period T1.

Note 4: The signal contains PDCCH for UEs other than the device under test as part of OCNG.

Note 5: SNR levels correspond to the signal to noise ratio over the cell-specific reference signal REs.

Note 6: The SNR in time periods T1, T2, T3, T4 and T5 is denoted as SNR1, SNR2, SNR3, SNR4 and SNR5 respectively in figure A.7.3.19.1-1.

Note 7: The SNR values are specified for testing a UE which supports 2RX on at least one band. For testing of a UE which supports 4RX on all bands, the SNR during T3 and T4 is modified as specified in section A.3.8.1.

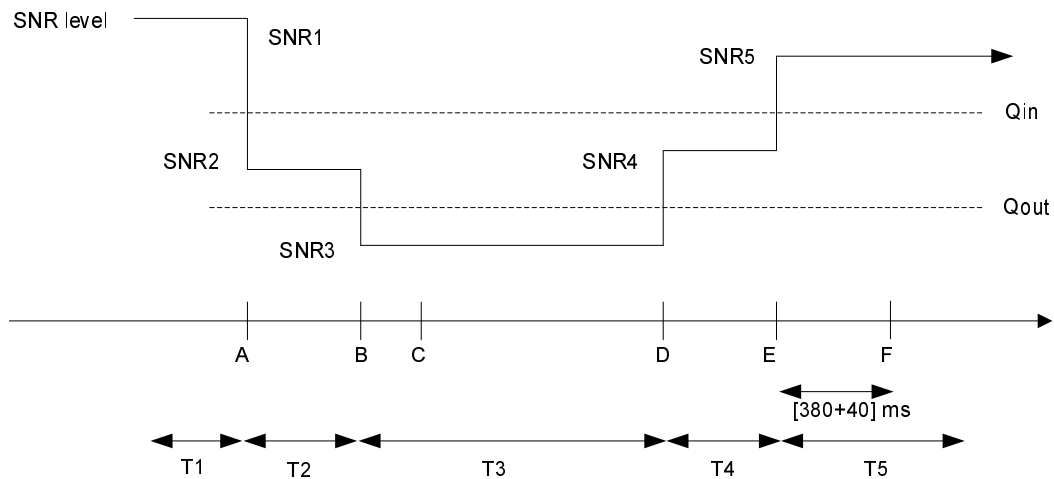

Figure A.7.3.19.1-1 SNR variation for in-sync testing

A.7.3.19.2 Test Requirements

The UE behaviour in each test during time durations T1, T2, T3, T4 and T5 shall be as follows:

During the period from time point A to time point F (420 ms after the start of time duration T5) the UE shall transmit uplink signal at least in all subframes configured for CQI transmission according to the configured CQI reporting mode (PUCCH 1-0).

The rate of correct events observed during repeated tests shall be at least 90%.

A.7.3.20 E-UTRAN TDD Radio Link Monitoring Test for In-sync under Time Domain Measurement Resource Restriction with CRS assistance information and Non-MBSFN ABS

A.7.3.20.1 Test Purpose and Environment

The purpose of this test is to verify that the UE properly detects the out of sync and in sync for the purpose of monitoring downlink radio link quality of the PCell under time domain measurement resource restriction with CRS assistance information. This test will partly verify the E-UTRAN TDD radio link monitoring requirements in section 7.6.

The test parameters are given in Tables A.7.3.20.1-1 and A.7.3.20.1-2 below. There are three active cells in the test: Cell 1 is the PCell and Cell 2 and 3 are the Neighbor cells. The test consists of five successive time periods, with time duration of T1, T2, T3, T4 and T5 respectively. Figure A.7.3.20.1-1 shows the variation of the downlink SNR in the PCell to emulate out-of-sync and in-sync states. Prior to the start of the time duration T1, the UE shall be fully synchronized to cell 1. The UE shall be configured for periodic CQI reporting in PUCCH 1-0 mode with a reporting periodicity of 2 ms.

Non-MBSFN ABS pattern is configured in both Cell 2 and Cell 3 in this test. The UE is configured by higher layers with a time domain measurement restriction pattern for performing PCell measurements. The UE is also provided via higher layers with the CRS assistance information for Cell 2 and Cell 3, which shall be valid during T1, T2, T3, T4 and T5 in this test. The Non-MBSFN ABS pattern, the time domain measurement resource restriction pattern and the CRS assistance information shall be configured prior to the start of T1.

Table A.7.3.20.1-1: General test parameters for E-UTRAN TDD in-sync radio link monitoring test

| Parameter | Unit | Value | | | Comment |
|---|------|----------|--------------------------------|--------------------------------|---|
| | | Test 1 | | | |
| | | Cell 1 | Cell 2 | Cell 3 | |
| PCFICH/PDCCH/PHICH parameters | | R.9 TDD | R.9 TDD | R.9 TDD | As specified in section A.3.1.2.2. None of the PDCCH are intended for the UE under test |
| OCNG parameters | | OP.2 TDD | OP.2 TDD | OP.2 TDD | As specified in section A.3.2.2.2. |
| Active cell | | PCell | Neighbor Cell | Neighbor Cell | Cell 1, Cell 2 and Cell 3 are on E-UTRA RF channel number 1 |
| CP length | | Normal | Normal | Normal | |
| E-UTRA RF Channel Number | | 1 | 1 | 1 | One E-UTRA TDD carrier frequency is used. |
| E-UTRA Channel Bandwidth (BW _{channel}) | MHz | 10 | 10 | 10 | |
| Correlation Matrix and Antenna Configuration | | 2x2 Low | 2x2 Low | 2x2 Low | Correlation Matrix and Antenna Configuration are defined in TS 36.101 [5] Annex B.2.3.2 |
| Neighbor Cell ABS configuration | | N/A | Non-MBSFN ABS | | As defined in Table A.3.4.1.2-1 |
| ABS Pattern | | N/A | '000010000 0000010000 0' | '000010000 0000010000 0' | TDD ABS Pattern Info IE, as defined in TS 36.423 [28], clause 9.2.54. Configured in Cell 2 and Cell 3. The first/leftmost bit corresponds to the Pcell subframe #0 of the radio frame satisfying SFN mod x = 0, where x is the size of the bit string (20) divided by 10. No MBSFN subframes are configured |

| | | | | | | |
|--|---------------------------------|-----------|--------------------------------|--|---|--|
| | | | | | | in the ABS subframes. |
| Time domain measurement resource restriction pattern | | | '000010000 0000010000 0' | N/A | N/A | Time domain measurement resource restriction pattern for serving cell measurement signalled to the UE in message measSubframePatternPCell-r10 as defined in TS 36.331, clause 6.3.2. |
| CRS assistant information | physCellId | | N/A | see PCI conditions below | see PCI conditions below | The CRS assistance information is provided for Cell 2 and Cell 3 in CRS-AssistanceInfo. It includes a single MBSFN-SubframeConfig element with subframe allocation oneFrame='000000' |
| | antennaPortsCount | | | an2 | an2 | |
| | mbsfn-SubframeConfigurationList | | | oneFrame = '000000' | oneFrame = '000000' | |
| Time offset from Cell 1 | us | 0 | 3 | 2 | | |
| Frequency offset | Hz | 0 | 300 | -100 | | |
| Physical Cell ID | | | PCI _{cell1} | (PCI _{cell1} -PCI _{cell2}) mod3 = 0, PCI _{cell1} not equal to PCI _{cell2} | (PCI _{cell1} -PCI _{cell3}) mod3! = 0 | Cell PCIs are selected so that all conditions are met |
| In sync transmission parameters (Note 1) | DCI format | | 1C | 1C | 1C | As defined in section 5.3.3.1.4 in TS 36.212 |
| | Number of Control OFDM symbols | | 3 | 3 | 3 | In sync threshold Q _{in} and the corresponding hypothetical PDCCH/PCFICH transmission parameters are as specified in section and Table 7.6.1-2 respectively. |
| | Aggregation level | CCE | 4 | 4 | 4 | |
| | ρ _A , ρ _B | | -3 | -3 | -3 | |
| | Ratio of PDCCH to RS EPRE | | -3 | Non-ABS and ABS subframe channel powers defined in Table A.3.4.1.2-2. | | |
| | Ratio of PCFICH to RS EPRE | | 1 | | | |
| | | | | | | |
| Out of sync transmission parameters (Note 1) | DCI format | | 1A | 1A | 1A | As defined in section 5.3.3.1.3 in TS 36.212 |
| | Number of Control OFDM symbols | | 3 | 3 | 3 | Out of sync threshold Q _{out} and the corresponding hypothetical PDCCH/PCFICH transmission parameters are as specified in section 7.6.1 and Table 7.6.1-1 respectively. |
| | Aggregation level | CCE | 8 | 8 | 8 | |
| | ρ _A , ρ _B | | -3 | -3 | -3 | |
| | Ratio of PDCCH to RS EPRE | dB | 1 | Non-ABS and ABS subframe channel powers defined in Table A.3.4.1.2-2. | | |
| | Ratio of PCFICH to RS EPRE | dB | 1 | | | |
| | | | | | | |
| DRX | | OFF | OFF | OFF | | |
| Layer 3 filtering | | Enabled | Disable | Disable | | Counters: N310 = 1; N311 = 1 |
| T310 timer | ms | 2000 | N/A | | | T310 is enabled |
| T311 timer | ms | 1000 | | | | T311 is enabled |
| Periodic CQI reporting mode | | PUCCH 1-0 | | | | As defined in table 7.2.2-1 in TS 36.213. |
| CQI reporting periodicity | ms | 1 | | | | Minimum CQI reporting |

| | | | | |
|--|---|------|-----|-------------|
| | | | | periodicity |
| T1 | s | 0.5 | N/A | |
| T2 | s | 0.4 | | |
| T3 | s | 1.46 | | |
| T4 | s | 0.4 | | |
| T5 | s | 1 | | |
| Note 1: PDCCH/PCFICH corresponding to the in-sync and out of sync transmission parameters need not be included in the Reference Measurement Channel. | | | | |

Table A.7.3.20.1-2: Cell specific test parameters for E-UTRAN TDD in-sync radio link monitoring test

| Parameter | Unit | Test 1 | | | | | | |
|---|------------|----------|----|----|----|----|---|----------|
| | | Cell1 | | | | | Cell2 | Cell3 |
| | | T1 | T2 | T3 | T4 | T5 | T1-T5 | T1-T5 |
| E-UTRA RF Channel Number | | 1 | | | | | 1 | 1 |
| BW _{channel} | MHz | 10 | | | | | 10 | 10 |
| Correlation Matrix and Antenna Configuration | | 2x2 Low | | | | | 2x2 Low | 2x2 Low |
| Special subframe configuration ^{Note 1} | | 6 | | | | | 6 | 6 |
| Uplink-downlink configuration ^{Note 2} | | 1 | | | | | 1 | 1 |
| PCFICH/PDCCH/PHICH parameters | | R.9 TDD | | | | | R.9 TDD | R.9 TDD |
| OCNG Pattern defined in A.3.2.2 (TDD) | | OP.2 TDD | | | | | OP.2 TDD | OP.2 TDD |
| ρ_A, ρ_B | | -3 | | | | | -3 | -3 |
| PCFICH_RB | dB | 1 | | | | | Non-ABS and ABS subframe channel powers defined in Table A.3.4.1.2-2. | |
| PDCCH_RA | dB | -3 | | | | | | |
| PDCCH_RB | dB | | | | | | | |
| PBCH_RA | dB | | | | | | | |
| PBCH_RB | dB | | | | | | | |
| PSS_RA | dB | | | | | | | |
| SSS_RA | dB | | | | | | | |
| PHICH_RA | dB | | | | | | | |
| PHICH_RB | dB | | | | | | | |
| PDSCH_RA | dB | | | | | | | |
| PDSCH_RB | dB | | | | | | | |
| OCNG_RA ^{Note 3} | dB | | | | | | | |
| OCNG_RB ^{Note 3} | dB | | | | | | | |
| SNR ^{Note 8,9} | dB | | | | | | -1.5 | -5.2 |
| N_{oc} | dBm/15 kHz | -98 | | | | | -98 | -98 |
| Propagation condition | Hz | ETU 30 | | | | | ETU 30 | ETU 30 |
| <p>Note 1: For the special subframe configuration see table 4.2-1 in 3GPP TS 36.211.</p> <p>Note 2: For the uplink-downlink configuration see table 4.2-2 in 3GPP TS 36.211.</p> <p>Note 3: OCNG shall be used such that the resources in cell # 1 are fully allocated and a constant total transmitted power spectral density is achieved for all OFDM symbols.</p> <p>Note 4: The uplink resources for CQI reporting are assigned to the UE prior to the start of time period T1.</p> <p>Note 5: The timers and layer 3 filtering related parameters are configured prior to the start of time period T1.</p> <p>Note 6: The signal contains PDCCH for UEs other than the device under test as part of OCNG.</p> <p>Note 7: SNR levels correspond to the signal to noise ratio over the cell-specific reference signal REs.</p> <p>Note 8: The SNR in time periods T1, T2, T3, T4 and T5 of active cell is denoted as SNR1, SNR2, SNR3, SNR4 and SNR5 respectively in figure A.7.3.20.1-1.</p> <p>Note 9: The SNR values are specified for testing a UE which supports 2RX on at least one band. For testing of a UE which supports 4RX on all bands, the SNR during T3 and T4 is modified as specified in section A.3.8.1.</p> | | | | | | | | |

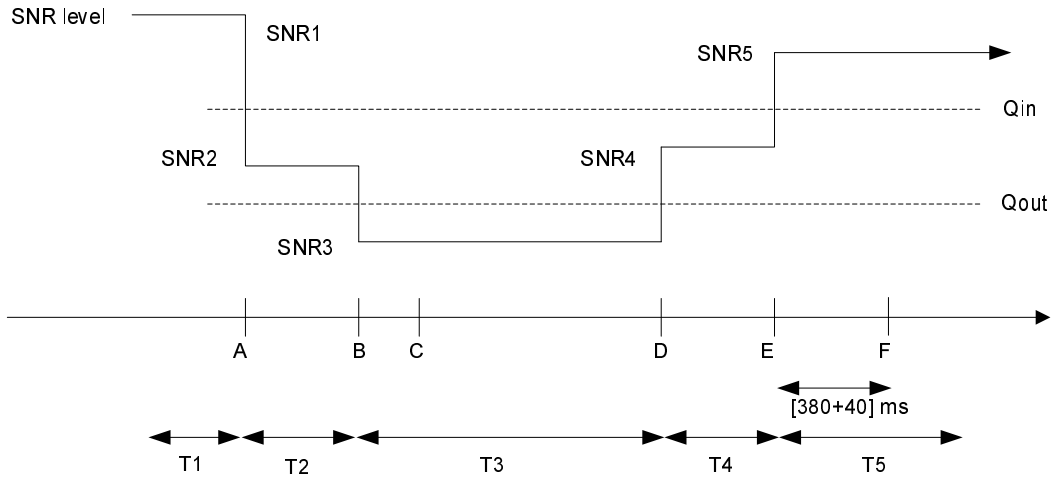

Figure A.7.3.20.1-1 SNR variation for in-sync testing

A.7.3.20.2 Test Requirements

The UE behaviour in each test during time durations T1, T2, T3, T4 and T5 shall be as follows:

During the period from time point A to time point F (420 ms after the start of time duration T5) the UE shall transmit uplink signal at least in all subframes configured for CQI transmission according to the configured CQI reporting mode (PUCCH 1-0).

The rate of correct events observed during repeated tests shall be at least 90%.

A.7.3.21 E-UTRAN FDD Radio Link Monitoring Test for In-sync under Time Domain Measurement Resource Restriction with CRS assistance information and MBSFN ABS

A.7.3.21.1 Test Purpose and Environment

The purpose of this test is to verify that the UE properly detects the out of sync and in sync for the purpose of monitoring downlink radio link quality of the PCell under time domain measurement resource restriction with CRS assistance information and MBSFN ABS. This test will partly verify the E-UTRAN FDD radio link monitoring requirements in section 7.6.

The test parameters are given in Tables A.7.3.21.1-1 and A.7.3.21.1-2 below. There are three active cells in the test: Cell 1 is the PCell cell and Cell 2 and 3 are the neighbour cells. The test consists of five successive time periods, with time duration of T1, T2, T3, T4 and T5 respectively. Figure A.7.3.21.1-1 shows the variation of the downlink SNR in the active cell to emulate out-of-sync and in-sync states. Prior to the start of the time duration T1, the UE shall be fully synchronized to cell 1. The UE shall be configured for periodic CQI reporting in PUCCH 1-0 mode with a reporting periodicity of 2 ms.

MBSFN ABS pattern is configured in both Cell 2 and Cell 3 in this test. The UE is configured by higher layers with a time domain measurement restriction pattern for performing PCell measurements. The UE is also provided via higher layers with the CRS assistance information for Cell 2 and Cell 3, which shall be valid during T1, T2, T3, T4 and T5 in this test. The MBSFN ABS pattern, the time domain measurement resource restriction pattern and the CRS assistance information shall be configured prior to the start of T1.

Table A.7.3.21.1-1: General test parameters for E-UTRAN FDD in-sync radio link monitoring test

| Parameter | Unit | Value | | | Comment |
|-------------------------------|------|---------|---------|---------|------------------------------------|
| | | Test 1 | | | |
| | | Cell 1 | Cell 2 | Cell 3 | |
| PCFICH/PDCCH/PHICH parameters | | R.9 FDD | R.9 FDD | R.9 FDD | As specified in section A.3.1.2.1. |

| | | | | | |
|--|--------------------------|--|--|--|--|
| | | | | | None of the PDCCH are intended for the UE under test |
| OCNG parameters | | OP.6 FDD | OP.9 FDD | OP.9 FDD | As specified in section A.3.2.1. |
| Active cell | | PCell | Neighbor Cell | Neighbor Cell | Cell 1, Cell 2 and Cell 3 are on E-UTRA RF channel number 1 |
| CP length | | Normal | Normal | Normal | |
| E-UTRA RF Channel Number | | 1 | 1 | 1 | One E-UTRA FDD carrier frequency is used. |
| E-UTRA Channel Bandwidth (BW _{channel}) | MHz | 10 | 10 | 10 | |
| Correlation Matrix and Antenna Configuration | | 2x2 Low | 2x2 Low | 2x2 Low | Correlation Matrix and Antenna Configuration are defined in TS 36.101 [5] Annex B.2.3.2 |
| Neighbor Cell ABS configuration | | N/A | MBSFN ABS | | As defined in Table A.3.4.2.2-2 |
| ABS Pattern | | N/A | '010000001 0000000100 0000000100 0000100000 0' | '010000001 0000000100 0000000100 0000100000 0' | FDD ABS Pattern Info IE, as defined in TS 36.423 [28], clause 9.2.54. The first/leftmost bit corresponds to the Pcell subframe #0 of the radio frame satisfying SFN mod x = 0, where x is the size of the bit string (40) divided by 10. MBSFN subframes are configured in the ABS subframes configured in Cell 2 and Cell 3 prior to the start of T1. |
| Time domain measurement resource restriction pattern | | '010000001 0000000100 0000000100 0000100000 0' | N/A | N/A | Time domain measurement resource restriction pattern for serving cell measurement signalled to the UE in message measSubframePatternPCell-r10 as defined in TS 36.331, clause 6.3.2. |
| CRS assistance information | physCellId | N/A | see PCI conditions below | see PCI conditions below | The CRS assistance information is provided for Cell 2 and Cell 3 in CRS-AssistanceInfo. It includes a single MBSFN-SubframeConfig element with subframe allocation fourFrames = '100001000100000100001000010000' |
| | antennaPortsCount | | an2 | an2 | |
| | mbsfn-SubframeConfigList | | fourFrames = '100001000100000100001000010000' | fourFrames = '100001000100000100001000010000' | |
| Time offset between cells (With respect to Cell 1) | us | 0 | 3 | 2 | |
| Frequency shift between cells (With respect to Cell 1) | Hz | 0 | 300 | -100 | |
| Physical Cell ID | | PCI _{cell1} | (PCI _{cell1} -PCI _{cell2}) mod3 = 0, PCI _{cell1} not equal to PCI _{cell2} | (PCI _{cell1} -PCI _{cell3}) mod3 != 0 | Cell PCIs are selected so that all conditions are met |
| In sync transmission parameters (Note 1) | DCI format | 1C | 1C | 1C | |
| | Number of Control | 3 | 3 | 3 | As defined in section 5.3.3.1.4 in TS 36.212 |

| | | | | | | | |
|--|--------------------------------|-----------|---------|---|---------------------------------|--|---|
| In sync transmission parameters (Note 1) | OFDM symbols | | | | | In sync threshold Q_{in} and the corresponding hypothetical PDCCH/PCFICH transmission parameters are as specified in section and Table 7.6.1-2 respectively. | |
| | Aggregation level | CCE | 4 | 4 | 4 | | |
| | ρ_A, ρ_B | | -3 | -3 | -3 | | |
| | Ratio of PDCCH to RS EPRE | | -3 | Non-ABS and ABS subframe channel powers defined in Table A.3.4.2.2-2. | | | |
| | Ratio of PCFICH to RS EPRE | | 1 | | | | |
| Out of sync transmission parameters (Note 1) | DCI format | | 1A | 1A | 1A | As defined in section 5.3.3.1.3 in TS 36.212 | |
| | Number of Control OFDM symbols | | 3 | 3 | 3 | | |
| | Aggregation level | CCE | 8 | 8 | 8 | | Out of sync threshold Q_{out} and the corresponding hypothetical PDCCH/PCFICH transmission parameters are as specified in section 7.6.1 and Table 7.6.1-1 respectively. |
| | ρ_A, ρ_B | | -3 | -3 | -3 | | |
| | Ratio of PDCCH to RS EPRE | dB | 1 | Non-ABS and ABS subframe channel powers defined in Table A.3.4.2.2-2. | | | |
| Ratio of PCFICH to RS EPRE | dB | 1 | | | | | |
| DRX | | OFF | OFF | OFF | | | |
| Layer 3 filtering | | Enabled | Disable | Disable | Counters: N310 = 1; N311 = 1 | | |
| T310 timer | ms | 2000 | N/A | | | T310 is enabled | |
| T311 timer | ms | 1000 | | | | T311 is enabled | |
| Periodic CQI reporting mode | | PUCCH 1-0 | | | | As defined in table 7.2.2-1 in TS 36.213. | |
| CQI reporting periodicity | ms | 2 | | | | Minimum CQI reporting periodicity | |
| T1 | s | 0.5 | | | | | |
| T2 | s | 0.4 | | | | | |
| T3 | s | 1.46 | | | | | |
| T4 | s | 0.4 | | | | | |
| T5 | s | 1 | | | | | |
| Note 1: PDCCH/PCFICH corresponding to the in-sync and out of sync transmission parameters need not be included in the Reference Measurement Channel. | | | | | | | |

Table A.7.3.21.1-2: Cell specific test parameters for E-UTRAN FDD in-sync radio link monitoring test

| Parameter | Unit | Test 1 | | | | | | |
|--|------|----------|----|----|----|----|---|----------|
| | | Cell1 | | | | | Cell2 | Cell3 |
| | | T1 | T2 | T3 | T4 | T5 | T1-T5 | T1-T5 |
| E-UTRA RF Channel Number | | 1 | | | | | 1 | 1 |
| $BW_{channel}$ | MHz | 10 | | | | | 10 | 10 |
| Correlation Matrix and Antenna Configuration | | 2x2 Low | | | | | 2x2 Low | 2x2 Low |
| PCFICH/PDCCH/PHICH parameters | | R.9 FDD | | | | | R.9 FDD | R.9 FDD |
| OCNG Pattern defined in A.3.2.1 (FDD) | | OP.6 FDD | | | | | OP.9 FDD | OP.9 FDD |
| ρ_A, ρ_B | | -3 | | | | | -3 | -3 |
| PCFICH_RB | dB | 1 | | | | | Non-ABS and ABS subframe channel powers defined in Table A.3.4.2.2-2. | |
| PDCCH_RA | dB | | | | | | | |
| PDCCH_RB | dB | | | | | | | |
| PBCH_RA | dB | | | | | | | |
| PBCH_RB | dB | | | | | | | |

| | | | | | | | | |
|---|------------|--------|------|-------|------|------|--------|--------|
| PSS_RA | dB | -3 | | | | | | |
| SSS_RA | dB | | | | | | | |
| PHICH_RA | dB | | | | | | | |
| PHICH_RB | dB | | | | | | | |
| PDSCH_RA | dB | | | | | | | |
| PDSCH_RB | dB | | | | | | | |
| OCNG_RA ^{Note 1} | dB | | | | | | | |
| OCNG_RB ^{Note 1} | dB | | | | | | | |
| SNR ^{Note 6,7} | dB | -1.5 | -5.2 | -13.7 | -8.6 | -1.5 | 4 | 2 |
| N_{oc} | dBm/15 kHz | -98 | | | | | -98 | -98 |
| Propagation condition | Hz | ETU 30 | | | | | ETU 30 | ETU 30 |
| <p>Note 1: OCNG shall be used such that the resources in cell 1 are fully allocated and a constant total transmitted power spectral density is achieved for all OFDM symbols.</p> <p>Note 2: The uplink resources for CQI reporting are assigned to the UE prior to the start of time period T1.</p> <p>Note 3: The timers and layer 3 filtering related parameters are configured prior to the start of time period T1.</p> <p>Note 4: The signal contains PDCCH for UEs other than the device under test as part of OCNG.</p> <p>Note 5: SNR levels correspond to the signal to noise ratio over the cell-specific reference signal REs.</p> <p>Note 6: The SNR in time periods T1, T2, T3, T4 and T5 is denoted as SNR1, SNR2, SNR3, SNR4 and SNR5 respectively in figure A.7.3.21.1-1.</p> <p>Note 7: The SNR values are specified for testing a UE which supports 2RX on at least one band. For testing of a UE which supports 4RX on all bands, the SNR during T3 and T4 is modified as specified in section A.3.8.1.</p> | | | | | | | | |

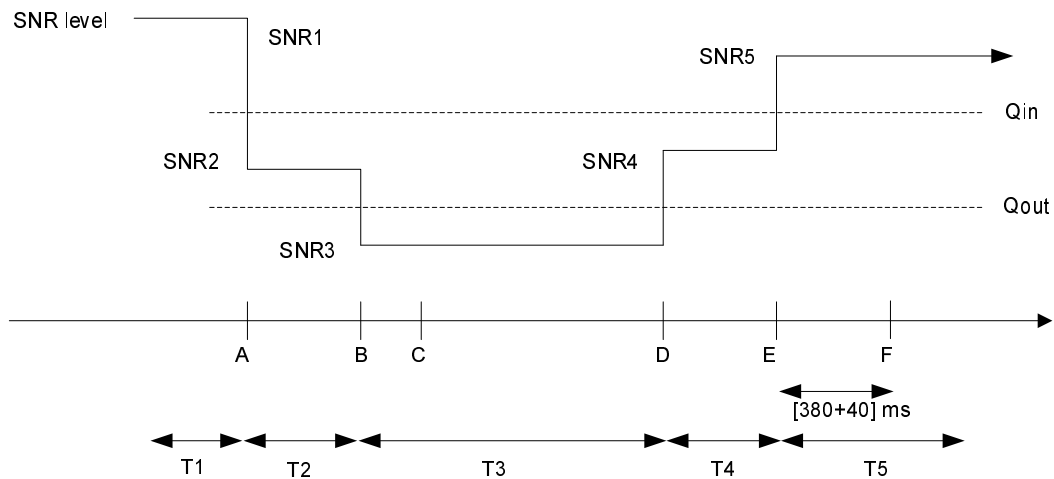

Figure A.7.3.21.1-1 SNR variation for in-sync testing

A.7.3.21.2 Test Requirements

The UE behaviour in each test during time durations T1, T2, T3, T4 and T5 shall be as follows:

During the period from time point A to time point F (420 ms after the start of time duration T5) the UE shall transmit uplink signal at least in all subframes configured for CQI transmission according to the configured CQI reporting mode (PUCCH 1-0).

The rate of correct events observed during repeated tests shall be at least 90%.

A.7.3.22 E-UTRAN TDD Radio Link Monitoring Test for In-sync under Time Domain Measurement Resource Restriction with CRS assistance information and MBSFN ABS

A.7.3.22.1 Test Purpose and Environment

The purpose of this test is to verify that the UE properly detects the out of sync and in sync for the purpose of monitoring downlink radio link quality of the PCell under time domain measurement resource restriction with CRS assistance information. This test will partly verify the E-UTRAN TDD radio link monitoring requirements in section 7.6.

The test parameters are given in Tables A.7.3.22.1-1 and A.7.3.22.1-2 below. There are three active cells in the test: Cell 1 is the PCell and Cell 2 and 3 are the Neighbor cells. The test consists of five successive time periods, with time duration of T1, T2, T3, T4 and T5 respectively. Figure A.7.3.22.1-1 shows the variation of the downlink SNR in the PCell to emulate out-of-sync and in-sync states. Prior to the start of the time duration T1, the UE shall be fully synchronized to cell 1. The UE shall be configured for periodic CQI reporting in PUCCH 1-0 mode with a reporting periodicity of 2 ms.

MBSFN ABS pattern is configured in both Cell 2 and Cell 3 in this test. The UE is configured by higher layers with a time domain measurement restriction pattern for performing PCell measurements. The UE is also provided via higher layers with the CRS assistance information for Cell 2 and Cell 3, which shall be valid during T1, T2, T3, T4 and T5 in this test. The MBSFN ABS pattern, the time domain measurement resource restriction pattern and the CRS assistance information shall be configured prior to the start of T1.

Table A.7.3.22.1-1: General test parameters for E-UTRAN TDD in-sync radio link monitoring test

| Parameter | Unit | Value | | | Comment |
|---|------|----------|--------------------------------|--------------------------------|---|
| | | Test 1 | | | |
| | | Cell 1 | Cell 2 | Cell 3 | |
| PCFICH/PDCCH/PHICH parameters | | R.9 TDD | R.9 TDD | R.9 TDD | As specified in section A.3.1.2.2. None of the PDCCH are intended for the UE under test |
| OCNG parameters | | OP.2 TDD | OP.6 TDD | OP.6 TDD | As specified in section A.3.2.2. |
| Active cell | | PCell | Neighbor Cell | Neighbor Cell | Cell 1, Cell 2 and Cell 3 are on E-UTRA RF channel number 1 |
| CP length | | Normal | Normal | Normal | |
| E-UTRA RF Channel Number | | 1 | 1 | 1 | One E-UTRA TDD carrier frequency is used. |
| E-UTRA Channel Bandwidth (BW _{channel}) | MHz | 10 | 10 | 10 | |
| Correlation Matrix and Antenna Configuration | | 2x2 Low | 2x2 Low | 2x2 Low | Correlation Matrix and Antenna Configuration are defined in TS 36.101 [5] Annex B.2.3.2 |
| Neighbor Cell ABS configuration | | N/A | MBSFN ABS | | As defined in Table A.3.4.2.2-1 |
| ABS Pattern | | N/A | '000010000 0000010000 0' | '000010000 0000010000 0' | TDD ABS Pattern Info IE, as defined in TS 36.423 [28], clause 9.2.54. Configured in Cell 2 and Cell 3 The first/leftmost bit corresponds to the subframe #0 of the radio frame satisfying SFN mod 20 = 0, where x is the size of the bit string (20) divided by 10. MBSFN subframes are configured in the ABS subframes. |

| | | | | | | |
|--|---------------------------------|-----|--------------------------------|--|---|---|
| Time domain measurement resource restriction pattern | | | '000010000 0000010000 0' | N/A | N/A | Time domain measurement resource restriction pattern for serving cell measurement signalled to the UE in message measSubframePatternPCell-r10 as defined in TS 36.331, clause 6.3.2. |
| CRS assistance information | physCellId | | N/A | see PCI conditions below | see PCI conditions below | The CRS assistance information is provided for Cell 2 and Cell 3 in CRS-AssistanceInfo. It includes a single MBSFN-SubframeConfig element with subframe allocation fourFrames = '0100001000010000100000000' |
| | antennaPortsCount | | | an2 | an2 | |
| | mbsfn-SubframeConfigList | | | fourFrames = '0100001000010000100000000' | fourFrames = '0100001000010000100000000' | |
| Time offset from Cell 1 | | us | 0 | 3 | 2 | |
| Frequency offset | | Hz | 0 | 300 | -100 | |
| Physical Cell ID | | | PCI _{cell1} | (PCI _{cell1} -PCI _{cell2}) mod3 = 0, PCI _{cell1} not equal to PCI _{cell2} | (PCI _{cell1} -PCI _{cell3}) mod3 != 0 | Cell PCIs are selected so that all conditions are met |
| In sync transmission parameters (Note 1) | DCI format | | 1C | 1C | 1C | As defined in section 5.3.3.1.4 in TS 36.212 |
| | Number of Control OFDM symbols | | 2 | 2 | 2 | In sync threshold Q _{in} and the corresponding hypothetical PDCCH/PCFICH transmission parameters are as specified in section and Table 7.6.1-2 respectively. |
| | Aggregation level | CCE | 4 | 4 | 4 | |
| | ρ _A , ρ _B | | -3 | -3 | -3 | |
| | Ratio of PDCCH to RS EPRE | | -3 | Non-ABS and ABS subframe channel powers defined in Table A.3.4.1.2-2. | | |
| | Ratio of PCFICH to RS EPRE | | 1 | | | |
| | | | | | | |
| Out of sync transmission parameters (Note 1) | DCI format | | 1A | 1A | 1A | As defined in section 5.3.3.1.3 in TS 36.212 |
| | Number of Control OFDM symbols | | 2 | 2 | 2 | Out of sync threshold Q _{out} and the corresponding hypothetical PDCCH/PCFICH transmission parameters are as specified in section 7.6.1 and Table 7.6.1-1 respectively. |
| | Aggregation level | CCE | 8 | 8 | 8 | |
| | ρ _A , ρ _B | | -3 | -3 | -3 | |
| | Ratio of PDCCH to RS EPRE | dB | 1 | Non-ABS and ABS subframe channel powers defined in Table A.3.4.1.2-2. | | |
| | Ratio of PCFICH to RS EPRE | dB | 1 | | | |
| | | | | | | |
| DRX | | | OFF | OFF | OFF | |
| Layer 3 filtering | | | Enabled | Disable | Disable | Counters: N310 = 1; N311 = 1 |
| T310 timer | | ms | 2000 | N/A | | T310 is enabled |
| T311 timer | | ms | 1000 | | | T311 is enabled |
| Periodic CQI reporting mode | | | PUCCH 1-0 | | | As defined in table 7.2.2-1 |

| | | | | |
|--|----|------|-----|-----------------------------------|
| | | | | in TS 36.213. |
| CQI reporting periodicity | ms | 1 | | Minimum CQI reporting periodicity |
| T1 | s | 0.5 | N/A | |
| T2 | s | 0.4 | | |
| T3 | s | 1.46 | | |
| T4 | s | 0.4 | | |
| T5 | s | 1 | | |
| Note 1: PDCCH/PCFICH corresponding to the in-sync and out of sync transmission parameters need not be included in the Reference Measurement Channel. | | | | |

Table A.7.3.22.1-2: Cell specific test parameters for E-UTRAN TDD in-sync radio link monitoring test

| Parameter | Unit | Test 1 | | | | | | | Cell2 T1-T5 | Cell3 T1-T5 |
|---|------------|----------|----|----|----|----|---|------|----------------|----------------|
| | | Cell1 | | | | | T1 | T2 | | |
| | | T1 | T2 | T3 | T4 | T5 | | | | |
| E-UTRA RF Channel Number | | 1 | | | | | | | 1 | 1 |
| BW _{channel} | MHz | 10 | | | | | | | 10 | 10 |
| Correlation Matrix and Antenna Configuration | | 2x2 Low | | | | | | | 2x2 Low | 2x2 Low |
| Special subframe configuration ^{Note 1} | | 6 | | | | | | | 6 | 6 |
| Uplink-downlink configuration ^{Note 2} | | 1 | | | | | | | 1 | 1 |
| PCFICH/PDCCH/PHICH parameters | | R.9 TDD | | | | | | | R.9 TDD | R.9 TDD |
| OCNG Pattern defined in A.3.2.2 (TDD) | | OP.2 TDD | | | | | | | OP.6 TDD | OP.6 TDD |
| ρ_A, ρ_B | | -3 | | | | | | | -3 | -3 |
| PCFICH_RB | dB | 1 | | | | | Non-ABS and ABS subframe channel powers defined in Table A.3.4.2.2-1. | | | |
| PDCCH_RA | dB | -3 | | | | | | | | |
| PDCCH_RB | dB | | | | | | | | | |
| PBCH_RA | dB | | | | | | | | | |
| PBCH_RB | dB | | | | | | | | | |
| PSS_RA | dB | | | | | | | | | |
| SSS_RA | dB | | | | | | | | | |
| PHICH_RA | dB | | | | | | | | | |
| PHICH_RB | dB | | | | | | | | | |
| PDSCH_RA | dB | | | | | | | | | |
| PDSCH_RB | dB | | | | | | | | | |
| OCNG_RA ^{Note 3} | dB | | | | | | | | | |
| OCNG_RB ^{Note 3} | dB | | | | | | | | | |
| SNR ^{Note 8,9} | dB | | | | | | -1.5 | -5.2 | -13.7 | -8.6 |
| N_{oc} | dBm/15 kHz | -98 | | | | | | | -98 | -98 |
| Propagation condition | Hz | ETU 30 | | | | | | | ETU 30 | ETU 30 |
| <p>Note 1: For the special subframe configuration see table 4.2-1 in 3GPP TS 36.211.</p> <p>Note 2: For the uplink-downlink configuration see table 4.2-2 in 3GPP TS 36.211.</p> <p>Note 3: OCNG shall be used such that the resources in cell # 1 are fully allocated and a constant total transmitted power spectral density is achieved for all OFDM symbols.</p> <p>Note 4: The uplink resources for CQI reporting are assigned to the UE prior to the start of time period T1.</p> <p>Note 5: The timers and layer 3 filtering related parameters are configured prior to the start of time period T1.</p> <p>Note 6: The signal contains PDCCH for UEs other than the device under test as part of OCNG.</p> <p>Note 7: SNR levels correspond to the signal to noise ratio over the cell-specific reference signal REs.</p> <p>Note 8: The SNR in time periods T1, T2, T3, T4 and T5 of active cell is denoted as SNR1, SNR2, SNR3, SNR4 and SNR5 respectively in figure A.7.3.22.1-1.</p> <p>Note 9: The SNR values are specified for testing a UE which supports 2RX on at least one band. For testing of a UE which supports 4RX on all bands, the SNR during T3 and T4 is modified as specified in section A.3.8.1.</p> | | | | | | | | | | |

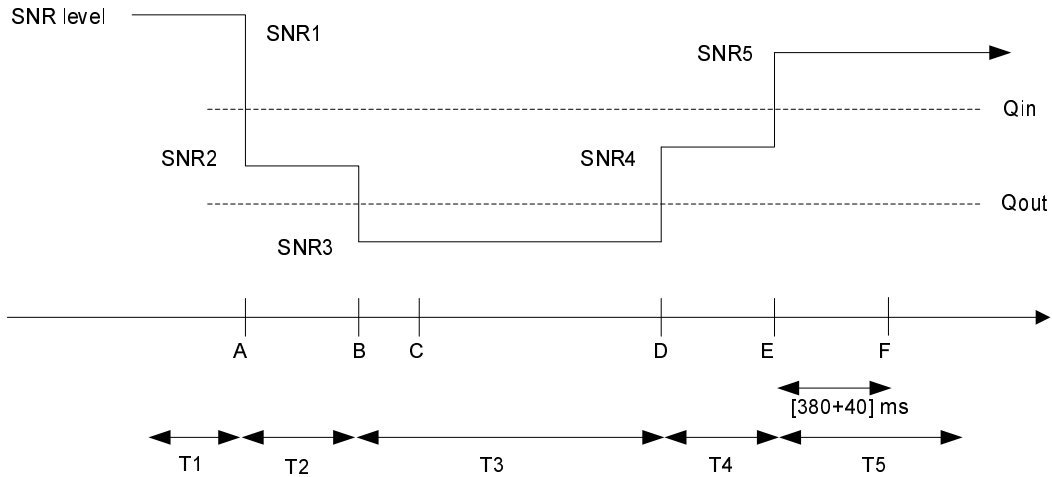

Figure A.7.3.22.1-1 SNR variation for in-sync testing

A.7.3.22.2 Test Requirements

The UE behaviour in each test during time durations T1, T2, T3, T4 and T5 shall be as follows:

During the period from time point A to time point F (420 ms after the start of time duration T5) the UE shall transmit uplink signal at least in all subframes configured for CQI transmission according to the configured CQI reporting mode (PUCCH 1-0).

The rate of correct events observed during repeated tests shall be at least 90%.

A.7.3.23 E-UTRAN FDD Radio Link Monitoring Test for Out-of-sync for 5MHz Bandwidth

A.7.3.23.1 Test Purpose and Environment

The purpose of this test case is the same as for the test defined in subclause A.7.3.1. The test parameters are the same except those described in the following section. The listed parameter values in Tables A.7.3.23.1-1 and A.7.3.23.1-2 will replace the values of corresponding parameters in Test 4 in Tables A.7.3.1.1-1 and A.7.3.1.1-2. Only Test 4 is defined for the 5MHz bandwidth.

Table A.7.3.23.1-1: General test parameters for E-UTRAN FDD out-of-sync testing under 5MHz Bandwidth

| Parameter | | Unit | Value | Comment |
|--|--------------------------------|------|-----------|---|
| | | | Test 4 | |
| PCFICH/PDCCH/PHICH parameters | | | R.12 FDD | As specified in clause A.3.1.2.1. None of the PDCCH are intended for the UE under test |
| OCNG parameters | | | OP.16 FDD | As specified in clause A.3.2.1.16. |
| E-UTRA Channel Bandwidth (BW _{channel}) | | MHz | 5 | |
| Out of sync transmission parameters (Note 1) | Number of Control OFDM Symbols | | 3 | Out of sync threshold Q _{out} and the corresponding hypothetical PDCCH/PCFICH transmission parameters are as specified in clause 7.6.1 and Table 7.6.1-1 respectively. |
| Note 1: PDCCH/PCFICH corresponding to the out of sync transmission parameters need not be included in the Reference Measurement Channel. | | | | |
| Note 2: See Table A.7.3.1.1-1 for other general test parameters. | | | | |
| Note 3: This test is according to the principle defined in section A.3.7.2. | | | | |

Table A.7.3.23.1-2: Cell specific test parameters for E-UTRAN FDD for out-of-sync radio link monitoring test #4 under 5MHz Bandwidth

| Parameter | Unit | Test 4 | | |
|--|--|-----------|------|-------|
| | | T1 | T2 | T3 |
| $BW_{channel}$ | MHz | 5 | | |
| OCNG Pattern defined in A.3.2.1.16 (FDD) | | OP.16 FDD | | |
| SNR ^{Note 1,2} | dB | -2.3 | -5.7 | -12.2 |
| Note 1: | See Table A.7.3.1.1-2 for other cell specific test parameters. | | | |
| Note 2: | The SNR values are specified for testing a UE which supports 2RX on at least one band. For testing of a UE which supports 4RX on all bands, the SNR during T3 is modified as specified in section A.3.8.1. | | | |

A.7.3.23.2 Test Requirements

The requirements defined in section A.7.3.1.2 shall apply to this test case.

A.7.3.24 E-UTRAN FDD Radio Link Monitoring Test for In-sync for 5MHz Bandwidth

A.7.3.24.1 Test Purpose and Environment

The purpose of this test case is the same as for the Test 2 defined in subclause A.7.3.2. The test parameters are the same except those described in the following section. The listed parameter values in Tables A.7.3.24.1-1 and A.7.3.24.1-2 will replace the values of corresponding parameters in Tables A.7.3.2.1-1 and A.7.3.2.1-2.

Table A.7.3.24.1-1: General test parameters for E-UTRAN FDD in-sync testing

| Parameter | | Unit | Value | Comment |
|--|--------------------------------|--|----------|--|
| PCFICH/PDCCH/PHICH parameters | | | R.12 FDD | As specified in clause A.3.1.2.1. None of the PDCCH are intended for the UE under test |
| E-UTRA Channel Bandwidth ($BW_{channel}$) | | MHz | 5 | |
| In sync transmission parameters (Note 1) | Number of Control OFDM symbols | | 3 | In sync threshold Q_{in} and the corresponding hypothetical PDCCH/PCFICH transmission parameters are as specified in clause and Table 7.6.1-2 respectively. |
| Out of sync transmission parameters (Note 1) | Number of Control OFDM symbols | | 3 | Out of sync threshold Q_{out} and the corresponding hypothetical PDCCH/PCFICH transmission parameters are as specified in clause 7.6.1 and Table 7.6.1-1 respectively. |
| Note 1: | | See Table A.7.3.2.1-1 for other general test parameters. | | |
| Note 2: | | This test is performed according to the principle defined in section A.3.7.2 | | |

Table A.7.3.24.1-2: Cell specific test parameters for E-UTRAN FDD (cell # 1) for in-sync radio link monitoring test

| Parameter | Unit | T1 | T2 | T3 | T4 | T5 |
|---|------|-----------|------|-------|------|------|
| $BW_{channel}$ | MHz | 5 | | | | |
| OCNG Pattern defined in A.3.2.1.16 (FDD) | | OP.16 FDD | | | | |
| SNR ^{Note 1,2} | dB | -2.3 | -5.7 | -12.2 | -7.3 | -2.3 |
| Propagation condition | | ETU 70 Hz | | | | |
| Note 1: See Table A.7.3.2.1-2 for other general test parameters. | | | | | | |
| Note 2: The SNR values are specified for testing a UE which supports 2RX on at least one band. For testing of a UE which supports 4RX on all bands, the SNR during T3 and T4 is modified as specified in section A.3.8.1. | | | | | | |

A.7.3.24.2 Test Requirements

The requirements defined in section A.7.3.2.2 shall apply to this test case.

A.7.3.25 E-UTRAN FDD Radio Link Monitoring Test for In-sync in DRX for 5MHz Bandwidth

A.7.3.25.1 Test Purpose and Environment

The purpose of this test case is the same as for the Test 2 defined in subclause A.7.3.6. The test parameters are the same except those described in the following section. The listed parameter values in Tables A.7.3.25.1-1 and A.7.3.25.1-2 will replace the values of corresponding parameters in Tables A.7.3.6.1-1 and A.7.3.6.1-2.

Table A.7.3.25.1-1: General test parameters for E-UTRAN FDD in-sync testing

| Parameter | | Unit | Value | Comment |
|--|--------------------------------|------|----------|--|
| PCFICH/PDCCH/PHICH parameters | | | R.12 FDD | As specified in clause A.3.1.2.1. None of the PDCCH are intended for the UE under test |
| E-UTRA Channel Bandwidth ($BW_{channel}$) | | MHz | 5 | |
| In sync transmission parameters (Note 1) | Number of Control OFDM symbols | | 3 | In sync threshold Q_{in} and the corresponding hypothetical PDCCH/PCFICH transmission parameters are as specified in clause and Table 7.6.1-2 respectively. |
| Out of sync transmission parameters (Note 1) | Number of Control OFDM symbols | | 3 | Out of sync threshold Q_{out} and the corresponding hypothetical PDCCH/PCFICH transmission parameters are as specified in clause 7.6.1 and Table 7.6.1-1 respectively. |
| Note 1: See Table A.7.3.6.1-1 for other general test parameters. | | | | |
| Note 2: This test is performed according to the principle defined in section A.3.7.2 | | | | |

Table A.7.3.25.1-2: Cell specific test parameters for E-UTRAN FDD (cell # 1) for in-sync radio link monitoring test

| Parameter | Unit | T1 | T2 | T3 | T4 | T5 |
|--|---|-----------|------|-------|------|------|
| BW_{channel} | MHz | 5 | | | | |
| OCNG Pattern defined in A.3.2.1.16 (FDD) | | OP.16 FDD | | | | |
| SNR ^{Note 1,2} | dB | -2.3 | -5.7 | -12.2 | -7.3 | -2.3 |
| Propagation condition | | AWGN | | | | |
| Note 1: | See Table A.7.3.6.1-2 for other general test parameters. | | | | | |
| Note 2: | The SNR values are specified for testing a UE which supports 2RX on at least one band. For testing of a UE which supports 4RX on all bands, the SNR during T3 and T4 is modified as specified in section A.3.8.1. | | | | | |

A.7.3.25.2 Test Requirements

The requirements defined in section A.7.3.6.2 shall apply to this test case.

A.7.3.26 E-UTRAN FD-FDD Radio Link Monitoring Test for Out-of-sync for UE Category 0

A.7.3.26.1 Test Purpose and Environment

The purpose of this test is to verify that the FD-FDD category 0 UE properly detects the out of sync and in sync for the purpose of monitoring downlink radio link quality of the PCell. This test will partly verify the E-UTRAN FDD radio link monitoring requirements in clause 7.11.

The test parameters are given in Tables A.7.3.26.1-1, A.7.3.26.1-2 and A.7.3.26.1-3 below. There is one cell (cell 1), which is the active cell, in the test. The test consists of three successive time periods, with time duration of T1, T2 and T3 respectively. Figure A.7.3.26.1-1 shows the variation of the downlink SNR in the active cell to emulate out-of-sync and in-sync states. Prior to the start of the time duration T1, the UE shall be fully synchronized to cell 1. The UE shall be configured for periodic CQI reporting in PUCCH 1-0 mode with a reporting periodicity of 2 ms.

Table A.7.3.26.1-1: General test parameters for E-UTRAN FD-FDD out-of-sync testing for UE Category 0

| Parameter | | Unit | Value | Comment |
|--|--------------------------------|------|---------|--|
| Active cell | | | Cell 1 | Cell 1 is on E-UTRA RF channel number 1 |
| E-UTRA RF Channel Number | | | 1 | One E-UTRA FDD carrier frequency is used. |
| E-UTRA Channel Bandwidth (BW_{channel}) | | MHz | 10 | |
| CP length | | | Normal | |
| Out of sync transmission parameters (Note 1) | DCI format | | 1A | As defined in section 5.3.3.1.3 in TS 36.212 |
| | Number of Control OFDM symbols | | 2 | Out of sync threshold Q_{out} and the corresponding hypothetical PDCCH/PCFICH transmission parameters are as specified in section 7.11.1 and Table 7.11.1-1 respectively. |
| | Aggregation level | CCE | 8 | |
| | ρ_A, ρ_B | | -3 | |
| | Ratio of PDCCH to RS EPRE | dB | 4 | |
| | Ratio of PCFICH to RS EPRE | dB | 1 | |
| DRX | | | OFF | |
| Layer 3 filtering | | | Enabled | Counters: |

| | | | |
|--|----|-----------|---|
| | | | N310 = 1; N311 = 1 |
| T310 timer | ms | 0 | T310 is disabled |
| T311 timer | ms | 1000 | T311 is enabled |
| Periodic CQI reporting mode | | PUCCH 1-0 | As defined in table 7.2.2-1 in TS 36.213. |
| CQI reporting periodicity | ms | 2 | Minimum CQI reporting periodicity |
| T1 | s | 1 | |
| T2 | s | 0.4 | |
| T3 | s | 0.5 | |
| Note 1: PDCCH/PCFICH corresponding to the out of sync transmission parameters need not be included in the Reference Measurement Channel. | | | |

Table A.7.3.26.1-2: Cell specific test parameters for E-UTRAN FD-FDD (cell # 1) for out-of-sync radio link monitoring tests for UE Category 0

| Parameter | Unit | Test 1 | | |
|--|------------|----------|------|-------|
| | | T1 | T2 | T3 |
| E-UTRA RF Channel Number | | 1 | | |
| BW _{channel} | MHz | 10 | | |
| PCFICH/PDCCH/PHICH parameters defined in A.3.1.2.1 | | R.7 FDD | | |
| OCNG Pattern defined in A.3.2.1 (FDD) | | OP.2 FDD | | |
| ρ_A, ρ_B | | -3 | | |
| PCFICH_RB | dB | 1 | | |
| PDCCH_RA | dB | 4 | | |
| PDCCH_RB | dB | 4 | | |
| PBCH_RA | dB | -3 | | |
| PBCH_RB | dB | | | |
| PSS_RA | dB | | | |
| SSS_RA | dB | | | |
| PHICH_RA | dB | | | |
| PHICH_RB | dB | | | |
| PDSCH_RA | dB | | | |
| PDSCH_RB | dB | | | |
| OCNG_RA ^{Note 1} | dB | | | |
| OCNG_RB ^{Note 1} | dB | | | |
| N_{oc} | dBm/15 kHz | -98 | | |
| SNR ^{Note 6} | dB | -2.1 | -6.9 | -12.9 |
| Propagation condition | | ETU 70Hz | | |
| Correlation Matrix and Antenna Configuration | | 2x1 Low | | |
| <p>Note 1: OCNG shall be used such that the resources in cell # 1 are fully allocated and a constant total transmitted power spectral density is achieved for all OFDM symbols.</p> <p>Note 2: The uplink resources for CQI reporting are assigned to the UE prior to the start of time period T1.</p> <p>Note 3: The timers and layer 3 filtering related parameters are configured prior to the start of time period T1.</p> <p>Note 4: The signal contains PDCCH for UEs other than the device under test as part of OCNG.</p> <p>Note 5: SNR levels correspond to the signal to noise ratio over the cell-specific reference signal REs.</p> <p>Note 6: The SNR in time periods T1, T2 and T3 is denoted as SNR1, SNR2 and SNR3 respectively in figure A.7.3.26.1-1.</p> | | | | |

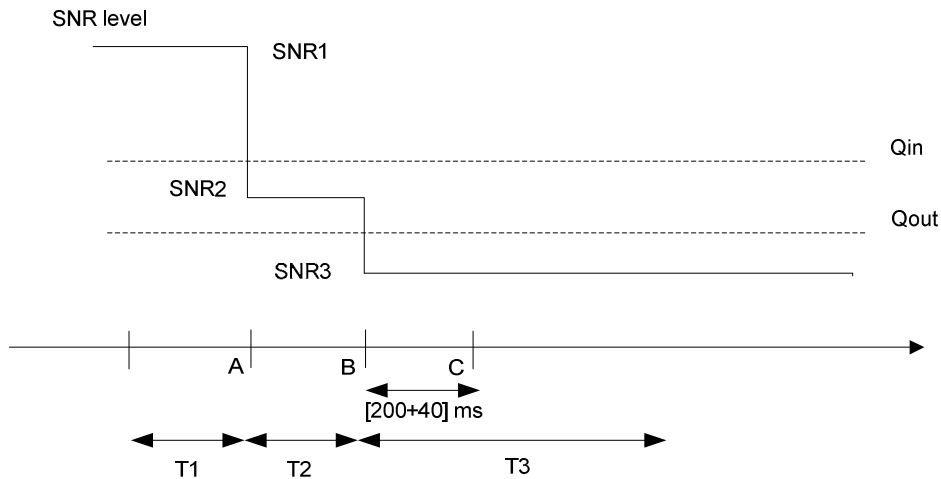

Figure A.7.3.26.1-1: SNR variation for out-of-sync testing

A.7.3.26.2 Test Requirements

The UE behaviour in each test during time durations T1, T2 and T3 shall be as follows:

During the period from time point A to time point B the UE shall transmit uplink signal at least in all subframes configured for CQI transmission according to the configured CQI reporting mode (PUCCH 1-0).

The UE shall stop transmitting uplink signal no later than time point C (240 ms after the start of time duration T3).

The rate of correct events observed during repeated tests shall be at least 90%.

A.7.3.27 E-UTRAN FD-FDD Radio Link Monitoring Test for In-sync for UE Category 0

A.7.3.27.1 Test Purpose and Environment

The purpose of this test is to verify that the FD-FDD category 0 UE properly detects the out of sync and in sync for the purpose of monitoring downlink radio link quality of the PCell. This test will partly verify the E-UTRAN FD-FDD radio link monitoring requirements in clause 7.11.

The test parameters are given in Tables A.7.3.27.1-1 and A.7.3.27.1-2 below. There is one cell (cell 1), which is the active cell, in the test. The test consists of five successive time periods, with time duration of T1, T2, T3, T4 and T5 respectively. Figure A.7.3.27.1-1 shows the variation of the downlink SNR in the active cell to emulate out-of-sync and in-sync states. Prior to the start of the time duration T1, the UE shall be fully synchronized to cell 1. The UE shall be configured for periodic CQI reporting in PUCCH 1-0 mode with a reporting periodicity of 2 ms.

Table A.7.3.27.1-1: General test parameters for E-UTRAN FD-FDD in-sync testing for UE Category 0

| Parameter | Unit | Value | Comment |
|---|------------------------|--------|---|
| Active cell | | Cell 1 | Cell 1 is on E-UTRA RF channel number 1 |
| E-UTRA RF Channel Number | | 1 | One E-UTRA FDD carrier frequency is used. |
| E-UTRA Channel Bandwidth (BW _{channel}) | MHz | 10 | |
| CP length | | Normal | |
| In sync transmission | DCI format | 1C | As defined in clause 5.3.3.1.4 in TS 36.212 |
| | Number of Control OFDM | 2 | In sync threshold Q _{in} and |

| | | | | |
|--|--------------------------------|-----|-----------|--|
| parameters (Note 1) | symbols | | | the corresponding hypothetical PDCCH/PCFICH transmission parameters are as specified in clause 7.11.1 and Table 7.11.1-2 respectively. |
| | Aggregation level | CCE | 4 | |
| | ρ_A, ρ_B | | -3 | |
| | Ratio of PDCCH to RS EPRE | dB | 1 | |
| Out of sync transmission parameters (Note 1) | DCI format | | 1A | As defined in clause 5.3.3.1.3 in TS 36.212 |
| | Number of Control OFDM symbols | | 2 | Out of sync threshold Q_{out} and the corresponding hypothetical PDCCH/PCFICH transmission parameters are as specified in clause 7.11.1 and Table 7.11.1-1 respectively. |
| | Aggregation level | CCE | 8 | |
| | ρ_A, ρ_B | | -3 | |
| | Ratio of PDCCH to RS EPRE | dB | 4 | |
| | Ratio of PCFICH to RS EPRE | dB | 1 | |
| DRX | | | OFF | |
| Layer 3 filtering | | | Enabled | Counters: $N_{310} = 1; N_{311} = 1$ |
| T310 timer | ms | | 2000 | T310 is enabled |
| T311 timer | ms | | 1000 | T311 is enabled |
| Periodic CQI reporting mode | | | PUCCH 1-0 | As defined in table 7.2.2-1 in TS 36.213. |
| CQI reporting periodicity | ms | | 2 | Minimum CQI reporting periodicity |
| T1 | s | | 0.5 | |
| T2 | s | | 0.4 | |
| T3 | s | | 1.46 | |
| T4 | s | | 0.4 | |
| T5 | s | | 1 | |
| Note 1: PDCCH/PCFICH corresponding to the in-sync and out of sync transmission parameters need not be included in the Reference Measurement Channel. | | | | |

Table A.7.3.27.1-2: Cell specific test parameters for E-UTRAN FD-FDD (cell # 1) for in-sync radio link monitoring test for UE Category 0

| Parameter | Unit | Test 1 | | | | |
|---|------|----------|----|----|----|----|
| | | T1 | T2 | T3 | T4 | T5 |
| E-UTRA RF Channel Number | | 1 | | | | |
| $BW_{channel}$ | MHz | 10 | | | | |
| PCFICH/PDCCH/PHICH parameters defined in clause A.3.1.2.1 | | R.7 FDD | | | | |
| OCNG Pattern defined in A.3.2.1 (FDD) | | OP.2 FDD | | | | |
| ρ_A, ρ_B | | -3 | | | | |
| PCFICH_RB | dB | 1 | | | | |
| PDCCH_RA | dB | 1 | | | | |
| PDCCH_RB | dB | 1 | | | | |
| PBCH_RA | dB | -3 | | | | |
| PBCH_RB | dB | | | | | |
| PSS_RA | dB | | | | | |
| SSS_RA | dB | | | | | |
| PHICH_RA | dB | | | | | |
| PHICH_RB | dB | | | | | |
| PDSCH_RA | dB | | | | | |
| PDSCH_RB | dB | | | | | |

| | | | | | | |
|--|------------|----------|------|-------|------|------|
| OCNG_RA ^{Note 1} | dB | | | | | |
| OCNG_RB ^{Note 1} | dB | | | | | |
| N_{oc} | dBm/15 kHz | -98 | | | | |
| SNR ^{Note 6} | dB | -2.1 | -6.9 | -12.9 | -7.1 | -2.1 |
| Propagation condition | | ETU 70Hz | | | | |
| Correlation Matrix and Antenna Configuration | | 2x1 Low | | | | |
| <p>Note 1: OCNG shall be used such that the resources in cell # 1 are fully allocated and a constant total transmitted power spectral density is achieved for all OFDM symbols.</p> <p>Note 2: The uplink resources for CQI reporting are assigned to the UE prior to the start of time period T1.</p> <p>Note 3: The timers and layer 3 filtering related parameters are configured prior to the start of time period T1.</p> <p>Note 4: The signal contains PDCCH for UEs other than the device under test as part of OCNG.</p> <p>Note 5: SNR levels correspond to the signal to noise ratio over the cell-specific reference signal REs.</p> <p>Note 6: The SNR in time periods T1, T2, T3, T4 and T5 is denoted as SNR1, SNR2, SNR3, SNR4 and SNR5 respectively in figure A.7.3.27.1-1.</p> | | | | | | |

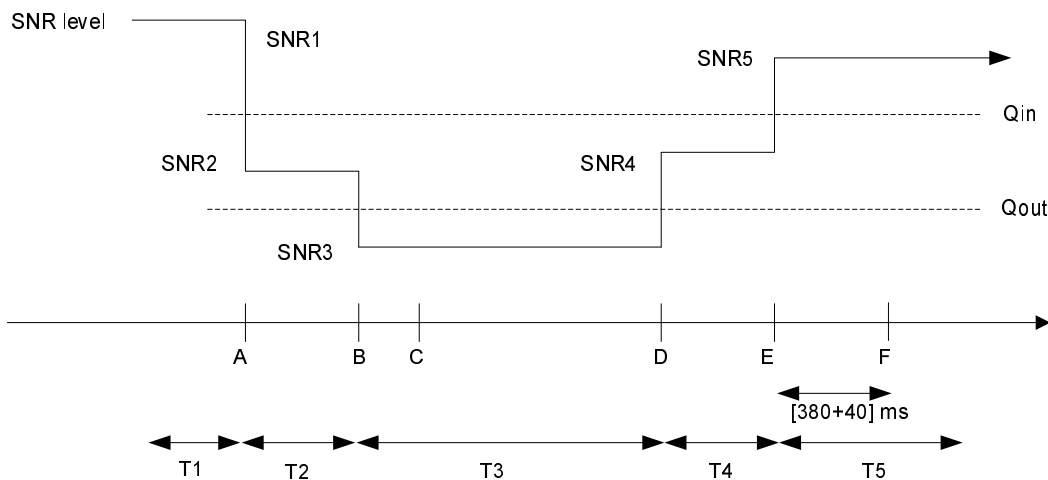

Figure A.7.3.27.1-1: SNR variation for in-sync testing

A.7.3.27.2 Test Requirements

The UE behaviour in each test during time durations T1, T2, T3, T4 and T5 shall be as follows:

During the period from time point A to time point F (420 ms after the start of time duration T5) the UE shall transmit uplink signal at least in all subframes configured for CQI transmission according to the configured CQI reporting mode (PUCCH 1-0).

The rate of correct events observed during repeated tests shall be at least 90%.

A.7.3.28 E-UTRAN FD-FDD Radio Link Monitoring Test for Out-of-sync in DRX for UE category 0

A.7.3.28.1 Test Purpose and Environment

The purpose of this test is to verify that the FD-FDD category 0 UE properly detects the out of sync and in sync for the purpose of monitoring downlink radio link quality of the PCell when DRX is used. This test will partly verify the E-UTRAN FD-FDD radio link monitoring requirements in clause 7.11.

The test parameters are given in Tables A.7.3.28.1-1, A.7.3.28.1-2, A.7.3.28.1-3 and A.7.3.28.1-4. There is one cell (cell 1), which is the active cell, in the test. The test consists of three successive time periods, with time duration of T1, T2 and T3 respectively. Figure A.7.3.28.1-1 shows the variation of the downlink SNR in the active cell to emulate out-of-sync and in-sync states. Prior to the start of the time duration T1, the UE shall be fully synchronized to cell 1. The UE shall be configured for periodic CQI reporting in PUCCH 1-0 mode with a reporting periodicity of 2 ms. In the test, DRX configuration is enabled and DRX inactivity timer has already been expired, i.e. UE tries to decode PDCCH and to send periodic CQI during the period when On-duration timer is running. Time alignment timers shall be set to “infinity” so that UL timing alignment is maintained during the test.

Table A.7.3.28.1-1: General test parameters for E-UTRAN FD-FDD out-of-sync tests in DRX for UE category 0

| Parameter | | Unit | Value | Comment |
|--|--------------------------------|------|-----------|---|
| Active cell | | | Cell 1 | Cell 1 is on E-UTRA RF channel number 1 |
| E-UTRA RF Channel Number | | | 1 | One E-UTRA FDD carrier frequency is used. |
| E-UTRA Channel Bandwidth (BW _{channel}) | | MHz | 10 | |
| CP length | | | Normal | |
| Out of sync transmission parameters (Note 1) | DCI format | | 1A | As defined in clause 5.3.3.1.3 in TS 36.212 |
| | Number of Control OFDM symbols | | 2 | Out of sync threshold Q _{out} and the corresponding hypothetical PDCCH/PCFICH transmission parameters are as specified in clause 7.11.1 and Table 7.11.1-1 respectively. |
| | Aggregation level | CCE | 8 | |
| | ρ_A, ρ_B | | -3 | |
| | Ratio of PDCCH to RS EPRE | dB | 4 | |
| | Ratio of PCFICH to RS EPRE | dB | 1 | |
| DRX cycle | | ms | 1280 | See Table A.7.3.28.1-3 |
| Layer 3 filtering | | | Enabled | Counters: N310 = 1; N311 = 1 |
| T310 timer | | ms | 0 | T310 is disabled |
| T311 timer | | ms | 1000 | T311 is enabled |
| Periodic CQI reporting mode | | | PUCCH 1-0 | As defined in table 7.2.2-1 in TS 36.213. |
| CQI reporting periodicity | | ms | 2 | Minimum CQI reporting periodicity |
| T1 | | s | 32 | |
| T2 | | s | 12.8 | |
| T3 | | s | 13 | |
| Note 1: PDCCH/PCFICH corresponding to the out of sync transmission parameters need not be included in the Reference Measurement Channel. | | | | |

Table A.7.3.28.1-2: Cell specific test parameters for E-UTRAN FD-FDD (cell # 1) for out-of-sync radio link monitoring tests in DRX for UE category 0

| Parameter | Unit | Test 1 | | |
|---|------|----------|----|----|
| | | T1 | T2 | T3 |
| E-UTRA RF Channel Number | | 1 | | |
| BW _{channel} | MHz | 10 | | |
| PCFICH/PDCCH/PHICH parameters defined in clause A.3.1.2.1 | | R.7 FDD | | |
| OCNG Pattern defined in A.3.2.1 (FDD) | | OP.2 FDD | | |
| ρ_A, ρ_B | | -3 | | |
| PCFICH_RB | dB | 1 | | |
| PDCCH_RA | dB | 4 | | |
| PDCCH_RB | dB | 4 | | |
| PBCH_RA | dB | | | |
| PBCH_RB | dB | | | |
| PSS_RA | dB | | | |
| SSS_RA | dB | | | |
| PHICH_RA | dB | | | |
| | | -3 | | |

| | | | | |
|--|---------------|------|-------|-------|
| PHICH_RB | dB | | | |
| PDSCH_RA | dB | | | |
| PDSCH_RB | dB | | | |
| OCNG_RA ^{Note1} | dB | | | |
| OCNG_RB ^{Note1} | dB | | | |
| N_{oc} | dBm/15 kHz | -98 | | |
| SNR ^{Note 6} | dB | -6.1 | -10.0 | -14.0 |
| Propagation condition | | AWGN | | |
| Correlation Matrix and Antenna Configuration | | 2x1 | | |
| <p>Note 1: OCNG shall be used such that the resources in cell # 1 are fully allocated and a constant total transmitted power spectral density is achieved for all OFDM symbols.</p> <p>Note 2: The uplink resources for CQI reporting are assigned to the UE prior to the start of time period T1.</p> <p>Note 3: The timers and layer 3 filtering related parameters are configured prior to the start of time period T1.</p> <p>Note 4: The signal contains PDCCH for UEs other than the device under test as part of OCNG.</p> <p>Note 5: SNR levels correspond to the signal to noise ratio over the cell-specific reference signal REs.</p> <p>Note 6: The SNR in time periods T1, T2 and T3 is denoted as SNR1, SNR2 and SNR3 respectively in figure A.7.3.28.1-1.</p> | | | | |

Table A.7.3.28.1-3: DRX-Configuration for E-UTRAN FD-FDD out-of-sync tests for UE category 0

| Field | Value | Comment |
|--------------------------|---------|---|
| onDurationTimer | psf2 | As specified in clause 6.3.2 in TS 36.331 |
| drx-InactivityTimer | psf1 | |
| drx-RetransmissionTimer | psf1 | |
| longDRX-CycleStartOffset | sf1280 | |
| shortDRX | disable | |

Table A.7.3.28.1-4: *TimeAlignmentTimer* -Configuration for E-UTRAN FD-FDD out-of-sync testing for UE category 0

| Field | Value | Comment |
|--------------------|----------|--|
| TimeAlignmentTimer | infinity | As specified in clause 6.3.2 in TS 36.331 |
| sr-ConfigIndex | 0 | For further information see clause 6.3.2 in TS 36.331 and section 10.1 in TS 36.213. |

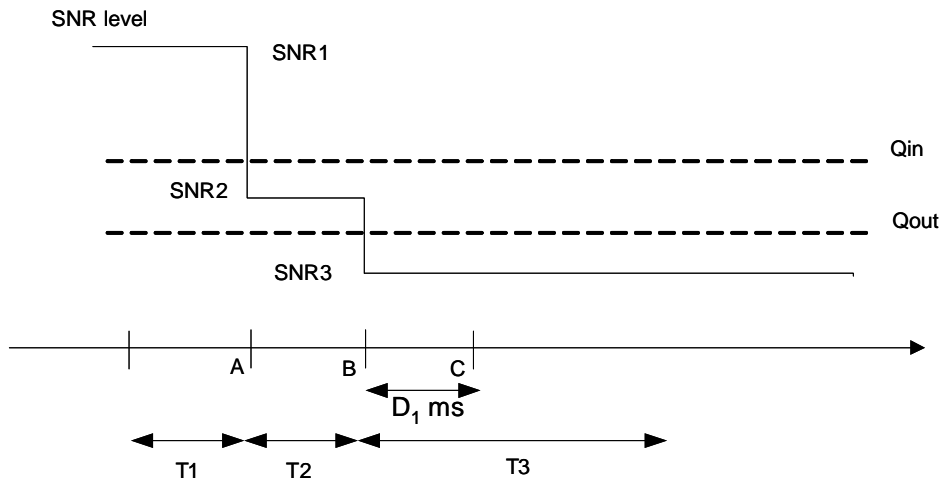

Figure A.7.3.28.1-1: SNR variation for out-of-sync testing in DRX

A.7.3.28.2 Test Requirements

The UE behaviour in each test during time durations T1, T2 and T3 shall be as follows:

During the period from time point A to time point B the UE shall transmit uplink signal at least once every DRX cycle, in the On-duration part of the cycle in the subframe according to the configured CQI reporting mode (PUCCH 1-0).

The UE shall stop transmitting uplink signal no later than time point C (duration $D_1 = 6500$ ms after the start of time duration T3).

The rate of correct events observed during repeated tests shall be at least 90%.

A.7.3.29 E-UTRAN FD-FDD Radio Link Monitoring Test for In-sync in DRX for UE Category 0

A.7.3.29.1 Test Purpose and Environment

The purpose of this test is to verify that the FD-FDD category 0 UE properly detects the out of sync and in sync for the purpose of monitoring downlink radio link quality of the PCell when DRX is used. This test will partly verify the E-UTRAN FD-FDD radio link monitoring requirements in clause 7.11.

The test parameters are given in Tables A.7.3.29.1-1, A.7.3.29.1-2, A.7.3.29.1-3 and A.7.3.29.1-4. There is one cell (cell 1), which is the active cell, in the test. The test consists of five successive time periods, with time duration of T1, T2, T3, T4 and T5 respectively. Figure A.7.3.29.1-1 shows the variation of the downlink SNR in the active cell to emulate out-of-sync and in-sync states. Prior to the start of the time duration T1, the UE shall be fully synchronized to cell 1. The UE shall be configured for periodic CQI reporting in PUCCH 1-0 mode with a reporting periodicity of 2 ms. In the test, DRX configuration is enabled and DRX inactivity timer has already been expired, i.e. UE tries to decode PDCCH and to send periodic CQI during the period when On-duration timer is running. Time alignment timers shall be set to “infinity” so that UL timing alignment is maintained during the test.

Table A.7.3.29.1-1: General test parameters for E-UTRAN FD-FDD in-sync test in DRX for UE category 0

| Parameter | Unit | Value | Comment |
|---|------|--------|---|
| Active cell | | Cell 1 | Cell 1 is on E-UTRA RF channel number 1 |
| E-UTRA RF Channel Number | | 1 | One E-UTRA FDD carrier frequency is used. |
| E-UTRA Channel Bandwidth (BW _{channel}) | MHz | 10 | |

| | | | | |
|--|--------------------------------|-----|-----------|--|
| CP length | | | Normal | |
| In sync transmission parameters (Note 1) | DCI format | | 1C | As defined in clause 5.3.3.1.4 in TS 36.212 |
| | Number of Control OFDM symbols | | 2 | In sync threshold Q_{in} and the corresponding hypothetical PDCCH/PCFICH transmission parameters are as specified in clause 7.11.1 and Table 7.11.1-2 respectively. |
| | Aggregation level | CCE | 4 | |
| | ρ_A, ρ_B | | -3 | |
| | Ratio of PDCCH to RS EPRE | | 1 | |
| | Ratio of PCFICH to RS EPRE | | 1 | |
| Out of sync transmission parameters (Note 1) | DCI format | | 1A | As defined in clause 5.3.3.1.3 in TS 36.212 |
| | Number of Control OFDM symbols | | 2 | Out of sync threshold Q_{out} and the corresponding hypothetical PDCCH/PCFICH transmission parameters are as specified in clause 7.11.1 and Table 7.11.1-1 respectively. |
| | Aggregation level | CCE | 8 | |
| | ρ_A, ρ_B | | -3 | |
| | Ratio of PDCCH to RS EPRE | dB | 4 | |
| | Ratio of PCFICH to RS EPRE | dB | 1 | |
| DRX cycle | ms | | 40 | See Table 7.3.29.1-3 |
| Layer 3 filtering | | | Enabled | Counters: $N_{310} = 1; N_{311} = 1$ |
| T310 timer | ms | | 2000 | T310 is enabled |
| T311 timer | ms | | 1000 | T311 is enabled |
| Periodic CQI reporting mode | | | PUCCH 1-0 | As defined in table 7.2.2-1 in TS 36.213. |
| CQI reporting periodicity | ms | | 2 | Minimum CQI reporting periodicity |
| T1 | s | | 4 | |
| T2 | s | | 1.6 | |
| T3 | s | | 1.46 | |
| T4 | s | | 0.4 | |
| T5 | s | | 4 | |
| Note 1: PDCCH/PCFICH corresponding to the in-sync and out of sync transmission parameters need not be included in the Reference Measurement Channel. | | | | |

Table A.7.3.29.1-2: Cell specific test parameters for E-UTRAN FD-FDD (cell # 1) for in-sync radio link monitoring test in DRX for UE category 0

| Parameter | Unit | Test 1 | | | | |
|---|------|--------|----|----------|----|----|
| | | T1 | T2 | T3 | T4 | T5 |
| E-UTRA RF Channel Number | | | | 1 | | |
| $BW_{channel}$ | MHz | | | 10 | | |
| PCFICH/PDCCH/PHICH parameters defined in clause A.3.1.2.1 | | | | R.7 FDD | | |
| OCNG Pattern defined in A.3.2.1 (FDD) | | | | OP.2 FDD | | |
| ρ_A, ρ_B | | | | -3 | | |
| PCFICH_RB | dB | | | 1 | | |
| PDCCH_RA | dB | | | 1 | | |
| PDCCH_RB | dB | | | 1 | | |
| PBCH_RA | dB | | | -3 | | |
| PBCH_RB | dB | | | | | |
| PSS_RA | dB | | | | | |
| SSS_RA | dB | | | | | |
| PHICH_RA | dB | | | | | |
| PHICH_RB | dB | | | | | |
| PDSCH_RA | dB | | | | | |
| PDSCH_RB | dB | | | | | |
| OCNG_RA ^{Note1} | dB | | | | | |
| OCNG_RB ^{Note1} | dB | | | | | |

| | | | | | | |
|--|------------|------|-------|-------|-------|------|
| N_{oc} | dBm/15 kHz | -98 | | | | |
| SNR ^{Note 8} | dB | -6.1 | -10.0 | -14.0 | -10.1 | -6.1 |
| Propagation condition | | AWGN | | | | |
| Correlation Matrix and Antenna Configuration | | 2x1 | | | | |
| <p>Note 1: OCNG shall be used such that the resources in cell # 1 are fully allocated and a constant total transmitted power spectral density is achieved for all OFDM symbols.</p> <p>Note 2: The uplink resources for CQI reporting are assigned to the UE prior to the start of time period T1.</p> <p>Note 3: The timers and layer 3 filtering related parameters are configured prior to the start of time period T1.</p> <p>Note 4: The signal contains PDCCH for UEs other than the device under test as part of OCNG.</p> <p>Note 5: SNR levels correspond to the signal to noise ratio over the cell-specific reference signal REs.</p> <p>Note 6: The SNR in time periods T1, T2, T3, T4 and T5 is denoted as SNR1, SNR2, SNR3, SNR4 and SNR5 respectively in figure A.7.3.29.1-1.</p> | | | | | | |

Table A.7.3.29.1-3: DRX-Configuration for E-UTRAN FD-FDD out-of-sync tests for UE category 0

| Field | Value | Comment |
|--------------------------|---------|---|
| onDurationTimer | psf2 | As specified in clause 6.3.2 in TS 36.331 |
| drx-InactivityTimer | psf1 | |
| drx-RetransmissionTimer | psf1 | |
| longDRX-CycleStartOffset | sf40 | |
| shortDRX | disable | |

Table A.7.3.29.1-4: TimeAlignmentTimer -Configuration for E-UTRAN FD-FDD out-of-sync testing for UE category 0

| Field | Value | Comment |
|--------------------|----------|--|
| TimeAlignmentTimer | infinity | As specified in clause 6.3.2 in TS 36.331 |
| sr-ConfigIndex | 0 | For further information see clause 6.3.2 in TS 36.331 and section 10.1 in TS 36.213. |

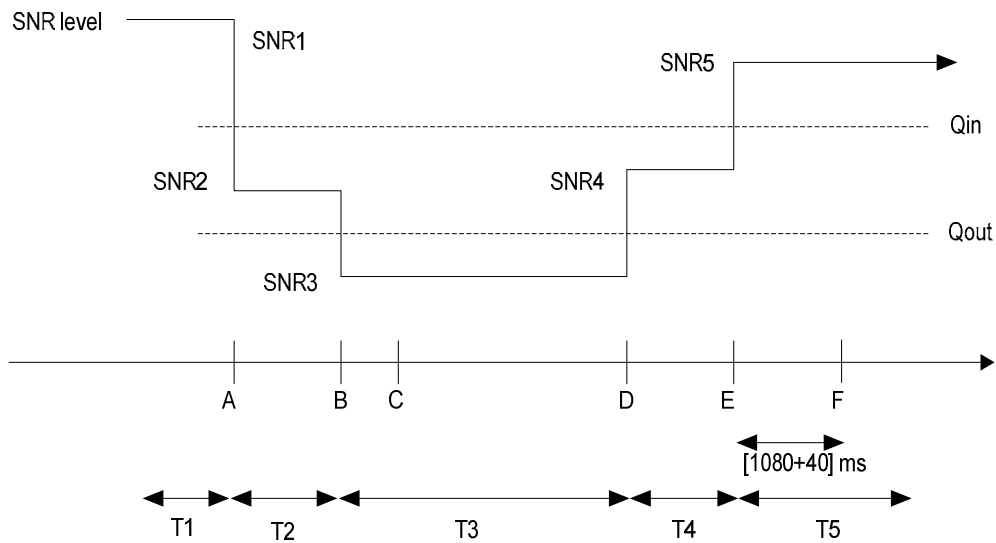

Figure A.7.3.29.1-1: SNR variation for in-sync testing in DRX

A.7.3.29.2 Test Requirements

The UE behaviour in each test during time durations T1, T2, T3, T4 and T5 shall be as follows:

During the period from time point A to time point F (1120 ms after the start of time duration T5) the UE shall transmit uplink signal at least once every DRX cycle, in the On-duration part of the cycle in the subframe according to the configured CQI reporting mode (PUCCH 1-0).

The rate of correct events observed during repeated tests shall be at least 90%.

A.7.3.30 E-UTRAN HD-FDD Radio Link Monitoring Test for Out-of-sync for UE Category 0

A.7.3.30.1 Test Purpose and Environment

The purpose of this test is to verify that the HD-FDD category 0 UE properly detects the out of sync and in sync for the purpose of monitoring downlink radio link quality of the PCell. This test will partly verify the E-UTRAN HD-FDD radio link monitoring requirements in clause 7.11.

The test parameters are given in Tables A.7.3.30.1-1, A.7.3.30.1-2 and A.7.3.30.1-3 below. There is one cell (cell 1), which is the active cell, in the test. The test consists of three successive time periods, with time duration of T1, T2 and T3 respectively. Figure A.7.3.30.1-1 shows the variation of the downlink SNR in the active cell to emulate out-of-sync and in-sync states. Prior to the start of the time duration T1, the UE shall be fully synchronized to cell 1. The UE shall be configured for periodic CQI reporting in PUCCH 1-0 mode with a reporting periodicity of 10 ms.

Table A.7.3.30.1-1: General test parameters for E-UTRAN HD-FDD out-of-sync testing for UE Category 0

| Parameter | | Unit | Value | Comment |
|--|--------------------------------|------|-----------|--|
| Active cell | | | Cell 1 | Cell 1 is on E-UTRA RF channel number 1 |
| E-UTRA RF Channel Number | | | 1 | One E-UTRA FDD carrier frequency is used. |
| E-UTRA Channel Bandwidth (BW _{channel}) | | MHz | 10 | |
| CP length | | | Normal | |
| Out of sync transmission parameters (Note 1) | DCI format | | 1A | As defined in section 5.3.3.1.3 in TS 36.212 |
| | Number of Control OFDM symbols | | 2 | Out of sync threshold Q _{out} and the corresponding hypothetical PDCCH/PCFICH transmission parameters are as specified in section 7.11.1 and Table 7.11.1-1 respectively. |
| | Aggregation level | CCE | 8 | |
| | ρ_A, ρ_B | | -3 | |
| | Ratio of PDCCH to RS EPRE | dB | 4 | |
| Ratio of PCFICH to RS EPRE | dB | 1 | | |
| DRX | | | OFF | |
| Layer 3 filtering | | | Enabled | Counters: N310 = 1; N311 = 1 |
| T310 timer | | ms | 0 | T310 is disabled |
| T311 timer | | ms | 1000 | T311 is enabled |
| Periodic CQI reporting mode | | | PUCCH 1-0 | As defined in table 7.2.2-1 in TS 36.213. |
| CQI reporting periodicity | | ms | [10] | Minimum CQI reporting periodicity |
| T1 | | s | 1 | |
| T2 | | s | 0.4 | |
| T3 | | s | 0.5 | |
| Note 1: PDCCH/PCFICH corresponding to the out of sync transmission | | | | |

parameters need not be included in the Reference Measurement Channel.

Table A.7.3.30.1-2: Cell specific test parameters for E-UTRAN HD-FDD (cell # 1) for out-of-sync radio link monitoring for UE Category 0

| Parameter | Unit | Test 1 | | |
|--|------------|------------|------|-------|
| | | T1 | T2 | T3 |
| E-UTRA RF Channel Number | | 1 | | |
| $BW_{channel}$ | MHz | 10 | | |
| PCFICH/PDCCH/PHICH parameters defined in section A.3.1.2.3 | | R.4 HD-FDD | | |
| OCNG Pattern defined in A.3.2.1 (FDD) | | OP.2 FDD | | |
| ρ_A, ρ_B | | -3 | | |
| PCFICH_RB | dB | 1 | | |
| PDCCH_RA | dB | 4 | | |
| PDCCH_RB | dB | 4 | | |
| PBCH_RA | dB | -3 | | |
| PBCH_RB | dB | | | |
| PSS_RA | dB | | | |
| SSS_RA | dB | | | |
| PHICH_RA | dB | | | |
| PHICH_RB | dB | | | |
| PDSCH_RA | dB | | | |
| PDSCH_RB | dB | | | |
| OCNG_RA ^{Note 1} | dB | | | |
| OCNG_RB ^{Note 1} | dB | | | |
| N_{oc} | dBm/15 kHz | -98 | | |
| SNR ^{Note 6} | dB | -1.2 | -6.0 | -12.0 |
| Propagation condition | | ETU 70Hz | | |
| Correlation Matrix and Antenna Configuration | | 2x1 Low | | |
| <p>Note 1: OCNG shall be used such that the resources in cell # 1 are fully allocated and a constant total transmitted power spectral density is achieved for all OFDM symbols.</p> <p>Note 2: The uplink resources for CQI reporting are assigned to the UE prior to the start of time period T1.</p> <p>Note 3: The timers and layer 3 filtering related parameters are configured prior to the start of time period T1.</p> <p>Note 4: The signal contains PDCCH for UEs other than the device under test as part of OCNG.</p> <p>Note 5: SNR levels correspond to the signal to noise ratio over the cell-specific reference signal REs.</p> <p>Note 6: The SNR in time periods T1, T2 and T3 is denoted as SNR1, SNR2 and SNR3 respectively in figure A.7.3.30.1-1.</p> | | | | |

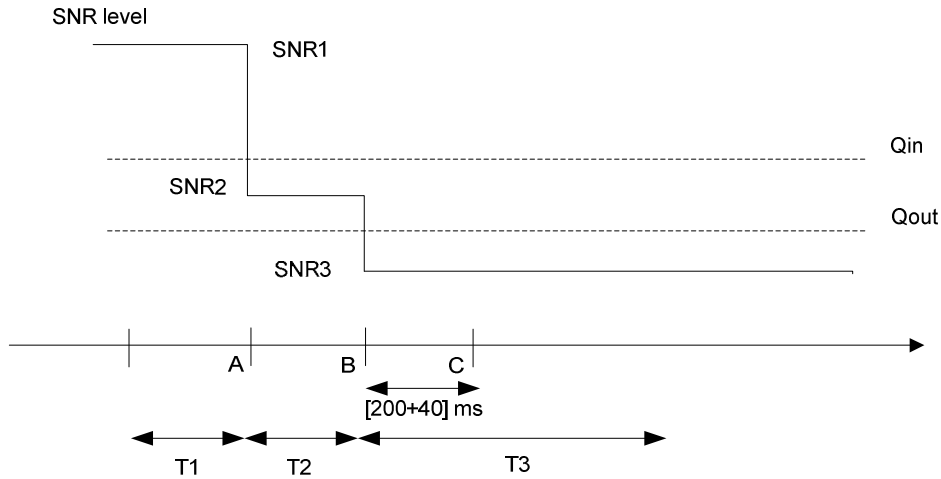

Figure A.7.3.30.1-1: SNR variation for out-of-sync testing

A.7.3.30.2 Test Requirements

The UE behaviour in each test during time durations T1, T2 and T3 shall be as follows:

During the period from time point A to time point B the UE shall transmit uplink signal at least in all subframes configured for CQI transmission according to the configured CQI reporting mode (PUCCH 1-0).

The UE shall stop transmitting uplink signal no later than time point C (240 ms after the start of time duration T3).

The rate of correct events observed during repeated tests shall be at least 90%.

A.7.3.31 E-UTRAN HD-FDD Radio Link Monitoring Test for In-sync for UE Category 0

A.7.3.31.1 Test Purpose and Environment

The purpose of this test is to verify that the HD-FDD category 0 UE properly detects the out of sync and in sync for the purpose of monitoring downlink radio link quality of the PCell. This test will partly verify the E-UTRAN HD-FDD radio link monitoring requirements in clause 7.11.

The test parameters are given in Tables A.7.3.31.1-1 and A.7.3.31.1-2 below. There is one cell (cell 1), which is the active cell, in the test. The test consists of five successive time periods, with time duration of T1, T2, T3, T4 and T5 respectively. Figure A.7.3.31.1-1 shows the variation of the downlink SNR in the active cell to emulate out-of-sync and in-sync states. Prior to the start of the time duration T1, the UE shall be fully synchronized to cell 1. The UE shall be configured for periodic CQI reporting in PUCCH 1-0 mode with a reporting periodicity of [10] ms.

Table A.7.3.31.1-1: General test parameters for E-UTRAN HD-FDD in-sync testing

| Parameter | Unit | Value | Comment |
|---|--------------------------------|--------|---|
| Active cell | | Cell 1 | Cell 1 is on E-UTRA RF channel number 1 |
| E-UTRA RF Channel Number | | 1 | One E-UTRA FDD carrier frequency is used. |
| E-UTRA Channel Bandwidth (BW _{channel}) | MHz | 10 | |
| CP length | | Normal | |
| In sync transmissio | DCI format | 1C | As defined in clause 5.3.3.1.4 in TS 36.212 |
| | Number of Control OFDM symbols | 2 | In sync threshold Q _{in} and the |

| | | | | |
|--|--------------------------------|-----|-----------|--|
| n parameters (Note 1) | Aggregation level | CCE | 4 | corresponding hypothetical PDCCH/PCFICH transmission parameters are as specified in clause 7.11.1 and Table 7.11.1-2 respectively. |
| | ρ_A, ρ_B | | -3 | |
| | Ratio of PDCCH to RS EPRE | dB | 1 | |
| | Ratio of PCFICH to RS EPRE | dB | 1 | |
| Out of sync transmission parameters (Note 1) | DCI format | | 1A | As defined in clause 5.3.3.1.3 in TS 36.212 |
| | Number of Control OFDM symbols | | 2 | Out of sync threshold Q_{out} and the corresponding hypothetical PDCCH/PCFICH transmission parameters are as specified in clause 7.11.1 and Table 7.11.1-1 respectively. |
| | Aggregation level | CCE | 8 | |
| | ρ_A, ρ_B | | -3 | |
| | Ratio of PDCCH to RS EPRE | dB | 4 | |
| | Ratio of PCFICH to RS EPRE | dB | 1 | |
| DRX | | | OFF | |
| Layer 3 filtering | | | Enabled | Counters: $N_{310} = 1; N_{311} = 1$ |
| T310 timer | ms | | 2000 | T310 is enabled |
| T311 timer | ms | | 1000 | T311 is enabled |
| Periodic CQI reporting mode | | | PUCCH 1-0 | As defined in table 7.2.2-1 in TS 36.213. |
| CQI reporting periodicity | ms | | [10] | Minimum CQI reporting periodicity |
| T1 | s | | 0.5 | |
| T2 | s | | 0.4 | |
| T3 | s | | 1.46 | |
| T4 | s | | 0.4 | |
| T5 | s | | 1 | |
| Note 1: PDCCH/PCFICH corresponding to the in-sync and out of sync transmission parameters need not be included in the Reference Measurement Channel. | | | | |

Table A.7.3.31.1-2: Cell specific test parameters for E-UTRAN HD-FDD (cell # 1) for in-sync radio link monitoring test for UE category 0

| Parameter | Unit | Test 1 | | | | |
|---|------------|------------|------|-------|------|------|
| | | T1 | T2 | T3 | T4 | T5 |
| E-UTRA RF Channel Number | | 1 | | | | |
| $BW_{channel}$ | MHz | 10 | | | | |
| PCFICH/PDCCH/PHICH parameters defined in clause A.3.1.2.3 | | R.4 HD-FDD | | | | |
| OCNG Pattern defined in A.3.2.1 (FDD) | | OP.2 FDD | | | | |
| ρ_A, ρ_B | | -3 | | | | |
| PCFICH_RB | dB | 1 | | | | |
| PDCCH_RA | dB | 1 | | | | |
| PDCCH_RB | dB | 1 | | | | |
| PBCH_RA | dB | -3 | | | | |
| PBCH_RB | dB | | | | | |
| PSS_RA | dB | | | | | |
| SSS_RA | dB | | | | | |
| PHICH_RA | dB | | | | | |
| PHICH_RB | dB | | | | | |
| PDSCH_RA | dB | | | | | |
| PDSCH_RB | dB | | | | | |
| OCNG_RA ^{Note 1} | dB | | | | | |
| OCNG_RB ^{Note 1} | dB | | | | | |
| N_{oc} | dBm/15 kHz | -98 | | | | |
| SNR ^{Note 6} | dB | -1.2 | -6.0 | -12.0 | -6.2 | -1.2 |
| Propagation condition | | ETU 70Hz | | | | |

| | | |
|--|--|---------|
| Correlation Matrix and Antenna Configuration | | 2x1 low |
| Note 1: | OCNG shall be used such that the resources in cell # 1 are fully allocated and a constant total transmitted power spectral density is achieved for all OFDM symbols. | |
| Note 2: | The uplink resources for CQI reporting are assigned to the UE prior to the start of time period T1. | |
| Note 3: | The timers and layer 3 filtering related parameters are configured prior to the start of time period T1. | |
| Note 4: | The signal contains PDCCH for UEs other than the device under test as part of OCNG. | |
| Note 5: | SNR levels correspond to the signal to noise ratio over the cell-specific reference signal REs. | |
| Note 6: | The SNR in time periods T1, T2, T3, T4 and T5 is denoted as SNR1, SNR2, SNR3, SNR4 and SNR5 respectively in figure A.7.3.31.1-1. | |

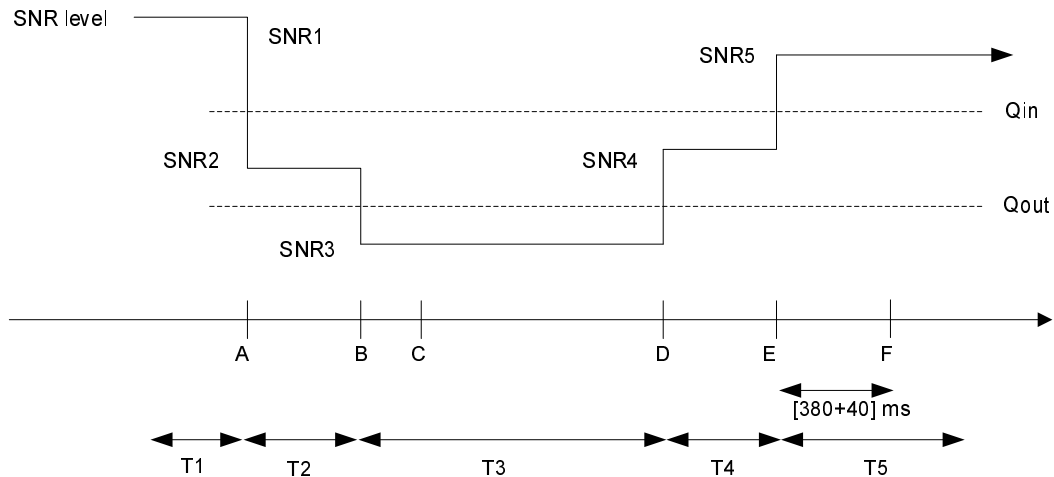

Figure A.7.3.31.1-1: SNR variation for in-sync testing

A.7.3.31.2 Test Requirements

The UE behaviour in each test during time durations T1, T2, T3, T4 and T5 shall be as follows:

During the period from time point A to time point F (420 ms after the start of time duration T5) the UE shall transmit uplink signal at least in all subframes configured for CQI transmission according to the configured CQI reporting mode (PUCCH 1-0).

The rate of correct events observed during repeated tests shall be at least 90%.

A.7.3.32 E-UTRAN HD-FDD Radio Link Monitoring Test for Out-of-sync in DRX for UE category 0

A.7.3.32.1 Test Purpose and Environment

The purpose of this test is to verify that the HD-FDD category 0 UE properly detects the out of sync and in sync for the purpose of monitoring downlink radio link quality of the PCell when DRX is used. This test will partly verify the E-UTRAN HD-FDD radio link monitoring requirements in clause 7.11.

The test parameters are given in Tables A.7.3.32.1-1, A.7.3.32.1-2, A.7.3.32.1-3 and A.7.3.32.1-4. There is one cell (cell 1), which is the active cell, in the test. The test consists of three successive time periods, with time duration of T1, T2 and T3 respectively. Figure A.7.3.32.1-1 shows the variation of the downlink SNR in the active cell to emulate out-of-sync and in-sync states. Prior to the start of the time duration T1, the UE shall be fully synchronized to cell 1. The UE shall be configured for periodic CQI reporting in PUCCH 1-0 mode with a reporting periodicity of 5ms. In the test, DRX configuration is enabled and DRX inactivity timer has already been expired, i.e. UE tries to decode PDCCH and to send periodic CQI during the period when On-duration timer is running. Time alignment timers shall be set to “infinity” so that UL timing alignment is maintained during the test.

Table A.7.3.32.1-1: General test parameters for E-UTRAN HD-FDD out-of-sync tests in DRX for UE category 0

| Parameter | | Unit | Value | Comment |
|--|--------------------------------|------|-----------|---|
| Active cell | | | Cell 1 | Cell 1 is on E-UTRA RF channel number 1 |
| E-UTRA RF Channel Number | | | 1 | One E-UTRA FDD carrier frequency is used. |
| E-UTRA Channel Bandwidth (BW _{channel}) | | MHz | 10 | |
| CP length | | | Normal | |
| Out of sync transmission parameters (Note 1) | DCI format | | 1A | As defined in clause 5.3.3.1.3 in TS 36.212 |
| | Number of Control OFDM symbols | | 2 | Out of sync threshold Q _{out} and the corresponding hypothetical PDCCH/PCFICH transmission parameters are as specified in clause 7.11.1 and Table 7.11.1-1 respectively. |
| | Aggregation level | CCE | 8 | |
| | ρ_A, ρ_B | | -3 | |
| | Ratio of PDCCH to RS EPRE | dB | 4 | |
| Ratio of PCFICH to RS EPRE | dB | 1 | | |
| DRX cycle | | ms | 1280 | See Table A.7.3.32.1-3 |
| Layer 3 filtering | | | Enabled | Counters: N310 = 1; N311 = 1 |
| T310 timer | | ms | 0 | T310 is disabled |
| T311 timer | | ms | 1000 | T311 is enabled |
| Periodic CQI reporting mode | | | PUCCH 1-0 | As defined in table 7.2.2-1 in TS 36.213. |
| CQI reporting periodicity | | ms | 5 | Minimum CQI reporting periodicity |
| T1 | | s | 32 | |
| T2 | | s | 12.8 | |
| T3 | | s | 13 | |
| Note 1: PDCCH/PCFICH corresponding to the out of sync transmission parameters need not be included in the Reference Measurement Channel. | | | | |

Table A.7.3.32.1-2: Cell specific test parameters for E-UTRAN HD-FDD (cell # 1) for out-of-sync radio link monitoring tests in DRX for UE category 0

| Parameter | Unit | Test 1 | | |
|---|------------|------------|----|----|
| | | T1 | T2 | T3 |
| E-UTRA RF Channel Number | | 1 | | |
| BW _{channel} | MHz | 10 | | |
| PCFICH/PDCCH/PHICH parameters specified in clause A.3.1.2.3 | | R.4 HD-FDD | | |
| OCNG Pattern defined in A.3.2.1 (FDD) | | OP.2 FDD | | |
| ρ_A, ρ_B | | -3 | | |
| PCFICH_RB | dB | 1 | | |
| PDCCH_RA | dB | 4 | | |
| PDCCH_RB | dB | 4 | | |
| PBCH_RA | dB | -3 | | |
| PBCH_RB | dB | | | |
| PSS_RA | dB | | | |
| SSS_RA | dB | | | |
| PHICH_RA | dB | | | |
| PHICH_RB | dB | | | |
| PDSCH_RA | dB | | | |
| PDSCH_RB | dB | | | |
| OCNG_RA ^{Note1} | dB | | | |
| OCNG_RB ^{Note1} | dB | | | |
| N_{oc} | dBm/15 kHz | -98 | | |

| | | | | |
|--|--|------|------|-------|
| SNR ^{Note 6} | dB | -5.4 | -9.5 | -13.5 |
| Propagation condition | | AWGN | | |
| Correlation Matrix and Antenna Configuration | | 2x1 | | |
| Note 1: | OCNG shall be used such that the resources in cell # 1 are fully allocated and a constant total transmitted power spectral density is achieved for all OFDM symbols. | | | |
| Note 2: | The uplink resources for CQI reporting are assigned to the UE prior to the start of time period T1. | | | |
| Note 3: | The timers and layer 3 filtering related parameters are configured prior to the start of time period T1. | | | |
| Note 4: | The signal contains PDCCH for UEs other than the device under test as part of OCNG. | | | |
| Note 5: | SNR levels correspond to the signal to noise ratio over the cell-specific reference signal REs. | | | |
| Note 6: | The SNR in time periods T1, T2 and T3 is denoted as SNR1, SNR2 and SNR3 respectively in figure A.7.3.32.1-1. | | | |

Table A.7.3.32.1-3: DRX-Configuration for E-UTRAN HD-FDD out-of-sync test for UE category 0

| Field | Value | Comment |
|--------------------------|---------|---|
| onDurationTimer | psf5 | As specified in clause 6.3.2 in TS 36.331 |
| drx-InactivityTimer | psf1 | |
| drx-RetransmissionTimer | psf1 | |
| longDRX-CycleStartOffset | sf1280 | |
| shortDRX | disable | |

Table A.7.3.32.1-4: *TimeAlignmentTimer* -Configuration for E-UTRAN HD-FDD out-of-sync testing for UE category 0

| Field | Value | Comment |
|--------------------|----------|--|
| TimeAlignmentTimer | infinity | As specified in clause 6.3.2 in TS 36.331 |
| sr-ConfigIndex | 0 | For further information see clause 6.3.2 in TS 36.331 and section 10.1 in TS 36.213. |

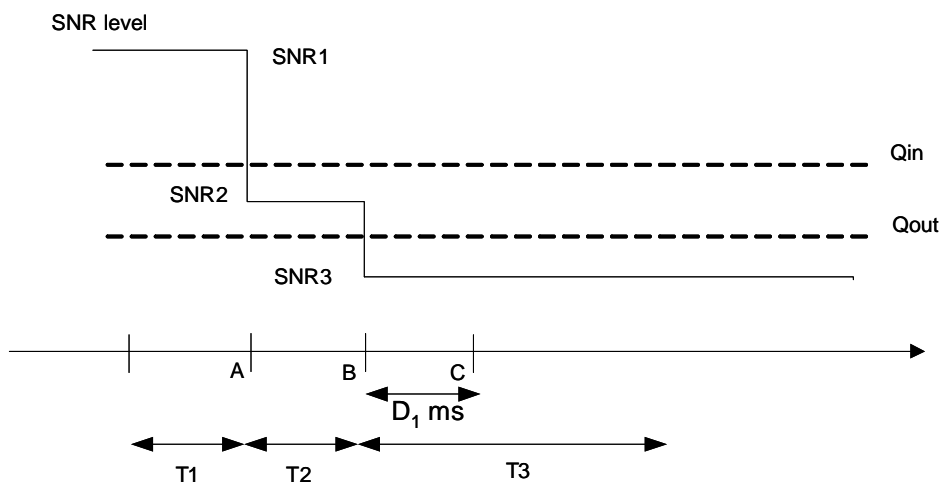

Figure A.7.3.32.1-1: SNR variation for out-of-sync testing in DRX

A.7.3.32.2 Test Requirements

The UE behaviour in each test during time durations T1, T2 and T3 shall be as follows:

During the period from time point A to time point B the UE shall transmit uplink signal at least once every DRX cycle, in the On-duration part of the cycle in the subframe according to the configured CQI reporting mode (PUCCH 1-0).

The UE shall stop transmitting uplink signal no later than time point C (duration $D_1 = 6500$ ms after the start of time duration T3).

The rate of correct events observed during link repeated tests shall be at least 90%.

A.7.3.33 E-UTRAN HD-FDD Radio Link Monitoring Test for In-sync in DRX for UE Category 0

A.7.3.33.1 Test Purpose and Environment

The purpose of this test is to verify that the HD-FDD category 0 UE properly detects the out of sync and in sync for the purpose of monitoring downlink radio link quality of the PCell when DRX is used. This test will partly verify the E-UTRAN HD-FDD radio link monitoring requirements in clause 7.11.

The test parameters are given in Tables A.7.3.33.1-1, A.7.3.33.1-2, A.7.3.33.1-3 and A.7.3.33.1-4. There is one cell (cell 1), which is the active cell, in the test. The test consists of five successive time periods, with time duration of T1, T2, T3, T4 and T5 respectively. Figure A.7.3.33.1-1 shows the variation of the downlink SNR in the active cell to emulate out-of-sync and in-sync states. Prior to the start of the time duration T1, the UE shall be fully synchronized to cell 1. The UE shall be configured for periodic CQI reporting in PUCCH 1-0 mode with a reporting periodicity of 5 ms. In the test, DRX configuration is enabled and DRX inactivity timer has already been expired, i.e. UE tries to decode PDCCH and to send periodic CQI during the period when On-duration timer is running. Time alignment timers shall be set to “infinity” so that UL timing alignment is maintained during the test.

Table A.7.3.33.1-1: General test parameters for E-UTRAN HD-FDD in-sync test in DRX for UE category 0

| Parameter | | Unit | Value | Comment |
|--|--------------------------------|------|--------|---|
| Active cell | | | Cell 1 | Cell 1 is on E-UTRA RF channel number 1 |
| E-UTRA RF Channel Number | | | 1 | One E-UTRA FDD carrier frequency is used. |
| E-UTRA Channel Bandwidth (BW_{channel}) | | MHz | 10 | |
| CP length | | | Normal | |
| In sync transmission parameters (Note 1) | DCI format | | 1C | As defined in clause 5.3.3.1.4 in TS 36.212 |
| | Number of Control OFDM symbols | | 2 | In sync threshold Q_{in} and the corresponding hypothetical PDCCH/PCFICH transmission parameters are as specified in clause 7.11.1 and Table 7.11.1-2 respectively. |
| | Aggregation level | CCE | 4 | |
| | ρ_A, ρ_B | | -3 | |
| | Ratio of PDCCH to RS EPRE | dB | 1 | |
| | Ratio of PCFICH to RS EPRE | dB | 1 | |
| Out of sync transmission parameters (Note 1) | DCI format | | 1A | As defined in clause 5.3.3.1.3 in TS 36.212 |
| | Number of Control OFDM symbols | | 2 | Out of sync threshold Q_{out} and the corresponding hypothetical PDCCH/PCFICH transmission parameters are as specified in clause 7.11.1 and Table 7.11.1-1 respectively. |
| | Aggregation level | CCE | 8 | |
| | ρ_A, ρ_B | | -3 | |
| | Ratio of PDCCH to RS EPRE | dB | 4 | |

| | | | | |
|--|----------------------------|----|-----------|---|
| | Ratio of PCFICH to RS EPRE | dB | 1 | |
| DRX cycle | | ms | 40 | See Table A.7.3.33.1-3 |
| Layer 3 filtering | | | Enabled | Counters: N310 = 1; N311 = 1 |
| T310 timer | | ms | 2000 | T310 is enabled |
| T311 timer | | ms | 1000 | T311 is enabled |
| Periodic CQI reporting mode | | | PUCCH 1-0 | As defined in table 7.2.2-1 in TS 36.213. |
| CQI reporting periodicity | | ms | 5 | Minimum CQI reporting periodicity |
| T1 | | s | 4 | |
| T2 | | s | 1.6 | |
| T3 | | s | 1.46 | |
| T4 | | s | 0.4 | |
| T5 | | s | 4 | |
| Note 1: PDCCH/PCFICH corresponding to the in-sync and out of sync transmission parameters need not be included in the Reference Measurement Channel. | | | | |

Table A.7.3.33.1-2: Cell specific test parameters for E-UTRAN HD-FDD (cell # 1) for in-sync radio link monitoring test in DRX for UE category 0

| Parameter | Unit | Test 1 | | | | |
|---|------------|------------|------|-------|------|------|
| | | T1 | T2 | T3 | T4 | T5 |
| E-UTRA RF Channel Number | | 1 | | | | |
| BW _{channel} | MHz | 10 | | | | |
| PCFICH/PDCCH/PHICH parameters specified in clause A.3.1.2.3 | | R.4 HD-FDD | | | | |
| OCNG Pattern defined in A.3.2.1 (FDD) | | OP.2 FDD | | | | |
| ρ_A, ρ_B | | -3 | | | | |
| PCFICH_RB | dB | 1 | | | | |
| PDCCH_RA | dB | 1 | | | | |
| PDCCH_RB | dB | 1 | | | | |
| PBCH_RA | dB | -3 | | | | |
| PBCH_RB | dB | | | | | |
| PSS_RA | dB | | | | | |
| SSS_RA | dB | | | | | |
| PHICH_RA | dB | | | | | |
| PHICH_RB | dB | | | | | |
| PDSCH_RA | dB | | | | | |
| PDSCH_RB | dB | | | | | |
| OCNG_RA ^{Note1} | dB | | | | | |
| OCNG_RB ^{Note1} | dB | | | | | |
| N_{oc} | dBm/15 kHz | -98 | | | | |
| SNR ^{Note 6} | dB | -5.4 | -9.5 | -13.5 | -9.4 | -5.4 |
| Propagation condition | | AWGN | | | | |
| Correlation Matrix and Antenna Configuration | | 2x1 | | | | |
| Note 1: OCNG shall be used such that the resources in cell # 1 are fully allocated and a constant total transmitted power spectral density is achieved for all OFDM symbols. Note 2: The uplink resources for CQI reporting are assigned to the UE prior to the start of time period T1. Note 3: The timers and layer 3 filtering related parameters are configured prior to the start of time period T1. Note 4: The signal contains PDCCH for UEs other than the device under test as part of OCNG. Note 5: SNR levels correspond to the signal to noise ratio over the cell-specific reference signal REs. Note 6: The SNR in time periods T1, T2, T3, T4 and T5 is denoted as SNR1, SNR2, SNR3, SNR4 and SNR5 respectively in figure A.7.3.33.1-1. | | | | | | |

Table A.7.3.33.1-3: DRX-Configuration for E-UTRAN HD-FDD out-of-sync test for UE category 0

| Field | Value | Comment |
|--------------------------|---------|---|
| onDurationTimer | psf5 | As specified in clause 6.3.2 in TS 36.331 |
| drx-InactivityTimer | psf1 | |
| drx-RetransmissionTimer | psf1 | |
| longDRX-CycleStartOffset | sf40 | |
| shortDRX | disable | |

Table A.7.3.33.1-4: TimeAlignmentTimer -Configuration for E-UTRAN HD-FDD out-of-sync testing for UE category 0

| Field | Value | Comment |
|--------------------|----------|--|
| TimeAlignmentTimer | infinity | As specified in clause 6.3.2 in TS 36.331 |
| sr-ConfigIndex | 0 | For further information see clause 6.3.2 in TS 36.331 and section 10.1 in TS 36.213. |

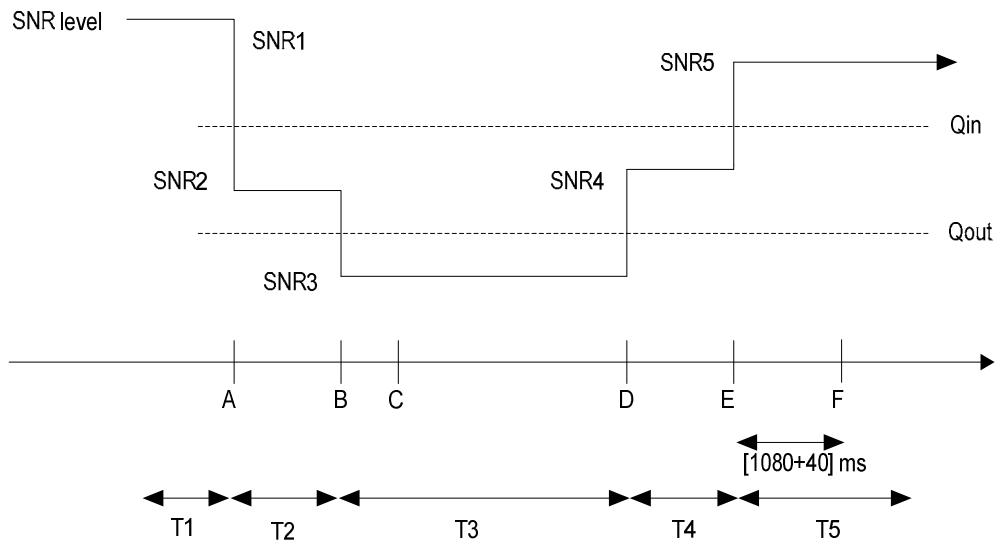

Figure A.7.3.33.1-1: SNR variation for in-sync testing in DRX

A.7.3.33.2 Test Requirements

The UE behaviour in each test during time durations T1, T2, T3, T4 and T5 shall be as follows:

During the period from time point A to time point F (1120 ms after the start of time duration T5) the UE shall transmit uplink signal at least once every DRX cycle, in the On-duration part of the cycle in the subframe according to the configured CQI reporting mode (PUCCH 1-0).

The rate of correct events observed during repeated tests shall be at least 90%.

A.7.3.34 E-UTRAN TDD Radio Link Monitoring Test for Out-of-sync for UE Category 0

A.7.3.34.1 Test Purpose and Environment

The purpose of this test is to verify that the TDD category 0 UE properly detects the out of sync and in sync for the purpose of monitoring downlink radio link quality of the PCell. This test will partly verify the E-UTRAN TDD radio link monitoring requirements in clause 7.11.

The test parameters are given in Tables A.7.3.34.1-1, A.7.3.34.1-2 and A.7.3.34.1-3 below. There is one cell (cell 1), which is the active cell, in the test. The test consists of three successive time periods, with time duration of T1, T2 and T3 respectively. Figure A.7.3.34.1-1 shows the variation of the downlink SNR in the active cell to emulate out-of-sync and in-sync states. Prior to the start of the time duration T1, the UE shall be fully synchronized to cell 1. The UE shall be configured for periodic CQI reporting in PUCCH 1-0 mode with a reporting periodicity of 1 ms.

Table A.7.3.34.1-1: General test parameters for E-UTRAN TDD out-of-sync testing for UE Category 0

| Parameter | | Unit | Value | Comment |
|--|--------------------------------|------|-----------|--|
| Active cell | | | Cell 1 | Cell 1 is on E-UTRA RF channel number 1 |
| E-UTRA RF Channel Number | | | 1 | One E-UTRA TDD carrier frequency is used. |
| E-UTRA Channel Bandwidth (BW_{channel}) | | MHz | 10 | |
| CP length | | | Normal | |
| Out of sync transmission parameters (Note 1) | DCI format | | 1A | As defined in section 5.3.3.1.3 in TS 36.212 |
| | Number of Control OFDM symbols | | 2 | Out of sync threshold Q_{out} and the corresponding hypothetical PDCCH/PCFICH transmission parameters are as specified in section 7.11.1 and Table 7.11.1-1 respectively. |
| | Aggregation level | CCE | 8 | |
| | ρ_A, ρ_B | | -3 | |
| | Ratio of PDCCH to RS EPRE | dB | 4 | |
| Ratio of PCFICH to RS EPRE | dB | 1 | | |
| DRX | | | OFF | |
| Layer 3 filtering | | | Enabled | Counters: $N_{310} = 1; N_{311} = 1$ |
| T310 timer | | ms | 0 | T310 is disabled |
| T311 timer | | ms | 1000 | T311 is enabled |
| Periodic CQI reporting mode | | | PUCCH 1-0 | As defined in table 7.2.2-1 in TS 36.213. |
| CQI reporting periodicity | | ms | 1 | Minimum CQI reporting periodicity |
| T1 | | s | 1 | |
| T2 | | s | 0.4 | |
| T3 | | s | 0.5 | |
| Note 1: PDCCH/PCFICH corresponding to the out of sync transmission parameters need not be included in the Reference Measurement Channel. | | | | |

Table A.7.3.34.1-2: Cell specific test parameters for E-UTRAN TDD (cell # 1) for out-of-sync radio link monitoring for UE Category 0

| Parameter | Unit | Test 1 | | |
|-----------|------|--------|----|----|
| | | T1 | T2 | T3 |
| | | | | |

| | | | | |
|--|------------|----------|------|-------|
| E-UTRA RF Channel Number | | 1 | | |
| $BW_{channel}$ | MHz | 10 | | |
| Special subframe configuration <small>Note 1</small> | | 6 | | |
| Uplink-downlink configuration <small>Note 1</small> | | 1 | | |
| PCFICH/PDCCH/PHICH parameters defined in section A.3.1.2.2 | | R.7 TDD | | |
| OCNG Pattern defined in A.3.2.2 (TDD) | | OP.2 TDD | | |
| ρ_A, ρ_B | | -3 | | |
| PCFICH_RB | dB | 1 | | |
| PDCCH_RA | dB | 4 | | |
| PDCCH_RB | dB | 4 | | |
| PBCH_RA | dB | -3 | | |
| PBCH_RB | dB | | | |
| PSS_RA | dB | | | |
| SSS_RA | dB | | | |
| PHICH_RA | dB | | | |
| PHICH_RB | dB | | | |
| PDSCH_RA | dB | | | |
| PDSCH_RB | dB | | | |
| OCNG_RA <small>Note 2</small> | dB | | | |
| OCNG_RB <small>Note 2</small> | dB | | | |
| N_{oc} | dBm/15 kHz | -98 | | |
| SNR <small>Note 7</small> | dB | -1.6 | -5.9 | -11.9 |
| Propagation condition | | ETU 70Hz | | |
| Correlation Matrix and Antenna Configuration | | 2x1 Low | | |
| <p>Note 1: For special subframe and uplink-downlink configurations see Tables 4.2-1 and 4.2-2 in TS 36.211.</p> <p>Note 2: OCNG shall be used such that the resources in cell # 1 are fully allocated and a constant total transmitted power spectral density is achieved for all OFDM symbols.</p> <p>Note 3: The uplink resources for CQI reporting are assigned to the UE prior to the start of time period T1.</p> <p>Note 4: The timers and layer 3 filtering related parameters are configured prior to the start of time period T1.</p> <p>Note 5: The signal contains PDCCH for UEs other than the device under test as part of OCNG.</p> <p>Note 6: SNR levels correspond to the signal to noise ratio over the cell-specific reference signal REs.</p> <p>Note 7: The SNR in time periods T1, T2 and T3 is denoted as SNR1, SNR2 and SNR3 respectively in figure A.7.3.34.1-1.</p> | | | | |

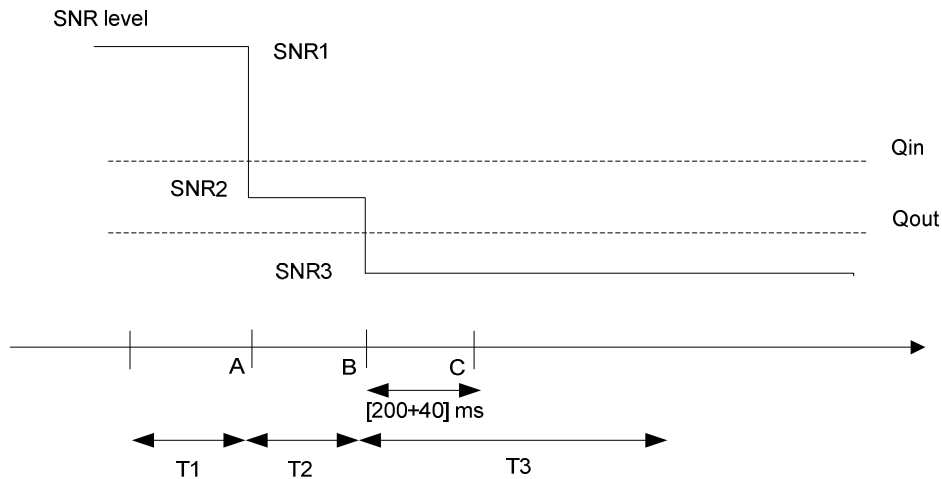

Figure A.7.3.34.1-1: SNR variation for out-of-sync testing

A.7.3.34.2 Test Requirements

The UE behaviour in each test during time durations T1, T2 and T3 shall be as follows:

During the period from time point A to time point B the UE shall transmit uplink signal at least in all uplink subframes configured for CQI transmission according to the configured CQI reporting mode (PUCCH 1-0).

The UE shall stop transmitting uplink signal no later than time point C (240 ms after the start of the time duration T3).

The rate of correct events observed during repeated tests shall be at least 90%.

A.7.3.35 E-UTRAN TDD Radio Link Monitoring Test for In-sync for UE category 0

A.7.3.35.1 Test Purpose and Environment

The purpose of this test is to verify that the TDD category 0 UE properly detects the out of sync and in sync for the purpose of monitoring downlink radio link quality of the PCell. This test will partly verify the E-UTRAN TDD radio link monitoring requirements in clause 7.11.

The test parameters are given in Tables A.7.3.35.1-1 and A.7.3.35.1-2 below. There is one cell (cell 1), which is the active cell, in the test. The test consists of five successive time periods, with time duration of T1, T2, T3, T4 and T5 respectively. Figure A.7.3.35.1-1 shows the variation of the downlink SNR in the active cell to emulate out-of-sync and in-sync states. Prior to the start of the time duration T1, the UE shall be fully synchronized to cell 1. The UE shall be configured for periodic CQI reporting in PUCCH 1-0 mode with a reporting periodicity of 1 ms.

Table A.7.3.35.1-1: General test parameters for E-UTRAN TDD in-sync testing

| Parameter | | Unit | Value | Comment |
|---|--------------------------------|------|--------|---|
| | | | Test 1 | |
| Active cell | | | Cell 1 | Cell 1 is on E-UTRA RF channel number 1 |
| E-UTRA RF Channel Number | | | 1 | One E-UTRA TDD carrier frequency is used. |
| E-UTRA Channel Bandwidth (BW _{channel}) | | MHz | 10 | |
| CP length | | | Normal | |
| In sync transmission parameters | DCI format | | 1C | As defined in clause 5.3.3.1.4 in TS 36.212 |
| | Number of Control OFDM symbols | | 2 | In sync threshold Q _{in} and |

| | | | | |
|--|--------------------------------|-----|-----------|--|
| (Note 1) | Aggregation level | CCE | 4 | the corresponding hypothetical PDCCH/PCFICH transmission parameters are as specified in clause 7.11.1 and Table 7.11.1-2 respectively. |
| | ρ_A, ρ_B | | -3 | |
| | Ratio of PDCCH to RS EPRE | dB | 1 | |
| | Ratio of PCFICH to RS EPRE | dB | 1 | |
| Out of sync transmission parameters (Note 1) | DCI format | | 1A | As defined in clause 5.3.3.1.3 in TS 36.212 |
| | Number of Control OFDM symbols | | 2 | Out of sync threshold Q_{out} and the corresponding hypothetical PDCCH/PCFICH transmission parameters are as specified in clause 7.11.1 and Table 7.11.1-1 respectively. |
| | Aggregation level | CCE | 8 | |
| | ρ_A, ρ_B | | -3 | |
| | Ratio of PDCCH to RS EPRE | dB | 4 | |
| | Ratio of PCFICH to RS EPRE | dB | 1 | |
| DRX | | | OFF | |
| Layer 3 filtering | | | Enabled | Counters: $N_{310} = 1; N_{311} = 1$ |
| T310 timer | ms | | 2000 | T310 is enabled |
| T311 timer | ms | | 1000 | T311 is enabled |
| Periodic CQI reporting mode | | | PUCCH 1-0 | As defined in table 7.2.2-1 in TS 36.213. |
| CQI reporting periodicity | ms | | 1 | Minimum CQI reporting periodicity |
| T1 | s | | 0.5 | |
| T2 | s | | 0.4 | |
| T3 | s | | 1.46 | |
| T4 | s | | 0.4 | |
| T5 | s | | 1 | |
| Note 1: PDCCH/PCFICH corresponding to the in-sync and out of sync transmission parameters need not be included in the Reference Measurement Channel. | | | | |

Table A.7.3.35.1-2: Cell specific test parameters for E-UTRAN TDD (cell # 1) for in-sync radio link monitoring test

| Parameter | Unit | Test 1 | | | | |
|--|------|--------|----|----------|----|----|
| | | T1 | T2 | T3 | T4 | T5 |
| E-UTRA RF Channel Number | | | | 1 | | |
| $BW_{channel}$ | MHz | | | 10 | | |
| Special subframe configuration ^{Note 1} | | | | 6 | | |
| Uplink-downlink configuration ^{Note 1} | | | | 1 | | |
| PCFICH/PDCCH/PHICH parameters defined in section A.3.1.2.2 | | | | R.7 TDD | | |
| OCNG Pattern defined in A.3.2.2 (TDD) | | | | OP.2 TDD | | |
| ρ_A, ρ_B | | | | -3 | | |
| PCFICH_RB | dB | | | 1 | | |
| PDCCH_RA | dB | | | 1 | | |
| PDCCH_RB | dB | | | 1 | | |
| PBCH_RA | dB | | | -3 | | |
| PBCH_RB | dB | | | | | |
| PSS_RA | dB | | | | | |
| SSS_RA | dB | | | | | |
| PHICH_RA | dB | | | | | |
| PHICH_RB | dB | | | | | |
| PDSCH_RA | dB | | | | | |
| PDSCH_RB | dB | | | | | |
| OCNG_RA ^{Note 2} | dB | | | | | |
| OCNG_RB ^{Note 2} | dB | | | | | |

| | | | | | | |
|--|--|----------|------|-------|------|------|
| N_{oc} | dBm/15 kHz | -98 | | | | |
| SNR ^{Note 7} | dB | -1.6 | -5.9 | -11.9 | -6.6 | -1.6 |
| Propagation condition | | ETU 70Hz | | | | |
| Correlation Matrix and Antenna Configuration | | 2x1 low | | | | |
| Note 1: | For special subframe and uplink-downlink configurations see Tables 4.2-1 and 4.2-2 in TS 36.211. | | | | | |
| Note 2: | OCNG shall be used such that the resources in cell # 1 are fully allocated and a constant total transmitted power spectral density is achieved for all OFDM symbols. | | | | | |
| Note 3: | The uplink resources for CQI reporting are assigned to the UE prior to the start of time period T1. | | | | | |
| Note 4: | The timers and layer 3 filtering related parameters are configured prior to the start of time period T1. | | | | | |
| Note 5: | The signal contains PDCCH for UEs other than the device under test as part of OCNG. | | | | | |
| Note 6: | SNR levels correspond to the signal to noise ratio over the cell-specific reference signal REs. | | | | | |
| Note 7: | The SNR in time periods T1, T2, T3, T4 and T5 is denoted as SNR1, SNR2, SNR3, SNR4 and SNR5 respectively in figure A.7.3.35.1-1. | | | | | |

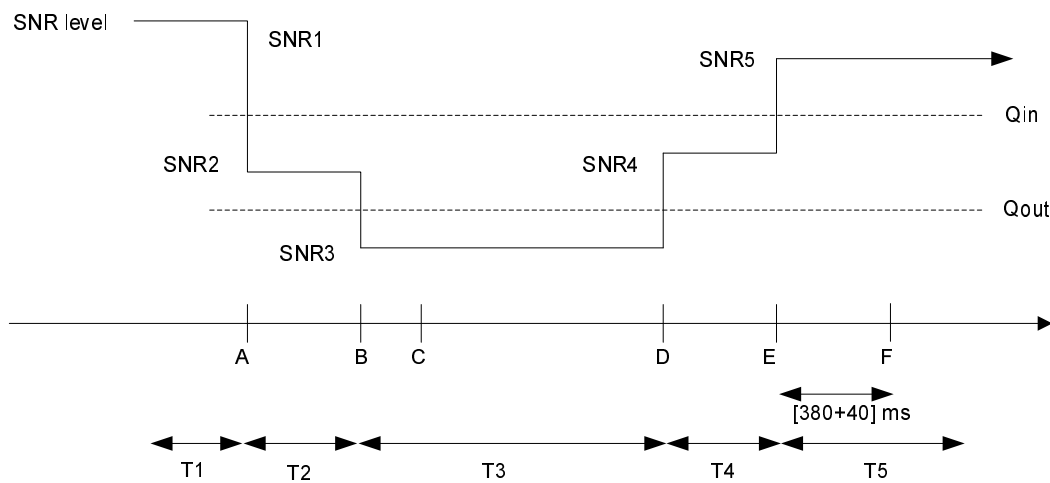

Figure A.7.3.35.1-1: SNR variation for in-sync testing

A.7.3.35.2 Test Requirements

The UE behaviour in each test during time durations T1, T2, T3, T4 and T5 shall be as follows:

During the period from time point A to time point F (420 ms after the start of time duration T5) the UE shall transmit uplink signal at least in all subframes configured for CQI transmission according to the configured CQI reporting mode (PUCCH 1-0).

The rate of correct events observed during repeated tests shall be at least 90%.

A.7.3.36 E-UTRAN TDD Radio Link Monitoring Test for Out-of-sync in DRX for UE category 0

A.7.3.36.1 Test Purpose and Environment

The purpose of this test is to verify that the TDD category 0 UE properly detects the out of sync and in sync for the purpose of monitoring downlink radio link quality of the PCell when DRX is used. This test will partly verify the E-UTRAN TDD radio link monitoring requirements in clause 7.11.

The test parameters are given in Tables A.7.3.36.1-1, A.7.3.36.1-2, A.7.3.36.1-3 and A.7.3.36.1-4. There is one cell (cell 1), which is the active cell, in the test. The test consists of three successive time periods, with time duration of T1, T2 and T3 respectively. Figure A.7.3.36.1-1 shows the variation of the downlink SNR in the active cell to emulate out-

of-sync and in-sync states. Prior to the start of the time duration T1, the UE shall be fully synchronized to cell 1. The UE shall be configured for periodic CQI reporting in PUCCH 1-0 mode with a reporting periodicity of 1 ms. In the test, DRX configuration is enabled and DRX inactivity timer has already been expired, i.e. UE tries to decode PDCCH and to send periodic CQI during the period when On-duration timer is running. Time alignment timers shall be set to “infinity” so that UL timing alignment is maintained during the test.

Table A.7.3.36.1-1: General test parameters for E-UTRAN TDD out-of-sync test in DRX for UE category 0

| Parameter | | Unit | Value | Comment |
|--|--------------------------------|------|-----------|---|
| Active cell | | | Cell 1 | Cell 1 is on E-UTRA RF channel number 1 |
| E-UTRA RF Channel Number | | | 1 | One E-UTRA TDD carrier frequency is used. |
| E-UTRA Channel Bandwidth (BW _{channel}) | | MHz | 10 | |
| CP length | | | Normal | |
| Out of sync transmission parameters (Note 1) | DCI format | | 1A | As defined in clause 5.3.3.1.3 in TS 36.212 |
| | Number of Control OFDM symbols | | 2 | Out of sync threshold Q _{out} and the corresponding hypothetical PDCCH/PCFICH transmission parameters are as specified in clause 7.11.1 and Table 7.11.1-1 respectively. |
| | Aggregation level | CCE | 8 | |
| | ρ_A, ρ_B | | -3 | |
| | Ratio of PDCCH to RS EPRE | dB | 4 | |
| Ratio of PCFICH to RS EPRE | dB | 1 | | |
| DRX cycle | | ms | 1280 | See Table A.7.3.36.1-3 |
| Layer 3 filtering | | | Enabled | Counters: N310 = 1; N311 = 1 |
| T310 timer | | ms | 0 | T310 is disabled |
| T311 timer | | ms | 1000 | T311 is enabled |
| Periodic CQI reporting mode | | | PUCCH 1-0 | As defined in table 7.2.2-1 in TS 36.213. |
| CQI reporting periodicity | | ms | 1 | Minimum CQI reporting periodicity |
| T1 | | s | 32 | |
| T2 | | s | 12.8 | |
| T3 | | s | 13 | |
| Note 1: PDCCH/PCFICH corresponding to the out of sync transmission parameters need not be included in the Reference Measurement Channel. | | | | |

Table A.7.3.36.1-2: Cell specific test parameters for E-UTRAN TDD (cell # 1) for out-of-sync radio link monitoring test in DRX for UE category 0

| Parameter | Unit | Test 2 | | |
|--|------|---------|----|----|
| | | T1 | T2 | T3 |
| E-UTRA RF Channel Number | | 1 | | |
| BW _{channel} | MHz | 10 | | |
| Special subframe configuration ^{Note 1} | | 6 | | |
| Uplink-downlink configuration ^{Note 1} | | 1 | | |
| PCFICH/PDCCH/PHICH parameters defined in section A.3.1.2.2 | | R.7 TDD | | |

| | | | | |
|--|--|----------|------|-------|
| OCNG Pattern defined in A.3.2.2 (TDD) | | OP.2 TDD | | |
| ρ_A, ρ_B | | -3 | | |
| PCFICH_RB | dB | 1 | | |
| PDCCH_RA | dB | 4 | | |
| PDCCH_RB | dB | 4 | | |
| PBCH_RA | dB | -3 | | |
| PBCH_RB | dB | | | |
| PSS_RA | dB | | | |
| SSS_RA | dB | | | |
| PHICH_RA | dB | | | |
| PHICH_RB | dB | | | |
| PDSCH_RA | dB | | | |
| PDSCH_RB | dB | | | |
| OCNG_RA ^{Note2} | dB | | | |
| OCNG_RB ^{Note2} | dB | | | |
| N_{oc} | dBm/15 kHz | -98 | | |
| SNR ^{Note 7} | dB | -5.6 | -9.6 | -13.6 |
| Propagation condition | | AWGN | | |
| Correlation Matrix and Antenna Configuration | | 2x1 | | |
| Note 1: | For special subframe and uplink-downlink configurations see Tables 4.2-1 and 4.2-2 in TS 36.211. | | | |
| Note 2: | OCNG shall be used such that the resources in cell # 1 are fully allocated and a constant total transmitted power spectral density is achieved for all OFDM symbols. | | | |
| Note 3: | The uplink resources for CQI reporting are assigned to the UE prior to the start of time period T1. | | | |
| Note 4: | The timers and layer 3 filtering related parameters are configured prior to the start of time period T1. | | | |
| Note 5: | The signal contains PDCCH for UEs other than the device under test as part of OCNG. | | | |
| Note 6: | SNR levels correspond to the signal to noise ratio over the cell-specific reference signal REs. | | | |
| Note 7: | The SNR in time periods T1, T2 and T3 is denoted as SNR1, SNR2 and SNR3 respectively in figure A.7.3.36.1-1. | | | |

Table A.7.3.36.1-3: DRX-Configuration for E-UTRAN TDD out-of-sync test for UE category 0

| Field | Value | Comment |
|--------------------------|---------|---|
| onDurationTimer | psf2 | As specified in clause 6.3.2 in TS 36.331 |
| drx-InactivityTimer | psf1 | |
| drx-RetransmissionTimer | psf1 | |
| longDRX-CycleStartOffset | sf1280 | |
| shortDRX | disable | |

Table A.7.3.36.1-4: *TimeAlignmentTimer* -Configuration for E-UTRAN TDD out-of-sync testing for UE category 0

| Field | Value | Comment |
|--------------------|----------|--|
| TimeAlignmentTimer | infinity | As specified in clause 6.3.2 in TS 36.331 |
| sr-ConfigIndex | 2 | For further information see clause 6.3.2 in TS 36.331 and section 10.1 in TS 36.213. |

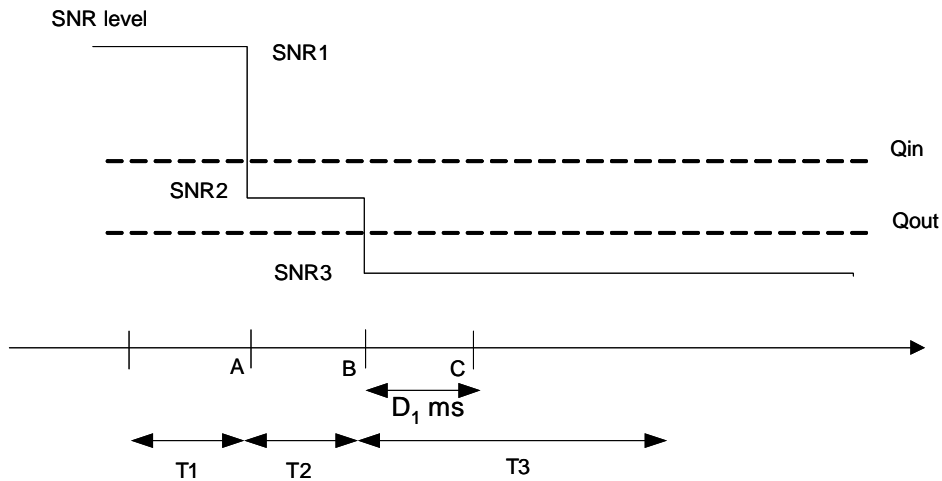

Figure A.7.3.36.1-1: SNR variation for out-of-sync testing in DRX

A.7.3.36.2 Test Requirements

The UE behaviour in each test during time durations T1, T2 and T3 shall be as follows:

During the period from time point A to time point B the UE shall transmit uplink signal at least once every DRX cycle, in the On-duration part of the cycle in the uplink subframe according to the configured CQI reporting mode (PUCCH 1-0).

The UE shall stop transmitting uplink signal no later than time point C (duration $D_1 = 6500$ ms after the start of time duration T3).

The rate of correct events observed during repeated tests shall be at least 90%.

A.7.3.37 E-UTRAN TDD Radio Link Monitoring Test for In-sync in DRX for UE category 0

A.7.3.37.1 Test Purpose and Environment

The purpose of this test is to verify that the TDD category 0 UE properly detects the out of sync and in sync for the purpose of monitoring downlink radio link quality of the PCell when DRX is used. This test will partly verify the E-UTRAN TDD radio link monitoring requirements in clause 7.11.

The test parameters are given in Tables A.7.3.37.1-1, A.7.3.37.1-2, A.7.3.37.1-3 and A.7.3.37.1-4. There is one cell (cell 1), which is the active cell, in the test. The test consists of five successive time periods, with time duration of T1, T2, T3, T4 and T5 respectively. Figure A.7.3.37.1-1 shows the variation of the downlink SNR in the active cell to emulate out-of-sync and in-sync states. Prior to the start of the time duration T1, the UE shall be fully synchronized to cell 1. The UE shall be configured for periodic CQI reporting in PUCCH 1-0 mode with a reporting periodicity of 1 ms. In the test, DRX configuration is enabled and DRX inactivity timer has already been expired, i.e. UE tries to decode PDCCH and to send periodic CQI during the period when On-duration timer is running. Time alignment timers shall be set to “infinity” so that UL timing alignment is maintained during the test.

Table A.7.3.37.1-1: General test parameters for E-UTRAN TDD in-sync test in DRX for UE category 0

| Parameter | Unit | Value | Comment |
|---|------|--------|---|
| Active cell | | Cell 1 | Cell 1 is on E-UTRA RF channel number 1 |
| E-UTRA RF Channel Number | | 1 | One E-UTRA TDD carrier frequency is used. |
| E-UTRA Channel Bandwidth ($BW_{channel}$) | MHz | 10 | |

| | | | | |
|--|--------------------------------|-----------|---|--|
| CP length | | | Normal | |
| In sync transmission parameters (Note 1) | DCI format | | 1C | As defined in clause 5.3.3.1.4 in TS 36.212 |
| | Number of Control OFDM symbols | | 2 | In sync threshold Q_{in} and the corresponding hypothetical PDCCH/PCFICH transmission parameters are as specified in clause 7.11.1 and Table 7.11.1-2 respectively. |
| | Aggregation level | CCE | 4 | |
| | ρ_A, ρ_B | | -3 | |
| | Ratio of PDCCH to RS EPRE | dB | 1 | |
| | Ratio of PCFICH to RS EPRE | dB | 1 | |
| Out of sync transmission parameters (Note 1) | DCI format | | 1A | As defined in clause 5.3.3.1.3 in TS 36.212 |
| | Number of Control OFDM symbols | | 2 | Out of sync threshold Q_{out} and the corresponding hypothetical PDCCH/PCFICH transmission parameters are as specified in clause 7.11.1 and Table 7.11.1-1 respectively. |
| | Aggregation level | CCE | 8 | |
| | ρ_A, ρ_B | | -3 | |
| | Ratio of PDCCH to RS EPRE | dB | 4 | |
| | Ratio of PCFICH to RS EPRE | dB | 1 | |
| DRX cycle | ms | 40 | See Table A.7.3.37.1-3 | |
| Layer 3 filtering | | Enabled | Counters: $N_{310} = 1; N_{311} = 1$ | |
| T310 timer | ms | 2000 | T310 is enabled | |
| T311 timer | ms | 1000 | T311 is enabled | |
| Periodic CQI reporting mode | | PUCCH 1-0 | As defined in table 7.2.2-1 in TS 36.213. | |
| CQI reporting periodicity | ms | 1 | Minimum CQI reporting periodicity | |
| T1 | s | 4 | | |
| T2 | s | 1.6 | | |
| T3 | s | 1.46 | | |
| T4 | s | 0.4 | | |
| T5 | s | 4 | | |
| Note 1: PDCCH/PCFICH corresponding to the in-sync and out of sync transmission parameters need not be included in the Reference Measurement Channel. | | | | |

Table A.7.3.37.1-2: Cell specific test parameters for E-UTRAN TDD (cell # 1) for in-sync radio link monitoring test in DRX for UE category 0

| Parameter | Unit | Test 1 | | | | |
|--|------|--------|----|----------|----|----|
| | | T1 | T2 | T3 | T4 | T5 |
| E-UTRA RF Channel Number | | | | 1 | | |
| $BW_{channel}$ | MHz | | | 10 | | |
| Special subframe configuration ^{Note 1} | | | | 6 | | |
| Uplink-downlink configuration ^{Note 1} | | | | 1 | | |
| PCFICH/PDCCH/PHICH parameters defined in section A.3.1.2.2 | | | | R.7 TDD | | |
| OCNG Pattern defined in A.3.2.2 (TDD) | | | | OP.2 TDD | | |
| ρ_A, ρ_B | | | | -3 | | |
| PCFICH_RB | dB | | | 1 | | |
| PDCCH_RA | dB | | | 1 | | |
| PDCCH_RB | dB | | | 1 | | |
| PBCH_RA | dB | | | -3 | | |
| PBCH_RB | dB | | | | | |
| PSS_RA | dB | | | | | |
| SSS_RA | dB | | | | | |
| PHICH_RA | dB | | | | | |
| PHICH_RB | dB | | | | | |
| PDSCH_RA | dB | | | | | |

| | | | | | | |
|--|------------|------|------|-------|------|------|
| PDSCH_RB | dB | | | | | |
| OCNG_RA ^{Note2} | dB | | | | | |
| OCNG_RB ^{Note2} | dB | | | | | |
| N_{oc} | dBm/15 kHz | -98 | | | | |
| SNR ^{Note 7} | dB | -5.6 | -9.6 | -13.6 | -9.6 | -5.6 |
| Propagation condition | | AWGN | | | | |
| Correlation Matrix and Antenna Configuration | | 2x1 | | | | |
| <p>Note 1: For special subframe and uplink-downlink configurations see Tables 4.2-1 and 4.2-2 in TS 36.211.</p> <p>Note 2: OCNG shall be used such that the resources in cell # 1 are fully allocated and a constant total transmitted power spectral density is achieved for all OFDM symbols.</p> <p>Note 3: The uplink resources for CQI reporting are assigned to the UE prior to the start of time period T1.</p> <p>Note 4: The timers and layer 3 filtering related parameters are configured prior to the start of time period T1.</p> <p>Note 5: The signal contains PDCCH for UEs other than the device under test as part of OCNG.</p> <p>Note 6: SNR levels correspond to the signal to noise ratio over the cell-specific reference signal REs.</p> <p>Note 7: The SNR in time periods T1, T2, T3, T4 and T5 is denoted as SNR1, SNR2, SNR3, SNR4 and SNR5 respectively in figure A.7.3.37.1-1.</p> | | | | | | |

Table A.7.3.37.1-3: DRX-Configuration for E-UTRAN TDD out-of-sync test for UE category 0

| Field | Value | Comment |
|--------------------------|---------|---|
| onDurationTimer | psf2 | As specified in clause 6.3.2 in TS 36.331 |
| drx-InactivityTimer | psf1 | |
| drx-RetransmissionTimer | psf1 | |
| longDRX-CycleStartOffset | sf40 | |
| shortDRX | disable | |

Table A.7.3.37.1-4: TimeAlignmentTimer -Configuration for E-UTRAN TDD out-of-sync testing for UE category 0

| Field | Value | Comment |
|--------------------|----------|--|
| TimeAlignmentTimer | infinity | As specified in clause 6.3.2 in TS 36.331 |
| sr-ConfigIndex | 2 | For further information see clause 6.3.2 in TS 36.331 and section 10.1 in TS 36.213. |

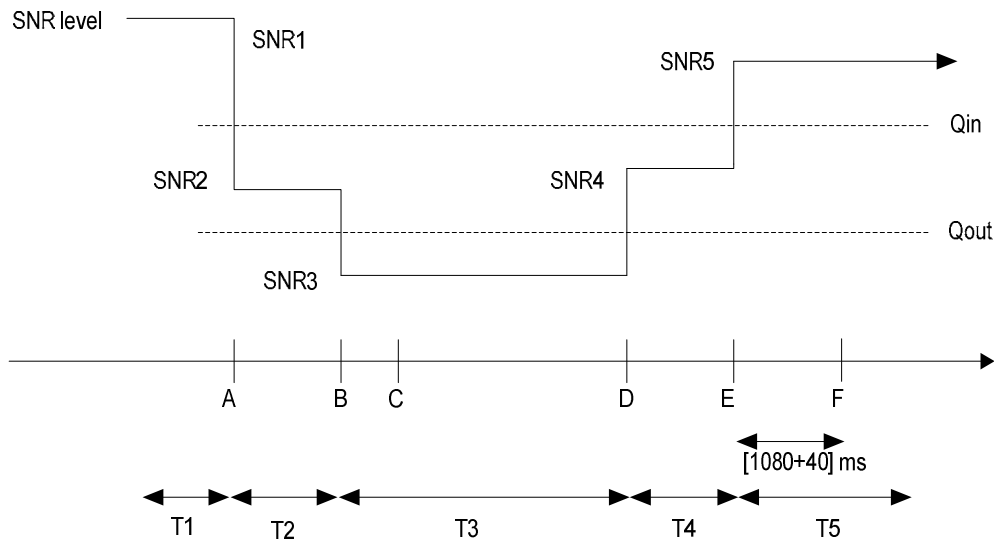

Figure A.7.3.37.1-1: SNR variation for in-sync testing in DRX

A.7.3.37.2 Test Requirements

The UE behaviour in each test during time durations T1, T2, T3, T4 and T5 shall be as follows:

During the period from time point A to time point F (1120 ms after the start of time duration T5) the UE shall transmit uplink signal at least once every DRX cycle, in the On-duration part of the cycle in the uplink subframe according to the configured CQI reporting mode (PUCCH 1-0).

The rate of correct events observed during repeated tests shall be at least 90%.

A.7.3.38 E-UTRAN FDD-FDD DC Radio Link Monitoring Test for Out-of-sync in DRX in synchronous DC

A.7.3.38.1 Test Purpose and Environment

The purpose of this test is to verify that the UE properly detects the out of sync for the purpose of monitoring downlink radio link quality of the PCell when DRX is used. This test will partly verify the E-UTRAN FDD radio link monitoring requirements in clause 7.6.

The test parameters are given in Tables A.7.3.38.1-1, A.7.3.38.1-2, A.7.3.38.1-3, and A.7.3.38.1-4. There are two cells, cell 1 is PCell and cell 2 is PSCell, in the test. The test consists of three successive time periods with time duration of T1, T2 and T3 respectively. Figure A.7.3.38.1-1 shows the variation of the downlink SNR in the PCell and PSCell to emulate out-of-sync and in-sync states. Prior to the start of the time duration T1, the UE shall be fully synchronized to cell 1 and cell 2. The UE shall be configured for periodic CQI reporting in PUCCH 1-0 mode with a reporting periodicity of 2 ms. In the test, DRX configuration is enabled and DRX inactivity timer has already been expired, i.e. UE tries to decode PDCCH and to send periodic CQI during the period when On-duration timer is running. Time alignment timers shall be set to “infinity” so that UL timing alignment is maintained during the test.

Table A.7.3.38.1-1: General test parameters for E-UTRAN FDD out-of-sync tests in DRX in synchronous dual connectivity

| Parameter | Unit | Value | Comment |
|--------------------------------------|------|------------------|---|
| Active cell | | Cell 1 Cell 2 | Cell 1 is PCell on E-UTRA RF channel number 1, and cell 2 is PSCell on E-UTRA RF channel number 2 |
| CP length | | Normal | |
| E-UTRA RF Channel Number | | 1, 2 | Two E-UTRA FDD carrier frequencies are used. |
| E-UTRA Channel Bandwidth (BWchannel) | MHz | 5, 10, 20 | |

| | | | | |
|--|--------------------------------|-----|---------------------------------|--|
| Correlation Matrix and Antenna Configuration | | | 2x2 Low | Correlation Matrix and Antenna Configuration are defined in TS 36.101 [5] Annex B.2.3.2 |
| Out of sync transmission parameters (Note 1) | DCI format | | 1A | As defined in clause 5.3.3.1.3 in TS 36.212 |
| | Number of Control OFDM symbols | | 5MHz: 3 10MHz: 2 20MHz: 2 | Out of sync threshold Q_{out} and the corresponding hypothetical PDCCH/PCFICH transmission parameters are as specified in clause 7.6.1 and Table 7.6.1-1 respectively. |
| | Aggregation level | CCE | 8 | |
| | ρ_A, ρ_B | | -3 | |
| | Ratio of PDCCH to RS EPRE | dB | 1 | |
| | Ratio of PCFICH to RS EPRE | dB | 1 | |
| DRX cycle on cell 1 | ms | | 640 | See Table A.7.3.38.1-3 |
| DRX cycle on cell 2 | ms | | 40 | See Table A.7.3.38.1-3 |
| Timing offset between cell 1 and cell 2 | μ s | | 33 | For synchronous dual connectivity |
| Layer 3 filtering | | | Enabled | Counters: N310 = 1; N311 = 1; N313 = 1; N314 = 1 |
| T310 timer | ms | | 0 | T310 is disabled |
| T311 timer | ms | | 1000 | T311 is enabled |
| T313 timer | ms | | 0 | T313 is disabled |
| Periodic CQI reporting mode | | | PUCCH 1-0 | As defined in table 7.2.2-1 in TS 36.213. |
| CQI reporting periodicity | ms | | 2 | Minimum CQI reporting periodicity |
| T1 | s | | 4 | |
| T2 | s | | 1.6 | |
| T3 | s | | 1.8 | |
| Note 1: PDCCH/PCFICH corresponding to the out of sync transmission parameters need not be included in the Reference Measurement Channel. | | | | |

Table A.7.3.38.1-2: Cell specific test parameters for E-UTRAN FDD out-of-sync radio link monitoring in DRX in synchronous dual connectivity

| Parameter | Unit | Cell 1 | | | Cell 2 | | |
|---|------|--|------|------|--|------|-------|
| | | T1 | T2 | T3 | T1 | T2 | T3 |
| E-UTRA RF Channel Number | | 1 | | | 2 | | |
| BW _{channel} | MHz | 5, 10, 20 | | | 5, 10, 20 | | |
| Correlation Matrix and Antenna Configuration | | 2x2 Low | | | 2x2 Low | | |
| PCFICH/PDCCH/PHICH parameters None of the PDCCH are intended for the UE under test | | 5MHz: R.12 FDD 10MHz: R.7 FDD 20MHz: R.13 FDD | | | 5MHz: R.12 FDD 10MHz: R.7 FDD 20MHz: R.13 FDD | | |
| OCNG Pattern | | 5MHz: OP.16 FDD 10MHz: OP.2 FDD 20MHz: OP.12 FDD | | | 5MHz: OP.16 FDD 10MHz: OP.2 FDD 20MHz: OP.12 FDD | | |
| ρ_A, ρ_B | | -3 | | | -3 | | |
| PCFICH_RB | dB | 1 | | | 1 | | |
| PDCCH_RA | dB | 1 | | | 1 | | |
| PDCCH_RB | dB | 1 | | | 1 | | |
| PBCH_RA | dB | -3 | | | -3 | | |
| PBCH_RB | dB | | | | | | |
| PSS_RA | dB | | | | | | |
| SSS_RA | dB | | | | | | |
| PHICH_RA | dB | | | | | | |
| PHICH_RB | dB | | | | | | |
| PDSCH_RA | dB | | | | | | |
| PDSCH_RB | dB | | | | | | |
| OCNG_RA ^{Note1} | dB | | | | | | |
| OCNG_RB ^{Note1} | dB | | | | | | |
| SNR ^{Note 6,7} (5MHz bandwidth) | dB | -2.3 | -2.3 | -2.3 | -2.3 | -5.7 | -12.2 |
| SNR ^{Note 6,7} (10MHz bandwidth) | dB | -2.3 | -2.3 | -2.3 | -2.3 | -6.2 | -12.2 |

| | | | | | | | |
|--|------------|-----------|------|------|-----------|------|-------|
| SNR ^{Note 6,7} (20MHz bandwidth) | dB | -2.9 | -2.9 | -2.9 | -2.9 | -6.8 | -12.8 |
| N_{oc} | dBm/15 kHz | -98 | | | -98 | | |
| Propagation condition | | ETU 70 Hz | | | ETU 70 Hz | | |
| Time offset to cell1 | μ s | - | | | 33 | | |
| <p>Note 1: OCNG shall be used such that the resources in cell 1 and cell 2 are fully allocated and a constant total transmitted power spectral density is achieved for all OFDM symbols.</p> <p>Note 2: The uplink resources for CQI reporting are assigned to the UE prior to the start of time period T1.</p> <p>Note 3: The timers and layer 3 filtering related parameters are configured prior to the start of time period T1.</p> <p>Note 4: The signal contains PDCCH for UEs other than the device under test as part of OCNG.</p> <p>Note 5: SNR levels correspond to the signal to noise ratio over the cell-specific reference signal REs.</p> <p>Note 6: The SNR in time periods T1, T2, and T3 are denoted as SNR1, SNR2 and SNR3 respectively in figure A.7.3.38.1-1.</p> <p>Note 7: The SNR values are specified for testing a UE which supports 2RX on the PSCell frequency. For testing of a UE which only supports 4RX on the PSCell frequency, the SNR during T3 is modified as specified in section A.3.8.1.</p> | | | | | | | |

Table A.7.3.38.1-3: DRX-Configuration for E-UTRAN FDD out-of-sync tests in synchronous dual connectivity

| Field | Value | | Comment |
|--------------------------|---------|---------|---|
| | Cell 1 | Cell 2 | |
| onDurationTimer | psf2 | psf2 | As specified in clause 6.3.2 in TS 36.331 |
| drx-InactivityTimer | psf1 | psf1 | |
| drx-RetransmissionTimer | psf1 | psf1 | |
| longDRX-CycleStartOffset | Sf640 | Sf40 | |
| shortDRX | disable | disable | |

Table A.7.3.38.1-4: TimeAlignmentTimer -Configuration for E-UTRAN FDD out-of-sync testing in synchronous dual connectivity

| Field | Value | Comment |
|--------------------|----------|--|
| TimeAlignmentTimer | infinity | As specified in clause 6.3.2 in TS 36.331 |
| sr-ConfigIndex | 0 | For further information see clause 6.3.2 in TS 36.331 and section 10.1 in TS 36.213. |

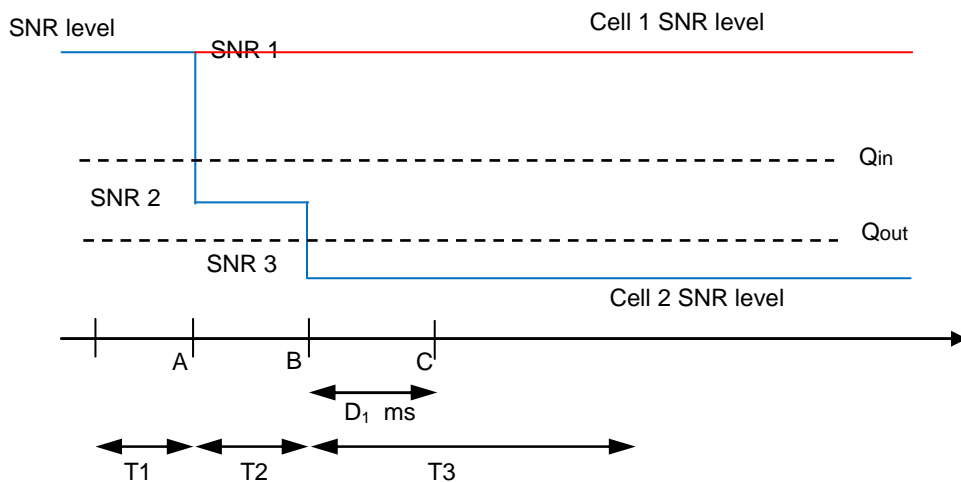

Figure A.7.3.38.1-1 SNR variation for out-of-sync testing in DRX

A.7.3.38.2 Test Requirements

The UE behaviour during time durations T1, T2, and T3 shall be as follows:

During time durations T1, T2 and T3, the UE shall transmit uplink signal at least in all subframes configured for CQI transmission on Cell1.

During the period from time point A to time point B the UE shall transmit uplink signal at least once every DRX cycle, in the On-duration part of the cycle in the uplink subframe on Cell2.

The UE shall stop transmitting uplink signal no later than time point C (duration D1 = 900 ms after the start of time duration T3) on PSCell.

The rate of correct events observed during repeated tests shall be at least 90%.

A.7.3.39 E-UTRAN FDD-FDD DC Radio Link Monitoring Test for Out-of-sync in DRX in asynchronous DC

A.7.3.39.1 Test Purpose and Environment

The purpose of this test is to verify that the UE properly detects the out of sync and in sync for the purpose of monitoring downlink radio link quality of the PSCell when DRX is used in asynchronous dual connectivity. This test will partly verify the E-UTRAN FDD radio link monitoring requirements in section 7.6.

The test parameters are given in Tables A.7.3.39.1-1, A.7.3.39.1-2, A.7.3.39.1-3 and A.7.3.39.1-4. There are two cells in the test. Cell 1 is PCell in MCG and cell 2 is PSCell in SCG. Before the test starts the UE is connected to cell 1 on radio channel 1 and to cell 2 on radio channel 2. The test consists of three successive time periods, with time duration of T1, T2 and T3 respectively. The downlink SNR in cell 1 keeps constant in the test. Figure A.7.3.39.1-1 shows the variation of the downlink SNR in the cell 2 to emulate out-of-sync and in-sync states. Prior to the start of the time duration T1, the UE shall be fully synchronized to cell 1 and cell 2 in asynchronous dual connectivity. For both cells, the UE shall be configured for periodic CQI reporting in PUCCH 1-0 mode with a reporting periodicity of 2 ms. In the test, DRX configuration is enabled and DRX inactivity timer has already been expired, i.e. UE tries to decode PDCCH and to send periodic CQI during the period when On-duration timer is running. Time alignment timers shall be set to “infinity” so that UL timing alignment is maintained during the test.

Table A.7.3.39.1-1: General test parameters for E-UTRAN FDD out-of-sync in DRX

| Parameter | | Unit | Value | Comment |
|--|--------------------------------|------|---------------------------------|---|
| Active cells | | | Cell 1 and cell 2 | Cell 1 (PCell) is on E-UTRA RF channel number 1 and cell 2 (PSCell) is on E-UTRA RF channel number 2 |
| CP length | | | Normal | |
| Correlation Matrix and Antenna Configuration | | | 2x2 Low | Correlation Matrix and Antenna Configuration are defined in TS 36.101 [5] Annex B.2.3.2 |
| Out of sync transmission parameters (Note 1) | DCI format | | 1A | As defined in section 5.3.3.1.3 in TS 36.212 |
| | Number of Control OFDM symbols | | 5MHz: 3 10MHz: 2 20MHz: 2 | Out of sync threshold Q_{out} and the corresponding hypothetical PDCCH/PCFICH transmission parameters are as specified in section 7.6.1 and Table 7.6.1-1 respectively. |
| | Aggregation level | CCE | 8 | |
| | ρ_A, ρ_B | | -3 | |
| | Ratio of PDCCH to RS EPRE | dB | 1 | |
| | Ratio of PCFICH to RS EPRE | dB | 1 | |
| DRX cycle in cell 1 | | ms | 640 | See Table A.7.3.39.1-3 |
| DRX cycle in cell 2 | | ms | 40 | See Table A.7.3.39.1-3 |
| Layer 3 filtering | | | Enabled | <i>Counters:</i> $N_{310} = 1; N_{311} = 1;$ $N_{313} = 1; N_{314} = 1;$ |
| T310 timer | | ms | 0 | T310 is disabled |
| T311 timer | | ms | 1000 | T311 is enabled |
| T313 timer | | ms | 0 | T313 is disabled |
| Periodic CQI reporting mode | | | PUCCH 1-0 | As defined in table 7.2.2-1 in TS |

| | | | |
|--|----|-----|-----------------------------------|
| | | | 36.213. |
| CQI reporting periodicity | ms | 2 | Minimum CQI reporting periodicity |
| T1 | s | 4 | |
| T2 | s | 1.6 | |
| T3 | s | 1.8 | |
| <p>Note 1: PDCCH/PCFICH corresponding to the out of sync transmission parameters need not be included in the Reference Measurement Channel.</p> <p>Note 2: The test parameters in the table apply to both cell 1 and cell 2 unless specified otherwise.</p> <p>Note 3: Even a UE capable of both synchronous and asynchronous DC operations is required to pass this test case in accordance with the principle defined in section A.3.6.11.</p> | | | |

Table A.7.3.39.1-2: Cell specific test parameters for E-UTRAN FDD for out-of-sync radio link monitoring in DRX

| Parameter | Unit | Cell 1 (PCell) | | | Cell 2 (PSCell) | | | |
|--|----------------------|--|------|------|--|------|------|-------|
| | | T1 | T2 | T3 | T1 | T2 | T3 | |
| E-UTRA RF Channel Number | | 1 | | | 2 | | | |
| E-UTRA Channel Bandwidth ($BW_{channel}$) | MHz | 5, 10, 20 | | | 5, 10, 20 | | | |
| PCFICH/PDCCH/PHICH parameters. None of the PDCCH are intended for the UE under test. | | 5MHz: R.12 FDD 10MHz: R.7 FDD 20MHz: R.13 FDD | | | 5MHz: R.12 FDD 10MHz: R.7 FDD 20MHz: R.13 FDD | | | |
| Correlation Matrix and Antenna Configuration | | 2x2 Low | | | 2x2 Low | | | |
| OCNG Pattern defined in A.3.2.1 (FDD) | | 5MHz: OP.16 FDD 10MHz: OP.2 FDD 20MHz: OP.12 FDD | | | 5MHz: OP.16 FDD 10MHz: OP.2 FDD 20MHz: OP.12 FDD | | | |
| ρ_A, ρ_B | | -3 | | | -3 | | | |
| PCFICH_RB | dB | 1 | | | 1 | | | |
| PDCCH_RA | dB | 1 | | | 1 | | | |
| PDCCH_RB | dB | 1 | | | 1 | | | |
| PBCH_RA | dB | -3 | | | -3 | | | |
| PBCH_RB | dB | | | | | | | |
| PSS_RA | dB | | | | | | | |
| SSS_RA | dB | | | | | | | |
| PHICH_RA | dB | | | | | | | |
| PHICH_RB | dB | | | | | | | |
| PDSCH_RA | dB | | | | | | | |
| PDSCH_RB | dB | | | | | | | |
| OCNG_RA ^{Note1} | dB | | | | | | | |
| OCNG_RB ^{Note1} | dB | | | | | | | |
| SNR ^{Note 6,8} | 5MHz $BW_{channel}$ | dB | -2.3 | -2.3 | -2.3 | -2.3 | -5.7 | -12.2 |
| | 10MHz $BW_{channel}$ | dB | -2.3 | -2.3 | -2.3 | -2.3 | -6.2 | -12.2 |
| | 20MHz $BW_{channel}$ | dB | -2.9 | -2.9 | -2.9 | -2.9 | -6.8 | -12.8 |
| N_{oc} | dBm/15 kHz | -98 | | | -98 | | | |
| Propagation condition | | ETU 70 Hz | | | ETU 70 Hz | | | |
| Receive time offset to cell1 ^{Note 7} | μ s | - | | | 500 | | | |

- Note 1: OCNG shall be used such that the resources in Cell 1 and Cell 2 are fully allocated and a constant total transmitted power spectral density is achieved for all OFDM symbols.
- Note 2: The uplink resources for CQI reporting are assigned to the UE prior to the start of time period T1.
- Note 3: The timers and layer 3 filtering related parameters are configured prior to the start of time period T1.
- Note 4: The signal contains PDCCH for UEs other than the device under test as part of OCNG.
- Note 5: SNR levels correspond to the signal to noise ratio over the cell-specific reference REs.
- Note 6: The SNR in time periods T1, T2 and T3 is denoted as SNR1, SNR2 and SNR3 respectively in figure A.7.3.39.1-1.
- Note 7: Receive time difference between subframe boundaries of signals received from the two cells at the UE antenna connector including time alignment error between the two cells.
- Note 8: The SNR values are specified for testing a UE which supports 2RX on the PSCell frequency. For testing of a UE which only supports 4RX on the PSCell frequency, the SNR during T3 is modified as specified in section A.3.8.1.

Table A.7.3.39.1-3: DRX-Configuration for E-UTRAN FDD out-of-sync tests

| Field | Value | | Comment |
|--------------------------|---------|---------|---|
| | Cell 1 | Cell 2 | |
| onDurationTimer | psf2 | psf2 | As specified in section 6.3.2 in 3GPP TS 36.331 |
| drx-InactivityTimer | psf1 | psf1 | |
| drx-RetransmissionTimer | psf1 | psf1 | |
| longDRX-CycleStartOffset | sf640 | sf40 | |
| shortDRX | disable | disable | |

Table A.7.3.39.1-4: TimeAlignmentTimer -Configuration for E-UTRAN FDD out-of-sync testing

| Field | Value | Comment |
|--------------------|----------|---|
| TimeAlignmentTimer | infinity | As specified in section 6.3.2 in 3GPP TS 36.331 |
| sr-ConfigIndex | 0 | For further information see section 6.3.2 in 3GPP TS 36.331 and section 10.1 in 3GPP TS 36.213. |

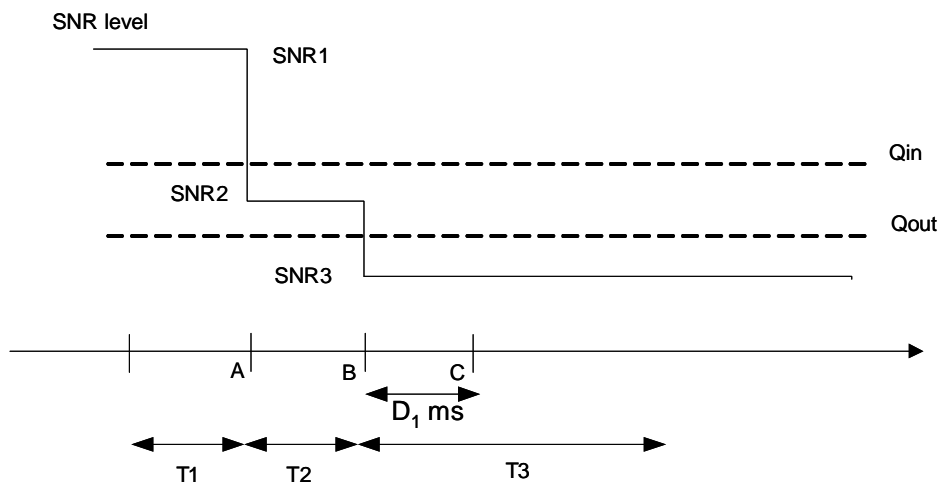

Figure A.7.3.39.1-1 SNR variation for out-of-sync test in DRX

A.7.3.39.2 Test Requirements

The UE behaviour in each test during time durations T1, T2 and T3 shall be as follows:

In the test, during time durations T1, T2 and T3, the UE shall transmit uplink signal on cell 1 at least once every DRX cycle, in the On-duration part of the cycle in the subframe according to the configured CQI reporting mode (PUCCH 1-0).

In the test, during the period from time point A to time point B the UE shall transmit uplink signal on cell 2 at least once every DRX cycle, in the On-duration part of the cycle in the subframe according to the configured CQI reporting mode (PUCCH 1-0).

In the test, the UE shall stop transmitting uplink signal on cell 2 no later than time point C (duration $D_1 = 900$ ms after the start of time duration T3).

The rate of correct events observed during repeated tests shall be at least 90%.

A.7.3.40 E-UTRAN TDD-TDD DC Radio Link Monitoring Test for Out-of-sync in DRX in synchronous DC

A.7.3.40.1 Test Purpose and Environment

The purpose of this test is to verify that the UE properly detects the out of sync for the purpose of monitoring downlink radio link quality of the PSCell when DRX is used. This test will partly verify the E-UTRAN TDD radio link monitoring requirements in clause 7.6.

The test parameters are given in Tables A.7.3.40.1-1, A.7.3.40.1-2, A.7.3.40.1-3, and A.7.3.40.1-4. There are two cells, cell 1 is PCell and cell 2 is PSCell, in the test. The test consists of three successive time periods with time duration of T1, T2 and T3 respectively. Figure A.7.3.40.1-1 shows the variation of the downlink SNR in the PCell and PSCell to emulate out-of-sync and in-sync states. Prior to the start of the time duration T1, the UE shall be fully synchronized to cell 1 and cell 2. The UE shall be configured for periodic CQI reporting in PUCCH 1-0 mode with a reporting periodicity of 1 ms. In the test, DRX configuration is enabled and DRX inactivity timer has already been expired, i.e. UE tries to decode PDCCH and to send periodic CQI during the period when On-duration timer is running. Time alignment timers shall be set to “infinity” so that UL timing alignment is maintained during the test.

Table A.7.3.40.1-1: General test parameters for E-UTRAN TDD out-of-sync tests in DRX in synchronous dual connectivity

| Parameter | | Unit | Value | Comment |
|--|--------------------------------|---------|---------------------------------|--|
| Active cell | | | Cell 1 Cell 2 | Cell 1 is PCell on E-UTRA RF channel number 1, and cell 2 is PSCell on E-UTRA RF channel number 2 |
| CP length | | | Normal | |
| E-UTRA RF Channel Number | | | 1, 2 | Two E-UTRA TDD carrier frequencies are used. |
| E-UTRA Channel Bandwidth (BWchannel) | | MHz | 5, 10, 20 | |
| Correlation Matrix and Antenna Configuration | | | 2x2 Low | Correlation Matrix and Antenna Configuration are defined in TS 36.101 [5] Annex B.2.3.2 |
| Out of sync transmission parameters (Note 1) | DCI format | | 1A | As defined in clause 5.3.3.1.3 in TS 36.212 |
| | Number of Control OFDM symbols | | 5MHz: 3 10MHz: 2 20MHz: 2 | Out of sync threshold Q_{out} and the corresponding hypothetical PDCCH/PCFICH transmission parameters are as specified in clause 7.6.1 and Table 7.6.1-1 respectively. |
| | Aggregation level | CCE | 8 | |
| | ρ_A, ρ_B | | -3 | |
| | Ratio of PDCCH to RS EPRE | dB | 1 | |
| Ratio of PCFICH to RS EPRE | dB | 1 | | |
| DRX cycle on cell 1 | | ms | 640 | See Table A.7.3.40.1-3 |
| DRX cycle on cell 2 | | ms | 40 | See Table A.7.3.40.1-3 |
| Timing offset between cell 1 and cell 2 | | μ s | 33 | For synchronous dual connectivity |
| Layer 3 filtering | | | Enabled | Counters: N310 = 1; N311 = 1; N313 = 1; N314 = 1 |
| T310 timer | | ms | 0 | T310 is disabled |
| T311 timer | | ms | 1000 | T311 is enabled |
| T313 timer | | ms | 0 | T313 is disabled |

| | | | |
|--|----|-----------|---|
| Periodic CQI reporting mode | | PUCCH 1-0 | As defined in table 7.2.2-1 in TS 36.213. |
| CQI reporting periodicity | ms | 1 | Minimum CQI reporting periodicity |
| T1 | s | 4 | |
| T2 | s | 1.6 | |
| T3 | s | 1.8 | |
| Note 1: PDCCH/PCFICH corresponding to the out of sync transmission parameters need not be included in the Reference Measurement Channel. | | | |

Table A.7.3.40.1-2: Cell specific test parameters for E-UTRAN TDD out-of-sync radio link monitoring in DRX in synchronous dual connectivity

| Parameter | Unit | Cell 1 | | | Cell 2 | | |
|---|------------|---|------|------|---|------|-------|
| | | T1 | T2 | T3 | T1 | T2 | T3 |
| E-UTRA RF Channel Number | | 1 | | | 2 | | |
| BW _{channel} | MHz | 5, 10, 20 | | | 5, 10, 20 | | |
| Correlation Matrix and Antenna Configuration | | 2x2 Low | | | 2x2 Low | | |
| Special subframe configuration ^{Note1} | | 6 | | | 6 | | |
| Uplink-downlink configuration ^{Note2} | | 1 | | | 1 | | |
| PCFICH/PDCCH/PHICH parameters None of the PDCCH are intended for the UE under test | | 5MHz: R.12 TDD 10MHz: R.7 TDD 20MHz: R.13 TDD | | | 5MHz: R.12 TDD 10MHz: R.7 TDD 20MHz: R.13 TDD | | |
| OCNG Pattern | | 5MHz: OP.10 TDD 10MHz: OP.2 TDD 20MHz: OP.8 TDD | | | 5MHz: OP.10 TDD 10MHz: OP.2 TDD 20MHz: OP.8 TDD | | |
| ρ_A, ρ_B | | -3 | | | -3 | | |
| PCFICH_RB | dB | 1 | | | 1 | | |
| PDCCH_RA | dB | 1 | | | 1 | | |
| PDCCH_RB | dB | 1 | | | 1 | | |
| PBCH_RA | dB | -3 | | | -3 | | |
| PBCH_RB | dB | | | | | | |
| PSS_RA | dB | | | | | | |
| SSS_RA | dB | | | | | | |
| PHICH_RA | dB | | | | | | |
| PHICH_RB | dB | | | | | | |
| PDSCH_RA | dB | | | | | | |
| PDSCH_RB | dB | | | | | | |
| OCNG_RA ^{Note3} | dB | | | | | | |
| OCNG_RB ^{Note3} | dB | | | | | | |
| SNR ^{Note 8,9} (5MHz bandwidth) | dB | -1.6 | -1.6 | -1.6 | -1.6 | -5.2 | -11.9 |
| SNR ^{Note 8,9} (10MHz bandwidth) | dB | -2.3 | -2.3 | -2.3 | -2.3 | -5.9 | -11.9 |
| SNR ^{Note 8,9} (20MHz bandwidth) | dB | -3.0 | -3.0 | -3.0 | -3.0 | -6.6 | -12.6 |
| N_{oc} | dBm/15 kHz | -98 | | | -98 | | |
| Propagation condition | | ETU 70 Hz | | | ETU 70 Hz | | |
| Time offset to cell1 | μ s | - | | | 33 | | |

- Note 1: For the special subframe configuration see table 4.2-1 in TS 36.211.
- Note 2: For the uplink-downlink configuration see table 4.2-2 in TS 36.211.
- Note 3: OCNB shall be used such that the resources in cell # 1 are fully allocated and a constant total transmitted power spectral density is achieved for all OFDM symbols.
- Note 4: The uplink resources for CQI reporting are assigned to the UE prior to the start of time period T1.
- Note 5: The timers and layer 3 filtering related parameters are configured prior to the start of time period T1.
- Note 6: The signal contains PDCCH for UEs other than the device under test as part of OCNB.
- Note 7: SNR levels correspond to the signal to noise ratio over the cell-specific reference signal REs.
- Note 8: The SNR in time periods T1, T2 and T3 is denoted as SNR1, SNR2 and SNR3 respectively in figure A.7.3.40.1-1.
- Note 9: The SNR values are specified for testing a UE which supports 2RX on the PSCell frequency. For testing of a UE which only supports 4RX on the PSCell frequency, the SNR during T3 is modified as specified in section A.3.8.1.

Table A.7.3.40.1-3: DRX-Configuration for E-UTRAN TDD out-of-sync tests in synchronous dual connectivity

| Field | Value | | Comment |
|--------------------------|---------|---------|---|
| | Cell 1 | Cell 2 | |
| onDurationTimer | psf2 | psf2 | As specified in clause 6.3.2 in TS 36.331 |
| drx-InactivityTimer | psf1 | psf1 | |
| drx-RetransmissionTimer | psf1 | psf1 | |
| longDRX-CycleStartOffset | Sf640 | Sf40 | |
| shortDRX | disable | disable | |

Table A.7.3.40.1-4: TimeAlignmentTimer -Configuration for E-UTRAN FDD out-of-sync testing in synchronous dual connectivity

| Field | Value | Comment |
|--------------------|----------|--|
| TimeAlignmentTimer | infinity | As specified in clause 6.3.2 in TS 36.331 |
| sr-ConfigIndex | 0 | For further information see clause 6.3.2 in TS 36.331 and section 10.1 in TS 36.213. |

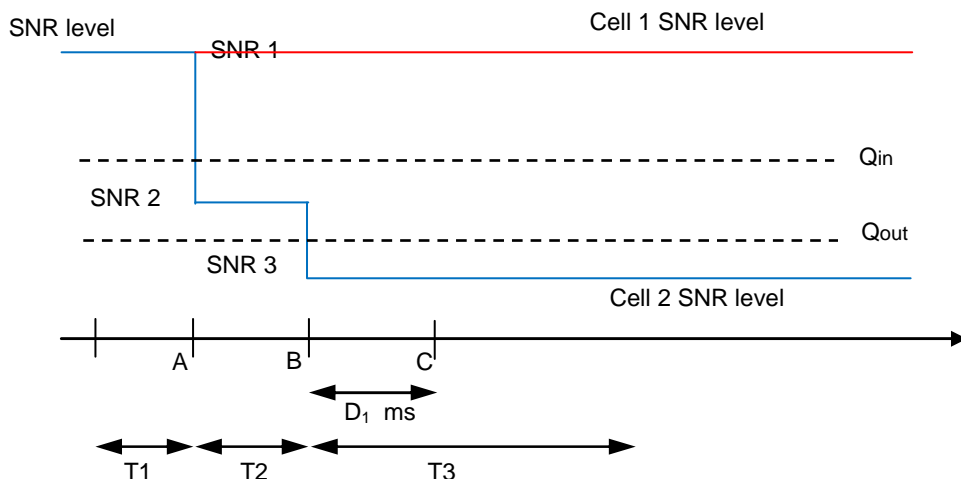

Figure A.7.3.40.1-1 SNR variation for out-of-sync testing in DRX

A.7.3.40.2 Test Requirements

The UE behaviour during time durations T1, T2, and T3 shall be as follows:

During time durations T1, T2 and T3, the UE shall transmit uplink signal at least in all subframes configured for CQI transmission on Cell1.

During the period from time point A to time point B the UE shall transmit uplink signal at least once every DRX cycle, in the On-duration part of the cycle in the uplink subframe on Cell2.

The UE shall stop transmitting uplink signal no later than time point C (duration D1 = 900 ms after the start of time duration T3) on PSCell.

The rate of correct events observed during repeated tests shall be at least 90%.

A.7.3.41 E-UTRAN FDD-FDD Radio Link Monitoring Test for In-sync in DRX in synchronous dual connectivity

A.7.3.41.1 Test Purpose and Environment

The purpose of this test is to verify that the UE properly detects the out of sync and in sync for the purpose of monitoring downlink radio link quality of the PSCell when DRX is used in dual connectivity. This test will partly verify the E-UTRAN FDD radio link monitoring requirements in clause 7.6.

The test parameters are given in Tables A.7.3.41.1-1, A.7.3.41.1-2, A.7.3.41.1-3 and A.7.3.41.1-4. There are two cells, cell 1 is PCell and cell 2 is PSCell, in the test. The test consists of five successive time periods, with time duration of T1, T2, T3, T4 and T5 respectively. Figure A.7.3.41.1-1 shows the variation of the downlink SNR in the PSCell to emulate out-of-sync and in-sync states. Prior to the start of the time duration T1, the UE shall be fully synchronized to cell 1 and cell 2. The UE shall be configured for periodic CQI reporting in PUCCH 1-0 mode with a reporting periodicity of 2 ms. In the test, DRX configuration for PCell and PSCell is enabled and DRX inactivity timer has already been expired, i.e. UE tries to decode PDCCH and to send periodic CQI during the period when On-duration timer is running. Time alignment timers shall be set to “infinity” so that UL timing alignment is maintained during the test.

Table A.7.3.41.1-1: General test parameters for E-UTRAN FDD-FDD Radio Link Monitoring Test for In-sync in DRX in synchronous dual connectivity

| Parameter | | Unit | Value | Comment |
|--|--------------------------------|------|----------------|--|
| E-UTRA RF Channel Number | | | 1, 2 | Two E-UTRA FDD carrier frequency are used. |
| Active cell | | | Cell 1, Cell 2 | Cell 1 is PCell on E-UTRA RF channel number 1, and cell 2 is PSCell on E-UTRA RF channel number 2 |
| CP length | | | Normal | |
| In sync transmission parameters (Note 1) | DCI format | | 1C | As defined in clause 5.3.3.1.4 in TS 36.212 |
| | Number of Control OFDM symbols | | 2 | For 10MHz and 20MHz channel BW |
| | Number of Control OFDM symbols | | 3 | For 5MHz channel BW |
| | Aggregation level | CCE | 4 | In sync threshold Q_{in} and the corresponding hypothetical PDCCH/PCFICH transmission parameters are as specified in clause 7.6.1 and Table 7.6.1-2 respectively. |
| | ρ_A, ρ_B | | 0 | |
| | Ratio of PDCCH to RS EPRE | | 0 | |
| Ratio of PCFICH to RS EPRE | | 4 | | |
| Out of sync transmission parameters (Note 1) | DCI format | | 1A | As defined in clause 5.3.3.1.3 in TS 36.212 |
| | Number of Control OFDM symbols | | 2 | For 10MHz and 20MHz channel BW |
| | Number of Control OFDM symbols | | 3 | For 5MHz channel BW |
| | Aggregation level | CCE | 8 | Out of sync threshold Q_{out} and the corresponding hypothetical PDCCH/PCFICH transmission parameters are as specified in clause 7.6.1 and Table 7.6.1-1 respectively. |
| | ρ_A, ρ_B | | 0 | |
| | Ratio of PDCCH to RS EPRE | dB | 4 | |
| Ratio of PCFICH to RS EPRE | dB | 4 | | |

| | | | |
|---|----|-----------|---|
| DRX cycle on Cell 1 | ms | 640 | See Table A.7.3.41.1-3 |
| DRX cycle on Cell 2 | ms | 40 | See Table A.7.3.41.1-3 |
| Layer 3 filtering | | Enabled | Counters: N310 = 1; N311 = 1, N313 = 1, N314 = 1 |
| T310 timer | ms | 2000 | T310 is enabled |
| T311 timer | ms | 1000 | T311 is enabled |
| T313 timer | ms | 2000 | T313 is enabled |
| Periodic CQI reporting mode | | PUCCH 1-0 | As defined in table 7.2.2-1 in TS 36.213. |
| CQI reporting periodicity | ms | 2 | Minimum CQI reporting periodicity |
| T1 | s | 4 | |
| T2 | s | 1.6 | |
| T3 | s | 1.46 | |
| T4 | s | 0.4 | |
| T5 | s | 4 | |
| Note 1: PDCCH/PCFICH corresponding to the in-sync and out of sync transmission parameters need not be included in the Reference Measurement Channel. | | | |
| Note 2: Even a UE capable of both synchronous and asynchronous DC operations is required to pass this test case in accordance with the principle defined in section A.3.11. | | | |

Table A.7.3.41.1-2: Cell specific test parameters for E-UTRAN FDD-FDD Radio Link Monitoring Test for In-sync in DRX in synchronous dual connectivity

| Parameter | Unit | Cell 1(PCell) | Cell 2 (PSCell) | | | | |
|--|-----------------------------|--|--|------|-------|------|------|
| | | T1 ~ T5 | T1 | T2 | T3 | T4 | T5 |
| E-UTRA RF Channel Number | | 1 | 2 | | | | |
| BW _{channel} | MHz | 5: N _{RB,c} = 25 10: N _{RB,c} = 50 20: N _{RB,c} = 100 | 5: N _{RB,c} = 25 10: N _{RB,c} = 50 20: N _{RB,c} = 100 | | | | |
| PCFICH/PDCCH/PHICH parameters defined in A.3.1.2.1 | | 5MHz: R.11 FDD 10MHz: R.6 FDD 20MHz: R.10 FDD | 5MHz: R.11 FDD 10MHz: R.6 FDD 20MHz: R.10 FDD | | | | |
| OCNG Pattern defined in A.3.2.1 (FDD) | | 5MHz: OP.16 FDD 10MHz: OP.2 FDD 20MHz: OP.12 FDD | 5MHz: OP.16 FDD 10MHz: OP.2 FDD 20MHz: OP.12 FDD | | | | |
| ρ _A , ρ _B | | 0 | 0 | | | | |
| PCFICH_RB | dB | 4 | 4 | | | | |
| PDCCH_RA | dB | 0 | 0 | | | | |
| PDCCH_RB | dB | 0 | 0 | | | | |
| PBCH_RA | dB | 0 | 0 | | | | |
| PBCH_RB | dB | | | | | | |
| PSS_RA | dB | | | | | | |
| SSS_RA | dB | | | | | | |
| PHICH_RA | dB | | | | | | |
| PHICH_RB | dB | | | | | | |
| PDSCH_RA | dB | | | | | | |
| PDSCH_RB | dB | | | | | | |
| OCNG_RA ^{Note1} | dB | | | | | | |
| OCNG_RB ^{Note1} | dB | | | | | | |
| SNR ^{Note 6,8} | 5MHz BW _{channel} | -2.3 | -2.3 | -5.7 | -12.2 | -7.3 | -2.3 |
| | 10MHz BW _{channel} | -4.7 | -4.7 | -9.5 | -13.5 | -8.7 | -4.7 |
| | 20MHz BW _{channel} | -4.7 | -4.7 | -9.5 | -13.5 | -8.7 | -4.7 |
| N _{oc} | dBm/15 kHz | -98 | | | | | |
| Propagation condition | | AWGN | AWGN | | | | |
| Correlation Matrix and Antenna Configuration | | 1x2 | 1x2 | | | | |
| Receive time offset to cell1 ^{Note 7} | μs | - | 33 | | | | |

- Note 1: OCNG shall be used such that the resources in cell 1 and cell 2 are fully allocated and a constant total transmitted power spectral density is achieved for all OFDM symbols.
- Note 2: The uplink resources for CQI reporting are assigned to the UE prior to the start of time period T1.
- Note 3: The timers and layer 3 filtering related parameters are configured prior to the start of time period T1.
- Note 4: The signal contains PDCCH for UEs other than the device under test as part of OCNG.
- Note 5: SNR levels correspond to the signal to noise ratio over the cell-specific reference signal REs.
- Note 6: The SNR of cell 2 in time periods T1, T2, T3, T4 and T5 is denoted as SNR1, SNR2, SNR3, SNR4 and SNR5 respectively in figure A.7.3.41.1-1.
- Note 7: Receive time difference between subframe boundaries of signals received from the two cells at the UE antenna connector including time alignment error between the two cells.
- Note 8: The SNR values are specified for testing a UE which supports 2RX on the PSCell frequency. For testing of a UE which only supports 4RX on the PSCell frequency, the SNR during T3 and T4 is modified as specified in section A.3.8.1.

Table A.7.3.41.1-3: DRX-Configuration for E-UTRAN FDD-FDD Radio Link Monitoring Test for In-sync in DRX in synchronous dual connectivity

| Field | Value | | Comment |
|--------------------------|---------|---------|---|
| | Cell 1 | Cell 2 | |
| onDurationTimer | psf2 | psf2 | As specified in section 6.3.2 in 3GPP TS 36.331 |
| drx-InactivityTimer | psf1 | psf1 | |
| drx-RetransmissionTimer | psf1 | psf1 | |
| longDRX-CycleStartOffset | sf640 | sf40 | |
| shortDRX | disable | disable | |

Table A.7.3.41.1-4: TimeAlignmentTimer -Configuration for E-UTRAN FDD-FDD Radio Link Monitoring Test for In-sync in DRX in synchronous dual connectivity

| Field | Value | Comment |
|--------------------|----------|--|
| TimeAlignmentTimer | infinity | As specified in clause 6.3.2 in TS 36.331 |
| sr-ConfigIndex | 0 | For further information see clause 6.3.2 in TS 36.331 and section 10.1 in TS 36.213. |

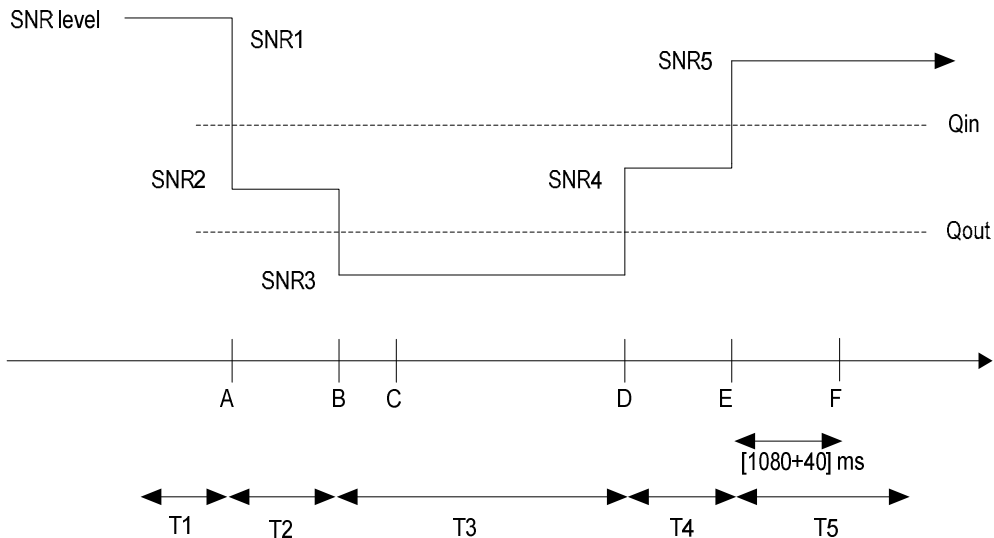

Figure A.7.3.41.1-1 SNR variation of cell 2 (PSCell) for in-sync testing in DRX

A.7.3.41.2 Test Requirements

The UE behaviour during time durations T1, T2, T3, T4 and T5 shall be as follows:

During the period from time point A to time point F (1120 ms after the start of time duration T5) the UE shall transmit uplink signal at least once every DRX cycle, in the On-duration part of the cycle in the subframe according to the configured CQI reporting mode (PUCCH 1-0) on PCell and PSCell.

The rate of correct events observed during repeated tests shall be at least 90%.

A.7.3.42 E-UTRAN FDD-FDD DC Radio Link Monitoring Test for In-sync in DRX in asynchronous DC

A.7.3.42.1 Test Purpose and Environment

The purpose of this test is to verify that the UE properly detects the out of sync and in sync for the purpose of monitoring downlink radio link quality of the PSCell when DRX is used in asynchronous dual connectivity. This test will partly verify the E-UTRAN FDD radio link monitoring requirements in clause 7.6.

The test parameters are given in Tables A.7.3.42.1-1, A.7.3.42.1-2, A.7.3.42.1-3 and A.7.3.42.1-4. There are two cells in the test. Cell 1 is PCell in MCG and cell 2 is PSCell in SCG. Before the test starts the UE is connected to cell 1 on radio channel 1 and to cell 2 on radio channel 2. The test consists of five successive time periods, with time duration of T1, T2, T3, T4 and T5 respectively. The downlink SNR in cell 1 keeps constant in the test. Figure A.7.3.42.1-1 shows the variation of the downlink SNR in cell 2 to emulate out-of-sync and in-sync states. Prior to the start of the time duration T1, the UE shall be fully synchronized to cell 1 and cell 2 in asynchronous dual connectivity. For both cell 1 and cell 2, the UE shall be configured for periodic CQI reporting in PUCCH 1-0 mode with a reporting periodicity of 2 ms. In the test, DRX configuration is enabled and DRX inactivity timer has already been expired, i.e. UE tries to decode PDCCH and to send periodic CQI during the period when On-duration timer is running. Time alignment timers shall be set to “infinity” so that UL timing alignment is maintained during the test.

Table A.7.3.42.1-1: General test parameters for E-UTRAN FDD in-sync test in DRX

| Parameter | | Unit | Value | Comment |
|--|--------------------------------|------|---------------------------------|--|
| Active cells | | | Cell 1 and cell 2 | Cell 1 (PCell) is on E-UTRA RF channel number 1 and cell 2 (PSCell) is on E-UTRA RF channel number 2 |
| CP length | | | Normal | |
| Antenna Configuration | | | 1x2 | |
| In sync transmission parameters (Note 1) | DCI format | | 1C | As defined in clause 5.3.3.1.4 in TS 36.212 |
| | Number of Control OFDM symbols | | 5MHz: 3 10MHz: 2 20MHz: 2 | In sync threshold Q_{in} and the corresponding hypothetical PDCCH/PCFICH transmission parameters are as specified in clause and Table 7.6.1-2 respectively. |
| | Aggregation level | CCE | 4 | |
| | ρ_A, ρ_B | | 0 | |
| | Ratio of PDCCH to RS EPRE | | 0 | |
| | Ratio of PCFICH to RS EPRE | | 4 | |
| Out of sync transmission parameters (Note 1) | DCI format | | 1A | As defined in clause 5.3.3.1.3 in TS 36.212 |
| | Number of Control OFDM symbols | | 2 | Out of sync threshold Q_{out} and the corresponding hypothetical PDCCH/PCFICH transmission parameters are as specified in clause 7.6.1 and Table 7.6.1-1 respectively. |
| | Aggregation level | CCE | 8 | |
| | ρ_A, ρ_B | | 0 | |
| | Ratio of PDCCH to RS EPRE | dB | 4 | |
| | Ratio of PCFICH to RS EPRE | dB | 4 | |
| DRX cycle in cell 1 | | ms | 640 | See Table A.7.3.42.1-3 |
| DRX cycle in cell 2 | | ms | 40 | See Table A.7.3.42.1-3 |
| Layer 3 filtering | | | <i>Enabled</i> | <i>Counters:</i> $N_{310} = 1; N_{311} = 1;$ $N_{313} = 1; N_{314} = 1$ |
| T310 timer | | ms | 2000 | <i>T310 is enabled</i> |
| T311 timer | | ms | 1000 | T311 is enabled |

| | | | |
|---|----|-----------|---|
| T313 timer | ms | 2000 | T313 is enabled |
| Periodic CQI reporting mode | | PUCCH 1-0 | As defined in table 7.2.2-1 in TS 36.213. |
| CQI reporting periodicity | ms | 2 | Minimum CQI reporting periodicity |
| T1 | s | 4 | |
| T2 | s | 1.6 | |
| T3 | s | 1.46 | |
| T4 | s | 0.4 | |
| T5 | s | 4 | |
| <p>Note 1: PDCCH/PCFICH corresponding to the in-sync and out of sync transmission parameters need not be included in the Reference Measurement Channel.</p> <p>Note 2: The parameters in the table apply to both cell 1 and cell 2 unless defined otherwise.</p> <p>Note 3: Even a UE capable of both synchronous and asynchronous DC operations is required to pass this test case in accordance with the principle defined in section A.3.6.11.</p> | | | |

Table A.7.3.42.1-2: Cell specific test parameters for E-UTRAN FDD for in-sync radio link monitoring in DRX

| Parameter | Unit | Cell 1 (PCell) | Cell 2 (PSCell) | | | | | | | | | | |
|--|-----------------------------|--|--|------|-------|------|------|------|------|------|-------|------|------|
| | | T1 ~ T5 | T1 | T2 | T3 | T4 | T5 | | | | | | |
| E-UTRA RF Channel Number | | 1 | 2 | | | | | | | | | | |
| E-UTRA Channel Bandwidth (BW _{channel}) | MHz | 5, 10, 20 | 5, 10, 20 | | | | | | | | | | |
| PCFICH/PDCCH/PHICH parameters. None of the PDCCH are intended for the UE under test. | | 5MHz: R.11 FDD 10MHz: R.6 FDD 20MHz: R.10 FDD | 5MHz: R.11 FDD 10MHz: R.6 FDD 20MHz: R.10 FDD | | | | | | | | | | |
| OCNG Pattern | | 5MHz: OP.16 FDD 10MHz: OP.2 FDD 20MHz: OP.12 FDD | 5MHz: OP.16 FDD 10MHz: OP.2 FDD 20MHz: OP.12 FDD | | | | | | | | | | |
| ρ _A , ρ _B | | 0 | 0 | | | | | | | | | | |
| PCFICH_RB | dB | 4 | 4 | | | | | | | | | | |
| PDCCH_RA | dB | 0 | 0 | | | | | | | | | | |
| PDCCH_RB | dB | 0 | 0 | | | | | | | | | | |
| PBCH_RA | dB | 0 | 0 | | | | | | | | | | |
| PBCH_RB | dB | | | | | | | | | | | | |
| PSS_RA | dB | | | | | | | | | | | | |
| SSS_RA | dB | | | | | | | | | | | | |
| PHICH_RA | dB | | | | | | | | | | | | |
| PHICH_RB | dB | | | | | | | | | | | | |
| PDSCH_RA | dB | | | | | | | | | | | | |
| PDSCH_RB | dB | | | | | | | | | | | | |
| OCNG_RA ^{Note1} | dB | | | | | | | | | | | | |
| OCNG_RB ^{Note1} | dB | | | | | | | | | | | | |
| SNR ^{Note 6,8} | 5MHz BW _{channel} | | | | | | | -2.3 | -2.3 | -5.7 | -12.2 | -7.3 | -2.3 |
| | 10MHz BW _{channel} | | | | | | | -4.7 | -4.7 | -9.5 | -13.5 | -8.7 | -4.7 |
| | 20MHz BW _{channel} | -4.7 | -4.7 | -9.5 | -13.5 | -8.7 | -4.7 | | | | | | |
| N _{oc} | dBm/15 kHz | -98 | | | | | | | | | | | |
| Propagation condition | | AWGN | | | | | | | | | | | |
| Receive time offset to cell1 ^{Note 7} | μs | - | 500 | | | | | | | | | | |

- Note 1: OCNG shall be used such that the resources in cell 1 and cell 2 are fully allocated and a constant total transmitted power spectral density is achieved for all OFDM symbols.
- Note 2: The uplink resources for CQI reporting are assigned to the UE prior to the start of time period T1.
- Note 3: The timers and layer 3 filtering related parameters are configured prior to the start of time period T1.
- Note 4: The signal contains PDCCH for UEs other than the device under test as part of OCNG.
- Note 5: SNR levels correspond to the signal to noise ratio over the cell-specific reference signal REs.
- Note 6: The SNR of cell 2 in time periods T1, T2, T3, T4 and T5 is denoted as SNR1, SNR2, SNR3, SNR4 and SNR5 respectively in figure A.7.3.6.1-1.
- Note 7: Receive time difference between subframe boundaries of signals received from the two cells at the UE antenna connector including time alignment error between the two cells.
- Note 8: The SNR values are specified for testing a UE which supports 2RX on the PSCell frequency. For testing of a UE which only supports 4RX on the PSCell frequency, the SNR during T3 and T4 is modified as specified in section A.3.8.1.

Table A.7.3.42.1-3: DRX-Configuration for E-UTRAN FDD out-of-sync tests

| Field | Cell 1 | Cell 2 | Comment |
|--------------------------|---------|---------|---|
| onDurationTimer | psf2 | psf2 | As specified in clause 6.3.2 in TS 36.331 |
| drx-InactivityTimer | psf1 | psf1 | |
| drx-RetransmissionTimer | psf1 | psf1 | |
| longDRX-CycleStartOffset | sf640 | sf40 | |
| shortDRX | disable | disable | |

Table A.7.3.42.1-4: TimeAlignmentTimer -Configuration for E-UTRAN FDD out-of-sync testing

| Field | Value | Comment |
|--------------------|----------|--|
| TimeAlignmentTimer | infinity | As specified in clause 6.3.2 in TS 36.331 |
| sr-ConfigIndex | 0 | For further information see clause 6.3.2 in TS 36.331 and section 10.1 in TS 36.213. |

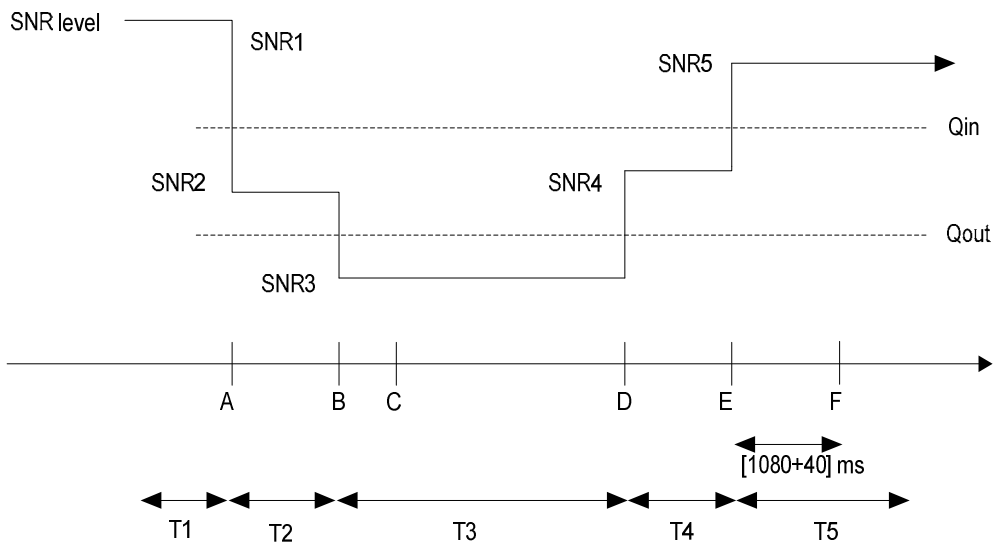

Figure A.7.3.42.1-1 Cell 2 SNR variation for in-sync testing in DRX

A.7.3.42.2 Test Requirements

The UE behaviour in each test during time durations T1, T2, T3, T4 and T5 shall be as follows:

During the period from time point A to time point F (1120 ms after the start of time duration T5) the UE shall transmit uplink signal on cell 2 at least once every DRX cycle, in the On-duration part of the cycle in the subframe according to the configured CQI reporting mode (PUCCH 1-0).

The rate of correct events observed during repeated tests shall be at least 90%.

A.7.3.43 E-UTRAN TDD-TDD Radio Link Monitoring Test for In-sync in DRX in synchronous dual connectivity

A.7.3.43.1 Test Purpose and Environment

The purpose of this test is to verify that the UE properly detects the out of sync and in sync for the purpose of monitoring downlink radio link quality of the PSCell when DRX is used in dual connectivity. This test will partly verify the E-UTRAN TDD radio link monitoring requirements in clause 7.6.

The test parameters are given in Tables A.7.3.43.1-1, A.7.3.43.1-2, A.7.3.43.1-3 and A.7.3.43.1-4. There are two cells, cell 1 is PCell and cell 2 is PSCell, in the test. The test consists of five successive time periods, with time duration of T1, T2, T3, T4 and T5 respectively. Figure A.7.3.43.1-1 shows the variation of the downlink SNR in the PSCell to emulate out-of-sync and in-sync states. Prior to the start of the time duration T1, the UE shall be fully synchronized to cell 1 and cell 2. The UE shall be configured for periodic CQI reporting in PUCCH 1-0 mode with a reporting periodicity of 1 ms. In the test, DRX configuration for PCell and PSCell is enabled and DRX inactivity timer has already been expired, i.e. UE tries to decode PDCCH and to send periodic CQI during the period when On-duration timer is running. Time alignment timers shall be set to “infinity” so that UL timing alignment is maintained during the test.

Table A.7.3.43.1-1: General test parameters for E-UTRAN TDD-TDD Radio Link Monitoring Test for In-sync in DRX in synchronous dual connectivity

| Parameter | | Unit | Value | Comment |
|--|--------------------------------|------|----------------|--|
| E-UTRA RF Channel Number | | | 1, 2 | Two E-UTRA TDD carrier frequency are used. |
| Active cell | | | Cell 1, Cell 2 | Cell 1 is PCell on E-UTRA RF channel number 1, and cell 2 is PSCell on E-UTRA RF channel number 2 |
| CP length | | | Normal | |
| In sync transmission parameters (Note 1) | DCI format | | 1C | As defined in clause 5.3.3.1.4 in TS 36.212 |
| | Number of Control OFDM symbols | | 2 | For 10MHz and 20MHz channel BW |
| | Number of Control OFDM symbols | | 3 | For 5MHz channel BW |
| | Aggregation level | CCE | 4 | In sync threshold Q_{in} and the corresponding hypothetical PDCCH/PCFICH transmission parameters are as specified in clause 7.6.1 and Table 7.6.1-2 respectively. |
| | ρ_A, ρ_B | | 0 | |
| | Ratio of PDCCH to RS EPRE | | 0 | |
| Ratio of PCFICH to RS EPRE | | 4 | | |
| Out of sync transmission parameters (Note 1) | DCI format | | 1A | As defined in clause 5.3.3.1.3 in TS 36.212 |
| | Number of Control OFDM symbols | | 2 | For 10MHz and 20MHz channel BW |
| | Number of Control OFDM symbols | | 3 | For 5MHz channel BW |
| | Aggregation level | CCE | 8 | Out of sync threshold Q_{out} and the corresponding hypothetical PDCCH/PCFICH transmission parameters are as specified in clause 7.6.1 and Table 7.6.1-1 respectively. |
| | ρ_A, ρ_B | | 0 | |
| | Ratio of PDCCH to RS EPRE | dB | 4 | |
| Ratio of PCFICH to RS EPRE | dB | 4 | | |
| DRX cycle on Cell 1 | | ms | 640 | See Table A.7.3.43.1-3 |
| DRX cycle on Cell 2 | | ms | 40 | See Table A.7.3.43.1-3 |
| Layer 3 filtering | | | Enabled | Counters: N310 = 1; N311 = 1, N313 = 1, N314 = 1 |
| T310 timer | | ms | 2000 | T310 is enabled |
| T311 timer | | ms | 1000 | T311 is enabled |

| | | | |
|---|----|-----------|---|
| T313 timer | ms | 2000 | T313 is enabled |
| Periodic CQI reporting mode | | PUCCH 1-0 | As defined in table 7.2.2-1 in TS 36.213. |
| CQI reporting periodicity | ms | 1 | Minimum CQI reporting periodicity |
| T1 | s | 4 | |
| T2 | s | 1.6 | |
| T3 | s | 1.46 | |
| T4 | s | 0.4 | |
| T5 | s | 4 | |
| Note 1: PDCCH/PCFICH corresponding to the in-sync and out of sync transmission parameters need not be included in the Reference Measurement Channel. | | | |
| Note 2: Even a UE capable of both synchronous and asynchronous DC operations is required to pass this test case in accordance with the principle defined in section A.3.11. | | | |

Table A.7.3.43.1-2: Cell specific test parameters for E-UTRAN TDD-TDD Radio Link Monitoring Test for In-sync in DRX in synchronous dual connectivity

| Parameter | Unit | Cell 1(PCell) | Cell 2 (PSCell) | | | | |
|--|-----------------------------|--|--|------|-------|------|------|
| | | T1 ~ T5 | T1 | T2 | T3 | T4 | T5 |
| E-UTRA RF Channel Number | | 1 | 2 | | | | |
| BW _{channel} | MHz | 5: N _{RB,c} = 25 10: N _{RB,c} = 50 20: N _{RB,c} = 100 | 5: N _{RB,c} = 25 10: N _{RB,c} = 50 20: N _{RB,c} = 100 | | | | |
| Special subframe configuration ^{Note1} | | 6 | 6 | | | | |
| Uplink-downlink configuration ^{Note2} | | 1 | 1 | | | | |
| PCFICH/PDCCH/PHICH parameters defined in A.3.1.2.1 | | 5MHz: R.11 TDD 10MHz: R.6 TDD 20MHz: R.10 TDD | 5MHz: R.11 TDD 10MHz: R.6 TDD 20MHz: R.10 TDD | | | | |
| OCNG Pattern defined in A.3.2.1 (FDD) | | 5MHz: OP.10 TDD 10MHz: OP.2 TDD 20MHz: OP.8 TDD | 5MHz: OP.10 TDD 10MHz: OP.2 TDD 20MHz: OP.8 TDD | | | | |
| ρ _A , ρ _B | | 0 | 0 | | | | |
| PCFICH_RB | dB | 4 | 4 | | | | |
| PDCCH_RA | dB | 0 | 0 | | | | |
| PDCCH_RB | dB | 0 | 0 | | | | |
| PBCH_RA | dB | 0 | 0 | | | | |
| PBCH_RB | dB | | | | | | |
| PSS_RA | dB | | | | | | |
| SSS_RA | dB | | | | | | |
| PHICH_RA | dB | | | | | | |
| PHICH_RB | dB | | | | | | |
| PDSCH_RA | dB | | | | | | |
| PDSCH_RB | dB | | | | | | |
| OCNG_RA ^{Note1} | dB | | | | | | |
| OCNG_RB ^{Note1} | dB | | | | | | |
| SNR ^{Note 6,10} | 5MHz BW _{channel} | -5.1 | -5.1 | -9.1 | -13.1 | -9.1 | -5.1 |
| | 10MHz BW _{channel} | -5.1 | -5.1 | -9.1 | -13.1 | -9.1 | -5.1 |
| | 20MHz BW _{channel} | -5.1 | -5.1 | -9.1 | -13.1 | -9.1 | -5.1 |
| N _{oc} | dBm/15 kHz | -98 | | | | | |
| Propagation condition | | AWGN | AWGN | | | | |
| Correlation Matrix and Antenna Configuration | | 1x2 | 1x2 | | | | |
| Receive time offset to cell1 ^{Note 9} | μs | - | 33 | | | | |

- Note 1: For the special subframe configuration see table 4.2-1 in TS 36.211.
- Note 2: For the uplink-downlink configuration see table 4.2-2 in TS 36.211.
- Note 3: OCNG shall be used such that the resources in cell # 1 are fully allocated and a constant total transmitted power spectral density is achieved for all OFDM symbols.
- Note 4: The uplink resources for CQI reporting are assigned to the UE prior to the start of time period T1.
- Note 5: The timers and layer 3 filtering related parameters are configured prior to the start of time period T1.
- Note 6: The signal contains PDCCH for UEs other than the device under test as part of OCNG.
- Note 7: SNR levels correspond to the signal to noise ratio over the cell-specific reference signal REs.
- Note 8: The SNR in time periods T1, T2, T3, T4 and T5 is denoted as SNR1, SNR2, SNR3, SNR4 and SNR5 respectively in figure A.7.3.43.1-1.
- Note 9: Receive time difference between subframe boundaries of signals received from the two cells at the UE antenna connector including time alignment error between the two cells.
- Note 10: The SNR values are specified for testing a UE which supports 2RX on the PSCell frequency. For testing of a UE which only supports 4RX on the PSCell frequency, the SNR during T3 and T4 is modified as specified in section A.3.8.1.

Table A.7.3.43.1-3: DRX-Configuration for E-UTRAN TDD-TDD Radio Link Monitoring Test for In-sync in DRX in synchronous dual connectivity

| Field | Value | | Comment |
|--------------------------|---------|---------|---|
| | Cell 1 | Cell 2 | |
| onDurationTimer | psf2 | psf2 | As specified in section 6.3.2 in 3GPP TS 36.331 |
| drx-InactivityTimer | psf1 | psf1 | |
| drx-RetransmissionTimer | psf1 | psf1 | |
| longDRX-CycleStartOffset | sf640 | sf40 | |
| shortDRX | disable | disable | |

Table A.7.3.43.1-4: TimeAlignmentTimer -Configuration for E-UTRAN TDD-TDD Radio Link Monitoring Test for In-sync in DRX in synchronous dual connectivity

| Field | Value | Comment |
|--------------------|----------|--|
| TimeAlignmentTimer | infinity | As specified in clause 6.3.2 in TS 36.331 |
| sr-ConfigIndex | 0 | For further information see clause 6.3.2 in TS 36.331 and section 10.1 in TS 36.213. |

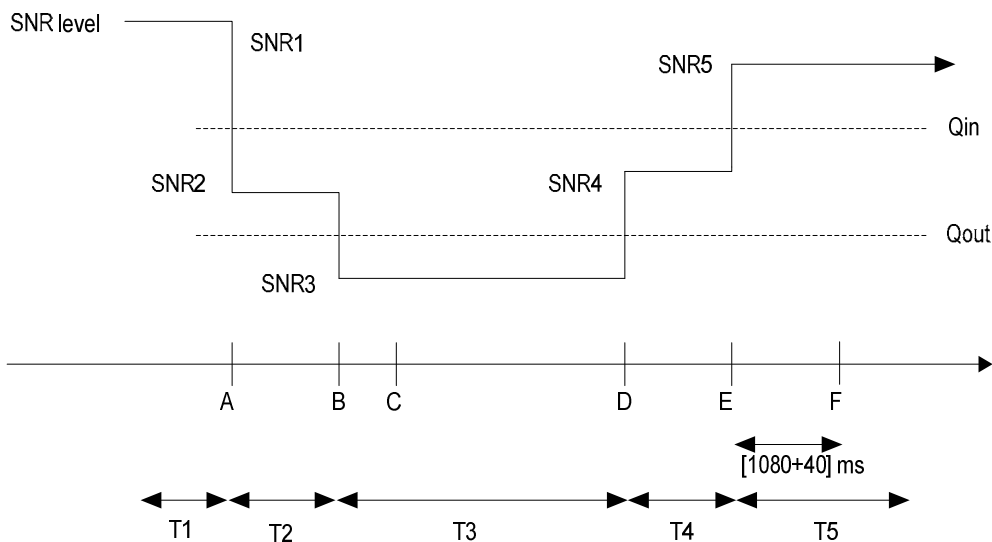

Figure A.7.3.43.1-1 SNR variation of cell 2 (PSCell) for in-sync testing in DRX

A.7.3.43.2 Test Requirements

The UE behaviour during time durations T1, T2, T3, T4 and T5 shall be as follows:

During the period from time point A to time point F (1120 ms after the start of time duration T5) the UE shall transmit uplink signal at least once every DRX cycle, in the On-duration part of the cycle in the subframe according to the configured CQI reporting mode (PUCCH 1-0) on PCell and PSCell.

The rate of correct events observed during repeated tests shall be at least 90%.

A.7.3.44 E-UTRAN TDD-FDD DC Radio Link Monitoring Test for Out-of-sync in DRX in synchronous DC with PCell in FDD

A.7.3.44.1 Test Purpose and Environment

The purpose of this test is to verify that the UE properly detects the out of sync for the purpose of monitoring downlink radio link quality of the PSCell when DRX is used. This test will partly verify the radio link monitoring requirements in clause 7.6.

The test parameters are given in Tables A.7.3.44.1-1, A.7.3.44.1-2, A.7.3.44.1-3, and A.7.3.44.1-4. There are two cells, cell 1 is PCell and cell 2 is PSCell, in the test. The test consists of three successive time periods with time duration of T1, T2 and T3 respectively. Figure A.7.3.44.1-1 shows the variation of the downlink SNR in the PCell and PSCell to emulate out-of-sync and in-sync states. Prior to the start of the time duration T1, the UE shall be fully synchronized to cell 1 and cell 2. The UE shall be configured for periodic CQI reporting in PUCCH 1-0 mode with a reporting periodicity of 2ms on cell 1 and 1ms on cell 2, respectively. In the test, DRX configuration is enabled and DRX inactivity timer has already been expired, i.e. UE tries to decode PDCCH and to send periodic CQI during the period when On-duration timer is running. Time alignment timers shall be set to “infinity” so that UL timing alignment is maintained during the test.

Table A.7.3.44.1-1: General test parameters for E-UTRAN TDD-FDD DC out-of-sync tests in DRX in synchronous dual connectivity with PCell in FDD

| Parameter | | Unit | Value | Comment |
|---|--------------------------------|---------|------------------|--|
| Active cell | | | Cell 1 Cell 2 | Cell 1 is PCell on E-UTRA FDD RF channel number 1, and cell 2 is PSCell on E-UTRA TDD RF channel number 2 |
| CP length | | | Normal | |
| E-UTRA RF Channel Number | | | 1, 2 | One E-UTRA FDD carrier frequency and one E-UTRA TDD carrier frequency are used. |
| E-UTRA Channel Bandwidth (BWchannel) | | MHz | 5, 10, 20 | |
| Correlation Matrix and Antenna Configuration | | | 2x2 Low | Correlation Matrix and Antenna Configuration are defined in TS 36.101 [5] Annex B.2.3.2 |
| Out of sync transmission parameters (Note 1) | DCI format | | 1A | As defined in clause 5.3.3.1.3 in TS 36.212 |
| | Number of Control OFDM symbols | | 2 | Out of sync threshold Q_{out} and the corresponding hypothetical PDCCH/PCFICH transmission parameters are as specified in clause 7.6.1 and Table 7.6.1-1 respectively. |
| | Aggregation level | CCE | 8 | |
| | ρ_A, ρ_B | | -3 | |
| | Ratio of PDCCH to RS EPRE | dB | 1 | |
| Ratio of PCFICH to RS EPRE | dB | 1 | | |
| DRX cycle on cell 1 | | ms | 640 | See Table A.7.3.38.1-3 |
| DRX cycle on cell 2 | | ms | 40 | See Table A.7.3.38.1-3 |
| Timing offset between cell 1 and cell 2 | | μ s | 33 | For synchronous dual connectivity |
| Layer 3 filtering | | | Enabled | Counters: N310 = 1; N311 = 1; N313 = 1; N314 = 1 |
| T310 timer | | ms | 0 | T310 is disabled |
| T311 timer | | ms | 1000 | T311 is enabled |
| T313 timer | | ms | 0 | T313 is disabled |
| Periodic CQI reporting mode | | | PUCCH 1-0 | As defined in table 7.2.2-1 in TS 36.213. |
| T1 | | s | 4 | |
| T2 | | s | 1.6 | |
| T3 | | s | 1.8 | |
| Note 1: PDCCH/PCFICH corresponding to the out of sync transmission parameters need not be included in the | | | | |

| |
|--------------------------------|
| Reference Measurement Channel. |
|--------------------------------|

Table A.7.3.44.1-2: Cell specific test parameters for E-UTRAN TDD-FDD DC out-of-sync radio link monitoring in DRX in synchronous dual connectivity with PCell in FDD

| Parameter | Unit | Cell 1 | | | Cell 2 | | |
|--|------------|--|------|------|---|------|-------|
| | | T1 | T2 | T3 | T1 | T2 | T3 |
| E-UTRA RF Channel Number | | 1 | | | 2 | | |
| BW _{channel} | MHz | 5, 10, 20 | | | 5, 10, 20 | | |
| Correlation Matrix and Antenna Configuration | | 2x2 Low | | | 2x2 Low | | |
| Special subframe configuration ^{Note7} | | - | | | 6 | | |
| Uplink-downlink configuration ^{Note8} | | - | | | 1 | | |
| PCFICH/PDCCH/PHICH parameters None of the PDCCH are intended for the UE under test | | 5MHz: R.12 FDD 10MHz: R.7 FDD 20MHz: R.13 FDD | | | 5MHz: R.12 TDD 10MHz: R.7 TDD 20MHz: R.13 TDD | | |
| OCNG Pattern | | 5MHz: OP.16 FDD 10MHz: OP.2 FDD 20MHz: OP.12 FDD | | | 5MHz: OP.10 TDD 10MHz: OP.2 TDD 20MHz: OP.8 TDD | | |
| ρA, ρB | | -3 | | | -3 | | |
| PCFICH_RB | dB | 1 | | | 1 | | |
| PDCCH_RA | dB | 1 | | | 1 | | |
| PDCCH_RB | dB | 1 | | | 1 | | |
| PBCH_RA | dB | -3 | | | -3 | | |
| PBCH_RB | dB | | | | | | |
| PSS_RA | dB | | | | | | |
| SSS_RA | dB | | | | | | |
| PHICH_RA | dB | | | | | | |
| PHICH_RB | dB | | | | | | |
| PDSCH_RA | dB | | | | | | |
| PDSCH_RB | dB | | | | | | |
| OCNG_RA ^{Note1} | dB | | | | | | |
| OCNG_RB ^{Note1} | dB | | | | | | |
| SNR ^{Note 6} (5MHz bandwidth) | dB | -2.3 | -2.3 | -2.3 | -1.6 | -5.2 | -11.9 |
| SNR ^{Note 6} (10MHz bandwidth) | dB | -2.3 | -2.3 | -2.3 | -2.3 | -5.9 | -11.9 |
| SNR ^{Note 6} (20MHz bandwidth) | dB | -2.9 | -2.9 | -2.9 | -3.0 | -6.6 | -12.6 |
| N _{oc} | dBm/15 kHz | -98 | | | -98 | | |
| Propagation condition | | ETU 70 Hz | | | ETU 70 Hz | | |
| Time offset to cell1 ^{Note 9} | μs | - | | | 33 | | |
| CQI reporting periodicity | ms | 2 | | | 1 | | |
| <p>Note 1: OCNG shall be used such that the resources in cell 1 and cell 2 are fully allocated and a constant total transmitted power spectral density is achieved for all OFDM symbols.</p> <p>Note 2: The uplink resources for CQI reporting are assigned to the UE prior to the start of time period T1.</p> <p>Note 3: The timers and layer 3 filtering related parameters are configured prior to the start of time period T1.</p> <p>Note 4: The signal contains PDCCH for UEs other than the device under test as part of OCNG.</p> <p>Note 5: SNR levels correspond to the signal to noise ratio over the cell-specific reference signal REs.</p> <p>Note 6: The SNR in time periods T1, T2, and T3 are denoted as SNR1, SNR2 and SNR3 respectively in figure A.7.3.38.1-1.</p> <p>Note 7: For the special subframe configuration see table 4.2-1 in TS 36.211.</p> <p>Note 8: For the uplink-downlink configuration see table 4.2-2 in TS 36.211.</p> <p>Note 9: Receive time difference between subframe boundaries of signals received from the two cells at the UE antenna connector including time alignment error between the two cells.</p> | | | | | | | |

Table A.7.3.44.1-3: DRX-Configuration for E-UTRAN TDD-FDD DC out-of-sync tests in synchronous dual connectivity with PCell in FDD

| Field | Value | | Comment |
|-------|--------|--------|---------|
| | Cell 1 | Cell 2 | |

| | | | |
|--------------------------|---------|---------|---|
| onDurationTimer | psf2 | psf2 | As specified in clause 6.3.2 in TS 36.331 |
| drx-InactivityTimer | psf1 | psf1 | |
| drx-RetransmissionTimer | psf1 | psf1 | |
| longDRX-CycleStartOffset | Sf640 | Sf40 | |
| shortDRX | disable | disable | |

Table A.7.3.44.1-4: TimeAlignmentTimer -Configuration for E-UTRAN TDD-FDD DC out-of-sync testing in synchronous dual connectivity with PCell in FDD

| Field | Value | Comment |
|--------------------|----------|--|
| TimeAlignmentTimer | infinity | As specified in clause 6.3.2 in TS 36.331 |
| sr-ConfigIndex | 0 | For further information see clause 6.3.2 in TS 36.331 and section 10.1 in TS 36.213. |

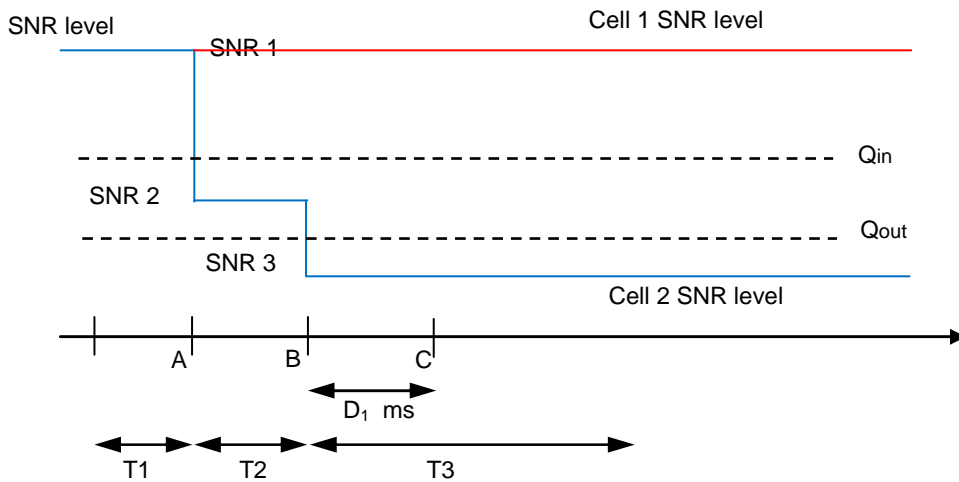

Figure A.7.3.44.1-1 SNR variation for out-of-sync testing in DRX

A.7.3.44.2 Test Requirements

The UE behaviour during time durations T1, T2, and T3 shall be as follows:

During time durations T1, T2 and T3, the UE shall transmit uplink signal at least in all subframes configured for CQI transmission on Cell1.

During the period from time point A to time point B the UE shall transmit uplink signal at least once every DRX cycle, in the On-duration part of the cycle in the uplink subframe on Cell2.

The UE shall stop transmitting uplink signal no later than time point C (duration D1 = 900 ms after the start of time duration T3) on PSCell.

The rate of correct events observed during repeated tests shall be at least 90%.

A.7.3.45 E-UTRAN TDD-FDD DC Radio Link Monitoring Test for Out-of-sync in DRX in synchronous DC with PCell in TDD

A.7.3.45.1 Test Purpose and Environment

The purpose of this test is to verify that the UE properly detects the out of sync for the purpose of monitoring downlink radio link quality of the PSCell when DRX is used. This test will partly verify the radio link monitoring requirements in clause 7.6.

The test parameters are given in Tables A.7.3.45.1-1, A.7.3.45.1-2, A.7.3.45.1-3, and A.7.3.45.1-4. There are two cells, cell 1 is PCell and cell 2 is PSCell, in the test. The test consists of three successive time periods with time duration of T1, T2 and T3 respectively. Figure A.7.3.45.1-1 shows the variation of the downlink SNR in the PCell and PSCell to emulate out-of-sync and in-sync states. Prior to the start of the time duration T1, the UE shall be fully synchronized to cell 1 and cell 2. The UE shall be configured for periodic CQI reporting in PUCCH 1-0 mode with a reporting periodicity of 1ms on cell 1 and 2ms on cell 2, respectively. In the test, DRX configuration is enabled and DRX inactivity timer has already been expired, i.e. UE tries to decode PDCCH and to send periodic CQI during the period when On-duration timer is running. Time alignment timers shall be set to “infinity” so that UL timing alignment is maintained during the test.

Table A.7.3.45.1-1: General test parameters for E-UTRAN TDD-FDD DC out-of-sync tests in DRX in synchronous dual connectivity with PCell in TDD

| Parameter | | Unit | Value | Comment |
|--|--------------------------------|---------|------------------|--|
| Active cell | | | Cell 1 Cell 2 | Cell 1 is PCell on E-UTRA TDD RF channel number 1, and cell 2 is PSCell on E-UTRA FDD RF channel number 2 |
| CP length | | | Normal | |
| E-UTRA RF Channel Number | | | 1, 2 | One E-UTRA TDD carrier frequencies and one E-UTRA FDD carrier frequencies are used. |
| E-UTRA Channel Bandwidth (BW _{channel}) | | MHz | 5, 10, 20 | |
| Correlation Matrix and Antenna Configuration | | | 2x2 Low | Correlation Matrix and Antenna Configuration are defined in TS 36.101 [5] Annex B.2.3.2 |
| Out of sync transmission parameters (Note 1) | DCI format | | 1A | As defined in clause 5.3.3.1.3 in TS 36.212 |
| | Number of Control OFDM symbols | | 2 | Out of sync threshold Q_{out} and the corresponding hypothetical PDCCH/PCFICH transmission parameters are as specified in clause 7.6.1 and Table 7.6.1-1 respectively. |
| | Aggregation level | CCE | 8 | |
| | ρ_A, ρ_B | | -3 | |
| | Ratio of PDCCH to RS EPRE | dB | 1 | |
| | Ratio of PCFICH to RS EPRE | dB | 1 | |
| DRX cycle on cell 1 | | ms | 640 | See Table A.7.3.40.1-3 |
| DRX cycle on cell 2 | | ms | 40 | See Table A.7.3.40.1-3 |
| Timing offset between cell 1 and cell 2 | | μ s | 33 | For synchronous dual connectivity |
| Layer 3 filtering | | | Enabled | Counters: N310 = 1; N311 = 1; N313 = 1; N314 = 1 |
| T310 timer | | ms | 0 | T310 is disabled |
| T311 timer | | ms | 1000 | T311 is enabled |
| T313 timer | | ms | 0 | T313 is disabled |
| Periodic CQI reporting mode | | | PUCCH 1-0 | As defined in table 7.2.2-1 in TS 36.213. |
| T1 | | s | 4 | |
| T2 | | s | 1.6 | |
| T3 | | s | 1.8 | |
| Note 1: PDCCH/PCFICH corresponding to the out of sync transmission parameters need not be included in the Reference Measurement Channel. | | | | |

Table A.7.3.45.1-2: Cell specific test parameters for E-UTRAN TDD-FDD DC out-of-sync radio link monitoring in DRX in synchronous dual connectivity with PCell in TDD

| Parameter | Unit | Cell 1 | | | Cell 2 | | |
|---|------|-----------|----|----|-----------|----|----|
| | | T1 | T2 | T3 | T1 | T2 | T3 |
| E-UTRA RF Channel Number | | 1 | | | 2 | | |
| BW _{channel} | MHz | 5, 10, 20 | | | 5, 10, 20 | | |
| Correlation Matrix and Antenna Configuration | | 2x2 Low | | | 2x2 Low | | |
| Special subframe configuration ^{Note1} | | 6 | | | - | | |
| Uplink-downlink configuration ^{Note2} | | 1 | | | - | | |

| | | | | | | | |
|---|------------|---|------|------|--|------|-------|
| PCFICH/PDCCH/PHICH parameters None of the PDCCH are intended for the UE under test | | 5MHz: R.12 TDD 10MHz: R.7 TDD 20MHz: R.13 TDD | | | 5MHz: R.12 FDD 10MHz: R.7 FDD 20MHz: R.13 FDD | | |
| OCNG Pattern | | 5MHz: OP.10 TDD 10MHz: OP.2 TDD 20MHz: OP.8 TDD | | | 5MHz: OP.16 FDD 10MHz: OP.2 FDD 20MHz: OP.12 FDD | | |
| ρ_A, ρ_B | | -3 | | | -3 | | |
| PCFICH_RB | dB | 1 | | | 1 | | |
| PDCCH_RA | dB | 1 | | | 1 | | |
| PDCCH_RB | dB | 1 | | | 1 | | |
| PBCH_RA | dB | -3 | | | -3 | | |
| PBCH_RB | dB | | | | | | |
| PSS_RA | dB | | | | | | |
| SSS_RA | dB | | | | | | |
| PHICH_RA | dB | | | | | | |
| PHICH_RB | dB | | | | | | |
| PDSCH_RA | dB | | | | | | |
| PDSCH_RB | dB | | | | | | |
| OCNG_RA ^{Note3} | dB | | | | | | |
| OCNG_RB ^{Note3} | dB | | | | | | |
| SNR ^{Note 8} (5MHz bandwidth) | dB | -1.6 | -1.6 | -1.6 | -2.3 | -5.7 | -12.2 |
| SNR ^{Note 8} (10MHz bandwidth) | dB | -2.3 | -2.3 | -2.3 | -2.3 | -6.2 | -12.2 |
| SNR ^{Note 8} (20MHz bandwidth) | dB | -3.0 | -3.0 | -3.0 | -2.9 | -6.8 | -12.8 |
| N_{oc} | dBm/15 kHz | -98 | | | -98 | | |
| Propagation condition | | ETU 70 Hz | | | ETU 70 Hz | | |
| Time offset to cell1 ^{Note 9} | μ s | - | | | 33 | | |
| CQI reporting periodicity | ms | 1 | | | 2 | | |
| <p>Note 1: For the special subframe configuration see table 4.2-1 in TS 36.211.</p> <p>Note 2: For the uplink-downlink configuration see table 4.2-2 in TS 36.211.</p> <p>Note 3: OCNG shall be used such that the resources in cell # 1 are fully allocated and a constant total transmitted power spectral density is achieved for all OFDM symbols.</p> <p>Note 4: The uplink resources for CQI reporting are assigned to the UE prior to the start of time period T1.</p> <p>Note 5: The timers and layer 3 filtering related parameters are configured prior to the start of time period T1.</p> <p>Note 6: The signal contains PDCCH for UEs other than the device under test as part of OCNG.</p> <p>Note 7: SNR levels correspond to the signal to noise ratio over the cell-specific reference signal REs.</p> <p>Note 8: The SNR in time periods T1, T2 and T3 is denoted as SNR1, SNR2 and SNR3 respectively in figure A.7.3.40.1-1.</p> <p>Note 9: Receive time difference between subframe boundaries of signals received from the two cells at the UE antenna connector including time alignment error between the two cells.</p> | | | | | | | |

Table A.7.3.45.1-3: DRX-Configuration for E-UTRAN TDD-FDD DC out-of-sync tests in synchronous dual connectivity with PCell in TDD

| Field | Value | | Comment |
|--------------------------|---------|---------|---|
| | Cell 1 | Cell 2 | |
| onDurationTimer | psf2 | psf2 | As specified in clause 6.3.2 in TS 36.331 |
| drx-InactivityTimer | psf1 | psf1 | |
| drx-RetransmissionTimer | psf1 | psf1 | |
| longDRX-CycleStartOffset | Sf640 | Sf40 | |
| shortDRX | disable | disable | |

Table A.7.3.45.1-4: TimeAlignmentTimer -Configuration for E-UTRAN TDD-FDD CA out-of-sync testing in synchronous dual connectivity with PCell in TDD

| Field | Value | Comment |
|--------------------|----------|--|
| TimeAlignmentTimer | infinity | As specified in clause 6.3.2 in TS 36.331 |
| sr-ConfigIndex | 0 | For further information see clause 6.3.2 in TS 36.331 and section 10.1 in TS 36.213. |

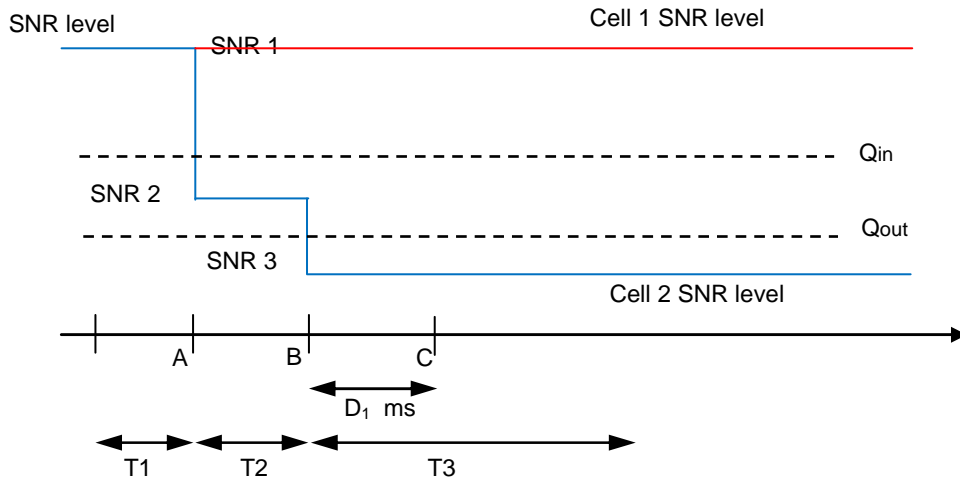

Figure A.7.3.45.1-1 SNR variation for out-of-sync testing in DRX

A.7.3.45.2 Test Requirements

The UE behaviour during time durations T1, T2, and T3 shall be as follows:

During time durations T1, T2 and T3, the UE shall transmit uplink signal at least in all subframes configured for CQI transmission on Cell1.

During the period from time point A to time point B the UE shall transmit uplink signal at least once every DRX cycle, in the On-duration part of the cycle in the uplink subframe on Cell2.

The UE shall stop transmitting uplink signal no later than time point C (duration D1 = 900 ms after the start of time duration T3) on PSCell.

The rate of correct events observed during repeated tests shall be at least 90%.

A.7.3.46 E-UTRAN TDD-FDD Radio Link Monitoring Test for In-sync in DRX for PSCell in synchronous DC with PCell in FDD

A.7.3.46.1 Test Purpose and Environment

The purpose of this test is to verify that the UE properly detects the out of sync and in sync for the purpose of monitoring downlink radio link quality of the PSCell when DRX is used in dual connectivity. This test will partly verify the E-UTRAN FDD and TDD radio link monitoring requirements in clause 7.6.

The test parameters are given in Tables A.7.3.46.1-1, A.7.3.46.1-2, A.7.3.46.1-3 and A.7.3.46.1-4. There are two cells, cell 1 is PCell and cell 2 is PSCell, in the test. The test consists of five successive time periods, with time duration of T1, T2, T3, T4 and T5 respectively. Figure A.7.3.46.1-1 shows the variation of the downlink SNR in the PSCell to emulate out-of-sync and in-sync states. Prior to the start of the time duration T1, the UE shall be fully synchronized to cell 1 and cell 2. The UE shall be configured for periodic CQI reporting in PUCCH 1-0 mode with a reporting periodicity of 2 ms on PCell and 1ms on PSCell. In the test, DRX configuration for PCell and PSCell is enabled and DRX inactivity timer has already been expired, i.e. UE tries to decode PDCCH and to send periodic CQI during the period when On-duration timer is running. Time alignment timers shall be set to “infinity” so that UL timing alignment is maintained during the test.

Table A.7.3.46.1-1: General test parameters for E-UTRAN TDD-FDD Radio Link Monitoring Test for In-sync in DRX for PSCell in synchronous DC with PCell in FDD

| Parameter | Unit | Value | Comment |
|--------------------------|------|-------|---|
| E-UTRA RF Channel Number | | 1, 2 | One E-UTRA FDD carrier frequency and One E-UTRA TDD carrier frequency are used. |

| | | | | |
|---|--------------------------------|-----|----------------|--|
| Active cell | | | Cell 1, Cell 2 | Cell 1 is PCell on E-UTRA FDD RF channel number 1, and cell 2 is PSCell on E-UTRA TDD RF channel number 2 |
| CP length | | | Normal | |
| In sync transmission parameters (Note 1) | DCI format | | 1C | As defined in clause 5.3.3.1.4 in TS 36.212 |
| | Number of Control OFDM symbols | | 2 | For 10MHz and 20MHz channel BW |
| | Number of Control OFDM symbols | | 3 | For 5MHz channel BW |
| | Aggregation level | CCE | 4 | In sync threshold Q_{in} and the corresponding hypothetical PDCCH/PCFICH transmission parameters are as specified in clause 7.6.1 and Table 7.6.1-2 respectively. |
| | ρ_A, ρ_B | | 0 | |
| | Ratio of PDCCH to RS EPRE | | 0 | |
| Ratio of PCFICH to RS EPRE | | 4 | | |
| Out of sync transmission parameters (Note 1) | DCI format | | 1A | As defined in clause 5.3.3.1.3 in TS 36.212 |
| | Number of Control OFDM symbols | | 2 | For 10MHz and 20MHz channel BW |
| | Number of Control OFDM symbols | | 3 | For 5MHz channel BW |
| | Aggregation level | CCE | 8 | Out of sync threshold Q_{out} and the corresponding hypothetical PDCCH/PCFICH transmission parameters are as specified in clause 7.6.1 and Table 7.6.1-1 respectively. |
| | ρ_A, ρ_B | | 0 | |
| | Ratio of PDCCH to RS EPRE | dB | 4 | |
| Ratio of PCFICH to RS EPRE | dB | 4 | | |
| DRX cycle on Cell 1 | ms | | 640 | See Table A.7.3.41.1-3 |
| DRX cycle on Cell 2 | ms | | 40 | See Table A.7.3.41.1-3 |
| Layer 3 filtering | | | Enabled | Counters: N310 = 1; N311 = 1, N313 = 1, N314 = 1 |
| T310 timer | ms | | 2000 | T310 is enabled |
| T311 timer | ms | | 1000 | T311 is enabled |
| T313 timer | ms | | 2000 | T313 is enabled |
| Periodic CQI reporting mode | | | PUCCH 1-0 | As defined in table 7.2.2-1 in TS 36.213. |
| T1 | s | | 4 | |
| T2 | s | | 1.6 | |
| T3 | s | | 1.46 | |
| T4 | s | | 0.4 | |
| T5 | s | | 4 | |
| Note 1: PDCCH/PCFICH corresponding to the in-sync and out of sync transmission parameters need not be included in the Reference Measurement Channel. | | | | |
| Note 2: Even a UE capable of both synchronous and asynchronous DC operations is required to pass this test case in accordance with the principle defined in section A.3.11. | | | | |

Table A.7.3.46.1-2: Cell specific test parameters for E-UTRAN TDD-FDD Radio Link Monitoring Test for In-sync in DRX for PSCell in synchronous DC with PCell in FDD

| Parameter | Unit | Cell 1(PCell) | Cell 2 (PSCell) | | | | |
|--|------|--|--|----|----|----|----|
| | | T1 ~ T5 | T1 | T2 | T3 | T4 | T5 |
| E-UTRA RF Channel Number | | 1 | 2 | | | | |
| BW _{channel} | MHz | 5: N _{RB,c} = 25 10: N _{RB,c} = 50 20: N _{RB,c} = 100 | 5: N _{RB,c} = 25 10: N _{RB,c} = 50 20: N _{RB,c} = 100 | | | | |
| Special subframe configuration ^{Note1} | | - | 6 | | | | |
| Uplink-downlink configuration ^{Note2} | | - | 1 | | | | |
| PCFICH/PDCCH/PHICH parameters defined in A.3.1.2.1 and A.3.1.2.2 | | 5MHz: R.11 FDD 10MHz: R.6 FDD 20MHz: R.10 FDD | 5MHz: R.11 TDD 10MHz: R.6 TDD 20MHz: R.10 TDD | | | | |
| OCNG Pattern defined in A.3.2.1 (FDD) and A.3.2.2 (TDD) | | 5MHz: OP.16 FDD 10MHz: OP.2 FDD 20MHz: OP.12 FDD | 5MHz: OP.10 TDD 10MHz: OP.2 TDD 20MHz: OP.8 TDD | | | | |

| | | | | | | | | |
|--|-----------------------------|------|------|------|------|-------|------|------|
| ρ_A, ρ_B | | 0 | 0 | | | | | |
| PCFICH_RB | dB | 4 | 4 | | | | | |
| PDCCH_RA | dB | 0 | 0 | | | | | |
| PDCCH_RB | dB | 0 | 0 | | | | | |
| PBCH_RA | dB | 0 | 0 | | | | | |
| PBCH_RB | dB | | | | | | | |
| PSS_RA | dB | | | | | | | |
| SSS_RA | dB | | | | | | | |
| PHICH_RA | dB | | | | | | | |
| PHICH_RB | dB | | | | | | | |
| PDSCH_RA | dB | | | | | | | |
| PDSCH_RB | dB | | | | | | | |
| OCNG_RA ^{Note3} | dB | | | | | | | |
| OCNG_RB ^{Note3} | dB | | | | | | | |
| SNR ^{Note 8} | 5MHz BW _{channel} | dB | -2.3 | -5.1 | -9.1 | -13.1 | -9.1 | -5.1 |
| | 10MHz BW _{channel} | dB | -4.7 | -5.1 | -9.1 | -13.1 | -9.1 | -5.1 |
| | 20MHz BW _{channel} | dB | -4.7 | -5.1 | -9.1 | -13.1 | -9.1 | -5.1 |
| N_{oc} | dBm/15 kHz | -98 | | | | | | |
| Propagation condition | | AWGN | | | AWGN | | | |
| Correlation Matrix and Antenna Configuration | | 1x2 | | | 1x2 | | | |
| Receive time offset to cell1 ^{Note 9} | μ s | - | 33 | | | | | |
| CQI reporting periodicity | ms | 2 | 1 | | | | | |
| <p>Note 1: For the special subframe configuration see table 4.2-1 in TS 36.211.</p> <p>Note 2: For the uplink-downlink configuration see table 4.2-2 in TS 36.211.</p> <p>Note 3: OCNG shall be used such that the resources in cell 1 and cell 2 are fully allocated and a constant total transmitted power spectral density is achieved for all OFDM symbols.</p> <p>Note 4: The uplink resources for CQI reporting are assigned to the UE prior to the start of time period T1.</p> <p>Note 5: The timers and layer 3 filtering related parameters are configured prior to the start of time period T1.</p> <p>Note 6: The signal contains PDCCH for UEs other than the device under test as part of OCNG.</p> <p>Note 7: SNR levels correspond to the signal to noise ratio over the cell-specific reference signal REs.</p> <p>Note 8: The SNR of Cell 2 in time periods T1, T2, T3, T4 and T5 is denoted as SNR1, SNR2, SNR3, SNR4 and SNR5 respectively in figure A.7.3.46.1-1.</p> <p>Note 9: Receive time difference between subframe boundaries of signals received from the two cells at the UE antenna connector including time alignment error between the two cells.</p> | | | | | | | | |

Table A.7.3.46.1-3: DRX-Configuration for E-UTRAN TDD-FDD Radio Link Monitoring Test for In-sync in DRX for PSCell in synchronous DC with PCell in FDD

| Field | Value | | Comment |
|--------------------------|---------|---------|---|
| | Cell 1 | Cell 2 | |
| onDurationTimer | psf2 | psf2 | As specified in section 6.3.2 in 3GPP TS 36.331 |
| drx-InactivityTimer | psf1 | psf1 | |
| drx-RetransmissionTimer | psf1 | psf1 | |
| longDRX-CycleStartOffset | sf640 | sf40 | |
| shortDRX | disable | disable | |

Table A.7.3.46.1-4: TimeAlignmentTimer -Configuration for E-UTRAN TDD-FDD Radio Link Monitoring Test for In-sync in DRX for PSCell in synchronous DC with PCell in FDD

| Field | Value | Comment |
|--------------------|----------|--|
| TimeAlignmentTimer | infinity | As specified in clause 6.3.2 in TS 36.331 |
| sr-ConfigIndex | 0 | For further information see clause 6.3.2 in TS 36.331 and section 10.1 in TS 36.213. |

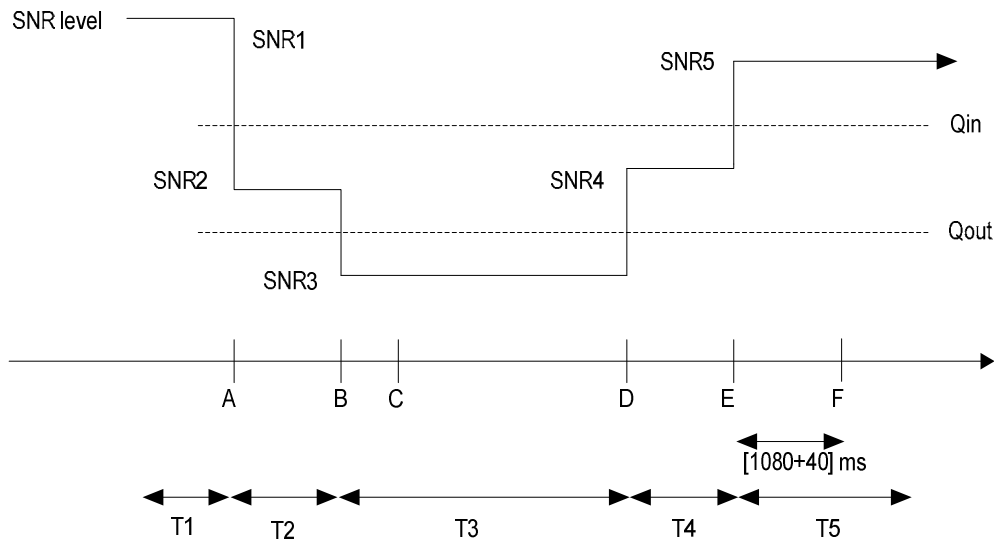

Figure A.7.3.46.1-1 SNR variation of cell 2 (PSCell) for in-sync testing in DRX

A.7.3.46.2 Test Requirements

The UE behaviour during time durations T1, T2, T3, T4 and T5 shall be as follows:

During the period from time point A to time point F (1120 ms after the start of time duration T5) the UE shall transmit uplink signal at least once every DRX cycle, in the On-duration part of the cycle in the subframe according to the configured CQI reporting mode (PUCCH 1-0) on PCell and PSCell.

The rate of correct events observed during repeated tests shall be at least 90%.

A.7.3.47 E-UTRAN TDD-FDD Radio Link Monitoring Test for In-sync in DRX for PSCell in synchronous DC with PCell in TDD

A.7.3.47.1 Test Purpose and Environment

The purpose of this test is to verify that the UE properly detects the out of sync and in sync for the purpose of monitoring downlink radio link quality of the PSCell when DRX is used in dual connectivity. This test will partly verify the E-UTRAN FDD and TDD radio link monitoring requirements in clause 7.6.

The test parameters are given in Tables A.7.3.47.1-1, A.7.3.47.1-2, A.7.3.47.1-3 and A.7.3.47.1-4. There are two cells, cell 1 is PCell and cell 2 is PSCell, in the test. The test consists of five successive time periods, with time duration of T1, T2, T3, T4 and T5 respectively. Figure A.7.3.47.1-1 shows the variation of the downlink SNR in the PSCell to emulate out-of-sync and in-sync states. Prior to the start of the time duration T1, the UE shall be fully synchronized to cell 1 and cell 2. The UE shall be configured for periodic CQI reporting in PUCCH 1-0 mode with a reporting periodicity of 1ms on PCell and 2ms on PSCell. In the test, DRX configuration for PCell and PSCell is enabled and DRX inactivity timer has already been expired, i.e. UE tries to decode PDCCH and to send periodic CQI during the period when On-duration timer is running. Time alignment timers shall be set to “infinity” so that UL timing alignment is maintained during the test.

Table A.7.3.47.1-1: General test parameters for E-UTRAN TDD-FDD Radio Link Monitoring Test for In-sync in DRX for PSCell in synchronous DC with PCell in TDD

| Parameter | Unit | Value | Comment |
|--------------------------|------|----------------|---|
| E-UTRA RF Channel Number | | 1, 2 | One E-UTRA TDD carrier frequency and One E-UTRA FDD carrier frequency are used. |
| Active cell | | Cell 1, Cell 2 | Cell 1 is PCell on E-UTRA TDD RF channel number 1, and cell 2 is PSCell on |

| | | | |
|---|--------------------------------|-----------|---|
| | | | E-UTRA FDD RF channel number 2 |
| CP length | | | Normal |
| In sync transmission parameters (Note 1) | DCI format | | 1C |
| | Number of Control OFDM symbols | | 2 |
| | Number of Control OFDM symbols | | 3 |
| | Aggregation level | CCE | 4 |
| | ρ_A, ρ_B | | 0 |
| | Ratio of PDCCH to RS EPRE | | 0 |
| | Ratio of PCFICH to RS EPRE | | 4 |
| Out of sync transmission parameters (Note 1) | DCI format | | 1A |
| | Number of Control OFDM symbols | | 2 |
| | Number of Control OFDM symbols | | 3 |
| | Aggregation level | CCE | 8 |
| | ρ_A, ρ_B | | 0 |
| | Ratio of PDCCH to RS EPRE | dB | 4 |
| | Ratio of PCFICH to RS EPRE | dB | 4 |
| DRX cycle on Cell 1 | ms | 640 | See Table A.7.3.43.1-3 |
| DRX cycle on Cell 2 | ms | 40 | See Table A.7.3.43.1-3 |
| Layer 3 filtering | | Enabled | Counters: N310 = 1; N311 = 1, N313 = 1, N314 = 1 |
| T310 timer | ms | 2000 | T310 is enabled |
| T311 timer | ms | 1000 | T311 is enabled |
| T313 timer | ms | 2000 | T313 is enabled |
| Periodic CQI reporting mode | | PUCCH 1-0 | As defined in table 7.2.2-1 in TS 36.213. |
| T1 | s | 4 | |
| T2 | s | 1.6 | |
| T3 | s | 1.46 | |
| T4 | s | 0.4 | |
| T5 | s | 4 | |
| Note 1: PDCCH/PCFICH corresponding to the in-sync and out of sync transmission parameters need not be included in the Reference Measurement Channel. | | | |
| Note 2: Even a UE capable of both synchronous and asynchronous DC operations is required to pass this test case in accordance with the principle defined in section A.3.11. | | | |

Table A.7.3.47.1-2: Cell specific test parameters for E-UTRAN TDD-FDD Radio Link Monitoring Test for In-sync in DRX for PSCell in synchronous DC with PCell in TDD

| Parameter | Unit | Cell 1 (PCell) | Cell 2 (PSCell) | | | | |
|--|------|---|---|----|----|----|----|
| | | T1 ~ T5 | T1 | T2 | T3 | T4 | T5 |
| E-UTRA RF Channel Number | | 1 | 2 | | | | |
| $BW_{channel}$ | MHz | 5: $N_{RB,c} = 25$ 10: $N_{RB,c} = 50$ 20: $N_{RB,c} = 100$ | 5: $N_{RB,c} = 25$ 10: $N_{RB,c} = 50$ 20: $N_{RB,c} = 100$ | | | | |
| Special subframe configuration ^{Note1} | | 6 | - | | | | |
| Uplink-downlink configuration ^{Note2} | | 1 | - | | | | |
| PCFICH/PDCCH/PHICH parameters defined in A.3.1.2.1 and A.3.1.2.2 | | 5MHz: R.11 TDD 10MHz: R.6 TDD 20MHz: R.10 TDD | 5MHz: R.11 FDD 10MHz: R.6 FDD 20MHz: R.10 FDD | | | | |
| OCNG Pattern defined in A.3.2.1 (FDD) and A.3.2.2 (TDD) | | 5MHz: OP.10 TDD 10MHz: OP.2 TDD 20MHz: OP.8 TDD | 5MHz: OP.16 FDD 10MHz: OP.2 FDD 20MHz: OP.12 FDD | | | | |
| ρ_A, ρ_B | | 0 | 0 | | | | |

| | | | | | | | | | | | | | | |
|---|-----------------------------|------|------|------|------|-------|------|------|------|------|------|-------|------|------|
| PCFICH_RB | dB | 4 | 4 | | | | | | | | | | | |
| PDCCH_RA | dB | 0 | 0 | | | | | | | | | | | |
| PDCCH_RB | dB | 0 | 0 | | | | | | | | | | | |
| PBCH_RA | dB | 0 | 0 | | | | | | | | | | | |
| PBCH_RB | dB | | | | | | | | | | | | | |
| PSS_RA | dB | | | | | | | | | | | | | |
| SSS_RA | dB | | | | | | | | | | | | | |
| PHICH_RA | dB | | | | | | | | | | | | | |
| PHICH_RB | dB | | | | | | | | | | | | | |
| PDSCH_RA | dB | | | | | | | | | | | | | |
| PDSCH_RB | dB | | | | | | | | | | | | | |
| OCNG_RA ^{Note1} | dB | | | | | | | | | | | | | |
| OCNG_RB ^{Note1} | dB | | | | | | | | | | | | | |
| SNR ^{Note 6} | 5MHz BW _{channel} | | | | | | | dB | -5.1 | -2.3 | -5.7 | -12.2 | -7.3 | -2.3 |
| | 10MHz BW _{channel} | | | | | | | dB | -5.1 | -4.7 | -9.5 | -13.5 | -8.7 | -4.7 |
| | 20MHz BW _{channel} | dB | -5.1 | -4.7 | -9.5 | -13.5 | -8.7 | -4.7 | | | | | | |
| N_{oc} | dBm/15 kHz | -98 | | | | | | | | | | | | |
| Propagation condition | | AWGN | | AWGN | | | | | | | | | | |
| Correlation Matrix and Antenna Configuration | | 1x2 | | 1x2 | | | | | | | | | | |
| Receive time offset to cell1 ^{Note 9} | µs | - | 33 | | | | | | | | | | | |
| CQI reporting periodicity | ms | 1 | 2 | | | | | | | | | | | |
| <p>Note 1: For the special subframe configuration see table 4.2-1 in TS 36.211.</p> <p>Note 2: For the uplink-downlink configuration see table 4.2-2 in TS 36.211.</p> <p>Note 3: OCNG shall be used such that the resources in cell # 1 are fully allocated and a constant total transmitted power spectral density is achieved for all OFDM symbols.</p> <p>Note 4: The uplink resources for CQI reporting are assigned to the UE prior to the start of time period T1.</p> <p>Note 5: The timers and layer 3 filtering related parameters are configured prior to the start of time period T1.</p> <p>Note 6: The signal contains PDCCH for UEs other than the device under test as part of OCNG.</p> <p>Note 7: SNR levels correspond to the signal to noise ratio over the cell-specific reference signal REs.</p> <p>Note 8: The SNR of Cell 2 in time periods T1, T2, T3, T4 and T5 is denoted as SNR1, SNR2, SNR3, SNR4 and SNR5 respectively in figure A.7.3.47.1-1.</p> <p>Note 9: Receive time difference between subframe boundaries of signals received from the two cells at the UE antenna connector including time alignment error between the two cells.</p> | | | | | | | | | | | | | | |

Table A.7.3.47.1-3: DRX-Configuration for E-UTRAN TDD-FDD Radio Link Monitoring Test for In-sync in DRX for PSCell in synchronous DC with PCell in TDD

| Field | Value | | Comment |
|--------------------------|---------|---------|---|
| | Cell 1 | Cell 2 | |
| onDurationTimer | psf2 | psf2 | As specified in section 6.3.2 in 3GPP TS 36.331 |
| drx-InactivityTimer | psf1 | psf1 | |
| drx-RetransmissionTimer | psf1 | psf1 | |
| longDRX-CycleStartOffset | sf640 | sf40 | |
| shortDRX | disable | disable | |

Table A.7.3.47.1-4: TimeAlignmentTimer -Configuration for E-UTRAN TDD-TDD Radio Link Monitoring Test for In-sync in DRX for PSCell in synchronous DC with PCell in TDD

| Field | Value | Comment |
|--------------------|----------|--|
| TimeAlignmentTimer | infinity | As specified in clause 6.3.2 in TS 36.331 |
| sr-ConfigIndex | 0 | For further information see clause 6.3.2 in TS 36.331 and section 10.1 in TS 36.213. |

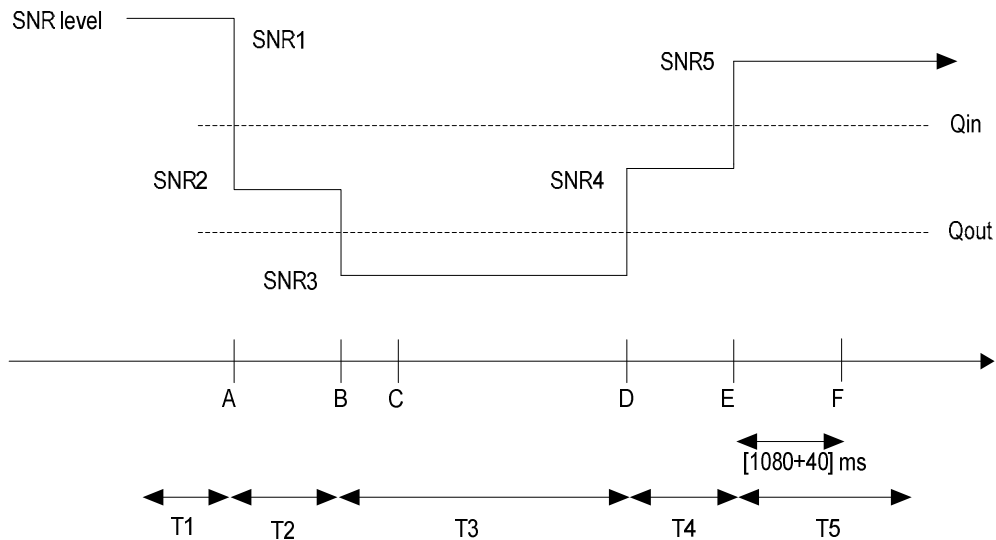

Figure A.7.3.47.1-1 SNR variation of cell 2 (PSCell) for in-sync testing in DRX

A.7.3.47.2 Test Requirements

The UE behaviour during time durations T1, T2, T3, T4 and T5 shall be as follows:

During the period from time point A to time point F (1120 ms after the start of time duration T5) the UE shall transmit uplink signal at least once every DRX cycle, in the On-duration part of the cycle in the subframe according to the configured CQI reporting mode (PUCCH 1-0) on PCell and PSCell.

The rate of correct events observed during repeated tests shall be at least 90%.

A.7.3.48 E-UTRAN FD-FDD Radio Link Monitoring Test for Out-of-sync for Cat-M1 UE in CEMode A

A.7.3.48.1 Test Purpose and Environment

The purpose of this test is to verify that the FD-FDD Cat-M1 UE properly detects the out of sync and in sync for the purpose of monitoring downlink radio link quality of the PCell in CEModeA. This test will partly verify the E-UTRAN FDD radio link monitoring requirements for Cat-M1 UE defined in clause 7.19.

The test parameters are given in Tables A.7.3.48.1-1 and A.7.3.48.1-2 below. There is one cell (cell 1), which is the active cell, in the test. The test consists of three successive time periods, with time duration of T1, T2 and T3 respectively. Figure A.7.3.48.1-1 shows the variation of the downlink SNR in the active cell to emulate out-of-sync and in-sync states. Prior to the start of the time duration T1, the UE shall be fully synchronized to cell 1. The UE shall be configured for periodic CQI reporting in PUCCH 1-0 mode without repetition with a reporting periodicity of 2 ms.

In the test, the RRC parameter *numberPRB-Pairs* is set to 6 and the RRC parameter *mPDCCH-NumRepetition* is set to 8. UE shall successfully complete the RRC reconfiguration accordingly prior to the start of time duration T1.

Table A.7.3.48.1-1: General test parameters for E-UTRAN FD-FDD out-of-sync testing for UE Cat-M1 in CEMode A

| Parameter | | Unit | Value | Comment |
|-------------|------------|------|--------|---|
| Active cell | | | Cell 1 | Cell 1 is on E-UTRA RF channel number 1 |
| CP length | | | Normal | |
| Out of sync | DCI format | | 6-1A | As defined in section 5.3.3.1.12 in TS 36.212 |
| | | | | |

| | | | | |
|--|--|------|-----------|---|
| transmission parameters (Note 1) | Number of OFDM symbols for legacy control channels | | 2 | Out of sync threshold Q_{out} and the corresponding hypothetical MPDCCH transmission parameters are as specified in section 7.19.2 and Table 7.19.2-1 respectively. |
| | M-PDCCH aggregation level | eCCE | 24 | |
| | M-PDCCH repetition level | | 8 | |
| | ρ_A, ρ_B | | -3 | |
| DRX | | | OFF | |
| Layer 3 filtering | | | Enabled | Counters: $N_{310} = 1; N_{311} = 1$ |
| T310 timer | | ms | 0 | T310 is disabled |
| T311 timer | | ms | 1000 | T311 is enabled |
| Periodic CQI reporting mode | | | PUCCH 1-0 | As defined in table 7.2.2-1 in TS 36.213. |
| CQI reporting periodicity | | ms | 2 | Minimum CQI reporting periodicity |
| T1 | | s | 2 | |
| T2 | | s | 0.8 | |
| T3 | | s | 1.8 | |
| Note 1: MPDCCH corresponding to the out of sync transmission parameters need not be included in the Reference Measurement Channel. | | | | |

Table A.7.3.48.1-2: Cell specific test parameters for E-UTRAN FD-FDD (cell # 1) for out-of-sync radio link monitoring tests for Cat-M1 in CEMode A

| Parameter | Unit | Test 1 | | |
|--|------------|-----------|------|-------|
| | | T1 | T2 | T3 |
| E-UTRA RF Channel Number | | 1 | | |
| $BW_{channel}$ | MHz | 10 | | |
| MPDCCH parameters as defined in A.3.1.3.1 | | R.17 FDD | | |
| OCNG Pattern defined in A.3.2.1.21 (FDD) | | OP.21 FDD | | |
| ρ_A, ρ_B | | -3 | | |
| MPDCCH_RA | dB | 0 | | |
| MPDCCH_RB | dB | 0 | | |
| PBCH_RA | dB | -3 | | |
| PBCH_RB | dB | | | |
| PSS_RA | dB | | | |
| SSS_RA | dB | | | |
| OCNG_RA ^{Note 1} | dB | | | |
| OCNG_RB ^{Note 1} | dB | | | |
| N_{oc} | dBm/15 kHz | | | |
| SNR ^{Note 6} | dB | 0.1 | -6.8 | -15.8 |
| Propagation condition | | ETU 30Hz | | |
| Correlation Matrix and Antenna Configuration | | 2x1 Low | | |

- | | |
|---------|--|
| Note 1: | OCNG shall be used such that the resources in cell # 1 are fully allocated and a constant total transmitted power spectral density is achieved for all OFDM symbols. |
| Note 2: | The uplink resources for CQI reporting are assigned to the UE prior to the start of time period T1. |
| Note 3: | The timers and layer 3 filtering related parameters are configured prior to the start of time period T1. |
| Note 4: | The signal contains PDCCH for UEs other than the device under test as part of OCNG. |
| Note 5: | SNR levels correspond to the signal to noise ratio over the cell-specific reference signal REs. |
| Note 6: | The SNR in time periods T1, T2 and T3 is denoted as SNR1, SNR2 and SNR3 respectively in figure A.7.3.48.1-1. |

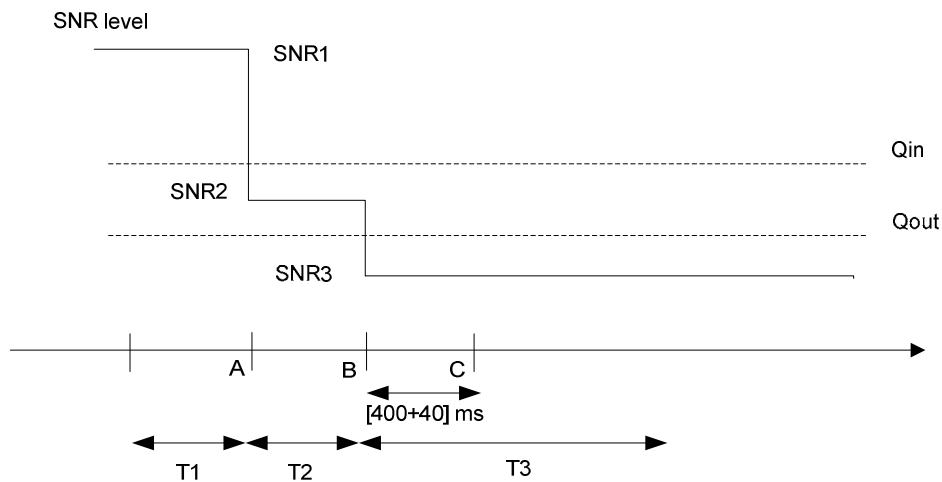

Figure A.7.3.48.1-1: SNR variation for out-of-sync testing

A.7.3.48.2 Test Requirements

The UE behaviour in each test during time durations T1, T2 and T3 shall be as follows:

During the period from time point A to time point B the UE shall transmit uplink signal at least in all subframes configured for CQI transmission according to the configured CQI reporting mode (PUCCH 1-0).

The UE shall stop transmitting uplink signal no later than time point C (440 ms after the start of time duration T3).

The rate of correct events observed during repeated tests shall be at least 90%.

A.7.3.49 E-UTRAN FD-FDD Radio Link Monitoring Test for In-Sync for Cat-M1 UE in CEMode A

A.7.3.49.1 Test Purpose and Environment

The purpose of this test is to verify that the FD-FDD Cat-M1 UE properly detects the out of sync and in sync for the purpose of monitoring downlink radio link quality of the PCell in CEModeA. This test will partly verify the E-UTRAN FDD radio link monitoring requirements for Cat-M1 UE defined in clause 7.19.

The test parameters are given in Tables A.7.3.49.1-1 and A.7.3.49.1-2 below. There is one cell (cell 1), which is the active cell, in the test. The test consists of five successive time periods, with time duration of T1, T2, T3, T4 and T5 respectively. Figure A.7.3.49.1-1 shows the variation of the downlink SNR in the active cell to emulate out-of-sync and in-sync states. Prior to the start of the time duration T1, the UE shall be fully synchronized to cell 1. The UE shall be configured for periodic CQI reporting in PUCCH 1-0 mode without repetition with a reporting periodicity of 2 ms.

In the test, the RRC parameter *numberPRB-Pairs* is set to 4 and the RRC parameter *mPDCCH-NumRepetition* is set to 4. UE shall successfully complete the RRC reconfiguration accordingly prior to the start of time duration T1.

Table A.7.3.49.1-1: General test parameters for E-UTRAN FD-FDD in-sync testing for UE Cat-M1 in CEMode A

| Parameter | | Unit | Value | Comment |
|--|--|------|-----------|---|
| Active cell | | | Cell 1 | Cell 1 is on E-UTRA RF channel number 1 |
| CP length | | | Normal | |
| In sync transmission parameters (Note 1) | DCI format | | 6-1A | As defined in section 5.3.3.1.12 in TS 36.212 |
| | Number of OFDM symbols for legacy control channels | | 2 | In sync threshold Q_{in} and the corresponding hypothetical MPDCCH transmission parameters are as specified in section 7.19.2 and Table 7.19.2-1 respectively. |
| | M-PDCCH aggregation level | eCCE | 4 | |
| | M-PDCCH repetition level | | 2 | |
| | ρ_A, ρ_B | | -3 | |
| | | | | |
| Out of sync transmission parameters (Note 1) | DCI format | | 6-1A | As defined in section 5.3.3.1.12 in TS 36.212 |
| | Number of OFDM symbols for legacy control channels | | 2 | Out of sync threshold Q_{out} and the corresponding hypothetical MPDCCH transmission parameters are as specified in section 7.19.2 and Table 7.19.2-1 respectively. |
| | M-PDCCH aggregation level | eCCE | 16 | |
| | M-PDCCH repetition level | | 4 | |
| | ρ_A, ρ_B | | -3 | |
| | | | | |
| DRX | | | OFF | |
| Layer 3 filtering | | | Enabled | Counters: N310 = 1; N311 = 1 |
| T310 timer | | ms | 2000 | T310 is enabled |
| T311 timer | | ms | 1000 | T311 is enabled |
| Periodic CQI reporting mode | | | PUCCH 1-0 | As defined in table 7.2.2-1 in TS 36.213. |
| CQI reporting periodicity | | ms | 2 | Minimum CQI reporting periodicity |
| T1 | | s | 2 | |
| T2 | | s | 0.8 | |
| T3 | | s | 1.36 | |
| T4 | | s | 0.4 | |
| T5 | | s | 2 | |
| Note 1: MPDCCH corresponding to the out of sync transmission parameters need not be included in the Reference Measurement Channel. | | | | |

Table A.7.3.49.1-2: Cell specific test parameters for E-UTRAN FD-FDD (cell # 1) for in-sync radio link monitoring tests for Cat-M1 in CEMode A

| Parameter | Unit | Test 1 | | | | |
|---|------|----------|----|----|----|----|
| | | T1 | T2 | T3 | T4 | T5 |
| E-UTRA RF Channel Number | | 1 | | | | |
| $BW_{channel}$ | MHz | 10 | | | | |
| MPDCCH parameters as defined in A.3.1.3.1 | | R.17 FDD | | | | |

| | | | | | | |
|--|------------|-----------|------|-------|------|-----|
| OCNG Pattern defined in A.3.2.1.21 (FDD) | | OP.21 FDD | | | | |
| ρ_A , dB | | -3 | | | | |
| MPDCCH_RA | dB | 0 | | | | |
| MPDCCH_RB | dB | 0 | | | | |
| PBCH_RA | dB | -3 | | | | |
| PBCH_RB | dB | | | | | |
| PSS_RA | dB | | | | | |
| SSS_RA | dB | | | | | |
| OCNG_RA ^{Note 1} | dB | | | | | |
| OCNG_RB ^{Note 1} | dB | | | | | |
| N_{oc} | dBm/15 kHz | -98 | | | | |
| SNR ^{Note 6} | dB | 5.4 | -3.8 | -12.8 | -1.6 | 5.4 |
| Propagation condition | | ETU 30Hz | | | | |
| Correlation Matrix and Antenna Configuration | | 2x1 Low | | | | |
| <p>Note 1: OCNG shall be used such that the resources in cell # 1 are fully allocated and a constant total transmitted power spectral density is achieved for all OFDM symbols.</p> <p>Note 2: The uplink resources for CQI reporting are assigned to the UE prior to the start of time period T1.</p> <p>Note 3: The timers and layer 3 filtering related parameters are configured prior to the start of time period T1.</p> <p>Note 4: The signal contains PDCCH for UEs other than the device under test as part of OCNG.</p> <p>Note 5: SNR levels correspond to the signal to noise ratio over the cell-specific reference signal REs.</p> <p>Note 6: The SNR in time periods T1, T2, T3, T4 and T5 is denoted as SNR1, SNR2, SNR3, SNR4 and SNR5 respectively in figure A.7.3.49.1-1.</p> | | | | | | |

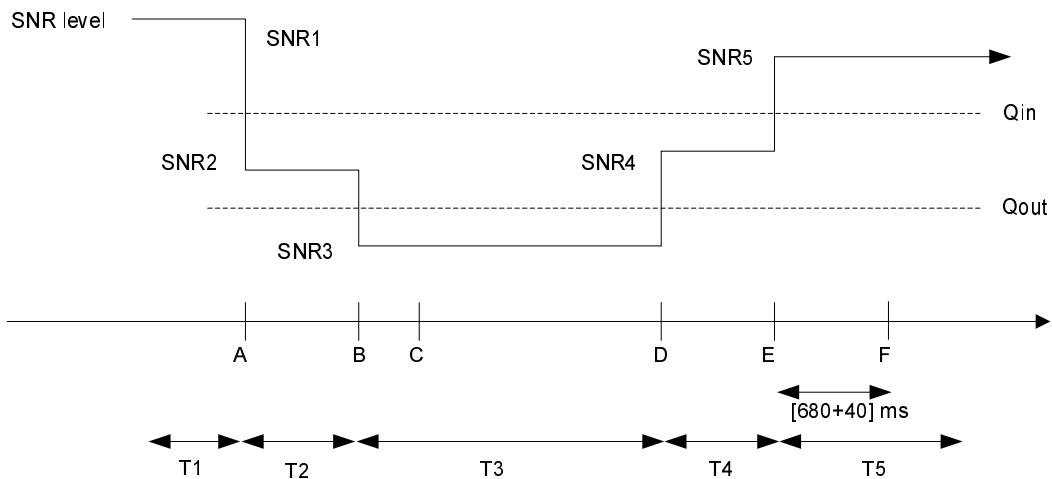

Figure A.7.3.49.1-1: SNR variation for in-sync testing

A.7.3.49.2 Test Requirements

The UE behaviour in each test during time durations T1, T2, T3, T4 and T5 shall be as follows:

During the period from time point A to time point F (720 ms after the start of time duration T5) the UE shall transmit uplink signal at least in all subframes configured for CQI transmission according to the configured CQI reporting mode (PUCCH 1-0).

The rate of correct events observed during repeated tests shall be at least 90%.

A.7.3.50 E-UTRAN FD-FDD Radio Link Monitoring Test for Out-of-sync in DRX for UE category M1 configured in CEMode A

A.7.3.50.1 Test Purpose and Environment

The purpose of this test is to verify that the FD-FDD category M1 UE configured in CEMode A properly detects the out of sync for the purpose of monitoring downlink radio link quality of the PCell when DRX is used. This test will partly verify the E-UTRAN FD-FDD radio link monitoring requirements in clause 7.19.

The test parameters are given in Tables A.7.3.50.1-1, A.7.3.50.1-2, A.7.3.50.1-3 and A.7.3.50.1-4. There is one cell (cell 1), which is the active cell, in the test. The test consists of three successive time periods, with time duration of T1, T2 and T3 respectively. Figure A.7.3.50.1-1 shows the variation of the downlink SNR in the active cell to emulate out-of-sync states. Prior to the start of the time duration T1, the UE shall be fully synchronized to cell 1. The UE shall be configured for periodic CQI reporting in PUCCH 1-0 mode with a reporting periodicity of 2 ms without repetition. In the test, DRX configuration is enabled and DRX inactivity timer has already been expired, i.e. UE tries to decode MPDCCH and to send periodic CQI during the period when On-duration timer is running. Time alignment timers shall be set to “infinity” so that UL timing alignment is maintained during the test.

In the test, the RRC parameter *numberPRB-Pairs* is set to 4 and the RRC parameter *mPDCCH-NumRepetition* is set 4. UE shall successfully complete the RRC reconfiguration accordingly prior to the start of time duration T1.

Table A.7.3.50.1-1: General test parameters for E-UTRAN FD-FDD out-of-sync tests in DRX for UE category M1 configured in CEMode A

| Parameter | | Unit | Value | Comment |
|--|--|------|------------------------|--|
| Active cell | | | Cell 1 | Cell 1 is on E-UTRA RF channel number 1 |
| CP length | | | Normal | |
| Out of sync transmission parameters (Note 1) | DCI format | | 6-1A | As defined in section 5.3.3.1.12 in TS 36.212 |
| | Number of OFDM symbols for legacy control channels | | 2 | Out of sync threshold $Q_{out, Cat M1}$ and the corresponding hypothetical MPDCCH transmission parameters are as specified in clause 7.19.2 and Table 7.19.2-1 respectively. |
| | MPDCCH aggregation level | eCCE | 16 | |
| | MPDCCH repletion level | | 4 | |
| | Ratio of MPDCCH to RS EPRE | | 0 | |
| | ρ_A, ρ_B | | -3 | |
| DRX cycle | ms | 1280 | See Table A.7.3.50.1-3 | |
| Layer 3 filtering | | | Enabled | Counters: N310 = 1; N311 = 1 |
| T310 timer | | ms | 0 | T310 is disabled |
| T311 timer | | ms | 1000 | T311 is enabled |
| Periodic CQI reporting mode | | | PUCCH 1-0 | As defined in table 7.2.2-1 in TS 36.213. |
| CQI reporting periodicity | | ms | 2 | Minimum CQI reporting periodicity |
| T1 | | s | 32 | |
| T2 | | s | 12.8 | |
| T3 | | s | 13 | |
| Note 1: MPDCCH corresponding to the out of sync transmission parameters need not be included in the Reference Measurement Channel. | | | | |

Table A.7.3.50.1-2: Cell specific test parameters for E-UTRAN FD-FDD (cell # 1) for out-of-sync radio link monitoring tests in DRX for UE category M1 configured in CEMode A

| Parameter | Unit | Test 1 | | |
|--|------------|-----------|-------|--------|
| | | T1 | T2 | T3 |
| E-UTRA RF Channel Number | | 1 | | |
| $BW_{channel}$ | MHz | 10 | | |
| MPDCCH parameters defined in A.3.1.3 | | R.17 FDD | | |
| OCNG Pattern defined in A.3.2.1 (FDD) | | OP.21 FDD | | |
| ρ_A, ρ_B | | -3 | | |
| MPDCCH_RA | dB | 0 | | |
| MPDCCH_RB | dB | 0 | | |
| PBCH_RA | dB | -3 | | |
| PBCH_RB | dB | | | |
| PSS_RA | dB | | | |
| SSS_RA | dB | | | |
| OCNG_RA ^{Note1} | dB | | | |
| OCNG_RB ^{Note1} | dB | | | |
| N_{oc} | dBm/15 kHz | | | |
| SNR ^{Note 6} | dB | 0.37 | -6.98 | -14.98 |
| Propagation condition | | AWGN | | |
| Correlation Matrix and Antenna Configuration | | 2x1 | | |

| | |
|---------|--|
| Note 1: | OCNG shall be used such that the resources in cell # 1 are fully allocated and a constant total transmitted power spectral density is achieved for all OFDM symbols. |
| Note 2: | The uplink resources for CQI reporting are assigned to the UE prior to the start of time period T1. |
| Note 3: | The timers and layer 3 filtering related parameters are configured prior to the start of time period T1. |
| Note 4: | The signal contains MPDCCH for UEs other than the device under test as part of OCNG. |
| Note 5: | SNR levels correspond to the signal to noise ratio over the cell-specific reference signal REs. |
| Note 6: | The SNR in time periods T1, T2 and T3 is denoted as SNR1, SNR2 and SNR3 respectively in figure A.7.3.50.1-1. |

Table A.7.3.50.1-3: DRX-Configuration for E-UTRAN FD-FDD out-of-sync tests for UE category M1 configured in CEMode A

| Field | Value | Comment |
|--------------------------|---------|---|
| onDurationTimer | psf10 | As specified in clause 6.3.2 in TS 36.331 |
| drx-InactivityTimer | psf1 | |
| drx-RetransmissionTimer | psf1 | |
| longDRX-CycleStartOffset | sf1280 | |
| shortDRX | disable | |

Table A.7.3.50.1-4: TimeAlignmentTimer-Configuration for E-UTRAN FD-FDD out-of-sync testing for UE category M1 configured in CEMode A

| Field | Value | Comment |
|--------------------|----------|--|
| TimeAlignmentTimer | infinity | As specified in clause 6.3.2 in TS 36.331 |
| sr-ConfigIndex | 30 | For further information see clause 6.3.2 in TS 36.331 and section 10.1 in TS 36.213. |

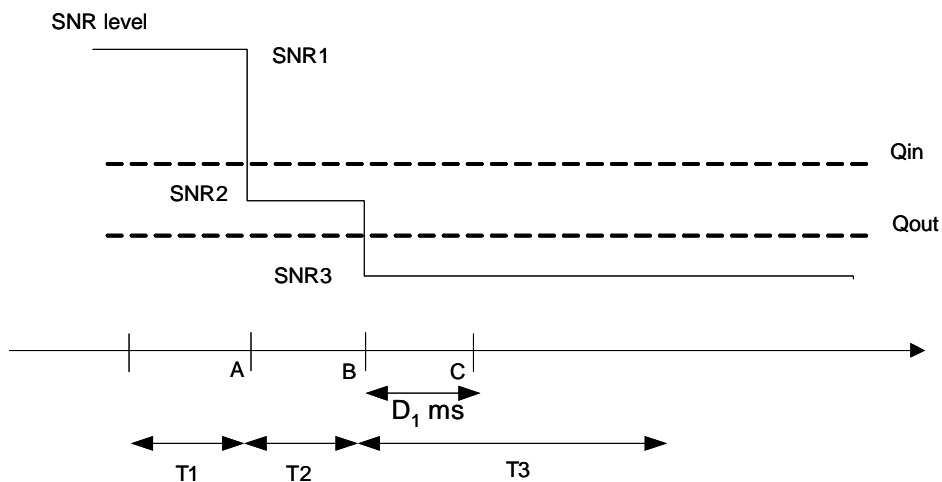

Figure A.7.3.50.1-1: SNR variation for out-of-sync testing in DRX

A.7.3.50.2 Test Requirements

The UE behaviour in each test during time durations T1, T2 and T3 shall be as follows:

During the period from time point A to time point B the UE shall transmit uplink signal at least once every DRX cycle, in the On-duration part of the cycle in the subframe according to the configured CQI reporting mode (PUCCH 1-0).

The UE shall stop transmitting uplink signal no later than time point C (duration $D_1 = 6500$ ms after the start of time duration T3).

The rate of correct events observed during repeated tests shall be at least 90%.

A.7.3.51 E-UTRAN FD-FDD Radio Link Monitoring Test for In-sync in DRX for UE Category M1 configured in CEMode A

A.7.3.51.1 Test Purpose and Environment

The purpose of this test is to verify that the FD-FDD category M1 UE configured in CEMode A properly detects the out of sync and in sync for the purpose of monitoring downlink radio link quality of the PCell when DRX is used. This test will partly verify the E-UTRAN FD-FDD radio link monitoring requirements in clause 7.19.

The test parameters are given in Tables A.7.3.51.1-1, A.7.3.51.1-2, A.7.3.51.1-3 and A.7.3.51.1-4. There is one cell (cell 1), which is the active cell, in the test. The test consists of five successive time periods, with time duration of T1, T2, T3, T4 and T5 respectively. Figure A.7.3.51.1-1 shows the variation of the downlink SNR in the active cell to emulate out-of-sync and in-sync states. Prior to the start of the time duration T1, the UE shall be fully synchronized to cell 1. The UE shall be configured for periodic CQI reporting in PUCCH 1-0 mode with a reporting periodicity of 2 ms without repetition. In the test, DRX configuration is enabled and DRX inactivity timer has already been expired, i.e. UE tries to decode MPDCCH and to send periodic CQI during the period when On-duration timer is running. Time alignment timers shall be set to “infinity” so that UL timing alignment is maintained during the test.

In the test, the RRC parameter *numberPRB-Pairs* is set to 6 and the RRC parameter *mPDCCH-NumRepetition* is set 8. UE shall successfully complete the RRC reconfiguration accordingly prior to the start of time duration T1.

Table A.7.3.51.1-1: General test parameters for E-UTRAN FD-FDD in-sync test in DRX for UE category M1 configured in CEMode A

| Parameter | | Unit | Value | Comment |
|--|--|------|-----------|--|
| Active cell | | | Cell 1 | Cell 1 is on E-UTRA RF channel number 1 |
| CP length | | | Normal | |
| In sync transmission parameters (Note 1) | DCI format | | 6-1A | As defined in section 5.3.3.1.12 in TS 36.212 |
| | Number of OFDM symbols for legacy control channels | | 2 | In sync threshold $Q_{in, Cat M1}$ and the corresponding hypothetical MPDCCH transmission parameters are as specified in clause 7.19.2 and Table 7.19.2-1 respectively. |
| | MPDCCH aggregation level | eCCE | 8 | |
| | MPDCCH repetition level | | 4 | |
| | ρ_A, ρ_B | | -3 | |
| Ratio of MPDCCH to RS EPRE | | 0 | | |
| Out of sync transmission parameters (Note 1) | DCI format | | 6-1A | As defined in section 5.3.3.1.12 in TS 36.212 |
| | Number of OFDM symbols for legacy control channels | | 2 | Out of sync threshold $Q_{out, Cat M1}$ and the corresponding hypothetical MPDCCH transmission parameters are as specified in clause 7.19.2 and Table 7.19.2-1 respectively. |
| | MPDCCH aggregation level | eCCE | 24 | |
| | MPDCCH repetition level | | 8 | |
| | ρ_A, ρ_B | | -3 | |
| Ratio of MPDCCH to RS EPRE | dB | 0 | | |
| DRX cycle | | ms | 40 | See Table A.7.3.51.1-3 |
| Layer 3 filtering | | | Enabled | Counters: $N_{310} = 1$; $N_{311} = 1$ |
| T310 timer | | ms | 2000 | T310 is enabled |
| T311 timer | | ms | 1000 | T311 is enabled |
| Periodic CQI reporting mode | | | PUCCH 1-0 | As defined in table 7.2.2-1 in |

| | | | |
|--|----|------|-----------------------------------|
| | | | TS 36.213. |
| CQI reporting periodicity | ms | 2 | Minimum CQI reporting periodicity |
| T1 | s | 4 | |
| T2 | s | 1.6 | |
| T3 | s | 1.46 | |
| T4 | s | 0.4 | |
| T5 | s | 4 | |
| Note 1: MPDCCH corresponding to the in-sync and out of sync transmission parameters need not be included in the Reference Measurement Channel. | | | |

Table A.7.3.51.1-2: Cell specific test parameters for E-UTRAN FD-FDD (cell # 1) for in-sync radio link monitoring test in DRX for UE category M1 configured in CEMode A

| Parameter | Unit | Test 1 | | | | |
|--|------------|-----------|-----|-----|--------|-------|
| | | T1 | T2 | T3 | T4 | T5 |
| E-UTRA RF Channel Number | | 1 | | | | |
| BW _{channel} | MHz | 10 | | | | |
| MPDCCH parameters defined in A.3.1.3 | | R.17 FDD | | | | |
| OCNG Pattern defined in A.3.2.1 (FDD) | | OP.21 FDD | | | | |
| ρ_A, ρ_B | | -3 | | | | |
| MPDCCH_RA | dB | 0 | | | | |
| MPDCCH_RB | dB | 0 | | | | |
| PBCH_RA | dB | -3 | | | | |
| PBCH_RB | dB | | | | | |
| PSS_RA | dB | | | | | |
| SSS_RA | dB | | | | | |
| OCNG_RA ^{Note1} | dB | | | | | |
| OCNG_RB ^{Note1} | dB | | | | | |
| N_{oc} | dBm/15 kHz | -98 | | | | |
| SNR ^{Note 8} | dB | -4.58 | -10 | -18 | -10.58 | -4.58 |
| Propagation condition | | AWGN | | | | |
| Correlation Matrix and Antenna Configuration | | 2x1 | | | | |
| Note 1: OCNG shall be used such that the resources in cell # 1 are fully allocated and a constant total transmitted power spectral density is achieved for all OFDM symbols. Note 2: The uplink resources for CQI reporting are assigned to the UE prior to the start of time period T1. Note 3: The timers and layer 3 filtering related parameters are configured prior to the start of time period T1. Note 4: The signal contains MPDCCH for UEs other than the device under test as part of OCNG. Note 5: SNR levels correspond to the signal to noise ratio over the cell-specific reference signal REs. Note 6: The SNR in time periods T1, T2, T3, T4 and T5 is denoted as SNR1, SNR2, SNR3, SNR4 and SNR5 respectively in figure A.7.3.51.1-1. | | | | | | |

Table A.7.3.51.1-3: DRX-Configuration for E-UTRAN FD-FDD out-of-sync tests for UE category M1 configured in CEMode A

| Field | Value | Comment |
|--------------------------|---------|---|
| onDurationTimer | psf10 | As specified in clause 6.3.2 in TS 36.331 |
| drx-InactivityTimer | psf1 | |
| drx-RetransmissionTimer | psf1 | |
| longDRX-CycleStartOffset | sf40 | |
| shortDRX | disable | |

Table A.7.3.51.1-4: TimeAlignmentTimer-Configuration for E-UTRAN FD-FDD out-of-sync testing for UE category M1 configured in CEMode A

| Field | Value | Comment |
|-------|-------|---------|
| | | |

| | | |
|--------------------|----------|--|
| TimeAlignmentTimer | infinity | As specified in clause 6.3.2 in TS 36.331 |
| sr-ConfigIndex | 30 | For further information see clause 6.3.2 in TS 36.331 and section 10.1 in TS 36.213. |

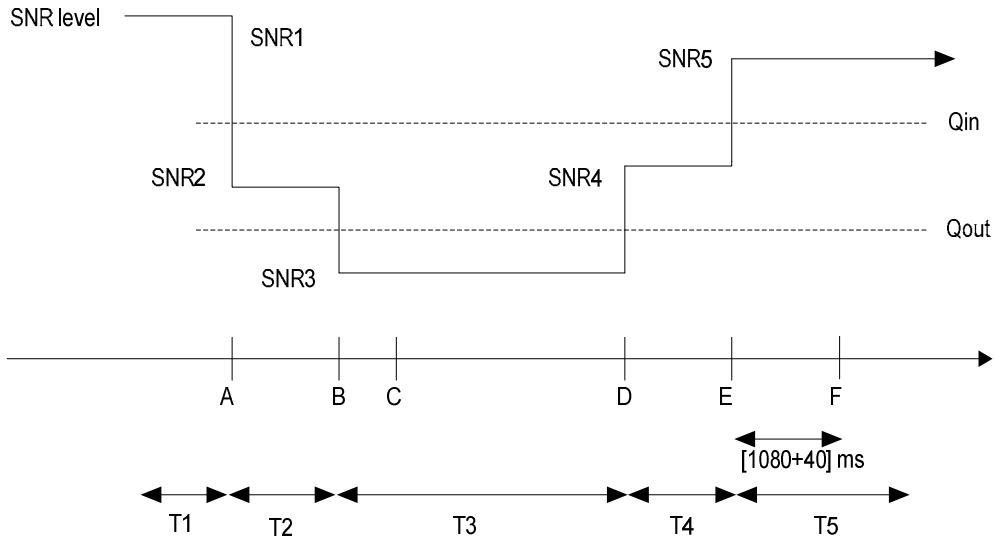

Figure A.7.3.51.1-1: SNR variation for in-sync testing in DRX

A.7.3.51.2 Test Requirements

The UE behaviour in each test during time durations T1, T2, T3, T4 and T5 shall be as follows:

During the period from time point A to time point F (1120 ms after the start of time duration T5) the UE shall transmit uplink signal at least once every DRX cycle, in the On-duration part of the cycle in the subframe according to the configured CQI reporting mode (PUCCH 1-0).

The rate of correct events observed during repeated tests shall be at least 90%.

A.7.3.52 E-UTRAN HD-FDD Radio Link Monitoring Test for Out-of-sync for Cat-M1 UE in CEMode A

A.7.3.52.1 Test Purpose and Environment

The purpose of this test is to verify that the HD-FDD Cat-M1 UE properly detects the out of sync and in sync for the purpose of monitoring downlink radio link quality of the PCell in CEModeA. This test will partly verify the E-UTRAN FDD radio link monitoring requirements for Cat-M1 UE defined in clause 7.19.

The test parameters are given in Tables A.7.3.52.1-1 and A.7.3.52.1-2 below. There is one cell (cell 1), which is the active cell, in the test. The test consists of three successive time periods, with time duration of T1, T2 and T3 respectively. Figure A.7.3.52.1-1 shows the variation of the downlink SNR in the active cell to emulate out-of-sync and in-sync states. Prior to the start of the time duration T1, the UE shall be fully synchronized to cell 1. The UE shall be configured for periodic CQI reporting in PUCCH 1-0 mode without repetition with a reporting periodicity of 20 ms.

In the test, the RRC parameter *numberPRB-Pairs* is set to 6 and the RRC parameter *mPDCCH-NumRepetition* is set to 8. UE shall successfully complete the RRC reconfiguration accordingly prior to the start of time duration T1.

Table A.7.3.52.1-1: General test parameters for E-UTRAN HD-FDD out-of-sync testing for UE Cat-M1 in CEMode A

| Parameter | | Unit | Value | Comment |
|---|--|------|-----------|---|
| Active cell | | | Cell 1 | Cell 1 is on E-UTRA RF channel number 1 |
| CP length | | | Normal | |
| Out of sync transmission parameters (Note 1) | DCI format | | 6-1A | As defined in section 5.3.3.1.12 in TS 36.212 |
| | Number of OFDM symbols for legacy control channels | | 2 | Out of sync threshold Q_{out} and the corresponding hypothetical MPDCCH transmission parameters are as specified in section 7.19.2 and Table 7.19.2-1 respectively. |
| | M-PDCCH aggregation level | eCCE | 24 | |
| | M-PDCCH repetition level | | 8 | |
| | ρ_A, ρ_B | | -3 | |
| DRX | | | OFF | |
| Layer 3 filtering | | | Enabled | Counters: N310 = 1; N311 = 1 |
| T310 timer | | ms | 0 | T310 is disabled |
| T311 timer | | ms | 1000 | T311 is enabled |
| Periodic CQI reporting mode | | | PUCCH 1-0 | As defined in table 7.2.2-1 in TS 36.213. |
| CQI reporting periodicity | | ms | 20 | Minimum CQI reporting periodicity |
| T1 | | s | 2 | |
| T2 | | s | 0.8 | |
| T3 | | s | 1.8 | |
| Note 1: MPDCCH transmission parameters corresponding to the in-sync and out of sync transmission need not be included in the Reference Measurement Channel. | | | | |

Table A.7.3.52.1-2: Cell specific test parameters for E-UTRAN HD-FDD (cell # 1) for out-of-sync radio link monitoring tests for Cat-M1 in CEMode A

| Parameter | Unit | Test 1 | | |
|---|------------|------------|----|----|
| | | T1 | T2 | T3 |
| E-UTRA RF Channel Number | | 1 | | |
| $BW_{channel}$ | MHz | 10 | | |
| MPDCCH parameters as defined in A.3.1.3.1 | | R.7 HD-FDD | | |
| OCNG Pattern defined in A.3.2.1.21 (FDD) | | OP.21 FDD | | |
| ρ_A, ρ_B | | -3 | | |
| MPDCCH_RA | dB | 0 | | |
| MPDCCH_RB | dB | 0 | | |
| PBCH_RA | dB | -3 | | |
| PBCH_RB | dB | | | |
| PSS_RA | dB | | | |
| SSS_RA | dB | | | |
| OCNG_RA ^{Note 1} | dB | | | |
| OCNG_RB ^{Note 1} | dB | | | |
| N_{oc} | dBm/15 kHz | | | |

| | | | | |
|--|----|----------|------|-------|
| SNR ^{Note 6} | dB | 0.1 | -6.8 | -15.8 |
| Propagation condition | | ETU 30Hz | | |
| Correlation Matrix and Antenna Configuration | | 2x1 Low | | |
| <p>Note 1: OCNG shall be used such that the resources in cell # 1 are fully allocated and a constant total transmitted power spectral density is achieved for all OFDM symbols.</p> <p>Note 2: The uplink resources for CQI reporting are assigned to the UE prior to the start of time period T1.</p> <p>Note 3: The timers and layer 3 filtering related parameters are configured prior to the start of time period T1.</p> <p>Note 4: The signal contains PDCCH for UEs other than the device under test as part of OCNG.</p> <p>Note 5: SNR levels correspond to the signal to noise ratio over the cell-specific reference signal REs.</p> <p>Note 6: The SNR in time periods T1, T2 and T3 is denoted as SNR1, SNR2 and SNR3 respectively in figure A.7.3.52.1-1.</p> | | | | |

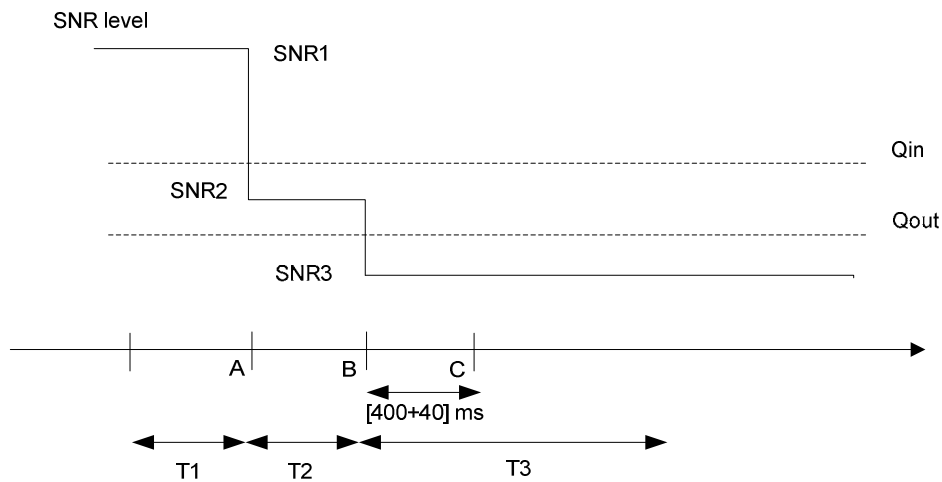

Figure A.7.3.52.1-1: SNR variation for out-of-sync testing

A.7.3.52.2 Test Requirements

The UE behaviour in each test during time durations T1, T2 and T3 shall be as follows:

During the period from time point A to time point B the UE shall transmit uplink signal at least in all subframes configured for CQI transmission according to the configured CQI reporting mode (PUCCH 1-0).

The UE shall stop transmitting uplink signal no later than time point C (440 ms after the start of time duration T3).

The rate of correct events observed during repeated tests shall be at least 90%.

A.7.3.53 E-UTRAN HD-FDD Radio Link Monitoring Test for In-Sync for Cat-M1 UE in CEMode A

A.7.3.53.1 Test Purpose and Environment

The purpose of this test is to verify that the HD-FDD Cat-M1 UE properly detects the out of sync and in sync for the purpose of monitoring downlink radio link quality of the PCell in CEModeA. This test will partly verify the E-UTRAN FDD radio link monitoring requirements for Cat-M1 UE defined in clause 7.19.

The test parameters are given in Tables A.7.3.53.1-1 and A.7.3.53.1-2 below. There is one cell (cell 1), which is the active cell, in the test. The test consists of five successive time periods, with time duration of T1, T2, T3, T4 and T5 respectively. Figure A.7.3.53.1-1 shows the variation of the downlink SNR in the active cell to emulate out-of-sync and in-sync states. Prior to the start of the time duration T1, the UE shall be fully synchronized to cell 1. The UE shall be configured for periodic CQI reporting in PUCCH 1-0 mode without repetition with a reporting periodicity of 20 ms.

In the test, the RRC parameter *numberPRB-Pairs* is set to 4 and the RRC parameter *mPDCCH-NumRepetition* is set to 4. UE shall successfully complete the RRC reconfiguration accordingly prior to the start of time duration T1.

Table A.7.3.53.1-1: General test parameters for E-UTRAN HD-FDD in-sync testing for UE Cat-M1 in CEMode A

| Parameter | | Unit | Value | Comment |
|--|--|------|-----------|---|
| Active cell | | | Cell 1 | Cell 1 is on E-UTRA RF channel number 1 |
| CP length | | | Normal | |
| In sync transmission parameters (Note 1) | DCI format | | 6-1A | As defined in section 5.3.3.1.12 in TS 36.212 |
| | Number of OFDM symbols for legacy control channels | | 2 | In sync threshold Q_{in} and the corresponding hypothetical MPDCCH transmission parameters are as specified in section 7.19.2 and Table 7.19.2-1 respectively. |
| | M-PDCCH aggregation level | eCCE | 4 | |
| | M-PDCCH repetition level | | 2 | |
| | ρ_A, ρ_B | | -3 | |
| Out of sync transmission parameters (Note 1) | DCI format | | 6-1A | As defined in section 5.3.3.1.12 in TS 36.212 |
| | Number of OFDM symbols for legacy control channels | | 2 | Out of sync threshold Q_{out} and the corresponding hypothetical MPDCCH transmission parameters are as specified in section 7.19.2 and Table 7.19.2-1 respectively. |
| | M-PDCCH aggregation level | eCCE | 16 | |
| | M-PDCCH repetition level | | 4 | |
| | ρ_A, ρ_B | | -3 | |
| DRX | | | OFF | |
| Layer 3 filtering | | | Enabled | Counters: N310 = 1; N311 = 1 |
| T310 timer | | ms | 2000 | T310 is enabled |
| T311 timer | | ms | 1000 | T311 is enabled |
| Periodic CQI reporting mode | | | PUCCH 1-0 | As defined in table 7.2.2-1 in TS 36.213. |
| CQI reporting periodicity | | ms | 20 | Minimum CQI reporting periodicity |
| T1 | | s | 2 | |
| T2 | | s | 0.8 | |
| T3 | | s | 1.36 | |
| T4 | | s | 0.4 | |
| T5 | | s | 2 | |
| Note 1: MPDCCH corresponding to the out of sync transmission parameters need not be included in the Reference Measurement Channel. | | | | |

Table A.7.3.53.1-2: Cell specific test parameters for E-UTRAN HD-FDD (cell # 1) for in-sync radio link monitoring tests for Cat-M1 in CEMode A

| Parameter | Unit | Test 1 |
|-----------|------|--------|
|-----------|------|--------|

| | | T1 | T2 | T3 | T4 | T5 |
|--|------------|------------|------|-------|------|-----|
| E-UTRA RF Channel Number | | 1 | | | | |
| BW _{channel} | MHz | 10 | | | | |
| MPDCCH parameters as defined in A.3.1.3.1 | | R.7 HD-FDD | | | | |
| OCNG Pattern defined in A.3.2.1.21 (FDD) | | OP.21 FDD | | | | |
| ρ_A, ρ_B | | -3 | | | | |
| MPDCCH_RA | dB | 0 | | | | |
| MPDCCH_RB | dB | 0 | | | | |
| PBCH_RA | dB | -3 | | | | |
| PBCH_RB | dB | | | | | |
| PSS_RA | dB | | | | | |
| SSS_RA | dB | | | | | |
| OCNG_RA ^{Note 1} | dB | | | | | |
| OCNG_RB ^{Note 1} | dB | | | | | |
| N_{oc} | dBm/15 kHz | -98 | | | | |
| SNR ^{Note 6} | dB | 5.4 | -3.8 | -12.8 | -1.6 | 5.4 |
| Propagation condition | | ETU 30Hz | | | | |
| Correlation Matrix and Antenna Configuration | | 2x1 Low | | | | |
| <p>Note 1: OCNG shall be used such that the resources in cell # 1 are fully allocated and a constant total transmitted power spectral density is achieved for all OFDM symbols.</p> <p>Note 2: The uplink resources for CQI reporting are assigned to the UE prior to the start of time period T1.</p> <p>Note 3: The timers and layer 3 filtering related parameters are configured prior to the start of time period T1.</p> <p>Note 4: The signal contains PDCCH for UEs other than the device under test as part of OCNG.</p> <p>Note 5: SNR levels correspond to the signal to noise ratio over the cell-specific reference signal REs.</p> <p>Note 6: The SNR in time periods T1, T2, T3, T4 and T5 is denoted as SNR1, SNR2, SNR3, SNR4 and SNR5 respectively in figure A.7.3.53.1-1.</p> | | | | | | |

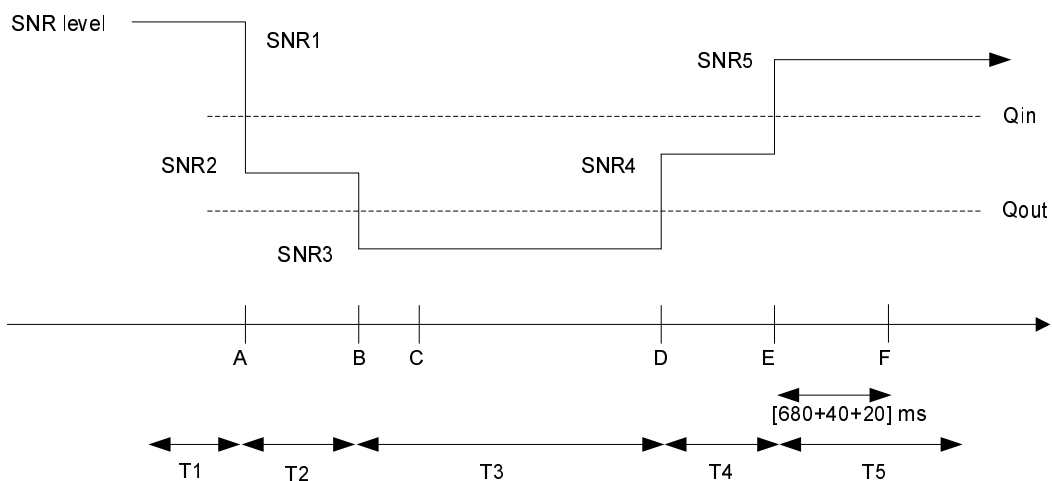

Figure A.7.3.53.1-1: SNR variation for in-sync testing

A.7.3.53.2 Test Requirements

The UE behaviour in each test during time durations T1, T2, T3, T4 and T5 shall be as follows:

During the period from time point A to time point F (740 ms after the start of time duration T5) the UE shall transmit uplink signal at least in all subframes configured for CQI transmission according to the configured CQI reporting mode (PUCCH 1-0).

The rate of correct events observed during repeated tests shall be at least 90%.

A.7.3.54 E-UTRAN HD-FDD Radio Link Monitoring Test for Out-of-sync in DRX for UE category M1 configured in CEMode A

A.7.3.54.1 Test Purpose and Environment

The purpose of this test is to verify that the HD-FDD category M1 UE configured in CEMode A properly detects the out of sync for the purpose of monitoring downlink radio link quality of the PCell when DRX is used. This test will partly verify the E-UTRAN HD-FDD radio link monitoring requirements in clause 7.19.

The test parameters are given in Tables A.7.3.54.1-1, A.7.3.54.1-2, A.7.3.54.1-3 and A.7.3.54.1-4. There is one cell (cell 1), which is the active cell, in the test. The test consists of three successive time periods, with time duration of T1, T2 and T3 respectively. Figure A.7.3.54.1-1 shows the variation of the downlink SNR in the active cell to emulate out-of-sync states. Prior to the start of the time duration T1, the UE shall be fully synchronized to cell 1. The UE shall be configured for periodic CQI reporting in PUCCH 1-0 mode with a reporting periodicity of 20 ms without repetition. In the test, DRX configuration is enabled and DRX inactivity timer has already been expired, i.e. UE tries to decode MPDCCH and to send periodic CQI during the period when On-duration timer is running. Time alignment timers shall be set to "infinity" so that UL timing alignment is maintained during the test.

In the test, the RRC parameter *numberPRB-Pairs* is set to 4 and the RRC parameter *mPDCCH-NumRepetition* is set 4. UE shall successfully complete the RRC reconfiguration accordingly prior to the start of time duration T1.

Table A.7.3.54.1-1: General test parameters for E-UTRAN HD-FDD out-of-sync tests in DRX for UE category M1 configured in CEMode A

| Parameter | | Unit | Value | Comment |
|--|--|------|-----------|--|
| Active cell | | | Cell 1 | Cell 1 is on E-UTRA RF channel number 1 |
| CP length | | | Normal | |
| Out of sync transmission parameters (Note 1) | DCI format | | 6-1A | As defined in section 5.3.3.1.12 in TS 36.212 |
| | Number of OFDM symbols for legacy control channels | | 2 | Out of sync threshold $Q_{out, Cat M1}$ and the corresponding hypothetical MPDCCH transmission parameters are as specified in clause 7.19.2 and Table 7.19.2-1 respectively. |
| | MPDCCH aggregation level | eCCE | 16 | |
| | MPDCCH repletion level | | 4 | |
| | ρ_A, ρ_B | | -3 | |
| | Ratio of PDCCH to RS EPRE | dB | 0 | |
| DRX cycle | | ms | 1280 | See Table A.7.3.54.1-3 |
| Layer 3 filtering | | | Enabled | Counters: N310 = 1; N311 = 1 |
| T310 timer | | ms | 0 | T310 is disabled |
| T311 timer | | ms | 1000 | T311 is enabled |
| Periodic CQI reporting mode | | | PUCCH 1-0 | As defined in table 7.2.2-1 in TS 36.213. |
| CQI reporting periodicity | | ms | 20 | |
| T1 | | s | 32 | |
| T2 | | s | 12.8 | |
| T3 | | s | 13 | |
| Note 1: MPDCCH corresponding to the out of sync transmission parameters need not be included in the Reference Measurement Channel. | | | | |

Table A.7.3.54.1-2: Cell specific test parameters for E-UTRAN HD-FDD (cell # 1) for out-of-sync radio link monitoring tests in DRX for UE category M1 configured in CEMode A

| Parameter | Unit | Test 1 | | |
|--|------------|------------|-------|--------|
| | | T1 | T2 | T3 |
| E-UTRA RF Channel Number | | 1 | | |
| BW _{channel} | MHz | 10 | | |
| MPDCCH parameters defined in A.3.1.3 | | R.7 HD-FDD | | |
| OCNG Pattern defined in A.3.2.1 (FDD) | | OP.21 FDD | | |
| ρ_A, ρ_B | | -3 | | |
| MPDCCH_RA | dB | 0 | | |
| MPDCCH_RB | dB | 0 | | |
| PBCH_RA | dB | -3 | | |
| PBCH_RB | dB | | | |
| PSS_RA | dB | | | |
| SSS_RA | dB | | | |
| OCNG_RA ^{Note1} | dB | | | |
| OCNG_RB ^{Note1} | dB | | | |
| N_{oc} | dBm/15 kHz | -98 | | |
| SNR ^{Note 6} | dB | 0.37 | -6.98 | -14.98 |
| Propagation condition | | AWGN | | |
| Correlation Matrix and Antenna Configuration | | 2x1 | | |

| | |
|---------|--|
| Note 1: | OCNG shall be used such that the resources in cell # 1 are fully allocated and a constant total transmitted power spectral density is achieved for all OFDM symbols. |
| Note 2: | The uplink resources for CQI reporting are assigned to the UE prior to the start of time period T1. |
| Note 3: | The timers and layer 3 filtering related parameters are configured prior to the start of time period T1. |
| Note 4: | The signal contains MPDCCH for UEs other than the device under test as part of OCNG. |
| Note 5: | SNR levels correspond to the signal to noise ratio over the cell-specific reference signal REs. |
| Note 6: | The SNR in time periods T1, T2 and T3 is denoted as SNR1, SNR2 and SNR3 respectively in figure A.7.3.54.1-1. |

Table A.7.3.54.1-3: DRX-Configuration for E-UTRAN HD-FDD out-of-sync tests for UE category M1 configured in CEMode A

| Field | Value | Comment |
|--------------------------|---------|---|
| onDurationTimer | psf20 | As specified in clause 6.3.2 in TS 36.331 |
| drx-InactivityTimer | psf1 | |
| drx-RetransmissionTimer | psf1 | |
| longDRX-CycleStartOffset | sf1280 | |
| shortDRX | disable | |

Table A.7.3.54.1-4: TimeAlignmentTimer -Configuration for E-UTRAN HD-FDD out-of-sync testing for UE category M1 configured in CEMode A

| Field | Value | Comment |
|--------------------|----------|--|
| TimeAlignmentTimer | infinity | As specified in clause 6.3.2 in TS 36.331 |
| sr-ConfigIndex | 30 | For further information see clause 6.3.2 in TS 36.331 and section 10.1 in TS 36.213. |

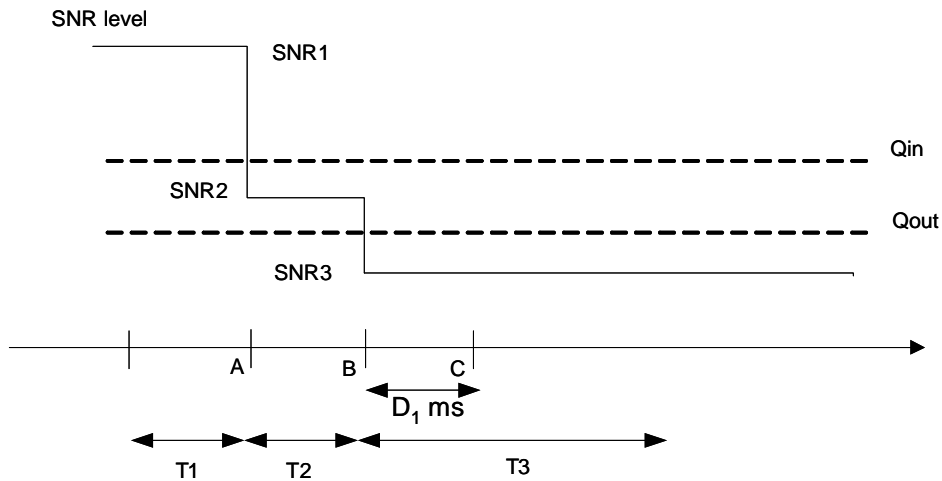

Figure A.7.3.54.1-1: SNR variation for out-of-sync testing in DRX

A.7.3.54.2 Test Requirements

The UE behaviour in each test during time durations T1, T2 and T3 shall be as follows:

During the period from time point A to time point B the UE shall transmit uplink signal at least once every DRX cycle, in the On-duration part of the cycle in the subframe according to the configured CQI reporting mode (PUCCH 1-0).

The UE shall stop transmitting uplink signal no later than time point C (duration $D_1 = 6520$ ms after the start of time duration T3).

The rate of correct events observed during repeated tests shall be at least 90%.

A.7.3.55 E-UTRAN HD-FDD Radio Link Monitoring Test for In-sync in DRX for UE Category M1 configured in CEMode A

A.7.3.55.1 Test Purpose and Environment

The purpose of this test is to verify that the HD-FDD category M1 UE configured in CEMode A properly detects the out of sync and in sync for the purpose of monitoring downlink radio link quality of the PCell when DRX is used. This test will partly verify the E-UTRAN HD-FDD radio link monitoring requirements in clause 7.19.

The test parameters are given in Tables A.7.3.55.1-1, A.7.3.55.1-2, A.7.3.55.1-3 and A.7.3.55.1-4. There is one cell (cell 1), which is the active cell, in the test. The test consists of five successive time periods, with time duration of T1, T2, T3, T4 and T5 respectively. Figure A.7.3.55.1-1 shows the variation of the downlink SNR in the active cell to emulate out-of-sync and in-sync states. Prior to the start of the time duration T1, the UE shall be fully synchronized to cell 1. The UE shall be configured for periodic CQI reporting in PUCCH 1-0 mode with a reporting periodicity of 20 ms without repetition. In the test, DRX configuration is enabled and DRX inactivity timer has already been expired, i.e. UE tries to decode MPDCCH and to send periodic CQI during the period when On-duration timer is running. Time alignment timers shall be set to “infinity” so that UL timing alignment is maintained during the test.

In the test, the RRC parameter *numberPRB-Pairs* is set to 6 and the RRC parameter *mPDCCH-NumRepetition* is set 8. UE shall successfully complete the RRC reconfiguration accordingly prior to the start of time duration T1.

Table A.7.3.55.1-1: General test parameters for E-UTRAN HD-FDD in-sync test in DRX for UE category M1 configured in CEMode A

| Parameter | | Unit | Value | Comment |
|--|--|------|-----------|--|
| Active cell | | | Cell 1 | Cell 1 is on E-UTRA RF channel number 1 |
| CP length | | | Normal | |
| In sync transmission parameters (Note 1) | DCI format | | 6-1A | As defined in section 5.3.3.1.12 in TS 36.212 |
| | Number of OFDM symbols for legacy control channels | | 2 | In sync threshold $Q_{in, Cat M1}$ and the corresponding hypothetical MPDCCH transmission parameters are as specified in clause 7.19.2 and Table 7.19.2-1 respectively. |
| | MPDCCH aggregation level | eCCE | 8 | |
| | MPDCCH repetition level | | 4 | |
| | ρ_A, ρ_B | | -3 | |
| Ratio of MPDCCH to RS EPRE | | 0 | | |
| Out of sync transmission parameters (Note 1) | DCI format | | 6-1A | As defined in TS 36.212 |
| | Number of OFDM symbols for legacy control channels | | 2 | Out of sync threshold $Q_{out, Cat M1}$ and the corresponding hypothetical MPDCCH transmission parameters are as specified in clause 7.19.2 and Table 7.19.2-1 respectively. |
| | MPDCCH aggregation level | eCCE | 24 | |
| | MPDCCH repetition level | | 8 | |
| | ρ_A, ρ_B | | -3 | |
| Ratio of MPDCCH to RS EPRE | dB | 0 | | |
| DRX cycle | | ms | 40 | See Table A.7.3.55.1-3 |
| Layer 3 filtering | | | Enabled | Counters: N310 = 1; N311 = 1 |
| T310 timer | | ms | 2000 | T310 is enabled |
| T311 timer | | ms | 1000 | T311 is enabled |
| Periodic CQI reporting mode | | | PUCCH 1-0 | As defined in table 7.2.2-1 in TS 36.213. |

| | | | |
|--|----|------|--|
| CQI reporting periodicity | ms | 20 | |
| T1 | s | 4 | |
| T2 | s | 1.6 | |
| T3 | s | 1.46 | |
| T4 | s | 0.4 | |
| T5 | s | 4 | |
| Note 1: MPDCCH corresponding to the in-sync and out of sync transmission parameters need not be included in the Reference Measurement Channel. | | | |

Table A.7.3.55.1-2: Cell specific test parameters for E-UTRAN HD-FDD (cell # 1) for in-sync radio link monitoring test in DRX for UE category M1 configured in CEMode A

| Parameter | Unit | Test 1 | | | | | | | | | |
|--|------------|------------|-----|-----|--------|-------|----|--|--|--|--|
| | | T1 | T2 | T3 | T4 | T5 | | | | | |
| E-UTRA RF Channel Number | | 1 | | | | | | | | | |
| BW _{channel} | MHz | 10 | | | | | | | | | |
| MPDCCH parameters defined in A.3.1.3 | | R.7 HD-FDD | | | | | | | | | |
| OCNG Pattern defined in A.3.2.1 (FDD) | | OP.21 FDD | | | | | | | | | |
| ρ_A, ρ_B | | -3 | | | | | | | | | |
| MPDCCH_RA | dB | 0 | | | | | | | | | |
| MPDCCH_RB | dB | 0 | | | | | | | | | |
| PBCH_RA | dB | | | | | | | | | | |
| PBCH_RB | dB | | | | | | | | | | |
| PSS_RA | dB | | | | | | | | | | |
| SSS_RA | dB | | | | | | | | | | |
| OCNG_RA ^{Note1} | dB | | | | | | -3 | | | | |
| OCNG_RB ^{Note1} | dB | | | | | | | | | | |
| N_{oc} | dBm/15 kHz | -98 | | | | | | | | | |
| SNR ^{Note 8} | dB | -4.58 | -10 | -18 | -10.58 | -4.58 | | | | | |
| Propagation condition | | AWGN | | | | | | | | | |
| Correlation Matrix and Antenna Configuration | | 2x1 | | | | | | | | | |
| Note 1: OCNG shall be used such that the resources in cell # 1 are fully allocated and a constant total transmitted power spectral density is achieved for all OFDM symbols. Note 2: The uplink resources for CQI reporting are assigned to the UE prior to the start of time period T1. Note 3: The timers and layer 3 filtering related parameters are configured prior to the start of time period T1. Note 4: The signal contains MPDCCH for UEs other than the device under test as part of OCNG. Note 5: SNR levels correspond to the signal to noise ratio over the cell-specific reference signal REs. Note 6: The SNR in time periods T1, T2, T3, T4 and T5 is denoted as SNR1, SNR2, SNR3, SNR4 and SNR5 respectively in figure A.7.3.55.1-1. | | | | | | | | | | | |

Table A.7.3.55.1-3: DRX-Configuration for E-UTRAN HD-FDD out-of-sync tests for UE category M1 configured in CEMode A

| Field | Value | Comment |
|--------------------------|---------|---|
| onDurationTimer | psf20 | As specified in clause 6.3.2 in TS 36.331 |
| drx-InactivityTimer | psf1 | |
| drx-RetransmissionTimer | psf1 | |
| longDRX-CycleStartOffset | sf40 | |
| shortDRX | disable | |

Table A.7.3.55.1-4: TimeAlignmentTimer -Configuration for E-UTRAN HD-FDD out-of-sync testing for UE category M1 configured in CEMode A

| Field | Value | Comment |
|--------------------|----------|---|
| TimeAlignmentTimer | infinity | As specified in clause 6.3.2 in TS 36.331 |

| | | |
|----------------|----|--|
| sr-ConfigIndex | 30 | For further information see clause 6.3.2 in TS 36.331 and section 10.1 in TS 36.213. |
|----------------|----|--|

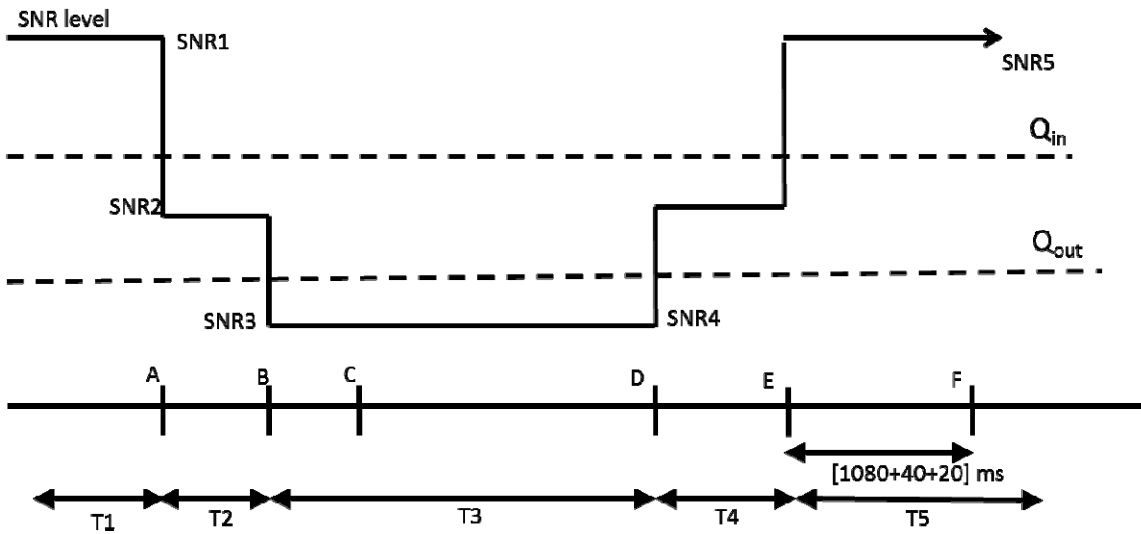

Figure A.7.3.55.1-1: SNR variation for in-sync testing in DRX

A.7.3.55.2 Test Requirements

The UE behaviour in each test during time durations T1, T2, T3, T4 and T5 shall be as follows:

During the period from time point A to time point F (1140 ms after the start of time duration T5) the UE shall transmit uplink signal at least once every DRX cycle, in the On-duration part of the cycle in the subframe according to the configured CQI reporting mode (PUCCH 1-0).

The rate of correct events observed during repeated tests shall be at least 90%.

A.7.3.56 E-UTRAN TDD Radio Link Monitoring Test for Out-of-sync for Cat-M1 UE in CEMode A

A.7.3.56.1 Test Purpose and Environment

The purpose of this test is to verify that the TDD Cat-M1 UE properly detects the out of sync and in sync for the purpose of monitoring downlink radio link quality of the PCell in CEModeA. This test will partly verify the E-UTRAN TDD radio link monitoring requirements for Cat-M1 UE defined in clause 7.19.

The test parameters are given in Tables A.7.3.56.1-1 and A.7.3.56.1-2 below. There is one cell (cell 1), which is the active cell, in the test. The test consists of three successive time periods, with time duration of T1, T2 and T3 respectively. Figure A.7.3.56.1-1 shows the variation of the downlink SNR in the active cell to emulate out-of-sync and in-sync states. Prior to the start of the time duration T1, the UE shall be fully synchronized to cell 1. The UE shall be configured for periodic CQI reporting in PUCCH 1-0 mode with a reporting periodicity of 1 ms.

In the test, the RRC parameter *numberPRB-Pairs* is set to 6 and the RRC parameter *mPDCCH-NumRepetition* is set to 8. UE shall successfully complete the RRC reconfiguration accordingly prior to the start of time duration T1.

Table A.7.3.56.1-1: General test parameters for E-UTRAN TDD out-of-sync testing for UE Cat-M1 in CEMode A

| Parameter | Unit | Value | Comment |
|-------------|------|--------|---------------------------------------|
| Active cell | | Cell 1 | Cell 1 is on E-UTRA RF channel number |

| | | | | |
|--|--|------|-----------|---|
| CP length | | | Normal | 1 |
| Out of sync transmission parameters (Note 1) | DCI format | | 6-1A | As defined in section 5.3.3.1.12 in TS 36.212 |
| | Number of OFDM symbols for legacy control channels | | 2 | Out of sync threshold Q_{out} and the corresponding hypothetical MPDCCH transmission parameters are as specified in section 7.19.2 and Table 7.19.2-1 respectively. |
| | M-PDCCH aggregation level | eCCE | 24 | |
| | M-PDCCH repetition level | | 8 | |
| | ρ_A, ρ_B | | -3 | |
| DRX | | | OFF | |
| Layer 3 filtering | | | Enabled | Counters: $N_{310} = 1; N_{311} = 1$ |
| T310 timer | | ms | 0 | T310 is disabled |
| T311 timer | | ms | 1000 | T311 is enabled |
| Periodic CQI reporting mode | | | PUCCH 1-0 | As defined in table 7.2.2-1 in TS 36.213. |
| CQI reporting periodicity | | ms | 1 | Minimum CQI reporting periodicity |
| T1 | | s | 2 | |
| T2 | | s | 0.8 | |
| T3 | | s | 1.8 | |
| Note 1: MPDCCH corresponding to the out of sync transmission parameters need not be included in the Reference Measurement Channel. | | | | |

Table A.7.3.56.1-2: Cell specific test parameters for E-UTRAN TDD (cell # 1) for out-of-sync radio link monitoring tests for Cat-M1 in CEMode A

| Parameter | Unit | Test 1 | | |
|--|------------|----------------------------|------|-------|
| | | T1 | T2 | T3 |
| E-UTRA RF Channel Number | | 1 | | |
| $BW_{channel}$ | MHz | 10 | | |
| Special subframe configuration ^{Note 1} | | 6 | | |
| Uplink-downlink configuration ^{Note 1} | | 1 | | |
| MPDCCH parameters as defined in A.3.1.3.1 | | R.15 TDD ^{Note 8} | | |
| OCNG Pattern defined in A.3.2.2.11 (TDD) | | OP.11 TDD | | |
| ρ_A, ρ_B | | -3 | | |
| PBCH_RA | dB | -3 | | |
| PBCH_RB | dB | | | |
| PSS_RA | dB | | | |
| SSS_RA | dB | | | |
| OCNG_RA ^{Note 1} | dB | | | |
| OCNG_RB ^{Note 1} | dB | | | |
| N_{oc} | dBm/15 kHz | | | |
| SNR ^{Note 7} | dB | -0.3 | -7.1 | -16.1 |
| Propagation condition | | ETU 30Hz | | |
| Correlation Matrix and Antenna Configuration | | 2x1 Low | | |

| | |
|---------|--|
| Note 1: | For special subframe and uplink-downlink configurations see Tables 4.2-1 and 4.2-2 in TS 36.211. |
| Note 2: | OCNG shall be used such that the resources in cell # 1 are fully allocated and a constant total transmitted power spectral density is achieved for all OFDM symbols. |
| Note 3: | The uplink resources for CQI reporting are assigned to the UE prior to the start of time period T1. |
| Note 4: | The timers and layer 3 filtering related parameters are configured prior to the start of time period T1. |
| Note 5: | The signal contains PDCCH for UEs other than the device under test as part of OCNG. |
| Note 6: | SNR levels correspond to the signal to noise ratio over the cell-specific reference signal REs. |
| Note 7: | The SNR in time periods T1, T2 and T3 is denoted as SNR1, SNR2 and SNR3 respectively in figure A.7.3.56.1-1. |
| Note 8: | Aggregation level and repetition levels specified in A.7.3.56.1-1 are used for this test. |

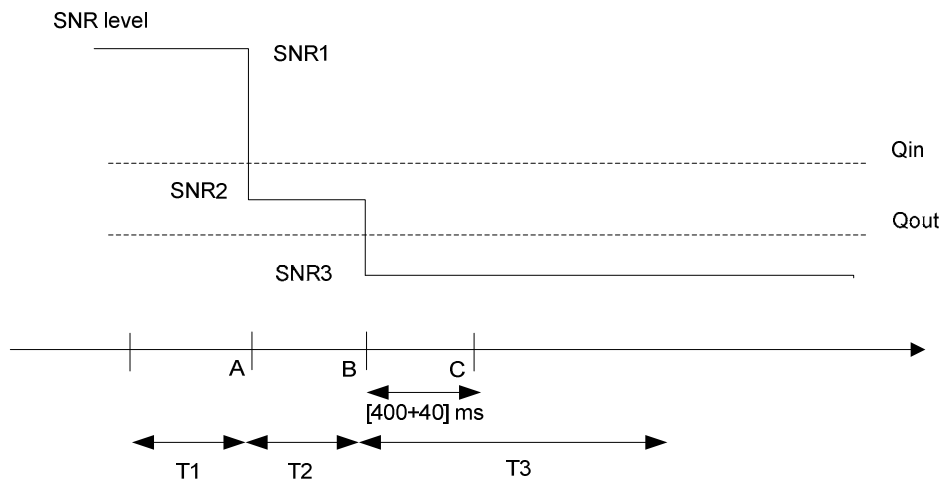

Figure A.7.3.56.1-1: SNR variation for out-of-sync testing

A.7.3.56.2 Test Requirements

The UE behaviour in each test during time durations T1, T2 and T3 shall be as follows:

During the period from time point A to time point B the UE shall transmit uplink signal at least in all subframes configured for CQI transmission according to the configured CQI reporting mode (PUCCH 1-0).

The UE shall stop transmitting uplink signal no later than time point C (440 ms after the start of time duration T3).

The rate of correct events observed during repeated tests shall be at least 90%.

A.7.3.57 E-UTRAN TDD Radio Link Monitoring Test for In-Sync for Cat-M1 UE in CEMode A

A.7.3.57.1 Test Purpose and Environment

The purpose of this test is to verify that the TDD Cat-M1 UE properly detects the out of sync and in sync for the purpose of monitoring downlink radio link quality of the PCell in CEModeA. This test will partly verify the E-UTRAN TDD radio link monitoring requirements for Cat-M1 UE defined in clause 7.19.

The test parameters are given in Tables A.7.3.57.1-1 and A.7.3.57.1-2 below. There is one cell (cell 1), which is the active cell, in the test. The test consists of five successive time periods, with time duration of T1, T2, T3, T4 and T5 respectively. Figure A.7.3.57.1-1 shows the variation of the downlink SNR in the active cell to emulate out-of-sync and

in-sync states. Prior to the start of the time duration T1, the UE shall be fully synchronized to cell 1. The UE shall be configured for periodic CQI reporting in PUCCH 1-0 mode without repetition with a reporting periodicity of 1 ms.

In the test, the RRC parameter *numberPRB-Pairs* is set to 4 and the RRC parameter *mPDCCH-NumRepetition* is set to 4. UE shall successfully complete the RRC reconfiguration accordingly prior to the start of time duration T1.

Table A.7.3.57.1-1: General test parameters for E-UTRAN TDD in-sync testing for UE Cat-M1 in CEMode A

| Parameter | | Unit | Value | Comment |
|--|--|------|-----------|---|
| Active cell | | | Cell 1 | Cell 1 is on E-UTRA RF channel number 1 |
| CP length | | | Normal | |
| In sync transmission parameters (Note 1) | DCI format | | 6-1A | As defined in section 5.3.3.1.12 in TS 36.212 |
| | Number of OFDM symbols for legacy control channels | | 2 | In sync threshold Q_{in} and the corresponding hypothetical MPDCCH transmission parameters are as specified in section 7.19.2 and Table 7.19.2-1 respectively. |
| | M-PDCCH aggregation level | eCCE | 4 | |
| | M-PDCCH repetition level | | 2 | |
| | ρ_A, ρ_B | | -3 | |
| Out of sync transmission parameters (Note 1) | DCI format | | 6-1A | As defined in section 5.3.3.1.12 in TS 36.212 |
| | Number of OFDM symbols for legacy control channels | | 2 | Out of sync threshold Q_{out} and the corresponding hypothetical MPDCCH transmission parameters are as specified in section 7.19.2 and Table 7.19.2-1 respectively. |
| | M-PDCCH aggregation level | eCCE | 16 | |
| | M-PDCCH repetition level | | 4 | |
| | ρ_A, ρ_B | | -3 | |
| DRX | | | OFF | |
| Layer 3 filtering | | | Enabled | Counters: $N_{310} = 1; N_{311} = 1$ |
| T310 timer | | ms | 2000 | T310 is enabled |
| T311 timer | | ms | 1000 | T311 is enabled |
| Periodic CQI reporting mode | | | PUCCH 1-0 | As defined in table 7.2.2-1 in TS 36.213. |
| CQI reporting periodicity | | ms | 1 | Minimum CQI reporting periodicity |
| T1 | | s | 2 | |
| T2 | | s | 0.8 | |
| T3 | | s | 1.36 | |
| T4 | | s | 0.4 | |
| T5 | | s | 2 | |
| Note 1: MPDCCH corresponding to the in-sync and out of sync transmission parameters need not be included in the Reference Measurement Channel. | | | | |

Table A.7.3.57.1-2: Cell specific test parameters for E-UTRAN TDD (cell # 1) for in-sync radio link monitoring tests for Cat-M1 in CEMode A

| Parameter | Unit | Test 1 | | | | |
|--------------------------|------|--------|----|----|----|----|
| | | T1 | T2 | T3 | T4 | T5 |
| E-UTRA RF Channel Number | | 1 | | | | |
| $BW_{channel}$ | MHz | 10 | | | | |

| | | | | | | |
|--|------------|-----------|------|-------|------|-----|
| Special subframe configuration ^{Note 1} | | 6 | | | | |
| Uplink-downlink configuration ^{Note 1} | | 1 | | | | |
| MPDCCH parameters as defined in A.3.1.3.1 | | R.15 TDD | | | | |
| OCNG Pattern defined in A.3.2.2.11 (TDD) | | OP.11 TDD | | | | |
| ρ_A, ρ_B | | -3 | | | | |
| MPDCCH_RA | dB | 0 | | | | |
| MPDCCH_RB | dB | 0 | | | | |
| PBCH_RA | dB | -3 | | | | |
| PBCH_RB | dB | | | | | |
| PSS_RA | dB | | | | | |
| SSS_RA | dB | | | | | |
| OCNG_RA ^{Note 2} | dB | | | | | |
| OCNG_RB ^{Note 2} | dB | | | | | |
| N_{oc} | dBm/15 kHz | -98 | | | | |
| SNR ^{Note 6} | dB | 5.1 | -3.8 | -12.8 | -1.9 | 5.1 |
| Propagation condition | | ETU 30Hz | | | | |
| Correlation Matrix and Antenna Configuration | | 2x1 Low | | | | |
| <p>Note 1: For special subframe and uplink-downlink configurations see Tables 4.2-1 and 4.2-2 in TS 36.211.</p> <p>Note 2: OCNG shall be used such that the resources in cell # 1 are fully allocated and a constant total transmitted power spectral density is achieved for all OFDM symbols.</p> <p>Note 3: The uplink resources for CQI reporting are assigned to the UE prior to the start of time period T1.</p> <p>Note 4: The timers and layer 3 filtering related parameters are configured prior to the start of time period T1.</p> <p>Note 5: The signal contains PDCCH for UEs other than the device under test as part of OCNG.</p> <p>Note 6: SNR levels correspond to the signal to noise ratio over the cell-specific reference signal REs.</p> <p>Note 7: The SNR in time periods T1, T2, T3, T4 and T5 is denoted as SNR1, SNR2, SNR3, SNR4 and SNR5 respectively in figure A.7.3.57.1-1.</p> | | | | | | |

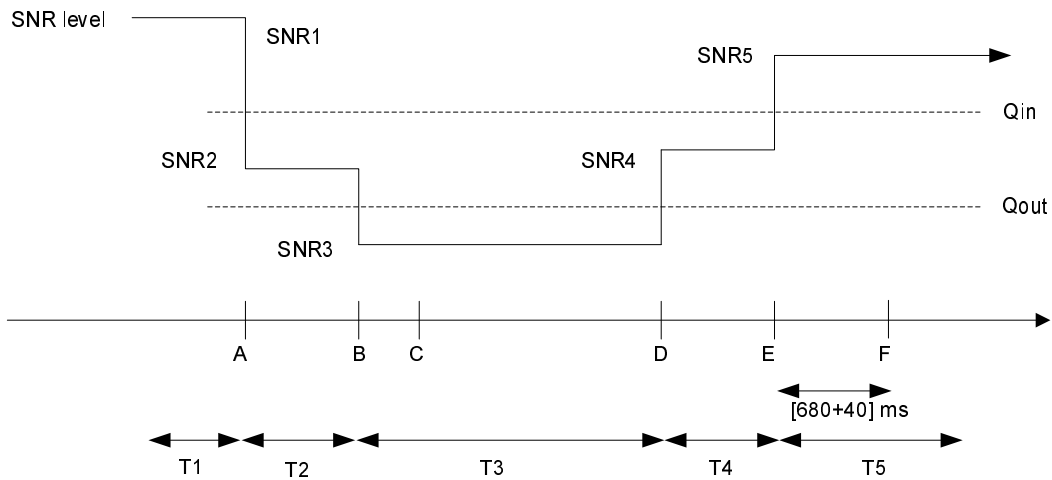

Figure A.7.3.57.1-1: SNR variation for in-sync testing

A.7.3.57.2 Test Requirements

The UE behaviour in each test during time durations T1, T2, T3, T4 and T5 shall be as follows:

During the period from time point A to time point F (720 ms after the start of time duration T5) the UE shall transmit uplink signal at least in all subframes configured for CQI transmission according to the configured CQI reporting mode (PUCCH 1-0).

The rate of correct events observed during repeated tests shall be at least 90%.

A.7.3.58 E-UTRAN TDD Radio Link Monitoring Test for Out-of-sync in DRX for UE category M1 configured in CEMode A

A.7.3.58.1 Test Purpose and Environment

The purpose of this test is to verify that the TDD category M1 UE configured in CEMode A properly detects the out of sync for the purpose of monitoring downlink radio link quality of the PCell when DRX is used. This test will partly verify the E-UTRAN TDD radio link monitoring requirements in clause 7.19.

The test parameters are given in Tables A.7.3.58.1-1, A.7.3.58.1-2, A.7.3.58.1-3 and A.7.3.58.1-4. There is one cell (cell 1), which is the active cell, in the test. The test consists of three successive time periods, with time duration of T1, T2 and T3 respectively. Figure A.7.3.58.1-1 shows the variation of the downlink SNR in the active cell to emulate out-of-sync states. Prior to the start of the time duration T1, the UE shall be fully synchronized to cell 1. The UE shall be configured for periodic CQI reporting in PUCCH 1-0 mode with a reporting periodicity of 1 ms without repetition. In the test, DRX configuration is enabled and DRX inactivity timer has already been expired, i.e. UE tries to decode MPDCCH and to send periodic CQI during the period when On-duration timer is running. Time alignment timers shall be set to "infinity" so that UL timing alignment is maintained during the test.

In the test, the RRC parameter *numberPRB-Pairs* is set to 4 and the RRC parameter *mPDCCH-NumRepetition* is set 4. UE shall successfully complete the RRC reconfiguration accordingly prior to the start of time duration T1.

Table A.7.3.58.1-1: General test parameters for E-UTRAN TDD out-of-sync tests in DRX for UE category M1 configured in CEMode A

| Parameter | | Unit | Value | Comment |
|--|--|------|-----------|--|
| Active cell | | | Cell 1 | Cell 1 is on E-UTRA RF channel number 1 |
| CP length | | | Normal | |
| Out of sync transmission parameters (Note 1) | DCI format | | 6-1A | As defined in section 5.3.3.1.12 in TS 36.212 |
| | Number of OFDM symbols for legacy control channels | | 2 | Out of sync threshold $Q_{out, Cat M1}$ and the corresponding hypothetical MPDCCH transmission parameters are as specified in clause 7.19.2 and Table 7.19.2-1 respectively. |
| | MPDCCH aggregation level | eCCE | 16 | |
| | MPDCCH repletion level | | 4 | |
| | ρ_A, ρ_B | | -3 | |
| | Ratio of MPDCCH to RS EPRE | dB | 0 | |
| DRX cycle | | ms | 1280 | See Table A.7.3.58.1-3 |
| Layer 3 filtering | | | Enabled | Counters: N310 = 1; N311 = 1 |
| T310 timer | | ms | 0 | T310 is disabled |
| T311 timer | | ms | 1000 | T311 is enabled |
| Periodic CQI reporting mode | | | PUCCH 1-0 | As defined in table 7.2.2-1 in TS 36.213. |
| CQI reporting periodicity | | ms | 1 | Minimum CQI reporting periodicity |
| T1 | | s | 32 | |
| T2 | | s | 12.8 | |
| T3 | | s | 13 | |
| Note 1: MPDCCH corresponding to the out of sync transmission parameters need not be included in the Reference Measurement Channel. | | | | |

Table A.7.3.58.1-2: Cell specific test parameters for E-UTRAN TDD (cell # 1) for out-of-sync radio link monitoring tests in DRX for UE category M1 configured in CEMode A

| Parameter | Unit | Test 1 | | |
|---------------------------------------|------------|-----------|----|----|
| | | T1 | T2 | T3 |
| E-UTRA RF Channel Number | | 1 | | |
| $BW_{channel}$ | MHz | 10 | | |
| Special subframe configuration | | 6 | | |
| Uplink-downlink configuration | | 1 | | |
| MPDCCH parameters defined in A.3.1.3 | | R.15 TDD | | |
| OCNG Pattern defined in A.3.2.2 (TDD) | | OP.11 TDD | | |
| ρ_A, ρ_B | | -3 | | |
| MPDCCH_RA | dB | 0 | | |
| MPDCCH_RB | dB | 0 | | |
| PBCH_RA | dB | -3 | | |
| PBCH_RB | dB | | | |
| PSS_RA | dB | | | |
| SSS_RA | dB | | | |
| OCNG_RA ^{Note1} | dB | | | |
| OCNG_RB ^{Note1} | dB | | | |
| N_{oc} | dBm/15 kHz | | | |

| | | | | |
|--|--|------|-------|--------|
| SNR ^{Note 6} | dB | 0.55 | -6.88 | -14.88 |
| Propagation condition | | AWGN | | |
| Correlation Matrix and Antenna Configuration | | 2x1 | | |
| Note 1: | OCNG shall be used such that the resources in cell # 1 are fully allocated and a constant total transmitted power spectral density is achieved for all OFDM symbols. | | | |
| Note 2: | The uplink resources for CQI reporting are assigned to the UE prior to the start of time period T1. | | | |
| Note 3: | The timers and layer 3 filtering related parameters are configured prior to the start of time period T1. | | | |
| Note 4: | The signal contains MPDCCH for UEs other than the device under test as part of OCNG. | | | |
| Note 5: | SNR levels correspond to the signal to noise ratio over the cell-specific reference signal REs. | | | |
| Note 6: | The SNR in time periods T1, T2 and T3 is denoted as SNR1, SNR2 and SNR3 respectively in figure A.7.3.58.1-1. | | | |

Table A.7.3.58.1-3: DRX-Configuration for E-UTRAN TDD out-of-sync tests for UE category M1 configured in CEMode A

| Field | Value | Comment |
|--------------------------|---------|---|
| onDurationTimer | psf10 | As specified in clause 6.3.2 in TS 36.331 |
| drx-InactivityTimer | psf1 | |
| drx-RetransmissionTimer | psf1 | |
| longDRX-CycleStartOffset | sf1280 | |
| shortDRX | disable | |

Table A.7.3.58.1-4: TimeAlignmentTimer -Configuration for E-UTRAN TDD out-of-sync testing for UE category M1 configured in CEMode A

| Field | Value | Comment |
|--------------------|----------|--|
| TimeAlignmentTimer | infinity | As specified in clause 6.3.2 in TS 36.331 |
| sr-ConfigIndex | 27 | For further information see clause 6.3.2 in TS 36.331 and section 10.1 in TS 36.213. |

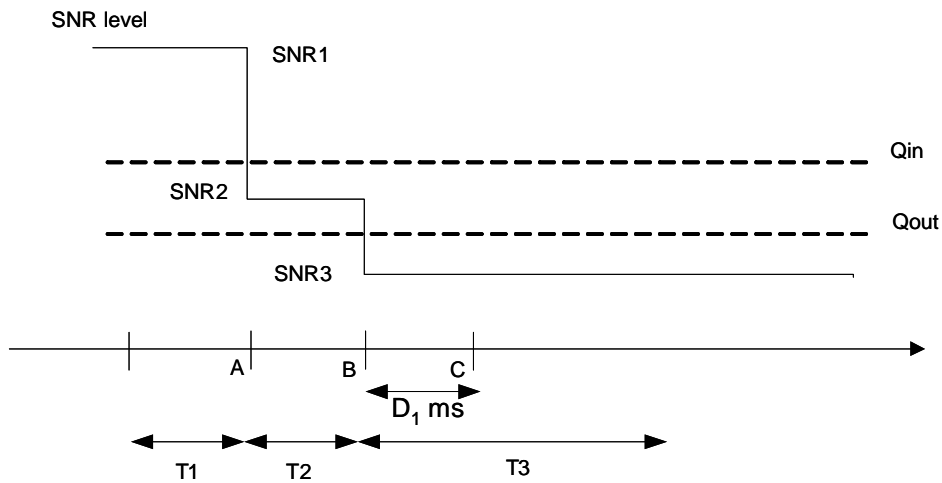

Figure A.7.3.58.1-1: SNR variation for out-of-sync testing in DRX

A.7.3.58.2 Test Requirements

The UE behaviour in each test during time durations T1, T2 and T3 shall be as follows:

During the period from time point A to time point B the UE shall transmit uplink signal at least once every DRX cycle, in the On-duration part of the cycle in the subframe according to the configured CQI reporting mode (PUCCH 1-0).

The UE shall stop transmitting uplink signal no later than time point C (duration $D_1 = 6500$ ms after the start of time duration T3).

The rate of correct events observed during repeated tests shall be at least 90%.

A.7.3.59 E-UTRAN TDD Radio Link Monitoring Test for In-sync in DRX for UE Category M1 configured in CEMode A

A.7.3.59.1 Test Purpose and Environment

The purpose of this test is to verify that the TDD category M1 UE configured in CEMode A properly detects the out of sync and in sync for the purpose of monitoring downlink radio link quality of the PCell when DRX is used. This test will partly verify the E-UTRAN TDD radio link monitoring requirements in clause 7.19.

The test parameters are given in Tables A.7.3.59.1-1, A.7.3.59.1-2, A.7.3.59.1-3 and A.7.3.59.1-4. There is one cell (cell 1), which is the active cell, in the test. The test consists of five successive time periods, with time duration of T1, T2, T3, T4 and T5 respectively. Figure A.7.3.59.1-1 shows the variation of the downlink SNR in the active cell to emulate out-of-sync and in-sync states. Prior to the start of the time duration T1, the UE shall be fully synchronized to cell 1. The UE shall be configured for periodic CQI reporting in PUCCH 1-0 mode with a reporting periodicity of 1 ms without repetition. In the test, DRX configuration is enabled and DRX inactivity timer has already been expired, i.e. UE tries to decode MPDCCH and to send periodic CQI during the period when On-duration timer is running. Time alignment timers shall be set to “infinity” so that UL timing alignment is maintained during the test.

In the test, the RRC parameter *numberPRB-Pairs* is set to 6 and the RRC parameter *mPDCCH-NumRepetition* is set 8. UE shall successfully complete the RRC reconfiguration accordingly prior to the start of time duration T1.

Table A.7.3.59.1-1: General test parameters for E-UTRAN TDD in-sync test in DRX for UE category M1 configured in CEMode A

| Parameter | | Unit | Value | Comment |
|--|--|------|--------|--|
| Active cell | | | Cell 1 | Cell 1 is on E-UTRA RF channel number 1 |
| CP length | | | Normal | |
| In sync transmission parameters (Note 1) | DCI format | | 6-1A | As defined in section 5.3.3.1.12 in TS 36.212 |
| | Number of OFDM symbols for legacy control channels | | 2 | In sync threshold $Q_{in, Cat M1}$ and the corresponding hypothetical MPDCCH transmission parameters are as specified in clause 7.19.2 and Table 7.19.2-1 respectively. |
| | MPDCCH aggregation level | eCCE | 8 | |
| | MPDCCH repetition level | | 4 | |
| | ρ_A, ρ_B | | -3 | |
| | Ratio of MPDCCH to RS EPRE | | 0 | |
| Out of sync transmission parameters (Note 1) | DCI format | | 6-1A | As defined in section 5.3.3.1.12 in TS 36.212 |
| | Number of OFDM symbols for legacy control channels | | 2 | Out of sync threshold $Q_{out, Cat M1}$ and the corresponding hypothetical MPDCCH transmission parameters are as specified in clause 7.19.2 and Table 7.19.2-1 respectively. |
| | MPDCCH aggregation level | eCCE | 24 | |
| | MPDCCH repetition level | | 8 | |
| | ρ_A, ρ_B | | -3 | |
| | Ratio of MPDCCH | dB | 0 | |

| | | | | |
|--|------------|----|-----------|---|
| | to RS EPRE | | | |
| DRX cycle | | ms | 40 | See Table A.7.3.59.1-3 |
| Layer 3 filtering | | | Enabled | Counters: N310 = 1; N311 = 1 |
| T310 timer | | ms | 2000 | T310 is enabled |
| T311 timer | | ms | 1000 | T311 is enabled |
| Periodic CQI reporting mode | | | PUCCH 1-0 | As defined in table 7.2.2-1 in TS 36.213. |
| CQI reporting periodicity | | ms | 1 | Minimum CQI reporting periodicity |
| T1 | | s | 4 | |
| T2 | | s | 1.6 | |
| T3 | | s | 1.46 | |
| T4 | | s | 0.4 | |
| T5 | | s | 4 | |
| Note 1: MPDCCH corresponding to the in-sync and out of sync transmission parameters need not be included in the Reference Measurement Channel. | | | | |

Table A.7.3.59.1-2: Cell specific test parameters for E-UTRAN TDD (cell # 1) for in-sync radio link monitoring test in DRX for UE category M1 configured in CEMode A

| Parameter | Unit | Test 1 | | | | |
|--|------------|-----------|-------|--------|-------|------|
| | | T1 | T2 | T3 | T4 | T5 |
| E-UTRA RF Channel Number | | 1 | | | | |
| BW _{channel} | MHz | 10 | | | | |
| Special subframe configuration | | 6 | | | | |
| Uplink-downlink configuration | | 1 | | | | |
| MPDCCH parameters defined in A.3.1.3 | | R.15 TDD | | | | |
| OCNG Pattern defined in A.3.2.2 (TDD) | | OP.11 TDD | | | | |
| ρ_A, ρ_B | | -3 | | | | |
| MPDCCH_RA | dB | 0 | | | | |
| MPDCCH_RB | dB | 0 | | | | |
| PBCH_RA | dB | -3 | | | | |
| PBCH_RB | dB | | | | | |
| PSS_RA | dB | | | | | |
| SSS_RA | dB | | | | | |
| OCNG_RA ^{Note1} | dB | | | | | |
| OCNG_RB ^{Note1} | dB | | | | | |
| N_{oc} | dBm/15 kHz | -98 | | | | |
| SNR ^{Note 8} | dB | -4.5 | -9.93 | -17.93 | -11.5 | -4.5 |
| Propagation condition | | AWGN | | | | |
| Correlation Matrix and Antenna Configuration | | 2x1 | | | | |
| Note 1: OCNG shall be used such that the resources in cell # 1 are fully allocated and a constant total transmitted power spectral density is achieved for all OFDM symbols. Note 2: The uplink resources for CQI reporting are assigned to the UE prior to the start of time period T1. Note 3: The timers and layer 3 filtering related parameters are configured prior to the start of time period T1. Note 4: The signal contains MPDCCH for UEs other than the device under test as part of OCNG. Note 5: SNR levels correspond to the signal to noise ratio over the cell-specific reference signal REs. Note 6: The SNR in time periods T1, T2, T3, T4 and T5 is denoted as SNR1, SNR2, SNR3, SNR4 and SNR5 respectively in figure A.7.3.59.1-1. | | | | | | |

Table A.7.3.59.1-3: DRX-Configuration for E-UTRAN TDD out-of-sync tests for UE category M1 configured in CEMode A

| Field | Value | Comment |
|---------------------|-------|---|
| onDurationTimer | psf10 | As specified in clause 6.3.2 in TS 36.331 |
| drx-InactivityTimer | psf1 | |

| | | |
|--------------------------|---------|--|
| drx-RetransmissionTimer | psf1 | |
| longDRX-CycleStartOffset | sf40 | |
| shortDRX | disable | |

Table A.7.3.59.1-4: TimeAlignmentTimer -Configuration for E-UTRAN TDD out-of-sync testing for UE category M1 configured in CEMode A

| Field | Value | Comment |
|--------------------|----------|--|
| TimeAlignmentTimer | infinity | As specified in clause 6.3.2 in TS 36.331 |
| sr-ConfigIndex | 27 | For further information see clause 6.3.2 in TS 36.331 and section 10.1 in TS 36.213. |

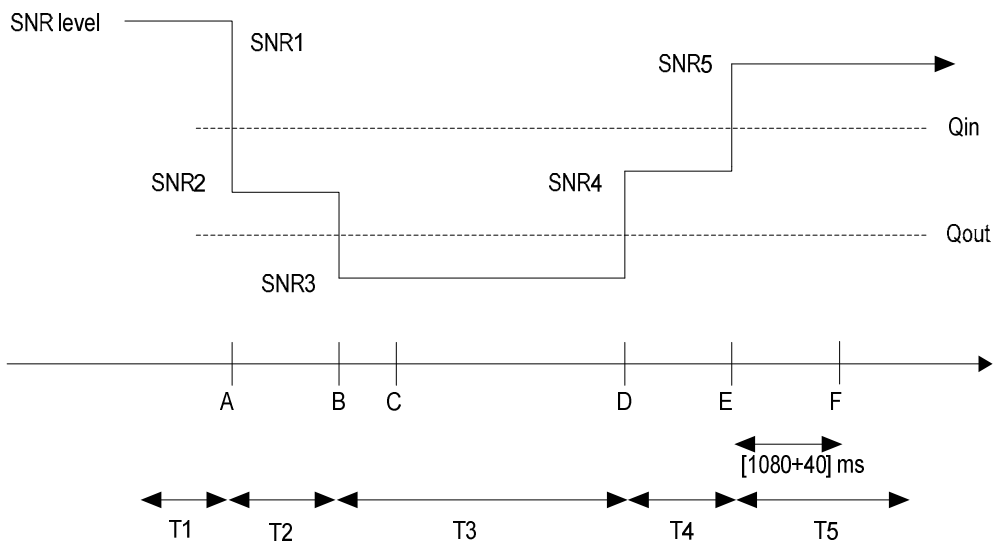

Figure A.7.3.59.1-1: SNR variation for in-sync testing in DRX

A.7.3.59.2 Test Requirements

The UE behaviour in each test during time durations T1, T2, T3, T4 and T5 shall be as follows:

During the period from time point A to time point F (1120 ms after the start of time duration T5) the UE shall transmit uplink signal at least once every DRX cycle, in the On-duration part of the cycle in the subframe according to the configured CQI reporting mode (PUCCH 1-0).

The rate of correct events observed during repeated tests shall be at least 90%.

A.7.3.60 HD-FDD Radio Link Monitoring Test for Out-of-sync in DRX for UE category NB1 In-band mode in normal coverage

A.7.3.60.1 Test Purpose and Environment

The purpose of this test is to verify that the HD-FDD category NB1 UE properly detects the out of sync for the purpose of monitoring downlink radio link quality of the NB-IoT Cell. This test will partly verify the NB-IoT HD-FDD radio link monitoring requirements in clause 7.23.

The test parameters are given in Tables A.7.3.60.1-1, A.7.3.60.1-2, A.7.3.60.1-2A, A.7.3.60.1-3 and A.7.3.60.1-4. nCell 1 is the active NB-IoT cell in the test. The test consists of four successive time periods with time duration of T1, T2, T3 and T4 respectively, excluding the transition time duration dT, where the SNR increases or decreases gradually in small

steps. Figure A.7.3.60.1-1 shows the variation of the downlink SNR in the active cell to emulate out-of-sync state with the following testing procedure:

- Prior to the start of the time duration T1, the UE shall be fully synchronized to nCell1
- Starting at point A, the SNR is decreased in small steps from SNR1 to SNR2 within dT
- At the start of the time duration T2, the UE is provided with a UL grant with NPDCCH

Note: The UE is expected to decode the NPDCCH and complete the UL transmission during T2 according to the UL grant. The UE shall not be provisioned with any more UL grants until the start of time period T4.

- Starting at point B, the SNR is decreased in small steps from SNR2 to SNR3 within dT
- During T3, the SNR is kept as SNR3
- Note: The UE is expected to detect OOS and declare RLF during T3.
- Starting at point C, the SNR is increased in small steps from SNR3 to SNR1 with dT
- At the start of the time period T4, the UE will be provided with another UL grant with NPDCCH

Note The UE is not expected to decode the UL grant and conduct any UL transmission during T4, since the UE is expected to declare RLF during T3.

In the test, DRX configuration is enabled and DRX inactivity timer has already been expired, i.e. UE tries to decode the NPDCCH and complete the UL transmission when On-duration timer is running. Time alignment timers shall be set to “infinity” so that UL timing alignment is maintained during the test.

Table A.7.3.60.1-1: General test parameters for HD-FDD Radio Link Monitoring Test for Out-of-sync in DRX for UE category NB1 In-band mode in normal coverage

| Parameter | Unit | Value | Comment |
|--|------|---------|---|
| Active cell | | nCell 1 | |
| Neighbour cell | | eCell 1 | |
| CP length | | Normal | |
| Deployment Mode | | In-band | |
| NPDCCH transmission parameters R_{max} | | 8 | Other NPDCCH parameters are defined in “out-of-sync” column in Table 7.23.2-1 |
| DRX cycle | ms | 256 | See Table A.7.3.60.1-3 |
| Layer 3 filtering ^{Note 2,3} | | Enabled | Counters: N310 = 1 N311 = 1 |
| T310 timer ^{Note 2,3} | ms | 0 | T310 is disabled |
| T311 timer ^{Note 2,3} | ms | 1000 | T311 is enabled |
| T1 | s | 5.12 | |
| dT | s | 0.8 | |
| T2 | s | 10.24 | |
| dT | s | 0.7 | |
| T3 | s | 5.12 | |
| dT | s | 1.4 | |
| T4 | s | 5.12 | |
| Note 1: NPDCCH corresponding to the out of sync transmission parameters need not be included in the Reference Measurement Channel. | | | |
| Note 2: N310, N311, T310 and T311 are defined in TS 36.331. | | | |
| Note 3: The timers and layer 3 filtering related parameters are configured prior to the start of time period T1. | | | |

Table A.7.3.60.1-2: nCell specific test parameters for HD-FDD Radio Link Monitoring Test for Out-of-sync in DRX for UE category NB1 In-band mode in normal coverage

| Parameter | Unit | nCell 1 | | | | | | | |
|---------------------------|------|---------|----|----|----|----|----|----|--|
| | | T1 | dT | T2 | dT | T3 | dT | T4 | |
| BW _{channel} | kHz | 180 | | | | | | | |
| PRB location within eCell | | 30 | | | | | | | |

| | | | | | | | | |
|--|------------|----------------------------------|--------|------|--------|-------|--------|------|
| NPDCCH parameters as defined in A.3.1.6.1 | | R.29 HD-FDD | | | | | | |
| NPBCH_RA | dB | -3 | | | | | | |
| NPBCH_RB | dB | | | | | | | |
| NPSS_RA | dB | | | | | | | |
| NSSS_RA | dB | | | | | | | |
| NPDCCH_RA | dB | | | | | | | |
| NPDCCH_RB | dB | | | | | | | |
| NPDSCH_RA | dB | | | | | | | |
| NPDSCH_RB | dB | | | | | | | |
| OCNG_RA ^{Note 1} | dB | | | | | | | |
| OCNG_RB ^{Note 1} | dB | | | | | | | |
| N_{oc} ^{Note 3} | dBm/15 kHz | Specified in Table A.7.3.60.1-2A | | | | | | |
| SNR ^{Note 4, 5} | dB | -3.1 | Note 6 | -9.1 | Note 7 | -14.1 | Note 8 | -3.1 |
| Propagation condition | | AWGN | | | | | | |
| Antenna Configuration | | 2x1 | | | | | | |
| <p>Note 1: OCNG shall be used such that the cell is fully allocated and a constant total transmitted power spectral density is achieved for all OFDM symbols. The OCNG pattern is chosen during the test according to the presence of a DL reference measurement channel.</p> <p>Note 2: Void</p> <p>Note 3: Void</p> <p>Note 4: SNR levels correspond to the signal to noise ratio over the cell-specific reference signal REs.</p> <p>Note 5: The SNRs in time periods T1, T2, T3 and T4 are denoted as SNR1, SNR2, SNR3 and SNR1 respectively in figure A.7.3.60.1-1.</p> <p>Note 6: The Test system shall reduce its transmit power in steps of $((SNR2-SNR1) / (10*dT))$ dB every 100ms until SNR2 is achieved at the end of dT.</p> <p>Note 7: The Test system shall reduce its transmit power in steps of $((SNR3-SNR2) / (10*dT))$ dB every 100ms until SNR3 is achieved at the end of dT.</p> <p>Note 8: The Test system shall increase its transmit power in steps of $((SNR1-SNR3) / (10*dT))$ dB every 100ms until SNR1 is achieved at the end of dT.</p> | | | | | | | | |

Table A.7.3.60.1-2A: eCell 1 specific test parameters for HD-FDD Out-of-sync radio link monitoring test in DRX for UE category NB1 In-band mode in normal coverage

| Parameter | Unit | eCell 1 |
|---|------------|-----------|
| | | T1-T4 |
| BW _{channel} | MHz | 10 |
| NOCNG Pattern | - | NOP.1 FDD |
| PBCH_RA | dB | -3 |
| PBCH_RB | dB | |
| PSS_RA | dB | |
| SSS_RA | dB | |
| PCFICH_RB | dB | |
| PDCCH_RA | dB | |
| PDCCH_RB | dB | |
| OCNG_RA ^{Note 1} | dB | |
| OCNG_RB ^{Note 1} | dB | |
| N_{oc} ^{Note2} | dBm/15 kHz | |
| \hat{E}_s / N_{oc} | dB | -12 |
| Propagation Condition | | AWGN |
| Antenna Configuration | | 2x1 |
| <p>Note 1: OCNG shall be used such that the eCell is fully allocated and a constant total transmitted power spectral density is achieved for all OFDM symbols.</p> <p>Note 2: Interference from other cells and noise sources not specified in the test is assumed to be constant over subcarriers and time and shall be modelled as AWGN of appropriate power N_{oc}.</p> | | |

Table A.7.3.60.1-3: DRX-Configuration for HD-FDD Radio Link Monitoring Test for Out-of-sync in DRX for UE category NB1 In-band mode in normal coverage

| Field | Value | Comment |
|-------------------------|-------|---|
| onDurationTimer | pp1 | As specified in clause 6.7.3 in TS 36.331 |
| drx-InactivityTimer | pp0 | |
| drx-RetransmissionTimer | pp0 | |
| drx-StartOffset | 0 | |

Table A.7.3.60.1-4: TimeAlignmentTimer-Configuration for NB-IoT HD-FDD out-of-sync testing for UE category NB1 In-band mode in normal coverage

| Field | Value | Comment |
|--------------------|----------|---|
| TimeAlignmentTimer | infinity | As specified in clause 6.3.2 in TS 36.331 |

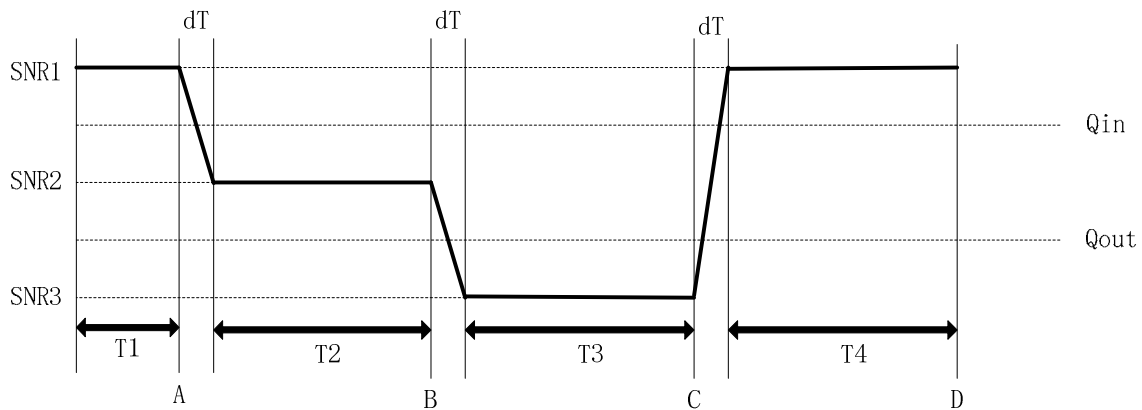

Figure A.7.3.60.1-1: SNR variation for out-of-sync testing in DRX for NB-IoT HD-FDD out-of-sync testing for UE category NB1 In-band mode in normal coverage

A.7.3.60.2 Test Requirements

The UE behaviors in each test shall be as follows:

- The UE shall complete the NPUSCH transmission during T2 according to the received UL grant;
- The UE shall not conduct any NPUSCH transmission during T4.

A correct event is defined as UE behaves correctly in all above steps. The correct events observed during repeated tests shall be at least 90%.

A.7.3.61 HD-FDD Radio Link Monitoring Test for Out-of-sync in DRX for UE category NB1 In-band mode in enhanced coverage

A.7.3.61.1 Test Purpose and Environment

The purpose of this test is to verify that the HD-FDD category NB1 UE properly detects the out of sync for the purpose of monitoring downlink radio link quality of the NB-IoT Cell. This test will partly verify the NB-IoT HD-FDD radio link monitoring requirements in clause 7.23.

The test parameters are given in Tables A.7.3.61.1-1, A.7.3.61.1-2, A.7.3.61.1-2A, A.7.3.61.1-3 and A.7.3.61.1-4. nCell 1 is the active NB-IoT cell in the test. The test consists of four successive time periods with time duration of T1, T2, T3 and T4 respectively, excluding the transition time duration dT, where the SNR increases or decreases gradually in small steps. Figure A.7.3.61.1-1 shows the variation of the downlink SNR in the active cell to emulate out-of-sync state with the following testing procedure:

- Prior to the start of the time duration T1, the UE shall be fully synchronized to nCell1
 - Starting at point A, the SNR is decreased in small steps from SNR1 to SNR2 within dT
 - At the start of the time duration T2, the UE is provided with a UL grant with NPDCCH
- Note: The UE is expected to decode the NPDCCH and complete the UL transmission during T2 according to the UL grant. The UE shall not be provisioned with any more UL grants until the start of time period T4.
- Starting at point B, the SNR is decreased in small steps from SNR2 to SNR3 within dT
 - During T3, the SNR is kept as SNR3
- Note: The UE is expected to detect OOS and declare RLF during T3.
- Starting at point C, the SNR is increased in small steps from SNR3 to SNR1 with dT
 - At the start of the time period T4, the UE will be provided with another UL grant with NPDCCH
- Note: The UE is not expected to decode the UL grant and conduct any UL transmission during T4, since the UE is expected to declare RLF during T3.

In the test, DRX configuration is enabled and DRX inactivity timer has already been expired, i.e. UE tries to decode the NPDCCH and complete the UL transmission when On-duration timer is running. Time alignment timers shall be set to “infinity” so that UL timing alignment is maintained during the test.

Table A.7.3.61.1-1: General test parameters for HD-FDD Radio Link Monitoring Test for Out-of-sync in DRX for UE category NB1 In-band mode in enhanced coverage

| Parameter | Unit | Value | Comment |
|--|------|---------|---|
| Active cell | | nCell 1 | |
| Neighbour cell | | eCell 1 | |
| CP length | | Normal | |
| Deployment Mode | | In-band | |
| NPDCCH transmission parameters R_{max} | | 8 | Other NPDCCH parameters are defined in "out-of-sync" column in Table 7.23.2-1 |
| DRX cycle | ms | 256 | See Table A.7.3.61.1-3 |
| Layer 3 filtering ^{Note 2,3} | | Enabled | Counters: N310 = 1 N311 = 1 |
| T310 timer ^{Note 2,3} | ms | 0 | T310 is disabled |
| T311 timer ^{Note 2,3} | ms | 1000 | T311 is enabled |
| T1 | s | 5.12 | |
| dT | s | 0.7 | |
| T2 | s | 10.24 | |
| dT | s | 0.8 | |
| T3 | s | 5.12 | |
| dT | s | 1.4 | |
| T4 | s | 5.12 | |
| Note 1: NPDCCH corresponding to the out of sync transmission parameters need not be included in the Reference Measurement Channel. | | | |
| Note 2: N310, N311, T310 and T311 are defined in TS 36.331. | | | |
| Note 3: The timers and layer 3 filtering related parameters are configured prior to the start of time period T1. | | | |

Table A.7.3.61.1-2: nCell specific test parameters for HD-FDD Radio Link Monitoring Test for Out-of-sync in DRX for UE category NB1 In-band mode in enhanced coverage

| Parameter | Unit | nCell 1 | | | | | | | |
|---|------|-------------|----|----|----|----|----|----|--|
| | | T1 | dT | T2 | dT | T3 | dT | T4 | |
| BW _{channel} | kHz | 180 | | | | | | | |
| PRB location within eCell | | 30 | | | | | | | |
| NPDCCH parameters as defined in A.3.1.6.1 | | R.29 HD-FDD | | | | | | | |
| NPBCH_RA | dB | -3 | | | | | | | |

| | | | | | | | | |
|--|------------|----------------------------------|--------|-------|--------|-------|--------|------|
| NPBCH_RB | dB | | | | | | | |
| NPSS_RA | dB | | | | | | | |
| NSSS_RA | dB | | | | | | | |
| NPDCCH_RA | dB | | | | | | | |
| NPDCCH_RB | dB | | | | | | | |
| NPDSCH_RA | dB | | | | | | | |
| NPDSCH_RB | dB | | | | | | | |
| OCNG_RA ^{Note 1} | dB | | | | | | | |
| OCNG_RB ^{Note 1} | dB | | | | | | | |
| N_{oc} ^{Note 3} | dBm/15 kHz | Specified in Table A.7.3.61.1-2A | | | | | | |
| SNR ^{Note 4, 5} | dB | -6.3 | Note 6 | -11.4 | Note 7 | -17.4 | Note 8 | -6.3 |
| Propagation condition | | AWGN | | | | | | |
| Antenna Configuration | | 2x1 | | | | | | |
| <p>Note 1: OCNG shall be used such that the cell is fully allocated and a constant total transmitted power spectral density is achieved for all OFDM symbols. The OCNG pattern is chosen during the test according to the presence of a DL reference measurement channel.</p> <p>Note 2: Void</p> <p>Note 3: Void</p> <p>Note 4: SNR levels correspond to the signal to noise ratio over the cell-specific reference signal REs.</p> <p>Note 5: The SNRs in time periods T1, T2, T3 and T4 are denoted as SNR1, SNR2, SNR3 and SNR1 respectively in figure A.7.3.61.1-1.</p> <p>Note 6: The Test system shall reduce its transmit power in steps of $\frac{((SNR2-SNR1) / (10 \cdot dT))}{dB}$ every 100ms until SNR2 is achieved at the end of dT.</p> <p>Note 7: The Test system shall reduce its transmit power in steps of $\frac{((SNR3-SNR2) / (10 \cdot dT))}{dB}$ every 100ms until SNR3 is achieved at the end of dT.</p> <p>Note 8: The Test system shall increase its transmit power in steps of $\frac{((SNR1-SNR3) / (10 \cdot dT))}{dB}$ every 100ms until SNR1 is achieved at the end of dT.</p> | | | | | | | | |

Table A.7.3.61.1-2A: eCell 1 specific test parameters for HD-FDD Out-of-sync radio link monitoring test in DRX for UE category NB1 In-band mode in enhanced coverage

| Parameter | Unit | eCell 1 |
|---|------------|-----------|
| | | T1-T4 |
| $BW_{channel}$ | MHz | 10 |
| NOCNG Pattern | - | NOP.1 FDD |
| PBCH_RA | dB | -3 |
| PBCH_RB | dB | |
| PSS_RA | dB | |
| SSS_RA | dB | |
| PCFICH_RB | dB | |
| PDCCH_RA | dB | |
| PDCCH_RB | dB | |
| OCNG_RA ^{Note 1} | dB | |
| OCNG_RB ^{Note 1} | dB | |
| N_{oc} ^{Note 2} | dBm/15 kHz | |
| \hat{E}_s / N_{oc} | dB | -12 |
| Propagation Condition | | AWGN |
| Antenna Configuration | | 2x1 |
| <p>Note 1: OCNG shall be used such that the eCell is fully allocated and a constant total transmitted power spectral density is achieved for all OFDM symbols.</p> <p>Note 2: Interference from other cells and noise sources not specified in the test is assumed to be constant over subcarriers and time and shall be modelled as AWGN of appropriate power N_{oc}.</p> | | |

Table A.7.3.61.1-3: DRX-Configuration for HD-FDD Radio Link Monitoring Test for Out-of-sync in DRX for UE category NB1 In-band mode in enhanced coverage

| Field | Value | Comment |
|-------------------------|-------|---|
| onDurationTimer | pp1 | As specified in clause 6.7.3 in TS 36.331 |
| drx-InactivityTimer | pp0 | |
| drx-RetransmissionTimer | pp0 | |
| drx-StartOffset | 0 | |

Table A.7.3.61.1-4: TimeAlignmentTimer-Configuration for HD-FDD Radio Link Monitoring Test for Out-of-sync in DRX for UE category NB1 In-band mode in enhanced coverage

| Field | Value | Comment |
|--------------------|----------|---|
| TimeAlignmentTimer | infinity | As specified in clause 6.3.2 in TS 36.331 |

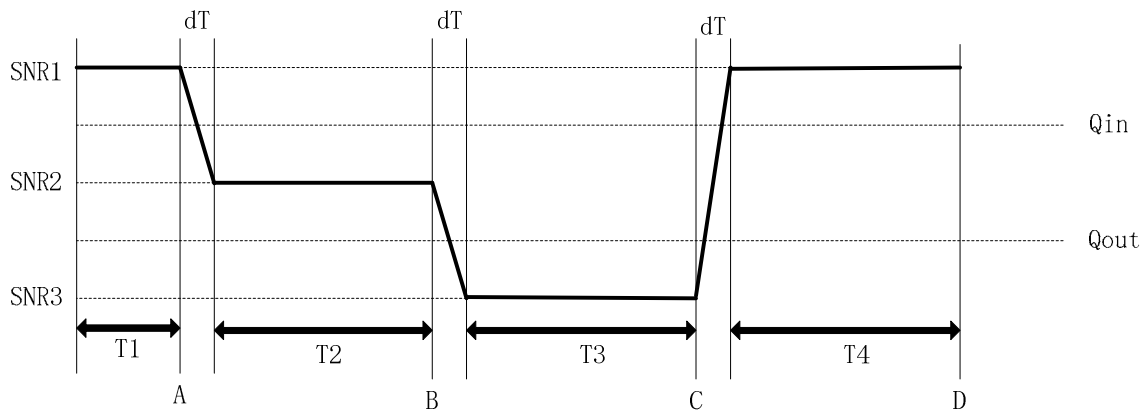

Figure A.7.3.61.1-1: SNR variation for HD-FDD Radio Link Monitoring Test for Out-of-sync in DRX for UE category NB1 In-band mode in enhanced coverage

A.7.3.61.2 Test Requirements

The UE behaviors in each test shall be as follows:

- The UE shall complete the NPUSCH transmission during T2 according to the received UL grant;
- The UE shall not conduct any NPUSCH transmission during T4.

A correct event is defined as UE behaves correctly in all above steps. The correct events observed during repeated tests shall be at least 90%.

A.7.3.62 HD-FDD Radio Link Monitoring Test for In-sync with DRX for UE Category NB1 In-Band mode in Enhanced Coverage

A.7.3.62.1 Test Purpose and Environment

The purpose of this test is to verify that the HD-FDD category NB1 UE configured in enhanced coverage properly detects the out of sync and in sync for the purpose of monitoring downlink radio link quality of the NB-IoT Cell when DRX is used. This test will partly verify the HD-FDD radio link monitoring requirements in clause 7.23.

The test parameters are given in Tables A.7.3.62.1-1, A.7.3.62.1-2, A.7.3.62.1-3, A.7.3.62.1-4 and A.7.3.62.1-5. nCell 1 is the active cell in the test. The test consists of three successive time periods, with time duration of T1, T2, and T3 respectively, excluding the transition time duration dT, where the SNR increases or decreases gradually in small steps. Figure A.7.3.62.1-1 shows the variation of the downlink SNR in the active cell to emulate out-of-sync and in-sync states.

Prior to the start of the time duration T1, the UE shall be fully be synchronized to nCell 1. The UE is scheduled in designated uplink subframes to transmit NPUSCH, which is received by the test equipment. By measuring the reception of the NPUSCH, detection of out of sync and in sync requirements can be measured. In the test, DRX configuration is enabled and DRX inactivity timer has already been expired, i.e. UE tries to decode NPDCCH and to send NPUSCH during the period when On-duration timer is running. Time alignment timers shall be set to “infinity” so that UL timing alignment is maintained during the test.

The test setup in each test during time durations T1, T2 and T3 shall be as follows:

- During the period from time point A to time point B, the SNR is decreasing linearly from SNR1 to SNR2.
- During the period from time point C to time point D, the SNR is increasing linearly from SNR2 to SNR3.
- During the period T3, the test system shall send the UE a grant to transmit in uplink. UE under test is expected to decode the uplink grant and switch to uplink and complete the uplink transmission. During the period from time point A to time point D, the UE shall not be provisioned with any UL grant.
- Thereafter UE switches back to downlink.

In each run of the test, the test equipment selects NPDCCH repetition level, and sends the RRC configuration to the UE. NPDCCH repetition level is determined by RRC parameter *npdcch-NumRepetitions* [3]. UE shall successfully complete the RRC reconfiguration accordingly prior to the start of time duration T1.

Table A.7.3.62.1-1: General test parameters for HD-FDD in-sync test with DRX for UE category NB1 In-Band mode in enhanced coverage

| Parameter | | Unit | Value | Comment |
|--|--|---------|---------------------------------|--|
| NB-IoT operational mode | | | In-band | |
| Active cell | | | nCell 1 | NB-IOT cell nCell1 is within E-UTRA cell eCell1 |
| CP length | | | Normal | |
| In sync transmission parameters (Note 1) | DCI format | | Format N1 | As defined in TS 36.212[21] |
| | Number of OFDM symbols for legacy control channels | | 3 | In sync threshold Q_{in_NB-IoT} and the corresponding hypothetical NPDCCH transmission parameters are as specified in clause 7.23.2 and Table 7.23.2-1 respectively. |
| | NPDCCH aggregation level | eCCE | 2 | |
| | NPDCCH repetition level | | 4 | |
| | Ratio of NPDSCH to NRS EPRE | | 0 | |
| | Ratio of NPDCCH to NRS EPRE | | 0 | |
| Out of sync transmission parameters (Note 1) | DCI format | | Format N1 | As defined in TS 36.212[21] |
| | Number of OFDM symbols for legacy control channels | | 3 | Out of sync threshold Q_{out_NB-IoT} and the corresponding hypothetical NPDCCH transmission parameters are as specified in clause 7.23.2 and Table 7.23.2-1 respectively. |
| | NPDCCH aggregation level | eCCE | 2 | |
| | NPDCCH repetition level | | 16 | |
| | Ratio of NPDSCH to NRS EPRE | | 0 | |
| | Ratio of NPDCCH to RS EPRE | dB | 0 | |
| DRX cycle | ms | 256 | See Table A.7.3.62.1-4 | |
| Layer 3 filtering | | Enabled | Counters: N310 = 1; N311 = 1 | |
| T310 timer | ms | 4000 | T310 is enabled | |
| T311 timer | ms | 1000 | T311 is enabled | |
| T1 | s | 4 | | |
| dT | s | 1.4 | | |
| T2 | s | 2.12 | | |
| dT | s | 1.4 | | |
| T3 | s | 4 | | |

Note 1: NPDCCH corresponding to the in-sync and out of sync transmission parameters need not be included in the Reference Measurement Channel.

Table A.7.3.62.1-2: nCell 1 specific test parameters for HD-FDD in-sync radio link monitoring test with DRX for UE category NB1 In-Band mode in enhanced coverage

| Parameter | Unit | nCell 1 | | | | |
|--|------------|-------------|--------|-------|--------|------|
| | | T1 | dT | T2 | dT | T3 |
| $BW_{channel}$ | kHz | 180 | | | | |
| PRB location within eCell | - | 30 | | | | |
| NPDCCH parameters defined in A.3.1.6.1 | | R.27 HD-FDD | | | | |
| Ratio of NPDSCH to NRS EPRE | | -3 | | | | |
| NPDCCH_RA | dB | -3 | | | | |
| NPDCCH_RB | dB | -3 | | | | |
| NPBCH_RA | dB | -3 | | | | |
| NPBCH_RB | dB | | | | | |
| NPSS_RA | dB | | | | | |
| NSSS_RA | dB | | | | | |
| NOCNG_RA ^{Note1} | dB | | | | | |
| NOCNG_RB ^{Note1} | dB | | | | | |
| N_{oc} | dBm/15 kHz | | | | | |
| SNR ^{Note 5, Note 6} | dB | -6.3 | Note 7 | -17.4 | Note 8 | -6.3 |
| Propagation condition | | AWGN | | | | |
| Antenna Configuration | | 2x1 | | | | |
| <p>Note 1: OCNG shall be used such that the resources in ncell1 are fully allocated and a constant total transmitted power spectral density is achieved for all OFDM symbols.</p> <p>Note 2: The uplink resources for CQI reporting are assigned to the UE prior to the start of time period T1.</p> <p>Note 3: The timers and layer 3 filtering related parameters are configured prior to the start of time period T1.</p> <p>Note 4: The signal contains NPDCCH for UEs other than the device under test as part of OCNG.</p> <p>Note 5: SNR levels correspond to the signal to noise ratio over the cell-specific reference signal REs.</p> <p>Note 6: The SNR in time periods T1, T2 and T3 is denoted as SNR1, SNR2, and SNR3 respectively in figure A.7.3.62.1-1.</p> <p>Note 7: The Test system shall reduce its transmit power in steps of $((SNR2-SNR1) / (10*dT))$ dB every 100ms till SNR2 is achieved at the end of dT.</p> <p>Note 8: The Test system shall increase its transmit power in steps of $((SNR1-SNR2) / (10*dT))$ dB every 100ms till SNR1 is achieved at the end of dT.</p> | | | | | | |

Table A.7.3.62.1-3: eCell 1 specific test parameters for HD-FDD in-sync radio link monitoring test with DRX for UE category NB1 In-Band mode in enhanced coverage

| Parameter | Unit | eCell 1 |
|---------------------------|------------|-----------|
| | | T1-T3 |
| $BW_{channel}$ | MHz | 10 |
| NOCNG Pattern | - | NOP.1 FDD |
| PBCH_RA | dB | -3 |
| PBCH_RB | dB | |
| PSS_RA | dB | |
| SSS_RA | dB | |
| PCFICH_RB | dB | |
| PDCCH_RA | dB | |
| PDCCH_RB | dB | |
| OCNG_RA ^{Note 1} | dB | |
| OCNG_RB ^{Note 1} | dB | |
| N_{oc} ^{Note2} | dBm/15 kHz | |
| \hat{E}_s / N_{oc} | dB | -12 |
| Propagation Condition | | AWGN |
| Antenna Configuration | | 2x1 |

| | |
|---------|---|
| Note 1: | OCNG shall be used such that the eCell is fully allocated and a constant total transmitted power spectral density is achieved for all OFDM symbols. |
| Note 2: | Interference from other cells and noise sources not specified in the test is assumed to be constant over subcarriers and time and shall be modelled as AWGN of appropriate power N_{oc} . |

Table A.7.3.62.1-4: DRX-Configuration for E-UTRAN HD-FDD in-sync tests with DRX for UE category NB1 In-Band mode in enhanced coverage

| Field | Value | Comment |
|--------------------------|---------|---|
| onDurationTimer | pp1 | As specified in clause 6.3.2 in TS 36.331 |
| drx-InactivityTimer | pp0 | |
| drx-RetransmissionTimer | pp0 | |
| longDRX-CycleStartOffset | Sf256 | |
| shortDRX | disable | |

Table A.7.3.62.1-5: TimeAlignmentTimer -Configuration for E-UTRAN HD-FDD in-sync tests with DRX for UE category NB1 In-Band mode in enhanced coverage

| Field | Value | Comment |
|--------------------|----------|---|
| TimeAlignmentTimer | infinity | As specified in clause 6.3.2 in TS 36.331 |

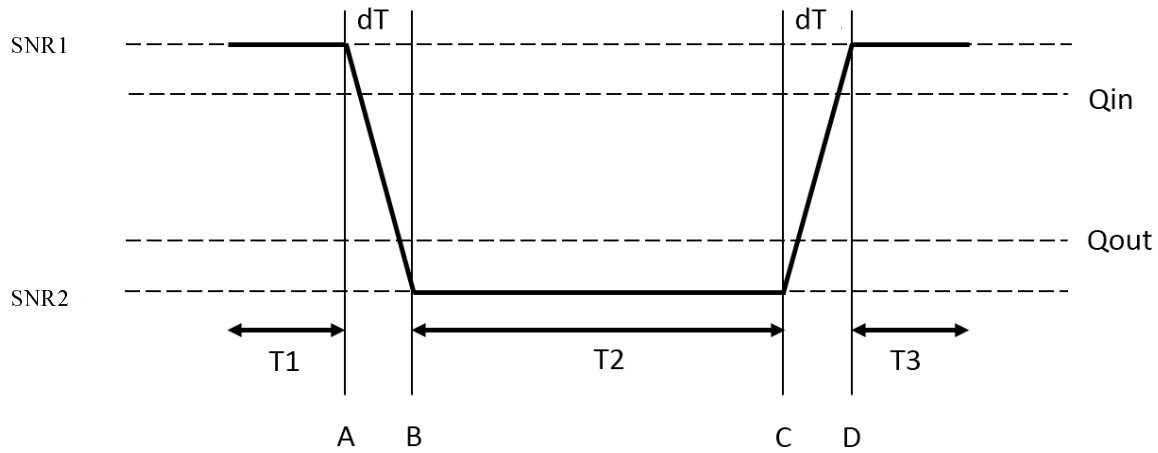

Figure A.7.3.62.1-1: SNR variation for in-sync testing with DRX

A.7.3.62.2 Test Requirements

The UE behaviour in each test shall be as follows:

During the period T3, the UE under test is expected to decode the uplink grant and switch to uplink and complete the uplink transmission. This is considered a correct event.

The rate of correct events observed during repeated tests shall be at least 90%.

A.7.3.63 HD-FDD Radio Link Monitoring Test for In-sync with DRX for UE Category NB1 In-Band mode in Normal Coverage

A.7.3.63.1 Test Purpose and Environment

The purpose of this test is to verify that the HD-FDD category NB1 UE configured in normal coverage properly detects the out of sync and in sync for the purpose of monitoring downlink radio link quality of the NB-IoT Cell when DRX is used. This test will partly verify the HD-FDD radio link monitoring requirements in clause 7.23.

The test parameters are given in Tables A.7.3.63.1-1, A.7.3.63.1-2, A.7.3.63.1-3, A.7.3.63.1-4 and A.7.3.63.1-5. nCell 1 is the active cell in the test. The test consists of three successive time periods, with time duration of T1, T2 and T3 respectively, excluding the transition time duration dT , where the SNR increases or decreases gradually in small steps. Figure A.7.3.63.1-1 shows the variation of the downlink SNR in the active cell to emulate out-of-sync and in-sync states.

Prior to the start of the time duration T1, the UE shall be fully be synchronized to nCell 1. The UE is scheduled in designated uplink subframes to transmit NPUSCH, which is received by the test equipment. By measuring the reception of the NPUSCH, detection of out of sync and in sync requirements can be measured. In the test, DRX configuration is enabled and DRX inactivity timer has already been expired, i.e. UE tries to decode NPDCCH and to send NPUSCH during the period when On-duration timer is running. Time alignment timers shall be set to “infinity” so that UL timing alignment is maintained during the test.

The test setup in each test during time durations T1, T2 and T3 are as follows:

- During the period from time point A to time point B, the SNR is decreasing linearly from SNR1 to SNR2.
- During the period from time point C to time point D, the SNR is increasing linearly from SNR2 to SNR3.
- During the period T3, the test system shall send the UE a grant to transmit in uplink. UE under test is expected to decode the uplink grant and switch to uplink and complete the uplink transmission. During the period from time point A to time point D, the UE shall not be provisioned with any UL grant.
- Thereafter UE switches back to downlink.

In each run of the test, the test equipment selects NPDCCH repetition level, and sends the RRC configuration to the UE. NPDCCH repetition level is determined by RRC parameter *npdcch-NumRepetitions* [2]. UE shall successfully complete the RRC reconfiguration accordingly prior to the start of time duration T1.

Table A.7.3.63.1-1: General test parameters for HD-FDD in-sync test with DRX for UE category NB1 In-Band mode in normal coverage

| Parameter | | Unit | Value | Comment |
|--|--|------|-----------|---|
| NB-IoT operational mode | | | In-band | |
| Active cell | | | nCell 1 | NB-IOT cell nCell1 is within E-UTRA cell eCell1 |
| CP length | | | Normal | |
| In sync transmission parameters (Note 1) | DCI format | | Format N1 | As defined in TS 36.212[21] |
| | Number of OFDM symbols for legacy control channels | | 3 | In sync threshold Q_{in_NB-IoT} and the corresponding hypothetical NPDCCH transmission parameters are as specified in clause 7.23.2 and Table 7.23.2-1 respectively. |
| | NPDCCH aggregation level | eCCE | 2 | |
| | NPDCCH repetition level | | 2 | |
| | Ratio of NPDSCH to NRS EPRE | | 0 | |
| Ratio of NPDCCH to NRS EPRE | | 0 | | |
| Out of sync transmission parameters (Note 1) | DCI format | | Format N1 | As defined in TS 36.212[21] |
| | Number of OFDM symbols for legacy control channels | | 3 | Out of sync threshold Q_{out_NB-IoT} and the corresponding hypothetical NPDCCH transmission parameters are as specified in clause 7.23.2 |
| NPDCCH aggregation level | eCCE | 2 | | |

| | | | | |
|--|-----------------------------|----|---------|----------------------------------|
| | NPDCCH repetition level | | 8 | and Table 7.23.2-1 respectively. |
| | Ratio of NPDSCH to NRS EPRE | | 0 | |
| | Ratio of NPDCCH to RS EPRE | dB | 0 | |
| DRX cycle | | ms | 256 | See Table A.7.3.63.1-4 |
| Layer 3 filtering | | | Enabled | Counters: N310 = 1; N311 = 1 |
| T310 timer | | ms | 4000 | T310 is enabled |
| T311 timer | | ms | 1000 | T311 is enabled |
| T1 | | s | 4 | |
| dT | | s | 1.4 | |
| T2 | | s | 2.12 | |
| dT | | s | 1.4 | |
| T3 | | s | 4 | |
| Note 1: NPDCCH corresponding to the in-sync and out of sync transmission parameters need not be included in the Reference Measurement Channel. | | | | |

Table A.7.3.63.1-2: nCell 1 specific test parameters for HD-FDD in-sync radio link monitoring test with DRX for UE category NB1 In-Band mode in normal coverage

| Parameter | Unit | nCell 1 | | | | |
|---|------------|---------------------------------|--------|-------|--------|------|
| | | T1 | dT | T2 | dT | T3 |
| $BW_{channel}$ | kHz | 180 | | | | |
| PRB location within eCell | - | 30 | | | | |
| NPDCCH parameters defined in A.3.1.6.1 | | R.27 HD-FDD | | | | |
| Ratio of NPDSCH to NRS EPRE | | -3 | | | | |
| NPDCCH_RA | dB | -3 | | | | |
| NPDCCH_RB | dB | -3 | | | | |
| NPBCH_RA | dB | -3 | | | | |
| NPBCH_RB | dB | | | | | |
| NPSS_RA | dB | | | | | |
| NSSS_RA | dB | | | | | |
| NOCNG_RA ^{Note1} | dB | | | | | |
| NOCNG_RB ^{Note1} | dB | | | | | |
| N_{oc} | dBm/15 kHz | Specified in Table A.7.3.63.1-3 | | | | |
| SNR ^{Note 5, Note 6} | dB | -3.1 | Note 7 | -14.1 | Note 8 | -3.1 |
| Propagation condition | | AWGN | | | | |
| Antenna Configuration | | 2x1 | | | | |
| Note 1: OCNG shall be used such that the resources in ncell1 are fully allocated and a constant total transmitted power spectral density is achieved for all OFDM symbols. Note 2: The uplink resources for CQI reporting are assigned to the UE prior to the start of time period T1. Note 3: The timers and layer 3 filtering related parameters are configured prior to the start of time period T1. Note 4: The signal contains NPDCCH for UEs other than the device under test as part of OCNG. Note 5: SNR levels correspond to the signal to noise ratio over the cell-specific reference signal REs. Note 6: The SNR in time periods T1, T2 and T3 is denoted as SNR1, SNR2, and SNR3 respectively in figure A.7.3.63.1-1. Note 7: The Test system shall reduce its transmit power in steps of $((SNR2-SNR1) / (10*dT))$ dB every 100ms till SNR2 is achieved at the end of dT. Note 8: The Test system shall increase its transmit power in steps of $((SNR1-SNR2) / (10*dT))$ dB every 100ms till SNR1 is achieved at the end of dT. | | | | | | |

Table A.7.3.63.1-3: eCell 1 specific test parameters for HD-FDD in-sync radio link monitoring test with DRX for UE category NB1 In-Band mode in normal coverage

| Parameter | Unit | eCell 1 |
|----------------|------|---------|
| | | T1-T3 |
| $BW_{channel}$ | MHz | 10 |

| | | |
|---|------------|-----------|
| NOCNG Pattern | - | NOP.1 FDD |
| PBCH_RA | dB | -3 |
| PBCH_RB | dB | |
| PSS_RA | dB | |
| SSS_RA | dB | |
| PCFICH_RB | dB | |
| PDCCH_RA | dB | |
| PDCCH_RB | dB | |
| OCNG_RA ^{Note 1} | dB | |
| OCNG_RB ^{Note 1} | dB | |
| N_{oc} ^{Note2} | dBm/15 kHz | |
| \hat{E}_s / N_{oc} | dB | 4 |
| Propagation Condition | | AWGN |
| Antenna Configuration | | 2x1 |
| <p>Note 1: OCNG shall be used such that the eCell is fully allocated and a constant total transmitted power spectral density is achieved for all OFDM symbols.</p> <p>Note 2: Interference from other cells and noise sources not specified in the test is assumed to be constant over subcarriers and time and shall be modelled as AWGN of appropriate power N_{oc}.</p> | | |

Table A.7.3.63.1-4: DRX-Configuration for E-UTRAN HD-FDD in-sync tests with DRX for UE category NB1 In-Band mode in normal coverage

| Field | Value | Comment |
|--------------------------|---------|---|
| onDurationTimer | pp1 | As specified in clause 6.3.2 in TS 36.331 |
| drx-InactivityTimer | pp0 | |
| drx-RetransmissionTimer | pp0 | |
| longDRX-CycleStartOffset | Sf256 | |
| shortDRX | disable | |

Table A.7.3.63.1-5: TimeAlignmentTimer -Configuration for E-UTRAN HD-FDD in-sync tests with DRX for UE category NB1 In-Band mode in normal coverage

| Field | Value | Comment |
|--------------------|----------|---|
| TimeAlignmentTimer | infinity | As specified in clause 6.3.2 in TS 36.331 |

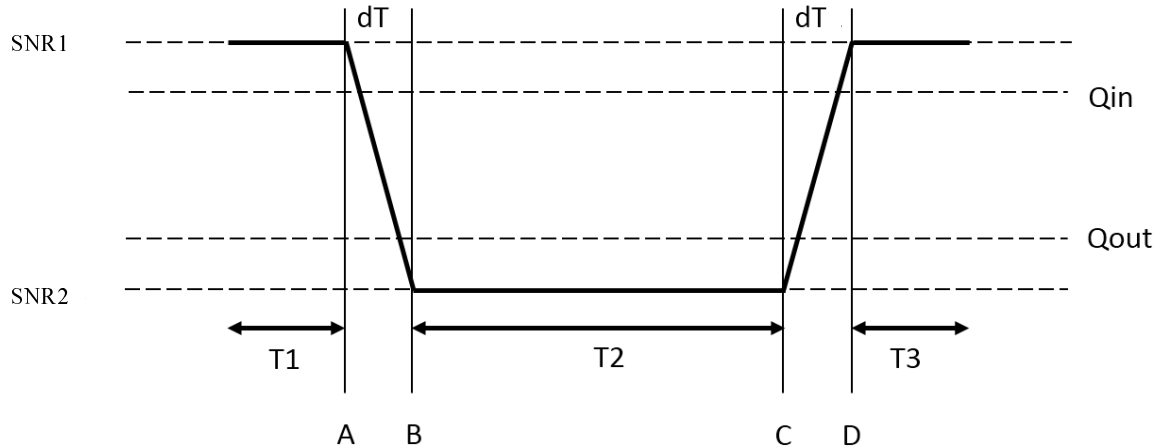

Figure A.7.3.63.1-1: SNR variation for in-sync testing with DRX

A.7.3.63.2 Test Requirements

The UE behaviour in each test shall be as follows:

During the period T3, the UE under test is expected to decode the uplink grant and switch to uplink and complete the uplink transmission. This is considered a correct event.

The rate of correct events observed during repeated tests shall be at least 90%.

A.7.3.64 HD-FDD Radio Link Monitoring Test for In-sync without DRX for UE Category NB1 In-Band mode in Normal Coverage

A.7.3.64.1 Test Purpose and Environment

The purpose of this test is to verify that the HD-FDD category NB1 UE configured in normal coverage properly detects the out of sync and in sync for the purpose of monitoring downlink radio link quality of the PCell when DRX is used. This test will partly verify the HD-FDD radio link monitoring requirements in clause 7.23.

The test parameters are given in Tables A.7.3.64.1-1, A.7.3.64.1-2, A.7.3.64.1-3, A.7.3.64.1-4 and A.7.3.64.1-5. nCell 1 is the active cell in the test. The test consists of three successive time periods, with time duration of T1, T2 and T3 respectively, excluding the transition time duration dT, where the SNR increases or decreases gradually in small steps. Figure A.7.3.64.1-1 shows the variation of the downlink SNR in the active cell to emulate out-of-sync and in-sync states.

Prior to the start of the time duration T1, the UE shall be fully be synchronized to nCell 1. The UE is scheduled in designated uplink subframes to transmit NPUSCH, which is received by the test equipment. By measuring the reception of the NPUSCH, detection of out of sync and in sync requirements can be measured. In the test, DRX configuration is disabled, i.e. UE tries to decode NPDCCH and to send NPUSCH during the period when On-duration timer is running. Time alignment timers shall be set to “infinity” so that UL timing alignment is maintained during the test.

The test setup in each test during time durations T1, T2, dT and T3 shall be as follows:

- During the period from time point A to time point B, the SNR is decreasing linearly from SNR1 to SNR2.
- During the period from time point C to time point D, the SNR is increasing linearly from SNR2 to SNR3.
- During the period T3, the test system shall send the UE a grant to transmit in uplink. UE under test is expected to decode the uplink grant and switch to uplink and complete the uplink transmission. During the period from time point A to time point D, the UE shall not be provisioned with any UL grant.
- Thereafter UE switches back to downlink.

In each run of the test, the test equipment selects NPDCCH repetition level, and sends the RRC configuration to the UE. UE shall successfully complete the RRC reconfiguration accordingly prior to the start of time duration T1.

Table A.7.3.64.1-1: General test parameters for HD-FDD in-sync test without DRX for UE category NB1 In-Band mode in normal coverage

| Parameter | | Unit | Value | Comment |
|--|--|------|-----------|--|
| NB-IoT operational mode | | | In-band | |
| Active cell | | | nCell 1 | NB-IOT cell nCell1 is within E-UTRA cell eCell1 |
| CP length | | | Normal | |
| In sync transmission parameters (Note 1) | DCI format | | Format N1 | As defined in TS 36.212[21] |
| | Number of OFDM symbols for legacy control channels | | 3 | In sync threshold Q_{in_NB-IoT} and the corresponding hypothetical NPDCCH transmission parameters are as specified in clause 7.23.2 and Table 7.23.2-1 respectively. |
| | NPDCCH aggregation level | eCCE | 2 | |
| | NPDCCH repetition level | | 2 | |
| | Ratio of NPDSCH to NRS EPRE | | 0 | |
| | Ratio of NPDCCH to NRS EPRE | | 0 | |
| Out of sync transmission parameters (Note 1) | DCI format | | Format N1 | As defined in TS 36.212[21] |
| | Number of OFDM symbols for legacy control channels | | 3 | Out of sync threshold Q_{out_NB-IoT} and the corresponding hypothetical NPDCCH transmission parameters are as specified in clause 7.23.2 and Table 7.23.2-1 respectively. |
| | NPDCCH aggregation level | eCCE | 2 | |
| | NPDCCH repetition level | | 8 | |
| | Ratio of NPDSCH to NRS EPRE | | 0 | |
| | Ratio of NPDCCH to RS EPRE | dB | 0 | |
| Layer 3 filtering | | | Enabled | Counters: N310 = 1; N311 = 1 |
| T310 timer | | ms | 4000 | T310 is enabled |
| T311 timer | | ms | 1000 | T311 is enabled |
| T1 | | s | 4 | |
| dT | | s | 1.4 | |
| T2 | | s | 2.12 | |
| dT | | s | 1.4 | |
| T3 | | s | 4 | |
| Note 1: NPDCCH corresponding to the in-sync and out of sync transmission parameters need not be included in the Reference Measurement Channel. | | | | |

Table A.7.3.64.1-2: nCell 1 specific test parameters for HD-FDD in-sync radio link monitoring test without DRX for UE category NB1 In-Band mode in normal coverage

| Parameter | Unit | nCell 1 | | | | |
|--|------|-------------|----|----|----|----|
| | | T1 | dT | T2 | dT | T3 |
| BW _{channel} | kHz | 200 | | | | |
| PRB location within eCell | - | 30 | | | | |
| NPDCCH parameters defined in A.3.1.6.1 | | R.27 HD-FDD | | | | |
| NPDSCH_RA | | -3 | | | | |
| NPDSCH_RB | | -3 | | | | |
| NPDCCH_RA | dB | -3 | | | | |
| NPDCCH_RB | dB | -3 | | | | |
| NPBCH_RA | dB | -3 | | | | |
| NPBCH_RB | dB | | | | | |
| NPSS_RA | dB | | | | | |
| NSSS_RA | dB | | | | | |

| | | | | | | |
|--|------------|---------------------------------|--------|-------|--------|------|
| NOCNG_RA ^{Note1} | dB | | | | | |
| NOCNG_RB ^{Note1} | dB | | | | | |
| N_{oc} | dBm/15 kHz | Specified in Table A.7.3.64.1-3 | | | | |
| SNR ^{Note 5, Note 6} | dB | -3.1 | Note 7 | -14.1 | Note 8 | -3.1 |
| Propagation condition | | AWGN | | | | |
| Antenna Configuration | | 2x1 | | | | |
| <p>Note 1: OCNG shall be used such that the resources in ncell1 are fully allocated and a constant total transmitted power spectral density is achieved for all OFDM symbols.</p> <p>Note 2: The uplink resources for CQI reporting are assigned to the UE prior to the start of time period T1.</p> <p>Note 3: The timers and layer 3 filtering related parameters are configured prior to the start of time period T1.</p> <p>Note 4: The signal contains NPDCCH for UEs other than the device under test as part of OCNG.</p> <p>Note 5: SNR levels correspond to the signal to noise ratio over the cell-specific reference signal REs.</p> <p>Note 6: The SNR in time periods T1, T2 and T3 is denoted as SNR1, SNR2, and SNR3 respectively in figure A.7.3.64.1-1.</p> <p>Note 7: The Test system shall reduce its transmit power in steps of $((SNR2-SNR1) / (10*dT))$ dB every 100ms till SNR2 is achieved at the end of dT</p> <p>Note 8: The Test system shall increase its transmit power in steps of $((SNR1-SNR2) / (10*dT))$ dB every 100ms till SNR1 is achieved at the end of dT</p> | | | | | | |

Table A.7.3.64.1-3: eCell 1 specific test parameters for HD-FDD in-sync radio link monitoring test without DRX for UE category NB1 In-Band mode in normal coverage

| Parameter | Unit | eCell 1 |
|---|------------|-----------|
| | | T1-T3 |
| $BW_{channel}$ | MHz | 10 |
| NOCNG Pattern | - | NOP.1 FDD |
| PBCH_RA | dB | -3 |
| PBCH_RB | dB | |
| PSS_RA | dB | |
| SSS_RA | dB | |
| PCFICH_RB | dB | |
| PDCCH_RA | dB | |
| PDCCH_RB | dB | |
| OCNG_RA ^{Note 1} | dB | |
| OCNG_RB ^{Note 1} | dB | |
| N_{oc} ^{Note2} | dBm/15 kHz | |
| \hat{E}_s / N_{oc} | dB | 6 |
| Propagation Condition | | AWGN |
| Antenna Configuration | | 2x1 |
| <p>Note 1: OCNG shall be used such that the eCell is fully allocated and a constant total transmitted power spectral density is achieved for all OFDM symbols.</p> <p>Note 2: Interference from other cells and noise sources not specified in the test is assumed to be constant over subcarriers and time and shall be modelled as AWGN of appropriate power N_{oc}.</p> | | |

Table A.7.3.64.1-4: TimeAlignmentTimer -Configuration for E-UTRAN HD-FDD in-sync tests without DRX for UE category NB1 In-Band mode in normal coverage

| Field | Value | Comment |
|--------------------|----------|---|
| TimeAlignmentTimer | infinity | As specified in clause 6.3.2 in TS 36.331 |

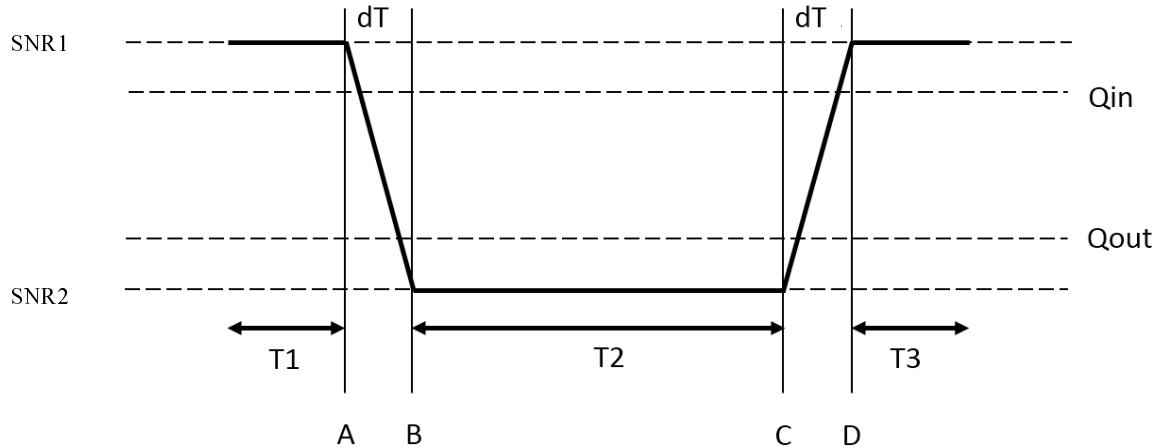

Figure A.7.3.64.1-1: SNR variation for in-sync testing without DRX

A.7.3.64.2 Test Requirements

The UE behavior in each test shall be as follows:

During the period T3, the UE under test is expected to decode the uplink grant and switch to uplink and complete the uplink transmission. This is considered a correct event.

The rate of correct events observed during repeated tests shall be at least 90%.

A.7.3.65 HD-FDD Radio Link Monitoring Test for In-sync without DRX for UE Category NB1 In-Band mode in Enhanced Coverage

A.7.3.65.1 Test Purpose and Environment

The purpose of this test is to verify that the HD-FDD category NB1 UE configured in enhanced coverage properly detects the out of sync and in sync for the purpose of monitoring downlink radio link quality of the PCell when DRX is used. This test will partly verify the HD-FDD radio link monitoring requirements in clause 7.23.

The test parameters are given in Tables A.7.3.65.1-1, A.7.3.65.1-2, A.7.3.65.1-3, A.7.3.65.1-4 and A.7.3.65.1-5. nCell 1 is the active cell in the test. The test consists of three successive time periods, with time duration of T1, T2 and T3 respectively, excluding the transition time duration dT, where the SNR increases or decreases gradually in small steps. Figure A.7.3.65.1-1 shows the variation of the downlink SNR in the active cell to emulate out-of-sync and in-sync states.

Prior to the start of the time duration T1, the UE shall be fully be synchronized to nCell 1. The UE is scheduled in designated uplink subframes to transmit NPUSCH, which is received by the test equipment. By measuring the reception of the NPUSCH, detection of out of sync and in sync requirements can be measured. In the test, DRX configuration is disabled, i.e. UE tries to decode NPDCCH and to send NPUSCH during the period when On-duration timer is running. Time alignment timers shall be set to “infinity” so that UL timing alignment is maintained during the test.

The test setup in each test during time durations T1, T2, dT and T3 shall be as follows:

- During the period from time point A to time point B, the SNR is decreasing linearly from SNR1 to SNR2.
- During the period from time point C to time point D, the SNR is increasing linearly from SNR2 to SNR3.
- During the period T3, the test system shall send the UE a grant to transmit in uplink. UE under test is expected to decode the uplink grant and switch to uplink and complete the uplink transmission. During the period from time point A to time point D, the UE shall not be provisioned with any UL grant.
- Thereafter UE switches back to downlink.

In each run of the test, the test equipment selects NPDCCH repetition level, and sends the RRC configuration to the UE. UE shall successfully complete the RRC reconfiguration accordingly prior to the start of time duration T1.

Table A.7.3.65.1-1: General test parameters for HD-FDD in-sync test without DRX for UE category NB1 In-Band mode in enhanced coverage

| Parameter | | Unit | Value | Comment |
|--|--|------|-----------|--|
| NB-IoT operational mode | | | In-band | NB-IOT cell nCell1 is within E-UTRA cell eCell1 |
| Active cell | | | nCell 1 | NB-IOT cell nCell1 is within E-UTRA cell eCell1 |
| CP length | | | Normal | |
| In sync transmission parameters (Note 1) | DCI format | | Format N1 | As defined in TS 36.212[21] |
| | Number of OFDM symbols for legacy control channels | | 3 | In sync threshold Q_{in_NB-IoT} and the corresponding hypothetical NPDCCH transmission parameters are as specified in clause 7.23.2 and Table 7.23.2-1 respectively. |
| | NPDCCH aggregation level | eCCE | 2 | |
| | NPDCCH repetition level | | 4 | |
| | Ratio of NPDSCH to NRS EPRE | | 0 | |
| | Ratio of NPDCCH to NRS EPRE | | 0 | |
| Out of sync transmission parameters (Note 1) | DCI format | | Format N1 | As defined in TS 36.212[21] |
| | Number of OFDM symbols for legacy control channels | | 3 | Out of sync threshold Q_{out_NB-IoT} and the corresponding hypothetical NPDCCH transmission parameters are as specified in clause 7.23.2 and Table 7.23.2-1 respectively. |
| | NPDCCH aggregation level | eCCE | 2 | |
| | NPDCCH repetition level | | 16 | |
| | Ratio of NPDSCH to NRS EPRE | | 0 | |
| | Ratio of NPDCCH to RS EPRE | dB | 0 | |
| Layer 3 filtering | | | Enabled | Counters: N310 = 1; N311 = 1 |
| T310 timer | | ms | 4000 | T310 is enabled |
| T311 timer | | ms | 1000 | T311 is enabled |
| T1 | | s | 4 | |
| dT | | s | 1.4 | |
| T2 | | s | 2.12 | |
| dT | | s | 1.4 | |
| T3 | | s | 4 | |
| Note 1: NPDCCH corresponding to the in-sync and out of sync transmission parameters need not be included in the Reference Measurement Channel. | | | | |

Table A.7.3.65.1-2: nCell 1 specific test parameters for HD-FDD in-sync radio link monitoring test without DRX for UE category NB1 In-Band mode in enhanced coverage

| Parameter | Unit | nCell 1 | | | | |
|--|------|-------------|----|----|----|----|
| | | T1 | dT | T2 | dT | T3 |
| BW _{channel} | kHz | 200 | | | | |
| PRB location within eCell | - | 30 | | | | |
| NPDCCH parameters defined in A.3.1.6.1 | | R.27 HD-FDD | | | | |
| NPDSCH_RA | | -3 | | | | |
| NPDSCH_RB | | -3 | | | | |
| NPDCCH_RA | dB | -3 | | | | |
| NPDCCH_RB | dB | -3 | | | | |
| NPBCH_RA | dB | -3 | | | | |
| NPBCH_RB | dB | | | | | |
| NPSS_RA | dB | | | | | |

| | | | | | | |
|--|------------|---------------------------------|--------|-------|--------|------|
| NSSS_RA | dB | | | | | |
| NOCNG_RA ^{Note1} | dB | | | | | |
| NOCNG_RB ^{Note1} | dB | | | | | |
| N_{oc} | dBm/15 kHz | Specified in Table A.7.3.65.1-3 | | | | |
| SNR ^{Note 5, Note 6} | dB | -6.3 | Note 7 | -17.4 | Note 8 | -6.3 |
| Propagation condition | | AWGN | | | | |
| Antenna Configuration | | 2x1 | | | | |
| <p>Note 1: OCNG shall be used such that the resources in ncell1 are fully allocated and a constant total transmitted power spectral density is achieved for all OFDM symbols.</p> <p>Note 2: The uplink resources for CQI reporting are assigned to the UE prior to the start of time period T1.</p> <p>Note 3: The timers and layer 3 filtering related parameters are configured prior to the start of time period T1.</p> <p>Note 4: The signal contains NPDCCH for UEs other than the device under test as part of OCNG.</p> <p>Note 5: SNR levels correspond to the signal to noise ratio over the cell-specific reference signal REs.</p> <p>Note 6: The SNR in time periods T1, T2 and T3 is denoted as SNR1, SNR2, and SNR3 respectively in figure A.7.3.65.1-1.</p> <p>Note 7: The Test system shall reduce its transmit power in steps of $((SNR2-SNR1) / (10*dT))$ dB every 100ms till SNR2 is achieved at the end of dT.</p> <p>Note 8: The Test system shall increase its transmit power in steps of $((SNR1-SNR2) / (10*dT))$ dB every 100ms till SNR1 is achieved at the end of dT.</p> | | | | | | |

Table A.7.3.65.1-3: eCell 1 specific test parameters for HD-FDD in-sync radio link monitoring test without DRX for UE category NB1 In-Band mode in enhanced coverage

| Parameter | Unit | eCell 1 |
|---|------------|-----------|
| | | T1-T3 |
| BW _{channel} | MHz | 10 |
| NOCNG Pattern | - | NOP.1 FDD |
| PBCH_RA | dB | -3 |
| PBCH_RB | dB | |
| PSS_RA | dB | |
| SSS_RA | dB | |
| PCFICH_RB | dB | |
| PDCCH_RA | dB | |
| PDCCH_RB | dB | |
| OCNG_RA ^{Note 1} | dB | |
| OCNG_RB ^{Note 1} | dB | |
| N_{oc} ^{Note2} | dBm/15 kHz | |
| \hat{E}_s / N_{oc} | dB | 0 |
| Propagation Condition | | AWGN |
| Antenna Configuration | | 2x1 |
| <p>Note 1: OCNG shall be used such that the eCell is fully allocated and a constant total transmitted power spectral density is achieved for all OFDM symbols.</p> <p>Note 2: Interference from other cells and noise sources not specified in the test is assumed to be constant over subcarriers and time and shall be modelled as AWGN of appropriate power N_{oc}.</p> | | |

Table A.7.3.65.1-4: TimeAlignmentTimer-Configuration for E-UTRAN HD-FDD in-sync tests without DRX for UE category NB1 In-Band mode in enhanced coverage

| Field | Value | Comment |
|--------------------|----------|---|
| TimeAlignmentTimer | infinity | As specified in clause 6.3.2 in TS 36.331 |

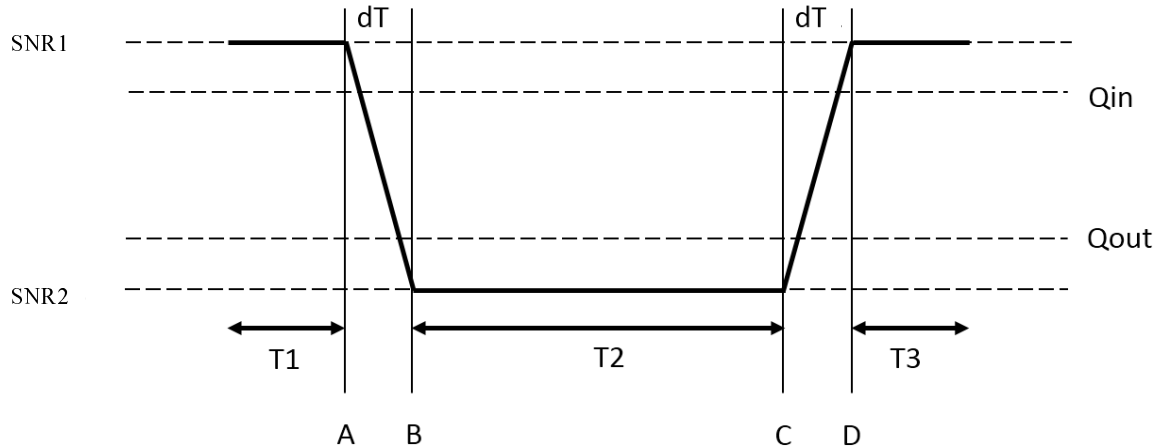

Figure A.7.3.65.1-1: SNR variation for in-sync testing without DRX

A.7.3.65.2 Test Requirements

The UE behavior in each test shall be as follows:

During the period T3, the UE under test is expected to decode the uplink grant and switch to uplink and complete the uplink transmission. This is considered a correct event.

The rate of correct events observed during repeated tests shall be at least 90%.

A.7.3.66 HD-FDD Radio Link Monitoring Test for Out-of-sync without DRX for UE Category NB1 Standalone mode in Normal Coverage

A.7.3.66.1 Test Purpose and Environment

The purpose of this test is to verify that the HD-FDD category NB1 UE properly detects the out of sync for the purpose of monitoring downlink radio link quality of the NB-IoT Cell. This test will partly verify the NB-IoT HD-FDD radio link monitoring requirements in clause 7.23.

The test parameters are given in Tables A.7.3.66.1-1 and A.7.3.66.1-2. nCell1 is the active NB-IoT cell in the test. The test consists of four successive time periods with time duration of T1, T2, T3 and T4 respectively, excluding the transition time duration dT, where the SNR increases or decreases gradually in small steps. Figure A.7.3.66.1-1 shows the variation of the downlink SNR in the active cell to emulate out-of-sync state with the following testing procedure:

- Prior to the start of the time duration T1, the UE shall be fully synchronized to nCell1
- Starting at point A, the SNR is decreased in small steps from SNR1 to SNR2 within dT
- At the start of the time duration T2, the UE is provided with a UL grant with NPDCCH

Note: The UE is expected to decode the NPDCCH and complete the UL transmission during T2 according to the UL grant. The UE shall not be provisioned with any more UL grants until the start of time period T4.

- Starting at point B, the SNR is decreased in small steps from SNR2 to SNR3 within dT
- During T3, the SNR is kept as SNR3

Note: The UE is expected to detect OOS and declare RLF during T3.

- Starting at point C, the SNR is increased in small steps from SNR3 to SNR1 with dT
- At the start of the time period T4, the UE will be provided with another UL grant with NPDCCH

Note: The UE is not expected to decode the UL grant and conduct any UL transmission during T4, since the UE is expected to declare RLF during T3.

Table A.7.3.66.1-1: General test parameters for HD-FDD Radio Link Monitoring Test for out-of-sync tests without DRX for UE Category NB1 Standalone mode in normal coverage

| Parameter | Unit | Value | Comment |
|---------------------------------------|--|------------|---|
| NB-IoT operational mode | | Standalone | |
| Active cell | | nCell 1 | |
| CP length | | Normal | |
| NPDCCH repetition level R_{max} | | 8 | Other NPDCCH parameters are defined in "out-of-sync" column in Table 7.23.2-1 |
| DRX | | OFF | |
| Layer 3 filtering ^{Note 2,3} | | Enabled | Counters: N310 = 1 N311 = 1 |
| T310 timer ^{Note 2,3} | ms | 0 | T310 is disabled |
| T311 timer ^{Note 2,3} | ms | 3000 | T311 is enabled |
| T1 | s | 2 | |
| dT | s | 0.8 | |
| T2 | s | 0.4 | |
| dT | s | 0.7 | |
| T3 | s | 0.5 | |
| dT | s | 1.4 | |
| T4 | s | 0.4 | |
| Note 1: | NPDCCH corresponding to the out of sync transmission parameters need not be included in the Reference Measurement Channel. | | |
| Note 2: | N310, N311, T310 and T311 are defined in TS 36.331. | | |
| Note 3: | The timers and layer 3 filtering related parameters are configured prior to the start of time period T1. | | |

Table A.7.3.66.1-2: nCell1 specific test parameters for HD-FDD Radio Link Monitoring Test for out-of-sync without DRX for UE Category NB1 Standalone mode in normal coverage

| Parameter | Unit | nCell 1 | | | | | | | |
|--|--|-------------|--------|------|--------|-------|--------|------|--|
| | | T1 | dT | T2 | dT | T3 | dT | T4 | |
| NB-IoT RF Channel Number | | 1 | | | | | | | |
| NB-IoT Channel Bandwidth ($BW_{channel}$) | kHz | 180 | | | | | | | |
| OCNG Pattern as defined in A.3.2.3.3 ^{Note 1} | | NOP.3 FDD | | | | | | | |
| NPDCCH parameters as defined in A.3.1.6.3 | | R.33 HD-FDD | | | | | | | |
| NPBCH_RA | dB | -3 | | | | | | | |
| NPBCH_RB | dB | | | | | | | | |
| NPSS_RA | dB | | | | | | | | |
| NSSS_RA | dB | | | | | | | | |
| NPDCCH_RA | dB | | | | | | | | |
| NPDCCH_RB | dB | | | | | | | | |
| NPDSCH_RA | dB | | | | | | | | |
| NPDSCH_RB | dB | | | | | | | | |
| OCNG_RA ^{Note 1} | dB | | | | | | | | |
| OCNG_RB ^{Note 1} | dB | | | | | | | | |
| N_{oc} | dBm/15 KHz | -98 | | | | | | | |
| SNR ^{Note 4,5} | - | -3.1 | Note 6 | -9.1 | Note 7 | -14.1 | Note 8 | -3.1 | |
| Propagation Condition | - | AWGN | | | | | | | |
| Antenna Configuration | - | 2x1 | | | | | | | |
| Note 1: | OCNG shall be used such that the cell is fully allocated and a constant total transmitted power spectral density is achieved for all OFDM symbols. The OCNG pattern is chosen during the test according to the presence of a DL reference measurement channel. | | | | | | | | |
| Note 2: | Void | | | | | | | | |
| Note 3: | Void | | | | | | | | |
| Note 4: | SNR levels correspond to the signal to noise ratio over the cell-specific reference signal REs. | | | | | | | | |
| Note 5: | The SNRs in time periods T1, T2, T3 and T4 are denoted as SNR1, SNR2, SNR3 and SNR1 respectively in | | | | | | | | |

figure A.7.3.66.1-1.

- Note 6: The Test system shall reduce its transmit power in steps of $\left(\frac{SNR2-SNR1}{10 \cdot dT}\right)$ dB every 100ms until SNR2 is achieved at the end of dT.
- Note 7: The Test system shall reduce its transmit power in steps of $\left(\frac{SNR3-SNR2}{10 \cdot dT}\right)$ dB every 100ms until SNR3 is achieved at the end of dT.
- Note 8: The Test system shall increase its transmit power in steps of $\left(\frac{SNR1-SNR3}{10 \cdot dT}\right)$ dB every 100ms until SNR1 is achieved at the end of dT.

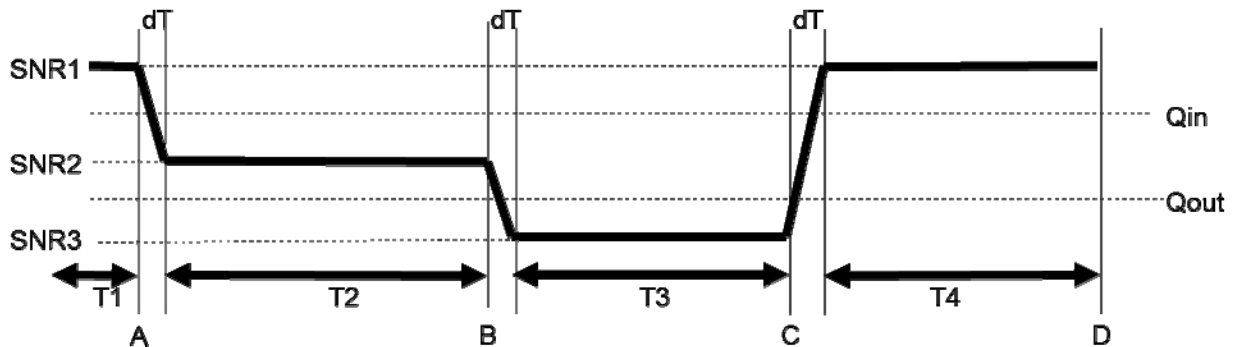

Figure A.7.3.66.1-1: SNR variation for out-of-sync testing

A.7.3.66.2 Test Requirements

The UE behaviors in each test shall be as follows:

- The UE shall complete the NPUSCH transmission during T2 according to the received UL grant;
- The UE shall not conduct any NPUSCH transmission during T4

A correct event is defined as UE behaves correctly in all above steps. The correct events observed during repeated tests shall be at least 90%.

A.7.3.67 HD-FDD Radio Link Monitoring Test for Out-of-sync without DRX for UE Category NB1 guard band mode in Enhanced Coverage

A.7.3.67.1 Test Purpose and Environment

The purpose of this test is to verify that the HD-FDD category NB1 UE properly detects the out of sync for the purpose of monitoring downlink radio link quality of the NB-IoT Cell. This test will partly verify the NB-IoT HD-FDD radio link monitoring requirements in clause 7.23.

The test parameters are given in Tables A.7.3.67.1-1 and A.7.3.67.1-2 below. nCell1 is the active NB-IoT cell, in the test. The test consists of four successive time periods with time duration of T1, T2, T3 and T4 respectively, excluding the transition time duration dT, where the SNR increases or decreases gradually in small steps. Figure A.7.3.67.1-1 shows the variation of the downlink SNR in the active cell to emulate out-of-sync state with the following testing procedure.

- Before the start of the time duration T1, the UE shall be fully synchronized to nCell1
- Starting at point A, the SNR is decreased in small steps from SNR1 to SNR2 with duration dT
- At the start of the time duration T2, the UE is provided with a UL grant with NPDCCH.

Note: The UE is expected to decode NPDCCH and complete the UL transmission during T2 according to the UL grant. The UE shall not be provisioned with any more UL grants until the start of time period T4.

- Starting at point B, the SNR is decreased in small steps from SNR2 to SNR3 with duration dT
- During T3, the SNR is kept at SNR3.

Note: The UE is expected to detect OOS and declare RLF during T3.

- Starting at point C, the SNR is increased in small steps from SNR3 to SNR1 with duration dT
- At the start of the time period T4, the UE will be provided with another UL grant with NPDCCH

Note: The UE is not expected to decode the UL grant and conduct the UL transmission during T4 since the UE is expected to declare RLF during T3.

Table A.7.3.67.1-1: General test parameters for HD-FDD Radio Link Monitoring Test for out-of-sync tests without DRX or UE Category NB1 Guard band mode in enhanced coverage

| Parameter | Unit | Value | Comment |
|---|------|-----------|---|
| NB-IoT operational mode | | Guardband | |
| Active cell | | nCell 1 | |
| CP length | | Normal | |
| NB-IoT RF Channel Number | | 1 | One NB-IoT carrier frequency |
| NPDCCH repetition level R_{max} | | 16 | Other NPDCCH parameters are defined in "out-of-sync" column in Table 7.23.2-1 |
| DRX | | OFF | |
| Layer 3 filtering ^{Note 2} | | Enabled | Counters: N310 = 1 N311 = 1 |
| T310 timer ^{Note 2} | ms | 0 | T310 is disabled |
| T311 timer ^{Note 2} | ms | 3000 | T311 is enabled |
| T1 | s | 2 | |
| dT | s | 0.7 | |
| T2 | s | 0.4 | |
| dT | s | 0.8 | |
| T3 | s | 0.5 | |
| dT | s | 1.4 | |
| T4 | s | 0.4 | |
| Note 1: NPDCCH corresponding to the out of sync transmission parameters need not be included in the Reference Measurement Channel. Note 2: N310, N311, T310 and T311 are defined in TS 36.331. Note 3: The timers and layer 3 filtering related parameters are configured prior to the start of time period T1. | | | |

Table A.7.3.67.1-2: nCell1 specific test parameters for HD-FDD Radio Link Monitoring Test for out-of-sync without DRX for UE Category NB1 Guard band mode in enhanced coverage

| Parameter | Unit | nCell 1 | | | | | | |
|---|------|-------------|----|----|----|----|----|----|
| | | T1 | dT | T2 | dT | T3 | dT | T4 |
| $BW_{channel}$ | KHz | 180 | | | | | | |
| PRB location within eCell | - | 50 | | | | | | |
| NPDCCH parameters as defined in A.3.1.6.5 | | R.37 HD-FDD | | | | | | |
| NPBCH_RA | dB | -3 | | | | | | |
| NPBCH_RB | dB | | | | | | | |
| NPSS_RA | dB | | | | | | | |
| NSSS_RA | dB | | | | | | | |
| NPDCCH_RA | dB | | | | | | | |
| NPDCCH_RB | dB | | | | | | | |
| NPDSCH_RA | dB | | | | | | | |
| NPDSCH_RB | dB | | | | | | | |

| | | | | | | | | |
|---------------------------|--|---------------------------------|--------|-------|--------|-------|--------|------|
| OCNG_RA ^{Note 1} | dB | | | | | | | |
| OCNG_RB ^{Note 1} | dB | | | | | | | |
| N_{oc} | dBm/15 KHz | Specified in Table A.7.3.67.1-3 | | | | | | |
| SNR ^{Note 4,5} | - | -6.3 | Note 6 | -11.4 | Note 7 | -17.4 | Note 8 | -6.3 |
| Propagation Condition | - | AWGN | | | | | | |
| Antenna Configuration | - | 2x1 | | | | | | |
| Note 1: | OCNG shall be used such that the cell is fully allocated and a constant total transmitted power spectral density is achieved for all OFDM symbols. The OCNG pattern is chosen during the test according to the presence of a DL reference measurement channel. | | | | | | | |
| Note 2: | Void | | | | | | | |
| Note 3: | Void | | | | | | | |
| Note 4: | SNR levels correspond to the signal to noise ratio over the cell-specific reference signal REs. | | | | | | | |
| Note 5: | The SNR in time periods T1, T2, T3 and T4 is denoted as SNR1, SNR2, SNR3 and SNR1 respectively in figure A.7.3.67.1-1. | | | | | | | |
| Note 6: | The Test system shall reduce its transmit power in steps of $((SNR2-SNR1) / (10*dT))$ dB every 100ms until SNR2 is achieved at the end of dT. | | | | | | | |
| Note 7: | The Test system shall reduce its transmit power in steps of $((SNR3-SNR2) / (10*dT))$ dB every 100ms until SNR3 is achieved at the end of dT. | | | | | | | |
| Note 8: | The Test system shall increase its transmit power in steps of $((SNR1-SNR3) / (10*dT))$ dB every 100ms until SNR1 is achieved at the end of dT. | | | | | | | |

Table A.7.3.67.1-3: eCell 1 specific test parameters for HD-FDD out-of-sync radio link monitoring test without DRX for UE category NB1 Guard band mode in enhanced coverage

| Parameter | Unit | eCell 1 |
|----------------------------|---|-----------|
| | | T1-T4 |
| $BW_{channel}$ | MHz | 10 |
| NOCNG Pattern | - | NOP.2 FDD |
| PBCH_RA | dB | -3 |
| PBCH_RB | dB | |
| PSS_RA | dB | |
| SSS_RA | dB | |
| PCFICH_RB | dB | |
| PDCCH_RA | dB | |
| PDCCH_RB | dB | |
| OCNG_RA ^{Note 1} | dB | |
| OCNG_RB ^{Note 1} | dB | |
| N_{oc} ^{Note 2} | dBm/15 kHz | |
| \hat{E}_s / N_{oc} | dB | -12 |
| Propagation Condition | | AWGN |
| Antenna Configuration | | 2x1 |
| Note 1: | OCNG shall be used such that the eCell 1 is fully allocated and a constant total transmitted power spectral density is achieved for all OFDM symbols. | |
| Note 2: | Interference from other cells and noise sources not specified in the test is assumed to be constant over subcarriers and time and shall be modelled as AWGN of appropriate power N_{oc} . | |

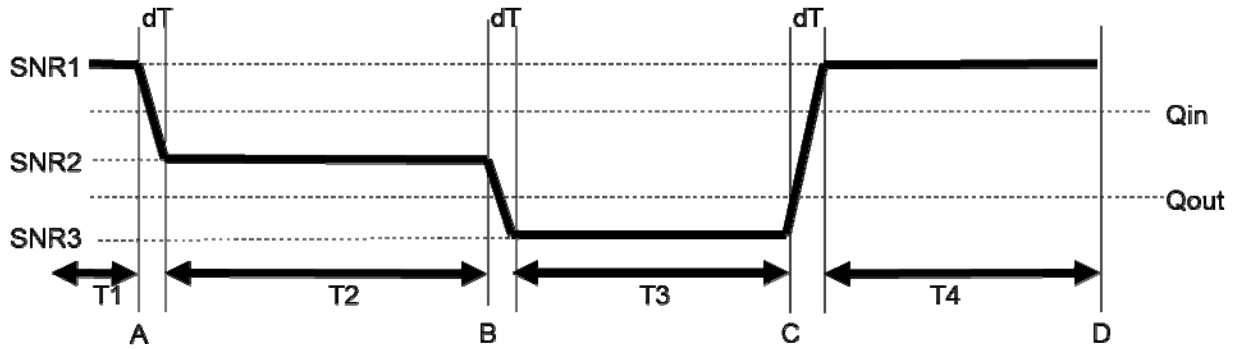

Figure A.7.3.67.1-1: SNR variation for out-of-sync testing

A.7.3.67.2 Test Requirements

The UE behaviors in each test shall be as follows:

- The UE shall complete the NPUSCH transmission during T2 according to the received UL grant;
- The UE shall not conduct any NPUSCH transmission during T4

A correct event is defined as UE behave correctly in all above steps. The correct events observed during repeated tests shall be at least 90%.

A.7.3.68 E-UTRAN FD-FDD Radio Link Monitoring Test for Out-of-sync for non-BL CE UE in CEMode A

A.7.3.68.1 Test Purpose and Environment

The purpose of this test is to verify that the FD-FDD non-BL CE UE properly detects the out of sync and in sync for the purpose of monitoring downlink radio link quality of the PCell in CEModeA. This test will partly verify the E-UTRAN FDD radio link monitoring requirements for non-BL CE UE defined in clause 7.19.

The test parameters are given in Tables A.7.3.68.1-1 and A.7.3.68.1-2 below. There is one cell (cell 1), which is the active cell, in the test. The test consists of three successive time periods, with time duration of T1, T2 and T3 respectively. Figure A.7.3.68.1-1 shows the variation of the downlink SNR in the active cell to emulate out-of-sync and in-sync states. Prior to the start of the time duration T1, the UE shall be fully synchronized to cell 1. The UE shall be configured for periodic CQI reporting in PUCCH 1-0 mode without repetition with a reporting periodicity of 2 ms.

In the test, the RRC parameter *numberPRB-Pairs* is set to 6 and the RRC parameter *mPDCCH-NumRepetition* is set to 4. UE shall successfully complete the RRC reconfiguration accordingly prior to the start of time duration T1.

Table A.7.3.68.1-1: General test parameters for E-UTRAN FD-FDD out-of-sync testing for non-BL CE UE in CEMode A

| Parameter | Unit | Value | Comment |
|--|--|--------|--|
| Active cell | | Cell 1 | Cell 1 is on E-UTRA RF channel number 1 |
| CP length | | Normal | |
| Out of sync transmission parameters (Note 1) | DCI format | 6-1A | As defined in section 5.3.3.1.12 in TS 36.212 |
| | Number of OFDM symbols for legacy control channels | 2 | Out of sync threshold Q_{out} and the corresponding hypothetical MPDCCH transmission parameters are as |
| | M-PDCCH aggregation | eCCE | 24 |

| | | | | |
|--|--------------------------|----|-----------|--|
| | level | | | specified in section 7.19.2 and Table 7.19.2-1 respectively. |
| | M-PDCCH repetition level | | 4 | |
| | ρ_A, ρ_B | | -3 | |
| DRX | | | OFF | |
| Layer 3 filtering | | | Enabled | Counters: N310 = 1; N311 = 1 |
| T310 timer | | ms | 0 | T310 is disabled |
| T311 timer | | ms | 1000 | T311 is enabled |
| Periodic CQI reporting mode | | | PUCCH 1-0 | As defined in table 7.2.2-1 in TS 36.213. |
| CQI reporting periodicity | | ms | 2 | Minimum CQI reporting periodicity |
| T1 | | s | 2 | |
| T2 | | s | 0.8 | |
| T3 | | s | 1.8 | |
| Note 1: MPDCCH corresponding to the out of sync transmission parameters need not be included in the Reference Measurement Channel. | | | | |

Table A.7.3.68.1-2: Cell specific test parameters for E-UTRAN FD-FDD (cell # 1) for out-of-sync radio link monitoring tests for non-BL CE UE in CEMode A

| Parameter | Unit | Test 1 | | |
|--|------------|--------------------|--------|------------------------------|
| | | T1 | T2 | T3 |
| E-UTRA RF Channel Number | | 1 | | |
| $BW_{channel}$ | MHz | 10 | | |
| MPDCCH parameters as defined in A.3.1.3.1 | | R.17 FDD | | |
| OCNG Pattern defined in A.3.2.1.21 (FDD) | | OP.21 FDD | | |
| ρ_A, ρ_B | | -3 | | |
| MPDCCH_RA | dB | 0 | | |
| MPDCCH_RB | dB | 0 | | |
| PBCH_RA | dB | -3 | | |
| PBCH_RB | dB | | | |
| PSS_RA | dB | | | |
| SSS_RA | dB | | | |
| OCNG_RA ^{Note 1} | dB | | | |
| OCNG_RB ^{Note 1} | dB | | | |
| N_{oc} | dBm/15 kHz | -98 | | |
| SNR ^{Note 6} | dB | [-1.5] | [-7.9] | [-15.9] ^{Note 7} |
| Propagation condition | | ETU 30Hz | | |
| Correlation Matrix and Antenna Configuration | | 2x2 Low 2x4 Low | | |

| | |
|---------|--|
| Note 1: | OCNG shall be used such that the resources in cell # 1 are fully allocated and a constant total transmitted power spectral density is achieved for all OFDM symbols. |
| Note 2: | The uplink resources for CQI reporting are assigned to the UE prior to the start of time period T1. |
| Note 3: | The timers and layer 3 filtering related parameters are configured prior to the start of time period T1. |
| Note 4: | The signal contains PDCCH for UEs other than the device under test as part of OCNG. |
| Note 5: | SNR levels correspond to the signal to noise ratio over the cell-specific reference signal REs. |
| Note 6: | The SNR in time periods T1, T2 and T3 is denoted as SNR1, SNR2 and SNR3 respectively in figure A.7.3.68.1-1. |
| Note 7: | For 4 Rx UE, SNR in T3 is -18.5 dB. |

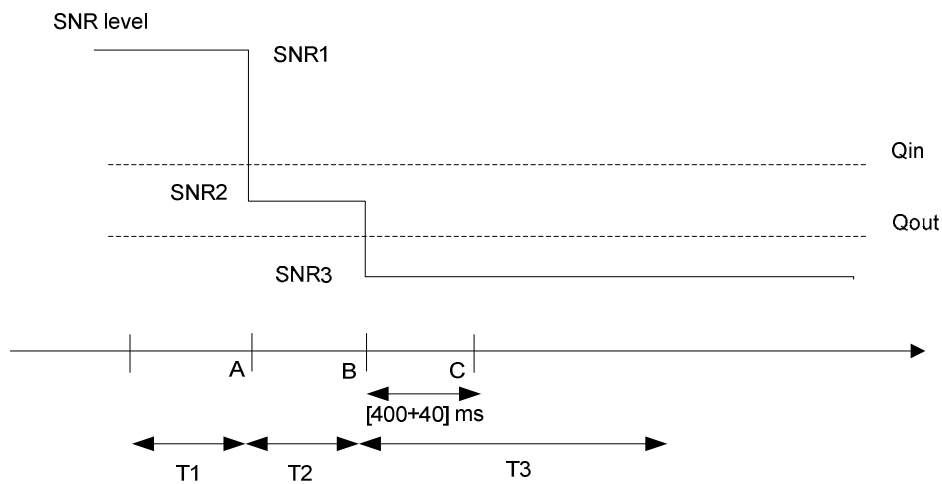

Figure A.7.3.68.1-1: SNR variation for out-of-sync testing

A.7.3.68.2 Test Requirements

The UE behaviour in each test during time durations T1, T2 and T3 shall be as follows:

During the period from time point A to time point B the UE shall transmit uplink signal at least in all subframes configured for CQI transmission according to the configured CQI reporting mode (PUCCH 1-0).

The UE shall stop transmitting uplink signal no later than time point C (440 ms after the start of time duration T3).

The rate of correct events observed during repeated tests shall be at least 90%.

A.7.3.69 E-UTRAN FD-FDD Radio Link Monitoring Test for In-Sync for non-BL CE UE in CEMode A

A.7.3.69.1 Test Purpose and Environment

The purpose of this test is to verify that the FD-FDD non-BL CE UE properly detects the out of sync and in sync for the purpose of monitoring downlink radio link quality of the PCell in CEModeA. This test will partly verify the E-UTRAN FDD radio link monitoring requirements for non-BL CE UE defined in clause 7.19.

The test parameters are given in Tables A.7.3.69.1-1 and A.7.3.69.1-2 below. There is one cell (cell 1), which is the active cell, in the test. The test consists of five successive time periods, with time duration of T1, T2, T3, T4 and T5 respectively. Figure A.7.3.69.1-1 shows the variation of the downlink SNR in the active cell to emulate out-of-sync and in-sync states. Prior to the start of the time duration T1, the UE shall be fully synchronized to cell 1. The UE shall be configured for periodic CQI reporting in PUCCH 1-0 mode without repetition with a reporting periodicity of 2 ms.

In the test, the RRC parameter *numberPRB-Pairs* is set to 4 and the RRC parameter *mPDCCH-NumRepetition* is set to 2. UE shall successfully complete the RRC reconfiguration accordingly prior to the start of time duration T1.

Table A.7.3.69.1-1: General test parameters for E-UTRAN FD-FDD in-sync testing for non-BL CE UE in CEMode A

| Parameter | | Unit | Value | Comment |
|--|--|------|-----------|---|
| Active cell | | | Cell 1 | Cell 1 is on E-UTRA RF channel number 1 |
| CP length | | | Normal | |
| In sync transmission parameters (Note 1) | DCI format | | 6-1A | As defined in section 5.3.3.1.12 in TS 36.212 |
| | Number of OFDM symbols for legacy control channels | | 2 | In sync threshold Q_{in} and the corresponding hypothetical MPDCCH transmission parameters are as specified in section 7.19.2 and Table 7.19.2-1 respectively. |
| | M-PDCCH aggregation level | eCCE | 4 | |
| | M-PDCCH repetition level | | 1 | |
| | ρ_A, ρ_B | | -3 | |
| Out of sync transmission parameters (Note 1) | DCI format | | 6-1A | As defined in section 5.3.3.1.12 in TS 36.212 |
| | Number of OFDM symbols for legacy control channels | | 2 | Out of sync threshold Q_{out} and the corresponding hypothetical MPDCCH transmission parameters are as specified in section 7.19.2 and Table 7.19.2-1 respectively. |
| | M-PDCCH aggregation level | eCCE | 16 | |
| | M-PDCCH repetition level | | 2 | |
| | ρ_A, ρ_B | | -3 | |
| DRX | | | OFF | |
| Layer 3 filtering | | | Enabled | Counters: N310 = 1; N311 = 1 |
| T310 timer | | ms | 2000 | T310 is enabled |
| T311 timer | | ms | 1000 | T311 is enabled |
| Periodic CQI reporting mode | | | PUCCH 1-0 | As defined in table 7.2.2-1 in TS 36.213. |
| CQI reporting periodicity | | ms | 2 | Minimum CQI reporting periodicity |
| T1 | | s | 2 | |
| T2 | | s | 0.8 | |
| T3 | | s | 1.36 | |
| T4 | | s | 0.4 | |
| T5 | | s | 2 | |
| Note 1: MPDCCH corresponding to the out of sync transmission parameters need not be included in the Reference Measurement Channel. | | | | |

Table A.7.3.69.1-2: Cell specific test parameters for E-UTRAN FD-FDD (cell # 1) for in-sync radio link monitoring tests for non-BL CE UE in CEMode A

| Parameter | Unit | Test 1 | | | | |
|---------------------------------------|------|-----------|----|----|----|----|
| | | T1 | T2 | T3 | T4 | T5 |
| E-UTRA RF Channel Number | | 1 | | | | |
| $BW_{channel}$ | MHz | 10 | | | | |
| MPDCCH parameters defined in A.3.1.3 | | R.17 FDD | | | | |
| OCNG Pattern defined in A.3.2.1 (FDD) | | OP.21 FDD | | | | |

| | | | | | | |
|---|------------|--------------------|--------|---------------------------|--------|-------|
| ρ_A, ρ_B | | -3 | | | | |
| MPDCCH_RA | dB | 0 | | | | |
| MPDCCH_RB | dB | 0 | | | | |
| PBCH_RA | dB | -3 | | | | |
| PBCH_RB | dB | | | | | |
| PSS_RA | dB | | | | | |
| SSS_RA | dB | | | | | |
| OCNG_RA ^{Note1} | dB | | | | | |
| OCNG_RB ^{Note1} | dB | | | | | |
| N_{oc} | dBm/15 kHz | -98 | | | | |
| SNR ^{Note 6} | dB | [3.3] | [-4.8] | [-12.8] ^{Note 7} | [-2.7] | [3.3] |
| Propagation condition | | ETU 30Hz | | | | |
| Correlation Matrix and Antenna Configuration | | 2x2 Low 2x4 Low | | | | |
| <p>Note 1: OCNG shall be used such that the resources in cell # 1 are fully allocated and a constant total transmitted power spectral density is achieved for all OFDM symbols.</p> <p>Note 2: The uplink resources for CQI reporting are assigned to the UE prior to the start of time period T1.</p> <p>Note 3: The timers and layer 3 filtering related parameters are configured prior to the start of time period T1.</p> <p>Note 4: The signal contains PDCCH for UEs other than the device under test as part of OCNG.</p> <p>Note 5: SNR levels correspond to the signal to noise ratio over the cell-specific reference signal REs.</p> <p>Note 6: The SNR in time periods T1, T2, T3, T4 and T5 is denoted as SNR1, SNR2, SNR3, SNR4 and SNR5 respectively in figure A.7.3.69.1-1.</p> <p>Note 7: For 4 Rx UE, SNR in T3 is -15.5 dB.</p> | | | | | | |

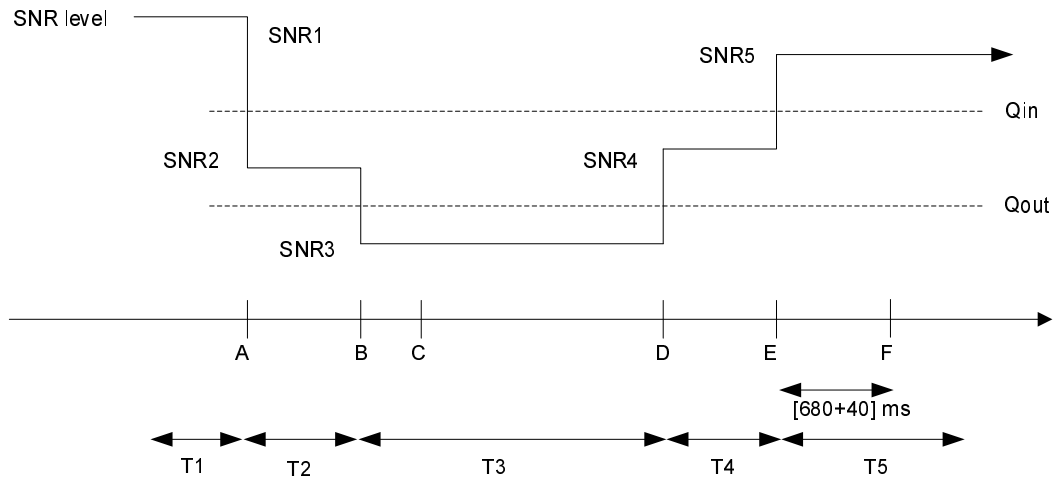

Figure A.7.3.69.1-1: SNR variation for in-sync testing

A.7.3.69.2 Test Requirements

The UE behaviour in each test during time durations T1, T2, T3, T4 and T5 shall be as follows:

During the period from time point A to time point F (720 ms after the start of time duration T5) the UE shall transmit uplink signal at least in all subframes configured for CQI transmission according to the configured CQI reporting mode (PUCCH 1-0).

The rate of correct events observed during repeated tests shall be at least 90%.

A.7.3.70 E-UTRAN FD-FDD Radio Link Monitoring Test for Out-of-sync in DRX for non-BL CE UE configured in CEMode A

A.7.3.70.1 Test Purpose and Environment

The purpose of this test is to verify that the FD-FDD non-BL CE UE configured in CEMode A properly detects the out of sync for the purpose of monitoring downlink radio link quality of the PCell when DRX is used. This test will partly verify the E-UTRAN FD-FDD radio link monitoring requirements in clause 7.19.

The test parameters are given in Tables A.7.3.70.1-1, A.7.3.70.1-2, A.7.3.70.1-3 and A.7.3.70.1-4. There is one cell (cell 1), which is the active cell, in the test. The test consists of three successive time periods, with time duration of T1, T2 and T3 respectively. Figure A.7.3.70.1-1 shows the variation of the downlink SNR in the active cell to emulate out-of-sync states. Prior to the start of the time duration T1, the UE shall be fully synchronized to cell 1. The UE shall be configured for periodic CQI reporting in PUCCH 1-0 mode with a reporting periodicity of 2 ms without repetition. In the test, DRX configuration is enabled and DRX inactivity timer has already been expired, i.e. UE tries to decode MPDCCH and to send periodic CQI during the period when On-duration timer is running. Time alignment timers shall be set to “infinity” so that UL timing alignment is maintained during the test.

In the test, the RRC parameter *numberPRB-Pairs* is set to 4 and the RRC parameter *mPDCCH-NumRepetition* is set 2. UE shall successfully complete the RRC reconfiguration accordingly prior to the start of time duration T1.

Table A.7.3.70.1-1: General test parameters for E-UTRAN FD-FDD out-of-sync tests in DRX for non-BL CE UE configured in CEMode A

| Parameter | | Unit | Value | Comment |
|--|--|------|------------------------|--|
| Active cell | | | Cell 1 | Cell 1 is on E-UTRA RF channel number 1 |
| CP length | | | Normal | |
| Out of sync transmission parameters (Note 1) | DCI format | | 6-1A | As defined in section 5.3.3.1.12 in TS 36.212 |
| | Number of OFDM symbols for legacy control channels | | 2 | Out of sync threshold $Q_{out, Cat M1}$ and the corresponding hypothetical MPDCCH transmission parameters are as specified in clause 7.19.2 and Table 7.19.2-1 respectively. |
| | MPDCCH aggregation level | eCCE | 16 | |
| | MPDCCH repletion level | | 2 | |
| | Ratio of MPDCCH to RS EPRE | | 0 | |
| | ρ_A, ρ_B | | -3 | |
| DRX cycle | ms | 1280 | See Table A.7.3.70.1-3 | |
| Layer 3 filtering | | | Enabled | Counters: N310 = 1; N311 = 1 |
| T310 timer | | ms | 0 | T310 is disabled |
| T311 timer | | ms | 1000 | T311 is enabled |
| Periodic CQI reporting mode | | | PUCCH 1-0 | As defined in table 7.2.2-1 in TS 36.213. |
| CQI reporting periodicity | | ms | 2 | Minimum CQI reporting periodicity |
| T1 | | s | 32 | |
| T2 | | s | 12.8 | |
| T3 | | s | 13 | |
| Note 1: MPDCCH corresponding to the out of sync transmission parameters need not be included in the Reference Measurement Channel. | | | | |

Table A.7.3.70.1-2: Cell specific test parameters for E-UTRAN FD-FDD (cell # 1) for out-of-sync radio link monitoring tests in DRX for non-BL CE UE configured in CEMode A

| Parameter | Unit | Test 1 | | |
|---------------------------------------|------------|-----------|--------|------------------------------|
| | | T1 | T2 | T3 |
| E-UTRA RF Channel Number | | 1 | | |
| $BW_{channel}$ | MHz | 10 | | |
| MPDCCH parameters defined in A.3.1.3 | | R.17 FDD | | |
| OCNG Pattern defined in A.3.2.1 (FDD) | | OP.21 FDD | | |
| ρ_A, ρ_B | | -3 | | |
| MPDCCH_RA | dB | 0 | | |
| MPDCCH_RB | dB | 0 | | |
| PBCH_RA | dB | -3 | | |
| PBCH_RB | dB | | | |
| PSS_RA | dB | | | |
| SSS_RA | dB | | | |
| OCNG_RA ^{Note1} | dB | | | |
| OCNG_RB ^{Note1} | dB | | | |
| N_{oc} | dBm/15 kHz | | | |
| SNR ^{Note 6} | dB | [-0.9] | [-7.7] | [-14.7] ^{Note 7} |
| Propagation condition | | AWGN | | |

| | | |
|--|--|------------|
| Correlation Matrix and Antenna Configuration | | 2x2 2x4 |
| Note 1: | OCNG shall be used such that the resources in cell # 1 are fully allocated and a constant total transmitted power spectral density is achieved for all OFDM symbols. | |
| Note 2: | The uplink resources for CQI reporting are assigned to the UE prior to the start of time period T1. | |
| Note 3: | The timers and layer 3 filtering related parameters are configured prior to the start of time period T1. | |
| Note 4: | The signal contains MPDCCH for UEs other than the device under test as part of OCNG. | |
| Note 5: | SNR levels correspond to the signal to noise ratio over the cell-specific reference signal REs. | |
| Note 6: | The SNR in time periods T1, T2 and T3 is denoted as SNR1, SNR2 and SNR3 respectively in figure A.7.3.70.1-1. | |
| Note 7: | For 4 Rx UE, SNR in T3 is -17.7 dB. | |

Table A.7.3.70.1-3: DRX-Configuration for E-UTRAN FD-FDD out-of-sync tests for non-BL CE UE configured in CEMode A

| Field | Value | Comment |
|--------------------------|---------|---|
| onDurationTimer | psf10 | As specified in clause 6.3.2 in TS 36.331 |
| drx-InactivityTimer | psf1 | |
| drx-RetransmissionTimer | psf1 | |
| longDRX-CycleStartOffset | sf1280 | |
| shortDRX | disable | |

Table A.7.3.70.1-4: TimeAlignmentTimer-Configuration for E-UTRAN FD-FDD out-of-sync testing for non-BL CE UE configured in CEMode A

| Field | Value | Comment |
|--------------------|----------|--|
| TimeAlignmentTimer | infinity | As specified in clause 6.3.2 in TS 36.331 |
| sr-ConfigIndex | 0 | For further information see clause 6.3.2 in TS 36.331 and section 10.1 in TS 36.213. |

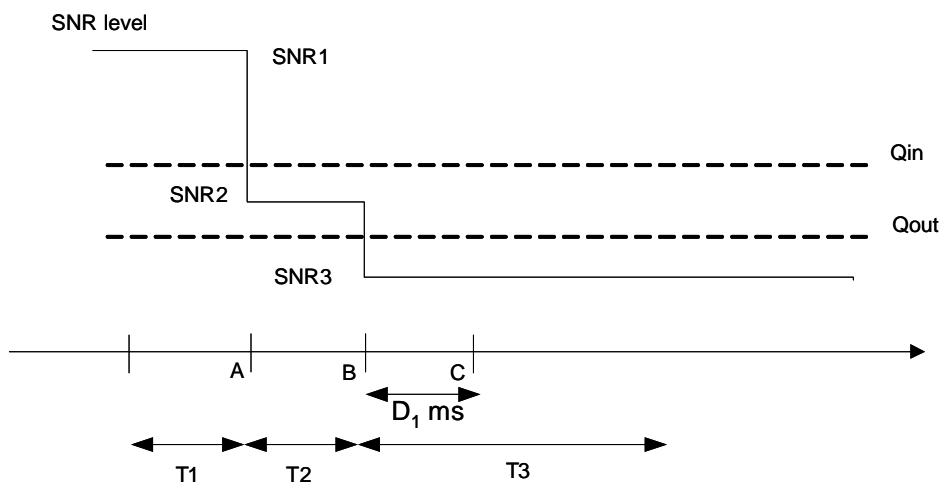

Figure A.7.3.70.1-1: SNR variation for out-of-sync testing in DRX

A.7.3.70.2 Test Requirements

The UE behaviour in each test during time durations T1, T2 and T3 shall be as follows:

During the period from time point A to time point B the UE shall transmit uplink signal at least once every DRX cycle, in the On-duration part of the cycle in the subframe according to the configured CQI reporting mode (PUCCH 1-0).

The UE shall stop transmitting uplink signal no later than time point C (duration $D_1 = 6500$ ms after the start of time duration T3).

The rate of correct events observed during repeated tests shall be at least 90%.

A.7.3.71 E-UTRAN FD-FDD Radio Link Monitoring Test for In-sync in DRX for non-BL CE UE configured in CEMode A

A.7.3.71.1 Test Purpose and Environment

The purpose of this test is to verify that the FD-FDD non-BL CE UE configured in CEMode A properly detects the out of sync and in sync for the purpose of monitoring downlink radio link quality of the PCell when DRX is used. This test will partly verify the E-UTRAN FD-FDD radio link monitoring requirements in clause 7.19.

The test parameters are given in Tables A.7.3.71.1-1, A.7.3.71.1-2, A.7.3.71.1-3 and A.7.3.71.1-4. There is one cell (cell 1), which is the active cell, in the test. The test consists of five successive time periods, with time duration of T1, T2, T3, T4 and T5 respectively. Figure A.7.3.71.1-1 shows the variation of the downlink SNR in the active cell to emulate out-of-sync and in-sync states. Prior to the start of the time duration T1, the UE shall be fully synchronized to cell 1. The UE shall be configured for periodic CQI reporting in PUCCH 1-0 mode with a reporting periodicity of 2 ms without repetition. In the test, DRX configuration is enabled and DRX inactivity timer has already been expired, i.e. UE tries to decode MPDCCH and to send periodic CQI during the period when On-duration timer is running. Time alignment timers shall be set to “infinity” so that UL timing alignment is maintained during the test.

In the test, the RRC parameter *numberPRB-Pairs* is set to 6 and the RRC parameter *mPDCCH-NumRepetition* is set 4. UE shall successfully complete the RRC reconfiguration accordingly prior to the start of time duration T1.

Table A.7.3.71.1-1: General test parameters for E-UTRAN FD-FDD in-sync test in DRX for non-BL CE UE configured in CEMode A

| Parameter | | Unit | Value | Comment |
|--|--|------|---------|--|
| Active cell | | | Cell 1 | Cell 1 is on E-UTRA RF channel number 1 |
| CP length | | | Normal | |
| In sync transmission parameters (Note 1) | DCI format | | 6-1A | As defined in section 5.3.3.1.12 in TS 36.212 |
| | Number of OFDM symbols for legacy control channels | | 2 | In sync threshold $Q_{in, Cat M1}$ and the corresponding hypothetical MPDCCH transmission parameters are as specified in clause 7.19.2 and Table 7.19.2-1 respectively. |
| | MPDCCH aggregation level | eCCE | 8 | |
| | MPDCCH repetition level | | 2 | |
| | ρ_A, ρ_B | | -3 | |
| | Ratio of MPDCCH to RS EPRE | | 0 | |
| Out of sync transmission parameters (Note 1) | DCI format | | 6-1A | As defined in section 5.3.3.1.12 in TS 36.212 |
| | Number of OFDM symbols for legacy control channels | | 2 | Out of sync threshold $Q_{out, Cat M1}$ and the corresponding hypothetical MPDCCH transmission parameters are as specified in clause 7.19.2 and Table 7.19.2-1 respectively. |
| | MPDCCH aggregation level | eCCE | 24 | |
| | MPDCCH repetition level | | 4 | |
| | ρ_A, ρ_B | | -3 | |
| | Ratio of MPDCCH to RS EPRE | dB | 0 | |
| DRX cycle | | ms | 40 | See Table A.7.3.71.1-3 |
| Layer 3 filtering | | | Enabled | Counters: N310 = 1; N311 = 1 |

| | | | |
|--|----|-----------|---|
| T310 timer | ms | 2000 | T310 is enabled |
| T311 timer | ms | 1000 | T311 is enabled |
| Periodic CQI reporting mode | | PUCCH 1-0 | As defined in table 7.2.2-1 in TS 36.213. |
| CQI reporting periodicity | ms | 2 | Minimum CQI reporting periodicity |
| T1 | s | 4 | |
| T2 | s | 1.6 | |
| T3 | s | 1.46 | |
| T4 | s | 0.4 | |
| T5 | s | 4 | |
| Note 1: MPDCCH corresponding to the in-sync and out of sync transmission parameters need not be included in the Reference Measurement Channel. | | | |

Table A.7.3.71.1-2: Cell specific test parameters for E-UTRAN FD-FDD (cell # 1) for in-sync radio link monitoring test in DRX for non-BL CE UE configured in CEMode A

| Parameter | Unit | Test 1 | | | | |
|---|------------|------------|--------|---------------------------|---------|--------|
| | | T1 | T2 | T3 | T4 | T5 |
| E-UTRA RF Channel Number | | 1 | | | | |
| BW _{channel} | MHz | 10 | | | | |
| MPDCCH parameters defined in A.3.1.3 | | R.17 FDD | | | | |
| OCNG Pattern defined in A.3.2.1 (FDD) | | OP.21 FDD | | | | |
| ρ_A, ρ_B | | -3 | | | | |
| MPDCCH_RA | dB | 0 | | | | |
| MPDCCH_RB | dB | 0 | | | | |
| PBCH_RA | dB | -3 | | | | |
| PBCH_RB | dB | | | | | |
| PSS_RA | dB | | | | | |
| SSS_RA | dB | | | | | |
| OCNG_RA ^{Note1} | dB | | | | | |
| OCNG_RB ^{Note1} | dB | | | | | |
| N_{oc} | dBm/15 kHz | | | | | |
| SNR ^{Note 6} | dB | [-5.7] | [-9.5] | [-16.5] ^{Note 7} | [-11.2] | [-5.2] |
| Propagation condition | | AWGN | | | | |
| Correlation Matrix and Antenna Configuration | | 2x2 2x4 | | | | |
| Note 1: OCNG shall be used such that the resources in cell # 1 are fully allocated and a constant total transmitted power spectral density is achieved for all OFDM symbols. Note 2: The uplink resources for CQI reporting are assigned to the UE prior to the start of time period T1. Note 3: The timers and layer 3 filtering related parameters are configured prior to the start of time period T1. Note 4: The signal contains MPDCCH for UEs other than the device under test as part of OCNG. Note 5: SNR levels correspond to the signal to noise ratio over the cell-specific reference signal REs. Note 6: The SNR in time periods T1, T2, T3, T4 and T5 is denoted as SNR1, SNR2, SNR3, SNR4 and SNR5 respectively in figure A.7.3.71.1-1. Note 7: For 4 Rx UE, SNR in T3 is -20.0 dB. | | | | | | |

Table A.7.3.71.1-3: DRX-Configuration for E-UTRAN FD-FDD out-of-sync tests for non-BL CE UE configured in CEMode A

| Field | Value | Comment |
|--------------------------|---------|---|
| onDurationTimer | psf10 | As specified in clause 6.3.2 in TS 36.331 |
| drx-InactivityTimer | psf1 | |
| drx-RetransmissionTimer | psf1 | |
| longDRX-CycleStartOffset | sf40 | |
| shortDRX | disable | |

Table A.7.3.71.1-4: *TimeAlignmentTimer* -Configuration for E-UTRAN FD-FDD out-of-sync testing for non-BL CE UE configured in CEMode A

| Field | Value | Comment |
|--------------------|----------|--|
| TimeAlignmentTimer | infinity | As specified in clause 6.3.2 in TS 36.331 |
| sr-ConfigIndex | 0 | For further information see clause 6.3.2 in TS 36.331 and section 10.1 in TS 36.213. |

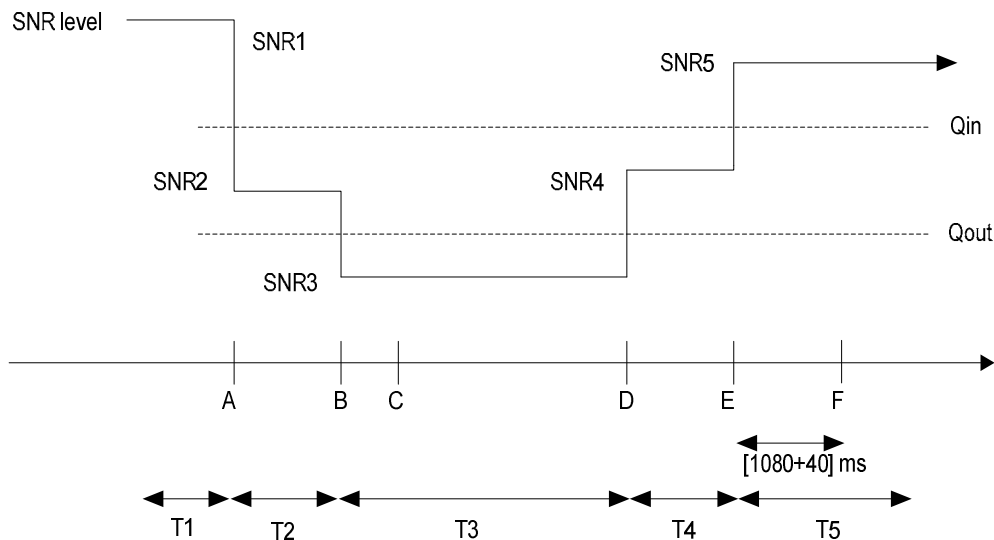

Figure A.7.3.71.1-1: SNR variation for in-sync testing in DRX

A.7.3.71.2 Test Requirements

The UE behaviour in each test during time durations T1, T2, T3, T4 and T5 shall be as follows:

During the period from time point A to time point F (1120 ms after the start of time duration T5) the UE shall transmit uplink signal at least once every DRX cycle, in the On-duration part of the cycle in the subframe according to the configured CQI reporting mode (PUCCH 1-0).

The rate of correct events observed during repeated tests shall be at least 90%.

A.7.3.72 E-UTRAN TDD Radio Link Monitoring Test for Out-of-sync for non-BL CE UE in CEMode A

A.7.3.72.1 Test Purpose and Environment

The purpose of this test is to verify that the TDD non-BL CE UE properly detects the out of sync and in sync for the purpose of monitoring downlink radio link quality of the PCell in CEModeA. This test will partly verify the E-UTRAN TDD radio link monitoring requirements for non-BL CE UE defined in clause 7.19.

The test parameters are given in Tables A.7.3.72.1-1 and A.7.3.72.1-2 below. There is one cell (cell 1), which is the active cell, in the test. The test consists of three successive time periods, with time duration of T1, T2 and T3 respectively. Figure A.7.3.72.1-1 shows the variation of the downlink SNR in the active cell to emulate out-of-sync and in-sync states. Prior to the start of the time duration T1, the UE shall be fully synchronized to cell 1. The UE shall be configured for periodic CQI reporting in PUCCH 1-0 mode with a reporting periodicity of 1 ms.

In the test, the RRC parameter *numberPRB-Pairs* is set to 6 and the RRC parameter *mPDCCH-NumRepetition* is set to 4. UE shall successfully complete the RRC reconfiguration accordingly prior to the start of time duration T1.

Table A.7.3.72.1-1: General test parameters for E-UTRAN TDD out-of-sync testing for non-BL CE UE in CEMode A

| Parameter | | Unit | Value | Comment |
|--|--|------|-----------|---|
| Active cell | | | Cell 1 | Cell 1 is on E-UTRA RF channel number 1 |
| CP length | | | Normal | |
| Out of sync transmission parameters (Note 1) | DCI format | | 6-1A | As defined in section 5.3.3.1.12 in TS 36.212 |
| | Number of OFDM symbols for legacy control channels | | 2 | Out of sync threshold Q_{out} and the corresponding hypothetical MPDCCH transmission parameters are as specified in section 7.19.2 and Table 7.19.2-1 respectively. |
| | M-PDCCH aggregation level | eCCE | 24 | |
| | M-PDCCH repetition level | | 4 | |
| | ρ_A, ρ_B | | -3 | |
| DRX | | | OFF | |
| Layer 3 filtering | | | Enabled | Counters: N310 = 1; N311 = 1 |
| T310 timer | | ms | 0 | T310 is disabled |
| T311 timer | | ms | 1000 | T311 is enabled |
| Periodic CQI reporting mode | | | PUCCH 1-0 | As defined in table 7.2.2-1 in TS 36.213. |
| CQI reporting periodicity | | ms | 1 | Minimum CQI reporting periodicity |
| T1 | | s | 2 | |
| T2 | | s | 0.8 | |
| T3 | | s | 1.8 | |
| Note 1: MPDCCH corresponding to the out of sync transmission parameters need not be included in the Reference Measurement Channel. | | | | |

Table A.7.3.72.1-2: Cell specific test parameters for E-UTRAN TDD (cell # 1) for out-of-sync radio link monitoring tests for non-BL CE CE in CEMode A

| Parameter | Unit | Test 1 | | |
|--|------------|----------------------------|----|----|
| | | T1 | T2 | T3 |
| E-UTRA RF Channel Number | | 1 | | |
| $BW_{channel}$ | MHz | 10 | | |
| Special subframe configuration ^{Note 1} | | 6 | | |
| Uplink-downlink configuration ^{Note 1} | | 1 | | |
| MPDCCH parameters as defined in A.3.1.3.1 | | R.15 TDD ^{Note 8} | | |
| OCNG Pattern defined in A.3.2.2.11 (TDD) | | OP.11 TDD | | |
| ρ_A, ρ_B | | -3 | | |
| PBCH_RA | dB | -3 | | |
| PBCH_RB | dB | | | |
| PSS_RA | dB | | | |
| SSS_RA | dB | | | |
| OCNG_RA ^{Note 1} | dB | | | |
| OCNG_RB ^{Note 1} | dB | | | |
| N_{oc} | dBm/15 kHz | -98 | | |

| | | | | |
|--|----|--------------------|--------|------------------------------|
| SNR ^{Note 7} | dB | [-1.5] | [-7.9] | [-15.9] ^{Note 9} |
| Propagation condition | | ETU 30Hz | | |
| Correlation Matrix and Antenna Configuration | | 2x2 Low 2x4 Low | | |
| <p>Note 1: For special subframe and uplink-downlink configurations see Tables 4.2-1 and 4.2-2 in TS 36.211.</p> <p>Note 2: OCNG shall be used such that the resources in cell # 1 are fully allocated and a constant total transmitted power spectral density is achieved for all OFDM symbols.</p> <p>Note 3: The uplink resources for CQI reporting are assigned to the UE prior to the start of time period T1.</p> <p>Note 4: The timers and layer 3 filtering related parameters are configured prior to the start of time period T1.</p> <p>Note 5: The signal contains PDCCH for UEs other than the device under test as part of OCNG.</p> <p>Note 6: SNR levels correspond to the signal to noise ratio over the cell-specific reference signal REs.</p> <p>Note 7: The SNR in time periods T1, T2 and T3 is denoted as SNR1, SNR2 and SNR3 respectively in figure A.7.3.72.1-1.</p> <p>Note 8: Aggregation level and repetition levels specified in A.7.3.72.1-1 are used for this test.</p> <p>Note 9: For 4 Rx UE, SNR in T3 is -18.5 dB.</p> | | | | |

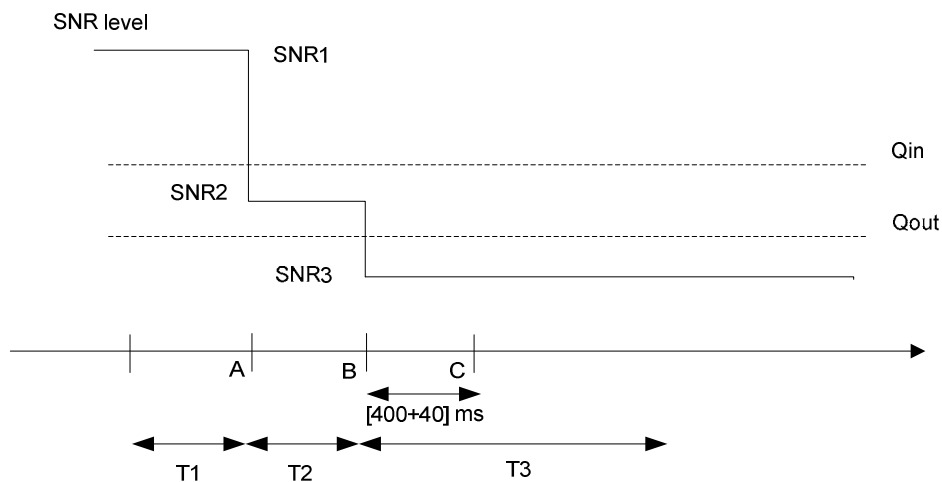

Figure A.7.3.72.1-1: SNR variation for out-of-sync testing

A.7.3.72.2 Test Requirements

The UE behaviour in each test during time durations T1, T2 and T3 shall be as follows:

During the period from time point A to time point B the UE shall transmit uplink signal at least in all subframes configured for CQI transmission according to the configured CQI reporting mode (PUCCH 1-0).

The UE shall stop transmitting uplink signal no later than time point C (440 ms after the start of time duration T3).

The rate of correct events observed during repeated tests shall be at least 90%.

A.7.3.73 E-UTRAN TDD Radio Link Monitoring Test for In-Sync for non-BL CE UE in CEMode A

A.7.3.73.1 Test Purpose and Environment

The purpose of this test is to verify that the TDD non-BL CE UE properly detects the out of sync and in sync for the purpose of monitoring downlink radio link quality of the PCell in CEModeA. This test will partly verify the E-UTRAN TDD radio link monitoring requirements for non-BL CE UE defined in clause 7.19.

The test parameters are given in Tables A.7.3.73.1-1 and A.7.3.73.1-2 below. There is one cell (cell 1), which is the active cell, in the test. The test consists of five successive time periods, with time duration of T1, T2, T3, T4 and T5 respectively. Figure A.7.3.73.1-1 shows the variation of the downlink SNR in the active cell to emulate out-of-sync and in-sync states. Prior to the start of the time duration T1, the UE shall be fully synchronized to cell 1. The UE shall be configured for periodic CQI reporting in PUCCH 1-0 mode without repetition with a reporting periodicity of 1 ms.

In the test, the RRC parameter *numberPRB-Pairs* is set to 4 and the RRC parameter *mPDCCH-NumRepetition* is set to 2. UE shall successfully complete the RRC reconfiguration accordingly prior to the start of time duration T1.

Table A.7.3.73.1-1: General test parameters for E-UTRAN TDD in-sync testing for non-BL CE UE in CEMode A

| Parameter | | Unit | Value | Comment |
|--|--|-----------|---|---|
| Active cell | | | Cell 1 | Cell 1 is on E-UTRA RF channel number 1 |
| CP length | | | Normal | |
| In sync transmission parameters (Note 1) | DCI format | | 6-1A | As defined in section 5.3.3.1.12 in TS 36.212 |
| | Number of OFDM symbols for legacy control channels | | 2 | In sync threshold Q_{in} and the corresponding hypothetical MPDCCH transmission parameters are as specified in section 7.19.2 and Table 7.19.2-1 respectively. |
| | M-PDCCH aggregation level | eCCE | 4 | |
| | M-PDCCH repetition level | | 1 | |
| | ρ_A, ρ_B | | -3 | |
| Out of sync transmission parameters (Note 1) | DCI format | | 6-1A | As defined in section 5.3.3.1.12 in TS 36.212 |
| | Number of OFDM symbols for legacy control channels | | 2 | Out of sync threshold Q_{out} and the corresponding hypothetical MPDCCH transmission parameters are as specified in section 7.19.2 and Table 7.19.2-1 respectively. |
| | M-PDCCH aggregation level | eCCE | 16 | |
| | M-PDCCH repetition level | | 2 | |
| | ρ_A, ρ_B | | -3 | |
| | DRX | | OFF | |
| Layer 3 filtering | | Enabled | Counters: N310 = 1; N311 = 1 | |
| T310 timer | ms | 2000 | T310 is enabled | |
| T311 timer | ms | 1000 | T311 is enabled | |
| Periodic CQI reporting mode | | PUCCH 1-0 | As defined in table 7.2.2-1 in TS 36.213. | |
| CQI reporting periodicity | ms | 1 | Minimum CQI reporting periodicity | |
| T1 | s | 2 | | |
| T2 | s | 0.8 | | |
| T3 | s | 1.36 | | |

| | | | |
|--|---|-----|--|
| T4 | s | 0.4 | |
| T5 | s | 2 | |
| Note 1: MPDCCH corresponding to the in-sync and out of sync transmission parameters need not be included in the Reference Measurement Channel. | | | |

Table A.7.3.73.1-2: Cell specific test parameters for E-UTRAN TDD (cell # 1) for in-sync radio link monitoring tests for non-BL CE UE in CEMode A

| Parameter | Unit | Test 1 | | | | |
|---|------------|------------|--------|---------------------------|--------|-------|
| | | T1 | T2 | T3 | T4 | T5 |
| E-UTRA RF Channel Number | | 1 | | | | |
| BW _{channel} | MHz | 10 | | | | |
| Special subframe configuration ^{Note 1} | | 6 | | | | |
| Uplink-downlink configuration ^{Note 1} | | 1 | | | | |
| MPDCCH parameters as defined in A.3.1.3.1 | | R.15 TDD | | | | |
| OCNG Pattern defined in A.3.2.2.11 (TDD) | | OP.11 TDD | | | | |
| ρ_A, ρ_B | | -3 | | | | |
| MPDCCH_RA | dB | 0 | | | | |
| MPDCCH_RB | dB | 0 | | | | |
| PBCH_RA | dB | -3 | | | | |
| PBCH_RB | dB | | | | | |
| PSS_RA | dB | | | | | |
| SSS_RA | dB | | | | | |
| OCNG_RA ^{Note 2} | dB | | | | | |
| OCNG_RB ^{Note 2} | dB | | | | | |
| N_{oc} | dBm/15 kHz | | | | | |
| SNR ^{Note 6} | dB | [3.3] | [-4.8] | [-12.8] ^{Note 8} | [-2.7] | [3.3] |
| Propagation condition | | AWGN | | | | |
| Correlation Matrix and Antenna Configuration | | 2x2 2x4 | | | | |
| <p>Note 1: For special subframe and uplink-downlink configurations see Tables 4.2-1 and 4.2-2 in TS 36.211.</p> <p>Note 2: OCNG shall be used such that the resources in cell # 1 are fully allocated and a constant total transmitted power spectral density is achieved for all OFDM symbols.</p> <p>Note 3: The uplink resources for CQI reporting are assigned to the UE prior to the start of time period T1.</p> <p>Note 4: The timers and layer 3 filtering related parameters are configured prior to the start of time period T1.</p> <p>Note 5: The signal contains PDCCH for UEs other than the device under test as part of OCNG.</p> <p>Note 6: SNR levels correspond to the signal to noise ratio over the cell-specific reference signal REs.</p> <p>Note 7: The SNR in time periods T1, T2, T3, T4 and T5 is denoted as SNR1, SNR2, SNR3, SNR4 and SNR5 respectively in figure A.7.3.73.1-1.</p> <p>Note 8: For 4 Rx UE, SNR in T3 is -15.5 dB.</p> | | | | | | |

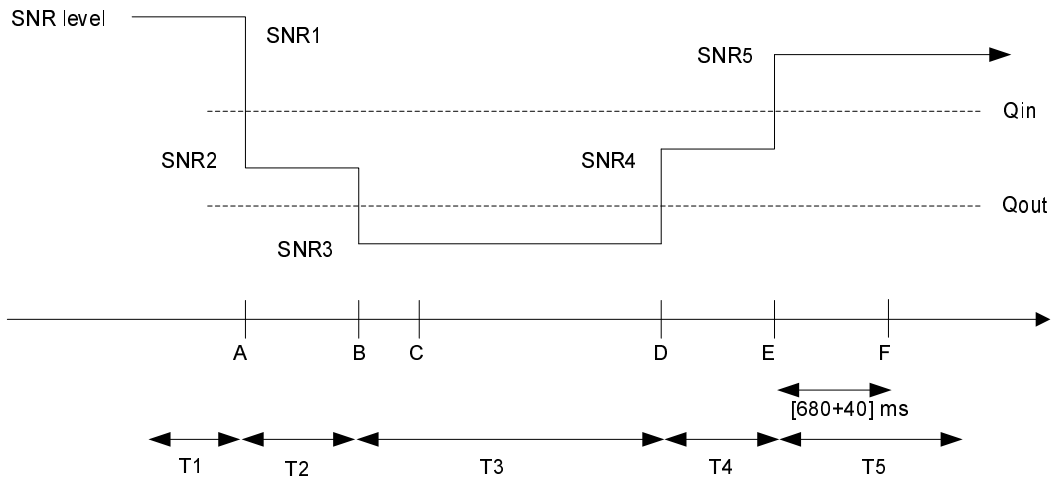

Figure A.7.3.73.1-1: SNR variation for in-sync testing

A.7.3.73.2 Test Requirements

The UE behaviour in each test during time durations T1, T2, T3, T4 and T5 shall be as follows:

During the period from time point A to time point F (720 ms after the start of time duration T5) the UE shall transmit uplink signal at least in all subframes configured for CQI transmission according to the configured CQI reporting mode (PUCCH 1-0).

The rate of correct events observed during repeated tests shall be at least 90%.

A.7.3.74 E-UTRAN TDD Radio Link Monitoring Test for Out-of-sync in DRX for non-BL CE UE configured in CEMode A

A.7.3.74.1 Test Purpose and Environment

The purpose of this test is to verify that the TDD non-BL CE UE configured in CEMode A properly detects the out of sync for the purpose of monitoring downlink radio link quality of the PCell when DRX is used. This test will partly verify the E-UTRAN TDD radio link monitoring requirements in clause 7.19.

The test parameters are given in Tables A.7.3.74.1-1, A.7.3.74.1-2, A.7.3.74.1-3 and A.7.3.74.1-4. There is one cell (cell 1), which is the active cell, in the test. The test consists of three successive time periods, with time duration of T1, T2 and T3 respectively. Figure A.7.3.74.1-1 shows the variation of the downlink SNR in the active cell to emulate out-of-sync states. Prior to the start of the time duration T1, the UE shall be fully synchronized to cell 1. The UE shall be configured for periodic CQI reporting in PUCCH 1-0 mode with a reporting periodicity of 1 ms without repetition. In the test, DRX configuration is enabled and DRX inactivity timer has already been expired, i.e. UE tries to decode MPDCCH and to send periodic CQI during the period when On-duration timer is running. Time alignment timers shall be set to “infinity” so that UL timing alignment is maintained during the test.

In the test, the RRC parameter *numberPRB-Pairs* is set to 4 and the RRC parameter *mPDCCH-NumRepetition* is set 2. UE shall successfully complete the RRC reconfiguration accordingly prior to the start of time duration T1.

Table A.7.3.74.1-1: General test parameters for E-UTRAN TDD out-of-sync tests in DRX for non-BL CE UE configured in CEMode A

| Parameter | | Unit | Value | Comment |
|--|--|------|-----------|--|
| Active cell | | | Cell 1 | Cell 1 is on E-UTRA RF channel number 1 |
| CP length | | | Normal | |
| Out of sync transmission parameters (Note 1) | DCI format | | 6-1A | As defined in section 5.3.3.1.12 in TS 36.212 |
| | Number of OFDM symbols for legacy control channels | | 2 | Out of sync threshold $Q_{out, Cat M1}$ and the corresponding hypothetical MPDCCH transmission parameters are as specified in clause 7.19.2 and Table 7.19.2-1 respectively. |
| | MPDCCH aggregation level | eCCE | 16 | |
| | MPDCCH repletion level | | 2 | |
| | ρ_A, ρ_B | | -3 | |
| | Ratio of MPDCCH to RS EPRE | dB | 0 | |
| DRX cycle | | ms | 1280 | See Table A.7.3.74.1-3 |
| Layer 3 filtering | | | Enabled | Counters: N310 = 1; N311 = 1 |
| T310 timer | | ms | 0 | T310 is disabled |
| T311 timer | | ms | 1000 | T311 is enabled |
| Periodic CQI reporting mode | | | PUCCH 1-0 | As defined in table 7.2.2-1 in TS 36.213. |
| CQI reporting periodicity | | ms | 1 | Minimum CQI reporting periodicity |
| T1 | | s | 32 | |
| T2 | | s | 12.8 | |
| T3 | | s | 13 | |
| Note 1: MPDCCH corresponding to the out of sync transmission parameters need not be included in the Reference Measurement Channel. | | | | |

Table A.7.3.74.1-2: Cell specific test parameters for E-UTRAN TDD (cell # 1) for out-of-sync radio link monitoring tests in DRX for non-BL CE UE configured in CEMode A

| Parameter | Unit | Test 1 | | |
|---------------------------------------|------------|-----------|----|----|
| | | T1 | T2 | T3 |
| E-UTRA RF Channel Number | | 1 | | |
| $BW_{channel}$ | MHz | 10 | | |
| Special subframe configuration | | 6 | | |
| Uplink-downlink configuration | | 1 | | |
| MPDCCH parameters defined in A.3.1.3 | | R.15 TDD | | |
| OCNG Pattern defined in A.3.2.2 (TDD) | | OP.11 TDD | | |
| ρ_A, ρ_B | | -3 | | |
| MPDCCH_RA | dB | 0 | | |
| MPDCCH_RB | dB | 0 | | |
| PBCH_RA | dB | -3 | | |
| PBCH_RB | dB | | | |
| PSS_RA | dB | | | |
| SSS_RA | dB | | | |
| OCNG_RA ^{Note1} | dB | | | |
| OCNG_RB ^{Note1} | dB | | | |
| N_{oc} | dBm/15 kHz | | | |

| | | | | |
|--|----|------------|--------|------------------------------|
| SNR ^{Note 6} | dB | [-0.9] | [-7.7] | [-14.7] ^{Note 7} |
| Propagation condition | | AWGN | | |
| Correlation Matrix and Antenna Configuration | | 2x2 2x4 | | |
| <p>Note 1: OCNG shall be used such that the resources in cell # 1 are fully allocated and a constant total transmitted power spectral density is achieved for all OFDM symbols.</p> <p>Note 2: The uplink resources for CQI reporting are assigned to the UE prior to the start of time period T1.</p> <p>Note 3: The timers and layer 3 filtering related parameters are configured prior to the start of time period T1.</p> <p>Note 4: The signal contains MPDCCH for UEs other than the device under test as part of OCNG.</p> <p>Note 5: SNR levels correspond to the signal to noise ratio over the cell-specific reference signal REs.</p> <p>Note 6: The SNR in time periods T1, T2 and T3 is denoted as SNR1, SNR2 and SNR3 respectively in figure A.7.3.74.1-1.</p> <p>Note 7: For 4 Rx UE, SNR in T3 is -17.7 dB.</p> | | | | |

Table A.7.3.74.1-3: DRX-Configuration for E-UTRAN TDD out-of-sync tests for non-BL CE UE configured in CEMode A

| Field | Value | Comment |
|--------------------------|---------|---|
| onDurationTimer | psf10 | As specified in clause 6.3.2 in TS 36.331 |
| drx-InactivityTimer | psf1 | |
| drx-RetransmissionTimer | psf1 | |
| longDRX-CycleStartOffset | sf1280 | |
| shortDRX | disable | |

Table A.7.3.74.1-4: TimeAlignmentTimer-Configuration for E-UTRAN TDD out-of-sync testing for non-BL CE UE configured in CEMode A

| Field | Value | Comment |
|--------------------|----------|--|
| TimeAlignmentTimer | infinity | As specified in clause 6.3.2 in TS 36.331 |
| sr-ConfigIndex | 0 | For further information see clause 6.3.2 in TS 36.331 and section 10.1 in TS 36.213. |

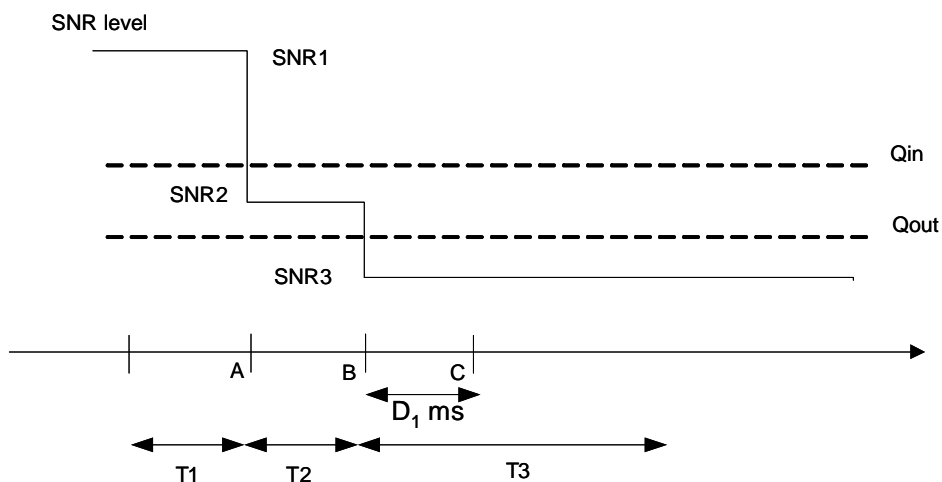

Figure A.7.3.74.1-1: SNR variation for out-of-sync testing in DRX

A.7.3.74.2 Test Requirements

The UE behaviour in each test during time durations T1, T2 and T3 shall be as follows:

During the period from time point A to time point B the UE shall transmit uplink signal at least once every DRX cycle, in the On-duration part of the cycle in the subframe according to the configured CQI reporting mode (PUCCH 1-0).

The UE shall stop transmitting uplink signal no later than time point C (duration $D_1 = 6500$ ms after the start of time duration T3).

The rate of correct events observed during repeated tests shall be at least 90%.

A.7.3.75 E-UTRAN TDD Radio Link Monitoring Test for In-sync in DRX for non-BL CE UE configured in CEMode A

A.7.3.75.1 Test Purpose and Environment

The purpose of this test is to verify that the TDD non-BL CE UE configured in CEMode A properly detects the out of sync and in sync for the purpose of monitoring downlink radio link quality of the PCell when DRX is used. This test will partly verify the E-UTRAN TDD radio link monitoring requirements in clause 7.19.

The test parameters are given in Tables A.7.3.75.1-1, A.7.3.75.1-2, A.7.3.75.1-3 and A.7.3.75.1-4. There is one cell (cell 1), which is the active cell, in the test. The test consists of five successive time periods, with time duration of T1, T2, T3, T4 and T5 respectively. Figure A.7.3.75.1-1 shows the variation of the downlink SNR in the active cell to emulate out-of-sync and in-sync states. Prior to the start of the time duration T1, the UE shall be fully synchronized to cell 1. The UE shall be configured for periodic CQI reporting in PUCCH 1-0 mode with a reporting periodicity of 1 ms without repetition. In the test, DRX configuration is enabled and DRX inactivity timer has already been expired, i.e. UE tries to decode MPDCCH and to send periodic CQI during the period when On-duration timer is running. Time alignment timers shall be set to “infinity” so that UL timing alignment is maintained during the test.

In the test, the RRC parameter *numberPRB-Pairs* is set to 6 and the RRC parameter *mPDCCH-NumRepetition* is set 4. UE shall successfully complete the RRC reconfiguration accordingly prior to the start of time duration T1.

Table A.7.3.75.1-1: General test parameters for E-UTRAN TDD in-sync test in DRX for non-BL CE UE configured in CEMode A

| Parameter | | Unit | Value | Comment |
|--|--|------|--------|--|
| Active cell | | | Cell 1 | Cell 1 is on E-UTRA RF channel number 1 |
| CP length | | | Normal | |
| In sync transmission parameters (Note 1) | DCI format | | 6-1A | As defined in section 5.3.3.1.12 in TS 36.212 |
| | Number of OFDM symbols for legacy control channels | | 2 | In sync threshold $Q_{in, Cat M1}$ and the corresponding hypothetical MPDCCH transmission parameters are as specified in clause 7.19.2 and Table 7.19.2-1 respectively. |
| | MPDCCH aggregation level | eCCE | 8 | |
| | MPDCCH repetition level | | 2 | |
| | ρ_A, ρ_B | | -3 | |
| | Ratio of MPDCCH to RS EPRE | | 0 | |
| Out of sync transmission parameters (Note 1) | DCI format | | 6-1A | As defined in section 5.3.3.1.12 in TS 36.212 |
| | Number of OFDM symbols for legacy control channels | | 2 | Out of sync threshold $Q_{out, Cat M1}$ and the corresponding hypothetical MPDCCH transmission parameters are as specified in clause 7.19.2 and Table 7.19.2-1 respectively. |
| | MPDCCH aggregation level | eCCE | 24 | |
| | MPDCCH repetition level | | 4 | |
| | ρ_A, ρ_B | | -3 | |
| | Ratio of MPDCCH | dB | 0 | |

| | | | | |
|--|------------|----|-----------|---|
| | to RS EPRE | | | |
| DRX cycle | | ms | 40 | See Table A.7.3.75.1-3 |
| Layer 3 filtering | | | Enabled | Counters: N310 = 1; N311 = 1 |
| T310 timer | | ms | 2000 | T310 is enabled |
| T311 timer | | ms | 1000 | T311 is enabled |
| Periodic CQI reporting mode | | | PUCCH 1-0 | As defined in table 7.2.2-1 in TS 36.213. |
| CQI reporting periodicity | | ms | 1 | Minimum CQI reporting periodicity |
| T1 | | s | 4 | |
| T2 | | s | 1.6 | |
| T3 | | s | 1.46 | |
| T4 | | s | 0.4 | |
| T5 | | s | 4 | |
| Note 1: MPDCCH corresponding to the in-sync and out of sync transmission parameters need not be included in the Reference Measurement Channel. | | | | |

Table A.7.3.75.1-2: Cell specific test parameters for E-UTRAN TDD (cell # 1) for in-sync radio link monitoring test in DRX for non-BL CE UE configured in CEMode A

| Parameter | Unit | Test 1 | | | | | | | | | |
|---|------------|------------|--------|---------------------------|---------|--------|----|--|--|--|--|
| | | T1 | T2 | T3 | T4 | T5 | | | | | |
| E-UTRA RF Channel Number | | 1 | | | | | | | | | |
| BW _{channel} | MHz | 10 | | | | | | | | | |
| Special subframe configuration | | 6 | | | | | | | | | |
| Uplink-downlink configuration | | 1 | | | | | | | | | |
| MPDCCH parameters defined in A.3.1.3 | | R.15 TDD | | | | | | | | | |
| OCNG Pattern defined in A.3.2.2 (TDD) | | OP.11 TDD | | | | | | | | | |
| ρ_A, ρ_B | | -3 | | | | | | | | | |
| MPDCCH_RA | dB | 0 | | | | | | | | | |
| MPDCCH_RB | dB | 0 | | | | | | | | | |
| PBCH_RA | dB | | | | | | | | | | |
| PBCH_RB | dB | | | | | | | | | | |
| PSS_RA | dB | | | | | | | | | | |
| SSS_RA | dB | | | | | | | | | | |
| OCNG_RA ^{Note1} | dB | | | | | | -3 | | | | |
| OCNG_RB ^{Note1} | dB | | | | | | | | | | |
| N_{oc} | dBm/15 kHz | -98 | | | | | | | | | |
| SNR ^{Note 6} | dB | [-5.7] | [-9.5] | [-16.5] ^{Note 7} | [-11.2] | [-5.2] | | | | | |
| Propagation condition | | AWGN | | | | | | | | | |
| Correlation Matrix and Antenna Configuration | | 2x2 2x4 | | | | | | | | | |
| Note 1: OCNG shall be used such that the resources in cell # 1 are fully allocated and a constant total transmitted power spectral density is achieved for all OFDM symbols. Note 2: The uplink resources for CQI reporting are assigned to the UE prior to the start of time period T1. Note 3: The timers and layer 3 filtering related parameters are configured prior to the start of time period T1. Note 4: The signal contains MPDCCH for UEs other than the device under test as part of OCNG. Note 5: SNR levels correspond to the signal to noise ratio over the cell-specific reference signal REs. Note 6: The SNR in time periods T1, T2, T3, T4 and T5 is denoted as SNR1, SNR2, SNR3, SNR4 and SNR5 respectively in figure A.7.3.75.1-1. Note 7: For 4 Rx UE, SNR in T3 is -20.0 dB. | | | | | | | | | | | |

Table A.7.3.75.1-3: DRX-Configuration for E-UTRAN TDD out-of-sync tests for non-BL CE UE configured in CEMode A

| Field | Value | Comment |
|-------|-------|---------|
|-------|-------|---------|

| | | |
|--------------------------|---------|---|
| onDurationTimer | psf10 | As specified in clause 6.3.2 in TS 36.331 |
| drx-InactivityTimer | psf1 | |
| drx-RetransmissionTimer | psf1 | |
| longDRX-CycleStartOffset | sf40 | |
| shortDRX | disable | |

Table A.7.3.75.1-4: TimeAlignmentTimer -Configuration for E-UTRAN TDD out-of-sync testing for non-BL CE UE configured in CEMode A

| Field | Value | Comment |
|--------------------|----------|--|
| TimeAlignmentTimer | infinity | As specified in clause 6.3.2 in TS 36.331 |
| sr-ConfigIndex | 0 | For further information see clause 6.3.2 in TS 36.331 and section 10.1 in TS 36.213. |

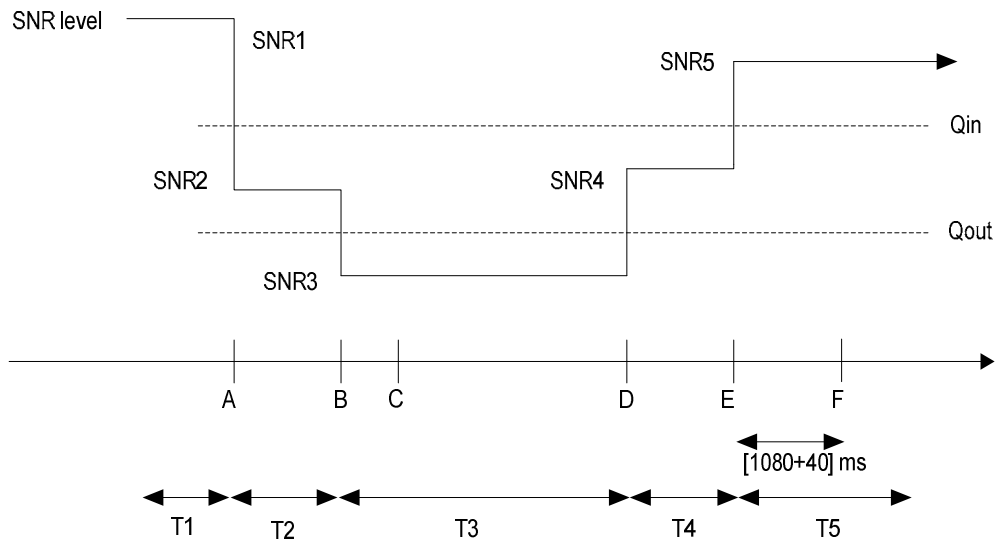

Figure A.7.3.75.1-1: SNR variation for in-sync testing in DRX

A.7.3.75.2 Test Requirements

The UE behaviour in each test during time durations T1, T2, T3, T4 and T5 shall be as follows:

During the period from time point A to time point F (1120 ms after the start of time duration T5) the UE shall transmit uplink signal at least once every DRX cycle, in the On-duration part of the cycle in the subframe according to the configured CQI reporting mode (PUCCH 1-0).

The rate of correct events observed during repeated tests shall be at least 90%.

A.7.4 Interruption for Dual Connectivity

A.7.4.1 E-UTRAN FDD-FDD DC interruption at transitions between active and non-active during DRX in synchronous DC

A.7.4.1.1 Test Purpose and Environment

The purpose of this test is to verify that when PCell is in non-DRX and PSCell is in DRX, PCell interruptions due to transitions from active to non-active and from non-active to active during PSCell DRX the UE missed ACK/NACK

does not exceed the limits. This test will verify the missed ACK/NACK rate for FDD PCell in dual connectivity requirements in clause 7.12.2.

The test parameters are given in Table A.7.4.1.1-1, A.7.4.1.1-2 and A.7.4.1.1-3 below. In the test there are two cells: Cell1 and Cell2. Cell1 is PCell and Cell2 is PSCell. PCell is continuously scheduled in DL while PSCell is not scheduled and has DRX configured. The test consists of one time period, with duration of T1. Prior to the start of the time duration T1, the UE shall be fully synchronized to Cell1 and Cell2. Cell1 shall be configured as PCell and Cell2 shall be configured as PSCell. Prior to start of T1 the DRX inactivity timer for the PSCell have already expired. During T1 the UE shall be continuously scheduled on PCell while not scheduled on PSCell.

Table A.7.4.1.1-1: General test parameters for E-UTRAN FDD-FDD DC interruption at transitions between active and non-active during DRX in synchronous DC

| Parameter | Unit | Value | Comment |
|---|------|--------|--|
| E-UTRA RF Channel Number | | 1, 2 | Two radio channels are used for this test. |
| Active PCell | | Cell1 | PCell on RF channel number 1. |
| Configured PSCell | | Cell2 | PSCell on RF channel number 2. |
| CP length | | Normal | |
| DRX | | ON | DRX related parameters are defined in Table A.8.23.4.1-3 |
| Measurement gap pattern Id | | OFF | |
| T1 | s | 10 | |
| Note 1: This test verifies the RRM requirement which is independent of channel bandwidth and is performed according to the principle defined in section A.3.6.1. | | | |
| Note 2: A UE capable of both synchronous and asynchronous DC operations is only required to pass this test case in accordance with the principle defined in section A.3.11. | | | |

Table A.7.4.1.1-2: Cell specific test parameters for E-UTRAN FDD-FDD DC interruption at transitions between active and non-active during DRX in synchronous DC

| Parameter | Unit | Cell1 | Cell2 |
|--|---------------|---|---|
| | | T1 | T1 |
| E-UTRA RF Channel Number | | 1 | 2 |
| BW _{channel} | MHz | 5MHz: N _{RB,c} = 25 10MHz: N _{RB,c} = 50 20MHz: N _{RB,c} = 100 | 5MHz: N _{RB,c} = 25 10MHz: N _{RB,c} = 50 20MHz: N _{RB,c} = 100 |
| PDSCH parameters: DL Reference Measurement Channel | | 5MHz: R.7 FDD 10MHz: R.3 FDD 20MHz: R.6 FDD | - |
| PCFICH/PDCCH/PHICH parameters: DL Reference Measurement Channel | | 5MHz: R.11 FDD 10MHz: R.6 FDD 20MHz: R.10 FDD | 5MHz: R.11 FDD 10MHz: R.6 FDD 20MHz: R.10 FDD |
| OCNG Patterns | | 5MHz: OP.20 FDD 10MHz: OP.10 FDD 20MHz: OP.17 FDD | 5MHz: OP.16 FDD 10MHz: OP.2 FDD 20MHz: OP.12 FDD |
| PBCH_RA | dB | 0 | 0 |
| PBCH_RB | dB | | |
| PSS_RA | dB | | |
| SSS_RA | dB | | |
| PCFICH_RB | dB | | |
| PHICH_RA | dB | | |
| PHICH_PB | dB | | |
| PDCCH_RA | dB | | |
| PDCCH_PB | dB | | |
| PDSCH_RA | dB | | |
| PDSCH_RB | dB | | |
| OCNG_RA ^{Note 1} | dB | | |
| OCNG_RB ^{Note 1} | dB | | |
| N _{oc} ^{Note 2} | dBm/15 KHz | -101 | -101 |

| | | | |
|---|--|---|---|
| \hat{E}_s / N_{oc} | dB | 19 | 19 |
| \hat{E}_s / I_{ot} | dB | 19 | 19 |
| RSRP ^{Note 3} | dBm/15 KHz | -82 | -82 |
| SCH_RP ^{Note 3} | dBm/15 KHz | -82 | -82 |
| I_o ^{Note 3} | dBm/Ch BW | -54.16 +10log ($N_{RB,c} / 50$) | -54.16 +10log ($N_{RB,c} / 50$) |
| Propagation Condition | | AWGN | AWGN |
| Correlation Matrix and Antenna Configuration | | 1x2 Low | 1x2 Low |
| Time offset to cell1 ^{Note 4} | μ s | - | 33 |
| Note 1: | OCNG shall be used such that both cells are fully allocated and a constant total transmitted power spectral density is achieved for all OFDM symbols. | | |
| Note 2: | Interference from other cells and noise sources not specified in the test is assumed to be constant over subcarriers and time and shall be modelled as AWGN of appropriate power for N_{oc} to be fulfilled. | | |
| Note 3: | RSRP, SCH_RP and I_o levels have been derived from other parameters for information purposes. They are not settable parameters themselves. | | |
| Note 4: | Receive time difference between subframe boundaries of signals received from the two cells at the UE antenna connector including time alignment error between the two cells. | | |

Table A.7.4.1.1-3: DRX-Configuration for E-UTRAN FDD-FDD DC interruption at transitions between active and non-active during DRX in synchronous DC

| Field | Cell1 | Cell2 | Comment |
|---|---------|---------|---|
| | Value | Value | |
| onDurationTimer | psf1 | psf1 | As specified in clause 6.3.2 in TS 36.331 |
| drx-InactivityTimer ^{Note 1} | psf1 | psf1 | |
| drx-RetransmissionTimer | psf1 | psf1 | |
| longDRX-CycleStartOffset | sf80 | Sf160 | |
| shortDRX | disable | disable | |
| Note 1: UE is continuously scheduled in PCell | | | |

A.7.4.1.2 Test Requirements

The UE shall be continuously scheduled in PCell during the entire length of T1. UE shall not be scheduled in PSCell during T1. During the time duration T1 the UE shall transmit at least 99% of ACK/NACK on PCell.

The UE shall not miss transmitting two consecutive ACK/NACK.

The rate of correct events observed during repeated tests shall be at least 90%.

A.7.4.2 E-UTRAN TDD-TDD DC interruption at transitions between active and non-active during DRX in synchronous DC

A.7.4.2.1 Test Purpose and Environment

The purpose of this test is to verify that when PCell is in non-DRX and PSCell is in DRX, PCell interruptions due to transitions from active to non-active and from non-active to active during PSCell DRX the UE missed ACK/NACK does not exceed the limits. This test will verify the missed ACK/NACK rate for TDD PCell in dual connectivity requirements in clause 7.12.2.

The test parameters are given in Table A.7.4.2.1-1, A.7.4.2.1-2 and A.7.4.2.1-3 below. In the test there are two cells: Cell1 and Cell2. Cell1 is PCell and Cell2 is PSCell. PCell is continuously scheduled in DL while PSCell is not scheduled and has DRX configured. The test consists of one time period, with duration of T1. Prior to the start of the time duration T1, the UE shall be fully synchronized to Cell1 and Cell2. Cell1 shall be configured as PCell and Cell2

shall be configured as PSCell. Prior to start of T1 the DRX inactivity timer for the PSCell have already expired. During T1 the UE shall be continuously scheduled on PCell while not scheduled on PSCell.

Table A.7.4.2.1-1: General test parameters for E-UTRAN TDD-TDD DC interruption at transitions between active and non-active during DRX in synchronous DC

| Parameter | Unit | Value | Comment |
|---|------|--------|--|
| E-UTRA RF Channel Number | | 1, 2 | Two radio channels are used for this test. |
| Active PCell | | Cell1 | PCell on RF channel number 1. |
| Configured PSCell | | Cell2 | PSCell on RF channel number 2. |
| Special subframe configuration | | 6 | As specified in table 4.2-1 in TS 36.211. Applicable to cell 1 |
| Uplink-downlink configuration | | 1 | As specified in table 4.2-1 in TS 36.211. Applicable to Cell1 |
| CP length | | Normal | As specified in table 4.2-2 in TS 36.211. Applicable to Cell1 |
| DRX | | ON | DRX related parameters are defined in Table A.8.23.4.1-3 |
| Measurement gap pattern Id | | OFF | |
| T1 | s | 10 | |
| Note 1: This test verifies the RRM requirement which is independent of channel bandwidth and is performed according to the principle defined in section A.3.6.1. | | | |
| Note 2: A UE capable of both synchronous and asynchronous DC operations is only required to pass this test case in accordance with the principle defined in section A.3.11. | | | |

Table A.7.4.2.1-2: Cell specific test parameters for E-UTRAN TDD-TDD DC interruption at transitions between active and non-active during DRX in synchronous DC

| Parameter | Unit | Cell1 | Cell2 |
|--|---------------|---|---|
| | | T1 | T1 |
| E-UTRA RF Channel Number | | 1 | 2 |
| BW _{channel} | MHz | 5MHz: N _{RB,c} = 25 10MHz: N _{RB,c} = 50 20MHz: N _{RB,c} = 100 | 5MHz: N _{RB,c} = 25 10MHz: N _{RB,c} = 50 20MHz: N _{RB,c} = 100 |
| PDSCH parameters: DL Reference Measurement Channel | | 5MHz: R.4 TDD 10MHz: R.0 TDD 20MHz: R.3 TDD | - |
| PCFICH/PDCCH/PHICH parameters: DL Reference Measurement Channel | | 5MHz: R.11 TDD 10MHz: R.6 TDD 20MHz: R.10 TDD | 5MHz: R.11 TDD 10MHz: R.6 TDD 20MHz: R.10 TDD |
| OCNG Patterns | | 5MHz: OP.9 TDD 10MHz: OP.1 TDD 20MHz: OP.7 TDD | 5MHz: OP.10 TDD 10MHz: OP.2 TDD 20MHz: OP.7 TDD |
| PBCH_RA | dB | 0 | 0 |
| PBCH_RB | dB | | |
| PSS_RA | dB | | |
| SSS_RA | dB | | |
| PCFICH_RB | dB | | |
| PHICH_RA | dB | | |
| PHICH_PB | dB | | |
| PDCCH_RA | dB | | |
| PDCCH_PB | dB | | |
| PDSCH_RA | dB | | |
| PDSCH_RB | dB | | |
| OCNG_RA ^{Note 1} | dB | | |
| OCNG_RB ^{Note 1} | dB | | |
| N _{oc} ^{Note 2} | dBm/15 KHz | -101 | -101 |
| \hat{E}_s / N_{oc} | dB | 19 | 19 |

| | | | |
|---|--|---------------------------------------|---------------------------------------|
| \hat{E}_s/I_{ot} | dB | 19 | 19 |
| RSRP ^{Note 3} | dBm/15 KHz | -82 | -82 |
| SCH_RP ^{Note 3} | dBm/15 KHz | -82 | -82 |
| I_o ^{Note 3} | dBm/Ch BW | -54.16 +10log ($N_{RB,c}/50$) | -54.16 +10log ($N_{RB,c}/50$) |
| Propagation Condition | | AWGN | AWGN |
| Correlation Matrix and Antenna Configuration | | 1x2 Low | 1x2 Low |
| Time offset to cell1 ^{Note 4} | μ s | - | 33 |
| Note 1: | OCNG shall be used such that both cells are fully allocated and a constant total transmitted power spectral density is achieved for all OFDM symbols. | | |
| Note 2: | Interference from other cells and noise sources not specified in the test is assumed to be constant over subcarriers and time and shall be modelled as AWGN of appropriate power for N_{oc} to be fulfilled. | | |
| Note 3: | RSRP, SCH_RP and I_o levels have been derived from other parameters for information purposes. They are not settable parameters themselves. | | |
| Note 4: | Receive time difference between subframe boundaries of signals received from the two cells at the UE antenna connector including time alignment error between the two cells. | | |

Table A.7.4.2.1-3: DRX-Configuration for E-UTRAN TDD-TDD DC interruption at transitions between active and non-active during DRX in synchronous DC

| Field | Cell1 | Cell2 | Comment |
|---|---------|---------|---|
| | Value | Value | |
| onDurationTimer | psf1 | psf1 | As specified in clause 6.3.2 in TS 36.331 |
| drx-InactivityTimer ^{Note 1} | psf1 | psf1 | |
| drx-RetransmissionTimer | psf1 | psf1 | |
| longDRX-CycleStartOffset | sf80 | Sf160 | |
| shortDRX | disable | disable | |
| Note 1: UE is continuously scheduled in PCell | | | |

A.7.4.2.2 Test Requirements

The UE shall be continuously scheduled in PCell during the entire length of T1. UE shall not be scheduled in PSCell during T1. During the time duration T1 the UE shall transmit at least 99% of ACK/NACK on PCell.

The UE shall not miss transmitting two consecutive ACK/NACK.

The rate of correct events observed during repeated tests shall be at least 90%.

A.7.4.3 E-UTRAN FDD-FDD Interruption at transitions between active and non-active during DRX in asynchronous dual connectivity

A.7.4.3.1 Test Purpose and Environment

The purpose of this test is to verify that the UE fulfils the requirement on interruptions on PCell at transitions between active and non-active during DRX in TS36.133 section 7.12.2.

The test parameters are given in Table A.7.4.3.1-1, Table A.7.4.3.1-2 and Table A.7.4.3.1-3 below. In the test there are two cells: Cell 1 and Cell 2. Cell 1 is PCell on the FDD primary component (RF channel 1). Cell 2 is PSCell on the FDD secondary component (RF channel 2). The test consists of 1 time period, with time duration of T1. PDCCH indicating a new transmission on PCell shall be sent continuously during the whole time duration to ensure UE would not enter DRX state on PCell. PSCell is in DRX state with 320ms DRX cycle.

Table A.7.4.3.1-1: General test parameters for E-UTRAN FDD-FDD Interruption at transitions between active and non-active during DRX in asynchronous dual connectivity

| Parameter | Unit | Value | Comment |
|---|------|----------------|---|
| E-UTRA RF Channel Number | | 1, 2 | Two radio channels are used for this test |
| Active Cell | | Cell 1, Cell 2 | Cell 1 is PCell on E-UTRA RF channel number 1, and cell 2 is PSCell on E-UTRA RF channel number 2 |
| CP length | | Normal | |
| DRX on Cell1 | | OFF | |
| DRX on Cell2 | ms | 320 | |
| Filter coefficient | | 0 | L3 filtering is not used |
| T1 | s | 5 | |
| Note 1: Even a UE capable of both synchronous and asynchronous DC operations is required to pass this test case in accordance with the principle defined in section A.3.11. | | | |

Table A.7.4.3.1-2: Cell specific test parameters for E-UTRAN FDD-FDD Interruption at transitions between active and non-active during DRX in asynchronous dual connectivity

| Parameter | Unit | Cell 1 | Cell 2 |
|--|------------|--|--|
| | | T1 | T1 |
| E-UTRA RF Channel Number | | 1 | 2 |
| BW _{channel} | MHz | 5: N _{RB,c} = 25 10: N _{RB,c} = 50 20: N _{RB,c} = 100 | 5: N _{RB,c} = 25 10: N _{RB,c} = 50 20: N _{RB,c} = 100 |
| PDSCH parameters | | 5MHz: R.7 FDD 10MHz: R.3 FDD 20MHz: R.6 FDD | - |
| PCFICH/PDCCH/PHICH parameters | | 5MHz: R.11 FDD 10MHz: R.6 FDD 20MHz: R.10 FDD | 5MHz: R.11 FDD 10MHz: R.6 FDD 20MHz: R.10 FDD |
| OCNG Patterns defined in A.3.2.1 | | 5MHz: OP.20 FDD 10MHz: OP.10 FDD 20MHz: OP.17 FDD | 5MHz: OP.16 FDD 10MHz: OP.2 FDD 20MHz: OP.12 FDD |
| PBCH_RA | dB | 0 | 0 |
| PBCH_RB | dB | | |
| PSS_RA | dB | | |
| SSS_RA | dB | | |
| PCFICH_RB | dB | | |
| PHICH_RA | dB | | |
| PHICH_PB | dB | | |
| PDCCH_RA | dB | | |
| PDCCH_PB | dB | | |
| PDSCH_RA | dB | | |
| PDSCH_RB | dB | | |
| OCNG_RA ^{Note 1} | dB | | |
| OCNG_RB ^{Note 1} | dB | | |
| N_{oc} ^{Note 2} | dBm/15 KHz | | |
| \hat{E}_s/N_{oc} | dB | 19 | 19 |
| \hat{E}_s/I_{ot} | dB | 19 | 19 |
| RSRP ^{Note 3} | dBm/15 KHz | -82 | -82 |
| SCH_RP ^{Note 3} | dBm/15 KHz | -82 | -82 |
| I_o ^{Note 3} | dBm/Ch BW | -54.16+10log (N _{RB,c} /50) | -54.16+10log (N _{RB,c} /50) |
| Propagation Condition | | AWGN | AWGN |
| Correlation Matrix and Antenna Configuration | | 1x2 Low | 1x2 Low |
| Receive timing offset to Cell1 ^{Note 4} | μs | - | 500 |

| | |
|---------|--|
| Note 1: | OCNG shall be used such that both cells are fully allocated and a constant total transmitted power spectral density is achieved for all OFDM symbols. |
| Note 2: | Interference from other cells and noise sources not specified in the test is assumed to be constant over subcarriers and time and shall be modelled as AWGN of appropriate power for N_{oc} to be fulfilled. |
| Note 3: | RSRP, SCH_RP and Io levels have been derived from other parameters for information purposes. They are not settable parameters themselves. |
| Note 4: | Receive time difference between subframe boundaries of signals received from the two cells at the UE antenna connector including time alignment error between the two cells. |

Table A.7.4.3.1-3: DRX-Configuration for E-UTRAN FDD-FDD Interruption at transitions between active and non-active during DRX in asynchronous dual connectivity

| Field | PSCell | Comment |
|--------------------------|--|---------|
| | Value | |
| onDurationTimer | psf1 | |
| drx-InactivityTimer | psf1 | |
| drx-RetransmissionTimer | psf1 | |
| longDRX-CycleStartOffset | sf320 | |
| shortDRX | disable | |
| Note: | For further information see clause 6.3.2 in TS 36.331. | |

Table A.7.4.3.1-4: *TimeAlignmentTimer* -Configuration for E-UTRAN FDD-FDD Interruption at transitions between active and non-active during DRX in asynchronous dual connectivity

| Field | PSCell | Comment |
|--------------------|--------|---|
| | Value | |
| TimeAlignmentTimer | sf500 | As specified in clause 6.3.2 in TS 36.331 |
| sr-ConfigIndex | 0 | For further information see clause 6.3.2 in TS 36.331 and section10.1 in TS 36.213. |

A.7.4.3.2 Test Requirements

The UE shall be scheduled on PCell continuously during the whole time duration T1. During time durations T1, at least 99% of all expected ACK/NACKs shall be transmitted on PCell by the UE.

Each interruption shall not exceed 1 subframe.

The rate of correct events observed during repeated tests shall be at least 90%.

A.7.4.4 E-UTRAN FDD-TDD DC interruption at transitions between active and non-active during DRX in synchronous DC

A.7.4.4.1 Test Purpose and Environment

The purpose of this test is to verify that when PCell is in non-DRX and PSCell is in DRX, PCell interruptions due to transitions from active to non-active and from non-active to active during PSCell DRX the UE missed ACK/NACK does not exceed the limits. This test will verify the missed ACK/NACK rate for FDD PCell in dual connectivity requirements in clause 7.12.2.

The test parameters are given in Table A.7.4.4.1-1, A.7.4.4.1-2 and A.7.4.4.1-3 below. In the test there are two cells: Cell1 and Cell2. Cell1 is PCell and Cell2 is PSCell. PCell is continuously scheduled in DL while PSCell is not scheduled and has DRX configured. The test consists of one time period, with duration of T1. Prior to the start of the time duration T1, the UE shall be fully synchronized to Cell1 and Cell2. Cell1 shall be configured as PCell and Cell2 shall be configured as PSCell. Prior to start of T1 the DRX inactivity timer for the PSCell have already expired. During T1 the UE shall be continuously scheduled on PCell while not scheduled on PSCell.

Table A.7.4.4.1-1: General test parameters for E-UTRAN FDD-TDD DC interruption at transitions between active and non-active during DRX in synchronous DC

| Parameter | Unit | Value | Comment |
|---|------|--------|--|
| E-UTRA RF Channel Number | | 1, 2 | Two radio channels are used for this test. |
| Active PCell | | Cell1 | PCell on RF channel number 1. |
| Configured PSCell | | Cell2 | PSCell on RF channel number 2. |
| CP length | | Normal | |
| DRX | | ON | DRX related parameters are defined in Table A.8.23.4.1-3 |
| Measurement gap pattern Id | | OFF | |
| T1 | s | 10 | |
| Note 1: This test verifies the RRM requirement which is independent of channel bandwidth and is performed according to the principle defined in section A.3.6.1. Note 2: A UE capable of both synchronous and asynchronous DC operations is only required to pass this test case in accordance with the principle defined in section A.3.11. | | | |

Table A.7.4.4.1-2: Cell specific test parameters for E-UTRAN FDD-TDD DC interruption at transitions between active and non-active during DRX in synchronous DC

| Parameter | Unit | Cell1 | Cell2 |
|--|------------|---|---|
| | | T1 | T1 |
| E-UTRA RF Channel Number | | 1 | 2 |
| BW _{channel} | MHz | 5MHz: N _{RB,c} = 25 10MHz: N _{RB,c} = 50 20MHz: N _{RB,c} = 100 | 5MHz: N _{RB,c} = 25 10MHz: N _{RB,c} = 50 20MHz: N _{RB,c} = 100 |
| PDSCH parameters: DL Reference Measurement Channel | | 5MHz: R.7 FDD 10MHz: R.3 FDD 20MHz: R.6 FDD | - |
| PCFICH/PDCCH/PHICH parameters: DL Reference Measurement Channel | | 5MHz: R.11 FDD 10MHz: R.6 FDD 20MHz: R.10 FDD | 5MHz: R.11 TDD 10MHz: R.6 TDD 20MHz: R.10 TDD |
| OCNG Patterns | | 5MHz: OP.20 FDD 10MHz: OP.10 FDD 20MHz: OP.17 FDD | 5MHz: OP.10 TDD 10MHz: OP.2 TDD 20MHz: OP.8 TDD |
| Special subframe configuration | | Not applicable | 6 |
| Uplink-downlink configuration | | Not applicable | 1 |
| PBCH_RA | dB | 0 | 0 |
| PBCH_RB | dB | | |
| PSS_RA | dB | | |
| SSS_RA | dB | | |
| PCFICH_RB | dB | | |
| PHICH_RA | dB | | |
| PHICH_PB | dB | | |
| PDCCH_RA | dB | | |
| PDCCH_PB | dB | | |
| PDSCH_RA | dB | | |
| PDSCH_RB | dB | | |
| OCNG_RA ^{Note 1} | dB | | |
| OCNG_RB ^{Note 1} | dB | | |
| N _{oc} ^{Note 2} | dBm/15 KHz | | |
| \hat{E}_s / N_{oc} | dB | 19 | 19 |
| \hat{E}_s / I_{ot} | dB | 19 | 19 |
| RSRP ^{Note 3} | dBm/15 KHz | -82 | -82 |
| SCH_RP ^{Note 3} | dBm/15 KHz | -82 | -82 |

| | | | |
|--|--------------|---|---|
| I_o ^{Note 3} | dBm/Ch BW | -54.16 +10log ($N_{RB,c} / 50$) | -54.16 +10log ($N_{RB,c} / 50$) |
| Propagation Condition | | AWGN | AWGN |
| Correlation Matrix and Antenna Configuration | | 1x2 Low | 1x2 Low |
| Time offset to cell1 ^{Note 4} | μ s | - | 33 |
| <p>Note 1: OCNG shall be used such that both cells are fully allocated and a constant total transmitted power spectral density is achieved for all OFDM symbols.</p> <p>Note 2: Interference from other cells and noise sources not specified in the test is assumed to be constant over subcarriers and time and shall be modelled as AWGN of appropriate power for N_{oc} to be fulfilled.</p> <p>Note 3: RSRP, SCH_RP and I_o levels have been derived from other parameters for information purposes. They are not settable parameters themselves.</p> <p>Note 4: Receive time difference between subframe boundaries of signals received from the two cells at the UE antenna connector including time alignment error between the two cells.</p> | | | |

Table A.7.4.4.1-3: DRX-Configuration for E-UTRAN FDD-TDD DC interruption at transitions between active and non-active during DRX in synchronous DC

| Field | Cell1 | Cell2 | Comment |
|---|---------|---------|---|
| | Value | Value | |
| onDurationTimer | psf1 | psf1 | As specified in clause 6.3.2 in TS 36.331 |
| drx-InactivityTimer ^{Note 1} | psf1 | psf1 | |
| drx-RetransmissionTimer | psf1 | psf1 | |
| longDRX-CycleStartOffset | sf80 | Sf160 | |
| shortDRX | disable | disable | |
| Note 1: UE is continuously scheduled in PCell | | | |

A.7.4.4.2 Test Requirements

The UE shall be continuously scheduled in PCell during the entire length of T1. UE shall not be scheduled in PSCell during T1. During the time duration T1 the UE shall transmit at least 99% of ACK/NACK on PCell.

The UE shall not miss transmitting two consecutive ACK/NACK.

The rate of correct events observed during repeated tests shall be at least 90%.

A.7.4.5 E-UTRAN TDD-FDD DC interruption at transitions between active and non-active during DRX in synchronous DC

A.7.4.5.1 Test Purpose and Environment

The purpose of this test is to verify that when PCell is in non-DRX and PSCell is in DRX, PCell interruptions due to transitions from active to non-active and from non-active to active during PSCell DRX the UE missed ACK/NACK does not exceed the limits. This test will verify the missed ACK/NACK rate for TDD PCell in dual connectivity requirements in clause 7.12.2.

The test parameters are given in Table A.7.4.5.1-1, A.7.4.5.1-2 and A.7.4.5.1-3 below. In the test there are two cells: Cell1 and Cell2. Cell1 is PCell and Cell2 is PSCell. PCell is continuously scheduled in DL while PSCell is not scheduled and has DRX configured. The test consists of one time period, with duration of T1. Prior to the start of the time duration T1, the UE shall be fully synchronized to Cell1 and Cell2. Cell1 shall be configured as PCell and Cell2 shall be configured as PSCell. Prior to start of T1 the DRX inactivity timer for the PSCell have already expired. During T1 the UE shall be continuously scheduled on PCell while not scheduled on PSCell.

Table A.7.4.5.1-1: General test parameters for E-UTRAN TDD-FDD DC interruption at transitions between active and non-active during DRX in synchronous DC

| Parameter | Unit | Value | Comment |
|-----------|------|-------|---------|
|-----------|------|-------|---------|

| | | | |
|---|---|--------|--|
| E-UTRA RF Channel Number | | 1, 2 | Two radio channels are used for this test. |
| Active PCell | | Cell1 | PCell on RF channel number 1. |
| Configured PSCell | | Cell2 | PSCell on RF channel number 2. |
| Special subframe configuration | | 6 | As specified in table 4.2-1 in TS 36.211. Applicable to cell 1 |
| Uplink-downlink configuration | | 1 | As specified in table 4.2-1 in TS 36.211. Applicable to Cell1 |
| CP length | | Normal | As specified in table 4.2-2 in TS 36.211. Applicable to Cell1 |
| DRX | | ON | DRX related parameters are defined in Table A.8.23.4.1-3 |
| Measurement gap pattern Id | | OFF | |
| T1 | s | 10 | |
| Note 1: This test verifies the RRM requirement which is independent of channel bandwidth and is performed according to the principle defined in section A.3.6.1. | | | |
| Note 2: A UE capable of both synchronous and asynchronous DC operations is only required to pass this test case in accordance with the principle defined in section A.3.11. | | | |

Table A.7.4.5.1-2: Cell specific test parameters for E-UTRAN TDD-FDD DC interruption at transitions between active and non-active during DRX in synchronous DC

| Parameter | Unit | Cell1 | Cell2 |
|--|---------------|---|---|
| | | T1 | T1 |
| E-UTRA RF Channel Number | | 1 | 2 |
| BW _{channel} | MHz | 5MHz: N _{RB,c} = 25 10MHz: N _{RB,c} = 50 20MHz: N _{RB,c} = 100 | 5MHz: N _{RB,c} = 25 10MHz: N _{RB,c} = 50 20MHz: N _{RB,c} = 100 |
| PDSCH parameters: DL Reference Measurement Channel | | 5MHz: R.4 TDD 10MHz: R.0 TDD 20MHz: R.3 TDD | - |
| PCFICH/PDCCH/PHICH parameters: DL Reference Measurement Channel | | 5MHz: R.11 TDD 10MHz: R.6 TDD 20MHz: R.10 TDD | 5MHz: R.11 FDD 10MHz: R.6 FDD 20MHz: R.10 FDD |
| OCNG Patterns | | 5MHz: OP.9 TDD 10MHz: OP.1 TDD 20MHz: OP.7 TDD | 5MHz: OP.16 FDD 10MHz: OP.2 FDD 20MHz: OP.12 FDD |
| Special subframe configuration | | 6 | Not applicable |
| Uplink-downlink configuration | | 1 | Not applicable |
| PBCH_RA | dB | 0 | 0 |
| PBCH_RB | dB | | |
| PSS_RA | dB | | |
| SSS_RA | dB | | |
| PCFICH_RB | dB | | |
| PHICH_RA | dB | | |
| PHICH_PB | dB | | |
| PDCCH_RA | dB | | |
| PDCCH_PB | dB | | |
| PDSCH_RA | dB | | |
| PDSCH_RB | dB | | |
| OCNG_RA ^{Note 1} | dB | | |
| OCNG_RB ^{Note 1} | dB | | |
| N _{oc} ^{Note 2} | dBm/15 KHz | -101 | -101 |
| \hat{E}_s / N_{oc} | dB | 19 | 19 |
| \hat{E}_s / I_{ot} | dB | 19 | 19 |
| RSRP ^{Note 3} | dBm/15 KHz | -82 | -82 |

| | | | |
|---|--|---|---|
| SCH_RP ^{Note 3} | dBm/15 KHz | -82 | -82 |
| I _o ^{Note 3} | dBm/Ch BW | -54.16 +10log (N _{RB,c} /50) | -54.16 +10log (N _{RB,c} /50) |
| Propagation Condition | | AWGN | AWGN |
| Correlation Matrix and Antenna Configuration | | 1x2 Low | 1x2 Low |
| Time offset to cell1 ^{Note 4} | μs | - | 33 |
| Note 1: | OCNG shall be used such that both cells are fully allocated and a constant total transmitted power spectral density is achieved for all OFDM symbols. | | |
| Note 2: | Interference from other cells and noise sources not specified in the test is assumed to be constant over subcarriers and time and shall be modelled as AWGN of appropriate power for N_{oc} to be fulfilled. | | |
| Note 3: | RSRP and SCH_RP levels have been derived from other parameters for information purposes. They are not settable parameters themselves. | | |
| Note 4: | Receive time difference between subframe boundaries of signals received from the two cells at the UE antenna connector including time alignment error between the two cells. | | |

Table A.7.4.5.1-3: DRX-Configuration for E-UTRAN TDD-FDD DC interruption at transitions between active and non-active during DRX in synchronous DC

| Field | Cell1 | Cell2 | Comment |
|---|---------|---------|---|
| | Value | Value | |
| onDurationTimer | psf1 | psf1 | As specified in clause 6.3.2 in TS 36.331 |
| drx-InactivityTimer ^{Note 1} | psf1 | psf1 | |
| drx-RetransmissionTimer | psf1 | psf1 | |
| longDRX-CycleStartOffset | sf80 | Sf160 | |
| shortDRX | disable | disable | |
| Note 1: UE is continuously scheduled in PCell | | | |

A.7.4.5.2 Test Requirements

The UE shall be continuously scheduled in PCell during the entire length of T1. UE shall not be scheduled in PSCell during T1. During the time duration T1 the UE shall transmit at least 99% of ACK/NACK on PCell.

The UE shall not miss transmitting two consecutive ACK/NACK.

The rate of correct events observed during repeated tests shall be at least 90%.

A.7.5 Proximity-based Services

A.7.5.1 E-UTRAN FDD – UE ProSe Direct Discovery Transmission Timing Accuracy Test

A.7.5.1.1 Test Purpose and Environment

The purpose of this test is to verify the timing requirements for ProSe Direct Discovery transmissions when PCell downlink timing is used as a reference with $N_{TA,SL} = 0$. This test will verify the requirements in clause 7.16.2.1.1.1 ProSe Direct Discovery transmissions. In the test the UE under test is configured for ProSe operation only on PCell and also the UE is configured only for PCell for WAN.

For this test, the UE is triggered by the test loop function or the upper layers to announce ProSe Direct Discovery.

The test parameters are given in Table A.7.5.1.1-1 below. There is one active cell (PCell) in this test. The transmit timing is verified using the transmission timing of PSDCH.

Table A.7.5.1.1-1: Test parameters for ProSe Transmission Timing Accuracy test for E-UTRAN FDD

| Parameter | Unit | Value | Comment | | |
|--|------------|---|--|-----|--|
| E-UTRA RF Channel Number | | 1 | | | |
| Channel Bandwidth (BW_{channel}) | MHz | 5 | | | |
| Active cell | | Cell 1 | E-UTRA FDD Cell1 on RF channel number 1 | | |
| CP length of Cell 1 | | Normal | | | |
| drx-Configuration | | DRX_P1 | As specified in Table A.3.12.2-1 | | |
| ProSe Direct Discovery resource pool configuration | | As specified in Table A.3.12.4-1 (Configuration #1) | IE values unless specified otherwise in this test. | | |
| PDCCH/PCFICH/PHICH Reference measurement channel ^{Note1} | | R.11 FDD | | | |
| OCNG Pattern ^{Note2} | | OP.16 FDD | | | |
| PBCH_RA | dB | 0 | | | |
| PBCH_RB | | | | | |
| PSS_RA | | | | | |
| SSS_RA | | | | | |
| PCFICH_RB | | | | | |
| PHICH_RA | | | | | |
| PHICH_RB | | | | | |
| PDCCH_RA | | | | | |
| PDCCH_RB | | | | | |
| OCNG_RA ^{Note3} | | | | | |
| OCNG_RB ^{Note3} | | | | | |
| N_{oc} | | | dBm/15 kHz | -98 | |
| \hat{E}_s/N_{oc} | | | dB | 3 | |
| RSRP ^{Note4} | dBm/15 kHz | -95 | | | |
| SCH_RP ^{Note 4} | dBm/15 kHz | -95 | | | |
| Propagation condition | | AWGN | | | |
| <p>Note 1: For the reference measurement channels, see clause A.3.1.</p> <p>Note 2: For the OCNG pattern, see clause A.3.2.</p> <p>Note 3: OCNG shall be used such that both cells are fully allocated and a constant total transmitted power spectral density is achieved for all OFDM symbols.</p> <p>Note 4: RSRP levels have been derived from other parameters for information purposes. They are not settable parameters themselves.</p> | | | | | |

A.7.5.1.2 Test Requirements

For parameters specified in Tables A.7.5.1.1-1, the timing accuracy for ProSe Direct Discovery transmissions shall be within the limits defined in clause 7.16.2.

The following sequence of events shall be used to verify that the requirements are met.

For the 5MHz channel bandwidth, the test sequence shall be carried out in RRC_CONNECTED DRX with a cycle length of 320ms:

- After a connection is set up with the cell, the test system shall verify that the ProSe UE transmit timing offset is within $\pm 12 \times T_s$ with respect to the first detected path (in time) of the corresponding downlink frame of cell 1.
- The test system adjusts the downlink transmit timing for the cell by $+32 \times T_s$ (approximately $+1 \mu\text{s}$) compared to that in (a). The test system shall wait for at least one discovery period (320ms) before verifying the requirement again in (c).
- The test system shall verify that the UE transmit timing offset stays within $\pm 12 \times T_s$ with respect to the first detected path (in time) of the corresponding downlink frame of cell 1.

A.7.5.2 E-UTRAN TDD – UE ProSe Direct Discovery Transmission Timing Accuracy Test

A.7.5.2.1 Test Purpose and Environment

The purpose of this test is to verify the timing requirements for ProSe Direct Discovery transmissions when PCell downlink timing is used as a reference with $N_{TA,SL} = 0$. This test will verify the requirements in clause 7.16.2.1.1.1 for ProSe Direct Discovery transmissions. In the test the UE under test is configured for ProSe operation only on PCell and also the UE is configured only for PCell for WAN.

For this test, the UE is triggered by the test loop function or the upper layers to announce ProSe Direct Discovery.

The test parameters are given in Table A.7.5.2.1-1 below. There is one active cell (PCell) in this test. The transmit timing is verified using the transmission timing of PSDCH.

Table A.7.5.2.1-1: Test parameters for ProSe Transmission Timing Accuracy test for E-UTRAN TDD

| Parameter | Unit | Value | Comment | | |
|---|---|---|--|-----|--|
| E-UTRA RF Channel Number | | 1 | | | |
| Channel Bandwidth ($BW_{channel}$) | MHz | 5 | | | |
| Active cell | | Cell 1 | E-UTRA FDD Cell1 on RF channel number 1 | | |
| Uplink/Downlink Configuration | | Config 0 | | | |
| Special Subframe Configuration | | 6 | | | |
| CP length of Cell 1 | | Normal | | | |
| drx-Configuration | | DRX_P1 | As specified in Table A.3.12.2-1 | | |
| ProSe Direct Discovery resource pool configuration | | As specified in Table A.3.12.4-3 (Configuration #3) | IE values unless specified otherwise in this test. | | |
| PDCCH/PCFICH/PHICH Reference measurement channel ^{Note1} | | R.11 TDD | | | |
| OCNG Pattern ^{Note2} | | OP.10 TDD | | | |
| PBCH_RA | dB | 0 | | | |
| PBCH_RB | | | | | |
| PSS_RA | | | | | |
| SSS_RA | | | | | |
| PCFICH_RB | | | | | |
| PHICH_RA | | | | | |
| PHICH_RB | | | | | |
| PDCCH_RA | | | | | |
| PDCCH_RB | | | | | |
| OCNG_RA ^{Note3} | | | | | |
| OCNG_RB ^{Note3} | | | | | |
| N_{oc} | | | dBm/15 kHz | -98 | |
| \hat{E}_s/N_{oc} | | | dB | 3 | |
| RSRP ^{Note4} | | | dBm/15 kHz | -95 | |
| SCH_RP ^{Note 4} | dBm/15 kHz | -95 | | | |
| Propagation condition | | AWGN | | | |
| Note 1: | For the reference measurement channels, see clause A.3.1. | | | | |
| Note 2: | For the OCNG pattern, see clause A.3.2. | | | | |
| Note 3: | OCNG shall be used such that both cells are fully allocated and a constant total transmitted power spectral density is achieved for all OFDM symbols. | | | | |
| Note 4: | RSRP levels have been derived from other parameters for information purposes. They are not settable parameters themselves. | | | | |

A.7.5.1.2 Test Requirements

For parameters specified in Tables A.7.5.2.1-1, the timing accuracy for ProSe Direct Discovery transmissions shall be within the limits defined in clause 7.16.2.

The following sequence of events shall be used to verify that the requirements are met.

For the 5MHz channel bandwidth, the test sequence shall be carried out in RRC_CONNECTED DRX with a cycle length of 320ms:

- a) After a connection is set up with the cell, the test system shall verify that the ProSe UE transmit timing offset is within $624 \times T_s \pm 12 \times T_s$ with respect to the first detected path (in time) of the corresponding downlink frame of cell 1.
- b) The test system adjusts the downlink transmit timing for the cell by $+32 \times T_s$ (approximately $+1 \mu\text{s}$) compared to that in (a). The test system shall wait for at least one discovery period (320ms) before verifying the requirement again in (c).
- c) The test system shall verify that the UE transmit timing offset stays within $624 \times T_s \pm 12 \times T_s$ with respect to the first detected path (in time) of the corresponding downlink frame of cell 1.

A.7.5.3 E-UTRAN FDD - Interruptions due to ProSe Direct Discovery

A.7.5.3.1 Test Purpose and Environment

The purpose of this test is to verify the requirements related to the allowed PCell interruptions due to ProSe Direct Discovery defined in clause 7.16.3.1 and clause 7.16.3.3. In the test the UE under test is configured for ProSe operation only on PCell and also the UE is configured only for PCell for WAN.

For this test, the UE is triggered by the test loop function or the upper layers to monitor ProSe Direct Discovery.

The test parameters are given in Table A.7.5.3.1-1 and Table A.7.5.3.1-2 below. There is one active cell (PCell) in this test and 24 active Sidelink transmissions in this test (with 12 active Sidelink UEs per configured discovery subframe). Two tests (Test 1 and Test 2) are defined to verify interruptions due to synchronous (Test 1) and asynchronous (Test 2) ProSe Direct Discovery.

The tests consist of three successive time periods, with time duration of T1, T2 and T3 respectively.

During T1, the UE is in RRC_IDLE and monitoring the ProSe Direct Discovery announcements from other active Sidelink UEs on the ProSe Direct Discovery resources.

During T2, the test system establishes a RRC connection with the UE. No PDSCH traffic is scheduled for UE during T2, and the UE is expected to transmit *SidelinkUEInformation* indicating *discRxInterest* during T2. On reception of *SidelinkUEInformation*, the test system shall RRC reconfiguration message to the UE and wait for the UE to respond with RRC reconfiguration complete message before transitioning to T3. If the UE does not transmit *SidelinkUEInformation* for up to [2] sec, the test system shall transition to T3.

During T3, the UE is scheduled with PDSCH traffic on PCell downlink. The test system will count the missed ACK/NACKs during T3 to verify the allowed interruptions during ProSe Direct Discovery.

Table A.7.5.3.1-1: Test parameters for interruption due to ProSe Direct Discovery tests

| Parameter | Unit | Value | | Comment |
|--|------|--|--------|---|
| | | Test 1 | Test 2 | |
| E-UTRA RF Channel Number | | 1 | | |
| Channel Bandwidth (BW _{channel}) | MHz | 5 | | |
| Active cell | | Cell 1 | | E-UTRA FDD Cell1 on RF channel number 1 |
| CP length of Cell 1 | | Normal | | |
| T1 | s | 5.12 | | |
| T2 | s | Up to receiving RRC reconfiguration setup complete from the UE, or up to [2] sec if UE | | |

| | | | |
|----|---|--|--|
| | | does not transmit <i>SidelinkUEInformation</i> during this period. | |
| T3 | s | 10.24 | |

Table A.7.5.3.1-2: ProSe Direct Discovery configuration for interruption due to ProSe Direct Discovery tests

| Parameter | Unit | Value | | Comment |
|--|------|---|---|--|
| | | Test 1 | Test 2 | |
| E-UTRA RF Channel Number | | 1 | | UL carrier frequency |
| Channel Bandwidth ($BW_{channel}$) | MHz | 5 | | |
| ProSe Direct Discovery resource pool configuration | | As specified in Table A.3.12.4-1 (Configuration #1) | As specified in Table A.3.12.4-2 (Configuration #2) | IE values unless specified otherwise in this test. |
| Active Sidelink UEs Configuration | | PDP.1.FDD As specified in Table A.3.12.8.2-1 | PDP.2.FDD As specified in Table A.3.12.8.2-1 | Transmitting ProSe Direct Discovery (Test 1 and 2) and SLSS (for Test 2) |

Table A.7.5.3.1-3: Cell specific test parameters for interruption due to ProSe Direct Discovery tests

| Parameter | | Unit | Cell 1 | | |
|--|--------------------|------------|-----------|-----------|---------|
| | | | T1 | T2 | T3 |
| E-UTRA RF Channel Number | | | 1 | | |
| $BW_{channel}$ | | MHz | 5 | | |
| UE RRC state | | | IDLE | CONNECTED | |
| Paging configuration | defaultPagingCycle | | rf256 | N/A | |
| | nB | | T / 32 | | |
| DRX | | | N/A | OFF | |
| PDSCH Reference measurement channel defined in A.3.1.1.1 ^{Note1} | | | N/A | None | R.5 FDD |
| PDCCH/PCFICH/PHICH Reference measurement channel defined in A.3.1.2.1 ^{Note1} | | | R.11 FDD | | |
| OCNG Pattern | | | OP.16 FDD | OP.15 FDD | |
| PBCH_RA | | dB | 0 | | |
| PBCH_RB | | | | | |
| PSS_RA | | | | | |
| SSS_RA | | | | | |
| PCFICH_RB | | | | | |
| PHICH_RA | | | | | |
| PHICH_RB | | | | | |
| PDCCH_RA | | | | | |
| PDCCH_RB | | | | | |
| PDSCH_RA | | | | | |
| PDSCH_RB | | | | | |
| OCNG_RA ^{Note 1} | | | | | |
| OCNG_RB ^{Note 1} | | | | | |
| N_{oc} ^{Note2} | | | | | |
| \hat{E}_s / N_{oc} | | dB | 16 | | |
| RSRP ^{Note3} | | dBm/15 kHz | -82 | | |
| SCH_RP ^{Note 3} | | dBm/15 kHz | -82 | | |
| Propagation Condition | | | AWGN | | |

| | |
|---------|--|
| Note 1: | OCNG shall be used such that cell is fully allocated and a constant total transmitted power spectral density is achieved for all OFDM symbols. |
| Note 2: | Interference from other cells and noise sources not specified in the test is assumed to be constant over subcarriers and time and shall be modelled as AWGN of appropriate power for N_{oc} to be fulfilled. |
| Note 3: | RSRP levels have been derived from other parameters for information purposes. They are not settable parameters themselves. |

A.7.5.3.2 Test Requirements

The UE shall be scheduled on PCell continuously during T3.

In Test 1, at least 98.75% of all expected ACK/NACKs during T3 shall be transmitted by the ProSe UE. The missed ACK/NACKs can occur only on subframe 'n', if either $n\pm 1$ subframe is a discovery subframe, or if $n-3$, or $n-5$ is a discovery subframe.

NOTE: For the test configuration in Table A.7.5.3.1-1 and Table A.7.5.3.1-2, the specific subframes where missed ACK/NACKs are allowed are when $(\text{subframe mod } 320) = 159, 163, 162, 166$, corresponding to allowed interruptions on subframe 159 and 162.

In Test 2, at least 97.5% of all expected ACK/NACKs during T3 shall be transmitted by the ProSe UE. The missed ACK/NACK can occur only on subframe 'n', if either $n\pm 5$ subframe is a discovery or SLSS subframe, or if $n+1$, or $n-9$ is a discovery or SLSS subframe.

NOTE: For the test configuration in Table A.7.5.3.1-1 and Table A.7.5.3.1-2, the specific subframes where missed ACK/NACKs are allowed are when $(\text{subframe mod } 320) = 135, 139, 145, 149, 155, 159, 166, 170$, corresponding to allowed interruptions on subframes 135, 145, 155 and 166.

A.7.5.4 E-UTRAN FDD – UE ProSe Direct Communication Transmission Timing Accuracy Test

A.7.5.4.1 Test Purpose and Environment

The purpose of this test is to verify the timing requirements for ProSe Direct Communication transmissions when PCell downlink timing is used as a reference with $N_{TA,SL} = 0$. This test will verify the requirements in clause 7.16.2.1.1.1 for ProSe Direct Communication transmissions. In the test the UE under test is configured for ProSe operation only on PCell and also the UE is configured only for PCell for WAN.

For this test, the UE is triggered by the test loop function or the upper layers to transmit for ProSe Direct Communication.

The test parameters are given in Table A.7.5.4.1-1 below. There is one active cell (PCell) in this test. The test system will configure the ProSe UE to transmit SLSS in each period (40ms) by configuring *networkControlledSyncTx* as ON via dedicated RRC signaling. The transmit timing is verified using the transmission timing of SLSS transmissions.

Table A.7.5.4.1-1: Test parameters for ProSe Transmission Timig Accuracy test for E-UTRAN FDD

| Parameter | Unit | Value | Comment |
|---|------|---|--|
| E-UTRA RF Channel Number | | 1 | |
| Channel Bandwidth (BW_{channel}) | MHz | 5 or 10 | Note 5 |
| Active cell | | Cell 1 | E-UTRA FDD Cell1 on RF channel number 1 |
| CP length of Cell 1 | | Normal | |
| drx-Configuration | | DRX_P1 | As specified in Table A.3.12.2-1 |
| ProSe Direct Communication configuration | | As specified in Table A.3.12.5-1 (Configuration #1) | IE values unless specified otherwise in this test. |
| networkControlledSyncTx | | ON | Configured |
| PDCCH/PCFICH/PHICH Reference measurement channel ^{Note1} | | 5 MHz: R.11 FDD 10 MHz: R.6 FDD | |

| | | | |
|--|------------|--------------------------------------|------------|
| OCNG Pattern ^{Note2} | | 5 MHz: OP.16 FDD 10 MHz: OP.2 FDD | |
| PBCH_RA | dB | 0 | |
| PBCH_RB | | | |
| PSS_RA | | | |
| SSS_RA | | | |
| PCFICH_RB | | | |
| PHICH_RA | | | |
| PHICH_RB | | | |
| PDCCH_RA | | | |
| PDCCH_RB | | | |
| OCNG_RA ^{Note3} | | | |
| OCNG_RB ^{Note3} | | | |
| N_{oc} | | | dBm/15 kHz |
| \hat{E}_s/N_{oc} | dB | 3 | |
| RSRP ^{Note4} | dBm/15 kHz | -95 | |
| SCH_RP ^{Note 4} | dBm/15 kHz | -95 | |
| Propagation condition | | AWGN | |
| <p>Note 1: For the reference measurement channels, see clause A.3.1.</p> <p>Note 2: For the OCNG pattern, see clause A.3.2.</p> <p>Note 3: OCNG shall be used such that both cells are fully allocated and a constant total transmitted power spectral density is achieved for all OFDM symbols.</p> <p>Note 4: RSRP levels have been derived from other parameters for information purposes. They are not settable parameters themselves.</p> <p>Note 5: This test is according to the principle defined in section A.3.12.3.</p> | | | |

A.7.5.4.2 Test Requirements

For parameters specified in Tables A.7.5.4.1-1, the timing accuracy for ProSe Direct Communication transmissions shall be within the limits defined in clause 7.16.2. The timing accuracy is verified using SLSS transmissions.

The following sequence of events shall be used to verify that the requirements are met.

For 5MHz or 10MHz channel bandwidth, the test sequence shall be carried out in RRC_CONNECTED DRX with a cycle length of 320ms:

- After a connection is set up with the cell, the test system shall verify that the ProSe UE SLSS transmission timing offset is within $\pm 12 \times T_S$ with respect to the first detected path (in time) of the corresponding downlink frame of cell 1.
- The test system adjusts the downlink transmit timing for the cell by $+32 \times T_S$ (approximately $+1 \mu s$) compared to that in (a). The test system shall wait for at least one SLSS period (40ms) before verifying the requirement again in (c).
- The test system shall verify that the UE SLSS transmission timing offset stays within $\pm 12 \times T_S$ with respect to the first detected path (in time) of the corresponding downlink frame of cell 1.

A.7.5.5 E-UTRAN FDD - Interruptions due to ProSe Direct Communication

A.7.5.5.1 Test Purpose and Environment

The purpose of this test is to verify the requirements related to PCell interruptions due to ProSe Direct Communication defined in clause 7.16.3. In the test the UE under test is configured for ProSe operation only on PCell and also the UE is configured only for PCell for WAN.

For this test, the UE is triggered by the test loop function or the upper layers to monitor ProSe Direct Communication.

The test parameters are given in Table A.7.5.5.1-1, Table A.7.5.5.1-2 and Table A.7.5.5.1-3 below. There is one active cell (PCell) in this test and 12 (5MHz) or 16 (10 MHz) active Sidelink UEs in this test transmitting ProSe Direct Communication.

The test consists of three successive time periods, with time duration of T1, T2 and T3 respectively.

During T1, the UE is in RRC_IDLE and monitoring the ProSe Direct Communication transmission from other active Sidelink UEs on the ProSe Direct Communication resources.

During T2, the test system establishes a RRC connection with the UE. No PDSCH traffic is scheduled for UE during T2, and the UE is expected to transmit *SidelinkUEInformation* indicating *commRxInterestedFreq* during T2. On reception of *SidelinkUEInformation*, the test system shall RRC reconfiguration message to the UE and wait for the UE to respond with RRC reconfiguration complete message before transitioning to T3. If the UE does not transmit *SidelinkUEInformation* for up to [2] sec, the test system shall transition to T3.

During T3, the UE is scheduled with PDSCH traffic on PCell downlink. The test system will count the missed ACK/NACKs during T3 to verify the allowed interruptions during ProSe Direct Communication (no missed ACK/NACKs are allowed).

Table A.7.5.5.1-1: Test parameters for interruption due to ProSe Direct Communication tests

| Parameter | Unit | Value | Comment |
|--|------|---|---|
| E-UTRA RF Channel Number | | 1 | |
| Channel Bandwidth (BW _{channel}) | MHz | 5 or 10 | According to principle defined in clause A.3.12.3 |
| Active cell | | Cell 1 | E-UTRA FDD Cell1 on RF channel number 1 |
| CP length of Cell 1 | | Normal | |
| T1 | s | 5.12 | |
| T2 | s | Up to receiving RRC reconfiguration setup complete from the UE, or up to [2] sec if UE does not transmit <i>SidelinkUEInformation</i> during this period. | |
| T3 | s | 10.24 | |
| Note 1: This test is according to the principle defined in section A.3.12.3. | | | |

Table A.7.5.5.1-2: ProSe Direct Communication specific configuration for interruption due to ProSe Direct Communication tests

| Parameter | Unit | Value | Comment |
|--|------|---|---|
| E-UTRA RF Channel Number | | 1 | UL carrier frequency |
| Channel Bandwidth (BW _{channel}) | MHz | 5 or 10 | According to principle defined in clause A.3.12.3 |
| ProSe Direct Communication configuration | | As specified in Table A.3.12.5-1 (Configuration #1) | IE values unless specified otherwise in this test. |
| Active Sidelink UEs Configuration ^{Note 1} | | PCP.1.FDD As specified in Table A.3.12.8.1-1 | Transmitting ProSe Direct Communication (PSCCH + PSSCH) |
| Note 1: This test is according to the principle defined in section A.3.12.3. | | | |

Table A.7.5.5.1-2: Cell specific test parameters for interruption due to ProSe Direct Communication tests

| Parameter | Unit | Cell 1 | | |
|--------------------------|------|--------|----|----|
| | | T1 | T2 | T3 |
| E-UTRA RF Channel Number | | 1 | | |

| | | | | |
|---|--------------------|------------|--------------------------------------|---|
| $BW_{channel}$ ^{Note 4} | | MHz | 5 or 10 | |
| UE RRC state | | | IDLE | CONNECTED |
| Paging configuration | defaultPagingCycle | | rf256 | N/A |
| | nB | | T / 32 | |
| DRX | | | N/A | OFF |
| PDSCH Reference measurement channel defined in A.3.1.1.1 ^{Note1, Note 4} | | | N/A | None R.7 FDD (5MHz) or R.3 FDD (10MHz) (Note 5 applies) |
| PDCCH/PCFICH/PHICH Reference measurement channel defined in A.3.1.2.1 ^{Note1, Note 4} | | | 5 MHz: R.11 FDD 10 MHz: R.6 FDD | |
| OCNG Pattern ^{Note 4} | | | 5 MHz: OP.16 10 MHz: OP.2 FDD | |
| OCNG Pattern ^{Note 4} | | | 5 MHz: OP.19 FDD 10 MHz: OP.6 FDD | OP.20 FDD (5MHz) or OP.10 FDD (10MHz) |
| PBCH_RA | | dB | 0 | |
| PBCH_RB | | | | |
| PSS_RA | | | | |
| SSS_RA | | | | |
| PCFICH_RB | | | | |
| PHICH_RA | | | | |
| PHICH_RB | | | | |
| PDCCH_RA | | | | |
| PDCCH_RB | | | | |
| PDSCH_RA | | | | |
| PDSCH_RB | | | | |
| OCNG_RA ^{Note 1} | | | | |
| OCNG_RB ^{Note 1} | | | | |
| N_{oc} ^{Note2} | | dBm/15 kHz | -98 | |
| \hat{E}_s / N_{oc} | | dB | 16 | |
| RSRP ^{Note3} | | dBm/15 kHz | -82 | |
| SCH_RP ^{Note 3} | | dBm/15 kHz | -82 | |
| Propagation Condition | | | AWGN | |
| <p>Note 1: OCNG shall be used such that cell is fully allocated and a constant total transmitted power spectral density is achieved for all OFDM symbols.</p> <p>Note 2: Interference from other cells and noise sources not specified in the test is assumed to be constant over subcarriers and time and shall be modelled as AWGN of appropriate power for N_{oc} to be fulfilled.</p> <p>Note 3: RSRP levels have been derived from other parameters for information purposes. They are not settable parameters themselves.</p> <p>Note 4: This test is according to the principle defined in section A.3.12.3.</p> <p>Note 5: The PDSCH scheduled subframes for R.7 FDD (5MHz) / R.3 FDD (10MHz) is changed as per the following bitmap that repeats every 40ms. PDSCH scheduled subframe bitmap: {01110111 11110111 11110111 11110111 11110110}.</p> | | | | |

A.7.5.5.2 Test Requirements

The UE shall be scheduled on PCell continuously during T3. During T3, 100% of all expected ACK/NACKs shall be transmitted by the ProSe UE.

A.7.5.6 E-UTRAN FDD - Interruptions due to ProSe Direct Discovery with discovery period less than 320ms

A.7.5.6.1 Test Purpose and Environment

The purpose of this test is to verify the requirements related to the allowed PCell interruptions due to ProSe Direct Discovery defined in clause 7.16.3.3 when the discovery period less than 320ms. In the test the UE under test is configured only with PCell with the ProSe operation on uplink carrier of the PCell.

This test is applicable to ProSe Direct Discovery capable UEs that support discovery periods of less than 320ms.

For this test, the UE is triggered by the test loop function or the upper layers to monitor ProSe Direct Discovery.

The test parameters are given in Table A.7.5.6.1-1, Table A.7.5.6.1-2, and Table A.7.5.6.1-3 below. There is one active cell (PCell) in this test and 24 active Sidelink transmissions in this test (with 12 active Sidelink UEs per configured discovery subframe).

The tests consist of three successive time periods, with time duration of T1, T2 and T3 respectively.

During T1, the UE is in RRC_IDLE and monitoring the ProSe Direct Discovery announcements from other active Sidelink UEs on the ProSe Direct Discovery resources.

During T2, the test system establishes a RRC connection with the UE. No PDSCH traffic is scheduled for UE during T2, and the UE is expected to transmit *SidelinkUEInformation* indicating *discRxInterest* during T2. On reception of *SidelinkUEInformation*, the test system shall RRC reconfiguration message to the UE and wait for the UE to respond with RRC reconfiguration complete message before transitioning to T3. If the UE does not transmit *SidelinkUEInformation* for up to [2] sec, the test system shall transition to T3.

During T3, the UE is scheduled with PDSCH traffic on PCell downlink. The test system will count the missed ACK/NACKs during T3 to verify the allowed interruptions during ProSe Direct Discovery.

Table A.7.5.6.1-1: Test parameters for interruption due to ProSe Direct Discovery test with discovery period less than 320ms for E-UTRAN FDD

| Parameter | Unit | Value | Comment |
|---|------|---|---|
| E-UTRA RF Channel Number | | 1 | |
| Channel Bandwidth (BW_{channel}) | MHz | 5 | |
| Active cell | | Cell 1 | E-UTRA FDD Cell1 on RF channel number 1 |
| CP length of Cell 1 | | Normal | |
| T1 | s | 0.64 | |
| T2 | s | Up to receiving RRC reconfiguration setup complete from the UE, or up to [2] sec if UE does not transmit <i>SidelinkUEInformation</i> during this period. | |
| T3 | s | 1.28 | |

Table A.7.5.6.1-2: ProSe Direct Discovery configuration for interruption test due to ProSe Direct Discovery with discovery period less than 320ms for E-UTRAN FDD

| Parameter | Unit | Value | Comment |
|--|------|---|--|
| E-UTRA RF Channel Number | | 1 | UL carrier frequency |
| Channel Bandwidth (BW_{channel}) | MHz | 5 | |
| ProSe Direct Discovery resource pool configuration | | As specified in Table A.3.12.4-4 (Configuration #4) | IE values unless specified otherwise in this test. |
| Active Sidelink UEs | | PDP.1.FDD | Transmitting ProSe |

| | | | |
|---------------|--|------------------------------------|------------------|
| Configuration | | As specified in Table A.3.12.8.2-1 | Direct Discovery |
|---------------|--|------------------------------------|------------------|

Table A.7.5.6.1-3: Cell specific test parameters for interruption due to ProSe Direct Discovery test with discovery period less than 320ms for E-UTRAN FDD

| Parameter | | Unit | Cell 1 | | |
|--|--------------------|------------|-----------|-----------|-----------|
| | | | T1 | T2 | T3 |
| E-UTRA RF Channel Number | | | 1 | | |
| BW _{channel} | | MHz | 5 | | |
| UE RRC state | | | IDLE | CONNECTED | |
| Paging configuration | defaultPagingCycle | | rf256 | N/A | |
| | nB | | T / 32 | | |
| DRX | | | N/A | OFF | |
| PDSCH Reference measurement channel defined in A.3.1.1.1 ^{Note1} | | | N/A | None | R.5 FDD |
| PDCCH/PCFICH/PHICH Reference measurement channel defined in A.3.1.2.1 ^{Note1} | | | R.11 FDD | | |
| OCNG Pattern | | | OP.16 FDD | | OP.15 FDD |
| PBCH_RA | | dB | 0 | | |
| PBCH_RB | | | | | |
| PSS_RA | | | | | |
| SSS_RA | | | | | |
| PCFICH_RB | | | | | |
| PHICH_RA | | | | | |
| PHICH_RB | | | | | |
| PDCCH_RA | | | | | |
| PDCCH_RB | | | | | |
| PDSCH_RA | | | | | |
| PDSCH_RB | | | | | |
| OCNG_RA ^{Note 1} | | | | | |
| OCNG_RB ^{Note 1} | | | | | |
| N_{oc} ^{Note2} | | dBm/15 kHz | -98 | | |
| \hat{E}_s / N_{oc} | | dB | 16 | | |
| RSRP ^{Note3} | | dBm/15 kHz | -82 | | |
| SCH_RP ^{Note 3} | | dBm/15 kHz | -82 | | |
| Propagation Condition | | | AWGN | | |
| <p>Note 1: OCNG shall be used such that cell is fully allocated and a constant total transmitted power spectral density is achieved for all OFDM symbols.</p> <p>Note 2: Interference from other cells and noise sources not specified in the test is assumed to be constant over subcarriers and time and shall be modelled as AWGN of appropriate power for N_{oc} to be fulfilled.</p> <p>Note 3: RSRP levels have been derived from other parameters for information purposes. They are not settable parameters themselves.</p> | | | | | |

A.7.5.6.2 Test Requirements

The UE shall be scheduled on PCell continuously during T3.

The test system shall verify that at least 98.75% of all expected ACK/NACKs during T3 shall be transmitted by the ProSe UE. The missed ACK/NACKs can occur only on subframe ‘n’, if either $n \pm 1$ subframe is a discovery subframe, or if $n-3$, or $n-5$ is a discovery subframe.

NOTE: For the test configuration in Table A.7.5.6.1-1 and Table A.7.5.6.1-2, the specific subframes where missed ACK/NACKs are allowed are when $(\text{subframe mod } 40) = 19, 23, 22, 26$, corresponding to allowed interruptions on subframe $(\text{subframe mod } 40) = 19$ and 22.

A.7.5.7 E-UTRAN FDD-FDD - Interruptions due to ProSe Direct Discovery

A.7.5.7.1 Test Purpose and Environment

The purpose of this test is to verify the requirements related to the allowed PCell interruptions due to ProSe Direct Discovery defined in clause 7.16.3.1 and clause 7.16.3.3. In the test the UE under test is configured with PCell and one SCell, with ProSe operation configured on the PCell.

A UE that meets the requirements of this clause is not required to be tested for the requirements of clause 7.5.3.

For this test, the UE is triggered by the test loop function or the upper layers to monitor ProSe Direct Discovery.

The test parameters are given in Table A.7.5.7.1-1, Table A.7.5.7.1-2, and Table A.7.5.7.1-3 below. There are two configured component carriers: PCC and SCC, and two active cells: Cell 1 and Cell2. Cell1 is the PCell on PCC, and Cell 2 is the SCell on SCC. Sidelink operation is configured on the PCC UL. There are 24 active Sidelink transmissions in this test (with 12 active Sidelink UEs per configured discovery subframe). Two tests (Test 1 and Test 2) are defined to verify interruptions due to synchronous (Test 1) and asynchronous (Test 2) ProSe Direct Discovery.

The tests consist of three successive time periods, with time duration of T1, T2 and T3 respectively.

During T1, the UE is in RRC_IDLE and monitoring the ProSe Direct Discovery announcements from other active Sidelink UEs on the ProSe Direct Discovery resources.

During T2, the test system establishes a RRC connection with the UE. The test system shall configure the UE with the SCC. No PDSCH traffic is scheduled for UE during T2, and the UE is expected to transmit *SidelinkUEInformation* indicating *discRxInterest* during T2. On reception of *SidelinkUEInformation*, the test system shall RRC reconfiguration message to the UE and wait for the UE to respond with RRC reconfiguration complete message before transitioning to T3. If the UE does not transmit *SidelinkUEInformation* for up to [2] sec, the test system shall transition to T3.

During T3, the UE is scheduled with PDSCH traffic on both PCell and SCell downlink. The test system will count the missed ACK/NACKs during T3 to verify the allowed interruptions during ProSe Direct Discovery.

Table A.7.5.7.1-1: Test parameters for interruption due to ProSe Direct Discovery tests

| Parameter | Unit | Value | | Comment |
|--------------------------------------|------|---|--------|--|
| | | Test 1 | Test 2 | |
| E-UTRA RF Channel Number | | 1 | | |
| Channel Bandwidth ($BW_{channel}$) | MHz | 5 | | |
| Active cell | | Cell 1, Cell 2 | | E-UTRA FDD Cell1 and Cell 2 on RF channel number 1 and 2, respectively |
| CP length of Cell 1, Cell 2 | | Normal | | |
| T1 | s | 5.12 | | |
| T2 | s | Up to receiving RRC reconfiguration setup complete from the UE, or up to [2] sec if UE does not transmit <i>SidelinkUEInformation</i> during this period. | | |
| T3 | s | 10.24 | | |

Table A.7.5.7.1-2: ProSe Direct Discovery configuration for interruption due to ProSe Direct Discovery tests

| Parameter | Unit | Value | | Comment |
|--|------|---|---|--|
| | | Test 1 | Test 2 | |
| E-UTRA RF Channel Number | | 1 | | UL carrier frequency |
| Channel Bandwidth ($BW_{channel}$) | MHz | 5 | | |
| ProSe Direct Discovery resource pool configuration | | As specified in Table A.3.12.4-1 (Configuration #1) | As specified in Table A.3.12.4-2 (Configuration #2) | IE values unless specified otherwise in this test. |

| | | | | |
|-----------------------------------|--|---|---|--|
| Active Sidelink UEs Configuration | | PDP.1.FDD As specified in Table A.3.12.8.2-1 | PDP.2.FDD As specified in Table A.3.12.8.2-1 | Transmitting ProSe Direct Discovery (Test 1 and 2) and SLSS (for Test 2) |
|-----------------------------------|--|---|---|--|

Table A.7.5.7.1-3: Cell specific test parameters for interruption due to ProSe Direct Discovery tests

| Parameter | Unit | Cell 1 | | | Cell 2 | | |
|--|---------------------|-----------|-----------|-----------|-----------|------|-----------|
| | | T1 | T2 | T3 | T1 | T2 | T3 |
| E-UTRA RF Channel Number | | 1 | | | 2 | | |
| BW _{channel} | MHz | 5 | | | 5 | | |
| UE RRC state | | IDLE | CONNECTED | | N/A | | |
| Paging configuration | defaultPaging Cycle | rf256 | N/A | | N/A | | |
| | nB | T / 32 | | | | | |
| DRX | | N/A | OFF | | N/A | OFF | |
| PDSCH Reference measurement channel defined in A.3.1.1.1 ^{Note1} | | N/A | None | R.5 FDD | N/A | None | R.5 FDD |
| PDCCH/PCFICH/PHICH Reference measurement channel defined in A.3.1.2.1 ^{Note1} | | R.11 FDD | | | R.11 FDD | | |
| OCNG Pattern | | OP.16 FDD | | OP.15 FDD | OP.16 FDD | | OP.15 FDD |
| PBCH_RA | dB | 0 | | | 0 | | |
| PBCH_RB | | | | | | | |
| PSS_RA | | | | | | | |
| SSS_RA | | | | | | | |
| PCFICH_RB | | | | | | | |
| PHICH_RA | | | | | | | |
| PHICH_RB | | | | | | | |
| PDCCH_RA | | | | | | | |
| PDCCH_RB | | | | | | | |
| PDSCH_RA | | | | | | | |
| PDSCH_RB | | | | | | | |
| OCNG_RA ^{Note 1} | | | | | | | |
| OCNG_RB ^{Note 1} | | | | | | | |
| N_{oc} ^{Note2} | dBm/15 kHz | -98 | | | -98 | | |
| \hat{E}_s/N_{oc} | dB | 16 | | | 16 | | |
| RSRP ^{Note3} | dBm/15 kHz | -82 | | | -82 | | |
| SCH_RP ^{Note 3} | dBm/15 kHz | -82 | | | -82 | | |
| Propagation Condition | | AWGN | | | AWGN | | |
| <p>Note 1: OCNG shall be used such that cell is fully allocated and a constant total transmitted power spectral density is achieved for all OFDM symbols.</p> <p>Note 2: Interference from other cells and noise sources not specified in the test is assumed to be constant over subcarriers and time and shall be modelled as AWGN of appropriate power for N_{oc} to be fulfilled.</p> <p>Note 3: RSRP levels have been derived from other parameters for information purposes. They are not settable parameters themselves.</p> | | | | | | | |

A.7.5.7.2 Test Requirements

The UE shall be scheduled on PCell and SCell downlink continuously during T3.

In Test 1, at least 98.75% of all expected ACK/NACKs during T3 shall be transmitted by the ProSe UE. The missed ACK/NACKs can occur only on subframe ‘n’, if either n±1 subframe is a discovery subframe, or if n-3, or n-5 is a discovery subframe.

NOTE: For the test configuration in Table A.7.5.12.1-1 and Table A.7.5.12.1-2, the specific subframes where missed ACK/NACKs are allowed are when $(\text{subframe mod } 320) = 159, 163, 162, 166$, corresponding to allowed interruptions on subframe 159 and 162.

In Test 2, at least 97.5% of all expected ACK/NACKs during T3 shall be transmitted by the ProSe UE. The missed ACK/NACK can occur only on subframe 'n', if either $n\pm 5$ subframe is a discovery or SLSS subframe, or if $n+1$, or $n-9$ is a discovery or SLSS subframe.

NOTE: For the test configuration in Table A.7.5.7.1-1 and Table A.7.5.7.1-2, the specific subframes where missed ACK/NACKs are allowed are when $(\text{subframe mod } 320) = 135, 139, 145, 149, 155, 159, 166, 170$, corresponding to allowed interruptions on subframes 135, 145, 155 and 166.

A.7.5.8 E-UTRAN FDD-FDD - Cell reselection and timing accuracy for ProSe Direct Discovery transmission on non-serving frequency

A.7.5.8.1 Test Purpose and Environment

The purpose of this test is to verify the requirements related to cell reselection and timing accuracy for ProSe Direct Discovery transmissions on a non-serving frequency defined in clauses 7.16.4 and 7.16.2.1.2, respectively. In the test the UE under test is configured with PCell on a serving frequency, and the PCell provides the ProSe Direct Discovery resources for a non-serving frequency.

This test is applicable for ProSe Direct Discovery capable UEs that support concurrent inter-band E-UTRAN and E-UTRAN ProSe operation, and indicates the support of inter-frequency discovery transmission using *discInterFreqTx*.

For this test, the UE is triggered by the test loop function or the upper layers to announce ProSe Direct Discovery.

The test parameters are given in Table A.7.5.8.1-1, Table A.7.5.8.1-2, and Table A.7.5.8.1-3 below. The test consists of one active serving cell (cell 1) on the serving RF channel 1, and two active non-serving cells (cell 2 and cell3) on the non-serving discovery RF channel 2.

The tests consist of three successive time periods, with time duration of T1, T2 and T3 respectively.

The serving cell (cell 1 on RF channel 1) is active during the entire test duration (T1, T2, T3) without any changes to cell 1 RSRP. Prior to start of the test, the test system shall verify that the UE is transmitting ProSe Direct Discovery transmissions on the non-serving RF channel 2.

During T1, only one non-serving cell (cell 2 on RF channel 2) is active. The UE is expected to be following the timing of cell 2 for its discovery transmissions on RF channel 2. During T2, cell 3 on the non-serving RF channel 2 is also turned ON and is configured to be better ranked than cell 2. The UE is expected to reselect to cell 3 for discovery transmit timing. During T3, RSRP of cell 2 is increased so that it becomes better ranked than cell 3. The UE is supposed to reselect back to cell 2 and follow its timing for discovery transmissions.

Table A.7.5.8.1-1: Test parameters for cell reselection and timing accuracy for ProSe Direct Discovery transmission on non-serving frequency test for E-UTRAN FDD-FDD

| Parameter | Unit | Value | Comment |
|---|------|----------------|--|
| E-UTRA RF Channel Number | | 1, 2 | RF channel 1 is serving RF channel 2 is non-serving |
| Channel Bandwidth (BW_{channel}) | MHz | 5 | |
| Active cell | | Cell 1 | Serving E-UTRA FDD cell on RF channel number 1 |
| Non-serving cell | | Cell 2, Cell 3 | Non-serving E-UTRA FDD cells on RF channel number 2 |
| CP length of Cell 1, 2, 3 | | Normal | |
| T1 | s | 2 | |
| T2 | s | 14 | |

| | | | |
|----|---|---|--|
| T3 | s | 5 | |
|----|---|---|--|

Table A.7.5.8.1-2: ProSe Direct Discovery configuration for cell reselection and timing accuracy for ProSe Direct Discovery transmission on non-serving frequency test for E-UTRAN FDD-FDD

| Parameter | Unit | Value | Comment |
|--|------|---|--|
| E-UTRA RF Channel Number | | 2 | UL carrier frequency |
| Channel Bandwidth ($BW_{channel}$) | MHz | 5 | |
| ProSe Direct Discovery resource pool configuration | | As specified in Table A.3.12.4-5 (Configuration #5) | IE values unless specified otherwise in this test. Broadcasted in SIB19 by Cell 1 on RF channel 1 |
| <i>discInterFreqList/carrierFreq</i> | | RF channel 2 (UL frequency) | |
| <i>freqInfo/ul-CarrierFreq</i> | | RF channel 2 (UL frequency) | |
| <i>rxParamsAddNeighFreq/physCellId</i> | | {phyCellId of Cell 2, phyCellId of Cell 3} | |
| <i>txParamsAddNeighFreq/physCellId</i> | | {phyCellId of Cell 2, phyCellId of Cell 3} | |

Table A.7.5.8.1-3: Cell specific test parameters for cell reselection and timing accuracy for ProSe Direct Discovery transmission on non-serving frequency test for E-UTRAN FDD-FDD

| Parameter | Unit | Cell 1 | | | Cell 2 | | | Cell 3 | | |
|------------------------------------|------------|--|----|----|-------------|-----|-----|-------------|-----|-----|
| | | T1 | T2 | T3 | T1 | T2 | T3 | T1 | T2 | T3 |
| E-UTRA RF Channel Number | | 1 | | | 2 | | | 2 | | |
| Serving / Non-serving | | Serving | | | Non-serving | | | Non-serving | | |
| $BW_{channel}$ | MHz | 5 | | | 5 | | | 5 | | |
| drx-Configuration | | DRX_P1 As specified in Table A.3.12.2-1 | | | N/A | | | N/A | | |
| OCNG Patterns defined in A.3.2.1.2 | | OP.16 FDD | | | OP.19 FDD | | | OP.19 FDD | | |
| PBCH_RA | dB | 0 | | | 0 | | | 0 | | |
| PBCH_RB | dB | | | | | | | | | |
| PSS_RA | dB | | | | | | | | | |
| SSS_RA | dB | | | | | | | | | |
| PCFICH_RB | dB | | | | | | | | | |
| PHICH_RA | dB | | | | | | | | | |
| PHICH_RB | dB | | | | | | | | | |
| PDCCH_RA | dB | | | | | | | | | |
| PDCCH_RB | dB | | | | | | | | | |
| PDSCH_RA | dB | | | | | | | | | |
| PDSCH_RB | dB | | | | | | | | | |
| OCNG_RA ^{Note 1} | dB | | | | | | | | | |
| OCNG_RB ^{Note 1} | dB | | | | | | | | | |
| Timing offset | us | | | | | | | | | |
| N_{oc} ^{Note 2} | dBm/15 kHz | -98 | | | | | | | | |
| RSRP ^{Note 3} | dBm/15 kHz | -82 | | | -82 | -85 | -82 | -infinity | -82 | -85 |

| | | | | | | | | |
|--------------------------|--|------|-----|-------|------|-----------|------|-------|
| \hat{E}_s/I_{ot} | dB | 16 | 16 | -3.11 | 2.79 | -infinity | 2.79 | -3.11 |
| \hat{E}_s/N_{oc} | dB | 16 | 16 | 13 | 16 | -infinity | 13 | 16 |
| SCH_RP ^{Note 3} | dBm/15 kHz | -82 | -82 | -85 | -82 | -infinity | -82 | -85 |
| Propagation Condition | | AWGN | | AWGN | | AWGN | | |
| Note 1: | OCNG shall be used such that cells are fully allocated and a constant total transmitted power spectral density is achieved for all OFDM symbols. | | | | | | | |
| Note 2: | Interference from other cells and noise sources not specified in the test is assumed to be constant over subcarriers and time and shall be modelled as AWGN of appropriate power for N_{oc} to be fulfilled. | | | | | | | |
| Note 3: | RSRP levels have been derived from other parameters for information purposes. They are not settable parameters themselves. | | | | | | | |

A.7.5.8.2 Test Requirements

During T1, the test system shall verify that the transmit timing offset of discovery transmission on RF channel 2 is within $\pm 12 \times T_S$ with respect to the first detected path (in time) of the corresponding downlink frame of cell 2.

During T2, the UE is expected to reselect to cell 3 for discovery timing synchronization after cell reselection delay to a newly detectable cell from start of T2. After the period of cell reselection delay to a newly detectable cell from the start of T2, the test system shall verify that the transmit timing offset of discovery transmission on RF channel 2 are within $\pm 12 \times T_S$ with respect to the first detected path (in time) of the corresponding downlink frame of cell 3.

The cell reselection delay to a newly detectable cell for discovery transmission on non-serving carrier shall be 10.56s.

NOTE: The cell reselection delay to a newly detectable cell for discovery transmission on non-serving carrier can be expressed as ($T_{\text{detect,EUTRAN_ProSe_Intra}} + 1$ discovery period).

During T3, the UE is expected to reselect back to cell 2 for discovery timing synchronization after cell reselection delay to an already detected cell from start of T3. After the period of cell reselection delay to a newly detectable cell from the start of T3, the test system shall verify that the transmit timing offset of discovery transmission on RF channel 2 are within $\pm 12 \times T_S$ with respect to the first detected path (in time) of the corresponding downlink frame of cell 2.

The cell reselection delay to an already detected cell for discovery transmission on non-serving carrier shall be 5.44s.

NOTE: The cell reselection delay to an already detected cell for discovery transmission on non-serving carrier can be expressed as ($T_{\text{evaluate, E-UTRAN_ProSe_Intra}} + 1$ discovery period).

The rate of correct events observed during repeated tests shall be at least 90%.

A.7.5.9 E-UTRAN FDD-FDD - Interruptions due to ProSe Direct Discovery reception on non-serving frequency

A.7.5.9.1 Test Purpose and Environment

The purpose of this test is to verify the requirements related to interruptions due to ProSe Direct Discovery reception on a non-serving frequency as defined in clause 7.16.3.3 and 7.16.3.4. In the test the UE under test is configured with PCell on a serving frequency, and the PCell provides the ProSe Direct Discovery resources for a non-serving frequency.

This test is applicable for ProSe Direct Discovery capable UEs that support concurrent inter-band E-UTRAN and E-UTRAN ProSe operation.

For this test, the UE is triggered by the test loop function or the upper layers to monitor ProSe Direct Discovery.

The test parameters are given in Table A.7.5.9.1-1, Table A.7.5.9.1-2, and Table A.7.5.9.1-3 below. The test consists of one active serving cell (cell 1) on the serving RF channel 1, and one active non-serving cells (cell 2) on the non-serving discovery RF channel 2. There are 96 active Sidelink transmissions in this test (with 12 active Sidelink UEs per configured discovery subframe) on RF channel 2.

After the test system establishes a RRC connection with the UE, the UE is expected to transmit *SidelinkUEInformation* indicating *discRxInterest*. On reception of *SidelinkUEInformation*, the test system shall RRC reconfiguration message to the UE and wait for the UE to respond with RRC reconfiguration complete message before start of the test. Further, depending on UE implementation, the UE may request for discovery reception gaps (using *discRxGapReq*) for the ProSe Direct Discovery reception operation on the non-serving frequency. If gaps are requested, the test system shall configure the gaps as requested and modify the PDSCH scheduling on cell 1 for this UE such that the UE is not scheduled on the DL on the subframes configured as reception gaps.

The test shall start after the completion of the RRC reconfiguration is complete following the *SidelinkUEInformation* message transmission from the UE. The test system shall then continuously schedule the UE on DL of cell 1 (apart from any subframes that are configured as discovery gaps).

Table A.7.5.9.1-1: Test parameters for interruptions due to ProSe Direct Discovery reception on non-serving frequency test for E-UTRAN FDD-FDD

| Parameter | Unit | Value | Comment |
|--------------------------------------|------|--------|--|
| E-UTRA RF Channel Number | | 1, 2 | RF channel 1 is serving RF channel 2 is non-serving |
| Channel Bandwidth ($BW_{channel}$) | MHz | 5 | |
| Active cell | | Cell 1 | Serving E-UTRA FDD cell on RF channel number 1 |
| Non-serving cell | | Cell 2 | Non-serving E-UTRA FDD cell on RF channel number 2 |
| CP length of Cell 1, 2 | | Normal | |

Table A.7.5.9.1-2: ProSe Direct Discovery configuration for interruptions due to ProSe Direct Discovery reception on non-serving frequency test for E-UTRAN FDD-FDD

| Parameter | Unit | Value | Comment |
|---|------|--|--|
| E-UTRA RF Channel Number | | 2 | UL carrier frequency |
| Channel Bandwidth ($BW_{channel}$) | MHz | 5 | |
| ProSe Direct Discovery resource pool configuration | | As specified in Table A.3.12.4-5 (Configuration #5) | IE values unless specified otherwise in this test. Broadcasted in SIB19 by Cell 1 on RF channel 1 |
| <i>discInterFreqList/carrierFreq</i> | | RF channel 2 (UL frequency) | |
| <i>freqInfo/ul-CarrierFreq</i> | | RF channel 2 (UL frequency) | |
| <i>rxParamsAddNeighFreq/physCellId</i> | | {phyCellId of Cell 2} | |
| <i>txParamsAddNeighFreq/physCellId</i> | | {phyCellId of Cell 2} | |
| <i>discResourcesNonPS/discRxResourcesInterFreq/tf-ResourceConfig/subframeBitmap</i> | | 11111111 00000000 00000000 00000000 00000000 | |
| Active Sidelink UEs Configuration | | PDP.1.FDD As specified in Table A.3.12.8.2-1 | Transmitting ProSe Direct Discovery on RF channel 2 |

Table A.7.5.9.1-3: Cell specific test parameters for interruptions due to ProSe Direct Discovery reception on non-serving frequency test for E-UTRAN FDD-FDD

| Parameter | Unit | Cell 1 | Cell 2 |
|-----------|------|--------|--------|
|-----------|------|--------|--------|

| E-UTRA RF Channel Number | | 1 | 2 |
|---|--|-----------------------------|-------------|
| Serving/Non-serving | | Serving | Non-serving |
| BW _{channel} | MHz | 5 | 5 |
| Correlation Matrix and Antenna Configuration | | 1x2 Low | 1x2 Low |
| drx-Configuration | | None | N/A |
| PDCCH/PCFICH/PHICH Reference measurement channel ^{Note1} | | R.11 FDD | R.11 FDD |
| PDSCH Reference measurement channel defined in A.3.1.1.1 ^{Note1} | | R.7 FDD (NOTE 5 applies) | N/A |
| OCNG Pattern defined in A.3.2.1 | | OP.20 FDD | OP.19 FDD |
| PCFICH_RB | dB | 0 | 0 |
| PDCCH_RA | dB | | |
| PDCCH_RB | dB | | |
| PBCH_RA | dB | | |
| PBCH_RB | dB | | |
| PSS_RA | dB | | |
| SSS_RA | dB | | |
| PHICH_RA | dB | | |
| PHICH_RB | dB | | |
| PDSCH_RA | dB | | |
| PDSCH_RB | dB | | |
| OCNG_RA ^{Note1} | dB | | |
| OCNG_RB ^{Note1} | dB | | |
| \hat{E}_s/N_{oc} | dB | | |
| N_{oc} | dBm/15 kHz | -98 | -98 |
| RSRP ^{Note4} | dBm/15 kHz | -82 | -82 |
| SCH_RP ^{Note 4} | dBm/15 kHz | -82 | -82 |
| Propagation condition | | AWGN | AWGN |
| Note 1: | For the reference measurement channels, see clause A.3.1. | | |
| Note 2: | For the OCNG pattern, see clause A.3.2. | | |
| Note 3: | OCNG shall be used such that cells are fully allocated and a constant total transmitted power spectral density is achieved for all OFDM symbols. | | |
| Note 4: | RSRP and SCH_RP levels have been derived from other parameters for information purposes. They are not settable parameters themselves. | | |
| Note 5: | Scheduling pattern for PDSCH modified to omit the subframes configured as Discovery Gaps in the test. | | |

A.7.5.9.2 Test Requirements

The test system shall verify the allowed interruptions for ProSe Direct Discovery reception on non-serving frequency, and depends on the discovery gap configuration for the UE.

If no discovery gaps are configured, the test system shall verify that the total number of missed ACK/NACKs on the serving cell are less than 0.5%.

If discovery gaps are configured as requested by the UE, then test system shall verify that the missed ACK/NACKs, if any, correspond to locations as specified in subclause 7.16.3.4:

- Missed ACK/NACKs is allowed on a subframe n , if subframe n is configured as downlink reception gap (using *discRxGapConfig*) and either the subframe immediately preceding or immediately following that subframe is not configured as reception gap, and

- One additional missed ACK/NACK per discovery period is allowed on a subframe m , such that the subframe m is configured as reception gap.

A.7.5.10 E-UTRAN FDD-FDD - Interruptions due to ProSe Direct Discovery transmission on non-serving frequency

A.7.5.10.1 Test Purpose and Environment

The purpose of this test is to verify the requirements related to interruptions due to ProSe Direct Discovery reception on a non-serving frequency as defined in clause 7.16.3.3 and 7.16.3.4. In the test the UE under test is configured with PCell on a serving frequency, and the PCell provides the ProSe Direct Discovery resources for a non-serving frequency.

This test is applicable for ProSe Direct Discovery capable UEs that support concurrent inter-band E-UTRAN and E-UTRAN ProSe operation, and indicates the support of inter-frequency discovery transmission using *discInterFreqTx*.

For this test, the UE is triggered by the test loop function or the upper layers to announce ProSe Direct Discovery.

The test parameters are given in Table A.7.5.10.1-1, Table A.7.5.10.1-2, and Table A.7.5.10.1-3 below. The test consists of one active serving cell (cell 1) on the serving RF channel 1, and one active non-serving cells (cell 2) on the non-serving discovery RF channel 2.

After the test system establishes a RRC connection with the UE, the UE is expected to transmit *SidelinkUEInformation*. On reception of *SidelinkUEInformation*, the test system shall RRC reconfiguration message to the UE and wait for the UE to respond with RRC reconfiguration complete message before start of the test. Further, depending on UE implementation, the UE may request for discovery transmission and/or reception gaps (using *discTxGapReq* and/or *discRxGapReq*) for the ProSe Direct Discovery transmission operation on the non-serving frequency. If transmission gap is requested, the test system shall configure the transmission gap as requested. The test system shall not configure any reception gap for the UE for the purpose of this test.

The test shall start after the completion of the RRC reconfiguration is complete following the *SidelinkUEInformation* message transmission from the UE. The test system shall then continuously schedule the UE on DL of cell 1.

Table A.7.5.10.1-1: Test parameters for interruptions due to ProSe Direct Discovery transmission on non-serving frequency test for E-UTRAN FDD-FDD

| Parameter | Unit | Value | Comment |
|---|------|--------|--|
| E-UTRA RF Channel Number | | 1, 2 | RF channel 1 is serving RF channel 2 is non-serving |
| Channel Bandwidth (BW_{channel}) | MHz | 5 | |
| Active cell | | Cell 1 | Serving E-UTRA FDD cell on RF channel number 1 |
| Non-serving cell | | Cell 2 | Non-serving E-UTRA FDD cell on RF channel number 2 |
| CP length of Cell 1, 2 | | Normal | |

Table A.7.5.10.1-2: ProSe Direct Discovery configuration for interruptions due to ProSe Direct Discovery transmission on non-serving frequency test for E-UTRAN FDD-FDD

| Parameter | Unit | Value | Comment |
|--|------|---|--|
| E-UTRA RF Channel Number | | 2 | UL carrier frequency |
| Channel Bandwidth (BW_{channel}) | MHz | 5 | |
| ProSe Direct Discovery resource pool configuration | | As specified in Table A.3.12.4-5 (Configuration #5) | IE values unless specified otherwise in this test. |

| | | | |
|--|--|--|---|
| | | | Broadcasted in SIB19 by Cell 1 on RF channel 1 |
| <i>discInterFreqList/carrierFreq</i> | | RF channel 2 (UL frequency) | |
| <i>freqInfo/ul-CarrierFreq</i> | | RF channel 2 (UL frequency) | |
| <i>txParamsAddNeighFreq/physCellId</i> | | {phyCellId of Cell 2} | |
| <i>discConfigOther/ refCarrierCommon</i> | | pCell | Configure UE to use pCell as reference for synchronization and measurements for discovery transmission on non-serving carrier |
| <i>discResourcesNonPS/ discRxResourcesInterFreq</i> | | Not configured | |
| <i>discResourcesNonPS/ discTxResourcesInterFreq/ tf-ResourceConfig/ subframeBitmap</i> | | 11111111 00000000 00000000 00000000 00000000 | |
| <i>discRxGapConfig</i> | | Not configured | Within <i>SL-DiscConfig</i> in RRC reconfiguration message |
| <i>discTxGapConfig</i> | | Configured as requested by UE in <i>discTxGapReq</i> | Within <i>SL-DiscConfig</i> in RRC connection reconfiguration message |

Table A.7.5.10.1-3: Cell specific test parameters for interruptions due to ProSe Direct Discovery transmission on non-serving frequency test for E-UTRAN FDD-FDD

| Parameter | Unit | Cell 1 | Cell 2 |
|---|------|-----------|-------------|
| E-UTRA RF Channel Number | | 1 | 2 |
| Serving/Non-serving | | Serving | Non-serving |
| BW _{channel} | MHz | 5 | 5 |
| Correlation Matrix and Antenna Configuration | | 1x2 Low | 1x2 Low |
| drx-Configuration | | None | N/A |
| PDCCH/PCFICH/PHICH Reference measurement channel ^{Note1} | | R.11 FDD | R.11 FDD |
| PDSCH Reference measurement channel defined in A.3.1.1.1 ^{Note1} | | R.7 FDD | N/A |
| OCNG Pattern defined in A.3.2.1 | | OP.20 FDD | OP.19 FDD |
| PCFICH_RB | dB | 0 | 0 |
| PDCCH_RA | dB | | |
| PDCCH_RB | dB | | |
| PBCH_RA | dB | | |
| PBCH_RB | dB | | |
| PSS_RA | dB | | |
| SSS_RA | dB | | |
| PHICH_RA | dB | | |
| PHICH_RB | dB | | |
| PDSCH_RA | dB | | |
| PDSCH_RB | dB | | |
| OCNG_RA ^{Note1} | dB | | |
| OCNG_RB ^{Note1} | dB | | |

| | | | |
|--|------------|------|------|
| \hat{E}_s/N_{oc} | dB | 16 | 16 |
| N_{oc} | dBm/15 kHz | -98 | -98 |
| RSRP ^{Note4} | dBm/15 kHz | -82 | -82 |
| SCH_RP ^{Note 4} | dBm/15 kHz | -82 | -82 |
| Propagation condition | | AWGN | AWGN |
| <p>Note 1: For the reference measurement channels, see clause A.3.1.</p> <p>Note 2: For the OCNG pattern, see clause A.3.2.</p> <p>Note 3: OCNG shall be used such that cells are fully allocated and a constant total transmitted power spectral density is achieved for all OFDM symbols.</p> <p>Note 4: RSRP and SCH_RP levels have been derived from other parameters for information purposes. They are not settable parameters themselves.</p> | | | |

A.7.5.10.2 Test Requirements

The test system shall verify the allowed interruptions for ProSe Direct Discovery transmission on non-serving frequency.

If no discovery transmission gaps are configured, the test system shall verify that the total number of missed ACK/NACKs on the serving cell are less than 0.5%.

If discovery transmission gaps are configured as requested by the UE, the test system shall verify that the number of missed ACK/NACKs are less than or equal to 5 missed ACK/NACKs during a discovery period (configured as 320ms in this test). Corresponding to discovery transmission on subframe n (with respect to PCell) on the non-serving carrier, the missed ACK/NACKs are allowed only on subframes $(n-1)$, n , $(n+1)$, $(n+3)$, $(n+5)$.

A.7.5.11 E-UTRAN FDD-FDD - Interruptions due to ProSe Direct Communication on non-serving frequency

A.7.5.11.1 Test Purpose and Environment

The purpose of this test is to verify the requirements related to interruptions due to ProSe Direct Communication on a non-serving frequency as defined in clause 7.16.3.5. In the test the UE under test is configured with PCell on a serving frequency, and is pre-configured with ProSe Direct Communication resources for a non-serving frequency.

This test is applicable for ProSe Direct Communication capable UEs that support concurrent inter-band E-UTRAN and E-UTRAN ProSe operation.

For this test, the UE is triggered by the test loop function or the upper layers to receive ProSe Direct Communication.

The test parameters are given in Table A.7.5.11.1-1, Table A.7.5.11.1-2, Table A.7.5.11.1-3 and Table A.7.5.11.1-4 below. The test consists of one active serving cell (cell 1) on the serving RF channel 1, and there are no active cells on RF channel 2. On RF channel 2, the test consists of one active SyncRef UE (SyncRef UE 1) transmitting synchronization signals and channels, and 12 (5MHz) or 16 (10 MHz) active Sidelink UEs in this test transmitting ProSe Direct Communication.

The serving cell (cell 1) on RF channel 1 is not broadcasting SIB18, and the UE is expected to use its preconfigured parameters for ProSe Direct Communication operation on RF channel 2.

The UE is continuously scheduled with PDSCH traffic on PCell downlink in RF channel 1.

Table A.7.5.11.1-1: Test parameters for interruptions due to ProSe Direct Communication on non-serving frequency test for E-UTRAN FDD-FDD

| Parameter | Unit | Value | Comment |
|--------------------------|------|-------|--|
| E-UTRA RF Channel Number | | 1, 2 | RF channel 1 is serving RF channel 2 is non-serving |

| | | | |
|---|-----|--------------|---|
| Channel Bandwidth (BW_{channel}) | MHz | 5 or 10 | According to principle defined in clause A.3.12.3 |
| Active cell | | Cell 1 | Serving E-UTRA FDD cell on RF channel number 1 (Not broadcasting SIB18) |
| Active SyncRef UEs | | SyncRef UE 1 | Transmitting SLSS+MIB-SL on uplink of RF channel number 2 |
| CP length of Cell 1 | | Normal | |

Table A.7.5.11.1-2: ProSe Direct Communication configuration for interruptions due to ProSe Direct Communication on non-serving frequency test for E-UTRAN FDD-FDD

| Parameter | Unit | Value | Comment |
|--|------|---|--|
| E-UTRA RF Channel Number | | 2 | UL carrier frequency |
| Channel Bandwidth (BW_{channel}) | MHz | 5 or 10 | According to principle defined in clause A.3.12.3 |
| ProSe Direct Communication resource pool configuration | | As specified in Table A.3.12.5-2 (Configuration #2) | IE values unless specified otherwise in this test. (Preconfigured) |
| Active Sidelink UEs Configuration ^{Note 1} | | PCP.1.FDD As specified in Table A.3.12.8.1-1 | Transmitting ProSe Direct Communication (PSCCH + PSSCH) Using SyncRef UE1 as synchronization source |
| Note 1: This test is according to the principle defined in section A.3.12.3. | | | |

Table A.7.5.11.1-3: SyncRef UE specific test parameters for interruptions due to ProSe Direct Communication on non-serving frequency test for E-UTRAN FDD-FDD

| Parameter | Unit | SyncRef UE 1 |
|--|------------|---|
| E-UTRA RF Channel Number | | 2 |
| BW_{channel} ^{Note 4} | MHz | 5 or 10 |
| ProSe Direct Communication resource pool configuration | | As specified in Table A.3.12.5-1 (Configuration #1) Note resource pool is same as Configuration #2 used by ProSe UE. |
| syncOffsetIndicator | | Set same as <i>syncOffsetIndicator1</i> in ProSe Direct Communication preconfiguration |
| slssid | | 30 |
| inCoverage | | TRUE |
| networkControlledSyncTx | | ON |
| N_{oc} ^{Note1} | dBm/15 kHz | -98 |
| \hat{E}_s / N_{oc} | dB | 16 |
| S-RSRP ^{Note2, Note3} | dBm/15 kHz | -82 |
| Propagation Condition | | AWGN |
| Note 1: Interference from other cells and noise sources not specified in the test is assumed to be constant over subcarriers and time and shall be modelled as AWGN of appropriate power for N_{oc} to be fulfilled. | | |
| Note 2: S-RSRP levels have been derived from other parameters for information purposes. They are not settable parameters themselves. | | |
| Note 3: SSSS Es/lot is set the same as PSSS/PSBCH Es/lot. | | |
| Note 4: This test is according to the principle defined in section A.3.12.3. | | |

Table A.7.5.11.1-4: Cell specific test parameters for interruptions due to ProSe Direct Communication on non-serving frequency test for E-UTRAN FDD-FDD

| Parameter | Unit | Cell 1 |
|--------------------------|------|--------|
| E-UTRA RF Channel Number | | 1 |

| | | | |
|--|------------|---------------------------------------|-----|
| Serving/Non-serving | | Serving | |
| BW_{channel} ^{Note 5} | MHz | 5 or 10 | |
| Correlation Matrix and Antenna Configuration | | 1x2 Low | |
| drx-Configuration | | None | |
| PDCCH/PCFICH/PHICH Reference measurement channel ^{Note1, Note 5} | | 5 MHz: R.11 FDD 10 MHz: R.6 FDD | |
| PDSCH Reference measurement channel defined in A.3.1.1.1 ^{Note1, Note 5} | | 5MHz: R.7 FDD 10MHz: R.3 FDD | |
| OCNG Pattern defined in A.3.2.1 | | 5 MHz: OP.20 FDD 10 MHz: OP.10 FDD | |
| PCFICH_RB | dB | 0 | |
| PDCCH_RA | dB | | |
| PDCCH_RB | dB | | |
| PBCH_RA | dB | | |
| PBCH_RB | dB | | |
| PSS_RA | dB | | |
| SSS_RA | dB | | |
| PHICH_RA | dB | | |
| PHICH_RB | dB | | |
| PDSCH_RA | dB | | |
| PDSCH_RB | dB | | |
| OCNG_RA ^{Note1} | dB | | |
| OCNG_RB ^{Note1} | dB | | |
| \hat{E}_s / N_{oc} | dB | | 16 |
| N_{oc} | dBm/15 kHz | | -98 |
| RSRP ^{Note4} | dBm/15 kHz | -82 | |
| SCH_RP ^{Note 4} | dBm/15 kHz | -82 | |
| Propagation condition | | AWGN | |
| <p>Note 1: For the reference measurement channels, see clause A.3.1.</p> <p>Note 2: For the OCNG pattern, see clause A.3.2.</p> <p>Note 3: OCNG shall be used such that cell is fully allocated and a constant total transmitted power spectral density is achieved for all OFDM symbols.</p> <p>Note 4: RSRP and SCH_RP levels have been derived from other parameters for information purposes. They are not settable parameters themselves.</p> <p>Note 5: This test is according to the principle defined in section A.3.12.3.</p> | | | |

A.7.5.11.2 Test Requirements

The test system shall verify that the total number of missed ACK/NACKs on the serving cell on RF channel 1 are less than 0.5%.

A.7.5.12 E-UTRAN FDD - Selection / Reselection of ProSe relay UE

A.7.5.12.1 Test Purpose and Environment

The purpose of this test is to verify the requirements related to selection / reselection of ProSe relay UE defined in clauses 7.16.5. In the test the UE under test is configured with PCell and is configured with ProSe Direct Discovery and ProSe Direct Communication resources as required for remote UE operation.

This test is applicable to UEs capable of ProSe Direct Discovery and ProSe Direct Communication, and further support the optional feature of sidelink remote UE operation.

The test parameters are given in Table A.7.5.12.1-1, Table A.7.5.12.1-2, Table A.7.5.12.1-3, Table A.7.5.12.1-4, and Table A.7.5.12.1-5 below. The test consists of one active serving cell (cell 1), and two active Sidelink relay UEs (Sidelink Relay UE 1, Sidelink Relay UE 2). The Sidelink relay UEs are configured to be transmitting relay discovery messages every discovery period.

The test system shall ensure that the remote UE under test has transmitted *SidelinkUEInformation* message and has been configured with the ProSe Direct Discovery resources for relay operation prior to the start of the test.

The tests consist of five successive time periods, with time duration of T1, T2, T3, and T4 respectively.

During T1, RSRP of cell 1 is kept higher than *threshHigh* (within *remoteUE-Config*), and the remote UE is not required to perform relay UE selection.

During T2, RSRP of cell 1 is configured to be lower than *threshHigh*. The UE is expected to start looking for relay UE and request the serving cell for ProSe Direct Communication resources for communicating with a candidate Sidelink Relay UE. The test system shall ensure that the UE under test transmits the *SidelinkUEInformation* message (requesting the ProSe Direct Communication resources) and has been configured the resource pool prior to end of T2 duration. During T2, the SD-RSRP of Sidelink Relay UE 1 and Sidelink Relay UE 2 is configured to be lower than the detection threshold and no relay UE will be available for the remote UE under test.

During T3, the SD-RSRP of Sidelink Relay UE 1 is raised above the detection threshold and the UE is expected to perform relay selection to Sidelink Relay 1. The test system can determine that the remote UE has selected a relay by monitoring the configured ProSe Direct Communication resource for the direct communication setup message to the relay UE.

During T4, the UE is expected to complete the direct communication setup with the relay UE. Note that the RSRP of the serving cell (cell 1) and the SD-RSRP of sidelink relay UEs is kept unchanged during T3. The period T3 ends when Sidelink Relay UE1 sends the direct communication accept message back to the remote UE.

During T5, SD-RSRP of Sidelink Relay UEs are modified such that the remote UE is expected to reselect to Sidelink Relay UE2.

Table A.7.5.12.1-1: Test parameters for selection / reselection of ProSe relay UE test for E-UTRAN FDD

| Parameter | Unit | Value | Comment |
|--------------------------------------|------|---|---|
| E-UTRA RF Channel Number | | 1 | |
| Channel Bandwidth ($BW_{channel}$) | MHz | 5 | |
| Active cell | | Cell 1 | Serving E-UTRA FDD cell on RF channel number 1 (Broadcasting SIB18 and SIB19) |
| Active Relay UEs | | Relay UE 1, Relay UE 2 | Transmitting relay discovery message |
| CP length of Cell 1 | | Normal | |
| T1 | ms | 100 | |
| T2 | s | Up to receiving RRC reconfiguration setup complete from the UE, or up to [1] sec if UE does not transmit <i>SidelinkUEInformation</i> during this period. | |
| T3 | s | 1 | |
| T4 | s | [2] | |
| T5 | s | 1 | |

Table A.7.5.12.1-2: ProSe Direct Discovery configuration for selection / reselection of ProSe relay UE test for E-UTRAN FDD

| Parameter | Unit | Value | Comment |
|---|------|---|--|
| E-UTRA RF Channel Number | | 1 | UL carrier frequency |
| Channel Bandwidth ($BW_{channel}$) | MHz | 5 | |
| ProSe Direct Discovery resource pool configuration | | As specified in Table A.3.12.4-4 (Configuration #4) | IE values unless specified otherwise in this test. |
| <i>discRxPoolPS/numRetx</i> | | 3 | |
| <i>discRxPoolPS/</i> <i>tf-ResourceConfig/</i> <i>offsetIndicator</i> | | 0 | To align with communications resource pool offset |
| <i>discRxPoolPS/</i> | | 00111100 | To avoid collision with |

| | | | |
|--|--|--|--|
| <i>tf-ResourceConfig/ subframeBitmap</i> | | 00000000 00000000 00000000 00000000 | communication resource pool, and allow for 4 retransmissions |
| <i>remoteUE-Config/threshHigh</i> | | -91dBm | |
| Note 1: This test is according to the principle defined in section A.3.12.3. | | | |

Table A.7.5.12.1-3: ProSe Direct Communication configuration for selection / reselection of ProSe relay UE test for E-UTRAN FDD

| Parameter | Unit | Value | Comment |
|--|------|--|--|
| E-UTRA RF Channel Number | | 1 | UL carrier frequency |
| Channel Bandwidth ($BW_{channel}$) | MHz | 5 | |
| ProSe Direct Communication resource pool configuration | | As specified in Table A.3.12.5-1 (Configuration #1) | IE values unless specified otherwise in this test. |
| <i>commRxPool/ sc-TFResourceConfig/ subframeBitmap</i> | | 00000011 00000000 00000000 00000000 00000000 | To avoid collision with discovery resource pool |
| <i>commTxPoolNormalCommon/ sc-TFResourceConfig/ subframeBitmap</i> | | 00000011 00000000 00000000 00000000 00000000 | |
| <i>commTxAllowRelayCommon</i> | | true | Configured in SIB18 |
| Note 1: This test is according to the principle defined in section A.3.12.3. | | | |

Table A.7.5.12.1-4: Sidelink Relay UE specific test parameters for selection / reselection of ProSe relay UE test for E-UTRAN FDD

| Parameter | Unit | Relay UE 1 | | | | | Relay UE 2 | | | | |
|--|------------|---|------|-------|-------|-------|------------|------|------|------|-------|
| | | T1 | T2 | T3 | T4 | T5 | T1 | T2 | T3 | T4 | T5 |
| E-UTRA RF Channel Number | | 1 (UL frequency) | | | | | | | | | |
| $BW_{channel}$ <small>Note 4</small> | MHz | 5 | | | | | | | | | |
| ProSe Direct Discovery resource pool configuration | | As specified in Table A.7.5.12.1-2 | | | | | | | | | |
| Transmission frequency | | Every discovery period (40ms) with 3 retransmissions per period | | | | | | | | | |
| Resource allocation | | Non-overlapping PRBs | | | | | | | | | |
| N_{oc} <small>Note1</small> | dBm/15 kHz | -97 | | | | | | | | | |
| \hat{E}_s / N_{oc} | dB | -inf | -inf | 10.5 | 10.5 | -1.5 | -inf | -inf | -inf | -inf | 10.5 |
| SD-RSRP <small>Note2, Note 3</small> | dBm/15 kHz | -inf | -inf | -86.5 | -86.5 | -98.5 | -inf | -inf | -inf | -inf | -86.5 |
| Propagation Condition | | AWGN | | | | | | | | | |
| <p>Note 1: Interference from other cells and noise sources not specified in the test is assumed to be constant over subcarriers and time and shall be modelled as AWGN of appropriate power for N_{oc} to be fulfilled.</p> <p>Note 2: SD-RSRP levels have been derived from other parameters for information purposes. They are not settable parameters themselves.</p> <p>Note 3: SSSS Es/lot is set the same as PSSS/PSBCH Es/lot.</p> <p>Note 4: This test is according to the principle defined in section A.3.12.3.</p> | | | | | | | | | | | |

Table A.7.5.12.1-5: Cell specific test parameters for interruptions due to ProSe Direct Communication on non-serving frequency test for E-UTRAN FDD-FDD

| Parameter | Unit | Cell 1 | | | | |
|--------------------------|------|--------|----|----|----|----|
| | | T1 | T2 | T3 | T4 | T5 |
| E-UTRA RF Channel Number | | 1 | | | | |

| | | | | | | |
|---|------------|--|-------|-------|-------|-------|
| Serving/Non-serving | | Serving | | | | |
| BW _{channel} ^{Note 5} | MHz | 5 | | | | |
| Correlation Matrix and Antenna Configuration | | 1x2 Low | | | | |
| drx-Configuration | | DRX_P1 As specified in Table A.3.12.2-1 | | | | |
| PDCCH/PCFICH/PHICH Reference measurement channel ^{Note1, Note 5} | | R.11 FDD | | | | |
| OCNG Pattern defined in A.3.2.1 | | OP.16 FDD | | | | |
| PCFICH_RB | dB | 0 | | | | |
| PDCCH_RA | dB | | | | | |
| PDCCH_RB | dB | | | | | |
| PBCH_RA | dB | | | | | |
| PBCH_RB | dB | | | | | |
| PSS_RA | dB | | | | | |
| SSS_RA | dB | | | | | |
| PHICH_RA | dB | | | | | |
| PHICH_RB | dB | | | | | |
| PDSCH_RA | dB | | | | | |
| PDSCH_RB | dB | | | | | |
| OCNG_RA ^{Note1} | dB | | | | | |
| OCNG_RB ^{Note1} | dB | | | | | |
| N_{oc} | dBm/15 kHz | | | | | |
| \hat{E}_s/N_{oc} | dB | 10.5 | 1.5 | 1.5 | 1.5 | 1.5 |
| RSRP ^{Note4} | dBm/15 kHz | -86.5 | -95.5 | -95.5 | -95.5 | -95.5 |
| Propagation condition | | AWGN | | | | |
| <p>Note 1: For the reference measurement channels, see clause A.3.1.</p> <p>Note 2: For the OCNG pattern, see clause A.3.2.</p> <p>Note 3: OCNG shall be used such that cell is fully allocated and a constant total transmitted power spectral density is achieved for all OFDM symbols.</p> <p>Note 4: RSRP levels have been derived from other parameters for information purposes. They are not settable parameters themselves.</p> <p>Note 5: This test is according to the principle defined in section A.3.12.3.</p> | | | | | | |

A.7.5.12.2 Test Requirements

Sidelink relay UE selection delay is defined as the time from the beginning of time period T3 to the moment when the UE selects the Sidelink Relay UE1 and transmits the PC5-SP direct communication setup message using ProSe Direct Communications.

The test system shall verify that the sidelink relay UE selection delay is less than 680ms.

NOTE: The sidelink relay UE selection delay can be expressed as ($T_{\text{evaluate, ProSe_Relay_intra}} + 1 \text{ sc-period}$).

Sidelink relay UE reselection time is defined as the time from the beginning of time period T5 to the moment when the UE reselects to Sidelink relay UE2 and transmits the direct communication setup message using ProSe Direct Communications.

The test system shall verify that the sidelink relay UE reselection delay is less than 800ms.

NOTE: The sidelink relay UE reselection delay can be expressed as ($T_{\text{measure, ProSe_Relay_Intra}} + T_{\text{evaluate, ProSe_Relay_intra}} + 1 \text{ sc-period}$).

A.8 UE Measurements Procedures

The reference channels in this clause assume transmission of PDSCH with a maximum number of 5 HARQ transmissions unless otherwise specified.

A.8.1 E-UTRAN FDD Intra-frequency Measurements

A.8.1.1 E-UTRAN FDD-FDD intra-frequency event triggered reporting under fading propagation conditions in asynchronous cells

A.8.1.1.1 Test Purpose and Environment

The purpose of this test is to verify that the UE makes correct reporting of an event. This test will partly verify the FDD intra-frequency cell search requirements in clause 8.1.2.2.1.1.

The test parameters are given in Table A.8.1.1.1-1 and A.8.1.1.1-2 below. In the measurement control information it is indicated to the UE that event-triggered reporting with Event A3 is used. The test consists of two successive time periods, with time duration of T1, and T2 respectively. During time duration T1, the UE shall not have any timing information of cell 2.

Table A.8.1.1.1-1: General test parameters for E-UTRAN FDD-FDD intra-frequency event triggered reporting under fading propagation conditions in asynchronous cells

| Parameter | Unit | Value | Comment |
|--|------|--|------------------------------------|
| PDSCH parameters | | DL Reference Measurement Channel R.0 FDD | As specified in clause A.3.1.1.1 |
| PCFICH/PDCCH/PHICH parameters | | DL Reference Measurement Channel R.6 FDD | As specified in clause A.3.1.2.1 |
| Active cell | | Cell 1 | |
| Neighbour cell | | Cell 2 | Cell to be identified. |
| E-UTRA RF Channel Number | | 1 | One FDD carrier frequency is used. |
| Channel Bandwidth (BW _{channel}) | MHz | 10 | |
| A3-Offset | dB | -6 | |
| CP length | | Normal | |
| Hysteresis | dB | 0 | |
| Time To Trigger | s | 0 | |
| Filter coefficient | | 0 | L3 filtering is not used |
| DRX | | | OFF |
| Time offset between cells | | 3 ms | Asynchronous cells |
| T1 | s | 5 | |
| T2 | s | 5 | |

Table A.8.1.1.1-2: Cell specific test parameters for E-UTRAN FDD-FDD intra-frequency event triggered reporting under fading propagation conditions in asynchronous cells

| Parameter | Unit | Cell 1 | | Cell 2 | |
|---|------|----------|----|----------|----|
| | | T1 | T2 | T1 | T2 |
| E-UTRA RF Channel Number | | 1 | | 1 | |
| BW _{channel} | MHz | 10 | | 10 | |
| Correlation Matrix and Antenna Configuration | | 1x2 Low | | 1x2 Low | |
| OCNG Patterns defined in A.3.2.1.1 (OP.1 FDD) and in A.3.2.1.2 (OP.2 FDD) | | OP.1 FDD | | OP.2 FDD | |
| PBCH_RA | dB | 0 | | 0 | |
| PBCH_RB | dB | | | | |
| PSS_RA | dB | | | | |
| SSS_RA | dB | | | | |
| PCFICH_RB | dB | | | | |
| PHICH_RA | dB | | | | |
| PHICH_PB | dB | | | | |
| PDCCH_RA | dB | | | | |
| PDCCH_PB | dB | | | | |

| | | | | | |
|--|------------|-------|-------|-----------|-------|
| PDSCH_RA | dB | | | | |
| PDSCH_RB | dB | | | | |
| OCNG_RA ^{Note 1} | dB | | | | |
| OCNG_RB ^{Note 1} | dB | | | | |
| \hat{E}_s / I_{ot} | dB | 4 | -1.46 | -Infinity | -1.46 |
| N_{oc} ^{Note 3} | dBm/15 KHz | -98 | | | |
| \hat{E}_s / N_{oc} | dB | 4 | 4 | -Infinity | 4 |
| RSRP ^{Note 4} | dBm/15 KHz | -94 | -94 | -Infinity | -94 |
| SCH_RP ^{Note 4} | dBm/15 KHz | -94 | -94 | -Infinity | -94 |
| Propagation Condition | | ETU70 | | | |
| <p>Note 1: OCNG shall be used such that both cells are fully allocated and a constant total transmitted power spectral density is achieved for all OFDM symbols.</p> <p>Note 2: The resources for uplink transmission are assigned to the UE prior to the start of time period T2.</p> <p>Note 3: Interference from other cells and noise sources not specified in the test is assumed to be constant over subcarriers and time and shall be modelled as AWGN of appropriate power for N_{oc} to be fulfilled.</p> <p>Note 4: RSRP and SCH_RP levels have been derived from other parameters for information purposes. They are not settable parameters themselves.</p> | | | | | |

A.8.1.1.2 Test Requirements

The UE shall send one Event A3 triggered measurement report, with a measurement reporting delay less than 800 ms from the beginning of time period T2.

The UE shall not send event triggered measurement reports, as long as the reporting criteria are not fulfilled.

The rate of correct events observed during repeated tests shall be at least 90%.

NOTE: The actual overall delays measured in the test may be up to $2 \times TTI_{DCCH}$ higher than the measurement reporting delays above because of TTI insertion uncertainty of the measurement report in DCCH.

A.8.1.2 E-UTRAN FDD-FDD intra-frequency event triggered reporting under fading propagation conditions in synchronous cells

A.8.1.2.1 Test Purpose and Environment

The purpose of this test is to verify that the UE makes correct reporting of an event. This test will partly verify the FDD intra-frequency cell search requirements in clause 8.1.2.2.1.1

The test parameters are given in Table A.8.1.2.1-1 and A.8.1.2.1-2 below. In the measurement control information it is indicated to the UE that event-triggered reporting with Event A3 is used. PDCCHs indicating new transmissions or retransmissions shall be sent continuously to ensure that the UE would not enter the DRX state. The test consists of two successive time periods, with time duration of T1, and T2 respectively. During time duration T1, the UE shall not have any timing information of cell 2.

Table A.8.1.2.1-1: General test parameters for E-UTRAN FDD-FDD intra-frequency event triggered reporting under fading propagation conditions in synchronous cells

| Parameter | Unit | Value | Comment |
|--|------|--|------------------------------------|
| PDSCH parameters | | DL Reference Measurement Channel R.0 FDD | As specified in clause A.3.1.1.1 |
| PCFICH/PDCCH/PHICH parameters | | DL Reference Measurement Channel R.6 FDD | As specified in clause A.3.1.2.1 |
| Active cell | | Cell 1 | |
| Neighbour cell | | Cell 2 | Cell to be identified. |
| E-UTRA RF Channel Number | | 1 | One FDD carrier frequency is used. |
| Channel Bandwidth (BW _{channel}) | MHz | 10 | |

| | | | |
|---------------------------|----|-----------|------------------------------|
| A3-Offset | dB | -6 | |
| CP length | | Normal | |
| Hysteresis | dB | 0 | |
| Time To Trigger | s | 0 | |
| Filter coefficient | | 0 | L3 filtering is not used |
| DRX | | DRX_L | As specified in clause A.3.3 |
| Time offset between cells | | 3 μ s | Synchronous cells |
| T1 | s | 5 | |
| T2 | s | 5 | |

Table A.8.1.2.1-2: Cell specific test parameters for E-UTRAN FDD-FDD intra-frequency event triggered reporting under fading propagation conditions in synchronous cells

| Parameter | Unit | Cell 1 | | Cell 2 | |
|---|--|----------|-----|-----------|-----|
| | | T1 | T2 | T1 | T2 |
| E-UTRA RF Channel Number | | 1 | | 1 | |
| BW _{channel} | MHz | 10 | | 10 | |
| Correlation Matrix and Antenna Configuration | | 1x2 Low | | 1x2 Low | |
| OCNG Patterns defined in A.3.2.1.1 (OP.1 FDD) and in A.3.2.1.2 (OP.2 FDD) | | OP.1 FDD | | OP.2 FDD | |
| PBCH_RA | dB | 0 | | 0 | |
| PBCH_RB | dB | | | | |
| PSS_RA | dB | | | | |
| SSS_RA | dB | | | | |
| PCFICH_RB | dB | | | | |
| PHICH_RA | dB | | | | |
| PHICH_RB | dB | | | | |
| PDCCH_RA | dB | | | | |
| PDCCH_RB | dB | | | | |
| PDSCH_RA | dB | | | | |
| PDSCH_RB | dB | | | | |
| OCNG_RA ^{Note 1} | dB | | | | |
| OCNG_RB ^{Note 1} | dB | | | | |
| \hat{E}_s / I_{ot} | dB | | | | |
| N_{oc} ^{Note 3} | dBm/15 KHz | -98 | | | |
| \hat{E}_s / N_{oc} | dB | 4 | 4 | -Infinity | 4 |
| RSRP ^{Note 4} | dBm/15 KHz | -94 | -94 | -Infinity | -94 |
| SCH_RP ^{Note 4} | dBm/15 KHz | -94 | -94 | -Infinity | -94 |
| Propagation Condition | | ETU70 | | | |
| Note 1: | OCNG shall be used such that both cells are fully allocated and a constant total transmitted power spectral density is achieved for all OFDM symbols. | | | | |
| Note 2: | The resources for uplink transmission are assigned to the UE prior to the start of time period T2. | | | | |
| Note 3: | Interference from other cells and noise sources not specified in the test is assumed to be constant over subcarriers and time and shall be modelled as AWGN of appropriate power for N_{oc} to be fulfilled. | | | | |
| Note 4: | RSRP and SCH_RP levels have been derived from other parameters for information purposes. They are not settable parameters themselves. | | | | |

A.8.1.2.2 Test Requirements

The UE shall send one Event A3 triggered measurement report, with a measurement reporting delay less than 800 ms from the beginning of time period T2.

The UE shall not send event triggered measurement reports, as long as the reporting criteria are not fulfilled.

The rate of correct events observed during repeated tests shall be at least 90%.

NOTE: The actual overall delays measured in the test may be up to $2xTTI_{DCCCH}$ higher than the measurement reporting delays above because of TTI insertion uncertainty of the measurement report in DCCCH.

A.8.1.3 E-UTRAN FDD-FDD intra-frequency event triggered reporting under fading propagation conditions in synchronous cells with DRX

A.8.1.3.1 Test Purpose and Environment

The purpose of the two tests is to verify that the UE makes correct reporting of an event in DRX. The tests will partly verify the FDD-FDD intra-frequency cell search in DRX requirements in clause 8.1.2.2.1.2.

The test parameters are given in Tables A.8.1.3.1-1, A.8.1.3.1-2, A.8.1.3.1-3 and A.8.1.3.1-4. In the measurement control information, it is indicated to the UE that event-triggered reporting with Event A3 is used. The test consists of two successive time periods, with time duration of T1, and T2 respectively. During time duration T1, the UE shall not have any timing information of cell 2.

In Test 1 UE needs to be provided at least once every 500ms with new Timing Advance Command MAC control element to restart the Time alignment timer to keep UE uplink time alignment. Furthermore UE is allocated with PUSCH resource at every DRX cycle.

In Test 2 the uplink time alignment is not maintained and UE needs to use RACH to obtain UL allocation for measurement reporting.

Table A.8.1.3.1-1: General test parameters for E-UTRAN FDD-FDD intra-frequency event triggered reporting under fading propagation conditions in synchronous cells when DRX is used

| Parameter | Unit | Value | | Comment |
|--------------------------------------|------|--|--------|---|
| | | Test 1 | Test 2 | |
| PDSCH parameters | | DL Reference Measurement Channel R.0 FDD | | As specified in clause A.3.1.1.1 |
| PCFICH/PDCCH/PHICH parameters | | DL Reference Measurement Channel R.6 FDD | | As specified in clause A.3.1.2.1 |
| Active cell | | Cell 1 | | |
| Neighbour cell | | Cell 2 | | Cell to be identified. |
| E-UTRA RF Channel Number | | 1 | | One FDD carrier frequency is used. |
| Channel Bandwidth ($BW_{channel}$) | MHz | 10 | | |
| A3-Offset | dB | -6 | | |
| CP length | | Normal | | |
| Hysteresis | dB | 0 | | |
| Time To Trigger | s | 0 | | |
| Filter coefficient | | 0 | | L3 filtering is not used |
| DRX | | ON | | DRX related parameters are defined in Table A.8.1.3.1-3 |
| Time offset between cells | | 3 μ s | | Synchronous cells |
| T1 | s | 5 | | |
| T2 | s | 5 | 30 | |

Table A.8.1.3.1-2: Cell specific test parameters for E-UTRAN FDD-FDD intra-frequency event triggered reporting under fading propagation conditions in synchronous cells when DRX is used

| Parameter | Unit | Cell 1 | | Cell 2 | |
|--|------|---------|----|---------|----|
| | | T1 | T2 | T1 | T2 |
| E-UTRA RF Channel Number | | 1 | | 1 | |
| $BW_{channel}$ | MHz | 10 | | 10 | |
| Correlation Matrix and Antenna Configuration | | 1x2 Low | | 1x2 Low | |

| OCNG Patterns defined in A.3.2.1.1 (OP.1 FDD) and in A.3.2.1.2 (OP.2 FDD) | | OP.1 FDD | | OP.2 FDD | |
|--|------------|----------|-------|-----------|-------|
| | | | | | |
| PBCH_RA | dB | 0 | | 0 | |
| PBCH_RB | dB | | | | |
| PSS_RA | dB | | | | |
| SSS_RA | dB | | | | |
| PCFICH_RB | dB | | | | |
| PHICH_RA | dB | | | | |
| PHICH_RB | dB | | | | |
| PDCCH_RA | dB | | | | |
| PDCCH_RB | dB | | | | |
| PDSCH_RA | dB | | | | |
| PDSCH_RB | dB | | | | |
| OCNG_RA ^{Note 1} | dB | | | | |
| OCNG_RB ^{Note 1} | dB | | | | |
| \hat{E}_s / I_{ot} | dB | 4 | -1.46 | -Infinity | -1.46 |
| N_{oc} ^{Note 2} | dBm/15 KHz | -98 | | | |
| \hat{E}_s / N_{oc} | dB | 4 | 4 | -Infinity | 4 |
| RSRP ^{Note 3} | dBm/15 KHz | -94 | -94 | -Infinity | -94 |
| SCH_RP ^{Note 3} | dBm/15 KHz | -94 | -94 | -Infinity | -94 |
| Propagation Condition | | ETU70 | | | |
| <p>Note 1: OCNG shall be used such that both cells are fully allocated and a constant total transmitted power spectral density is achieved for all OFDM symbols.</p> <p>Note 2: Interference from other cells and noise sources not specified in the test is assumed to be constant over subcarriers and time and shall be modelled as AWGN of appropriate power for N_{oc} to be fulfilled.</p> <p>Note 3: RSRP and SCH_RP levels have been derived from other parameters for information purposes. They are not settable parameters themselves.</p> | | | | | |

Table A.8.1.3.1-3: DRX-Configuration for E-UTRAN FDD-FDD intra-frequency event triggered reporting in DRX under fading propagation conditions in synchronous cells

| Field | Test1 | Test2 | Comment |
|--------------------------|---------|---------|---|
| | Value | Value | |
| onDurationTimer | psf1 | psf1 | As specified in clause 6.3.2 in TS 36.331 |
| drx-InactivityTimer | psf1 | psf1 | |
| drx-RetransmissionTimer | psf1 | psf1 | |
| longDRX-CycleStartOffset | sf40 | sf1280 | |
| shortDRX | disable | disable | |

Table A.8.1.3.1-4: TimeAlignmentTimer -Configuration for E-UTRAN FDD-FDD intra-frequency event triggered reporting in DRX under fading propagation conditions in synchronous cells

| Field | Test1 | Test2 | Comment |
|--------------------|-------|-------|--|
| | Value | Value | |
| TimeAlignmentTimer | sf500 | sf500 | As specified in clause 6.3.2 in TS 36.331 |
| sr-ConfigIndex | 0 | 0 | For further information see clause 6.3.2 in TS 36.331 and section 10.1 in TS 36.213. |

A.8.1.3.2 Test Requirements

In Test 1, the UE shall send one Event A3 triggered measurement report, with a measurement reporting delay less than 800 ms from the beginning of time period T2. The measurement reporting delay is defined as the time from the beginning of time period T2 to the moment when the UE send the measurement report on PUSCH.

In Test 2, the UE shall send one Event A3 triggered measurement report, with a measurement reporting delay less than 25600 ms from the beginning of time period T2. The measurement reporting delay is defined as the time from the beginning of time period T2 to the moment when the UE starts to send preambles on the PRACH for scheduling request (SR) to obtain allocation to send the measurement report on PUSCH.

The UE shall not send event triggered measurement reports, as long as the reporting criteria are not fulfilled.

The rate of correct events observed during repeated tests shall be at least 90%.

NOTE 1: The actual overall delays measured in the test may be up to one DRX cycle higher than the measurement reporting delays above because UE is allowed to delay the initiation of the measurement reporting procedure to the next until the Active Time.

NOTE 2: In order to calculate the rate of correct events the system simulator shall verify that it has received correct Event A3 measurement report.

A.8.1.4 Void

A.8.1.5 E-UTRAN FDD - FDD Intra-frequency identification of a new CGI of E-UTRA cell using autonomous gaps

A.8.1.5.1 Test Purpose and Environment

This test is to verify the requirement for identification of a new CGI of E-UTRA cell with autonomous gaps in clause 8.1.2.2.3.

The test scenario comprises of one E-UTRA FDD carrier and two cells as given in tables A.8.1.5.1-1 and A.8.1.5.1-2. PDCCHs indicating new transmissions shall be sent continuously to ensure that the UE would have ACK/NACK sending during identifying a new CGI of E-UTRAN cell. The test consists of three successive time periods, with time durations of T1, T2 and T3 respectively. At the start of time duration T1, the UE does not have any timing information of cell 2. Starting T2, cell 2 becomes detectable and the UE is expected to detect and send a measurement report.

A RRC message implying SI reading shall be sent to the UE during period T2, after the UE has reported Event A3. The RRC message shall create a measurement report configuration with purpose *reportCGI* and *si-RequestForHO* set to TRUE. The start of T3 is the instant when the last TTI containing the RRC message implying SI reading is sent to the UE.

Table A.8.1.5.1-1: General test parameters for E-UTRAN FDD - FDD Intra-frequency identification of a new CGI of E-UTRA cell using autonomous gaps

| Parameter | Unit | Value | Comment |
|---|------|--|--|
| PDSCH parameters | | DL Reference Measurement Channel R.3 FDD | As specified in clause A.3.1.1.1 |
| PCFICH/PDCCH/PHICH parameters | | DL Reference Measurement Channel R.6 FDD | As specified in clause A.3.1.2.1 |
| Active cell | | Cell 1 | |
| Neighbour cell | | Cell 2 | Cell to be identified. |
| E-UTRA RF Channel Number | | 1 | Only one FDD carrier frequency is used. |
| Channel Bandwidth (BW_{channel}) | MHz | 10 | |
| CP length | | Normal | |
| A3-Offset | dB | -3 | |
| Hysteresis | dB | 0 | |
| Time To Trigger | s | 0 | |
| Filter coefficient | | 0 | L3 filtering is not used |
| DRX | | OFF | |
| si-RequestForHO | | TRUE | As specified in clause 5.5.3.1 in TS 36.331. |
| Time offset between cells | ms | 3 | Asynchronous cells |
| T1 | s | 5 | |
| T2 | s | ≤10 | |

| | | | |
|----|---|---|--|
| T3 | s | 5 | |
|----|---|---|--|

Table A.8.1.5.1-2: Cell specific test parameters for E-UTRAN FDD - FDD Intra-frequency identification of a new CGI of E-UTRA cell using autonomous gaps

| Parameter | Unit | Cell 1 | | | Cell 2 | | |
|--|------------|-----------|-----------|-----------|-----------|----------|----------|
| | | T1 | T2 | T3 | T1 | T2 | T3 |
| E-UTRA RF Channel Number | | 1 | | | 1 | | |
| BW _{channel} | MHz | 10 | | | 10 | | |
| OCNG Patterns defined in A.3.2.1.10 (OP.10 FDD) and in A.3.2.1.2 (OP.2 FDD) | | OP.10 FDD | OP.10 FDD | OP.10 FDD | OP.2 FDD | OP.2 FDD | OP.2 FDD |
| PBCH_RA | dB | 0 | | | 0 | | |
| PBCH_RB | dB | | | | | | |
| PSS_RA | dB | | | | | | |
| SSS_RA | dB | | | | | | |
| PCFICH_RB | dB | | | | | | |
| PHICH_RA | dB | | | | | | |
| PHICH_PB | dB | | | | | | |
| PDCCH_RA | dB | | | | | | |
| PDCCH_PB | dB | | | | | | |
| PDSCH_RA | dB | | | | | | |
| PDSCH_RB | dB | | | | | | |
| OCNG_RA ^{Note 1} | dB | | | | | | |
| OCNG_RB ^{Note 1} | dB | | | | | | |
| \hat{E}_s / I_{ot} | dB | 8 | -3.3 | -3.3 | -Infinity | 2.36 | 2.36 |
| N_{oc} ^{Note 2} | dBm/15 KHz | -98 | | | | | |
| \hat{E}_s / N_{oc} | dB | 8 | 8 | 8 | -Infinity | 11 | 11 |
| RSRP ^{Note 3} | dBm/15 KHz | -90 | -90 | -90 | -Infinity | -87 | -87 |
| SCH_RP ^{Note 3} | dBm/15 KHz | -90 | -90 | -90 | -Infinity | -87 | -87 |
| Propagation Condition | | AWGN | | | | | |
| <p>Note 1: OCNG shall be used such that both cells are fully allocated and a constant total transmitted power spectral density is achieved for all OFDM symbols.</p> <p>Note 2: Interference from other cells and noise sources not specified in the test is assumed to be constant over subcarriers and time and shall be modelled as AWGN of appropriate power for N_{oc} to be fulfilled.</p> <p>Note 3: RSRP and SCH_RP levels have been derived from other parameters for information purposes. They are not settable parameters themselves.</p> | | | | | | | |

A.8.1.5.2 Test Requirements

The UE shall transmit a measurement report containing the cell global identifier of cell 2 within 170 milliseconds from the start of T3.

Test requirement = RRC Procedure delay + $T_{identify_CGI, intra}$ + reporting delay

= 15 + 150 + 2ms from the start of T3

= 167 ms, allow 170 ms.

The UE shall be scheduled continuously throughout the test, and from the start of T3 until 170 ms at least 80 ACK/NACK shall be detected as being transmitted by the UE.

The rate of correct events observed during repeated tests shall be at least 90%.

NOTE: The overall 80 ACK/NACK number is caused by two parts. Firstly, at least 60 ACK/NACK shall be sent during identifying the cell global identifier of cell 2 according to the requirement in Clause 8.1.2.2.3.1. Secondly, given that continuous DL data allocation, additional 20 ACK/NACK shall be sent from the start of T3 until 170 ms excludes 150 ms for identifying the cell global identifier of cell 2.

A.8.1.6 E-UTRAN FDD - FDD Intra-frequency identification of a new CGI of E-UTRA cell using autonomous gaps with DRX

A.8.1.6.1 Test Purpose and Environment

This test is to verify the requirement for identification of a new CGI of E-UTRA cell with autonomous gaps in clause 8.1.2.2.3. The requirement is verified in a DRX configuration.

The test scenario comprises of one E-UTRA FDD carrier and two cells as given in tables A.8.1.6.1-1, A.8.1.6.1-2, A.8.1.6.1-3 and A.8.1.6.1-4. The test consists of three successive time periods, with time durations of T1, T2 and T3 respectively. At the start of time duration T1, the UE does not have any timing information of cell 2. Starting T2, cell 2 becomes detectable and the UE is expected to detect and send a measurement report.

A RRC message implying SI reading shall be sent to the UE during period T2, after the UE has reported Event A3. The RRC message shall create a measurement report configuration with purpose *reportCGI* and *si-RequestForHO* set to TRUE. The start of T3 is the instant when the last TTI containing the RRC message implying SI reading is sent to the UE.

In the test UE needs to be provided at least once every 1280ms with new Timing Advance Command MAC control element to restart the Time alignment timer to keep UE uplink time alignment. Furthermore UE sends scheduling request (SR) to obtain allocation to send the measurement report on PUSCH.

Table A.8.1.6.1-1: General test parameters for E-UTRAN FDD - FDD Intra-frequency identification of a new CGI of E-UTRA cell using autonomous gaps with DRX

| Parameter | Unit | Value | Comment |
|--------------------------------------|------|--|---|
| PDSCH parameters | | DL Reference Measurement Channel R.0 FDD | As specified in clause A.3.1.1.1 |
| PCFICH/PDCCH/PHICH parameters | | DL Reference Measurement Channel R.6 FDD | As specified in clause A.3.1.2.1 |
| Active cell | | Cell 1 | |
| Neighbour cell | | Cell 2 | Cell to be identified. |
| E-UTRA RF Channel Number | | 1 | Only one FDD carrier frequency is used. |
| Channel Bandwidth ($BW_{channel}$) | MHz | 10 | |
| CP length | | Normal | |
| A3-Offset | dB | -3 | |
| Hysteresis | dB | 0 | |
| Time To Trigger | s | 0 | |
| Filter coefficient | | 0 | L3 filtering is not used |
| DRX | | ON | DRX related parameters are defined in Table A.8.1.6.1-3 |
| si-RequestForHO | | TRUE | As specified in clause 5.5.3.1 in TS 36.331. |
| Time offset between cells | ms | 3 | Asynchronous cells |
| T1 | s | 5 | |
| T2 | s | ≤30 | UE shall report cell within 25.6s (20 DRX cycles) |
| T3 | s | 5 | |

Table A.8.1.6.1-2: Cell specific test parameters for E-UTRAN FDD - FDD Intra-frequency identification of a new CGI of E-UTRA cell using autonomous gaps with DRX

| Parameter | Unit | Cell 1 | | | Cell 2 | | |
|---|------|----------|----------|----------|----------|----------|----------|
| | | T1 | T2 | T3 | T1 | T2 | T3 |
| E-UTRA RF Channel Number | | 1 | | | 1 | | |
| $BW_{channel}$ | MHz | 10 | | | 10 | | |
| OCNG Patterns defined in A.3.2.1.1 (OP.1 FDD) and in A.3.2.1.2 (OP.2 FDD) | | OP.1 FDD | OP.1 FDD | OP.1 FDD | OP.2 FDD | OP.2 FDD | OP.2 FDD |
| PBCH_RA | dB | | | | | | |
| PBCH_RB | dB | | | | | | |

| | | | | | | | |
|--|------------|------|------|------|-----------|------|------|
| PSS_RA | dB | 0 | | | 0 | | |
| SSS_RA | dB | | | | | | |
| PCFICH_RB | dB | | | | | | |
| PHICH_RA | dB | | | | | | |
| PHICH_PB | dB | | | | | | |
| PDCCH_RA | dB | | | | | | |
| PDCCH_PB | dB | | | | | | |
| PDSCH_RA | dB | | | | | | |
| PDSCH_RB | dB | | | | | | |
| OCNG_RA ^{Note 1} | dB | | | | | | |
| OCNG_RB ^{Note 1} | dB | | | | | | |
| \hat{E}_s / I_{ot} | dB | 8 | -3.3 | -3.3 | -Infinity | 2.36 | 2.36 |
| N_{oc} ^{Note 2} | dBm/15 KHz | -98 | | | | | |
| \hat{E}_s / N_{oc} | dB | 8 | 8 | 8 | -Infinity | 11 | 11 |
| RSRP ^{Note 3} | dBm/15 KHz | -90 | -90 | -90 | -Infinity | -87 | -87 |
| SCH_RP ^{Note 3} | dBm/15 KHz | -90 | -90 | -90 | -Infinity | -87 | -87 |
| Propagation Condition | | AWGN | | | | | |
| <p>Note 1: OCNG shall be used such that both cells are fully allocated and a constant total transmitted power spectral density is achieved for all OFDM symbols.</p> <p>Note 2: Interference from other cells and noise sources not specified in the test is assumed to be constant over subcarriers and time and shall be modelled as AWGN of appropriate power for N_{oc} to be fulfilled.</p> <p>Note 3: RSRP and SCH_RP levels have been derived from other parameters for information purposes. They are not settable parameters themselves.</p> | | | | | | | |

Table A.8.1.6.1-3: DRX configuration for E-UTRAN FDD - FDD Intra-frequency identification of a new CGI of E-UTRA cell using autonomous gaps with DRX

| Field | Value | Comment |
|--------------------------|---------|---|
| onDurationTimer | psf1 | As specified in clause 6.3.2 in TS 36.331 |
| drx-InactivityTimer | psf1 | |
| drx-RetransmissionTimer | psf1 | |
| longDRX-CycleStartOffset | sf1280 | |
| shortDRX | disable | |

Table A.8.1.6.1-4: TimeAlignmentTimer-Configuration for E-UTRAN FDD - FDD Intra-frequency identification of a new CGI of E-UTRA cell using autonomous gaps with DRX

| Field | Value | Comment |
|--------------------|----------|--|
| TimeAlignmentTimer | Infinity | As specified in clause 6.3.2 in TS 36.331 |
| sr-ConfigIndex | 0 | For further information see clause 6.3.2 in TS 36.331 and section 10.1 in TS 36.213. |

A.8.1.6.2 Test Requirements

The UE shall transmit a measurement report containing the cell global identifier of cell 2 within 170 milliseconds from the start of T3.

$$\begin{aligned}
 \text{Test requirement} &= \text{RRC Procedure delay} + T_{\text{identify_CGI, intra}} + \text{reporting delay} \\
 &= 15 + 150 + 2\text{ms from the start of T3} \\
 &= 167 \text{ ms, allow 170 ms.}
 \end{aligned}$$

The rate of correct events observed during repeated tests shall be at least 90%.

A.8.1.7 E-UTRAN FDD-FDD Intra-Frequency Event-Triggered Reporting under Time Domain Measurement Resource Restriction with Non-MBSFN ABS

A.8.1.7.1 Test Purpose and Environment

The purpose of this test is to verify that the UE correctly detects and reports Event A3 (Neighbour becomes offset better than PCell) defined in TS 36.331 [2] within the requirements specified in Clause 8.1.2.8.1.1 under a time domain measurement resource restriction and non-MBSFN ABS configured in the aggressor cell.

The test parameters are given in Tables A.8.1.7.1-1 and A.8.1.7.1-2 below. It is indicated to the UE in the measurement control information that event-triggered reporting with Event A3 is used. In the test there are two synchronous cells, Cell 1 and Cell 2, on the same RF channel. Cell 1 is the PCell, and it is also the aggressor cell to Cell 2. Cell 2 is the cell to be identified. The test consists of two successive time periods with time duration of T1 and T2, respectively. During time duration T1, the UE shall not have any timing information on Cell 2.

Non-MBSFN ABS pattern is configured for Cell 1 during the test. The UE is configured by higher layers via Cell 1 with a time domain measurement resource restriction pattern for performing E-UTRAN FDD intra-frequency measurements on neighbour cells. The UE is also configured with a time domain measurement resource restriction pattern for the PCell measurements. The information for both measurement patterns shall be provided to the UE via higher layers during T1.

Table A.8.1.7.1-1: General test parameters for E-UTRAN FDD-FDD intra-frequency event triggered reporting under time domain measurement resource restriction with non-MBSFN ABS

| Parameter | Unit | Value | Comment |
|--|------|---|--|
| PDSCH parameters | | DL Reference Measurement Channel R.0 FDD | As specified in clause A.3.1.1.1 |
| PCFICH/PDCCH/PHICH parameters | | DL Reference Measurement Channel R.6 FDD | As specified in clause A.3.1.2.1 |
| PCell | | Cell 1 | Also the aggressor cell. Active in T1 and T2 |
| Neighbour cell | | Cell 2 | Cell to be identified. Active only in T2. |
| PCell ABS configuration | | Non-MBSFN ABS | As defined in Table A.3.4.1.1-1 |
| E-UTRA RF Channel Number | | 1 | One FDD carrier frequency is used |
| Channel Bandwidth ($BW_{channel}$) | MHz | 10 | For all cells in the test |
| A3-Offset | dB | -11 | |
| Event A3 measurement quantity | | RSRP | |
| CP length | | Normal | |
| Hysteresis | dB | 0 | |
| Time To Trigger | s | 0 | |
| Filter coefficient | | 0 | L3 filtering is not used |
| DRX | | | OFF |
| Time offset between cells | | 3 μ s | Synchronous cells |
| T1 | s | 5 | |
| T2 | s | 5 | |
| Physical cell ID PCI | | $(PCI_{cell1} - PCI_{cell2}) \bmod 6 \neq 0$ | Cell PCIs are selected so that the condition is met |
| ABS pattern | | '1000000010000000100000001000000000000000000000000000000' | FDD ABS Pattern Info IE, as defined in TS 36.423 [28], clause 9.2.54. Configured in Cell 1 during T1. The first/leftmost bit corresponds to the subframe #0 of the radio frame satisfying $SFN \bmod x = 0$, where x is the size of the bit string (40) divided by 10. No MBSFN subframes are configured in the ABS subframes. |
| Time domain measurement resource restriction pattern for neighbour cell measurements on RF Channel 1 | | '1000000010000000100000001000000000000000000000000000000' | Time domain measurement resource restriction pattern for neighbor cell measurement signalled to the UE in measSubframePattern-Neigh IE in measSubframePatternConfig-Neigh, as defined in TS 36.331, clause 6.3.5. Configured during T1 for Cell 2 measurements. |

| | | | |
|---|--|--|--|
| Time domain measurement resource restriction pattern for PCell measurements | | '0100000001000000010000001000000001000000' | Configured during T1 for Cell 1 measurements |
|---|--|--|--|

Table A.8.1.7.1-2: Cell specific test parameters for E-UTRAN FDD-FDD intra-frequency event triggered reporting under time domain measurement resource restriction with non-MBSFN ABS

| Parameter | Unit | Cell 1 | | Cell 2 | |
|---|------------|---|------|-----------|------|
| | | T1 | T2 | T1 | T2 |
| E-UTRA RF Channel Number | | 1 | | 1 | |
| BW _{channel} | MHz | 10 | | 10 | |
| Correlation Matrix and Antenna Configuration | | 1x2 Low | | 1x2 Low | |
| OCNG Patterns defined in A.3.2.1.5 (OP.5 FDD) and in A.3.2.1.6 (OP.6 FDD) | | OP.5 FDD | | OP.6 FDD | |
| PBCH_RA | dB | Non-ABS and ABS subframe channel powers defined in Table A.3.4.1.1-1. | | 0 | |
| PBCH_RB | dB | | | | |
| PSS_RA | dB | | | | |
| SSS_RA | dB | | | | |
| PCFICH_RB | dB | | | | |
| PHICH_RA | dB | | | | |
| PHICH_RB | dB | | | | |
| PDCCH_RA | dB | | | | |
| PDCCH_RB | dB | | | | |
| PDSCH_RA | dB | | | | |
| PDSCH_RB | dB | | | | |
| OCNG_RA ^{Note 1} | dB | | | | |
| OCNG_RB ^{Note 1} | dB | | | | |
| N_{oc} ^{Note 3} | dBm/15 kHz | | | | |
| $(\hat{E}_s / N_{oc})_{meas}$ ^{Note 5} | dB | 1 | 1 | -Infinity | -4 |
| $(\hat{E}_s / N_{oc})_{ABS}$ | dB | 1 | 1 | N/A | N/A |
| RSRP ^{Note 4,5} | dBm/15 kHz | -97 | -97 | -Infinity | -102 |
| SCH_RP ^{Note 4} | dBm/15 kHz | -97 | -97 | -Infinity | -102 |
| CRS \hat{E}_s / I_{ot} | dB | 1 | -0.5 | -Infinity | -4 |
| SCH \hat{E}_s / I_{ot} | dB | 1 | -0.5 | -Infinity | -7.5 |
| Propagation Condition | | ETU30 | | | |
| <p>Note 1: OCNG shall be used such that both cells are fully allocated and a constant total transmitted power spectral density is achieved for all OFDM symbols.</p> <p>Note 2: The resources for uplink transmission are assigned to the UE prior to the start of time period T2.</p> <p>Note 3: Interference from other cells and noise sources not specified in the test is assumed to be constant over subcarriers and time and shall be modelled as AWGN of appropriate power for N_{oc} to be fulfilled. Applies to all subframes.</p> <p>Note 4: RSRP and SCH_RP levels have been derived from other parameters for information purposes. They are not settable parameters themselves.</p> <p>Note 5: RSPP is estimated for Cell 2 during the restricted measurement subframes for neighbour cells. RSPP is estimated for Cell 1 during the PCell restricted subframes.</p> | | | | | |

A.8.1.7.2 Test Requirements

The UE shall send one Event A3 triggered measurement report for Cell 2, with a measurement reporting delay less than 1000 ms from the beginning of time period T2.

The UE shall not send event-triggered measurement reports as long as the reporting criteria are not fulfilled.

The rate of correct events observed during repeated tests shall be at least 90% for the tested Event A3.

NOTE: The actual overall delays measured in the tests may be up to $2 \times TTI_{DCCH}$ higher than the measurement reporting delays above because of TTI insertion uncertainty of the measurement report in DCCH.

A.8.1.8 E-UTRAN FDD-FDD Intra-Frequency Event-Triggered Reporting under Time Domain Measurement Resource Restriction with CRS Assistance Information and Non-MBSFN ABS

A.8.1.8.1 Test Purpose and Environment

The purpose of this test is to verify that the UE correctly detects and reports Event A3 (neighbour becomes offset better than PCell) defined in TS 36.331 [2] within the requirements specified in Clause 8.1.2.8.3, when the UE is provided with a time-domain measurement resource restriction pattern and CRS assistance information, and when non-MBSFN ABS configured in the interfering cells.

The test parameters are given in Tables A.8.1.8.1-1 and A.8.1.8.1-2 below. It is indicated to the UE in the measurement control information that event-triggered reporting with Event A3 is used. In the test, there are three synchronous cells, Cell 1, Cell 2, and Cell 3, on the same RF channel. Cell 1 is the PCell. Cell 3 is the cell to be identified. A non-MBSFN ABS pattern is configured in each of the Cell 1 and Cell 2 during the entire test. The test consists of two successive time periods with time duration of T1 and T2, respectively. During time duration T1, the UE shall not have any timing information on Cell 3.

The UE is configured by higher layers with a time domain measurement resource restriction pattern for performing E-UTRAN FDD intra-frequency measurements on neighbour cells, nsamely Cell 3 measurements. The UE is also provided via higher layers with the CRS assistance information for Cell 2. The information for both measurement patterns and the CRS assistance information shall be provided via RRC to the UE during T1.

Table A.8.1.8.1-1: General test parameters for E-UTRAN FDD-FDD intra-frequency event triggered reporting under time domain measurement resource restriction with CRS assistance information and non-MBSFN ABS

| Parameter | Unit | Value | Comment |
|--------------------------------------|---------|---|---|
| PDSCH parameters | | DL Reference Measurement Channel R.0 FDD | As specified in clause A.3.1.1.1 |
| PCFICH/PDCCH/PHICH parameters | | DL Reference Measurement Channel R.6 FDD | As specified in clause A.3.1.2.1 |
| PCell | | Cell 1 | Also a first interfering cell to Cell 3. Active in T1 and T2. |
| Neighbour cells | | Cell 2 and Cell 3 | Cell 2 is a second interfering cell; Cell 2 is active in T1 and T2. Cell 3 is the cell to be identified; Cell 3 is active only in T2. |
| ABS transmission configuration | | Non-MBSFN ABS | As defined in Table A.3.4.1.1-1 |
| E-UTRA RF Channel Number | | 1 | One FDD carrier frequency is used |
| Channel Bandwidth ($BW_{channel}$) | MHz | 10 | For all cells in the test |
| A3-Offset | dB | -14 | |
| Event A3 measurement quantity | | RSRP | |
| CP length | | Normal | |
| Hysteresis | dB | 0 | |
| Time To Trigger | s | 0 | |
| Filter coefficient | | 0 | L3 filtering is not used |
| DRX | | | OFF |
| Time offset between cells | μ s | Cell 2 offset with respect to Cell 1: 0 Cell 3 offset with respect to Cell 1: -2.5 | Three synchronous cells |
| T1 | S | 5 | |
| T2 | S | 5 | |
| Physical cell IDs | | $(PCI_{cell1} - PCI_{cell3}) \bmod 6 = 0$ $(PCI_{cell2} - PCI_{cell3}) \bmod 6 \neq 0$ PCI_{cell1} not equal to PCI_{cell3} | Cell PCIs are selected so that all conditions are met |

| | | | | |
|--|--------------------------|--|--|---|
| ABS pattern | | | '1000000010000000100000 001000000010000000' | FDD ABS Pattern Info IE, as defined in TS 36.423 [28], clause 9.2.54. The first/leftmost bit corresponds to the Pcell subframe #0 of the radio frame satisfying SFN mod x = 0, where x is the size of the bit string (40) divided by 10. No MBSFN subframes are configured in the ABS subframes. Configured in Cell 1 and Cell 2 during T1. |
| Time domain measurement resource restriction pattern for neighbour cell measurements on RF Channel 1 | | | '1000000010000000100000 001000000010000000' | Time domain measurement resource restriction pattern for neighbor cell measurement signalled to the UE in measSubframePatternNeigh IE in measSubframePatternConfigNeigh, as defined in TS 36.331, clause 6.3.5. Configured during T1 for Cell 3 measurements. The cell list in measSubframeCellList IE shall contain Cell 3 but not Cell 2. |
| Time domain measurement resource restriction pattern for PCell measurements | | | '0100000001000000010000 000100000001000000' | Configured during T1 for Cell 1 measurements |
| CRS assistance information | physCellId | | see PCI conditions above | The CRS assistance information is provided for Cell 2 only in CRS-AssistanceInfo. It includes a single MBSFN-SubframeConfig element with subframe allocation <i>one Frame</i> ='000000'. |
| | antennaPortsCount | | 1 | |
| | mbsfn-SubframeConfigList | | <i>oneFrame</i> = '000000' | |

Table A.8.1.8.1-2: Cell specific test parameters for E-UTRAN FDD-FDD intra-frequency event triggered reporting under time domain measurement resource restriction with CRS assistance information and non-MBSFN ABS

| Parameter | Unit | Cell 1 | | Cell 2 | | Cell 3 | |
|---|------------|---|-----|---|-----|-----------|----------|
| | | T1 | T2 | T1 | T2 | T1 | T2 |
| E-UTRA RF Channel Number | | 1 | | 1 | | 1 | |
| BW _{channel} | MHz | 10 | | 10 | | 10 | |
| Correlation Matrix and Antenna Configuration | | 1x2 Low | | 1x2 Low | | 1x2 Low | |
| OCNG Patterns defined in A.3.2.1.5 (OP.5 FDD) and in A.3.2.1.6 (OP.6 FDD) | | OP.5 FDD | | OP.6 FDD | | N/A | OP.6 FDD |
| PBCH_RA | dB | Non-ABS and ABS subframe channel powers defined in Table A.3.4.1.1-1. | | Non-ABS and ABS subframe channel powers defined in Table A.3.4.1.1-1. | | N/A | |
| PBCH_RB | dB | | | | | | |
| PSS_RA | dB | | | | | | |
| SSS_RA | dB | | | | | | |
| PCFICH_RB | dB | | | | | | |
| PHICH_RA | dB | | | | | | |
| PHICH_RB | dB | | | | | | |
| PDCCH_RA | dB | | | | | | |
| PDCCH_RB | dB | | | | | | |
| PDSCH_RA | dB | | | | | | |
| PDSCH_RB | dB | | | | | | |
| OCNG_RA ^{Note 1} | dB | | | | | | |
| OCNG_RB ^{Note 1} | dB | | | | | | |
| N_{oc} ^{Note 3} | dBm/15 kHz | -98 | | | | | |
| (\hat{E}_s / N_{oc}) | dB | 4 | 4 | 2 | 2 | -Infinity | -4 |
| RSRP ^{Note 4} | dBm/15 kHz | -94 | -94 | -96 | -96 | -Infinity | -102 |
| SCH_RP ^{Note 4} | dBm/15 kHz | -94 | -94 | -96 | -96 | -Infinity | -102 |

| | | | | | | | |
|--|----|-------|-------|-------|-------|-----------|--------|
| CRS \hat{E}_s/I_{ot} ^{Note 5} | dB | 4 | 2.54 | 2 | 0.54 | -Infinity | -9.46 |
| SCH \hat{E}_s/I_{ot} | dB | -0.12 | -0.75 | -3.45 | -3.92 | -Infinity | -11.07 |
| Propagation Condition | | ETU30 | | ETU30 | | ETU30 | |
| NOTE 1: OCNG shall be used such that all cells are fully allocated and a constant total transmitted power spectral density is achieved for all OFDM symbols. | | | | | | | |
| NOTE 2: The resources for uplink transmission are assigned to the UE prior to the start of time period T2. | | | | | | | |
| NOTE 3: Interference from other cells and noise sources not specified in the test is assumed to be constant over subcarriers and time and shall be modelled as AWGN of appropriate power for N_{oc} to be fulfilled. Applies to all subframes. | | | | | | | |
| NOTE 4: RSRP, SCH_RP, and \hat{E}_s/I_{ot} levels have been derived from other parameters for information purposes. They are not settable parameters themselves. | | | | | | | |
| NOTE 5: Applies during the restricted measurement subframes configured for neighbour cell (Cell 3) measurements. | | | | | | | |

A.8.1.8.2 Test Requirements

The UE shall send one Event A3 triggered measurement report for Cell 3, with a measurement reporting delay less than 1000 ms from the beginning of time period T2.

The UE shall not send event-triggered measurement reports as long as the reporting criteria are not fulfilled.

The rate of correct events observed during repeated tests shall be at least 90% for the tested Event A3.

NOTE: The actual overall delays measured in the tests may be up to $2 \times TTI_{DCCH}$ higher than the measurement reporting delays above because of TTI insertion uncertainty of the measurement report in DCCH.

A.8.1.9 E-UTRAN FDD-FDD intra-frequency event triggered reporting under fading propagation conditions in asynchronous cells for 5MHz bandwidth

A.8.1.9.1 Test Purpose and Environment

The purpose of this test case is the same as for the test defined in subclause A.8.1.1.1.

The parameters of this test are the same as defined in Subclause A.8.1.1.1 except that the values of the parameters in the Table A.8.1.9.1-1 will replace the values of the corresponding parameters in A.8.1.1.1-1, and the values of the parameters in the Table A.8.1.9.1-2 will replace the values of the corresponding parameters in A.8.1.1.1-2.

Table A.8.1.9.1-1: General test parameters for E-UTRAN FDD-FDD intra-frequency event triggered reporting under fading propagation conditions in asynchronous cells for 5MHz bandwidth

| Parameter | Unit | Value | Comment |
|---|------|---|----------------------------------|
| PDSCH parameters | | DL Reference Measurement Channel R.5 FDD | As specified in clause A.3.1.1.1 |
| PCFICH/PDCCH/PHICH parameters | | DL Reference Measurement Channel R.11 FDD | As specified in clause A.3.1.2.1 |
| Note 1: See Table A.8.1.1.1-1 for the other parameters. | | | |
| Note 2: This test is according to the principle defined in section A.3.7.2. | | | |

Table A.8.1.9.1-2: Cell specific test parameters for E-UTRAN FDD-FDD intra-frequency event triggered reporting under fading propagation conditions in asynchronous cells for 5MHz

| Parameter | Unit | Cell 1 | | Cell 2 | |
|-----------------------|------|--------|----|--------|----|
| | | T1 | T2 | T1 | T2 |
| BW _{channel} | MHz | 5 | | 5 | |

| | | | |
|---|--|-----------|-----------|
| OCNG Patterns defined in A.3.2.1.15 (OP.15 FDD) and A.3.2.1.16 (OP.16 FDD) | | OP.15 FDD | OP.16 FDD |
| Note 1: OCNG shall be used such that both cells are fully allocated and a constant total transmitted power spectral density is achieved for all OFDM symbols. | | | |
| Note 2: See Table A.8.1.1.1-2 for the other parameters. | | | |

A.8.1.9.2 Test Requirements

The test requirements defined in section A.8.1.1.2 shall apply to this test case.

A.8.1.10 E-UTRAN FDD-FDD Intra-Frequency Event Triggered Reporting under Fading Propagation Conditions in Synchronous Cells with DRX for 5 MHz Bandwidth

A.8.1.10.1 Test Purpose and Environment

The purpose of the two tests is to verify that the UE makes correct reporting of an event in DRX. The tests will partly verify the FDD-FDD intra-frequency cell search in DRX requirements in clause 8.1.2.2.1.2.

The parameters of this test are the same as defined in Section A.8.1.3.1 except that the values of the parameters in the Table A.8.1.10.1-1 will replace the values of the corresponding parameters in A.8.1.3.1-1, and the values of the parameters in the Table A.8.1.10.1-2 will replace the values of the corresponding parameters in A.8.1.3.1-2.

Table A.8.1.10.1-1: General test parameters for E-UTRAN FDD-FDD intra-frequency event triggered reporting under fading propagation conditions in synchronous cells when DRX is used

| Parameter | Unit | Value | | Comment |
|---|------|---|--------|----------------------------------|
| | | Test 1 | Test 2 | |
| PDSCH parameters | | DL Reference Measurement Channel R.5 FDD | | As specified in clause A.3.1.1.1 |
| PCFICH/PDCCH/PHICH parameters | | DL Reference Measurement Channel R.11 FDD | | As specified in clause A.3.1.2.1 |
| Channel Bandwidth (BW_{channel}) | MHz | 5 | | |
| NOTE 1: See Table A.8.1.3.1-1 for the other parameters. | | | | |
| NOTE 2: This test is according to the principle defined in Section A.3.7.2. | | | | |

Table A.8.1.10.1-2: Cell specific test parameters for E-UTRAN FDD-FDD intra-frequency event triggered reporting under fading propagation conditions in synchronous cells when DRX is used

| Parameter | Unit | Cell 1 | | Cell 2 | |
|---|------|-----------|----|-----------|----|
| | | T1 | T2 | T1 | T2 |
| BW_{channel} | MHz | 5 | | 5 | |
| OCNG Patterns defined in A.3.2.1.15 (OP.15 FDD) and in A.3.2.1.16 (OP.16 FDD) | | OP.15 FDD | | OP.16 FDD | |
| NOTE 1: See Table A.8.1.3.1-2 for the other parameters. | | | | | |

A.8.1.10.2 Test Requirements

The test requirements defined in Section A.8.1.3 shall apply to this test case.

A.8.1.11 E-UTRAN FDD-FDD intra-frequency event triggered reporting under fading propagation conditions in asynchronous cells for UE category 0

A.8.1.11.1 Test Purpose and Environment

The purpose of this test is to verify that the UE makes correct reporting of an event. This test will partly verify the FDD intra-frequency cell search requirements in clause 8.5.2.1.1.

The test parameters are given in Table A.8.1.11.1-1 and A.8.1.11.1-2 below. In the measurement control information it is indicated to the UE that event-triggered reporting with Event A3 is used. The test consists of two successive time periods, with time duration of T1, and T2 respectively. During time duration T1, the UE shall not have any timing information of cell 2.

Table A.8.1.11.1-1: General test parameters for E-UTRAN FDD-FDD intra-frequency event triggered reporting under fading propagation conditions in asynchronous cells

| Parameter | Unit | Value | Comment |
|--|------|--------|------------------------------------|
| Active cell | | Cell 1 | |
| Neighbour cell | | Cell 2 | Cell to be identified. |
| E-UTRA RF Channel Number | | 1 | One FDD carrier frequency is used. |
| Channel Bandwidth (BW _{channel}) | MHz | 10 | |
| A3-Offset | dB | -10 | |
| CP length | | Normal | |
| Hysteresis | dB | 0 | |
| Time To Trigger | s | 0 | |
| Filter coefficient | | 0 | L3 filtering is not used |
| DRX | | | OFF |
| Time offset between cells | | 3 ms | Asynchronous cells |
| T1 | s | 5 | |
| T2 | s | 5 | |

Table A.8.1.11.1-2: Cell specific test parameters for E-UTRAN FDD-FDD intra-frequency event triggered reporting under fading propagation conditions in asynchronous cells

| Parameter | Unit | Cell 1 | | Cell 2 | |
|--|------|----------|----|----------|----|
| | | T1 | T2 | T1 | T2 |
| E-UTRA RF Channel Number | | 1 | | 1 | |
| BW _{channel} | MHz | 10 | | 10 | |
| Correlation Matrix and Antenna Configuration | | 2x1 | | 2x1 | |
| PDSCH parameters: DL Reference Measurement Channel defined in A.3.1.1.3 | | R.14 FDD | | - | |
| PCFICH/PDCCH/PHICH parameters: DL Reference Measurement Channel defined in A.3.1.2.1 | | R.7 FDD | | R.7 FDD | |
| OCNG Patterns defined in A.3.2.1.1 (OP.1 FDD) and in A.3.2.1.2 (OP.2 FDD) | | OP.1 FDD | | OP.2 FDD | |
| PBCH_RA | dB | | | | |
| PBCH_RB | dB | | | | |
| PSS_RA | dB | | | | |
| SSS_RA | dB | | | | |
| PCFICH_RB | dB | | | | |
| PHICH_RA | dB | | | | |
| | | -3 | | -3 | |

| | | | | | |
|---|------------|--------|--------|-----------------------------|-------|
| PHICH_PB | dB | | | | |
| PDCCH_RA | dB | | | | |
| PDCCH_PB | dB | | | | |
| PDSCH_RA | dB | | | | |
| PDSCH_RB | dB | | | | |
| OCNG_RA ^{Note 1} | dB | | | | |
| OCNG_RB ^{Note 1} | dB | | | | |
| \hat{E}_s/I_{ot} | dB | 7 | 1.54 | -Infinity | -3.79 |
| N_{oc} ^{Note 3} | dBm/15 KHz | -98 | | | |
| \hat{E}_s/N_{oc} | dB | 7 | 7 | -Infinity | 4 |
| RSRP ^{Note 4} | dBm/15 KHz | -91 | -91 | -Infinity | -94 |
| SCH_RP ^{Note 4} | dBm/15 KHz | -91 | -91 | -Infinity | -94 |
| I_o ^{Note 4} | dBm/9MHz | -62.43 | -60.91 | Specified in Cell 1 columns | |
| Propagation Condition | | ETU70 | | | |
| <p>Note 1: OCNG shall be used such that both cells are fully allocated and a constant total transmitted power spectral density is achieved for all OFDM symbols.</p> <p>Note 2: The resources for uplink transmission are assigned to the UE prior to the start of time period T2.</p> <p>Note 3: Interference from other cells and noise sources not specified in the test is assumed to be constant over subcarriers and time and shall be modelled as AWGN of appropriate power for N_{oc} to be fulfilled.</p> <p>Note 4: E_s/I_{ot}, RSRP, SCH_RP and I_o levels have been derived from other parameters for information purposes. They are not settable parameters themselves.</p> | | | | | |

A.8.1.11.2 Test Requirements

The UE shall send one Event A3 triggered measurement report, with a measurement reporting delay less than 1000 ms from the beginning of time period T2.

The UE shall not send event triggered measurement reports, as long as the reporting criteria are not fulfilled.

The rate of correct events observed during repeated tests shall be at least 90%.

NOTE: The actual overall delays measured in the test may be up to $2 \times TTI_{DCCCH}$ higher than the measurement reporting delays above because of TTI insertion uncertainty of the measurement report in DCCCH.

A.8.1.12 E-UTRAN FDD-FDD intra-frequency event triggered reporting under fading propagation conditions in synchronous cells for UE category 0

A.8.1.12.1 Test Purpose and Environment

The purpose of this test is to verify that the UE makes correct reporting of an event. This test will partly verify the FDD intra-frequency cell search requirements in clause 8.5.2.1.1

The test parameters are given in Table A.8.1.12.1-1 and A.8.1.12.1-2 below. In the measurement control information it is indicated to the UE that event-triggered reporting with Event A3 is used. PDCCHs indicating new transmissions or retransmissions should be sent continuously to ensure that the UE would not enter the DRX state. The test consists of two successive time periods, with time duration of T1, and T2 respectively. During time duration T1, the UE shall not have any timing information of cell 2.

Table A.8.1.12.1-1: General test parameters for E-UTRAN FDD-FDD intra-frequency event triggered reporting under fading propagation conditions in synchronous cells

| Parameter | Unit | Value | Comment |
|----------------|------|--------|------------------------|
| Active cell | | Cell 1 | |
| Neighbour cell | | Cell 2 | Cell to be identified. |

| | | | |
|--------------------------------------|-----|-----------|------------------------------------|
| E-UTRA RF Channel Number | | 1 | One FDD carrier frequency is used. |
| Channel Bandwidth ($BW_{channel}$) | MHz | 10 | |
| A3-Offset | dB | -10 | |
| CP length | | Normal | |
| Hysteresis | dB | 0 | |
| Time To Trigger | s | 0 | |
| Filter coefficient | | 0 | L3 filtering is not used |
| DRX | | DRX_L | As specified in clause A.3.3 |
| Time offset between cells | | 3 μ s | Synchronous cells |
| T1 | s | 5 | |
| T2 | s | 5 | |

Table A.8.1.12.1-2: Cell specific test parameters for E-UTRAN FDD-FDD intra-frequency event triggered reporting under fading propagation conditions in synchronous cells

| Parameter | Unit | Cell 1 | | Cell 2 | |
|--|------------|----------|--------|-----------------------------|-----|
| | | T1 | T2 | T1 | T2 |
| E-UTRA RF Channel Number | | 1 | | 1 | |
| $BW_{channel}$ | MHz | 10 | | 10 | |
| Correlation Matrix and Antenna Configuration | | 2x1 | | 2x1 | |
| PDSCH parameters: DL Reference Measurement Channel defined in A.3.1.1.3 | | R.14 FDD | | - | |
| PCFICH/PDCCH/PHICH parameters: DL Reference Measurement Channel defined in A.3.1.2.1 | | R.7 FDD | | R.7 FDD | |
| OCNG Patterns defined in A.3.2.1.1 (OP.1 FDD) and in A.3.2.1.2 (OP.2 FDD) | | OP.1 FDD | | OP.2 FDD | |
| PBCH_RA | dB | -3 | | -3 | |
| PBCH_RB | dB | | | | |
| PSS_RA | dB | | | | |
| SSS_RA | dB | | | | |
| PCFICH_RB | dB | | | | |
| PHICH_RA | dB | | | | |
| PHICH_RB | dB | | | | |
| PDCCH_RA | dB | | | | |
| PDCCH_RB | dB | | | | |
| PDSCH_RA | dB | | | | |
| PDSCH_RB | dB | | | | |
| OCNG_RA ^{Note 1} | dB | | | | |
| OCNG_RB ^{Note 1} | dB | | | | |
| \hat{E}_s / I_{ot} | dB | | | | |
| N_{oc} ^{Note 3} | dBm/15 KHz | -98 | | | |
| \hat{E}_s / N_{oc} | dB | 7 | 7 | -Infinity | 4 |
| RSRP ^{Note 4} | dBm/15 KHz | -91 | -91 | -Infinity | -94 |
| SCH_RP ^{Note 4} | dBm/15 KHz | -91 | -91 | -Infinity | -94 |
| Propagation Condition | | ETU70 | | | |
| I_o ^{Note 4} | dBm/9MHz | -62.43 | -60.91 | Specified in Cell 1 columns | |

| | |
|---------|--|
| Note 1: | OCNG shall be used such that both cells are fully allocated and a constant total transmitted power spectral density is achieved for all OFDM symbols. |
| Note 2: | The resources for uplink transmission are assigned to the UE prior to the start of time period T2. |
| Note 3: | Interference from other cells and noise sources not specified in the test is assumed to be constant over subcarriers and time and shall be modelled as AWGN of appropriate power for N_{oc} to be fulfilled. |
| Note 4: | Es/lot, RSRP, SCH_RP and Io levels have been derived from other parameters for information purposes. They are not settable parameters themselves. |

A.8.1.12.2 Test Requirements

The UE shall send one Event A3 triggered measurement report, with a measurement reporting delay less than 1000 ms from the beginning of time period T2.

The UE shall not send event triggered measurement reports, as long as the reporting criteria are not fulfilled.

The rate of correct events observed during repeated tests shall be at least 90%.

NOTE: The actual overall delays measured in the test may be up to $2xTTI_{DCCCH}$ higher than the measurement reporting delays above because of TTI insertion uncertainty of the measurement report in DCCH.

A.8.1.13 E-UTRAN FDD-FDD intra-frequency event triggered reporting under fading propagation conditions in synchronous cells with DRX for UE category 0

A.8.1.13.1 Test Purpose and Environment

The purpose of the two tests is to verify that the UE makes correct reporting of an event in DRX. The tests will partly verify the FDD-FDD intra-frequency cell search in DRX requirements in clause 8.5.2.1.1.2.

The test parameters are given in Tables A.8.1.13.1-1, A.8.1.13.1-2, A.8.1.13.1-3 and A.8.1.13.1-4. In the measurement control information, it is indicated to the UE that event-triggered reporting with Event A3 is used. The test consists of two successive time periods, with time duration of T1, and T2 respectively. During time duration T1, the UE shall not have any timing information of cell 2.

In Test 1 UE needs to be provided at least once every 500ms with new Timing Advance Command MAC control element to restart the Time alignment timer to keep UE uplink time alignment. Furthermore UE is allocated with PUSCH resource at every DRX cycle.

In Test 2 the uplink time alignment is not maintained and UE needs to use RACH to obtain UL allocation for measurement reporting.

Table A.8.1.13.1-1: General test parameters for E-UTRAN FDD-FDD intra-frequency event triggered reporting under fading propagation conditions in synchronous cells when DRX is used

| Parameter | Unit | Value | | Comment |
|--|------|--------|--------|--|
| | | Test 1 | Test 2 | |
| Active cell | | Cell 1 | | |
| Neighbour cell | | Cell 2 | | Cell to be identified. |
| E-UTRA RF Channel Number | | 1 | | One FDD carrier frequency is used. |
| Channel Bandwidth (BW _{channel}) | MHz | 10 | | |
| A3-Offset | dB | -10 | | |
| CP length | | Normal | | |
| Hysteresis | dB | 0 | | |
| Time To Trigger | s | 0 | | |
| Filter coefficient | | 0 | | L3 filtering is not used |
| DRX | | ON | | DRX related parameters are defined in Table A.8.1.13.1-3 |
| Time offset between cells | | 3 μs | | Synchronous cells |

| | | | |
|----|---|---|----|
| T1 | s | 5 | |
| T2 | s | 5 | 30 |

Table A.8.1.13.11-2: Cell specific test parameters for E-UTRAN FDD-FDD intra-frequency event triggered reporting under fading propagation conditions in synchronous cells when DRX is used

| Parameter | Unit | Cell 1 | | Cell 2 | |
|---|------------|----------|--------|-----------------------------|-----|
| | | T1 | T2 | T1 | T2 |
| E-UTRA RF Channel Number | | 1 | | 1 | |
| BW _{channel} | MHz | 10 | | 10 | |
| Correlation Matrix and Antenna Configuration | | 2x1 | | 2x1 | |
| PDSCH parameters: DL Reference Measurement Channel defined in A.3.1.1.3 | | R.14 FDD | | - | |
| PCFICH/PDCCH/PHICH parameters: DL Reference Measurement Channel defined in A.3.1.2.1 | | R.7 FDD | | R.7 FDD | |
| OCNG Patterns defined in A.3.2.1.1 (OP.1 FDD) and in A.3.2.1.2 (OP.2 FDD) | | OP.1 FDD | | OP.2 FDD | |
| PBCH_RA | dB | -3 | | -3 | |
| PBCH_RB | dB | | | | |
| PSS_RA | dB | | | | |
| SSS_RA | dB | | | | |
| PCFICH_RB | dB | | | | |
| PHICH_RA | dB | | | | |
| PHICH_RB | dB | | | | |
| PDCCH_RA | dB | | | | |
| PDCCH_RB | dB | | | | |
| PDSCH_RA | dB | | | | |
| PDSCH_RB | dB | | | | |
| OCNG_RA ^{Note 1} | dB | | | | |
| OCNG_RB ^{Note 1} | dB | | | | |
| \hat{E}_s / I_{ot} | dB | | | | |
| N_{oc} ^{Note 2} | dBm/15 KHz | -98 | | | |
| \hat{E}_s / N_{oc} | dB | 7 | 7 | -Infinity | 4 |
| RSRP ^{Note 3} | dBm/15 KHz | -91 | -91 | -Infinity | -94 |
| SCH_RP ^{Note 3} | dBm/15 KHz | -91 | -91 | -Infinity | -94 |
| I_o ^{Note 4} | dBm/9MHz | -62.43 | -60.91 | Specified in Cell 1 columns | |
| Propagation Condition | | ETU70 | | | |
| <p>Note 1: OCNG shall be used such that both cells are fully allocated and a constant total transmitted power spectral density is achieved for all OFDM symbols.</p> <p>Note 2: Interference from other cells and noise sources not specified in the test is assumed to be constant over subcarriers and time and shall be modelled as AWGN of appropriate power for N_{oc} to be fulfilled.</p> <p>Note 3: E_s/I_{ot}, RSRP, SCH_RP and I_o levels have been derived from other parameters for information purposes. They are not settable parameters themselves.</p> | | | | | |

Table A.8.1.13.1-3: DRX-Configuration for E-UTRAN FDD-FDD intra-frequency event triggered reporting in DRX under fading propagation conditions in synchronous cells

| Field | Test1 | Test2 | Comment |
|-----------------|-------|-------|------------------------------------|
| | Value | Value | |
| onDurationTimer | psf1 | psf1 | As specified in clause 6.3.2 in TS |

| | | | |
|--------------------------|---------|---------|--------|
| drx-InactivityTimer | psf1 | psf1 | 36.331 |
| drx-RetransmissionTimer | psf1 | psf1 | |
| longDRX-CycleStartOffset | sf40 | sf1280 | |
| shortDRX | disable | disable | |

Table A.8.1.13.1-4: TimeAlignmentTimer -Configuration for E-UTRAN FDD-FDD intra-frequency event triggered reporting in DRX under fading propagation conditions in synchronous cells

| Field | Test1 | Test2 | Comment |
|--------------------|-------|-------|--|
| | Value | Value | |
| TimeAlignmentTimer | sf500 | sf500 | As specified in clause 6.3.2 in TS 36.331 |
| sr-ConfigIndex | 0 | 0 | For further information see clause 6.3.2 in TS 36.331 and section 10.1 in TS 36.213. |

A.8.1.13.2 Test Requirements

In Test 1, the UE shall send one Event A3 triggered measurement report, with a measurement reporting delay less than 1000 ms from the beginning of time period T2. The measurement reporting delay is defined as the time from the beginning of time period T2 to the moment when the UE send the measurement report on PUSCH.

In Test 2, the UE shall send one Event A3 triggered measurement report, with a measurement reporting delay less than 25600 ms from the beginning of time period T2. The measurement reporting delay is defined as the time from the beginning of time period T2 to the moment when the UE starts to send preambles on the PRACH for scheduling request (SR) to obtain allocation to send the measurement report on PUSCH.

The UE shall not send event triggered measurement reports, as long as the reporting criteria are not fulfilled.

The rate of correct events observed during repeated tests shall be at least 90%.

NOTE 1: The actual overall delays measured in the test may be up to one DRX cycle higher than the measurement reporting delays above because UE is allowed to delay the initiation of the measurement reporting procedure to the next until the Active Time.

NOTE 2: In order to calculate the rate of correct events the system simulator shall verify that it has received correct Event A3 measurement report.

A.8.1.14 E-UTRAN HD-FDD intra-frequency event triggered reporting under fading propagation conditions in asynchronous cells for UE category 0

A.8.1.14.1 Test Purpose and Environment

The purpose of this test is to verify that the UE makes correct reporting of an event. This test will partly verify the FDD intra-frequency cell search requirements in clause 8.5.2.1.2.1.

The test parameters are given in Table A.8.1.14.1-1 and A.8.1.14.1-2 below. In the measurement control information it is indicated to the UE that event-triggered reporting with Event A3 is used. The test consists of two successive time periods, with time duration of T1, and T2 respectively. During time duration T1, the UE shall not have any timing information of cell 2.

Table A.8.1.14.1-1: General test parameters for E-UTRAN HD-FDD intra-frequency event triggered reporting under fading propagation conditions in asynchronous cells

| Parameter | Unit | Value | Comment |
|--------------------------|------|--------|------------------------------------|
| Active cell | | Cell 1 | |
| Neighbour cell | | Cell 2 | Cell to be identified. |
| E-UTRA RF Channel Number | | 1 | One FDD carrier frequency is used. |

| | | | |
|--|-----|--------|--------------------------|
| Channel Bandwidth (BW_{channel}) | MHz | 10 | |
| A3-Offset | dB | -10 | |
| CP length | | Normal | |
| Hysteresis | dB | 0 | |
| Time To Trigger | s | 0 | |
| Filter coefficient | | 0 | L3 filtering is not used |
| DRX | | | OFF |
| Time offset between cells | | 3 ms | Asynchronous cells |
| T1 | s | 5 | |
| T2 | s | 5 | |

Table A.8.1.14.1-2: Cell specific test parameters for E-UTRAN HD-FDD intra-frequency event triggered reporting under fading propagation conditions in asynchronous cells

| Parameter | Unit | Cell 1 | | Cell 2 | |
|---|------------|------------|--------|-----------------------------|-----|
| | | T1 | T2 | T1 | T2 |
| E-UTRA RF Channel Number | | 1 | | 1 | |
| BW_{channel} | MHz | 10 | | 10 | |
| Correlation Matrix and Antenna Configuration | | 2x1 | | 2x1 | |
| PDSCH parameters: DL Reference Measurement Channel defined in A.3.1.1.4 | | R.2 HD-FDD | | - | |
| PCFICH/PDCCH/PHICH parameters: DL Reference Measurement Channel defined in A.3.1.2.3 | | R.4 HD-FDD | | R.4 HD-FDD | |
| OCNG Patterns defined in A.3.2.1.1 (OP.1 FDD) and in A.3.2.1.2 (OP.2 FDD) | | OP.1 FDD | | OP.2 FDD | |
| PBCH_RA | dB | -3 | | -3 | |
| PBCH_RB | dB | | | | |
| PSS_RA | dB | | | | |
| SSS_RA | dB | | | | |
| PCFICH_RB | dB | | | | |
| PHICH_RA | dB | | | | |
| PHICH_PB | dB | | | | |
| PDCCH_RA | dB | | | | |
| PDCCH_PB | dB | | | | |
| PDSCH_RA | dB | | | | |
| PDSCH_RB | dB | | | | |
| OCNG_RA ^{Note 1} | dB | | | | |
| OCNG_RB ^{Note 1} | dB | | | | |
| $\hat{E}_s / I_{\text{ot}}$ | dB | | | | |
| N_{oc} ^{Note 3} | dBm/15 KHz | -98 | | | |
| \hat{E}_s / N_{oc} | dB | 7 | 7 | -Infinity | 4 |
| RSRP ^{Note 4} | dBm/15 KHz | -91 | -91 | -Infinity | -94 |
| SCH_RP ^{Note 4} | dBm/15 KHz | -91 | -91 | -Infinity | -94 |
| I_o ^{Note 4} | dBm/9MHz | -62.43 | -60.91 | Specified in Cell 1 columns | |
| Propagation Condition | | ETU70 | | | |

| | |
|---------|--|
| Note 1: | OCNG shall be used such that both cells are fully allocated and a constant total transmitted power spectral density is achieved for all OFDM symbols. |
| Note 2: | The resources for uplink transmission are assigned to the UE prior to the start of time period T2. |
| Note 3: | Interference from other cells and noise sources not specified in the test is assumed to be constant over subcarriers and time and shall be modelled as AWGN of appropriate power for N_{oc} to be fulfilled. |
| Note 4: | Es,lot, RSRP, SCH_RP and Io levels have been derived from other parameters for information purposes. They are not settable parameters themselves. |

A.8.1.14.2 Test Requirements

The UE shall send one Event A3 triggered measurement report, with a measurement reporting delay less than 1000 ms from the beginning of time period T2.

The UE shall not send event triggered measurement reports, as long as the reporting criteria are not fulfilled.

The rate of correct events observed during repeated tests shall be at least 90%.

NOTE: The actual overall delays measured in the test may be up to $2 \times TTI_{DCCH}$ higher than the measurement reporting delays above because of TTI insertion uncertainty of the measurement report in DCCH.

A.8.1.15 E-UTRAN HD-FDD intra-frequency event triggered reporting under fading propagation conditions in synchronous cells for UE category 0

A.8.1.15.1 Test Purpose and Environment

The purpose of this test is to verify that the UE makes correct reporting of an event. This test will partly verify the FDD intra-frequency cell search requirements in clause 8.5.2.1.2.1

The test parameters are given in Table A.8.1.15.1-1 and A.8.1.15.1-2 below. In the measurement control information it is indicated to the UE that event-triggered reporting with Event A3 is used. PDCCHs indicating new transmissions or retransmissions should be sent continuously to ensure that the UE would not enter the DRX state. The test consists of two successive time periods, with time duration of T1, and T2 respectively. During time duration T1, the UE shall not have any timing information of cell 2.

Table A.8.1.15.1-1: General test parameters for E-UTRAN HD-FDD intra-frequency event triggered reporting under fading propagation conditions in synchronous cells

| Parameter | Unit | Value | Comment |
|--------------------------------------|------|-----------|------------------------------------|
| Active cell | | Cell 1 | |
| Neighbour cell | | Cell 2 | Cell to be identified. |
| E-UTRA RF Channel Number | | 1 | One FDD carrier frequency is used. |
| Channel Bandwidth ($BW_{channel}$) | MHz | 10 | |
| A3-Offset | dB | -10 | |
| CP length | | Normal | |
| Hysteresis | dB | 0 | |
| Time To Trigger | s | 0 | |
| Filter coefficient | | 0 | L3 filtering is not used |
| DRX | | DRX_L | As specified in clause A.3.3 |
| Time offset between cells | | 3 μ s | Synchronous cells |
| T1 | s | 5 | |
| T2 | s | 5 | |

Table A.8.1.15.1-2: Cell specific test parameters for E-UTRAN HD-FDD intra-frequency event triggered reporting under fading propagation conditions in synchronous cells

| Parameter | Unit | Cell 1 | | Cell 2 | |
|---|------------|------------|--------|-----------------------------|-----|
| | | T1 | T2 | T1 | T2 |
| E-UTRA RF Channel Number | | 1 | | 1 | |
| $BW_{channel}$ | MHz | 10 | | 10 | |
| Correlation Matrix and Antenna Configuration | | 2x1 | | 2x1 | |
| PDSCH parameters: DL Reference Measurement Channel defined in A.3.1.1.4 | | R.2 HD-FDD | | - | |
| PCFICH/PDCCH/PHICH parameters: DL Reference Measurement Channel defined in A.3.1.2.3 | | R.4 HD-FDD | | R.4 HD-FDD | |
| OCNG Patterns defined in A.3.2.1.1 (OP.1 FDD) and in A.3.2.1.2 (OP.2 FDD) | | OP.1 FDD | | OP.2 FDD | |
| PBCH_RA | dB | -3 | | -3 | |
| PBCH_RB | dB | | | | |
| PSS_RA | dB | | | | |
| SSS_RA | dB | | | | |
| PCFICH_RB | dB | | | | |
| PHICH_RA | dB | | | | |
| PHICH_RB | dB | | | | |
| PDCCH_RA | dB | | | | |
| PDCCH_RB | dB | | | | |
| PDSCH_RA | dB | | | | |
| PDSCH_RB | dB | | | | |
| OCNG_RA ^{Note 1} | dB | | | | |
| OCNG_RB ^{Note 1} | dB | | | | |
| \hat{E}_s / I_{ot} | dB | | | | |
| N_{oc} ^{Note 3} | dBm/15 KHz | -98 | | | |
| \hat{E}_s / N_{oc} | dB | 7 | 7 | -Infinity | 4 |
| RSRP ^{Note 4} | dBm/15 KHz | -91 | -91 | -Infinity | -94 |
| SCH_RP ^{Note 4} | dBm/15 KHz | -91 | -91 | -Infinity | -94 |
| I_o ^{Note 4} | dBm/9MHz | -62.43 | -60.91 | Specified in Cell 1 columns | |
| Propagation Condition | | ETU70 | | | |
| <p>Note 1: OCNG shall be used such that both cells are fully allocated and a constant total transmitted power spectral density is achieved for all OFDM symbols.</p> <p>Note 2: The resources for uplink transmission are assigned to the UE prior to the start of time period T2.</p> <p>Note 3: Interference from other cells and noise sources not specified in the test is assumed to be constant over subcarriers and time and shall be modelled as AWGN of appropriate power for N_{oc} to be fulfilled.</p> <p>Note 4: E_s/I_{ot}, RSRP, SCH_RP and I_o levels have been derived from other parameters for information purposes. They are not settable parameters themselves.</p> | | | | | |

A.8.1.15.2 Test Requirements

The UE shall send one Event A3 triggered measurement report, with a measurement reporting delay less than 1000 ms from the beginning of time period T2.

The UE shall not send event triggered measurement reports, as long as the reporting criteria are not fulfilled.

The rate of correct events observed during repeated tests shall be at least 90%.

NOTE: The actual overall delays measured in the test may be up to $2xTTI_{DCCH}$ higher than the measurement reporting delays above because of TTI insertion uncertainty of the measurement report in DCCH.

A.8.1.16 E-UTRAN HD-FDD intra-frequency event triggered reporting under fading propagation conditions in synchronous cells with DRX for UE category 0

A.8.1.16.1 Test Purpose and Environment

The purpose of the two tests is to verify that the UE makes correct reporting of an event in DRX. The tests will partly verify the FDD-FDD intra-frequency cell search in DRX requirements in clause 8.5.2.1.2.2.

The test parameters are given in Tables A.8.1.16.1-1, A.8.1.16.1-2, A.8.1.16.1-3 and A.8.1.16.1-4. In the measurement control information, it is indicated to the UE that event-triggered reporting with Event A3 is used. The test consists of two successive time periods, with time duration of T1, and T2 respectively. During time duration T1, the UE shall not have any timing information of cell 2.

In Test 1 UE needs to be provided at least once every 500ms with new Timing Advance Command MAC control element to restart the Time alignment timer to keep UE uplink time alignment. Furthermore UE is allocated with PUSCH resource at every DRX cycle.

In Test 2 the uplink time alignment is not maintained and UE needs to use RACH to obtain UL allocation for measurement reporting.

Table A.8.1.16.1-1: General test parameters for E-UTRAN HD-FDD intra-frequency event triggered reporting under fading propagation conditions in synchronous cells when DRX is used

| Parameter | Unit | Value | | Comment |
|--------------------------------------|------|-----------|--------|--|
| | | Test 1 | Test 2 | |
| Active cell | | Cell 1 | | |
| Neighbour cell | | Cell 2 | | Cell to be identified. |
| E-UTRA RF Channel Number | | 1 | | One FDD carrier frequency is used. |
| Channel Bandwidth ($BW_{channel}$) | MHz | 10 | | |
| A3-Offset | dB | -10 | | |
| CP length | | Normal | | |
| Hysteresis | dB | 0 | | |
| Time To Trigger | s | 0 | | |
| Filter coefficient | | 0 | | L3 filtering is not used |
| DRX | | ON | | DRX related parameters are defined in Table A.8.1.16.1-3 |
| Time offset between cells | | 3 μ s | | Synchronous cells |
| T1 | s | 5 | | |
| T2 | s | 5 | 30 | |

Table A.8.1.16.1-2: Cell specific test parameters for E-UTRAN HD-FDD intra-frequency event triggered reporting under fading propagation conditions in synchronous cells when DRX is used

| Parameter | Unit | Cell 1 | | Cell 2 | |
|---|------|------------|----|--------|----|
| | | T1 | T2 | T1 | T2 |
| E-UTRA RF Channel Number | | 1 | | 1 | |
| $BW_{channel}$ | MHz | 10 | | 10 | |
| Correlation Matrix and Antenna Configuration | | 2x1 | | 2x1 | |
| PDSCH parameters: DL Reference Measurement Channel defined in A.3.1.1.4 | | R.2 HD-FDD | | - | |

| | | | | | |
|---|------------|------------|--------|-----------------------------|-----|
| PCFICH/PDCCH/PHICH parameters: DL Reference Measurement Channel defined in A.3.1.2.3 | | R.4 HD-FDD | | R.4 HD-FDD | |
| OCNG Patterns defined in A.3.2.1.1 (OP.1 FDD) and in A.3.2.1.2 (OP.2 FDD) | | OP.1 FDD | | OP.2 FDD | |
| PBCH_RA | dB | -3 | | -3 | |
| PBCH_RB | dB | | | | |
| PSS_RA | dB | | | | |
| SSS_RA | dB | | | | |
| PCFICH_RB | dB | | | | |
| PHICH_RA | dB | | | | |
| PHICH_RB | dB | | | | |
| PDCCH_RA | dB | | | | |
| PDCCH_RB | dB | | | | |
| PDSCH_RA | dB | | | | |
| PDSCH_RB | dB | | | | |
| OCNG_RA ^{Note 1} | dB | | | | |
| OCNG_RB ^{Note 1} | dB | | | | |
| \hat{E}_s/I_{ot} | dB | | | | |
| N_{oc} ^{Note 2} | dBm/15 KHz | -98 | | | |
| \hat{E}_s/N_{oc} | dB | 7 | 7 | -Infinity | 4 |
| RSRP ^{Note 3} | dBm/15 KHz | -91 | -91 | -Infinity | -94 |
| SCH_RP ^{Note 3} | dBm/15 KHz | -91 | -91 | -Infinity | -94 |
| I_o ^{Note 4} | dBm/9MHz | -62.43 | -60.91 | Specified in Cell 1 columns | |
| Propagation Condition | | ETU70 | | | |
| <p>Note 1: OCNG shall be used such that both cells are fully allocated and a constant total transmitted power spectral density is achieved for all OFDM symbols.</p> <p>Note 2: Interference from other cells and noise sources not specified in the test is assumed to be constant over subcarriers and time and shall be modelled as AWGN of appropriate power for N_{oc} to be fulfilled.</p> <p>Note 3: E_s/I_{ot}, RSRP, SCH_RP and I_o levels have been derived from other parameters for information purposes. They are not settable parameters themselves.</p> | | | | | |

Table A.8.1.16.1-3: DRX-Configuration for E-UTRAN HD-FDD intra-frequency event triggered reporting in DRX under fading propagation conditions in synchronous cells

| Field | Test1 | Test2 | Comment |
|--------------------------|---------|---------|---|
| | Value | Value | |
| onDurationTimer | psf1 | psf1 | As specified in clause 6.3.2 in TS 36.331 |
| drx-InactivityTimer | psf1 | psf1 | |
| drx-RetransmissionTimer | psf1 | psf1 | |
| longDRX-CycleStartOffset | sf40 | sf1280 | |
| shortDRX | disable | disable | |

Table A.8.1.16.1-4: TimeAlignmentTimer-Configuration for E-UTRAN HD-FDD intra-frequency event triggered reporting in DRX under fading propagation conditions in synchronous cells

| Field | Test1 | Test2 | Comment |
|--------------------|-------|-------|--|
| | Value | Value | |
| TimeAlignmentTimer | sf500 | sf500 | As specified in clause 6.3.2 in TS 36.331 |
| sr-ConfigIndex | 0 | 0 | For further information see clause 6.3.2 in TS 36.331 and section 10.1 in TS 36.213. |

A.8.1.16.2 Test Requirements

In Test 1, the UE shall send one Event A3 triggered measurement report, with a measurement reporting delay less than 1000 ms from the beginning of time period T2. The measurement reporting delay is defined as the time from the beginning of time period T2 to the moment when the UE send the measurement report on PUSCH.

In Test 2, the UE shall send one Event A3 triggered measurement report, with a measurement reporting delay less than 25600 ms from the beginning of time period T2. The measurement reporting delay is defined as the time from the beginning of time period T2 to the moment when the UE starts to send preambles on the PRACH for scheduling request (SR) to obtain allocation to send the measurement report on PUSCH.

The UE shall not send event triggered measurement reports, as long as the reporting criteria are not fulfilled.

The rate of correct events observed during repeated tests shall be at least 90%.

NOTE 1: The actual overall delays measured in the test may be up to one DRX cycle higher than the measurement reporting delays above because UE is allowed to delay the initiation of the measurement reporting procedure to the next until the Active Time.

NOTE 2: In order to calculate the rate of correct events the system simulator shall verify that it has received correct Event A3 measurement report.

A.8.1.17 Void

A.8.1.18 Void

A.8.1.19 E-UTRAN FDD-FDD Intra-frequency identification of a new CGI of E-UTRA cell using autonomous gaps for UE category 0

A.8.1.19.1 Test Purpose and Environment

This test is to verify the requirement for identification of a new CGI of E-UTRA cell with autonomous gaps in clause 8.5.2.1.4.

The test scenario comprises of one E-UTRA FDD carrier and two cells as given in tables A.8.1.19.1-1 and A.8.1.19.1-2. PDCCHs indicating new transmissions should be sent continuously to ensure that the UE would have ACK/NACK sending during identifying a new CGI of E-UTRAN cell. The test consists of three successive time periods, with time durations of T1, T2 and T3 respectively. At the start of time duration T1, the UE does not have any timing information of cell 2. Starting T2, cell 2 becomes detectable and the UE is expected to detect and send a measurement report.

A RRC message implying SI reading shall be sent to the UE during period T2, after the UE has reported Event A3. The RRC message shall create a measurement report configuration with purpose *reportCGI* and *si-RequestForHO* set to TRUE. The start of T3 is the instant when the last TTI containing the RRC message implying SI reading is sent to the UE.

Table A.8.1.19.1-1: General test parameters for E-UTRAN FDD - FDD Intra-frequency identification of a new CGI of E-UTRA cell using autonomous gaps for UE category 0

| Parameter | Unit | Value | Comment |
|--------------------------------------|------|---|---|
| PDSCH parameters | | DL Reference Measurement Channel R.15 FDD | As specified in clause A.3.1.1.3 |
| PCFICH/PDCCH/PHICH parameters | | DL Reference Measurement Channel R.7 FDD | As specified in clause A.3.1.2.1 |
| Active cell | | Cell 1 | |
| Neighbour cell | | Cell 2 | Cell to be identified. |
| E-UTRA RF Channel Number | | 1 | Only one FDD carrier frequency is used. |
| Channel Bandwidth ($BW_{channel}$) | MHz | 10 | |
| CP length | | Normal | |
| A3-Offset | dB | -3 | |
| Hysteresis | dB | 0 | |
| Time To Trigger | s | 0 | |

| | | | |
|--------------------|---|------|--|
| Filter coefficient | | 0 | L3 filtering is not used |
| DRX | | OFF | |
| si-RequestForHO | | TRUE | As specified in clause 5.5.3.1 in TS 36.331. |
| T1 | s | 5 | |
| T2 | s | ≤10 | |
| T3 | s | 5 | |

Table A.8.1.19.1-2: Cell specific test parameters for E-UTRAN FDD - FDD Intra-frequency identification of a new CGI of E-UTRA cell using autonomous gaps for UE category 0

| Parameter | Unit | Cell 1 | | | Cell 2 | | |
|--|------------|-----------|-----------|-----------|-----------|----------|----------|
| | | T1 | T2 | T3 | T1 | T2 | T3 |
| E-UTRA RF Channel Number | | 1 | | | 1 | | |
| BW _{channel} | MHz | 10 | | | 10 | | |
| Correlation Matrix and Antenna Configuration | | 2x1 | | | 2x1 | | |
| OCNG Patterns defined in A.3.2.1.10 (OP.10 FDD) and in A.3.2.1.2 (OP.2 FDD) | | OP.10 FDD | OP.10 FDD | OP.10 FDD | OP.2 FDD | OP.2 FDD | OP.2 FDD |
| PBCH_RA | dB | -3 | | | -3 | | |
| PBCH_RB | dB | | | | | | |
| PSS_RA | dB | | | | | | |
| SSS_RA | dB | | | | | | |
| PCFICH_RB | dB | 0 | | | 0 | | |
| PHICH_RA | dB | -3 | | | -3 | | |
| PHICH_PB | dB | 0 | | | 0 | | |
| PDCCH_RA | dB | | | | | | |
| PDCCH_PB | dB | | | | | | |
| PDSCH_RA | dB | | | | | | |
| PDSCH_RB | dB | -3 | | | -3 | | |
| OCNG_RA ^{Note 1} | dB | 8 | | | -Infinity | | |
| OCNG_RB ^{Note 1} | dB | | | | | | |
| \hat{E}_s / I_{ot} | dB | -3.3 | -3.3 | -3.3 | -Infinity | 2.36 | 2.36 |
| N_{oc} ^{Note 2} | dBm/15 KHz | -98 | | | | | |
| \hat{E}_s / N_{oc} | dB | 8 | 8 | 8 | -Infinity | 11 | 11 |
| RSRP ^{Note 3} | dBm/15 KHz | -90 | -90 | -90 | -Infinity | -87 | -87 |
| SCH_RP ^{Note3} | dBm/15 KHz | -90 | -90 | -90 | -Infinity | -87 | -87 |
| Propagation Condition | | AWGN | | | | | |
| Timing offset to Cell 1 | ms | - | | | 3 | | |
| <p>Note 1: OCNG shall be used such that both cells are fully allocated and a constant total transmitted power spectral density is achieved for all OFDM symbols.</p> <p>Note 2: Interference from other cells and noise sources not specified in the test is assumed to be constant over subcarriers and time and shall be modelled as AWGN of appropriate power for N_{oc} to be fulfilled.</p> <p>Note 3: RSRP and SCH_RP levels have been derived from other parameters for information purposes. They are not settable parameters themselves.</p> | | | | | | | |

A.8.1.19.2 Test Requirements

The UE shall transmit a measurement report containing the cell global identifier of cell 2 within 210 milliseconds from the start of T3.

$$\text{Test requirement} = \text{RRC Procedure delay} + T_{\text{identify_CGI_LC-UE, intra}} + \text{reporting delay}$$

$$= 15 + 190 + 2\text{ms from the start of T3}$$

$$= 207 \text{ ms, allow 210 ms.}$$

The UE shall be scheduled continuously throughout the test, and from the start of T3 until 210 ms at least 112 ACK/NACK shall be detected as being transmitted by the UE.

The rate of correct events observed during repeated tests shall be at least 90%.

NOTE: The overall 112 ACK/NACK number is caused by two parts. Firstly, at least 92 ACK/NACK shall be sent during identifying the cell global identifier of cell 2 according to the requirement in Clause 8.5.2.1.4. Secondly, given that continuous DL data allocation, additional 20 ACK/NACK shall be sent from the start of T3 until 210 ms excludes 190 ms for identifying the cell global identifier of cell 2.

A.8.1.20 E-UTRAN FDD - FDD Intra-frequency identification of a new CGI of E-UTRA cell using autonomous gaps with DRX for UE category 0

A.8.1.20.1 Test Purpose and Environment

This test is to verify the requirement for identification of a new CGI of E-UTRA cell with autonomous gaps in clause 8.5.2.1.4. The requirement is verified in a DRX configuration.

The test scenario comprises of one E-UTRA FDD carrier and two cells as given in tables A.8.1.20.1-1, A.8.1.20.1-2, A.8.1.20.1-3 and A.8.1.20.1-4. The test consists of three successive time periods, with time durations of T1, T2 and T3 respectively. At the start of time duration T1, the UE does not have any timing information of cell 2. Starting T2, cell 2 becomes detectable and the UE is expected to detect and send a measurement report.

A RRC message implying SI reading shall be sent to the UE during period T2, after the UE has reported Event A3. The RRC message shall create a measurement report configuration with purpose *reportCGI* and *si-RequestForHO* set to TRUE. The start of T3 is the instant when the last TTI containing the RRC message implying SI reading is sent to the UE.

In the test UE needs to be provided at least once every 1280ms with new Timing Advance Command MAC control element to restart the Time alignment timer to keep UE uplink time alignment. Furthermore UE sends scheduling request (SR) to obtain allocation to send the measurement report on PUSCH.

Table A.8.1.20.1-1: General test parameters for E-UTRAN FDD - FDD Intra-frequency identification of a new CGI of E-UTRA cell using autonomous gaps with DRX for UE category 0

| Parameter | Unit | Value | Comment |
|--------------------------------------|------|---|---|
| PDSCH parameters | | DL Reference Measurement Channel R.15 FDD | As specified in clause A.3.1.1.3 |
| PCFICH/PDCCH/PHICH parameters | | DL Reference Measurement Channel R.7 FDD | As specified in clause A.3.1.2.1 |
| Active cell | | Cell 1 | |
| Neighbour cell | | Cell 2 | Cell to be identified. |
| E-UTRA RF Channel Number | | 1 | Only one FDD carrier frequency is used. |
| Channel Bandwidth ($BW_{channel}$) | MHz | 10 | |
| CP length | | Normal | |
| A3-Offset | dB | -3 | |
| Hysteresis | dB | 0 | |
| Time To Trigger | s | 0 | |
| Filter coefficient | | 0 | L3 filtering is not used |
| DRX | | ON | DRX related parameters are defined in Table A.8.1.6.1-3 |
| si-RequestForHO | | TRUE | As specified in clause 5.5.3.1 in TS 36.331. |
| T1 | s | 5 | |
| T2 | s | ≤30 | UE should report cell within 25.6s (20 DRX cycles) |
| T3 | s | 5 | |

Table A.8.1.20.1-2: Cell specific test parameters for E-UTRAN FDD - FDD Intra-frequency identification of a new CGI of E-UTRA cell using autonomous gaps with DRX for UE category 0

| Parameter | Unit | Cell 1 | Cell 2 |
|-----------|------|--------|--------|
|-----------|------|--------|--------|

| | | T1 | T2 | T3 | T1 | T2 | T3 |
|--|------------|----------|----------|----------|-----------|----------|----------|
| E-UTRA RF Channel Number | | 1 | | | 1 | | |
| BW _{channel} | MHz | 10 | | | 10 | | |
| Correlation Matrix and Antenna Configuration | | 2x1 | | | 2x1 | | |
| OCNG Patterns defined in A.3.2.1.1 (OP.1 FDD) and in A.3.2.1.2 (OP.2 FDD) | | OP.1 FDD | OP.1 FDD | OP.1 FDD | OP.2 FDD | OP.2 FDD | OP.2 FDD |
| PBCH_RA | dB | -3 | | | -3 | | |
| PBCH_RB | dB | | | | | | |
| PSS_RA | dB | | | | | | |
| SSS_RA | dB | | | | | | |
| PCFICH_RB | dB | 0 | | | 0 | | |
| PHICH_RA | dB | -3 | | | -3 | | |
| PHICH_PB | dB | 0 | | | 0 | | |
| PDCCH_RA | dB | | | | | | |
| PDCCH_PB | dB | -3 | | | -3 | | |
| PDSCH_RA | dB | | | | | | |
| PDSCH_RB | dB | | | | | | |
| OCNG_RA ^{Note 1} | dB | | | | | | |
| OCNG_RB ^{Note 1} | dB | 8 | | | -3.3 | | |
| \hat{E}_s / I_{ot} | dB | -3.3 | | | -3.3 | | |
| N_{oc} ^{Note 2} | dBm/15 KHz | -98 | | | | | |
| \hat{E}_s / N_{oc} | dB | 8 | 8 | 8 | -Infinity | 11 | 11 |
| RSRP ^{Note 3} | dBm/15 KHz | -90 | -90 | -90 | -Infinity | -87 | -87 |
| SCH_RP ^{Note 3} | dBm/15 KHz | -90 | -90 | -90 | -Infinity | -87 | -87 |
| Propagation Condition | | AWGN | | | | | |
| Timing offset to Cell 1 | ms | - | | | 3 | | |
| <p>Note 1: OCNG shall be used such that both cells are fully allocated and a constant total transmitted power spectral density is achieved for all OFDM symbols.</p> <p>Note 2: Interference from other cells and noise sources not specified in the test is assumed to be constant over subcarriers and time and shall be modelled as AWGN of appropriate power for N_{oc} to be fulfilled.</p> <p>Note 3: RSRP and SCH_RP levels have been derived from other parameters for information purposes. They are not settable parameters themselves.</p> | | | | | | | |

Table A.8.1.20.1-3: DRX configuration for E-UTRAN FDD - FDD Intra-frequency identification of a new CGI of E-UTRA cell using autonomous gaps with DRX for UE category 0

| Field | Value | Comment |
|--------------------------|---------|---|
| onDurationTimer | psf1 | As specified in clause 6.3.2 in TS 36.331 |
| drx-InactivityTimer | psf1 | |
| drx-RetransmissionTimer | psf1 | |
| longDRX-CycleStartOffset | sf1280 | |
| shortDRX | disable | |

Table A.8.1.20.1-4: TimeAlignmentTimer -Configuration for E-UTRAN FDD - FDD Intra-frequency identification of a new CGI of E-UTRA cell using autonomous gaps with DRX for UE category 0

| Field | Value | Comment |
|--------------------|----------|--|
| TimeAlignmentTimer | Infinity | As specified in clause 6.3.2 in TS 36.331 |
| sr-ConfigIndex | 0 | For further information see clause 6.3.2 in TS 36.331 and section 10.1 in TS 36.213. |

A.8.1.20.2 Test Requirements

The UE shall transmit a measurement report containing the cell global identifier of cell 2 within 210 milliseconds from the start of T3.

$$\begin{aligned} \text{Test requirement} &= \text{RRC Procedure delay} + T_{\text{identify_CGL_LC-UE, intra}} + \text{reporting delay} \\ &= 15 + 190 + 2\text{ms from the start of T3} \\ &= 207 \text{ ms, allow 210 ms.} \end{aligned}$$

The rate of correct events observed during repeated tests shall be at least 90%.

A.8.1.21 E-UTRAN HD - FDD Intra-frequency identification of a new CGI of E-UTRA cell using autonomous gaps for UE category 0

A.8.1.21.1 Test Purpose and Environment

This test is to verify the requirement for identification of a new CGI of E-UTRA cell with autonomous gaps in clause 8.5.2.1.5.

The test scenario comprises of one E-UTRA FDD carrier and two cells as given in tables A.8.1.21.1-1 and A.8.1.21.1-2. PDCCHs indicating new transmissions should be sent continuously to ensure that the UE would have ACK/NACK sending during identifying a new CGI of E-UTRAN cell. The test consists of three successive time periods, with time durations of T1, T2 and T3 respectively. At the start of time duration T1, the UE does not have any timing information of cell 2. Starting T2, cell 2 becomes detectable and the UE is expected to detect and send a measurement report.

A RRC message implying SI reading shall be sent to the UE during period T2, after the UE has reported Event A3. The RRC message shall create a measurement report configuration with purpose *reportCGI* and *si-RequestForHO* set to TRUE. The start of T3 is the instant when the last TTI containing the RRC message implying SI reading is sent to the UE.

Table A.8.1.21.1-1: General test parameters for E-UTRAN HD - FDD Intra-frequency identification of a new CGI of E-UTRA cell using autonomous gaps for UE category 0

| Parameter | Unit | Value | Comment |
|---|------|---|--|
| PDSCH parameters | | DL Reference Measurement Channel R.2 HD-FDD | As specified in clause A.3.1.1.4 |
| PCFICH/PDCCH/PHICH parameters | | DL Reference Measurement Channel R.4 HD-FDD | As specified in clause A.3.1.2.3 |
| Active cell | | Cell 1 | |
| Neighbour cell | | Cell 2 | Cell to be identified. |
| E-UTRA RF Channel Number | | 1 | Only one FDD carrier frequency is used. |
| Channel Bandwidth (BW_{channel}) | MHz | 10 | |
| CP length | | Normal | |
| A3-Offset | dB | -3 | |
| Hysteresis | dB | 0 | |
| Time To Trigger | s | 0 | |
| Filter coefficient | | 0 | L3 filtering is not used |
| DRX | | OFF | |
| si-RequestForHO | | TRUE | As specified in clause 5.5.3.1 in TS 36.331. |
| T1 | s | 5 | |
| T2 | s | ≤10 | |
| T3 | s | 5 | |

Table A.8.1.21.1-2: Cell specific test parameters for E-UTRAN HD - FDD Intra-frequency identification of a new CGI of E-UTRA cell using autonomous gaps for UE category 0

| Parameter | Unit | Cell 1 | | | Cell 2 | | |
|-----------|------|--------|----|----|--------|----|----|
| | | T1 | T2 | T3 | T1 | T2 | T3 |
| | | | | | | | |

| | | | | | | | |
|--|------------|-----------|-----------|-----------|-----------|----------|----------|
| E-UTRA RF Channel Number | | 1 | | | 1 | | |
| BW _{channel} | MHz | 10 | | | 10 | | |
| Correlation Matrix and Antenna Configuration | | 2x1 | | | 2x1 | | |
| OCNG Patterns defined in A.3.2.1.10 (OP.10 FDD) and in A.3.2.1.2 (OP.2 FDD) | | OP.10 FDD | OP.10 FDD | OP.10 FDD | OP.2 FDD | OP.2 FDD | OP.2 FDD |
| PBCH_RA | dB | -3 | | | -3 | | |
| PBCH_RB | dB | | | | | | |
| PSS_RA | dB | | | | | | |
| SSS_RA | dB | | | | | | |
| PCFICH_RB | dB | 0 | | | 0 | | |
| PHICH_RA | dB | -3 | | | -3 | | |
| PHICH_PB | dB | 0 | | | 0 | | |
| PDCCH_RA | dB | | | | | | |
| PDCCH_PB | dB | | | | | | |
| PDSCH_RA | dB | | | | | | |
| PDSCH_RB | dB | -3 | | | -3 | | |
| OCNG_RA ^{Note 1} | dB | 8 | | | -Infinity | | |
| OCNG_RB ^{Note 1} | dB | | | | | | |
| \hat{E}_s / I_{ot} | dB | 8 | -3.3 | -3.3 | -Infinity | 2.36 | 2.36 |
| N_{oc} ^{Note 2} | dBm/15 KHz | -98 | | | | | |
| \hat{E}_s / N_{oc} | dB | 8 | 8 | 8 | -Infinity | 11 | 11 |
| RSRP ^{Note 3} | dBm/15 KHz | -90 | -90 | -90 | -Infinity | -87 | -87 |
| SCH_RP ^{Note 3} | dBm/15 KHz | -90 | -90 | -90 | -Infinity | -87 | -87 |
| Propagation Condition | | AWGN | | | | | |
| Timing offset to Cell 1 | ms | - | | | 3 | | |
| <p>Note 1: OCNG shall be used such that both cells are fully allocated and a constant total transmitted power spectral density is achieved for all OFDM symbols.</p> <p>Note 2: Interference from other cells and noise sources not specified in the test is assumed to be constant over subcarriers and time and shall be modelled as AWGN of appropriate power for N_{oc} to be fulfilled.</p> <p>Note 3: RSRP and SCH_RP levels have been derived from other parameters for information purposes. They are not settable parameters themselves.</p> | | | | | | | |

A.8.1.21.2 Test Requirements

The UE shall transmit a measurement report containing the cell global identifier of cell 2 within 210 milliseconds from the start of T3.

Test requirement = RRC Procedure delay + $T_{\text{identify_CGI_LC-UE, intra}}$ + reporting delay

= 15 + 190 + 2ms from the start of T3

= 207 ms, allow 210 ms.

The UE shall be scheduled continuously throughout the test, and from the start of T3 until 210 ms at least 112 ACK/NACK shall be detected as being transmitted by the UE.

The rate of correct events observed during repeated tests shall be at least 90%.

NOTE: The overall 112 ACK/NACK number is caused by two parts. Firstly, at least 92 ACK/NACK shall be sent during identifying the cell global identifier of cell 2 according to the requirement in Clause 8.5.2.1.5. Secondly, given that continuous DL data allocation, additional 20 ACK/NACK shall be sent from the start of T3 until 210 ms excludes 190 ms for identifying the cell global identifier of cell 2.

A.8.1.22 E-UTRAN HD - FDD Intra-frequency identification of a new CGI of E-UTRA cell using autonomous gaps with DRX for UE category 0

A.8.1.22.1 Test Purpose and Environment

This test is to verify the requirement for identification of a new CGI of E-UTRA cell with autonomous gaps in clause 8.5.2.1.5. The requirement is verified in a DRX configuration.

The test scenario comprises of one E-UTRA FDD carrier and two cells as given in tables A.8.1.22.1-1, A.8.1.22.1-2, A.8.1.22.1-3 and A.8.1.22.1-4. The test consists of three successive time periods, with time durations of T1, T2 and T3 respectively. At the start of time duration T1, the UE does not have any timing information of cell 2. Starting T2, cell 2 becomes detectable and the UE is expected to detect and send a measurement report.

A RRC message implying SI reading shall be sent to the UE during period T2, after the UE has reported Event A3. The RRC message shall create a measurement report configuration with purpose *reportCGI* and *si-RequestForHO* set to TRUE. The start of T3 is the instant when the last TTI containing the RRC message implying SI reading is sent to the UE.

In the test UE needs to be provided at least once every 1280ms with new Timing Advance Command MAC control element to restart the Time alignment timer to keep UE uplink time alignment. Furthermore UE sends scheduling request (SR) to obtain allocation to send the measurement report on PUSCH.

Table A.8.1.22.1-1: General test parameters for E-UTRAN HD - FDD Intra-frequency identification of a new CGI of E-UTRA cell using autonomous gaps with DRX for UE category 0

| Parameter | Unit | Value | Comment |
|--------------------------------------|------|---|---|
| PDSCH parameters | | DL Reference Measurement Channel R.2 HD-FDD | As specified in clause A.3.1.1.4 |
| PCFICH/PDCCH/PHICH parameters | | DL Reference Measurement Channel R.4 HD-FDD | As specified in clause A.3.1.2.3 |
| Active cell | | Cell 1 | |
| Neighbour cell | | Cell 2 | Cell to be identified. |
| E-UTRA RF Channel Number | | 1 | Only one FDD carrier frequency is used. |
| Channel Bandwidth ($BW_{channel}$) | MHz | 10 | |
| CP length | | Normal | |
| A3-Offset | dB | -3 | |
| Hysteresis | dB | 0 | |
| Time To Trigger | s | 0 | |
| Filter coefficient | | 0 | L3 filtering is not used |
| DRX | | ON | DRX related parameters are defined in Table A.8.1.6.1-3 |
| si-RequestForHO | | TRUE | As specified in clause 5.5.3.1 in TS 36.331. |
| T1 | s | 5 | |
| T2 | s | ≤30 | UE should report cell within 25.6s (20 DRX cycles) |
| T3 | s | 5 | |

Table A.8.1.22.1-2: Cell specific test parameters for E-UTRAN HD - FDD Intra-frequency identification of a new CGI of E-UTRA cell using autonomous gaps with DRX for UE category 0

| Parameter | Unit | Cell 1 | | | Cell 2 | | |
|---|------|----------|----------|----------|----------|----------|----------|
| | | T1 | T2 | T3 | T1 | T2 | T3 |
| E-UTRA RF Channel Number | | 1 | | | 1 | | |
| $BW_{channel}$ | MHz | 10 | | | 10 | | |
| Correlation Matrix and Antenna Configuration | | 2x1 | | | 2x1 | | |
| OCNG Patterns defined in A.3.2.1.1 (OP.1 FDD) and in A.3.2.1.2 (OP.2 FDD) | | OP.1 FDD | OP.1 FDD | OP.1 FDD | OP.2 FDD | OP.2 FDD | OP.2 FDD |
| PBCH_RA | dB | | | | | | |

| | | | | | | | |
|--|------------|------|------|------|-----------|------|------|
| PBCH_RB | dB | | | | | | |
| PSS_RA | dB | -3 | | | -3 | | |
| SSS_RA | dB | | | | | | |
| PCFICH_RB | dB | 0 | | | 0 | | |
| PHICH_RA | dB | -3 | | | -3 | | |
| PHICH_PB | dB | | | | | | |
| PDCCH_RA | dB | 0 | | | 0 | | |
| PDCCH_PB | dB | | | | | | |
| PDSCH_RA | dB | -3 | | | -3 | | |
| PDSCH_RB | dB | | | | | | |
| OCNG_RA ^{Note 1} | dB | | | | | | |
| OCNG_RB ^{Note 1} | dB | | | | | | |
| \hat{E}_s / I_{ot} | dB | 8 | -3.3 | -3.3 | -Infinity | 2.36 | 2.36 |
| N_{oc} ^{Note 2} | dBm/15 KHz | -98 | | | | | |
| \hat{E}_s / N_{oc} | dB | 8 | 8 | 8 | -Infinity | 11 | 11 |
| RSRP ^{Note 3} | dBm/15 KHz | -90 | -90 | -90 | -Infinity | -87 | -87 |
| SCH_RP ^{Note 3} | dBm/15 KHz | -90 | -90 | -90 | -Infinity | -87 | -87 |
| Propagation Condition | | AWGN | | | | | |
| Timing offset to Cell 1 | ms | - | | | 3 | | |
| <p>Note 1: OCNG shall be used such that both cells are fully allocated and a constant total transmitted power spectral density is achieved for all OFDM symbols.</p> <p>Note 2: Interference from other cells and noise sources not specified in the test is assumed to be constant over subcarriers and time and shall be modelled as AWGN of appropriate power for N_{oc} to be fulfilled.</p> <p>Note 3: RSRP and SCH_RP levels have been derived from other parameters for information purposes. They are not settable parameters themselves.</p> | | | | | | | |

Table A.8.1.22.1-3: DRX configuration for E-UTRAN HD - FDD Intra-frequency identification of a new CGI of E-UTRA cell using autonomous gaps with DRX for UE category 0

| Field | Value | Comment |
|--------------------------|---------|---|
| onDurationTimer | psf1 | As specified in clause 6.3.2 in TS 36.331 |
| drx-InactivityTimer | psf1 | |
| drx-RetransmissionTimer | psf1 | |
| longDRX-CycleStartOffset | sf1280 | |
| shortDRX | disable | |

Table A.8.1.22.1-4: TimeAlignmentTimer-Configuration for E-UTRAN HD - FDD Intra-frequency identification of a new CGI of E-UTRA cell using autonomous gaps with DRX for UE category 0

| Field | Value | Comment |
|--------------------|----------|--|
| TimeAlignmentTimer | Infinity | As specified in clause 6.3.2 in TS 36.331 |
| sr-ConfigIndex | 0 | For further information see clause 6.3.2 in TS 36.331 and section 10.1 in TS 36.213. |

A.8.1.22.2 Test Requirements

The UE shall transmit a measurement report containing the cell global identifier of cell 2 within 210 milliseconds from the start of T3.

$$\text{Test requirement} = \text{RRC Procedure delay} + T_{\text{identify_CGL_LC-UE, intra}} + \text{reporting delay}$$

$$= 15 + 190 + 2\text{ms from the start of T3}$$

$$= 207 \text{ ms, allow 210 ms.}$$

The rate of correct events observed during repeated tests shall be at least 90%.

A.8.1.23 E-UTRAN FDD-FDD intra-frequency event triggered reporting under fading propagation conditions in asynchronous cells for Cat-M1 UE in CEModeA

A.8.1.23.1 Test Purpose and Environment

The purpose of this test is to verify that the Cat-M1 UE makes correct reporting of an event. This test will partly verify the FDD intra-frequency cell search requirements for Cat-M1 UE in clause 8.13.2.1.1.1.

The test parameters are given in Table A.8.1.23.1-1 and A.8.1.23.1-2 below. In the measurement control information it is indicated to the UE that event-triggered reporting with Event A3 is used. The test consists of two successive time periods, with time duration of T1, and T2 respectively. During time duration T1, the UE shall not have any timing information of cell 2. At the beginning of T2 the transmission power of cell 2 is increased to the same level as for cell 1, and due to usage of an offset this shall result in reporting of Event A3.

Table A.8.1.23.1-1: General test parameters for E-UTRAN FDD-FDD intra-frequency event triggered reporting under fading propagation conditions in asynchronous cells for Cat-M1 UE in CEModeA

| Parameter | | Unit | Value | Comment |
|--------------------------|-----------------|------|--------|----------------------------|
| E-UTRA RF Channel Number | | | 1 | One radio channel is used. |
| Active cell | | | Cell 1 | |
| Neighbour cell | | | Cell 2 | Cell to be identified. |
| CP length | | | Normal | |
| DRX | | | OFF | |
| A3 | Offset | dB | -6 | |
| | Hysteresis | dB | 0 | |
| | Time To Trigger | S | 0 | |
| Filter coefficient | | | 0 | L3 filtering is not used |
| Gap pattern ID | | | 1 | |
| T1 | | S | 5 | |
| T2 | | S | 5 | |

Table A.8.1.23.1-2: Cell specific test parameters for E-UTRAN FDD-FDD intra-frequency event triggered reporting under fading propagation conditions in asynchronous cells for Cat-M1 UE in CEModeA

| Parameter | Unit | Cell 1 | | Cell 2 | |
|---|------|-----------|----|----------|----|
| | | T1 | T2 | T1 | T2 |
| E-UTRA RF Channel Number | | 1 | | | |
| BW _{channel} | MHz | 10 | | | |
| PDSCH parameters: DL Reference Measurement Channel | | R.21 FDD | | - | |
| MPDCCH parameters: DL Reference Measurement Channel | | R.17 FDD | | R.17 FDD | |
| OCNG Patterns | | OP.21 FDD | | OP.6 FDD | |
| PBCH_RA | dB | -3 | | -3 | |
| PBCH_RB | dB | | | | |
| PSS_RA | dB | | | | |
| SSS_RA | dB | | | | |
| PCFICH_RB | dB | | | | |
| PHICH_RA | dB | | | | |
| PHICH_RB | dB | | | | |
| MPDCCH_RA | dB | | | | |
| MPDCCH_RB | dB | | | | |
| PDSCH_RA | dB | | | | |
| PDSCH_RB | dB | | | | |

| | | | | | |
|---|------------|---------|--------|-----------------------------|-------|
| OCNG_RA ^{Note 1} | dB | | | | |
| OCNG_RB ^{Note 1} | dB | | | | |
| N_{oc} ^{Note 2} | dBm/15 KHz | -98 | | | |
| \hat{E}_s/N_{oc} | dB | 4 | 4 | -Infinity | 4 |
| \hat{E}_s/I_{ot} ^{Note 3} | dB | 4 | -1.46 | -Infinity | -1.46 |
| RSRP ^{Note 3} | dBm/15 KHz | -94 | -94 | -Infinity | -94 |
| SCH_RP ^{Note 3} | dBm/15 KHz | -94 | -94 | -Infinity | -94 |
| I_o ^{Note 3} | dBm/9MHz | -64.76 | -62.42 | Specified in Cell 1 columns | |
| Propagation Condition | | ETU30 | | ETU30 | |
| Correlation Matrix and Antenna Configuration | | 2x1 Low | | 2x1 Low | |
| Timing offset to Cell 1 | ms | - | | 3 | |
| <p>Note 1: OCNG shall be used such that all cells are fully allocated and a constant total transmitted power spectral density is achieved for all OFDM symbols.</p> <p>Note 2: Interference from other cells and noise sources not specified in the test is assumed to be constant over subcarriers and time and shall be modelled as AWGN of appropriate power for N_{oc} to be fulfilled.</p> <p>Note 3: E_s/I_{ot}, RSRP, SCH_RP and I_o have been derived from other parameters for information purposes. They are not settable parameters themselves.</p> <p>Note 4: The resources for uplink transmission are assigned to the UE prior to the start of time period T2.</p> | | | | | |

A.8.1.23.2 Test Requirements

The UE shall send one Event A3 triggered measurement report, with a measurement reporting delay less than 2.88s from the beginning of time period T2.

The UE shall not send event triggered measurement reports, as long as the reporting criteria are not fulfilled.

The rate of correct events observed during repeated tests shall be at least 90%.

NOTE: The actual overall delays measured in the test may be up to $2 \times TTI_{DCCH}$ higher than the measurement reporting delays above because of TTI insertion uncertainty of the measurement report in DCCH.

A.8.1.24 E-UTRAN FDD-FDD intra-frequency event triggered reporting under fading propagation conditions in synchronous cells for Cat-M1 UE in CEModeA

A.8.1.24.1 Test Purpose and Environment

The purpose of this test is to verify that the Cat-M1 UE makes correct reporting of an event. This test will partly verify the FDD intra-frequency cell search requirements in clause 8.13.2.1.1.1.

The test parameters are given in Table A.8.1.24.1-1 and A.8.1.24.1-2 below. In the measurement control information it is indicated to the UE that event-triggered reporting with Event A3 is used. MPDCCHs indicating new transmissions or retransmissions shall be sent continuously to ensure that the UE would not enter the DRX state. The test consists of two successive time periods, with time duration of T1, and T2 respectively. During time duration T1, the UE shall not have any timing information of cell 2. At the beginning of T2 the transmission power of cell 2 is increased to the same level as for cell 1, and due to usage of an offset this shall result in reporting of Event A3.

Table A.8.1.24.1-1: General test parameters for E-UTRAN FDD-FDD intra-frequency event triggered reporting under fading propagation conditions in synchronous cells for Cat-M1 UE in CEModeA

| Parameter | Unit | Value | Comment |
|--------------------------|------|--------|----------------------------|
| E-UTRA RF Channel Number | | 1 | One radio channel is used. |
| Active cell | | Cell 1 | |
| Neighbour cell | | Cell 2 | Cell to be identified. |

| | | | |
|--------------------|-----------------|--------|--|
| CP length | | Normal | |
| DRX | | ON | DRX related parameters are defined in Table A.8.1.24.1-3 |
| A3 | Offset | dB | -6 |
| | Hysteresis | dB | 0 |
| | Time To Trigger | s | 0 |
| Filter coefficient | | 0 | L3 filtering is not used |
| Gap pattern ID | | 1 | Gap offset of 14 is used |
| T1 | s | 5 | |
| T2 | s | 5 | |

Table A.8.1.24.1-2: Cell specific test parameters for E-UTRAN FDD-FDD intra-frequency event triggered reporting under fading propagation conditions for Cat-M1 UE in synchronous cells in CEModeA

| Parameter | Unit | Cell 1 | | Cell 2 | |
|---|------------|-----------|--------|-----------------------------|-------|
| | | T1 | T2 | T1 | T2 |
| E-UTRA RF Channel Number | | 1 | | | |
| BW _{channel} | MHz | 10 | | | |
| PDSCH parameters: DL Reference Measurement Channel | | R.33 FDD | | - | |
| MPDCCH parameters: DL Reference Measurement Channel | | R.17 FDD | | R.17 FDD | |
| OCNG Patterns | | OP.21 FDD | | OP.6 FDD | |
| PBCH_RA | dB | -3 | | -3 | |
| PBCH_RB | dB | | | | |
| PSS_RA | dB | | | | |
| SSS_RA | dB | | | | |
| PCFICH_RB | dB | | | | |
| PHICH_RA | dB | | | | |
| PHICH_RB | dB | | | | |
| MPDCCH_RA | dB | | | | |
| MPDCCH_RB | dB | | | | |
| PDSCH_RA | dB | | | | |
| PDSCH_RB | dB | | | | |
| OCNG_RA ^{Note 1} | dB | | | | |
| OCNG_RB ^{Note 1} | dB | | | | |
| N_{oc} ^{Note 2} | dBm/15 KHz | | | | |
| \hat{E}_s / N_{oc} | dB | 4 | 4 | -Infinity | 4 |
| \hat{E}_s / I_{ot} ^{Note 3} | dB | 4 | -1.46 | -Infinity | -1.46 |
| RSRP ^{Note 3} | dBm/15 KHz | -94 | -94 | -Infinity | -94 |
| SCH_RP ^{Note 3} | dBm/15 KHz | -94 | -94 | -Infinity | -94 |
| I_o ^{Note 3} | dBm/9MHz | -64.76 | -62.42 | Specified in Cell 1 columns | |
| Propagation Condition | | ETU30 | | ETU30 | |
| Correlation Matrix and Antenna Configuration | | 2x1 Low | | 2x1 Low | |
| Timing offset to Cell 1 | μs | - | | 3 | |
| <p>Note 1: OCNG shall be used such that all cells are fully allocated and a constant total transmitted power spectral density is achieved for all OFDM symbols.</p> <p>Note 2: Interference from other cells and noise sources not specified in the test is assumed to be constant over subcarriers and time and shall be modelled as AWGN of appropriate power for N_{oc} to be fulfilled.</p> <p>Note 3: E_s/I_{ot}, RSRP, SCH_RP and I_o have been derived from other parameters for information purposes. They are not settable parameters themselves.</p> <p>Note 4: The resources for uplink transmission are assigned to the UE prior to the start of time period T2.</p> | | | | | |

Table A.8.1.24.1-3: DRX-Configuration for E-UTRAN FDD-FDD intra-frequency event triggered reporting in under fading propagation conditions in synchronous cells for Cat-M1 UE in CEModeA

| Field | Comment | |
|--------------------------|---------|---|
| | Value | |
| onDurationTimer | psf20 | As specified in clause 6.3.2 in TS 36.331 |
| drx-InactivityTimer | psf1920 | |
| drx-RetransmissionTimer | psf16 | |
| longDRX-CycleStartOffset | sf1280 | |
| shortDRX | disable | |

A.8.1.24.2 Test Requirements

The UE shall send one Event A3 triggered measurement report, with a measurement reporting delay less than 2.88 s from the beginning of time period T2.

The UE shall not send event triggered measurement reports, as long as the reporting criteria are not fulfilled.

The rate of correct events observed during repeated tests shall be at least 90%.

NOTE: The actual overall delays measured in the test may be up to $2 \times TTI_{DCCH}$ higher than the measurement reporting delays above because of TTI insertion uncertainty of the measurement report in DCCH.

A.8.1.25 E-UTRAN FDD-FDD intra-frequency event triggered reporting under fading propagation conditions in synchronous cells for Cat-M1 UE in CEModeA in DRX

A.8.1.25.1 Test Purpose and Environment

The purpose of the two tests is to verify that the Cat-M1 UE makes correct reporting of an event in DRX. The tests will partly verify the FDD intra-frequency cell search in DRX requirements in clause 8.13.2.1.1.2.

The test parameters are given in Tables A.8.1.25.1-1, A.8.1.25.1-2, A.8.1.25.1-3 and A.8.1.25.1-4. In the measurement control information, it is indicated to the UE that event-triggered reporting with Event A3 is used. The test consists of two successive time periods, with time duration of T1, and T2 respectively. During time duration T1, the UE shall not have any timing information of cell 2. At the beginning of T2 the transmission power of cell 2 is increased to the same level as for cell 1, and due to usage of an offset this shall result in reporting of Event A3.

In Test 1 UE needs to be provided at least once every 500ms with new Timing Advance Command MAC control element to restart the Time alignment timer to keep UE uplink time alignment. Furthermore UE is allocated with PUSCH resource at every DRX cycle.

In Test 2 the uplink time alignment is not maintained and UE needs to use RACH to obtain UL allocation for measurement reporting.

Table A.8.1.25.1-1: General test parameters for E-UTRAN FDD-FDD intra-frequency event triggered reporting under fading propagation conditions in synchronous cells for Cat-M1 UE when DRX is used

| Parameter | Unit | Value | | Comment |
|--------------------------|-----------------|--------|--------|--|
| | | Test1 | Test2 | |
| E-UTRA RF Channel Number | | 1 | 1 | One radio channel is used. |
| Active cell | | Cell 1 | Cell 1 | |
| Neighbour cell | | Cell 2 | Cell 2 | Cell to be identified. |
| CP length | | Normal | Normal | |
| DRX | | ON | ON | DRX related parameters are defined in Table A.8.1.25.1-3 |
| A3 | Offset | dB | -6 | -6 |
| | Hysteresis | dB | 0 | 0 |
| | Time To Trigger | s | 0 | 0 |
| Filter coefficient | | 0 | 0 | L3 filtering is not used |

| | | | | |
|----------------|---|---|----|--|
| Gap pattern ID | | 0 | 0 | |
| T1 | s | 5 | 5 | |
| T2 | s | 5 | 30 | |

Table A.8.1.25.1-2: Cell specific test parameters for E-UTRAN FDD-FDD intra-frequency event triggered reporting under fading propagation conditions in synchronous cells for Cat-M1 UE when DRX is used

| Parameter | Unit | Cell 1 | | Cell 2 | |
|---|------------|-----------|--------|-----------------------------|-------|
| | | T1 | T2 | T1 | T2 |
| E-UTRA RF Channel Number | | 1 | | | |
| BW _{channel} | MHz | 10 | | | |
| PDSCH parameters: DL Reference Measurement Channel | | R.21 FDD | | - | |
| MPDCCH parameters: DL Reference Measurement Channel | | R.17 FDD | | R.17 FDD | |
| OCNG Patterns | | OP.33 FDD | | OP.6 FDD | |
| PBCH_RA | dB | -3 | | -3 | |
| PBCH_RB | dB | | | | |
| PSS_RA | dB | | | | |
| SSS_RA | dB | | | | |
| PCFICH_RB | dB | | | | |
| PHICH_RA | dB | | | | |
| PHICH_RB | dB | | | | |
| MPDCCH_RA | dB | | | | |
| MPDCCH_RB | dB | | | | |
| PDSCH_RA | dB | | | | |
| PDSCH_RB | dB | | | | |
| OCNG_RA ^{Note 1} | dB | | | | |
| OCNG_RB ^{Note 1} | dB | | | | |
| N_{oc} ^{Note 2} | dBm/15 KHz | | | | |
| \hat{E}_s/N_{oc} | dB | 4 | 4 | -Infinity | 4 |
| \hat{E}_s/I_{ot} ^{Note 3} | dB | 4 | -1.46 | -Infinity | -1.46 |
| RSRP ^{Note 3} | dBm/15 KHz | -94 | -94 | -Infinity | -94 |
| SCH_RP ^{Note 3} | dBm/15 KHz | -94 | -94 | -Infinity | -94 |
| I_o ^{Note 3} | dBm/9MHz | -64.76 | -62.42 | Specified in Cell 1 columns | |
| Propagation Condition | | ETU30 | | ETU30 | |
| Correlation Matrix and Antenna Configuration | | 2x1 Low | | 2x1 Low | |
| Timing offset to Cell 1 | μs | - | | 3 | |
| <p>Note 1: OCNG shall be used such that all cells are fully allocated and a constant total transmitted power spectral density is achieved for all OFDM symbols.</p> <p>Note 2: Interference from other cells and noise sources not specified in the test is assumed to be constant over subcarriers and time and shall be modelled as AWGN of appropriate power for N_{oc} to be fulfilled.</p> <p>Note 3: E_s/I_{ot}, RSRP, SCH_RP and I_o have been derived from other parameters for information purposes. They are not settable parameters themselves.</p> <p>Note 4: The resources for uplink transmission are assigned to the UE prior to the start of time period T2.</p> | | | | | |

Table A.8.1.25.1-3: DRX-Configuration for E-UTRAN FDD-FDD intra-frequency event triggered reporting in DRX under fading propagation conditions in synchronous cells for Cat-M1 UE in CEModeA

| Field | Test1 | Test2 | Comment |
|-----------------|-------|-------|------------------------------------|
| | Value | Value | |
| onDurationTimer | psf1 | psf1 | As specified in clause 6.3.2 in TS |

| | | | |
|--------------------------|---------|---------|--------|
| drx-InactivityTimer | psf1 | psf1 | 36.331 |
| drx-RetransmissionTimer | psf1 | psf1 | |
| longDRX-CycleStartOffset | sf40 | sf1280 | |
| shortDRX | disable | disable | |

Table A.8.1.25.1-4: TimeAlignmentTimer -Configuration for E-UTRAN FDD-FDD intra-frequency event triggered reporting in DRX under fading propagation conditions in synchronous cells for Cat-M1 UE in CEModeA

| Field | Test1 | Test2 | Comment |
|--------------------|-------|-------|--|
| | Value | Value | |
| TimeAlignmentTimer | sf500 | sf500 | As specified in clause 6.3.2 in TS 36.331 |
| sr-ConfigIndex | 0 | 0 | For further information see clause 6.3.2 in TS 36.331 and section 10.1 in TS 36.213. |

A.8.1.25.2 Test Requirements

In Test 1, the UE shall send one Event A3 triggered measurement report, with a measurement reporting delay less than 1.44 s from the beginning of time period T2. The measurement reporting delay is defined as the time from the beginning of time period T2 to the moment when the UE send the measurement report on PUSCH.

In Test 2, the UE shall send one Event A3 triggered measurement report, with a measurement reporting delay less than 25600 ms from the beginning of time period T2. The measurement reporting delay is defined as the time from the beginning of time period T2 to the moment when the UE starts to send preambles on the PRACH for scheduling request (SR) to obtain allocation to send the measurement report on PUSCH.

The UE shall not send event triggered measurement reports, as long as the reporting criteria are not fulfilled.

The rate of correct events observed during repeated tests shall be at least 90%.

NOTE 1: The actual overall delays measured in the test may be up to one DRX cycle higher than the measurement reporting delays above because UE is allowed to delay the initiation of the measurement reporting procedure to the next until the Active Time.

NOTE 2: In order to calculate the rate of correct events the system simulator shall verify that it has received correct Event A3 measurement report.

A.8.1.26 E-UTRAN HD-FDD intra-frequency event triggered reporting under fading propagation conditions in asynchronous cells for Cat-M1 UE in CEModeA

A.8.1.26.1 Test Purpose and Environment

The purpose of this test is to verify that the Cat-M1 UE makes correct reporting of an event. This test will partly verify the HD-FDD intra-frequency cell search requirements in clause 8.13.2.1.2.1.

The test parameters are given in Table A.8.1.26.1-1 and A.8.1.26.1-2 below. In the measurement control information it is indicated to the UE that event-triggered reporting with Event A3 is used. The test consists of two successive time periods, with time duration of T1 and T2 respectively. During time duration T1, the UE shall not have any timing information of cell 2. At the beginning of T2 the transmission power of cell 2 is increased to the same level as for cell 1, and due to usage of an offset this shall result in reporting of Event A3.

Table A.8.1.26.1-1: General test parameters for E-UTRAN HD-FDD intra-frequency event triggered reporting under fading propagation conditions in asynchronous cells for Cat-M1 UE in CEModeA

| Parameter | Unit | Value | Comment |
|--------------------------|------|-------|---|
| E-UTRA RF Channel Number | | 1 | One radio channel is used for this test |

| | | | | |
|--------------------|-----------------|----|--------|--------------------------|
| Active Cell | | | Cell 1 | |
| Neighbour cell | | | Cell 2 | Cell to be identified |
| CP length | | | Normal | |
| DRX | | | OFF | |
| A3 | Offset | dB | -6 | |
| | Hysteresis | dB | 0 | |
| | Time To Trigger | s | 0 | |
| Filter coefficient | | | 0 | L3 filtering is not used |
| Gap pattern ID | | | 1 | |
| T1 | | s | 5 | |
| T2 | | s | 5 | |

Table A.8.1.26.1-2: Cell specific test parameters for E-UTRAN HD-FDD intra-frequency event triggered reporting under fading propagation conditions in asynchronous cells for Cat-M1 UE in CEModeA

| Parameter | Unit | Cell 1 | | Cell 2 | |
|--|------------|-------------|--------|-----------------------------|-------|
| | | T1 | T2 | T1 | T2 |
| E-UTRA RF Channel Number | | 1 | | | |
| BW _{channel} | MHz | 10 | | | |
| PDSCH parameters: DL Reference Measurement Channel | | R.25 HD-FDD | | - | |
| MPDCCH parameters: DL Reference Measurement Channel | | R.7 HD-FDD | | R.7 HD-FDD | |
| OCNG Patterns | | OP.21 FDD | | OP.6 FDD | |
| PBCH_RA | dB | -3 | | | |
| PBCH_RB | dB | | | | |
| PSS_RA | dB | | | | |
| SSS_RA | dB | | | | |
| PCFICH_RB | dB | | | | |
| PHICH_RA | dB | | | | |
| PHICH_RB | dB | | | | |
| MPDCCH_RA | dB | | | | |
| MPDCCH_RB | dB | | | | |
| PDSCH_RA | dB | | | | |
| PDSCH_RB | dB | | | | |
| OCNG_RA ^{Note 1} | dB | | | | |
| OCNG_RB ^{Note 1} | dB | | | | |
| N _{oc} ^{Note 2} | dBm/15 kHz | | | | |
| E _s /N _{oc} | dB | 4 | 4 | -infinity | 4 |
| E _s /I _{ot} ^{Note 3} | dB | 4 | -1.46 | -infinity | -1.46 |
| RSRP ^{Note 3} | dBm/15 kHz | -94 | -94 | -infinity | -94 |
| SCH_RP ^{Note 3} | dBm/15 kHz | -94 | -94 | -infinity | -94 |
| I _o ^{Note 3} | dBm/9MHz | -64.76 | -62.42 | Specified in Cell 1 columns | |
| Propagation Condition | | ETU30 | | ETU30 | |
| Correlation Matrix and Antenna Configuration | | 2x1 Low | | 2x1 Low | |
| Timing offset to Cell 1 | ms | - | | 3 | |
| <p>Note 1: OCNG shall be used such that all cells are fully allocated and a constant total transmitted power spectral density is achieved for all OFDM symbols.</p> <p>Note 2: Interference from other cells and noise sources not specified in the test is assumed to be constant over subcarriers and time and shall be modelled as AWGN of appropriate power for N_{oc} to be fulfilled.</p> <p>Note 3: E_s/I_{ot}, RSRP, SCH_RP and I_o have been derived from other parameters for information purposes. They are not settable parameters themselves.</p> <p>Note 4: The resources for uplink transmission are assigned to the UE prior to the start of time period T2.</p> | | | | | |

A.8.1.26.2 Test Requirements

The UE shall send one Event A3 triggered measurement report, with a measurement reporting delay less than 2.88s from the beginning of time period T2.

The UE shall not send event triggered measurement reports as long as the reporting criteria are not fulfilled.

The rate of correct events observed during repeated tests shall be at least 90%.

NOTE: The actual overall delays measured in the tests may be up to $2 \times TTI_{DCCH}$ higher than the measurement reporting delays above because of TTI insertion uncertainty of the measurement report in DCCH.

A.8.1.27 E-UTRAN HD-FDD intra-frequency event triggered reporting under fading propagation conditions in synchronous cells for Cat-M1 UE in CEModeA

A.8.1.27.1 Test Purpose and Environment

The purpose of this test is to verify that the Cat-M1 UE makes correct reporting of an event. This test will partly verify the HD-FDD intra-frequency cell search requirements in clause 8.13.2.1.2.1.

The test parameters are given in Table A.8.1.27.1-1 and A.8.1.27.1-2 below. In the measurement control information it is indicated to the UE that event-triggered reporting with Event A3 is used. MPDCCHs indicating new transmissions or retransmissions shall be sent continuously to ensure that the UE would not enter the DRX state. The test consists of two successive time periods, with time duration of T1 and T2 respectively. During time duration T1, the UE shall not have any timing information of cell 2. At the beginning of T2 the transmission power of cell 2 is increased to the same level as for cell 1, and due to usage of an offset this shall result in reporting of Event A3.

Table A.8.1.27.1-1: General test parameters for E-UTRAN HD-FDD intra-frequency event triggered reporting under fading propagation conditions in synchronous cells for Cat-M1 UE in CEModeA

| Parameter | | Unit | Value | Comment |
|--------------------------|-----------------|------|--------|--|
| E-UTRA RF Channel Number | | | 1 | One radio channel is used for this test |
| Active cell | | | Cell 1 | |
| Neighbour cell | | | Cell 2 | Cell to be identified. |
| CP length | | | Normal | |
| DRX | | | ON | DRX related parameters are defined in Table A.8.1.27.1-3 |
| A3 | Offset | dB | -6 | |
| | Hysteresis | dB | 0 | |
| | Time To Trigger | s | 0 | |
| Filter coefficient | | | 0 | L3 filtering is not used |
| Gap pattern ID | | | 1 | As specified in TS 36.133 clause 8.1.2.1. |
| T1 | | s | 5 | |
| T2 | | s | 5 | |

Table A.8.1.27.1-2: Cell specific test parameters for E-UTRAN HD-FDD intra-frequency event triggered reporting under fading propagation conditions in synchronous cells for Cat-M1 UE in CEModeA

| Parameter | Unit | Cell 1 | | Cell 2 | |
|---|------|-------------|----|------------|----|
| | | T1 | T2 | T1 | T2 |
| E-UTRA RF Channel Number | | 1 | | | |
| $BW_{channel}$ | MHz | 10 | | | |
| PDSCH parameters: DL Reference Measurement Channel | | R.25 HD-FDD | | - | |
| MPDCCH parameters: DL Reference Measurement Channel | | R.7 HD-FDD | | R.7 HD-FDD | |
| OCNG Patterns | | OP.21 FDD | | OP.6 FDD | |

| | | | | | |
|---|------------|---------|--------|-----------------------------|-------|
| PBCH_RA | dB | -3 | | -3 | |
| PBCH_RB | dB | | | | |
| PSS_RA | dB | | | | |
| SSS_RA | dB | | | | |
| PCFICH_RB | dB | | | | |
| PHICH_RA | dB | | | | |
| PHICH_RB | dB | | | | |
| MPDCCH_RA | dB | | | | |
| MPDCCH_RB | dB | | | | |
| PDSCH_RA | dB | | | | |
| PDSCH_RB | dB | | | | |
| OCNG_RA ^{Note 1} | dB | | | | |
| OCNG_RB ^{Note 1} | dB | | | | |
| N_{oc} ^{Note 2} | dBm/15 KHz | | | | |
| \hat{E}_s/N_{oc} | dB | 4 | 4 | -Infinity | 4 |
| \hat{E}_s/I_{ot} ^{Note 3} | dB | 4 | -1.46 | -Infinity | -1.46 |
| RSRP ^{Note 3} | dBm/15 KHz | -94 | -94 | -Infinity | -94 |
| SCH_RP ^{Note 3} | dBm/15 KHz | -94 | -94 | -Infinity | -94 |
| I_o ^{Note 3} | dBm/9MHz | -64.76 | -62.42 | Specified in Cell 1 columns | |
| Propagation Condition | | ETU30 | | ETU30 | |
| Correlation Matrix and Antenna Configuration | | 2x1 Low | | 2x1 Low | |
| Timing offset to Cell 1 | μ s | - | | 3 | |
| <p>Note 1: OCNG shall be used such that all cells are fully allocated and a constant total transmitted power spectral density is achieved for all OFDM symbols.</p> <p>Note 2: Interference from other cells and noise sources not specified in the test is assumed to be constant over subcarriers and time and shall be modelled as AWGN of appropriate power for N_{oc} to be fulfilled.</p> <p>Note 3: E_s/I_{ot}, RSRP, SCH_RP and I_o have been derived from other parameters for information purposes. They are not settable parameters themselves.</p> <p>Note 4: The resources for uplink transmission are assigned to the UE prior to the start of time period T2.</p> | | | | | |

Table A.8.1.27.1-3: DRX-Configuration for E-UTRAN HD-FDD intra-frequency event triggered reporting in under fading propagation conditions in synchronous cells for Cat-M1 UE in CEModeA

| Field | Comment | |
|--------------------------|---------|---|
| | Value | |
| onDurationTimer | psf20 | As specified in clause 6.3.2 in TS 36.331 |
| drx-InactivityTimer | psf1920 | |
| drx-RetransmissionTimer | psf16 | |
| longDRX-CycleStartOffset | sf1280 | |
| shortDRX | disable | |

A.8.1.27.2 Test Requirements

The UE shall send one Event A3 triggered measurement report, with a measurement reporting delay less than 2.88s from the beginning of time period T2.

The UE shall not send event triggered measurement reports, as long as the reporting criteria are not fulfilled.

The rate of correct events observed during repeated tests shall be at least 90%.

NOTE: The actual overall delays measured in the test may be up to $2 \times TTI_{DCCH}$ higher than the measurement reporting delays above because of TTI insertion uncertainty of the measurement report in DCCH.

A.8.1.28 E-UTRAN HD-FDD intra-frequency event triggered reporting under fading propagation conditions in synchronous cells for Cat-M1 UE in CEModeA in DRX

A.8.1.28.1 Test Purpose and Environment

The purpose of the two tests is to verify that the Cat-M1 UE makes correct reporting of an event in DRX. The tests will partly verify the HD-FDD intra-frequency cell search in DRX requirements in clause 8.13.2.1.2.2.

The test parameters are given in Tables A.8.1.28.1-1, A.8.1.28.1-2, A.8.1.28.1-3 and A.8.1.28.1-4. In the measurement control information, it is indicated to the UE that event-triggered reporting with Event A3 is used. The test consists of two successive time periods, with time duration of T1, and T2 respectively. During time duration T1, the UE shall not have any timing information of cell 2.

In Test 1 UE needs to be provided at least once every 500ms with new Timing Advance Command MAC control element to restart the Time alignment timer to keep UE uplink time alignment. Furthermore UE is allocated with PUSCH resource at every DRX cycle.

In Test 2 the uplink time alignment is not maintained and UE needs to use RACH to obtain UL allocation for measurement reporting.

Table A.8.1.28.1-1: General test parameters for E-UTRAN HD-FDD intra-frequency event triggered reporting under fading propagation conditions in synchronous cells for Cat-M1 UE in CEModeA when DRX is used

| Parameter | Unit | Value | | Comment |
|--------------------------|-----------------|--------|--------|--|
| | | Test1 | Test2 | |
| E-UTRA RF Channel Number | | 1 | 1 | One radio channel is used for this test |
| Active cell | | Cell 1 | Cell1 | |
| Neighbour cell | | Cell 2 | Cell2 | Cell to be identified. |
| CP length | | Normal | Normal | |
| DRX | | ON | ON | DRX related parameters are defined in Table A.8.1.28.1-3 |
| A3 | Offset | dB | -6 | -6 |
| | Hysteresis | dB | 0 | 0 |
| | Time To Trigger | s | 0 | 0 |
| Filter coefficient | | 0 | 0 | L3 filtering is not used |
| Gap pattern ID | | 0 | 0 | As specified in TS 36.133 clause 8.1.2.1. |
| T1 | s | 5 | 5 | |
| T2 | s | 5 | 35 | |

Table A.8.1.28.1-2: Cell specific test parameters for E-UTRAN HD-FDD intra-frequency event triggered reporting under fading propagation conditions in synchronous cells for Cat-M1 UE in CEModeA when DRX is used

| Parameter | Unit | Cell 1 | | Cell 2 | |
|---|------|-------------|----|------------|----|
| | | T1 | T2 | T1 | T2 |
| E-UTRA RF Channel Number | | 1 | | | |
| BW _{channel} | MHz | 10 | | | |
| PDSCH parameters: DL Reference Measurement Channel | | R.25 HD-FDD | | - | |
| MPDCCH parameters: DL Reference Measurement Channel | | R.7 HD-FDD | | R.7 HD-FDD | |
| OCNG Patterns | | OP.21 FDD | | OP.6 FDD | |
| PBCH_RA | dB | | | | |
| PBCH_RB | dB | | | | |
| PSS_RA | dB | | | | |
| SSS_RA | dB | | | | |
| PCFICH_RB | dB | | | | |
| PHICH_RA | dB | | | | |
| PHICH_RB | dB | | | | |
| | | -3 | | -3 | |

| | | | | | |
|---|------------|---------|--------|-----------------------------|-------|
| PHICH_RB | dB | | | | |
| MPDCCH_RA | dB | | | | |
| MPDCCH_RB | dB | | | | |
| PDSCH_RA | dB | | | | |
| PDSCH_RB | dB | | | | |
| OCNG_RA ^{Note 1} | dB | | | | |
| OCNG_RB ^{Note 1} | dB | | | | |
| N_{oc} ^{Note 2} | dBm/15 KHz | -98 | | | |
| \hat{E}_s/N_{oc} | dB | 4 | 4 | -Infinity | 4 |
| \hat{E}_s/I_{ot} ^{Note 3} | dB | 4 | -1.46 | -Infinity | -1.46 |
| RSRP ^{Note 3} | dBm/15 KHz | -94 | -94 | -Infinity | -94 |
| SCH_RP ^{Note 3} | dBm/15 KHz | -94 | -94 | -Infinity | -94 |
| I_o ^{Note 3} | dBm/9MHz | -64.76 | -62.42 | Specified in Cell 1 columns | |
| Propagation Condition | | ETU30 | | ETU30 | |
| Correlation Matrix and Antenna Configuration | | 2x1 Low | | 2x1 Low | |
| Timing offset to Cell 1 | μ s | - | | 3 | |
| <p>Note 1: OCNG shall be used such that all cells are fully allocated and a constant total transmitted power spectral density is achieved for all OFDM symbols.</p> <p>Note 2: Interference from other cells and noise sources not specified in the test is assumed to be constant over subcarriers and time and shall be modelled as AWGN of appropriate power for N_{oc} to be fulfilled.</p> <p>Note 3: E_s/I_{ot}, RSRP, SCH_RP and I_o have been derived from other parameters for information purposes. They are not settable parameters themselves.</p> <p>Note 4: The resources for uplink transmission are assigned to the UE prior to the start of time period T2.</p> | | | | | |

Table A.8.1.28.1-3: DRX-Configuration for E-UTRAN HD-FDD intra-frequency event triggered reporting in DRX under fading propagation conditions in synchronous cells for Cat-M1 UE in CEModeA

| Field | Test1 | Test2 | Comment |
|--------------------------|---------|---------|---|
| | Value | Value | |
| onDurationTimer | psf1 | psf1 | As specified in clause 6.3.2 in TS 36.331 |
| drx-InactivityTimer | psf1 | psf1 | |
| drx-RetransmissionTimer | psf1 | psf1 | |
| longDRX-CycleStartOffset | sf40 | sf1280 | |
| shortDRX | disable | disable | |

Table A.8.1.28.1-4: TimeAlignmentTimer-Configuration for E-UTRAN HD-FDD intra-frequency event triggered reporting in DRX under fading propagation conditions in synchronous cells for Cat-M1 UE in CEModeA

| Field | Test1 | Test2 | Comment |
|--------------------|-------|-------|--|
| | Value | Value | |
| TimeAlignmentTimer | sf500 | sf500 | As specified in clause 6.3.2 in TS 36.331 |
| sr-ConfigIndex | 10 | 10 | For further information see clause 6.3.2 in TS 36.331 and section 10.1 in TS 36.213. |

A.8.1.28.2 Test Requirements

In Test 1, the UE shall send one Event A3 triggered measurement report, with a measurement reporting delay less than 1.44 s from the beginning of time period T2. The measurement reporting delay is defined as the time from the beginning of time period T2 to the moment when the UE send the measurement report on PUSCH.

In Test 2, the UE shall send one Event A3 triggered measurement report, with a measurement reporting delay less than 32 s from the beginning of time period T2. The measurement reporting delay is defined as the time from the beginning of time period T2 to the moment when the UE starts to send preambles on the PRACH for scheduling request (SR) to obtain allocation to send the measurement report on PUSCH.

The UE shall not send event triggered measurement reports, as long as the reporting criteria are not fulfilled.

The rate of correct events observed during repeated tests shall be at least 90%.

NOTE 1: The actual overall delays measured in the test may be up to one DRX cycle higher than the measurement reporting delays above because UE is allowed to delay the initiation of the measurement reporting procedure to the next until the Active Time.

NOTE 2: In order to calculate the rate of correct events the system simulator shall verify that it has received correct Event A3 measurement report.

A.8.1.29 E-UTRAN TDD intra-frequency event triggered reporting under fading propagation conditions in synchronous cells for Cat-M1 UE in CEModeA

A.8.1.29.1 Test Purpose and Environment

The purpose of this test is to verify that the Cat-M1 UE in CEModeA makes correct reporting of an event. This test will partly verify the TDD intra-frequency cell search requirements in clause 8.13.2.1.3.1.

The test parameters are given in Table A.8.1.29.1-1 and A.8.1.29.1-2 below. In the measurement control information it is indicated to the UE that event-triggered reporting with Event A3 is used. The test consists of two successive time periods, with time duration of T1 and T2 respectively. During time duration T1, the UE shall not have any timing information of cell 2. At the beginning of T2 the transmission power of cell 2 is increased to the same level as for cell 1, and due to usage of an offset this shall result in reporting of Event A3.

Table A.8.1.29.1-1: General test parameters for E-UTRAN TDD intra-frequency event triggered reporting under fading propagation conditions in synchronous cells for Cat-M1 UE in CEModeA

| Parameter | | Unit | Value | Comments |
|--------------------------------|-----------------|------|--------|--|
| E-UTRA RF Channel Number | | | 1 | One radio channel is used for this test. |
| Active cell | | | Cell 1 | |
| Neighbour cell | | | Cell 2 | Cell to be identified. |
| CP length | | | Normal | |
| DRX | | | OFF | |
| A3 | Offset | dB | -6 | |
| | Hysteresis | dB | 0 | |
| | Time To Trigger | s | 0 | |
| Special subframe configuration | | | 6 | As specified in table 4.2-1 in TS 36.211. The same configuration in both cells |
| Uplink-downlink configuration | | | 1 | As specified in table 4.2-2 in TS 36.211. The same configuration in both cells |
| Filter coefficient | | | 0 | L3 filtering is not used |
| Gap Pattern Id | | | 1 | |
| T1 | | s | 5 | |
| T2 | | s | 5 | |

Table A.8.1.29.1-2: Cell specific test parameters for E-UTRAN TDD intra-frequency event triggered reporting under fading propagation conditions in synchronous cells for Cat-M1 UE in CEModeA

| Parameter | Unit | Cell 1 | | Cell 2 | |
|--|------|----------|----|--------|----|
| | | T1 | T2 | T1 | T2 |
| E-UTRA RF Channel Number | | 1 | | | |
| BW _{channel} | MHz | 10 | | | |
| PDSCH parameters: DL Reference Measurement Channel | | R.17 TDD | | - | |

| | | | | | |
|---|---|-----------|--------|-----------|--------|
| MPDCCH parameters: DL Reference Measurement Channel | | R.15 TDD | | R.15 TDD | |
| OCNG Patterns | | OP.11 TDD | | OP.2 TDD | |
| PBCH_RA | dB | -3 | | -3 | |
| PBCH_RB | dB | | | | |
| PSS_RA | dB | | | | |
| SSS_RA | dB | | | | |
| PCFICH_RB | dB | | | | |
| PHICH_RA | dB | | | | |
| PHICH_RB | dB | | | | |
| MPDCCH_RA | dB | | | | |
| MPDCCH_RB | dB | | | | |
| PDSCH_RA | dB | | | | |
| PDSCH_RB | dB | | | | |
| OCNG_RA ^{Note 1} | dB | | | | |
| OCNG_RB ^{Note 1} | dB | | | | |
| N _{oc} ^{Note 2} | dBm/15 kHz | -98 | | | |
| \hat{E}_s/N_{oc} | dB | 4 | 4 | -Infinity | 4 |
| \hat{E}_s/I_{ot} ^{Note 3} | dB | 4 | -1.46 | -Infinity | -1.46 |
| RSRP ^{Note 3} | dBm/15 kHz | -94 | -94 | -Infinity | -94 |
| SCH_RP ^{Note 3} | dBm/15 kHz | -94 | -94 | -Infinity | -94 |
| I _o ^{Note 3} | dBm/9 MHz | -64.76 | -62.42 | -64.76 | -62.42 |
| Propagation Condition | | ETU30 | | ETU30 | |
| Correlation Matrix and Antenna Configuration | | 2x1 Low | | 2x1 Low | |
| Time offset to Cell 1 | μs | - | | 3 | |
| Note 1 | OCNG shall be used such that both cells are fully allocated and a constant total transmitted power spectral density is achieved for all OFDM symbols. | | | | |
| Note 2: | Interference from other cells and noise sources not specified in the test is assumed to be constant over subcarriers and time and shall be modelled as AWGN of appropriate power for N _{oc} to be fulfilled. | | | | |
| Note 3: | \hat{E}_s/I_{ot} , RSRP, SCH_RP and I _o levels have been derived from other parameters for information purposes. They are not settable parameters themselves. | | | | |
| Note 4: | The resources for uplink transmission are assigned to the UE prior to the start of time period T2. | | | | |

A.8.1.29.2 Test Requirements

The UE shall send one Event A3 triggered measurement report, with a measurement reporting delay less than 2.88 second from the beginning of time period T2.

The UE shall not send event triggered measurement reports, as long as the reporting criteria are not fulfilled.

The rate of correct events observed during repeated tests shall be at least 90%.

NOTE: The actual overall delays measured in the test may be up to 2xTTI_{DCCH} higher than the measurement reporting delays above because of TTI insertion uncertainty of the measurement report in DCCH.

A.8.1.30 E-UTRAN TDD intra-frequency event triggered reporting under fading propagation conditions in synchronous cells for Cat-M1 UE in CEModeA in DRX

A.8.1.30.1 Test Purpose and Environment

The purpose of the two tests is to verify that the Cat-M1 UE in CEModeA makes correct reporting of an event in DRX. The tests will partly verify the TDD intra-frequency cell search in DRX requirements in clause 8.13.2.1.3.2.

The test parameters are given in Tables A.8.1.30.1-1, A.8.1.30.1-2, A.8.1.30.1-3 and A.8.1.30.1-4. In the measurement control information, it is indicated to the UE that event-triggered reporting with Event A3 is used. The test consists of two successive time periods, with time duration of T1, and T2 respectively. During time duration T1, the UE shall not have any timing information of cell 2. At the beginning of T2 the transmission power of cell 2 is increased to the same level as for cell 1, and due to usage of an offset this shall result in reporting of Event A3.

In Test 1 UE needs to be provided at least once every 500ms with new Timing Advance Command MAC control element to restart the Time alignment timer to keep UE uplink time alignment. Furthermore UE is allocated with PUSCH resource at every DRX cycle.

In Test 2 the uplink time alignment is not maintained and UE needs to use RACH to obtain UL allocation for measurement reporting.

Table A.8.1.30.1-1: General test parameters for E-UTRAN TDD intra-frequency event triggered reporting under fading propagation conditions in synchronous cells when DRX is used for Cat-M1 UE in CEModeA

| Parameter | | Unit | Value | | Comments |
|--------------------------------|-----------------|------|--------|--------|--|
| | | | Test 1 | Test 2 | |
| E-UTRA RF Channel Number | | | 1 | | One radio channel is used for both tests. |
| Active cell | | | Cell 1 | | |
| Neighbour cell | | | Cell 2 | | Cell to be identified. |
| CP length | | | Normal | | |
| DRX | | | ON | | DRX related parameters are defined in Table A.8.1.30.1-3 |
| A3 | Offset | dB | -6 | | |
| | Hysteresis | dB | 0 | | |
| | Time To Trigger | s | 0 | | |
| Special subframe configuration | | | 6 | | As specified in table 4.2-1 in TS 36.211. The same configuration in both cells |
| Uplink-downlink configuration | | | 1 | | As specified in table 4.2-2 in TS 36.211. The same configuration in both cells |
| Filter coefficient | | | 0 | | L3 filtering is not used |
| Gap Pattern Id | | | 0 | | |
| T1 | | s | 5 | | |
| T2 | | s | 5 | 30 | |

Table A.8.1.30.1-2: Cell specific test parameters for E-UTRAN TDD intra-frequency event triggered reporting under fading propagation conditions in synchronous cells when DRX is used for Cat-M1 UE in CEModeA

| Parameter | Unit | Cell 1 | | Cell 2 | |
|--|------------|-----------|-------|-----------|-------|
| | | T1 | T2 | T1 | T2 |
| E-UTRA RF Channel Number | | 1 | | | |
| $BW_{channel}$ | MHz | 10 | | | |
| PDSCH parameters: DL Reference Measurement Channel | | R.17 TDD | | - | |
| MPDCCH parameters: DL Reference Measurement Channel | | R.15 TDD | | R.15 TDD | |
| OCNG Patterns | | OP.11 TDD | | OP.2 TDD | |
| PBCH_RA | dB | -3 | | | |
| PBCH_RB | dB | | | | |
| PSS_RA | dB | | | | |
| SSS_RA | dB | | | | |
| PCFICH_RB | dB | | | | |
| PHICH_RA | dB | | | | |
| PHICH_RB | dB | | | | |
| MPDCCH_RA | dB | | | | |
| MPDCCH_RB | dB | | | | |
| PDSCH_RA | dB | | | | |
| PDSCH_RB | dB | | | | |
| OCNG_RA ^{Note 1} | dB | | | | |
| OCNG_RB ^{Note 1} | dB | | | | |
| N_{oc} ^{Note 2} | dBm/15 kHz | -98 | | | |
| \hat{E}_s/N_{oc} | dB | 4 | 4 | -Infinity | 4 |
| \hat{E}_s/I_{ot} ^{Note 3} | dB | 4 | -1.46 | -Infinity | -1.46 |

| | | | | | |
|--|---|---------|--------|-----------|--------|
| RSRP ^{Note 3} | dBm/15 kHz | -94 | -94 | -Infinity | -94 |
| SCH_RP ^{Note 3} | dBm/15 kHz | -94 | -94 | -Infinity | -94 |
| I _o ^{Note 3} | dBm/9 MHz | -64.76 | -62.42 | -64.76 | -62.42 |
| Propagation Condition | | ETU30 | | ETU30 | |
| Correlation Matrix and Antenna Configuration | | 2x1 Low | | 2x1 Low | |
| Time offset to Cell 1 | μs | - | | 3 | |
| Note 1 | OCNG shall be used such that both cells are fully allocated and a constant total transmitted power spectral density is achieved for all OFDM symbols. | | | | |
| Note 2: | Interference from other cells and noise sources not specified in the test is assumed to be constant over subcarriers and time and shall be modelled as AWGN of appropriate power for N _{oc} to be fulfilled. | | | | |
| Note 3: | Ê _s /I _{ot} , RSRP, SCH_RP and I _o levels have been derived from other parameters for information purposes. They are not settable parameters themselves. | | | | |
| Note 4: | The resources for uplink transmission are assigned to the UE prior to the start of time period T2. | | | | |

Table A.8.1.30.1-3: DRX-Configuration for E-UTRAN TDD intra-frequency event triggered reporting in DRX under fading propagation conditions in synchronous cells

| Field | Test1 | Test2 | Comment |
|--------------------------|---------|---------|---|
| | Value | Value | |
| onDurationTimer | psf1 | psf1 | As specified in clause 6.3.2 in TS 36.331 |
| drx-InactivityTimer | psf1 | psf1 | |
| drx-RetransmissionTimer | psf1 | psf1 | |
| longDRX-CycleStartOffset | sf40 | sf1280 | |
| shortDRX | disable | disable | |

Table A.8.1.30.1-4: TimeAlignmentTimer-Configuration for E-UTRAN TDD intra-frequency event triggered reporting in DRX under fading propagation conditions in synchronous cells

| Field | Test1 | Test2 | Comment |
|--------------------|-------|-------|---|
| | Value | Value | |
| TimeAlignmentTimer | sf500 | sf500 | As specified in clause 6.3.2 in TS 36.331 |
| sr-ConfigIndex | 2 | 2 | For further information see clause 6.3.2 in TS 36.331 and clause 10.1 in TS 36.213. |

A.8.1.30.2 Test Requirements

In Test 1, the UE shall send one Event A3 triggered measurement report, with a measurement reporting delay less than 1.44 second from the beginning of time period T2. The measurement reporting delay is defined as the time from the beginning of time period T2 to the moment when the UE send the measurement report on PUSCH.

In Test 2, the UE shall send one Event A3 triggered measurement report, with a measurement reporting delay less than 25.6 second from the beginning of time period T2. The measurement reporting delay is defined as the time from the beginning of time period T2 to the moment when the UE starts to send preambles on the PRACH for scheduling request (SR) to obtain allocation to send the measurement report on PUSCH.

The UE shall not send event triggered measurement reports, as long as the reporting criteria are not fulfilled.

The rate of correct events observed during repeated tests shall be at least 90%.

NOTE 1: The actual overall delays measured in the test may be up to one DRX cycle higher than the measurement reporting delays above because UE is allowed to delay the initiation of the measurement reporting procedure to the next until the Active Time.

NOTE 2: In order to calculate the rate of correct events the system simulator shall verify that it has received correct Event A3 measurement report.

A.8.1.31 E-UTRAN FDD-FDD intra-frequency event triggered reporting under fading propagation conditions in asynchronous cells for Cat-M1 UE in CEModeB

A.8.1.31.1 Test Purpose and Environment

The purpose of this test is to verify that the Cat-M1 UE makes correct reporting of an event. This test will partly verify the FDD intra-frequency cell search requirements for Cat-M1 UE in clause 8.13.3.1.1.1.

The test parameters are given in Table A.8.1.31.1-1 and A.8.1.31.1-2 below. In the measurement control information it is indicated to the UE that event-triggered reporting with Event A3 is used. The test consists of two successive time periods, with time duration of T1, and T2 respectively. During time duration T1, the UE shall not have any timing information of cell 2. At the beginning of T2 the transmission power of cell 2 is increased to the same level as for cell 1, and due to usage of an offset this shall result in reporting of Event A3.

Table A.8.1.31.1-1: General test parameters for E-UTRAN FDD-FDD intra-frequency event triggered reporting under fading propagation conditions in asynchronous cells for Cat-M1 UE in CEModeB

| Parameter | | Unit | Value | Comment |
|--------------------------|-----------------|------|--------|----------------------------|
| E-UTRA RF Channel Number | | | 1 | One radio channel is used. |
| Active cell | | | Cell 1 | |
| Neighbour cell | | | Cell 2 | Cell to be identified. |
| CP length | | | Normal | |
| DRX | | | OFF | |
| A3 | Offset | dB | -8 | |
| | Hysteresis | dB | 0 | |
| | Time To Trigger | s | 0 | |
| Filter coefficient | | | 0 | L3 filtering is not used |
| Gap pattern ID | | | 0 | |
| T1 | | s | 5 | |
| T2 | | s | ≤325 | |

Table A.8.1.31.1-2: Cell specific test parameters for E-UTRAN FDD-FDD intra-frequency event triggered reporting under fading propagation conditions in asynchronous cells for Cat-M1 UE in CEModeB

| Parameter | Unit | Cell 1 | | Cell 2 | |
|--|------|-----------|----|----------|----|
| | | T1 | T2 | T1 | T2 |
| E-UTRA RF Channel Number | | 1 | | | |
| BW _{channel} | MHz | 10 | | | |
| PDSCH parameters: DL Reference Measurement Channel | | R.23 FDD | | - | |
| MPDCCH parameters: DL Reference Measurement Channel | | R.19 FDD | | R.19 FDD | |
| OCNG Patterns | | OP.21 FDD | | OP.6 FDD | |
| PBCH_RA | dB | -3 | | -3 | |
| PBCH_RB | dB | | | | |
| PSS_RA | dB | | | | |
| SSS_RA | dB | | | | |
| PCFICH_RB | dB | | | | |
| PHICH_RA | dB | | | | |
| PHICH_RB | dB | | | | |
| MPDCCH_RA | dB | | | | |
| MPDCCH_PB | dB | | | | |
| PDSCH_RA | dB | | | | |
| PDSCH_RB | dB | | | | |
| OCNG_RA ^{Note 1} | dB | | | | |
| OCNG_RB ^{Note 1} | dB | | | | |

| | | | | | |
|---|------------|---------|--------|-----------------------------|--------|
| N_{oc} <small>Note 2</small> | dBm/15 KHz | -98 | | | |
| \hat{E}_s/N_{oc} | dB | -12 | -12 | -Infinity | -12 |
| \hat{E}_s/I_{ot} <small>Note 3</small> | dB | -12 | -12.27 | -Infinity | -12.27 |
| RSRP <small>Note 3</small> | dBm/15 KHz | -110 | -110 | -Infinity | -110 |
| SCH_RP <small>Note 3</small> | dBm/15 KHz | -110 | -110 | -Infinity | -110 |
| I_o <small>Note 3</small> | dBm/9MHz | -69.95 | -69.70 | Specified in Cell 1 columns | |
| Propagation Condition | | ETU30 | | ETU30 | |
| Correlation Matrix and Antenna Configuration | | 2x1 Low | | 2x1 Low | |
| Timing offset to Cell 1 | ms | - | | 3 | |
| <p>Note 1: OCNG shall be used such that all cells are fully allocated and a constant total transmitted power spectral density is achieved for all OFDM symbols.</p> <p>Note 2: Interference from other cells and noise sources not specified in the test is assumed to be constant over subcarriers and time and shall be modelled as AWGN of appropriate power for N_{oc} to be fulfilled.</p> <p>Note 3: E_s/I_{ot}, RSRP, SCH_RP and I_o have been derived from other parameters for information purposes. They are not settable parameters themselves.</p> <p>Note 4: The resources for uplink transmission are assigned to the UE prior to the start of time period T2.</p> | | | | | |

A.8.1.31.2 Test Requirements

The UE shall send one Event A3 triggered measurement report, with a measurement reporting delay less than 320.8 s from the beginning of time period T2.

The UE shall not send event triggered measurement reports, as long as the reporting criteria are not fulfilled.

The rate of correct events observed during repeated tests shall be at least 90%.

NOTE: The actual overall delays measured in the test may be up to $2 \times TTI_{DCCH}$ higher than the measurement reporting delays above because of TTI insertion uncertainty of the measurement report in DCCH.

A.8.1.32 E-UTRAN FDD-FDD intra-frequency event triggered reporting under fading propagation conditions in synchronous cells for Cat-M1 UE in CEModeB

A.8.1.32.1 Test Purpose and Environment

The purpose of this test is to verify that the Cat-M1 UE makes correct reporting of an event. This test will partly verify the FDD intra-frequency cell search requirements in clause 8.13.3.1.1.1.

The test parameters are given in Table A.8.1.32.1-1 and A.8.1.32.1-2 below. In the measurement control information it is indicated to the UE that event-triggered reporting with Event A3 is used. MPDCCHs indicating new transmissions or retransmissions shall be sent continuously to ensure that the UE would not enter the DRX state. The test consists of two successive time periods, with time duration of T1, and T2 respectively. During time duration T1, the UE shall not have any timing information of cell 2. At the beginning of T2 the transmission power of cell 2 is increased to the same level as for cell 1, and due to usage of an offset this shall result in reporting of Event A3.

Table A.8.1.32.1-1: General test parameters for E-UTRAN FDD-FDD intra-frequency event triggered reporting under fading propagation conditions in synchronous cells for Cat-M1 UE in CEModeB

| Parameter | Unit | Value | Comment |
|--------------------------|------|--------|----------------------------|
| E-UTRA RF Channel Number | | 1 | One radio channel is used. |
| Active cell | | Cell 1 | |
| Neighbour cell | | Cell 2 | Cell to be identified. |
| CP length | | Normal | |
| DRX | | OFF | |

| | | | | |
|--------------------|-----------------|----|------|--------------------------|
| A3 | Offset | dB | -8 | |
| | Hysteresis | dB | 0 | |
| | Time To Trigger | s | 0 | |
| Filter coefficient | | | 0 | L3 filtering is not used |
| Gap pattern ID | | | 0 | |
| T1 | | s | 5 | |
| T2 | | s | ≤325 | |

Table A.8.1.32.1-2: Cell specific test parameters for E-UTRAN FDD-FDD intra-frequency event triggered reporting under fading propagation conditions for Cat-M1 UE in synchronous cells in CEModeB

| Parameter | Unit | Cell 1 | | Cell 2 | |
|---|------------|-----------|--------|-----------------------------|--------|
| | | T1 | T2 | T1 | T2 |
| E-UTRA RF Channel Number | | 1 | | | |
| $BW_{channel}$ | MHz | 10 | | | |
| PDSCH parameters: DL Reference Measurement Channel | | R.23 FDD | | - | |
| MPDCCH parameters: DL Reference Measurement Channel | | R.19 FDD | | R.19 FDD | |
| OCNG Patterns | | OP.21 FDD | | OP.6 FDD | |
| PBCH_RA | dB | -3 | | -3 | |
| PBCH_RB | dB | | | | |
| PSS_RA | dB | | | | |
| SSS_RA | dB | | | | |
| PCFICH_RB | dB | | | | |
| PHICH_RA | dB | | | | |
| PHICH_RB | dB | | | | |
| MPDCCH_RA | dB | | | | |
| MPDCCH_PB | dB | | | | |
| PDSCH_RA | dB | | | | |
| PDSCH_RB | dB | | | | |
| OCNG_RA ^{Note 1} | dB | | | | |
| OCNG_RB ^{Note 1} | dB | | | | |
| N_{oc} ^{Note 2} | dBm/15 KHz | | | | |
| \hat{E}_s / N_{oc} | dB | -12 | -12 | -Infinity | -12 |
| \hat{E}_s / I_{ot} ^{Note 3} | dB | -12 | -12.27 | -Infinity | -12.27 |
| RSRP ^{Note 3} | dBm/15 KHz | -110 | -110 | -Infinity | -110 |
| SCH_RP ^{Note 3} | dBm/15 KHz | -110 | -110 | -Infinity | -110 |
| I_o ^{Note 3} | dBm/9MHz | -69.95 | -69.70 | Specified in Cell 1 columns | |
| Propagation Condition | | ETU30 | | ETU30 | |
| Correlation Matrix and Antenna Configuration | | 2x1 Low | | 2x1 Low | |
| Timing offset to Cell 1 | μs | - | | 3 | |
| <p>Note 1: OCNG shall be used such that all cells are fully allocated and a constant total transmitted power spectral density is achieved for all OFDM symbols.</p> <p>Note 2: Interference from other cells and noise sources not specified in the test is assumed to be constant over subcarriers and time and shall be modelled as AWGN of appropriate power for N_{oc} to be fulfilled.</p> <p>Note 3: E_s/I_{ot}, RSRP, SCH_RP and I_o have been derived from other parameters for information purposes. They are not settable parameters themselves.</p> <p>Note 4: The resources for uplink transmission are assigned to the UE prior to the start of time period T2.</p> | | | | | |

A.8.1.32.2 Test Requirements

The UE shall send one Event A3 triggered measurement report, with a measurement reporting delay less than 320.8 s from the beginning of time period T2.

The UE shall not send event triggered measurement reports, as long as the reporting criteria are not fulfilled.

The rate of correct events observed during repeated tests shall be at least 90%.

NOTE: The actual overall delays measured in the test may be up to $2xTTI_{DCCH}$ higher than the measurement reporting delays above because of TTI insertion uncertainty of the measurement report in DCCH.

A.8.1.33 E-UTRAN HD-FDD intra-frequency event triggered reporting under fading propagation conditions in asynchronous cells for Cat-M1 UE in CEModeB

A.8.1.33.1 Test Purpose and Environment

The purpose of this test is to verify that the Cat-M1 UE makes correct reporting of an event. This test will partly verify the HD-FDD intra-frequency cell search requirements in clause 8.13.3.1.2.1.

The test parameters are given in Table A.8.1.33.1-1 and A.8.1.33.1-2 below. In the measurement control information it is indicated to the UE that event-triggered reporting with Event A3 is used. The test consists of two successive time periods, with time duration of T1 and T2 respectively. During time duration T1, the UE shall not have any timing information of cell 2. At the beginning of T2 the transmission power of cell 2 is increased to the same level as for cell 1, and due to usage of an offset this shall result in reporting of Event A3.

Table A.8.1.33.1-1: General test parameters for E-UTRAN HD-FDD intra-frequency event triggered reporting under fading propagation conditions in asynchronous cells for Cat-M1 UE in CEModeB

| Parameter | | Unit | Value | Comment |
|--------------------------|-----------------|------|------------|---|
| E-UTRA RF Channel Number | | | 1 | One radio channel is used for this test |
| Active Cell | | | Cell 1 | |
| Neighbour cell | | | Cell 2 | Cell to be identified |
| CP length | | | Normal | |
| DRX | | | OFF | |
| A3 | Offset | dB | -8 | |
| | Hysteresis | dB | 0 | |
| | Time To Trigger | s | 0 | |
| Filter coefficient | | | 0 | L3 filtering is not used |
| Gap pattern ID | | | 0 | |
| T1 | | s | 5 | |
| T2 | | s | ≤ 325 | |

Table A.8.1.33.1-2: Cell specific test parameters for E-UTRAN HD-FDD intra-frequency event triggered reporting under fading propagation conditions in asynchronous cells for Cat-M1 UE in CEModeB

| Parameter | Unit | Cell 1 | | Cell 2 | |
|--|------|-------------|----|------------|----|
| | | T1 | T2 | T1 | T2 |
| E-UTRA RF Channel Number | | 1 | | | |
| BW _{channel} | MHz | 10 | | | |
| PDSCH parameters: DL Reference Measurement Channel | | R.13 HD-FDD | | - | |
| MPDCCH parameters: DL Reference Measurement Channel | | R.9 HD-FDD | | R.9 HD-FDD | |
| OCNG Patterns | | OP.21 FDD | | OP.6 FDD | |

| | | | | | |
|--|--|---------|--------|-----------------------------|--------|
| PBCH_RA | dB | -3 | -3 | | |
| PBCH_RB | dB | | | | |
| PSS_RA | dB | | | | |
| SSS_RA | dB | | | | |
| PCFICH_RB | dB | | | | |
| PHICH_RA | dB | | | | |
| PHICH_RB | dB | | | | |
| MPDCCH_RA | dB | | | | |
| MPDCCH_PB | dB | | | | |
| PDSCH_RA | dB | | | | |
| PDSCH_RB | dB | | | | |
| OCNG_RA ^{Note 1} | dB | | | | |
| OCNG_RB ^{Note 1} | dB | | | | |
| N_{oc} ^{Note 2} | dBm/15 kHz | | | -98 | |
| \bar{E}_s/N_{oc} | dB | -12 | -12 | -infinity | -12 |
| \bar{E}_s/I_{ot} ^{Note 3} | dB | -12 | -12.27 | -infinity | -12.27 |
| RSRP ^{Note 3} | dBm/15 kHz | -110 | -110 | -infinity | -110 |
| SCH_RP ^{Note 3} | dBm/15 kHz | -110 | -110 | -infinity | -110 |
| I_o ^{Note 3} | dBm/9MHz | -69.95 | -69.70 | Specified in Cell 1 columns | |
| Propagation Condition | | ETU30 | | ETU30 | |
| Correlation Matrix and Antenna Configuration | | 2x1 Low | | 2x1 Low | |
| Timing offset to Cell 1 | ms | - | | 3 | |
| Note 1: | OCNG shall be used such that all cells are fully allocated and a constant total transmitted power spectral density is achieved for all OFDM symbols. | | | | |
| Note 2: | Interference from other cells and noise sources not specified in the test is assumed to be constant over subcarriers and time and shall be modelled as AWGN of appropriate power for N_{oc} to be fulfilled. | | | | |
| Note 3: | \bar{E}_s/I_{ot} , RSRP, SCH_RP and I_o have been derived from other parameters for information purposes. They are not settable parameters themselves. | | | | |
| Note 4: | The resources for uplink transmission are assigned to the UE prior to the start of time period T2. | | | | |

A.8.1.33.2 Test Requirements

The UE shall send one Event A3 triggered measurement report, with a measurement reporting delay less than 320.8s from the beginning of time period T2.

The UE shall not send event triggered measurement reports as long as the reporting criteria are not fulfilled.

The rate of correct events observed during repeated tests shall be at least 90%.

NOTE: The actual overall delays measured in the tests may be up to $2 \times TTI_{DCCH}$ higher than the measurement reporting delays above because of TTI insertion uncertainty of the measurement report in DCCH.

A.8.1.34 E-UTRAN HD-FDD intra-frequency event triggered reporting under fading propagation conditions in synchronous cells for Cat-M1 UE in CEModeB

A.8.1.34.1 Test Purpose and Environment

The purpose of this test is to verify that the Cat-M1 UE makes correct reporting of an event. This test will partly verify the HD-FDD intra-frequency cell search requirements in clause 8.13.3.1.2.1.

The test parameters are given in Table A.8.1.34.1-1 and A.8.1.34.1-2 below. In the measurement control information it is indicated to the UE that event-triggered reporting with Event A3 is used. The test consists of two successive time periods, with time duration of T1 and T2 respectively. During time duration T1, the UE shall not have any timing information of cell 2. At the beginning of T2 the transmission power of cell 2 is increased to the same level as for cell 1, and due to usage of an offset this shall result in reporting of Event A3.

Table A.8.1.34.1-1: General test parameters for E-UTRAN HD-FDD intra-frequency event triggered reporting under fading propagation conditions in synchronous cells for Cat-M1 UE in CEModeB

| Parameter | | Unit | Value | Comment |
|--------------------------|-----------------|------|--------|---|
| E-UTRA RF Channel Number | | | 1 | One radio channel is used for this test |
| Active cell | | | Cell 1 | |
| Neighbour cell | | | Cell 2 | Cell to be identified. |
| CP length | | | Normal | |
| DRX | | | OFF | |
| A3 | Offset | dB | -8 | |
| | Hysteresis | dB | 0 | |
| | Time To Trigger | s | 0 | |
| Filter coefficient | | | 0 | L3 filtering is not used |
| Gap pattern ID | | | 0 | As specified in TS 36.133 clause 8.1.2.1. |
| T1 | | s | 5 | |
| T2 | | s | ≤325 | |

Table A.8.1.34.1-2: Cell specific test parameters for E-UTRAN HD-FDD intra-frequency event triggered reporting under fading propagation conditions in synchronous cells for Cat-M1 UE in CEModeB

| Parameter | Unit | Cell 1 | | Cell 2 | |
|---|------------|-------------|--------|--------------------------------|--------|
| | | T1 | T2 | T1 | T2 |
| E-UTRA RF Channel Number | | 1 | | | |
| $BW_{channel}$ | MHz | 10 | | | |
| PDSCH parameters: DL Reference Measurement Channel | | R.13 HD-FDD | | - | |
| MPDCCH parameters: DL Reference Measurement Channel | | R.9 HD-FDD | | R.9 HD-FDD | |
| OCNG Patterns | | OP.21 FDD | | OP.6 FDD | |
| PBCH_RA | dB | -3 | | -3 | |
| PBCH_RB | dB | | | | |
| PSS_RA | dB | | | | |
| SSS_RA | dB | | | | |
| PCFICH_RB | dB | | | | |
| PHICH_RA | dB | | | | |
| PHICH_RB | dB | | | | |
| MPDCCH_RA | dB | | | | |
| MPDCCH_PB | dB | | | | |
| PDSCH_RA | dB | | | | |
| PDSCH_RB | dB | | | | |
| OCNG_RA ^{Note 1} | dB | | | | |
| OCNG_RB ^{Note 1} | dB | | | | |
| N_{oc} ^{Note 2} | dBm/15 KHz | | | | |
| \hat{E}_s/N_{oc} | dB | -12 | -12 | -infinity | -12 |
| \hat{E}_s/I_{ot} ^{Note 3} | dB | -12 | -12.27 | -infinity | -12.27 |
| RSRP ^{Note 3} | dBm/15 KHz | -110 | -110 | -infinity | -110 |
| SCH_RP ^{Note 3} | dBm/15 KHz | -110 | -110 | -infinity | -110 |
| I_o ^{Note 3} | dBm/9MHz | -69.95 | -69.70 | Specified in Cell 1 columns | |
| Propagation Condition | | ETU30 | | ETU30 | |
| Correlation Matrix and Antenna Configuration | | 2x1 Low | | 2x1 Low | |
| Timing offset to Cell 1 | μs | - | | 3 | |

| | |
|---------|--|
| Note 1: | OCNG shall be used such that all cells are fully allocated and a constant total transmitted power spectral density is achieved for all OFDM symbols. |
| Note 2: | Interference from other cells and noise sources not specified in the test is assumed to be constant over subcarriers and time and shall be modelled as AWGN of appropriate power for N_{oc} to be fulfilled. |
| Note 3: | E_s/lot , $RSRP$, SCH_RP and I_o have been derived from other parameters for information purposes. They are not settable parameters themselves. |
| Note 4: | The resources for uplink transmission are assigned to the UE prior to the start of time period T2. |

A.8.1.34.2 Test Requirements

The UE shall send one Event A3 triggered measurement report, with a measurement reporting delay less than 320.8s from the beginning of time period T2.

The UE shall not send event triggered measurement reports, as long as the reporting criteria are not fulfilled.

The rate of correct events observed during repeated tests shall be at least 90%.

NOTE: The actual overall delays measured in the test may be up to $2xTTI_{DCCH}$ higher than the measurement reporting delays above because of TTI insertion uncertainty of the measurement report in DCCH.

A.8.1.35 E-UTRAN TDD intra-frequency event triggered reporting under fading propagation conditions in synchronous cells for Cat-M1 UE in CEModeB

A.8.1.35.1 Test Purpose and Environment

The purpose of this test is to verify that the Cat-M1 UE in CEModeB makes correct reporting of an event. This test will partly verify the TDD intra-frequency cell search requirements in clause 8.13.3.1.3.1.

The test parameters are given in Table A.8.1.35.1-1 and A.8.1.35.1-2 below. In the measurement control information it is indicated to the UE that event-triggered reporting with Event A3 is used. The test consists of two successive time periods, with time duration of T1 and T2 respectively. During time duration T1, the UE shall not have any timing information of cell 2. At the beginning of T2 the transmission power of cell 2 is increased to the same level as for cell 1, and due to usage of an offset this shall result in reporting of Event A3.

Table A.8.1.35.1-1: General test parameters for E-UTRAN TDD intra-frequency event triggered reporting under fading propagation conditions in synchronous cells for Cat-M1 UE in CEModeB

| Parameter | Unit | Value | Comments |
|--------------------------------|-----------------|------------|--|
| E-UTRA RF Channel Number | | 1 | One radio channel is used for this test. |
| Active cell | | Cell 1 | |
| Neighbour cell | | Cell 2 | Cell to be identified. |
| CP length | | Normal | |
| DRX | | OFF | |
| A3 | Offset | dB | -8 |
| | Hysteresis | dB | 0 |
| | Time To Trigger | s | 0 |
| Special subframe configuration | | 6 | As specified in table 4.2-1 in TS 36.211. The same configuration in both cells |
| Uplink-downlink configuration | | 1 | As specified in table 4.2-2 in TS 36.211. The same configuration in both cells |
| Filter coefficient | | 0 | L3 filtering is not used |
| Gap Pattern Id | | 0 | |
| T1 | s | 5 | |
| T2 | s | ≤ 325 | |

Table A.8.1.35.1-2: Cell specific test parameters for E-UTRAN TDD intra-frequency event triggered reporting under fading propagation conditions in synchronous cells for Cat-M1 UE in CEModeB

| Parameter | Unit | Cell 1 | | Cell 2 | |
|--|--|-----------|--------|-----------------------------|-----------------------------|
| | | T1 | T2 | T1 | T2 |
| E-UTRA RF Channel Number | | 1 | | | |
| $BW_{channel}$ | MHz | 10 | | | |
| PDSCH parameters: DL Reference Measurement Channel | | R.19 TDD | | - | |
| MPDCCH parameters: DL Reference Measurement Channel | | R.17 TDD | | R.17 TDD | |
| OCNG Patterns | | OP.11 TDD | | OP.2 TDD | |
| PBCH_RA | dB | -3 | | -3 | |
| PBCH_RB | dB | | | | |
| PSS_RA | dB | | | | |
| SSS_RA | dB | | | | |
| PCFICH_RB | dB | | | | |
| PHICH_RA | dB | | | | |
| PHICH_RB | dB | | | | |
| MPDCCH_RA | dB | | | | |
| MPDCCH_RB | dB | | | | |
| PDSCH_RA | dB | | | | |
| PDSCH_RB | dB | | | | |
| OCNG_RA ^{Note 1} | dB | | | | |
| OCNG_RB ^{Note 1} | dB | | | | |
| N_{oc} ^{Note 2} | dBm/15 kHz | | | | |
| \hat{E}_s/N_{oc} | dB | -12 | -12 | -Infinity | -12 |
| \hat{E}_s/I_{ot} ^{Note 3} | dB | -12 | -12.27 | -Infinity | -12.27 |
| RSRP ^{Note 3} | dBm/15 kHz | -110 | -110 | -Infinity | -110 |
| SCH_RP ^{Note 3} | dBm/15 kHz | -110 | -110 | -Infinity | -110 |
| I_o ^{Note 3} | dBm/9 MHz | -69.95 | -69.70 | Specified in Cell 1 columns | Specified in Cell 1 columns |
| Propagation Condition | | ETU30 | | ETU30 | |
| Correlation Matrix and Antenna Configuration | | 2x1 Low | | 2x1 Low | |
| Time offset to Cell 1 | μ s | - | | 3 | |
| Note 1 | OCNG shall be used such that both cells are fully allocated and a constant total transmitted power spectral density is achieved for all OFDM symbols. | | | | |
| Note 2: | Interference from other cells and noise sources not specified in the test is assumed to be constant over subcarriers and time and shall be modelled as AWGN of appropriate power for N_{oc} to be fulfilled. | | | | |
| Note 3: | \hat{E}_s/I_{ot} , RSRP, SCH_RP and I_o levels have been derived from other parameters for information purposes. They are not settable parameters themselves. | | | | |
| Note 4: | The resources for uplink transmission are assigned to the UE prior to the start of time period T2. | | | | |

A.8.1.35.2 Test Requirements

The UE shall send one Event A3 triggered measurement report, with a measurement reporting delay less than 323.2 seconds from the beginning of time period T2.

The UE shall not send event triggered measurement reports, as long as the reporting criteria are not fulfilled.

The rate of correct events observed during repeated tests shall be at least 90%.

NOTE: The actual overall delays measured in the test may be up to $2xTTI_{DCCH}$ higher than the measurement reporting delays above because of TTI insertion uncertainty of the measurement report in DCCH.

A.8.1.36 E-UTRAN FDD Intra-frequency identification of a new CGI of E-UTRA cell using autonomous gaps for Cat-M1 UE in CEModeB

A.8.1.36.1 Test Purpose and Environment

This test is to verify the requirement for identification of a new CGI of E-UTRA cell with autonomous gaps in clause 8.13.3.1.4.

The test scenario comprises of one E-UTRA FDD carrier and two cells as given in tables A.8.1.36.1-1 and A.8.1.36.1-2. The test consists of three successive time periods, with time durations of T1, T2 and T3 respectively. At the start of time duration T1, the UE does not have any timing information of cell 2. Starting T2, cell 2 becomes detectable and the UE is expected to detect and send a measurement report.

A RRC message implying SI reading shall be sent to the UE during period T2, after the UE has reported Event A3. The RRC message shall create a measurement report configuration with purpose *reportCGI* and *si-RequestForHO* set to TRUE. The start of T3 is the instant when the last TTI containing the RRC message implying SI reading is sent to the UE.

Table A.8.1.36.1-1: General test parameters for E-UTRAN FDD Intra-frequency identification of a new CGI of E-UTRA cell using autonomous gaps for Cat-M1 UE in CEModeB

| Parameter | Unit | Value | Comment |
|--------------------|------|--------|--|
| Active cell | | Cell 1 | |
| Neighbour cell | | Cell 2 | Cell to be identified. |
| CP length | | Normal | |
| A3-Offset | dB | -16 | |
| Hysteresis | dB | 0 | |
| Time To Trigger | s | 0 | |
| Filter coefficient | | 0 | L3 filtering is not used |
| DRX | | OFF | |
| si-RequestForHO | | TRUE | As specified in clause 5.5.3.1 in TS 36.331. |
| T1 | s | 5 | |
| T2 | s | ≤ 325 | |
| T3 | s | 7 | |

Table A.8.1.36.1-2: Cell specific test parameters for E-UTRAN FDD Intra-frequency identification of a new CGI of E-UTRA cell using autonomous gaps for Cat-M1 UE in CEModeB

| Parameter | Unit | Cell 1 | | | Cell 2 | | | | | | | | |
|---|------|-----------|----|----|----------|----|----|----|--|--|----|--|--|
| | | T1 | T2 | T3 | T1 | T2 | T3 | | | | | | |
| E-UTRA RF Channel Number | | 1 | | | | | | | | | | | |
| BW _{channel} | MHz | 10 | | | | | | | | | | | |
| PDSCH Reference Channel in clause A.3.1.4.4 | | R.23 FDD | | | N/A | | | | | | | | |
| MPDCCH Reference Channel in clause A.3.1.3.4 | | R.19 FDD | | | N/A | | | | | | | | |
| OCNG Patterns defined in A.3.2.1.21 (OP.21 FDD) and in A.3.2.1.6 (OP.6 FDD) | | OP.21 FDD | | | OP.6 FDD | | | | | | | | |
| PBCH_RA | dB | | | | | | | | | | | | |
| PBCH_RB | dB | | | | | | | | | | | | |
| PSS_RA | dB | | | | | | | -3 | | | -3 | | |
| SSS_RA | dB | | | | | | | | | | | | |
| PHICH_RA | dB | | | | | | | -3 | | | -3 | | |
| PHICH_PB | dB | | | | | | | | | | | | |
| MPDCCH_RA | dB | 0 | | | 0 | | | | | | | | |
| MPDCCH_PB | dB | | | | | | | | | | | | |
| PDSCH_RA | dB | | | | | | | | | | | | |

| | | | | | | | |
|----------------------------|--|--------|--------|--------|---|--------|--------|
| PDSCH_RB | dB | -3 | | | -3 | | |
| OCNG_RA ^{Note 1} | dB | | | | | | |
| OCNG_RB ^{Note 1} | dB | | | | | | |
| N_{oc} ^{Note 2} | dBm/15 KHz | -98 | | | | | |
| \hat{E}_s / N_{oc} | dB | 8 | 8 | 8 | -Infinity | -3 | -3 |
| \hat{E}_s / I_{ot} | | 8 | 6.24 | 6.24 | -Infinity | -11.64 | -11.64 |
| RSRP ^{Note 3} | dBm/15 KHz | -90 | -90 | -90 | -Infinity | -101 | -101 |
| SCH_RP ^{Note 3} | dBm/15 KHz | -90 | -90 | -90 | -Infinity | -101 | -101 |
| I_o ^{Note 3} | dBm/9MHz | -61.58 | -61.29 | -61.29 | Specified in columns for Cell 1 | | |
| Propagation Condition | | AWGN | | | AWGN | | |
| Antenna Configuration | | 2x1 | | | 2x1 | | |
| Timing offset to Cell 1 | ms | - | | | 3 | | |
| PBCH repetition | | | | | Configured as specified in TS 36.211 [16] | | |
| SIB1-BR repetition level | | - | | | 16 | | |
| Note 1: | OCNG shall be used such that both cells are fully allocated and a constant total transmitted power spectral density is achieved for all OFDM symbols. | | | | | | |
| Note 2: | Interference from other cells and noise sources not specified in the test is assumed to be constant over subcarriers and time and shall be modelled as AWGN of appropriate power for N_{oc} to be fulfilled. | | | | | | |
| Note 3: | E_s/I_{ot} , RSRP, SCH_RP and I_o levels have been derived from other parameters for information purposes. They are not settable parameters themselves. | | | | | | |

A.8.1.36.2 Test Requirements

The UE shall transmit a measurement report containing the cell global identifier of cell 2 within 5137 ms from the start of T3.

Test requirement = RRC Procedure delay + $T_{\text{identify_CGI_Cat M1, intra}}$ + reporting delay

= 15 + 5120 + 2ms from the start of T3

= 5137 ms.

The rate of correct events observed during repeated tests shall be at least 90%.

A.8.1.37 E-UTRAN FDD Intra-frequency identification of a new CGI of E-UTRA cell using autonomous gaps with DRX for Cat-M1 UE in CEModeB

A.8.1.37.1 Test Purpose and Environment

This test is to verify the requirement for identification of a new CGI of E-UTRA cell with autonomous gaps in clause 8.13.3.1.4. The requirement is verified in a DRX configuration.

The test scenario comprises of one E-UTRA FDD carrier and two cells as given in tables A.8.1.37.1-1 and A.8.1.37.1-2. The test consists of three successive time periods, with time durations of T1, T2 and T3 respectively. At the start of time duration T1, the UE does not have any timing information of cell 2. Starting T2, cell 2 becomes detectable and the UE is expected to detect and send a measurement report.

A RRC message implying SI reading shall be sent to the UE during period T2, after the UE has reported Event A3. The RRC message shall create a measurement report configuration with purpose *reportCGI* and *si-RequestForHO* set to TRUE. The start of T3 is the instant when the last TTI containing the RRC message implying SI reading is sent to the UE.

In the test UE needs to be provided at least once every 1280ms with new Timing Advance Command MAC control element to restart the Time alignment timer to keep UE uplink time alignment. Furthermore UE sends scheduling request (SR) to obtain allocation to send the measurement report on NPUSCH.

Table A.8.1.37.1-1: General test parameters for E-UTRAN FDD Intra-frequency identification of a new CGI of E-UTRA cell using autonomous gaps with DRX for Cat-M1 UE in CEModeB

| Parameter | Unit | Value | Comment |
|--------------------------------------|------|------------|--|
| Active cell | | Cell 1 | |
| Neighbour cell | | Cell 2 | Cell to be identified. |
| Channel Bandwidth ($BW_{channel}$) | MHz | 10 | |
| CP length | | Normal | |
| A3-Offset | dB | -16 | |
| Hysteresis | dB | 0 | |
| Time To Trigger | s | 0 | |
| Filter coefficient | | 0 | L3 filtering is not used |
| DRX | | ON | DRX related parameters are defined in Table A.8.1.37.1-3 |
| si-RequestForHO | | TRUE | As specified in clause 5.5.3.1 in TS 36.331. |
| T1 | s | 5 | |
| T2 | s | ≤ 325 | |
| T3 | s | 7 | |

Table A.8.1.37.1-2: Cell specific test parameters for E-UTRAN FDD Intra-frequency identification of a new CGI of E-UTRA cell using autonomous gaps with DRX for Cat-M1 UE in CEModeB

| Parameter | Unit | Cell 1 | | | Cell 2 | | |
|---|------------|---|--------|--------|---------------------------------|--------|--------|
| | | T1 | T2 | T3 | T1 | T2 | T3 |
| E-UTRA RF Channel Number | | 1 | | | | | |
| $BW_{channel}$ | MHz | 10 | | | | | |
| PDSCH Reference Channel in clause A.3.1.4.4 | | R.23 FDD | | | N/A | | |
| MPDCCH Reference Channel in clause A.3.1.3.4 | | R.19 FDD | | | N/A | | |
| OCNG Patterns defined in A.3.2.1.21 (OP.21 FDD) and in A.3.2.1.6 (OP.6 FDD) | | OP.21 FDD | | | OP.6 FDD | | |
| PBCH_RA | dB | | | | | | |
| PBCH_RB | dB | | | | | | |
| PSS_RA | dB | | | | | | |
| SSS_RA | dB | | | | | | |
| PHICH_RA | dB | | | | | | |
| PHICH_PB | dB | | | | | | |
| MPDCCH_RA | dB | | | | | | |
| MPDCCH_PB | dB | | | | | | |
| PDSCH_RA | dB | | | | | | |
| PDSCH_RB | dB | | | | | | |
| OCNG_RA ^{Note 1} | dB | -3 | | | -3 | | |
| OCNG_RB ^{Note 1} | dB | -3 | | | -3 | | |
| N_{oc} ^{Note 2} | | -98 | | | | | |
| \hat{E}_s / N_{oc} | dB | 8 | 8 | 8 | -Infinity | -3 | -3 |
| \hat{E}_s / I_{ot} | dB | 8 | 6.24 | 6.24 | -Infinity | -11.64 | -11.64 |
| RSRP ^{Note 3} | dBm/15 KHz | -90 | -90 | -90 | -Infinity | -101 | -101 |
| SCH_RP ^{Note3} | dBm/15 KHz | -90 | -90 | -90 | -Infinity | -101 | -101 |
| I_0 ^{Note 3} | dBm/9MHz | -61.58 | -61.29 | -61.29 | Specified in columns for Cell 1 | | |
| Propagation Condition | | AWGN | | | | | |
| Antenna Configuration | | 2x1 | | | 2x1 | | |
| Timing offset to Cell 1 | ms | - | | | | | |
| PBCH repetition | | 3 | | | | | |
| SIB1-BR repetition level | | Configured as specified in TS 36.211 [16] | | | | | |
| | | 16 | | | | | |

| | |
|---------|--|
| Note 1: | OCNG shall be used such that both cells are fully allocated and a constant total transmitted power spectral density is achieved for all OFDM symbols. |
| Note 2: | Interference from other cells and noise sources not specified in the test is assumed to be constant over subcarriers and time and shall be modelled as AWGN of appropriate power for N_{oc} to be fulfilled. |
| Note 3: | Es/lot, RSRP, SCH_RP and Io levels have been derived from other parameters for information purposes. They are not settable parameters themselves. |

Table A.8.1.37.1-3: DRX configuration for E-UTRAN FDD Intra-frequency identification of a new CGI of E-UTRA cell using autonomous gaps with DRX for Cat-M1 UE in CEModeB

| Field | Value | Comment |
|--------------------------|---------|---|
| onDurationTimer | psf1 | As specified in clause 6.3.2 in TS 36.331 |
| drx-InactivityTimer | psf1 | |
| drx-RetransmissionTimer | psf1 | |
| longDRX-CycleStartOffset | sf1280 | |
| shortDRX | disable | |

Table A.8.1.37.1-4: *TimeAlignmentTimer* -Configuration for E-UTRAN FDD Intra-frequency identification of a new CGI of E-UTRA cell using autonomous gaps with DRX for Cat-M1 UE in CeModeB

| Field | Value | Comment |
|--------------------|----------|--|
| TimeAlignmentTimer | Infinity | As specified in clause 6.3.2 in TS 36.331 |
| sr-ConfigIndex | 0 | For further information see clause 6.3.2 in TS 36.331 and section 10.1 in TS 36.213. |

A.8.1.37.2 Test Requirements

The UE shall transmit a measurement report containing the cell global identifier of cell 2 within 5120 ms from the start of T3.

$$\begin{aligned} \text{Test requirement} &= \text{RRC Procedure delay} + T_{\text{identify_CGI_Cat M1, intra}} + \text{reporting delay} \\ &= 15 + 5120 + 2 \text{ms from the start of T3} \\ &= 5137 \text{ ms.} \end{aligned}$$

The rate of correct events observed during repeated tests shall be at least 90%.

A.8.1.38 E-UTRAN HD - FDD Intra-frequency identification of a new CGI of E-UTRA cell using autonomous gaps for Cat-M1 UE in CEModeB

A.8.1.38.1 Test Purpose and Environment

This test is to verify the requirement for identification of a new CGI of E-UTRA cell with autonomous gaps in clause 8.13.3.1.5.

The test scenario comprises of one E-UTRA FDD carrier and two cells as given in tables A.8.1.38.1-1 and A.8.1.38.1-2. The test consists of three successive time periods, with time durations of T1, T2 and T3 respectively. At the start of time duration T1, the UE does not have any timing information of cell 2. Starting T2, cell 2 becomes detectable and the UE is expected to detect and send a measurement report.

A RRC message implying SI reading shall be sent to the UE during period T2, after the UE has reported Event A3. The RRC message shall create a measurement report configuration with purpose *reportCGI* and *si-RequestForHO* set to

TRUE. The start of T3 is the instant when the last TTI containing the RRC message implying SI reading is sent to the UE.

Table A.8.1.38.1-1: General test parameters for E-UTRAN HD - FDD Intra-frequency identification of a new CGI of E-UTRA cell using autonomous gaps for Cat-M1 UE in CEModeB

| Parameter | Unit | Value | Comment |
|--------------------------------------|------|------------|--|
| Active cell | | Cell 1 | |
| Neighbour cell | | Cell 2 | Cell to be identified. |
| Channel Bandwidth ($BW_{channel}$) | MHz | 10 | |
| CP length | | Normal | |
| A3-Offset | dB | -16 | |
| Hysteresis | dB | 0 | |
| Time To Trigger | s | 0 | |
| Filter coefficient | | 0 | L3 filtering is not used |
| DRX | | OFF | |
| si-RequestForHO | | TRUE | As specified in clause 5.5.3.1 in TS 36.331. |
| T1 | s | 5 | |
| T2 | s | ≤ 325 | |
| T3 | s | 7 | |

Table A.8.1.38.1-2: Cell specific test parameters for E-UTRAN HD - FDD Intra-frequency identification of a new CGI of E-UTRA cell using autonomous gaps for Cat-M1 UE in CEModeB

| Parameter | Unit | Cell 1 | | | Cell 2 | | |
|---|------------|-------------|-----------|-----------|---------------------------------|----------|----------|
| | | T1 | T2 | T3 | T1 | T2 | T3 |
| E-UTRA RF Channel Number | | 1 | | | 1 | | |
| $BW_{channel}$ | MHz | 10 | | | 10 | | |
| PDSCH Reference Channel in clause A.3.1.4.5 | | R.13 HD-FDD | | | N/A | | |
| MPDCCH Reference Channel in clause A.3.1.3.5 | | R.9 HD-FDD | | | N/A | | |
| OCNG Patterns defined in A.3.2.1.21 (OP.21 FDD) and in A.3.2.1.2 (OP.2 FDD) | | OP.21 FDD | OP.21 FDD | OP.21 FDD | OP.6 FDD | OP.6 FDD | OP.6 FDD |
| PBCH_RA | dB | | | | | | |
| PBCH_RB | dB | | | | | | |
| PSS_RA | dB | -3 | | | -3 | | |
| SSS_RA | dB | | | | | | |
| PHICH_RA | dB | -3 | | | -3 | | |
| PHICH_PB | dB | | | | | | |
| MPDCCH_RA | dB | 0 | | | 0 | | |
| MPDCCH_PB | dB | | | | | | |
| PDSCH_RA | dB | | | | | | |
| PDSCH_RB | dB | -3 | | | -3 | | |
| OCNG_RA ^{Note 1} | dB | | | | | | |
| OCNG_RB ^{Note 1} | dB | | | | | | |
| N_{oc} ^{Note 2} | | -98 | | | | | |
| \hat{E}_s / N_{oc} | dB | 8 | 8 | 8 | -Infinity | -3 | -3 |
| \hat{E}_s / I_{ot} | dB | 8 | 6.24 | 6.24 | -Infinity | -11.64 | -11.64 |
| RSRP ^{Note 3} | dBm/15 KHz | -90 | -90 | -90 | -Infinity | -101 | -101 |
| SCH_RP ^{Note 3} | dBm/15 KHz | -90 | -90 | -90 | -Infinity | -101 | -101 |
| I_o ^{Note 3} | dBm/9MHz | -61.58 | -61.29 | -61.29 | Specified in columns for Cell 1 | | |
| Propagation Condition | | AWGN | | | | | |
| Antenna Configuration | | 2x1 | | | 2x1 | | |
| Timing offset to Cell 1 | ms | - | | | 3 | | |

| | | | |
|--------------------------|--|--|---|
| PBCH repetition | | | Configured as specified in TS 36.211 [16] |
| SIB1-BR repetition level | | | 16 |
| Note 1: | OCNG shall be used such that both cells are fully allocated and a constant total transmitted power spectral density is achieved for all OFDM symbols. | | |
| Note 2: | Interference from other cells and noise sources not specified in the test is assumed to be constant over subcarriers and time and shall be modelled as AWGN of appropriate power for N_{oc} to be fulfilled. | | |
| Note 3: | Es/lot, RSRP, SCH_RP and Io levels have been derived from other parameters for information purposes. They are not settable parameters themselves. | | |

A.8.1.38.2 Test Requirements

The UE shall transmit a measurement report containing the cell global identifier of cell 2 within 5137 ms from the start of T3.

Test requirement = RRC Procedure delay + $T_{\text{identify_CGI_Cat M1, intra}}$ + reporting delay

$$= 15 + 5120 + 2\text{ms from the start of T3}$$

$$= 5137 \text{ ms.}$$

The rate of correct events observed during repeated tests shall be at least 90%.

A.8.1.39 E-UTRAN HD - FDD Intra-frequency identification of a new CGI of E-UTRA cell using autonomous gaps with DRX for Cat-M1 UE in CEModeB

A.8.1.39.1 Test Purpose and Environment

This test is to verify the requirement for identification of a new CGI of E-UTRA cell with autonomous gaps in clause 8.13.3.1.5. The requirement is verified in a DRX configuration.

The test scenario comprises of one E-UTRA FDD carrier and two cells as given in tables A.8.1.39.1-1 and A.8.1.39.1-2. The test consists of three successive time periods, with time durations of T1, T2 and T3 respectively. At the start of time duration T1, the UE does not have any timing information of cell 2. Starting T2, cell 2 becomes detectable and the UE is expected to detect and send a measurement report.

A RRC message implying SI reading shall be sent to the UE during period T2, after the UE has reported Event A3. The RRC message shall create a measurement report configuration with purpose *reportCGI* and *si-RequestForHO* set to TRUE. The start of T3 is the instant when the last TTI containing the RRC message implying SI reading is sent to the UE.

In the test UE needs to be provided at least once every 1280ms with new Timing Advance Command MAC control element to restart the Time alignment timer to keep UE uplink time alignment. Furthermore UE sends scheduling request (SR) to obtain allocation to send the measurement report on NPUSCH.

Table A.8.1.39.1-1: General test parameters for E-UTRAN HD - FDD Intra-frequency identification of a new CGI of E-UTRA cell using autonomous gaps with DRX for Cat-M1 UE in CEModeB

| Parameter | Unit | Value | Comment |
|---|------|--------|--|
| Active cell | | Cell 1 | |
| Neighbour cell | | Cell 2 | Cell to be identified. |
| Channel Bandwidth (BW_{channel}) | MHz | 10 | |
| CP length | | Normal | |
| A3-Offset | dB | -16 | |
| Hysteresis | dB | 0 | |
| Time To Trigger | s | 0 | |
| Filter coefficient | | 0 | L3 filtering is not used |
| DRX | | ON | DRX related parameters are defined in Table A.8.1.39.1-3 |

| | | | |
|-----------------|---|------|--|
| si-RequestForHO | | TRUE | As specified in clause 5.5.3.1 in TS 36.331. |
| T1 | s | 5 | |
| T2 | s | ≤325 | |
| T3 | s | 7 | |

Table A.8.1.39.1-2: Cell specific test parameters for E-UTRAN HD - FDD Intra-frequency identification of a new CGI of E-UTRA cell using autonomous gaps with DRX for Cat-M1 UE in CEModeB

| Parameter | Unit | Cell 1 | | | Cell 2 | | |
|---|------------|--|-----------|-----------|---|----------|----------|
| | | T1 | T2 | T3 | T1 | T2 | T3 |
| E-UTRA RF Channel Number | | 1 | | | 1 | | |
| BW _{channel} | MHz | 10 | | | 10 | | |
| PDSCH Reference Channel as specified in clause A.3.1.4.5 | | DL Reference Measurement Channel R.13 HD-FDD | | | N/A | | |
| MPDCCH Reference Channel as specified in clause A.3.1.3.5 | | DL Reference Measurement Channel R.9 HD-FDD | | | N/A | | |
| OCNG Patterns defined in A.3.2.1.21 (OP.21 FDD) and in A.3.2.1.6 (OP.6 FDD) | | OP.21 FDD | OP.21 FDD | OP.21 FDD | OP.6 FDD | OP.6 FDD | OP.6 FDD |
| PBCH_RA | dB | | | | | | |
| PBCH_RB | dB | | | | | | |
| PSS_RA | dB | -3 | | | -3 | | |
| SSS_RA | dB | | | | | | |
| PHICH_RA | dB | -3 | | | -3 | | |
| PHICH_PB | dB | | | | | | |
| MPDCCH_RA | dB | 0 | | | 0 | | |
| MPDCCH_PB | dB | | | | | | |
| PDSCH_RA | dB | | | | | | |
| PDSCH_RB | dB | -3 | | | -3 | | |
| OCNG_RA ^{Note 1} | dB | | | | | | |
| OCNG_RB ^{Note 1} | dB | | | | | | |
| N_{oc} ^{Note 2} | dBm/15 KHz | -98 | | | | | |
| \hat{E}_s / N_{oc} | dB | 8 | 8 | 8 | -Infinity | -3 | -3 |
| \hat{E}_s / I_{ot} | dB | 8 | 6.24 | 6.24 | -Infinity | -11.64 | -11.64 |
| RSRP ^{Note 3} | dBm/15 KHz | -90 | -90 | -90 | -Infinity | -101 | -101 |
| SCH_RP ^{Note 3} | dBm/15 KHz | -90 | -90 | -90 | -Infinity | -101 | -101 |
| I_o ^{Note 3} | dBm/9MHz | -61.58 | -61.29 | -61.29 | Specified in columns for Cell 1 | | |
| Propagation Condition | | AWGN | | | | | |
| Antenna Configuration | | 2x1 | | | 2x1 | | |
| Timing offset to Cell 1 | ms | - | | | 3 | | |
| PBCH repetition | | - | | | Configured as specified in TS 36.211 [16] | | |
| SIB1-BR repetition level | | - | | | 16 | | |
| <p>Note 1: OCNG shall be used such that both cells are fully allocated and a constant total transmitted power spectral density is achieved for all OFDM symbols.</p> <p>Note 2: Interference from other cells and noise sources not specified in the test is assumed to be constant over subcarriers and time and shall be modelled as AWGN of appropriate power for N_{oc} to be fulfilled.</p> <p>Note 3: E_s/I_{ot}, RSRP, SCH_RP and I_o levels have been derived from other parameters for information purposes. They are not settable parameters themselves.</p> | | | | | | | |

Table A.8.1.39.1-3: DRX configuration for E-UTRAN HD - FDD Intra-frequency identification of a new CGI of E-UTRA cell using autonomous gaps with DRX for Cat-M1 UE in CEModeB

| Field | Value | Comment |
|-----------------|-------|------------------------------------|
| onDurationTimer | psf1 | As specified in clause 6.3.2 in TS |

| | | |
|--------------------------|---------|--------|
| drx-InactivityTimer | psf1 | 36.331 |
| drx-RetransmissionTimer | psf1 | |
| longDRX-CycleStartOffset | sf1280 | |
| shortDRX | disable | |

Table A.8.1.39.1-4: TimeAlignmentTimer -Configuration for E-UTRAN HD - FDD Intra-frequency identification of a new CGI of E-UTRA cell using autonomous gaps with DRX for Cat-M1 UE in CEModeB

| Field | Value | Comment |
|--------------------|----------|--|
| TimeAlignmentTimer | Infinity | As specified in clause 6.3.2 in TS 36.331 |
| sr-ConfigIndex | 0 | For further information see clause 6.3.2 in TS 36.331 and section 10.1 in TS 36.213. |

A.8.1.39.2 Test Requirements

The UE shall transmit a measurement report containing the cell global identifier of cell 2 within 5137 ms from the start of T3.

Test requirement = RRC Procedure delay + $T_{\text{identify_CGI_Cat M1, intra}}$ + reporting delay

= 15 + 5120 + 2ms from the start of T3

= 5137 ms.

The rate of correct events observed during repeated tests shall be at least 90%.

A.8.2 E-UTRAN TDD Intra-frequency Measurements

A.8.2.1 E-UTRAN TDD-TDD intra-frequency event triggered reporting under fading propagation conditions in synchronous cells

A.8.2.1.1 Test Purpose and Environment

The purpose of this test is to verify that the UE makes correct reporting of an event. This test will partly verify the TDD intra-frequency cell search requirements in clause 8.1.2.2.1.

The test parameters are given in Table A.8.2.1.1-1 and A.8.2.1.1-2 below. In the measurement control information it is indicated to the UE that event-triggered reporting with Event A3 is used. PDCCHs indicating new transmissions or retransmissions shall be sent continuously to ensure that the UE would not enter the DRX state. The test consists of two successive time periods, with time duration of T1, and T2 respectively. During time duration T1, the UE shall not have any timing information of cell 2.

Table A.8.2.1.1-1: General test parameters for E-UTRAN TDD-TDD intra-frequency event triggered reporting under fading propagation conditions in synchronous cells

| Parameter | Unit | Value | Comment |
|---|------|--|------------------------------------|
| PDSCH parameters | | DL Reference Measurement Channel R.0 TDD | As specified in clause A.3.1.1.2 |
| PCFICH/PDCCH/PHICH parameters | | DL Reference Measurement Channel R.6 TDD | As specified in clause A.3.1.2.2 |
| Active cell | | Cell 1 | |
| Neighbour cell | | Cell 2 | Cell to be identified. |
| E-UTRA RF Channel Number | | 1 | One TDD carrier frequency is used. |
| Channel Bandwidth (BW_{channel}) | MHz | 10 | |
| A3-Offset | dB | -6 | |
| CP length | | Normal | |

| | | | |
|--------------------------------|----|-------|--|
| Special subframe configuration | | 6 | As specified in table 4.2-1 in TS 36.211. The same configuration in both cells |
| Uplink-downlink configuration | | 1 | As specified in table 4.2-2 in TS 36.211. The same configuration in both cells |
| Hysteresis | dB | 0 | |
| Time To Trigger | s | 0 | |
| Filter coefficient | | 0 | L3 filtering is not used |
| DRX | | DRX_L | As specified in clause A.3.3 |
| Time offset between cells | | 3 μs | Synchronous cells |
| T1 | s | 5 | |
| T2 | s | 5 | |

Table A.8.2.1.1-2: Cell specific test parameters for E-UTRAN TDD-TDD intra-frequency event triggered reporting under fading propagation conditions in synchronous cells

| Parameter | Unit | Cell 1 | | Cell 2 | |
|--|------------|----------|-------|-----------|-------|
| | | T1 | T2 | T1 | T2 |
| E-UTRA RF Channel Number | | 1 | | 1 | |
| BW _{channel} | MHz | 10 | | 10 | |
| Correlation Matrix and Antenna Configuration | | 1x2 Low | | 1x2 Low | |
| OCNG Pattern defined in A.3.2.2.1 (OP.1 TDD) and in A.3.2.2.2 (OP.2) | | OP.1 TDD | | OP.2 TDD | |
| PBCH_RA | dB | 0 | | 0 | |
| PBCH_RB | dB | | | | |
| PSS_RA | dB | | | | |
| SSS_RA | dB | | | | |
| PCFICH_RB | dB | | | | |
| PHICH_RA | dB | | | | |
| PHICH_RB | dB | | | | |
| PDCCH_RA | dB | | | | |
| PDCCH_RB | dB | | | | |
| PDSCH_RA | dB | | | | |
| PDSCH_RB | dB | | | | |
| OCNG_RA ^{Note 1} | dB | | | | |
| OCNG_RB ^{Note 1} | dB | | | | |
| N_{oc} ^{Note 3} | dBm/15 kHz | | | | |
| RSRP ^{Note 4} | dBm/15 kHz | -94 | -94 | -Infinity | -94 |
| \hat{E}_s / I_{ot} | dB | 4 | -1.46 | -Infinity | -1.46 |
| SCH_RP ^{Note 4} | dBm/15 kHz | -94 | -94 | -Infinity | -94 |
| \hat{E}_s / N_{oc} | dB | 4 | 4 | -Infinity | 4 |
| Propagation Condition | | ETU70 | | | |
| <p>Note 1: OCNG shall be used such that both cells are fully allocated and a constant total transmitted power spectral density is achieved for all OFDM symbols.</p> <p>Note 2: The resources for uplink transmission are assigned to the UE prior to the start of time period T2.</p> <p>Note 3: Interference from other cells and noise sources not specified in the test is assumed to be constant over subcarriers and time and shall be modelled as AWGN of appropriate power for N_{oc} to be fulfilled.</p> <p>Note 4: RSRP and SCH_RP levels have been derived from other parameters for information purposes. They are not settable parameters themselves.</p> | | | | | |

A.8.2.1.2 Test Requirements

The UE shall send one Event A3 triggered measurement report, with a measurement reporting delay less than 800 ms from the beginning of time period T2.

The UE shall not send event triggered measurement reports, as long as the reporting criteria are not fulfilled.

The rate of correct events observed during repeated tests shall be at least 90%.

NOTE: The actual overall delays measured in the test may be up to $2 \times TTI_{DCCH}$ higher than the measurement reporting delays above because of TTI insertion uncertainty of the measurement report in DCCH.

A.8.2.2 E-UTRAN TDD-TDD intra-frequency event triggered reporting under fading propagation conditions in synchronous cells with DRX

A.8.2.2.1 Test Purpose and Environment

The purpose of the two tests is to verify that the UE makes correct reporting of an event in DRX. The tests will partly verify the TDD-TDD intra-frequency cell search in DRX requirements in clause 8.1.2.2.1.2.

The test parameters are given in Tables A.8.1.3.1-1, A.8.1.3.1-2, A.8.1.3.1-3 and A.8.1.3.1-4. In the measurement control information, it is indicated to the UE that event-triggered reporting with Event A3 is used. The test consists of two successive time periods, with time duration of T1, and T2 respectively. During time duration T1, the UE shall not have any timing information of cell 2.

In Test 1 UE needs to be provided at least once every 500ms with new Timing Advance Command MAC control element to restart the Time alignment timer to keep UE uplink time alignment. Furthermore UE is allocated with PUSCH resource at every DRX cycle.

In Test 2 the uplink time alignment is not maintained and UE needs to use RACH to obtain UL allocation for measurement reporting.

Table A.8.2.2.1-1: General test parameters for E-UTRAN TDD-TDD intra-frequency event triggered reporting under fading propagation conditions in synchronous cells when DRX is used

| Parameter | Unit | Value | | Comment |
|--------------------------------------|------|--|--------|--|
| | | Test 1 | Test 2 | |
| PDSCH parameters | | DL Reference Measurement Channel R.0 TDD | | As specified in clause A.3.1.1.2 |
| PCFICH/PDCCH/PHICH parameters | | DL Reference Measurement Channel R.6 TDD | | As specified in clause A.3.1.2.2 |
| Active cell | | Cell 1 | | |
| Neighbour cell | | Cell 2 | | Cell to be identified. |
| E-UTRA RF Channel Number | | 1 | | One TDD carrier frequency is used. |
| Channel Bandwidth ($BW_{channel}$) | MHz | 10 | | |
| A3-Offset | dB | -6 | | |
| CP length | | Normal | | |
| Special subframe configuration | | 6 | | As specified in table 4.2-1 in TS 36.211. The same configuration in both cells |
| Uplink-downlink configuration | | 1 | | As specified in table 4.2-2 in TS 36.211. The same configuration in both cells |
| Hysteresis | dB | 0 | | |
| Time To Trigger | s | 0 | | |
| Filter coefficient | | 0 | | L3 filtering is not used |
| DRX | | ON | | DRX related parameters are defined in Table A.8.2.2.1-3 |
| Time offset between cells | | 3 μ s | | Synchronous cells |
| T1 | s | 5 | | |
| T2 | s | 5 | 30 | |

Table A.8.2.2.1-2: Cell specific test parameters for E-UTRAN TDD-TDD intra-frequency event triggered reporting under fading propagation conditions in synchronous cells when DRX is used

| Parameter | Unit | Cell 1 | | Cell 2 | |
|--------------------------|------|--------|----|--------|----|
| | | T1 | T2 | T1 | T2 |
| E-UTRA RF Channel Number | | 1 | | 1 | |
| $BW_{channel}$ | MHz | 10 | | 10 | |

| | | | | | |
|--|------------|----------|-------|-----------|-------|
| Correlation Matrix and Antenna Configuration | | 1x2 Low | | 1x2 Low | |
| OCNG Pattern defined in A.3.2.2.1 (OP.1 TDD) and in A.3.2.2.2 (OP.2) | | OP.1 TDD | | OP.2 TDD | |
| PBCH_RA | dB | 0 | | 0 | |
| PBCH_RB | dB | | | | |
| PSS_RA | dB | | | | |
| SSS_RA | dB | | | | |
| PCFICH_RB | dB | | | | |
| PHICH_RA | dB | | | | |
| PHICH_RB | dB | | | | |
| PDCCH_RA | dB | | | | |
| PDCCH_RB | dB | | | | |
| PDSCH_RA | dB | | | | |
| PDSCH_RB | dB | | | | |
| OCNG_RA ^{Note 1} | dB | | | | |
| OCNG_RB ^{Note 1} | dB | | | | |
| N_{oc} ^{Note 2} | dBm/15 kHz | -98 | | | |
| RSRP ^{Note 3} | dBm/15 kHz | -94 | -94 | -Infinity | -94 |
| \hat{E}_s / I_{ot} | dB | 4 | -1.46 | -Infinity | -1.46 |
| SCH_RP ^{Note 3} | dBm/15 kHz | -94 | -94 | -Infinity | -94 |
| \hat{E}_s / N_{oc} | dB | 4 | 4 | -Infinity | 4 |
| Propagation Condition | | ETU70 | | | |

Note 1: OCNG shall be used such that both cells are fully allocated and a constant total transmitted power spectral density is achieved for all OFDM symbols.

Note 2: Interference from other cells and noise sources not specified in the test is assumed to be constant over subcarriers and time and shall be modelled as AWGN of appropriate power for N_{oc} to be fulfilled.

Note 3: RSRP and SCH_RP levels have been derived from other parameters for information purposes. They are not settable parameters themselves.

Table A.8.2.2.1-3: DRX-Configuration for E-UTRAN TDD-TDD intra-frequency event triggered reporting in DRX under fading propagation conditions in synchronous cells

| Field | Test1 | Test2 | Comment |
|--------------------------|---------|---------|---|
| | Value | Value | |
| onDurationTimer | psf1 | psf1 | As specified in clause 6.3.2 in TS 36.331 |
| drx-InactivityTimer | psf1 | psf1 | |
| drx-RetransmissionTimer | psf1 | psf1 | |
| longDRX-CycleStartOffset | sf40 | sf1280 | |
| shortDRX | disable | disable | |

Table A.8.2.2.1-4: TimeAlignmentTimer-Configuration for E-UTRAN TDD-TDD intra-frequency event triggered reporting in DRX under fading propagation conditions in synchronous cells

| Field | Test1 | Test2 | Comment |
|--------------------|-------|-------|---|
| | Value | Value | |
| TimeAlignmentTimer | sf500 | sf500 | As specified in clause 6.3.2 in TS 36.331 |
| sr-ConfigIndex | 2 | 2 | For further information see clause 6.3.2 in TS 36.331 and clause 10.1 in TS 36.213. |

A.8.2.2.2 Test Requirements

In Test 1, the UE shall send one Event A3 triggered measurement report, with a measurement reporting delay less than 800 ms from the beginning of time period T2. The measurement reporting delay is defined as the time from the beginning of time period T2 to the moment when the UE send the measurement report on PUSCH.

In Test 2, the UE shall send one Event A3 triggered measurement report, with a measurement reporting delay less than 25600 ms from the beginning of time period T2. The measurement reporting delay is defined as the time from the beginning of time period T2 to the moment when the UE starts to send preambles on the PRACH for scheduling request (SR) to obtain allocation to send the measurement report on PUSCH.

The UE shall not send event triggered measurement reports, as long as the reporting criteria are not fulfilled.

The rate of correct events observed during repeated tests shall be at least 90%.

NOTE: The actual overall delays measured in the test may be up to one DRX cycle higher than the measurement reporting delays above because UE is allowed to delay the initiation of the measurement reporting procedure to the next until the Active Time.

NOTE 2: In order to calculate the rate of correct events the system simulator shall verify that it has received correct Event A3 measurement report.

A.8.2.3 E-UTRAN TDD - TDD Intra-frequency identification of a new CGI of E-UTRA cell using autonomous gaps

A.8.2.3.1 Test Purpose and Environment

This test is to verify the requirement for identification of a new CGI of E-UTRA cell with autonomous gaps in clause 8.1.2.2.4.

The test scenario comprises of one E-UTRA TDD carrier and two cells as given in tables A.8.2.3.1-1 and A.8.2.3.1-2. PDCCHs indicating new transmissions shall be sent continuously to ensure that the UE would have ACK/NACK sending during identifying a new CGI of E-UTRAN cell. The test consists of three successive time periods, with time durations of T1, T2 and T3 respectively. At the start of time duration T1, the UE does not have any timing information of cell 2. Starting T2, cell 2 becomes detectable and the UE is expected to detect and send a measurement report.

A RRC message implying SI reading shall be sent to the UE during period T2, after the UE has reported Event A3. The RRC message shall create a measurement report configuration with purpose *reportCGI* and *si-RequestForHO* set to TRUE. The start of T3 is the instant when the last TTI containing the RRC message implying SI reading is sent to the UE.

Table A.8.2.3.1-1: General test parameters for E-UTRAN TDD - TDD Intra-frequency identification of a new CGI of E-UTRA cell using autonomous gaps

| Parameter | Unit | Value | Comment |
|--|------|--|--|
| PDSCH parameters | | DL Reference Measurement Channel R.0 TDD | As specified in clause A.3.1.1.2 |
| PCFICH/PDCCH/PHICH parameters | | DL Reference Measurement Channel R.6 TDD | As specified in clause A.3.1.2.2 |
| Active cell | | Cell 1 | |
| Neighbour cell | | Cell 2 | Cell to be identified. |
| E-UTRA RF Channel Number | | 1 | Only one TDD carrier frequency is used. |
| Channel Bandwidth (BW _{channel}) | MHz | 10 | |
| CP length | | Normal | |
| Special subframe configuration | | 6 | As specified in table 4.2-1 in TS 36.211. The same configuration in both cells |
| Uplink-downlink configuration | | 1 | As specified in table 4.2-2 in TS 36.211. The same configuration in both cells |
| A3-Offset | dB | -3 | |
| Hysteresis | dB | 0 | |
| Time To Trigger | s | 0 | |

| | | | |
|---------------------------|----|------|--|
| Filter coefficient | | 0 | L3 filtering is not used |
| DRX | | OFF | |
| si-RequestForHO | | TRUE | As specified in clause 5.5.3.1 in TS 36.331. |
| Time offset between cells | μs | 3 | Synchronous cells |
| T1 | s | 5 | |
| T2 | s | ≤10 | |
| T3 | s | 5 | |

Table A.8.2.3.1-2: Cell specific test parameters for E-UTRAN TDD - TDD Intra-frequency identification of a new CGI of E-UTRA cell using autonomous gaps

| Parameter | Unit | Cell 1 | | | Cell 2 | | |
|--|------------|----------|----------|----------|-----------|----------|----------|
| | | T1 | T2 | T3 | T1 | T2 | T3 |
| E-UTRA RF Channel Number | | 1 | | | 1 | | |
| BW _{channel} | MHz | 10 | | | 10 | | |
| OCNG Patterns defined in A.3.2.2.1 (OP.1 TDD) and in A.3.2.2.2 (OP.2 TDD) | | OP.1 TDD | OP.1 TDD | OP.1 TDD | OP.2 TDD | OP.2 TDD | OP.2 TDD |
| PBCH_RA | dB | 0 | | | 0 | | |
| PBCH_RB | dB | | | | | | |
| PSS_RA | dB | | | | | | |
| SSS_RA | dB | | | | | | |
| PCFICH_RB | dB | | | | | | |
| PHICH_RA | dB | | | | | | |
| PHICH_RB | dB | | | | | | |
| PDCCH_RA | dB | | | | | | |
| PDCCH_RB | dB | | | | | | |
| PDSCH_RA | dB | | | | | | |
| PDSCH_RB | dB | | | | | | |
| OCNG_RA ^{Note 1} | dB | | | | | | |
| OCNG_RB ^{Note 1} | dB | | | | | | |
| \hat{E}_s / I_{ot} | dB | 8 | -3.3 | -3.3 | -Infinity | 2.36 | 2.36 |
| N_{oc} ^{Note 2} | dBm/15 KHz | -98 | | | | | |
| \hat{E}_s / N_{oc} | dB | 8 | 8 | 8 | -Infinity | 11 | 11 |
| RSRP ^{Note 3} | dBm/15 KHz | -90 | -90 | -90 | -Infinity | -87 | -87 |
| SCH_RP ^{Note 3} | dBm/15 KHz | -90 | -90 | -90 | -Infinity | -87 | -87 |
| Propagation Condition | | AWGN | | | | | |
| <p>Note 1: OCNG shall be used such that both cells are fully allocated and a constant total transmitted power spectral density is achieved for all OFDM symbols.</p> <p>Note 2: Interference from other cells and noise sources not specified in the test is assumed to be constant over subcarriers and time and shall be modelled as AWGN of appropriate power for N_{oc} to be fulfilled.</p> <p>Note 3: RSRP and SCH_RP levels have been derived from other parameters for information purposes. They are not settable parameters themselves.</p> | | | | | | | |

A.8.2.3.2 Test Requirements

The UE shall transmit a measurement report containing the cell global identifier of cell 2 within 170 milliseconds from the start of T3.

$$\text{Test requirement} = \text{RRC Procedure delay} + T_{\text{identify_CGI, intra}} + \text{reporting delay}$$

$$= 15 + 150 + 2\text{ms from the start of T3}$$

$$= 167 \text{ ms, allow } 170 \text{ ms.}$$

The UE shall be scheduled continuously throughout the test, and from the start of T3 until 170 ms at least 47 ACK/NACK shall be detected as being transmitted by the UE.

The rate of correct events observed during repeated tests shall be at least 90%.

NOTE: The overall 47 ACK/NACK number is caused by two parts. Firstly, at least 35 ACK/NACK shall be sent during identifying the cell global identifier of cell 2 according to the requirement for UL/DL configuration #1 in Table 8.1.2.2.4.1-1 of Clause 8.1.2.2.4.1. Secondly, given that continuous DL data allocation, additional 12 ACK/NACK shall be sent from the start of T3 until 170 ms excludes 150 ms for identifying the cell global identifier of cell 2.

A.8.2.4 E-UTRAN TDD - TDD Intra-frequency identification of a new CGI of E-UTRA cell using autonomous gaps with DRX

A.8.2.4.1 Test Purpose and Environment

This test is to verify the requirement for identification of a new CGI of E-UTRA cell with autonomous gaps in clause 8.1.2.2.4. The requirement is verified in a DRX configuration.

The test scenario comprises of one E-UTRA TDD carrier and two cells as given in tables A.8.2.4.1-1, A.8.2.4.1-2, A.8.2.4.1-3 and A.8.2.4.1-4. The test consists of three successive time periods, with time durations of T1, T2 and T3 respectively. At the start of time duration T1, the UE does not have any timing information of cell 2. Starting T2, cell 2 becomes detectable and the UE is expected to detect and send a measurement report.

A RRC message implying SI reading shall be sent to the UE during period T2, after the UE has reported Event A3. The RRC message shall create a measurement report configuration with purpose *reportCGI* and *si-RequestForHO* set to TRUE. The start of T3 is the instant when the last TTI containing the RRC message implying SI reading is sent to the UE.

In the test UE needs to be provided at least once every 1280ms with new Timing Advance Command MAC control element to restart the Time alignment timer to keep UE uplink time alignment. Furthermore UE sends scheduling request (SR) to obtain allocation to send the measurement report on PUSCH.

Table A.8.2.4.1-1: General test parameters for E-UTRAN TDD - TDD Intra-frequency identification of a new CGI of E-UTRA cell using autonomous gaps with DRX

| Parameter | Unit | Value | Comment |
|--------------------------------|------|--|--|
| PDSCH parameters | | DL Reference Measurement Channel R.0 TDD | As specified in clause A.3.1.1.2 |
| PCFICH/PDCCH/PHICH parameters | | DL Reference Measurement Channel R.6 TDD | As specified in clause A.3.1.2.2 |
| Active cell | | Cell 1 | |
| Neighbour cell | | Cell 2 | Cell to be identified. |
| E-UTRA RF Channel Number | | 1 | Only one TDD carrier frequency is used. |
| Channel Bandwidth (BWchannel) | MHz | 10 | |
| CP length | | Normal | |
| Special subframe configuration | | 6 | As specified in table 4.2-1 in TS 36.211. The same configuration in both cells |
| Uplink-downlink configuration | | 1 | As specified in table 4.2-2 in TS 36.211. The same configuration in both cells |
| A3-Offset | dB | -3 | |
| Hysteresis | dB | 0 | |
| Time To Trigger | s | 0 | |
| Filter coefficient | | 0 | L3 filtering is not used |
| DRX | | ON | DRX related parameters are defined in Table A.8.2.4.1-3 |
| si-RequestForHO | | TRUE | As specified in clause 5.5.3.1 in TS 36.331. |
| Time offset between cells | μs | 3 | Synchronous cells |
| T1 | s | 5 | |
| T2 | s | ≤30 | UE shall report cell within 25.6s (20 DRX cycles) |
| T3 | s | 5 | |

Table A.8.2.4.1-2: Cell specific test parameters for E-UTRAN TDD - TDD Intra-frequency identification of a new CGI of E-UTRA cell using autonomous gaps with DRX

| Parameter | Unit | Cell 1 | | | Cell 2 | | |
|--|------------|----------|----------|----------|-----------|----------|----------|
| | | T1 | T2 | T3 | T1 | T2 | T3 |
| E-UTRA RF Channel Number | | 1 | | | 1 | | |
| BW _{channel} | MHz | 10 | | | 10 | | |
| OCNG Patterns defined in A.3.2.2.1 (OP.1 TDD) and in A.3.2.2.2 (OP.2 TDD) | | OP.1 TDD | OP.1 TDD | OP.1 TDD | OP.2 TDD | OP.2 TDD | OP.2 TDD |
| PBCH_RA | dB | 0 | | | 0 | | |
| PBCH_RB | dB | | | | | | |
| PSS_RA | dB | | | | | | |
| SSS_RA | dB | | | | | | |
| PCFICH_RB | dB | | | | | | |
| PHICH_RA | dB | | | | | | |
| PHICH_RB | dB | | | | | | |
| PDCCH_RA | dB | | | | | | |
| PDCCH_RB | dB | | | | | | |
| PDSCH_RA | dB | | | | | | |
| PDSCH_RB | dB | | | | | | |
| OCNG_RA ^{Note 1} | dB | | | | | | |
| OCNG_RB ^{Note 1} | dB | | | | | | |
| \hat{E}_s / I_{ot} | dB | 8 | -3.3 | -3.3 | -Infinity | 2.36 | 2.36 |
| N_{oc} ^{Note 2} | dBm/15 KHz | -98 | | | | | |
| \hat{E}_s / N_{oc} | dB | 8 | 8 | 8 | -Infinity | 11 | 11 |
| RSRP ^{Note 3} | dBm/15 KHz | -90 | -90 | -90 | -Infinity | -87 | -87 |
| SCH_RP ^{Note 3} | dBm/15 KHz | -90 | -90 | -90 | -Infinity | -87 | -87 |
| Propagation Condition | | AWGN | | | | | |
| <p>Note 1: OCNG shall be used such that both cells are fully allocated and a constant total transmitted power spectral density is achieved for all OFDM symbols.</p> <p>Note 2: Interference from other cells and noise sources not specified in the test is assumed to be constant over subcarriers and time and shall be modelled as AWGN of appropriate power for N_{oc} to be fulfilled.</p> <p>Note 3: RSRP and SCH_RP levels have been derived from other parameters for information purposes. They are not settable parameters themselves.</p> | | | | | | | |

Table A.8.2.4.1-3: DRX configuration for E-UTRAN TDD - TDD Intra-frequency identification of a new CGI of E-UTRA cell using autonomous gaps with DRX

| Field | Value | Comment |
|--------------------------|---------|---|
| onDurationTimer | psf1 | As specified in clause 6.3.2 in TS 36.331 |
| drx-InactivityTimer | psf1 | |
| drx-RetransmissionTimer | psf1 | |
| longDRX-CycleStartOffset | sf1280 | |
| shortDRX | disable | |

Table A.8.2.4.1-4: TimeAlignmentTimer-Configuration for E-UTRAN TDD - TDD Intra frequency identification of a new CGI of E-UTRA cell using autonomous gaps with DRX

| Field | Value | Comment |
|--------------------|----------|--|
| TimeAlignmentTimer | Infinity | As specified in clause 6.3.2 in TS 36.331 |
| sr-ConfigIndex | 2 | For further information see clause 6.3.2 in TS 36.331 and section 10.1 in TS 36.213. |

A.8.2.4.2 Test Requirements

The UE shall transmit a measurement report containing the cell global identifier of cell 2 within 170 milliseconds from the start of T3.

Test requirement = RRC Procedure delay + $T_{\text{identify_CGI, intra}}$ + reporting delay

= 15 + 150 + 2ms from the start of T3

= 167 ms, allow 170 ms.

The rate of correct events observed during repeated tests shall be at least 90%.

A.8.2.5 E-UTRAN TDD-TDD Intra-Frequency Event-Triggered Reporting under Time Domain Measurement Resource Restriction with Non-MBSFN ABS

A.8.2.5.1 Test Purpose and Environment

The purpose of this test is to verify that the UE correctly detects and reports Event A3 (Neighbour becomes offset better than PCell) defined in TS 36.331 [2] within the requirements specified in Clause 8.1.2.8.2.1 under a time domain measurement resource restriction and non-MBSFN ABS configured in the aggressor cell.

The test parameters are given in Tables A.8.2.5.1-1 and A.8.2.5.1-2 below. It is indicated to the UE in the measurement control information that event-triggered reporting with Event A3 is used. In the test there are two synchronous cells, Cell 1 and Cell 2, on the same RF channel. Cell 1 is the PCell, and it is also the aggressor cell to Cell 2. Cell 2 is the cell to be identified. The test consists of two successive time periods with time duration of T1 and T2, respectively. During time duration T1, the UE shall not have any timing information on Cell 2.

Non-MBSFN ABS pattern is configured for Cell 1 during the test. The UE is configured by higher layers via Cell 1 with a time domain measurement resource restriction pattern for performing E-UTRAN TDD intra-frequency measurements on neighbour cells. The UE is also configured with a time domain measurement resource restriction pattern for the PCell measurements. The information for both measurement patterns shall be provided to the UE via higher layers during T1.

Table A.8.2.5.1-1: General test parameters for E-UTRAN TDD-TDD intra-frequency event triggered reporting under time domain measurement resource restriction with non-MBSFN ABS

| Parameter | Unit | Value | Comment |
|---|------|--|--|
| PDSCH parameters | | DL Reference Measurement Channel R.0 TDD | As specified in clause A.3.1.1.2 |
| PCFICH/PDCCH/PHICH parameters | | DL Reference Measurement Channel R.6 TDD | As specified in clause A.3.1.2.2 |
| PCell | | Cell 1 | Also the aggressor cell. Active in T1 and T2 |
| Neighbour cell | | Cell 2 | Cell to be identified. Active only in T2. |
| PCell ABS configuration | | Non-MBSFN ABS | As defined in Table A.3.4.1.1-1 |
| E-UTRA RF Channel Number | | 1 | One TDD carrier frequency is used. |
| Channel Bandwidth (BW_{channel}) | MHz | 10 | |
| A3-Offset | dB | -11 | |
| Event A3 measurement quantity | | RSRP | |
| CP length | | Normal | |
| Special subframe configuration | | 6 | As specified in Table 4.2-1 in TS 36.211. The same configuration in both cells |
| Uplink-downlink configuration | | 1 | As specified in Table 4.2-2 in TS 36.211. The same configuration in both cells |
| Hysteresis | dB | 0 | |
| Time To Trigger | s | 0 | |
| Filter coefficient | | 0 | L3 filtering is not used |
| DRX | | | OFF |
| Time offset between cells | | 3 μ s | Synchronous cells |
| T1 | s | 5 | |

| | | | |
|--|---|--|--|
| T2 | s | 5 | |
| Physical cell ID PCI | | $(PCI_{cell1} - PCI_{cell2}) \bmod 6 \neq 0$ | Cell PCIs are selected so that the condition is met |
| ABS pattern | | '00000000010000000001' | TDD ABS Pattern Info IE, as defined in TS 36.423 [28], clause 9.2.54. Configured in Cell 1 during T1. The first/leftmost bit corresponds to the subframe #0 of the radio frame satisfying $SFN \bmod x = 0$, where x is the size of the bit string (20) divided by 10. No MBSFN subframes are configured in the ABS subframes. |
| Time domain measurement resource restriction pattern for neighbour cell measurements on RF Channel 1 | | '00000000010000000001' | Time domain measurement resource restriction pattern for neighbor cell measurement signalled to the UE in measSubframePattern-Neigh IE in measSubframePatternConfig-Neigh, as defined in TS 36.331, clause 6.3.5. Configured during T1 for Cell 2 measurements. |
| Time domain measurement resource restriction pattern for PCell measurements | | '10000000001000000000' | Configured during T1 for Cell 1 measurements |

Table A.8.2.5.1-2: Cell specific test parameters for E-UTRAN TDD-TDD intra-frequency event triggered reporting under time domain measurement resource restriction with non-MBSFN ABS

| Parameter | Unit | Cell 1 | | Cell 2 | |
|--|------------|---|------|-----------|------|
| | | T1 | T2 | T1 | T2 |
| E-UTRA RF Channel Number | | 1 | | 1 | |
| BW _{channel} | MHz | 10 | | 10 | |
| Correlation Matrix and Antenna Configuration | | 1x2 Low | | 1x2 Low | |
| OCNG Pattern defined in A.3.2.2.1 (OP.1 TDD) and in A.3.2.2.2 (OP.2) | | OP.1 TDD | | OP.2 TDD | |
| PBCH_RA | dB | Non-ABS and ABS subframe channel powers defined in Table A.3.4.1.1-1. | | 0 | |
| PBCH_RB | dB | | | | |
| PSS_RA | dB | | | | |
| SSS_RA | dB | | | | |
| PCFICH_RB | dB | | | | |
| PHICH_RA | dB | | | | |
| PHICH_RB | dB | | | | |
| PDCCH_RA | dB | | | | |
| PDCCH_RB | dB | | | | |
| PDSCH_RA | dB | | | | |
| PDSCH_RB | dB | | | | |
| OCNG_RA ^{Note 1} | dB | | | | |
| OCNG_RB ^{Note 1} | dB | | | | |
| N_{oc} ^{Note 3} | dBm/15 kHz | | | | |
| $(\hat{E}_s / N_{oc})_{meas}$ ^{Note 5} | dB | 1 | 1 | -Infinity | -4 |
| $(\hat{E}_s / N_{oc})_{ABS}$ | dB | 1 | 1 | N/A | N/A |
| RSRP ^{Note 4,5} | dBm/15 kHz | -97 | -97 | -Infinity | -102 |
| SCH_RP ^{Note 4} | dBm/15 kHz | -97 | -97 | -Infinity | -102 |
| CRS \hat{E}_s / I_{ot} | dB | 1 | -0.5 | -Infinity | -4 |
| SCH \hat{E}_s / I_{ot} | dB | 1 | -0.5 | -Infinity | -7.5 |
| Propagation Condition | | ETU30 | | | |

| | |
|---------|--|
| Note 1: | OCNG shall be used such that both cells are fully allocated and a constant total transmitted power spectral density is achieved for all OFDM symbols. |
| Note 2: | The resources for uplink transmission are assigned to the UE prior to the start of time period T2. |
| Note 3: | Interference from other cells and noise sources not specified in the test is assumed to be constant over subcarriers and time and shall be modelled as AWGN of appropriate power for N_{oc} to be fulfilled. Applies to all subframes. |
| Note 4: | RSRP and SCH_RP levels have been derived from other parameters for information purposes. They are not settable parameters themselves. |
| Note 5: | RSPP is estimated for Cell 2 during the restricted measurement subframes for neighbour cells. RSPP is estimated for Cell 1 during the PCell restricted subframes. |

A.8.2.5.2 Test Requirements

The UE shall send one Event A3 triggered measurement report for Cell 2, with a measurement reporting delay less than 1000 ms from the beginning of time period T2.

The UE shall not send event-triggered measurement reports as long as the reporting criteria are not fulfilled.

The rate of correct events observed during repeated tests shall be at least 90% for the tested Event A3.

NOTE: The actual overall delays measured in the tests may be up to $2 \times TTI_{DCCH}$ higher than the measurement reporting delays above because of TTI insertion uncertainty of the measurement report in DCCH.

A.8.2.6 E-UTRAN TDD-TDD Intra-Frequency Event-Triggered Reporting under Time Domain Measurement Resource Restriction with CRS Assistance Information and Non-MBSFN ABS

A.8.2.6.1 Test Purpose and Environment

The purpose of this test is to verify that the UE correctly detects and reports Event A3 (neighbour becomes offset better than PCell) defined in TS 36.331 [2] within the requirements specified in Clause 8.1.2.8.4, when the UE is provided with a time-domain measurement resource restriction pattern and CRS assistance information, and when non-MBSFN ABS configured in the interfering cells.

The test parameters are given in Tables A.8.2.6.1-1 and A.8.2.6.1-2 below. It is indicated to the UE in the measurement control information that event-triggered reporting with Event A3 is used. In the test, there are three synchronous cells, Cell 1, Cell 2, and Cell 3, on the same RF channel. Cell 1 is the PCell. Cell 3 is the cell to be identified. A non-MBSFN ABS pattern is configured in each of the Cell 1 and Cell 2 during the entire test. The test consists of two successive time periods with time duration of T1 and T2, respectively. During time duration T1, the UE shall not have any timing information on Cell 3.

The UE is configured by higher layers with a time domain measurement resource restriction pattern for performing E-UTRAN TDD intra-frequency measurements on neighbour cells, namely Cell 3 measurements. The UE is also provided via higher layers with the CRS assistance information for Cell 2. The information for both measurement patterns and the CRS assistance information shall be provided via RRC to the UE during T1.

Table A.8.2.6.1-1: General test parameters for E-UTRAN TDD-TDD intra-frequency event triggered reporting under time domain measurement resource restriction with CRS assistance information and non-MBSFN ABS

| Parameter | Unit | Value | Comment |
|-------------------------------|------|--|--|
| PDSCH parameters | | DL Reference Measurement Channel R.0 TDD | As specified in clause A.3.1.1.2 |
| PCFICH/PDCCH/PHICH parameters | | DL Reference Measurement Channel R.6 TDD | As specified in clause A.3.1.2.2 |
| PCell | | Cell 1 | Also a first interfering cell to Cell 3. Active in T1 and T2. |
| Neighbour cells | | Cell 2 and Cell 3 | Cell 2 is a second interfering cell; Cell 2 is active in T1 and T2. Cell 3 is the cell to be identified; Cell 3 is active only in T2. |

| | | | | |
|--|--------------------------|---|--|---|
| ABS transmission configuration | | Non-MBSFN ABS | | As defined in Table A.3.4.1.1-1 |
| E-UTRA RF Channel Number | | 1 | | One TDD carrier frequency is used |
| Channel Bandwidth ($BW_{channel}$) | MHz | 10 | | For all cells in the test |
| A3-Offset | dB | -14 | | |
| Event A3 measurement quantity | | RSRP | | |
| CP length | | Normal | | |
| Special subframe configuration | | 6 | | As specified in Table 4.2-1 in TS 36.211. The same configuration in both cells |
| Uplink-downlink configuration | | 1 | | As specified in Table 4.2-2 in TS 36.211. The same configuration in both cells |
| Hysteresis | dB | 0 | | |
| Time To Trigger | s | 0 | | |
| Filter coefficient | | 0 | | L3 filtering is not used |
| DRX | | | | OFF |
| Time offset between cells | μ s | Cell 2 offset with respect to Cell 1: 0 Cell 3 offset with respect to Cell 1: -2.5 | | Three synchronous cells |
| T1 | s | 5 | | |
| T2 | s | 5 | | |
| Physical cell IDs | | $(PCI_{cell1} - PCI_{cell3}) \bmod 6 = 0$ $(PCI_{cell2} - PCI_{cell3}) \bmod 6 \neq 0$ PCI_{cell1} not equal to PCI_{cell3} | | Cell PCIs are selected so that all conditions are met |
| ABS pattern | | '00000000010000000001' | | TDD ABS Pattern Info IE, as defined in TS 36.423 [28], clause 9.2.54. The first/leftmost bit corresponds to the Pcell subframe #0 of the radio frame satisfying $SFN \bmod x = 0$, where x is the size of the bit string (20) divided by 10. No MBSFN subframes are configured in the ABS subframes. Provided to the UE for Cell 1 and Cell 2 during T1. |
| Time domain measurement resource restriction pattern for neighbour cell measurements on RF Channel 1 | | '00000000010000000001' | | Time domain measurement resource restriction pattern for neighbor cell measurement signalled to the UE in measSubframePatternNeigh IE in measSubframePatternConfigNeigh, as defined in TS 36.331, clause 6.3.5. Provided to the UE during T1 for Cell 3 measurements. The cell list in measSubframeCellList IE shall contain Cell 3 but not Cell 2. |
| Time domain measurement resource restriction pattern for PCell measurements | | '10000000001000000000' | | Configured during T1 for Cell 1 measurements |
| CRS assistance information | physCellId | see PCI conditions above | | The CRS assistance information is provided for Cell 2 only in CRS-AssistanceInfo. It includes a single MBSFN-SubframeConfig element with subframe allocation <i>one Frame</i> ='000000'. |
| | antennaPortsCount | 1 | | |
| | mbsfn-SubframeConfigList | <i>oneFrame</i> = '000000' | | |

Table A.8.2.6.1-2: Cell specific test parameters for E-UTRAN TDD-TDD intra-frequency event triggered reporting under time domain measurement resource restriction with CRS assistance information and non-MBSFN ABS

| Parameter | Unit | Cell 1 | | Cell 2 | | Cell 3 | |
|--------------------------|------|--------|----|--------|----|--------|----|
| | | T1 | T2 | T1 | T2 | T1 | T2 |
| E-UTRA RF Channel Number | | 1 | | 1 | | 1 | |
| $BW_{channel}$ | MHz | 10 | | 10 | | 10 | |

| Correlation Matrix and Antenna Configuration | | 1x2 Low | | 1x2 Low | | 1x2 Low | |
|---|------------|---|-------|---|-------|-----------|----------|
| OCNG Patterns defined in A.3.2.2.1 (OP.1 TDD) and in A.3.2.2.2 (OP.2 TDD) | | OP.1 TDD | | OP.2 TDD | | N/A | OP.2 TDD |
| PBCH_RA | dB | Non-ABS and ABS subframe channel powers defined in Table A.3.4.1.1-1. | | Non-ABS and ABS subframe channel powers defined in Table A.3.4.1.1-1. | | N/A | 0 |
| PBCH_RB | dB | | | | | | |
| PSS_RA | dB | | | | | | |
| SSS_RA | dB | | | | | | |
| PCFICH_RB | dB | | | | | | |
| PHICH_RA | dB | | | | | | |
| PHICH_RB | dB | | | | | | |
| PDCCH_RA | dB | | | | | | |
| PDCCH_RB | dB | | | | | | |
| PDSCH_RA | dB | | | | | | |
| PDSCH_RB | dB | | | | | | |
| OCNG_RA ^{Note 1} | dB | | | | | | |
| OCNG_RB ^{Note 1} | dB | | | | | | |
| N_{oc} ^{Note 3} | dBm/15 kHz | -98 | | | | | |
| (\hat{E}_s / N_{oc}) | dB | 4 | 4 | 2 | 2 | -Infinity | -4 |
| RSRP ^{Note 4} | dBm/15 kHz | -94 | -94 | -96 | -96 | -Infinity | -102 |
| SCH_RP ^{Note 4} | dBm/15 kHz | -94 | -94 | -96 | -96 | -Infinity | -102 |
| CRS \hat{E}_s / I_{ot} ^{Note 5} | dB | 4 | 2.54 | 2 | 0.54 | -Infinity | -9.46 |
| SCH \hat{E}_s / I_{ot} | dB | -0.12 | -0.75 | -3.45 | -3.92 | -Infinity | -11.07 |
| Propagation Condition | | ETU30 | | ETU30 | | ETU30 | |
| <p>NOTE 1: OCNG shall be used such that all cells are fully allocated and a constant total transmitted power spectral density is achieved for all OFDM symbols.</p> <p>NOTE 2: The resources for uplink transmission are assigned to the UE prior to the start of time period T2.</p> <p>NOTE 3: Interference from other cells and noise sources not specified in the test is assumed to be constant over subcarriers and time and shall be modelled as AWGN of appropriate power for N_{oc} to be fulfilled. Applies to all subframes.</p> <p>NOTE 4: RSRP, SCH_RP, and \hat{E}_s / I_{ot} levels have been derived from other parameters for information purposes. They are not settable parameters themselves.</p> <p>NOTE 5: Applies during the restricted measurement subframes configured for neighbour cell (Cell 3) measurements.</p> | | | | | | | |

A.8.2.6.2 Test Requirements

The UE shall send one Event A3 triggered measurement report for Cell 3, with a measurement reporting delay less than 1000 ms from the beginning of time period T2.

The UE shall not send event-triggered measurement reports as long as the reporting criteria are not fulfilled.

The rate of correct events observed during repeated tests shall be at least 90% for the tested Event A3.

NOTE: The actual overall delays measured in the tests may be up to $2 \times TTI_{DCCH}$ higher than the measurement reporting delays above because of TTI insertion uncertainty of the measurement report in DCCH.

A.8.2.7 E-UTRAN TDD Intra-frequency identification of a new CGI of E-UTRA cell using autonomous gaps

A.8.2.7.1 Test Purpose and Environment

This test is to verify the requirement for identification of a new CGI of E-UTRA cell with autonomous gaps in clause 8.5.2.1.6.

The test scenario comprises of one E-UTRA TDD carrier and two cells as given in tables A.8.2.7.1-1 and A.8.2.7.1-2. PDCCHs indicating new transmissions should be sent continuously to ensure that the UE would have ACK/NACK sending during identifying a new CGI of E-UTRAN cell. The test consists of three successive time periods, with time durations of T1, T2 and T3 respectively. At the start of time duration T1, the UE does not have any timing information of cell 2. Starting T2, cell 2 becomes detectable and the UE is expected to detect and send a measurement report.

A RRC message implying SI reading shall be sent to the UE during period T2, after the UE has reported Event A3. The RRC message shall create a measurement report configuration with purpose *reportCGI* and *si-RequestForHO* set to TRUE. The start of T3 is the instant when the last TTI containing the RRC message implying SI reading is sent to the UE.

Table A.8.2.7.1-1: General test parameters for E-UTRAN TDD Intra-frequency identification of a new CGI of E-UTRA cell using autonomous gaps

| Parameter | Unit | Value | Comment |
|--|------|---|--|
| PDSCH parameters | | DL Reference Measurement Channel R.13 TDD | As specified in clause A.3.1.1.5 |
| PCFICH/PDCCH/PHICH parameters | | DL Reference Measurement Channel R.7 TDD | As specified in clause A.3.1.2.2 |
| Active cell | | Cell 1 | |
| Neighbour cell | | Cell 2 | Cell to be identified. |
| E-UTRA RF Channel Number | | 1 | Only one TDD carrier frequency is used. |
| Channel Bandwidth (BW _{channel}) | MHz | 10 | |
| CP length | | Normal | |
| Special subframe configuration | | 6 | As specified in table 4.2-1 in TS 36.211. The same configuration in both cells |
| Uplink-downlink configuration | | 1 | As specified in table 4.2-2 in TS 36.211. The same configuration in both cells |
| A3-Offset | dB | -3 | |
| Hysteresis | dB | 0 | |
| Time To Trigger | s | 0 | |
| Filter coefficient | | 0 | L3 filtering is not used |
| DRX | | OFF | |
| si-RequestForHO | | TRUE | As specified in clause 5.5.3.1 in TS 36.331. |
| T1 | s | 5 | |
| T2 | s | ≤10 | |
| T3 | s | 5 | |

Table A.8.2.7.1-2: Cell specific test parameters for E-UTRAN TDD Intra-frequency identification of a new CGI of E-UTRA cell using autonomous gaps

| Parameter | Unit | Cell 1 | | | Cell 2 | | |
|---|------|----------|----------|----------|----------|----------|----------|
| | | T1 | T2 | T3 | T1 | T2 | T3 |
| E-UTRA RF Channel Number | | 1 | | | 1 | | |
| BW _{channel} | MHz | 10 | | | 10 | | |
| Correlation Matrix and Antenna Configuration | | 2x1 | | | 2x1 | | |
| OCNG Patterns defined in A.3.2.2.1 (OP.1 TDD) and in A.3.2.2.2 (OP.2 TDD) | | OP.1 TDD | OP.1 TDD | OP.1 TDD | OP.2 TDD | OP.2 TDD | OP.2 TDD |
| PBCH_RA | dB | -3 | | | -3 | | |
| PBCH_RB | dB | | | | | | |
| PSS_RA | dB | | | | | | |
| SSS_RA | dB | | | | | | |
| PCFICH_RB | dB | 0 | | | 0 | | |
| PHICH_RA | dB | -3 | | | -3 | | |
| PHICH_RB | dB | | | | | | |
| PDCCH_RA | dB | 0 | | | 0 | | |
| PDCCH_RB | dB | | | | | | |
| PDSCH_RA | dB | | | | | | |

| | | | | | | | |
|----------------------------|--|------|------|------|-----------|------|------|
| PDSCH_RB | dB | -3 | | | -3 | | |
| OCNG_RA ^{Note 1} | dB | | | | | | |
| OCNG_RB ^{Note 1} | dB | | | | | | |
| \hat{E}_s / I_{ot} | dB | 8 | -3.3 | -3.3 | -Infinity | 2.36 | 2.36 |
| N_{oc} ^{Note 2} | dBm/15 KHz | -98 | | | | | |
| \hat{E}_s / N_{oc} | dB | 8 | 8 | 8 | -Infinity | 11 | 11 |
| RSRP ^{Note 3} | dBm/15 KHz | -90 | -90 | -90 | -Infinity | -87 | -87 |
| SCH_RP ^{Note 3} | dBm/15 KHz | -90 | -90 | -90 | -Infinity | -87 | -87 |
| Propagation Condition | | AWGN | | | | | |
| Timing offset to Cell 1 | μ s | - | | | 3 | | |
| Note 1: | OCNG shall be used such that both cells are fully allocated and a constant total transmitted power spectral density is achieved for all OFDM symbols. | | | | | | |
| Note 2: | Interference from other cells and noise sources not specified in the test is assumed to be constant over subcarriers and time and shall be modelled as AWGN of appropriate power for N_{oc} to be fulfilled. | | | | | | |
| Note 3: | RSRP and SCH_RP levels have been derived from other parameters for information purposes. They are not settable parameters themselves. | | | | | | |

A.8.2.7.2 Test Requirements

The UE shall transmit a measurement report containing the cell global identifier of cell 2 within 210 milliseconds from the start of T3.

Test requirement = RRC Procedure delay + $T_{\text{identify_CGI_LC-UE, intra}}$ + reporting delay

= 15 + 190 + 2ms from the start of T3

= 207 ms, allow 210 ms.

The UE shall be scheduled continuously throughout the test, and from the start of T3 until 190 ms at least 66 ACK/NACK shall be detected as being transmitted by the UE.

The rate of correct events observed during repeated tests shall be at least 90%.

NOTE: The overall 66 ACK/NACK number is caused by two parts. Firstly, at least 54 ACK/NACK shall be sent during identifying the cell global identifier of cell 2 according to the requirement for UL/DL configuration #1 in Table 8.1.2.2.4.1-1 of Clause 8.1.2.2.4.1. Secondly, given that continuous DL data allocation, additional 12 ACK/NACK shall be sent from the start of T3 until 210 ms excludes 190 ms for identifying the cell global identifier of cell 2.

A.8.2.8 E-UTRAN TDD Intra-frequency identification of a new CGI of E-UTRA cell using autonomous gaps with DRX

A.8.2.8.1 Test Purpose and Environment

This test is to verify the requirement for identification of a new CGI of E-UTRA cell with autonomous gaps in clause 8.5.2.1.6. The requirement is verified in a DRX configuration.

The test scenario comprises of one E-UTRA TDD carrier and two cells as given in tables A.8.2.8.1-1, A.8.2.8.1-2, A.8.2.8.1-3 and A.8.2.8.1-4. The test consists of three successive time periods, with time durations of T1, T2 and T3 respectively. At the start of time duration T1, the UE does not have any timing information of cell 2. Starting T2, cell 2 becomes detectable and the UE is expected to detect and send a measurement report.

A RRC message implying SI reading shall be sent to the UE during period T2, after the UE has reported Event A3. The RRC message shall create a measurement report configuration with purpose *reportCGI* and *si-RequestForHO* set to TRUE. The start of T3 is the instant when the last TTI containing the RRC message implying SI reading is sent to the UE.

In the test UE needs to be provided at least once every 1280ms with new Timing Advance Command MAC control element to restart the Time alignment timer to keep UE uplink time alignment. Furthermore UE sends scheduling request (SR) to obtain allocation to send the measurement report on PUSCH.

Table A.8.2.8.1-1: General test parameters for E-UTRAN TDD Intra-frequency identification of a new CGI of E-UTRA cell using autonomous gaps with DRX

| Parameter | Unit | Value | Comment |
|--|------|---|--|
| PDSCH parameters | | DL Reference Measurement Channel R.13 TDD | As specified in clause A.3.1.1.5 |
| PCFICH/PDCCH/PHICH parameters | | DL Reference Measurement Channel R.7 TDD | As specified in clause A.3.1.2.2 |
| Active cell | | Cell 1 | |
| Neighbour cell | | Cell 2 | Cell to be identified. |
| E-UTRA RF Channel Number | | 1 | Only one TDD carrier frequency is used. |
| Channel Bandwidth (BW _{channel}) | MHz | 10 | |
| CP length | | Normal | |
| Special subframe configuration | | 6 | As specified in table 4.2-1 in TS 36.211. The same configuration in both cells |
| Uplink-downlink configuration | | 1 | As specified in table 4.2-2 in TS 36.211. The same configuration in both cells |
| A3-Offset | dB | -3 | |
| Hysteresis | dB | 0 | |
| Time To Trigger | s | 0 | |
| Filter coefficient | | 0 | L3 filtering is not used |
| DRX | | ON | DRX related parameters are defined in Table A.8.2.4.1-3 |
| si-RequestForHO | | TRUE | As specified in clause 5.5.3.1 in TS 36.331. |
| T1 | s | 5 | |
| T2 | s | ≤30 | UE should report cell within 25.6s (20 DRX cycles) |
| T3 | s | 5 | |

Table A.8.2.8.1-2: Cell specific test parameters for E-UTRAN TDD Intra-frequency identification of a new CGI of E-UTRA cell using autonomous gaps with DRX

| Parameter | Unit | Cell 1 | | | Cell 2 | | |
|---|------|----------|----------|----------|-----------|----------|----------|
| | | T1 | T2 | T3 | T1 | T2 | T3 |
| E-UTRA RF Channel Number | | 1 | | | 1 | | |
| BW _{channel} | MHz | 10 | | | 10 | | |
| Correlation Matrix and Antenna Configuration | | 2x1 | | | 2x1 | | |
| OCNG Patterns defined in A.3.2.2.1 (OP.1 TDD) and in A.3.2.2.2 (OP.2 TDD) | | OP.1 TDD | OP.1 TDD | OP.1 TDD | OP.2 TDD | OP.2 TDD | OP.2 TDD |
| PBCH_RA | dB | -3 | | | -3 | | |
| PBCH_RB | dB | | | | | | |
| PSS_RA | dB | | | | | | |
| SSS_RA | dB | | | | | | |
| PCFICH_RB | dB | 0 | | | 0 | | |
| PHICH_RA | dB | -3 | | | -3 | | |
| PHICH_RB | dB | | | | | | |
| PDCCH_RA | dB | 0 | | | 0 | | |
| PDCCH_RB | dB | | | | | | |
| PDSCH_RA | dB | -3 | | | -3 | | |
| PDSCH_RB | dB | | | | | | |
| OCNG_RA ^{Note 1} | dB | | | | | | |
| OCNG_RB ^{Note 1} | dB | 8 | | | -Infinity | | |
| \hat{E}_s/I_{ot} | dB | | | | | | |

| | | | | | | | |
|----------------------------|--|------|-----|-----|-----------|-----|-----|
| N_{oc} ^{Note 2} | dBm/15 KHz | -98 | | | | | |
| \hat{E}_s/N_{oc} | dB | 8 | 8 | 8 | -Infinity | 11 | 11 |
| RSRP ^{Note 3} | dBm/15 KHz | -90 | -90 | -90 | -Infinity | -87 | -87 |
| SCH_RP ^{Note 3} | dBm/15 KHz | -90 | -90 | -90 | -Infinity | -87 | -87 |
| Propagation Condition | | AWGN | | | | | |
| Timing offset to Cell 1 | μ s | - | | | 3 | | |
| Note 1: | OCNG shall be used such that both cells are fully allocated and a constant total transmitted power spectral density is achieved for all OFDM symbols. | | | | | | |
| Note 2: | Interference from other cells and noise sources not specified in the test is assumed to be constant over subcarriers and time and shall be modelled as AWGN of appropriate power for N_{oc} to be fulfilled. | | | | | | |
| Note 3: | RSRP and SCH_RP levels have been derived from other parameters for information purposes. They are not settable parameters themselves. | | | | | | |

Table A.8.2.8.1-3: DRX configuration for E-UTRAN TDD Intra-frequency identification of a new CGI of E-UTRA cell using autonomous gaps with DRX

| Field | Value | Comment |
|--------------------------|---------|---|
| onDurationTimer | psf1 | As specified in clause 6.3.2 in TS 36.331 |
| drx-InactivityTimer | psf1 | |
| drx-RetransmissionTimer | psf1 | |
| longDRX-CycleStartOffset | sf1280 | |
| shortDRX | disable | |

Table A.8.2.8.1-4: *TimeAlignmentTimer* -Configuration for E-UTRAN TDD Intra frequency identification of a new CGI of E-UTRA cell using autonomous gaps with DRX

| Field | Value | Comment |
|--------------------|----------|--|
| TimeAlignmentTimer | Infinity | As specified in clause 6.3.2 in TS 36.331 |
| sr-ConfigIndex | 2 | For further information see clause 6.3.2 in TS 36.331 and section 10.1 in TS 36.213. |

A.8.2.8.2 Test Requirements

The UE shall transmit a measurement report containing the cell global identifier of cell 2 within 210 milliseconds from the start of T3.

Test requirement = RRC Procedure delay + $T_{\text{identify_CGI_LC-UE, intra}}$ + reporting delay

= 15 + 190 + 2ms from the start of T3

= 207 ms, allow 210 ms.

The rate of correct events observed during repeated tests shall be at least 90%.

A.8.2.9 E-UTRAN TDD Intra-frequency identification of a new CGI of E-UTRA cell using autonomous gaps for Cat-M1 UE in CEModeB

A.8.2.9.1 Test Purpose and Environment

This test is to verify the requirement for identification of a new CGI of E-UTRA cell with autonomous gaps in clause 8.13.3.1.6.

The test scenario comprises of one E-UTRA TDD carrier and two cells as given in tables A.8.2.9.1-1 and A.8.2.9.1-2. The test consists of three successive time periods, with time durations of T1, T2 and T3 respectively. At the start of time duration T1, the UE does not have any timing information of cell 2. Starting T2, cell 2 becomes detectable and the UE is expected to detect and send a measurement report.

A RRC message implying SI reading shall be sent to the UE during period T2, after the UE has reported Event A3. The RRC message shall create a measurement report configuration with purpose *reportCGI* and *si-RequestForHO* set to TRUE. The start of T3 is the instant when the last TTI containing the RRC message implying SI reading is sent to the UE.

Table A.8.2.9.1-1: General test parameters for E-UTRAN TDD Intra-frequency identification of a new CGI of E-UTRA cell using autonomous gaps for Cat-M1 UE in CEModeB

| Parameter | Unit | Value | Comment |
|--------------------------------|------|--------|--|
| Active cell | | Cell 1 | |
| Neighbour cell | | Cell 2 | Cell to be identified. |
| Channel Bandwidth (BWchannel) | MHz | 10 | |
| CP length | | Normal | |
| Special subframe configuration | | 6 | As specified in table 4.2-1 in TS 36.211. The same configuration in both cells |
| Uplink-downlink configuration | | 1 | As specified in table 4.2-2 in TS 36.211. The same configuration in both cells |
| A3-Offset | dB | -16 | |
| Hysteresis | dB | 0 | |
| Time To Trigger | s | 0 | |
| Filter coefficient | | 0 | L3 filtering is not used |
| DRX | | OFF | |
| si-RequestForHO | | TRUE | As specified in clause 5.5.3.1 in TS 36.331. |
| T1 | s | 5 | |
| T2 | s | ≤325 | |
| T3 | s | 7 | |

Table A.8.2.9.1-2: Cell specific test parameters for E-UTRAN TDD Intra-frequency identification of a new CGI of E-UTRA cell using autonomous gaps for Cat-M1 UE in CEModeB

| Parameter | Unit | Cell 1 | | | Cell 2 | | |
|---|------|---|-----------|-----------|----------|----------|----------|
| | | T1 | T2 | T3 | T1 | T2 | T3 |
| E-UTRA RF Channel Number | | 1 | | | 1 | | |
| BW _{channel} | MHz | 10 | | | 10 | | |
| PDSCH reference measurement channel as specified in clause A.3.1.4.6 | | DL Reference Measurement Channel R.19 TDD | | | N/A | | |
| MPDDCH reference channel as specified in clause A.3.1.3.6 | | DL Reference Measurement Channel R.16 TDD | | | N/A | | |
| OCNG Patterns defined in A.3.2.2.1 (OP.1 TDD) and in A.3.2.2.2 (OP.2 TDD) | | OP.11 TDD | OP.11 TDD | OP.11 TDD | OP.2 TDD | OP.2 TDD | OP.2 TDD |
| PBCH_RA | dB | -3 | | | -3 | | |
| PBCH_RB | dB | | | | | | |
| PSS_RA | dB | | | | | | |
| SSS_RA | dB | | | | | | |
| PCFICH_RB | dB | 0 | | | 0 | | |
| PHICH_RA | dB | -3 | | | -3 | | |
| PHICH_RB | dB | | | | | | |
| PDCCH_RA | dB | 0 | | | 0 | | |
| PDCCH_RB | dB | -3 | | | -3 | | |
| PDSCH_RA | dB | | | | | | |
| PDSCH_RB | dB | | | | | | |
| OCNG_RA ^{Note 1} | dB | | | | | | |

| | | | | | | | |
|---|------------|--------|--------|--------|---|--------|--------|
| OCNG_RB ^{Note 1} | dB | | | | | | |
| N_{oc} ^{Note 2} | dBm/15 KHz | -98 | | | | | |
| | | | | | | | |
| \hat{E}_s / N_{oc} | dB | 8 | 8 | 8 | -Infinity | -3 | -3 |
| \hat{E}_s / I_{ot} | dB | 8 | 6.24 | 6.24 | -Infinity | -11.64 | -11.64 |
| RSRP ^{Note 3} | dBm/15 KHz | -90 | -90 | -90 | -Infinity | -101 | -101 |
| SCH_RP ^{Note 3} | dBm/15 KHz | -90 | -90 | -90 | -Infinity | -101 | -101 |
| I_o ^{Note 3} | dBm/9MHz | -61.58 | -61.29 | -61.29 | Specified in columns for Cell 1 | | |
| Propagation Condition | | AWGN | | | | | |
| Antenna Configuration | | 2x1 | | | 2x1 | | |
| Timing offset to Cell 1 | μ s | - | | | 3 | | |
| PBCH repetition | | - | | | Configured as specified in TS 36.211 [16] | | |
| SIB1-BR repetition level | | - | | | 16 | | |
| <p>Note 1: OCNG shall be used such that both cells are fully allocated and a constant total transmitted power spectral density is achieved for all OFDM symbols.</p> <p>Note 2: Interference from other cells and noise sources not specified in the test is assumed to be constant over subcarriers and time and shall be modelled as AWGN of appropriate power for N_{oc} to be fulfilled.</p> <p>Note 3: E_s/I_{ot}, RSRP, SCH_RP and I_o levels have been derived from other parameters for information purposes. They are not settable parameters themselves.</p> | | | | | | | |

A.8.2.9.2 Test Requirements

The UE shall transmit a measurement report containing the cell global identifier of cell 2 within 5137 ms from the start of T3.

$$\begin{aligned}
 \text{Test requirement} &= \text{RRC Procedure delay} + T_{\text{identify_CGI_Cat M1, intra}} + \text{reporting delay} \\
 &= 15 + 5120 + 2\text{ms from the start of T3} \\
 &= 5137 \text{ ms.}
 \end{aligned}$$

The rate of correct events observed during repeated tests shall be at least 90%.

A.8.2.10 E-UTRAN TDD Intra-frequency identification of a new CGI of E-UTRA cell using autonomous gaps with DRX for Cat-M1 UE in CEModeB

A.8.2.10.1 Test Purpose and Environment

This test is to verify the requirement for identification of a new CGI of E-UTRA cell with autonomous gaps in clause 8.13.3.1.6. The requirement is verified in a DRX configuration.

The test scenario comprises of one E-UTRA TDD carrier and two cells as given in tables A.8.2.10.1-1 and A.8.2.10.1-2. The test consists of three successive time periods, with time durations of T1, T2 and T3 respectively. At the start of time duration T1, the UE does not have any timing information of cell 2. Starting T2, cell 2 becomes detectable and the UE is expected to detect and send a measurement report.

A RRC message implying SI reading shall be sent to the UE during period T2, after the UE has reported Event A3. The RRC message shall create a measurement report configuration with purpose *reportCGI* and *si-RequestForHO* set to TRUE. The start of T3 is the instant when the last TTI containing the RRC message implying SI reading is sent to the UE.

In the test UE needs to be provided at least once every 1280ms with new Timing Advance Command MAC control element to restart the Time alignment timer to keep UE uplink time alignment. Furthermore UE sends scheduling request (SR) to obtain allocation to send the measurement report on NPUSCH.

Table A.8.2.10.1-1: General test parameters for E-UTRAN TDD Intra-frequency identification of a new CGI of E-UTRA cell using autonomous gaps with DRX for Cat-M1 UE in CEModeB

| Parameter | Unit | Value | Comment |
|--|------|--------|--|
| Active cell | | Cell 1 | |
| Neighbour cell | | Cell 2 | Cell to be identified. |
| Channel Bandwidth (BW _{channel}) | MHz | 10 | |
| CP length | | Normal | |
| Special subframe configuration | | 6 | As specified in table 4.2-1 in TS 36.211. The same configuration in both cells |
| Uplink-downlink configuration | | 1 | As specified in table 4.2-2 in TS 36.211. The same configuration in both cells |
| A3-Offset | dB | -16 | |
| Hysteresis | dB | 0 | |
| Time To Trigger | s | 0 | |
| Filter coefficient | | 0 | L3 filtering is not used |
| DRX | | ON | DRX related parameters are defined in Table A.8.2.8.1-3 |
| si-RequestForHO | | TRUE | As specified in clause 5.5.3.1 in TS 36.331. |
| T1 | s | 5 | |
| T2 | s | ≤325 | |
| T3 | s | 7 | |

Table A.8.2.10.1-2: Cell specific test parameters for E-UTRAN TDD Intra-frequency identification of a new CGI of E-UTRA cell using autonomous gaps with DRX for Cat-M1 UE in CEModeB

| Parameter | Unit | Cell 1 | | | Cell 2 | | |
|---|------------|-----------|-----------|-----------|---------------------------------|----------|----------|
| | | T1 | T2 | T3 | T1 | T2 | T3 |
| E-UTRA RF Channel Number | | 1 | | | 1 | | |
| BW _{channel} | MHz | 10 | | | 10 | | |
| PDSCH reference channel as specified in clause A.3.1.4.6 | | R.19 TDD | | | N/A | | |
| MPDCCH reference channel as specified in clause A.3.1.3.6 | | R.16 TDD | | | N/A | | |
| OCNG Patterns defined in A.3.2.2.11 (OP.11 TDD) and in A.3.2.2.2 (OP.2 TDD) | | OP.11 TDD | OP.11 TDD | OP.11 TDD | OP.2 TDD | OP.2 TDD | OP.2 TDD |
| PBCH_RA | dB | -3 | | | -3 | | |
| PBCH_RB | dB | | | | | | |
| PSS_RA | dB | | | | | | |
| SSS_RA | dB | | | | | | |
| PCFICH_RB | dB | 0 | | | 0 | | |
| PHICH_RA | dB | -3 | | | -3 | | |
| PHICH_RB | dB | 0 | | | 0 | | |
| PDCCH_RA | dB | | | | | | |
| PDCCH_RB | dB | -3 | | | -3 | | |
| PDSCH_RA | dB | | | | | | |
| PDSCH_RB | dB | | | | | | |
| OCNG_RA ^{Note 1} | dB | | | | | | |
| OCNG_RB ^{Note 1} | dB | -98 | | | | | |
| N_{oc} ^{Note 2} | dBm/15 KHz | | | | | | |
| \hat{E}_s / N_{oc} | dB | 8 | 8 | 8 | -Infinity | -3 | -3 |
| \hat{E}_s / I_{ot} | dB | 8 | 6.24 | 6.24 | -Infinity | -11.64 | -11.64 |
| RSRP ^{Note 3} | dBm/15 KHz | -90 | -90 | -90 | -Infinity | -101 | -101 |
| SCH_RP ^{Note 3} | dBm/15 KHz | -90 | -90 | -90 | -Infinity | -101 | -101 |
| I_o ^{Note 3} | dBm/9MHz | -61.58 | -61.29 | -61.29 | Specified in columns for Cell 1 | | |

| | | | |
|--------------------------|--|------|---|
| Antenna Configuration | | 2x1 | 2x1 |
| Propagation Condition | | AWGN | |
| Timing offset to Cell 1 | μ s | - | 3 |
| PBCH repetition | | - | Configured as specified in TS 36.211 [16] |
| SIB1-BR repetition level | | - | 16 |
| Note 1: | OCNG shall be used such that both cells are fully allocated and a constant total transmitted power spectral density is achieved for all OFDM symbols. | | |
| Note 2: | Interference from other cells and noise sources not specified in the test is assumed to be constant over subcarriers and time and shall be modelled as AWGN of appropriate power for N_{oc} to be fulfilled. | | |
| Note 3: | Es/lot, RSRP, SCH_RP and Io levels have been derived from other parameters for information purposes. They are not settable parameters themselves. | | |

Table A.8.2.8.1-3: DRX configuration for E-UTRAN TDD Intra-frequency identification of a new CGI of E-UTRA cell using autonomous gaps with DRX for Cat-M1 UE in CEModeB

| Field | Value | Comment |
|--------------------------|---------|---|
| onDurationTimer | psf1 | As specified in clause 6.3.2 in TS 36.331 |
| drx-InactivityTimer | psf1 | |
| drx-RetransmissionTimer | psf1 | |
| longDRX-CycleStartOffset | sf1280 | |
| shortDRX | disable | |

Table A.8.2.8.1-4: *TimeAlignmentTimer* -Configuration for E-UTRAN TDD Intra frequency identification of a new CGI of E-UTRA cell using autonomous gaps with DRX for Cat-M1 UE in CEModeB

| Field | Value | Comment |
|--------------------|----------|--|
| TimeAlignmentTimer | Infinity | As specified in clause 6.3.2 in TS 36.331 |
| sr-ConfigIndex | 2 | For further information see clause 6.3.2 in TS 36.331 and section 10.1 in TS 36.213. |

A.8.2.10.2 Test Requirements

The UE shall transmit a measurement report containing the cell global identifier of cell 2 within 5137 ms from the start of T3.

Test requirement = RRC Procedure delay + $T_{\text{identify_CGI_Cat M1, intra}}$ + reporting delay

= 15 + 5120 + 2ms from the start of T3

= 5137 ms.

The rate of correct events observed during repeated tests shall be at least 90%.

A.8.2.11 Void

A.8.2.12 E-UTRAN TDD-TDD intra-frequency event triggered reporting under fading propagation conditions in synchronous cells for UE category 0

A.8.2.12.1 Test Purpose and Environment

The purpose of this test is to verify that the UE makes correct reporting of an event. This test case is applicable to UE category 0 as defined in Section 3.1. This test will partly verify the TDD intra-frequency cell search requirements in clause 8.5.2.1.3.1.

The test parameters are given in Table A.8.2.12.1-1 and A.8.2.12.1-2 below. In the measurement control information it is indicated to the UE that event-triggered reporting with Event A3 is used. PDCCHs indicating new transmissions or retransmissions should be sent continuously to ensure that the UE would not enter the DRX state. The test consists of two successive time periods, with time duration of T1, and T2 respectively. During time duration T1, the UE shall not have any timing information of cell 2.

Table A.8.2.12.1-1: General test parameters for E-UTRAN TDD-TDD intra-frequency event triggered reporting under fading propagation conditions in synchronous cells for UE category 0

| Parameter | Unit | Value | Comment |
|---|------|-----------|--|
| Active cell | | Cell 1 | |
| Neighbour cell | | Cell 2 | Cell to be identified. |
| E-UTRA RF Channel Number | | 1 | One TDD carrier frequency is used. |
| Channel Bandwidth (BW_{channel}) | MHz | 10 | |
| A3-Offset | dB | -10 | |
| CP length | | Normal | |
| Special subframe configuration | | 6 | As specified in table 4.2-1 in TS 36.211. The same configuration in both cells |
| Uplink-downlink configuration | | 1 | As specified in table 4.2-2 in TS 36.211. The same configuration in both cells |
| Hysteresis | dB | 0 | |
| Time To Trigger | s | 0 | |
| Filter coefficient | | 0 | L3 filtering is not used |
| DRX | | DRX_L | As specified in clause A.3.3 |
| Time offset between cells | | 3 μ s | Synchronous cells |
| T1 | s | 5 | |
| T2 | s | 5 | |

Table A.8.2.12.1-2: Cell specific test parameters for E-UTRAN TDD-TDD intra-frequency event triggered reporting under fading propagation conditions in synchronous cells for UE category 0

| Parameter | Unit | Cell 1 | | Cell 2 | |
|--|------|----------|----|---------|----|
| | | T1 | T2 | T1 | T2 |
| E-UTRA RF Channel Number | | 1 | | 1 | |
| BW_{channel} | MHz | 10 | | 10 | |
| Correlation Matrix and Antenna Configuration | | 2x1 | | 2x1 | |
| PDSCH parameters: DL Reference Measurement Channel defined in A.3.1.1.5 | | R.13 TDD | | - | |
| PCFICH/PDCCH/PHICH parameters: DL Reference Measurement Channel defined in A.3.1.2.2 | | R.7 TDD | | R.7 TDD | |

| OCNG Pattern defined in A.3.2.2.1 (OP.1 TDD) and in A.3.2.2.2 (OP.2) | | OP.1 TDD | | OP.2 TDD | |
|---|------------|----------|--------|-----------------------------|-------|
| PBCH_RA | dB | -3 | | -3 | |
| PBCH_RB | dB | | | | |
| PSS_RA | dB | | | | |
| SSS_RA | dB | | | | |
| PCFICH_RB | dB | | | | |
| PHICH_RA | dB | | | | |
| PHICH_RB | dB | | | | |
| PDCCH_RA | dB | | | | |
| PDCCH_RB | dB | | | | |
| PDSCH_RA | dB | | | | |
| PDSCH_RB | dB | | | | |
| OCNG_RA ^{Note 1} | dB | | | | |
| OCNG_RB ^{Note 1} | dB | | | | |
| N_{oc} ^{Note 3} | dBm/15 kHz | -98 | | | |
| RSRP ^{Note 4} | dBm/15 kHz | -91 | -91 | -Infinity | -94 |
| \hat{E}_s/I_{ot} | dB | 7 | 1.54 | -Infinity | -3.79 |
| SCH_RP ^{Note 4} | dBm/15 kHz | -91 | -91 | -Infinity | -94 |
| \hat{E}_s/N_{oc} | dB | 7 | 7 | -Infinity | 4 |
| I_o ^{Note 4} | dBm/9MHz | -62.43 | -60.91 | Specified in Cell 1 columns | |
| Propagation Condition | | ETU70 | | ETU70 | |
| <p>Note 1: OCNG shall be used such that both cells are fully allocated and a constant total transmitted power spectral density is achieved for all OFDM symbols.</p> <p>Note 2: The resources for uplink transmission are assigned to the UE prior to the start of time period T2.</p> <p>Note 3: Interference from other cells and noise sources not specified in the test is assumed to be constant over subcarriers and time and shall be modelled as AWGN of appropriate power for N_{oc} to be fulfilled.</p> <p>Note 4: E_s/I_{ot}, RSRP, SCH_RP and I_o levels have been derived from other parameters for information purposes. They are not settable parameters themselves.</p> | | | | | |

A.8.2.12.2 Test Requirements

The UE shall send one Event A3 triggered measurement report, with a measurement reporting delay less than 1000 ms from the beginning of time period T2.

The UE shall not send event triggered measurement reports, as long as the reporting criteria are not fulfilled.

The rate of correct events observed during repeated tests shall be at least 90%.

NOTE: The actual overall delays measured in the test may be up to $2 \times TTI_{DCCH}$ higher than the measurement reporting delays above because of TTI insertion uncertainty of the measurement report in DCCH.

A.8.2.13 E-UTRAN TDD-TDD intra-frequency event triggered reporting under fading propagation conditions in synchronous cells with DRX for UE category 0

A.8.2.13.1 Test Purpose and Environment

The purpose of the two tests is to verify that the UE makes correct reporting of an event in DRX. This test case is applicable to UE category 0 as defined in Section 3.1. The tests will partly verify the TDD-TDD intra-frequency cell search in DRX requirements in clause 8.5.2.1.3.2.

The test parameters are given in Tables A.8.2.13.1-1, A.8.2.13.1-2, A.8.2.13.1-3 and A.8.2.13.1-4. In the measurement control information, it is indicated to the UE that event-triggered reporting with Event A3 is used. The test consists of

two successive time periods, with time duration of T1, and T2 respectively. During time duration T1, the UE shall not have any timing information of cell 2.

In Test 1 UE needs to be provided at least once every 500ms with new Timing Advance Command MAC control element to restart the Time alignment timer to keep UE uplink time alignment. Furthermore UE is allocated with PUSCH resource at every DRX cycle.

In Test 2 the uplink time alignment is not maintained and UE needs to use RACH to obtain UL allocation for measurement reporting.

Table A.8.2.13.1-1: General test parameters for E-UTRAN TDD-TDD intra-frequency event triggered reporting under fading propagation conditions in synchronous cells when DRX is used for UE category 0

| Parameter | Unit | Value | | Comment |
|--------------------------------------|------|-----------|--------|---|
| | | Test 1 | Test 2 | |
| Active cell | | Cell 1 | | |
| Neighbour cell | | Cell 2 | | Cell to be identified. |
| E-UTRA RF Channel Number | | 1 | | One TDD carrier frequency is used. |
| Channel Bandwidth ($BW_{channel}$) | MHz | 10 | | |
| A3-Offset | dB | -10 | | |
| CP length | | Normal | | |
| Special subframe configuration | | 6 | | As specified in table 4.2-1 in TS 36.211. The same configuration in both cells |
| Uplink-downlink configuration | | 1 | | As specified in table 4.2-2 in TS 36.211. The same configuration in both cells |
| Hysteresis | dB | 0 | | |
| Time To Trigger | s | 0 | | |
| Filter coefficient | | 0 | | L3 filtering is not used |
| DRX | | ON | | DRX related parameters are defined in Table A.8.2.13.1-3 |
| Time offset between cells | | 3 μ s | | Synchronous cells |
| T1 | s | 5 | | |
| T2 | s | 5 | 30 | |

Table A.8.2.13.1-2: Cell specific test parameters for E-UTRAN TDD-TDD intra-frequency event triggered reporting under fading propagation conditions in synchronous cells when DRX is used for UE category 0

| Parameter | Unit | Cell 1 | | Cell 2 | |
|---|------|----------|----|----------|----|
| | | T1 | T2 | T1 | T2 |
| E-UTRA RF Channel Number | | 1 | | 1 | |
| $BW_{channel}$ | MHz | 10 | | 10 | |
| Correlation Matrix and Antenna Configuration | | 2x1 | | 2x1 | |
| PDSCH parameters: DL Reference Measurement Channel defined in A.3.1.1.5 | | R.13 TDD | | - | |
| PCFICH/PDCCH/PHICH parameters: DL Reference Measurement Channel defined in A.3.1.2.2 | | R.7 TDD | | R.7 TDD | |
| OCNG Pattern defined in A.3.2.2.1 (OP.1 TDD) and in A.3.2.2.2 (OP.2) | | OP.1 TDD | | OP.2 TDD | |
| PBCH_RA | dB | | | | |
| PBCH_RB | dB | | | | |
| PSS_RA | dB | | | | |
| SSS_RA | dB | | | | |
| PCFICH_RB | dB | | | | |
| PHICH_RA | dB | | | | |

| | | | | | |
|---|------------|--------|--------|-----------------------------|-------|
| PHICH_RB | dB | -3 | | -3 | |
| PDCCH_RA | dB | | | | |
| PDCCH_RB | dB | | | | |
| PDSCH_RA | dB | | | | |
| PDSCH_RB | dB | | | | |
| OCNG_RA ^{Note 1} | dB | | | | |
| OCNG_RB ^{Note 1} | dB | | | | |
| N_{oc} ^{Note 2} | dBm/15 kHz | -98 | | | |
| RSRP ^{Note 3} | dBm/15 kHz | -91 | -91 | -Infinity | -94 |
| \hat{E}_s/I_{ot} | dB | 7 | 1.54 | -Infinity | -3.79 |
| SCH_RP ^{Note 3} | dBm/15 kHz | -91 | -91 | -Infinity | -94 |
| \hat{E}_s/N_{oc} | dB | 7 | 7 | -Infinity | 4 |
| I_o ^{Note 4} | dBm/9MHz | -62.43 | -60.91 | Specified in Cell 1 columns | |
| Propagation Condition | | ETU70 | | ETU70 | |
| <p>Note 1: OCNG shall be used such that both cells are fully allocated and a constant total transmitted power spectral density is achieved for all OFDM symbols.</p> <p>Note 2: Interference from other cells and noise sources not specified in the test is assumed to be constant over subcarriers and time and shall be modelled as AWGN of appropriate power for N_{oc} to be fulfilled.</p> <p>Note 3: E_s/I_{ot}, RSRP, SCH_RP and I_o levels have been derived from other parameters for information purposes. They are not settable parameters themselves.</p> | | | | | |

Table A.8.2.13.1-3: DRX-Configuration for E-UTRAN TDD-TDD intra-frequency event triggered reporting in DRX under fading propagation conditions in synchronous cells for UE category 0

| Field | Test1 | Test2 | Comment |
|--------------------------|---------|---------|---|
| | Value | Value | |
| onDurationTimer | psf1 | psf1 | As specified in clause 6.3.2 in TS 36.331 |
| drx-InactivityTimer | psf1 | psf1 | |
| drx-RetransmissionTimer | psf1 | psf1 | |
| longDRX-CycleStartOffset | sf40 | sf1280 | |
| shortDRX | disable | disable | |

Table A.8.2.13.1-4: TimeAlignmentTimer-Configuration for E-UTRAN TDD-TDD intra-frequency event triggered reporting in DRX under fading propagation conditions in synchronous cells for UE category 0

| Field | Test1 | Test2 | Comment |
|--------------------|-------|-------|---|
| | Value | Value | |
| TimeAlignmentTimer | sf500 | sf500 | As specified in clause 6.3.2 in TS 36.331 |
| sr-ConfigIndex | 2 | 2 | For further information see clause 6.3.2 in TS 36.331 and clause 10.1 in TS 36.213. |

A.8.2.13.2 Test Requirements

In Test 1, the UE shall send one Event A3 triggered measurement report, with a measurement reporting delay less than 1000 ms from the beginning of time period T2. The measurement reporting delay is defined as the time from the beginning of time period T2 to the moment when the UE send the measurement report on PUSCH.

In Test 2, the UE shall send one Event A3 triggered measurement report, with a measurement reporting delay less than 25600 ms from the beginning of time period T2. The measurement reporting delay is defined as the time from the beginning of time period T2 to the moment when the UE starts to send preambles on the PRACH for scheduling request (SR) to obtain allocation to send the measurement report on PUSCH.

The UE shall not send event triggered measurement reports, as long as the reporting criteria are not fulfilled.

The rate of correct events observed during repeated tests shall be at least 90%.

NOTE 1: The actual overall delays measured in the test may be up to one DRX cycle higher than the measurement reporting delays above because UE is allowed to delay the initiation of the measurement reporting procedure to the next until the Active Time.

NOTE 2: In order to calculate the rate of correct events the system simulator shall verify that it has received correct Event A3 measurement report.

A.8.3 E-UTRAN FDD - FDD Inter-frequency Measurements

A.8.3.1 E-UTRAN FDD-FDD Inter-frequency event triggered reporting under fading propagation conditions in asynchronous cells

A.8.3.1.1 Test Purpose and Environment

The purpose of this test is to verify that the UE makes correct reporting of an event. This test will partly verify the FDD-FDD inter-frequency cell search requirements in clause 8.1.2.3.

The test parameters are given in Tables A.8.3.1.1-1 and A.8.3.1.1-2. In this test, there are two cells on different carrier frequencies and gap pattern configuration # 0 as defined in Table 8.1.2.1-1 is provided.

In the measurement control information, it is indicated to the UE that event-triggered reporting with Event A3 is used. The test consists of two successive time periods, with time duration of T1, and T2 respectively. During time duration T1, the UE shall not have any timing information of cell 2.

Table A.8.3.1.1-1: General test parameters for E-UTRAN FDD-FDD inter-frequency event triggered reporting in fading propagation conditions

| Parameter | Unit | Value | Comment |
|--|------|--|---|
| PDSCH parameters | | DL Reference Measurement Channel R.0 FDD | As specified in clause A.3.1.1.1 |
| PCFICH/PDCCH/PHICH parameters | | DL Reference Measurement Channel R.6 FDD | As specified in clause A.3.1.2.1 |
| E-UTRA RF Channel Number | | 1, 2 | Two FDD carrier frequencies are used. |
| Channel Bandwidth (BW _{channel}) | MHz | 10 | |
| Active cell | | Cell 1 | Cell 1 is on RF channel number 1 |
| Neighbour cell | | Cell 2 | Cell 2 is on RF channel number 2 |
| Gap Pattern Id | | 0 | As specified in TS 36.133 clause 8.1.2.1. |
| A3-Offset | dB | -6 | |
| Hysteresis | dB | 0 | |
| CP length | | Normal | |
| TimeToTrigger | s | 0 | |
| Filter coefficient | | 0 | L3 filtering is not used |
| DRX | | OFF | OFF |
| Time offset between cells | | 3 ms | Asynchronous cells |
| T1 | s | 5 | |
| T2 | s | 5 | |

Table A.8.3.1.1-2: Cell specific test parameters for E-UTRAN FDD-FDD inter-frequency event triggered reporting under fading propagation conditions in synchronous cells

| Parameter | Unit | Cell 1 | | Cell 2 | |
|--|------|---------|----|---------|----|
| | | T1 | T2 | T1 | T2 |
| E-UTRA RF Channel Number | | 1 | | 2 | |
| BW _{channel} | MHz | 10 | | 10 | |
| Correlation Matrix and Antenna Configuration | | 1x2 Low | | 1x2 Low | |

| OCNG Patterns defined in A.3.2.1.1 (OP.1 FDD) and in A.3.2.1.2 (OP.2 FDD) | | OP.1 FDD | | OP.2 FDD | |
|--|------------|----------|-----|-----------|-----|
| PBCH_RA | dB | 0 | | 0 | |
| PBCH_RB | dB | | | | |
| PSS_RA | dB | | | | |
| SSS_RA | dB | | | | |
| PCFICH_RB | dB | | | | |
| PHICH_RA | dB | | | | |
| PHICH_RB | dB | | | | |
| PDCCH_RA | dB | | | | |
| PDCCH_RB | dB | | | | |
| PDSCH_RA | dB | | | | |
| PDSCH_RB | dB | | | | |
| OCNG_RA ^{Note 1} | dB | | | | |
| OCNG_RB ^{Note 1} | dB | | | | |
| N_{oc} ^{Note 3} | dBm/15 kHz | -98 | | | |
| RSRP ^{Note 4} | dBm/15 kHz | -94 | -94 | -Infinity | -91 |
| \hat{E}_s / I_{ot} | dB | 4 | 4 | -Infinity | 7 |
| SCH_RP ^{Note 4} | dBm/15 kHz | -94 | -94 | -Infinity | -91 |
| \hat{E}_s / N_{oc} | dB | 4 | 4 | -Infinity | 7 |
| Propagation Condition | | ETU70 | | | |
| <p>Note 1: OCNG shall be used such that both cells are fully allocated and a constant total transmitted power spectral density is achieved for all OFDM symbols.</p> <p>Note 2: The resources for uplink transmission are assigned to the UE prior to the start of time period T2.</p> <p>Note 3: Interference from other cells and noise sources not specified in the test is assumed to be constant over subcarriers and time and shall be modelled as AWGN of appropriate power for N_{oc} to be fulfilled.</p> <p>Note 4: RSRP and SCH_RP levels have been derived from other parameters for information purposes. They are not settable parameters themselves.</p> | | | | | |

A.8.3.1.2 Test Requirements

The UE shall send one Event A3 triggered measurement report, with a measurement reporting delay less than 3840 ms from the beginning of time period T2.

The UE shall not send event triggered measurement reports, as long as the reporting criteria are not fulfilled.

The rate of correct events observed during repeated tests shall be at least 90%.

NOTE: The actual overall delays measured in the test may be up to $2xTTI_{DCCH}$ higher than the measurement reporting delays above because of TTI insertion uncertainty of the measurement report in DCCH.

A.8.3.2 E-UTRAN FDD-FDD Inter-frequency event triggered reporting when DRX is used under fading propagation conditions in asynchronous cells

A.8.3.2.1 Test Purpose and Environment

The purpose of these tests is to verify that the UE makes correct reporting of an event in DRX. These test will partly verify the FDD-FDD inter-frequency cell search requirements when DRX is used in clause 8.1.2.3.

The common test parameters are given in Tables A.8.3.2.1-1 and A.8.3.2.1-2. DRX configuration for Test1 and Test2 are given in Table A.8.3.2.1-3 and time alignment timer and scheduling request related parameters in Table A.8.3.2.1-4. In this tests, there are two cells on different carrier frequencies and gap pattern configuration # 0 as defined in Table 8.1.2.1-1 is provided.

In Test 1 UE needs to be provided at least once every 500ms with new Timing Advance Command MAC control element to restart the Time alignment timer to keep UE uplink time alignment. Furthermore UE is allocated with PUSCH

resource at every DRX cycle. In Test 2 the uplink time alignment is not maintained and UE needs to use RACH to obtain UL allocation for measurement reporting.

In the measurement control information, it is indicated to the UE that event-triggered reporting with Event A3 is used. The tests consists of two successive time periods, with time duration of T1, and T2 respectively. During time duration T1, the UE shall not have any timing information of cell 2.

Table A.8.3.2.1-1: General test parameters for E-UTRAN FDD-FDD inter-frequency event triggered reporting when DRX is used in fading propagation conditions

| Parameter | Unit | Test 1 | Test 2 | Comment |
|--|------|--|--------|---|
| | | Value | | |
| PDSCH parameters | | DL Reference Measurement Channel R.0 FDD | | As specified in clause A.3.1.1.1 Note that UE may only be allocated at <i>On Duration</i> |
| PCFICH/PDCCH/PHICH parameters | | DL Reference Measurement Channel R.6 FDD | | As specified in clause A.3.1.2.1. |
| E-UTRA RF Channel Number | | 1, 2 | | Two FDD carrier frequencies are used. |
| Channel Bandwidth (BW _{channel}) | MHz | 10 | | |
| Active cell | | Cell 1 | | Cell 1 is on RF channel number 1 |
| Neighbour cell | | Cell 2 | | Cell 2 is on RF channel number 2 |
| Gap Pattern Id | | 0 | | As specified in TS 36.133 clause 8.1.2.1. |
| A3-Offset | dB | -6 | | |
| Hysteresis | dB | 0 | | |
| CP length | | Normal | | |
| TimeToTrigger | s | 0 | | |
| Filter coefficient | | 0 | | L3 filtering is not used |
| PRACH configuration | | 4 | | As specified in table 5.7.1-2 in TS 36.211 |
| Access Barring Information | - | Not Sent | | No additional delays in random access procedure. |
| DRX | | ON | | DRX related parameters are defined in Table A.8.3.2.1-3 |
| Time offset between cells | | 3 ms | | Asynchronous cells |
| T1 | s | 5 | | |
| T2 | s | 5 | 30 | |

Table A.8.3.2.1-2: Cell specific test parameters for E-UTRAN FDD-FDD inter-frequency event triggered reporting under fading propagation conditions in synchronous cells

| Parameter | Unit | Cell 1 | | Cell 2 | |
|---|------|----------|----|----------|----|
| | | T1 | T2 | T1 | T2 |
| E-UTRA RF Channel Number | | 1 | | 2 | |
| BW _{channel} | MHz | 10 | | 10 | |
| Correlation Matrix and Antenna Configuration | | 1x2 Low | | 1x2 Low | |
| OCNG Patterns defined in A.3.2.1.1 (OP.1 FDD) and in A.3.2.1.2 (OP.2 FDD) | | OP.1 FDD | | OP.2 FDD | |
| PBCH_RA | dB | 0 | | 0 | |
| PBCH_RB | dB | | | | |
| PSS_RA | dB | | | | |
| SSS_RA | dB | | | | |
| PCFICH_RB | dB | | | | |
| PHICH_RA | dB | | | | |
| PHICH_RB | dB | | | | |
| PDCCH_RA | dB | | | | |
| PDCCH_RB | dB | | | | |
| PDSCH_RA | dB | | | | |
| PDSCH_RB | dB | | | | |
| OCNG_RA ^{Note 1} | dB | | | | |
| OCNG_RB ^{Note 1} | dB | | | | |

| | | | | | |
|--|------------|-------|-----|-----------|-----|
| N_{oc} Note 2 | dBm/15 kHz | -98 | | | |
| RSRP Note 3 | dBm/15 kHz | -94 | -94 | -Infinity | -91 |
| \hat{E}_s/I_{ot} | dB | 4 | 4 | -Infinity | 7 |
| SCH_RP Note 3 | dBm/15 kHz | -94 | -94 | -Infinity | -91 |
| \hat{E}_s/N_{oc} | dB | 4 | 4 | -Infinity | 7 |
| Propagation Condition | | ETU70 | | | |
| Note 1: OCNG shall be used such that both cells are fully allocated and a constant total transmitted power spectral density is achieved for all OFDM symbols. | | | | | |
| Note 2: Interference from other cells and noise sources not specified in the test is assumed to be constant over subcarriers and time and shall be modelled as AWGN of appropriate power for N_{oc} to be fulfilled. | | | | | |
| Note 3: RSRP and SCH_RP levels have been derived from other parameters for information purposes. They are not settable parameters themselves. | | | | | |

Table A.8.3.2.1-3: drx-Configuration to be used in E-UTRAN FDD-FDD inter-frequency event triggered reporting when DRX is used in fading propagation conditions

| Field | Test1 | Test2 | Comment |
|--|---------|---------|---------|
| | Value | Value | |
| onDurationTimer | psf1 | psf1 | |
| drx-InactivityTimer | psf1 | psf1 | |
| drx-RetransmissionTimer | psf1 | psf1 | |
| longDRX-CycleStartOffset | sf40 | sf1280 | |
| shortDRX | disable | disable | |
| Note: For further information see clause 6.3.2 in TS 36.331. | | | |

Table A.8.3.2.1-4: TimeAlignmentTimer and sr-ConfigIndex -Configuration to be used in E-UTRAN FDD-FDD inter-frequency event triggered reporting when DRX is used in fading propagation conditions

| Field | Test1 | Test2 | Comment |
|--------------------|-------|-------|---|
| | Value | Value | |
| TimeAlignmentTimer | sf500 | sf500 | For further information see clause 6.3.2 in TS 36.331. |
| sr-ConfigIndex | 0 | 0 | For further information see clause 6.3.2 in TS 36.331 and section 10.1 in TS 36.213.. |

A.8.3.2.2 Test Requirements

In Test1 the UE shall send one Event A3 triggered measurement report, with a measurement reporting delay less than 3840 ms from the beginning of time period T2. The measurement reporting delay is defined as the time from the beginning of time period T2, to the moment when the UE send the measurement report on PUSCH.

In Test2 the UE shall send one Event A3 triggered measurement report, with a measurement reporting delay less than 20*1280ms from the beginning of time period T2. The measurement reporting delay is defined as the time from the beginning of time period T2, to the moment when the UE starts to send preambles on the PRACH for scheduling request (SR) to obtain allocation to send the measurement report on PUSCH.

The UE shall not send event triggered measurement reports, as long as the reporting criteria are not fulfilled.

The rate of correct events observed during repeated tests shall be at least 90%.

NOTE 1: The actual overall delays measured in the test may be up to one DRX cycle higher than the measurement reporting delays above because UE is allowed to delay the initiation of the measurement reporting procedure to the next until the Active Time.

NOTE 2: In order to calculate the rate of correct events the system simulator shall verify that it has received correct Event A3 measurement report

A.8.3.3 E-UTRAN FDD-FDD inter-frequency event triggered reporting under AWGN propagation conditions in asynchronous cells with DRX when L3 filtering is used

A.8.3.3.1 Test Purpose and Environment

The purpose of this test is to verify that the UE makes correct reporting of an event in DRX when L3 filtering is used. This test will partly verify the FDD-FDD inter-frequency cell search in DRX requirements in clause 8.1.2.3.1.2 and the UE behaviour with the *filterCoefficient* defined in TS 36.331 [2].

The test parameters are given in Tables A.8.3.3.1-1, A.8.3.3.1-2, A.8.3.3.1-3 and A.8.3.3.1-4. In the measurement control information, it is indicated to the UE that event-triggered reporting with Event A3 and the filter coefficient is used. The test consists of two successive time periods, with time duration of T1, and T2 respectively. In this test, there are two cells on different carrier frequencies and gap pattern configuration # 1 as defined in Table 8.1.2.1-1 is provided.

The uplink time alignment is not maintained and UE needs to use RACH to obtain UL allocation for measurement reporting.

Table A.8.3.3.1-1: General test parameters for E-UTRAN FDD-FDD inter-frequency event triggered reporting under AWGN propagation conditions in asynchronous cells with DRX when L3 filtering is used

| Parameter | Unit | Value | Comment |
|--|------|--|---|
| PDSCH parameters | | DL Reference Measurement Channel R.0 FDD | As specified in clause A.3.1.1.1 |
| PCFICH/PDCCH/PHICH parameters | | DL Reference Measurement Channel R.6 FDD | As specified in clause A.3.1.2.1 |
| Active cell | | Cell 1 | |
| Neighbour cell | | Cell 2 | Cell to be identified. |
| E-UTRA RF Channel Number | | 1, 2 | Two FDD carrier frequencies are used. |
| Channel Bandwidth (BW _{channel}) | MHz | 10 | |
| Gap Pattern Id | | 1 | As specified in TS 36.133 clause 8.1.2.1. |
| Neighbour A3-Offset Ofn | dB | -14 | |
| CP length | | Normal | |
| Hysteresis | dB | 0 | |
| Time To Trigger | s | 0 | |
| Filter coefficient | | 9 | L3 filtering is used |
| DRX | | ON | DRX related parameters are defined in Table A.8.3.3.1-3 |
| Time offset between cells | | 3 ms | Asynchronous cells |
| T1 | S | 30 | |
| T2 | S | 9 | |

Table A.8.3.3.1-2: Cell specific test parameters for E-UTRAN FDD-FDD inter-frequency event triggered reporting under AWGN propagation conditions in asynchronous cells with DRX when L3 filtering is used

| Parameter | Unit | Cell 1 | | Cell 2 | |
|---|------------|----------|-----|----------|-----|
| | | T1 | T2 | T1 | T2 |
| E-UTRA RF Channel Number | | 1 | | 2 | |
| $BW_{channel}$ | MHz | 10 | | 10 | |
| OCNG Patterns defined in A.3.2.1.1 (OP.1 FDD) and in A.3.2.1.2 (OP.2 FDD) | | OP.1 FDD | | OP.2 FDD | |
| PBCH_RA | dB | 0 | | 0 | |
| PBCH_RB | dB | | | | |
| PSS_RA | dB | | | | |
| SSS_RA | dB | | | | |
| PCFICH_RB | dB | | | | |
| PHICH_RA | dB | | | | |
| PHICH_RB | dB | | | | |
| PDCCH_RA | dB | | | | |
| PDCCH_RB | dB | | | | |
| PDSCH_RA | dB | | | | |
| PDSCH_RB | dB | | | | |
| OCNG_RA ^{Note 1} | dB | | | | |
| OCNG_RB ^{Note 1} | dB | | | | |
| \hat{E}_s / I_{ot} | dB | 4 | 4 | 4 | 24 |
| N_{oc} ^{Note 2} | dBm/15 KHz | -98 | | | |
| \hat{E}_s / N_{oc} | dB | 4 | 4 | 4 | 24 |
| RSRP ^{Note 3} | dBm/15 KHz | -94 | -94 | -94 | -74 |
| SCH_RP ^{Note 3} | dBm/15 KHz | -94 | -94 | -94 | -74 |
| Propagation Condition | | AWGN | | | |

Note 1: OCNG shall be used such that both cells are fully allocated and a constant total transmitted power spectral density is achieved for all OFDM symbols.

Note 2: Interference from other cells and noise sources not specified in the test is assumed to be constant over subcarriers and time and shall be modelled as AWGN of appropriate power for N_{oc} to be fulfilled.

Note 3: RSRP and SCH_RP levels have been derived from other parameters for information purposes. They are not settable parameters themselves.

Table A.8.3.3.1-3: DRX-Configuration for E-UTRAN FDD-FDD inter-frequency event triggered reporting in DRX under AWGN propagation conditions in asynchronous cells with DRX when L3 filtering is used

| Field | Value | Comment |
|--------------------------|---------|---|
| onDurationTimer | psf1 | As specified in clause 6.3.2 in TS 36.331 |
| drx-InactivityTimer | psf1 | |
| drx-RetransmissionTimer | psf1 | |
| longDRX-CycleStartOffset | sf1280 | |
| shortDRX | disable | |

Table A.8.3.3.1-4: *TimeAlignmentTimer* -Configuration for E-UTRAN FDD-FDD inter-frequency event triggered reporting in DRX under AWGN propagation conditions in asynchronous cells with DRX when L3 filtering is used

| Field | Value | Comment |
|--------------------|-------|--|
| TimeAlignmentTimer | sf500 | As specified in clause 6.3.2 in TS 36.331 |
| sr-ConfigIndex | 0 | For further information see clause 6.3.2 in TS 36.331 and section 10.1 in TS 36.213. |

A.8.3.3.2 Test Requirements

The UE shall send one Event A3 triggered measurement report, with a measurement reporting delay less than 6400 ms from the beginning of time period T2. The measurement reporting delay is defined as the time from the beginning of time period T2 to the moment when the UE starts to send preambles on the PRACH for scheduling request (SR) to obtain allocation to send the measurement report on PUSCH.

The UE shall not send event triggered measurement reports, as long as the reporting criteria are not fulfilled.

The rate of correct events observed during repeated tests shall be at least 90%.

NOTE 1: The actual overall delays measured in the test may be up to one DRX cycle higher than the measurement reporting delays above because UE is allowed to delay the initiation of the measurement reporting procedure to the next until the Active Time.

NOTE 2: In order to calculate the rate of correct events the system simulator shall verify that it has received correct Event A3 measurement report.

A.8.3.4 E-UTRAN FDD - FDD Inter-frequency identification of a new CGI of E-UTRA cell using autonomous gaps

A.8.3.4.1 Test Purpose and Environment

This test is to verify the requirement for identification of a new CGI of E-UTRA cell with autonomous gaps in clause 8.1.2.3.5.

The test scenario comprises of two E-UTRA FDD carriers and one cell on each carrier as given in tables A.8.3.4.1-1 and A.8.3.4.1-2. PDCCHs indicating new transmissions shall be sent continuously to ensure that the UE would have ACK/NACK sending during identifying a new CGI of E-UTRAN cell. The test consists of three successive time periods, with time durations of T1, T2 and T3 respectively. At the start of time duration T1, the UE does not have any timing information of cell 2. Starting T2, cell 2 becomes detectable and the UE is expected to detect and send a measurement report. Gap pattern configuration with id #0 as specified in Table 8.1.2.1-1 is configured before T2 begins to enable inter-frequency monitoring.

A RRC message implying SI reading shall be sent to the UE during period T2, after the UE has reported Event A3. The RRC message shall create a measurement report configuration with purpose *reportCGI* and *si-RequestForHO* set to TRUE. The start of T3 is the instant when the last TTI containing the RRC message implying SI reading is sent to the UE. Measurement gaps shall be deconfigured before the start of T3.

Table A.8.3.4.1-1: General test parameters for E-UTRAN FDD - FDD Inter-frequency identification of a new CGI of E-UTRA cell using autonomous gaps

| Parameter | Unit | Value | Comment |
|---|------|--|---|
| PDSCH parameters | | DL Reference Measurement Channel R.3 FDD | As specified in clause A.3.1.1.1 |
| PCFICH/PDCCH/PHICH parameters | | DL Reference Measurement Channel R.6 FDD | As specified in clause A.3.1.2.1 |
| E-UTRA RF channel number | | 1, 2 | Two FDD carrier frequencies are used. |
| Channel Bandwidth (BW_{channel}) | MHz | 10 | |
| Active cell | | Cell 1 | Cell 1 is on RF channel number 1. |
| Neighbour cell | | Cell 2 | Cell 1 is on RF channel number 2. |
| CP length | | Normal | |
| Gap Pattern Id | | 0 | As specified in TS 36.133 clause 8.1.2.1. |
| A3-Offset | dB | -6 | |
| Hysteresis | dB | 0 | |
| TimeToTrigger | s | 0 | |
| Filter coefficient | | 0 | L3 filtering is not used |
| DRX | | OFF | |

| | | | |
|---------------------------|----|------|--|
| si-RequestForHO | | TRUE | As specified in clause 5.5.3.1 in TS 36.331. |
| Time offset between cells | ms | 3 | Asynchronous cells |
| T1 | s | 5 | |
| T2 | s | ≤10 | |
| T3 | s | 5 | |

Table A.8.3.4.1-2: Cell specific test parameters for E-UTRAN FDD - FDD Inter-frequency identification of a new CGI of E-UTRA cell using autonomous gaps

| Parameter | Unit | Cell 1 | | | Cell 2 | | |
|--|------------|-----------|-----------|-----------|-----------|----------|----------|
| | | T1 | T2 | T3 | T1 | T2 | T3 |
| E-UTRA RF Channel Number | | 1 | | | 2 | | |
| BW _{channel} | MHz | 10 | | | 10 | | |
| OCNG Patterns defined in A.3.2.1.10 (OP.10 FDD) and in A.3.2.1.2 (OP.2 FDD) | | OP.10 FDD | OP.10 FDD | OP.10 FDD | OP.2 FDD | OP.2 FDD | OP.2 FDD |
| PBCH_RA | dB | 0 | | | 0 | | |
| PBCH_RB | dB | | | | | | |
| PSS_RA | dB | | | | | | |
| SSS_RA | dB | | | | | | |
| PCFICH_RB | dB | | | | | | |
| PHICH_RA | dB | | | | | | |
| PHICH_PB | dB | | | | | | |
| PDCCH_RA | dB | | | | | | |
| PDCCH_PB | dB | | | | | | |
| PDSCH_RA | dB | | | | | | |
| PDSCH_RB | dB | | | | | | |
| OCNG_RA ^{Note 1} | dB | | | | | | |
| OCNG_RB ^{Note 1} | dB | | | | | | |
| \hat{E}_s / I_{ot} | dB | 4 | 4 | 4 | -Infinity | 7 | 7 |
| N_{oc} ^{Note 2} | dBm/15 KHz | -98 | | | | | |
| \hat{E}_s / N_{oc} | dB | 4 | 4 | 4 | -Infinity | 7 | 7 |
| RSRP ^{Note 3} | dBm/15 KHz | -94 | -94 | -94 | -Infinity | -91 | -91 |
| SCH_RP ^{Note 3} | dBm/15 KHz | -94 | -94 | -94 | -Infinity | -91 | -91 |
| Propagation Condition | | AWGN | | | | | |
| <p>Note 1: OCNG shall be used such that both cells are fully allocated and a constant total transmitted power spectral density is achieved for all OFDM symbols.</p> <p>Note 2: Interference from other cells and noise sources not specified in the test is assumed to be constant over subcarriers and time and shall be modelled as AWGN of appropriate power for N_{oc} to be fulfilled.</p> <p>Note 3: RSRP and SCH_RP levels have been derived from other parameters for information purposes. They are not settable parameters themselves.</p> | | | | | | | |

A.8.3.4.2 Test Requirements

The UE shall transmit a measurement report containing the cell global identifier of cell 2 within 170 milliseconds from the start of T3.

Test requirement = RRC Procedure delay + $T_{\text{identify_CGI,inter}}$ + reporting delay

= 15 + 150 + 2ms from the start of T3

= 167 ms, allow 170 ms.

The UE shall be scheduled continuously throughout the test, and from the start of T3 until 170 ms at least 80 ACK/NACK shall be detected as being transmitted by the UE.

The rate of correct events observed during repeated tests shall be at least 90%.

NOTE: The overall 80 ACK/NACK number is caused by two parts. Firstly, at least 60 ACK/NACK shall be sent during identifying the cell global identifier of cell 2 according to the requirement in Clause 8.1.2.3.5.1. Secondly, given that continuous DL data allocation, and the measurement gaps have been deconfigured before the start of T3, additional 20 ACK/NACK shall be sent from the start of T3 until 170 ms excludes 150 ms for identifying the cell global identifier of cell 2.

A.8.3.5 E-UTRAN FDD - FDD Inter-frequency identification of a new CGI of E-UTRA cell using autonomous gaps with DRX

This test is to verify the requirement for identification of a new CGI of E-UTRA cell with autonomous gaps in clause 8.1.2.3.5. The requirement is verified in a DRX configuration.

The test scenario comprises of two E-UTRA FDD carriers and one cell on each carrier as given in tables A.8.3.5.1-1, A.8.3.5.1-2, A.8.3.5.1-3 and A.8.3.5.1-4. The test consists of three successive time periods, with time durations of T1, T2 and T3 respectively. At the start of time duration T1, the UE does not have any timing information of cell 2. Starting T2, cell 2 becomes detectable and the UE is expected to detect and send a measurement report. Gap pattern configuration with id #0 as specified in Table 8.1.2.1-1 is configured before T2 begins to enable inter-frequency monitoring.

A RRC message implying SI reading shall be sent to the UE during period T2, after the UE has reported Event A3. The RRC message shall create a measurement report configuration with purpose *reportCGI* and *si-RequestForHO* set to TRUE. The start of T3 is the instant when the last TTI containing the RRC message implying SI reading is sent to the UE. Measurement gaps shall be deconfigured before the start of T3.

In the test UE needs to be provided at least once every 1280ms with new Timing Advance Command MAC control element to restart the Time alignment timer to keep UE uplink time alignment. Furthermore UE sends scheduling request (SR) to obtain allocation to send the measurement report on PUSCH.

Table A.8.3.5.1-1: General test parameters for E-UTRAN FDD - FDD Inter-frequency identification of a new CGI of E-UTRA cell using autonomous gaps with DRX

| Parameter | Unit | Value | Comment |
|--------------------------------------|------|--|---|
| PDSCH parameters | | DL Reference Measurement Channel R.0 FDD | As specified in clause A.3.1.1.1 |
| PCFICH/PDCCH/PHICH parameters | | DL Reference Measurement Channel R.6 FDD | As specified in clause A.3.1.2.1 |
| E-UTRA RF channel number | | 1, 2 | Two FDD carrier frequencies are used. |
| Channel Bandwidth ($BW_{channel}$) | MHz | 10 | |
| Active cell | | Cell 1 | Cell 1 is on RF channel number 1. |
| Neighbour cell | | Cell 2 | Cell 1 is on RF channel number 2. |
| CP length | | Normal | |
| Gap Pattern Id | | 0 | As specified in TS 36.133 clause 8.1.2.1. |
| A3-Offset | dB | -6 | |
| Hysteresis | dB | 0 | |
| TimeToTrigger | s | 0 | |
| Filter coefficient | | 0 | L3 filtering is not used |
| DRX | | ON | DRX related parameters are defined in Table A.8.3.5.1-3 |
| si-RequestForHO | | TRUE | As specified in clause 5.5.3.1 in TS 36.331. |
| Time offset between cells | ms | 3 | Asynchronous cells |
| T1 | s | 5 | |
| T2 | s | ≤30 | UE shall report cell within 25.6s (20 DRX cycles) |
| T3 | s | 5 | |

Table A.8.3.5.1-2: Cell specific test parameters for E-UTRAN FDD - FDD Inter-frequency identification of a new CGI of E-UTRA cell using autonomous gaps with DRX

| Parameter | Unit | Cell 1 | | | Cell 2 | | |
|-----------|------|--------|----|----|--------|----|----|
| | | T1 | T2 | T3 | T1 | T2 | T3 |
| | | | | | | | |

| E-UTRA RF Channel Number | | 1 | | | 2 | | |
|--|------------|----------|----------|----------|-----------|----------|----------|
| BW _{channel} | MHz | 10 | | | 10 | | |
| OCNG Patterns defined in A.3.2.1.1 (OP.1 FDD) and in A.3.2.1.2 (OP.2 FDD) | | OP.1 FDD | OP.1 FDD | OP.1 FDD | OP.2 FDD | OP.2 FDD | OP.2 FDD |
| PBCH_RA | dB | 0 | | | 0 | | |
| PBCH_RB | dB | | | | | | |
| PSS_RA | dB | | | | | | |
| SSS_RA | dB | | | | | | |
| PCFICH_RB | dB | | | | | | |
| PHICH_RA | dB | | | | | | |
| PHICH_PB | dB | | | | | | |
| PDCCH_RA | dB | | | | | | |
| PDCCH_PB | dB | | | | | | |
| PDSCH_RA | dB | | | | | | |
| PDSCH_RB | dB | | | | | | |
| OCNG_RA ^{Note 1} | dB | | | | | | |
| OCNG_RB ^{Note 1} | dB | | | | | | |
| \hat{E}_s / I_{ot} | dB | 4 | 4 | 4 | -Infinity | 7 | 7 |
| N_{oc} ^{Note 2} | dBm/15 KHz | -98 | | | | | |
| \hat{E}_s / N_{oc} | dB | 4 | 4 | 4 | -Infinity | 7 | 7 |
| RSRP ^{Note 3} | dBm/15 KHz | -94 | -94 | -94 | -Infinity | -91 | -91 |
| SCH_RP ^{Note 3} | dBm/15 KHz | -94 | -94 | -94 | -Infinity | -91 | -91 |
| Propagation Condition | | AWGN | | | | | |
| <p>Note 1: OCNG shall be used such that both cells are fully allocated and a constant total transmitted power spectral density is achieved for all OFDM symbols.</p> <p>Note 2: Interference from other cells and noise sources not specified in the test is assumed to be constant over subcarriers and time and shall be modelled as AWGN of appropriate power for N_{oc} to be fulfilled.</p> <p>Note 3: RSRP and SCH_RP levels have been derived from other parameters for information purposes. They are not settable parameters themselves.</p> | | | | | | | |

Table A.8.3.5.1-3: DRX configuration for E-UTRAN FDD - FDD Inter-frequency identification of a new CGI of E-UTRA cell using autonomous gaps with DRX

| Field | Value | Comment |
|--------------------------|---------|---|
| onDurationTimer | psf1 | As specified in clause 6.3.2 in TS 36.331 |
| drx-InactivityTimer | psf1 | |
| drx-RetransmissionTimer | psf1 | |
| longDRX-CycleStartOffset | sf1280 | |
| shortDRX | disable | |

Table A.8.3.5.1-4: TimeAlignmentTimer-Configuration for E-UTRAN FDD - FDD Inter-frequency identification of a new CGI of E-UTRA cell using autonomous gaps with DRX

| Field | Value | Comment |
|--------------------|----------|--|
| TimeAlignmentTimer | Infinity | As specified in clause 6.3.2 in TS 36.331 |
| sr-ConfigIndex | 0 | For further information see clause 6.3.2 in TS 36.331 and section 10.1 in TS 36.213. |

A.8.3.5.2 Test Requirements

The UE shall transmit a measurement report containing the cell global identifier of cell 2 within 170 milliseconds from the start of T3.

$$\begin{aligned} \text{Test requirement} &= \text{RRC Procedure delay} + T_{\text{identify_CGI, inter}} + \text{reporting delay} \\ &= 15 + 150 + 2\text{ms from the start of T3} \\ &= 167 \text{ ms, allow } 170 \text{ ms.} \end{aligned}$$

The rate of correct events observed during repeated tests shall be at least 90%.

A.8.3.6 E-UTRAN FDD-FDD Inter-frequency event triggered reporting without measurement gaps under AWGN propagation conditions in asynchronous cells

A.8.3.6.1 Test Purpose and Environment

The purpose of this test is to verify that the UE makes correct reporting of an event without measurement gaps. This test will partly verify the FDD-FDD inter-frequency cell search requirements in section 8.1.2.3.

The test parameters are given in Tables A.8.3.6.1-1 and A.8.3.6.1-2. In this test, there are two cells on different carrier frequencies and no gaps are configured in this test. In the measurement control information, it is indicated to the UE that event-triggered reporting with Event A3 is used. The test consists of two successive time periods, with time duration of T1, and T2 respectively. During time duration T1, the UE shall not have any timing information of cell 2. PDCCH on the PCell shall be sent continuously to ensure that the UE sends ACK/NACKs throughout the test.

Table A.8.3.6.1-1: General test parameters for E-UTRAN FDD-FDD inter-frequency event triggered reporting without measurement gaps

| Parameter | Unit | Value | Comment |
|--|------|--|---------------------------------------|
| PDSCH parameters | | DL Reference Measurement Channel R.3 FDD | As specified in section A.3.1.1.1 |
| PCFICH/PDCCH/PHICH parameters | | DL Reference Measurement Channel R.6 FDD | As specified in section A.3.1.2.1 |
| E-UTRA RF Channel Number | | 1, 2 | Two FDD carrier frequencies are used. |
| Channel Bandwidth (BW _{channel}) | MHz | 10 | |
| Active PCell | | Cell 1 | Cell 1 is on RF channel number 1 |
| Neighbour cell | | Cell 2 | Cell 2 is on RF channel number 2 |
| A3-Offset | dB | -6 | |
| Hysteresis | dB | 0 | |
| CP length | | Normal | |
| TimeToTrigger | s | 0 | |
| Filter coefficient | | 0 | L3 filtering is not used |
| DRX | | OFF | OFF |
| Time offset between cells | | 3 ms | Asynchronous cells |
| T1 | s | 5 | |
| T2 | s | 5 | |

Table A.8.3.6.1-2: Cell specific test parameters for E-UTRAN FDD-FDD inter-frequency event triggered reporting without measurement gaps

| Parameter | Unit | Cell 1 | | Cell 2 | |
|---|------|-----------|----|----------|----|
| | | T1 | T2 | T1 | T2 |
| E-UTRA RF Channel Number | | 1 | | 2 | |
| BW _{channel} | MHz | 10 | | 10 | |
| OCNG Patterns defined in A.3.2.1.10 (OP.10 FDD) and in A.3.2.1.2 (OP.2 FDD) | | OP.10 FDD | | OP.2 FDD | |
| PBCH_RA | dB | | | | |
| PBCH_RB | dB | | | | |

| | | | | | |
|--|------------|------|-----|-----------|-----|
| PSS_RA | dB | 0 | | 0 | |
| SSS_RA | dB | | | | |
| PCFICH_RB | dB | | | | |
| PHICH_RA | dB | | | | |
| PHICH_RB | dB | | | | |
| PDCCH_RA | dB | | | | |
| PDCCH_RB | dB | | | | |
| PDSCH_RA | dB | | | | |
| PDSCH_RB | dB | | | | |
| OCNG_RA ^{Note 1} | dB | | | | |
| OCNG_RB ^{Note 1} | dB | | | | |
| N_{oc} ^{Note 2} | dBm/15 kHz | | | | |
| RSRP ^{Note 3} | dBm/15 kHz | -94 | -94 | -Infinity | -91 |
| \hat{E}_s/I_{ot} | dB | 4 | 4 | -Infinity | 7 |
| SCH_RP ^{Note 3} | dBm/15 kHz | -94 | -94 | -Infinity | -91 |
| \hat{E}_s/N_{oc} | dB | 4 | 4 | -Infinity | 7 |
| Propagation Condition | | AWGN | | | |
| <p>Note 1: OCNG shall be used such that both cells are fully allocated and a constant total transmitted power spectral density is achieved for all OFDM symbols.</p> <p>Note 2: Interference from other cells and noise sources not specified in the test is assumed to be constant over subcarriers and time and shall be modelled as AWGN of appropriate power for N_{oc} to be fulfilled.</p> <p>Note 3: RSRP and SCH_RP levels have been derived from other parameters for information purposes. They are not settable parameters themselves.</p> | | | | | |

A.8.3.6.2 Test Requirements

The UE shall send one Event A3 triggered measurement report, with a measurement reporting delay less than 3840 ms from the beginning of time period T2.

The UE shall not send event triggered measurement reports, as long as the reporting criteria are not fulfilled.

The UE shall send continuous ACK/NACK throughout the test, and from the start of T2 until Event A3 is reported, at least 85% ACK/NACK shall be detected.

For a test to be considered successful requirements on both event detection and percentage of transmitted ACK/NACKs have to be fulfilled simultaneously. The rate of correct events observed during repeated tests shall be at least 90%.

NOTE: The actual overall delays measured in the test may be up to $2 \times TTI_{DCCH}$ higher than the measurement reporting delays above because of TTI insertion uncertainty of the measurement report in DCCH.

A.8.3.7 E-UTRAN FDD-FDD Inter-frequency event triggered reporting under fading propagation conditions in asynchronous cells for Increased Carrier Monitoring without Reduced Performance Group

A.8.3.7.1 Test Purpose and Environment

The purpose of this test is to verify that the UE makes correct reporting of an event. This test will partly verify the FDD-FDD inter-frequency cell search requirements in clause 8.1.2.3.

The test parameters are given in Tables A.8.3.1.1-1 and A.8.3.1.1-2. In this test, there are four cells on different carrier frequencies and gap pattern configuration # 0 as defined in Table 8.1.2.1-1 is provided.

In the measurement control information, it is indicated to the UE that event-triggered reporting with Event A3 is used. The test consists of two successive time periods, with time duration of T1, and T2 respectively. During time duration T1, the UE shall not have any timing information of cells 2, 3 or 4.

Table A.8.3.7.1-1: General test parameters for E-UTRAN FDD-FDD inter-frequency event triggered reporting in fading propagation conditions

| Parameter | Unit | Value | Comment |
|--|------|------------------------|--|
| UE configured E-UTRA RF Channel Number | | 1, 2,3,4,5,6,7,8,9 | Serving cell and eight FDD carrier frequencies are used in the UE neighbour cell list. |
| Active cell | | Cell 1 | Cell 1 is on RF channel number 1 |
| Neighbour cells | | Cell 2, Cell 3, Cell 4 | Cells 2, 3, 4 are randomly selected to use different frequencies selected from frequencies 2,3,4,5,6,7,8,9 |
| Gap Pattern Id | | 0 | As specified in TS 36.133 clause 8.1.2.1. |
| A3-Offset | dB | -6 | |
| Hysteresis | dB | 0 | |
| Reduced Performance Group Scaling factor | - | 8 | |
| CP length | | Normal | |
| TimeToTrigger | s | 0 | |
| Filter coefficient | | 0 | L3 filtering is not used |
| DRX | | OFF | OFF |
| T1 | s | 5 | |
| T2 | s | 40 | |

Table A.8.3.7.1-2: Cell specific test parameters for E-UTRAN FDD-FDD inter-frequency event triggered reporting under fading propagation conditions in synchronous cells (Cell # 1 and Cell # 2)

| Parameter | Unit | Cell 1 | | Cell 2 | |
|--|------------------------|---|----|--|----|
| | | T1 | T2 | T1 | T2 |
| E-UTRA RF Channel Number | | 1 | | Randomly selected from 2,3,4,5,6,7,8 such that cell 2 is in the normal performance group | |
| BW _{channel} | MHz | 5MHz: N _{RB} = 25 10MHz: N _{RB} = 50 | | 5MHz: N _{RB} ,= 25 10MHz: N _{RB} ,= 50 | |
| Measurement bandwidth | <i>n_{PRB}</i> | 5MHz: 10-15 10MHz: 22-27 | | 5MHz: 10-15 10MHz: 22-27 | |
| PDSCH Reference measurement channel defined in A.3.1.1. | | 5MHz: R.5 FDD 10MHz: R.0 FDD | | - | |
| PDSCH allocation | <i>n_{PRB}</i> | 5MHz: 7-17 10MHz: 13-36 | | - | |
| PDCCH/PCFICH/PHICH Reference measurement channel defined in A.3.1.2. | | 5MHz: R.11 FDD 10MHz: R.6 FDD | | 5MHz: R.11 FDD 10MHz: R.6 FDD | |
| OCNG Patterns defined in A.3.2. | | 5MHz: OP.15 FDD 10MHz: OP.1 FDD | | 5MHz: OP.16 FDD 10MHz: OP.2 FDD | |
| PBCH_RA | dB | 0 | | 0 | |
| PBCH_RB | dB | | | | |
| PSS_RA | dB | | | | |
| SSS_RA | dB | | | | |
| PCFICH_RB | dB | | | | |
| PHICH_RA | dB | | | | |
| PHICH_RB | dB | | | | |
| PDCCH_RA | dB | | | | |
| PDCCH_RB | dB | | | | |
| PDSCH_RA | dB | | | | |
| PDSCH_RB | dB | | | | |
| OCNG_RA ^{Note 1} | dB | | | | |
| OCNG_RB ^{Note 1} | dB | | | | |
| <i>N_{oc}</i> ^{Note 3} | dBm/15 kHz | | | | |
| \hat{E}_s / N_{oc} | dB | 4 | 4 | -Infinity | 7 |
| \hat{E}_s / I_{ot} | dB | 4 | 4 | -Infinity | 7 |

| | | | | | |
|---|----------------------------|-----------------------------|-----------------------------|-----------------------------|-----------------------------|
| RSRP ^{Note 4} | dBm/15 kHz | -94 | -94 | -Infinity | -91 |
| SCH_RP ^{Note 4} | dBm/15 kHz | -94 | -94 | -Infinity | -91 |
| I_o ^{Note 4} | dBm/ BW _{channel} | - | - | - | - |
| | | $64.76+10\log(N_{RB,c}/50)$ | $64.76+10\log(N_{RB,c}/50)$ | $70.22+10\log(N_{RB,c}/50)$ | $62.43+10\log(N_{RB,c}/50)$ |
| Propagation Condition | | ETU70 | | ETU70 | |
| Correlation Matrix and Antenna Configuration | | 1x2 Low | | 1x2 Low | |
| Timing offset to cell 1 | ms | - | | 3 | |
| <p>Note 1: OCNG shall be used such that both cells are fully allocated and a constant total transmitted power spectral density is achieved for all OFDM symbols.</p> <p>Note 2: The resources for uplink transmission are assigned to the UE prior to the start of time period T2.</p> <p>Note 3: Interference from other cells and noise sources not specified in the test is assumed to be constant over subcarriers and time and shall be modelled as AWGN of appropriate power for N_{oc} to be fulfilled.</p> <p>Note 4: E_s/I_{ot}, RSRP, SCH_RP and I_o levels have been derived from other parameters for information purposes. They are not settable parameters themselves.</p> | | | | | |

Table A.8.3.7.1-3: Cell specific test parameters for E-UTRAN FDD-FDD inter-frequency event triggered reporting under fading propagation conditions in synchronous cells (Cell # 3 and Cell # 4)

| Parameter | Unit | Cell 3 | | Cell 4 | |
|--|------------|--|-----|--|-----|
| | | T1 | T2 | T1 | T2 |
| E-UTRA RF Channel Number | | Randomly selected from 2,3,4,5,6,7,8 such that cell 3 is in the normal performance group | | Randomly selected from 2,3,4,5,6,7,8 such that cell 4 is in the normal performance group | |
| BW _{channel} | MHz | 5MHz: N _{RB} = 25 10MHz: N _{RB} = 50 | | 5MHz: N _{RB} = 25 10MHz: N _{RB} = 50 | |
| Measurement bandwidth | n_{PRB} | 5MHz: 10-15 10MHz: 22-27 | | 5MHz: 10-15 10MHz: 22-27 | |
| PDSCH Reference measurement channel defined in A.3.1.1. | | - | | - | |
| PDSCH allocation | n_{PRB} | - | | - | |
| PDCCH/PCFICH/PHICH Reference measurement channel defined in A.3.1.2. | | 5MHz: R.11 FDD 10MHz: R.6 FDD | | 5MHz: R.11 FDD 10MHz: R.6 FDD | |
| OCNG Patterns defined in A.3.2. | | 5MHz: OP.16 FDD 10MHz: OP.2 FDD | | 5MHz: OP.16 FDD 10MHz: OP.2 FDD | |
| PBCH_RA | dB | 0 | | 0 | |
| PBCH_RB | dB | | | | |
| PSS_RA | dB | | | | |
| SSS_RA | dB | | | | |
| PCFICH_RB | dB | | | | |
| PHICH_RA | dB | | | | |
| PHICH_RB | dB | | | | |
| PDCCH_RA | dB | | | | |
| PDCCH_RB | dB | | | | |
| PDSCH_RA | dB | | | | |
| PDSCH_RB | dB | | | | |
| OCNG_RA ^{Note 1} | dB | | | | |
| OCNG_RB ^{Note 1} | dB | | | | |
| N_{oc} ^{Note 3} | dBm/15 kHz | -98 | | -98 | |
| \hat{E}_s/N_{oc} | dB | -Infinity | 7 | -Infinity | 7 |
| \hat{E}_s/I_{ot} | dB | -Infinity | 7 | -Infinity | 7 |
| RSRP ^{Note 4} | dBm/15 kHz | -Infinity | -91 | -Infinity | -91 |
| SCH_RP ^{Note 4} | dBm/15 kHz | -Infinity | -91 | -Infinity | -91 |

| | | | | | |
|--|--|----------------------------------|----------------------------------|----------------------------------|----------------------------------|
| $I_{o}^{\text{Note 4}}$ | dBm/ BW_{channel} | - $70.22+10\log(N_{RB,c}/50)$ | - $62.43+10\log(N_{RB,c}/50)$ | - $70.22+10\log(N_{RB,c}/50)$ | - $62.43+10\log(N_{RB,c}/50)$ |
| Propagation Condition | | ETU70 | | ETU70 | |
| Correlation Matrix and Antenna Configuration | | 1x2 Low | | 1x2 Low | |
| Timing offset to cell 1 | ms | 3 | | 3 | |
| Note 1: | OCNG shall be used such that both cells are fully allocated and a constant total transmitted power spectral density is achieved for all OFDM symbols. | | | | |
| Note 2: | The resources for uplink transmission are assigned to the UE prior to the start of time period T2. | | | | |
| Note 3: | Interference from other cells and noise sources not specified in the test is assumed to be constant over subcarriers and time and shall be modelled as AWGN of appropriate power for N_{oc} to be fulfilled. | | | | |
| Note 4: | E_s/I_{ot} , R_{SRP} , SCH_RP and I_o levels have been derived from other parameters for information purposes. They are not settable parameters themselves. | | | | |

A.8.3.7.2 Test Requirements

The UE shall send Event A3 triggered measurement reports for cells 2, 3 and 4, with a measurement reporting delay less than 30.72s from the beginning of time period T2.

The UE shall not send event triggered measurement reports, as long as the reporting criteria are not fulfilled.

The rate of correct events observed during repeated tests shall be at least 90%.

NOTE: The actual overall delays measured in the test may be up to $2 \times TTI_{DCCH}$ higher than the measurement reporting delays above because of TTI insertion uncertainty of the measurement report in DCCH.

A.8.3.8 FDD-FDD Interfrequency correct reporting of measurement events with reduced performance group configured, non DRX

A.8.3.8.1 Test Purpose and Environment

The purpose of this test is to verify that the UE makes correct reporting of an event. This test will partly verify the FDD-FDD inter-frequency cell measurement requirements for increased UE carrier monitoring in clause 8.1.2.3.

The test parameters are given in Tables A.8.3.8.1-1, A.8.3.8.1-2 and A.8.3.8.1-3. In this test, there are 4 cells on different carrier frequencies and gap pattern configuration #0 as defined in table A.8.3.8.1-1 is provided.

In the measurement control information, it is indicated to the UE that event-triggered reporting with Events A3 is used. The test consists of two successive time periods for every repetition, with time duration of T1, and T2 respectively. During time duration T1, the UE shall not have any timing information of neighbour cells. At the start of each repetition of T1, the test equipment provides signals for cell 1 (serving cell), and cells 2, 3 and 4 which are selected from the 8 cells which are configured in the UE neighbour cell list. Cells 2, 3 and 4 are chosen randomly, such that one frequency belongs to the normal performance group and two frequencies belong to the reduced performance group.

Table A.8.3.8.1-1: General test parameters for FDD-FDD Interfrequency correct reporting of measurement events with reduced performance group configured, non DRX

| Parameter | Unit | Value | Comment |
|--|------|---|---|
| UE configured E-UTRA RF Channel Number | | 1,2,3,4,5,6,7,8,9 | Serving cell and 8 FDD carrier frequencies are used in the UE neighbour cell list. Frequencies 5,6,7,8 and 9 are indicated to have reduced performance |
| Test equipment configuration | | Cell 1 uses E-UTRA RF channel number 1 Cell 2,3,4 are randomly selected to use different frequencies selected from frequencies 2,3,4,5,6,7,8,9 | Cell 1 uses E-UTRA RF channel number 1 Cell 2 is randomly selected to use different frequencies selected from E-UTRA frequencies 2, 3, 4. Cells 3, 4 are randomly selected to use different frequencies selected from E-UTRA frequencies 5, 6, 7, 8, 9. |
| Active cell | | Cell 1 | Cell 1 is on RF channel number 1 |
| Gap Pattern Id | | 0 | As specified in TS 36.133 clause 8.1.2.1. |

| | | | |
|-------------------------------|----|--------|---|
| A3-Offset | dB | -6 | |
| Hysteresis | dB | 0 | |
| CP length | | Normal | |
| TimeToTrigger | s | 0 | |
| Filter coefficient | | 0 | L3 filtering is not used |
| DRX | | OFF | OFF |
| Scaling factor configurations | | 8 | As specified in TS 36.133 clause 8.1.2.1.1a |
| T1 | s | 5 | |
| T2 | s | 155 | |

Table A.8.3.8.1-2: Cell specific test parameters for FDD-FDD Interfrequency correct reporting of measurement events with reduced performance group configured, non DRX (cell #1, cell #2)

| Parameter | Unit | Cell 1 | | Cell 2 | |
|--|------------|---|---|--|---|
| | | T1 | T2 | T1 | T2 |
| E-UTRA RF Channel Number | | 1 | | Randomly selected from 2,3,4 such that cell 2 is in the normal performance group | |
| BW _{channel} | | 5MHz: N _{RB} = 25 10MHz: N _{RB} = 50 | | 5MHz: N _{RB} ,= 25 10MHz: N _{RB} ,= 50 | |
| PDSCH parameters: DL Reference Measurement Channel As specified in clause A.3.1.1.1 | | 5MHz: R.5 FDD 10MHz:R.0 FDD | | - | |
| PCFICH/PDCCH/PHICH parameters: DL Reference Measurement Channel As specified in clause A.3.1.2.1 | | 5MHz: R.11 FDD 10MHz:R.6 FDD | | 5MHz: R.11 FDD 10MHz:R.6 FDD | |
| OCNG Patterns defined in A.3.2.1.1, A.3.2.1.2 ,A.3.2.1.15 and A.3.2.1.16 | | 5MHz: OP.15 FDD 10MHz:OP.1 FDD | | 5MHz: OP.16.FDD 10MHz:OP.2 FDD | |
| PBCH_RA | dB | 0 | | 0 | |
| PBCH_RB | dB | | | | |
| PSS_RA | dB | | | | |
| SSS_RA | dB | | | | |
| PCFICH_RB | dB | | | | |
| PHICH_RA | dB | | | | |
| PHICH_RB | dB | | | | |
| PDCCH_RA | dB | | | | |
| PDCCH_RB | dB | | | | |
| PDSCH_RA | dB | | | | |
| PDSCH_RB | dB | | | | |
| OCNG_RA ^{Note 1} | dB | | | | |
| OCNG_RB ^{Note 1} | dB | | | | |
| N _{oc} ^{Note 3} | dBm/15 kHz | | | | |
| \hat{E}_s / N_{oc} | dB | 4 | 4 | -Infinity | 7 |
| \hat{E}_s / I_{ot} ^{Note 4} | dB | 4 | 4 | -Infinity | 7 |
| RSRP ^{Note 4} | dBm/15 kHz | -94 | -94 | -Infinity | -91 |
| SCH_RP ^{Note 4} | dBm/15 kHz | -94 | -94 | -Infinity | -91 |
| I _o ^{Note 4} | dBm/Ch BW | -64.76 +10log (N _{RB,c} /50) | -64.76 +10log (N _{RB,c} /50) | -70.22 +10log (N _{RB,c} /50) | -62.43 +10log (N _{RB,c} /50) |
| Propagation Condition | | AWGN | | AWGN | |
| Antenna Configuration | | 1x2 | | 1x2 | |
| Timing offset to Cell 1 | | - | | 3ms | |

| | |
|---------|--|
| Note 1: | OCNG shall be used such that both cells are fully allocated and a constant total transmitted power spectral density is achieved for all OFDM symbols. |
| Note 2: | The resources for uplink transmission are assigned to the UE prior to the start of time period T2. |
| Note 3: | Interference from other cells and noise sources not specified in the test is assumed to be constant over subcarriers and time and shall be modelled as AWGN of appropriate power for N_{oc} to be fulfilled. |
| Note 4: | Es/Iot, RSRP, SCH_RP and Io have been derived from other parameters for information purposes. They are not settable parameters themselves. |

Table A.8.3.8.1-3: Cell specific test parameters for FDD-FDD Interfrequency correct reporting of measurement events with reduced performance group configured, non DRX (cell #3, cell #4)

| Parameter | Unit | Cell 3 | | Cell 4 | |
|--|------------|---|---|---|---|
| | | T1 | T2 | T1 | T2 |
| E-UTRA RF Channel Number | | Randomly selected from 5,6,7,8,9 such that cell 3 is in the reduced performance group | | Randomly selected from 5,6,7,8,9 such that cell 4 is in the reduced performance group. Cell 4 RF channel is different from Cell 3 RF channel. | |
| BW _{channel} | | 5MHz: N _{RB} = 25 10MHz: N _{RB} = 50 | | 5MHz: N _{RB} = 25 10MHz: N _{RB} = 50 | |
| PDSCH parameters: DL Reference Measurement Channel As specified in clause A.3.1.1.1 | | - | | - | |
| PCFICH/PDCCH/PHICH parameters: DL Reference Measurement Channel As specified in clause A.3.1.2.1 | | 5MHz: R.11 FDD 10MHz:R.6 FDD | | 5MHz: R.11 FDD 10MHz:R.6 FDD | |
| OCNG Patterns defined in A.3.2.1.2 and A.3.2.1.16 | | 5MHz: OP.16.FDD 10MHz:OP.2 FDD | | 5MHz: OP.16.FDD 10MHz:OP.2 FDD | |
| PBCH_RA | dB | 0 | | 0 | |
| PBCH_RB | dB | | | | |
| PSS_RA | dB | | | | |
| SSS_RA | dB | | | | |
| PCFICH_RB | dB | | | | |
| PHICH_RA | dB | | | | |
| PHICH_RB | dB | | | | |
| PDCCH_RA | dB | | | | |
| PDCCH_RB | dB | | | | |
| PDSCH_RA | dB | | | | |
| PDSCH_RB | dB | | | | |
| OCNG_RA ^{Note 1} | dB | | | | |
| OCNG_RB ^{Note 1} | dB | | | | |
| N _{oc} ^{Note 3} | dBm/15 kHz | | | | |
| \hat{E}_s / N_{oc} | dB | -Infinity | 7 | -Infinity | 7 |
| \hat{E}_s / I_{ot} ^{Note 4} | dB | -Infinity | 7 | -Infinity | 7 |
| RSRP ^{Note 4} | dBm/15 kHz | -Infinity | -91 | -Infinity | -91 |
| SCH_RP ^{Note 4} | dBm/15 kHz | -Infinity | -91 | -Infinity | -91 |
| Io ^{Note 4} | dBm/Ch BW | -70.22 +10log (N _{RB,c} /50) | -62.43 +10log (N _{RB,c} /50) | -70.22 +10log (N _{RB,c} /50) | -62.43 +10log (N _{RB,c} /50) |
| Propagation Condition | | AWGN | | AWGN | |
| Antenna Configuration | | 1x2 | | 1x2 | |
| Timing offset to Cell 1 | | 3ms | | 3ms | |

| | |
|---------|--|
| Note 1: | OCNG shall be used such that both cells are fully allocated and a constant total transmitted power spectral density is achieved for all OFDM symbols. |
| Note 2: | The resources for uplink transmission are assigned to the UE prior to the start of time period T2. |
| Note 3: | Interference from other cells and noise sources not specified in the test is assumed to be constant over subcarriers and time and shall be modelled as AWGN of appropriate power for N_{oc} to be fulfilled. |
| Note 4: | Es/Iot, RSRP, SCH_RP and Io have been derived from other parameters for information purposes. They are not settable parameters themselves. |

A.8.3.8.2 Test Requirements

The UE shall send Event A3 triggered measurement reports for cells 2, 3 and 4, with a measurement reporting delay less than 13.17s (cell 2) and 153.6s (cell 3 and 4) from the beginning of time period T2.

The UE shall not send event triggered measurement reports, as long as the reporting criteria are not fulfilled.

The rate of correct events observed during repeated tests shall be at least 90%.

NOTE: The actual overall delays measured in the test may be up to $2 \times TTI_{DCC}$ higher than the measurement reporting delays above because of TTI insertion uncertainty of the measurement report.

A.8.3.9 FDD-FDD Inter-frequency correct reporting of measurement events with reduced performance group configured, DRX

A.8.3.9.1 Test Purpose and Environment

The purpose of this test is to verify that the UE makes correct reporting of an event in DRX. This test will partly verify the FDD-FDD inter-frequency cell search requirements when DRX is used in clause 8.1.2.3.

The test parameters are given in Tables A.8.3.9.1-1, A.8.3.9.1-2, A.8.3.9.1-3 and A.8.3.9.1-4. In this test, there are four cells on different carrier frequencies and gap pattern configuration # 0 as defined in Table 8.1.2.1-1 is provided.

The UE needs to be provided at least once every 500ms with new Timing Advance Command MAC control element to restart the Time alignment timer to keep UE uplink time alignment. Furthermore UE is allocated with PUSCH resource at every DRX cycle..

In the measurement control information, it is indicated to the UE that event-triggered reporting with Event A3 is used. The test consists of two successive time periods for every repetition, with time duration of T1 and T2 respectively. During time duration T1, the UE shall not have any timing information of cell 2, 3 or 4. At the start of each repetition of T1, the test equipment provides signals for cell 1 (serving cell), and cells 2, 3 and 4 which are selected from the 8 cells on different frequencies which are configured in the UE neighbour cell list. Cells 2, 3 and 4 are chosen randomly, such that one frequency belongs to the normal performance group and two frequencies belong to the reduced performance group.

Table A.8.3.9.1-1: General test parameters for E-UTRAN FDD-FDD inter-frequency event triggered reporting for IncMon

| Parameter | Unit | Value | Comment |
|--|------|--------------------|---|
| UE configured E-UTRA RF Channel Number | | 1, 2,3,4,5,6,7,8,9 | Serving cell and eight FDD carrier frequencies are used in the UE neighbour cell list. Frequencies 5,6,7,8 and 9 are indicated to have reduced performance |
| Test equipment configuration | | Cell 1,2,3,4 | Cell 1 uses E-UTRA RF channel number 1 Cells 2 are randomly selected to use different frequencies selected from E-UTRA frequencies 2, 3, 4. Cells 3, 4 are randomly selected to use different frequencies selected from E-UTRA frequencies 5, 6, 7, 8, 9. |
| Active cell | | Cell 1 | Cell 1 is on RF channel number 1 |
| Neighbour cells | | Cell 2,3,4 | |
| Gap Pattern Id | | 0 | As specified in TS 36.133 clause 8.1.2.1. |
| A3-Offset | dB | -5 | |

| | | | |
|--|----|--------|---|
| Hysteresis | dB | 0 | |
| CP length | | Normal | |
| TimeToTrigger | s | 0 | |
| Filter coefficient | | 0 | L3 filtering is not used |
| DRX | | ON | DRX related parameters are defined in Table A.8.3.9.1-3 |
| Scaling factor for reduced performance group | | 8 | |
| T1 | s | 5 | |
| T2 | s | 155 | |

Table A.8.3.9.1-2: Cell specific test parameters for E-UTRAN FDD-FDD inter-frequency event triggered reporting for IncMon

| Parameter | Unit | Cell 1 | | Cell 2 | | Cell 3 | | Cell 4 | |
|--|------------|------------------------------------|--------------------------------|--|--------------------------------|---|--------------------------------|---|--------------------------------|
| | | T1 | T2 | T1 | T2 | T1 | T2 | T1 | T2 |
| E-UTRA RF Channel Number | | 1 | | Randomly selected from 2,3,4 such that cell 2 is in the normal performance group | | Randomly selected from 5, 6, 7, 8, 9 such that cell 3 is in the reduced performance group | | Randomly selected from 5, 6, 7, 8, 9 such that cell 4 is in the reduced performance group | |
| Channel Bandwidth ($BW_{channel}$) | MHz | 5MHz: NRB = 25 10MHz: NRB = 50 | | 5MHz: NRB, = 25 10MHz: NRB, = 50 | | 5MHz: NRB = 25 10MHz: NRB = 50 | | 5MHz: NRB, = 25 10MHz: NRB, = 50 | |
| PDSCH parameters as specified in clause A.3.1.1.1 | | 5MHz: R.5 FDD 10MHz: R.0 FDD | | - | | - | | - | |
| PCFICH/PDCCH/PHICH parameters as specified in clause A.3.1.2.1 | | 5MHz: R.11 FDD 10MHz: R.6 FDD | | 5MHz: R.11 FDD 10MHz: R.6 FDD | | 5MHz: R.11 FDD 10MHz: R.6 FDD | | 5MHz: R.11 FDD 10MHz: R.6 FDD | |
| OCNG Patterns defined in A.3.2.1 | | 5MHz: OP.15 FDD 10MHz: OP.1 FDD | | 5MHz: OP.16 FDD 10MHz: OP.2 FDD | | 5MHz: OP.16 FDD 10MHz: OP.2 FDD | | 5MHz: OP.16 FDD 10MHz: OP.2 FDD | |
| PBCH_RA | dB | 0 | | 0 | | 0 | | 0 | |
| PBCH_RB | dB | | | | | | | | |
| PSS_RA | dB | | | | | | | | |
| SSS_RA | dB | | | | | | | | |
| PCFICH_RB | dB | | | | | | | | |
| PHICH_RA | dB | | | | | | | | |
| PHICH_RB | dB | | | | | | | | |
| PDCCH_RA | dB | | | | | | | | |
| PDCCH_RB | dB | | | | | | | | |
| PDSCH_RA | dB | | | | | | | | |
| PDSCH_RB | dB | | | | | | | | |
| OCNG_RA ^{Note 1} | dB | | | | | | | | |
| OCNG_RB ^{Note 1} | dB | | | | | | | | |
| N_{oc} ^{Note 3} | dBm/15 kHz | | | | | | | | |
| \hat{E}_s / N_{oc} | dB | 4 | 4 | -Infinity | 4 | -Infinity | 4 | -Infinity | 4 |
| \hat{E}_s / I_{ot} ^{Note 4} | dB | 4 | 4 | -Infinity | 4 | -Infinity | 4 | -Infinity | 4 |
| RSRP ^{Note 4} | dBm/15 kHz | -94 | -94 | -Infinity | -94 | -Infinity | -94 | -Infinity | -94 |
| SCH_RP ^{Note 4} | dBm/15 kHz | -94 | -94 | -Infinity | -94 | -Infinity | -94 | -Infinity | -94 |
| I_o ^{Note 4} | dBm/Ch BW | $-64.76+10\log(N_{RB,c} / 50)$ | $-64.76+10\log(N_{RB,c} / 50)$ | $-70.22+10\log(N_{RB,c} / 50)$ | $-64.76+10\log(N_{RB,c} / 50)$ | $-70.22+10\log(N_{RB,c} / 50)$ | $-64.76+10\log(N_{RB,c} / 50)$ | $-70.22+10\log(N_{RB,c} / 50)$ | $-64.76+10\log(N_{RB,c} / 50)$ |
| Propagation Condition | | AWGN | | AWGN | | AWGN | | AWGN | |
| Antenna Configuration | | 1x2 | | 1x2 | | 1x2 | | 1x2 | |
| Time offset to cell1 | ms | - | | 3 | | 3 | | 3 | |

- Note 1: OCNG shall be used such that both cells are fully allocated and a constant total transmitted power spectral density is achieved for all OFDM symbols.
- Note 2: The resources for uplink transmission are assigned to the UE prior to the start of time period T2.
- Note 3: Interference from other cells and noise sources not specified in the test is assumed to be constant over subcarriers and time and shall be modelled as AWGN of appropriate power for N_{oc} to be fulfilled.
- Note 4: E_s/I_{ot} , RSRP, SCH_RP and I_o levels have been derived from other parameters for information purposes. They are not settable parameters themselves.

Table A.8.3.9.1-3: *drx-Configuration* to be used in E-UTRAN FDD-FDD inter-frequency event triggered reporting when DRX is used for IncMon

| Field | Value | Comment |
|--|---------|---------|
| onDurationTimer | psf1 | |
| drx-InactivityTimer | psf1 | |
| drx-RetransmissionTimer | psf1 | |
| longDRX-CycleStartOffset | sf160 | |
| shortDRX | disable | |
| Note: For further information see clause 6.3.2 in TS 36.331. | | |

Table A.8.3.9.1-4: *TimeAlignmentTimer* and *sr-ConfigIndex* Configuration to be used in E-UTRAN FDD-FDD inter-frequency event triggered reporting when DRX is used for IncMon

| Field | Value | Comment |
|--------------------|-------|---|
| TimeAlignmentTimer | sf500 | For further information see clause 6.3.2 in TS 36.331. |
| sr-ConfigIndex | 0 | For further information see clause 6.3.2 in TS 36.331 and section 10.1 in TS 36.213.. |

A.8.3.9.2 Test Requirements

The UE shall send Event A3 triggered measurement reports for cells 2, 3 and 4, with a measurement reporting delay less than 13.2s (cell 2) and 153.6s (cell 3 and 4) from the beginning of time period T2.

The UE shall not send event triggered measurement reports, as long as the reporting criteria are not fulfilled.

The rate of correct events observed during repeated tests shall be at least 90%.

NOTE: The actual overall delays measured in the test may be up to $2 \times TTI_{DCC}$ higher than the measurement reporting delays above because of TTI insertion uncertainty of the measurement report.

Where:

When DRX cycle is 160ms, the delay requirement of cell identification and measurement period are specified in section 8.1.2.3.1.2 and Non DRX Requirements in clause 8.1.2.3.1.1 are applicable.

The requirement of inter frequency cell identification delay are specified as

$$T_{\text{Identify_Inter}} = T_{\text{Basic_Identify_Inter}} \cdot \frac{480}{T_{\text{Inter1}}} \cdot N_{\text{freq},n} \cdot K_n \quad \text{ms (normal performance) and}$$

$$T_{\text{Identify_Inter}} = T_{\text{Basic_Identify_Inter}} \cdot \frac{480}{T_{\text{Inter1}}} \cdot N_{\text{freq},r} \cdot K_r \quad \text{ms (reduced performance)}$$

$T_{\text{Basic_Identify_inter}}$ 480ms, See section 8.1.2.3.1.1

T_{Inter1} 60ms, See section 8.1.2.1

$N_{\text{freq},n}$ and $N_{\text{freq},r}$ 3 and 5 set in this test case.

K_n and K_r 8/7 and 8, See section 8.1.2.1.1a.

This gives 13165.7ms for cells 2 on normal carrier, and 153600ms for cell 3 and cell 4 on reduced carriers for Event A3 triggered measurement reporting delay. The test requirements allow 13.2s and 153.6s.

A.8.4 E-UTRAN TDD - TDD Inter-frequency Measurements

A.8.4.1 E-UTRAN TDD-TDD Inter-frequency event triggered reporting under fading propagation conditions in synchronous cells

A.8.4.1.1 Test Purpose and Environment

The purpose of this test is to verify that the UE makes correct reporting of an event. This test will partly verify the TDD-TDD inter-frequency cell search requirements in clause 8.1.2.3.2.

The test parameters are given in Table A.8.4.1.1-1 and A.8.4.1.1-2 below. In the measurement control information it is indicated to the UE that event-triggered reporting with Event A3 is used. The test consists of two successive time periods, with time duration of T1, and T2 respectively. During time duration T1, the UE shall not have any timing information of cell 2.

Table A.8.4.1.1-1: General test parameters for E-UTRAN TDD-TDD inter-frequency event triggered reporting in fading propagation conditions

| Parameter | Unit | Value | Comment |
|--------------------------------------|------|--|--|
| PDSCH parameters | | DL Reference Measurement Channel R.0 TDD | As specified in clause A.3.1.1.2 |
| PCFICH/PDCCH/PHICH parameters | | DL Reference Measurement Channel R.6 TDD | As specified in clause A.3.1.2.2 |
| Gap Pattern Id | | 1 | As specified in TS 36.133 clause 8.1.2.1. |
| Special subframe configuration | | 6 | As specified in table 4.2-1 in TS 36.211. The same configuration in both cells |
| Uplink-downlink configuration | | 1 | As specified in TS 36.211 clause 4.2 Table 4.2-2 |
| CP length | | Normal | |
| E-UTRA RF Channel Number | | 1, 2 | Two TDD carrier frequencies are used. |
| Channel Bandwidth ($BW_{channel}$) | MHz | 10 | |
| Active cell | | Cell 1 | Cell 1 is on RF channel number 1 |
| Neighbour cell | | Cell 2 | Cell 2 is on RF channel number 2 |
| A3-Offset | dB | -6 | |
| Hysteresis | dB | 0 | |
| TimeToTrigger | s | 0 | |
| Filter coefficient | | 0 | L3 filtering is not used |
| DRX | | OFF | |
| Time offset between cells | | 3 μ s | Synchronous cells |
| T1 | s | 5 | |
| T2 | s | 10 | |

Table A.8.4.1.1-2: Cell specific test parameters for E-UTRAN TDD-TDD inter-frequency event triggered reporting under fading propagation conditions in synchronous cells

| Parameter | Unit | Cell 1 | | Cell 2 | |
|--|------|----------|----|----------|----|
| | | T1 | T2 | T1 | T2 |
| E-UTRA RF Channel Number | | 1 | | 2 | |
| $BW_{channel}$ | MHz | 10 | | 10 | |
| Correlation Matrix and Antenna Configuration | | 1x2 Low | | 1x2 Low | |
| OCNG Pattern defined in A.3.2.2.1 (OP.1 TDD) and in A.3.2.2.2 (OP.2) | | OP.1 TDD | | OP.2 TDD | |
| PBCH_RA | dB | | | | |
| PBCH_RB | dB | | | | |
| PSS_RA | dB | | | | |
| SSS_RA | dB | | | | |

| | | | | | |
|--|------------|-----|-----|-----------|-----|
| PCFICH_RB | dB | 0 | | 0 | |
| PHICH_RA | dB | | | | |
| PHICH_RB | dB | | | | |
| PDCCH_RA | dB | | | | |
| PDCCH_RB | dB | | | | |
| PDSCH_RA | dB | | | | |
| PDSCH_RB | dB | | | | |
| OCNG_RA ^{Note 1} | dB | | | | |
| OCNG_RB ^{Note 1} | dB | | | | |
| \hat{E}_s / I_{ot} | dB | | | | |
| N_{oc} ^{Note 3} | dBm/15 kHz | -98 | | | |
| RSRP ^{Note 4} | dBm/15 kHz | -94 | -94 | -Infinity | -91 |
| SCH_RP ^{Note 4} | dBm/15 kHz | -94 | -94 | -infinity | -91 |
| \hat{E}_s / N_{oc} | dB | 4 | 4 | -Infinity | 7 |
| Propagation Condition | ETU70 | | | | |
| Note 1: OCNG shall be used such that both cells are fully allocated and a constant total transmitted power spectral density is achieved for all OFDM symbols. | | | | | |
| Note 2: The resources for uplink transmission are assigned to the UE priori to the start of time period T2. | | | | | |
| Note 3: Interference from other cells and noise sources not specified in the test is assumed to be constant over subcarriers and time and shall be modelled as AWGN of appropriate power for N_{oc} to be fulfilled. | | | | | |
| Note 4: RSRP and SCH_RP levels have been derived from other parameters for information purposes. They are not settable parameters themselves. | | | | | |

A.8.4.1.2 Test Requirements

The UE shall send one Event A3 triggered measurement report, with a measurement reporting delay less than 7680 ms from the beginning of time period T2.

The UE shall not send event triggered measurement reports, as long as the reporting criteria are not fulfilled.

The rate of correct events observed during repeated tests shall be at least 90%.

NOTE: The actual overall delays measured in the test may be up to $2 \times TTI_{DCCH}$ higher than the measurement reporting delays above because of TTI insertion uncertainty of the measurement report in DCCH.

A.8.4.2 E-UTRAN TDD-TDD Inter-frequency event triggered reporting when DRX is used under fading propagation conditions in synchronous cells

A.8.4.2.1 Test Purpose and Environment

The purpose of these tests is to verify that the UE makes correct reporting of an event in DRX. These test will partly verify the TDD-TDD inter-frequency cell search requirements when DRX is used in clause 8.1.2.3.

The common test parameters are given in Tables A.8.4.2.1-1 and A.8.4.2.1-2. DRX configuration for Test1 and Test2 are given in Table A.8.4.2.1-3 and time alignment timer and scheduling request related parameters in Table A.8.4.2.1-4. In these tests, there are two cells on different carrier frequencies and gap pattern configuration # 0 as defined in Table 8.1.2.1-1 is provided.

In Test 1 UE needs to be provided at least once every 500ms with new Timing Advance Command MAC control element to restart the Time alignment timer to keep UE uplink time alignment. Furthermore UE is allocated with PUSCH resource at every DRX cycle. In Test 2 the uplink time alignment is not maintained and UE needs to use RACH to obtain UL allocation for measurement reporting.

In the measurement control information, it is indicated to the UE that event-triggered reporting with Event A3 is used. The tests consists of two successive time periods, with time duration of T1, and T2 respectively. During time duration T1, the UE shall not have any timing information of cell 2.

Table A.8.4.2.1-1: General test parameters for E-UTRAN TDD-TDD inter-frequency event triggered reporting when DRX is used in fading propagation conditions

| Parameter | Unit | Test 1 | Test 2 | Comment |
|--------------------------------------|------|--|--------|--|
| | | Value | | |
| PDSCH parameters | | DL Reference Measurement Channel R.0 TDD | | As specified in clause A.3.1.1.2. Note that UE may only be allocated at <i>On Duration</i> |
| PCFICH/PDCCH/PHICH parameters | | DL Reference Measurement Channel R.6 TDD | | As specified in clause A.3.1.2.2. |
| E-UTRA RF Channel Number | | 1, 2 | | Two TDD carrier frequencies are used. |
| Channel Bandwidth ($BW_{channel}$) | MHz | 10 | | |
| Active cell | | Cell 1 | | Cell 1 is on RF channel number 1 |
| Neighbour cell | | Cell 2 | | Cell 2 is on RF channel number 2 |
| Gap Pattern Id | | 0 | | As specified in TS 36.133 clause 8.1.2.1. |
| Uplink-downlink configuration | | 1 | | As specified in TS 36.211 clause 4.2 Table 4.2-2 |
| Special subframe configuration | | 6 | | As specified in table 4.2-1 in TS 36.211. The same configuration in both cells |
| A3-Offset | dB | -6 | | |
| Hysteresis | dB | 0 | | |
| CP length | | Normal | | |
| TimeToTrigger | s | 0 | | |
| Filter coefficient | | 0 | | L3 filtering is not used |
| PRACH configuration | | 4 | | As specified in table 5.7.1-3 in TS 36.211 |
| Access Barring Information | - | Not Sent | | No additional delays in random access procedure. |
| DRX | | ON | | DRX related parameters are defined in Table A.8.4.2.1-3 |
| Time offset between cells | | 3 μ s | | Synchronous cells |
| T1 | s | 5 | | |
| T2 | s | 5 | 30 | |

Table A.8.4.2.1-2: Cell specific test parameters for E-UTRAN TDD-TDD inter-frequency event triggered reporting under fading propagation conditions in synchronous cells

| Parameter | Unit | Cell 1 | | Cell 2 | |
|---|------------|----------|-----|-----------|-----|
| | | T1 | T2 | T1 | T2 |
| E-UTRA RF Channel Number | | 1 | | 2 | |
| $BW_{channel}$ | MHz | 10 | | 10 | |
| Correlation Matrix and Antenna Configuration | | 1x2 Low | | 1x2 Low | |
| OCNG Patterns defined in A.3.2.2.1 (OP.1 TDD) and in A.3.2.2.2 (OP.2 TDD) | | OP.1 TDD | | OP.2 TDD | |
| PBCH_RA | dB | 0 | | 0 | |
| PBCH_RB | dB | | | | |
| PSS_RA | dB | | | | |
| SSS_RA | dB | | | | |
| PCFICH_RB | dB | | | | |
| PHICH_RA | dB | | | | |
| PHICH_RB | dB | | | | |
| PDCCH_RA | dB | | | | |
| PDCCH_RB | dB | | | | |
| PDSCH_RA | dB | | | | |
| PDSCH_RB | dB | | | | |
| OCNG_RA ^{Note 1} | dB | | | | |
| OCNG_RB ^{Note 1} | dB | | | | |
| N_{oc} ^{Note 2} | dBm/15 kHz | | | | |
| RSRP ^{Note 3} | dBm/15 kHz | -94 | -94 | -Infinity | -91 |

| | | | | | |
|--|------------|-----|-----|-----------|-----|
| \hat{E}_s / I_{ot} | dB | 4 | 4 | -Infinity | 7 |
| SCH_RP ^{Note 3} | dBm/15 kHz | -94 | -94 | -Infinity | -91 |
| \hat{E}_s / N_{oc} | dB | 4 | 4 | -Infinity | 7 |
| Propagation Condition | ETU70 | | | | |
| Note 1: OCNG shall be used such that both cells are fully allocated and a constant total transmitted power spectral density is achieved for all OFDM symbols. | | | | | |
| Note 2: Interference from other cells and noise sources not specified in the test is assumed to be constant over subcarriers and time and shall be modelled as AWGN of appropriate power for N_{oc} to be fulfilled. | | | | | |
| Note 3: RSRP and SCH_RP levels have been derived from other parameters for information purposes. They are not settable parameters themselves. | | | | | |

Table A.8.4.2.1-3: drx-Configuration to be used in E-UTRAN TDD-TDD inter-frequency event triggered reporting when DRX is used in fading propagation conditions

| Field | Test1 | Test2 | Comment |
|--------------------------|---------|---------|---------|
| | Value | Value | |
| onDurationTimer | psf1 | psf1 | |
| drx-InactivityTimer | psf1 | psf1 | |
| drx-RetransmissionTimer | psf1 | psf1 | |
| longDRX-CycleStartOffset | sf40 | sf1280 | |
| shortDRX | disable | disable | |

Table A.8.4.2.1-4: *TimeAlignmentTimer* and *sr-ConfigIndex* -Configuration to be used in E-UTRAN TDD-TDD inter-frequency event triggered reporting when DRX is used in fading propagation conditions

| Field | Test1 | Test2 | Comment |
|--------------------|-------|-------|--|
| | Value | Value | |
| TimeAlignmentTimer | sf500 | sf500 | For further information see clause 6.3.2 in TS 36.331. |
| sr-ConfigIndex | 2 | 2 | For further information see clause 6.3.2 in TS 36.331 and 10.1 in TS 36.213. |

A.8.4.2.2 Test Requirements

In Test1 the UE shall send one Event A3 triggered measurement report, with a measurement reporting delay less than 3840 ms from the beginning of time period T2. The measurement reporting delay is defined as the time from the beginning of time period T2, to the moment when the UE send the measurement report on PUSCH.

In Test2 the UE shall send one Event A3 triggered measurement report, with a measurement reporting delay less than 20*1280ms from the beginning of time period T2. The measurement reporting delay is defined as the time from the beginning of time period T2, to the moment when the UE starts to send preambles on the PRACH for scheduling request (SR) to obtain allocation to send the measurement report on PUSCH.

The UE shall not send event triggered measurement reports, as long as the reporting criteria are not fulfilled.

The rate of correct events observed during repeated tests shall be at least 90%.

NOTE 1: The actual overall delays measured in the test may be up to one DRX cycle higher than the measurement reporting delays above because UE is allowed to delay the initiation of the measurement reporting procedure to the next until the Active Time.

NOTE 2: In order to calculate the rate of correct events the system simulator shall verify that it has received correct Event A3 measurement report.

A.8.4.3 E-UTRAN TDD-TDD inter-frequency event triggered reporting under AWGN propagation conditions in synchronous cells with DRX when L3 filtering is used

A.8.4.3.1 Test Purpose and Environment

The purpose of this test is to verify that the UE makes correct reporting of an event in DRX when L3 filtering is used. This test will partly verify the TDD-TDD inter-frequency cell search in DRX requirements in clause 8.1.2.3.2.2 and the UE behaviour with the filterCoefficient defined in TS 36.331 [2].

The test parameters are given in Tables A.8.4.3.1-1, A.8.4.3.1-2, A.8.4.3.1-3 and A.8.4.3.1-4. In the measurement control information, it is indicated to the UE that event-triggered reporting with Event A3 and the filter coefficient is used. The test consists of two successive time periods, with time duration of T1, and T2 respectively. In this test, there are two cells on different carrier frequencies and gap pattern configuration # 1 as defined in Table 8.1.2.1-1 is provided.

The uplink time alignment is not maintained and UE needs to use RACH to obtain UL allocation for measurement reporting.

Table A.8.4.3.1-1: General test parameters for E-UTRAN TDD-TDD inter-frequency event triggered reporting under AWGN propagation conditions with DRX when L3 filtering is used

| Parameter | Unit | Value | Comment |
|---|---------|--|---|
| PDSCH parameters | | DL Reference Measurement Channel R.0 TDD | As specified in clause A.3.1.1.2 |
| PCFICH/PDCCH/PHICH parameters | | DL Reference Measurement Channel R.6 TDD | As specified in clause A.3.1.2.2 |
| Active cell | | Cell 1 | |
| Neighbour cell | | Cell 2 | Cell to be identified. |
| E-UTRA RF Channel Number | | 1, 2 | Two TDD carrier frequencies are used. |
| Channel Bandwidth ($BW_{channel}$) | MHz | 10 | |
| Time offset between cells | μ s | 3 | synchronous cells |
| Gap Pattern Id | | 1 | As specified in TS 36.133 clause 8.1.2.1. |
| Uplink-downlink configuration of cells | | 1 | As specified in table 4.2.2 in TS 36.211 |
| Special subframe configuration of cells | | 6 | As specified in table 4.2.1 in TS 36.211 |
| Neighbour A3-Offset Ofn | dB | -14 | |
| CP length | | Normal | |
| Hysteresis | dB | 0 | |
| Time To Trigger | s | 0 | |
| Filter coefficient | | 9 | L3 filtering is used |
| DRX | | ON | DRX related parameters are defined in Table A.8.4.3.1-3 |
| T1 | s | 30 | |
| T2 | s | 9 | |

Table A.8.4.3.1-2: Cell specific test parameters for E-UTRAN TDD-TDD inter-frequency event triggered reporting under AWGN propagation conditions with DRX when L3 filtering is used

| Parameter | Unit | Cell 1 | | Cell 2 | |
|---|------|----------|----|----------|----|
| | | T1 | T2 | T1 | T2 |
| E-UTRA RF Channel Number | | 1 | | 2 | |
| $BW_{channel}$ | MHz | 10 | | 10 | |
| OCNG Patterns defined in A.3.2.2.1 (OP.1 TDD) and in A.3.2.2.2 (OP.2 TDD) | | OP.1 TDD | | OP.2 TDD | |
| PBCH_RA | dB | 0 | | 0 | |
| PBCH_RB | dB | | | | |
| PSS_RA | dB | | | | |
| SSS_RA | dB | | | | |
| PCFICH_RB | dB | | | | |

| | | | | | |
|--|------------|------|-----|-----|-----|
| PHICH_RA | dB | | | | |
| PHICH_RB | dB | | | | |
| PDCCH_RA | dB | | | | |
| PDCCH_RB | dB | | | | |
| PDSCH_RA | dB | | | | |
| PDSCH_RB | dB | | | | |
| OCNG_RA ^{Note 1} | dB | | | | |
| OCNG_RB ^{Note 1} | dB | | | | |
| \hat{E}_s/I_{ot} | dB | 4 | 4 | 4 | 24 |
| N_{oc} ^{Note 2} | dBm/15 KHz | -98 | | | |
| \hat{E}_s/N_{oc} | dB | 4 | 4 | 4 | 24 |
| RSRP ^{Note 3} | dBm/15 KHz | -94 | -94 | -94 | -74 |
| SCH_RP ^{Note 3} | dBm/15 KHz | -94 | -94 | -94 | -74 |
| Propagation Condition | | AWGN | | | |
| <p>Note 1: OCNG shall be used such that both cells are fully allocated and a constant total transmitted power spectral density is achieved for all OFDM symbols.</p> <p>Note 2: Interference from other cells and noise sources not specified in the test is assumed to be constant over subcarriers and time and shall be modelled as AWGN of appropriate power for N_{oc} to be fulfilled.</p> <p>Note 3: RSRP and SCH_RP levels have been derived from other parameters for information purposes. They are not settable parameters themselves.</p> | | | | | |

Table A.8.4.3.1-3: DRX-Configuration for E-UTRAN TDD-TDD inter-frequency event triggered reporting in DRX under AWGN propagation conditions with DRX when L3 filtering is used

| Field | Value | Comment |
|--------------------------|---------|---|
| onDurationTimer | psf1 | As specified in clause 6.3.2 in TS 36.331 |
| drx-InactivityTimer | psf1 | |
| drx-RetransmissionTimer | sf1 | |
| longDRX-CycleStartOffset | sf1280 | |
| shortDRX | disable | |

Table A.8.4.3.1-4: TimeAlignmentTimer -Configuration for E-UTRAN TDD-TDD inter-frequency event triggered reporting in DRX under AWGN propagation conditions with DRX when L3 filtering is used

| Field | Value | Comment |
|--------------------|-------|--|
| TimeAlignmentTimer | sf500 | As specified in clause 6.3.2 in TS 36.331 |
| sr-ConfigIndex | 2 | For further information see clause 6.3.2 in TS 36.331 and section 10.1 in TS 36.213. |

A.8.4.3.2 Test Requirements

The UE shall send one Event A3 triggered measurement report, with a measurement reporting delay less than 6400 ms from the beginning of time period T2. The measurement reporting delay is defined as the time from the beginning of time period T2 to the moment when the UE starts to send preambles on the PRACH for scheduling request (SR) to obtain allocation to send the measurement report on PUSCH.

The UE shall not send event triggered measurement reports, as long as the reporting criteria are not fulfilled.

The rate of correct events observed during repeated tests shall be at least 90%.

NOTE 1: The actual overall delays measured in the test may be up to one DRX cycle higher than the measurement reporting delays above because UE is allowed to delay the initiation of the measurement reporting procedure to the next until the Active Time.

NOTE 2: In order to calculate the rate of correct events the system simulator shall verify that it has received correct Event A3 measurement report.

A.8.4.4 E-UTRAN TDD - TDD Inter-frequency identification of a new CGI of E-UTRA cell using autonomous gaps

A.8.4.4.1 Test Purpose and Environment

This test is to verify the requirement for identification of a new CGI of E-UTRA cell with autonomous gaps in clause 8.1.2.3.7.

The test scenario comprises of two E-UTRA TDD carriers and one cell on each carrier as given in tables A.8.4.4.1-1 and A.8.4.4.1-2. PDCCHs indicating new transmissions shall be sent continuously to ensure that the UE would have ACK/NACK sending during identifying a new CGI of E-UTRAN cell. The test consists of three successive time periods, with time durations of T1, T2 and T3 respectively. At the start of time duration T1, the UE does not have any timing information of cell 2. Starting T2, cell 2 becomes detectable and the UE is expected to detect and send a measurement report. Gap pattern configuration with id #0 as specified in Table 8.1.2.1-1 is configured before T2 begins to enable inter-frequency monitoring.

A RRC message implying SI reading shall be sent to the UE during period T2, after the UE has reported Event A3. The RRC message shall create a measurement report configuration with purpose *reportCGI* and *si-RequestForHO* set to TRUE. The start of T3 is the instant when the last TTI containing the RRC message implying SI reading is sent to the UE. Measurement gaps shall be deconfigured before the start of T3.

Table A.8.4.4.1-1: General test parameters for E-UTRAN TDD - TDD Inter-frequency identification of a new CGI of E-UTRA cell using autonomous gaps

| Parameter | Unit | Value | Comment |
|--------------------------------------|---------|--|--|
| PDSCH parameters | | DL Reference Measurement Channel R.0 TDD | As specified in clause A.3.1.1.2 |
| PCFICH/PDCCH/PHICH parameters | | DL Reference Measurement Channel R.6 TDD | As specified in clause A.3.1.2.2 |
| E-UTRA RF channel number | | 1, 2 | Two TDD carrier frequencies are used. |
| Channel Bandwidth ($BW_{channel}$) | MHz | 10 | |
| Active cell | | Cell 1 | Cell 1 is on RF channel number 1. |
| Neighbour cell | | Cell 2 | Cell 1 is on RF channel number 2. |
| CP length | | Normal | |
| Special subframe configuration | | 6 | As specified in table 4.2-1 in TS 36.211. The same configuration in both cells |
| Uplink-downlink configuration | | 1 | As specified in table 4.2-2 in TS 36.211. The same configuration in both cells |
| Gap Pattern Id | | 0 | As specified in TS 36.133 clause 8.1.2.1. |
| A3-Offset | dB | -6 | |
| Hysteresis | dB | 0 | |
| TimeToTrigger | s | 0 | |
| Filter coefficient | | 0 | L3 filtering is not used |
| DRX | | OFF | |
| si-RequestForHO | | TRUE | As specified in clause 5.5.3.1 in TS 36.331. |
| Time offset between cells | μ s | 3 | Synchronous cells |
| T1 | s | 5 | |
| T2 | s | ≤ 10 | |
| T3 | s | 5 | |

Table A.8.4.4.1-2: Cell specific test parameters for E-UTRAN TDD - TDD Inter-frequency identification of a new CGI of E-UTRA cell using autonomous gaps

| Parameter | Unit | Cell 1 | | | Cell 2 | | |
|--------------------------|------|--------|----|----|--------|----|----|
| | | T1 | T2 | T3 | T1 | T2 | T3 |
| E-UTRA RF Channel Number | | 1 | | | 2 | | |
| $BW_{channel}$ | MHz | 10 | | | 10 | | |

| OCNG Patterns defined in A.3.2.2.1 (OP.1 TDD) and in A.3.2.2.2 (OP.2 TDD) | | OP.1 TDD | OP.1 TDD | OP.1 TDD | OP.2 TDD | OP.2 TDD | OP.2 TDD |
|--|------------|----------|----------|----------|-----------|----------|----------|
| PBCH_RA | dB | 0 | | | 0 | | |
| PBCH_RB | dB | | | | | | |
| PSS_RA | dB | | | | | | |
| SSS_RA | dB | | | | | | |
| PCFICH_RB | dB | | | | | | |
| PHICH_RA | dB | | | | | | |
| PHICH_RB | dB | | | | | | |
| PDCCH_RA | dB | | | | | | |
| PDCCH_RB | dB | | | | | | |
| PDSCH_RA | dB | | | | | | |
| PDSCH_RB | dB | | | | | | |
| OCNG_RA ^{Note 1} | dB | | | | | | |
| OCNG_RB ^{Note 1} | dB | | | | | | |
| \hat{E}_s / I_{ot} | dB | 4 | 4 | 4 | -Infinity | 7 | 7 |
| N_{oc} ^{Note 2} | dBm/15 KHz | -98 | | | | | |
| \hat{E}_s / N_{oc} | dB | 4 | 4 | 4 | -Infinity | 7 | 7 |
| RSRP ^{Note 3} | dBm/15 KHz | -94 | -94 | -94 | -Infinity | -91 | -91 |
| SCH_RP ^{Note 3} | dBm/15 KHz | -94 | -94 | -94 | -Infinity | -91 | -91 |
| Propagation Condition | | AWGN | | | | | |
| <p>Note 1: OCNG shall be used such that both cells are fully allocated and a constant total transmitted power spectral density is achieved for all OFDM symbols.</p> <p>Note 2: Interference from other cells and noise sources not specified in the test is assumed to be constant over subcarriers and time and shall be modelled as AWGN of appropriate power for N_{oc} to be fulfilled.</p> <p>Note 3: RSRP and SCH_RP levels have been derived from other parameters for information purposes. They are not settable parameters themselves.</p> | | | | | | | |

A.8.4.4.2 Test Requirements

The UE shall transmit a measurement report containing the cell global identifier of cell 2 within 170 milliseconds from the start of T3.

$$\text{Test requirement} = \text{RRC Procedure delay} + T_{\text{identify_CGI, inter}} + \text{reporting delay}$$

$$= 15 + 150 + 2\text{ms from the start of T3}$$

$$= 167 \text{ ms, allow } 170 \text{ ms.}$$

The UE shall be scheduled continuously throughout the test, and from the start of T3 until 170 ms at least 42 ACK/NACK shall be detected as being transmitted by the UE.

The rate of correct events observed during repeated tests shall be at least 90%.

NOTE: The overall 42 ACK/NACK number is caused by two parts. Firstly, at least 30 ACK/NACK shall be sent during identifying the cell global identifier of cell 2 according to the requirement in Clause 8.1.2.3.7.1. Secondly, given that continuous DL data allocation, and the measurement gaps have been deconfigured before the start of T3, additional 12 ACK/NACK shall be sent from the start of T3 until 170 ms excludes 150 ms for identifying the cell global identifier of cell 2.

A.8.4.5 E-UTRAN TDD - TDD Inter-frequency identification of a new CGI of E-UTRA cell using autonomous gaps with DRX

A.8.4.5.1 Test Purpose and Environment

This test is to verify the requirement for identification of a new CGI of E-UTRA cell with autonomous gaps in clause 8.1.2.3.7. The requirement is verified in a DRX configuration.

The test scenario comprises of two E-UTRA TDD carriers and one cell on each carrier as given in tables A.8.4.5.1-1, A.8.4.5.1-2, A.8.4.5.1-3 and A.8.4.5.1-4. The test consists of three successive time periods, with time durations of T1, T2 and T3 respectively. At the start of time duration T1, the UE does not have any timing information of cell 2. Starting T2, cell 2 becomes detectable and the UE is expected to detect and send a measurement report. Gap pattern configuration with id #0 as specified in Table 8.1.2.1-1 is configured before T2 begins to enable inter-frequency monitoring.

A RRC message implying SI reading shall be sent to the UE during period T2, after the UE has reported Event A3. The RRC message shall create a measurement report configuration with purpose *reportCGI* and *si-RequestForHO* set to TRUE. The start of T3 is the instant when the last TTI containing the RRC message implying SI reading is sent to the UE. Measurement gaps shall be deconfigured before the start of T3.

In the test UE needs to be provided at least once every 1280ms with new Timing Advance Command MAC control element to restart the Time alignment timer to keep UE uplink time alignment. Furthermore UE sends scheduling request (SR) to obtain allocation to send the measurement report on PUSCH.

Table A.8.4.5.1-1: General test parameters for E-UTRAN TDD - TDD Inter-frequency identification of a new CGI of E-UTRA cell using autonomous gaps with DRX

| Parameter | Unit | Value | Comment |
|--------------------------------------|---------|--|--|
| PDSCH parameters | | DL Reference Measurement Channel R.0 TDD | As specified in clause A.3.1.1.2 |
| PCFICH/PDCCH/PHICH parameters | | DL Reference Measurement Channel R.6 TDD | As specified in clause A.3.1.2.2 |
| E-UTRA RF channel number | | 1, 2 | Two TDD carrier frequencies are used. |
| Channel Bandwidth ($BW_{channel}$) | MHz | 10 | |
| Active cell | | Cell 1 | Cell 1 is on RF channel number 1. |
| Neighbour cell | | Cell 2 | Cell 1 is on RF channel number 2. |
| CP length | | Normal | |
| Special subframe configuration | | 6 | As specified in table 4.2-1 in TS 36.211. The same configuration in both cells |
| Uplink-downlink configuration | | 1 | As specified in table 4.2-2 in TS 36.211. The same configuration in both cells |
| Gap Pattern Id | | 0 | As specified in TS 36.133 clause 8.1.2.1. |
| A3-Offset | dB | -6 | |
| Hysteresis | dB | 0 | |
| TimeToTrigger | s | 0 | |
| Filter coefficient | | 0 | L3 filtering is not used |
| DRX | | ON | DRX related parameters are defined in Table A.8.4.5.1-3 |
| si-RequestForHO | | TRUE | As specified in clause 5.5.3.1 in TS 36.331. |
| Time offset between cells | μ s | 3 | Synchronous cells |
| T1 | s | 5 | |
| T2 | s | ≤ 30 | UE shall report cell within 25.6s (20 DRX cycles) |
| T3 | s | 5 | |

Table A.8.4.5.1-2: Cell specific test parameters for E-UTRAN TDD - TDD Inter-frequency identification of a new CGI of E-UTRA cell using autonomous gaps with DRX

| Parameter | Unit | Cell 1 | | | Cell 2 | | |
|---|------|----------|----------|----------|----------|----------|----------|
| | | T1 | T2 | T3 | T1 | T2 | T3 |
| E-UTRA RF Channel Number | | 1 | | | 2 | | |
| $BW_{channel}$ | MHz | 10 | | | 10 | | |
| OCNG Patterns defined in A.3.2.2.1 (OP.1 TDD) and in A.3.2.2.2 (OP.2 TDD) | | OP.1 TDD | OP.1 TDD | OP.1 TDD | OP.2 TDD | OP.2 TDD | OP.2 TDD |
| PBCH_RA | dB | | | | | | |
| PBCH_RB | dB | | | | | | |

| | | | | | | | |
|--|------------|------|-----|-----|-----------|-----|-----|
| PSS_RA | dB | 0 | | | 0 | | |
| SSS_RA | dB | | | | | | |
| PCFICH_RB | dB | | | | | | |
| PHICH_RA | dB | | | | | | |
| PHICH_RB | dB | | | | | | |
| PDCCH_RA | dB | | | | | | |
| PDCCH_RB | dB | | | | | | |
| PDSCH_RA | dB | | | | | | |
| PDSCH_RB | dB | | | | | | |
| OCNG_RA ^{Note 1} | dB | | | | | | |
| OCNG_RB ^{Note 1} | dB | | | | | | |
| \hat{E}_s / I_{ot} | dB | 4 | 4 | 4 | -Infinity | 7 | 7 |
| N_{oc} ^{Note 2} | dBm/15 KHz | -98 | | | | | |
| \hat{E}_s / N_{oc} | dB | 4 | 4 | 4 | -Infinity | 7 | 7 |
| RSRP ^{Note 3} | dBm/15 KHz | -94 | -94 | -94 | -Infinity | -91 | -91 |
| SCH_RP ^{Note 3} | dBm/15 KHz | -94 | -94 | -94 | -Infinity | -91 | -91 |
| Propagation Condition | | AWGN | | | | | |
| <p>Note 1: OCNG shall be used such that both cells are fully allocated and a constant total transmitted power spectral density is achieved for all OFDM symbols.</p> <p>Note 2: Interference from other cells and noise sources not specified in the test is assumed to be constant over subcarriers and time and shall be modelled as AWGN of appropriate power for N_{oc} to be fulfilled.</p> <p>Note 3: RSRP and SCH_RP levels have been derived from other parameters for information purposes. They are not settable parameters themselves.</p> | | | | | | | |

Table A.8.4.5.1-3: DRX configuration for E-UTRAN TDD - TDD Inter-frequency identification of a new CGI of E-UTRA cell using autonomous gaps with DRX

| Field | Value | Comment |
|--------------------------|---------|---|
| onDurationTimer | psf1 | As specified in clause 6.3.2 in TS 36.331 |
| drx-InactivityTimer | psf1 | |
| drx-RetransmissionTimer | psf1 | |
| longDRX-CycleStartOffset | sf1280 | |
| shortDRX | disable | |

Table A.8.4.5.1-4: TimeAlignmentTimer -Configuration for E-UTRAN TDD - TDD Inter-frequency identification of a new CGI of E-UTRA cell using autonomous gaps with DRX

| Field | Value | Comment |
|--------------------|----------|--|
| TimeAlignmentTimer | Infinity | As specified in clause 6.3.2 in TS 36.331 |
| sr-ConfigIndex | 2 | For further information see clause 6.3.2 in TS 36.331 and section 10.1 in TS 36.213. |

A.8.4.5.2 Test Requirements

The UE shall transmit a measurement report containing the cell global identifier of cell 2 within 170 milliseconds from the start of T3.

$$\text{Test requirement} = \text{RRC Procedure delay} + T_{\text{identify_CGI, inter}} + \text{reporting delay}$$

$$= 15 + 150 + 2\text{ms from the start of T3}$$

$$= 167 \text{ ms, allow } 170 \text{ ms.}$$

The rate of correct events observed during repeated tests shall be at least 90%.

A.8.4.6 E-UTRAN TDD-TDD Inter-frequency event triggered reporting for TDD UL/DL configuration 0

A.8.4.6.1 Test Purpose and Environment

The purpose of this test is to verify that the UE makes correct reporting of an event. This test will partly verify the TDD-TDD inter-frequency cell search requirements in clause 8.1.2.3.2.

The test parameters are given in Table A.8.4.6.1-1 and A.8.4.6.1-2 below. In the measurement control information it is indicated to the UE that event-triggered reporting with Event A3 is used. The test consists of two successive time periods, with time duration of T1, and T2 respectively. During time duration T1, the UE shall not have any timing information of cell 2.

Table A.8.4.6.1-1: General test parameters for E-UTRAN TDD-TDD inter-frequency event triggered reporting for TDD UL/DL configuration 0

| Parameter | Unit | Value | Comment |
|--------------------------------------|------|--|--|
| PDSCH parameters | | DL Reference Measurement Channel R.5 TDD | As specified in clause A.3.1.1.2 |
| PCFICH/PDCCH/PHICH parameters | | DL Reference Measurement Channel R.6 TDD | As specified in clause A.3.1.2.2 |
| Gap Pattern Id | | 1 | As specified in TS 36.133 clause 8.1.2.1. |
| Special subframe configuration | | 6 | As specified in table 4.2-1 in TS 36.211. The same configuration in both cells |
| Uplink-downlink configuration | | 0 | As specified in TS 36.211 clause 4.2 Table 4.2-2 |
| CP length | | Normal | |
| E-UTRA RF Channel Number | | 1, 2 | Two TDD carrier frequencies are used. |
| Channel Bandwidth ($BW_{channel}$) | MHz | 10 | |
| Active cell | | Cell 1 | Cell 1 is on RF channel number 1 |
| Neighbour cell | | Cell 2 | Cell 2 is on RF channel number 2 |
| A3-Offset | dB | -6 | |
| Hysteresis | dB | 0 | |
| TimeToTrigger | s | 0 | |
| Filter coefficient | | 0 | L3 filtering is not used |
| DRX | | OFF | |
| Time offset between cells | | 3 μ s | Synchronous cells |
| T1 | s | 5 | |
| T2 | s | 10 | |

Table A.8.4.6.1-2: Cell specific test parameters for E-UTRAN TDD-TDD inter-frequency event triggered reporting for TDD UL/DL configuration 0

| Parameter | Unit | Cell 1 | | Cell 2 | |
|--|------|----------|----|----------|----|
| | | T1 | T2 | T1 | T2 |
| E-UTRA RF Channel Number | | 1 | | 2 | |
| $BW_{channel}$ | MHz | 10 | | 10 | |
| Correlation Matrix and Antenna Configuration | | 1x2 Low | | 1x2 Low | |
| OCNG Pattern defined in A.3.2.2 (TDD) | | OP.1 TDD | | OP.2 TDD | |
| PBCH_RA | dB | 0 | | 0 | |
| PBCH_RB | dB | | | | |
| PSS_RA | dB | | | | |
| SSS_RA | dB | | | | |
| PCFICH_RB | dB | | | | |
| PHICH_RA | dB | | | | |
| PHICH_RB | dB | | | | |
| PDCCH_RA | dB | | | | |
| PDCCH_RB | dB | | | | |

| | | | | | |
|--|------------|-----|-----|-----------|-----|
| PDSCH_RA | dB | | | | |
| PDSCH_RB | dB | | | | |
| OCNG_RA ^{Note 1} | dB | | | | |
| OCNG_RB ^{Note 1} | dB | | | | |
| \hat{E}_s / I_{ot} | dB | 4 | 4 | -Infinity | 7 |
| N_{oc} ^{Note 3} | dBm/15 kHz | -98 | | | |
| RSRP ^{Note 4} | dBm/15 kHz | -94 | -94 | -Infinity | -91 |
| SCH_RP ^{Note 4} | dBm/15 kHz | -94 | -94 | -infinity | -91 |
| \hat{E}_s / N_{oc} | dB | 4 | 4 | -Infinity | 7 |
| Propagation Condition | ETU70 | | | | |
| Note 1: OCNG shall be used such that both cells are fully allocated and a constant total transmitted power spectral density is achieved for all OFDM symbols. | | | | | |
| Note 2: The resources for uplink transmission are assigned to the UE priori to the start of time period T2. | | | | | |
| Note 3: Interference from other cells and noise sources not specified in the test is assumed to be constant over subcarriers and time and shall be modelled as AWGN of appropriate power for N_{oc} to be fulfilled. | | | | | |
| Note 4: RSRP and SCH_RP levels have been derived from other parameters for information purposes. They are not settable parameters themselves. | | | | | |

A.8.4.6.2 Test Requirements

The UE shall send one Event A3 triggered measurement report, with a measurement reporting delay less than 7920 ms from the beginning of time period T2.

The UE shall not send event triggered measurement reports, as long as the reporting criteria are not fulfilled.

The rate of correct events observed during repeated tests shall be at least 90%.

NOTE: The actual overall delays measured in the test may be up to $2 \times TTI_{DCCH}$ higher than the measurement reporting delays above because of TTI insertion uncertainty of the measurement report in DCCH.

A.8.4.7 E-UTRAN TDD-TDD Inter-frequency event triggered reporting under fading propagation conditions in synchronous cells for Increased Carrier Monitoring without Reduced Performance Group

A.8.4.7.1 Test Purpose and Environment

The purpose of this test is to verify that the UE makes correct reporting of an event. This test will partly verify the TDD-TDD inter-frequency cell search requirements in clause 8.1.2.3.2.

The test parameters are given in Table A.8.4.1.1-1 and A.8.4.1.1-2 below. In the measurement control information it is indicated to the UE that event-triggered reporting with Event A3 is used. The test consists of two successive time periods, with time duration of T1, and T2 respectively. During time duration T1, the UE shall not have any timing information of cells 2, 3 or 4.

Table A.8.4.7.1-1: General test parameters for E-UTRAN TDD-TDD inter-frequency event triggered reporting in fading propagation conditions

| Parameter | Unit | Value | Comment |
|--|------|--|--|
| UE configured E-UTRA RF Channel Number | | 1, 2,3,4,5,6,7,8,9 | Serving cell and eight TDD carrier frequencies are used in the UE neighbour cell list. |
| Test equipment configuration | | Cell 1 uses UTRA RF channel number 1 Cells 2,3,4 are randomly selected to use different frequencies selected from frequencies 2,3,4,5,6,7,8,9 | |
| Gap Pattern Id | | 1 | As specified in TS 36.133 clause 8.1.2.1. |
| CP length | | Normal | |

| | | | |
|--------------------------|----|--------|---------------------------------------|
| E-UTRA RF Channel Number | | 1, 2 | Two TDD carrier frequencies are used. |
| Active cell | | Cell 1 | Cell 1 is on RF channel number 1 |
| Neighbour cell | | Cell 2 | Cell 2 is on RF channel number 2 |
| A3-Offset | dB | -6 | |
| Hysteresis | dB | 0 | |
| TimeToTrigger | s | 0 | |
| Filter coefficient | | 0 | L3 filtering is not used |
| DRX | | OFF | |
| T1 | s | 5 | |
| T2 | s | 80 | |

Table A.8.4.7.1-2: Cell specific test parameters for E-UTRAN TDD-TDD inter-frequency event triggered reporting under fading propagation conditions in synchronous cells (Cell # 1 and Cell # 2)

| Parameter | Unit | Cell 1 | | Cell 2 | |
|--|---------------------|---|-----------------------------|--|-----------------------------|
| | | T1 | T2 | T1 | T2 |
| E-UTRA RF Channel Number | | 1 | | Randomly selected from 2,3,4,5,6,7,8 such that cell 2 is in the normal performance group | |
| $BW_{channel}$ | MHz | 5MHz: $N_{RB} = 25$ 10MHz: $N_{RB} = 50$ | | 5MHz: $N_{RB} = 25$ 10MHz: $N_{RB} = 50$ | |
| Measurement bandwidth | n_{PRB} | 5MHz: 10-15 10MHz: 22-27 | | 5MHz: 10-15 10MHz: 22-27 | |
| PDSCH Reference measurement channel defined in A.3.1.1. | | 5MHz: R.5 TDD 10MHz: R.0 TDD | | - | |
| PDSCH allocation | n_{PRB} | 5MHz: 7-17 10MHz: 13-36 | | - | |
| PDCCH/PCFICH/PHICH Reference measurement channel defined in A.3.1.2. | | 5MHz: R.11 TDD 10MHz: R.6 TDD | | 5MHz: R.11 TDD 10MHz: R.6 TDD | |
| OCNG Patterns defined in A.3.2. | | 5MHz: OP.15 TDD 10MHz: OP.1 TDD | | 5MHz: OP.16 TDD 10MHz: OP.2 TDD | |
| PBCH_RA | dB | 0 | | 0 | |
| PBCH_RB | dB | | | | |
| PSS_RA | dB | | | | |
| SSS_RA | dB | | | | |
| PCFICH_RB | dB | | | | |
| PHICH_RA | dB | | | | |
| PHICH_RB | dB | | | | |
| PDCCH_RA | dB | | | | |
| PDCCH_RB | dB | | | | |
| PDSCH_RA | dB | | | | |
| PDSCH_RB | dB | | | | |
| OCNG_RA ^{Note 1} | dB | | | | |
| OCNG_RB ^{Note 1} | dB | | | | |
| N_{oc} ^{Note 3} | dBm/15 kHz | | | | |
| \hat{E}_s/N_{oc} | dB | 4 | 4 | -Infinity | 7 |
| \hat{E}_s/I_{ot} | dB | 4 | 4 | -Infinity | 7 |
| RSRP ^{Note 4} | dBm/15 kHz | -94 | -94 | -Infinity | -91 |
| SCH_RP ^{Note 4} | dBm/15 kHz | -94 | -94 | -infinity | -91 |
| I_o ^{Note 4} | dBm/ $BW_{channel}$ | - | - | - | - |
| | | $64.76+10\log(N_{RB,c}/50)$ | $64.76+10\log(N_{RB,c}/50)$ | $70.22+10\log(N_{RB,c}/50)$ | $62.43+10\log(N_{RB,c}/50)$ |
| Propagation Condition | | ETU70 | | ETU70 | |
| Correlation Matrix and Antenna Configuration | | 1x2 Low | | 1x2 Low | |
| Timing offset to cell 1 | ms | - | | 3 | |

| | |
|---------|--|
| Note 1: | OCNG shall be used such that both cells are fully allocated and a constant total transmitted power spectral density is achieved for all OFDM symbols. |
| Note 2: | The resources for uplink transmission are assigned to the UE priori to the start of time period T2. |
| Note 3: | Interference from other cells and noise sources not specified in the test is assumed to be constant over subcarriers and time and shall be modelled as AWGN of appropriate power for N_{oc} to be fulfilled. |
| Note 4: | RSRP and SCH_RP levels have been derived from other parameters for information purposes. They are not settable parameters themselves. |

Table A.8.4.7.1-2: Cell specific test parameters for E-UTRAN TDD-TDD inter-frequency event triggered reporting under fading propagation conditions in synchronous cells (Cell # 3 and Cell # 4)

| Parameter | Unit | Cell 3 | | Cell 4 | |
|--|----------------------------|--|-----------------------------|--|-----------------------------|
| | | T1 | T2 | T1 | T2 |
| E-UTRA RF Channel Number | | Randomly selected from 2,3,4,5,6,7,8 such that cell 3 is in the normal performance group | | Randomly selected from 2,3,4,5,6,7,8 such that cell 4 is in the normal performance group | |
| BW _{channel} | MHz | 5MHz: N _{RB} = 25 10MHz: N _{RB} = 50 | | 5MHz: N _{RB} = 25 10MHz: N _{RB} = 50 | |
| Correlation Matrix and Antenna Configuration | | 1x2 Low | | 1x2 Low | |
| Measurement bandwidth | n_{PRB} | 5MHz: 10-15 10MHz: 22-27 | | 5MHz: 10-15 10MHz: 22-27 | |
| PDSCH Reference measurement channel defined in A.3.1.1. | | - | | - | |
| PDSCH allocation | n_{PRB} | - | | - | |
| PDCCH/PCFICH/PHICH Reference measurement channel defined in A.3.1.2. | | 5MHz: R.11 TDD 10MHz: R.6 TDD | | 5MHz: R.11 TDD 10MHz: R.6 TDD | |
| OCNG Patterns defined in A.3.2. | | 5MHz: OP.16 TDD 10MHz: OP.2 TDD | | 5MHz: OP.16 TDD 10MHz: OP.2 TDD | |
| PBCH_RA | dB | 0 | | 0 | |
| PBCH_RB | dB | | | | |
| PSS_RA | dB | | | | |
| SSS_RA | dB | | | | |
| PCFICH_RB | dB | | | | |
| PHICH_RA | dB | | | | |
| PHICH_RB | dB | | | | |
| PDCCH_RA | dB | | | | |
| PDCCH_RB | dB | | | | |
| PDSCH_RA | dB | | | | |
| PDSCH_RB | dB | | | | |
| OCNG_RA ^{Note 1} | dB | | | | |
| OCNG_RB ^{Note 1} | dB | | | | |
| N_{oc} ^{Note 3} | dBm/15 kHz | | | | |
| \hat{E}_s/N_{oc} | dB | -Infinity | 7 | -Infinity | 7 |
| \hat{E}_s/I_{ot} | dB | -Infinity | 7 | -Infinity | 7 |
| RSRP ^{Note 4} | dBm/15 kHz | -Infinity | -91 | -Infinity | -91 |
| SCH_RP ^{Note 4} | dBm/15 kHz | -infinity | -91 | -infinity | -91 |
| I_o ^{Note 4} | dBm/ BW _{channel} | - | - | - | - |
| | | $70.22+10\log(N_{RB,c}/50)$ | $62.43+10\log(N_{RB,c}/50)$ | $70.22+10\log(N_{RB,c}/50)$ | $62.43+10\log(N_{RB,c}/50)$ |
| Propagation Condition | | ETU70 | | ETU70 | |
| Correlation Matrix and Antenna Configuration | | 1x2 Low | | 1x2 Low | |
| Timing offset to cell 1 | ms | 3 | | 3 | |

| | |
|---------|--|
| Note 1: | OCNG shall be used such that both cells are fully allocated and a constant total transmitted power spectral density is achieved for all OFDM symbols. |
| Note 2: | The resources for uplink transmission are assigned to the UE priori to the start of time period T2. |
| Note 3: | Interference from other cells and noise sources not specified in the test is assumed to be constant over subcarriers and time and shall be modelled as AWGN of appropriate power for N_{oc} to be fulfilled. |
| Note 4: | RSRP and SCH_RP levels have been derived from other parameters for information purposes. They are not settable parameters themselves. |

A.8.4.7.2 Test Requirements

The UE shall send Event A3 triggered measurement reports for cells 2, 3 and 4, with a measurement reporting delay less than 61.44s from the beginning of time period T2.

The UE shall not send event triggered measurement reports, as long as the reporting criteria are not fulfilled.

The rate of correct events observed during repeated tests shall be at least 90%.

NOTE: The actual overall delays measured in the test may be up to $2 \times TTI_{DCCH}$ higher than the measurement reporting delays above because of TTI insertion uncertainty of the measurement report in DCCH.

A.8.4.8 TDD-TDD Interfrequency correct reporting of measurement events with reduced performance group configured, non DRX

A.8.4.8.1 Test Purpose and Environment

The purpose of this test is to verify that the UE makes correct reporting of an event. This test will partly verify the TDD-TDD inter-frequency cell measurement requirements for increased UE carrier monitoring in clause 8.1.2.3.

The test parameters are given in Tables A.8.4.8.1-1, A.8.4.8.1-2 and A.8.4.8.1-3. In this test, there are 4 cells on different carrier frequencies and gap pattern configuration #0 as defined in table A.8.4.8.1-1 is provided.

In the measurement control information, it is indicated to the UE that event-triggered reporting with Events A3 is used. The test consists of two successive time periods for every repetition, with time duration of T1, and T2 respectively. During time duration T1, the UE shall not have any timing information of neighbour cells. At the start of each repetition of T1, the test equipment provides signals for cell 1 (serving cell), and cells 2, 3 and 4 which are selected from the 8 cells which are configured in the UE neighbour cell list. Cells 2, 3 and 4 are chosen randomly, such that one frequency belongs to the normal performance group and two frequencies belong to the reduced performance group.

Table A.8.4.8.1-1: General test parameters for TDD-TDD Interfrequency correct reporting of measurement events with reduced performance group configured, non DRX

| Parameter | Unit | Value | Comment |
|--|------|---|---|
| UE configured E-UTRA RF Channel Number | | 1,2,3,4,5,6,7,8,9 | Serving cell and 8 TDD carrier frequencies are used in the UE neighbour cell list. Frequencies 5,6,7,8 and 9 are indicated to have reduced performance |
| Test equipment configuration | | Cell 1 uses E-UTRA RF channel number 1 Cell 2,3,4 are randomly selected to use different frequencies selected from frequencies 2,3,4,5,6,7,8,9 | Cell 1 uses E-UTRA RF channel number 1 Cells 2 are randomly selected to use different frequencies selected from E-UTRA frequencies 2, 3, 4. Cells 3, 4 are randomly selected to use different frequencies selected from E-UTRA frequencies 5, 6, 7, 8, 9. |
| Active cell | | Cell 1 | Cell 1 is on RF channel number 1 |
| Gap Pattern Id | | 0 | As specified in TS 36.133 clause 8.1.2.1. |
| A3-Offset | dB | -6 | |
| Hysteresis | dB | 0 | |
| CP length | | Normal | |
| TimeToTrigger | s | 0 | |

| | | | |
|-------------------------------|---|-----|---|
| Filter coefficient | | 0 | L3 filtering is not used |
| DRX | | OFF | OFF |
| Scaling factor configurations | | 8 | As specified in TS 36.133 clause 8.1.2.1.1a |
| T1 | s | 5 | |
| T2 | s | 155 | |

Table A.8.4.8.1-2: Cell specific test parameters for TDD-TDD Interfrequency correct reporting of measurement events with reduced performance group configured, non DRX (Cell #1 and Cell #2)

| Parameter | Unit | Cell 1 | | Cell 2, Cell 3, Cell 4 | |
|--|------------|---|---|--|---|
| | | T1 | T2 | T1 | T2 |
| E-UTRA RF Channel Number | | 1 | | Randomly selected from 2,3,4 such that cell 2 is in the normal performance group | |
| BW _{channel} | | 5MHz: N _{RB} = 25 10MHz: N _{RB} = 50 | | 5MHz: N _{RB} = 25 10MHz: N _{RB} = 50 | |
| Special subframe configuration ^{Note1} | | 6 | | | |
| Uplink-downlink configuration ^{Note1} | | 1 | | | |
| PDSCH parameters: DL Reference Measurement Channel As specified in clause A.3.1.1.2 | | 5MHz: R.4 TDD 10MHz:R.0 TDD | | - | |
| PCFICH/PDCCH/PHICH parameters: DL Reference Measurement Channel As specified in clause A.3.1.2.2 | | 5MHz: R.11 TDD 10MHz:R.6 TDD | | 5MHz: R.11 TDD 10MHz:R.6 TDD | |
| OCNG Patterns defined in A.3.2.2.1, A.3.2.2.2 ,A.3.2.2.9 and A.3.2.2.10 | | 5MHz: OP.9 TDD 10MHz:OP.1 TDD | | 5MHz: OP.10.TDD 10MHz:OP.2 TDD | |
| PBCH_RA | dB | 0 | | 0 | |
| PBCH_RB | dB | | | | |
| PSS_RA | dB | | | | |
| SSS_RA | dB | | | | |
| PCFICH_RB | dB | | | | |
| PHICH_RA | dB | | | | |
| PHICH_RB | dB | | | | |
| PDCCH_RA | dB | | | | |
| PDCCH_RB | dB | | | | |
| PDSCH_RA | dB | | | | |
| PDSCH_RB | dB | | | | |
| OCNG_RA ^{Note 2} | dB | | | | |
| OCNG_RB ^{Note 2} | dB | | | | |
| N _{oc} ^{Note 4} | dBm/15 kHz | | | | |
| \hat{E}_s / N_{oc} | dB | 4 | 4 | -Infinity | 7 |
| \hat{E}_s / I_{ot} ^{Note 5} | dB | 4 | 4 | -Infinity | 7 |
| RSRP ^{Note 5} | dBm/15 kHz | -94 | -94 | -Infinity | -91 |
| SCH_RP ^{Note 5} | dBm/15 kHz | -94 | -94 | -Infinity | -91 |
| I _o ^{Note 4} | dBm/Ch BW | -64.76 +10log (N _{RB,c} /50) | -64.76 +10log (N _{RB,c} /50) | -70.22 +10log (N _{RB,c} /50) | -62.43 +10log (N _{RB,c} /50) |
| Propagation Condition | | AWGN | | AWGN | |
| Antenna Configuration | | 1x2 | | 1x2 | |
| Timing offset to Cell 1 | | - | | 3 μs | |

Note 1: For special subframe and uplink-downlink configurations see Tables 4.2-1 and 4.2-2 in TS 36.211.
 Note 2: OCNG shall be used such that both cells are fully allocated and a constant total transmitted power spectral density is achieved for all OFDM symbols.
 Note 3: The resources for uplink transmission are assigned to the UE priori to the start of time period T2.
 Note 4: Interference from other cells and noise sources not specified in the test is assumed to be constant over subcarriers and time and shall be modelled as AWGN of appropriate power for N_{oc} to be fulfilled.
 Note 5: E_s/I_{ot} , RSRP, SCH_RP and I_o have been derived from other parameters for information purposes. They are not settable parameters themselves.

Table A.8.4.8.1-3: Cell specific test parameters for TDD-TDD Interfrequency correct reporting of measurement events with reduced performance group configured, non DRX (Cell #3, Cell #4)

| Parameter | Unit | Cell 3 | | Cell 4 | |
|---|------------|---|---|---|---|
| | | T1 | T2 | T1 | T2 |
| E-UTRA RF Channel Number | | Randomly selected from 5,6,7,8,9 such that cell 3 is in the reduced performance group | | Randomly selected from 5,6,7,8,9 such that cell 4 is in the reduced performance group. Cell 4 RF channel is different from Cell 3 RF channel. | |
| BW _{channel} | | 5MHz: N _{RB} = 25 10MHz: N _{RB} = 50 | | 5MHz: N _{RB} = 25 10MHz: N _{RB} = 50 | |
| Special subframe configuration <small>Note1</small> | | 6 | | | |
| Uplink-downlink configuration <small>Note1</small> | | 1 | | | |
| PDSCH parameters: DL Reference Measurement Channel As specified in clause A.3.1.1.2 | | - | | - | |
| PCFICH/PDCCH/PHICH parameters: DL Reference Measurement Channel As specified in clause A.3.1.2.2 | | 5MHz: R.11 TDD 10MHz:R.6 TDD | | 5MHz: R.11 TDD 10MHz:R.6 TDD | |
| OCNG Patterns defined in A.3.2.2.2 and A.3.2.2.10 | | 5MHz: OP.10.TDD 10MHz:OP.2 TDD | | 5MHz: OP.10.TDD 10MHz:OP.2 TDD | |
| PBCH_RA | dB | 0 | | 0 | |
| PBCH_RB | dB | | | | |
| PSS_RA | dB | | | | |
| SSS_RA | dB | | | | |
| PCFICH_RB | dB | | | | |
| PHICH_RA | dB | | | | |
| PHICH_RB | dB | | | | |
| PDCCH_RA | dB | | | | |
| PDCCH_RB | dB | | | | |
| PDSCH_RA | dB | | | | |
| PDSCH_RB | dB | | | | |
| OCNG_RA <small>Note 2</small> | dB | | | | |
| OCNG_RB <small>Note 2</small> | dB | | | | |
| N_{oc} <small>Note 4</small> | dBm/15 kHz | | | | |
| \hat{E}_s / N_{oc} | dB | -Infinity | 7 | -Infinity | 7 |
| \hat{E}_s / I_{ot} <small>Note 5</small> | dB | -Infinity | 7 | -Infinity | 7 |
| RSRP <small>Note 5</small> | dBm/15 kHz | -Infinity | -91 | -Infinity | -91 |
| SCH_RP <small>Note 5</small> | dBm/15 kHz | -Infinity | -91 | -Infinity | -91 |
| I_o <small>Note 5</small> | dBm/Ch BW | -70.22 +10log (N _{RB,c} /50) | -62.43 +10log (N _{RB,c} /50) | -70.22 +10log (N _{RB,c} /50) | -62.43 +10log (N _{RB,c} /50) |
| Propagation Condition | | AWGN | | AWGN | |

| | | | |
|-------------------------|--|-----------|-----------|
| Antenna Configuration | | 1x2 | 1x2 |
| Timing offset to Cell 1 | | 3 μ s | 3 μ s |
| Note 1: | For special subframe and uplink-downlink configurations see Tables 4.2-1 and 4.2-2 in TS 36.211. | | |
| Note 2: | OCNG shall be used such that both cells are fully allocated and a constant total transmitted power spectral density is achieved for all OFDM symbols. | | |
| Note 3: | The resources for uplink transmission are assigned to the UE priori to the start of time period T2. | | |
| Note 4: | Interference from other cells and noise sources not specified in the test is assumed to be constant over subcarriers and time and shall be modelled as AWGN of appropriate power for N_{oc} to be fulfilled. | | |
| Note 5: | Es/lot, RSRP, SCH_RP and Io have been derived from other parameters for information purposes. They are not settable parameters themselves. | | |

A.8.4.8.2 Test Requirements

The UE shall send Event A3 triggered measurement reports for cells 2, 3 and 4, with a measurement reporting delay less than 13.17s (cell 2) and 153.6s (cell 3 and 4) from the beginning of time period T2.

The UE shall not send event triggered measurement reports, as long as the reporting criteria are not fulfilled.

The rate of correct events observed during repeated tests shall be at least 90%.

NOTE: The actual overall delays measured in the test may be up to $2 \times TTI_{DCC}$ higher than the measurement reporting delays above because of TTI insertion uncertainty of the measurement report.

A.8.4.9 TDD-TDD Inter-frequency correct reporting of measurement events with reduced performance group configured, DRX

A.8.4.9.1 Test Purpose and Environment

The purpose of this test is to verify that the UE makes correct reporting of an event in DRX. This test will partly verify the TDD-TDD inter-frequency cell search requirements when DRX is used in clause 8.1.2.3.

The test parameters are given in Tables A.8.4.9.1-1, A.8.4.9.1-2, A.8.4.9.1-3 and A.8.4.9.1-4. In this test, there are four cells on different carrier frequencies and gap pattern configuration # 0 as defined in Table 8.1.2.1-1 is provided.

The UE needs to be provided at least once every 500ms with new Timing Advance Command MAC control element to restart the Time alignment timer to keep UE uplink time alignment. Furthermore UE is allocated with PUSCH resource at every DRX cycle..

In the measurement control information, it is indicated to the UE that event-triggered reporting with Event A3 is used. The test consists of two successive time periods for every repetition, with time duration of T1 and T2 respectively. During time duration T1, the UE shall not have any timing information of cell 2, 3 or 4. At the start of each repetition of T1, the test equipment provides signals for cell 1 (serving cell), and cells 2, 3 and 4 which are selected from the 8 cells on different frequencies which are configured in the UE neighbour cell list. Cells 2, 3 and 4 are chosen randomly, such that one frequency belongs to the normal performance group and two frequencies belong to the reduced performance group.

Table A.8.4.9.1-1: General test parameters for E-UTRAN TDD-TDD inter-frequency event triggered reporting for IncMon

| Parameter | Unit | Value | Comment |
|--|------|--------------------|---|
| UE configured E-UTRA RF Channel Number | | 1, 2,3,4,5,6,7,8,9 | Serving cell and eight TDD carrier frequencies are used in the UE neighbour cell list. Frequencies 5,6,7,8 and 9 are indicated to have reduced performance |
| Test equipment configuration | | Cell 1,2,3,4 | Cell 1 uses E-UTRA RF channel number 1 Cells 2 are randomly selected to use different frequencies selected from E-UTRA frequencies 2, 3, 4. Cells 3, 4 are randomly selected to use different frequencies selected from E-UTRA frequencies 5, 6, 7, 8, 9. |
| Active cell | | Cell 1 | Cell 1 is on RF channel number 1 |

| | | | |
|--|----|------------|--|
| Neighbour cells | | Cell 2,3,4 | |
| Gap Pattern Id | | 0 | As specified in TS 36.133 clause 8.1.2.1. |
| Special subframe configuration | | 6 | As specified in table 4.2-1 in TS 36.211. The same configuration in both cells |
| Uplink-downlink configuration | | 1 | As specified in TS 36.211 clause 4.2 Table 4.2-2 |
| A3-Offset | dB | -5 | |
| Hysteresis | dB | 0 | |
| CP length | | Normal | |
| TimeToTrigger | s | 0 | |
| Filter coefficient | | 0 | L3 filtering is not used |
| DRX | | ON | DRX related parameters are defined in Table A.8.3.9.1-3 |
| Scaling factor for reduced performance group | | 8 | |
| T1 | s | 5 | |
| T2 | s | 155 | |

Table A.8.4.9.1-2: Cell specific test parameters for E-UTRAN TDD-TDD inter-frequency event triggered reporting for IncMon

| Parameter | Unit | Cell 1 | | Cell 2 | | Cell 3 | | Cell 4 | |
|--|------------|-----------------------------------|------------------------------|--|------------------------------|---|------------------------------|---|------------------------------|
| | | T1 | T2 | T1 | T2 | T1 | T2 | T1 | T2 |
| E-UTRA RF Channel Number | | 1 | | Randomly selected from 2,3,4 such that cell 2 is in the normal performance group | | Randomly selected from 5, 6, 7, 8, 9 such that cell 3 is in the reduced performance group | | Randomly selected from 5, 6, 7, 8, 9 such that cell 4 is in the reduced performance group | |
| Channel Bandwidth (BW _{channel}) | MHz | 5MHz: NRB = 25 10MHz: NRB = 50 | | 5MHz: NRB,= 25 10MHz: NRB,= 50 | | 5MHz: NRB = 25 10MHz: NRB = 50 | | 5MHz: NRB,= 25 10MHz: NRB,= 50 | |
| PDSCH parameters as specified in clause A.3.1.1.2 | | 5MHz: R.4 TDD 10MHz: R.0 TDD | | - | | - | | - | |
| PCFICH/PDCCH/PHICH parameters as specified in clause A.3.1.2.2 | | 5MHz: R.11 TDD 10MHz: R.6 TDD | | 5MHz: R.11 TDD 10MHz: R.6 TDD | | 5MHz: R.11 TDD 10MHz: R.6 TDD | | 5MHz: R.11 TDD 10MHz: R.6 TDD | |
| OCNG Patterns defined in A.3.2.2 | | 5MHz: OP.9 TDD 10MHz: OP.1 TDD | | 5MHz: OP.10 TDD 10MHz: OP.2 TDD | | 5MHz: OP.10 TDD 10MHz: OP.2 TDD | | 5MHz: OP.10 TDD 10MHz: OP.2 TDD | |
| PBCH_RA | dB | 0 | | 0 | | 0 | | 0 | |
| PBCH_RB | dB | | | | | | | | |
| PSS_RA | dB | | | | | | | | |
| SSS_RA | dB | | | | | | | | |
| PCFICH_RB | dB | | | | | | | | |
| PHICH_RA | dB | | | | | | | | |
| PHICH_RB | dB | | | | | | | | |
| PDCCH_RA | dB | | | | | | | | |
| PDCCH_RB | dB | | | | | | | | |
| PDSCH_RA | dB | | | | | | | | |
| PDSCH_RB | dB | | | | | | | | |
| OCNG_RA ^{Note 1} | dB | | | | | | | | |
| OCNG_RB ^{Note 1} | dB | | | | | | | | |
| N_{oc} ^{Note 3} | dBm/15 kHz | | | | | | | | |
| \hat{E}_s/N_{oc} | dB | 4 | 4 | -Infinity | 4 | -Infinity | 4 | -Infinity | 4 |
| \hat{E}_s/I_{ot} ^{Note 4} | dB | 4 | 4 | -Infinity | 4 | -Infinity | 4 | -Infinity | 4 |
| RSRP ^{Note 4} | dBm/15 kHz | -94 | -94 | -Infinity | -94 | -Infinity | -94 | -Infinity | -94 |
| SCH_RP ^{Note 4} | dBm/15 kHz | -94 | -94 | -Infinity | -94 | -Infinity | -94 | -Infinity | -94 |
| I_o ^{Note 4} | dBm/Ch BW | $-64.76+10\log(N_{RB,c}/50)$ | $-64.76+10\log(N_{RB,c}/50)$ | $-70.22+10\log(N_{RB,c}/50)$ | $-64.76+10\log(N_{RB,c}/50)$ | $-70.22+10\log(N_{RB,c}/50)$ | $-64.76+10\log(N_{RB,c}/50)$ | $-70.22+10\log(N_{RB,c}/50)$ | $-64.76+10\log(N_{RB,c}/50)$ |
| Propagation Condition | | AWGN | | AWGN | | AWGN | | AWGN | |
| Antenna Configuration | | 1x2 | | 1x2 | | 1x2 | | 1x2 | |
| Time offset to cell1 | µs | - | | 3 | | 3 | | 3 | |

- Note 1: OCNG shall be used such that both cells are fully allocated and a constant total transmitted power spectral density is achieved for all OFDM symbols.
- Note 2: The resources for uplink transmission are assigned to the UE prior to the start of time period T2.
- Note 3: Interference from other cells and noise sources not specified in the test is assumed to be constant over subcarriers and time and shall be modelled as AWGN of appropriate power for N_{oc} to be fulfilled.
- Note 4: E_s/I_{ot} , RSRP, SCH_RP and I_o levels have been derived from other parameters for information purposes. They are not settable parameters themselves.

Table A.8.4.9.1-3: *drx-Configuration* to be used in E-UTRAN TDD-TDD inter-frequency event triggered reporting when DRX is used for IncMon

| Field | Value | Comment |
|--------------------------|--|---------|
| onDurationTimer | psf1 | |
| drx-InactivityTimer | psf1 | |
| drx-RetransmissionTimer | psf1 | |
| longDRX-CycleStartOffset | sf160 | |
| shortDRX | disable | |
| Note: | For further information see clause 6.3.2 in TS 36.331. | |

Table A.8.4.9.1-4: *TimeAlignmentTimer* and *sr-ConfigIndex* Configuration to be used in E-UTRAN TDD-TDD inter-frequency event triggered reporting when DRX is used for IncMon

| Field | Value | Comment |
|--------------------|-------|---|
| TimeAlignmentTimer | sf500 | For further information see clause 6.3.2 in TS 36.331. |
| sr-ConfigIndex | 0 | For further information see clause 6.3.2 in TS 36.331 and section 10.1 in TS 36.213.. |

A.8.4.9.2 Test Requirements

The UE shall send Event A3 triggered measurement reports for cells 2, 3 and 4, with a measurement reporting delay less than 13.2s (cell 2) and 153.6s (cell 3 and 4) from the beginning of time period T2.

The UE shall not send event triggered measurement reports, as long as the reporting criteria are not fulfilled.

The rate of correct events observed during repeated tests shall be at least 90%.

NOTE: The actual overall delays measured in the test may be up to $2xTTI_{DCC}$ higher than the measurement reporting delays above because of TTI insertion uncertainty of the measurement report.

Where:

When DRX cycle is 160ms, the delay requirement of cell identification and measurement period are specified in section 8.1.2.3.1.2 and Non DRX Requirements in clause 8.1.2.3.1.1 are applicable.

The requirement of inter frequency cell identification delay are specified as

$$T_{\text{Identify_Inter}} = T_{\text{Basic_Identify_Inter}} \cdot \frac{480}{T_{\text{Inter1}}} \cdot N_{\text{freq},n} \cdot K_n \quad \text{ms (normal performance) and}$$

$$T_{\text{Identify_Inter}} = T_{\text{Basic_Identify_Inter}} \cdot \frac{480}{T_{\text{Inter1}}} \cdot N_{\text{freq},r} \cdot K_r \quad \text{ms (reduced performance)}$$

$T_{\text{Basic_Identify_inter}}$ 480ms, See section 8.1.2.3.1.1

T_{Inter1} 60ms, See section 8.1.2.1

$N_{\text{freq},n}$ and $N_{\text{freq},r}$ 3 and 5 set in this test case.

K_n and K_r 8/7 and 8, See section 8.1.2.1.1a.

This gives 13165.7ms for cells 2 on normal carrier, and 153600ms for cell 3 and cell 4 on reduced carriers for Event A3 triggered measurement reporting delay. The test requirements allow 13.2s and 153.6s.

A.8.5 E-UTRAN FDD - UTRAN FDD Measurements

A.8.5.1 E-UTRAN FDD - UTRAN FDD event triggered reporting under fading propagation conditions

A.8.5.1.1 Test Purpose and Environment

The purpose of this test is to verify that the UE makes correct reporting of an event. This test will partly verify the E-UTRAN FDD- UTRAN FDD cell search requirements in clause 8.1.2.4.1.

The test parameters are given in Tables A.8.5.1.1-1, A.8.5.1.1-2 and A.8.5.1.1-3 below. In the measurement control information it is indicated to the UE that event-triggered reporting with Event B1 is used. The test consists of two successive time periods, with time duration of T1, and T2 respectively. During time duration T1, the UE shall not have any timing information of cell 2.

Table A.8.5.1.1-1: General test parameters for E-UTRAN FDD-UTRAN FDD event triggered reporting in fading propagation conditions

| Parameter | Unit | Value | Comment |
|---|------|--|--|
| PDSCH parameters (E-UTRAN FDD) | | DL Reference Measurement Channel R.0 FDD | As specified in clause A.3.1.1.1. |
| PCFICH/PDCCH/PHICH parameters (E-UTRAN FDD) | | DL Reference Measurement Channel R.6 FDD | As specified in clause A.3.1.2.1. |
| Gap Pattern Id | | 1 | As specified in TS 36.133 clause 8.1.2.1. |
| Active cell | | Cell 1 | Cell 1 is on E-UTRA RF channel number 1. |
| Neighbour cell | | Cell 2 | Cell 2 is on UTRA RF channel number 1. |
| CP length | | Normal | Applicable to cell 1 |
| E-UTRA RF Channel Number | | 1 | One E-UTRA FDD carrier frequency is used. |
| E-UTRA Channel Bandwidth (BW _{channel}) | MHz | 10 | |
| UTRA RF Channel Number | | 1 | One UTRA FDD carrier frequency is used. |
| Inter-RAT (UTRA FDD) measurement quantity | | CPICH Ec/Io | |
| b1-Threshold-UTRA | dB | -18 | CPICH Ec/Io threshold for event B1. |
| Hysteresis | dB | 0 | |
| Time To Trigger | ms | 0 | |
| Filter coefficient | | 0 | L3 filtering is not used. |
| DRX | | OFF | |
| Monitored UTRA FDD cell list size | | 12 | UTRA cells on UTRA RF channel 1 provided in the cell list. |
| T1 | s | 5 | |
| T2 | s | 6 | |

Table A.8.5.1.1-2: Cell specific test parameters for E-UTRAN FDD (cell # 1) for event triggered reporting of UTRAN FDD cell under fading propagation conditions

| Parameter | Unit | Cell 1 | |
|--|------|----------|----|
| | | T1 | T2 |
| E-UTRA RF Channel Number | | 1 | 1 |
| BW _{channel} | MHz | 10 | 10 |
| Correlation Matrix and Antenna Configuration | | 1x2 Low | |
| OCNG Pattern defined in A.3.2.1.1 (OP.1 FDD) | | OP.1 FDD | |
| PBCH_RA | dB | 0 | |
| PBCH_RB | dB | | |
| PSS_RA | dB | | |
| SSS_RA | dB | | |
| PCFICH_RB | dB | | |
| PHICH_RA | dB | | |
| PHICH_RB | dB | | |
| PDCCH_RA | dB | | |
| PDCCH_RB | dB | | |
| PDSCH_RA | dB | | |
| PDSCH_RB | dB | | |

| | | | |
|---|------------|-------|-----|
| OCNG_RA ^{Note 1} | dB | | |
| OCNG_RB ^{Note 1} | dB | | |
| \hat{E}_s/I_{ot} | dB | 4 | 4 |
| \hat{E}_s/N_{oc} | dB | 4 | 4 |
| N_{oc} | dBm/15 kHz | -98 | |
| RSRP | dBm/15 kHz | -94 | -94 |
| SCH_RP | dBm/15 kHz | -94 | -94 |
| Propagation Condition | | ETU70 | |
| Note 1: OCNG shall be used such that both cells are fully allocated and a constant total transmitted power spectral density is achieved for all OFDM symbols. | | | |
| Note 2: The resources for uplink transmission are assigned to the UE prior to the start of time period T2. | | | |

Table A.8.5.1.1-3: Cell specific test parameters for UTRAN FDD (cell # 2) for event triggered reporting of UTRAN FDD cell under fading propagation conditions

| Parameter | Unit | Cell 2 | |
|---|--------------|-----------------|------|
| | | T1 | T2 |
| UTRA RF Channel Number | | 1 | |
| CPICH_Ec/I _{or} | dB | -10 | |
| PCCPCH_Ec/I _{or} | dB | -12 | |
| SCH_Ec/I _{or} | dB | -12 | |
| PICH_Ec/I _{or} | dB | -15 | |
| DPCH_Ec/I _{or} | dB | N/A | |
| OCNS | | -0.941 | |
| \hat{I}_{or}/I_{oc} | dB | -Infinity | -1.8 |
| I_{oc} | dBm/3.84 MHz | -70 | |
| CPICH_Ec/I _o | dB | -Infinity | -14 |
| Propagation Condition | | Case 5 (Note 3) | |
| Note 1: The DPCH level is controlled by the power control loop. | | | |
| Note 2: The power of the OCNS channel that is added shall make the total power from the cell to be equal to I _{or} . | | | |
| Note 3: Case 5 propagation conditions are defined in Annex A of TS 25.101. | | | |

A.8.5.1.2 Test Requirements

The UE shall send one Event B1 triggered measurement report, with a measurement reporting delay less than 4800 ms from the beginning of time period T2.

The UE shall not send event triggered measurement reports, as long as the reporting criteria are not fulfilled.

The rate of correct events observed during repeated tests shall be at least 90%.

NOTE: The actual overall delays measured in the test may be up to $2xTTI_{DCCH}$ higher than the measurement reporting delays above because of TTI insertion uncertainty of the measurement report in DCCH.

A.8.5.2 E-UTRAN FDD - UTRAN FDD SON ANR cell search reporting under AWGN propagation conditions

A.8.5.2.1 Test Purpose and Environment

The purpose of this test is to verify that the UE makes correct reporting of the strongest UTRAN cell for SON automatic neighbour relations. This test will partly verify the E-UTRAN FDD - UTRAN FDD cell search requirements for identification of a new UTRA FDD cell for SON given in clause 8.1.2.4.7.1.

The test parameters are given in Tables A.8.5.2.1-1, A.8.5.2.1-2 and A.8.5.2.1-3 below. In the measurement control information it is indicated to the UE that periodical reporting with the purpose 'reportStrongestCellsForSON' is used. The test consists of two successive time periods, with time duration of T1, and T2 respectively. Prior to the start of time period T1, an interRATperiodic

measurement reporting configuration with purpose reportStrongestCellsForSON is configured, and linked to a UTRA measurement object corresponding to channel UARFCN 1. During time duration T1, the UE shall not have any timing information of cell 2.

Table A.8.5.2.1-1: General test parameters for E-UTRAN FDD-UTRAN FDD cell search reporting for SON ANR in AWGN propagation conditions

| Parameter | Unit | Value | Comment |
|---|------|--|---|
| PDSCH parameters (E-UTRAN FDD) | | DL Reference Measurement Channel R.0 FDD | As specified in clause A.3.1.1.1. |
| PCFICH/PDCCH/PHICH parameters (E-UTRAN FDD) | | DL Reference Measurement Channel R.6 FDD | As specified in clause A.3.1.2.1. |
| Gap Pattern Id | | 1 | As specified in TS 36.133 clause 8.1.2.1. |
| Active cell | | Cell 1 | Cell 1 is on E-UTRA RF channel number 1. |
| Neighbour cell | | Cell 2 | Cell 2 is on UTRA RF channel number 1. |
| CP length | | Normal | Applicable to cell 1 |
| E-UTRA RF Channel Number | | 1 | One E-UTRA FDD carrier frequency is used. |
| E-UTRA Channel Bandwidth (BW _{channel}) | MHz | 10 | |
| UTRA RF Channel Number | | 1 | One UTRA FDD carrier frequency is used. |
| Inter-RAT (UTRA FDD) measurement quantity | | CPICH Ec/lo | |
| Filter coefficient | | 0 | L3 filtering is not used. |
| DRX | | OFF | |
| Monitored UTRA FDD cell list size | | None | No explicit neighbour list is provided to the UE |
| T1 | s | >5 | During T1, cell 2 shall be powered off, and during the off time the primary scrambling code shall be changed, The intention is to ensure that cell 2 has not been detected by the UE prior to the start of period T2. |
| T2 | s | 6 | |

Table A.8.5.2.1-2: Cell specific test parameters for E-UTRAN FDD (cell # 1) for UTRAN FDD cell search for SON ANR under AWGN propagation conditions

| Parameter | Unit | Cell 1 | |
|--|------------|----------|-----|
| | | T1 | T2 |
| E-UTRA RF Channel Number | | 1 | |
| BW _{channel} | MHz | 10 | |
| OCNG Pattern defined in A.3.2.1.1 (OP.1 FDD) | | OP.1 FDD | |
| PBCH_RA | dB | 0 | |
| PBCH_RB | dB | | |
| PSS_RA | dB | | |
| SSS_RA | dB | | |
| PCFICH_RB | dB | | |
| PHICH_RA | dB | | |
| PHICH_RB | dB | | |
| PDCCH_RA | dB | | |
| PDCCH_RB | dB | | |
| PDSCH_RA | dB | | |
| PDSCH_RB | dB | | |
| OCNG_RA ^{Note 1} | dB | | |
| OCNG_RB ^{Note 1} | dB | | |
| \hat{E}_s / \hat{I}_{ot} | dB | 4 | 4 |
| N_{oc} ^{Note 3} | dBm/15 kHz | -98 | |
| \hat{E}_s / N_{oc} | dB | 4 | 4 |
| RSRP ^{Note 4} | dBm/15 kHz | -94 | -94 |
| SCH_RP | dBm/15 kHz | -94 | -94 |
| Propagation Condition | | AWGN | |

- Note 1: OCNG shall be used such that both cells are fully allocated and a constant total transmitted power spectral density is achieved for all OFDM symbols.
- Note 2: The resources for uplink transmission are assigned to the UE prior to the start of time period T2.
- Note 3: Interference from other cells and noise sources not specified in the test is assumed to be constant over subcarriers and time and shall be modelled as AWGN of appropriate power for N_{oc} to be fulfilled.
- Note 4: RSRP levels have been derived from other parameters for information purposes. They are not settable parameters themselves.

Table A.8.5.2.1-3: Cell specific test parameters for UTRAN FDD (cell # 2) for UTRAN FDD cell search for SON ANR under AWGN propagation conditions

| Parameter | Unit | Cell 2 | |
|---|--------------|-----------|--------|
| | | T1 | T2 |
| UTRA RF Channel Number | | | 1 |
| CPICH_Ec/I _{or} | dB | | -10 |
| PCCPCH_Ec/I _{or} | dB | | -12 |
| SCH_Ec/I _{or} | dB | | -12 |
| PICH_Ec/I _{or} | dB | | -15 |
| DPCH_Ec/I _{or} | dB | | N/A |
| OCNS | | | -0.941 |
| \hat{I}_{or}/I_{oc} | dB | -Infinity | -3.35 |
| I_{oc} | dBm/3.84 MHz | | -70 |
| CPICH_Ec/I _o | dB | -Infinity | -15 |
| Propagation Condition | | AWGN | |
| Note 1: The DPCH level is controlled by the power control loop. | | | |
| Note 2: The power of the OCNS channel that is added shall make the total power from the cell to be equal to I _{or} . | | | |

A.8.5.2.2 Test Requirements

The UE shall send the first measurement report containing the primary scrambling code of cell 2, with a measurement reporting delay less than 4800 ms from the beginning of time period T2.

The rate of correct measurement reports observed with this delay during repeated tests shall be at least 90%.

NOTE: The actual overall delays measured in the test may be up to $2 \times TTI_{DCCH}$ higher than the measurement reporting delays above because of TTI insertion uncertainty of the measurement report in DCCH.

A.8.5.3 E-UTRAN FDD-UTRAN FDD event triggered reporting when DRX is used under fading propagation conditions

A.8.5.3.1 Test Purpose and Environment

The purpose of these tests is to verify that the UE makes correct reporting of an event in DRX. These tests will partly verify the E-UTRAN FDD-UTRAN FDD cell search requirements when DRX is used in clause 8.1.2.4.1.2.

In these tests, there are two cells, one E-UTRAN cell and one UTRAN cell, and gap pattern configuration # 0 as defined in Table 8.1.2.1-1 is provided.

The common test parameters are given in Table A.8.5.3.1-1. Cell specific test parameters are given in Table A.8.5.3.1-2 for E-UTRAN and in Table A.8.5.3.1-5 for UTRAN. DRX configuration for Test1 and Test2 are given in Table A.8.5.2.1-3 and time alignment timer and scheduling request related parameters in Table A.8.5.2.1-4.

In Test 1 UE needs to be provided at least once every 500ms with new Timing Advance Command MAC control element to restart the Time alignment timer to keep UE uplink time alignment. Furthermore UE is allocated with PUSCH resource at every DRX cycle. In Test 2 the uplink time alignment is not maintained and UE needs to use RACH to obtain UL allocation for measurement reporting.

In the measurement control information, it is indicated to the UE that event-triggered reporting with Event B1 is used. The tests consist of two successive time periods, with time duration of T1, and T2 respectively. During time duration T1, the UE shall not have any timing information of cell 2.

Table A.8.5.3.1-1: General test parameters for E-UTRAN FDD-UTRAN FDD event triggered reporting when DRX is used in fading propagation conditions

| Parameter | Unit | Test 1 | Test 2 | Comment |
|---|------|--|--------|---|
| | | Value | | |
| PDSCH parameters (E-UTRAN FDD) | | DL Reference Measurement Channel R.0 FDD | | As specified in clause A.3.1.1.1 Note that UE may only be allocated at <i>On Duration</i> |
| PCFICH/PDCCH/PHICH parameters (E-UTRAN FDD) | | DL Reference Measurement Channel R.6 FDD | | As specified in clause A.3.1.2.1. |
| Gap Pattern Id | | 0 | | As specified in TS 36.133 clause 8.1.2.1. |
| Active cell | | Cell 1 | | Cell 1 is on E-UTRA RF channel number 1. |
| Neighbour cell | | Cell 2 | | Cell 2 is on UTRA RF channel number 1. |
| CP length | | Normal | | Applicable to cell 1 |
| E-UTRA RF Channel Number | | 1 | | One E-UTRA FDD carrier frequency is used. |
| E-UTRA Channel Bandwidth (BW _{channel}) | MHz | 10 | | |
| UTRA RF Channel Number | | 1 | | One UTRA FDD carrier frequency is used. |
| Inter-RAT (UTRA FDD) measurement quantity | | CPICH Ec/Io | | |
| b1-Threshold-UTRA | dB | -18 | | CPICH Ec/Io threshold for event B1. |
| Hysteresis | dB | 0 | | |
| TimeToTrigger | s | 0 | | |
| Filter coefficient | | 0 | | L3 filtering is not used |
| PRACH configuration | | 4 | | As specified in table 5.7.1-2 in TS 36.211 |
| Access Barring Information | - | Not Sent | | No additional delays in random access procedure. |
| DRX | | ON | | DRX related parameters are defined in Table A.8.5.3.1-3 |
| Monitored UTRA FDD cell list size | | 12 | | UTRA cells on UTRA RF channel 1 provided in the cell list. |
| T1 | s | 5 | | |
| T2 | s | 6 | 30 | |

Table A.8.5.3.1-2: Cell specific test parameters for E-UTRAN FDD (cell #1) event triggered reporting of UTRAN FDD cell when DRX is used under fading propagation conditions

| Parameter | Unit | Cell 1 | |
|--|------------|----------|----|
| | | T1 | T2 |
| E-UTRA RF Channel Number | | 1 | |
| BW _{channel} | MHz | 10 | |
| Correlation Matrix and Antenna Configuration | | 1x2 Low | |
| OCNG Pattern defined in A.3.2.1.1 (OP.1 FDD) | | OP.1 FDD | |
| PBCH_RA | dB | 0 | |
| PBCH_RB | dB | | |
| PSS_RA | dB | | |
| SSS_RA | dB | | |
| PCFICH_RB | dB | | |
| PHICH_RA | dB | | |
| PHICH_RB | dB | | |
| PDCCH_RA | dB | | |
| PDCCH_RB | dB | | |
| PDSCH_RA | dB | | |
| PDSCH_RB | dB | | |
| OCNG_RA ^{Note 1} | dB | | |
| OCNG_RB ^{Note 1} | dB | | |
| \hat{E}_s / I_{ot} | dB | | |
| N_{oc} ^{Note 2} | dBm/15 kHz | -98 | |

| | | | |
|------------------------|--|-------|-----|
| RSRP ^{Note 3} | dBm/15 kHz | -94 | -94 |
| SCH_RP | dBm/15 kHz | -94 | -94 |
| \hat{E}_s / N_{oc} | dB | 4 | 4 |
| Propagation Condition | | ETU70 | |
| Note 1: | OCNG shall be used such that both cells are fully allocated and a constant total transmitted power spectral density is achieved for all OFDM symbols. | | |
| Note 2: | Interference from other cells and noise sources not specified in the test is assumed to be constant over subcarriers and time and shall be modelled as AWGN of appropriate power for N_{oc} to be fulfilled. | | |
| Note 3: | RSRP and SCH_RP levels have been derived from other parameters for information purposes. They are not settable parameters themselves. | | |

Table A.8.5.3.1-3: drx-Configuration to be used in E-UTRAN FDD-UTRAN FDD event triggered reporting when DRX is used in fading propagation conditions

| Field | Test1 | Test2 | Comment |
|--|---------|---------|---------|
| | Value | Value | |
| onDurationTimer | psf1 | psf1 | |
| drx-InactivityTimer | psf1 | psf1 | |
| drx-RetransmissionTimer | psf1 | psf1 | |
| longDRX-CycleStartOffset | sf40 | sf1280 | |
| shortDRX | Disable | Disable | |
| Note: For further information see clause 6.3.2 in TS 36.331. | | | |

Table A.8.5.3.1-4: TimeAlignmentTimer and sr-ConfigIndex -Configuration to be used in E-UTRAN FDD-UTRAN FDD event triggered reporting when DRX is used in fading propagation conditions

| Field | Test1 | Test2 | Comment |
|--------------------|-------|-------|--|
| | Value | Value | |
| TimeAlignmentTimer | sf500 | sf500 | For further information see clause 6.3.2 in TS 36.331. |
| sr-ConfigIndex | 0 | 0 | For further information see clause 6.3.2 in TS 36.331 and section 10.1 in TS 36.213. |

Table A.8.5.3.1-5: Cell specific test parameters for UTRAN FDD (cell # 2) for event triggered reporting of UTRAN FDD cell when DRX is used under fading propagation conditions

| Parameter | Unit | Cell 2 | |
|-------------------------|--|-----------------|------|
| | | T1 | T2 |
| UTRA RF Channel Number | | 1 | |
| CPICH_Ec/lor | dB | -10 | |
| PCCPCH_Ec/lor | dB | -12 | |
| SCH_Ec/lor | dB | -12 | |
| PICH_Ec/lor | dB | -15 | |
| DPCH_Ec/lor | dB | N/A | |
| OCNS | | -0.941 | |
| \hat{I}_{or} / I_{oc} | dB | -Infinity | -1.8 |
| I_{oc} | dBm/3.84 MHz | -70 | |
| CPICH_Ec/lo | dB | -Infinity | -14 |
| Propagation Condition | | Case 5 (Note 3) | |
| Note 1: | The DPCH level is controlled by the power control loop. | | |
| Note 2: | The power of the OCNS channel that is added shall make the total power from the cell to be equal to I_{or} . | | |
| Note 3: | Case 5 propagation conditions are defined in Annex A of TS 25.101. | | |

A.8.5.3.2 Test Requirements

In Test1 the UE shall send one Event B1 triggered measurement report, with a measurement reporting delay less than 2400 ms from the beginning of time period T2. The measurement reporting delay is defined as the time from the beginning of time period T2, to the moment when the UE sends the measurement report on PUSCH.

In Test2 the UE shall send one Event B1 triggered measurement report, with a measurement reporting delay less than 20*1280ms from the beginning of time period T2. The measurement reporting delay is defined as the time from the beginning of time period T2, to the moment when the UE starts to send preambles on the PRACH for scheduling request (SR) to obtain allocation to send the measurement report on PUSCH.

The UE shall not send event triggered measurement reports, as long as the reporting criteria are not fulfilled.

The rate of correct events observed during repeated tests shall be at least 90%.

NOTE 1: The actual overall delays measured in the test may be up to one DRX cycle higher than the measurement reporting delays above because UE is allowed to delay the initiation of the measurement reporting procedure to the next until the Active Time.

NOTE 2: In order to calculate the rate of correct events the system simulator shall verify that it has received correct Event B1 measurement report.

A.8.5.4 E-UTRAN FDD - UTRAN FDD enhanced cell identification under AWGN propagation conditions

A.8.5.4.1 Test Purpose and Environment

The purpose of this test is to verify that the UE makes correct enhanced reporting of UTRAN cells. This test will partly verify the Enhanced UTRA FDD cell identification requirements in clause 8.1.2.4.1.1.1a.

The test parameters are given in Tables A.8.5.4.1-1, A.8.5.4.1-2 and A.8.5.4.1-3 below. In the measurement control information it is indicated to the UE that event-triggered reporting with Event B1 is used. The test consists of two successive time periods, with time duration of T1, and T2 respectively. During time period T1, gaps are activated and an interRAT measurement reporting configuration is configured, and linked to a UTRA measurement object corresponding to channel UARFCN 1. Prior to time duration T2, the UE shall not have any timing information of cell 2. Cell 2 is powered up at the beginning of the T2

Table A.8.5.4.1-1: General test parameters for E-UTRAN FDD - UTRAN FDD enhanced cell identification under AWGN propagation conditions

| Parameter | Unit | Value | Comment |
|---|------|--|---|
| PDSCH parameters (E-UTRAN FDD) | | DL Reference Measurement Channel R.0 FDD | As specified in clause A.3.1.1.1. |
| PCFICH/PDCCH/PHICH parameters (E-UTRAN FDD) | | DL Reference Measurement Channel R.6 FDD | As specified in clause A.3.1.2.1. |
| Gap Pattern Id | | 0 | As specified in TS 36.133 clause 8.1.2.1. |
| Active cell | | Cell 1 | Cell 1 is on E-UTRA RF channel number 1. |
| Neighbour cell | | Cell 2 | Cell 2 is on UTRA RF channel number 1. |
| CP length | | Normal | Applicable to cell 1 |
| E-UTRA RF Channel Number | | 1 | One E-UTRA FDD carrier frequency is used. |
| E-UTRA Channel Bandwidth (BW _{channel}) | MHz | 10 | |
| UTRA RF Channel Number | | 1 | One UTRA FDD carrier frequency is used. |
| Inter-RAT (UTRA FDD) measurement quantity | | CPICH Ec/Io | |
| b1-Threshold-UTRA | dB | -18 | CPICH Ec/Io threshold for event B1. |
| Hysteresis | dB | 0 | |
| Time To Trigger | ms | 0 | |
| Filter coefficient | | 0 | L3 filtering is not used. |
| DRX | | OFF | |
| Monitored UTRA FDD cell list size | | 12 | UTRA cells on UTRA RF channel 1 provided in the cell list |
| T1 | s | 5 | |
| T2 | s | 2 | |

Table A.8.5.4.1-2: Cell specific test parameters for cell #1 E-UTRAN FDD - UTRAN FDD enhanced cell identification under AWGN propagation conditions

| Parameter | Unit | Cell 1 | |
|--|------------|----------|-----|
| | | T1 | T2 |
| E-UTRA RF Channel Number | | 1 | |
| BW_{channel} | MHz | 10 | |
| OCNG Pattern defined in A.3.2.1.1 (OP.1 FDD) | | OP.1 FDD | |
| PBCH_RA | dB | 0 | |
| PBCH_RB | dB | | |
| PSS_RA | dB | | |
| SSS_RA | dB | | |
| PCFICH_RB | dB | | |
| PHICH_RA | dB | | |
| PHICH_RB | dB | | |
| PDCCH_RA | dB | | |
| PDCCH_RB | dB | | |
| PDSCH_RA | dB | | |
| PDSCH_RB | dB | | |
| OCNG_RA ^{Note 1} | dB | | |
| OCNG_RB ^{Note 1} | dB | | |
| \hat{E}_s/I_{ot} | dB | | |
| N_{oc} ^{Note 3} | dBm/15 kHz | -98 | |
| \hat{E}_s/N_{oc} | dB | 4 | 4 |
| RSRP ^{Note 4} | dBm/15 kHz | -94 | -94 |
| SCH_RP | dBm/15 kHz | -94 | -94 |
| Propagation Condition | | AWGN | |
| <p>Note 1: OCNG shall be used such that both cells are fully allocated and a constant total transmitted power spectral density is achieved for all OFDM symbols.</p> <p>Note 2: The resources for uplink transmission are assigned to the UE prior to the start of time period T2.</p> <p>Note 3: Interference from other cells and noise sources not specified in the test is assumed to be constant over subcarriers and time and shall be modelled as AWGN of appropriate power for N_{oc} to be fulfilled.</p> <p>Note 4: RSRP levels have been derived from other parameters for information purposes. They are not settable parameters themselves.</p> | | | |

Table A.8.5.4.1-3: Cell specific test parameters for cell #2 E-UTRAN FDD - UTRAN FDD enhanced cell identification under AWGN propagation conditions

| Parameter | Unit | Cell 2 | |
|--|--------------|-----------|------|
| | | T1 | T2 |
| UTRA RF Channel Number | | 1 | |
| CPICH_Ec/I _{or} | dB | -10 | |
| PCCPCH_Ec/I _{or} | dB | -12 | |
| SCH_Ec/I _{or} | dB | -12 | |
| PICH_Ec/I _{or} | dB | -15 | |
| DPCH_Ec/I _{or} | dB | N/A | |
| OCNS | | -0.941 | |
| $\hat{I}_{\text{or}}/I_{\text{oc}}$ | dB | $-\infty$ | 0.02 |
| I_{oc} | dBm/3.84 MHz | -70 | |
| CPICH_Ec/I _o ^{Note 3} | dB | $-\infty$ | -13 |
| Propagation Condition | | AWGN | |
| <p>Note 1: The DPCH level is controlled by the power control loop.</p> <p>Note 2: The power of the OCNS channel that is added shall make the total power from the cell to be equal to I_{or}.</p> <p>Note 3: This gives an SCH Ec/I_o of -15dB</p> | | | |

A.8.5.4.2 Test Requirements

The UE shall send the first measurement report containing the primary scrambling code of cell 2, with a measurement reporting delay less than 960 ms from the beginning of time period T2. The rate of correct measurement reports observed with this delay during repeated tests shall be at least 90%.

NOTE: The actual overall delays measured in the test may be up to $2 \times TTI_{DCCH}$ higher than the measurement reporting delays above because of TTI insertion uncertainty of the measurement report in DCCH

A.8.5.5 E- UTRAN FDD - UTRAN FDD identification of a new CGI of UTRAN cell using autonomous gaps

A.8.5.5.1 Test Purpose and Environment

This test is to verify the requirement for identification of a new CGI of UTRA cell with autonomous gaps in clause 8.1.2.4.17.

The test parameters are given in Tables A.8.5.5.1-1, A.8.5.5.1-2 and A.8.5.5.1-3 below. The test consists of three successive time periods, with time durations of T1, T2 and T3 respectively. At the start of time duration T1, the UE does not have any timing information of cell 2. Starting T2, cell 2 becomes detectable and the UE is expected to detect and send a measurement report. Gap pattern configuration with id #0 as specified in Table 8.1.2.1-1 is configured before T2 begins to enable inter-frequency monitoring.

A RRC message implying SI reading shall be sent to the UE during period T2, after the UE has reported Event B1. The RRC message shall create a measurement report configuration with purpose *reportCGI* and *si-RequestForHO* set to TRUE. The start of T3 is the instant when the last TTI containing the RRC message implying SI reading is sent to the UE.

Table A.8.5.5.1-1: General test parameters for E-UTRAN FDD - UTRAN FDD identification of a new CGI of UTRAN cell using autonomous gaps

| Parameter | Unit | Value | Comment |
|---|--------|--|--|
| PDSCH parameters (E-UTRAN FDD) | | DL Reference Measurement Channel R.0 FDD | As specified in clause A.3.1.1.1. |
| PCFICH/PDCCH/PHICH parameters (E-UTRAN FDD) | | DL Reference Measurement Channel R.6 FDD | As specified in clause A.3.1.2.1. |
| Gap Pattern Id | | 0 | As specified in TS 36.133 clause 8.1.2.1. |
| Active cell | | Cell 1 | Cell 1 is on E-UTRA RF channel number 1. |
| Neighbour cell | | Cell 2 | Cell 2 is on UTRA RF channel number 1. |
| CP length | | Normal | Applicable to cell 1 |
| E-UTRA RF Channel Number | | 1 | One E-UTRA FDD carrier frequency is used. |
| E-UTRA Channel Bandwidth (BW _{channel}) | MHz | 10 | |
| UTRA RF Channel Number | | 1 | One UTRA FDD carrier frequency is used. |
| Inter-RAT (UTRA FDD) measurement quantity | | CPICH Ec/Io | |
| b1-Threshold-UTRA | dB | -18 | CPICH Ec/Io threshold for event B1. |
| Hysteresis | dB | 0 | |
| Time To Trigger | ms | 0 | |
| Filter coefficient | | 0 | L3 filtering is not used. |
| DRX | | OFF | |
| SIB3_REP | Frames | 32 | Applicable for cell 2 SIB3 scheduling |
| SIB3_SEG_COUNT | | 1 | Applicable for cell 2 SIB3 scheduling |
| si-RequestForHO | | TRUE | As specified in clause 5.5.3.1 in TS 36.331. |
| Monitored UTRA FDD cell list size | | 12 | UTRA cells on UTRA RF channel 1 provided in the cell list. |
| CSG id (of cell 2) | | Set to any non-empty value | |
| T1 | s | 5 | |
| T2 | s | ≤10 | |
| T3 | s | 5 | |

Table A.8.5.5.1-2: Cell specific test parameters for cell #1 E-UTRAN FDD - UTRAN FDD identification of a new CGI of UTRAN cell using autonomous gaps

| Parameter | Unit | Cell 1 | |
|--------------------------|------|--------|----|
| | | T1 | T2 |
| E-UTRA RF Channel Number | | | 1 |

| | | | |
|---|------------|----------|-----|
| BW _{channel} | MHz | 10 | |
| OCNG Pattern defined in A.3.2.1.1 (OP.1 FDD) | | OP.1 FDD | |
| PBCH_RA | dB | 0 | |
| PBCH_RB | dB | | |
| PSS_RA | dB | | |
| SSS_RA | dB | | |
| PCFICH_RB | dB | | |
| PHICH_RA | dB | | |
| PHICH_RB | dB | | |
| PDCCH_RA | dB | | |
| PDCCH_RB | dB | | |
| PDSCH_RA | dB | | |
| PDSCH_RB | dB | | |
| OCNG_RA ^{Note 1} | dB | | |
| OCNG_RB ^{Note 1} | dB | | |
| \hat{E}_s/I_{ot} | dB | 4 | 4 |
| N_{oc} ^{Note 3} | dBm/15 kHz | -98 | |
| \hat{E}_s/N_{oc} | dB | 4 | 4 |
| RSRP ^{Note 4} | dBm/15 kHz | -94 | -94 |
| SCH_RP | dBm/15 kHz | -94 | -94 |
| Propagation Condition | | AWGN | |
| <p>Note 1: OCNG shall be used such that both cells are fully allocated and a constant total transmitted power spectral density is achieved for all OFDM symbols.</p> <p>Note 2: The resources for uplink transmission are assigned to the UE prior to the start of time period T2.</p> <p>Note 3: Interference from other cells and noise sources not specified in the test is assumed to be constant over subcarriers and time and shall be modelled as AWGN of appropriate power for N_{oc} to be fulfilled.</p> <p>Note 4: RSRP levels have been derived from other parameters for information purposes. They are not settable parameters themselves.</p> | | | |

Table A.8.5.5.1-3: Cell specific test parameters for cell #2 E-UTRAN FDD - UTRAN FDD identification of a new CGI of UTRAN cell using autonomous gaps

| Parameter | Unit | Cell 2 | |
|---|--------------|-----------|------|
| | | T1 | T2 |
| UTRA RF Channel Number | | 1 | |
| CPICH_Ec/I _{or} | dB | -10 | |
| PCCPCH_Ec/I _{or} | dB | -12 | |
| SCH_Ec/I _{or} | dB | -12 | |
| PICH_Ec/I _{or} | dB | -15 | |
| DPCH_Ec/I _{or} | dB | N/A | |
| OCNS | | -0.941 | |
| \hat{I}_{or}/I_{oc} | dB | $-\infty$ | 0.02 |
| I_{oc} | dBm/3.84 MHz | -70 | |
| CPICH_Ec/I _o ^{Note 3} | dB | $-\infty$ | -13 |
| Propagation Condition | | AWGN | |
| <p>Note 1: The DPCH level is controlled by the power control loop.</p> <p>Note 2: The power of the OCNS channel that is added shall make the total power from the cell to be equal to I_{or}.</p> <p>Note 3: This gives an SCH Ec/I_o of -15dB</p> | | | |

A.8.5.5.2 Test Requirements

The UE shall transmit a measurement report containing the cell global identifier of cell 2 within [1965] milliseconds from the start of T3.

Test requirement = RRC Procedure delay + T_{identify_CGI, UTRAN FDD} + reporting delay

= 50 + [630]+40*32 + 2ms from the start of T3

= [1962] ms, allow [1965] ms.

The rate of correct events observed during repeated tests shall be at least 90%.

A.8.5.6 E-UTRAN FDD - UTRAN FDD event triggered reporting without measurement gaps under AWGN propagation conditions

A.8.5.6.1 Test Purpose and Environment

The purpose of this test is to verify that the UE makes correct reporting of an event without measurement gaps. This test will partly verify the E-UTRAN FDD- UTRAN FDD cell search requirements in clause 8.1.2.4.1.

The test parameters are given in Tables A.8.5.6.1-1, A.8.5.6.1-2 and A.8.5.6.1-3 below. In the measurement control information it is indicated to the UE that event-triggered reporting with Event B1 is used. The test consists of two successive time periods, with time duration of T1, and T2 respectively. During time duration T1, the UE shall not have any timing information of cell 2. PDCCH on the PCell shall be sent continuously to ensure that the UE sends ACK/NACKs throughout the test.

Table A.8.5.6.1-1: General test parameters for E-UTRAN FDD-UTRAN FDD event triggered reporting without measurement gaps under AWGN propagation conditions

| Parameter | Unit | Value | Comment |
|---|------|--|--|
| PDSCH parameters (E-UTRAN FDD) | | DL Reference Measurement Channel R.3 FDD | As specified in clause A.3.1.1.1. |
| PCFICH/PDCCH/PHICH parameters (E-UTRAN FDD) | | DL Reference Measurement Channel R.6 FDD | As specified in clause A.3.1.2.1. |
| Active cell | | Cell 1 | Cell 1 is on E-UTRA RF channel number 1. |
| Neighbour cell | | Cell 2 | Cell 2 is on UTRA RF channel number 1. |
| CP length | | Normal | Applicable to cell 1 |
| E-UTRA RF Channel Number | | 1 | One E-UTRA FDD carrier frequency is used. |
| E-UTRA Channel Bandwidth ($BW_{channel}$) | MHz | 10 | |
| UTRA RF Channel Number | | 1 | One UTRA FDD carrier frequency is used. |
| Inter-RAT (UTRA FDD) measurement quantity | | CPICH Ec/Io | |
| b1-Threshold-UTRA | dB | -18 | CPICH Ec/Io threshold for event B1. |
| Hysteresis | dB | 0 | |
| Time To Trigger | ms | 0 | |
| Filter coefficient | | 0 | L3 filtering is not used. |
| DRX | | OFF | |
| Monitored UTRA FDD cell list size | | 12 | UTRA cells on UTRA RF channel 1 provided in the cell list. |
| T1 | s | 5 | |
| T2 | s | 6 | |

Table A.8.5.6.1-2: Cell specific test parameters for E-UTRAN FDD (cell # 1) for event triggered reporting of UTRAN FDD cell without measurement gaps under AWGN propagation conditions

| Parameter | Unit | Cell 1 | |
|--|------|-----------|----|
| | | T1 | T2 |
| E-UTRA RF Channel Number | | 1 | |
| $BW_{channel}$ | MHz | 10 | |
| OCNG Pattern defined in A.3.2.1.10 (OP.10 FDD) | | OP.10 FDD | |
| PBCH_RA | dB | 0 | |
| PBCH_RB | dB | | |
| PSS_RA | dB | | |
| SSS_RA | dB | | |
| PCFICH_RB | dB | | |
| PHICH_RA | dB | | |
| PHICH_RB | dB | | |
| PDCCH_RA | dB | | |
| PDCCH_RB | dB | | |
| PDSCH_RA | dB | | |
| PDSCH_RB | dB | | |
| OCNG_RA ^{Note 1} | dB | | |

| | | | |
|---|------------|------|-----|
| OCNG_RB ^{Note 1} | dB | | |
| \hat{E}_s/I_{ot} | dB | 4 | 4 |
| \hat{E}_s/N_{oc} | dB | 4 | 4 |
| N_{oc} | dBm/15 kHz | -98 | |
| RSRP | dBm/15 kHz | -94 | -94 |
| SCH_RP | dBm/15 kHz | -94 | -94 |
| Propagation Condition | | AWGN | |
| Note 1: OCNG shall be used such that both cells are fully allocated and a constant total transmitted power spectral density is achieved for all OFDM symbols. | | | |
| Note 2: The resources for uplink transmission are assigned to the UE prior to the start of time period T2. | | | |

Table A.8.5.6.1-3: Cell specific test parameters for UTRAN FDD (cell # 2) for event triggered reporting of UTRAN FDD cell without measurement gaps under AWGN propagation conditions

| Parameter | Unit | Cell 2 | |
|---|--------------|-----------|------|
| | | T1 | T2 |
| UTRA RF Channel Number | | 1 | |
| CPICH_Ec/I _{or} | dB | -10 | |
| PCCPCH_Ec/I _{or} | dB | -12 | |
| SCH_Ec/I _{or} | dB | -12 | |
| PICH_Ec/I _{or} | dB | -15 | |
| DPCH_Ec/I _{or} | dB | N/A | |
| OCNS | | -0.941 | |
| \hat{I}_{or}/I_{oc} | dB | -Infinity | -1.8 |
| I_{oc} | dBm/3.84 MHz | -70 | |
| CPICH_Ec/I _o | dB | -Infinity | -14 |
| Propagation Condition | | AWGN | |
| Note 1: The DPCH level is controlled by the power control loop. | | | |
| Note 2: The power of the OCNS channel that is added shall make the total power from the cell to be equal to I _{or} | | | |

A.8.5.6.2 Test Requirements

The UE shall send one Event B1 triggered measurement report, with a measurement reporting delay less than 4800 ms from the beginning of time period T2.

The UE shall not send event triggered measurement reports, as long as the reporting criteria are not fulfilled.

The UE shall send continuous ACK/NACK throughout the test, and from the start of T2 until Event B1 is reported, at least 85% ACK/NACK shall be detected.

For a test to be considered successful requirements on both event detection and percentage of transmitted ACK/NACKs have to be fulfilled simultaneously. The rate of correct events observed during repeated tests shall be at least 90%.

NOTE: The actual overall delays measured in the test may be up to $2 \times TTI_{DCCH}$ higher than the measurement reporting delays above because of TTI insertion uncertainty of the measurement report in DCCH.

A.8.5.7 E-UTRAN FDD - UTRAN FDD Event Triggered Reporting under Fading Propagation Conditions for 5 MHz Bandwidth

A.8.5.7.1 Test Purpose and Environment

The purpose of this test is to verify that the UE makes correct reporting of an event. This test will partly verify the E-UTRAN FDD- UTRAN FDD cell search requirements in clause 8.1.2.4.1.

The parameters of this test are the same as defined in Section A.8.5.1.1 except that the values of the parameters in the Table A.8.5.7.1-1 will replace the values of the corresponding parameters in A.8.5.1.1-1, and the values of the parameters in the Table A.8.5.7.1-2 will replace the values of the corresponding parameters in A.8.5.1.1-2.

Table A.8.5.7.1-1: General test parameters for E-UTRAN FDD-UTRAN FDD event triggered reporting in fading propagation conditions

| Parameter | Unit | Value | Comment |
|---|------|---|-----------------------------------|
| PDSCH parameters (E-UTRAN FDD) | | DL Reference Measurement Channel R.5 FDD | As specified in clause A.3.1.1.1. |
| PCFICH/PDCCH/PHICH parameters (E-UTRAN FDD) | | DL Reference Measurement Channel R.11 FDD | As specified in clause A.3.1.2.1. |
| E-UTRA Channel Bandwidth (BW _{channel}) | MHz | 5 | |
| NOTE 1: See Table A.8.5.1.1-1 for the other parameters. | | | |
| NOTE 2: This test is according to the principle defined in Section A.3.7.2. | | | |

Table A.8.5.7.1-2: Cell specific test parameters for E-UTRAN FDD (cell # 1) for event triggered reporting of UTRAN FDD cell under fading propagation conditions

| Parameter | Unit | Cell 1 | |
|---|------|-----------|----|
| | | T1 | T2 |
| BW _{channel} | MHz | 5 | |
| OCNG Pattern defined in A.3.2.1.15 | | OP.15 FDD | |
| NOTE: See Table A.8.1.3.1-2 for the other parameters. | | | |

A.8.5.7.2 Test Requirements

The test requirements defined in Section A.8.5.1 shall apply to this test case.

A.8.5.8 E-UTRA FDD InterRAT UTRA FDD correct reporting of measurement events with reduced performance group configured, non DRX

A.8.5.8.1 Test Purpose and Environment

The purpose of this test is to verify that the UE makes correct reporting of an event. This test will partly verify the E-UTRA FDD-UTRA FDD inter-RAT cell search requirements in clause 8.1.2.4.1.

The test parameters are given in Tables A.8.5.8.1-1 and A.8.5.8.1-2. In this test, there are two cells on different carrier frequencies and gap pattern configuration # 0 as defined in Table 8.1.2.1-1 is provided.

In the measurement control information, it is indicated to the UE that event-triggered reporting with Event B1 is used. The test consists of two successive time periods, with time duration of T1, and T2 respectively. During time duration T1, the UE shall not have any timing information of cell 2, 3 or 4. At the start of each repetition of T1, the test equipment provides signals for cell 1 (serving cell), and cells 2, 3 and 4 which are selected from the 8 cells which are configured in the UE neighbour cell list. Cells 2, 3 and 4 are chosen randomly, such that one frequency belongs to the normal performance group and two frequencies belong to the reduced performance group.

Table A.8.5.8.1-1: General test parameters for E-UTRAN FDD-UTRAN FDD for correct reporting of measurement events with reduced performance group configured, non DRX

| Parameter | Unit | Value | Comment |
|--|------|--|---|
| UE configured E-UTRA RF Channel Number | | 1 | Serving cell and six UTRA FDD carrier frequencies are used in the UE neighbour cell list. Frequencies 5,6 and 7 are indicated to have reduced performance |
| UE is configured UTRA RF channel numbers | | 2, 3, 4, 5, 6, 7 | |
| Test equipment configuration | | Cell 1 uses E-UTRA RF channel number 1 Cells 2,3,4 are randomly selected to use different frequencies selected from UTRA RF channel numbers 2,3,4,5,6,7 | Cells 2, 3 and 4 are chosen randomly, such that one frequency belongs to the normal performance group and two frequencies belong to the reduced performance group |
| PDSCH parameters (E-UTRAN FDD) | | DL Reference Measurement Channel R.0 FDD | As specified in clause A.3.1.1.1. |

| | | | |
|--|----|--|---|
| PCFICH/PDCCH/PHICH parameters (E-UTRAN FDD) | | DL Reference Measurement Channel R.6 FDD | As specified in clause A.3.1.2.1. |
| Correlation Matrix and Antenna Configuration | | 1x2 low | |
| Active cell | | Cell 1 | Cell 1 is on RF channel number 1 |
| Time offset with respect to cell1 | | 0 | |
| Gap Pattern Id | | 0 | As specified in TS 36.133 clause 8.1.2.1. |
| Inter-RAT (UTRA FDD) measurement quantity | | CPICH Ec/Io | |
| b1-Threshold-UTRA | dB | -18 | |
| Hysteresis | dB | 0 | |
| CP length | | Normal | |
| TimeToTrigger | s | 0 | |
| Filter coefficient | | 0 | L3 filtering is not used |
| DRX | | OFF | OFF |
| Scaling factor for reduced performance group | | 16 | |
| T1 | s | 5 | |
| T2 | s | 155 | |

Table A.8.5.8.1-2: Cell specific test parameters for E-UTRAN FDD (cell # 1) for correct reporting of measurement events with reduced performance group configured, non DRX

| Parameter | Unit | Cell 1 | |
|---|------------|---|-----|
| | | T1 | T2 |
| E-UTRA RF Channel Number | | 1 | |
| BW _{channel} | MHz | 5MHz: N _{RB} = 25 10MHz: N _{RB} = 50 | |
| Correlation Matrix and Antenna Configuration | | 1x2 Low | |
| OCNG Pattern defined in A.3.2.1.1 (OP.1 FDD) | | OP.1 FDD | |
| PBCH_RA | dB | 0 | |
| PBCH_RB | dB | | |
| PSS_RA | dB | | |
| SSS_RA | dB | | |
| PCFICH_RB | dB | | |
| PHICH_RA | dB | | |
| PHICH_RB | dB | | |
| PDCCH_RA | dB | | |
| PDCCH_RB | dB | | |
| PDSCH_RA | dB | | |
| PDSCH_RB | dB | | |
| OCNG_RA ^{Note 1} | dB | | |
| OCNG_RB ^{Note 1} | dB | | |
| \hat{E}_s / I_{ot} | dB | | |
| \hat{E}_s / N_{oc} | dB | 4 | 4 |
| N _{oc} | dBm/15 kHz | -98 | |
| RSRP | dBm/15 kHz | -94 | -94 |
| SCH_RP | dBm/15 kHz | -94 | -94 |
| Propagation Condition | | ETU70 | |
| Note 1: OCNG shall be used such that both cells are fully allocated and a constant total transmitted power spectral density is achieved for all OFDM symbols. | | | |
| Note 2: The resources for uplink transmission are assigned to the UE prior to the start of time period T2. | | | |

Table A.8.5.8.1-3: Cell specific test parameters for UTRAN FDD (cell # 2, 3 and 4) for correct reporting of measurement events with reduced performance group configured, non DRX

| Parameter | Unit | Cell 2 | | Cell 3 | | Cell 4 | |
|-----------|------|--------|----|--------|----|--------|----|
| | | T1 | T2 | T1 | T2 | T1 | T2 |

| | | | | | | | |
|------------------------|--------------|---|---|---|------|----------------|------|
| UTRA RF Channel Number | | Cells 2 is randomly selected to use different frequencies selected from UTRA RF channel numbers 2,3,4,5,6,7 | Cells 3 is randomly selected to use different frequencies selected from UTRA RF channel numbers 2,3,4,5,6,7 | Cells 4 is randomly selected to use different frequencies selected from UTRA RF channel numbers 2,3,4,5,6,7 | | | |
| CPICH_Ec/lor | dB | -10 | | | | | |
| PCCPCH_Ec/lor | dB | -12 | | | | | |
| SCH_Ec/lor | dB | -12 | | | | | |
| PICH_Ec/lor | dB | -15 | | | | | |
| DPCH_Ec/lor | dB | N/A | | | | | |
| OCNS | | -0.941 | | | | | |
| \hat{I}_{or}/I_{oc} | dB | - infinit y | -1.8 | - infinit y | -1.8 | - infinit y | -1.8 |
| I_{oc} | dBm/3.84 MHz | -70 | | | | | |
| CPICH_Ec/lo | dB | - infinit y | -14 | - infinit y | -14 | - infinit y | -14 |
| Propagation Conditions | | Case 5 (Note 3) | | | | | |
| Notes | TBD | | | | | | |

A.8.5.8.2 Test Requirements

The UE shall send Event B1 triggered measurement reports for cells 2, 3 and 4, with a measurement reporting delay less than 7.68s (cell 2) and 115,2s (cell 3 and 4) from the beginning of time period T2.

The UE shall not send event triggered measurement reports, as long as the reporting criteria are not fulfilled.

The rate of correct events observed during repeated tests shall be at least 90%.

NOTE: The actual overall delays measured in the test may be up to $2 \times TTI_{DCC}$ higher than the measurement reporting delays above because of TTI insertion uncertainty of the measurement report.

A.8.6 E-UTRAN TDD - UTRAN FDD Measurements

A.8.6.1 E-UTRAN TDD - UTRAN FDD event triggered reporting under fading propagation conditions

A.8.6.1.1 Test Purpose and Environment

The purpose of this test is to verify that the UE makes correct reporting of an event. This test will partly verify the E-UTRAN TDD- UTRAN FDD cell search requirements in clause 8.1.2.4.2.

The test parameters are given in Tables A.8.6.1.1-1, A.8.6.1.1-2 and A.8.6.1.1-3 below. In the measurement control information it is indicated to the UE that event-triggered reporting with Event B1 is used. The test consists of two successive time periods, with time duration of T1, and T2 respectively. During time duration T1, the UE shall not have any timing information of cell 2.

Table A.8.6.1.1-1: General test parameters for E-UTRAN TDD-UTRAN FDD event triggered reporting in fading propagation conditions

| Parameter | Unit | Value | Comment |
|---|------|--|---|
| PDSCH parameters (E-UTRAN TDD) | | DL Reference Measurement Channel R.0 TDD | As specified in clause A.3.1.1.2. |
| PCFICH/PDCCH/PHICH parameters (E-UTRAN TDD) | | DL Reference Measurement Channel R.6 TDD | As specified in clause A.3.1.2.2. |
| Gap Pattern Id | | 1 | As specified in TS 36.133 clause 8.1.2.1. |
| Active cell | | Cell 1 | Cell 1 is on E-UTRA RF channel number 1. |
| Neighbour cell | | Cell 2 | Cell 2 is on UTRA RF channel number 1. |

| | | | |
|---|-----|-------------|---|
| Special subframe configuration | | 6 | As specified in table 4.2-1 in TS 36.211. Applicable to cell 1. |
| Uplink-downlink configuration | | 1 | As specified in table 4.2-2 in TS 36.211. Applicable to cell 1. |
| CP length | | Normal | Applicable to cell 1. |
| E-UTRA RF Channel Number | | 1 | One E-UTRA TDD carrier frequency is used. |
| E-UTRA Channel Bandwidth ($BW_{channel}$) | MHz | 10 | |
| UTRA RF Channel Number | | 1 | One UTRA FDD carrier frequency is used. |
| Inter-RAT (UTRA FDD) measurement quantity | | CPICH Ec/Io | |
| b1-Threshold-UTRA | dB | -18 | CPICH Ec/Io threshold for event B1. |
| Hysteresis | dB | 0 | |
| Time To Trigger | ms | 0 | |
| Filter coefficient | | 0 | L3 filtering is not used. |
| DRX | | OFF | |
| Monitored UTRA cell list size | | 12 | UTRA cells on UTRA RF channel 1 provided in the cell list. |
| T1 | s | 5 | |
| T2 | s | 6 | |

Table A.8.6.1.1-2: Cell specific test parameters for E-UTRAN TDD (cell # 1) for event triggered reporting of UTRAN FDD cell under fading propagation conditions

| Parameter | Unit | Cell 1 | |
|---|------------|----------|-----|
| | | T1 | T2 |
| E-UTRA RF Channel Number | | 1 | |
| $BW_{channel}$ | MHz | 10 | |
| Correlation Matrix and Antenna Configuration | | 1x2 Low | |
| OCNG Pattern defined in A.3.2.2.1 (OP.1 TDD) | | OP.1 TDD | |
| PBCH_RA | dB | 0 | |
| PBCH_RB | dB | | |
| PSS_RA | dB | | |
| SSS_RA | dB | | |
| PCFICH_RB | dB | | |
| PHICH_RA | dB | | |
| PHICH_RB | dB | | |
| PDCCH_RA | dB | | |
| PDCCH_RB | dB | | |
| PDSCH_RA | dB | | |
| PDSCH_RB | dB | | |
| OCNG_RA ^{Note 1} | dB | | |
| OCNG_RB ^{Note 1} | dB | | |
| \hat{E}_s/I_{ot} | dB | | |
| \hat{E}_s/N_{oc} | dB | 4 | 4 |
| N_{oc} | dBm/15 kHz | -98 | |
| RSRP | dBm/15 kHz | -94 | -94 |
| SCH_RP | dBm/15 kHz | -94 | -94 |
| Propagation Condition | | ETU70 | |
| Note 1: OCNG shall be used such that both cells are fully allocated and a constant total transmitted power spectral density is achieved for all OFDM symbols. | | | |
| Note 2: The resources for uplink transmission are assigned to the UE prior to the start of time period T2. | | | |

Table A.8.6.1.1-3: Cell specific test parameters for UTRAN FDD (cell # 2) for event triggered reporting of UTRAN FDD cell under fading propagation conditions

| Parameter | Unit | Cell 2 | |
|------------------------|------|--------|----|
| | | T1 | T2 |
| UTRA RF Channel Number | | 1 | |
| CPICH_Ec/Ior | dB | -10 | |
| PCCPCH_Ec/Ior | dB | -12 | |

| | | | |
|---|--------------|-----------------|------|
| SCH_Ec/I _{or} | dB | -12 | |
| PICH_Ec/I _{or} | dB | -15 | |
| DPCH_Ec/I _{or} | dB | N/A | |
| OCNS | | -0.941 | |
| \hat{I}_{or}/I_{oc} | dB | -Infinity | -1.8 |
| I_{oc} | dBm/3.84 MHz | -70 | |
| CPICH_Ec/I _o | dB | -Infinity | -14 |
| Propagation Condition | | Case 5 (Note 3) | |
| Note 1: The DPCH level is controlled by the power control loop. | | | |
| Note 2: The power of the OCNS channel that is added shall make the total power from the cell to be equal to I _{or} . | | | |
| Note 3: Case 5 propagation conditions are defined in Annex A of TS 25.101. | | | |

A.8.6.1.2 Test Requirements

The UE shall send one Event B1 triggered measurement report, with a measurement reporting delay less than 4800 ms from the beginning of time period T2.

The UE shall not send event triggered measurement reports, as long as the reporting criteria are not fulfilled.

The rate of correct events observed during repeated tests shall be at least 90%.

NOTE: The actual overall delays measured in the test may be up to $2 \times TTI_{DCCH}$ higher than the measurement reporting delays above because of TTI insertion uncertainty of the measurement report in DCCH.

A.8.6.2 E- UTRAN TDD - UTRAN FDD identification of a new CGI of UTRAN cell using autonomous gaps

A.8.6.2.1 Test Purpose and Environment

This test is to verify the requirement for identification of a new CGI of UTRA cell with autonomous gaps in clause 8.1.2.4.18.

The test parameters are given in Tables A.8.6.2.1-1, A.8.6.2.1-2 and A.8.6.2.1-3 below. The test consists of three successive time periods, with time durations of T1, T2 and T3 respectively. At the start of time duration T1, the UE does not have any timing information of cell 2. Starting T2, cell 2 becomes detectable and the UE is expected to detect and send a measurement report. Gap pattern configuration with id #0 as specified in Table 8.1.2.1-1 is configured before T2 begins to enable inter-frequency monitoring.

A RRC message implying SI reading shall be sent to the UE during period T2, after the UE has reported Event B1. The RRC message shall create a measurement report configuration with purpose *reportCGI* and *si-RequestForHO* set to TRUE. The start of T3 is the instant when the last TTI containing the RRC message implying SI reading is sent to the UE.

Table A.8.6.2.1-1: General test parameters for E-UTRAN TDD - UTRAN FDD identification of a new CGI of UTRAN cell using autonomous gaps

| Parameter | Unit | Value | Comment |
|---|------|--|---|
| PDSCH parameters (E-UTRAN TDD) | | DL Reference Measurement Channel R.0 TDD | As specified in clause A.3.1.1.2. |
| PCFICH/PDCCH/PHICH parameters (E-UTRAN TDD) | | DL Reference Measurement Channel R.6 TDD | As specified in clause A.3.1.2.2. |
| Gap Pattern Id | | 0 | As specified in TS 36.133 clause 8.1.2.1. |
| Active cell | | Cell 1 | Cell 1 is on E-UTRA RF channel number 1. |
| Neighbour cell | | Cell 2 | Cell 2 is on UTRA RF channel number 1. |
| Special subframe configuration | | 6 | As specified in table 4.2-1 in TS 36.211. Applicable to cell 1. |
| Uplink-downlink configuration | | 1 | As specified in table 4.2-2 in TS 36.211. Applicable to cell 1. |
| CP length | | Normal | Applicable to cell 1. |
| E-UTRA RF Channel Number | | 1 | One E-UTRA TDD carrier frequency is used. |
| E-UTRA Channel Bandwidth (BW _{channel}) | MHz | 10 | |
| UTRA RF Channel Number | | 1 | One UTRA FDD carrier frequency is used. |

| | | | |
|---|--------|----------------------------|--|
| Inter-RAT (UTRA FDD) measurement quantity | | CPICH Ec/Io | |
| b1-Threshold-UTRA | dB | -18 | CPICH Ec/Io threshold for event B1. |
| Hysteresis | dB | 0 | |
| Time To Trigger | ms | 0 | |
| Filter coefficient | | 0 | L3 filtering is not used. |
| DRX | | OFF | |
| SIB3_REP | Frames | 32 | Applicable for cell 2 SIB3 scheduling. |
| SIB3_SEG_COUNT | | 1 | Applicable for cell 2 SIB3 scheduling. |
| si-RequestForHO | | TRUE | As specified in clause 5.5.3.1 in TS 36.331. |
| Monitored UTRA FDD cell list size | | 12 | UTRA cells on UTRA RF channel 1 provided in the cell list. |
| CSG id (of cell 2) | | Set to any non-empty value | |
| T1 | s | 5 | |
| T2 | s | ≤10 | |
| T3 | s | 5 | |

Table A.8.6.2.1-2: Cell specific test parameters for cell #1 E-UTRAN TDD - UTRAN FDD identification of a new CGI of UTRAN cell using autonomous gaps

| Parameter | Unit | Cell 1 | |
|---|------------|----------|-----|
| | | T1 | T2 |
| E-UTRA RF Channel Number | | 1 | |
| BW _{channel} | MHz | 10 | |
| OCNG Pattern defined in A.3.2.2.1 (OP.1 TDD) | | OP.1 TDD | |
| PBCH_RA | dB | 0 | |
| PBCH_RB | dB | | |
| PSS_RA | dB | | |
| SSS_RA | dB | | |
| PCFICH_RB | dB | | |
| PHICH_RA | dB | | |
| PHICH_RB | dB | | |
| PDCCH_RA | dB | | |
| PDCCH_RB | dB | | |
| PDSCH_RA | dB | | |
| PDSCH_RB | dB | | |
| OCNG_RA ^{Note 1} | dB | 4 | |
| OCNG_RB ^{Note 1} | dB | | |
| \hat{E}_s / I_{ot} | dB | 4 | 4 |
| N_{oc} ^{Note 3} | dBm/15 kHz | -98 | |
| \hat{E}_s / N_{oc} | dB | 4 | 4 |
| RSRP ^{Note 4} | dBm/15 kHz | -94 | -94 |
| SCH_RP | dBm/15 kHz | -94 | -94 |
| Propagation Condition | | AWGN | |
| <p>Note 1: OCNG shall be used such that both cells are fully allocated and a constant total transmitted power spectral density is achieved for all OFDM symbols.</p> <p>Note 2: The resources for uplink transmission are assigned to the UE prior to the start of time period T2.</p> <p>Note 3: Interference from other cells and noise sources not specified in the test is assumed to be constant over subcarriers and time and shall be modelled as AWGN of appropriate power for N_{oc} to be fulfilled.</p> <p>Note 4: RSRP levels have been derived from other parameters for information purposes. They are not settable parameters themselves.</p> | | | |

Table A.8.6.2.1-3: Cell specific test parameters for cell #2 E-UTRAN TDD - UTRAN FDD identification of a new CGI of UTRAN cell using autonomous gaps

| Parameter | Unit | Cell 2 | |
|------------------------|------|--------|----|
| | | T1 | T2 |
| UTRA RF Channel Number | | 1 | |
| CPICH_Ec/Ior | dB | -10 | |
| PCCPCH_Ec/Ior | dB | -12 | |

| | | | |
|---|--------------|-----------|------|
| SCH_Ec/I _{or} | dB | -12 | |
| PICH_Ec/I _{or} | dB | -15 | |
| DPCH_Ec/I _{or} | dB | N/A | |
| OCNS | | -0.941 | |
| \hat{I}_{or}/I_{oc} | dB | $-\infty$ | 0.02 |
| I_{oc} | dBm/3.84 MHz | -70 | |
| CPICH_Ec/I _o ^{Note 3} | dB | $-\infty$ | -13 |
| Propagation Condition | | AWGN | |
| Note 1: The DPCH level is controlled by the power control loop. | | | |
| Note 2: The power of the OCNS channel that is added shall make the total power from the cell to be equal to I _{or} . | | | |
| Note 3: This gives an SCH Ec/I _o of -15dB | | | |

A.8.6.2.2 Test Requirements

The UE shall transmit a measurement report containing the cell global identifier of cell 2 within [1965] milliseconds from the start of T3.

Test requirement = RRC Procedure delay + T_{identify_CGI, UTRAN FDD} + reporting delay

= 50 + [630]+40*32 + 2ms from the start of T3

= [1962] ms, allow [1965] ms.

The rate of correct events observed during repeated tests shall be at least 90%.

A.8.6.3 E-UTRA TDD InterRAT UTRA FDD correct reporting of measurement events with reduced performance group configured, non DRX

A.8.6.3.1 Test Purpose and Environment

The purpose of this test is to verify that the UE makes correct reporting of an event. This test will partly verify the E-UTRA TDD-UTRA FDD inter-RAT cell search requirements in clause 8.1.2.4.2.

The test parameters are given in Tables A.8.6.3.1-1 and A.8.6.3.1-2. In this test, there are two cells on different carrier frequencies and gap pattern configuration # 0 as defined in Table 8.1.2.1-1 is provided.

In the measurement control information, it is indicated to the UE that event-triggered reporting with Event B1 is used. The test consists of two successive time periods, with time duration of T1, and T2 respectively. During time duration T1, the UE shall not have any timing information of cell 2, 3 or 4. At the start of each repetition of T1, the test equipment provides signals for cell 1 (serving cell), and cells 2, 3 and 4 which are selected from the 8 cells which are configured in the UE neighbour cell list. Cells 2, 3 and 4 are chosen randomly, such that one frequency belongs to the normal performance group and two frequencies belong to the reduced performance group.

Table A.8.6.3.1-1: General test parameters for E-UTRAN TDD-UTRAN FDD for correct reporting of measurement events with reduced performance group configured, non DRX

| Parameter | Unit | Value | Comment |
|--|------|--|---|
| UE configured E-UTRA RF Channel Number | | 1 | Serving cell and seven UTRA FDD carrier frequencies are used in the UE neighbour cell list. Frequencies 5,6 and 7 are indicated to have reduced performance |
| UE is configured UTRA RF channel numbers | | 2, 3, 4, 5, 6, 7,8 | |
| Test equipment configuration | | Cell 1 uses E-UTRA RF channel number 1 Cells 2,3,4 are randomly selected to use different frequencies selected from UTRA RF channel numbers 2,3,4,5,6,7,8 | Cells 2, 3 and 4 are chosen randomly, such that one frequency belongs to the normal performance group and two frequencies belong to the reduced performance group |
| PDSCH parameters (E-UTRAN TDD) | | DL Reference Measurement Channel R.0 TDD | As specified in clause A.3.1.1.2. |

| | | | |
|--|----|--|--|
| PCFICH/PDCCH/PHICH parameters (E-UTRAN TDD) | | DL Reference Measurement Channel R.6 TDD | As specified in clause A.3.1.2.2 |
| Correlation Matrix and Antenna Configuration | | 1x2 low | |
| Special subframe configuration | | 6 | As specified in table 4.2-1 in TS 36.211. Applicable to cell 1 |
| Uplink-downlink configuration | | 1 | As specified in table 4.2-2 in TS 36.211. Applicable to cell 1 |
| Active cell | | Cell 1 | Cell 1 is on RF channel number 1 |
| Gap Pattern Id | | 0 | As specified in TS 36.133 clause 8.1.2.1. |
| Inter-RAT (UTRA FDD) measurement quantity | | CPICH Ec/Io | |
| b1-Threshold-UTRA | dB | -18 | CPICH Ec/Io threshold for event B1 |
| Hysteresis | dB | 0 | |
| CP length | | Normal | |
| TimeToTrigger | s | 0 | |
| Filter coefficient | | 0 | L3 filtering is not used |
| DRX | | OFF | OFF |
| Scaling factor for reduced performance group | | 16 | |
| T1 | s | 5 | |
| T2 | s | 155 | |

Table A.8.6.3.1-2: Cell specific test parameters for E-UTRAN TDD (cell # 1) for correct reporting of measurement events with reduced performance group configured, non DRX

| Parameter | Unit | Cell 1 | |
|---|------------|----------|-----|
| | | T1 | T2 |
| E-UTRA RF Channel Number | | 1 | |
| BW _{channel} | MHz | 10 | |
| Correlation Matrix and Antenna Configuration | | 1x2 Low | |
| OCNG Pattern defined in A.3.2.1.1 (OP.1 FDD) | | OP.1 FDD | |
| PBCH_RA | dB | 0 | |
| PBCH_RB | dB | | |
| PSS_RA | dB | | |
| SSS_RA | dB | | |
| PCFICH_RB | dB | | |
| PHICH_RA | dB | | |
| PHICH_RB | dB | | |
| PDCCH_RA | dB | | |
| PDCCH_RB | dB | | |
| PDSCH_RA | dB | | |
| PDSCH_RB | dB | | |
| OCNG_RA ^{Note 1} | dB | | |
| OCNG_RB ^{Note 1} | dB | | |
| \hat{E}_s / I_{ot} | dB | 4 | 4 |
| \hat{E}_s / N_{oc} | dB | 4 | 4 |
| N_{oc} | dBm/15 kHz | -98 | |
| RSRP | dBm/15 kHz | -94 | -94 |
| SCH_RP | dBm/15 kHz | -94 | -94 |
| Propagation Condition | | ETU70 | |
| Note 1: OCNG shall be used such that both cells are fully allocated and a constant total transmitted power spectral density is achieved for all OFDM symbols. Note 2: The resources for uplink transmission are assigned to the UE prior to the start of time period T2. | | | |

Table A.8.6.3.1-3: Cell specific test parameters for UTRAN FDD (cell # 2, 3 and 4) for correct reporting of measurement events with reduced performance group configured, non DRX

| Parameter | Unit | Cell 2 | Cell 3 | Cell 4 |
|-----------|------|--------|--------|--------|
|-----------|------|--------|--------|--------|

| | | T1 | T2 | T1 | T2 | T1 | T2 |
|------------------------|-----------------|---|------|---|------|---|------|
| UTRA RF Channel Number | | Cells 2 is randomly selected to use different frequencies selected from UTRA RF channel numbers 2,3,4,5,6,7 | | Cells 3 is randomly selected to use different frequencies selected from UTRA RF channel numbers 2,3,4,5,6,7 | | Cells 4 is randomly selected to use different frequencies selected from UTRA RF channel numbers 2,3,4,5,6,7 | |
| CPICH_Ec/lor | dB | -10 | | | | | |
| PCCPCH_Ec/lor | dB | -12 | | | | | |
| SCH_Ec/lor | dB | -12 | | | | | |
| PICH_Ec/lor | dB | -15 | | | | | |
| DPCH_Ec/lor | dB | N/A | | | | | |
| OCNS | | -0.941 | | | | | |
| \hat{I}_{or}/I_{oc} | dB | - infini y | -1.8 | - infini y | -1.8 | - infini y | -1.8 |
| I_{oc} | dBm/3.84 MHz | -70 | | | | | |
| CPICH_Ec/lo | dB | - infini y | -14 | - infini y | -14 | - infini y | -14 |
| Propagation Conditions | | Case 5 (Note 3) | | | | | |
| Notes TBD | | | | | | | |

A.8.6.3.2 Test Requirements

The UE shall send Event B1 triggered measurement reports for cells 2, 3 and 4, with a measurement reporting delay less than 7.68s (cell 2) and 115,2s (cell 3 and 4) from the beginning of time period T2.

The UE shall not send event triggered measurement reports, as long as the reporting criteria are not fulfilled.

The rate of correct events observed during repeated tests shall be at least 90%.

NOTE: The actual overall delays measured in the test may be up to $2 \times TTI_{DCC}$ higher than the measurement reporting delays above because of TTI insertion uncertainty of the measurement report.

A.8.7 E-UTRAN TDD – UTRAN TDD Measurements

A.8.7.1 E-UTRAN TDD to UTRAN TDD cell search under fading propagation conditions

A.8.7.1.1 Test Purpose and Environment

A.8.7.1.1.1 Void

A.8.7.1.1.2 1.28 Mcps TDD option

The purpose of this test is to verify that the UE makes correct reporting of an event. This test will partly verify the E-UTRA TDD to UTRA TDD cell search requirements in clause 8.1.2.4.3 under fading propagation conditions.

This test scenario comprised of 1 E-UTRA TDD PCell, and 1 UTRA TDD cell to be searched. Test parameters are given in Table A.8.7.1.1.2-1, A.8.7.1.1.2-2, and A.8.7.1.1.2-3. Gap pattern configuration #0 as defined in table 8.1.2.1-1 is provided.

In the measurement control information, it is indicated to the UE that event-triggered reporting with Event B1 is used. The test consists of two successive time periods, with time duration of T1 and T2 respectively. During time duration T1, the UE shall not have any timing information of cell 2.

Table A.8.7.1.1.2-1: General test parameters for E-UTRA TDD to UTRA(1.28 Mcps TDD OPTION) cell search in fading propagation conditions

| Parameter | Unit | Value | Comment |
|--|------|--|---|
| PDSCH parameters | | DL Reference Measurement Channel R.0 TDD | As specified in clause A.3.1.1.2 |
| PCFICH/PDCCH/PHICH parameters | | DL Reference Measurement Channel R.6 TDD | As specified in clause A.3.1.2.2 |
| Active cell | | Cell 1 | E-UTRA TDD cell |
| Neighbour cell | | Cell 2 | UTRA 1.28Mcps TDD Cell |
| Gap Pattern Id | | 0 | As specified in TS 36.133 clause 8.1.2.1. |
| Uplink-downlink configuration of cell 1 | | 1 | As specified in table 4.2.2 in TS 36.211 |
| Special subframe configuration of cell 1 | | 6 | As specified in table 4.2.1 in TS 36.211 |
| CP length of cell 1 | | normal | |
| Hysteresis | dB | 0 | |
| TimeToTrigger | s | 0 | |
| Filter coefficient | | 0 | L3 filtering is not used |
| DRX | | OFF | |
| Time offset between cells | | 3 ms | Asynchronous cells |
| Ofn | dB | 0 | |
| Thresh | dBm | -87 | |
| T1 | s | 5 | |
| T2 | s | 10 | |

Table A.8.7.1.1.2-2: Cell specific test parameters for cell search E-UTRA TDD to UTRA TDD test case (cell 1)

| Parameter | Unit | Cell 1 | |
|---|-----------|----------|-----|
| | | T1 | T2 |
| E-UTRA RF Channel Number | | 1 | |
| BW _{channel} | MHz | 10 | |
| Correlation Matrix and Antenna Configuration | | 1x2 Low | |
| OCNG Pattern defined in A.3.2.2.1 (OP.1 TDD) | | OP.1 TDD | |
| PBCH_RA | dB | 0 | 0 |
| PBCH_RB | dB | | |
| PSS_RA | dB | | |
| SSS_RA | dB | | |
| PCFICH_RB | dB | | |
| PHICH_RA | dB | | |
| PHICH_RB | dB | | |
| PDCCH_RA | dB | | |
| PDCCH_RB | dB | | |
| PDSCH_RA | dB | | |
| PDSCH_RB | dB | | |
| OCNG_RA ^{Note1} | dB | | |
| OCNG_RB ^{Note1} | dB | | |
| \hat{E}_s / I_{ot} | dB | | |
| \hat{E}_s / N_{oc} | dB | 9 | 9 |
| N_{oc} | dBm/15kHz | -98 | |
| RSRP | dBm/15kHz | -89 | -89 |
| SCH_RP | dBm/15kHz | -89 | -89 |
| Propagation Condition | | ETU70 | |
| <p>Note 1: OCNG shall be used such that cell is fully allocated and a constant total transmitted power spectral density is achieved for all OFDM symbols.</p> <p>Note 2: The resources for uplink transmission are assigned to the UE prior to the start of time period T2.</p> | | | |

Table A.8.7.1.1.2-3: Cell specific test parameters for cell search E-UTRA TDD to UTRA TDD test case (cell 2)

| Parameter | Unit | Cell 2 (UTRA) | | | |
|---|--------------|-------------------------|-----|-------|------|
| | | 0 | | DwPTS | |
| Timeslot Number | | T1 | T2 | T1 | T2 |
| UTRA RF Channel Number ^{NOTE1} | | Channel 2 | | | |
| PCCPCH_Ec/I _{or} | dB | -3 | -3 | | |
| DwPCH_Ec/I _{or} | dB | | | 0 | 0 |
| OCNS_Ec/I _{or} ^{NOTE2} | dB | -3 | -3 | | |
| \hat{I}_{or}/I_{oc} | dB | -inf | 5 | -inf | 5 |
| I_{oc} | dBm/1.28 MHz | -80 | | | |
| PCCPCH RSCP | dBm | -inf | -78 | n.a. | n.a. |
| Propagation Condition | | Case 3 ^{NOTE3} | | | |
| <p>Note 1: In the case of multi-frequency cell, the UTRA RF Channel Number is the primary frequency's channel number.</p> <p>Note 2: The power of the OCNS channel that is added shall make the total power from the cell to be equal to I_{or}.</p> <p>Note 3: Case 3 propagation conditions are defined in Annex B of TS 25.102</p> | | | | | |

A.8.7.1.1.3 Void

A.8.7.1.2 Test Requirements

A.8.7.1.2.1 Void

A.8.7.1.2.2 1.28 Mcps TDD option

The UE shall send one Event B1 triggered measurement report, with a measurement reporting delay less than 6400 ms from the beginning of time period T2.

The UE shall not send event triggered measurement reports, as long as the reporting criteria are not fulfilled.

The rate of correct events observed during repeated tests shall be at least 90%.

NOTE: The actual overall delays measured in the test may be up to $2 \times TTI_{DCCH}$ higher than the measurement reporting delays above because of TTI insertion uncertainty of the measurement report in DCCH.

A.8.7.1.2.3 Void

A.8.7.2 E-UTRAN TDD-UTRAN TDD cell search when DRX is used under fading propagation conditions

A.8.7.2.1 Test Purpose and Environment

The purpose of these tests is to verify that the UE makes correct reporting of an event in DRX. These tests will partly verify the E-UTRAN TDD to UTRAN TDD inter-RAT cell search requirements when DRX is used in clause 8.1.2.4.3.2 under fading propagation conditions.

The common test parameters are given in Tables A.8.7.2.1-1, A.8.7.2.1-2 and A.8.7.2.1-3. DRX configuration for Test1 and Test2 are given in Table A.8.7.2.1-4 and time alignment timer and scheduling request related parameters in Table A.8.7.2.1-5. In these tests, there are two cells, 1 E-UTRAN TDD PCell and 1 UTRAN TDD cell to be searched, Gap pattern configuration # 0 as defined in table 8.1.2.1-1 is provided.

In Test 1 UE needs to be provided at least once every 500ms with new Timing Advance Command MAC control element to restart the Time alignment timer to keep UE uplink time alignmend. Furhtermore UE is allocated with PUSCH resource at every DRX cycle. In Test 2 the uplink time alignment is not maintained and UE needs to use RACH to obtain UL allocation for measurement reporting.

In the measurement control information, it is indicated to the UE that event-triggered reporting with Event B1 is used. The tests consist of two successive time periods, with time duration of T1, and T2 respectively. During time duration T1, the UE shall not have any timing information of cell 2.

Table A.8.7.2.1-1: General test parameters for E-UTRAN TDD to UTRAN 1.28Mcps TDD cell search when DRX is used in fading propagation conditions

| Parameter | Unit | Test 1 | Test 2 | Comment |
|--------------------------------|------|--|--------|---|
| | | Value | | |
| PDSCH parameters | | DL Reference Measurement Channel R.0 TDD | | As specified in clause A.3.1.1.2. Note that UE may only be allocated at On Duration |
| PCFICH/PDCCH/PHICH parameters | | DL Reference Measurement Channel R.6 TDD | | As specified in clause A.3.1.2.2. |
| Active cell | | Cell 1 | | E-UTRAN TDD cell |
| Neighbour cell | | Cell 2 | | UTRAN 1.28Mcps TDD cell |
| Gap Pattern Id | | 0 | | As specified in TS 36.133 clause 8.1.2.1. |
| Uplink-downlink configuration | | 1 | | As specified in TS 36.211 clause 4.2 Table 4.2-2 |
| Special subframe configuration | | 6 | | As specified in table 4.2-1 in TS 36.211. The same configuration in both cells |
| PRACH configuration | | 4 | | As specified in table 5.7.1-3 in TS 36.211 |
| CP length of cell 1 | | Normal | | |
| Ofn | dB | 0 | | |
| Thresh | dBm | -83 | | Absolute P-CCPCH RSCP threshold for event B1 |
| Hysteresis | dB | 0 | | |
| TimeToTrigger | s | 0 | | |
| Filter coefficient | | 0 | | L3 filtering is not used |
| Access Barring Information | - | Not Sent | | No additional delays in random access procedure. |
| DRX | | ON | | DRX related parameters are defined in Table A.8.4.2.1-3 |
| Time offset between cells | | 3 ms | | Asynchronous cells |
| T1 | s | 5 | | |
| T2 | s | 8 | 30 | |

Table A.8.7.2.1-2: Cell specific test parameters for E-UTRAN TDD to UTRAN 1.28Mcps TDD cell search when DRX is used in fading propagation conditions(cell 1)

| Parameter | Unit | Cell 1 | |
|---|-----------|----------|-----|
| | | T1 | T2 |
| E-UTRA RF Channel Number | | 1 | |
| BWchannel | MHz | 10 | |
| Correlation Matrix and Antenna Configuration | | 1x2 Low | |
| OCNG Patterns defined in A.3.2.2.1 (OP.1 TDD) | | OP.1 TDD | |
| PBCH_RA | dB | 0 | 0 |
| PBCH_RB | dB | | |
| PSS_RA | dB | | |
| SSS_RA | dB | | |
| PCFICH_RB | dB | | |
| PHICH_RA | dB | | |
| PHICH_RB | dB | | |
| PDCCH_RA | dB | | |
| PDCCH_RB | dB | | |
| PDSCH_RA | dB | | |
| PDSCH_RB | dB | | |
| OCNG_RANote1 | dB | | |
| OCNG_RBNote1 | dB | | |
| \hat{E}_s / I_{ot} | dB | | |
| \hat{E}_s / N_{oc} | dB | 4 | 4 |
| N_{oc} Note 2 | dBm/15kHz | -98 | |
| RSRP Note 3 | dBm/15kHz | -94 | -94 |

| | | | |
|--------------------------|--|-----|-----|
| SCH_RP ^{Note 3} | dBm/15kHz | -94 | -94 |
| Propagation Condition | ETU70 | | |
| Note 1: | OCNG shall be used such that cell is fully allocated and a constant total transmitted power spectral density is achieved for all OFDM symbols. | | |
| Note 2: | Interference from other cells and noise sources not specified in the test is assumed to be constant over subcarriers and time and shall be modelled as AWGN of appropriate power for N_{oc} to be fulfilled. | | |
| Note 3: | RSRP and SCH_RP levels have been derived from other parameters for information purposes. They are not settable parameters themselves. | | |

Table A.8.7.2.1-3: Cell specific test parameters for E-UTRAN TDD to UTRAN 1.28Mcps TDD cell search when DRX is used in fading propagation conditions(cell 2)

| Parameter | Unit | Cell 2 (UTRA) | | | |
|------------------------------|--|-------------------------|-----|-------|------|
| | | 0 | | DwPTS | |
| Timeslot Number | | T1 | T2 | T1 | T2 |
| UTRA RF Channel Number NOTE1 | | Channel 2 | | | |
| PCCPCH_Ec/lor | dB | -3 | -3 | | |
| DwPCH_Ec/lor | dB | | | 0 | 0 |
| OCNS_Ec/lor ^{NOTE2} | dB | -3 | -3 | | |
| \hat{I}_{or}/I_{oc} | dB | -inf | 9 | -inf | 9 |
| I_{oc} | dBm/1.28 MHz | -80 | | | |
| PCCPCH RSCP | dBm | -inf | -74 | n.a. | n.a. |
| Propagation Condition | | Case 3 ^{NOTE3} | | | |
| Note 1: | In the case of multi-frequency cell, the UTRA RF Channel Number is the primary frequency's channel number. | | | | |
| Note 2: | The power of the OCNS channel that is added shall make the total power from the cell to be equal to lor. | | | | |
| Note 3: | Case 3 propagation conditions are defined in Annex B of TS 25.102 | | | | |

Table A.8.7.2.1-4: drx-Configuration to be used in E-UTRAN TDD to UTRAN 1.28Mcps TDD cell search when DRX is used in fading propagation conditions

| Field | Test1 | Test2 | Comment |
|--------------------------|---------|---------|---------|
| | Value | Value | |
| onDurationTimer | psf1 | psf1 | |
| drx-InactivityTimer | psf1 | psf1 | |
| drx-RetransmissionTimer | psf1 | psf1 | |
| longDRX-CycleStartOffset | sf40 | sf1280 | |
| shortDRX | disable | disable | |

Table A.8.7.2.1-5: TimeAlignmentTimer and sr-ConfigIndex -Configuration to be used in E-UTRAN TDD to UTRAN 1.28Mcps TDD cell search when DRX is used in fading propagation conditions

| Field | Test1 | Test2 | Comment |
|--------------------|-------|-------|--|
| | Value | Value | |
| TimeAlignmentTimer | sf500 | sf500 | For further information see clause 6.3.2 in TS 36.331. |
| sr-ConfigIndex | 2 | 2 | For further information see clause 6.3.2 in TS 36.331 and 10.1 in TS 36.213. |

A.8.7.2.2 Test Requirements

In Test1 the UE shall send one Event B1 triggered measurement report, with a measurement reporting delay less than 6400ms from the beginning of time period T2. The measurement reporting delay is defined as the time from the beginning of time period T2, to the moment when the UE send the measurement report on PUSCH.

In Test2 the UE shall send one Event B1 triggered measurement report, with a measurement reporting delay less than 25.6s from the beginning of time period T2. The measurement reporting delay is defined as the time from the beginning of time period T2, to the moment when the UE starts to send preambles on the PRACH for scheduling request (SR) to obtain allocation to send the measurement report on PUSCH.

The UE shall not send event triggered measurement reports, as long as the reporting criteria are not fulfilled.

The rate of correct events observed during repeated tests shall be at least 90%.

NOTE 1: The actual overall delays measured in the test may be up to one DRX cycle higher than the measurement reporting delays above because UE is allowed to delay the initiation of the measurement reporting procedure to the next until the Active Time.

NOTE 2: In order to calculate the rate of correct events the system simulator shall verify that it has received correct Event B1 measurement report

A.8.7.3 E-UTRAN TDD - UTRAN TDD SON ANR cell search reporting in AWGN propagation conditions

A.8.7.3.1 Test Purpose and Environment

The purpose of this test is to verify that the UE makes correct reporting of the strongest UTRAN TDD cell for SON automatic neighbour relations. This test will partly verify the E-UTRAN TDD - UTRAN TDD cell search requirements for identification of a new UTRA TDD cell for SON given in clause 8.1.2.4.13.

In the measurement control information it is indicated to the UE that periodical reporting with the purpose 'reportStrongestCellsForSON' is used. The test consists of two successive time periods, with time duration of T1, and T2 respectively. Prior to the start of time period T1, an interRATperiodic measurement reporting configuration with purpose reportStrongestCellsForSON is configured, and linked to a UTRA measurement object corresponding to channel UARFCN 1. During time duration T1, the UE shall not have any timing information of cell 2.

A.8.7.3.2 Test Parameters

The test parameters are given in Tables A.8.7.3.1-1, A.8.7.3.1-2 and A.8.7.3.1-3.

Table A.8.7.3.1-1: General test parameters for E-UTRAN TDD-UTRAN TDD cell search reporting for SON ANR in AWGN propagation conditions

| Parameter | Unit | Value | Comment |
|---|------|--|---|
| PDSCH parameters (E-UTRAN TDD) | | DL Reference Measurement Channel R.0 TDD | As specified in clause A.3.1.1.2 |
| PCFICH/PDCCH/PHICH parameters (E-UTRAN TDD) | | DL Reference Measurement Channel R.6 TDD | As specified in clause A.3.1.2.2 |
| Gap Pattern Id | | 1 | As specified in TS 36.133 clause 8.1.2.1. |
| Active cell | | Cell 1 | Cell 1 is on E-UTRA RF channel number 1. |
| Neighbour cell | | Cell 2 | Cell 2 is on UTRA RF channel number 1. |
| CP length | | Normal | Applicable to cell 1 |
| E-UTRA RF Channel Number | | 1 | One E-UTRA TDD carrier frequency is used. |
| UTRA RF Channel Number | | 1 | One UTRA TDD carrier frequency is used. |
| E-UTRA Channel Bandwidth (BW _{channel}) | MHz | 10 | |
| Uplink-downlink configuration of cell 1 | | 1 | As specified in table 4.2.2 in TS 36.211 |
| Special subframe configuration of cell 1 | | 6 | As specified in table 4.2.1 in TS 36.211 |
| Inter-RAT (UTRA TDD) measurement quantity | | P-CCPCH RSCP | |
| Filter coefficient | | 0 | L3 filtering is not used. |
| DRX | | OFF | |

| | | | |
|-----------------------------------|---|------|---|
| Monitored UTRA TDD cell list size | | None | No explicit neighbour list is provided to the UE |
| T1 | s | >5 | During T1, cell 2 shall be powered off, and during the off time the primary scrambling code shall be changed, The intention is to ensure that cell 2 has not been detected by the UE prior to the start of period T2. |
| T2 | s | 14 | |

Table A.8.7.3.1-2: Cell specific test parameters for E-UTRAN TDD (cell # 1) for UTRAN TDD cell search for SON ANR under AWGN propagation conditions

| Parameter | Unit | Cell 1 | |
|---|------------|----------|-----|
| | | T1 | T2 |
| E-UTRA RF Channel Number | | 1 | |
| BW _{channel} | MHz | 10 | |
| OCNG Patterns defined in A.3.2.2.1 (OP.1 TDD) | | OP.1 TDD | |
| PBCH_RA | dB | 0 | |
| PBCH_RB | dB | | |
| PSS_RA | dB | | |
| SSS_RA | dB | | |
| PCFICH_RB | dB | | |
| PHICH_RA | dB | | |
| PHICH_RB | dB | | |
| PDCCH_RA | dB | | |
| PDCCH_RB | dB | | |
| PDSCH_RA | dB | | |
| PDSCH_RB | dB | | |
| OCNG_RA ^{Note 1} | dB | | |
| OCNG_RB ^{Note 1} | dB | | |
| \hat{E}_s/I_{ot} | dB | | |
| N_{oc} ^{Note 3} | dBm/15 kHz | -98 | |
| \hat{E}_s/N_{oc} | dB | 4 | 4 |
| RSRP ^{Note 4} | dBm/15 kHz | -94 | -94 |
| SCH_RP | dBm/15 kHz | -94 | -94 |
| Propagation Condition | | AWGN | |
| <p>Note 1: OCNG shall be used such that both cells are fully allocated and a constant total transmitted power spectral density is achieved for all OFDM symbols.</p> <p>Note 2: The resources for uplink transmission are assigned to the UE prior to the start of time period T2.</p> <p>Note 3: Interference from other cells and noise sources not specified in the test is assumed to be constant over subcarriers and time and shall be modelled as AWGN of appropriate power for N_{oc} to be fulfilled.</p> <p>Note 4: RSRP levels have been derived from other parameters for information purposes. They are not settable parameters themselves.</p> | | | |

Table A.8.7.3.1-3: Cell specific test parameters for UTRAN TDD (cell # 2) for UTRAN TDD cell search for SON ANR under AWGN propagation conditions

| Parameter | Unit | Cell 2 | | | |
|---|-------------|-----------|-------|--------|-------|
| | | T1 | | T2 | |
| UTRA RF Channel number ^{Note2} | | Channel 2 | | | |
| DL timeslot number | | 0 | DwPTS | 0 | DwPTS |
| PCCPCH_Ec/lor | dB | -3 | | -3 | |
| DwPCH_Ec/lor | dB | | 0 | | 0 |
| OCNS_Ec/lor | dB | -3 | | -3 | |
| I _{or} /I _{oc} | dB | -Infinity | | 5 | |
| PCCPCH RSCP ^{Note1} | dBm | -Infinity | n.a. | -73 | n.a. |
| I _o ^{Note1} | dBm/1.28MHz | -Infinity | | -70.88 | |
| I _{oc} | dBm/1.28MHz | -75 | | | |
| Propagation condition | | AWGN | | | |

Note 1: PCCPCH RSCP and I_0 levels have been calculated from other parameters for information purposes. They are not settable parameters themselves.

Note 2: In the case of multi-frequency network of 1.28 Mcps TDD, the UTRA RF Channel Number can be set for the primary frequency in this test.

A.8.7.3.3 Test Requirements

The UE shall send the first measurement report containing the physical cell identity of cell 2, with a measurement reporting delay less than 12800 ms from the beginning of time period T2.

The rate of correct measurement reports observed with this delay during repeated tests shall be at least 90%.

NOTE: The actual overall delays measured in the test may be up to $2 \times TTI_{DCCH}$ higher than the measurement reporting delays above because of TTI insertion uncertainty of the measurement report in DCCH.

A.8.7.4 E-UTRAN TDD - UTRAN TDD enhanced cell identification under AWGN propagation conditions

A.8.7.4.1 Test Purpose and Environment

The purpose of this test is to verify that the UE makes correct enhanced reporting of UTRAN TDD cells. This test will partly verify the Enhanced UTRA TDD cell identification requirements in clause 8.1.2.4.3.1.1a under AWGN propagation conditions.

The test parameters are given in Tables A.8.7.4.1-1, A.8.7.4.1-2 and A.8.7.4.1-3 below. In the measurement control information it is indicated to the UE that event-triggered reporting with Event B1 is used. The test consists of two successive time periods of T1 and T2 respectively. During time period T1, measurement gaps are activated and an inter-RAT measurement reporting configuration is configured with linkage to a UTRA measurement object corresponding to UARFCN channel number 1. Prior to time duration T2, the UE shall not have any timing information of cell 2. Cell 2 is powered up at the beginning of T2.

Table A.8.7.4.1-1: General test parameters for E-UTRAN TDD - UTRAN TDD enhanced cell identification under AWGN propagation conditions

| Parameter | Unit | Value | Comment |
|---|------|--|---|
| PDSCH parameters (E-UTRAN TDD) | | DL Reference Measurement Channel R.0 TDD | As specified in section A.3.1.1.2. |
| PCFICH/PDCCH/PHICH parameters (E-UTRAN TDD) | | DL Reference Measurement Channel R.6 TDD | As specified in section A.3.1.2.2. |
| Gap Pattern Id | | 0 | As specified in 3GPP TS 36.133 section 8.1.2.1. |
| Active cell | | Cell 1 | Cell 1 is on E-UTRA RF channel number 1. |
| Neighbour cell | | Cell 2 | Cell 2 is on UTRA RF channel number 1. |
| Time offset between cells | ms | 3 | Asynchronous cells |
| E-UTRA RF Channel Number | | 1 | One E-UTRA TDD carrier frequency is used. |
| E-UTRA Channel Bandwidth ($BW_{channel}$) | MHz | 10 | |
| CP length | | Normal | Applicable to cell 1 |
| Uplink-downlink configuration of cell 1 | | 1 | As specified in table 4.2.2 in TS 36.211 |
| Special subframe configuration of cell 1 | | 6 | As specified in table 4.2.1 in TS 36.211 |
| UTRA RF Channel Number | | 1 | One UTRA TDD carrier frequency is used. |
| Inter-RAT (UTRA TDD) measurement quantity | | P-CCPCH RSCP | |
| Thresh | dBm | -83 | Absolute P-CCPCH RSCP threshold for event B1 |
| Hysteresis | dB | 0 | |
| Time To Trigger | ms | 0 | |
| Filter coefficient | | 0 | L3 filtering is not used. |
| DRX | | OFF | |
| Monitored UTRA TDD cell list size | | 12 | UTRA cells on UTRA RF channel 1 provided in the cell list |
| T1 | s | 5 | |
| T2 | s | 2 | |

Table A.8.7.4.1-2: Cell specific test parameters for cell 1 in E-UTRAN TDD - UTRAN TDD enhanced cell identification test under AWGN propagation conditions

| Parameter | Unit | Cell 1 | |
|---|------------|----------|-----|
| | | T1 | T2 |
| E-UTRA RF Channel Number | | 1 | |
| BW _{channel} | MHz | 10 | |
| OCNG Pattern defined in A.3.2.2.1 (OP.1 TDD) | | OP.1 TDD | |
| PBCH_RA | dB | 0 | |
| PBCH_RB | dB | | |
| PSS_RA | dB | | |
| SSS_RA | dB | | |
| PCFICH_RB | dB | | |
| PHICH_RA | dB | | |
| PHICH_RB | dB | | |
| PDCCH_RA | dB | | |
| PDCCH_RB | dB | | |
| PDSCH_RA | dB | | |
| PDSCH_RB | dB | | |
| OCNG_RA ^{Note 1} | dB | | |
| OCNG_RB ^{Note 1} | dB | | |
| \hat{E}_s / I_{ot} | dB | | |
| N_{oc} ^{Note 3} | dBm/15 kHz | -98 | |
| \hat{E}_s / N_{oc} | dB | 4 | 4 |
| RSRP ^{Note 4} | dBm/15 kHz | -94 | -94 |
| SCH_RP | dBm/15 kHz | -94 | -94 |
| Propagation Condition | | AWGN | |
| <p>Note 1: OCNG shall be used such that both cells are fully allocated and a constant total transmitted power spectral density is achieved for all OFDM symbols.</p> <p>Note 2: The resources for uplink transmission are assigned to the UE prior to the start of time period T2.</p> <p>Note 3: Interference from other cells and noise sources not specified in the test is assumed to be constant over subcarriers and time and shall be modelled as AWGN of appropriate power for N_{oc} to be fulfilled.</p> <p>Note 4: RSRP levels have been derived from other parameters for information purposes. They are not settable parameters themselves.</p> | | | |

Table A.8.7.4.1-3: Cell specific test parameters for cell 2 in E-UTRAN TDD - UTRAN TDD enhanced cell identification test under AWGN propagation conditions

| Parameter | Unit | Cell 2 (UTRA TDD) | | | |
|--|--------------|-------------------|--------|-------|-------|
| | | 0 | | DwPTS | |
| Timeslot Number | | T1 | T2 | T1 | T2 |
| UTRA RF Channel Number ^{Note1} | | Channel 1 | | | |
| P-CCPCH_Ec/I _{or} | dB | -4.77 | -4.77 | | |
| DwPCH_Ec/I _{or} | dB | | | 0 | 0 |
| OCNS_Ec/I _{or} ^{Note2} | dB | -1.76 | -1.76 | | |
| \hat{I}_{or} / I_{oc} | dB | -inf | 8 | -inf | 8 |
| I_{oc} | dBm/1.28 MHz | -80 | | | |
| P-CCPCH RSCP ^{Note3} | dBm | -inf | -76.77 | n.a. | n.a. |
| P-CCPCH_Ec/I _o ^{Note3} | dB | -inf | -5.41 | n.a. | n.a. |
| DwPCH_Ec/I _o ^{Note3} | dB | n.a. | n.a. | -inf | -0.64 |
| Propagation Condition | | AWGN | | | |
| <p>Note 1: In the case of multi-frequency cell, the UTRA RF Channel Number is the primary frequency's channel number.</p> <p>Note 2: The power of the OCNS channel that is added shall make the total power from the cell to be equal to I_{or}.</p> <p>Note 3: P-CCPCH RSCP, PCCPCH_Ec/I_o and DwPCH_Ec/I_o levels have been derived from other parameters for information purposes. They are not settable parameters themselves.</p> | | | | | |

A.8.7.4.2 Test Requirements

The UE shall send the first measurement report containing the primary scrambling code of cell 2, with a measurement reporting delay less than 1120 ms from the beginning of time period T2.

The UE shall not send event triggered measurement reports, as long as the reporting criteria are not fulfilled.

The rate of correct measurement reports observed during repeated tests shall be at least 90%.

NOTE: The actual overall delays measured in the test may be up to $2xTTI_{DCCH}$ higher than the measurement reporting delays above because of TTI insertion uncertainty of the measurement report in DCCH

A.8.7.5 E-UTRA TDD InterRAT UTRA TDD correct reporting of measurement events with reduced performance group configured, non DRX

A.8.7.5.1 Test Purpose and Environment

The purpose of this test is to verify that the UE makes correct reporting of an event. This test will partly verify the E-UTRAN TDD- UTRAN TDD measurement requirements for increased UE carrier monitoring in clause 8.1.2.4.3.

The test parameters are given in Tables A.8.7.5.1-1, A.8.7.5.1-2 and A.8.7.5.1-3. In this test, there are 4 cells on different carrier frequencies and gap pattern configuration #0 as defined in table A.8.7.5.1-1 is provided.

In the measurement control information, it is indicated to the UE that event-triggered reporting with Events B1 is used. The test consists of two successive time periods for every repetition, with time duration of T1, and T2 respectively. During time duration T1, the UE shall not have any timing information of neighbour cells. At the start of each repetition of T1, the test equipment provides signals for cell 1 (serving cell), and cells 2, 3 and 4 which are selected from the 7 cells which are configured in the UE neighbour cell list. Cells 2, 3 and 4 are chosen randomly, such that one frequency belongs to the normal performance group and two frequencies belong to the reduced performance group.

Table A.8.7.5.1-1: General test parameters for E-UTRA TDD InterRAT UTRA TDD correct reporting of measurement events with reduced performance group configured, non DRX

| Parameter | Unit | Value | Comment |
|--|------|--|---|
| UE configured E-UTRA RF Channel Number | | 1 | Serving cell |
| UE is configured UTRA RF channel numbers | | 2, 3, 4, 5, 6, 7, 8 | 7 UTRA TDD carrier frequencies are used in the UE neighbour cell list. Frequencies 5,6, 7,and 8 are indicated to have reduced performance |
| Test equipment configuration | | Cell 1 uses E-UTRA RF cannel number 1 Cell 2,3,4 are randomly selected to use different frequencies selected from frequencies 2,3,4,5,6,7, 8 | |
| Active cell | | Cell 1 | E-UTRA TDD cell |
| Gap Pattern Id | | 0 | As specified in TS 36.133 clause 8.1.2.1. |
| CP length of cell 1 | | normal | |
| Inter-RAT measurement quantity | | UTRA TDD PCCPCH RSCP | |
| B1 Threshold | dBm | -75 | UTRA TDD PCCPCH RSCP threshold for event B1 |
| Hysteresis | dB | 0 | |
| Ofn | dB | 0 | |
| TimeToTrigger | s | 0 | |
| Filter coefficient | | 0 | L3 filtering is not used |
| DRX | | OFF | |
| Scaling factor configurations | | 8 | |
| T1 | s | 5 | |
| T2 | s | 205 | |

Table A.8.7.5.1-2: Cell specific test parameters for E-UTRA TDD InterRAT UTRA TDD correct reporting of measurement events with reduced performance group configured, non DRX (cell #1)

| Parameter | Unit | Cell 1 | |
|--|------------|---|---|
| | | T1 | T2 |
| E-UTRA RF Channel Number | | 1 | |
| BW _{channel} | | 5MHz: N _{RB} = 25 10MHz: N _{RB} = 50 | |
| Uplink-downlink configuration of cell 1 as specified in table 4.2.2 in TS 36.211 | | 1 | |
| Special subframe configuration of cell 1 as specified in table 4.2.1 in TS 36.211 | | 6 | |
| PDSCH parameters: DL Reference Measurement Channel as specified in clause A.3.1.1.2 | | 5MHz: R.4 TDD 10MHz: R.0 TDD | |
| PCFICH/PDCCH/PHICH parameters: DL Reference Measurement Channel as specified in clause A.3.1.2.2 | | 5MHz: R.11 TDD 10MHz:R.6 TDD | |
| OCNG Pattern defined in A.3.2.2.1 and A.3.2.2.9 | | 5MHz: OP.9 TDD 10MHz:OP.1 TDD | |
| PBCH_RA | dB | 0 | |
| PBCH_RB | dB | | |
| PSS_RA | dB | | |
| SSS_RA | dB | | |
| PCFICH_RB | dB | | |
| PHICH_RA | dB | | |
| PHICH_RB | dB | | |
| PDCCH_RA | dB | | |
| PDCCH_RB | dB | | |
| PDSCH_RA | dB | | |
| PDSCH_RB | dB | | |
| OCNG_RA ^{Note 1} | dB | | |
| OCNG_RB ^{Note 1} | dB | | |
| N _{oc} | dBm/15 kHz | | |
| \hat{E}_s / N_{oc} | dB | 4 | 4 |
| \hat{E}_s / I_{ot} ^{Note 3} | dB | 4 | 4 |
| RSRP ^{Note 3} | dBm/15 kHz | -94 | -94 |
| SCH_RP ^{Note 3} | dBm/15 kHz | -94 | -94 |
| I _o ^{Note 3} | dBm/Ch BW | -64.70 +10log (N _{RB,c} /50) | -64.70 +10log (N _{RB,c} /50) |
| Propagation Condition | | ETU70 | |
| Correlation Matrix and Antenna Configuration | | 1x2 Low | |
| <p>Note 1: OCNG shall be used such that both cells are fully allocated and a constant total transmitted power spectral density is achieved for all OFDM symbols.</p> <p>Note 2: The resources for uplink transmission are assigned to the UE prior to the start of time period T2.</p> <p>Note 3: Es/Iot, RSRP, SCH_RP and Io have been derived from other parameters for information purposes. They are not settable parameters themselves.</p> | | | |

Table A.8.7.5.1-3: Cell specific test parameters for E-UTRA TDD InterRAT UTRA TDD correct reporting of measurement events with reduced performance group configured, non DRX (cell #2, cell #3 and cell #4)

| Parameter | Unit | Cell 2 | | | | Cell 3 | | | | Cell 4 | | | |
|--------------------------------|------|--|-------|----|-------|---|-------|----|-------|---|-------|----|-------|
| | | T1 | | T2 | | T1 | | T2 | | T1 | | T2 | |
| Timeslot Number | | 0 | DwPTS | 0 | DwPTS | 0 | DwPTS | 0 | DwPTS | 0 | DwPTS | 0 | DwPTS |
| UTRA RF Channel Number (NOTE1) | | Randomly selected from 2,3,4 such that cell 2 is in the normal performance group | | | | Randomly selected from 5,6,7,8 such that cell 3 is in the reduced performance group | | | | Randomly selected from 5,6,7,8 such that cell 4 is in the reduced performance group. Cell 4 RF channel is different from Cell 3 RF channel. | | | |

| | | | | | | | | | | |
|---|--------------|----------------|-------|---|----------------|-------|---|----------------|-------|---|
| PCCPCH_Ec/Ior | dB | -Infinity | -3 | | -Infinity | -3 | | -Infinity | -3 | |
| DwPCH_Ec/Ior | dB | -Infinity | | 0 | -Infinity | | 0 | -Infinity | | 0 |
| OCNS_Ec/Ior | | -Infinity | -3 | | -Infinity | -3 | | -Infinity | -3 | |
| \hat{I}_{or}/I_{oc} | dB | -Infinity | 9 | | -Infinity | 9 | | -Infinity | 9 | |
| I_{oc} | dBm/1.28 MHz | -70 | | | -70 | | | -70 | | |
| PCCPCH_RSCP Note 3 | dB | -Infinity | -64 | | -Infinity | -64 | | -Infinity | -64 | |
| I_o Note 3 | dBm/1.28 MHz | -70.00 | - | | -70.00 | - | | -70.00 | - | |
| | | | 60.49 | | | 60.49 | | | 60.49 | |
| Propagation Condition | | Case 3 (NOTE2) | | | Case 3 (NOTE2) | | | Case 3 (NOTE2) | | |
| NOTE1: The DPCH of the cell is located in a timeslot other than 0. NOTE2: Case 3 propagation conditions are specified in TS25.102 Annex B NOTE3: PCCPCH_RSCP and I_o levels have been derived from other parameters for information purposes. They are not settable parameters themselves | | | | | | | | | | |

A.8.7.5.2 Test Requirements

The UE shall send Event B1 triggered measurement reports for cells 2, 3 and 4, with a measurement reporting delay less than 21.95s (cell 2) and 204.8s (cell 3 and 4) from the beginning of time period T2.

The UE shall not send event triggered measurement reports, as long as the reporting criteria are not fulfilled.

The rate of correct events observed during repeated tests shall be at least 90%.

NOTE: The actual overall delays measured in the test may be up to $2xTTI_{DCC}$ higher than the measurement reporting delays above because of TTI insertion uncertainty of the measurement report.

A.8.7A TBD

A.8.7A.1 E-UTRA FDD InterRAT UTRA TDD correct reporting of measurement events with reduced performance group configured, non DRX

A.8.7A.1.1 Test Purpose and Environment

The purpose of this test is to verify that the UE makes correct reporting of an event. This test will partly verify the E-UTRAN FDD- UTRAN TDD measurement requirements for increased UE carrier monitoring in clause 8.1.2.4.4.

The test parameters are given in Tables A.8.7A.1.1-1, A.8.7A.1.1-2 and A.8.7A.1.1-3. In this test, there are 4 cells on different carrier frequencies and gap pattern configuration #0 as defined in table A.8.7A.1.1-1 is provided.

In the measurement control information, it is indicated to the UE that event-triggered reporting with Events B1 is used. The test consists of two successive time periods for every repetition, with time duration of T1, and T2 respectively. During time duration T1, the UE shall not have any timing information of neighbour cells. At the start of each repetition of T1, the test equipment provides signals for cell 1 (serving cell), and cells 2, 3 and 4 which are selected from the 7 cells which are configured in the UE neighbour cell list. Cells 2, 3 and 4 are chosen randomly, such that one frequency belongs to the normal performance group and two frequencies belong to the reduced performance group.

Table A.8.7A.1.1-1: General test parameters for E-UTRA FDD InterRAT UTRA TDD correct reporting of measurement events with reduced performance group configured, non DRX

| Parameter | Unit | Value | Comment |
|--|------|--|---|
| UE configured E-UTRA RF Channel Number | | 1 | Serving cell |
| UE is configured UTRA RF channel numbers | | 2, 3, 4, 5, 6, 7, 8 | 7 UTRA TDD carrier frequencies are used in the UE neighbour cell list. Frequencies 5,6, 7,and 8 are indicated to have reduced performance |
| Test equipment configuration | | Cell 1 uses E-UTRA RF channel number 1 Cell 2,3,4 are randomly selected | |

| | | | |
|--------------------------------|-----|---|---|
| | | to use different frequencies selected from frequencies 2,3,4,5,6,7, 8 | |
| Active cell | | Cell 1 | E-UTRA FDD cell |
| Gap Pattern Id | | 0 | As specified in TS 36.133 clause 8.1.2.1. |
| CP length of cell 1 | | normal | |
| Inter-RAT measurement quantity | | UTRA TDD PCCPCH RSCP | |
| B1 Threshold | dBm | -75 | UTRA TDD PCCPCH RSCP threshold for event B1 |
| Hysteresis | dB | 0 | |
| TimeToTrigger | s | 0 | |
| Filter coefficient | | 0 | L3 filtering is not used |
| DRX | | OFF | |
| Scaling factor configurations | | 8 | |
| T1 | s | 5 | |
| T2 | s | 205 | |

Table A.8.7A.1.1-2: Cell specific test parameters for E-UTRA FDD InterRAT UTRA TDD correct reporting of measurement events with reduced performance group configured, non DRX (cell #1)

| Parameter | Unit | Cell 1 | |
|--|------------|---|---|
| | | T1 | T2 |
| E-UTRA RF Channel Number | | 1 | |
| BW _{channel} | | 5MHz: N _{RB} = 25 10MHz: N _{RB} = 50 | |
| PDSCH parameters: DL Reference Measurement Channel as specified in clause A.3.1.1.1 | | 5MHz: R.5 FDD 10MHz: R.0 FDD | |
| PCFICH/PDCCH/PHICH parameters: DL Reference Measurement Channel as specified in clause A.3.1.2.1 | | 5MHz: R.11 FDD 10MHz:R.6 FDD | |
| OCNG Pattern defined in A.3.2.1.1 and A.3.2.1.15 | | 5MHz: OP.15 FDD 10MHz:OP.1 FDD | |
| PBCH_RA | dB | 0 | |
| PBCH_RB | dB | | |
| PSS_RA | dB | | |
| SSS_RA | dB | | |
| PCFICH_RB | dB | | |
| PHICH_RA | dB | | |
| PHICH_RB | dB | | |
| PDCCH_RA | dB | | |
| PDCCH_RB | dB | | |
| PDSCH_RA | dB | | |
| PDSCH_RB | dB | | |
| OCNG_RA ^{Note 1} | dB | | |
| OCNG_RB ^{Note 1} | dB | | |
| N _{oc} | dBm/15 kHz | | |
| \hat{E}_s/N_{oc} | dB | 4 | 4 |
| \hat{E}_s/I_{ot} ^{Note 3} | dB | 4 | 4 |
| RSRP ^{Note 3} | dBm/15 kHz | -94 | -94 |
| SCH_RP ^{Note 3} | dBm/15 kHz | -94 | -94 |
| I _o ^{Note 3} | dBm/Ch BW | -64.76 +10log (N _{RB,c} /50) | -64.76 +10log (N _{RB,c} /50) |
| Propagation Condition | | ETU70 | |
| Correlation Matrix and Antenna Configuration | | 1x2 Low | |

Note 1: OCNG shall be used such that both cells are fully allocated and a constant total transmitted power spectral density is achieved for all OFDM symbols.
 Note 2: The resources for uplink transmission are assigned to the UE prior to the start of time period T2.
 Note 3: Es/lot, RSRP, SCH_RP and lo have been derived from other parameters for information purposes. They are not settable parameters themselves.

Table A.8.7A.1.1-3: Cell specific test parameters for E-UTRA FDD InterRAT UTRA TDD correct reporting of measurement events with reduced performance group configured, non DRX (cell #2, cell #3 and cell #4)

| Parameter | Unit | Cell 2 | | | | Cell 3 | | | | Cell 4 | | | |
|--------------------------------|--------------|--|-------|----|-------|---|--------|----|-------|---|-------|----|-------|
| | | T1 | | T2 | | T1 | | T2 | | T1 | | T2 | |
| Timeslot Number | | 0 | DwPTS | 0 | DwPTS | 0 | DwPTS | 0 | DwPTS | 0 | DwPTS | 0 | DwPTS |
| UTRA RF Channel Number (NOTE1) | | Randomly selected from 2,3,4 such that cell 2 is in the normal performance group | | | | Randomly selected from 5,6,7,8 such that cell 3 is in the reduced performance group | | | | Randomly selected from 5,6,7,8 such that cell 4 is in the reduced performance group. Cell 4 RF channel is different from Cell 3 RF channel. | | | |
| PCCPCH_Ec/lor | dB | -Infinity | -3 | | | -Infinity | -3 | | | -Infinity | -3 | | |
| DwPCH_Ec/lor | dB | -Infinity | | | 0 | -Infinity | | | 0 | -Infinity | | | 0 |
| OCNS_Ec/lor | | -Infinity | -3 | | | -Infinity | -3 | | | -Infinity | -3 | | |
| \hat{I}_{or}/I_{oc} | dB | -Infinity | 9 | | | -Infinity | 9 | | | -Infinity | 9 | | |
| I_{oc} | dBm/1.28 MHz | -70 | | | | -70 | | | | -70 | | | |
| PCCPCH_RSCP Note 3 | dB | -Infinity | -64 | | | -Infinity | -64 | | | -Infinity | -64 | | |
| I_o Note 3 | dBm/1.28 MHz | -70.00 | - | | 60.49 | -70.00 | -60.49 | | | -70.00 | - | | 60.49 |
| Propagation Condition | | Case 3 (NOTE2) | | | | Case 3 (NOTE2) | | | | Case 3 (NOTE2) | | | |

NOTE1: The DPCH of the cell is located in a timeslot other than 0.

NOTE2: Case 3 propagation conditions are specified in TS25.102 Annex B

NOTE3: PCCPCH_RSRP and I_o levels have been derived from other parameters for information purposes. They are not settable parameters themselves

A.8.7A.1.2 Test Requirements

The UE shall send Event B1 triggered measurement reports for cells 2, 3 and 4, with a measurement reporting delay less than 21.95s (cell 2) and 204.8s (cell 3 and 4) from the beginning of time period T2.

The UE shall not send event triggered measurement reports, as long as the reporting criteria are not fulfilled.

The rate of correct events observed during repeated tests shall be at least 90%.

NOTE: The actual overall delays measured in the test may be up to $2xTTI_{DCC}$ higher than the measurement reporting delays above because of TTI insertion uncertainty of the measurement report.

A.8.8 E-UTRAN FDD – GSM Measurements

A.8.8.1 E-UTRAN FDD – GSM event triggered reporting in AWGN

A.8.8.1.1 Test Purpose and Environment

The purpose of this test is to verify that the UE makes correct reporting of an event when doing inter-RAT (GSM) measurements. This test will partly verify the E-UTRAN FDD - GSM cell search requirements in clause 8.1.2.4.5.

The test parameters are given in Tables A.8.8.1.1-1, A.8.8.1.1-2 and A.8.8.1.1-3 below. In the measurement control information it is indicated to the UE that event-triggered reporting with Event B1 is used. The test consists of two successive time periods, with time duration of T1, and T2 respectively. During time duration T1, the UE shall not have any timing information of cell 2.

Table A.8.8.1.1-1: General test parameters for E-UTRAN FDD-GSM event triggered reporting in AWGN

| Parameter | Unit | Value | Comment |
|-----------|------|-------|---------|
|-----------|------|-------|---------|

| | | | |
|---|-----|--|--|
| PDSCH parameters (E-UTRAN FDD) | | DL Reference Measurement Channel R.0 FDD | As specified in clause A.3.1.1.1. |
| PCFICH/PDCCH/PHICH parameters (E-UTRAN FDD) | | DL Reference Measurement Channel R.6 FDD | As specified in clause A.3.1.2.1. |
| Gap Pattern Id | | 0 | As specified in TS 36.133 clause 8.1.2.1. |
| Active cell | | Cell 1 | Cell 1 is on E-UTRA RF channel number 1. |
| Neighbour cell | | Cell 2 | Cell 2 is on Absolute RF Channel Number 1 (GSM cell) |
| CP length | | Normal | Applicable to cell 1 |
| E-UTRA RF Channel Number | | 1 | One E-UTRA FDD carrier frequency is used. |
| E-UTRA Channel Bandwidth ($BW_{channel}$) | MHz | 10 | |
| Inter-RAT (GSM) measurement quantity | | GSM Carrier RSSI | |
| b1-Threshold-GERAN | dBm | -80 | GSM Carrier RSSI threshold for event B1. |
| Hysteresis | dB | 0 | |
| Time To Trigger | ms | 0 | |
| Filter coefficient | | 0 | L3 filtering is not used. |
| DRX | | OFF | |
| Monitored GSM cell list size | | 6 GSM neighbours including ARFCN 1 | List of GSM cells provided before T2 starts. |
| T1 | s | 5 | |
| T2 | s | 5 | |

Table A.8.8.1.1-2: Cell specific test parameters for E-UTRAN FDD (cell # 1) for event triggered reporting of GSM cell in AWGN

| Parameter | Unit | Cell 1 | |
|---|------------|----------|-----|
| | | T1 | T2 |
| E-UTRA RF Channel Number | | 1 | |
| $BW_{channel}$ | MHz | 10 | |
| OCNG Pattern defined in A.3.2.1.1 (OP.1 FDD) | | OP.1 FDD | |
| PBCH_RA | dB | 0 | |
| PBCH_RB | dB | | |
| PSS_RA | dB | | |
| SSS_RA | dB | | |
| PCFICH_RB | dB | | |
| PHICH_RA | dB | | |
| PHICH_RB | dB | | |
| PDCCH_RA | dB | | |
| PDCCH_RB | dB | | |
| PDSCH_RA | dB | | |
| PDSCH_RB | dB | | |
| OCNG_RA ^{Note 1} | dB | | |
| OCNG_RB ^{Note 1} | dB | | |
| \hat{E}_s / I_{ot} | dB | 4 | 4 |
| \hat{E}_s / N_{oc} | dB | 4 | 4 |
| N_{oc} | dBm/15 kHz | -98 | |
| RSRP | dBm/15 kHz | -94 | -94 |
| SCH_RP | dBm/15 kHz | -94 | -94 |
| Propagation Condition | | AWGN | |
| Note 1: OCNG shall be used such that both cells are fully allocated and a constant total transmitted power spectral density is achieved for all OFDM symbols. | | | |
| Note 2: The resources for uplink transmission are assigned to the UE prior to the start of time period T2. | | | |

Table A.8.8.1.1-3: Cell specific test parameters for GSM (cell # 2) for event triggered reporting of GSM cell in AWGN

| Parameter | Unit | Cell 2 | |
|----------------------------|------|-----------|-----|
| | | T1 | T2 |
| Absolute RF Channel Number | | ARFNC 1 | |
| RXLEV | dBm | -Infinity | -75 |

| | | | |
|----------|--|-----|-------|
| GSM BSIC | | N/A | Valid |
|----------|--|-----|-------|

A.8.8.1.2 Test Requirements

The UE shall send one Event B1 triggered measurement report including BSIC of cell # 2, with a measurement reporting delay less than 3120 ms from the beginning of time period T2.

The UE shall not send event triggered measurement reports, as long as the reporting criteria are not fulfilled.

The rate of correct events observed during repeated tests shall be at least 90%.

NOTE 1: The actual overall delays measured in the test may be up to $2 \times TTI_{DCCH}$ higher than the measurement reporting delays above because of TTI insertion uncertainty of the measurement report in DCCH.

NOTE 2: The delay for GSM cell identification with BSIC verified is equal to 3120 ms, which is the sum of the event triggered measurement reporting delay and the initial BSIC identification delay.

The event triggered measurement reporting delay = $2 \times T_{\text{Measurement Period, GSM}} = 2 \times 480\text{ms} = 960\text{ms}$.

Initial BSIC identification delay = 2160 ms.

A.8.8.2 E-UTRAN FDD-GSM event triggered reporting when DRX is used in AWGN

A.8.8.2.1 Test Purpose and Environment

The purpose of these tests is to verify that the UE makes correct reporting of an event in DRX. These tests will partly verify the E-UTRAN FDD-GSM cell search requirements when DRX is used in clause 8.1.2.4.5.2.

In these tests, there are two cells, one E-UTRAN cell and one GSM cell, and gap pattern configuration # 0 as defined in Table 8.1.2.1-1 is provided.

The common test parameters are given in Table A.8.8.2.1-1. Cell specific test parameters are given in Table A.8.8.2.1-2 for E-UTRAN and in Table A.8.8.2.1-5 for GSM. DRX configuration for Test1 and Test2 are given in Table A.8.8.2.1-3 and time alignment timer and scheduling request related parameters in Table A.8.8.2.1-4.

In Test 1 UE needs to be provided at least once every 500ms with new Timing Advance Command MAC control element to restart the Time alignment timer to keep UE uplink time alignment. Furthermore UE is allocated with PUSCH resource at every DRX cycle. In Test 2 the uplink time alignment is not maintained and UE needs to use RACH to obtain UL allocation for measurement reporting.

In the measurement control information, it is indicated to the UE that event-triggered reporting with Event B1 is used. The tests consist of two successive time periods, with time duration of T1, and T2 respectively. During time duration T1, the UE shall not have any timing information of cell 2.

Table A.8.8.2.1-1: General test parameters for E-UTRAN FDD-GSM event triggered reporting when DRX is used in AWGN

| Parameter | Unit | Test 1 | Test 2 | Comment |
|--|------|--|--------|--|
| | | Value | | |
| PDSCH parameters (E-UTRAN FDD) | | DL Reference Measurement Channel R.0 FDD | | As specified in clause A.3.1.1.1. |
| PCFICH/PDCCH/PHICH parameters (E-UTRAN FDD) | | DL Reference Measurement Channel R.6 FDD | | As specified in clause A.3.1.2.1. |
| Gap Pattern Id | | 0 | | As specified in TS 36.133 clause 8.1.2.1. |
| Active cell | | Cell 1 | | Cell 1 is on E-UTRA RF channel number 1. |
| Neighbour cell | | Cell 2 | | Cell 2 is on Absolute RF Channel Number 1 (GSM cell) |
| CP length | | Normal | | Applicable to cell 1 |
| E-UTRA RF Channel Number | | 1 | | One E-UTRA FDD carrier frequency is used. |
| E-UTRA Channel Bandwidth (BW_{channel}) | MHz | 10 | | |
| Inter-RAT (GSM) measurement quantity | | GSM Carrier RSSI | | |
| B1-Threshold-GERAN | dBm | -80 | | GSM Carrier RSSI threshold for event B1. |

| | | | |
|------------------------------|----|------------------------------------|---|
| Hysteresis | dB | 0 | |
| TimeToTrigger | s | 0 | |
| Filter coefficient | | 0 | L3 filtering is not used |
| PRACH configuration | | 4 | As specified in table 5.7.1-2 in TS 36.211 |
| Access Barring Information | - | Not Sent | No additional delays in random access procedure. |
| DRX | | ON | DRX related parameters are defined in Table A.8.8.2.1-3 |
| Monitored GSM cell list size | | 6 GSM neighbours including ARFCN 1 | List of GSM cells provided before T2 starts. |
| T1 | s | 5 | |
| T2 | s | 5 | 45 |

Table A.8.8.2.1-2: Cell specific test parameters for E-UTRAN FDD (cell #1) event triggered reporting of GSM cell when DRX is used in AWGN

| Parameter | Unit | Cell 1 | |
|--|------------|----------|-----|
| | | T1 | T2 |
| E-UTRA RF Channel Number | | 1 | |
| $BW_{channel}$ | MHz | 10 | |
| OCNG Pattern defined in A.3.2.1.1 (OP.1 FDD) | | OP.1 FDD | |
| PBCH_RA | dB | 0 | |
| PBCH_RB | dB | | |
| PSS_RA | dB | | |
| SSS_RA | dB | | |
| PCFICH_RB | dB | | |
| PHICH_RA | dB | | |
| PHICH_RB | dB | | |
| PDCCH_RA | dB | | |
| PDCCH_RB | dB | | |
| PDSCH_RA | dB | | |
| PDSCH_RB | dB | | |
| OCNG_RA ^{Note 1} | dB | | |
| OCNG_RB ^{Note 1} | dB | | |
| \hat{E}_s/I_{ot} | dB | 4 | 4 |
| N_{oc} ^{Note 2} | dBm/15 kHz | -98 | |
| RSRP ^{Note 3} | dBm/15 kHz | -94 | -94 |
| SCH_RP | dBm/15 kHz | -94 | -94 |
| \hat{E}_s/N_{oc} | dB | 4 | 4 |
| Propagation Condition | | AWGN | |
| Note 1: OCNG shall be used such that both cells are fully allocated and a constant total transmitted power spectral density is achieved for all OFDM symbols. | | | |
| Note 2: Interference from other cells and noise sources not specified in the test is assumed to be constant over subcarriers and time and shall be modelled as AWGN of appropriate power for N_{oc} to be fulfilled. | | | |
| Note 3: RSRP and SCH_RP levels have been derived from other parameters for information purposes. They are not settable parameters themselves. | | | |

Table A.8.8.2.1-3: drx-Configuration to be used in E-UTRAN FDD-GSM event triggered reporting when DRX is used in AWGN

| Field | Test1 | Test2 | Comment |
|--|---------|---------|---------|
| | Value | Value | |
| onDurationTimer | psf1 | psf1 | |
| drx-InactivityTimer | psf1 | psf1 | |
| drx-RetransmissionTimer | psf1 | psf1 | |
| longDRX-CycleStartOffset | sf40 | sf1280 | |
| shortDRX | Disable | Disable | |
| Note: For further information see clause 6.3.2 in TS 36.331. | | | |

Table A.8.8.2.1-4: TimeAlignmentTimer and sr-ConfigIndex -Configuration to be used in E-UTRAN FDD-GSM event triggered reporting when DRX is used in AWGN

| Field | Test1 | Test2 | Comment |
|--------------------|-------|-------|---|
| | Value | Value | |
| TimeAlignmentTimer | sf500 | sf500 | For further information see clause 6.3.2 in TS 36.331. |
| sr-ConfigIndex | 0 | 0 | For further information see clause 6.3.2 in TS 36.331 and clause 10.1 in TS 36.213. |

Table A.8.8.2.1-5: Cell specific test parameters for GSM (cell # 2) for event triggered reporting of GSM cell when DRX is used in AWGN

| Parameter | Unit | Cell 2 | |
|----------------------------|------|-----------|-------|
| | | T1 | T2 |
| Absolute RF Channel Number | | ARFNC 1 | |
| RXLEV | dBm | -Infinity | -75 |
| GSM BSIC | | N/A | Valid |

A.8.8.2.2 Test Requirements

In Test1 the UE shall send one Event B1 triggered measurement report including BSIC of cell # 2, with a measurement reporting delay less than 3120 ms from the beginning of time period T2. The measurement reporting delay is defined as the time from the beginning of time period T2, to the moment when the UE send the measurement report on PUSCH.

In Test2 the UE shall send one Event B1 triggered measurement report, with a measurement reporting delay less than 42.8 seconds from the beginning of time period T2. The measurement reporting delay is defined as the time from the beginning of time period T2, to the moment when the UE starts to send preambles on the PRACH for scheduling request (SR) to obtain allocation to send the measurement report on PUSCH.

The UE shall not send event triggered measurement reports, as long as the reporting criteria are not fulfilled.

The rate of correct events observed during repeated tests shall be at least 90%.

NOTE 1: The actual overall delays measured in the test may be up to one DRX cycle higher than the measurement reporting delays above because UE is allowed to delay the initiation of the measurement reporting procedure to the next until the Active Time.

NOTE 2: In order to calculate the rate of correct events the system simulator shall verify that it has received correct Event B1 measurement report

A.8.8.3 E-UTRAN FDD – GSM event triggered reporting in AWGN with enhanced BSIC identification

A.8.8.3.1 Test Purpose and Environment

The purpose of this test is to verify that the UE makes correct reporting of an event when doing inter-RAT (GSM) measurements with enhanced BSIC identification. This test will partly verify the E-UTRAN FDD - GSM cell search requirements in clause 8.1.2.4.5.1.2a

The test parameters are given in Tables A.8.8.3.1-1, A.8.8.1.1-2 and A.8.8.3.1-3 below. In the measurement control information it is indicated to the UE that event-triggered reporting with Event B1 is used. The test consists of two successive time periods, with time duration of T1, and T2 respectively. Prior time duration T1, the UE shall not have any timing information of cell 2. . During time period T1, gaps are activated and an interRAT measurement reporting configuration is configured, and linked to a GSM measurement object including channel ARFCN 1. Cell 2 is powered up at the beginning of T2.

Table A.8.8.3.1-1: General test parameters for E-UTRAN FDD-GSM event triggered reporting in AWGN with enhanced BSIC identification

| Parameter | Unit | Value | Comment |
|--------------------------------|------|--|-----------------------------------|
| PDSCH parameters (E-UTRAN FDD) | | DL Reference Measurement Channel R.0 FDD | As specified in clause A.3.1.1.1. |

| | | | |
|---|-----|--|---|
| PCFICH/PDCCH/PHICH parameters (E-UTRAN FDD) | | DL Reference Measurement Channel R.6 FDD | As specified in clause A.3.1.2.1. |
| Gap Pattern Id | | 0 | As specified in TS 36.133 clause 8.1.2.1. |
| Active cell | | Cell 1 | Cell 1 is on E-UTRA RF channel number 1. |
| Neighbour cell | | Cell 2 | Cell 2 is on Absolute RF Channel Number 1 (GSM cell) |
| CP length | | Normal | Applicable to cell 1 |
| E-UTRA RF Channel Number | | 1 | One E-UTRA FDD carrier frequency is used. |
| E-UTRA Channel Bandwidth ($BW_{channel}$) | MHz | 10 | |
| Inter-RAT (GSM) measurement quantity | | GSM Carrier RSSI | |
| b1-Threshold-GERAN | dBm | -80 | GSM Carrier RSSI threshold for event B1. |
| Hysteresis | dB | 0 | |
| Time To Trigger | ms | 0 | |
| Filter coefficient | | 0 | L3 filtering is not used. |
| DRX | | OFF | |
| Monitored GSM cell list size | | 6 GSM neighbours including ARFCN 1 | List of GSM cells provided before T2 starts. |
| T1 | s | 5 | T1 ends at the end of the last TTI where the measurement configuration is given |
| T2 | s | 3 | |

Table A.8.8.3.1-2: Cell specific test parameters for E-UTRAN FDD (cell # 1) for event triggered reporting of GSM cell in AWGN with enhanced BSIC identification

| Parameter | Unit | Cell 1 | |
|---|------------|----------|-----|
| | | T1 | T2 |
| E-UTRA RF Channel Number | | 1 | |
| $BW_{channel}$ | MHz | 10 | |
| OCNG Pattern defined in A.3.2.1.1 (OP.1 FDD) | | OP.1 FDD | |
| PBCH_RA | dB | 0 | |
| PBCH_RB | dB | | |
| PSS_RA | dB | | |
| SSS_RA | dB | | |
| PCFICH_RB | dB | | |
| PHICH_RA | dB | | |
| PHICH_RB | dB | | |
| PDCCH_RA | dB | | |
| PDCCH_RB | dB | | |
| PDSCH_RA | dB | | |
| PDSCH_RB | dB | | |
| OCNG_RA ^{Note 1} | dB | | |
| OCNG_RB ^{Note 1} | dB | | |
| \hat{E}_s/I_{ot} | dB | | |
| \hat{E}_s/N_{oc} | dB | 4 | 4 |
| N_{oc} | dBm/15 kHz | -98 | |
| RSRP | dBm/15 kHz | -94 | -94 |
| SCH_RP | dBm/15 kHz | -94 | -94 |
| Propagation Condition | | AWGN | |
| Note 1: OCNG shall be used such that both cells are fully allocated and a constant total transmitted power spectral density is achieved for all OFDM symbols. | | | |
| Note 2: The resources for uplink transmission are assigned to the UE prior to the start of time period T2. | | | |

Table A.8.8.3.1-3: Cell specific test parameters for GSM (cell # 2) for event triggered reporting of GSM cell in AWGN with enhanced BSIC identification

| Parameter | Unit | Cell 2 | |
|----------------------------|------|-----------|-------|
| | | T1 | T2 |
| Absolute RF Channel Number | | ARFCN 1 | |
| RXLEV | dBm | $-\infty$ | -75 |
| GSM BSIC | | N/A | Valid |

A.8.8.3.2 Test Requirements

The UE shall send one Event B1 triggered measurement report including BSIC of cell # 2, with a measurement reporting delay less than 2280 ms from the beginning of time period T2.

The UE shall not send event triggered measurement reports, as long as the reporting criteria are not fulfilled.

The rate of correct events observed during repeated tests shall be at least 90%.

NOTE 1: The actual overall delays measured in the test may be up to $2 \times TTI_{DCCH}$ higher than the measurement reporting delays above because of TTI insertion uncertainty of the measurement report in DCCH.

NOTE 2: The delay for GSM cell identification with BSIC verified is equal to 2280 ms, which is the sum of the event triggered measurement reporting delay and the enhanced initial BSIC identification delay.

The event triggered measurement reporting delay = $2 \times T_{\text{Measurement Period, GSM}} = 2 \times 480\text{ms} = 960\text{ms}$.

Initial BSIC identification delay = 1320 ms.

A.8.9 E-UTRAN FDD - UTRAN TDD measurements

A.8.9.1 E-UTRAN FDD - UTRAN TDD event triggered reporting in fading propagation conditions

A.8.9.1.1 Test Purpose and Environment

The purpose of this test is to verify that the UE makes correct reporting of an event. The test will partly verify the E-UTRAN FDD - UTRAN TDD cell search requirements in clause 8.1.2.4.4 in fading environment.

The test parameters are given in Table A.8.9.1.1-1, A.8.9.1.1-2 and A.8.9.1.1-3 below. In the measurement control information it is indicated to the UE that event-triggered reporting with Event B1 is used. The test consists of two successive time periods, with time duration of T1, and T2 respectively. During time duration T1, the UE shall not have any timing information of cell 2.

Table A.8.9.1.1-1: General test parameters for Event triggered reporting in fading propagation conditions

| Parameter | Unit | Value | Comment |
|--------------------------------|------|--|---|
| PDSCH parameters | | DL Reference Measurement Channel R.0 FDD | As specified in clause A.3.1.1.1 |
| PCFICH/PDCCH/PHICH parameters | | DL Reference Measurement Channel R.6 FDD | As specified in clause A.3.1.2.1 |
| Active cell | | Cell 1 | E-UTRA FDD Cell 1 |
| Neighbour cell | | Cell 2 | UTRA TDD Cell 2 is to be identified. |
| Gap Pattern Id | | 1 | As specified in TS 36.133 section 8.1.2.1. Measurement Gap Repetition Period = 80ms |
| Inter-RAT measurement quantity | | UTRA TDD PCCPCH RSCP | |
| Threshold other system | dBm | -75 | UTRA TDD PCCPCH RSCP threshold for event B1. |
| Hysteresis | dB | 0 | |
| CP length | | Normal | |
| TimeToTrigger | s | 0 | |
| Filter coefficient | | 0 | L3 filtering is not used |
| DRX | | | OFF |
| T1 | s | 5 | |
| T2 | s | 15 | |

Table A.8.9.1.1-2: Cell specific test parameters for Event triggered reporting of UTRA TDD neighbours in fading propagation conditions (cell1)

| Parameter | Unit | Cell 1 |
|-----------|------|--------|
|-----------|------|--------|

| | | T1 | T2 |
|--|---------------|----------|-----|
| E-UTRA RF Channel Number | | 1 | |
| $BW_{channel}$ | MHz | 10 | |
| Correlation Matrix and Antenna Configuration | | 1x2 Low | |
| OCNG Patterns defined in A.3.2.1.1 (OP.1 FDD) | | OP.1 FDD | |
| PBCH_RA | dB | 0 | |
| PBCH_RB | dB | | |
| PSS_RA | dB | | |
| SSS_RA | dB | | |
| PCFICH_RB | dB | | |
| PHICH_RA | dB | | |
| PHICH_RB | dB | | |
| PDCCH_RA | dB | | |
| PDCCH_RB | dB | | |
| PDSCH_RA | dB | | |
| PDSCH_RB | dB | | |
| OCNG_RA ^{Note 1} | dB | | |
| OCNG_RB ^{Note 1} | dB | | |
| N_{oc} | dBm/15KH z | | |
| RSRP | dBm | -94 | -94 |
| \hat{E}_s / I_{ot} | dB | 4 | 4 |
| P-SCH_RP | dBm | -94 | |
| S-SCH_RP | dBm | -94 | |
| Propagation Condition | | ETU70 | |
| Note 1: OCNG shall be used such that cell 1 is fully allocated and a constant total transmitted power spectral density is achieved for all OFDM symbols. Note 2: The resources for uplink transmission are assigned to the UE prior to the start of time period T2. | | | |

Table A.8.9.1.1-3: Cell specific test parameters for Event triggered reporting of UTRA TDD neighbours in fading propagation conditions (cell2)

| Parameter | Unit | Cell 2 | | | |
|---|--------------|----------------|-------|--------|-------|
| | | T1 | | T2 | |
| Timeslot Number | | 0 | DwPTS | 0 | DwPTS |
| UTRA RF Channel Number (NOTE1) | | Channel1 | | | |
| PCCPCH_Ec/lor | dB | -Infinity | | -3 | |
| DwPCH_Ec/lor | dB | -Infinity | | | 0 |
| OCNS_Ec/lor | | -Infinity | | -3 | |
| \hat{I}_{or} / I_{oc} | dB | -Infinity | | 9 | |
| I_{oc} | dBm/1.28 MHz | -70 | | | |
| PCCPCH_RSCP ^{Note 3} | dB | -Infinity | | -64 | |
| I_o ^{Note 3} | dBm/1.28 MHz | -70.00 | | -60.49 | |
| Propagation Condition | | Case 3 (NOTE2) | | | |
| NOTE1: The DPCH of the cell is located in a timeslot other than 0. NOTE2: Case 3 propagation conditions are specified in TS25.102 Annex B NOTE3: PCCPCH_RSCP and I_o levels have been derived from other parameters for information purposes. They are not settable parameters themselves | | | | | |

A.8.9.1.2 Test Requirements

The UE shall send one Event B1 triggered measurement report, with a measurement reporting delay less than 12800 ms from the beginning of time period T2.

The UE shall not send event triggered measurement reports, as long as the reporting criteria are not fulfilled.

The rate of correct events observed during repeated tests shall be at least 90%.

NOTE: The actual overall delays measured in the test may be up to $2 \times TTI_{DCCH}$ higher than the measurement reporting delays above because of TTI insertion uncertainty of the measurement report in DCCH.

A.8.9.2 E-UTRAN FDD - UTRAN TDD enhanced cell identification under AWGN propagation conditions

A.8.9.2.1 Test Purpose and Environment

The purpose of this test is to verify that the UE makes correct enhanced reporting of UTRAN cells. This test will partly verify the enhanced UTRA TDD cell identification requirements in clause 8.1.2.4.4 under AWGN propagation conditions.

This test scenario comprised of 1 E-UTRA FDD serving cell, and 1 UTRA TDD cell to be searched. Test parameters are given in Table A.8.9.2.1-1, A.8.9.2.1-2, and A.8.9.2.1-3. In the measurement control information it is indicated to the UE that event-triggered reporting with Event B1 is used. The test consists of two successive time periods, with time duration of T1, and T2 respectively. During time period T1, gaps are activated and an interRAT measurement reporting configuration is configured, and linked to a UTRA measurement object corresponding to channel UARFCN 1. Prior to time duration T2, the UE shall not have any timing information of cell 2. Cell 2 is powered up at the beginning of the T2.

Table A.8.9.2.1-1: General test parameters for E-UTRAN FDD- UTRAN TDD enhanced cell search in AWGN propagation conditions

| Parameter | Unit | Value | Comment |
|---|------|--|---|
| PDSCH parameters (E-UTRAN FDD) | | DL Reference Measurement Channel R.0 FDD | As specified in clause A.3.1.1.1. |
| PCFICH/PDCCH/PHICH parameters (E-UTRAN FDD) | | DL Reference Measurement Channel R.6 FDD | As specified in clause A.3.1.2.1. |
| Gap Pattern Id | | 0 | As specified in TS 36.133 clause 8.1.2.1. |
| Active cell | | Cell 1 | Cell 1 is on E-UTRA RF channel number 1. |
| Neighbour cell | | Cell 2 | Cell 2 is on UTRA RF channel number 1. |
| CP length | | Normal | Applicable to cell 1 |
| E-UTRA RF Channel Number | | 1 | One E-UTRA FDD carrier frequency is used. |
| E-UTRA Channel Bandwidth ($BW_{channel}$) | MHz | 10 | |
| UTRA RF Channel Number | | 1 | One UTRA TDD carrier frequency is used. |
| Inter-RAT (UTRA TDD) measurement quantity | | P-CCPCH RSCP | |
| Thresh | dBm | -83 | Absolute P-CCPCH RSCP threshold for event B1 |
| Hysteresis | dB | 0 | |
| Time To Trigger | ms | 0 | |
| Filter coefficient | | 0 | L3 filtering is not used. |
| DRX | | OFF | |
| Monitored UTRA TDD cell list size | | 12 | UTRA cells on UTRA RF channel 1 provided in the cell list |
| Time offset between cells | ms | 3 | |
| T1 | s | 5 | |
| T2 | s | 2 | |

Table A.8.9.2.1-2: Cell specific test parameters for cell #1 E-UTRAN FDD - UTRAN TDD enhanced cell identification under AWGN propagation conditions

| Parameter | Unit | Cell 1 | |
|---|------|----------|----|
| | | T1 | T2 |
| E-UTRA RF Channel Number | | 1 | |
| $BW_{channel}$ | MHz | 10 | |
| OCNG Patterns defined in A.3.2.1.1 (OP.1 FDD) | | OP.1 FDD | |
| PBCH_RA | dB | 0 | |
| PBCH_RB | dB | | |
| PSS_RA | dB | | |
| SSS_RA | dB | | |
| PCFICH_RB | dB | | |
| PHICH_RA | dB | | |
| PHICH_RB | dB | | |
| PDCCH_RA | dB | | |

| | | | |
|---|------------|------|-----|
| PDCCH_RB | dB | | |
| PDSCH_RA | dB | | |
| PDSCH_RB | dB | | |
| OCNG_RA ^{Note 1} | dB | | |
| OCNG_RB ^{Note 1} | dB | | |
| \hat{E}_s/I_{ot} | dB | 4 | 4 |
| N_{oc} ^{Note 3} | dBm/15 kHz | -98 | |
| \hat{E}_s/N_{oc} | dB | 4 | 4 |
| RSRP ^{Note 4} | dBm/15 kHz | -94 | -94 |
| SCH_RP | dBm/15 kHz | -94 | -94 |
| Propagation Condition | | AWGN | |
| <p>Note 1: OCNG shall be used such that both cells are fully allocated and a constant total transmitted power spectral density is achieved for all OFDM symbols.</p> <p>Note 2: The resources for uplink transmission are assigned to the UE prior to the start of time period T2.</p> <p>Note 3: Interference from other cells and noise sources not specified in the test is assumed to be constant over subcarriers and time and shall be modelled as AWGN of appropriate power for N_{oc} to be fulfilled.</p> <p>Note 4: RSRP levels have been derived from other parameters for information purposes. They are not settable parameters themselves.</p> | | | |

Table A.8.9.2.1-3: Cell specific test parameters for cell #2 E-UTRAN FDD - UTRAN TDD enhanced cell identification under AWGN propagation conditions

| Parameter | Unit | Cell 2 (UTRA TDD) | | | |
|---|--------------|-------------------|--------|-------|-------|
| | | 0 | | DwPTS | |
| Timeslot Number | | T1 | T2 | T1 | T2 |
| UTRA RF Channel Number ^{Note1} | | Channel 1 | | | |
| P-CCPCH_Ec/I _{or} | dB | -4.77 | -4.77 | | |
| DwPCH_Ec/I _{or} | dB | | | 0 | 0 |
| OCNS_Ec/I _{or} ^{Note2} | dB | -1.76 | -1.76 | | |
| \hat{I}_{or}/I_{oc} | dB | -inf | 8 | -inf | 8 |
| I_{oc} | dBm/1.28 MHz | -80 | | | |
| P-CCPCH RSCP ^{Note3} | dBm | -inf | -76.77 | n.a. | n.a. |
| P-CCPCH_Ec/I _o ^{Note3} | dB | -inf | -5.41 | n.a. | n.a. |
| DwPCH_Ec/I _o ^{Note3} | dB | n.a. | n.a. | -inf | -0.64 |
| Propagation Condition | | AWGN | | | |
| <p>Note 1: In the case of multi-frequency cell, the UTRA RF Channel Number is the primary frequency's channel number.</p> <p>Note 2: The power of the OCNS channel that is added shall make the total power from the cell to be equal to I_{or}.</p> <p>Note 3: P-CCPCH RSRP, PCCPCH_Ec/I_o and DwPCH_Ec/I_o levels have been derived from other parameters for information purposes. They are not settable parameters themselves.</p> | | | | | |

A.8.9.2.2 Test Requirements

The UE shall send one Event B1 triggered measurement report, with a measurement reporting delay less than 1120 ms from the beginning of time period T2.

The UE shall not send event triggered measurement reports, as long as the reporting criteria are not fulfilled.

The rate of correct events observed during repeated tests shall be at least 90%.

NOTE: The actual overall delays measured in the test may be up to $2xTTI_{DCCH}$ higher than the measurement reporting delays above because of TTI insertion uncertainty of the measurement report in DCCH.

A.8.10 E-UTRAN TDD – GSM Measurements

A.8.10.1 E-UTRAN TDD – GSM event triggered reporting in AWGN

A.8.10.1.1 Test Purpose and Environment

The purpose of this test is to verify that the UE makes correct reporting of an event when doing inter-RAT (GSM) measurements. This test will partly verify the E-UTRAN TDD - GSM cell search requirements in clause 8.1.2.4.6.

The test parameters are given in Tables A.8.10.1.1-1, A.8.8.1.1-2 and A.8.10.1.1-3 below. In the measurement control information it is indicated to the UE that event-triggered reporting with Event B1 is used. The test consists of two successive time periods, with time duration of T1, and T2 respectively. During time duration T1, the UE shall not have any timing information of cell 2.

Table A.8.10.1.1-1: General test parameters for E-UTRAN TDD-GSM event triggered reporting in AWGN

| Parameter | Unit | Value | Comment |
|---|------|--|--|
| PDSCH parameters (E-UTRAN TDD) | | DL Reference Measurement Channel R.0 TDD | As specified in clause A.3.1.1.2. |
| PCFICH/PDCCH/PHICH parameters (E-UTRAN TDD) | | DL Reference Measurement Channel R.6 TDD | As specified in clause A.3.1.2.2. |
| Gap Pattern Id | | 0 | As specified in TS 36.133 clause 8.1.2.1. |
| Active cell | | Cell 1 | Cell 1 is on E-UTRA RF channel number 1. |
| Neighbour cell | | Cell 2 | Cell 2 is on Absolute RF Channel Number 1 (GSM cell) |
| Special subframe configuration | | 6 | As specified in table 4.2-1 in TS 36.211 |
| Uplink-downlink configuration | | 1 | As specified in table 4.2-2 in TS 36.211 |
| CP length | | Normal | Applicable to cell 1 |
| E-UTRA RF Channel Number | | 1 | One E-UTRA TDD carrier frequency is used. |
| E-UTRA Channel Bandwidth ($BW_{channel}$) | MHz | 10 | |
| Inter-RAT (GSM) measurement quantity | | GSM Carrier RSSI | |
| b1-Threshold-GERAN | dBm | -80 | GSM Carrier RSSI threshold for event B1. |
| Hysteresis | dB | 0 | |
| Time To Trigger | ms | 0 | |
| Filter coefficient | | 0 | L3 filtering is not used. |
| DRX | | OFF | |
| Monitored GSM cell list size | | 6 GSM neighbours including ARFCN 1 | List of GSM cells provided before T2 starts. |
| T1 | s | 5 | |
| T2 | s | 5 | |

Table A.8.10.1.1-2: Cell specific test parameters for E-UTRAN TDD (cell # 1) for event triggered reporting of GSM cell in AWGN

| Parameter | Unit | Cell 1 | |
|--|------|----------|----|
| | | T1 | T2 |
| E-UTRA RF Channel Number | | 1 | |
| $BW_{channel}$ | MHz | 10 | |
| OCNG Pattern defined in A.3.2.2.1 (OP.1 TDD) | | OP.1 TDD | |
| PBCH_RA | dB | 0 | |
| PBCH_RB | dB | | |
| PSS_RA | dB | | |
| SSS_RA | dB | | |
| PCFICH_RB | dB | | |
| PHICH_RA | dB | | |
| PHICH_RB | dB | | |
| PDCCH_RA | dB | | |
| PDCCH_RB | dB | | |
| PDSCH_RA | dB | | |
| PDSCH_RB | dB | | |
| OCNG_RA ^{Note 1} | dB | | |
| OCNG_RB ^{Note 1} | dB | | |

| | | | |
|-----------------------|--|-----|-----|
| \hat{E}_s / I_{ot} | dB | 4 | 4 |
| N_{oc} Note 3 | dBm/15 kHz | -98 | |
| \hat{E}_s / N_{oc} | dB | 4 | 4 |
| RSRP Note 4 | dBm/15 kHz | -94 | -94 |
| SCH_RP | dBm/15 kHz | -94 | -94 |
| Propagation Condition | AWGN | | |
| Note 1: | OCNG shall be used such that both cells are fully allocated and a constant total transmitted power spectral density is achieved for all OFDM symbols. | | |
| Note 2: | The resources for uplink transmission are assigned to the UE prior to the start of time period T2. | | |
| Note 3: | Interference from other cells and noise sources not specified in the test is assumed to be constant over subcarriers and time and shall be modelled as AWGN of appropriate power for N_{oc} to be fulfilled. | | |
| Note 4: | RSRP levels have been derived from other parameters for information purposes. They are not settable parameters themselves. | | |

Table A.8.10.1.1-3: Cell specific test parameters for GSM (cell # 2) for event triggered reporting of GSM cell in AWGN

| Parameter | Unit | Cell 2 | |
|----------------------------|------|-----------|-------|
| | | T1 | T2 |
| Absolute RF Channel Number | | ARFNC 1 | |
| RXLEV | dBm | -Infinity | -75 |
| GSM BSIC | | N/A | Valid |
| Propagation Condition | | AWGN | |

A.8.10.1.2 Test Requirements

The UE shall send one Event B1 triggered measurement report including the valid BSIC of cell # 2, with a measurement reporting delay less than 3120 ms from the beginning of time period T2.

The UE shall not send event triggered measurement reports, as long as the reporting criteria are not fulfilled.

The rate of correct events observed during repeated tests shall be at least 90%.

NOTE 1: The actual overall delays measured in the test may be up to $2 \times TTI_{DCCH}$ higher than the measurement reporting delays above because of TTI insertion uncertainty of the measurement report in DCCH.

NOTE 2: The delay for GSM cell identification with BSIC verified is equal to 3120 ms, which is the sum of the event triggered measurement reporting delay and the initial BSIC identification delay.

The event triggered measurement reporting delay = $2 \times T_{\text{Measurement Period, GSM}} = 2 \times 480\text{ms} = 960\text{ms}$.

Initial BSIC identification delay = 2160 ms.

A.8.10.2 E-UTRAN TDD-GSM event triggered reporting when DRX is used in AWGN

A.8.10.2.1 Test Purpose and Environment

The purpose of these tests is to verify that the UE makes correct reporting of an event in DRX. These tests will partly verify the E-UTRAN TDD-GSM cell search requirements when DRX is used in clause 8.1.2.4.6.

In these tests, there are two cells, one E-UTRAN cell and one GSM cell, and gap pattern configuration # 0 as defined in Table 8.1.2.1-1 is provided.

The common test parameters are given in Table A.8.10.2.1-1. Cell specific test parameters are given in Table A.8.10.2.1-2 for E-UTRAN and in Table A.8.10.2.1-5 for GSM. DRX configuration for Test1 and Test2 are given in Table A.8.10.2.1-3 and time alignment timer and scheduling request related parameters in Table A.8.10.2.1-4.

In Test 1 UE needs to be provided at least once every 500ms with new Timing Advance Command MAC control element to restart the Time alignment timer to keep UE uplink time alignment. Furthermore UE is allocated with PUSCH resource at every DRX

cycle. In Test 2 the uplink time alignment is not maintained and UE needs to use RACH to obtain UL allocation for measurement reporting.

In the measurement control information, it is indicated to the UE that event-triggered reporting with Event B1 is used. The tests consist of two successive time periods, with time duration of T1, and T2 respectively. During time duration T1, the UE shall not have any timing information of cell 2.

Table A.8.10.2.1-1: General test parameters for E-UTRAN TDD-GSM event triggered reporting when DRX is used in AWGN

| Parameter | Unit | Test 1 | Test 2 | Comment |
|---|------|--|--------|--|
| | | Value | | |
| PDSCH parameters (E-UTRAN TDD) | | DL Reference Measurement Channel R.0 TDD | | As specified in clause A.3.1.1.2. Note that UE may only be allocated at <i>On Duration</i> |
| PCFICH/PDCCH/PHICH parameters (E-UTRAN TDD) | | DL Reference Measurement Channel R.6 TDD | | As specified in clause A.3.1.2.2. |
| Gap Pattern Id | | 0 | | As specified in TS 36.133 clause 8.1.2.1. |
| Active cell | | Cell 1 | | Cell 1 is on E-UTRA RF channel number 1. |
| Neighbour cell | | Cell 2 | | Cell 2 is on Absolute RF Channel Number 1 (GSM cell) |
| Special subframe configuration | | 6 | | As specified in table 4.2-1 in TS 36.211. |
| Uplink-downlink configuration | | 1 | | As specified in TS 36.211 clause 4.2 Table 4.2-2 |
| CP length | | Normal | | Applicable to cell 1 |
| E-UTRA RF Channel Number | | 1 | | One E-UTRA TDD carrier frequency is used. |
| E-UTRA Channel Bandwidth ($BW_{channel}$) | MHz | 10 | | |
| Inter-RAT (GSM) measurement quantity | | GSM Carrier RSSI | | |
| B1-Threshold-GERAN | dBm | -80 | | GSM Carrier RSSI threshold for event B1. |
| Hysteresis | dB | 0 | | |
| TimeToTrigger | s | 0 | | |
| Filter coefficient | | 0 | | L3 filtering is not used |
| PRACH configuration | | 4 | | As specified in table 5.7.1-2 in TS 36.211 |
| Access Barring Information | - | Not Sent | | No additional delays in random access procedure. |
| DRX | | ON | | DRX related parameters are defined in Table A.8.10.2.1-3 |
| Monitored GSM cell list size | | 6 GSM neighbours including ARFCN 1 | | List of GSM cells provided before T2 starts. |
| T1 | s | 5 | | |
| T2 | s | 5 | 45 | |

Table A.8.10.2.1-2: Cell specific test parameters for E-UTRAN TDD (cell #1) event triggered reporting of GSM cell when DRX is used in AWGN

| Parameter | Unit | Cell 1 | |
|---|------|----------|----|
| | | T1 | T2 |
| E-UTRA RF Channel Number | | 1 | |
| $BW_{channel}$ | MHz | 10 | |
| OCNG Patterns defined in A.3.2.2.1 (OP.1 TDD) | | OP.1 TDD | |
| PBCH_RA | dB | 0 | |
| PBCH_RB | dB | | |
| PSS_RA | dB | | |
| SSS_RA | dB | | |
| PCFICH_RB | dB | | |
| PHICH_RA | dB | | |
| PHICH_RB | dB | | |
| PDCCH_RA | dB | | |
| PDCCH_RB | dB | | |
| PDSCH_RA | dB | | |
| PDSCH_RB | dB | | |
| OCNG_RA ^{Note 1} | dB | | |

| | | | |
|----------------------------|--|-----|-----|
| OCNG_RB ^{Note 1} | dB | | |
| \hat{E}_s/I_{ot} | dB | 4 | 4 |
| N_{oc} ^{Note 2} | dBm/15 kHz | | |
| RSRP ^{Note 3} | dBm/15 kHz | -94 | -94 |
| SCH_RP | dBm/15 kHz | -94 | -94 |
| \hat{E}_s/N_{oc} | dB | 4 | 4 |
| Propagation Condition | AWGN | | |
| Note 1: | OCNG shall be used such that both cells are fully allocated and a constant total transmitted power spectral density is achieved for all OFDM symbols. | | |
| Note 2: | Interference from other cells and noise sources not specified in the test is assumed to be constant over subcarriers and time and shall be modelled as AWGN of appropriate power for N_{oc} to be fulfilled. | | |
| Note 3: | RSRP and SCH_RP levels have been derived from other parameters for information purposes. They are not settable parameters themselves. | | |

Table A.8.10.2.1-3: drx-Configuration to be used in E-UTRAN TDD-GSM event triggered reporting when DRX is used in AWGN

| Field | Test1 | Test2 | Comment |
|--|---------|---------|---------|
| | Value | Value | |
| onDurationTimer | psf1 | psf1 | |
| drx-InactivityTimer | psf1 | psf1 | |
| drx-RetransmissionTimer | psf1 | psf1 | |
| longDRX-CycleStartOffset | sf40 | sf1280 | |
| shortDRX | Disable | Disable | |
| Note: For further information see clause 6.3.2 in TS 36.331. | | | |

Table A.8.10.2.1-4: TimeAlignmentTimer and sr-ConfigIndex -Configuration to be used in E-UTRAN TDD-GSM event triggered reporting when DRX is used in AWGN

| Field | Test1 | Test2 | Comment |
|--------------------|-------|-------|---|
| | Value | Value | |
| TimeAlignmentTimer | sf500 | sf500 | For further information see clause 6.3.2 in TS 36.331. |
| sr-ConfigIndex | 2 | 2 | For further information see clause 6.3.2 in TS 36.331 and clause 10.1 in TS 36.213. |

Table A.8.10.2.1-5: Cell specific test parameters for GSM (cell # 2) for event triggered reporting of GSM cell when DRX is used in AWGN

| Parameter | Unit | Cell 2 | |
|----------------------------|------|-----------|-------|
| | | T1 | T2 |
| Absolute RF Channel Number | | ARFNC 1 | |
| RXLEV | dBm | -Infinity | -75 |
| GSM BSIC | | N/A | Valid |

A.8.10.2.2 Test Requirements

In Test1 the UE shall send one Event B1 triggered measurement report including BSIC of cell # 2, with a measurement reporting delay less than 3120 ms from the beginning of time period T2. The measurement reporting delay is defined as the time from the beginning of time period T2, to the moment when the UE send the measurement report on PUSCH.

In Test2 the UE shall send one Event B1 triggered measurement report, with a measurement reporting delay less than 42.8 seconds from the beginning of time period T2. The measurement reporting delay is defined as the time from the beginning of time period T2, to the moment when the UE starts to send preambles on the PRACH for scheduling request (SR) to obtain allocation to send the measurement report on PUSCH.

The UE shall not send event triggered measurement reports, as long as the reporting criteria are not fulfilled.

The rate of correct events observed during repeated tests shall be at least 90%.

NOTE 1: The actual overall delays measured in the test may be up to one DRX cycle higher than the measurement reporting delays above because UE is allowed to delay the initiation of the measurement reporting procedure to the next until the Active Time.

NOTE 2: In order to calculate the rate of correct events the system simulator shall verify that it has received correct Event B1 measurement report

A.8.11 Monitoring of Multiple Layers

A.8.11.1 Multiple E-UTRAN FDD-FDD Inter-frequency event triggered reporting under fading propagation conditions

A.8.11.1.1 Test Purpose and Environment

The purpose of this test is to verify that the UE makes correct reporting of multiple events. This test will partly verify the FDD-FDD inter-frequency cell search requirements in clause 8.1.2.3.

The test parameters are given in Tables A.8.11.1.1-1 and A.8.11.1.1-2. In this test, there are three cells on different carrier frequencies and gap pattern configuration # 0 as defined in Table 8.1.2.1-1 is provided.

In the measurement control information, it is indicated to the UE that event-triggered reporting with Event A3 is used. The test consists of two successive time periods, with time duration of T1, and T2 respectively. During time duration T1, the UE shall not have any timing information of cell 2 or cell 3.

Table A. 8.11.1.1-1: General test parameters for Inter-frequency E-UTRA FDD – E-UTRA FDD and E-UTRA FDD cell search under fading

| Parameter | Unit | Value | Comment |
|--|------|--|---|
| PDSCH parameters | | DL Reference Measurement Channel R.0 FDD | As specified in clause A.3.1.1.1 |
| PCFICH/PDCCH/PHICH parameters | | DL Reference Measurement Channel R.6 FDD | As specified in clause A.3.1.2.1 |
| E-UTRA RF Channel Number | | 1, 2, 3 | Three FDD carrier frequencies are used. |
| Channel Bandwidth (BW _{channel}) | MHz | 10 | |
| Active cell | | Cell 1 | Cell 1 is on RF channel number 1 |
| Neighbour cell | | Cell 2 and cell 3 | Cell 2 is on RF channel number 2 and cell 3 is on RF channel number 3 |
| Gap Pattern Id | | 0 | As specified in TS 36.133 clause 8.1.2.1. |
| A3-Offset | dB | -6 | |
| Hysteresis | dB | 0 | |
| CP length | | Normal | |
| TimeToTrigger | s | 0 | |
| Filter coefficient | | 0 | L3 filtering is not used |
| DRX | | OFF | OFF |
| Time offset between E-UTRAN FDD cells | | 3 ms | Asynchronous cells |
| T1 | s | 5 | |
| T2 | s | 10 | |

Table A.8.11.1.1-2: Cell specific test parameters for Inter-frequency E-UTRA FDD – E-UTRA FDD and E-UTRA FDD cell search under fading

| Parameter | Unit | Cell 1 | | Cell 2 | | Cell 3 | |
|--|------|--------|----|---------|----|---------|----|
| | | T1 | T2 | T1 | T2 | T1 | T2 |
| E-UTRA RF Channel Number | | 1 | | 2 | | 3 | |
| BW _{channel} | MHz | 10 | | 10 | | 10 | |
| Correlation Matrix and Antenna Configuration | | 1x2 | | 1x2 Low | | 1x2 Low | |

| OCNG Patterns defined in A.3.2.1.1 (OP.1 FDD) and in A.3.2.1.2 (OP.2 FDD) | | OP.1 FDD | | OP.2 FDD | | OP.2 FDD | |
|---|--|----------|-----|-----------|-----|-----------|-----|
| PBCH_RA | dB | 0 | | 0 | | 0 | |
| PBCH_RB | dB | | | | | | |
| PSS_RA | dB | | | | | | |
| SSS_RA | dB | | | | | | |
| PCFICH_RB | dB | | | | | | |
| PHICH_RA | dB | | | | | | |
| PHICH_RB | dB | | | | | | |
| PDCCH_RA | dB | | | | | | |
| PDCCH_RB | dB | | | | | | |
| PDSCH_RA | dB | | | | | | |
| PDSCH_RB | dB | | | | | | |
| OCNG_RA ^{Note 1} | dB | | | | | | |
| OCNG_RB ^{Note 1} | dB | | | | | | |
| N_{oc} ^{Note 3} | dBm/15 kHz | | | | | | |
| RSRP ^{Note 4} | dBm/15 kHz | -98 | -98 | -Infinity | -95 | -Infinity | -95 |
| \hat{E}_s/I_{ot} | dB | 0 | 0 | -Infinity | 3 | -Infinity | 3 |
| SCH_RP ^{Note 4} | dBm/15 kHz | -98 | -98 | -Infinity | -95 | -Infinity | -95 |
| \hat{E}_s/N_{oc} | dB | 0 | 0 | -Infinity | 3 | -Infinity | 3 |
| Propagation Condition | | AWGN | | ETU70 | | ETU70 | |
| Note 1: | OCNG shall be used such that both cells are fully allocated and a constant total transmitted power spectral density is achieved for all OFDM symbols. | | | | | | |
| Note 2: | The resources for uplink transmission are assigned to the UE prior to the start of time period T2. | | | | | | |
| Note 3: | Interference from other cells and noise sources not specified in the test is assumed to be constant over subcarriers and time and shall be modelled as AWGN of appropriate power for N_{oc} to be fulfilled. | | | | | | |
| Note 4: | RSRP and SCH_RP levels have been derived from other parameters for information purposes. They are not settable parameters themselves. | | | | | | |

A.8.11.1.2 Test Requirements

The UE shall send Event A3 triggered measurement reports for both cell 2 and cell 3, with a measurement reporting delay less than 7680 ms from the beginning of time period T2.

The UE shall not send event triggered measurement reports, as long as the reporting criteria are not fulfilled.

The rate of correct events observed during repeated tests shall be at least 90%.

NOTE: The actual overall delays measured in the test may be up to $2xTTI_{DCCH}$ higher than the measurement reporting delays above because of TTI insertion uncertainty of the measurement report in DCCH.

A.8.11.2 E-UTRAN TDD – E-UTRAN TDD and E-UTRAN TDD Inter-frequency event triggered reporting under fading propagation conditions

A.8.11.2.1 Test Purpose and Environment

The purpose of this test is to verify that the UE makes correct reporting of two events. This test will partly verify the TDD-TDD inter-frequency cell search requirements in clause 8.1.2.3.

The test parameters are given in Tables A.8.11.2.1-1 and A.8.11.2.1-2. In this test, there are three cells on different carrier frequencies and gap pattern configuration # 0 as defined in Table 8.1.2.1-1 is provided.

In the measurement control information, it is indicated to the UE that event-triggered reporting with Event A3 is used. The test consists of two successive time periods, with time duration of T1 and T2 respectively. During time duration T1, the UE shall not have any timing information of cell 2 and cell 3.

Table A.8.11.2.1-1: General test parameters for E-UTRAN TDD - E-UTRAN TDD and E-UTRAN TDD Inter-frequency event triggered reporting under fading propagation conditions

| Parameter | Unit | Value | Comment |
|--------------------------------------|------|--|--|
| PDSCH parameters | | DL Reference Measurement Channel R.0 TDD | As specified in clause A.3.1.1.2 |
| PCFICH/PDCCH/PHICH parameters | | DL Reference Measurement Channel R.6 TDD | As specified in clause A.3.1.2.2 |
| Special subframe configuration | | 6 | As specified in table 4.2-1 in TS 36.211. The same configuration in both cells |
| Uplink-downlink configuration | | 1 | As specified in TS 36.211 clause 4.2 Table 4.2-2 |
| E-UTRA RF Channel Number | | 1, 2, 3 | Three TDD carrier frequencies are used. |
| Channel Bandwidth ($BW_{channel}$) | MHz | 10 | |
| Active cell | | Cell 1 | Cell 1 is on RF channel number 1 |
| Neighbor cells | | Cell 2 and Cell 3 | Cell 2 and 3 are on RF channel numbers 2 and 3 respectively |
| Gap Pattern Id | | 0 | As specified in TS 36.133 clause 8.1.2.1. |
| A3-Offset | dB | -6 | |
| Hysteresis | dB | 0 | |
| CP length | | Normal | |
| TimeToTrigger | s | 0 | |
| Filter coefficient | | 0 | L3 filtering is not used |
| DRX | | OFF | OFF |
| Time offset between cells | | 3 μ s | Synchronous cells |
| T1 | s | 5 | |
| T2 | s | 10 | |

Table A.8.11.2.1-2: Cell specific test parameters for E-UTRAN TDD - E-UTRAN TDD and E-UTRAN TDD Inter-frequency event triggered reporting under fading propagation conditions cells

| Parameter | Unit | Cell 1 | | Cell 2 | | Cell 3 | |
|--|------------|----------|-----|----------|-----|----------|-----|
| | | T1 | T2 | T1 | T2 | T1 | T2 |
| E-UTRA RF Channel Number | | 1 | | 2 | | 3 | |
| $BW_{channel}$ | MHz | 10 | | 10 | | 10 | |
| Correlation Matrix and | | 1x2 | | 1x2 Low | | 1x2 Low | |
| OCNG Patterns defined in A.3.2.2.1 (OP.1 TDD) and in A.3.2.2.2 (OP.2 TDD) | | OP.1 TDD | | OP.2 TDD | | OP.2 TDD | |
| PBCH_RA | dB | 0 | | 0 | | 0 | |
| PBCH_RB | dB | | | | | | |
| PSS_RA | dB | | | | | | |
| SSS_RA | dB | | | | | | |
| PCFICH_RB | dB | | | | | | |
| PHICH_RA | dB | | | | | | |
| PHICH_RB | dB | | | | | | |
| PDCCH_RA | dB | | | | | | |
| PDCCH_RB | dB | | | | | | |
| PDSCH_RA | dB | | | | | | |
| PDSCH_RB | dB | | | | | | |
| OCNG_RA ^{Note 1} | dB | | | | | | |
| OCNG_RB ^{Note 1} | dB | | | | | | |
| N_{oc} ^{Note 3} | dBm/15 kHz | | | | | | |
| RSRP ^{Note 4} | dBm/15 kHz | -98 | -98 | -inf | -95 | -inf | -95 |
| \hat{E}_s / I_{ot} | dB | 0 | 0 | -inf | 3 | -inf | 3 |
| SCH_RP ^{Note 4} | dBm/15 kHz | -98 | -98 | -inf | -95 | -inf | -95 |
| \hat{E}_s / N_{oc} | dB | 0 | 0 | -inf | 3 | -inf | 3 |
| Propagation Condition | | AWGN | | ETU70 | | ETU70 | |
| Note 1: OCNG shall be used such that all cells are fully allocated and a constant total transmitted power spectral density is achieved for all OFDM symbols. | | | | | | | |
| Note 2: The resources for uplink transmission are assigned to the UE prior to the start of time period T2. | | | | | | | |

Note 3: Interference from other cells and noise sources not specified in the test is assumed to be constant over subcarriers and time and shall be modelled as AWGN of appropriate power for N_{oc} to be fulfilled.

Note 4: RSRP and SCH_RP levels have been derived from other parameters for information purposes. They are not settable parameters themselves.

A.8.11.2.2 Test Requirements

The UE shall send one Event A3 triggered measurement report for cell 2 with a measurement reporting delay less than 7680 ms from the beginning of time period T2.

The UE shall send one Event A3 triggered measurement report for cell 3 with a measurement reporting delay less than 7680 ms from the beginning of time period T2.

The UE shall not send event triggered measurement reports, as long as the reporting criteria are not fulfilled.

The rate of correct events observed during repeated tests shall be at least 90%.

NOTE 1: The actual overall delays measured in the test may be up to $2 \times TTI_{DCCH}$ higher than the measurement reporting delays above because of TTI insertion uncertainty of the measurement report in DCCH.

A.8.11.3 E-UTRAN FDD-FDD Inter-frequency and UTRAN FDD event triggered reporting under fading propagation conditions

A.8.11.3.1 Test Purpose and Environment

The purpose of this test is to verify that the UE makes correct reporting of an event when doing inter frequency and UTRAN FDD measurements. This test will partly verify the FDD-FDD inter-frequency cell search requirements in clause 8.1.2.3 and the E-UTRAN FDD- UTRAN FDD cell search requirements in clause 8.1.2.4.1.

The test parameters are given in Tables A.8.11.3.1-1, A.8.11.3.1-2 and A.8.11.3.1-3. In this test, there are two cells on different carrier frequencies and one cell on UTRAN carrier frequency and gap pattern configuration # 0 as defined in Table 8.1.2.1-1 is provided.

In the measurement control information, it is indicated to the UE that event-triggered reporting with Event A3 and B2 is used. The test consists of two successive time periods, with time duration of T1 and T2 respectively. During time duration T1, the UE shall not have any timing information of cell 2 and cell 3.

Table A.8.11.3.1-1: General test parameters for Combined inter-frequency and UTRAN event triggered reporting in fading propagation conditions

| Parameter | Unit | Value | Comment |
|---|------|--|--|
| PDSCH parameters (E-UTRAN FDD) | | DL Reference Measurement Channel R.0 FDD | As specified in clause A.3.1.1.1. |
| PCFICH/PDCCH/PHICH parameters (E-UTRAN FDD) | | DL Reference Measurement Channel R.6 FDD | As specified in clause A.3.1.2.1. |
| Gap Pattern Id | | 0 | As specified in TS 36.133 clause 8.1.2.1. |
| Active cell | | Cell 1 | Cell 1 is on E-UTRA RF channel number 1. |
| Neighbour cells | | Cell 2, 3 | Cell 2 is on E-UTRA RF channel number 2. Cell 3 is on UTRA RF channel number 1. |
| CP length | | Normal | Applicable to cell 1 |
| E-UTRA RF Channel Number | | 1, 2 | Two FDD carrier frequencies are used. |
| E-UTRA Channel Bandwidth (BW _{channel}) | MHz | 10 | |
| UTRA RF Channel Number | | 1 | One UTRA FDD carrier frequency is used. |
| E-UTRAN FDD measurement quantity | | RSRP | |
| Inter-RAT (UTRA FDD) measurement quantity | | CPICH Ec/N0 | |
| A3-Offset | dB | -6 | |
| b2-Threshold-E-UTRA | dB | -86 | RSRP threshold for event B2. |
| b2-Threshold-UTRA | dB | -18 | CPICH Ec/N0 threshold for event B2. |
| Hysteresis | dB | 0 | |
| Time To Trigger | ms | 0 | |
| Filter coefficient | | 0 | L3 filtering is not used. |

| | | | |
|-----------------------------------|---|------|--|
| DRX | | OFF | |
| Monitored UTRA FDD cell list size | | 12 | UTRA cells on UTRA RF channel 1 provided in the cell list. |
| Time offset between cells | | 3 ms | Asynchronous cells |
| T1 | s | 5 | |
| T2 | s | 8 | |

Table A.8.11.3.1-2: Cell specific test parameters for Combined inter-frequency and UTRAN event triggered reporting in fading propagation conditions

| Parameter | Unit | Cell 1 | | Cell 2 | |
|--|------------|----------|-----|-----------|-----|
| | | T1 | T2 | T1 | T2 |
| E-UTRA RF Channel Number | | 1 | | 2 | |
| BW _{channel} | MHz | 10 | | 10 | |
| Correlation Matrix and Antenna Configuration | | 1x2 | | 1x2 Low | |
| OCNG Patterns defined in A.3.2.1.1 (OP.1 FDD) and in A.3.2.1.2 (OP.2 FDD) | | OP.1 FDD | | OP.2 FDD | |
| PBCH_RA | dB | 0 | | 0 | |
| PBCH_RB | dB | | | | |
| PSS_RA | dB | | | | |
| SSS_RA | dB | | | | |
| PCFICH_RB | dB | | | | |
| PHICH_RA | dB | | | | |
| PHICH_RB | dB | | | | |
| PDCCH_RA | dB | | | | |
| PDCCH_RB | dB | | | | |
| PDSCH_RA | dB | | | | |
| PDSCH_RB | dB | | | | |
| OCNG_RA ^{Note 1} | dB | | | | |
| OCNG_RB ^{Note 1} | dB | | | | |
| N_{oc} ^{Note 3} | dBm/15 kHz | | | | |
| RSRP ^{Note 4} | dBm/15 kHz | -94 | -94 | -Infinity | -91 |
| \hat{E}_s/I_{ot} | dB | 4 | 4 | -Infinity | 7 |
| SCH_RP ^{Note 4} | dBm/15 kHz | -94 | -94 | -Infinity | -91 |
| \hat{E}_s/N_{oc} | dB | 4 | 4 | -Infinity | 7 |
| Propagation Condition | | AWGN | | ETU70 | |
| <p>Note 1: OCNG shall be used such that both cells are fully allocated and a constant total transmitted power spectral density is achieved for all OFDM symbols.</p> <p>Note 2: The resources for uplink transmission are assigned to the UE prior to the start of time period T2.</p> <p>Note 3: Interference from other cells and noise sources not specified in the test is assumed to be constant over subcarriers and time and shall be modelled as AWGN of appropriate power for N_{oc} to be fulfilled.</p> <p>Note 4: RSRP and SCH_RP levels have been derived from other parameters for information purposes. They are not settable parameters themselves.</p> | | | | | |

Table A.8.11.3.1-3: Cell specific test parameters for UTRAN FDD (cell # 3) for event triggered reporting of UTRAN FDD cell under fading propagation conditions

| Parameter | Unit | Cell 3 | |
|---------------------------|------|-----------|------|
| | | T1 | T2 |
| UTRA RF Channel Number | | 1 | |
| CPICH_Ec/I _{or} | dB | -10 | |
| PCCPCH_Ec/I _{or} | dB | -12 | |
| SCH_Ec/I _{or} | dB | -12 | |
| PICH_Ec/I _{or} | dB | -15 | |
| DPCH_Ec/I _{or} | dB | N/A | |
| OCNS | | -0.941 | |
| \hat{I}_{or}/I_{oc} | dB | -Infinity | -1.8 |

| | | | |
|-----------------------|--|-----------------|-----|
| I_{oc} | dBm/3.84 MHz | -70 | |
| CPICH_Ec/Io | dB | -Infinity | -14 |
| Propagation Condition | | Case 5 (Note 3) | |
| Note 1: | The DPCH level is controlled by the power control loop. | | |
| Note 2: | The power of the OCNS channel that is added shall make the total power from the cell to be equal to I_{or} . | | |
| Note 3: | Case 5 propagation conditions are defined in Annex A of TS 25.101. | | |

A.8.11.3.2 Test Requirements

The UE shall send one Event A3 triggered measurement report, with a measurement reporting delay less than 7680 ms from the beginning of time period T2.

The UE shall send one Event B2 triggered measurement report, with a measurement reporting delay less than 4800 ms from the beginning of time period T2.

The UE shall not send event triggered measurement reports, as long as the reporting criteria are not fulfilled.

The rate of correct events observed during repeated tests shall be at least 90%.

NOTE: The actual overall delays measured in the test may be up to $2 \times TTI_{DCCH}$ higher than the measurement reporting delays above because of TTI insertion uncertainty of the measurement report in DCCH.

A.8.11.4 InterRAT E-UTRA TDD to E-UTRA TDD and UTRA TDD cell search test case

A.8.11.4.1 Test Purpose and Environment

This test is to verify that the UE makes correct reporting of an event when doing inter frequency measurements and UTRA TDD measurements. The test will partly verify the requirements in clause 8.1.2.3.2 combined 8.1.2.4.3 under fading propagation conditions.

This test scenario comprised of 2 E-UTRA TDD cells operating on different frequency, and 1 UTRA TDD cell. Test parameters are given in table A.8.11.4.1-1, A.8.11.4.1-2, and A.8.11.4.1-3. Gap pattern configuration #0 as defined in clause 8.1.2.1 is provided.

The test consists of 2 successive time periods, with time duration T1 and T2. In the measurement control information it is indicated to the UE that event-triggered reporting with Event A3 and B2 shall be used.

Table A.8.11.4.1-1: General test parameters for combined E-UTRA TDD inter-frequency and UTRA TDD cells search under fading propagation conditions

| Parameter | Unit | Value | Comment |
|---|------|--|--|
| PDSCH parameters | | DL Reference Measurement Channel R.0 TDD | As specified in clause A.3.1.1.2 |
| PCFICH/PDCCH/PHICH parameters | | DL Reference Measurement Channel R.6 TDD | As specified in clause A.3.1.2.2 |
| Active cell | | Cell 1 | E-UTRA TDD cell is on RF channel number 1 |
| Neighbour cell | | Cell 2 | E-UTRA TDD cell is on RF channel number 2 |
| | | Cell 3 | 1.28Mcps TDD cell |
| CP length of cell1 and cell2 | | Normal | |
| Uplink-downlink configuration of cell1 and cell2 | | 1 | As specified in Table 4.2-2 in TS 36.211. The same configuration in both cells |
| Special subframe configuration of cell1 and cell2 | | 6 | As specified in table 4.2-1 in TS 36.211. The same configuration in both cells |
| Gap Pattern Id | | 0 | As specified in TS 36.133 clause 8.1.2.1. |
| E-UTRAN TDD measurement quantity | | RSRP | |
| UTRAN TDD measurement quantity | | RSCP | |
| DRX | | OFF | |

| | | | |
|---------------------------------------|-----|-----|---|
| Ofn | dB | 0 | Parameter for A3 and B2 event |
| Ocn | dB | 0 | Parameter for A3 event |
| Hysteresis | dB | 0 | Parameter for A3 and B2 event |
| Ofs | dB | 0 | Parameter for A3 event |
| Ocs | dB | 0 | Parameter for A3 event |
| A3-Offset | dB | -6 | Parameter for A3 event |
| Thresh1 | dBm | -86 | Absolute E-UTRAN RSRP threshold for event B2 |
| Thresh2 | dBm | -84 | Absolute UTRAN RSCP threshold for event B2 |
| TimeToTrigger | s | 0 | |
| Filter coefficient | | 0 | L3 filtering is not used |
| Time offset between E-UTRAN TDD cells | μs | 3 | Synchronous cells |
| T1 | s | >5 | During T1, cell 2 and cell 3 shall be powered off. During the off time the physical layer cell identity of cell 2 shall be changed, and the primary scrambling code of cell 3 shall be changed. |
| T2 | s | 15 | |

Table A.8.11.4.1-2: Cell specific test parameters for combined E-UTRAN TDD inter-frequency and UTRA TDD cell search under fading propagation conditions(cell1 and cell2)

| Parameter | Unit | Cell 1 | | Cell 2 | |
|--|------------|----------|-----|-----------|-----|
| | | T1 | T2 | T1 | T2 |
| E-UTRA RF Channel Number | | 1 | | 2 | |
| BWchannel | MHz | 10 | | 10 | |
| Correlation Matrix and Antenna Configuration | | 1x2 | | 1x2 Low | |
| OCNG Pattern defined in A.3.2.2.1 (OP.1 TDD) and in A.3.2.2.2 (OP.2) | | OP.1 TDD | | OP.2 TDD | |
| PBCH_RA | dB | 0 | | 0 | |
| PBCH_RB | dB | | | | |
| PSS_RA | dB | | | | |
| SSS_RA | dB | | | | |
| PCFICH_RB | dB | | | | |
| PHICH_RA | dB | | | | |
| PHICH_RB | dB | | | | |
| PDCCH_RA | dB | | | | |
| PDCCH_RB | dB | | | | |
| PDSCH_RA | dB | | | | |
| PDSCH_RB | dB | | | | |
| OCNG_RANote 1 | dB | | | | |
| OCNG_RBNote 1 | dB | | | | |
| \hat{E}_s / I_{ot} | dB | | | | |
| \hat{E}_s / N_{oc} | dB | 4 | 4 | -Infinity | 7 |
| N_{oc} | dBm/15 kHz | -98 | | | |
| RSRP | dBm/15 kHz | -94 | -94 | -Infinity | -91 |
| SCH_RP | dBm/15 kHz | -94 | -94 | -infinity | -91 |
| Propagation Condition | | AWGN | | ETU70 | |
| <p>Note 1: OCNG shall be used such that both cells are fully allocated and a constant total transmitted power spectral density is achieved for all OFDM symbols.</p> <p>Note 2: The resources for uplink transmission are assigned to the UE priori to the start of time period T2.</p> <p>Note 3: RSRP and SCH_RP levels have been derived from other parameters for information purposes. They are not settable parameters themselves.</p> | | | | | |

Table A.8.11.4.1-3: Cell specific test parameters for combined E-UTRA TDD inter-frequency and UTRA TDD cell search under fading propagation conditions(cell3)

| Parameter | Unit | Cell 3 (UTRA) | |
|-----------------|------|---------------|-------|
| Timeslot Number | | 0 | DwPTS |

| | | T1 | T2 | T1 | T2 |
|-------------------------|--|-----------|-----|-----------|----|
| UTRA RF Channel Number* | | Channel 3 | | | |
| PCCPCH_Ec/Ior | dB | -3 | | | |
| DwPCH_Ec/Ior | dB | | | 0 | |
| OCNS_Ec/Ior | dB | -3 | | | |
| \hat{I}_{or}/I_{oc} | dB | -Infinity | 9 | -Infinity | 9 |
| I_{oc} | dBm/1.28 MHz | -80 | | | |
| PCCPCH RSCP | dBm | -Infinity | -74 | n.a. | |
| Propagation Condition | | Case 3 | | | |
| Note1: | The DPCH of all cells are located in a timeslot other than 0. | | | | |
| Note2: | In the case of multi-frequency network, the UTRA RF Channel Number can be set for the primary frequency in this test. | | | | |
| Note3: | P-CCPCH RSCP levels have been derived from other parameters for information purposes. They are not settable parameters themselves. | | | | |

A.8.11.4.2 Test Requirements

The UE shall send one Event A3 triggered measurement report, with a measurement reporting delay less than 7680ms from the beginning of time period T2.

The UE shall send one Event B2 triggered measurement report, with a measurement reporting delay less than 12.8s from the beginning of time period T2.

The UE shall not send event triggered measurement reports, as long as the reporting criteria are not fulfilled.

The rate of correct events observed during repeated tests shall be at least 90%.

NOTE: The actual overall delays measured in the test may be up to $2 \times TTI_{DCCCH}$ higher than the measurement reporting delays above because of TTI insertion uncertainty of the measurement report in DCCCH.

A.8.11.5 Combined E-UTRAN FDD – E-UTRA FDD and GSM cell search. E-UTRA cells in fading; GSM cell in static propagation conditions

A.8.11.5.1 Test Purpose and Environment

The purpose of this test is to verify that the UE makes correct reporting of multiple events when doing inter frequency and GSM measurements. This test will partly verify the E-UTRAN FDD-FDD inter-frequency cell search requirements in clause 8.1.2.3.1 and simultaneously the E-UTRAN FDD- GSM cell search requirements in clause 8.1.2.4.5.

The test parameters are given in Tables A.8.11.5.1-1, A.8.11.5.1-2 and A.8.11.5.1-3. In this test, there are two cells on different carrier frequencies and one GSM cell. Gap pattern configuration # 0 as defined in Table 8.1.2.1-1 is provided.

In the measurement control information, it is indicated to the UE that event-triggered reporting with Event A3 and B2 is used. The test consists of two successive time periods, with time duration of T1 and T2 respectively. During time duration T1, the UE shall not have any timing information of cell 2 and cell 3.

Table A.8.11.5.1-1: General test parameters for combined E-UTRAN FDD – E-UTRA FDD and GSM cell search. E-UTRA cells in fading; GSM cell in static propagation conditions

| Parameter | Unit | Value | Comment |
|---|------|--|---|
| PDSCH parameters (E-UTRAN FDD) | | DL Reference Measurement Channel R.0 FDD | As specified in clause A.3.1.1.1. |
| PCFICH/PDCCH/PHICH parameters (E-UTRAN FDD) | | DL Reference Measurement Channel R.6 FDD | As specified in clause A.3.1.2.1. |
| Gap Pattern Id | | 0 | As specified in TS 36.133 clause 8.1.2.1. |
| Active cell | | Cell 1 | Cell 1 is on E-UTRA RF channel number 1. |
| Neighbour cells | | Cell 2, 3 | Cell 2 is on E-UTRA RF channel number 2. Cell 3 is on Absolute RF Channel Number 3 (GSM cell). |
| CP length | | Normal | Applicable to cell 1 and cell 2 |

| | | | |
|---|-----|------------------------------------|---|
| E-UTRA Channel Bandwidth ($BW_{channel}$) | MHz | 10 | |
| E-UTRAN FDD measurement quantity | | RSRP | |
| Hysteresis | dB | 0 | Parameter for A3 and B2 event |
| A3-Offset | dB | -6 | |
| TimeToTrigger | s | 0 | |
| Filter coefficient | | 0 | L3 filtering is not used |
| DRX | | OFF | OFF |
| Time offset between E-UTRAN FDD cells | ms | 3 ms | Asynchronous cells |
| Inter-RAT (GSM) measurement quantity | | GSM Carrier RSSI | |
| b2-Threshold-E-UTRA | dBm | -83 | RSRP threshold for event B2. This is the threshold for E-UTRA in the B2 configuration. E-UTRA PCell RSRP is below this throughout the test to account for measurement accuracy and fading |
| b2-Threshold-GERAN | dBm | -80 | GSM Carrier RSSI threshold for event B2. |
| Monitored GSM cell list size | | 6 GSM neighbours including ARFCN 3 | List of GSM cells provided before T2 starts. |
| T1 | s | 5 | |
| T2 | s | 10 | |

Table A.8.11.5.1-2: Cell specific test parameters for E-UTRAN FDD cells for combined E-UTRAN FDD – E-UTRA FDD and GSM cell search. E-UTRA cells in fading; GSM cell in static propagation conditions

| Parameter | Unit | Cell 1 | | Cell 2 | |
|---|------------|----------|-----|-----------|-----|
| | | T1 | T2 | T1 | T2 |
| E-UTRA RF Channel Number | | 1 | | 2 | |
| $BW_{channel}$ | MHz | 10 | | 10 | |
| Correlation Matrix and Antenna Configuration | | 1x2 Low | | 1x2 Low | |
| OCNG Patterns defined in A.3.2.1.1 (OP.1 FDD) and in A.3.2.1.2 (OP.2 FDD) | | OP.1 FDD | | OP.2 FDD | |
| PBCH_RA | dB | 0 | | 0 | |
| PBCH_RB | dB | | | | |
| PSS_RA | dB | | | | |
| SSS_RA | dB | | | | |
| PCFICH_RB | dB | | | | |
| PHICH_RA | dB | | | | |
| PHICH_RB | dB | | | | |
| PDCCH_RA | dB | | | | |
| PDCCH_RB | dB | | | | |
| PDSCH_RA | dB | | | | |
| PDSCH_RB | dB | | | | |
| OCNG_RA ^{Note 1} | dB | | | | |
| OCNG_RB ^{Note 1} | dB | | | | |
| N_{oc} ^{Note 3} | dBm/15 kHz | | | | |
| RSRP ^{Note 4} | dBm/15 kHz | -94 | -94 | -Infinity | -91 |
| \hat{E}_s / I_{ot} | dB | 4 | 4 | -Infinity | 7 |
| SCH_RP ^{Note 4} | dBm/15 kHz | -94 | -94 | -Infinity | -91 |
| \hat{E}_s / N_{oc} | dB | 4 | 4 | -Infinity | 7 |
| Propagation Condition | | ETU70 | | ETU70 | |

| | |
|---------|--|
| Note 1: | OCNG shall be used such that both cells are fully allocated and a constant total transmitted power spectral density is achieved for all OFDM symbols. |
| Note 2: | The resources for uplink transmission are assigned to the UE prior to the start of time period T2. |
| Note 3: | Interference from other cells and noise sources not specified in the test is assumed to be constant over subcarriers and time and shall be modelled as AWGN of appropriate power for N_{oc} to be fulfilled. |
| Note 4: | RSRP and SCH_RP levels have been derived from other parameters for information purposes. They are not settable parameters themselves. |

Table A.8.11.5.1-3: Cell specific test parameters for GSM (cell # 3) for combined E-UTRAN FDD – E-UTRA FDD and GSM cell search. E-UTRA cells in fading; GSM cell in static propagation conditions

| Parameter | Unit | Cell 3 | |
|----------------------------|------|-----------|-------|
| | | T1 | T2 |
| Absolute RF Channel Number | | ARFCN3 | |
| RXLEV | dBm | -Infinity | -75 |
| GSM BSIC | | N/A | Valid |

A.8.11.5.2 Test Requirements

The UE shall send one Event A3 triggered measurement report for cell 2, with a measurement reporting delay less than 7680 ms from the beginning of time period T2.

The UE shall send one Event B2 triggered measurement report including BSIC of cell 3, with a measurement reporting delay less than 7200 ms from the beginning of time period T2.

The UE shall not send event triggered measurement reports, as long as the reporting criteria are not fulfilled.

The rate of correct events observed during repeated tests shall be at least 90%.

NOTE 1: The actual overall delays measured in the test may be up to $2 \times TTI_{DCCH}$ higher than the measurement reporting delays above because of TTI insertion uncertainty of the measurement report in DCCH.

NOTE 2: The delay for GSM cell identification with BSIC verified is equal to 7200 ms, which is the sum of the event triggered measurement reporting delay and the initial BSIC identification delay.

The event triggered measurement reporting delay = $2 \times T_{\text{Measurement Period, GSM}} = 2 \times N_{\text{freq}} \times 480 \text{ms} = 1920 \text{ms}$.

Initial BSIC identification delay = 5280 ms, when one carrier frequency other than GSM is monitored in the gaps.

A.8.11.6 Combined E-UTRAN TDD – E-UTRA TDD and GSM cell search. E-UTRA cells in fading; GSM cell in static propagation conditions

A.8.11.6.1 Test Purpose and Environment

The purpose of this test is to verify that the UE makes correct reporting of multiple events when doing inter frequency and GSM measurements. This test will partly verify the E-UTRAN TDD-TDD inter-frequency cell search requirements in clause 8.1.2.3.2 and simultaneously the E-UTRAN TDD- GSM cell search requirements in clause 8.1.2.4.6.

The test parameters are given in Tables A.8.11.6.1-1, A.8.11.6.1-2 and A.8.11.6.1-3. In this test, there are two cells on different carrier frequencies and one GSM cell. Gap pattern configuration # 0 as defined in Table 8.1.2.1-1 is provided.

In the measurement control information, it is indicated to the UE that event-triggered reporting with Event A3 and B2 is used. The test consists of two successive time periods, with time duration of T1 and T2 respectively. During time duration T1, the UE shall not have any timing information of cell 2 and cell 3.

Table A.8.11.6.1-1: General test parameters for combined E-UTRAN TDD – E-UTRA TDD and GSM cell search. E-UTRA cells in fading; GSM cell in static propagation conditions

| Parameter | Unit | Value | Comment |
|---|---------|--|---|
| PDSCH parameters (E-UTRAN TDD) | | DL Reference Measurement Channel R.0 TDD | As specified in clause A.3.1.1.2. |
| PCFICH/PDCCH/PHICH parameters (E-UTRAN TDD) | | DL Reference Measurement Channel R.6 TDD | As specified in clause A.3.1.2.2. |
| Special subframe configuration of cell1 and cell2 | | 6 | As specified in table 4.2-1 in TS 36.211. The same configuration in both cells |
| Uplink-downlink configuration of cell1 and cell2 | | 1 | As specified in TS 36.211 clause 4.2 Table 4.2-2 |
| Gap Pattern Id | | 0 | As specified in TS 36.133 clause 8.1.2.1. |
| Active cell | | Cell 1 | Cell 1 is on E-UTRA RF channel number 1. |
| Neighbour cells | | Cell 2, 3 | Cell 2 is on E-UTRA RF channel number 2. Cell 3 is on Absolute RF Channel Number 3 (GSM cell). |
| CP length | | Normal | Applicable to cell 1 and cell 2 |
| E-UTRA Channel Bandwidth ($BW_{channel}$) | MHz | 10 | |
| E-UTRAN TDD measurement quantity | | RSRP | |
| Hysteresis | dB | 0 | Parameter for A3 and B2 event |
| A3-Offset | dB | -6 | |
| TimeToTrigger | s | 0 | |
| Filter coefficient | | 0 | L3 filtering is not used |
| DRX | | OFF | OFF |
| Time offset between E-UTRAN TDD cells | μ s | 3 | Synchronous cells |
| Inter-RAT (GSM) measurement quantity | | GSM Carrier RSSI | |
| b2-Threshold-E-UTRA | dBm | -83 | RSRP threshold for event B2. This is the threshold for E-UTRA in the B2 configuration. E-UTRA PCell RSRP is below this throughout the test to account for measurement accuracy and fading |
| b2-Threshold-GERAN | dBm | -80 | GSM Carrier RSSI threshold for event B2. |
| Monitored GSM cell list size | | 6 GSM neighbours including ARFCN 3 | List of GSM cells provided before T2 starts. |
| T1 | s | 5 | |
| T2 | s | 10 | |

Table A.8.11.6.1-2: Cell specific test parameters for E-UTRAN TDD cells for combined E-UTRAN TDD – E-UTRA TDD and GSM cell search. E-UTRA cells in fading; GSM cell in static propagation conditions

| Parameter | Unit | Cell 1 | | Cell 2 | |
|---|------|----------|----|----------|----|
| | | T1 | T2 | T1 | T2 |
| E-UTRA RF Channel Number | | 1 | | 2 | |
| $BW_{channel}$ | MHz | 10 | | 10 | |
| Correlation Matrix and Antenna Configuration | | 1x2 Low | | 1x2 Low | |
| OCNG Patterns defined in A.3.2.2.1 (OP.1 TDD) and in A.3.2.2.2 (OP.2 TDD) | | OP.1 TDD | | OP.2 TDD | |
| PBCH_RA | dB | 0 | | 0 | |
| PBCH_RB | dB | | | | |
| PSS_RA | dB | | | | |
| SSS_RA | dB | | | | |
| PCFICH_RB | dB | | | | |
| PHICH_RA | dB | | | | |
| PHICH_RB | dB | | | | |
| PDCCH_RA | dB | | | | |
| PDCCH_RB | dB | | | | |
| PDSCH_RA | dB | | | | |

| | | | | | |
|--|------------|-------|-----|-----------|-----|
| PDSCH_RB | dB | | | | |
| OCNG_RA ^{Note 1} | dB | | | | |
| OCNG_RB ^{Note 1} | dB | | | | |
| N_{oc} ^{Note 3} | dBm/15 kHz | -98 | | | |
| RSRP ^{Note 4} | dBm/15 kHz | -94 | -94 | -Infinity | -91 |
| \hat{E}_s/I_{ot} | dB | 4 | 4 | -Infinity | 7 |
| SCH_RP ^{Note 4} | dBm/15 kHz | -94 | -94 | -Infinity | -91 |
| \hat{E}_s/N_{oc} | dB | 4 | 4 | -Infinity | 7 |
| Propagation Condition | | ETU70 | | ETU70 | |
| Note 1: OCNG shall be used such that both cells are fully allocated and a constant total transmitted power spectral density is achieved for all OFDM symbols. | | | | | |
| Note 2: The resources for uplink transmission are assigned to the UE prior to the start of time period T2. | | | | | |
| Note 3: Interference from other cells and noise sources not specified in the test is assumed to be constant over subcarriers and time and shall be modelled as AWGN of appropriate power for N_{oc} to be fulfilled. | | | | | |
| Note 4: RSRP and SCH_RP levels have been derived from other parameters for information purposes. They are not settable parameters themselves. | | | | | |

Table A.8.11.6.1-3: Cell specific test parameters for GSM (cell # 3) for combined E-UTRAN TDD – E-UTRA TDD and GSM cell search. E-UTRA cells in fading; GSM cell in static propagation conditions

| Parameter | Unit | Cell 3 | |
|----------------------------|------|-----------|-------|
| | | T1 | T2 |
| Absolute RF Channel Number | | ARFCN3 | |
| RXLEV | dBm | -Infinity | -75 |
| GSM BSIC | | N/A | Valid |

A.8.11.6.2 Test Requirements

The UE shall send one Event A3 triggered measurement report for cell 2, with a measurement reporting delay less than 7680 ms from the beginning of time period T2.

The UE shall send one Event B2 triggered measurement report including BSIC of cell 3, with a measurement reporting delay less than 7200 ms from the beginning of time period T2.

The UE shall not send event triggered measurement reports, as long as the reporting criteria are not fulfilled.

The rate of correct events observed during repeated tests shall be at least 90%.

NOTE 1: The actual overall delays measured in the test may be up to $2 \times TTI_{DCCH}$ higher than the measurement reporting delays above because of TTI insertion uncertainty of the measurement report in DCCH.

NOTE 2: The delay for GSM cell identification with BSIC verified is equal to 7200 ms, which is the sum of the event triggered measurement reporting delay and the initial BSIC identification delay.

The event triggered measurement reporting delay = $2 \times T_{\text{Measurement Period, GSM}} = 2 \times N_{\text{freq}} \times 480 \text{ms} = 1920 \text{ms}$.

Initial BSIC identification delay = 5280 ms, when one carrier frequency other than GSM is monitored in the gaps.

A.8.12 RSTD Intra-frequency Measurements

A.8.12.1 E-UTRAN FDD intra-frequency RSTD measurement reporting delay test case

A.8.12.1.1 Test Purpose and Environment

The purpose of the test is to verify that the RSTD measurement meets the requirements specified in Clause 8.1.2.5.1 in an environment with fading propagation conditions.

In the test there are three synchronous cells: Cell 1, Cell 2 and Cell 3. Cell 1 is the reference as well as the PCell. Cell 2 and Cell 3 are the neighbour cells. All cells are on the same RF channel.

The test consists of three consecutive time intervals, with duration of T1, T2 and T3. Cell 1 is active in T1, T2 and T3, whilst Cell 2 and Cell 3 are activated only in the beginning of T2. Cell 2 is active until the end of T3, and Cell 3 is active until the end of T2. The beginning of the time interval T2 shall be aligned with the first PRS positioning subframe of a positioning occasion in the reference cell, where the PRS positioning occasion is as defined in Clause 8.1.2.5.1. Cell 1 transmits PRS in T2, while Cell 2 transmits PRS only in T3, and Cell 3 transmits PRS only in T2. Note: The information on when PRS is muted is conveyed to the UE using PRS muting information.

The OTDOA assistance data as defined in TS 36.355, Clause 6.5.1, shall be provided to the UE during T1. The last TTI containing the OTDOA assistance data shall be provided to the UE ΔT ms before the start of T2, where $\Delta T = 150$ ms is the maximum processing time of the OTDOA assistance data.

The test parameters are as given in Table A.8.12.1.1-1, Table A.8.12.1.1-2, Table A.8.12.1.1-3 and Table A.8.12.1.1-4.

Table A.8.12.1.1-1: General test parameters for E-UTRAN FDD intra-frequency RSTD measurement reporting delay under fading propagation conditions

| Parameter | Unit | Value | Comment |
|---|---------------|---|---|
| Reference cell | | Cell 1 | Reference cell is the cell in the OTDOA assistance data with respect to which the RSTD measurement is defined, as specified in TS 36.214 [4] and TS 36.355 [24]. The reference cell is the PCell in this test case. |
| Neighbor cells | | Cell 2 and Cell 3 | Cell 2 and Cell 3 appear at random places in the neighbour cell list in the OTDOA assistance data, but Cell 2 always appears in the first half of the list, whilst Cell 3 appears in the second half of the list. |
| PCFICH/PDCCH/PHICH parameters | | DL Reference Measurement Channel R.6 FDD | As specified in clause A.3.1.2.1 |
| Channel Bandwidth (BW_{channel}) | MHz | 10 | |
| PRS Transmission Bandwidth | RB | 50 | PRS are transmitted over the system bandwidth |
| PRS configuration index I_{PRS} | | 171 | This corresponds to periodicity of 320 ms and PRS subframe offset of $I_{\text{PRS}} - 160$ DL subframes, as defined in TS 36.211 [16], Table 6.10.4.3-1 |
| Number of consecutive downlink positioning subframes N_{PRS} | | 1 | As defined in TS 36.211 [16]. The number of subframes in a positioning occasion |
| Physical cell ID PCI | | (PCI of Cell 1 – PCI of Cell 2) mod 6 = 0 and (PCI of Cell 1 – PCI of Cell 3) mod 6 = 0 | The cell PCIs are selected such that the relative shifts of PRS patterns among cells are as given by the test parameters |
| CP length | | Normal | |
| DRX | | ON | DRX parameters are further specified in Table A.8.12.1.1-3 |
| Radio frame receive time offset between the cells at the UE antenna connector | μs | Cell 2 to Cell 1: 1 Cell 3 to Cell 1: -1 | PRS are transmitted from synchronous cells |
| Expected RSTD | μs | Cell 2: 3 Cell 3: 3 Other neighbour cells: randomly between -3 and 3 | The expected RSTD is what is expected at the receiver. The corresponding parameter in the OTDOA assistance data specified in TS 36.355 [24] is the expectedRSTD indicator |
| Expected RSTD uncertainty for all neighbour cells | μs | 5 | The corresponding parameter in the OTDOA assistance data specified in TS 36.355 [24] is the expectedRSTD-Uncertainty index |
| Number of cells provided in OTDOA assistance data | | 16 | Including the reference cell |

| | | | |
|-----------------|---|--|---|
| PRS muting info | | Cell 1: '11110000' Cell 2: '00001111' Cell 3: '11110000' | Corresponds to prs-MutingInfo defined in TS 36.355 [24] |
| T1 | s | 3 | The length of the time interval from the beginning of each test |
| T2 | s | 1.28 | The length of the time interval that follows immediately after time interval T1 |
| T3 | s | 1.28 | The length of the time interval that follows immediately after time interval T2 |

Table A.8.12.1.1-2: Cell-specific test parameters for E-UTRAN FDD intra-frequency RSTD measurement reporting delay under fading propagation conditions during T1

| Parameter | Unit | Cell 1 | Cell 2 | Cell 3 |
|---|----------------|-----------|-----------|-----------|
| E-UTRA RF Channel Number | | 1 | 1 | 1 |
| Correlation Matrix and Antenna Configuration | | 1x2 Low | 1x2 Low | 1x2 Low |
| OCNG patterns defined in A.3.2.1 | | OP.5 FDD | N/A | N/A |
| PBCH_RA | dB | 0 | N/A | N/A |
| PBCH_RB | | | | |
| PSS_RA | | | | |
| SSS_RA | | | | |
| PCFICH_RB | | | | |
| PHICH_RA | | | | |
| PHICH_RB | | | | |
| PDCCH_RA | | | | |
| PDCCH_RB | | | | |
| OCNG_RA ^{Note 1} | | | | |
| OCNG_RB ^{Note 1} | | | | |
| N_{oc} ^{Note 3} | dBm/ 15 kHz | -95 | | |
| PRS \hat{E}_s/N_{oc} | dB | -Infinity | -Infinity | -Infinity |
| I_o ^{Note 4} | dBm/ 9 MHz | -67.22 | -67.22 | -67.22 |
| \hat{E}_s/N_{oc} | dB | 0 | -Infinity | -Infinity |
| Propagation Condition | | ETU30 | | |
| <p>Note 1: OCNG shall be used such that active cell (Cell 1) is fully allocated and a constant total transmitted power spectral density is achieved for all OFDM symbols.</p> <p>Note 2: The resources for uplink transmission are assigned to the UE prior to the start of time period T2.</p> <p>Note 3: Interference from other cells and noise sources not specified in the test are assumed to be constant over subcarriers and time and shall be modelled as AWGN of appropriate power for N_{oc} to be fulfilled.</p> <p>Note 4: I_o levels have been derived from other parameters and are given for information purpose. These are not settable test parameters.</p> | | | | |

Table A.8.12.1.1-3: Cell-specific test parameters for E-UTRAN FDD intra-frequency RSTD measurement reporting delay under fading propagation conditions during T2 and T3

| Parameter | Unit | Cell 1 | | Cell 2 | | Cell 3 | |
|--|------|----------|----|----------|----|----------|-----|
| | | T2 | T3 | T2 | T3 | T2 | T3 |
| E-UTRA RF Channel Number | | 1 | | 1 | | 1 | |
| Correlation Matrix and Antenna Configuration | | 1x2 Low | | 1x2 Low | | 1x2 Low | |
| OCNG patterns defined in A.3.2.1 | | OP.5 FDD | | OP.6 FDD | | OP.6 FDD | N/A |
| PBCH_RA | dB | 0 | | 0 | | 0 | N/A |

| | | | | | | | |
|---|----------------|--------|-----------|-----------|--------|--------|-----------|
| PBCH_RB | | | | | | | |
| PSS_RA | | | | | | | |
| SSS_RA | | | | | | | |
| PCFICH_RB | | | | | | | |
| PHICH_RA | | | | | | | |
| PHICH_RB | | | | | | | |
| PDCCH_RA | | | | | | | |
| PDCCH_RB | | | | | | | |
| OCNG_RA ^{Note 1} | | | | | | | |
| OCNG_RB ^{Note 1} | | | | | | | |
| PRS_RA | dB | -3 | N/A | N/A | 3 | 3 | N/A |
| N_{oc} ^{Note 3} | dBm/ 15 kHz | -98 | -95 | -98 | -95 | -98 | -95 |
| PRS \hat{E}_s/N_{oc} | dB | -1 | -Infinity | -Infinity | -7 | -7 | -Infinity |
| PRS \hat{E}_s/I_{ot} ^{Note 4} | dB | -1.79 | -Infinity | -Infinity | -7 | -9.54 | -Infinity |
| I_o ^{Note 4} | dBm/ 9 MHz | -69.55 | -67.08 | -69.55 | -67.08 | -69.55 | -67.08 |
| PRP ^{Note 4} | dBm/ 15 kHz | -99 | -Infinity | -Infinity | -102 | -105 | -Infinity |
| RSRP ^{Note 4} | dBm/ 15 kHz | -96 | -93 | -105 | -105 | -108 | -Infinity |
| \hat{E}_s/N_{oc} ^{Note 4} | dB | 2 | 2 | -7 | -10 | -10 | -Infinity |
| Propagation Condition | | ETU30 | | | | | |
| <p>Note 1: OCNG shall be used such that active cells (all, except Cell 3 in T3) are fully allocated and a constant total transmitted power spectral density is achieved for all OFDM symbols other than those in the subframes with transmitted PRS.</p> <p>Note 2: The resources for uplink transmission are assigned to the UE prior to the start of time period T2.</p> <p>Note 3: Interference from other cells and noise sources not specified in the test are assumed to be constant over subcarriers and time and shall be modelled as AWGN of appropriate power for N_{oc} to be fulfilled.</p> <p>Note 4: If PRS_RA is not "N/A", \hat{E}_s/N_{oc}, PRS \hat{E}_s/I_{ot}, I_o, RSRP and PRP levels have been derived from other parameters and are given for information purpose. If PRS_RA is "N/A", I_o and RSRP levels have been derived from other parameters and are given for information purpose. These are not settable test parameters. Interference conditions shall be applied to all PRS symbols of DL positioning subframes.</p> | | | | | | | |

Table A.8.12.1.1-4: DRX parameters for the test of E-UTRAN FDD intra-frequency RSTD measurement reporting delay under fading propagation conditions

| Field | Value | Comment |
|--------------------------|---------|--|
| onDurationTimer | psf1 | As specified in TS 36.331 [2], Clause 6.3.2 |
| Drx-InactivityTimer | psf1 | |
| drx-RetransmissionTimer | sf1 | |
| longDRX-CycleStartOffset | sf320 | |
| shortDRX | Disable | |

A.8.12.1.2 Test Requirements

The RSTD measurement time fulfils the requirements specified in Clause 8.1.2.5.1.

The UE shall perform and report the RSTD measurements for Cell 2 and Cell 3 with respect to the reference cell in the OTDOA assistance data, Cell 1, within 2560 ms starting from the beginning of time interval T2.

The rate of the correct events for each neighbour cell observed during repeated tests shall be at least 90%, where the reported RSTD measurement for each correct event shall be within the RSTD reporting range specified in Clause 9.1.10.3, i.e., between RSTD_0000 and RSTD_12711.

NOTE: The RSTD measurement time in the test is derived from the following expression, $T_{PRS}(M-1) + 160 \left\lceil \frac{n}{M} \right\rceil$, where $M=8$ and $n=16$ are the parameters specified in Clause 8.1.2.5.1, Table 8.1.2.5.1-1, under Note 1. This gives the total RSTD measurement time of 2560 ms for Cell 2 and Cell 3 with respect to the reference cell Cell 1.

A.8.12.2 E-UTRAN TDD intra-frequency RSTD measurement reporting delay test case

A.8.12.2.1 Test Purpose and Environment

The purpose of the test is to verify that the RSTD measurement meets the requirements specified in Clause 8.1.2.5.2 in an environment with fading propagation conditions.

In the test there are three synchronous cells: Cell 1, Cell 2 and Cell 3. Cell 1 is the reference as well as the PCell. Cell 2 and Cell 3 are the neighbour cells. All cells are on the same RF channel.

The test consists of three consecutive time intervals, with duration of T1 and T2. Cell 1 is active in T1, T2 and T3, whilst Cell 2 and Cell 3 are activated only in the beginning of T2. Cell 2 is active until the end of T3, and Cell 3 is active until the end of T2. The beginning of the time interval T2 shall be aligned with the first PRS positioning subframe of a positioning occasion in the reference cell, where the PRS positioning occasion is as defined in Clause 8.1.2.5.1. Cell 1 transmits PRS in T2, while Cell 2 transmits PRS only in T3, and Cell 3 transmits PRS only in T2. Note: The information on when PRS is muted is conveyed to the UE using PRS muting information.

The OTDOA assistance data as defined in TS 36.355, Clause 6.5.1, shall be provided to the UE during T1. The last TTI containing the OTDOA assistance data shall be provided to the UE ΔT ms before the start of T2, where $\Delta T = 150$ ms is the maximum processing time of the OTDOA assistance data.

The test parameters are as given in Table A.8.12.2.1-1, Table A.8.12.2.1-2, Table A.8.12.2.1-3, and Table A.8.12.2.1-4.

Table A.8.12.2.1-1: General test parameters for E-UTRAN TDD intra-frequency RSTD measurement reporting delay under fading propagation conditions

| Parameter | Unit | Value | Comment |
|---|------|---|---|
| Reference cell | | Cell 1 | Reference is the cell in the OTDOA assistance data with respect to which the RSTD measurement is defined, as specified in TS 36.214 [4] and TS 36.355 [24]. The reference cell is the PCell in this test case. |
| Neighbor cells | | Cell 2 and Cell 3 | Cell 2 and Cell 3 appear at random places in the neighbour cell list in the OTDOA assistance data, but Cell 2 always appears in the first half of the list, whilst Cell 3 appears in the second half of the list. |
| PCFICH/PDCCH/PHICH parameters | | DL Reference Measurement Channel R.6 TDD | As specified in clause A.3.1.2.2 |
| Channel Bandwidth (BW_{channel}) | MHz | 10 | |
| PRS Transmission Bandwidth | RB | 50 | PRS are transmitted over the system bandwidth |
| PRS configuration index I_{PRS} | | 174 | This corresponds to periodicity of 320 ms and PRS subframe offset of $I_{\text{PRS}} - 160$ DL subframes, as defined in TS 36.211 [16], Table 6.10.4.3-1 |
| Number of consecutive downlink positioning subframes N_{PRS} | | 1 | As defined in TS 36.211 [16]. The number of subframes in a positioning occasion |
| Physical cell ID PCI | | (PCI of Cell 1 – PCI of Cell 2) mod 6 = 0 and (PCI of Cell 1 – PCI of Cell 3) mod 6 = 0 | The cell PCIs are selected such that the relative shifts of PRS patterns among cells are as given by the test parameters |

| | | | |
|---|---------------|--|---|
| TDD uplink-downlink configuration | | 1 | As specified in TS 36.211 [16], Clause 4.2; corresponds to a configuration with 5 ms switch-point periodicity and two downlink consecutive subframes |
| TDD special subframe configuration | | 6 | As specified in TS 36.211 [16], Clause 4.2; corresponds to DwPTS of $19760 \cdot T_s$ and UpPTS of $4384 \cdot T_s$ |
| CP length | | Normal | The same CP length applies for DL and UL |
| DRX | | ON | DRX parameters are further specified in Table A.8.12.2.1-3 |
| Radio frame receive time offset between the cells at the UE antenna connector | μs | Cell 2 to Cell 1: 1 Cell 3 to Cell 1: -1 | PRS are transmitted from synchronous cells |
| Expected RSTD | μs | Cell 2: 3 Cell 3: 3 Other neighbour cells: randomly between -3 and 3 | The expected RSTD is what is expected at the receiver. The corresponding parameter in the OTDOA assistance data specified in TS 36.355 [24] is the expectedRSTD indicator |
| Expected RSTD uncertainty for all neighbour cells | μs | 5 | The corresponding parameter in the OTDOA assistance data specified in TS 36.355 [24] is the expectedRSTD-Uncertainty index |
| Number of cells provided in OTDOA assistance data | | 16 | Including the reference cell |
| PRS muting info | | Cell 1: '11110000' Cell 2: '00001111' Cell 3: '11110000' | Corresponds to prs-MutingInfo defined in TS 36.355 [24] |
| T1 | s | 3 | The length of the time interval from the beginning of each test |
| T2 | s | 1.28 | The length of the time interval that follows immediately after time interval T1 |
| T3 | s | 1.28 | The length of the time interval that follows immediately after time interval T2 |

Table A.8.12.2.1-2: Cell-specific test parameters for E-UTRAN TDD intra-frequency RSTD measurement reporting delay under fading propagation conditions during T1

| Parameter | Unit | Cell 1 | Cell 2 | Cell 3 |
|--|----------------|-----------|-----------|-----------|
| E-UTRA RF Channel Number | | 1 | 1 | 1 |
| Correlation Matrix and Antenna Configuration | | 1x2 Low | 1x2 Low | 1x2 Low |
| OCNG patterns defined in A.3.2.2 | | OP.1 TDD | N/A | N/A |
| PBCH_RA | dB | 0 | N/A | N/A |
| PBCH_RB | | | | |
| PSS_RA | | | | |
| SSS_RA | | | | |
| PCFICH_RB | | | | |
| PHICH_RA | | | | |
| PHICH_RB | | | | |
| PDCCH_RA | | | | |
| PDCCH_RB | | | | |
| OCNG_RA ^{Note 1} | | | | |
| OCNG_RB ^{Note 1} | | | | |
| N_{oc} ^{Note 3} | dBm/ 15 kHz | -95 | | |
| PRS \hat{E}_s/N_{oc} | dB | -Infinity | -Infinity | -Infinity |
| I_o ^{Note 4} | dBm/ 9 MHz | -67.22 | -67.22 | -67.22 |
| \hat{E}_s/N_{oc} | dB | 0 | -Infinity | -Infinity |
| Propagation Condition | | ETU30 | | |

| | |
|---------|---|
| Note 1: | OCNG shall be used such that active cell (Cell 1) is fully allocated and a constant total transmitted power spectral density is achieved for all OFDM symbols. |
| Note 2: | The resources for uplink transmission are assigned to the UE prior to the start of time period T2. |
| Note 3: | Interference from other cells and noise sources not specified in the test are assumed to be constant over subcarriers and time and shall be modelled as AWGN of appropriate power for N_{oc} to be fulfilled. |
| Note 4: | Io levels have been derived from other parameters and are given for information purpose. These are not settable test parameters. |

Table A.8.12.2.1-3: Cell-specific test parameters for E-UTRAN TDD intra-frequency RSTD measurement reporting delay under fading propagation conditions

| Parameter | Unit | Cell 1 | | Cell 2 | | Cell 3 | | |
|--|--|----------|-----------|-----------|--------|----------|-----------|-----|
| | | T2 | T3 | T2 | T3 | T2 | T3 | |
| E-UTRA RF Channel Number | | 1 | | 1 | | 1 | | |
| Correlation Matrix and Antenna Configuration | | 1x2 Low | | 1x2 Low | | 1x2 Low | | |
| OCNG patterns defined in A.3.2.2 | | OP.1 TDD | | OP.2 TDD | | OP.2 TDD | N/A | |
| PBCH_RA | dB | 0 | | 0 | | 0 | | N/A |
| PBCH_RB | | | | | | | | |
| PSS_RA | | | | | | | | |
| SSS_RA | | | | | | | | |
| PCFICH_RB | | | | | | | | |
| PHICH_RA | | | | | | | | |
| PHICH_RB | | | | | | | | |
| PDCCH_RA | | | | | | | | |
| PDCCH_RB | | | | | | | | |
| OCNG_RA ^{Note 1} | | | | | | | | |
| OCNG_RB ^{Note 1} | | | | | | | | |
| PRS_RA | dB | -3 | N/A | N/A | 3 | 3 | N/A | |
| N_{oc} ^{Note 3} | dBm/ 15 kHz | -98 | -95 | -98 | -95 | -98 | -95 | |
| PRS \hat{E}_s/N_{oc} | dB | -1 | -Infinity | -Infinity | -7 | -7 | -Infinity | |
| PRS \hat{E}_s/I_{ot} ^{Note 4} | dB | -1.79 | -Infinity | -Infinity | -7 | -9.54 | -Infinity | |
| I_o ^{Note 4} | dBm/ 9 MHz | -69.55 | -67.08 | -69.55 | -67.08 | -69.55 | -67.08 | |
| PRP ^{Note 4} | dBm/ 15 kHz | -99 | -Infinity | -Infinity | -102 | -105 | -Infinity | |
| RSRP ^{Note 4} | dBm/ 15 kHz | -96 | -93 | -105 | -105 | -108 | -Infinity | |
| \hat{E}_s/N_{oc} ^{Note 4} | dB | 2 | 2 | -7 | -10 | -10 | -Infinity | |
| Propagation Condition | | ETU30 | | | | | | |
| Note 1: | OCNG shall be used such that active cells (all, except Cell 3 in T3) are fully allocated and a constant total transmitted power spectral density is achieved for all OFDM symbols other than those in the subframes with transmitted PRS. | | | | | | | |
| Note 2: | The resources for uplink transmission are assigned to the UE prior to the start of time period T2. | | | | | | | |
| Note 3: | Interference from other cells and noise sources not specified in the test and assumed to be constant over subcarriers and time and shall be modelled as AWGN of appropriate power for N_{oc} to be fulfilled. | | | | | | | |
| Note 4: | If PRS_RA is not "N/A", \hat{E}_s/N_{oc} , PRS \hat{E}_s/I_{ot} , I_o , RSRP and PRP levels have been derived from other parameters and are given for information purpose. If PRS_RA is "N/A", I_o and RSRP levels have been derived from other parameters and are given for information purpose. These are not settable test parameters. Interference conditions shall be applied to all PRS symbols of DL positioning subframes. | | | | | | | |

Table A.8.12.2.1-4: DRX parameters for the test of E-UTRAN TDD intra-frequency RSTD measurement reporting delay under fading propagation conditions

| Field | Value | Comment |
|--------------------------|---------|--|
| onDurationTimer | psf1 | As specified in TS 36.331 [2], Clause 6.3.2. |
| drx-InactivityTimer | psf1 | |
| drx-RetransmissionTimer | sf1 | |
| longDRX-CycleStartOffset | sf320 | |
| shortDRX | disable | |

A.8.12.2.2 Test Requirements

The RSTD measurement time fulfils the requirements specified in Clause 8.1.2.5.2.

The UE shall perform and report the RSTD measurements for Cell 2 and Cell 3 with respect to the reference cell in the OTDOA assistance data, Cell 1, within 2560 ms starting from the beginning of time interval T2.

The rate of the correct events for each neighbour cell observed during repeated tests shall be at least 90%, where the reported RSTD measurement for each correct event shall be within the RSTD reporting range specified in Clause 9.1.10.3, i.e., between RSTD_0000 and RSTD_12711.

NOTE: The RSTD measurement time in the test is derived from the following expression, $T_{PRS} (M - 1) + 160 \left\lceil \frac{n}{M} \right\rceil$,

where $M = 8$ and $n = 16$ are the parameters specified for this test case in Clause 8.1.2.5.2, Table 8.1.2.5.2-1, under Note 1. This gives the total RSTD measurement time of 2560 ms for Cell 2 and Cell 3 with respect to the reference cell Cell 1.

A.8.13 RSTD Inter-frequency Measurements

A.8.13.1 E-UTRAN FDD-FDD inter-frequency RSTD measurement reporting delay test case with the reference cell on the serving carrier frequency

A.8.13.1.1 Test Purpose and Environment

The purpose of the test is to verify that the FDD-FDD inter-frequency RSTD measurement meets the requirements specified in Clause 8.1.2.6.1, specifically for Note 2 in Table 8.1.2.6.1-1, in an environment with fading propagation conditions.

In the test there are three synchronous cells: Cell 1, Cell 2 and Cell 3. Cell 1 is the reference as well as the PCell. Cell 2 and Cell 3 are the neighbour cells. Cell 1 is on FDD RF channel 1. Cell 2 and Cell 3 are on a FDD RF channel 2.

The UE requires measurement gaps to perform inter-frequency measurements. Gap pattern configuration # 0 as defined in Table 8.1.2.1-1 is provided and configured to not overlap with PRS subframes of Cell 1.

The test consists of three consecutive time intervals, with duration of T1, T2 and T3. Cell 1 is active in T1, T2 and T3, whilst Cell 2 and Cell 3 are activated only in the beginning of T2. Cell 2 is active until the end of T3, and Cell 3 is active until the end of T2. The beginning of the time interval T2 shall be aligned with the first PRS positioning subframe of a positioning occasion in the Cell 3, where the PRS positioning occasion is as defined in Clause 8.1.2.5.1. Cell 1 and Cell 3 transmit PRS only in T2. Cell 2 transmits PRS only in T3. Note: The information on when PRS is muted is conveyed to the UE using PRS muting information.

The OTDOA assistance data as defined in TS 36.355, Clause 6.5.1, shall be provided to the UE during T1. The last TTI containing the OTDOA assistance data shall be provided to the UE ΔT ms before the start of T2, where $\Delta T = 150$ ms is the maximum processing time of the OTDOA assistance data. The measurement gap configuration is known and configured in the UE at the start of T1. DRX is configured before T2.

The test parameters are as given in Table A.8.13.1.1-1, Table A.8.13.1.1-2, Table A.8.13.1.1-3 and Table A.8.13.1.1-4.

Table A.8.13.1.1-1: General test parameters for E-UTRAN FDD-FDD inter-frequency RSTD measurement reporting delay under fading propagation conditions

| Parameter | Unit | Value | Comment |
|-----------|------|-------|---------|
|-----------|------|-------|---------|

| | | | |
|---|-----|---|--|
| Reference cell | | Cell 1 | Reference cell is the cell with respect to which the RSTD measurement is defined, as specified in TS 36.214 [4]. The reference cell is the PCell on RF channel 1 in this test case. |
| Neighbor cells | | Cell 2 and Cell 3 | Cells on RF channel 2. The cells appear at random places in the neighbour cell list in the OTDOA assistance data, but Cell 2 always appears in the first half of the list, whilst Cell 3 appears in the second half of the list. |
| PCFICH/PDCCH/PHICH parameters | | DL Reference Measurement Channel R.6 FDD | As specified in clause A.3.1.2.1 |
| Channel Bandwidth (BW _{channel}) | MHz | 10 | |
| PRS Bandwidth | RB | 50 | PRS bandwidth is as indicated in prs-Bandwidth in the OTDOA assistance data defined in [24]. Here, PRS are transmitted over the system bandwidth |
| Gap pattern Id | | 0 | As specified in Table 8.1.2.1-1. Applies for measurements on Cell 2 and Cell 3 |
| Gap offset | | 9 | As specified in TS 36.331 [2], Clause 6.3.5 |
| PRS configuration index I_{PRS} | | Cell 1: 181, Cell 2, Cell 3: 171 | This corresponds to periodicity of 320 ms and PRS subframe offset of $I_{PRS} - 160$ DL subframes, as defined in TS 36.211 [16], Table 6.10.4.3-1 |
| Number of consecutive downlink positioning subframes N_{PRS} | | 1 | As defined in TS 36.211 [16]. The number of subframes in a positioning occasion |
| Physical cell ID PCI | | (PCI of Cell 1 – PCI of Cell 2) mod 6 = 0 and (PCI of Cell 1 – PCI of Cell 3) mod 6 = 0 | The cell PCIs are selected such that the relative shifts of PRS patterns among cells are as given by the test parameters |
| CP length | | Normal | |
| DRX | | ON | DRX parameters are further specified in Table A.8.13.1.1-3. |
| prs-SubframeOffset | | 310 | Number of subframes rounded to the closest integer. The corresponding parameter in the OTDOA assistance data is prs-SubframeOffset specified in TS 36.355 [24] |
| slotNumberOffset | | 0 | The slot number offset at the transmitter between a neighbour cell and the assistance data reference cell specified in TS 36.355 [24] |
| Radio frame receive time offset between the cells at the UE antenna connector | μs | Cell 2 to Cell 1: 1 Cell 3 to Cell 1: -1 | PRS are transmitted from synchronous cells |
| Expected RSTD | μs | Cell 2: -2 Cell 3: 2 Other neighbour cells: randomly between -3 and 3 | The expected RSTD is what is expected at the receiver. The corresponding parameter in the OTDOA assistance data specified in TS 36.355 [24] is the expectedRSTD indicator |
| Expected RSTD uncertainty for all neighbour cells | μs | 5 | The corresponding parameter in the OTDOA assistance data specified in TS 36.355 [24] is the expectedRSTD-Uncertainty index |

| | | | |
|---|---|--|---|
| Number of cells provided in OTDOA assistance data | | 16 | The list includes the reference cell (received in <i>OTDOA-ReferenceCellInfo</i> [24]) on RF channel 1 and 15 other cells on RF channel 2, all received in <i>OTDOA-ProvideAssistanceData</i> [24]. |
| PRS muting info | | Cell 1: '1111111100000000' Cell 2: '0000000011111111' Cell 3: '1111111100000000' | Corresponds to prs-MutingInfo defined in TS 36.355 [24] |
| T1 | s | 3 | The length of the time interval from the beginning of each test |
| T2 | s | 2.48 | The length of the time interval that follows immediately after time interval T1 |
| T3 | s | 2.48 | The length of the time interval that follows immediately after time interval T2 |

Table A.8.13.1.1-2: Cell-specific test parameters for E-UTRAN FDD-FDD inter-frequency RSTD measurement reporting delay under fading propagation conditions during T1

| Parameter | Unit | Cell 1 | Cell 2 | Cell 3 |
|---|------------|-----------|-----------|-----------|
| E-UTRA RF Channel Number | | 1 | 2 | 2 |
| Correlation Matrix and Antenna Configuration | | 1x2 Low | 1x2 Low | 1x2 Low |
| OCNG patterns defined in A.3.2.1 | | OP.5 FDD | N/A | N/A |
| PBCH_RA | dB | 0 | N/A | N/A |
| PBCH_RB | | | | |
| PSS_RA | | | | |
| SSS_RA | | | | |
| PCFICH_RB | | | | |
| PHICH_RA | | | | |
| PHICH_RB | | | | |
| PDCCH_RA | | | | |
| PDCCH_RB | | | | |
| OCNG_RA ^{Note 1} | | | | |
| OCNG_RB ^{Note 1} | | | | |
| N_{oc} ^{Note 3} | dBm/15 kHz | -95 | -95 | -95 |
| PRS \hat{E}_s/N_{oc} | dB | -Infinity | -Infinity | -Infinity |
| I_o ^{Note 4} | dBm/9 MHz | -67.22 | -67.22 | -67.22 |
| \hat{E}_s/N_{oc} | dB | 0 | -Infinity | -Infinity |
| Propagation Condition | | ETU30 | | |
| <p>Note 1: OCNG shall be used such that the active cell (Cell 1) is fully allocated and a constant total transmitted power spectral density is achieved for all OFDM symbols.</p> <p>Note 2: The resources for uplink transmission are assigned to the UE prior to the start of time period T2.</p> <p>Note 3: Interference from other cells and noise sources not specified in the test are assumed to be constant over subcarriers and time and shall be modelled as AWGN of appropriate power for N_{oc} to be fulfilled.</p> <p>Note 4: I_o levels have been derived from other parameters and are given for information purpose. These are not settable test parameters.</p> | | | | |

Table A.8.13.1.1-3: Cell-specific test parameters for E-UTRAN FDD-FDD inter-frequency RSTD measurement reporting delay under fading propagation conditions during T2 and T3

| Parameter | Unit | Cell 1 | | Cell 2 | | Cell 3 | |
|--------------------------|------|--------|----|--------|----|--------|----|
| | | T2 | T3 | T2 | T3 | T2 | T3 |
| E-UTRA RF Channel Number | | 1 | | 2 | | 2 | |

| | | | | | | | |
|--|----------------|----------|-----------|-----------|--------|----------|-----------|
| Correlation Matrix and Antenna Configuration | | 1x2 Low | | 1x2 Low | | 1x2 Low | |
| OCNG patterns defined in A.3.2.1 | | OP.5 FDD | | OP.6 FDD | | OP.6 FDD | N/A |
| PBCH_RA | dB | 0 | | 0 | | 0 | N/A |
| PBCH_RB | | | | | | | |
| PSS_RA | | | | | | | |
| SSS_RA | | | | | | | |
| PCFICH_RB | | | | | | | |
| PHICH_RA | | | | | | | |
| PHICH_RB | | | | | | | |
| PDCCH_RA | | | | | | | |
| PDCCH_RB | | | | | | | |
| OCNG_RA ^{Note 1} | | | | | | | |
| OCNG_RB ^{Note 1} | | | | | | | |
| PRS_RA | dB | -3 | N/A | N/A | 3 | 3 | N/A |
| N_{oc} ^{Note 3} | dBm/ 15 kHz | -98 | -98 | -98 | -95 | -98 | -95 |
| PRS \hat{E}_s/N_{oc} | dB | -1 | -Infinity | -Infinity | -7 | -8 | -Infinity |
| PRS \hat{E}_s/I_{ot} ^{Note 4} | dB | -1 | -Infinity | -Infinity | -7 | -8 | -Infinity |
| I_o ^{Note 4} | dBm/ 9 MHz | -69.68 | -70.22 | -70.11 | -67.08 | -70.11 | -67.08 |
| PRP ^{Note 4} | dBm/ 15 kHz | -99 | -Infinity | -Infinity | -102 | -106 | -Infinity |
| RSRP ^{Note 4} | dBm/ 15 kHz | -96 | -96 | -105 | -105 | -109 | -Infinity |
| \hat{E}_s/N_{oc} ^{Note 4} | dB | 2 | 2 | -7 | -10 | -11 | -Infinity |
| Propagation Condition | | ETU30 | | | | | |
| <p>Note 1: OCNG shall be used such that active cells (all, except Cell 3 in T3) are fully allocated and a constant total transmitted power spectral density is achieved for all OFDM symbols other than those in the subframes with transmitted PRS.</p> <p>Note 2: The resources for uplink transmission are assigned to the UE prior to the start of time period T2.</p> <p>Note 3: Interference from other cells and noise sources not specified in the test are assumed to be constant over subcarriers and time and shall be modelled as AWGN of appropriate power for N_{oc} to be fulfilled.</p> <p>Note 4: If PRS_RA is not "N/A", \hat{E}_s/N_{oc}, PRS \hat{E}_s/I_{ot}, I_o, RSRP and PRP levels have been derived from other parameters and are given for information purpose. If PRS_RA is "N/A", I_o and RSRP levels have been derived from other parameters and are given for information purpose. These are not settable test parameters. Interference conditions shall be applied to all PRS symbols of DL positioning subframes</p> | | | | | | | |

Table A.8.13.1.1-4: DRX parameters for the test of E-UTRAN FDD-FDD inter-frequency RSTD measurement reporting delay under fading propagation conditions

| Field | Value | Comment |
|--------------------------|---------|---|
| onDurationTimer | psf1 | As specified in TS 36.331 [2], Clause 6.3.2 |
| Drx-InactivityTimer | psf1 | |
| drx-RetransmissionTimer | sf1 | |
| longDRX-CycleStartOffset | sf320 | |
| shortDRX | Disable | |

A.8.13.1.2 Test Requirements

The RSTD measurement time fulfils the requirements specified in Clause 8.1.2.6.1.

The UE shall perform and report the RSTD measurements for Cell 2 and Cell 3 with respect to the reference cell Cell 1 within 4960 ms starting from the beginning of time interval T2.

The rate of the correct events for each neighbour cell observed during repeated tests shall be at least 90%, where the reported RSTD measurement for each correct event shall be within the RSTD reporting range specified in Clause 9.1.10.3, i.e., between RSTD_0000 and RSTD_12711.

NOTE: The RSTD measurement time in the test is derived from the following expression, $T_{PRS} (M - 1) + 160 \left\lceil \frac{n}{M} \right\rceil$, where $M = 16$ and $n = 16$ are the parameters specified in Clause 8.1.2.6.1, Table 8.1.2.6.1-1, under Note 2. This gives the total RSTD measurement time of 4960 ms for Cell 2 and Cell 3 with respect to the reference cell Cell 1.

A.8.13.2 E-UTRAN TDD-TDD inter-frequency RSTD measurement reporting delay test case with the reference cell on the serving carrier frequency

A.8.13.2.1 Test Purpose and Environment

The purpose of the test is to verify that the TDD-TDD inter-frequency RSTD measurement meets the requirements specified in Clause 8.1.2.6.3, specifically for Note 2 in Table 8.1.2.6.3-1, in an environment with fading propagation conditions.

In the test there are three synchronous cells: Cell 1, Cell 2 and Cell 3. Cell 1 is the reference as well as the PCell. Cell 2 and Cell 3 are the neighbour cells. Cell 1 is on TDD RF channel 1. Cell 2 and Cell 3 are on TDD RF channel 2.

The UE requires measurement gaps to perform inter-frequency measurements. Gap pattern configuration # 0 as defined in Table 8.1.2.1-1 is provided and configured to not overlap with PRS subframes of Cell 1.

The test consists of three consecutive time intervals, with duration of T1 and T2. Cell 1 is active in T1, T2 and T3, whilst Cell 2 and Cell 3 are activated only in the beginning of T2. Cell 2 is active until the end of T3, and Cell 3 is active until the end of T2. The beginning of the time interval T2 shall be aligned with the first PRS positioning subframe of a positioning occasion in the Cell 3, where the PRS positioning occasion is as defined in Clause 8.1.2.5.1. Cell 1 and Cell 3 transmit PRS only in T2. Cell 2 transmits PRS only in T3. Note: The information on when PRS is muted is conveyed to the UE using PRS muting information.

The OTDOA assistance data as defined in TS 36.355, Clause 6.5.1, shall be provided to the UE during T1. The last TTI containing the OTDOA assistance data shall be provided to the UE ΔT ms before the start of T2, where $\Delta T = 150$ ms is the maximum processing time of the OTDOA assistance data. The measurement gap configuration is known and configured in the UE at the start of T1. DRX is configured before T2.

The test parameters are as given in Table A.8.13.2.1-1, Table A.8.13.2.1-2, Table A.8.13.2.1-3, and Table A.8.13.2.1-4.

Table A.8.13.2.1-1: General test parameters for E-UTRAN TDD-TDD inter-frequency RSTD measurement reporting delay under fading propagation conditions

| Parameter | Unit | Value | Comment |
|--|------|--|--|
| Reference cell | | Cell 1 | Reference cell is the cell with respect to which the RSTD measurement is defined, as specified in TS 36.214 [4]. The reference cell is the PCell on RF channel 1 in this test case. |
| Neighbor cells | | Cell 2 and Cell 3 | Cells on RF channel 2. The cells appear at random places in the neighbour cell list in the OTDOA assistance data, but Cell 2 always appears in the first half of the list, whilst Cell 3 appears in the second half of the list. |
| PCFICH/PDCCH/PHICH parameters | | DL Reference Measurement Channel R.6 TDD | As specified in clause A.3.1.2.2 |
| Channel Bandwidth (BW _{channel}) | MHz | 10 | |
| PRS Bandwidth | RB | 50 | PRS bandwidth is as indicated in prs-Bandwidth in the OTDOA assistance data defined in [24]. Here, PRS are transmitted over the system bandwidth |
| Gap pattern Id | | 0 | As specified in Table 8.1.2.1-1. Applies for measurements on Cell 2 and Cell 3 |
| Gap offset | | 12 | As specified in TS 36.331 [2], Clause 6.3.5 |

| | | | |
|---|---------------|---|---|
| PRS configuration index I_{PRS} | | Cell 1: 184, Cell 2, Cell 3: 174 | This corresponds to periodicity of 320 ms and PRS subframe offset of $I_{PRS} - 160$ DL subframes, as defined in TS 36.211 [16], Table 6.10.4.3-1 |
| Number of consecutive downlink positioning subframes N_{PRS} | | 1 | As defined in TS 36.211 [16]. The number of subframes in a positioning occasion |
| Physical cell ID PCI | | (PCI of Cell 1 – PCI of Cell 2) mod 6 = 0 and (PCI of Cell 1 – PCI of Cell 3) mod 6 = 0 | The cell PCIs are selected such that the relative shifts of PRS patterns among cells are as given by the test parameters |
| TDD uplink-downlink configuration | | 1 | As specified in TS 36.211 [16], Clause 4.2; corresponds to a configuration with 5 ms switch-point periodicity and two downlink consecutive subframes |
| TDD special subframe configuration | | 6 | As specified in TS 36.211 [16], Clause 4.2; corresponds to DwPTS of $19760 \cdot T_s$ and UpPTS of $4384 \cdot T_s$ |
| CP length | | Normal | The same CP length for DL and UL |
| DRX | | ON | DRX parameters are further specified in Table A.8.13.2.1-3. |
| prs-SubframeOffset | | 310 | Number of subframes rounded to the closest integer. The corresponding parameter in the OTDOA assistance data is prs-SubframeOffset specified in TS 36.355 [24] |
| slotNumberOffset | | 0 | The slot number offset at the transmitter between a neighbour cell and the assistance data reference cell specified in TS 36.355 [24] |
| Radio frame receivetime offset between the cells at the UE antenna connecto | μs | Cell 2 to Cell 1: 1 Cell 3 to Cell 1: -1 | PRS are transmitted from synchronous cells |
| Expected RSTD | μs | Cell 2: -2 Cell 3: 2 Other neighbour cells: randomly between -3 and 3 | The expected RSTD is what is expected at the receiver. The corresponding parameter in the OTDOA assistance data specified in TS 36.355 [24] is the expectedRSTD indicator |
| Expected RSTD uncertainty for all neighbour cells | μs | 5 | The corresponding parameter in the OTDOA assistance data specified in TS 36.355 [24] is the expectedRSTD-Uncertainty index |
| Number of cells provided in OTDOA assistance data | | 16 | The list includes the reference cell (received in <i>OTDOA-ReferenceCellInfo</i> [24]) on RF channel 1 and 15 other cells on RF channel 2, all received in <i>OTDOA-ProvideAssistanceData</i> [24]. |
| PRS muting info | | Cell 1: '1111111100000000' Cell 2: '0000000011111111' Cell 3: '1111111100000000' | Correponds to prs-MutingInfo defined in TS 36.355 [24] |
| T1 | s | 3 | The length of the time interval from the beginning of each test |
| T2 | s | 2.48 | The length of the time interval that follows immediately after time interval T1 |
| T3 | s | 2.48 | The length of the time interval that follows immediately after time interval T2 |

Table A.8.13.2.1-2: Cell-specific test parameters for E-UTRAN TDD-TDD inter-frequency RSTD measurement reporting delay under fading propagation conditions during T1

| Parameter | Unit | Cell 1 | Cell 2 | Cell 3 |
|--|------|----------|---------|---------|
| E-UTRA RF Channel Number | | 1 | 2 | 2 |
| Correlation Matrix and Antenna Configuration | | 1x2 Low | 1x2 Low | 1x2 Low |
| OCNG patterns defined in A.3.2.2 | | OP.1 TDD | N/A | N/A |

| | | | | |
|---|----------------|-----------|-----------|-----------|
| PBCH_RA | dB | 0 | N/A | N/A |
| PBCH_RB | | | | |
| PSS_RA | | | | |
| SSS_RA | | | | |
| PCFICH_RB | | | | |
| PHICH_RA | | | | |
| PHICH_RB | | | | |
| PDCCH_RA | | | | |
| PDCCH_RB | | | | |
| OCNG_RA ^{Note 1} | | | | |
| OCNG_RB ^{Note 1} | | | | |
| N_{oc} ^{Note 3} | dBm/ 15 kHz | -95 | -95 | -95 |
| $PRS \hat{E}_s / N_{oc}$ | dB | -Infinity | -Infinity | -Infinity |
| I_o ^{Note 4} | dBm/ 9 MHz | -67.22 | -67.22 | -67.22 |
| \hat{E}_s / N_{oc} | dB | 0 | -Infinity | -Infinity |
| Propagation Condition | ETU30 | | | |
| <p>Note 1: OCNG shall be used such that the active cell (Cell 1) is fully allocated and a constant total transmitted power spectral density is achieved for all OFDM symbols.</p> <p>Note 2: The resources for uplink transmission are assigned to the UE prior to the start of time period T2.</p> <p>Note 3: Interference from other cells and noise sources not specified in the test are assumed to be constant over subcarriers and time and shall be modelled as AWGN of appropriate power for N_{oc} to be fulfilled.</p> <p>Note 4: I_o levels have been derived from other parameters and are given for information purpose. These are not settable test parameters.</p> | | | | |

Table A.8.13.2.1-3: Cell-specific test parameters for E-UTRAN TDD-TDD inter-frequency RSTD measurement reporting delay under fading propagation conditions

| Parameter | Unit | Cell 1 | | Cell 2 | | Cell 3 | |
|--|----------------|----------|-----------|-----------|--------|----------|-----------|
| | | T2 | T3 | T2 | T3 | T2 | T3 |
| E-UTRA RF Channel Number | | 1 | | 2 | | 2 | |
| Correlation Matrix and Antenna Configuration | | 1x2 Low | | 1x2 Low | | 1x2 Low | |
| OCNG patterns defined in A.3.2.2 | | OP.1 TDD | | OP.2 TDD | | OP.2 TDD | N/A |
| PBCH_RA | dB | 0 | 0 | 0 | 0 | 0 | N/A |
| PBCH_RB | | | | | | | |
| PSS_RA | | | | | | | |
| SSS_RA | | | | | | | |
| PCFICH_RB | | | | | | | |
| PHICH_RA | | | | | | | |
| PHICH_RB | | | | | | | |
| PDCCH_RA | | | | | | | |
| PDCCH_RB | | | | | | | |
| OCNG_RA ^{Note 1} | | | | | | | |
| OCNG_RB ^{Note 1} | | | | | | | |
| PRS_RA | dB | -3 | N/A | N/A | 3 | 3 | N/A |
| N_{oc} ^{Note 3} | dBm/ 15 kHz | -98 | -98 | -98 | -95 | -98 | -95 |
| $PRS \hat{E}_s / N_{oc}$ | dB | -1 | -Infinity | -Infinity | -7 | -8 | -Infinity |
| $PRS \hat{E}_s / I_{ot}$ ^{Note 4} | dB | -1 | -Infinity | -Infinity | -7 | -8 | -Infinity |
| I_o ^{Note 4} | dBm/ 9 MHz | -69.68 | -70.22 | -70.11 | -67.08 | -70.11 | -67.08 |
| PRP ^{Note 4} | dBm/ 15 kHz | -99 | -Infinity | -Infinity | -102 | -106 | -Infinity |
| RSRP ^{Note 4} | dBm/ 15 kHz | -96 | -96 | -105 | -105 | -109 | -Infinity |
| \hat{E}_s / N_{oc} ^{Note 4} | dB | 2 | 2 | -7 | -10 | -11 | -Infinity |

| Propagation Condition | ETU30 |
|-----------------------|--|
| Note 1: | OCNG shall be used such that active cells (all, except Cell 3 in T3) are fully allocated and a constant total transmitted power spectral density is achieved for all OFDM symbols other than those in the subframes with transmitted PRS. |
| Note 2: | The resources for uplink transmission are assigned to the UE prior to the start of time period T2. |
| Note 3: | Interference from other cells and noise sources not specified in the test and assumed to be constant over subcarriers and time and shall be modelled as AWGN of appropriate power for N_{oc} to be fulfilled. |
| Note 4: | If PRS_RA is not "N/A", \hat{E}_s/N_{oc} , PRS \hat{E}_s/I_{ot} , I_o , RSRP and PRP levels have been derived from other parameters and are given for information purpose. If PRS_RA is "N/A", I_o and RSRP levels have been derived from other parameters and are given for information purpose. These are not settable test parameters. Interference conditions shall be applied to all PRS symbols of DL positioning subframes. |

Table A.8.13.2.1-4: DRX parameters for the test of E-UTRAN TDD-TDD inter-frequency RSTD measurement reporting delay under fading propagation conditions

| Field | Value | Comment |
|--------------------------|---------|--|
| onDurationTimer | psf1 | As specified in TS 36.331 [2], Clause 6.3.2. |
| drx-InactivityTimer | psf1 | |
| drx-RetransmissionTimer | sf1 | |
| longDRX-CycleStartOffset | sf320 | |
| shortDRX | disable | |

A.8.13.2.2 Test Requirements

The RSTD measurement time fulfils the requirements specified in Clause 8.1.2.6.3.

The UE shall perform and report the RSTD measurements for Cell 2 and Cell 3 with respect to the reference cell Cell 1 within 4960 ms starting from the beginning of time interval T2.

The rate of the correct events for each neighbour cell observed during repeated tests shall be at least 90%, where the reported RSTD measurement for each correct event shall be within the RSTD reporting range specified in Clause 9.1.10.3, i.e., between RSTD_0000 and RSTD_12711.

NOTE: The RSTD measurement time in the test is derived from the following expression, $T_{PRS}(M-1) + 160 \left\lceil \frac{n}{M} \right\rceil$,

where $M=16$ and $n=16$ are the parameters specified in Clause 8.1.2.6.3, Table 8.1.2.6.3-1, under Note 2. This gives the total RSTD measurement time of 4960 ms for Cell 2 and Cell 3 with respect to the reference cell Cell 1.

A.8.14 E-UTRAN TDD - FDD Inter-frequency Measurements

A.8.14.1 E-UTRAN TDD-FDD Inter-frequency event triggered reporting under fading propagation conditions in asynchronous cells

A.8.14.1.1 Test Purpose and Environment

The purpose of this test is to verify that the UE makes correct reporting of an event. This test will partly verify the TDD-FDD inter-frequency cell search requirements in clause 8.1.2.3.3.

The test parameters are given in Tables A.8.14.1.1-1 and A.8.14.1.1-2. In this test, there are two cells on different carrier frequencies and gap pattern configuration # 0 as defined in Table 8.1.2.1-1 is provided.

In the measurement control information, it is indicated to the UE that event-triggered reporting with Event A3 is used. The test consists of two successive time periods, with time duration of T1, and T2 respectively. During time duration T1, the UE shall not have any timing information of cell 2.

Table A.8.14.1.1-1: General test parameters for E-UTRAN TDD-FDD inter-frequency event triggered reporting in fading propagation conditions

| Parameter | Unit | Value | Comment |
|--|------|--|---|
| Cell 1 PDSCH parameters | | DL Reference Measurement Channel R.0 TDD | As specified in clause A.3.1.1.2 |
| Cell 1 PCFICH/PDCCH/PHICH parameters | | DL Reference Measurement Channel R.6 TDD | As specified in clause A.3.1.2.2 |
| Cell1 Special subframe configuration | | 6 | As specified in table 4.2-1 in TS 36.211. |
| Cell1 Uplink-downlink configuration | | 1 | As specified in TS 36.211 clause 4.2 Table 4.2-2. |
| Cell 2 PCFICH/PDCCH/PHICH parameters | | DL Reference Measurement Channel R.6 FDD | As specified in clause A.3.1.2.1 |
| Cell 1 E-UTRA TDD RF Channel Number | | 1 | One TDD carrier frequency is used. |
| Cell 2 E-UTRA FDD RF Channel Number | | 2 | One FDD carrier frequency is used. |
| Channel Bandwidth (BW _{channel}) | MHz | 10 | |
| Active cell | | Cell 1 | Cell 1 is on RF channel number 1 |
| Neighbour cell | | Cell 2 | Cell 2 is on RF channel number 2 |
| Gap Pattern Id | | 0 | As specified in TS 36.133 clause 8.1.2.1. |
| A3-Offset | dB | -6 | |
| Hysteresis | dB | 0 | |
| CP length | | Normal | |
| TimeToTrigger | s | 0 | |
| Filter coefficient | | 0 | L3 filtering is not used |
| DRX | | OFF | OFF |
| Time offset between cells | | 3 ms | Asynchronous cells |
| T1 | s | 5 | |
| T2 | s | 5 | |

Table A.8.14.1.1-2: Cell specific test parameters for E-UTRAN TDD-FDD inter-frequency event triggered reporting under fading propagation conditions in asynchronous cells

| Parameter | Unit | Cell 1 | | Cell 2 | |
|--|------------|----------|-----|-----------|-----|
| | | T1 | T2 | T1 | T2 |
| E-UTRA RF Channel Number | | 1 | | 2 | |
| BW _{channel} | MHz | 10 | | 10 | |
| Correlation Matrix and Antenna Configuration | | 1x2 Low | | 1x2 Low | |
| OCNG Patterns defined in A.3.2.2.1 (OP.1 TDD) and in A.3.2.1.2 (OP.2 FDD) | | OP.1 TDD | | OP.2 FDD | |
| PBCH_RA | dB | 0 | | 0 | |
| PBCH_RB | dB | | | | |
| PSS_RA | dB | | | | |
| SSS_RA | dB | | | | |
| PCFICH_RB | dB | | | | |
| PHICH_RA | dB | | | | |
| PHICH_RB | dB | | | | |
| PDCCH_RA | dB | | | | |
| PDCCH_RB | dB | | | | |
| PDSCH_RA | dB | | | | |
| PDSCH_RB | dB | | | | |
| OCNG_RA ^{Note 1} | dB | | | | |
| OCNG_RB ^{Note 1} | dB | | | | |
| N_{oc} ^{Note 3} | dBm/15 kHz | | | | |
| RSRP ^{Note 4} | dBm/15 kHz | -94 | -94 | -Infinity | -91 |
| \hat{E}_s/I_{ot} | dB | 4 | 4 | -Infinity | 7 |
| SCH_RP ^{Note 4} | dBm/15 kHz | -94 | -94 | -Infinity | -91 |
| \hat{E}_s/N_{oc} | dB | 4 | 4 | -Infinity | 7 |
| Propagation Condition | | ETU70 | | | |
| <p>Note 1: OCNG shall be used such that both cells are fully allocated and a constant total transmitted power spectral density is achieved for all OFDM symbols.</p> <p>Note 2: The resources for uplink transmission are assigned to the UE prior to the start of time period T2.</p> <p>Note 3: Interference from other cells and noise sources not specified in the test is assumed to be constant over subcarriers and time and shall be modelled as AWGN of appropriate power for N_{oc} to be fulfilled.</p> <p>Note 4: RSRP and SCH_RP levels have been derived from other parameters for information purposes. They are not settable parameters themselves.</p> | | | | | |

A.8.14.1.2 Test Requirements

The UE shall send one Event A3 triggered measurement report, with a measurement reporting delay less than 3840 ms from the beginning of time period T2.

The UE shall not send event triggered measurement reports, as long as the reporting criteria are not fulfilled.

The rate of correct events observed during repeated tests shall be at least 90%.

NOTE: The actual overall delays measured in the test may be up to $2 \times TTI_{DCCH}$ higher than the measurement reporting delays above because of TTI insertion uncertainty of the measurement report in DCCH.

A.8.14.2 E-UTRAN TDD-FDD Inter-frequency event triggered reporting when DRX is used under fading propagation conditions in asynchronous cells

A.8.14.2.1 Test Purpose and Environment

The purpose of these tests is to verify that the UE makes correct reporting of an event in DRX. These test will partly verify the TDD-FDD inter-frequency cell search requirements when DRX is used in clause 8.1.2.3.

The common test parameters are given in Tables A.8.14.2.1-1 and A.8.14.2.1-2. DRX configuration for Test1 and Test2 are given in Table A.8.14.2.1-3 and time alignment timer and scheduling request related parameters in Table A.8.14.2.1-4. In these tests, there are two cells on different carrier frequencies and gap pattern configuration # 0 as defined in Table 8.1.2.1-1 is provided.

In Test 1 UE needs to be provided at least once every 500ms with new Timing Advance Command MAC control element to restart the Time alignment timer to keep UE uplink time alignment. Furthermore UE is allocated with PUSCH resource at every DRX cycle. In Test 2 the uplink time alignment is not maintained and UE needs to use RACH to obtain UL allocation for measurement reporting.

In the measurement control information, it is indicated to the UE that event-triggered reporting with Event A3 is used. The tests consist of two successive time periods, with time duration of T1, and T2 respectively. During time duration T1, the UE shall not have any timing information of cell 2.

Table A.8.14.2.1-1: General test parameters for E-UTRAN TDD-FDD inter-frequency event triggered reporting when DRX is used in fading propagation conditions

| Parameter | Unit | Test 1 | Test 2 | Comment |
|--|------|--|--------|--|
| | | Value | | |
| Cell1 PDSCH parameters | | DL Reference Measurement Channel R.0 TDD | | As specified in clause A.3.1.1.2. Note that UE may only be allocated at <i>On Duration</i> |
| Cell1PCFICH/PDCCH/PHICH parameters | | DL Reference Measurement Channel R.6 TDD | | As specified in clause A.3.1.2.2. |
| Cell2 PDSCH parameters | | DL Reference Measurement Channel R.0 FDD | | As specified in clause A.3.1.1.1. Note that UE may only be allocated at <i>On Duration</i> |
| Cell2PCFICH/PDCCH/PHICH parameters | | DL Reference Measurement Channel R.6 FDD | | As specified in clause A.3.1.2.1. |
| E-UTRA RF Channel Number | | 1 | | one TDD carrier frequencies is used. |
| E-UTRA RF Channel Number | | 2 | | one FDD carrier frequencies is used. |
| Channel Bandwidth (BW _{channel}) | MHz | 10 | | |
| Active cell | | Cell 1 | | Cell 1 is on RF channel number 1 |
| Neighbour cell | | Cell 2 | | Cell 2 is on RF channel number 2 |
| Gap Pattern Id | | 0 | | As specified in TS 36.133 clause 8.1.2.1. |
| Cell1 Uplink-downlink configuration | | 1 | | As specified in TS 36.211 clause 4.2 Table 4.2-2 |
| Cell1 Special subframe configuration | | 6 | | As specified in table 4.2-1 in TS 36.211. The same configuration in both cells |
| A3-Offset | dB | -6 | | |
| Hysteresis | dB | 0 | | |
| CP length | | Normal | | |
| TimeToTrigger | s | 0 | | |
| Filter coefficient | | 0 | | L3 filtering is not used |
| PRACH configuration | | 4 | | As specified in table 5.7.1-3 in TS 36.211 |
| Access Barring Information | - | Not Sent | | No additional delays in random access procedure. |
| DRX | | ON | | DRX related parameters are defined in Table A.8.14.2.1-3 |
| Time offset between cells | | 3 ms | | Asynchronous cells |
| T1 | s | 5 | | |
| T2 | s | 5 | 30 | |

Table A.8.14.2.1-2: Cell specific test parameters for E-UTRAN TDD-FDD inter-frequency event triggered reporting under fading propagation conditions in asynchronous cells

| Parameter | Unit | Cell 1 | | Cell 2 | |
|---|------|----------|----|----------|----|
| | | T1 | T2 | T1 | T2 |
| E-UTRA RF Channel Number | | 1 | | 2 | |
| BW _{channel} | MHz | 10 | | 10 | |
| Correlation Matrix and Antenna Configuration | | 1x2 Low | | 1x2 Low | |
| OCNG Patterns defined in A.3.2.2.1 (OP.1 TDD) and in A.3.2.1.2 (OP.2 FDD) | | OP.1 TDD | | OP.2 FDD | |

| | | | | | |
|--|------------|-------|-----|-----------|-----|
| PBCH_RA | dB | 0 | | 0 | |
| PBCH_RB | dB | | | | |
| PSS_RA | dB | | | | |
| SSS_RA | dB | | | | |
| PCFICH_RB | dB | | | | |
| PHICH_RA | dB | | | | |
| PHICH_RB | dB | | | | |
| PDCCH_RA | dB | | | | |
| PDCCH_RB | dB | | | | |
| PDSCH_RA | dB | | | | |
| PDSCH_RB | dB | | | | |
| OCNG_RA ^{Note 1} | dB | | | | |
| OCNG_RB ^{Note 1} | dB | | | | |
| N_{oc} ^{Note 2} | dBm/15 kHz | | | | |
| RSRP ^{Note 3} | dBm/15 kHz | -94 | -94 | -Infinity | -91 |
| \hat{E}_s / I_{ot} | dB | 4 | 4 | -Infinity | 7 |
| SCH_RP ^{Note 3} | dBm/15 kHz | -94 | -94 | -Infinity | -91 |
| \hat{E}_s / N_{oc} | dB | 4 | 4 | -Infinity | 7 |
| Propagation Condition | | ETU70 | | | |
| Note 1: OCNG shall be used such that both cells are fully allocated and a constant total transmitted power spectral density is achieved for all OFDM symbols. | | | | | |
| Note 2: Interference from other cells and noise sources not specified in the test is assumed to be constant over subcarriers and time and shall be modelled as AWGN of appropriate power for N_{oc} to be fulfilled. | | | | | |
| Note 3: RSRP and SCH_RP levels have been derived from other parameters for information purposes. They are not settable parameters themselves. | | | | | |

Table A.8.14.2.1-3: drx-Configuration to be used in E-UTRAN TDD-FDD inter-frequency event triggered reporting when DRX is used in fading propagation conditions

| Field | Test1 | Test2 | Comment |
|--------------------------|---------|---------|---------|
| | Value | Value | |
| onDurationTimer | psf1 | psf1 | |
| drx-InactivityTimer | psf1 | psf1 | |
| drx-RetransmissionTimer | psf1 | psf1 | |
| longDRX-CycleStartOffset | sf40 | sf1280 | |
| shortDRX | disable | disable | |

Table A.8.14.2.1-4: TimeAlignmentTimer and sr-ConfigIndex -Configuration to be used in E-UTRAN TDD-FDD inter-frequency event triggered reporting when DRX is used in fading propagation conditions

| Field | Test1 | Test2 | Comment |
|--------------------|-------|-------|--|
| | Value | Value | |
| TimeAlignmentTimer | sf500 | sf500 | For further information see clause 6.3.2 in TS 36.331. |
| sr-ConfigIndex | 2 | 2 | For further information see clause 6.3.2 in TS 36.331 and 10.1 in TS 36.213. |

A.8.14.2.2 Test Requirements

In Test1 the UE shall send one Event A3 triggered measurement report, with a measurement reporting delay less than 3840 ms from the beginning of time period T2. The measurement reporting delay is defined as the time from the beginning of time period T2, to the moment when the UE send the measurement report on PUSCH.

In Test2 the UE shall send one Event A3 triggered measurement report, with a measurement reporting delay less than 20*1280ms from the beginning of time period T2. The measurement reporting delay is defined as the time from the beginning of time period T2, to the moment when the UE starts to send preambles on the PRACH for scheduling request (SR) to obtain allocation to send the measurement report on PUSCH.

The UE shall not send event triggered measurement reports, as long as the reporting criteria are not fulfilled.

The rate of correct events observed during repeated tests shall be at least 90%.

NOTE 1: The actual overall delays measured in the test may be up to one DRX cycle higher than the measurement reporting delays above because UE is allowed to delay the initiation of the measurement reporting procedure to the next until the Active Time.

NOTE 2: In order to calculate the rate of correct events the system simulator shall verify that it has received correct Event A3 measurement report

A.8.14.3 E-UTRAN TDD - FDD Inter-frequency identification of a new CGI of E-UTRA cell using autonomous gaps

A.8.14.3.1 Test Purpose and Environment

This test is to verify the requirement for identification of a new CGI of E-UTRA cell with autonomous gaps in clause 8.1.2.3.6.

The test scenario comprises of one E-UTRA FDD carriers and one cell on each carrier as given in tables A.8.14.3.1-1 and A.8.14.3.1-2. PDCCHs indicating new transmissions shall be sent continuously to ensure that the UE would have ACK/NACK sending during identifying a new CGI of E-UTRAN cell. The test consists of three successive time periods, with time durations of T1, T2 and T3 respectively. At the start of time duration T1, the UE does not have any timing information of cell 2. Starting T2, cell 2 becomes detectable and the UE is expected to detect and send a measurement report. Gap pattern configuration with id #0 as specified in Table 8.1.2.1-1 is configured before T2 begins to enable inter-frequency monitoring.

A RRC message implying SI reading shall be sent to the UE during period T2, after the UE has reported Event A3. The RRC message shall create a measurement report configuration with purpose *reportCGI* and *si-RequestForHO* set to TRUE. The start of T3 is the instant when the last TTI containing the RRC message implying SI reading is sent to the UE. Measurement gaps shall be deconfigured before the start of T3.

Table A.8.14.3.1-1: General test parameters for E-UTRAN TDD - FDD Inter-frequency identification of a new CGI of E-UTRA cell using autonomous gaps

| Parameter | Unit | Value | Comment |
|--------------------------------------|------|--|---|
| Cell1PDSCH parameters | | DL Reference Measurement Channel R.0 TDD | As specified in clause A.3.1.1.2 |
| Cell1 PCFICH/PDCCH/PHICH parameters | | DL Reference Measurement Channel R.6 TDD | As specified in clause A.3.1.2.2 |
| Cell2 PDSCH parameters | | DL Reference Measurement Channel R.0 FDD | As specified in clause A.3.1.1.1 |
| Cell2 PCFICH/PDCCH/PHICH parameters | | DL Reference Measurement Channel R.6 FDD | As specified in clause A.3.1.2.1 |
| Cell1 E-UTRA RF channel number | | 1 | One TDD carrier is used |
| Cell2 E-UTRA RF channel number | | 2 | One FDD carrier is used |
| Channel Bandwidth ($BW_{channel}$) | MHz | 10 | |
| Active cell | | Cell 1 | Cell 1 is on RF channel number 1. |
| Neighbour cell | | Cell 2 | Cell 1 is on RF channel number 2. |
| CP length | | Normal | |
| Cell1 special subframe configuration | | 6 | As specified in table 4.2-1 in TS 36.211. |
| Cell1 Uplink-downlink configuration | | 1 | As specified in table 4.2-2 in TS 36.211. |
| Gap Pattern Id | | 0 | As specified in 3GPP TS 36.133 section 8.1.2.1. |
| A3-Offset | dB | -6 | |
| Hysteresis | dB | 0 | |
| TimeToTrigger | s | 0 | |
| Filter coefficient | | 0 | L3 filtering is not used |
| DRX | | OFF | |
| si-RequestForHO | | TRUE | As specified in clause 5.5.3.1 in TS 36.331. |
| Time offset between cells | ms | 3 | Asynchronous cells |
| T1 | s | 5 | |
| T2 | s | ≤10 | |
| T3 | s | 5 | |

Table A.8.14.3.1-2: Cell specific test parameters for E-UTRAN TDD - FDD Inter-frequency identification of a new CGI of E-UTRA cell using autonomous gaps

| Parameter | Unit | Cell 1 | | | Cell 2 | | |
|--|------------|----------|----------|----------|-----------|----------|----------|
| | | T1 | T2 | T3 | T1 | T2 | T3 |
| E-UTRA RF Channel Number | | 1 | | | 2 | | |
| $BW_{channel}$ | MHz | 10 | | | 10 | | |
| OCNG Patterns defined in A.3.2.2.1 (OP.1 TDD) and in A.3.2.1.2 (OP.2 FDD) | | OP.1 TDD | OP.1 TDD | OP.1 TDD | OP.2 FDD | OP.2 FDD | OP.2 FDD |
| PBCH_RA | dB | 0 | | | 0 | | |
| PBCH_RB | dB | | | | | | |
| PSS_RA | dB | | | | | | |
| SSS_RA | dB | | | | | | |
| PCFICH_RB | dB | | | | | | |
| PHICH_RA | dB | | | | | | |
| PHICH_PB | dB | | | | | | |
| PDCCH_RA | dB | | | | | | |
| PDCCH_PB | dB | | | | | | |
| PDSCH_RA | dB | | | | | | |
| PDSCH_RB | dB | | | | | | |
| OCNG_RA ^{Note 1} | dB | | | | | | |
| OCNG_RB ^{Note 1} | dB | | | | | | |
| \hat{E}_s / I_{ot} | dB | 4 | 4 | 4 | -Infinity | 7 | 7 |
| N_{oc} ^{Note 2} | dBm/15 KHz | -98 | | | | | |
| \hat{E}_s / N_{oc} | dB | 4 | 4 | 4 | -Infinity | 7 | 7 |
| RSRP ^{Note 3} | dBm/15 KHz | -94 | -94 | -94 | -Infinity | -91 | -91 |
| SCH_RP ^{Note 3} | dBm/15 KHz | -94 | -94 | -94 | -Infinity | -91 | -91 |
| Propagation Condition | | AWGN | | | | | |
| <p>Note 1: OCNG shall be used such that both cells are fully allocated and a constant total transmitted power spectral density is achieved for all OFDM symbols.</p> <p>Note 2: Interference from other cells and noise sources not specified in the test is assumed to be constant over subcarriers and time and shall be modelled as AWGN of appropriate power for N_{oc} to be fulfilled.</p> <p>Note 3: RSRP and SCH_RP levels have been derived from other parameters for information purposes. They are not settable parameters themselves.</p> | | | | | | | |

A.8.14.3.2 Test Requirements

The UE shall transmit a measurement report containing the cell global identifier of cell 2 within 170 milliseconds from the start of T3.

Test requirement = RRC Procedure delay + $T_{identify_CGI,inter}$ + reporting delay

$$= 15 + 150 + 2\text{ms from the start of T3}$$

$$= 167 \text{ ms, allow } 170 \text{ ms.}$$

The UE shall be scheduled continuously throughout the test, and from the start of T3 until 170 ms at least 42 ACK/NACK shall be detected as being transmitted by the UE.

The rate of correct events observed during repeated tests shall be at least 90%.

NOTE: The overall 42 ACK/NACK number is caused by two parts. Firstly, at least 30 ACK/NACK shall be sent during identifying the cell global identifier of cell 2 according to the requirement in Clause 8.1.2.3.7.1. Secondly, given that continuous DL data allocation, and the measurement gaps have been deconfigured before the start of T3, additional 12 ACK/NACK shall be sent from the start of T3 until 170 ms excludes 150 ms for identifying the cell global identifier of cell 2.

A.8.15 E-UTRAN FDD - TDD Inter-frequency Measurements

A.8.15.1 E-UTRAN FDD-TDD Inter-frequency event triggered reporting under fading propagation conditions in asynchronous cells

A.8.15.1.1 Test Purpose and Environment

The purpose of this test is to verify that the UE makes correct reporting of an event. This test will partly verify the FDD-TDD inter-frequency cell search requirements in clause 8.1.2.3.4.

The test parameters are given in Table A.8.15.1.1-1 and A.8.15.1.1-2 below. In the measurement control information it is indicated to the UE that event-triggered reporting with Event A3 is used. The test consists of two successive time periods, with time duration of T1, and T2 respectively. During time duration T1, the UE shall not have any timing information of cell 2.

Table A.8.15.1.1-1: General test parameters for E-UTRAN FDD-TDD inter-frequency event triggered reporting in fading propagation conditions

| Parameter | Unit | Value | Comment |
|--|------|--|---|
| Cell 1 PDSCH parameters | | DL Reference Measurement Channel R.0 FDD | As specified in clause A.3.1.1.1 |
| Cell 1 PCFICH/PDCCH/PHICH parameters | | DL Reference Measurement Channel R.6 FDD | As specified in clause A.3.1.2.1 |
| Cell 2 PCFICH/PDCCH/PHICH parameters | | DL Reference Measurement Channel R.6 TDD | As specified in clause A.3.1.2.2 |
| Gap Pattern Id | | 1 | As specified in TS 36.133 clause 8.1.2.1. |
| Cell2 Special subframe configuration | | 6 | As specified in table 4.2-1 in TS 36.211. Applicable to Cell 2. |
| Cell2 Uplink-downlink configuration | | 1 | As specified in TS 36.211 clause 4.2 Table 4.2-2. Applicable to Cell 2. |
| CP length | | Normal | |
| Cell 1 E-UTRA FDD RF Channel Number | | 1 | One TDD carrier frequency is used. |
| Cell 2 E-UTRA TDD RF Channel Number | | 2 | One FDD carrier frequency is used. |
| Channel Bandwidth (BW _{channel}) | MHz | 10 | |
| Active cell | | Cell 1 | Cell 1 is on RF channel number 1 |
| Neighbour cell | | Cell 2 | Cell 2 is on RF channel number 2 |
| A3-Offset | dB | -6 | |
| Hysteresis | dB | 0 | |
| TimeToTrigger | s | 0 | |
| Filter coefficient | | 0 | L3 filtering is not used |
| DRX | | OFF | |
| Time offset between cells | | 3 ms | Asynchronous cells |
| T1 | s | 5 | |
| T2 | s | 10 | |

Table A.8.15.1.1-2: Cell specific test parameters for E-UTRAN FDD-TDD inter-frequency event triggered reporting under fading propagation conditions in synchronous cells

| Parameter | Unit | Cell 1 | | Cell 2 | |
|--|------|----------|----|----------|----|
| | | T1 | T2 | T1 | T2 |
| E-UTRA RF Channel Number | | 1 | | 2 | |
| BW _{channel} | MHz | 10 | | 10 | |
| Correlation Matrix and Antenna Configuration | | 1x2 Low | | 1x2 Low | |
| OCNG Pattern defined in A.3.2.1.1 (OP.1 FDD) and in A.3.2.2.2 (OP.2 TDD) | | OP.1 FDD | | OP.2 TDD | |
| PBCH_RA | dB | | | | |
| PBCH_RB | dB | | | | |

| | | | | | |
|----------------------------|--|-------|-----|-----------|-----|
| PSS_RA | dB | 0 | | 0 | |
| SSS_RA | dB | | | | |
| PCFICH_RB | dB | | | | |
| PHICH_RA | dB | | | | |
| PHICH_RB | dB | | | | |
| PDCCH_RA | dB | | | | |
| PDCCH_RB | dB | | | | |
| PDSCH_RA | dB | | | | |
| PDSCH_RB | dB | | | | |
| OCNG_RA ^{Note 1} | dB | | | | |
| OCNG_RB ^{Note 1} | dB | | | | |
| \hat{E}_s / I_{ot} | dB | 4 | 4 | -Infinity | 7 |
| N_{oc} ^{Note 3} | dBm/15 kHz | -98 | | | |
| RSRP ^{Note 4} | dBm/15 kHz | -94 | -94 | -Infinity | -91 |
| SCH_RP ^{Note 4} | dBm/15 kHz | -94 | -94 | -infinity | -91 |
| \hat{E}_s / N_{oc} | dB | 4 | 4 | -Infinity | 7 |
| Propagation Condition | | ETU70 | | | |
| Note 1: | OCNG shall be used such that both cells are fully allocated and a constant total transmitted power spectral density is achieved for all OFDM symbols. | | | | |
| Note 2: | The resources for uplink transmission are assigned to the UE prior to the start of time period T2. | | | | |
| Note 3: | Interference from other cells and noise sources not specified in the test is assumed to be constant over subcarriers and time and shall be modelled as AWGN of appropriate power for N_{oc} to be fulfilled. | | | | |
| Note 4: | RSRP and SCH_RP levels have been derived from other parameters for information purposes. They are not settable parameters themselves. | | | | |

A.8.15.1.2 Test Requirements

The UE shall send one Event A3 triggered measurement report, with a measurement reporting delay less than 7680 ms from the beginning of time period T2.

The UE shall not send event triggered measurement reports, as long as the reporting criteria are not fulfilled.

The rate of correct events observed during repeated tests shall be at least 90%.

NOTE: The actual overall delays measured in the test may be up to $2xTTI_{DCC}$ higher than the measurement reporting delays above because of TTI insertion uncertainty of the measurement report in DCC

A.8.15.2 E-UTRAN FDD-TDD Inter-frequency event triggered reporting when DRX is used under fading propagation conditions in asynchronous cells

A.8.15.2.1 Test Purpose and Environment

The purpose of these tests is to verify that the UE makes correct reporting of an event in DRX. These tests will partly verify the FDD-TDD inter-frequency cell search requirements when DRX is used in clause 8.1.2.3.4.

The common test parameters are given in Tables A.8.15.2.1-1 and A.8.15.2.1-2. DRX configuration for Test1 and Test2 are given in Table A.8.15.2.1-3 and time alignment timer and scheduling request related parameters in Table A.8.15.2.1-4. In these tests, there are two cells on different carrier frequencies and gap pattern configuration # 0 as defined in Table 8.1.2.1-1 is provided.

In Test 1 UE needs to be provided at least once every 500ms with new Timing Advance Command MAC control element to restart the Time alignment timer to keep UE uplink time alignment. Furthermore UE is allocated with PUSCH resource at every DRX cycle. In Test 2 the uplink time alignment is not maintained and UE needs to use RACH to obtain UL allocation for measurement reporting.

In the measurement control information, it is indicated to the UE that event-triggered reporting with Event A3 is used. The tests consist of two successive time periods, with time duration of T1, and T2 respectively. During time duration T1, the UE shall not have any timing information of cell 2.

Table A.8.15.2.1-1: General test parameters for E-UTRAN FDD-TDD inter-frequency event triggered reporting when DRX is used under fading propagation conditions in asynchronous cells

| Parameter | Unit | Test 1 | Test 2 | Comment |
|--|------|--|--------|---|
| | | Value | | |
| Cell 1 PDSCH parameters | | DL Reference Measurement Channel R.0 FDD | | As specified in clause A.3.1.1.1 Note that UE may only be allocated at <i>On Duration</i> |
| Cell 1 PCFICH/PDCCH/PHICH parameters | | DL Reference Measurement Channel R.6 FDD | | As specified in clause A.3.1.2.1. |
| Cell 2 PCFICH/PDCCH/PHICH parameters | | DL Reference Measurement Channel R.6 TDD | | As specified in clause A.3.1.2.2. |
| Cell 1 E-UTRA FDD RF Channel Number | | 1 | | One FDD carrier frequency is used. |
| Cell 2 E-UTRA TDD RF Channel Number | | 2 | | One TDD carrier frequency is used. |
| Channel Bandwidth (BW _{channel}) | MHz | 10 | | |
| Active cell | | Cell 1 | | Cell 1 is on RF channel number 1 |
| Neighbour cell | | Cell 2 | | Cell 2 is on RF channel number 2 |
| Gap Pattern Id | | 0 | | As specified in TS 36.133 clause 8.1.2.1. |
| A3-Offset | dB | -6 | | |
| Hysteresis | dB | 0 | | |
| CP length | | Normal | | |
| TimeToTrigger | s | 0 | | |
| Filter coefficient | | 0 | | L3 filtering is not used |
| E-UTRA FDD PRACH configuration | | 4 | | As specified in table 5.7.1-2 in TS 36.211 |
| Cell 2 Special subframe configuration | | 6 | | As specified in table 4.2-1 in TS 36.211 |
| Cell 2 Uplink-downlink configuration | | 1 | | As specified in table 4.2-2 in TS 36.211 |
| E-UTRA TDD Access Barring Information | - | Not Sent | | No additional delays in random access procedure. |
| DRX | | ON | | DRX related parameters are defined in Table A.8.15.2.1-3 |
| Time offset between cells | ms | 3 | | Asynchronous cells |
| T1 | s | 5 | | |
| T2 | s | 5 | 30 | |

Table A.8.15.2.1-2: Cell specific test parameters for E-UTRAN FDD-TDD inter-frequency event triggered reporting when DRX is used under fading propagation conditions in asynchronous cells

| Parameter | Unit | Cell 1 | | Cell 2 | |
|---|------|----------|----|----------|----|
| | | T1 | T2 | T1 | T2 |
| E-UTRA RF Channel Number | | 1 | | 2 | |
| BW _{channel} | MHz | 10 | | 10 | |
| Correlation Matrix and Antenna Configuration | | 1x2 Low | | 1x2 Low | |
| OCNG Patterns defined in A.3.2.1.1 (OP.1 FDD) and in A.3.2.2.2 (OP.2 TDD) | | OP.1 FDD | | OP.2 TDD | |
| PBCH_RA | dB | 0 | | 0 | |
| PBCH_RB | dB | | | | |
| PSS_RA | dB | | | | |
| SSS_RA | dB | | | | |
| PCFICH_RB | dB | | | | |
| PHICH_RA | dB | | | | |
| PHICH_RB | dB | | | | |
| PDCCH_RA | dB | | | | |
| PDCCH_RB | dB | | | | |
| PDSCH_RA | dB | | | | |
| PDSCH_RB | dB | | | | |
| OCNG_RA ^{Note 1} | dB | | | | |
| OCNG_RB ^{Note 1} | dB | | | | |

| | | | | | |
|-----------------------|--|-----|-----|-----------|-----|
| N_{oc} Note 2 | dBm/15 kHz | -98 | | | |
| RSRP Note 3 | dBm/15 kHz | -94 | -94 | -Infinity | -91 |
| \hat{E}_s/I_{ot} | dB | 4 | 4 | -Infinity | 7 |
| SCH_RP Note 3 | dBm/15 kHz | -94 | -94 | -Infinity | -91 |
| \hat{E}_s/N_{oc} | dB | 4 | 4 | -Infinity | 7 |
| Propagation Condition | ETU70 | | | | |
| Note 1: | OCNG shall be used such that both cells are fully allocated and a constant total transmitted power spectral density is achieved for all OFDM symbols. | | | | |
| Note 2: | Interference from other cells and noise sources not specified in the test is assumed to be constant over subcarriers and time and shall be modelled as AWGN of appropriate power for N_{oc} to be fulfilled. | | | | |
| Note 3: | RSRP and SCH_RP levels have been derived from other parameters for information purposes. They are not settable parameters themselves. | | | | |

Table A.8.15.2.1-3: drx-Configuration to be used in E-UTRAN FDD-TDD inter-frequency event triggered reporting when DRX is used under fading propagation conditions in asynchronous cells

| Field | Test1 | Test2 | Comment |
|--------------------------|--|---------|---------|
| | Value | Value | |
| onDurationTimer | psf1 | psf1 | |
| drx-InactivityTimer | psf1 | psf1 | |
| drx-RetransmissionTimer | psf1 | psf1 | |
| longDRX-CycleStartOffset | sf40 | sf1280 | |
| shortDRX | disable | disable | |
| Note: | For further information see clause 6.3.2 in TS 36.331. | | |

Table A.8.15.2.1-4: TimeAlignmentTimer and sr-ConfigIndex -Configuration to be used in E-UTRAN FDD-TDD inter-frequency event triggered reporting when DRX is used under fading propagation conditions in asynchronous cells

| Field | Test1 | Test2 | Comment |
|--------------------|-------|-------|--|
| | Value | Value | |
| TimeAlignmentTimer | sf500 | sf500 | For further information see clause 6.3.2 in TS 36.331. |
| sr-ConfigIndex | 0 | 0 | For further information see clause 6.3.2 in TS 36.331 and section 10.1 in TS 36.213. |

A.8.15.2.2 Test Requirements

In Test1 the UE shall send one Event A3 triggered measurement report, with a measurement reporting delay less than 3840 ms from the beginning of time period T2. The measurement reporting delay is defined as the time from the beginning of time period T2, to the moment when the UE send the measurement report on PUSCH.

In Test2 the UE shall send one Event A3 triggered measurement report, with a measurement reporting delay less than 20*1280ms from the beginning of time period T2. The measurement reporting delay is defined as the time from the beginning of time period T2, to the moment when the UE starts to send preambles on the PRACH for scheduling request (SR) to obtain allocation to send the measurement report on PUSCH.

The UE shall not send event triggered measurement reports, as long as the reporting criteria are not fulfilled.

The rate of correct events observed during repeated tests shall be at least 90%.

NOTE 1: The actual overall delays measured in the test may be up to one DRX cycle higher than the measurement reporting delays above because UE is allowed to delay the initiation of the measurement reporting procedure to the next until the Active Time.

NOTE 2: In order to calculate the rate of correct events the system simulator shall verify that it has received correct Event A3 measurement report.

A.8.15.3 E-UTRAN FDD - TDD Inter-frequency identification of a new CGI of E-UTRA cell using autonomous gaps

A.8.15.3.1 Test Purpose and Environment

This test is to verify the requirement for identification of a new CGI of E-UTRA cell with autonomous gaps in clause 8.1.2.3.8.

The test scenario comprises of one E-UTRA FDD carrier and one E-UTRA TDD carrier and one cell on each carrier as given in tables A.8.15.3-1 and A.8.15.3-2. PDCCHs indicating new transmissions shall be sent continuously to ensure that the UE would have ACK/NACK sending during identifying a new CGI of E-UTRAN cell. The test consists of three successive time periods, with time durations of T1, T2 and T3 respectively. At the start of time duration T1, the UE does not have any timing information of cell 2. Starting T2, cell 2 becomes detectable and the UE is expected to detect and send a measurement report. Gap pattern configuration with id #0 as specified in Table 8.1.2.1-1 is configured before T2 begins to enable inter-frequency monitoring.

A RRC message implying SI reading shall be sent to the UE during period T2, after the UE has reported Event A3. The RRC message shall create a measurement report configuration with purpose *reportCGI* and *si-RequestForHO* set to TRUE. The start of T3 is the instant when the last TTI containing the RRC message implying SI reading is sent to the UE. Measurement gaps shall be deconfigured before the start of T3.

Table A.8.15.3-1: General test parameters for E-UTRAN FDD - TDD Inter-frequency identification of a new CGI of E-UTRA cell using autonomous gaps

| Parameter | Unit | Value | Comment |
|---------------------------------------|------|--|---|
| Cell1 PDSCH parameters | | DL Reference Measurement Channel R.3 FDD | As specified in clause A.3.1.1.1 |
| Cell1 PCFICH/PDCCH/PHICH parameters | | DL Reference Measurement Channel R.6 FDD | As specified in clause A.3.1.2.1 |
| Cell2 PCFICH/PDCCH/PHICH parameters | | DL Reference Measurement Channel R.6 TDD | As specified in clause A.3.1.2.2 |
| E-UTRA RF channel number | | 1, 2 | One FDD and one TDD carrier frequency are used. |
| Channel Bandwidth ($BW_{channel}$) | MHz | 10 | |
| Active cell | | Cell 1 | Cell 1 is on RF channel number 1. |
| Neighbour cell | | Cell 2 | Cell 1 is on RF channel number 2. |
| CP length | | Normal | |
| Cell 2 Special subframe configuration | | 6 | As specified in table 4.2-1 in TS 36.211. |
| Cell 2 Uplink-downlink configuration | | 1 | As specified in table 4.2-2 in TS 36.211. |
| Gap Pattern Id | | 0 | As specified in TS 36.133 clause 8.1.2.1. |
| A3-Offset | dB | -6 | |
| Hysteresis | dB | 0 | |
| TimeToTrigger | s | 0 | |
| Filter coefficient | | 0 | L3 filtering is not used |
| DRX | | OFF | |
| si-RequestForHO | | TRUE | As specified in clause 5.5.3.1 in TS 36.331. |
| Time offset between cells | ms | 3 | Asynchronous cells |
| T1 | s | 5 | |
| T2 | s | ≤10 | |
| T3 | s | 5 | |

Table A.8.15.3-2: Cell specific test parameters for E-UTRAN FDD - TDD Inter-frequency identification of a new CGI of E-UTRA cell using autonomous gaps

| Parameter | Unit | Cell 1 | | | Cell 2 | | |
|---|------|-----------|-----------|-----------|----------|----------|----------|
| | | T1 | T2 | T3 | T1 | T2 | T3 |
| E-UTRA RF Channel Number | | 1 | | | 2 | | |
| $BW_{channel}$ | MHz | 10 | | | 10 | | |
| OCNG Patterns defined in A.3.2.1.10 (OP.10 FDD) and in A.3.2.2.1 (OP.2 TDD) | | OP.10 FDD | OP.10 FDD | OP.10 FDD | OP.2 TDD | OP.2 TDD | OP.2 TDD |
| PBCH_RA | dB | | | | | | |
| PBCH_RB | dB | | | | | | |
| PSS_RA | dB | | | | | | |

| | | | | | | | |
|----------------------------|--|------|-----|-----|-----------|-----|-----|
| SSS_RA | dB | 0 | | | 0 | | |
| PCFICH_RB | dB | | | | | | |
| PHICH_RA | dB | | | | | | |
| PHICH_PB | dB | | | | | | |
| PDCCH_RA | dB | | | | | | |
| PDCCH_PB | dB | | | | | | |
| PDSCH_RA | dB | | | | | | |
| PDSCH_RB | dB | | | | | | |
| OCNG_RA ^{Note 1} | dB | | | | | | |
| OCNG_RB ^{Note 1} | dB | | | | | | |
| \hat{E}_s / I_{ot} | dB | 4 | 4 | 4 | -Infinity | 7 | 7 |
| N_{oc} ^{Note 2} | dBm/15 KHz | -98 | | | | | |
| \hat{E}_s / N_{oc} | dB | 4 | 4 | 4 | -Infinity | 7 | 7 |
| RSRP ^{Note 3} | dBm/15 KHz | -94 | -94 | -94 | -Infinity | -91 | -91 |
| SCH_RP ^{Note 3} | dBm/15 KHz | -94 | -94 | -94 | -Infinity | -91 | -91 |
| Propagation Condition | | AWGN | | | | | |
| Note 1: | OCNG shall be used such that both cells are fully allocated and a constant total transmitted power spectral density is achieved for all OFDM symbols. | | | | | | |
| Note 2: | Interference from other cells and noise sources not specified in the test is assumed to be constant over subcarriers and time and shall be modelled as AWGN of appropriate power for N_{oc} to be fulfilled. | | | | | | |
| Note 3: | RSRP and SCH_RP levels have been derived from other parameters for information purposes. They are not settable parameters themselves. | | | | | | |

A.8.15.3.2 Test Requirements

The UE shall transmit a measurement report containing the cell global identifier of cell 2 within 170 milliseconds from the start of T3.

$$\begin{aligned} \text{Test requirement} &= \text{RRC Procedure delay} + T_{\text{identify_CGI,inter}} + \text{reporting delay} \\ &= 15 + 150 + 2\text{ms from the start of T3} \\ &= 167 \text{ ms, allow 170 ms.} \end{aligned}$$

The UE shall be scheduled continuously throughout the test, and from the start of T3 until 170 ms at least 60 ACK/NACK shall be detected as being transmitted by the UE.

The rate of correct events observed during repeated tests shall be at least 90%.

NOTE: The overall 80 ACK/NACK number is caused by two parts. Firstly, at least 60 ACK/NACK shall be sent during identifying the cell global identifier of cell 2 according to the requirement in Clause 8.1.2.3.5.1. Secondly, given that continuous DL data allocation, and the measurement gaps have been deconfigured before the start of T3, additional 20 ACK/NACK shall be sent from the start of T3 until 170 ms excludes 150 ms for identifying the cell global identifier of cell 2.

A.8.16 E-UTRAN Carrier Aggregation Measurements

A.8.16.1 E-UTRAN FDD event triggered reporting under deactivated SCell in non-DRX

A.8.16.1.1 Test Purpose and Environment

The purpose of this test is to verify that the UE correctly detects events A2 (Serving cell becomes worse than threshold) and A6 (Neighbour becomes better than SCell) defined in TS 36.331 [2] within the requirements stated in clause 8.3.3.2.1.

The test parameters are given in Tables A.8.16.1.1-1 and A.8.16.1.1-2 below. It is indicated to the UE in the measurement control information that event-triggered reporting with Events A2 (PCell and SCell) and A6 is used. The test consists of three successive time periods, with duration of T1, T2 and T3, respectively. During T1 the UE shall not have any information on cell 3. Immediately at beginning of T2 the transmission power of cell 3 is increased to same level as for cell 2, and due to usage of an

offset this shall result in reporting of Event A6. At beginning of T3 the transmission powers of cells 1, 2 and 3 are reduced below a threshold value and this shall result in reporting of Event A2 for PCell and SCell, respectively.

Table A.8.16.1.1-1: General test parameters for E-UTRAN FDD event triggered reporting on configured but deactivated SCell in non-DRX under fading propagation conditions

| Parameter | Unit | Value | Comment | |
|---|--|---|--|---|
| PDSCH parameters | | DL Reference Measurement Channel R.0 FDD | As specified in clause A.3.1.1.1 | |
| PCFICH/PDCCH/PHICH parameters | | DL Reference Measurement Channel R.6 FDD | As specified in clause A.3.1.2.1 | |
| E-UTRA RF Channel Number | | 1, 2 | Two radio channels are used for this test | |
| Active PCell | | Cell 1 | Primary cell on RF channel number 1. | |
| Configured deactivated SCell | | Cell 2 | Configured deactivated secondary cell on RF channel number 2. | |
| Neighbour cell | | Cell 3 | Neighbor cell to be identified on RF channel number 2. | |
| Channel Bandwidth (BW _{channel}) | MHz | 10 | Channel bandwidth for cells on primary and secondary component carriers | |
| CP length | | Normal | | |
| DRX | | OFF | Continuous monitoring of primary cell | |
| A2 | Hysteresis | dB | 0 | Hysteresis for evaluation of event A2. |
| | Threshold RSRP | dBm | -93 | Actual RSRP threshold for event A2. Needs to take absolute accuracy tolerance in clause 9.1.11.1 into account plus margin. |
| | Time To Trigger | s | 0 | |
| A6 | Hysteresis | dB | 0 | Hysteresis for evaluation of event A6. |
| | Offset | dB | -6 | Offset parameter for evaluation of event A6. Needs to take relative accuracy tolerance in clause 9.1.11.2 into account plus margin. |
| | Report on leave | | False | |
| | Time To Trigger | s | 0 | |
| Cell-individual offset for cells on RF channel number 1 | dB | 0 | Individual offset for cells on primary component carrier. | |
| Cell-individual offset for cells on RF channel number 2 | dB | 0 | Individual offset for cells on secondary component carrier. | |
| Filter coefficient | | 0 | L3 filtering is not used | |
| SCell measurement cycle (measCycleSCell) | ms | 320 | | |
| Cell2 timing offset to cell1 | μs | 0 | | |
| Time alignment error between cell2 and cell1 | μs | ≤ Time alignment error as specified in TS 36.104 [30] clause 6.5.3.1. | The value of time alignment error depends upon the type of carrier aggregation. | |
| Cell3 timing offset to cell1 | μs | 3 | Synchronous cells | |
| T1 | s | 5 | During this time the UE shall be aware of cells 1 and 2 but not cell 3. | |
| T2 | s | ≤12 | UE shall report Event A6 within 6.4s (20×scellMeasCycle) | |
| T3 | s | 5 | UE shall report Event A2 within 200 ms and 1.6s for cells 1 and 2, respectively. | |
| NOTE: | This test verifies the RRM requirement which is independent of channel bandwidth and is performed according to the principle defined in section A.3.6.1. | | | |

Table A.8.16.1.1-2: Cell specific test parameters for E-UTRAN FDD event triggered reporting on configured but deactivated SCell in non-DRX under fading propagation conditions

| Parameter | Unit | Cell 1 | | | Cell 2 | | | Cell 3 | | |
|--|------|---------|----|----|---------|----|----|---------|----|----|
| | | T1 | T2 | T3 | T1 | T2 | T3 | T1 | T2 | T3 |
| E-UTRA RF Channel Number | | 1 | | | 2 | | | 2 | | |
| BW _{channel} | MHz | 10 | | | 10 | | | 10 | | |
| Correlation Matrix and Antenna Configuration | | 1x2 Low | | | 1x2 Low | | | 1x2 Low | | |

| OCNG Patterns defined in A.3.2.1.1 (OP.1 FDD) and in A.3.2.1.2 (OP.2 FDD) | | OP.1 FDD | | | OP.2 FDD | | | OP.2 FDD | | |
|---|--|----------|-----|------|----------|-------|-------|-----------|-------|-------|
| PBCH_RA | dB | 0 | | | 0 | | | 0 | | |
| PBCH_RB | dB | | | | | | | | | |
| PSS_RA | dB | | | | | | | | | |
| SSS_RA | dB | | | | | | | | | |
| PCFICH_RB | dB | | | | | | | | | |
| PHICH_RA | dB | | | | | | | | | |
| PHICH_RB | dB | | | | | | | | | |
| PDCCH_RA | dB | | | | | | | | | |
| PDCCH_RB | dB | | | | | | | | | |
| PDSCH_RA | dB | | | | | | | | | |
| PDSCH_RB | dB | | | | | | | | | |
| OCNG_RA ^{Note 1} | dB | | | | | | | | | |
| OCNG_RB ^{Note 1} | dB | | | | | | | | | |
| N_{oc} ^{Note 2} | dBm/15 kHz | | | | | | | | | |
| RSRP ^{Note 3} | dBm/15 kHz | -82 | -82 | -104 | -82 | -82 | -104 | -infinity | -82 | -104 |
| \hat{E}_s/I_{ot} | dB | 19 | 19 | -3 | 19 | -0.05 | -4.76 | -infinity | -0.05 | -4.76 |
| SCH_RP ^{Note 3} | dBm/15 kHz | -82 | -82 | -104 | -82 | -82 | -104 | -infinity | -82 | -104 |
| \hat{E}_s/N_{oc} | dB | 19 | 19 | -3 | 19 | 19 | -3 | -infinity | 19 | -3 |
| Propagation Condition | | ETU70 | | | | | | | | |
| Note 1: | OCNG shall be used such that all cells are fully allocated and a constant total transmitted power spectral density is achieved for all OFDM symbols. | | | | | | | | | |
| Note 2: | Interference from other cells and noise sources not specified in the test is assumed to be constant over subcarriers and time and shall be modelled as AWGN of appropriate power for N_{oc} to be fulfilled. | | | | | | | | | |
| Note 3: | RSRP and SCH_RP levels have been derived from other parameters for information purposes. They are not settable parameters themselves. | | | | | | | | | |
| Note 4: | The resources for uplink transmission are assigned to the UE prior to the start of time period T2. | | | | | | | | | |

A.8.16.1.2 Test Requirements

The UE shall send one Event A6 triggered measurement report with a measurement reporting delay of less than 6.4s ($20 \times \text{measCycleSCell}$) from the beginning of time T2.

The UE shall send one Event A2 triggered measurement report for Cell 1 with a measurement reporting delay of less than 200 ms from beginning of time T3.

The UE shall send one Event A2 triggered measurement report for Cell 2 with a measurement reporting delay of less than 1.6s ($5 \times \text{measCycleSCell}$) from beginning of time T3.

The UE shall not send event triggered measurement reports as long as the reporting criteria are not fulfilled.

The rate of correct events observed during repeated tests shall be at least 90% for each of the events.

NOTE: The actual overall delays measured in the tests may be up to $2 \times TTI_{DCCH}$ higher than the measurement reporting delays above because of TTI insertion uncertainty of the measurement report in DCCH.

A.8.16.2 E-UTRAN TDD event triggered reporting under deactivated SCell in non-DRX

A.8.16.2.1 Test Purpose and Environment

The purpose of this test is to verify that the UE correctly detects events A2 (Serving cell becomes worse than threshold) and A6 (Neighbour becomes better than SCell) defined in TS 36.331 [2] within the requirements stated in clause 8.3.3.2.1.

The test parameters are given in Tables A.8.16.2.1-1 and A.8.16.2.1-2 below. It is indicated to the UE in the measurement control information that event-triggered reporting with Events A2 (PCell and SCell) and A6 is used. The test consists of three successive time periods, with duration of T1, T2 and T3, respectively. During T1 the UE shall not have any information on cell 3. Immediately at beginning of T2 the transmission power of cell 3 is increased to same level as for cell 2, and due to usage of an offset this shall result in reporting of Event A6. At beginning of T3 the transmission powers of cells 1, 2 and 3 are reduced below a threshold value and this shall result in reporting of Event A2 for PCell and SCell, respectively.

Table A.8.16.2.1-1: General test parameters for E-UTRAN TDD event triggered reporting on configured but deactivated SCell in non-DRX under fading propagation conditions

| Parameter | | Unit | Value | Comment |
|--|-----------------|------|---|---|
| PDSCH parameters | | | DL Reference Measurement Channel R.0 TDD | As specified in clause A.3.1.1.2 |
| PCFICH/PDCCH/PHICH parameters | | | DL Reference Measurement Channel R.6 TDD | As specified in clause A.3.1.2.2 |
| E-UTRA RF Channel Number | | | 1, 2 | Two radio channels are used for this test |
| Active PCell | | | Cell 1 | Primary cell on RF channel number 1. |
| Configured deactivated SCell | | | Cell 2 | Configured deactivated secondary cell on RF channel number 2. |
| Neighbour cell | | | Cell 3 | Neighbor cell to be identified on RF channel number 2. |
| Channel Bandwidth (BW _{channel}) | | MHz | 10 | Channel bandwidth for cells on primary and secondary component carriers |
| CP length | | | Normal | |
| Special subframe configuration | | | 6 | As specified in table 4.2.1 in TS 36.211. The same configuration applies to all cells. |
| Uplink-downlink configuration | | | 1 | |
| DRX | | | OFF | Continuous monitoring of primary cell |
| A2 | Hysteresis | dB | 0 | Hysteresis for evaluation of event A2. |
| | Threshold RSRP | dBm | -93 | Actual RSRP threshold for event A2. Needs to take absolute accuracy tolerance in clause 9.1.11.1 into account plus margin. |
| | Time To Trigger | s | 0 | |
| A6 | Hysteresis | dB | 0 | Hysteresis for evaluation of event A6. |
| | Offset | dB | -6 | Offset parameter for evaluation of event A6. Needs to take relative accuracy tolerance in clause 9.1.11.2 into account plus margin. |
| | Report on leave | | False | |
| | Time To Trigger | s | 0 | |
| Cell-individual offset for cells on RF channel number 1 | | dB | 0 | Individual offset for cells on primary component carrier. |
| Cell-individual offset for cells on RF channel number 2 | | dB | 0 | Individual offset for cells on secondary component carrier. |
| Filter coefficient | | | 0 | L3 filtering is not used |
| SCell measurement cycle (measCycleSCell) | | ms | 320 | |
| Cell2 timing offset to cell1 | | μs | 0 | |
| Time alignment error between cell2 and cell1 | | μs | ≤ Time alignment error as specified in TS 36.104 [30] clause 6.5.3.1. | The value of time alignment error depends upon the type of carrier aggregation. |
| Cell3 timing offset to cell1 | | μs | 3 | Synchronous cells |
| T1 | | s | 5 | During this time the UE shall be aware of cells 1 and 2 but not cell 3. |
| T2 | | s | ≤12 | UE shall report Event A6 within 6.4s (20xscellMeasCycle) |
| T3 | | s | 5 | UE shall report Event A2 within 200 ms and 1.6s for cells 1 and 2, respectively. |
| NOTE: This test verifies the RRM requirement which is independent of channel bandwidth and is performed according to the principle defined in section A.3.6.1. | | | | |

Table A.8.16.2.1-2: Cell specific test parameters for E-UTRAN TDD event triggered reporting on configured but deactivated SCell in non-DRX under fading propagation conditions

| Parameter | Unit | Cell 1 | | | Cell 2 | | | Cell 3 | | |
|--|------|---------|----|----|---------|----|----|---------|----|----|
| | | T1 | T2 | T3 | T1 | T2 | T3 | T1 | T2 | T3 |
| E-UTRA RF Channel Number | | 1 | | | 2 | | | 2 | | |
| BW _{channel} | MHz | 10 | | | 10 | | | 10 | | |
| Correlation Matrix and Antenna Configuration | | 1x2 Low | | | 1x2 Low | | | 1x2 Low | | |

| OCNG Patterns defined in A.3.2.2.1 (OP.1 TDD) and in A.3.2.2.2 (OP.2 TDD) | | OP.1 TDD | | | OP.2 TDD | | | OP.2 TDD | | |
|---|--|----------|-----|------|----------|-------|-------|-----------|-------|-------|
| PBCH_RA | dB | 0 | | | 0 | | | 0 | | |
| PBCH_RB | dB | | | | | | | | | |
| PSS_RA | dB | | | | | | | | | |
| SSS_RA | dB | | | | | | | | | |
| PCFICH_RB | dB | | | | | | | | | |
| PHICH_RA | dB | | | | | | | | | |
| PHICH_RB | dB | | | | | | | | | |
| PDCCH_RA | dB | | | | | | | | | |
| PDCCH_RB | dB | | | | | | | | | |
| PDSCH_RA | dB | | | | | | | | | |
| PDSCH_RB | dB | | | | | | | | | |
| OCNG_RA ^{Note 1} | dB | | | | | | | | | |
| OCNG_RB ^{Note 1} | dB | | | | | | | | | |
| N_{oc} ^{Note 2} | dBm/15 kHz | | | | | | | | | |
| RSRP ^{Note 3} | dBm/15 kHz | -82 | -82 | -104 | -82 | -82 | -104 | -infinity | -82 | -104 |
| \hat{E}_s/lot | dB | 19 | 19 | -3 | 19 | -0.05 | -4.76 | -infinity | -0.05 | -4.76 |
| SCH_RP ^{Note 3} | dBm/15 kHz | -82 | -82 | -104 | -82 | -82 | -104 | -infinity | -82 | -104 |
| \hat{E}_s/N_{oc} | dB | 19 | 19 | -3 | 19 | 19 | -3 | -infinity | 19 | -3 |
| Propagation Condition | | ETU70 | | | | | | | | |
| Note 1: | OCNG shall be used such that all cells are fully allocated and a constant total transmitted power spectral density is achieved for all OFDM symbols. | | | | | | | | | |
| Note 2: | Interference from other cells and noise sources not specified in the test is assumed to be constant over subcarriers and time and shall be modelled as AWGN of appropriate power for N_{oc} to be fulfilled. | | | | | | | | | |
| Note 3: | RSRP and SCH_RP levels have been derived from other parameters for information purposes. They are not settable parameters themselves. | | | | | | | | | |
| Note 4: | The resources for uplink transmission are assigned to the UE prior to the start of time period T2. | | | | | | | | | |

A.8.16.2.2 Test Requirements

The UE shall send one Event A6 triggered measurement report with a measurement reporting delay of less than 6.4s ($20 \times \text{measCycleSCell}$) from the beginning of time T2.

The UE shall send one Event A2 triggered measurement report for Cell 1 with a measurement reporting delay of less than 200 ms from beginning of time T3.

The UE shall send one Event A2 triggered measurement report for Cell 2 with a measurement reporting delay of less than 1.6s ($5 \times \text{measCycleSCell}$) from beginning of time T3.

The UE shall not send event triggered measurement reports as long as the reporting criteria are not fulfilled.

The rate of correct events observed during repeated tests shall be at least 90% for each of the events.

NOTE: The actual overall delays measured in the tests may be up to $2 \times TTI_{DCCH}$ higher than the measurement reporting delays above because of TTI insertion uncertainty of the measurement report in DCCH.

A.8.16.3 E-UTRAN FDD-FDD Event triggered reporting on deactivated SCell with PCell interruption in non-DRX

A.8.16.3.1 Test Purpose and Environment

The purpose of this test is to verify that the UE correctly detects event A6 (Neighbour becomes better than SCell) defined in TS 36.331 [2] within the requirements stated in clause 8.3.3.2.1 while at the same time fulfilling the requirement on interruption rate.

The test parameters are given in Table A.8.16.3.1-1 and A.8.16.3.1-2 below. In the test there are three synchronous cells: Cell1, Cell2 and Cell3. Cell1 is PCell, Cell2 is deactivated SCell, and Cell3 is the neighbour cell. It is indicated to the UE in the measurement control information that event-triggered reporting with Event A6 is used. The test consists of two successive time periods, with duration of T1 and T2, respectively. During T1 the UE shall not have any information of cell 3. Immediately at beginning of T2 the transmission power of cell 3 is increased to same level as for cell 2, and due to usage of an offset this shall result in reporting of Event A6. PDCCH indicating a new transmission on the PCell shall be sent continuously to ensure that the UE sends ACK/NACKs throughout the test.

Table A.8.16.3.1-1: General test parameters for E-UTRAN FDD-FDD Event triggered reporting on configured but deactivated SCell with PCell interruption in non-DRX

| Parameter | Unit | Value | Comment | |
|--|-----------------|---|---|---|
| PDSCH parameters | | DL Reference Measurement Channel R.3 FDD | As specified in clause A.3.1.1.1 | |
| PCFICH/PDCCH/PHICH parameters | | DL Reference Measurement Channel R.6 FDD | As specified in clause A.3.1.2.1 | |
| E-UTRA RF Channel Number | | 1, 2 | Two radio channels are used for this test | |
| Active PCell | | Cell 1 | Primary cell on RF channel number 1. | |
| Configured deactivated SCell | | Cell 2 | Configured deactivated secondary cell on RF channel number 2. | |
| Neighbour cell | | Cell 3 | Neighbor cell to be identified on RF channel number 2. | |
| Channel Bandwidth (BW _{channel}) | MHz | 10 | Channel bandwidth for cells on primary and secondary component carriers | |
| CP length | | Normal | | |
| DRX | | OFF | Continuous monitoring of primary cell | |
| A6 | Hysteresis | dB | 0 | Hysteresis for evaluation of event A6. |
| | Offset | dB | -3 | Offset parameter for evaluation of event A6. Needs to take relative accuracy tolerance in clause 9.1.11.2 into account plus margin. |
| | Report on leave | | False | |
| | Time To Trigger | s | 0 | |
| Cell-individual offset for cells on RF channel number 1 | dB | 0 | Individual offset for cells on primary component carrier. | |
| Cell-individual offset for cells on RF channel number 2 | dB | 0 | Individual offset for cells on secondary component carrier. | |
| Filter coefficient | | 0 | L3 filtering is not used | |
| SCell measurement cycle | ms | 1280 | | |
| Cell2 timing offset to cell1 | μs | 0 | | |
| Time alignment error between cell2 and cell1 | μs | ≤ Time alignment error as specified in TS 36.104 [30] clause 6.5.3.1. | The value of time alignment error depends upon the type of carrier aggregation. | |
| Cell3 timing offset to cell1 | μs | 3 | Synchronous cells | |
| T1 | s | 5 | During this time the UE shall be aware of cells 1 and 2 but not cell 3. | |
| T2 | s | ≤30 | UE shall report Event A6 within 25.6s (20×scellMeasCycle) | |
| NOTE: This test verifies the RRM requirement which is independent of channel bandwidth and is performed according to the principle defined in section A.3.6.1. | | | | |

Table A.8.16.3.1-2: Cell specific test parameters for E-UTRAN FDD-FDD Event triggered reporting on configured but deactivated SCell with PCell interruption in non-DRX

| Parameter | Unit | Cell 1 | | Cell 2 | | Cell 3 | |
|--|------|-----------|----|----------|----|----------|----|
| | | T1 | T2 | T1 | T2 | T1 | T2 |
| E-UTRA RF Channel Number | | 1 | | 2 | | 2 | |
| BW _{channel} | MHz | 10 | | 10 | | 10 | |
| OCNG Pattern defined in A.3.2.1.10 (OP.10 FDD) and in A.3.2.1.2 (OP.2) | | OP.10 FDD | | OP.2 FDD | | OP.2 FDD | |
| PBCH_RA | dB | 0 | | 0 | | 0 | |
| PBCH_RB | dB | | | | | | |
| PSS_RA | dB | | | | | | |
| SSS_RA | dB | | | | | | |
| PCFICH_RB | dB | | | | | | |
| PHICH_RA | dB | | | | | | |
| PHICH_RB | dB | | | | | | |
| PDCCH_RA | dB | | | | | | |
| PDCCH_RB | dB | | | | | | |
| PDSCH_RA | dB | | | | | | |
| PDSCH_RB | dB | | | | | | |

| | | | | | | | |
|---|------------|------|-----|-----|-------|-----------|-------|
| OCNG_RA ^{Note 1} | dB | | | | | | |
| OCNG_RB ^{Note 1} | dB | | | | | | |
| N_{oc} ^{Note 3} | dBm/15 kHz | -98 | | | | | |
| RSRP ^{Note 4} | dBm/15 kHz | -82 | -82 | -82 | -82 | -Infinity | -82 |
| \hat{E}_s / I_{ot} | dB | 16 | 16 | 16 | -0.11 | -Infinity | -0.11 |
| SCH_RP ^{Note 4} | dBm/15 kHz | -82 | -82 | -82 | -82 | -Infinity | -82 |
| \hat{E}_s / N_{oc} | dB | 16 | 16 | 16 | 16 | -Infinity | 16 |
| Propagation Condition | | AWGN | | | | | |
| <p>Note 1: OCNG shall be used such that all cells are fully allocated and a constant total transmitted power spectral density is achieved for all OFDM symbols.</p> <p>Note 2: The resources for uplink transmission are assigned to the UE prior to the start of time period T2.</p> <p>Note 3: Interference from other cells and noise sources not specified in the test is assumed to be constant over subcarriers and time and shall be modelled as AWGN of appropriate power for N_{oc} to be fulfilled.</p> <p>Note 4: RSRP and SCH_RP levels have been derived from other parameters for information purposes. They are not settable parameters themselves.</p> | | | | | | | |

A.8.16.3.2 Test Requirements

The UE shall send one Event A6 triggered measurement report, with a measurement reporting delay less than 25.6s from the beginning of time period T2.

The UE shall not send event triggered measurement reports, as long as the reporting criteria are not fulfilled.

The UE shall be scheduled on PCell continuously throughout the test. From the start of T1 until the measurement report is received during T2, at least 99.5% of all expected ACK/NACKs shall be transmitted by the UE.

For a test to be considered successful requirements on both event detection and percentage of transmitted ACK/NACKs have to be fulfilled simultaneously.

The rate of correct events observed during repeated tests shall be at least 90%.

NOTE: The actual overall delays measured in the test may be up to $2 \times TTI_{DCCH}$ higher than the measurement reporting delays above because of TTI insertion uncertainty of the measurement report in DCCH.

A.8.16.4 E-UTRAN TDD-TDD Event triggered reporting on deactivated SCell with PCell interruption in non-DRX

A.8.16.4.1 Test Purpose and Environment

The purpose of this test is to verify that the UE correctly detects event A6 (Neighbour becomes better than SCell) defined in TS 36.331 [2] within the requirements stated in clause 8.3.3.2.1 while at the same time fulfilling the requirement on interruption rate.

The test parameters are given in Table A.8.16.4.1-1 and A.8.16.4.1-2 below. In the test there are three synchronous cells: Cell1, Cell2 and Cell3. Cell1 is PCell, Cell2 is deactivated SCell, and Cell3 is the neighbour cell. It is indicated to the UE in the measurement control information that event-triggered reporting with Event A6 is used. The test consists of two successive time periods, with duration of T1 and T2, respectively. During T1 the UE shall not have any information of cell 3. Immediately at beginning of T2 the transmission power of cell 3 is increased to same level as for cell 2, and due to usage of an offset this shall result in reporting of Event A6. PDCCH indicating a new transmission on the PCell shall be sent continuously to ensure that the UE sends ACK/NACKs throughout the test.

Table A.8.16.4.1-1: General test parameters for E-UTRAN TDD-TDD Event triggered reporting on configured but deactivated SCell with PCell interruption in non-DRX

| Parameter | Unit | Value | Comment |
|-------------------------------|------|--|---|
| PDSCH parameters | | DL Reference Measurement Channel R.0 TDD | As specified in clause A.3.1.1.2 |
| PCFICH/PDCCH/PHICH parameters | | DL Reference Measurement Channel R.6 TDD | As specified in clause A.3.1.2.2 |
| E-UTRA RF Channel Number | | 1, 2 | Two radio channels are used for this test |
| Active PCell | | Cell 1 | Primary cell on RF channel number 1. |

| | | | |
|--|-----------------|---|--|
| Configured deactivated SCell | | Cell 2 | Configured deactivated secondary cell on RF channel number 2. |
| Neighbour cell | | Cell 3 | Neighbor cell to be identified on RF channel number 2. |
| Channel Bandwidth (BW _{channel}) | MHz | 10 | Channel bandwidth for cells on primary and secondary component carriers |
| CP length | | Normal | |
| Special subframe configuration | | 6 | As specified in table 4.2.1 in TS 36.211. The same configuration applies to all cells. |
| Uplink-downlink configuration | | 1 | |
| DRX | | OFF | Continuous monitoring of primary cell |
| A6 | Hysteresis | dB | 0 |
| | Offset | dB | -3 |
| | Report on leave | | False |
| | Time To Trigger | s | 0 |
| Cell-individual offset for cells on RF channel number 1 | dB | 0 | Individual offset for cells on primary component carrier. |
| Cell-individual offset for cells on RF channel number 2 | dB | 0 | Individual offset for cells on secondary component carrier. |
| Filter coefficient | | 0 | L3 filtering is not used |
| SCell measurement cycle | ms | 1280 | |
| Cell2 timing offset to cell1 | μs | 0 | |
| Time alignment error between cell2 and cell1 | μs | ≤ Time alignment error as specified in TS 36.104 [30] clause 6.5.3.1. | The value of time alignment error depends upon the type of carrier aggregation. |
| Cell3 timing offset to cell1 | μs | 3 | Synchronous cells |
| T1 | s | 5 | During this time the UE shall be aware of cells 1 and 2 but not cell 3. |
| T2 | s | ≤30 | UE shall report Event A6 within 25.6s (20×scellMeasCycle) |
| NOTE: This test verifies the RRM requirement which is independent of channel bandwidth and is performed according to the principle defined in section A.3.6.1. | | | |

Table A.8.16.4.1-2: Cell specific test parameters for E-UTRAN TDD-TDD Event triggered reporting on configured but deactivated SCell with PCell interruption in non-DRX

| Parameter | Unit | Cell 1 | | Cell 2 | | Cell 3 | |
|--|------------|----------|-----|----------|-------|-----------|-------|
| | | T1 | T2 | T1 | T2 | T1 | T2 |
| E-UTRA RF Channel Number | | 1 | | 2 | | 2 | |
| BW _{channel} | MHz | 10 | | 10 | | 10 | |
| OCNG Pattern defined in A.3.2.2.1 (OP.1 TDD) and in A.3.2.2.2 (OP.2 TDD) | | OP.1 TDD | | OP.2 TDD | | OP.2 TDD | |
| PBCH_RA | dB | 0 | | 0 | | 0 | |
| PBCH_RB | dB | | | | | | |
| PSS_RA | dB | | | | | | |
| SSS_RA | dB | | | | | | |
| PCFICH_RB | dB | | | | | | |
| PHICH_RA | dB | | | | | | |
| PHICH_RB | dB | | | | | | |
| PDCCH_RA | dB | | | | | | |
| PDCCH_RB | dB | | | | | | |
| PDSCH_RA | dB | | | | | | |
| PDSCH_RB | dB | | | | | | |
| OCNG_RA ^{Note 1} | dB | | | | | | |
| OCNG_RB ^{Note 1} | dB | | | | | | |
| N_{oc} ^{Note 3} | dBm/15 kHz | | | | | | |
| RSRP ^{Note 4} | dBm/15 kHz | -82 | -82 | -82 | -82 | -Infinity | -82 |
| \hat{E}_s / I_{ot} | dB | 16 | 16 | 16 | -0.11 | -Infinity | -0.11 |

| | | | | | | | |
|--------------------------|--|------|-----|-----|-----|-----------|-----|
| SCH_RP ^{Note 4} | dBm/15 kHz | -82 | -82 | -82 | -82 | -Infinity | -82 |
| \hat{E}_s / N_{oc} | dB | 16 | 16 | 16 | 16 | -Infinity | 16 |
| Propagation Condition | | AWGN | | | | | |
| Note 1: | OCNG shall be used such that all cells are fully allocated and a constant total transmitted power spectral density is achieved for all OFDM symbols. | | | | | | |
| Note 2: | The resources for uplink transmission are assigned to the UE prior to the start of time period T2. | | | | | | |
| Note 3: | Interference from other cells and noise sources not specified in the test is assumed to be constant over subcarriers and time and shall be modelled as AWGN of appropriate power for N_{oc} to be fulfilled. | | | | | | |
| Note 4: | RSRP and SCH_RP levels have been derived from other parameters for information purposes. They are not settable parameters themselves. | | | | | | |

A.8.16.4.2 Test Requirements

The UE shall send one Event A6 triggered measurement report, with a measurement reporting delay less than 25.6s from the beginning of time period T2.

The UE shall not send event triggered measurement reports, as long as the reporting criteria are not fulfilled.

The UE shall be scheduled on PCell continuously throughout the test. From the start of T1 until the measurement report is received during T2, at least 99.5% of all expected ACK/NACKs shall be transmitted by the UE.

For a test to be considered successful requirements on both event detection and percentage of transmitted ACK/NACKs have to be fulfilled simultaneously.

The rate of correct events observed during repeated tests shall be at least 90%.

NOTE: The actual overall delays measured in the test may be up to $2 \times TTI_{DCCH}$ higher than the measurement reporting delays above because of TTI insertion uncertainty of the measurement report in DCCH.

A.8.16.5 E-UTRAN FDD event triggered reporting under deactivated SCell in non-DRX for 20 MHz bandwidth

A.8.16.5.1 Test Purpose and Environment

The purpose of this test case is the same as for the test defined in subclause A.8.16.1. The test parameters are the same except those described in the following section. The listed parameter values in Tables A.8.16.5.1-1 and A.8.16.5.1-2 will replace the values of corresponding parameters in Tables A.8.16.1.1-1 and A.8.16.1.1-2.

Table A.8.16.5.1-1: General test parameters for E-UTRAN FDD event triggered reporting on configured but deactivated SCell in non-DRX under fading propagation conditions, 20 MHz

| Parameter | Unit | Value | Comment |
|--------------------------------------|--|---|---|
| PDSCH parameters | | DL Reference Measurement Channel R.4 FDD | As specified in section A.3.1.1.1 |
| PCFICH/PDCCH/PHICH parameters | | DL Reference Measurement Channel R.10 FDD | As specified in section A.3.1.2.1 |
| Channel Bandwidth ($BW_{channel}$) | MHz | 20 | Channel bandwidth for cells on primary and secondary component carriers |
| A2 | Threshold RSRP | dBm | -96 Actual RSRP threshold for event A2. Needs to take absolute accuracy tolerance in clause 9.1.11.1 into account plus margin. |
| Note 1: | See Table A.8.16.1.1-1 for other general test parameters. | | |
| Note 2: | This test verifies the RRM requirement which is independent of channel bandwidth and is performed according to the principle defined in section A.3.6.1. | | |

Table A.8.16.5.1-2: Cell specific test parameters for E-UTRAN FDD event triggered reporting on configured but deactivated SCell in non-DRX under fading propagation conditions, 20 MHz

| Parameter | Unit | Cell 1 | | | Cell 2 | | | Cell 3 | | |
|----------------|------|--------|----|----|--------|----|----|--------|----|----|
| | | T1 | T2 | T3 | T1 | T2 | T3 | T1 | T2 | T3 |
| $BW_{channel}$ | MHz | 20 | | | 20 | | | 20 | | |

| | | | | | | | | | | |
|---|------------|-----------|-----|------|-----------|-------|-------|-----------|-------|-------|
| OCNG Patterns defined in A.3.2.1.11 (OP.11 FDD) and in A.3.2.1.12 (OP.12 FDD) | | OP.11 FDD | | | OP.12 FDD | | | OP.12 FDD | | |
| N_{oc} ^{Note 2} | dBm/15 kHz | -104 | | | -104 | | | | | |
| RSRP ^{Note 3} | dBm/15 kHz | -85 | -85 | -107 | -85 | -85 | -107 | -infinity | -85 | -107 |
| \hat{E}_s/lot | dB | 19 | 19 | -3 | 19 | -0.05 | -4.76 | -infinity | -0.05 | -4.76 |
| SCH_RP ^{Note 3} | dBm/15 kHz | -85 | -85 | -107 | -85 | -85 | -107 | -infinity | -85 | -107 |
| \hat{E}_s/N_{oc} | dB | 19 | 19 | -3 | 19 | 19 | -3 | -infinity | 19 | -3 |
| Note: See Table A.8.16.1.1-2 for other cell-specific test parameters. | | | | | | | | | | |

A.8.16.5.2 Test Requirements

The test requirements defined in section A.8.16.1.2 shall apply to this test case.

A.8.16.6 E-UTRAN TDD event triggered reporting under deactivated SCell in non-DRX for 20 MHz bandwidth

A.8.16.6.1 Test Purpose and Environment

The purpose of this test case is the same as for the test defined in subclause A.8.16.2. The test parameters are the same except those described in the following section. The listed parameter values in Tables A.8.16.6.1-1 and A.8.16.6.1-2 will replace the values of corresponding parameters in Tables A.8.16.2.1-1 and A.8.16.2.1-2.

Table A.8.16.6.1-1: General test parameters for E-UTRAN TDD event triggered reporting on configured but deactivated SCell in non-DRX under fading propagation conditions, 20 MHz

| Parameter | | Unit | Value | Comment |
|--|----------------|------|---|--|
| PDSCH parameters | | | DL Reference Measurement Channel R.3 TDD | As specified in section A.3.1.1.2 |
| PCFICH/PDCCH/PHICH parameters | | | DL Reference Measurement Channel R.10 TDD | As specified in section A.3.1.2.2 |
| Channel Bandwidth (BW _{channel}) | | MHz | 20 | Channel bandwidth for cells on primary and secondary component carriers |
| A2 | Threshold RSRP | dBm | -96 | Actual RSRP threshold for event A2. Needs to take absolute accuracy tolerance in clause 9.1.11.1 into account plus margin. |
| Note 1: See Table A.8.16.2.1-1 for other general test parameters. | | | | |
| Note 2: This test verifies the RRM requirement which is independent of channel bandwidth and is performed according to the principle defined in section A.3.6.1. | | | | |

Table A.8.16.6.1-2: Cell specific test parameters for E-UTRAN TDD event triggered reporting on configured but deactivated SCell in non-DRX under fading propagation conditions, 20 MHz

| Parameter | Unit | Cell 1 | | | Cell 2 | | | Cell 3 | | |
|---|------------|----------|----|----|----------|----|----|----------|----|----|
| | | T1 | T2 | T3 | T1 | T2 | T3 | T1 | T2 | T3 |
| BW _{channel} | MHz | 20 | | | 20 | | | 20 | | |
| OCNG Patterns defined in A.3.2.2.7 (OP.7 TDD) and in A.3.2.2.8 (OP.8 TDD) | | OP.7 TDD | | | OP.8 TDD | | | OP.8 TDD | | |
| N_{oc} ^{Note 2} | dBm/15 kHz | -104 | | | -104 | | | | | |

| | | | | | | | | | | |
|---|------------|-----|-----|------|-----|-------|-------|-----------|-------|-------|
| RSRP ^{Note 3} | dBm/15 kHz | -85 | -85 | -107 | -85 | -85 | -107 | -infinity | -85 | -107 |
| \hat{E}_s/I_{ot} | dB | 19 | 19 | -3 | 19 | -0.05 | -4.76 | -infinity | -0.05 | -4.76 |
| SCH_RP ^{Note 3} | dBm/15 kHz | -85 | -85 | -107 | -85 | -85 | -107 | -infinity | -85 | -107 |
| \hat{E}_s/N_{oc} | dB | 19 | 19 | -3 | 19 | 19 | -3 | -infinity | 19 | -3 |
| Note: See Table A.8.16.2.1-2 for other cell-specific test parameters. | | | | | | | | | | |

A.8.16.6.2 Test Requirements

The test requirements defined in section A.8.16.2.2 shall apply to this test case.

A.8.16.7 E-UTRA FDD event triggered reporting on deactivated SCell with PCell interruption in non-DRX for 20 MHz bandwidth

A.8.16.7.1 Test Purpose and Environment

The purpose of this test case is the same as for the test defined in subclause A.8.16.3. The test parameters are the same except those described in the following section. The listed parameter values in Tables A.8.16.7.1-1 and A.8.16.7.1-2 will replace the values of corresponding parameters in Tables A.8.16.3.1-1 and A.8.16.3.1-2.

Table A.8.16.7.1-1: General test parameters for E-UTRAN FDD event-triggered reporting on configured but deactivated SCell with PCell interruption in non-DRX, 20 MHz

| Parameter | Unit | Value | Comment |
|--|------|---|---|
| PDSCH parameters | | DL Reference Measurement Channel R.6 FDD | As specified in section A.3.1.1.1 |
| PCFICH/PDCCH/PHICH parameters | | DL Reference Measurement Channel R.10 FDD | As specified in section A.3.1.2.1 |
| Channel Bandwidth ($BW_{channel}$) | MHz | 20 | Channel bandwidth for cells on primary and secondary component carriers |
| Note 1: See Table A.8.16.3.1-1 for other general test parameters. | | | |
| Note 2: This test verifies the RRM requirement which is independent of channel bandwidth and is performed according to the principle defined in section A.3.6.1. | | | |

Table A.8.16.7.1-2: Cell specific test parameters for E-UTRAN FDD event triggered reporting on configured but deactivated SCell with PCell interruption in non-DRX, 20 MHz

| Parameter | Unit | Cell 1 | | Cell 2 | | Cell 3 | |
|---|------------|-----------|-----|-----------|-------|-----------|-------|
| | | T1 | T2 | T1 | T2 | T1 | T2 |
| $BW_{channel}$ | MHz | 20 | | 20 | | 20 | |
| OCNG Patterns defined in A.3.2.1.17 (OP.17 FDD) and in A.3.2.1.12 (OP.12 FDD) | | OP.17 FDD | | OP.12 FDD | | OP.12 FDD | |
| N_{oc} ^{Note 3} | dBm/15 kHz | -101 | | -101 | | | |
| RSRP ^{Note 4} | dBm/15 kHz | -85 | -85 | -85 | -85 | -Infinity | -85 |
| \hat{E}_s/I_{ot} | dB | 16 | 16 | 16 | -0.11 | -Infinity | -0.11 |
| SCH_RP ^{Note 4} | dBm/15 kHz | -85 | -85 | -85 | -85 | -Infinity | -85 |
| \hat{E}_s/N_{oc} | dB | 16 | 16 | 16 | 16 | -Infinity | 16 |
| Note: See Table A.8.16.3.1-2 for other cell-specific test parameters. | | | | | | | |

A.8.16.7.2 Test Requirements

The test requirements defined in section A.8.16.3.2 shall apply to this test case.

A.8.16.8 E-UTRA TDD event triggered reporting on deactivated SCell with PCell interruption in non-DRX for 20 MHz bandwidth

A.8.16.8.1 Test Purpose and Environment

The purpose of this test case is the same as for the test defined in subclause A.8.16.4. The test parameters are the same except those described in the following section. The listed parameter values in Tables A.8.16.8.1-1 and A.8.16.8.1-2 will replace the values of corresponding parameters in Tables A.8.16.4.1-1 and A.8.16.4.1-2.

Table A.8.16.8.1-1: General test parameters for E-UTRAN TDD event-triggered reporting on configured but deactivated SCell with PCell interruption in non-DRX, 20 MHz

| Parameter | Unit | Value | Comment |
|--|------|---|---|
| PDSCH parameters | | DL Reference Measurement Channel R.3 TDD | As specified in section A.3.1.1.2 |
| PCFICH/PDCCH/PHICH parameters | | DL Reference Measurement Channel R.10 TDD | As specified in section A.3.1.2.2 |
| Channel Bandwidth (BW_{channel}) | MHz | 20 | Channel bandwidth for cells on primary and secondary component carriers |
| Note 1: See Table A.8.16.4.1-1 for other general test parameters. | | | |
| Note 2: This test verifies the RRM requirement which is independent of channel bandwidth and is performed according to the principle defined in section A.3.6.1. | | | |

Table A.8.16.8.1-2: Cell specific test parameters for E-UTRAN TDD event triggered reporting on configured but deactivated SCell with PCell interruption in non-DRX, 20 MHz

| Parameter | Unit | Cell 1 | | Cell 2 | | Cell 3 | |
|---|------------|----------|-----|----------|-------|-----------|-------|
| | | T1 | T2 | T1 | T2 | T1 | T2 |
| BW_{channel} | MHz | 20 | | 20 | | 20 | |
| OCNG Patterns defined in A.3.2.2.7 (OP.7 TDD) and in A.3.2.2.8 (OP.8 TDD) | | OP.7 TDD | | OP.8 TDD | | OP.8 TDD | |
| N_{oc} ^{Note 3} | dBm/15 kHz | -101 | | -101 | | | |
| RSRP ^{Note 4} | dBm/15 kHz | -85 | -85 | -85 | -85 | -Infinity | -85 |
| \hat{E}_s / I_{ot} | dB | 16 | 16 | 16 | -0.11 | -Infinity | -0.11 |
| SCH_RP ^{Note 4} | dBm/15 kHz | -85 | -85 | -85 | -85 | -Infinity | -85 |
| \hat{E}_s / N_{oc} | dB | 16 | 16 | 16 | 16 | -Infinity | 16 |
| Note: See Table A.8.16.4.1-2 for other cell-specific test parameters. | | | | | | | |

A.8.16.8.2 Test Requirements

The test requirements defined in section A.8.16.4.2 shall apply to this test case.

A.8.16.9 E-UTRAN FDD event triggered reporting under deactivated SCell in non-DRX for 10MHz+5MHz

A.8.16.9.1 Test Purpose and Environment

The purpose of this test case is the same as for the test defined in subclause A.8.16.1.1.

The test parameters are the same as defined in Subclause A.8.16.1.1 except those described in the following section. The listed parameter values in Tables A.8.16.9.1-1 and A.8.16.9.1-2 will replace the values of corresponding parameters in Tables A.8.16.1.1-1 and A.8.16.1.1-2.

Table A.8.16.9.1-1: General test parameters for E-UTRAN FDD event triggered reporting on configured but deactivated SCell in non-DRX under fading propagation conditions for 10MHz+5MHz bandwidth

| Parameter | Unit | Value | Comment |
|--|------|-------|---|
| Channel bandwidth for cells on primary carriers ($BW_{channel}$) | MHz | 10 | Channel bandwidth for cells on primary carriers |
| Channel bandwidth for cells on secondary carriers ($BW_{channel}$) | MHz | 5 | Channel bandwidth for cells on secondary carriers |
| Note 1: See Table A.8.16.1.1-1 for the other general parameters. | | | |
| Note 2: This test verifies the RRM requirement which is independent of channel bandwidth and is performed according to the principle defined in section A.3.6.1. | | | |

Table A.8.16.9.1-2: Cell specific test parameters for E-UTRAN FDD event triggered reporting on configured but deactivated SCell in non-DRX under fading propagation conditions for 10MHz+5MHz bandwidth

| Parameter | Unit | Cell 1 | | | Cell 2 | | | Cell 3 | | |
|---|-----------|----------|----|----|-----------|----|----|-----------|----|----|
| | | T1 | T2 | T3 | T1 | T2 | T3 | T1 | T2 | T3 |
| $BW_{channel}$ | MHz | 10 | | | 5 | | | 5 | | |
| PDSCH Reference measurement channel defined in A.3.1.1.1 | | R.0 FDD | | | N/A | | | N/A | | |
| PDSCH allocation | n_{PRB} | 13–36 | | | N/A | | | N/A | | |
| PCFICH/PDCCH/PHICH parameters defined in A.3.1.2.1 | | R.6 FDD | | | R.11 FDD | | | R.11 FDD | | |
| OCNG Patterns defined in A.3.2.1.1 (OP.1 FDD) and in A.3.2.1.16 (OP.16 FDD) | | OP.1 FDD | | | OP.16 FDD | | | OP.16 FDD | | |
| Note 1: See Table A.8.16.1.1-2 for the other specific parameters. | | | | | | | | | | |

A.8.16.9.2 Test Requirements

The test requirements defined in section A.8.16.1.2 shall apply to this test case.

A.8.16.10 E-UTRAN TDD event triggered reporting under deactivated SCell in non-DRX for 10MHz+5MHz

A.8.16.10.1 Test Purpose and Environment

The purpose of this test case is the same as for the test defined in subclause A.8.16.2.1.

The test parameters are the same as defined in Subclause A.8.16.2.1 except those described in the following section. The listed parameter values in Tables A.8.16.10.1-1 and A.8.16.10.1-2 will replace the values of corresponding parameters in Tables A.8.16.2.1-1 and A.8.16.2.1-2.

Table A.8.16.10.1-1: General test parameters for E-UTRAN TDD event triggered reporting on configured but deactivated SCell in non-DRX under fading propagation conditions for 10MHz+5MHz bandwidth

| Parameter | Unit | Value | Comment |
|--|------|-------|---|
| Channel bandwidth for cells on primary carriers ($BW_{channel}$) | MHz | 10 | Channel bandwidth for cells on primary carriers |
| Channel bandwidth for cells on secondary carriers ($BW_{channel}$) | MHz | 5 | Channel bandwidth for cells on secondary carriers |
| Note 1: See Table A.8.16.2.1-1 for the other general parameters. | | | |
| Note 2: This test verifies the RRM requirement which is independent of channel bandwidth and is performed according to the principle defined in section A.3.6.1. | | | |

Table A.8.16.10.1-2: Cell specific test parameters for E-UTRAN TDD event triggered reporting on configured but deactivated SCell in non-DRX under fading propagation conditions for 10MHz+5MHz bandwidth

| Parameter | Unit | Cell 1 | | | Cell 2 | | | Cell 3 | | |
|---|-----------|----------|----|----|-----------|----|----|-----------|----|----|
| | | T1 | T2 | T3 | T1 | T2 | T3 | T1 | T2 | T3 |
| BW_{channel} | MHz | 10 | | | 5 | | | 5 | | |
| PDSCH Reference measurement channel defined in A.3.1.1.2 | | R.0 TDD | | | N/A | | | N/A | | |
| PDSCH allocation | n_{PRB} | 13–36 | | | N/A | | | N/A | | |
| PCFICH/PDCCH/PHICH parameters defined in A.3.1.2.2 | | R.6 TDD | | | R.11 TDD | | | R.11 TDD | | |
| OCNG Patterns defined in A.3.2.2.1 (OP.1 TDD) and in A.3.2.2.10 (OP.10 TDD) | | OP.1 TDD | | | OP.10 TDD | | | OP.10 TDD | | |
| Note 1: See Table A.8.16.2.1-2 for the other specific parameters. | | | | | | | | | | |

A.8.16.10.2 Test Requirements

The test requirements defined in section A.8.16.2.2 shall apply to this test case.

A.8.16.11 E-UTRAN FDD event triggered reporting on deactivating SCell with PCell interruption in non-DRX for 10MHz+5MHz

A.8.16.11.1 Test Purpose and Environment

The purpose of this test case is the same as for the test defined in subclause A.8.16.3. The test parameters are the same except those described in the following section. The listed parameter values in Tables A.8.16.11.1-1 and A.8.16.11.1-2 will replace the values of corresponding parameters in Tables A.8.16.3.1-1 and A.8.16.3.1-2.

Table A.8.16.11.1-1: General test parameters for E-UTRAN FDD event triggered reporting on deactivating SCell with PCell interruption in non-DRX for 10MHz+5MHz

| Parameter | Unit | Value | Comment |
|--|------|---|--|
| Channel bandwidth for cells on primary carrier (BW_{channel}) | MHz | 10 | Channel bandwidth for cells on primary component carrier |
| PDSCH parameters for cells on primary carriers | | DL Reference Measurement Channel R.3 FDD | As specified in section A.3.1.1.1 |
| PCFICH/PDCCH/PHICH parameters for cells on primary carriers | | DL Reference Measurement Channel R.6 FDD | As specified in section A.3.1.2.1 |
| Channel bandwidth for cells on secondary carriers (BW_{channel}) | MHz | 5 | Channel bandwidth for cells on secondary component carrier |
| PCFICH/PDCCH/PHICH parameters for cells on secondary carrier | | DL Reference Measurement Channel R.11 FDD | As specified in section A.3.1.2.1 |
| Note 1: See Table A.8.16.3.1-1 for other general test parameters. | | | |
| Note 2: This test verifies the RRM requirement which is independent of channel bandwidth and is performed according to the principle defined in section A.3.6.1. | | | |

Table A.8.16.11.1-2: Cell specific test parameters for E-UTRAN FDD event triggered reporting on deactivating SCell with PCell interruption in non-DRX for 10MHz+5MHz

| Parameter | Unit | Cell 1 | | Cell 2 | | Cell 3 | |
|---|------|-----------|----|-----------|----|-----------|----|
| | | T1 | T2 | T1 | T2 | T1 | T2 |
| BW_{channel} | MHz | 10 | | 5 | | 5 | |
| OCNG Patterns defined in A.3.2.1 | | OP.10 FDD | | OP.16 FDD | | OP.16 FDD | |
| Note: See Table A.8.16.3.1-2 for other cell-specific test parameters. | | | | | | | |

A.8.16.11.2 Test Requirements

The test requirements defined in section A.8.16.3.2 shall apply to this test case.

A.8.16.12 E-UTRAN TDD event triggered reporting on deactivating SCell with PCell interruption in non-DRX for 10MHz+5MHz

A.8.16.12.1 Test Purpose and Environment

The purpose of this test case is the same as for the test defined in subclause A.8.16.4. The test parameters are the same except those described in the following section. The listed parameter values in Tables A.8.16.12.1-1 and A.8.16.12.1-2 will replace the values of corresponding parameters in Tables A.8.16.4.1-1 and A.8.16.4.1-2.

Table A.8.16.12.1-1: General test parameters for E-UTRAN TDD event triggered reporting on deactivating SCell with PCell interruption in non-DRX for 10MHz+5MHz

| Parameter | Unit | Value | Comment |
|--|------|---|--|
| Channel bandwidth for cells on primary carrier ($BW_{channel}$) | MHz | 10 | Channel bandwidth for cells on primary component carrier |
| PDSCH parameters for cells on primary carriers | | DL Reference Measurement Channel R.0 TDD | As specified in section A.3.1.1.2 |
| PCFICH/PDCCH/PHICH parameters for cells on primary carriers | | DL Reference Measurement Channel R.6 TDD | As specified in section A.3.1.2.2 |
| Channel bandwidth for cells on secondary carriers ($BW_{channel}$) | MHz | 5 | Channel bandwidth for cells on secondary component carrier |
| PCFICH/PDCCH/PHICH parameters for cells on secondary carrier | | DL Reference Measurement Channel R.11 TDD | As specified in section A.3.1.2.2 |
| Note 1: See Table A.8.16.4.1-1 for other general test parameters. | | | |
| Note 2: This test verifies the RRM requirement which is independent of channel bandwidth and is performed according to the principle defined in section A.3.6.1. | | | |

Table A.8.16.12.1-2: Cell specific test parameters for E-UTRAN TDD event triggered reporting on deactivating SCell with PCell interruption in non-DRX for 10MHz+5MHz

| Parameter | Unit | Cell 1 | | Cell 2 | | Cell 3 | |
|---|------|----------|----|-----------|----|-----------|----|
| | | T1 | T2 | T1 | T2 | T1 | T2 |
| $BW_{channel}$ | MHz | 10 | | 5 | | 5 | |
| OCNG Patterns defined in A.3.2.2 | | OP.1 TDD | | OP.10 TDD | | OP.10 TDD | |
| Note: See Table A.8.16.4.1-2 for other cell-specific test parameters. | | | | | | | |

A.8.16.12.2 Test Requirements

The test requirements defined in section A.8.16.4.2 shall apply to this test case.

A.8.16.13 E-UTRAN FDD event triggered reporting under deactivated SCell in non-DRX for 5MHz +5 MHz bandwidth

A.8.16.13.1 Test Purpose and Environment

The purpose of this test case is the same as for the test defined in subclause A.8.16.1. The test parameters are the same except those described in the following section. The listed parameter values in Tables A.8.16.13.1-1 and A.8.16.13.1-2 will replace the values of corresponding parameters in Tables A.8.16.1.1-1 and A.8.16.1.1-2.

Table A.8.16.13.1-1: General test parameters for E-UTRAN FDD event triggered reporting on configured but deactivated SCell in non-DRX under fading propagation conditions, 5MHz +5 MHz bandwidth

| Parameter | Unit | Value | Comment |
|--|------|---|--|
| PDSCH parameters | | DL Reference Measurement Channel R.5 FDD | As specified in section A.3.1.1.1 |
| PCFICH/PDCCH/PHICH parameters | | DL Reference Measurement Channel R.11 FDD | As specified in section A.3.1.2.1 |
| Channel Bandwidth (BW _{channel}) | MHz | 5 | Channel bandwidth for cells on primary component carrier |
| Channel Bandwidth (BW _{channel}) | MHz | 5 | Channel bandwidth for cells on secondary component carrier |
| Note 1: See Table A.8.16.1.1-1 for other general test parameters. | | | |
| Note 2: This test verifies the RRM requirement which is independent of channel bandwidth and is performed according to the principle defined in section A.3.6.1. | | | |

Table A.8.16.13.1-2: Cell specific test parameters for E-UTRAN FDD event triggered reporting on configured but deactivated SCell in non-DRX under fading propagation conditions, 5MHz +5 MHz bandwidth

| Parameter | Unit | Cell 1 | | | Cell 2 | | | Cell 3 | | |
|---|------|-----------|----|----|-----------|----|----|-----------|----|----|
| | | T1 | T2 | T3 | T1 | T2 | T3 | T1 | T2 | T3 |
| BW _{channel} | MHz | 5 | | | 5 | | | 5 | | |
| OCNG Patterns defined in A.3.2.1.15 (OP.15.FDD) and in A.3.2.1.16 (OP.16 FDD) | | OP.15 FDD | | | OP.16 FDD | | | OP.16 FDD | | |
| Note: See Table A.8.16.1.1-2 for other cell-specific test parameters. | | | | | | | | | | |

A.8.16.13.2 Test Requirements

The test requirements defined in section A.8.16.1.2 shall apply to this test case.

A.8.16.14 E-UTRAN TDD event triggered reporting under deactivated SCell in non-DRX for 5 MHz +5 MHz bandwidth

A.8.16.14.1 Test Purpose and Environment

The purpose of this test case is the same as for the test defined in subclause A.8.16.2. The test parameters are the same except those described in the following section. The listed parameter values in Tables A.8.16.14.1-1 and A.8.16.14.1-2 will replace the values of corresponding parameters in Tables A.8.16.2.1-1 and A.8.16.2.1-2.

Table A.8.16.14.1-1: General test parameters for E-UTRAN TDD event triggered reporting on configured but deactivated SCell in non-DRX under fading propagation conditions, 5 MHz +5 MHz bandwidth

| Parameter | Unit | Value | Comment |
|--|------|---|--|
| PDSCH parameters | | DL Reference Measurement Channel R.4.TDD | As specified in section A.3.1.1.2 |
| PCFICH/PDCCH/PHICH parameters | | DL Reference Measurement Channel R.11 TDD | As specified in section A.3.1.2.2 |
| Channel Bandwidth (BW _{channel}) | MHz | 5 | Channel bandwidth for cells on primary component carrier |
| Channel Bandwidth (BW _{channel}) | MHz | 5 | Channel bandwidth for cells on secondary component carrier |
| Note 1: See Table A.8.16.2.1-1 for other general test parameters. | | | |
| Note 2: This test verifies the RRM requirement which is independent of channel bandwidth and is performed according to the principle defined in section A.3.6.1. | | | |

Table A.8.16.14.1-2: Cell specific test parameters for E-UTRAN TDD event triggered reporting on configured but deactivated SCell in non-DRX under fading propagation conditions, 5 MHz +5 MHz bandwidth

| Parameter | Unit | Cell 1 | | | Cell 2 | | | Cell 3 | | |
|-----------|------|--------|----|----|--------|----|----|--------|----|----|
| | | T1 | T2 | T3 | T1 | T2 | T3 | T1 | T2 | T3 |

| | | | | |
|---|-----|----------|-----------|----------|
| BW _{channel} | MHz | 5 | 5 | 5 |
| OCNG Patterns defined in A.3.2.2.9 (OP.9 TDD) and in A.3.2.2.10 (OP.10 TDD) | | OP.9 TDD | OP.10 TDD | OP10 TDD |
| Note: See Table A.8.16.2.1-2 for other cell-specific test parameters. | | | | |

A.8.16.14.2 Test Requirements

The test requirements defined in section A.8.16.2.2 shall apply to this test case.

A.8.16.15 E-UTRA FDD event triggered reporting on deactivated SCell with PCell interruption in non-DRX for 5 +5 MHz bandwidth

A.8.16.15.1 Test Purpose and Environment

The purpose of this test case is the same as for the test defined in subclause A.8.16.3. The test parameters are the same except those described in the following section. The listed parameter values in Tables A.8.16.15.1-1 and A.8.16.14.1-2 will replace the values of corresponding parameters in Tables A.8.16.3.1-1 and A.8.16.3.1-2.

Table A.8.16.15.1-1: General test parameters for E-UTRAN FDD event-triggered reporting on configured but deactivated SCell with PCell interruption in non-DRX, 5 + 5 MHz bandwidth

| Parameter | Unit | Value | Comment |
|--|------|---|---|
| PDSCH parameters | | DL Reference Measurement Channel R.7 FDD (Cell 1) | As specified in section A.3.1.1.1 |
| PCFICH/PDCCH/PHICH parameters | | DL Reference Measurement Channel R.11 FDD | As specified in section A.3.1.2.1 |
| Channel Bandwidth (BW _{channel}) | MHz | 5 | Channel bandwidth for cells on primary and secondary component carriers |
| Note 1: See Table A.8.16.3.1-1 for other general test parameters. | | | |
| Note 2: This test verifies the RRM requirement which is independent of channel bandwidth and is performed according to the principle defined in section A.3.6.1. | | | |

Table A.8.16.15.1-2: Cell specific test parameters for E-UTRAN FDD event triggered reporting on configured but deactivated SCell with PCell interruption in non-DRX, 5+5 MHz bandwidth

| Parameter | Unit | Cell 1 | | Cell 2 | | Cell 3 | |
|---|------|-----------|----|-----------|----|-----------|----|
| | | T1 | T2 | T1 | T2 | T1 | T2 |
| BW _{channel} | MHz | 5 | | 5 | | 5 | |
| OCNG Patterns defined in A.3.2.1.20 (OP.20 FDD) and in A.3.2.1.16 (OP.16 FDD) | | OP.20 FDD | | OP.16 FDD | | OP.16 FDD | |
| Note: See Table A.8.16.3.1-2 for other cell-specific test parameters. | | | | | | | |

A.8.16.7.2 Test Requirements

The test requirements defined in section A.8.16.3.2 shall apply to this test case.

A.8.16.16 E-UTRA TDD event triggered reporting on deactivated SCell with PCell interruption in non-DRX for 5+5 MHz bandwidth

A.8.16.16.1 Test Purpose and Environment

The purpose of this test case is the same as for the test defined in subclause A.8.16.4. The test parameters are the same except those described in the following section. The listed parameter values in Tables A.8.16.16.1-1 and A.8.16.16.1-2 will replace the values of corresponding parameters in Tables A.8.16.4.1-1 and A.8.16.4.1-2.

Table A.8.16.16.1-1: General test parameters for E-UTRAN TDD event-triggered reporting on configured but deactivated SCell with PCell interruption in non-DRX, 5+5 MHz bandwidth

| Parameter | Unit | Value | Comment |
|--|------|---|---|
| PDSCH parameters | | DL Reference Measurement Channel R.4 TDD | As specified in section A.3.1.1.2 |
| PCFICH/PDCCH/PHICH parameters | | DL Reference Measurement Channel R.11 TDD | As specified in section A.3.1.2.2 |
| Channel Bandwidth (BW _{channel}) | MHz | 5 | Channel bandwidth for cells on primary and secondary component carriers |
| Note 1: See Table A.8.16.4.1-1 for other general test parameters. | | | |
| Note 2: This test verifies the RRM requirement which is independent of channel bandwidth and is performed according to the principle defined in section A.3.6.1. | | | |

Table A.8.16.16.1-2: Cell specific test parameters for E-UTRAN TDD event triggered reporting on configured but deactivated SCell with PCell interruption in non-DRX, 5+5 MHz bandwidth

| Parameter | Unit | Cell 1 | | Cell 2 | | Cell 3 | |
|---|------|----------|----|-----------|----|-----------|----|
| | | T1 | T2 | T1 | T2 | T1 | T2 |
| BW _{channel} | MHz | 5 | | 5 | | 5 | |
| OCNG Patterns defined in A.3.2.2.9 (OP.9 TDD) and in A.3.2.2.10 (OP.10 TDD) | | OP.9 TDD | | OP.10 TDD | | OP.10 TDD | |
| Note: See Table A.8.16.4.1-2 for other cell-specific test parameters. | | | | | | | |

A.8.16.16.2 Test Requirements

The test requirements defined in section A.8.16.4.2 shall apply to this test case.

A.8.16.17 E-UTRAN FDD activation and deactivation of known SCell in non-DRX

A.8.16.17.1 Test Purpose and Environment

The purpose of this test is to verify that the SCell activation and deactivation times are within the requirements stated in section 7.7, when the SCell is known by the UE at the time of activation.

The test parameters are given in Tables A.8.16.17.1-1 and cell-specific parameters in A.8.16.17.1-2 below. The test consists of three successive time periods, with duration of T1, T2 and T3, respectively. There are two carriers, each with one cell. Both cells have constant signal levels throughout the test. Before the test starts the UE is connected to Cell 1 (PCell) on radio channel 1 (PCC) but is not aware of Cell 2 on radio channel 2. The UE is only monitoring the PCC. The UE shall be continuously scheduled in the PCell throughout the whole test.

At the beginning of T1 the UE receives an RRC message by which the SCell (Cell 2) becomes configured on radio channel 2 (SCC). The UE now starts monitoring also the SCC. The test equipment sends a MAC message for activation of the SCell.

The point in time at which the MAC message is received at the UE antenna connector, in a subframe # denoted m which is an even number, defines the start of time period T2. The UE shall be able to report valid CSI for the activated SCell at latest in subframe (m+24). The UE shall start reporting CSI in subframe (m+8) and shall report CQI index 0 (out-of-range) until the SCell activation has been completed. Any PCell interruption due to activation of SCell shall occur in the subframes (m+5) to (m+9).

Time period T3 starts when a MAC message for deactivation of SCell, sent from the test equipment to the UE in a subframe # denoted n which is an even number, is received at the UE antenna connector. The UE shall carry out deactivation of the SCell in a subframe (n+8), and any PCell interruption due to the deactivation shall occur in the subframes (n+5) to (n+9).

The test equipment verifies that potential interruption is carried out in the correct time span by monitoring ACK/NACK sent in PCell during activation and deactivation of SCell, respectively.

The test equipment verifies the activation time by counting the subframes from the time when the SCell activation command is sent until a CSI report with other than CQI index 0 is received.

The test equipment verifies the deactivation time by counting the subframes from the time when the SCell deactivation command is sent until CQI reporting for SCell is discontinued.

Table A.8.16.17.1-1: General test parameters for known SCell activation case

| Parameter | Unit | Value | Comment |
|---|--|--|--|
| PDSCH parameters | | DL Reference Measurement Channel R.3 FDD (Cell 1) | As specified in section A.3.1.1.1 |
| PCFICH/PDCCH/PHICH parameters | | DL Reference Measurement Channel R.6 FDD | As specified in section A.3.1.2.1 |
| E-UTRA RF Channel Number | | 1, 2 | Two radio channels are used for this test |
| Active PCell | | Cell 1 | Primary cell on RF channel number 1. |
| Configured deactivated SCell | | Cell 2 | Configured deactivated secondary cell on RF channel number 2. |
| CP length | | Normal | |
| DRX | | OFF | Continuous monitoring of primary cell |
| CQI/PMI periodicity and offset configuration index | | 0 | CQI reporting for SCell every second subframe |
| Cell-individual offset for cells on RF channel number 1 | dB | 0 | Individual offset for cells on primary component carrier. |
| Cell-individual offset for cells on RF channel number 2 | dB | 0 | Individual offset for cells on secondary component carrier. |
| SCell measurement cycle (measCycleSCell) | ms | 320 | |
| Cell2 timing offset to cell1 | μs | 0 | |
| Time alignment error between cell2 and cell1 | μs | ≤ Time alignment error as specified in 3GPP TS 36.104 [30] clause 6.5.3.1. | The value of time alignment error depends upon the type of carrier aggregation. |
| T1 | s | 7 | During this time the PCell shall be known and the SCell configured and detected. |
| T2 | s | 1 | During this time the UE shall activate the SCell. |
| T3 | s | 1 | During this time the UE shall deactivate the SCell. |
| Note: | This test verifies the RRM requirement which is independent of channel bandwidth and is performed according to the principle defined in section A.3.6.1. | | |

Table A.8.16.17.1-2: Cell specific test parameters for E-UTRAN FDD known SCell activation

| Parameter | Unit | Cell 1 | | | Cell 2 | | |
|---|------------|-----------|----|----|----------|----|----|
| | | T1 | T2 | T3 | T1 | T2 | T3 |
| E-UTRA RF Channel Number | | 1 | | | 2 | | |
| BW _{channel} | MHz | 10 | | | 10 | | |
| OCNG Patterns defined in A.3.2.1.1 (OP.1 FDD) and in A.3.2.1.2 (OP.2 FDD) | | OP.10 FDD | | | OP.2 FDD | | |
| PBCH_RA | dB | 0 | | | 0 | | |
| PBCH_RB | dB | | | | | | |
| PSS_RA | dB | | | | | | |
| SSS_RA | dB | | | | | | |
| PCFICH_RB | dB | | | | | | |
| PHICH_RA | dB | | | | | | |
| PHICH_RB | dB | | | | | | |
| PDCCH_RA | dB | | | | | | |
| PDCCH_RB | dB | | | | | | |
| PDSCH_RA | dB | | | | | | |
| PDSCH_RB | dB | | | | | | |
| OCNG_RA ^{Note 1} | dB | | | | | | |
| OCNG_RB ^{Note 1} | dB | | | | | | |
| N _{oc} ^{Note 2} | dBm/15 kHz | | | | | | |
| RSRP ^{Note 3} | dBm/15 kHz | -87 | | | -87 | | |
| \bar{E}_s/I_{ot} | dB | 17 | | | 17 | | |
| SCH_RP ^{Note 3} | dBm/15 kHz | -87 | | | -87 | | |
| \bar{E}_s/N_{oc} | dB | 17 | | | 17 | | |
| Propagation Condition | | AWGN | | | | | |

| | |
|---------|--|
| Note 1: | OCNG shall be used such that all cells are fully allocated and a constant total transmitted power spectral density is achieved for all OFDM symbols. |
| Note 2: | Interference from other cells and noise sources not specified in the test is assumed to be constant over subcarriers and time and shall be modelled as AWGN of appropriate power for N_{oc} to be fulfilled. |
| Note 3: | E_s/lot , RSRP and SCH_RP levels have been derived from other parameters for information purposes. They are not settable parameters themselves. |
| Note 4: | The uplink resources for CSI reporting are assigned to the UE prior to the start of time period T2. |

A.8.16.17.2 Test Requirements

During T2 the UE shall send the first CSI report for SCell in a subframe (m+8), or in a subframe (m+10) if the subframe (m+8) was subject to interruption. Whether CSI report in subframe (m+8) was interrupted or not is checked by monitoring ACK/NACK sent in PCell in subframe (m+8).

During T2 the UE shall start sending CSI reports for SCell with non-zero CQI index at latest in a subframe (m+24).

During T3 the UE shall stop sending CSI reports for SCell at latest in a subframe (n+8).

During T2 interruption of PCell during SCell activation shall not happen outside the subframes (m+5) to (m+9).

During T3 interruption of PCell during SCell deactivation shall not happen outside the subframes (n+5) to (n+9).

The interruption of PCell shall not be more than the values specified for intra-band CA and inter-band CA in Section 7.8.2.

All of the above test requirements shall be fulfilled in order for the observed SCell activation delay and SCell deactivation delay to be counted as correct. The rate of correct observed SCell activation delay and SCell deactivation delay during repeated tests shall be at least 90%.

NOTE: During T2 if there are no uplink resources for reporting the valid CSI in a subframe (m+24) then the UE shall use the next available uplink resource for reporting the corresponding valid CSI.

A.8.16.17A E-UTRAN FDD activation and deactivation of known SCell in non-DRX for 20MHz

A.8.16.17A.1 Test Purpose and Environment

The purpose of this test case is the same as for the test defined in subclause A.8.16.17. The test parameters are the same except those described in the following section. The listed parameter values in Tables A.8.16.17A.1-1 and A.8.16.17A.1-2 will replace the values of corresponding parameters in Tables A.8.16.17.1-1 and A.8.16.17.1-2.

Table A.8.16.17A.1-1: General test parameters for known SCell activation case, 20MHz bandwidth

| Parameter | Unit | Value | Comment |
|-------------------------------|------|---|-----------------------------------|
| PDSCH parameters | | DL Reference Measurement Channel R.6 FDD | As specified in section A.3.1.1.1 |
| PCFICH/PDCCH/PHICH parameters | | DL Reference Measurement Channel R.10 FDD | As specified in section A.3.1.2.1 |

Table A.8.16.17A.1-2: Cell specific test parameters for E-UTRAN FDD known SCell activation, 20MHz bandwidth

| Parameter | Unit | Cell 1 | | | Cell 2 | | |
|---|------|-----------|----|----|-----------|----|----|
| | | T1 | T2 | T3 | T1 | T2 | T3 |
| $BW_{channel}$ | MHz | 20 | | | 20 | | |
| OCNG Patterns defined in A.3.2.1.17 (OP.17 FDD) and in A.3.2.1.12 (OP.12 FDD) | | OP.17 FDD | | | OP.12.FDD | | |

A.8.16.17A.2 Test Requirements

The test requirements defined in section A.8.16.17.2 shall apply to this test case.

A.8.16.17B E-UTRAN FDD activation and deactivation of known SCell in non-DRX for 10MHz + 5MHz

A.8.16.17B.1 Test Purpose and Environment

The purpose of this test case is the same as for the test defined in subclause A.8.16.17. The test parameters are the same except those described in the following section. The listed parameter values in Tables A.8.16.17B.1-1 and A.8.16.17B.1-2 will replace the values of corresponding parameters in Tables A.8.16.17.1-1 and A.8.16.17.1-2.

Table A.8.16.17B.1-1: General test parameters for known SCell activation case, 10+5MHz bandwidth

| Parameter | Unit | Value | Comment |
|-------------------------------|------|---|-----------------------------------|
| PDSCH parameters | | DL Reference Measurement Channel R.3 FDD (Cell 1) | As specified in section A.3.1.1.1 |
| PCFICH/PDCCH/PHICH parameters | | DL Reference Measurement Channel R.6 FDD (Cell 1) DL Reference Measurement Channel R.11 FDD (Cell 2) | As specified in section A.3.1.2.1 |

Table A.8.16.17B.1-2: Cell specific test parameters for E-UTRAN FDD known SCell activation, 10+5MHz bandwidth

| Parameter | Unit | Cell 1 | | | Cell 2 | | |
|---|------|-----------|----|----|-----------|----|----|
| | | T1 | T2 | T3 | T1 | T2 | T3 |
| BW _{channel} | MHz | 10 | | | 5 | | |
| OCNG Patterns defined in A.3.2.1.11 (OP.11 FDD) and in A.3.2.1.16 (OP.16 FDD) | | OP.10 FDD | | | OP.16.FDD | | |

A.8.16.17B.2 Test Requirements

The test requirements defined in section A.8.16.17.2 shall apply to this test case.

A.8.16.17C E-UTRAN FDD activation and deactivation of known SCell in non-DRX for 5MHz + 5MHz

A.8.16.17C.1 Test Purpose and Environment

The purpose of this test case is the same as for the test defined in subclause A.8.16.17. The test parameters are the same except those described in the following section. The listed parameter values in Tables A.8.16.17C.1-1 and A.8.16.17C.1-2 will replace the values of corresponding parameters in Tables A.8.16.17.1-1 and A.8.16.17.1-2.

Table A.8.16.17C.1-1: General test parameters for known SCell activation case, 5+5MHz bandwidth

| Parameter | Unit | Value | Comment |
|-------------------------------|------|---|-----------------------------------|
| PDSCH parameters | | DL Reference Measurement Channel R.7 FDD (Cell 1) | As specified in section A.3.1.1.1 |
| PCFICH/PDCCH/PHICH parameters | | DL Reference Measurement Channel R.11 FDD | As specified in section A.3.1.2.1 |

Table A.8.16.17C.1-2: Cell specific test parameters for E-UTRAN FDD known SCell activation, 5+5MHz bandwidth

| Parameter | Unit | Cell 1 | Cell 2 |
|-----------|------|--------|--------|
|-----------|------|--------|--------|

| | | T1 | T2 | T3 | T1 | T2 | T3 |
|---|-----|-----------|----|----|-----------|----|----|
| BW _{channel} | MHz | 5 | | | 5 | | |
| OCNG Patterns defined in A.3.2.1.15 (OP.15 FDD) and in A.3.2.1.16 (OP.16 FDD) | | OP.20 FDD | | | OP.16.FDD | | |

A.8.16.17C.2 Test Requirements

The test requirements defined in section A.8.16.17.2 shall apply to this test case.

A.8.16.18 E-UTRAN TDD activation and deactivation of known SCell in non-DRX

A.8.16.18.1 Test Purpose and Environment

The purpose of this test is to verify that the SCell activation and deactivation times are within the requirements stated in section 7.7, when the SCell is known by the UE at the time of activation.

The test parameters are given in Tables A.8.16.18.1-1 and cell-specific parameters in A.8.16.18.1-2 below. The test consists of three successive time periods, with duration of T1, T2 and T3, respectively. There are two carriers, each with one cell. Both cells have constant signal levels throughout the test. Before the test starts the UE is connected to Cell 1 (PCell) on radio channel 1 (PCC) but is not aware of Cell 2 on radio channel 2. The UE is only monitoring the PCC. The UE shall be continuously scheduled in the PCell throughout the whole test.

At the beginning of T1 the UE receives an RRC message by which the SCell (Cell 2) becomes configured on radio channel 2 (SCC). The UE now starts monitoring also the SCC. The test equipment sends a MAC message for activation of the SCell.

The point in time at which the MAC message is received at the UE antenna connector, in a subframe # denoted m, where m is 4 or 9, defines the start of time period T2. The UE shall be able to report valid CSI for the activated SCell at latest in subframe (m+24). The UE shall start reporting CSI in subframe (m+8) and shall report CQI index 0 (out-of-range) until the SCell activation has been completed. Any PCell interruption due to activation of SCell shall occur in the subframes (m+5) to (m+11).

Time period T3 starts when a MAC message for deactivation of SCell, sent from the test equipment to the UE in a subframe # denoted n where n is 4 or 9, is received at the UE antenna connector. The UE shall carry out deactivation of the SCell and any PCell interruption due to the deactivation shall occur in the subframes (n+5) to (n+11).

The test equipment verifies that potential interruption is carried out in the correct time span by monitoring ACK/NACK sent in PCell during activation and deactivation of SCell, respectively.

The test equipment verifies the activation time by counting the subframes from the time when the SCell activation command is sent until a CSI report with other than CQI index 0 is received.

The test equipment verifies the deactivation time by counting the subframes from the time when the SCell deactivation command is sent until CQI reporting for SCell is discontinued.

Table A.8.16.18.1-1: General test parameters for known SCell activation case

| Parameter | Unit | Value | Comment |
|--|------|--|--|
| PDSCH parameters | | DL Reference Measurement Channel R.0 TDD | As specified in section A.3.1.1.2 |
| PCFICH/PDCCH/PHICH parameters | | DL Reference Measurement Channel R.6 TDD | As specified in section A.3.1.2.2 |
| E-UTRA RF Channel Number | | 1, 2 | Two radio channels are used for this test |
| Active PCell | | Cell 1 | Primary cell on RF channel number 1. |
| Configured deactivated SCell | | Cell 2 | Configured deactivated secondary cell on RF channel number 2. |
| Channel Bandwidth (BW _{channel}) | MHz | 10 | Channel bandwidth for cells on primary and secondary component carriers |
| CP length | | Normal | |
| Special subframe configuration | | 6 | As specified in table 4.2.1 in TS 36.211. The same configuration applies to all cells. |

| | | | |
|---|--|---|--|
| Uplink-downlink configuration | | 1 | |
| DRX | | OFF | Continuous monitoring of primary cell |
| CQI/PMI periodicity and offset configuration index | | 0 | CQI reporting for SCell every UL subframe |
| Cell-individual offset for cells on RF channel number 1 | dB | 0 | Individual offset for cells on primary component carrier. |
| Cell-individual offset for cells on RF channel number 2 | dB | 0 | Individual offset for cells on secondary component carrier. |
| SCell measurement cycle (measCycleSCell) | ms | 320 | |
| Cell2 timing offset to cell1 | μ s | 0 | |
| Time alignment error between cell2 and cell1 | μ s | \leq Time alignment error as specified in 3GPP TS 36.104 [30] clause 6.5.3.1. | The value of time alignment error depends upon the type of carrier aggregation. |
| Cell3 timing offset to cell1 | μ s | 3 | Synchronous cells |
| T1 | s | 7 | During this time the PCell shall be known and the SCell configured and detected. |
| T2 | s | 1 | During this time the UE shall activate the SCell. |
| T3 | s | 1 | During this time the UE shall deactivate the SCell. |
| Note: | This test verifies the RRM requirement which is independent of channel bandwidth and is performed according to the principle defined in section A.3.6.1. | | |

Table A.8.16.18.1-2: Cell specific test parameters for E-UTRAN TDD known SCell activation

| Parameter | Unit | Cell 1 | | | Cell 2 | | |
|---|--|----------|----|----|----------|----|----|
| | | T1 | T2 | T3 | T1 | T2 | T3 |
| E-UTRA RF Channel Number | | 1 | | | 2 | | |
| $BW_{channel}$ | MHz | 10 | | | 10 | | |
| OCNG Patterns defined in A.3.2.2.1 (OP.1 TDD) and in A.3.2.2.2 (OP.2 TDD) | | OP.1 TDD | | | OP.2 TDD | | |
| PBCH_RA | dB | 0 | | | 0 | | |
| PBCH_RB | dB | | | | | | |
| PSS_RA | dB | | | | | | |
| SSS_RA | dB | | | | | | |
| PCFICH_RB | dB | | | | | | |
| PHICH_RA | dB | | | | | | |
| PHICH_RB | dB | | | | | | |
| PDCCH_RA | dB | | | | | | |
| PDCCH_RB | dB | | | | | | |
| PDSCH_RA | dB | | | | | | |
| PDSCH_RB | dB | | | | | | |
| OCNG_RA ^{Note 1} | dB | | | | | | |
| OCNG_RB ^{Note 1} | dB | | | | | | |
| N_{oc} ^{Note 2} | dBm/15 kHz | | | | | | |
| RSRP ^{Note 3} | dBm/15 kHz | -87 | | | -87 | | |
| \bar{E}_s/I_{ot} | dB | 17 | | | 17 | | |
| SCH_RP ^{Note 3} | dBm/15 kHz | -87 | | | -87 | | |
| \bar{E}_s/N_{oc} | dB | 17 | | | 17 | | |
| Propagation Condition | | AWGN | | | | | |
| Note 1: | OCNG shall be used such that all cells are fully allocated and a constant total transmitted power spectral density is achieved for all OFDM symbols. | | | | | | |
| Note 2: | Interference from other cells and noise sources not specified in the test is assumed to be constant over subcarriers and time and shall be modelled as AWGN of appropriate power for N_{oc} to be fulfilled. | | | | | | |
| Note 3: | \bar{E}_s/I_{ot} , RSRP and SCH_RP levels have been derived from other parameters for information purposes. They are not settable parameters themselves. | | | | | | |
| Note 4: | The uplink resources for CSI reporting are assigned to the UE prior to the start of time period T2. | | | | | | |

A.8.16.18.2 Test Requirements

During T2 the UE shall send the first CSI report for SCell in a subframe (m+8), or in a subframe (m+9) if the subframe (m+8) was subject to interruption, or in a subframe (m+13) if the subframes (m+8) and (m+9) were subject to interruption when an intra-band SCell is activated. Whether CSI report in subframe (m+8) and/or (m+9) was interrupted or not is checked by monitoring ACK/NACK sent in PCell in subframe (m+8) and/or (m+9).

During T2 the UE shall start sending CSI reports for SCell with non-zero CQI index at latest in a subframe (m+24).

During T3 the UE shall stop sending CSI reports for SCell at latest in a subframe (m+8).

During T2 interruption of PCell during SCell activation shall not happen outside the subframes (m+5) to (m+11).

During T3 interruption of PCell during SCell deactivation shall not happen outside the subframes (n+5) to (n+11).

The interruption of PCell shall not be more than the values specified for intra-band CA and inter-band CA in Section 7.8.2.

All of the above test requirements shall be fulfilled in order for the observed SCell activation delay and SCell deactivation delay to be counted as correct. The rate of correct observed SCell activation delay and SCell deactivation delay during repeated tests shall be at least 90%.

NOTE: During T2 if there are no uplink resources for reporting the valid CSI in a subframe (m+24) then the UE shall use the next available uplink resource for reporting the corresponding valid CSI.

A.8.16.18A E-UTRAN TDD activation and deactivation of known SCell in non-DRX for 20MHz

A.8.16.18A.1 Test Purpose and Environment

The purpose of this test case is the same as for the test defined in subclause A.8.16.18. The test parameters are the same except those described in the following section. The listed parameter values in Tables A.8.16.18A.1-1 and A.8.16.18A.1-2 will replace the values of corresponding parameters in Tables A.8.16.18.1-1 and A.8.16.18.1-2.

Table A.8.16.18A.1-1: General test parameters for known SCell activation case, 20MHz bandwidth

| Parameter | Unit | Value | Comment |
|-------------------------------|------|---|-----------------------------------|
| PDSCH parameters | | DL Reference Measurement Channel R.3 TDD | As specified in section A.3.1.1.2 |
| PCFICH/PDCCH/PHICH parameters | | DL Reference Measurement Channel R.10 TDD | As specified in section A.3.1.2.2 |

Table A.8.16.18A.1-2: Cell specific test parameters for E-UTRAN TDD known SCell activation, 20MHz bandwidth

| Parameter | Unit | Cell 1 | | | Cell 2 | | |
|---|------|----------|----|----|----------|----|----|
| | | T1 | T2 | T3 | T1 | T2 | T3 |
| BW _{channel} | MHz | 20 | | | 20 | | |
| OCNG Patterns defined in A.3.2.2.7 (OP.7 TDD) and in A.3.2.2.2 (OP.2 TDD) | | OP.7 TDD | | | OP.8.TDD | | |

A.8.16.18A.2 Test Requirements

The test requirements defined in section A.8.16.18.2 shall apply to this test case.

A.8.16.18B E-UTRAN TDD activation and deactivation of known SCell in non-DRX for 10MHz + 5MHz

A.8.16.18B.1 Test Purpose and Environment

The purpose of this test case is the same as for the test defined in subclause A.8.16.18. The test parameters are the same except those described in the following section. The listed parameter values in Tables A.8.16.18B.1-1 and A.8.16.18B.1-2 will replace the values of corresponding parameters in Tables A.8.16.18.1-1 and A.8.16.18.1-2.

Table A.8.16.18B.1-1: General test parameters for known SCell activation case, 10 + 5MHz bandwidth

| Parameter | Unit | Value | Comment |
|-------------------------------|------|---|-----------------------------------|
| PDSCH parameters | | DL Reference Measurement Channel R.0 TDD | As specified in section A.3.1.1.2 |
| PCFICH/PDCCH/PHICH parameters | | DL Reference Measurement Channel R.6 TDD (cell 1) DL Reference Measurement Channel R.11 TDD (cell 2) | As specified in section A.3.1.2.2 |

Table A.8.16.18B.1-2: Cell specific test parameters for E-UTRAN TDD known SCell activation, 20 + 10MHz bandwidth

| Parameter | Unit | Cell 1 | | | Cell 2 | | |
|---|------|----------|----|----|-----------|----|----|
| | | T1 | T2 | T3 | T1 | T2 | T3 |
| $BW_{channel}$ | MHz | 10 | | | 5 | | |
| OCNG Patterns defined in A.3.2.2.1 (OP.1 TDD) and in A.3.2.2.10 (OP.10 TDD) | | OP.1 TDD | | | OP.10.TDD | | |

A.8.16.18B.2 Test Requirements

The test requirements defined in section A.8.16.18.2 shall apply to this test case.

A.8.16.18C E-UTRAN TDD activation and deactivation of known SCell in non-DRX for 5MHz + 5MHz

A.8.16.18C.1 Test Purpose and Environment

The purpose of this test case is the same as for the test defined in subclause A.8.16.18. The test parameters are the same except those described in the following section. The listed parameter values in Tables A.8.16.18C.1-1 and A.8.16.18C.1-2 will replace the values of corresponding parameters in Tables A.8.16.18.1-1 and A.8.16.18.1-2.

Table A.8.16.18C.1-1: General test parameters for known SCell activation case, 5MHz bandwidth

| Parameter | Unit | Value | Comment |
|-------------------------------|------|---|-----------------------------------|
| PDSCH parameters | | DL Reference Measurement Channel R.4 TDD | As specified in section A.3.1.1.2 |
| PCFICH/PDCCH/PHICH parameters | | DL Reference Measurement Channel R.11 TDD | As specified in section A.3.1.2.2 |

Table A.8.16.18C.1-2: Cell specific test parameters for E-UTRAN TDD known SCell activation, 5MHz bandwidth

| Parameter | Unit | Cell 1 | | | Cell 2 | | |
|----------------|------|--------|----|----|--------|----|----|
| | | T1 | T2 | T3 | T1 | T2 | T3 |
| $BW_{channel}$ | MHz | 5 | | | 5 | | |

| | | | |
|---|--|----------|-----------|
| OCNG Patterns defined in A.3.2.2.9 (OP.9 TDD) and in A.3.2.2.10 (OP.10 TDD) | | OP.9 TDD | OP.10.TDD |
|---|--|----------|-----------|

A.8.16.18C.2 Test Requirements

The test requirements defined in section A.8.16.18.2 shall apply to this test case.

A.8.16.18 DE-UTRAN TDD activation and deactivation of known SCell in non-DRX for 20MHz + 10MHz

A.8.16.18D.1 Test Purpose and Environment

The purpose of this test case is the same as for the test defined in subclause A.8.16.18. The test parameters are the same except those described in the following section. The listed parameter values in Tables A.8.16.18D.1-1 and A.8.16.18D.1-2 will replace the values of corresponding parameters in Tables A.8.16.18.1-1 and A.8.16.18.1-2.

Table A.8.16.18D.1-1: General test parameters for known SCell activation case, 20 + 10MHz bandwidth

| Parameter | Unit | Value | Comment |
|-------------------------------|------|---|-----------------------------------|
| PDSCH parameters | | DL Reference Measurement Channel R.3 TDD | As specified in section A.3.1.1.2 |
| PCFICH/PDCCH/PHICH parameters | | DL Reference Measurement Channel R.10 TDD (cell 1) DL Reference Measurement Channel R.6 TDD (cell 2) | As specified in section A.3.1.2.2 |

Table A.8.16.18D.1-2: Cell specific test parameters for E-UTRAN TDD known SCell activation, 10 + 5MHz bandwidth

| Parameter | Unit | Cell 1 | | | Cell 2 | | |
|---|------|----------|----|----|----------|----|----|
| | | T1 | T2 | T3 | T1 | T2 | T3 |
| BW _{channel} | MHz | 20 | | | 10 | | |
| OCNG Patterns defined in A.3.2.2.7 (OP.7 TDD) and in A.3.2.2.2 (OP.2 TDD) | | OP.7 TDD | | | OP.2.TDD | | |

A.8.16.18D.2 Test Requirements

The test requirements defined in section A.8.16.18.2 shall apply to this test case.

A.8.16.19 E-UTRAN FDD activation and deactivation of unknown SCell in non-DRX

A.8.16.19.1 Test Purpose and Environment

The purpose of this test is to verify that the SCell activation and deactivation times are within the requirements stated in section 7.7, when the SCell is unknown by the UE at the time of activation.

The test parameters are given in Tables A.8.16.19.1-1 and cell-specific parameters in A.8.16.19.1-2 below. The test consists of three successive time periods, with duration of T1, T2 and T3, respectively. There are two carriers, each with one cell. Cell 1 has constant signal level throughout the test. Before the test starts the UE is connected to Cell 1 (PCell) on radio channel 1 (PCC) but is not aware of Cell 2 on radio channel 2. The UE is only monitoring the PCC. The UE shall be continuously scheduled in the PCell throughout the whole test.

At the beginning of T1 the UE receives an RRC message by which the SCell (cell2) becomes configured on radio channel 2 (SCC). During T1 the SCell is powered off and UE is not aware of SCell.

A MAC message for activation of SCell is sent by the test equipment 100ms after the RRC message, in a subframe # denoted m which is an even number. The point in time at which the MAC message for activation of SCell is received at the UE antenna connector defines the start of time period T2. Immediately at beginning of T2 the transmission power of cell 2 is increased to same level as for cell 1. The UE shall be able to report valid CSI for the activated SCell at latest in subframe (m+34) provided the SCell can be successfully detected on the first attempt. The UE shall start reporting CSI in subframe (m+8) and shall report CQI index 0 (out-of-range) until the SCell activation has been completed. Any PCell interruption due to activation of SCell shall occur in the subframes (m+5) to (m+9).

Time period T3 starts when a MAC message for deactivation of the SCell, sent from the test equipment to the UE in a subframe # denoted n which is an even number, is received at the UE antenna connector. The UE shall carry out deactivation of the SCell at latest in subframe (n+8), and any PCell interruption due to the deactivation shall occur in the subframes (n+5) to (n+9).

The test equipment verifies that potential interruption is carried out in the correct time span by monitoring ACK/NACK sent in PCell during activation of SCell, respectively.

The test equipment verifies the activation time by counting the subframes from the time when the SCell activation command is sent until a CSI report with other than CQI index 0 is received.

The test equipment verifies the deactivation time by counting the subframes from the time when the SCell1 deactivation command is sent until CQI reporting for SCell1 is discontinued.

Table A.8.16.19.1-1: General test parameters for unknown SCell activation case

| Parameter | Unit | Value | Comment |
|--|--|--|---|
| PDSCH parameters | | DL Reference Measurement Channel R.0 FDD | As specified in section A.3.1.1.1 |
| PCFICH/PDCCH/PHICH parameters | | DL Reference Measurement Channel R.6 FDD | As specified in section A.3.1.2.1 |
| E-UTRA RF Channel Number | | 1, 2 | Two radio channels are used for this test |
| Active PCell | | Cell 1 | Primary cell on RF channel number 1. |
| Configured deactivated SCell | | Cell 2 | Configured deactivated secondary cell on RF channel number 2. |
| CP length | | Normal | |
| DRX | | OFF | Continuous monitoring of primary cell |
| CQI/PMI periodicity and offset configuration index | | 0 | CQI reporting for SCell every second subframe |
| SCell measurement cycle (measCycleSCell) | ms | 320 | |
| Cell2 timing offset to cell1 | μs | 0 | |
| Time alignment error between cell2 and cell1 | μs | ≤ Time alignment error as specified in 3GPP TS 36.104 [30] clause 6.5.3.1. | The value of time alignment error depends upon the type of carrier aggregation. |
| T1 | ms | 100 | During this time the PCell shall be known and the SCell configured, but not detected. |
| T2 | s | 1 | During this time the UE shall activate the SCell. |
| T3 | s | 1 | During this time the UE shall deactivate the SCell. |
| Note: | This test verifies the RRM requirement which is independent of channel bandwidth and is performed according to the principle defined in section A.3.6.1. | | |

Table A.8.16.19.1-2: Cell specific test parameters for E-UTRAN FDD unknown SCell activation

| Parameter | Unit | Cell 1 | | | Cell 2 | | |
|---|------|----------|----|----|----------|----|----|
| | | T1 | T2 | T3 | T1 | T2 | T3 |
| E-UTRA RF Channel Number | | 1 | | | 2 | | |
| BW _{channel} | MHz | 10 | | | 10 | | |
| OCNG Patterns defined in A.3.2.1.1 (OP.1 FDD) and in A.3.2.1.2 (OP.2 FDD) | | OP.1 FDD | | | OP.2 FDD | | |
| PBCH_RA | dB | 0 | | | 0 | | |
| PBCH_RB | dB | | | | | | |
| PSS_RA | dB | | | | | | |

| | | | | |
|---|------------|------|-----------|------|
| SSS_RA | dB | | | |
| PCFICH_RB | dB | | | |
| PHICH_RA | dB | | | |
| PHICH_RB | dB | | | |
| PDCCH_RA | dB | | | |
| PDCCH_RB | dB | | | |
| PDSCH_RA | dB | | | |
| PDSCH_RB | dB | | | |
| OCNG_RA ^{Note 1} | dB | | | |
| OCNG_RB ^{Note 1} | dB | | | |
| N_{oc} ^{Note 2} | dBm/15 kHz | -104 | | -104 |
| RSRP ^{Note 3} | dBm/15 kHz | -87 | -infinity | -87 |
| \bar{E}_s/I_{ot} | dB | 17 | -infinity | 17 |
| SCH_RP ^{Note 3} | dBm/15 kHz | -87 | -infinity | -87 |
| \bar{E}_s/N_{oc} | dB | 17 | -infinity | 17 |
| Propagation Condition | | AWGN | | |
| <p>Note 1: OCNG shall be used such that all cells are fully allocated and a constant total transmitted power spectral density is achieved for all OFDM symbols.</p> <p>Note 2: Interference from other cells and noise sources not specified in the test is assumed to be constant over subcarriers and time and shall be modelled as AWGN of appropriate power for N_{oc} to be fulfilled.</p> <p>Note 3: \bar{E}_s/I_{ot}, RSRP and SCH_RP levels have been derived from other parameters for information purposes. They are not settable parameters themselves.</p> <p>Note 4: The uplink resources for CSI reporting are assigned to the UE prior to the start of time period T2.</p> | | | | |

A.8.16.19.2 Test Requirements

During T2 the UE shall send the first CSI report for SCell (m+8), or in a subframe (m+10) if the subframe (m+8) was subject to interruption. Whether CSI report in subframe (m+8) was interrupted or not is checked by monitoring ACK/NACK sent in PCell in subframe (m+8).

During T2 the UE shall start sending CSI reports for SCell with non-zero CQI index at latest in a subframe (m+34).

During T3 the UE shall stop sending CSI reports for SCell1 at latest in a subframe (n+8).

During T2 Interruption of PCell during SCell activation shall not happen outside the subframes (m+5) to (m+9).

During T3 Interruption of PCell during SCell1 deactivation shall not happen outside the subframes (n+5) to (n+9).

The interruption of PCell shall not be more than the values specified for intra-band CA and inter-band CA in Section 7.8.2.

All of the above test requirements shall be fulfilled in order for the observed SCell activation delay to be counted as correct. The rate of correct observed SCell activation and deactivation delay during repeated tests shall be at least 90%.

NOTE: During T2 if there are no uplink resources for reporting the valid CSI in a subframe (m+34) then the UE shall use the next available uplink resource for reporting the corresponding valid CSI.

A.8.16.19A E-UTRAN FDD activation and deactivation of unknown SCell in non-DRX for 20MHz

A.8.16.19A.1 Test Purpose and Environment

The purpose of this test case is the same as for the test defined in subclause A.8.16.19. The test parameters are the same except those described in the following section. The listed parameter values in Tables A.8.16.19A.1-1 and A.8.16.19A.1-2 will replace the values of corresponding parameters in Tables A.8.16.19.1-1 and A.8.16.19.1-2.

Table A.8.16.19A.1-1: General test parameters for unknown SCell activation case, 20MHz bandwidth

| Parameter | Unit | Value | Comment |
|-------------------------------|------|---|-----------------------------------|
| PDSCH parameters | | DL Reference Measurement Channel R.6 FDD | As specified in section A.3.1.1.1 |
| PCFICH/PDCCH/PHICH parameters | | DL Reference Measurement Channel R.10 FDD | As specified in section A.3.1.2.1 |

Table A.8.16.19A.1-2: Cell specific test parameters for E-UTRAN FDD unknown SCell activation, 20MHz bandwidth

| Parameter | Unit | Cell 1 | | | Cell 2 | | |
|---|------|-----------|----|----|-----------|----|----|
| | | T1 | T2 | T3 | T1 | T2 | T3 |
| BW _{channel} | MHz | 20 | | | 20 | | |
| OCNG Patterns defined in A.3.2.1.17 (OP.17 FDD) and in A.3.2.1.12 (OP.12 FDD) | | OP.17 FDD | | | OP.12.FDD | | |

A.8.16.19A.2 Test Requirements

The test requirements defined in section A.8.16.19.2 shall apply to this test case.

A.8.16.19B E-UTRAN FDD activation and deactivation of unknown SCell in non-DRX for 10MHz + 5MHz

A.8.16.19B.1 Test Purpose and Environment

The purpose of this test case is the same as for the test defined in subclause A.8.16.19. The test parameters are the same except those described in the following section. The listed parameter values in Tables A.8.16.19B.1-1 and A.8.16.19B.1-2 will replace the values of corresponding parameters in Tables A.8.16.19.1-1 and A.8.16.19.1-2.

Table A.8.16.19B.1-1: General test parameters for unknown SCell activation case, 10+5MHz bandwidth

| Parameter | Unit | Value | Comment |
|-------------------------------|------|---|-----------------------------------|
| PDSCH parameters | | DL Reference Measurement Channel R.3 FDD (Cell 1) | As specified in section A.3.1.1.1 |
| PCFICH/PDCCH/PHICH parameters | | DL Reference Measurement Channel R.6 FDD (Cell 1) DL Reference Measurement Channel R.11 FDD (Cell 2) | As specified in section A.3.1.2.1 |

Table A.8.16.19B.1-2: Cell specific test parameters for E-UTRAN FDD unknown SCell activation, 10+5MHz bandwidth

| Parameter | Unit | Cell 1 | | | Cell 2 | | |
|---|------|-----------|----|----|-----------|----|----|
| | | T1 | T2 | T3 | T1 | T2 | T3 |
| BW _{channel} | MHz | 10 | | | 5 | | |
| OCNG Patterns defined in A.3.2.1.11 (OP.11 FDD) and in A.3.2.1.16 (OP.16 FDD) | | OP.10 FDD | | | OP.16.FDD | | |

A.8.16.19B.2 Test Requirements

The test requirements defined in section A.8.16.19.2 shall apply to this test case.

A.8.16.19C E-UTRAN FDD activation and deactivation of unknown SCell in non-DRX for 5MHz + 5MHz

A.8.16.19C.1 Test Purpose and Environment

The purpose of this test case is the same as for the test defined in subclause A.8.16.19. The test parameters are the same except those described in the following section. The listed parameter values in Tables A.8.16.19C.1-1 and A.8.16.19C.1-2 will replace the values of corresponding parameters in Tables A.8.16.19.1-1 and A.8.16.19.1-2.

Table A.8.16.19C.1-1: General test parameters for unknown SCell activation case, 5+5MHz bandwidth

| Parameter | Unit | Value | Comment |
|-------------------------------|------|---|-----------------------------------|
| PDSCH parameters | | DL Reference Measurement Channel R.7 FDD (Cell 1) | As specified in section A.3.1.1.1 |
| PCFICH/PDCCH/PHICH parameters | | DL Reference Measurement Channel R.11 FDD | As specified in section A.3.1.2.1 |

Table A.8.16.19C.1-2: Cell specific test parameters for E-UTRAN FDD unknown SCell activation, 5+5MHz bandwidth

| Parameter | Unit | Cell 1 | | | Cell 2 | | |
|---|------|-----------|----|----|-----------|----|----|
| | | T1 | T2 | T3 | T1 | T2 | T3 |
| BW _{channel} | MHz | 5 | | | 5 | | |
| OCNG Patterns defined in A.3.2.1.15 (OP.15 FDD) and in A.3.2.1.16 (OP.16 FDD) | | OP.20 FDD | | | OP.16.FDD | | |

A.8.16.19C.2 Test Requirements

The test requirements defined in section A.8.16.19.2 shall apply to this test case.

A.8.16.20 E-UTRAN TDD activation and deactivation of unknown SCell in non-DRX

A.8.16.20.1 Test Purpose and Environment

The purpose of this test is to verify that the SCell activation and deactivation times are within the requirements stated in section 7.7, when the SCell is unknown by the UE at the time of activation.

The test parameters are given in Tables A.8.16.20.1-1 and cell-specific parameters in A.8.16.20.1-2 below. The test consists of three successive time periods, with duration of T1, T2 and T3, respectively. There are two carriers, each with one cell. Cell 1 has constant signal level throughout the test. Before the test starts the UE is connected to Cell 1 (PCell) on radio channel 1 (PCC) but is not aware of Cell 2 on radio channel 2. The UE is only monitoring the PCC. The UE shall be continuously scheduled in the PCell throughout the whole test.

At the beginning of T1 the UE receives an RRC message by which the SCell (cell2) becomes configured on radio channel 2 (SCC). During T1 the signal level of SCell is powered off and UE is not aware of SCell.

A MAC message for activation of SCell is sent by the test equipment 100ms after the RRC message, in a subframe # denoted m, where m is 4 or 9. The point in time at which the MAC message for activation of SCell is received at the UE antenna connector defines the start of time period T2. Immediately at beginning of T2 the transmission power of cell 2 is increased to same level as for cell 1. The UE shall be able to report valid CSI for the activated SCell at latest in subframe (m+34) provided the SCell can be successfully detected on the first attempt. The UE shall start reporting CSI in subframe (m+8) and shall report CQI index 0 (out-of-range) until the SCell activation has been completed. Any PCell interruption due to activation of SCell shall occur in the subframes (m+5) to (m+11).

Time period T3 starts when a MAC message for deactivation of the SCell, sent from the test equipment to the UE in a subframe # denoted n, where n is 4 or 9, is received at the UE antenna connector. The UE shall carry out deactivation of the SCell at latest in subframe (n+8), and any PCell interruption due to the deactivation shall occur in the subframes (n+5) to (n+11).

The test equipment verifies that potential interruption is carried out in the correct time span by monitoring ACK/NACK sent in PCell during activation of SCell, respectively.

The test equipment verifies the activation time by counting the subframes from the time when the SCell activation command is sent until a CSI report with other than CQI index 0 is received.

The test equipment verifies the deactivation time by counting the subframes from the time when the SCell1 deactivation command is sent until CQI reporting for SCell1 is discontinued.

Table A.8.16.20.1-1: General test parameters for unknown SCell activation case

| Parameter | Unit | Value | Comment |
|--|--|--|--|
| PDSCH parameters | | DL Reference Measurement Channel R.0 TDD | As specified in section A.3.1.1.2 |
| PCFICH/PDCCH/PHICH parameters | | DL Reference Measurement Channel R.6 TDD | As specified in section A.3.1.2.2 |
| E-UTRA RF Channel Number | | 1, 2 | Two radio channels are used for this test |
| Active PCell | | Cell 1 | Primary cell on RF channel number 1. |
| Configured deactivated SCell | | Cell 2 | Configured deactivated secondary cell on RF channel number 2. |
| Channel Bandwidth (BW _{channel}) | MHz | 10 | Channel bandwidth for cells on primary and secondary component carriers |
| CP length | | Normal | |
| Special subframe configuration | | 6 | As specified in table 4.2.1 in TS 36.211. The same configuration applies to all cells. |
| Uplink-downlink configuration | | 1 | |
| DRX | | OFF | Continuous monitoring of primary cell |
| CQI/PMI periodicity and offset configuration index | | 0 | CQI reporting for SCell every UL subframe |
| SCell measurement cycle (measCycleSCell) | ms | 320 | |
| Cell2 timing offset to cell1 | μs | 0 | |
| Time alignment error between cell2 and cell1 | μs | ≤ Time alignment error as specified in 3GPP TS 36.104 [30] clause 6.5.3.1. | The value of time alignment error depends upon the type of carrier aggregation. |
| Cell3 timing offset to cell1 | μs | 3 | Synchronous cells |
| T1 | ms | 100 | During this time the PCell shall be known and the SCell configured, but not detected. |
| T2 | s | 1 | During this time the UE shall activate the SCell. |
| T3 | s | 1 | During this time the UE shall deactivate the SCell. |
| Note: | This test verifies the RRM requirement which is independent of channel bandwidth and is performed according to the principle defined in section A.3.6.1. | | |

Table A.8.16.20.1-2: Cell specific test parameters for E-UTRAN TDD unknown SCell activation

| Parameter | Unit | Cell 1 | | | Cell 2 | | |
|---|------------|----------|----|----|-----------|-----|----|
| | | T1 | T2 | T3 | T1 | T2 | T3 |
| E-UTRA RF Channel Number | | 1 | | | 2 | | |
| BW _{channel} | MHz | 10 | | | 10 | | |
| OCNG Patterns defined in A.3.2.2.1 (OP.1 TDD) and in A.3.2.2.2 (OP.2 TDD) | | OP.1 TDD | | | OP.2 TDD | | |
| PBCH_RA | dB | 0 | | | 0 | | |
| PBCH_RB | dB | | | | | | |
| PSS_RA | dB | | | | | | |
| SSS_RA | dB | | | | | | |
| PCFICH_RB | dB | | | | | | |
| PHICH_RA | dB | | | | | | |
| PHICH_RB | dB | | | | | | |
| PDCCH_RA | dB | | | | | | |
| PDCCH_RB | dB | | | | | | |
| PDSCH_RA | dB | | | | | | |
| PDSCH_RB | dB | | | | | | |
| OCNG_RA ^{Note 1} | dB | | | | | | |
| OCNG_RB ^{Note 1} | dB | | | | | | |
| N _{oc} ^{Note 2} | dBm/15 kHz | | | | | | |
| RSRP ^{Note 3} | dBm/15 kHz | -87 | | | -infinity | -87 | |
| \bar{E}_s/I_{ot} | dB | 17 | | | -infinity | 17 | |
| SCH_RP ^{Note 3} | dBm/15 kHz | -87 | | | -infinity | -87 | |
| \bar{E}_s/N_{oc} | dB | 17 | | | -infinity | 17 | |

| Propagation Condition | AWGN |
|-----------------------|--|
| Note 1: | OCNG shall be used such that all cells are fully allocated and a constant total transmitted power spectral density is achieved for all OFDM symbols. |
| Note 2: | Interference from other cells and noise sources not specified in the test is assumed to be constant over subcarriers and time and shall be modelled as AWGN of appropriate power for N_{oc} to be fulfilled. |
| Note 3: | E_s/lot , RSRP and SCH_RP levels have been derived from other parameters for information purposes. They are not settable parameters themselves. |
| Note 4: | The uplink resources for CSI reporting are assigned to the UE prior to the start of time period T2. |

A.8.16.20.2 Test Requirements

During T2 the UE shall send the first CSI report for SCell at in a subframe (m+8), or in a subframe (m+9) if the subframe (m+8) was subject to interruption, or in a subframe (m+13) if the subframes (m+8) and (m+9) were subject to interruption when an intra-band SCell is activated. Whether first CSI report was interrupted or not is checked by monitoring ACK/NACK sent in PCell at the same time as the first CSI report.

During T2 the UE shall start sending CSI reports for SCell with non-zero CQI index at latest in a subframe (m+34).

During T3 the UE shall stop sending CSI reports for SCell1 at latest in a subframe (n+8).

During T2 Interruption of PCell during SCell activation shall not happen outside the subframes (m+5) to (m+11).

During T3 Interruption of PCell during SCell1 deactivation shall not happen outside the subframes (n+5) to (n+11).

The interruption of PCell shall not be more than the values specified for intra-band CA and inter-band CA in Section 7.8.2.

All of the above test requirements shall be fulfilled in order for the observed SCell activation delay to be counted as correct. The rate of correct observed SCell activation and deactivation delay during repeated tests shall be at least 90%.

NOTE: During T2 if there are no uplink resources for reporting the valid CSI in a subframe (m+34) then the UE shall use the next available uplink resource for reporting the corresponding valid CSI.

A.8.16.20A E-UTRAN TDD activation and deactivation of unknown SCell in non-DRX for 20MHz

A.8.16.20A.1 Test Purpose and Environment

The purpose of this test case is the same as for the test defined in subclause A.8.16.20. The test parameters are the same except those described in the following section. The listed parameter values in Tables A.8.16.20A.1-1 and A.8.16.20A.1-2 will replace the values of corresponding parameters in Tables A.8.16.20.1-1 and A.8.16.20.1-2.

Table A.8.16.20A.1-1: General test parameters for unknown SCell activation case, 20MHz bandwidth

| Parameter | Unit | Value | Comment |
|-------------------------------|------|--|-----------------------------------|
| PDSCH parameters | | DL Reference Measurement Channel R.0 TDD | As specified in section A.3.1.1.2 |
| PCFICH/PDCCH/PHICH parameters | | DL Reference Measurement Channel R.6 TDD | As specified in section A.3.1.2.2 |

Table A.8.16.20A.1-2: Cell specific test parameters for E-UTRAN TDD unknown SCell activation, 20MHz bandwidth

| Parameter | Unit | Cell 1 | | | Cell 2 | | |
|---|------|----------|----|----|----------|----|----|
| | | T1 | T2 | T3 | T1 | T2 | T3 |
| $BW_{channel}$ | MHz | 20 | | | 20 | | |
| OCNG Patterns defined in A.3.2.2.7 (OP.7 TDD) and in A.3.2.2.2 (OP.2 TDD) | | OP.7 TDD | | | OP.2.TDD | | |

A.8.16.20A.2 Test Requirements

The test requirements defined in section A.8.16.20.2 shall apply to this test case.

A.8.16.20B E-UTRAN TDD activation and deactivation of unknown SCell in non-DRX for 10MHz + 5MHz

A.8.16.20B.1 Test Purpose and Environment

The purpose of this test case is the same as for the test defined in subclause A.8.16.20. The test parameters are the same except those described in the following section. The listed parameter values in Tables A.8.16.20B.1-1 and A.8.16.20B.1-2 will replace the values of corresponding parameters in Tables A.8.16.20.1-1 and A.8.16.20.1-2.

Table A.8.16.20B.1-1: General test parameters for unknown SCell activation case, 10 + 5MHz bandwidth

| Parameter | Unit | Value | Comment |
|-------------------------------|------|---|-----------------------------------|
| PDSCH parameters | | DL Reference Measurement Channel R.0 TDD | As specified in section A.3.1.1.2 |
| PCFICH/PDCCH/PHICH parameters | | DL Reference Measurement Channel R.6 TDD (cell 1) DL Reference Measurement Channel R.12 TDD (cell 2) | As specified in section A.3.1.2.2 |

Table A.8.16.20B.1-2: Cell specific test parameters for E-UTRAN TDD unknown SCell activation, 10 + 5MHz bandwidth

| Parameter | Unit | Cell 1 | | | Cell 2 | | |
|---|------|----------|----|----|-----------|----|----|
| | | T1 | T2 | T3 | T1 | T2 | T3 |
| BW _{channel} | MHz | 10 | | | 5 | | |
| OCNG Patterns defined in A.3.2.2.1 (OP.1 TDD) and in A.3.2.2.10 (OP.10 TDD) | | OP.1 TDD | | | OP.10.TDD | | |

A.8.16.20B.2 Test Requirements

The test requirements defined in section A.8.16.20.2 shall apply to this test case.

A.8.16.20C E-UTRAN TDD activation and deactivation of unknown SCell in non-DRX for 5MHz + 5MHz

A.8.16.20C.1 Test Purpose and Environment

The purpose of this test case is the same as for the test defined in subclause A.8.16.20. The test parameters are the same except those described in the following section. The listed parameter values in Tables A.8.16.20C.1-1 and A.8.16.20C.1-2 will replace the values of corresponding parameters in Tables A.8.16.20.1-1 and A.8.16.20.1-2.

Table A.8.16.20C.1-1: General test parameters for unknown SCell activation case, 5MHz bandwidth

| Parameter | Unit | Value | Comment |
|-------------------------------|------|---|-----------------------------------|
| PDSCH parameters | | DL Reference Measurement Channel R.4 TDD | As specified in section A.3.1.1.2 |
| PCFICH/PDCCH/PHICH parameters | | DL Reference Measurement Channel R.11 TDD | As specified in section A.3.1.2.2 |

Table A.8.16.20C.1-2: Cell specific test parameters for E-UTRAN TDD unknown SCell activation, 5MHz bandwidth

| Parameter | Unit | Cell 1 | Cell 2 |
|-----------|------|--------|--------|
|-----------|------|--------|--------|

| | | T1 | T2 | T3 | T1 | T2 | T3 |
|---|-----|----------|----|----|-----------|----|----|
| BW _{channel} | MHz | 5 | | | 5 | | |
| OCNG Patterns defined in A.3.2.2.9 (OP.9 TDD) and in A.3.2.2.10 (OP.10 TDD) | | OP.9 TDD | | | OP.10.TDD | | |

A.8.16.20C.2 Test Requirements

The test requirements defined in section A.8.16.20.2 shall apply to this test case.

A.8.16.20 DE-UTRAN TDD activation and deactivation of unknown SCell in non-DRX for 20MHz + 10MHz

A.8.16.20D.1 Test Purpose and Environment

The purpose of this test case is the same as for the test defined in subclause A.8.16.20. The test parameters are the same except those described in the following section. The listed parameter values in Tables A.8.16.20D.1-1 and A.8.16.20D.1-2 will replace the values of corresponding parameters in Tables A.8.16.20.1-1 and A.8.16.20.1-2.

Table A.8.16.20D.1-1: General test parameters for unknown SCell activation case, 20 + 10MHz bandwidth

| Parameter | Unit | Value | Comment |
|-------------------------------|------|---|-----------------------------------|
| PDSCH parameters | | DL Reference Measurement Channel R.3 TDD | As specified in section A.3.1.1.2 |
| PCFICH/PDCCH/PHICH parameters | | DL Reference Measurement Channel R.10 TDD (cell 1) DL Reference Measurement Channel R.6 TDD (cell 2) | As specified in section A.3.1.2.2 |

Table A.8.16.20D.1-2: Cell specific test parameters for E-UTRAN TDD unknown SCell activation, 20 + 10MHz bandwidth

| Parameter | Unit | Cell 1 | | | Cell 2 | | |
|---|------|----------|----|----|----------|----|----|
| | | T1 | T2 | T3 | T1 | T2 | T3 |
| BW _{channel} | MHz | 20 | | | 10 | | |
| OCNG Patterns defined in A.3.2.2.7 (OP.7 TDD) and in A.3.2.2.2 (OP.2 TDD) | | OP.7 TDD | | | OP.2.TDD | | |

A.8.16.20D.2 Test Requirements

The test requirements defined in section A.8.16.20.2 shall apply to this test case.

A.8.16.21 E-UTRAN TDD event triggered reporting under deactivated SCell in non-DRX for 20MHz+10MHz

A.8.16.21.1 Test Purpose and Environment

The purpose of this test case is the same as for the test defined in subclause A.8.16.2.

The test parameters are given in Tables A.8.16.21.1-1 and A.8.16.21.1-2 below. It is indicated to the UE in the measurement control information that event-triggered reporting with Events A2 (PCell and SCell) and A6 is used. The test consists of three successive time periods, with duration of T1, T2 and T3, respectively. During T1 the UE shall not have any information on cell 3. Immediately at beginning of T2 the transmission power of cell 3 is increased to same level as for cell 2, and due to usage of an offset this shall result in reporting of Event A6. At beginning of T3 the transmission powers of cells 1, 2 and 3 are reduced below a threshold value and this shall result in reporting of Event A2 for PCell and SCell, respectively.

Table A.8.16.21.1-1: E-UTRAN TDD event triggered reporting under deactivated SCell in non-DRX for 20MHz+10MHz

| Parameter | Unit | Value | Comment | |
|---|--|--|--|---|
| E-UTRA RF Channel Number | | 1, 2 | Two radio channels are used for this test | |
| Active PCell | | Cell 1 | Primary cell on RF channel number 1. | |
| Configured deactivated SCell | | Cell 2 | Configured deactivated secondary cell on RF channel number 2. | |
| Neighbour cell | | Cell 3 | Neighbor cell to be identified on RF channel number 2. | |
| CP length | | Normal | | |
| Special subframe configuration | | 6 | As specified in table 4.2.1 in TS 36.211. The same configuration applies to all cells. | |
| Uplink-downlink configuration | | 1 | | |
| DRX | | OFF | Continuous monitoring of primary cell | |
| A2 | Hysteresis | dB | 0 | Hysteresis for evaluation of event A2. |
| | Threshold RSRP | dBm | -96 | Actual RSRP threshold for event A2. Needs to take absolute accuracy tolerance in clause 9.1.11.1 into account plus margin. |
| | Time To Trigger | s | 0 | |
| A6 | Hysteresis | dB | 0 | Hysteresis for evaluation of event A6. |
| | Offset | dB | -6 | Offset parameter for evaluation of event A6. Needs to take relative accuracy tolerance in clause 9.1.11.2 into account plus margin. |
| | Report on leave | | False | |
| | Time To Trigger | s | 0 | |
| Cell-individual offset for cells on RF channel number 1 | dB | 0 | Individual offset for cells on primary component carrier. | |
| Cell-individual offset for cells on RF channel number 2 | dB | 0 | Individual offset for cells on secondary component carrier. | |
| Filter coefficient | | 0 | L3 filtering is not used | |
| SCell measurement cycle (measCycleSCell) | ms | 320 | | |
| Cell2 timing offset to cell1 | μ s | 0 | | |
| Time alignment error between cell2 and cell1 | μ s | \leq Time alignment error as specified in TS 36.104 [30] clause 6.5.3.1. | The value of time alignment error depends upon the type of carrier aggregation. | |
| Cell3 timing offset to cell1 | μ s | 3 | Synchronous cells | |
| T1 | s | 5 | During this time the UE shall be aware of cells 1 and 2 but not cell 3. | |
| T2 | s | ≤ 12 | UE shall report Event A6 within 6.4s (20 \times scellMeasCycle) | |
| T3 | s | 5 | UE shall report Event A2 within 200 ms and 1.6s for cells 1 and 2, respectively. | |
| NOTE: | This test verifies the RRM requirement which is independent of channel bandwidth and is performed according to the principle defined in section C.3.3.1. | | | |

Table A.8.16.21.1-2: Cell specific test parameters for E-UTRAN TDD event triggered reporting under deactivated SCell in non-DRX for 20MHz+10MHz

| Parameter | Unit | Combination | Cell 1 | | | Cell 2 | | | Cell 3 | | |
|--|------|-------------|--------------------------------|----|----|--------------------------------|----|----|--------------------------------|----|----|
| | | | T1 | T2 | T3 | T1 | T2 | T3 | T1 | T2 | T3 |
| E-UTRA RF Channel Number | | All | 1 | | | 2 | | | 2 | | |
| BW _{channel} | | 20MHz+10MHz | 20MHz: N _{RB,c} = 100 | | | 10MHz: N _{RB,c} = 50 | | | 10MHz: N _{RB,c} = 50 | | |
| | | 10MHz+20MHz | 10MHz: N _{RB,c} = 50 | | | 20MHz: N _{RB,c} = 100 | | | 20MHz: N _{RB,c} = 100 | | |
| Correlation Matrix and Antenna Configuration | | All | 1x2 Low | | | 1x2 Low | | | 1x2 Low | | |
| PDSCH Reference measurement channel defined in A.3.1.1.2 | | 20MHz+10MHz | R.3 TDD | | | N/A | | | N/A | | |
| | | 10MHz+20MHz | R.0 TDD | | | N/A | | | N/A | | |
| PDCCH/PCFICH/PHICH | | 20MHz+10MHz | R.10 TDD | | | R.6 TDD | | | R.6 TDD | | |

| Reference measurement channel defined in A.3.1.2.2 | | 10MHz+20MHz | R.6 TDD | | | R.10 TDD | | | R.10 TDD | | | | |
|---|------------|-------------|----------|-----|------|----------|------|------|----------|---|---|----------|----------|
| OCNG Patterns defined in A.3.2.2 | | 20MHz+10MHz | OP.7 TDD | | | OP.2 TDD | | | OP.2 TDD | | | | |
| | | 10MHz+20MHz | OP.1 TDD | | | OP.8 TDD | | | OP.8 TDD | | | | |
| PBCH_RA | dB | All | 0 | | | 0 | | | 0 | | | | |
| PBCH_RB | dB | | | | | | | | | | | | |
| PSS_RA | dB | | | | | | | | | | | | |
| SSS_RA | dB | | | | | | | | | | | | |
| PCFICH_RB | dB | | | | | | | | | | | | |
| PHICH_RA | dB | | | | | | | | | | | | |
| PHICH_RB | dB | | | | | | | | | | | | |
| PDCCH_RA | dB | | | | | | | | | | | | |
| PDCCH_RB | dB | | | | | | | | | | | | |
| PDSCH_RA | dB | | | | | | | | | | | | |
| PDSCH_RB | dB | | | | | | | | | | | | |
| OCNG_RA ^{Note 1} | dB | | | | | | | | | | | | |
| OCNG_RB ^{Note 1} | dB | | | | | | | | | | | | |
| N_{oc} ^{Note 2} | dBm/15 kHz | | | | | | | | | | | All | -104 |
| RSRP ^{Note 3} | dBm/15 kHz | All | -85 | -85 | -107 | -85 | -85 | -107 | - | - | - | -85 | -107 |
| \bar{E}_s/I_{ot} | dB | All | 19 | 19 | -3 | 19.00 | 0.05 | 4.76 | - | - | - | infinity | infinity |
| SCH_RP ^{Note 3} | dBm/15 kHz | All | -85 | -85 | -107 | -85 | -85 | -107 | - | - | - | - | - |
| \bar{E}_s/N_{oc} | dB | All | 19 | 19 | -3 | 19 | 19 | -3 | - | - | - | infinity | infinity |
| Propagation Condition | | All | ETU70 | | | | | | | | | | |
| <p>Note 1: OCNG shall be used such that all cells are fully allocated and a constant total transmitted power spectral density is achieved for all OFDM symbols.</p> <p>Note 2: Interference from other cells and noise sources not specified in the test is assumed to be constant over subcarriers and time and shall be modelled as AWGN of appropriate power for N_{oc} to be fulfilled.</p> <p>Note 3: RSRP and SCH_RP levels have been derived from other parameters for information purposes. They are not settable parameters themselves.</p> <p>Note 4: The resources for uplink transmission are assigned to the UE prior to the start of time period T2.</p> | | | | | | | | | | | | | |

A.8.16.21.2 Test Requirements

The test requirements defined in section A.8.16.2.2 shall apply to this test case.

A.8.16.22 E-UTRAN TDD event triggered reporting on deactivating SCell with PCell interruption in non-DRX for 20MHz+10MHz

A.8.16.22.1 Test Purpose and Environment

The purpose of this test case is the same as for the test defined in subclause A.8.16.4.

The test parameters are given in Tables A.8.16.22.1-1 and A.8.16.22.1-2 below. In the test there are three synchronous cells: Cell1, Cell2 and Cell3. Cell1 is PCell, Cell2 is deactivated SCell, and Cell3 is the neighbour cell. It is indicated to the UE in the measurement control information that event-triggered reporting with Event A6 is used. The test consists of two successive time periods, with duration of T1 and T2, respectively. During T1 the UE shall not have any information of cell 3. Immediately at beginning of T2 the transmission power of cell 3 is increased to same level as for cell 2, and due to usage of an offset this shall result in reporting of Event A6. PDCCH indicating a new transmission on the PCell shall be sent continuously to ensure that the UE sends ACK/NACKs throughout the test.

Table A.8.16.22.1-1: General test parameters for E-UTRAN TDD event triggered reporting on deactivating SCell with PCell interruption in non-DRX for 20MHz+10MHz

| Parameter | Unit | Value | Comment |
|------------------------------|------|--------|---|
| E-UTRA RF Channel Number | | 1, 2 | Two radio channels are used for this test |
| Active PCell | | Cell 1 | Primary cell on RF channel number 1. |
| Configured deactivated SCell | | Cell 2 | Configured deactivated secondary cell on RF channel number 2. |

| | | | | |
|--|-----------------|--|--|---|
| Neighbour cell | | Cell 3 | Neighbor cell to be identified on RF channel number 2. | |
| CP length | | Normal | | |
| Special subframe configuration | | 6 | As specified in table 4.2.1 in TS 36.211. The same configuration applies to all cells. | |
| Uplink-downlink configuration | | 1 | | |
| DRX | | OFF | Continuous monitoring of primary cell | |
| A6 | Hysteresis | dB | 0 | Hysteresis for evaluation of event A6. |
| | Offset | dB | -3 | Offset parameter for evaluation of event A6. Needs to take relative accuracy tolerance in clause 9.1.11.2 into account plus margin. |
| | Report on leave | | False | |
| | Time To Trigger | s | 0 | |
| Cell-individual offset for cells on RF channel number 1 | dB | 0 | Individual offset for cells on primary component carrier. | |
| Cell-individual offset for cells on RF channel number 2 | dB | 0 | Individual offset for cells on secondary component carrier. | |
| Filter coefficient | | 0 | L3 filtering is not used | |
| SCell measurement cycle | ms | 1280 | | |
| Cell2 timing offset to cell1 | μ s | 0 | | |
| Time alignment error between cell2 and cell1 | μ s | \leq Time alignment error as specified in TS 36.104 [30] clause 6.5.3.1. | The value of time alignment error depends upon the type of carrier aggregation. | |
| Cell3 timing offset to cell1 | μ s | 3 | Synchronous cells | |
| T1 | s | 5 | During this time the UE shall be aware of cells 1 and 2 but not cell 3. | |
| T2 | s | ≤ 30 | UE shall report Event A6 within 25.6s (20 \times sCellMeasCycle) | |
| NOTE: This test verifies the RRM requirement which is independent of channel bandwidth and is performed according to the principle defined in section A.3.6.1. | | | | |

Table A.8.16.22.1-2: Cell specific test parameters for E-UTRAN TDD event triggered reporting on deactivating SCell with PCell interruption in non-DRX for 20MHz+10MHz

| Parameter | Unit | Combination | Cell 1 | | Cell 2 | | Cell 3 | |
|---|------------|-------------|--------------------------------|-----|--------------------------------|-----|--------------------------------|-----|
| | | | T1 | T2 | T1 | T2 | T1 | T2 |
| E-UTRA RF Channel Number | | All | 1 | | 2 | | 2 | |
| BW _{channel} | | 20MHz+10MHz | 20MHz: N _{RB,c} = 100 | | 10MHz: N _{RB,c} = 50 | | 10MHz: N _{RB,c} = 50 | |
| | | 10MHz+20MHz | 10MHz: N _{RB,c} = 50 | | 20MHz: N _{RB,c} = 100 | | 20MHz: N _{RB,c} = 100 | |
| PDSCH Reference measurement channel defined in A.3.1.1.2 | | 20MHz+10MHz | R.3 TDD | | N/A | | N/A | |
| | | 10MHz+20MHz | R.0 TDD | | N/A | | N/A | |
| PDCCH/PCFICH/PHICH Reference measurement channel defined in A.3.1.2.2 | | 20MHz+10MHz | R.10 TDD | | R.6 TDD | | R.6 TDD | |
| | | 10MHz+20MHz | R.6 TDD | | R.10 TDD | | R.10 TDD | |
| OCNG Pattern defined in A.3.2.2 | | 20MHz+10MHz | OP.7 TDD | | OP.2 TDD | | OP.2 TDD | |
| | | 10MHz+20MHz | OP.1 TDD | | OP.8 TDD | | OP.8 TDD | |
| PBCH_RA | dB | All | 0 | | 0 | | 0 | |
| PBCH_RB | dB | | | | | | | |
| PSS_RA | dB | | | | | | | |
| SSS_RA | dB | | | | | | | |
| PCFICH_RB | dB | | | | | | | |
| PHICH_RA | dB | | | | | | | |
| PHICH_RB | dB | | | | | | | |
| PDCCH_RA | dB | | | | | | | |
| PDCCH_RB | dB | | | | | | | |
| PDSCH_RA | dB | | | | | | | |
| PDSCH_RB | dB | | | | | | | |
| OCNG_RA ^{Note 1} | dB | | | | | | | |
| OCNG_RB ^{Note 1} | dB | | | | | | | |
| N _{oc} ^{Note 3} | dBm/15 kHz | | | | | | | |
| RSRP ^{Note 4} | dBm/15 kHz | All | -85 | -85 | -85 | -85 | -Infinity | -85 |

| | | | | | | | | |
|--------------------------|--|-----|------|-----|------|-------|-----------|-------|
| \hat{E}_s / I_{ot} | dB | All | 16 | 16 | 16 | -0.11 | -Infinity | -0.11 |
| SCH_RP ^{Note 4} | dBm/15 kHz | All | -85 | -85 | -85 | -85 | -Infinity | -85 |
| \hat{E}_s / N_{oc} | dB | All | 16 | 16 | 16 | 16 | -Infinity | 16 |
| Propagation Condition | | All | AWGN | | AWGN | | AWGN | |
| Note 1: | OCNG shall be used such that all cells are fully allocated and a constant total transmitted power spectral density is achieved for all OFDM symbols. | | | | | | | |
| Note 2: | The resources for uplink transmission are assigned to the UE prior to the start of time period T2. | | | | | | | |
| Note 3: | Interference from other cells and noise sources not specified in the test is assumed to be constant over subcarriers and time and shall be modelled as AWGN of appropriate power for N_{oc} to be fulfilled. | | | | | | | |
| Note 4: | RSRP and SCH_RP levels have been derived from other parameters for information purposes. They are not settable parameters themselves. | | | | | | | |

A.8.16.22.2 Test Requirements

The test requirements defined in section A.8.16.4.2 shall apply to this test case.

A.8.16.23 E-UTRAN TDD-FDD CA Event Triggered Reporting Under Deactivated SCell in Non-DRX with PCell in FDD

A.8.16.23.1 Test Purpose and Environment

The purpose of this test is to verify that in TDD-FDD CA with PCell in FDD the UE correctly detects events A2 (Serving cell becomes worse than threshold) and A6 (Neighbour becomes better than SCell) defined in TS 36.331 [2] within the requirements for SCell stated in clause 8.3.3.2.1 and the requirements for PCell stated in clause 8.3.2.

In this test case there are 3 cells: Cell 1, Cell 2 and Cell 3. Cell 1 is the PCell on the FDD primary component carrier, Cell 2 is the configured and deactivated SCell on the TDD secondary component carrier, and Cell 3 is the neighbor cell on the TDD secondary component carrier. It is indicated to the UE in the measurement control information that event-triggered reporting with Events A2 (PCell and SCell) and A6 is used. The test consists of three successive time periods, with duration of T1, T2 and T3, respectively. During T1 the UE shall not have any information on cell 3. Immediately at beginning of T2 the transmission power of cell 3 is increased to same level as for cell 2, and due to usage of an offset this shall result in reporting of Event A6. At the beginning of T3 the transmission powers of cells 1, 2 and 3 are reduced below a threshold value and this shall result in reporting of Event A2 for PCell and SCell, respectively.

The test parameters are given in Table A.8.16.23.1-1 and A.8.16.23.1-2 below.

Table A.8.16.23.1-1: General test parameters for E-UTRAN TDD-FDD CA event triggered reporting on configured but deactivated SCell in non-DRX under fading propagation conditions with PCell in FDD

| Parameter | Unit | Value | Comment | |
|--------------------------------|-----------------|--------|---|--|
| E-UTRA RF Channel Number | | 1, 2 | Two radio channels are used for this test | |
| Active PCell | | Cell 1 | Primary cell on RF channel number 1. | |
| Configured deactivated SCell | | Cell 2 | Configured deactivated secondary cell on RF channel number 2. | |
| Neighbour cell | | Cell 3 | Neighbor cell to be identified on RF channel number 2. | |
| CP length | | Normal | | |
| Special subframe configuration | | 6 | As specified in table 4.2-1 in TS 36.211. The same configuration in TDD cells | |
| Uplink-downlink configuration | | 1 | As specified in table 4.2-2 in TS 36.211. The same configuration in TDD cells | |
| DRX | | OFF | Continuous monitoring of primary cell | |
| A2 | Hysteresis | dB | 0 | Hysteresis for evaluation of event A2. |
| | Threshold RSRP | dBm | -98 | Actual RSRP threshold for event A2. Needs to take absolute accuracy tolerance in clause 9.1.11.1 into account plus margin. |
| | Time To Trigger | s | 0 | |
| A6 | Hysteresis | dB | 0 | Hysteresis for evaluation of event A6. |

| | | | | |
|---|-----------------|-----|--|---|
| | Offset | dB | -6 | Offset parameter for evaluation of event A6. Needs to take relative accuracy tolerance in clause 9.1.11.2 into account plus margin. |
| | Report on leave | | False | |
| | Time To Trigger | s | 0 | |
| Cell-individual offset for cells on RF channel number 1 | dB | 0 | Individual offset for cells on primary component carrier. | |
| Cell-individual offset for cells on RF channel number 2 | dB | 0 | Individual offset for cells on secondary component carrier. | |
| Filter coefficient | | 0 | L3 filtering is not used | |
| SCell measurement cycle (measCycleSCell) | ms | 320 | | |
| T1 | s | 5 | During this time the UE shall be aware of cells 1 and 2 but not cell 3. | |
| T2 | s | ≤12 | UE shall report Event A6 within 6.4s (20×scellMeasCycle) | |
| T3 | s | 5 | UE shall report Event A2 within 200 ms and 1.6s for cells 1 and 2, respectively. | |

Table A.8.16.23.1-2: Cell specific test parameters for E-UTRAN TDD-FDD CA event triggered reporting on configured but deactivated SCell in non-DRX under fading propagation conditions with PCell in FDD

| Parameter | Unit | Cell 1 | | | Cell 2 | | | Cell 3 | | |
|---|------------|---|-----|------|---|-------|-------|---|-------|-------|
| | | T1 | T2 | T3 | T1 | T2 | T3 | T1 | T2 | T3 |
| E-UTRA RF Channel Number | | 1 | | | 2 | | | | | |
| BW _{channel} | | 5MHz: N _{RB,c} = 25 10MHz: N _{RB,c} = 50 20MHz: N _{RB,c} = 100 | | | 5MHz: N _{RB,c} = 25 10MHz: N _{RB,c} = 50 20MHz: N _{RB,c} = 100 | | | | | |
| PDSCH parameters: DL Reference Measurement Channel | | 5MHz: R.5 FDD 10MHz: R.0 FDD 20MHz: R.4 FDD | | | - | | | - | | |
| PCFICH/PDCCH/PHICH parameters: DL Reference Measurement Channel | | 5MHz: R.11 FDD 10MHz: R.6 FDD 20MHz: R.10 FDD | | | 5MHz: R.11 TDD 10MHz: R.6 TDD 20MHz: R.10 TDD | | | 5MHz: R.11 TDD 10MHz: R.6 TDD 20MHz: R.10 TDD | | |
| OCNG Patterns defined | | 5MHz: OP.15 FDD 10MHz: OP.1 FDD 20MHz: OP.11 FDD | | | 5MHz: OP.10 TDD 10MHz: OP.2 TDD 20MHz: OP.8 TDD | | | 5MHz: OP.10 TDD 10MHz: OP.2 TDD 20MHz: OP.8 TDD | | |
| PBCH_RA | dB | 0 | | | 0 | | | 0 | | |
| PBCH_RB | dB | | | | | | | | | |
| PSS_RA | dB | | | | | | | | | |
| SSS_RA | dB | | | | | | | | | |
| PCFICH_RB | dB | | | | | | | | | |
| PHICH_RA | dB | | | | | | | | | |
| PHICH_RB | dB | | | | | | | | | |
| PDCCH_RA | dB | | | | | | | | | |
| PDCCH_RB | dB | | | | | | | | | |
| PDSCH_RA | dB | | | | | | | | | |
| PDSCH_RB | dB | | | | | | | | | |
| OCNG_RA ^{Note 1} | dB | | | | | | | | | |
| OCNG_RB ^{Note 1} | dB | | | | | | | | | |
| N _{oc} ^{Note 2} | dBm/15 kHz | -104 | | | -104 | | | | | |
| \bar{E}_s/N_{oc} | dB | 17 | 17 | -3 | 17 | 17 | -3 | -infinity | 17 | -3 |
| \bar{E}_s/I_{ot} | dB | 17 | 17 | -3 | 17 | -0.09 | -4.76 | -infinity | -0.09 | -4.76 |
| RSRP ^{Note 3} | dBm/15 kHz | -87 | -87 | -107 | -87 | -87 | -107 | -infinity | -87 | -107 |
| SCH_RP ^{Note 3} | dBm/15 kHz | -87 | -87 | -107 | -87 | -87 | -107 | -infinity | -87 | -107 |

| I_0 ^{Note 3} | dBm/Ch BW | -59.13 +10log ($N_{RB,c}$ /50) | -59.13 +10log ($N_{RB,c}$ /50) | -74.45 +10log ($N_{RB,c}$ /50) | -59.17 +10log ($N_{RB,c}$ /50) | -56.13 +10log ($N_{RB,c}$ /50) | -73.20 +10log ($N_{RB,c}$ /50) | Specified in columns for Cell 2 |
|---|--|--|--|--|--|--|--|------------------------------------|
| Propagation Condition | | AWGN | | | ETU70 | | | ETU70 |
| Correlation Matrix and Antenna Configuration | | 1x2 Low | | | 1x2 Low | | | 1x2 Low |
| Timing offset to Cell 1 | μ s | - | | | 0 | | | 3 |
| Time alignment error relative to cell 1 ^{Note 5} | μ s | - | | | \leq TAE | | | N/A |
| Note 1: | OCNG shall be used such that all cells are fully allocated and a constant total transmitted power spectral density is achieved for all OFDM symbols. | | | | | | | |
| Note 2: | Interference from other cells and noise sources not specified in the test is assumed to be constant over subcarriers and time and shall be modelled as AWGN of appropriate power for N_{oc} to be fulfilled. | | | | | | | |
| Note 3: | Es/Iot, RSRP, SCH_RP and I_0 levels have been derived from other parameters for information purposes. They are not settable parameters themselves. | | | | | | | |
| Note 4: | The resources for uplink transmission are assigned to the UE prior to the start of time period T2. | | | | | | | |
| Note 5: | Time alignment error (TAE) as specified in TS 36.104 [30] clause 6.5.3.1. The TAE value depends upon the type of carrier aggregation. | | | | | | | |

A.8.16.23.2 Test Requirements

The UE shall send one Event A6 triggered measurement report for cell 3 with a measurement reporting delay of less than 6.4s ($20 \times \text{measCycleSCell}$) from the beginning of time T2.

The UE shall send one Event A2 triggered measurement report for Cell 1 with a measurement reporting delay of less than 200 ms from beginning of time T3.

The UE shall send one Event A2 triggered measurement report for Cell 2 with a measurement reporting delay of less than 1.6s ($5 \times \text{measCycleSCell}$) from beginning of time T3.

The UE shall not send event triggered measurement reports as long as the reporting criteria are not fulfilled.

The rate of correct events observed during repeated tests shall be at least 90% for each of the events.

NOTE: The actual overall delays measured in the tests may be up to $2 \times \text{TTIDCCH}$ higher than the measurement reporting delays above because of TTI insertion uncertainty of the measurement report in DCCH.

A.8.16.24 E-UTRAN TDD-FDD CA Event Triggered Reporting Under Deactivated SCell in Non-DRX with PCell in TDD

A.8.16.24.1 Test Purpose and Environment

The purpose of this test is to verify that in TDD-FDD CA with PCell in TDD the UE correctly detects events A2 (Serving cell becomes worse than threshold) and A6 (Neighbour becomes better than SCell) defined in TS 36.331 [2] within the requirements for SCell stated in clause 8.3.3.2.1 and the requirements for PCell stated in clause 8.3.2.

In this test case there are 3 cells: Cell 1, Cell 2 and Cell 3. Cell 1 is the PCell on the TDD primary component carrier, Cell 2 is the configured and deactivated SCell on the FDD secondary component carrier, and Cell 3 is the neighbor cell on the FDD secondary component carrier. It is indicated to the UE in the measurement control information that event-triggered reporting with Events A2 (PCell and SCell) and A6 is used. The test consists of three successive time periods, with duration of T1, T2 and T3, respectively. During T1 the UE shall not have any information on cell 3. Immediately at beginning of T2 the transmission power of cell 3 is increased to same level as for cell 2, and due to usage of an offset this shall result in reporting of Event A6. At the beginning of T3 the transmission powers of cells 1, 2 and 3 are reduced below a threshold value and this shall result in reporting of Event A2 for PCell and SCell, respectively.

The test parameters are given in Table A.8.16.24.1-1 and Table A.8.16.24.1-2.

Table A.8.16.24.1-1: General test parameters for E-UTRAN TDD-FDD CA event triggered reporting on configured but deactivated SCell in non-DRX under fading propagation conditions with PCell in TDD

| Parameter | Unit | Value | Comment | |
|---|-----------------|--------|--|---|
| E-UTRA RF Channel Number | | 1, 2 | Two radio channels are used for this test | |
| Active PCell | | Cell 1 | Primary cell on RF channel number 1. | |
| Configured deactivated SCell | | Cell 2 | Configured deactivated secondary cell on RF channel number 2. | |
| Neighbour cell | | Cell 3 | Neighbor cell to be identified on RF channel number 2. | |
| CP length | | Normal | | |
| Special subframe configuration | | 6 | As specified in table 4.2-1 in TS 36.211. | |
| Uplink-downlink configuration | | 1 | As specified in table 4.2-2 in TS 36.211. | |
| DRX | | OFF | Continuous monitoring of primary cell | |
| A2 | Hysteresis | dB | 0 | Hysteresis for evaluation of event A2. |
| | Threshold RSRP | dBm | -98 | Actual RSRP threshold for event A2. Needs to take absolute accuracy tolerance in clause 9.1.11.1 into account plus margin. |
| | Time To Trigger | s | 0 | |
| A6 | Hysteresis | dB | 0 | Hysteresis for evaluation of event A6. |
| | Offset | dB | -6 | Offset parameter for evaluation of event A6. Needs to take relative accuracy tolerance in clause 9.1.11.2 into account plus margin. |
| | Report on leave | | False | |
| | Time To Trigger | s | 0 | |
| Cell-individual offset for cells on RF channel number 1 | dB | 0 | Individual offset for cells on primary component carrier. | |
| Cell-individual offset for cells on RF channel number 2 | dB | 0 | Individual offset for cells on secondary component carrier. | |
| Filter coefficient | | 0 | L3 filtering is not used | |
| SCell measurement cycle (measCycleSCell) | ms | 320 | | |
| T1 | s | 5 | During this time the UE shall be aware of cells 1 and 2 but not cell 3. | |
| T2 | s | ≤12 | UE shall report Event A6 within 6.4s (20×sCellMeasCycle) | |
| T3 | s | 5 | UE shall report Event A2 within 200 ms and 1.6s for cells 1 and 2, respectively. | |

Table A.8.16.24.1-2: Cell specific test parameters for E-UTRAN TDD-FDD CA event triggered reporting on configured but deactivated SCell in non-DRX under fading propagation conditions with PCell in TDD

| Parameter | Unit | Cell 1 | | | Cell 2 | | | Cell 3 | | |
|---|------|---|----|----|---|----|----|--|----|----|
| | | T1 | T2 | T3 | T1 | T2 | T3 | T1 | T2 | T3 |
| E-UTRA RF Channel Number | | 1 | | | 2 | | | | | |
| BW _{channel} | | 5MHz: N _{RB,c} = 25 10MHz: N _{RB,c} = 50 20MHz: N _{RB,c} = 100 | | | 5MHz: N _{RB,c} = 25 10MHz: N _{RB,c} = 50 20MHz: N _{RB,c} = 100 | | | | | |
| PDSCH parameters: DL Reference Measurement Channel | | 5MHz: R.4 TDD 10MHz: R.0 TDD 20MHz: R.3 TDD | | | - | | | - | | |
| PCFICH/PDCCH/PHICH parameters: DL Reference Measurement Channel | | 5MHz: R.11 TDD 10MHz: R.6 TDD 20MHz: R.10 TDD | | | 5MHz: R.11 FDD 10MHz: R.6 FDD 20MHz: R.10 FDD | | | 5MHz: R.11 FDD 10MHz: R.6 FDD 20MHz: R.10 FDD | | |
| OCNG Patterns defined | | 5MHz: OP.9 TDD 10MHz: OP.1 TDD 20MHz: OP.7 TDD | | | 5MHz: OP.16 FDD 10MHz: OP.2 FDD 20MHz: OP.12 FDD | | | 5MHz: OP.16 FDD 10MHz: OP.2 FDD 20MHz: OP.12 FDD | | |

| | | | | | | | | | | |
|---|------------|--|--|--|--|--|--|---------------------------------|-------|-------|
| PBCH_RA | dB | | | | | | | | | |
| PBCH_RB | dB | | | | | | | | | |
| PSS_RA | dB | | | | | | | | | |
| SSS_RA | dB | | | | | | | | | |
| PCFICH_RB | dB | | | | | | | | | |
| PHICH_RA | dB | | | | | | | | | |
| PHICH_RB | dB | 0 | | | 0 | | | 0 | | |
| PDCCH_RA | dB | | | | | | | | | |
| PDCCH_RB | dB | | | | | | | | | |
| PDSCH_RA | dB | | | | | | | | | |
| PDSCH_RB | dB | | | | | | | | | |
| OCNG_RA ^{Note 1} | dB | | | | | | | | | |
| OCNG_RB ^{Note 1} | dB | | | | | | | | | |
| N_{oc} ^{Note 2} | dBm/15 kHz | -104 | | | -104 | | | | | |
| \bar{E}_s/N_{oc} | dB | 17 | 17 | -3 | 17 | 17 | -3 | -infinity | 17 | -3 |
| \bar{E}_s/I_{ot} | dB | 17 | 17 | -3 | 17 | -0.09 | -4.76 | -infinity | -0.09 | -4.76 |
| RSRP ^{Note 3} | dBm/15 kHz | -87 | -87 | -107 | -87 | -87 | -107 | -infinity | -87 | -107 |
| SCH_RP ^{Note 3} | dBm/15 kHz | -87 | -87 | -107 | -87 | -87 | -107 | -infinity | -87 | -107 |
| I_o ^{Note 3} | dBm/Ch BW | -59.13 +10log ($N_{RB,c}$ /50) | -59.13 +10log ($N_{RB,c}$ /50) | -74.45 +10log ($N_{RB,c}$ /50) | -59.17 +10log ($N_{RB,c}$ /50) | -56.13 +10log ($N_{RB,c}$ /50) | -73.20 +10log ($N_{RB,c}$ /50) | Specified in columns for Cell 2 | | |
| Propagation Condition | | AWGN | | | ETU70 | | | ETU70 | | |
| Correlation Matrix and Antenna Configuration | | 1x2 Low | | | 1x2 Low | | | 1x2 Low | | |
| Timing offset to Cell 1 | μ s | - | | | 0 | | | 3 | | |
| Time alignment error relative to cell 1 ^{Note 5} | μ s | - | | | \leq TAE | | | N/A | | |
| <p>Note 1: OCNG shall be used such that all cells are fully allocated and a constant total transmitted power spectral density is achieved for all OFDM symbols.</p> <p>Note 2: Interference from other cells and noise sources not specified in the test is assumed to be constant over subcarriers and time and shall be modelled as AWGN of appropriate power for N_{oc} to be fulfilled.</p> <p>Note 3: \bar{E}_s/I_{ot}, RSRP, SCH_RP and I_o levels have been derived from other parameters for information purposes. They are not settable parameters themselves.</p> <p>Note 4: The resources for uplink transmission are assigned to the UE prior to the start of time period T2.</p> <p>Note 5: Time alignment error (TAE) as specified in TS 36.104 [30] clause 6.5.3.1. The TAE value depends upon the type of carrier aggregation.</p> | | | | | | | | | | |

A.8.16.24.2 Test Requirements

The UE shall send one Event A6 triggered measurement report for cell3 with a measurement reporting delay of less than 6.4s ($20 \times$ measCycleSCell) from the beginning of time T2.

The UE shall send one Event A2 triggered measurement report for Cell 1 with a measurement reporting delay of less than 200 ms from beginning of time T3.

The UE shall send one Event A2 triggered measurement report for Cell 2 with a measurement reporting delay of less than 1.6s ($5 \times$ measCycleSCell) from beginning of time T3.

The UE shall not send event triggered measurement reports as long as the reporting criteria are not fulfilled.

The rate of correct events observed during repeated tests shall be at least 90% for each of the events.

NOTE: The actual overall delays measured in the tests may be up to $2 \times TTIDCCH$ higher than the measurement reporting delays above because of TTI insertion uncertainty of the measurement report in DCCH.

A.8.16.25 E-UTRAN TDD-FDD CA Event triggered reporting on deactivated SCell with PCell interruption in non-DRX with PCell in FDD

A.8.16.25.1 Test Purpose and Environment

The purpose of this test is to verify that in TDD-FDD CA with PCell in FDD the UE correctly detects event A6 (Neighbour becomes better than SCell) defined in TS 36.331 [2] within the requirements stated in clause 8.3.3.2.1 and the requirements for PCell stated in clause 8.3.2 while at the same time fulfilling the requirement on interruption rate.

In this test case there are three cells: Cell1, Cell2 and Cell3. Cell 1 is the PCell on the FDD primary component carrier, Cell 2 is the configured and deactivated SCell on the TDD secondary component carrier, and Cell 3 is the neighbor cell on the TDD secondary component carrier. It is indicated to the UE in the measurement control information that event-triggered reporting with Event A6 is used. The test consists of two successive time periods, with duration of T1 and T2, respectively. During T1 the UE shall not have any information of cell 3. Immediately at beginning of T2 the transmission power of cell 3 is increased to same level as for cell 2, and due to usage of an offset this shall result in reporting of Event A6. PDCCH indicating a new transmission on the PCell shall be sent continuously to ensure that the UE sends ACK/NACKs throughout the test.

The test parameters are given in Table A.8.16.25.1-1 and Table A.8.16.25.1-2 below.

Table A.8.16.25.1-1: General test parameters for E-UTRAN TDD-FDD CA Event triggered reporting on configured but deactivated SCell with PCell interruption in non-DRX with PCell in FDD

| Parameter | Unit | Value | Comment | |
|---|-----------------|--------|---|---|
| E-UTRA RF Channel Number | | 1, 2 | Two radio channels are used for this test | |
| Active PCell | | Cell 1 | Primary cell on RF channel number 1. | |
| Configured deactivated SCell | | Cell 2 | Configured deactivated secondary cell on RF channel number 2. | |
| Neighbour cell | | Cell 3 | Neighbor cell to be identified on RF channel number 2. | |
| CP length | | Normal | | |
| Special subframe configuration | | 6 | As specified in table 4.2-1 in TS 36.211. The same configuration in TDD cells | |
| Uplink-downlink configuration | | 1 | As specified in table 4.2-2 in TS 36.211. The same configuration in TDD cells | |
| DRX | | OFF | Continuous monitoring of primary cell | |
| A6 | Hysteresis | dB | 0 | Hysteresis for evaluation of event A6. |
| | Offset | dB | -3 | Offset parameter for evaluation of event A6. Needs to take relative accuracy tolerance in clause 9.1.11.2 into account plus margin. |
| | Report on leave | | False | |
| | Time To Trigger | s | 0 | |
| Cell-individual offset for cells on RF channel number 1 | dB | 0 | Individual offset for cells on primary component carrier. | |
| Cell-individual offset for cells on RF channel number 2 | dB | 0 | Individual offset for cells on secondary component carrier. | |
| Filter coefficient | | 0 | L3 filtering is not used | |
| SCell measurement cycle (measCycleSCell) | ms | 1280 | | |
| T1 | s | 5 | During this time the UE shall be aware of cells 1 and 2 but not cell 3. | |
| T2 | s | ≤30 | UE shall report Event A6 within 25.6s (20×scellMeasCycle) | |

Table A.8.16.25.1-2: Cell specific test parameters for E-UTRAN TDD-FDD CA Event triggered reporting on configured but deactivated SCell with PCell interruption in non-DRX with PCell in FDD

| Parameter | Unit | Cell 1 | | Cell 2 | | Cell 3 | |
|--------------------------|------|---|----|---|----|--------|----|
| | | T1 | T2 | T1 | T2 | T1 | T2 |
| E-UTRA RF Channel Number | | 1 | | 2 | | | |
| BW _{channel} | | 5MHz: N _{RB,c} = 25 10MHz: N _{RB,c} = 50 20MHz: N _{RB,c} = 100 | | 5MHz: N _{RB,c} = 25 10MHz: N _{RB,c} = 50 20MHz: N _{RB,c} = 100 | | | |

| | | | | | | | |
|---|------------|---|---------------------------------------|---|---|---------------------------------|-------|
| PDSCH parameters: DL Reference Measurement Channel | | 5MHz: R.7 FDD 10MHz: R.3 FDD 20MHz: R.6 FDD | | - | - | | |
| PCFICH/PDCCH/PHICH parameters: DL Reference Measurement Channel | | 5MHz: R.11 FDD 10MHz: R.6 FDD 20MHz: R.10 FDD | | 5MHz: R.11 TDD 10MHz: R.6 TDD 20MHz: R.10 TDD | 5MHz: R.11 TDD 10MHz: R.6 TDD 20MHz: R.10 TDD | | |
| OCNG Patterns defined | | 5MHz: OP.20 FDD 10MHz: OP.10 FDD 20MHz: OP.17 FDD | | 5MHz: OP.10 TDD 10MHz: OP.2 TDD 20MHz: OP.8 TDD | 5MHz: OP.10 TDD 10MHz: OP.2 TDD 20MHz: OP.8 TDD | | |
| PBCH_RA | dB | 0 | | 0 | | 0 | |
| PBCH_RB | dB | | | | | | |
| PSS_RA | dB | | | | | | |
| SSS_RA | dB | | | | | | |
| PCFICH_RB | dB | | | | | | |
| PHICH_RA | dB | | | | | | |
| PHICH_RB | dB | | | | | | |
| PDCCH_RA | dB | | | | | | |
| PDCCH_RB | dB | | | | | | |
| PDSCH_RA | dB | | | | | | |
| PDSCH_RB | dB | | | | | | |
| OCNG_RA ^{Note 1} | dB | | | | | | |
| OCNG_RB ^{Note 1} | dB | | | | | | |
| N_{oc} ^{Note 2} | dBm/15 kHz | | | | | | |
| \bar{E}_s/N_{oc} | dB | 16 | 16 | 16 | 16 | -infinity | 16 |
| \bar{E}_s/I_{ot} | dB | 16 | 16 | 16 | -0.11 | -infinity | -0.11 |
| RSRP ^{Note 3} | dBm/15 kHz | -85 | -85 | -85 | -85 | -infinity | -85 |
| SCH_RP ^{Note 3} | dBm/15 kHz | -85 | -85 | -85 | -85 | -infinity | -85 |
| I_o ^{Note 3} | dBm/Ch BW | -57.11 +10log ($N_{RB,c}/50$) | -57.11 +10log ($N_{RB,c}/50$) | -57.11 +10log ($N_{RB,c}/50$) | -54.15 +10log ($N_{RB,c}/50$) | Specified in columns for Cell 2 | |
| Propagation Condition | | AWGN | | AWGN | | AWGN | |
| Correlation Matrix and Antenna Configuration | | 1x2 Low | | 1x2 Low | | 1x2 Low | |
| Timing offset to Cell 1 | μ s | - | | 0 | | 3 | |
| Time alignment error relative to cell 1 ^{Note 5} | μ s | - | | \leq TAE | | N/A | |
| <p>Note 1: OCNG shall be used such that all cells are fully allocated and a constant total transmitted power spectral density is achieved for all OFDM symbols.</p> <p>Note 2: Interference from other cells and noise sources not specified in the test is assumed to be constant over subcarriers and time and shall be modelled as AWGN of appropriate power for N_{oc} to be fulfilled.</p> <p>Note 3: E_s/I_{ot}, RSRP, SCH_RP and I_o levels have been derived from other parameters for information purposes. They are not settable parameters themselves.</p> <p>Note 4: The resources for uplink transmission are assigned to the UE prior to the start of time period T2.</p> <p>Note 5: Time alignment error (TAE) as specified in TS 36.104 [30] clause 6.5.3.1. The TAE value depends upon the type of carrier aggregation.</p> | | | | | | | |

A.8.16.25.2 Test Requirements

The UE shall send one Event A6 triggered measurement report for cell 3, with a measurement reporting delay less than 25.6s from the beginning of time period T2.

The UE shall not send event triggered measurement reports, as long as the reporting criteria are not fulfilled.

The UE shall be scheduled on PCell continuously throughout the test. From the start of T1 until the measurement report is received during T2, at least 99.5% of all expected ACK/NACKs shall be transmitted by the UE.

For a test to be considered successful requirements on both event detection and percentage of transmitted ACK/NACKs have to be fulfilled simultaneously.

The rate of correct events observed during repeated tests shall be at least 90%.

NOTE: The actual overall delays measured in the test may be up to $2 \times \text{TTIDCCH}$ higher than the measurement reporting delays above because of TTI insertion uncertainty of the measurement report in DCCH.

A.8.16.26 E-UTRAN TDD-FDD CA Event triggered reporting on deactivated SCell with PCell interruption in non-DRX with PCell in TDD

A.8.16.26.1 Test Purpose and Environment

The purpose of this test is to verify that in TDD-FDD CA with PCell in TDD the UE correctly detects event A6 (Neighbour becomes better than SCell) defined in TS 36.331 [2] within the requirements stated in clause 8.3.3.2.1 and the requirements for PCell stated in clause 8.3.2 while at the same time fulfilling the requirement on interruption rate.

In this test case there are three cells: Cell1, Cell2 and Cell3. Cell 1 is the PCell on the TDD primary component carrier, Cell 2 is the configured and deactivated SCell on the FDD secondary component carrier, and Cell 3 is the neighbor cell on the FDD secondary component carrier. It is indicated to the UE in the measurement control information that event-triggered reporting with Event A6 is used. The test consists of two successive time periods, with duration of T1 and T2, respectively. During T1 the UE shall not have any information of cell 3. Immediately at beginning of T2 the transmission power of cell 3 is increased to same level as for cell 2, and due to usage of an offset this shall result in reporting of Event A6. PDCCH indicating a new transmission on the PCell shall be sent continuously to ensure that the UE sends ACK/NACKs throughout the test.

The test parameters are given in Table A.8.16.26.1-1 and Table A.8.16.26.1-1 below.

Table A.8.16.26.1-1: General test parameters for E-UTRAN TDD-FDD CA Event triggered reporting on configured but deactivated SCell with PCell interruption in non-DRX with PCell in TDD

| Parameter | Unit | Value | Comment | |
|---|-----------------|-----------|---|---|
| E-UTRA RF Channel Number | | 1, 2 | Two radio channels are used for this test | |
| Active PCell | | Cell 1 | Primary cell on RF channel number 1. | |
| Configured deactivated SCell | | Cell 2 | Configured deactivated secondary cell on RF channel number 2. | |
| Neighbour cell | | Cell 3 | Neighbor cell to be identified on RF channel number 2. | |
| CP length | | Normal | | |
| Special subframe configuration | | 6 | As specified in table 4.2-1 in TS 36.211. The same configuration in TDD cells | |
| Uplink-downlink configuration | | 1 | As specified in table 4.2-2 in TS 36.211. The same configuration in TDD cells | |
| DRX | | OFF | Continuous monitoring of primary cell | |
| A6 | Hysteresis | dB | 0 | Hysteresis for evaluation of event A6. |
| | Offset | dB | -3 | Offset parameter for evaluation of event A6. Needs to take relative accuracy tolerance in clause 9.1.11.2 into account plus margin. |
| | Report on leave | | False | |
| | Time To Trigger | s | 0 | |
| Cell-individual offset for cells on RF channel number 1 | dB | 0 | Individual offset for cells on primary component carrier. | |
| Cell-individual offset for cells on RF channel number 2 | dB | 0 | Individual offset for cells on secondary component carrier. | |
| Filter coefficient | | 0 | L3 filtering is not used | |
| SCell measurement cycle (measCycleSCell) | ms | 1280 | | |
| T1 | s | 5 | During this time the UE shall be aware of cells 1 and 2 but not cell 3. | |
| T2 | s | ≤ 30 | UE shall report Event A6 within 25.6s ($20 \times \text{scellMeasCycle}$) | |

Table A.8.16.26.1-2: Cell specific test parameters for E-UTRAN TDD-FDD CA Event triggered reporting on configured but deactivated SCell with PCell interruption in non-DRX with PCell in TDD

| Parameter | Unit | Cell 1 | | Cell 2 | | Cell 3 | |
|--|------------|---|---|---|---|--|-------|
| | | T1 | T2 | T1 | T2 | T1 | T2 |
| E-UTRA RF Channel Number | | 1 | | 2 | | | |
| BW _{channel} | | 5MHz: N _{RB,c} = 25 10MHz: N _{RB,c} = 50 20MHz: N _{RB,c} = 100 | | 5MHz: N _{RB,c} = 25 10MHz: N _{RB,c} = 50 20MHz: N _{RB,c} = 100 | | | |
| PDSCH parameters: DL Reference Measurement Channel | | 5MHz: R.4 TDD 10MHz: R.0 TDD 20MHz: R.3 TDD | | - | | - | |
| PCFICH/PDCCH/PHICH parameters: DL Reference Measurement Channel | | 5MHz: R.11 TDD 10MHz: R.6 TDD 20MHz: R.10 TDD | | 5MHz: R.11 FDD 10MHz: R.6 FDD 20MHz: R.10 FDD | | 5MHz: R.11 FDD 10MHz: R.6 FDD 20MHz: R.10 FDD | |
| OCNG Patterns defined | | 5MHz: OP.9 TDD 10MHz: OP.1 TDD 20MHz: OP.7 TDD | | 5MHz: OP.16 FDD 10MHz: OP.2 FDD 20MHz: OP.12 FDD | | 5MHz: OP.16 FDD 10MHz: OP.2 FDD 20MHz: OP.12 FDD | |
| PBCH_RA | dB | 0 | | 0 | | 0 | |
| PBCH_RB | dB | | | | | | |
| PSS_RA | dB | | | | | | |
| SSS_RA | dB | | | | | | |
| PCFICH_RB | dB | | | | | | |
| PHICH_RA | dB | | | | | | |
| PHICH_RB | dB | | | | | | |
| PDCCH_RA | dB | | | | | | |
| PDCCH_RB | dB | | | | | | |
| PDSCH_RA | dB | | | | | | |
| PDSCH_RB | dB | | | | | | |
| OCNG_RA ^{Note 1} | dB | | | | | | |
| OCNG_RB ^{Note 1} | dB | | | | | | |
| N _{oc} ^{Note 2} | dBm/15 kHz | | | | | | |
| \hat{E}_s/N_{oc} | dB | 16 | 16 | 16 | 16 | -infinity | 16 |
| \hat{E}_s/I_{ot} | dB | 16 | 16 | 16 | -0.11 | -infinity | -0.11 |
| RSRP ^{Note 3} | dBm/15 kHz | -85 | -85 | -85 | -85 | -infinity | -85 |
| SCH_RP ^{Note 3} | dBm/15 kHz | -85 | -85 | -85 | -85 | -infinity | -85 |
| I _o ^{Note 3} | dBm/Ch BW | -57.11 +10log (N _{RB,c} /50) | -57.11 +10log (N _{RB,c} /50) | -57.11 +10log (N _{RB,c} /50) | -54.15 +10log (N _{RB,c} /50) | Specified in columns for Cell 2 | |
| Propagation Condition | | AWGN | | AWGN | | AWGN | |
| Correlation Matrix and Antenna Configuration | | 1x2 Low | | 1x2 Low | | 1x2 Low | |
| Timing offset to Cell 1 | μs | - | | 0 | | 3 | |
| Time alignment error relative to cell 1 ^{Note 5} | μs | - | | ≤ TAE | | N/A | |

Note 1: OCNG shall be used such that all cells are fully allocated and a constant total transmitted power spectral density is achieved for all OFDM symbols.

Note 2: Interference from other cells and noise sources not specified in the test is assumed to be constant over subcarriers and time and shall be modelled as AWGN of appropriate power for N_{oc} to be fulfilled.

Note 3: Es/I_{ot}, RSRP, SCH_RP and I_o levels have been derived from other parameters for information purposes. They are not settable parameters themselves.

Note 4: The resources for uplink transmission are assigned to the UE prior to the start of time period T2.

Note 5: Time alignment error (TAE) as specified in TS 36.104 [30] clause 6.5.3.1. The TAE value depends upon the type of carrier aggregation.

A.8.16.26.2 Test Requirements

The UE shall send one Event A6 triggered measurement report for cell 3, with a measurement reporting delay less than 25.6s from the beginning of time period T2.

The UE shall not send event triggered measurement reports, as long as the reporting criteria are not fulfilled.

The UE shall be scheduled on PCell continuously throughout the test. From the start of T1 until the measurement report is received during T2, at least 99.5% of all expected ACK/NACKs shall be transmitted by the UE.

For a test to be considered successful requirements on both event detection and percentage of transmitted ACK/NACKs have to be fulfilled simultaneously.

The rate of correct events observed during repeated tests shall be at least 90%.

NOTE: The actual overall delays measured in the test may be up to $2 \times T_{TTIDCCH}$ higher than the measurement reporting delays above because of TTI insertion uncertainty of the measurement report in DCCH.

A.8.16.27 3 DL PCell in FDD CA Event Triggered Reporting with 2 Deactivated SCells in Non-DRX

A.8.16.27.1 Test Purpose and Environment

The purpose of this test is to verify that the UE correctly detects events A1 (Serving cell becomes better than threshold), A2 (Serving cell becomes worse than threshold) and A6 (Neighbour becomes better than SCell) defined in TS 36.331 [2] within the requirements stated in clause 8.3.3.2.1.

The test parameters are given in Tables A.8.16.27.1-1 and A.8.16.27.1-2 below. It is indicated to the UE in the measurement control information that event-triggered reporting with Events A1 (for only SCell1 i.e. cell2), A2 (PCell and SCells) and A6 is used. The test consists of three successive time periods, with duration of T1, T2 and T3, respectively. During T1 the UE shall not have any information on cell 4. At the beginning of T2 the transmission power of cell 4 is increased to the same level as for cell 3, and due to usage of an offset this shall result in reporting of Event A6. Also, at the beginning of T2 the transmission power of cell 2 is increased to the same level as for cell 1, which shall result in reporting of Event A1. At the beginning of T3 the transmission powers of cells 1, 2, 3 and 4 are reduced below a threshold value and this shall result in reporting of Event A2 for Cell 1, for Cell 2 and for Cell 3.

Table A.8.16.27.1-1: General test parameters for E-UTRAN TDD-FDD 3 DL CA event triggered reporting under fading propagation conditions with 2 configured but deactivated SCells in non-DRX with PCell in FDD

| Parameter | | Unit | Value | Comment |
|--------------------------------|-----------------|------|---------|---|
| E-UTRA RF Channel Number | | | 1, 2, 3 | Three radio channels are used for this test |
| Active PCell | | | Cell 1 | Primary cell on RF channel number 1. |
| Configured deactivated SCell | | | Cell 2 | Configured deactivated secondary cell on RF channel number 2. |
| Configured deactivated SCell | | | Cell 3 | Configured deactivated secondary cell on RF channel number 3. |
| Neighbour cell | | | Cell 4 | Neighbour cell to be identified on RF channel number 3. |
| CP length | | | Normal | |
| DRX | | | OFF | Continuous monitoring of primary cell |
| Special subframe configuration | | | 6 | As specified in table 4.2-1 in TS 36.211. The same configuration applies to all TDD cells (cell2, cell3 and cell4). |
| Uplink-downlink configuration | | | 1 | As specified in table 4.2-2 in TS 36.211. The same configuration applies to all TDD cells (cell2, cell3 and cell4). |
| A1 | Hysteresis | dB | 0 | Hysteresis for evaluation of event A1. |
| | Threshold RSRP | dBm | -98 | Actual RSRP threshold for event A1. Needs to take absolute accuracy tolerance in section 9.1.11.1 into account plus margin. |
| | Time To Trigger | s | 0 | |
| A2 | Hysteresis | dB | 0 | Hysteresis for evaluation of event A2. |
| | Threshold RSRP | dBm | -98 | Actual RSRP threshold for event A2. Needs to take absolute accuracy tolerance in section 9.1.11.1 into account plus margin. |

| | | | | |
|---|-----------------|----|-------|--|
| | Time To Trigger | s | 0 | |
| A6 | Hysteresis | dB | 0 | Hysteresis for evaluation of event A6. |
| | Offset | dB | -6 | Offset parameter for evaluation of event A6. Needs to take relative accuracy tolerance in section 9.1.11.2 into account plus margin. |
| | Report on leave | | False | |
| | Time To Trigger | s | 0 | |
| Cell-individual offset for cells on RF channel number 1 | | dB | 0 | Individual offset for cells on primary component carrier. |
| Cell-individual offset for cells on RF channel number 2 | | dB | 0 | Individual offset for cells on secondary component carrier. |
| Cell-individual offset for cells on RF channel number 3 | | dB | 0 | Individual offset for cells on secondary component carrier. |
| Filter coefficient | | | 0 | L3 filtering is not used |
| SCell measurement cycle (measCycleSCell) | | ms | 320 | |
| T1 | | s | 5 | During this time the cell1 and cell3 shall be known to the UE; but cell2 and cell 4 shall be unknown to the UE. |
| T2 | | s | ≤12 | UE should report Event A1 for cell2 and event A6 for cell4 within 6.4s (20xscellMeasCycle) |
| T3 | | s | 5 | UE should report Event A2 within 200 ms. 1.6s, and 1.6s for cells 1, 2 and 3, respectively. |

Table A.8.16.27.1-2: Cell specific test parameters for E-UTRAN TDD-FDD 3 DL CA event triggered reporting under fading propagation conditions with 2 configured but deactivated SCells in non-DRX with PCell in FDD

| Parameter | Unit | Cell 1 | | | Cell 2 | | | Cell 3 | | | Cell 4 | | |
|---|------------|---|--|--|---|--|--|---|--|--|---|-------|-------|
| | | T1 | T2 | T3 | T1 | T2 | T3 | T1 | T2 | T3 | T1 | T2 | T3 |
| E-UTRA RF Channel Number | | 1 | | | 2 | | | 3 | | | | | |
| BW _{channel} | | 5MHz: N _{RB,c} = 25 10MHz: N _{RB,c} = 50 20MHz: N _{RB,c} = 100 | | | 5MHz: N _{RB,c} = 25 10MHz: N _{RB,c} = 50 20MHz: N _{RB,c} = 100 | | | 5MHz: N _{RB,c} = 25 10MHz: N _{RB,c} = 50 20MHz: N _{RB,c} = 100 | | | | | |
| PDSCH parameters: DL Reference Measurement Channel | | 5MHz: R.5 FDD 10MHz: R.0 FDD 20MHz: R.4 FDD | | | - | | | - | | | - | | |
| PCFICH/PDCCH/PHICH parameters: DL Reference Measurement Channel | | 5MHz: R.11 FDD 10MHz: R.6 FDD 20MHz: R.10 FDD | | | 5MHz: R.11 TDD 10MHz: R.6 TDD 20MHz: R.10 TDD | | | 5MHz: R.11 TDD 10MHz: R.6 TDD 20MHz: R.10 TDD | | | 5MHz: R.11 TDD 10MHz: R.6 TDD 20MHz: R.10 TDD | | |
| OCNG Patterns | | 5MHz: OP.15 FDD 10MHz: OP.1 FDD 20MHz: OP.11 FDD | | | 5MHz: OP.10 TDD 10MHz: OP.2 TDD 20MHz: OP.8 TDD | | | 5MHz: OP.10 TDD 10MHz: OP.2 TDD 20MHz: OP.8 TDD | | | 5MHz: OP.10 TDD 10MHz: OP.2 TDD 20MHz: OP.8 TDD | | |
| PBCH_RA | dB | 0 | | | 0 | | | 0 | | | 0 | | |
| PBCH_RB | dB | | | | | | | | | | | | |
| PSS_RA | dB | | | | | | | | | | | | |
| SSS_RA | dB | | | | | | | | | | | | |
| PCFICH_RB | dB | | | | | | | | | | | | |
| PHICH_RA | dB | | | | | | | | | | | | |
| PHICH_RB | dB | | | | | | | | | | | | |
| PDCCH_RA | dB | | | | | | | | | | | | |
| PDCCH_RB | dB | | | | | | | | | | | | |
| PDSCH_RA | dB | | | | | | | | | | | | |
| PDSCH_RB | dB | | | | | | | | | | | | |
| OCNG_RA ^{Note 1} | dB | | | | | | | | | | | | |
| OCNG_RB ^{Note 1} | dB | | | | | | | | | | | | |
| N _{oc} ^{Note 2} | dBm/15 KHz | | | | | | | | | | | | |
| \bar{E}_s/N_{oc} | dB | 17 | 17 | -3 | -infinity | 17 | -3 | 17 | 17 | -3 | -infinity | 17 | -3 |
| \bar{E}_s/I_{ot} ^{Note 3} | dB | 17 | 17 | -3 | -infinity | 17 | -3 | 17 | -0.09 | -4.76 | -infinity | -0.09 | -4.76 |
| RSRP ^{Note 3} | dBm/15 kHz | -87 | -87 | -107 | -infinity | -87 | -107 | -87 | -87 | -107 | -infinity | -87 | -107 |
| SCH_RP ^{Note 3} | dBm/15 kHz | -87 | -87 | -107 | -infinity | -87 | -107 | -87 | -87 | -107 | -infinity | -87 | -107 |
| I _o ^{Note 3} | dBm/Ch BW | -59.13 +10log (N _{RB,c} /50) | -59.13 +10log (N _{RB,c} /50) | -74.45 +10log (N _{RB,c} /50) | -76.22 +10log (N _{RB,c} /50) | -59.13 +10log (N _{RB,c} /50) | -74.45 +10log (N _{RB,c} /50) | -59.13 +10log (N _{RB,c} /50) | -56.17 +10log (N _{RB,c} /50) | -73.20 +10log (N _{RB,c} /50) | Specified in columns for Cell 3 | | |
| Propagation Condition | | AWGN | | | ETU70 | | | ETU70 | | | ETU70 | | |
| Correlation Matrix and Antenna Configuration | | 1x2 | | | 1x2 Low | | | 1x2 Low | | | 1x2 Low | | |

| | | | | | |
|--|---------------|---|-------------------|-------------------|-----|
| Timing offset to Cell 1 | μs | - | 0 | 0 | 3 |
| Time alignment error relative to cell 1 <small>Note 5</small> | μs | - | $\leq \text{TAE}$ | $\leq \text{TAE}$ | N/A |
| Time alignment error relative to cell 2 <small>Note 5</small> | μs | - | - | $\leq \text{TAE}$ | N/A |
| <p>Note 1: OCNG shall be used such that all cells are fully allocated and a constant total transmitted power spectral density is achieved for all OFDM symbols.</p> <p>Note 2: Interference from other cells and noise sources not specified in the test is assumed to be constant over subcarriers and time and shall be modelled as AWGN of appropriate power for N_{oc} to be fulfilled.</p> <p>Note 3: E_s/I_{ot}, RSRP, SCH_RP and I_o have been derived from other parameters for information purposes. They are not settable parameters themselves.</p> <p>Note 4: The resources for uplink transmission are assigned to the UE prior to the start of time period T2.</p> <p>Note 5: Time alignment error (TAE) as specified in TS 36.104 [30] clause 6.5.3.1. The TAE value depends upon the type of carrier aggregation.</p> | | | | | |

A.8.16.27.2 Test Requirements

The UE shall send one Event A6 triggered measurement report for cell 4 with a measurement reporting delay of less than 6.4s ($20 \times \text{measCycleSCell}$) from the beginning of time T2.

The UE shall send one Event A1 triggered measurement report for Cell 2 with a measurement reporting delay of less than 6.4s ($20 \times \text{measCycleSCell}$) from beginning of time T2.

The UE shall send one Event A2 triggered measurement report for Cell 1 with a measurement reporting delay of less than 200 ms from beginning of time T3.

The UE shall send one Event A2 triggered measurement report for Cell 2 with a measurement reporting delay of less than 1.6s ($5 \times \text{measCycleSCell}$) from beginning of time T3.

The UE shall send one Event A2 triggered measurement report for Cell 3 with a measurement reporting delay of less than 1.6s ($5 \times \text{measCycleSCell}$) from beginning of time T3.

The UE shall not send event triggered measurement reports as long as the reporting criteria are not fulfilled.

The rate of correct events observed during repeated tests shall be at least 90% for each of the events.

NOTE: The actual overall delays measured in the tests may be up to $2 \times \text{TTI}_{\text{DCCH}}$ higher than the measurement reporting delays above because of TTI insertion uncertainty of the measurement report in DCCH.

A.8.16.28 3 DL PCell in TDD CA Event Triggered Reporting with 2 Deactivated SCells in Non-DRX

A.8.16.28.1 Test Purpose and Environment

The purpose of this test is to verify that the UE correctly detects events A1 (Serving cell becomes better than threshold), A2 (Serving cell becomes worse than threshold) and A6 (Neighbour becomes better than SCell) defined in TS 36.331 [2] within the requirements stated in clause 8.3.3.2.1.

The test parameters are given in Tables A.8.16.28.1-1 and A.8.16.28.1-2 below. It is indicated to the UE in the measurement control information that event-triggered reporting with Events A1 (for only SCell1 i.e. cell2), A2 (PCell and SCells) and A6 is used. The test consists of three successive time periods, with duration of T1, T2 and T3, respectively. During T1 the UE shall not have any information on cell 4. At the beginning of T2 the transmission power of cell 4 is increased to the same level as for cell 3, and due to usage of an offset this shall result in reporting of Event A6. Also, at the beginning of T2 the transmission power of cell 2 is increased to the same level as for cell 1, which shall result in reporting of Event A1. At the beginning of T3 the transmission powers of cells 1, 2, 3 and 4 are reduced below a threshold value and this shall result in reporting of Event A2 for Cell 1, for Cell 2 and for Cell 3.

Table A.8.16.28.1-1: General test parameters for E-UTRAN TDD-FDD 3 DL CA event triggered reporting under fading propagation conditions with 2 configured but deactivated SCells in non-DRX with PCell in TDD

| Parameter | Unit | Value | Comment | |
|--------------------------------|------------|---------|---|--|
| E-UTRA RF Channel Number | | 1, 2, 3 | Three radio channels are used for this test | |
| Active PCell | | Cell 1 | Primary cell on RF channel number 1. | |
| Configured deactivated SCell | | Cell 2 | Configured deactivated secondary cell on RF channel number 2. | |
| Configured deactivated SCell | | Cell 3 | Configured deactivated secondary cell on RF channel number 3. | |
| Neighbour cell | | Cell 4 | Neighbour cell to be identified on RF channel number 3. | |
| CP length | | Normal | | |
| DRX | | OFF | Continuous monitoring of primary cell | |
| Special subframe configuration | | 6 | As specified in table 4.2-1 in TS 36.211. The same configuration applies to TDD cell (cell1). | |
| Uplink-downlink configuration | | 1 | As specified in table 4.2-2 in TS 36.211. The same configuration applies to TDD cell (cell1). | |
| A1 | Hysteresis | dB | 0 | Hysteresis for evaluation of event A1. |

| | | | | |
|----|---|-----|-------|--|
| | Threshold RSRP | dBm | -98 | Actual RSRP threshold for event A1. Needs to take absolute accuracy tolerance in section 9.1.11.1 into account plus margin. |
| | Time To Trigger | s | 0 | |
| A2 | Hysteresis | dB | 0 | Hysteresis for evaluation of events A1 A2. |
| | Threshold RSRP | dBm | -98 | Actual RSRP threshold for events A2. Needs to take absolute accuracy tolerance in section 9.1.11.1 into account plus margin. |
| | Time To Trigger | s | 0 | |
| A6 | Hysteresis | dB | 0 | Hysteresis for evaluation of event A6. |
| | Offset | dB | -6 | Offset parameter for evaluation of event A6. Needs to take relative accuracy tolerance in section 9.1.11.2 into account plus margin. |
| | Report on leave | | False | |
| | Time To Trigger | s | 0 | |
| | Cell-individual offset for cells on RF channel number 1 | dB | 0 | Individual offset for cells on primary component carrier. |
| | Cell-individual offset for cells on RF channel number 2 | dB | 0 | Individual offset for cells on secondary component carrier. |
| | Cell-individual offset for cells on RF channel number 3 | dB | 0 | Individual offset for cells on secondary component carrier. |
| | Filter coefficient | | 0 | L3 filtering is not used |
| | SCell measurement cycle (measCycleSCell) | ms | 320 | |
| | T1 | s | 5 | During this time the cell1 and cell3 shall be known to the UE; but cell2 and cell 4 shall be unknown to the UE. |
| | T2 | s | ≤12 | UE should report Event A1 for cell2 and event A6 for cell4 within 6.4s (20xscellMeasCycle) |
| | T3 | s | 5 | UE should report Event A2 within 200 ms. 1.6s, and 1.6s for cells 1, 2 and 3, respectively. |

Table A.8.16.28.1-2: Cell specific test parameters for E-UTRAN TDD-FDD 3 DL CA event triggered reporting under fading propagation

conditions with 2 configured but deactivated SCells in non-DRX with PCell in TDD

| Parameter | Unit | Cell 1 | | | Cell 2 | | | Cell 3 | | | Cell 4 | | |
|--|------------|---|--|--|---|--|--|---|--|--|--|-------|-------|
| | | T1 | T2 | T3 | T1 | T2 | T3 | T1 | T2 | T3 | T1 | T2 | T3 |
| E-UTRA RF Channel Number | | 1 | | | 2 | | | 3 | | | | | |
| BW _{channel} | | 5MHz: N _{RB,c} = 25 10MHz: N _{RB,c} = 50 20MHz: N _{RB,c} = 100 | | | 5MHz: N _{RB,c} = 25 10MHz: N _{RB,c} = 50 20MHz: N _{RB,c} = 100 | | | 5MHz: N _{RB,c} = 25 10MHz: N _{RB,c} = 50 20MHz: N _{RB,c} = 100 | | | | | |
| PDSCH parameters: DL Reference Measurement Channel | | 5MHz: R.4 TDD 10MHz: R.0 TDD 20MHz: R.3 TDD | | | - | | | - | | | - | | |
| PCFICH/PDCCH/PHI CH parameters: DL Reference Measurement Channel | | 5MHz: R.11 TDD 10MHz: R.6 TDD 20MHz: R.10 TDD | | | 5MHz: R.11 FDD 10MHz: R.6 FDD 20MHz: R.10 FDD | | | 5MHz: R.11 FDD 10MHz: R.6 FDD 20MHz: R.10 FDD | | | 5MHz: R.11 FDD 10MHz: R.6 FDD 20MHz: R.10 FDD | | |
| OCNG Patterns | | 5MHz: OP.9 TDD 10MHz: OP.1 TDD 20MHz: OP.7 TDD | | | 5MHz: OP.16 FDD 10MHz: OP.2 FDD 20MHz: OP.12 FDD | | | 5MHz: OP.16 FDD 10MHz: OP.2 FDD 20MHz: OP.12 FDD | | | 5MHz: OP.16 FDD 10MHz: OP.2 FDD 20MHz: OP.12 FDD | | |
| PBCH_RA | dB | 0 | | | 0 | | | 0 | | | 0 | | |
| PBCH_RB | dB | | | | | | | | | | | | |
| PSS_RA | dB | | | | | | | | | | | | |
| SSS_RA | dB | | | | | | | | | | | | |
| PCFICH_RB | dB | | | | | | | | | | | | |
| PHICH_RA | dB | | | | | | | | | | | | |
| PHICH_RB | dB | | | | | | | | | | | | |
| PDCCH_RA | dB | | | | | | | | | | | | |
| PDCCH_RB | dB | | | | | | | | | | | | |
| PDSCH_RA | dB | | | | | | | | | | | | |
| PDSCH_RB | dB | | | | | | | | | | | | |
| OCNG_RA ^{Note 1} | dB | | | | | | | | | | | | |
| OCNG_RB ^{Note 1} | dB | | | | | | | | | | | | |
| N _{oc} ^{Note 2} | dBm/15 KHz | | | | | | | | | | | | |
| \bar{E}_s/N_{oc} | dB | 17 | 17 | -3 | -infinity | 17 | -3 | 17 | 17 | -3 | -infinity | 17 | -3 |
| \bar{E}_s/I_{ot} ^{Note 3} | dB | 17 | 17 | -3 | -infinity | 17 | -3 | 17 | -0.09 | -4.76 | -infinity | -0.09 | -4.76 |
| RSRP ^{Note 3} | dBm/15 kHz | -87 | -87 | -107 | -infinity | -87 | -107 | -87 | -87 | -107 | -infinity | -87 | -107 |
| SCH_RP ^{Note 3} | dBm/15 kHz | -87 | -87 | -107 | -infinity | -87 | -107 | -87 | -87 | -107 | -infinity | -87 | -107 |
| I _o ^{Note 3} | dBm/Ch BW | -59.13 +10log (N _{RB,c} /50) | -59.13 +10log (N _{RB,c} /50) | -74.45 +10log (N _{RB,c} /50) | -76.22 +10log (N _{RB,c} /50) | -59.13 +10log (N _{RB,c} /50) | -74.45 +10log (N _{RB,c} /50) | -59.13 +10log (N _{RB,c} /50) | -56.17 +10log (N _{RB,c} /50) | -73.20 +10log (N _{RB,c} /50) | Specified in columns for Cell 3 | | |
| Propagation Condition | | AWGN | | | ETU70 | | | ETU70 | | | ETU70 | | |
| Correlation Matrix and Antenna Configuration | | 1x2 | | | 1x2 Low | | | 1x2 Low | | | 1x2 Low | | |

| | | | | | |
|--|---------------|---|-------------------|-------------------|-----|
| Timing offset to Cell 1 | μs | - | 0 | 0 | 3 |
| Time alignment error relative to cell 1 ^{Note 5} | μs | - | $\leq \text{TAE}$ | $\leq \text{TAE}$ | N/A |
| Time alignment error relative to cell 2 ^{Note 5} | μs | - | - | $\leq \text{TAE}$ | N/A |
| <p>Note 1: OCNG shall be used such that all cells are fully allocated and a constant total transmitted power spectral density is achieved for all OFDM symbols.</p> <p>Note 2: Interference from other cells and noise sources not specified in the test is assumed to be constant over subcarriers and time and shall be modelled as AWGN of appropriate power for N_{oc} to be fulfilled.</p> <p>Note 3: E_s/I_{ot}, RSRP, SCH_RP and I_o have been derived from other parameters for information purposes. They are not settable parameters themselves.</p> <p>Note 4: The resources for uplink transmission are assigned to the UE prior to the start of time period T2.</p> <p>Note 5: Time alignment error (TAE) as specified in TS 36.104 [30] clause 6.5.3.1. The TAE value depends upon the type of carrier aggregation.</p> | | | | | |

A.8.16.28.2 Test Requirements

The UE shall send one Event A6 triggered measurement report for cell 4 with a measurement reporting delay of less than 6.4s ($20 \times \text{measCycleSCell}$) from the beginning of time T2.

The UE shall send one Event A1 triggered measurement report for Cell 2 with a measurement reporting delay of less than 6.4s ($20 \times \text{measCycleSCell}$) from beginning of time T2.

The UE shall send one Event A2 triggered measurement report for Cell 1 with a measurement reporting delay of less than 200 ms from beginning of time T3.

The UE shall send one Event A2 triggered measurement report for Cell 2 with a measurement reporting delay of less than 1.6s ($5 \times \text{measCycleSCell}$) from beginning of time T3.

The UE shall send one Event A2 triggered measurement report for Cell 3 with a measurement reporting delay of less than 1.6s ($5 \times \text{measCycleSCell}$) from beginning of time T3.

The UE shall not send event triggered measurement reports as long as the reporting criteria are not fulfilled.

The rate of correct events observed during repeated tests shall be at least 90% for each of the events.

NOTE: The actual overall delays measured in the tests may be up to $2 \times \text{TTI}_{\text{DCCH}}$ higher than the measurement reporting delays above because of TTI insertion uncertainty of the measurement report in DCCH.

A.8.16.29 3 DL FDD CA Event Triggered Reporting under Deactivated SCells in Non-DRX

A.8.16.29.1 Test Purpose and Environment

The purpose of this test is to verify that the UE correctly detects Events A1 (Serving cell becomes better than threshold), A2 (Serving cell becomes worse than threshold) and A6 (Neighbour becomes better than SCell) defined in TS 36.331 [2] within the requirements stated in clause 8.3.3.2.1.

The test parameters are given in Tables A.8.16.29.1-1 and A.8.16.29.1-2 below. It is indicated to the UE in the measurement control information that event-triggered reporting with Events A1 (SCell 1), Events A2 (PCell and SCell 1/2) and A6 is used. The test consists of three successive time periods, with duration of T1, T2 and T3, respectively. During T1 the UE shall not have any information on cell 4. Immediately at beginning of T2 the transmission power of cell 2 is increased above a threshold value such that this shall result in reporting of Event A1 for SCell 1, and cell 4 is increased to the same level as for Cell 3. Due to usage of an offset this shall result in reporting of Event A6. At beginning of T3 the transmission powers of cells 1, 2, 3 and 4 are reduced below a threshold value and this shall result in reporting of Event A2 for PCell and SCell 1/2, respectively.

Table A.8.16.29.1-1: General test parameters for E-UTRAN FDD event triggered reporting on configured but deactivated SCell in non-DRX under fading propagation conditions

| Parameter | Unit | Value | Comment | |
|------------------------------|----------------|------------------|---|--|
| E-UTRA RF Channel Number | | 1, 2, 3 | Three radio channels are used for this test | |
| Active PCell | | Cell 1 | Primary cell on RF channel number 1. | |
| Configured deactivated SCell | | Cell 2 (SCell 1) | Configured deactivated secondary cell 1 on RF channel number 2. | |
| | | Cell 3 (SCell 2) | Configured deactivated secondary cell 2 on RF channel number 3. | |
| Neighbour cell | | Cell 4 | Neighbor cell to be identified on RF channel number 3. | |
| CP length | | Normal | | |
| DRX | | OFF | Continuous monitoring of primary cell | |
| A1 | Hysteresis | dB | 0 | Hysteresis for evaluation of event A1. |
| | Threshold RSRP | dBm | -98 | Actual RSRP threshold for event A1. Needs to take absolute accuracy tolerance in clause 9.1.11.1 into account plus margin. No event A1 reporting is configured for cell 1 and 3. |

| | | | | |
|--|-----------------|-----|---|---|
| | Time To Trigger | s | 0 | |
| A2 | Hysteresis | dB | 0 | Hysteresis for evaluation of event A2. |
| | Threshold RSRP | dBm | -98 | Actual RSRP threshold for event A2. Needs to take absolute accuracy tolerance in clause 9.1.11.1 into account plus margin. |
| | Time To Trigger | s | 0 | |
| A6 | Hysteresis | dB | 0 | Hysteresis for evaluation of event A6. |
| | Offset | dB | -6 | Offset parameter for evaluation of event A6. Needs to take relative accuracy tolerance in clause 9.1.11.2 into account plus margin. |
| | Report on leave | | False | |
| | Time To Trigger | s | 0 | |
| Cell-individual offset for cells on RF channel number 1 | dB | 0 | Individual offset for cells on primary component carrier. | |
| Cell-individual offset for cells on RF channel number 2 | dB | 0 | Individual offset for cells on secondary component carrier 1. | |
| Cell-individual offset for cells on RF channel number 3 | dB | 0 | Individual offset for cells on secondary component carrier 2. | |
| Filter coefficient | | 0 | L3 filtering is not used | |
| SCell measurement cycle (measCycleSCell) for SCell 1 and 2 | ms | 320 | | |
| T1 | s | 5 | During this time cell1 and cell3 shall be known to the UE; but cell2 and cell 4 shall be unknown to the UE. | |
| T2 | s | ≤12 | UE should report Event A1 for cell2 and Event A6 for cell4 within 6.4s (20×scellMeasCycle) | |
| T3 | s | 5 | UE should report Event A2 within 200 ms, 1.6s and 1.6s for cells 1, 2 and 3, respectively. | |

Table A.8.16.29.1-2: Cell specific test parameters for E-UTRAN FDD event triggered reporting on configured but deactivated SCell in non-DRX under fading propagation conditions

| Parameter | Unit | Cell 1 | | | Cell 2 | | | Cell 3 | | | Cell 4 | | |
|--|------------|---|--|--|---|--|--|---|--|--|--|-------|-------|
| | | T1 | T2 | T3 | T1 | T2 | T3 | T1 | T2 | T3 | T1 | T2 | T3 |
| E-UTRA RF Channel Number | | 1 | | | 2 | | | 3 | | | | | |
| BW _{channel} | | 5MHz: N _{RB,c} = 25 10MHz: N _{RB,c} = 50 20MHz: N _{RB,c} = 100 | | | 5MHz: N _{RB,c} = 25 10MHz: N _{RB,c} = 50 20MHz: N _{RB,c} = 100 | | | 5MHz: N _{RB,c} = 25 10MHz: N _{RB,c} = 50 20MHz: N _{RB,c} = 100 | | | | | |
| PDSCH parameters: DL Reference Measurement Channel | | 5MHz: R.5 FDD 10MHz: R.0 FDD 20MHz: R.4 FDD | | | - | | | - | | | - | | |
| PCFICH/PDCCH/PHI CH parameters: DL Reference Measurement Channel | | 5MHz: R.11 FDD 10MHz: R.6 FDD 20MHz: R.10 FDD | | | 5MHz: R.11 FDD 10MHz: R.6 FDD 20MHz: R.10 FDD | | | 5MHz: R.11 FDD 10MHz: R.6 FDD 20MHz: R.10 FDD | | | 5MHz: R.11 FDD 10MHz: R.6 FDD 20MHz: R.10 FDD | | |
| OCNG Patterns | | 5MHz: OP.15 FDD 10MHz: OP.1 FDD 20MHz: OP.11 FDD | | | 5MHz: OP.16 FDD 10MHz: OP.2 FDD 20MHz: OP.12 FDD | | | 5MHz: OP.16 FDD 10MHz: OP.2 FDD 20MHz: OP.12 FDD | | | 5MHz: OP.16 FDD 10MHz: OP.2 FDD 20MHz: OP.12 FDD | | |
| PBCH_RA | dB | 0 | | | 0 | | | 0 | | | 0 | | |
| PBCH_RB | dB | | | | | | | | | | | | |
| PSS_RA | dB | | | | | | | | | | | | |
| SSS_RA | dB | | | | | | | | | | | | |
| PCFICH_RB | dB | | | | | | | | | | | | |
| PHICH_RA | dB | | | | | | | | | | | | |
| PHICH_RB | dB | | | | | | | | | | | | |
| PDCCH_RA | dB | | | | | | | | | | | | |
| PDCCH_RB | dB | | | | | | | | | | | | |
| PDSCH_RA | dB | | | | | | | | | | | | |
| PDSCH_RB | dB | | | | | | | | | | | | |
| OCNG_RA ^{Note 1} | dB | | | | | | | | | | | | |
| OCNG_RB ^{Note 1} | dB | | | | | | | | | | | | |
| N _{oc} ^{Note 2} | | | | | | | | | | | | | |
| \hat{E}_s/N_{oc} | dB | 17 | 17 | -3 | -infinity | 17 | -3 | 17 | 17 | -3 | -infinity | 17 | -3 |
| \hat{E}_s/I_{ot} ^{Note 3} | dB | 17 | 17 | -3 | -infinity | 17 | -3 | 17 | -0.09 | -4.76 | -infinity | -0.05 | -4.76 |
| RSRP ^{Note 3} | dBm/15 kHz | -87 | -87 | -107 | -infinity | -87 | -107 | -87 | -87 | -107 | -infinity | -87 | -107 |
| SCH_RP ^{Note 3} | dBm/15 kHz | -87 | -87 | -107 | -infinity | -87 | -107 | -87 | -87 | -107 | -infinity | -87 | -107 |
| I _o ^{Note 3} | dBm/Ch BW | -59.13 +10log (N _{RB,c} /50) | -59.13 +10log (N _{RB,c} /50) | -74.45 +10log (N _{RB,c} /50) | -76.22 +10log (N _{RB,c} /50) | -59.13 +10log (N _{RB,c} /50) | -74.45 +10log (N _{RB,c} /50) | -59.13 +10log (N _{RB,c} /50) | -56.17 +10log (N _{RB,c} /50) | -73.20 +10log (N _{RB,c} /50) | Specified in columns for Cell 3 | | |

| Propagation Condition | | AWGN | ETU70 | ETU70 | ETU70 |
|--|---------------|------|-------------------|-------------------|---------|
| Correlation Matrix and Antenna Configuration | | 1x2 | 1x2 Low | 1x2 Low | 1x2 Low |
| Timing offset to Cell 1 | μs | - | 0 | 0 | 3 |
| Time alignment error relative to cell 1 <small>Note 5</small> | μs | - | $\leq \text{TAE}$ | $\leq \text{TAE}$ | N/A |
| Time alignment error relative to cell 2 <small>Note 5</small> | μs | - | - | $\leq \text{TAE}$ | N/A |
| <p>Note 1: OCNG shall be used such that all cells are fully allocated and a constant total transmitted power spectral density is achieved for all OFDM symbols.</p> <p>Note 2: Interference from other cells and noise sources not specified in the test is assumed to be constant over subcarriers and time and shall be modelled as AWGN of appropriate power for N_{oc} to be fulfilled.</p> <p>Note 3: E_s/I_{ot}, RSRP, SCH_RP and I_o have been derived from other parameters for information purposes. They are not settable parameters themselves.</p> <p>Note 4: The resources for uplink transmission are assigned to the UE prior to the start of time period T2.</p> <p>Note 5: Time alignment error (TAE) as specified in TS 36.104 [30] clause 6.5.3.1. The TAE value depends upon the type of carrier aggregation.</p> | | | | | |

A.8.16.29.2 Test Requirements

The UE shall send one Event A6 triggered measurement report for cell 4 with a measurement reporting delay of less than 6.4s ($20 \times \text{measCycleSCell}$) from the beginning of time T2.

The UE shall send one Event A1 triggered measurement report for Cell 2 with a measurement reporting delay of less than 6.4s ($20 \times \text{measCycleSCell}$) from beginning of time T2.

The UE shall send one Event A2 triggered measurement report for Cell 1 with a measurement reporting delay of less than 200 ms from beginning of time T3.

The UE shall send one Event A2 triggered measurement report for Cell 2 with a measurement reporting delay of less than 1.6s ($5 \times \text{measCycleSCell}$) from beginning of time T3.

The UE shall send one Event A2 triggered measurement report for Cell 3 with a measurement reporting delay of less than 1.6s ($5 \times \text{measCycleSCell}$) from beginning of time T3.

The UE shall not send event triggered measurement reports as long as the reporting criteria are not fulfilled.

The rate of correct events observed during repeated tests shall be at least 90% for each of the events.

NOTE: The actual overall delays measured in the tests may be up to $2 \times \text{TTI}_{\text{DCCH}}$ higher than the measurement reporting delays above because of TTI insertion uncertainty of the measurement report in DCCH.

A.8.16.30 3 DL TDD CA Event Triggered Reporting under Deactivated SCells in Non-DRX

A.8.16.30.1 Test Purpose and Environment

The purpose of this test is to verify that the UE correctly detects Events A1 (Serving cell becomes better than threshold), A2 (Serving cell becomes worse than threshold) and A6 (Neighbour becomes better than SCell) defined in TS 36.331 [2] within the requirements stated in clause 8.3.3.2.1.

The test parameters are given in Tables A.8.16.30.1-1 and A.8.16.30.1-2 below. It is indicated to the UE in the measurement control information that event-triggered reporting with Events A1 (SCell 1), Events A2 (PCell and SCell 1/2) and A6 is used. The test consists of three successive time periods, with duration of T1, T2 and T3, respectively. During T1 the UE shall not have any information on cell 4. Immediately at beginning of T2 the transmission power of cell 2 is increased above a threshold value such that this shall result in reporting of Event A1 for SCell 1, and cell 4 is increased to the same level as for Cell 3. Due to usage of an offset this shall result in reporting of Event A6. At beginning of T3 the transmission powers of cells 1, 2, 3 and 4 are reduced below a threshold value and this shall result in reporting of Event A2 for PCell and SCell 1/2, respectively.

Table A.8.16.30.1-1: General test parameters for E-UTRAN TDD event triggered reporting on configured but deactivated SCell in non-DRX under fading propagation conditions

| Parameter | Unit | Value | Comment | |
|------------------------------|----------------|------------------|---|--|
| E-UTRA RF Channel Number | | 1, 2, 3 | Three radio channels are used for this test | |
| Active PCell | | Cell 1 | Primary cell on RF channel number 1. | |
| Configured deactivated SCell | | Cell 2 (SCell 1) | Configured deactivated secondary cell 1 on RF channel number 2. | |
| | | Cell 3 (SCell 2) | Configured deactivated secondary cell 2 on RF channel number 3. | |
| Neighbour cell | | Cell 4 | Neighbor cell to be identified on RF channel number 3. | |
| CP length | | Normal | | |
| DRX | | OFF | Continuous monitoring of primary cell | |
| A1 | Hysteresis | dB | 0 | Hysteresis for evaluation of event A1. |
| | Threshold RSRP | dBm | -98 | Actual RSRP threshold for event A1. Needs to take absolute accuracy tolerance in clause 9.1.11.1 into account plus margin. No event A1 reporting is configured for cell 1 and 3. |

| | | | | |
|--|-----------------|-----|---|---|
| | Time To Trigger | s | 0 | |
| A2 | Hysteresis | dB | 0 | Hysteresis for evaluation of event A2. |
| | Threshold RSRP | dBm | -98 | Actual RSRP threshold for event A2. Needs to take absolute accuracy tolerance in clause 9.1.11.1 into account plus margin. |
| | Time To Trigger | s | 0 | |
| A6 | Hysteresis | dB | 0 | Hysteresis for evaluation of event A6. |
| | Offset | dB | -6 | Offset parameter for evaluation of event A6. Needs to take relative accuracy tolerance in clause 9.1.11.2 into account plus margin. |
| | Report on leave | | False | |
| | Time To Trigger | s | 0 | |
| Cell-individual offset for cells on RF channel number 1 | dB | 0 | Individual offset for cells on primary component carrier. | |
| Cell-individual offset for cells on RF channel number 2 | dB | 0 | Individual offset for cells on secondary component carrier 1. | |
| Cell-individual offset for cells on RF channel number 3 | dB | 0 | Individual offset for cells on secondary component carrier 2. | |
| Filter coefficient | | 0 | L3 filtering is not used | |
| SCell measurement cycle (measCycleSCell) for SCell 1 and 2 | ms | 320 | | |
| T1 | s | 5 | During this time cell1 and cell3 shall be known to the UE; but cell2 and cell 4 shall be unknown to the UE. | |
| T2 | s | ≤12 | UE should report Event A1 for cell2 and Event A6 for cell4 within 6.4s (20×scellMeasCycle) | |
| T3 | s | 5 | UE should report Event A2 within 200 ms, 1.6s and 1.6s for cells 1, 2 and 3, respectively. | |

Table A.8.16.30.1-2: Cell specific test parameters for E-UTRAN TDD event triggered reporting on configured but deactivated SCell in non-DRX under fading propagation conditions

| Parameter | Unit | Cell 1 | | | Cell 2 | | | Cell 3 | | | Cell 4 | | |
|--|------------|---|--|--|---|--|--|---|--|--|---|-------|-------|
| | | T1 | T2 | T3 | T1 | T2 | T3 | T1 | T2 | T3 | T1 | T2 | T3 |
| E-UTRA RF Channel Number | | 1 | | | 2 | | | 3 | | | | | |
| BW _{channel} | | 5MHz: N _{RB,c} = 25 10MHz: N _{RB,c} = 50 20MHz: N _{RB,c} = 100 | | | 5MHz: N _{RB,c} = 25 10MHz: N _{RB,c} = 50 20MHz: N _{RB,c} = 100 | | | 5MHz: N _{RB,c} = 25 10MHz: N _{RB,c} = 50 20MHz: N _{RB,c} = 100 | | | | | |
| PDSCH parameters: DL Reference Measurement Channel | | 5MHz: R.4 TDD 10MHz: R.0 TDD 20MHz: R.3 TDD | | | - | | | - | | | - | | |
| PCFICH/PDCCH/PHI CH parameters: DL Reference Measurement Channel | | 5MHz: R.11 TDD 10MHz: R.6 TDD 20MHz: R.10 TDD | | | 5MHz: R.11 TDD 10MHz: R.6 TDD 20MHz: R.10 TDD | | | 5MHz: R.11 TDD 10MHz: R.6 TDD 20MHz: R.10 TDD | | | 5MHz: R.11 TDD 10MHz: R.6 TDD 20MHz: R.10 TDD | | |
| OCNG Patterns | | 5MHz: OP.9 TDD 10MHz: OP.1 TDD 20MHz: OP.7 TDD | | | 5MHz: OP.10 TDD 10MHz: OP.2 TDD 20MHz: OP.8 TDD | | | 5MHz: OP.10 TDD 10MHz: OP.2 TDD 20MHz: OP.8 TDD | | | 5MHz: OP.10 TDD 10MHz: OP.2 TDD 20MHz: OP.8 TDD | | |
| PBCH_RA | dB | 0 | | | 0 | | | 0 | | | 0 | | |
| PBCH_RB | dB | | | | | | | | | | | | |
| PSS_RA | dB | | | | | | | | | | | | |
| SSS_RA | dB | | | | | | | | | | | | |
| PCFICH_RB | dB | | | | | | | | | | | | |
| PHICH_RA | dB | | | | | | | | | | | | |
| PHICH_RB | dB | | | | | | | | | | | | |
| PDCCH_RA | dB | | | | | | | | | | | | |
| PDCCH_RB | dB | | | | | | | | | | | | |
| PDSCH_RA | dB | | | | | | | | | | | | |
| PDSCH_RB | dB | | | | | | | | | | | | |
| OCNG_RA ^{Note 1} | dB | | | | | | | | | | | | |
| OCNG_RB ^{Note 1} | dB | | | | | | | | | | | | |
| N _{oc} ^{Note 2} | | | | | | | | | | | | | |
| \bar{E}_s/N_{oc} | dB | 17 | 17 | -3 | -infinity | 17 | -3 | 17 | 17 | -3 | -infinity | 17 | -3 |
| \bar{E}_s/I_{ot} ^{Note 3} | dB | 17 | 17 | -3 | -infinity | 17 | -3 | 17 | -0.09 | -4.76 | -infinity | -0.05 | -4.76 |
| RSRP ^{Note 3} | dBm/15 kHz | -87 | -87 | -107 | -infinity | -87 | -107 | -87 | -87 | -107 | -infinity | -87 | -107 |
| SCH_RP ^{Note 3} | dBm/15 kHz | -87 | -87 | -107 | -infinity | -87 | -107 | -87 | -87 | -107 | -infinity | -87 | -107 |
| I _o ^{Note 3} | dBm/Ch BW | -59.13 +10log (N _{RB,c} /50) | -59.13 +10log (N _{RB,c} /50) | -74.45 +10log (N _{RB,c} /50) | -76.22 +10log (N _{RB,c} /50) | -59.13 +10log (N _{RB,c} /50) | -74.45 +10log (N _{RB,c} /50) | -59.13 +10log (N _{RB,c} /50) | -56.17 +10log (N _{RB,c} /50) | -73.20 +10log (N _{RB,c} /50) | Specified in columns for Cell 3 | | |

| Propagation Condition | | AWGN | ETU70 | ETU70 | ETU70 |
|--|---------------|---------|-------------------|-------------------|---------|
| Correlation Matrix and Antenna Configuration | | 1x2 Low | 1x2 Low | 1x2 Low | 1x2 Low |
| Timing offset to Cell 1 | μs | - | 0 | 0 | 3 |
| Time alignment error relative to cell 1 <small>Note 5</small> | μs | - | $\leq \text{TAE}$ | $\leq \text{TAE}$ | N/A |
| Time alignment error relative to cell 2 <small>Note 5</small> | μs | - | - | $\leq \text{TAE}$ | N/A |
| <p>Note 1: OCNG shall be used such that all cells are fully allocated and a constant total transmitted power spectral density is achieved for all OFDM symbols.</p> <p>Note 2: Interference from other cells and noise sources not specified in the test is assumed to be constant over subcarriers and time and shall be modelled as AWGN of appropriate power for N_{oc} to be fulfilled.</p> <p>Note 3: E_s/I_{ot}, RSRP, SCH_RP and I_o have been derived from other parameters for information purposes. They are not settable parameters themselves.</p> <p>Note 4: The resources for uplink transmission are assigned to the UE prior to the start of time period T2.</p> <p>Note 5: Time alignment error (TAE) as specified in TS 36.104 [30] clause 6.5.3.1. The TAE value depends upon the type of carrier aggregation.</p> | | | | | |

A.8.16.30.2 Test Requirements

The UE shall send one Event A6 triggered measurement report for cell 4 with a measurement reporting delay of less than 6.4s ($20 \times \text{measCycleSCell}$) from the beginning of time T2.

The UE shall send one Event A1 triggered measurement report for Cell 2 with a measurement reporting delay of less than 6.4s ($20 \times \text{measCycleSCell}$) from beginning of time T2.

The UE shall send one Event A2 triggered measurement report for Cell 1 with a measurement reporting delay of less than 200 ms from beginning of time T3.

The UE shall send one Event A2 triggered measurement report for Cell 2 with a measurement reporting delay of less than 1.6s ($5 \times \text{measCycleSCell}$) from beginning of time T3.

The UE shall send one Event A2 triggered measurement report for Cell 3 with a measurement reporting delay of less than 1.6s ($5 \times \text{measCycleSCell}$) from beginning of time T3.

The UE shall not send event triggered measurement reports as long as the reporting criteria are not fulfilled.

The rate of correct events observed during repeated tests shall be at least 90% for each of the events.

NOTE: The actual overall delays measured in the tests may be up to $2 \times \text{TTI}_{\text{DCCH}}$ higher than the measurement reporting delays above because of TTI insertion uncertainty of the measurement report in PDCCH.

A.8.16.31 E-UTRAN TDD-FDD 3 DL CA Event Triggered Reporting on Deactivated SCell with PCell and SCell Interruptions in Non-DRX and with PCell in FDD

A.8.16.31.1 Test Purpose and Environment

The purpose of this test is to verify that the UE correctly detects event A6 (Neighbour becomes better than SCell) defined in TS 36.331 [2] within the requirements stated in clause 8.3.3.2.1 while at the same time fulfilling the requirement on interruption rate.

The test parameters are given in Table A.8.16.31.1-1 and A.8.16.31.1-2 below. In the test there are four cells: Cell 1, Cell 2, Cell 3 and Cell 4. Cell 1 is PCell on the FDD primary component (RF Channel 1), Cell 2 is SCell on the TDD secondary component (RF Channel 2), and Cell 3 is SCell on the TDD secondary component (RF Channel 3) and Cell 4 is the neighbour cell on the TDD secondary component (RF Channel 3). It is indicated to the UE in the measurement control information that event-triggered reporting with Event A6 is used. The test consists of four successive time periods, with duration of T1, T2, T3 and T4, respectively. During T1 and T2, both Cell2 and Cell3 are deactivated. During T1 the UE shall not have any information of cell 4. Immediately at beginning of T2 the transmission power of cell 4 is increased to same level as for cell 3, and due to usage of an offset this shall result in reporting of Event A6.

At the beginning of T3, the transmission power of Cell 4 is turned off and the test equipment sends a MAC message for activation of Cell 2 to UE but Cell3 remains deactivated. Immediately at beginning of T4 the transmission power of cell 4 is increased to same level as for cell 3, and due to usage of an offset this shall result in reporting of Event A6. The UE shall be continuously scheduled in the PCell throughout the whole test and continuously scheduled in Cell 2 during T4.

Table A.8.16.31.1-1: General test parameters for E-UTRAN TDD-FDD 3 DL CA Event Triggered Reporting on Deactivated SCell with PCell and SCell Interruptions in Non-DRX and with PCell in FDD

| Parameter | Unit | Value | Comment |
|------------------------------|------|---------|---|
| E-UTRA RF Channel Number | | 1, 2, 3 | three radio channels are used for this test |
| Active PCell | | Cell 1 | Primary cell on RF channel number 1. |
| Configured deactivated SCell | | Cell 2 | Configured deactivated secondary cell on RF channel number 2. |
| Configured deactivated SCell | | Cell 3 | Configured deactivated secondary cell on RF channel number 3. |

| | | | | |
|---|-----------------|----|--------|---|
| Neighbour cell | | | Cell 4 | Neighbor cell to be identified on RF channel number 3. |
| CP length | | | Normal | |
| Special subframe configuration | | | 6 | As specified in table 4.2-1 in TS 36.211. The same configuration in TDD cells |
| Uplink-downlink configuration | | | 1 | As specified in table 4.2-2 in TS 36.211. The same configuration in TDD cells |
| DRX | | | OFF | Continuous monitoring of primary cell |
| A6 | Hysteresis | dB | 0 | Hysteresis for evaluation of event A6. |
| | Offset | dB | -3 | Offset parameter for evaluation of event A6. Needs to take relative accuracy tolerance in clause 9.1.11.2 into account plus margin. |
| | Report on leave | | False | |
| | Time To Trigger | s | 0 | |
| Cell-individual offset for cells on RF channel number 1 | | dB | 0 | Individual offset for cells on primary component carrier. |
| Cell-individual offset for cells on RF channel number 2 | | dB | 0 | Individual offset for cells on secondary component carrier. |
| Cell-individual offset for cells on RF channel number 3 | | dB | 0 | Individual offset for cells on secondary component carrier. |
| Filter coefficient | | | 0 | L3 filtering is not used |
| SCell measurement cycle | | ms | 640 | |
| T1 | | s | 4 | During this time the UE shall be aware of cells 1, 2 and 3 but not cell 4. |
| T2 | | s | ≤15 | UE should report Event A6 within 12.8s (20xscellMeasCycle) |
| T3 | | s | 4 | During this time the UE shall activate cell 2 |
| T4 | | s | ≤4 | UE should report Event A6 within 3.2s (5xscellMeasCycle) |

Table A.8.16.31.1-2: Cell specific test parameters for E-UTRAN TDD-FDD 3 DL CA Event Triggered Reporting on Deactivated SCell with PCell and SCell Interruptions in Non-DRX and with PCell in FDD

| Parameter | Unit | Cell 1 | | | | Cell 2 | | | | Cell 3 | | | | Cell 4 | | | |
|---|------|---|----|----|----|---|---|---|--|---|----|----|----|---|----|----|----|
| | | T1 | T2 | T3 | T4 | T1 | T2 | T3 | T4 | T1 | T2 | T3 | T4 | T1 | T2 | T3 | T4 |
| E-UTRA RF Channel Number | | 1 | | | | 2 | | | | 3 | | | | 3 | | | |
| BW _{channel} | MHz | 5MHz: N _{RB,c} = 25 10MHz: N _{RB,c} = 50 20MHz: N _{RB,c} = 100 | | | | 5MHz: N _{RB,c} = 25 10MHz: N _{RB,c} = 50 20MHz: N _{RB,c} = 100 | | | | 5MHz: N _{RB,c} = 25 10MHz: N _{RB,c} = 50 20MHz: N _{RB,c} = 100 | | | | 5MHz: N _{RB,c} = 25 10MHz: N _{RB,c} = 50 20MHz: N _{RB,c} = 100 | | | |
| PDSCH parameters: DL Reference Measurement Channel | | 5MHz: R.7 FDD 10MHz: R.3 FDD 20MHz: R.6 FDD | | | | N/A | N/A | N/A | 5MHz: R.4 TDD 10MHz: R.0 TDD 20MHz: R.3 TDD | N/A | | | | N/A | | | |
| PCFICH/PDCCH/PHICH parameters: DL Reference Measurement Channel | | 5MHz: R.11 FDD 10MHz: R.6 FDD 20MHz: R.10 FDD | | | | 5MHz: R.11 TDD 10MHz: R.6 TDD 20MHz: R.10 TDD | | | | 5MHz: R.11 TDD 10MHz: R.6 TDD 20MHz: R.10 TDD | | | | 5MHz: R.11 TDD 10MHz: R.6 TDD 20MHz: R.10 TDD | | | |
| OCNG Pattern defined in A.3.2.1 and A.3.2.2 | | 5MHz: OP.20 FDD 10MHz: OP.10 FDD 20MHz: OP.17 FDD | | | | 5MHz: OP.10 TDD 10MHz: OP.2 TDD 20MHz: OP.8 TDD | 5MHz: OP.10 TDD 10MHz: OP.2 TDD 20MHz: OP.8 TDD | 5MHz: OP.10 TDD 10MHz: OP.2 TDD 20MHz: OP.8 TDD | 5MHz: OP.9 TDD 10MHz: OP.1 TDD 20MHz: OP.7 TDD | 5MHz: OP.10 TDD 10MHz: OP.2 TDD 20MHz: OP.8 TDD | | | | 5MHz: OP.10 TDD 10MHz: OP.2 TDD 20MHz: OP.8 TDD | | | |
| PBCH_RA | dB | 0 | | | | 0 | | | | 0 | | | | 0 | | | |
| PBCH_RB | dB | | | | | | | | | | | | | | | | |
| PSS_RA | dB | | | | | | | | | | | | | | | | |
| SSS_RA | dB | | | | | | | | | | | | | | | | |
| PCFICH_RB | dB | | | | | | | | | | | | | | | | |
| PHICH_RA | dB | | | | | | | | | | | | | | | | |
| PHICH_RB | dB | | | | | | | | | | | | | | | | |
| PDCCH_RA | dB | | | | | | | | | | | | | | | | |
| PDCCH_RB | dB | | | | | | | | | | | | | | | | |
| PDSCH_RA | dB | | | | | | | | | | | | | | | | |
| PDSCH_RB | dB | | | | | | | | | | | | | | | | |

| | | | | | | | | | | | | | | | | | |
|---|------------|--|--|--|--|--|--|--|--|--|--|--|--|--|--|--|--|
| OCNG_RA ^{Note 1} | dB | | | | | | | | | | | | | | | | |
| OCNG_RB ^{Note 1} | dB | | | | | | | | | | | | | | | | |
| N_{oc} ^{Note 3} | dBm/15 kHz | -101 | | | | -101 | | | | -101 | | | | | | | |
| \hat{E}_s / N_{oc} | dB | 16 | 16 | 16 | 16 | 16 | 16 | 16 | 16 | 16 | 16 | 16 | 16 | -Infinity | 16 | -Infinity | 16 |
| \hat{E}_s / I_{ot} ^{Note 4} | dB | 16 | 16 | 16 | 16 | 16 | 16 | 16 | 16 | 16 | -0.11 | 16 | -0.11 | -Infinity | -0.11 | -Infinity | -0.11 |
| RSRP ^{Note 4} | dBm/15 kHz | -85 | -85 | -85 | -85 | -85 | -85 | -85 | -85 | -85 | -85 | -85 | -85 | -Infinity | -85 | -Infinity | -85 |
| SCH_RP ^{Note 4} | dBm/15 kHz | -85 | -85 | -85 | -85 | -85 | -85 | -85 | -85 | -85 | -85 | -85 | -85 | -Infinity | -85 | -Infinity | -85 |
| I_o ^{Note 4} | dBm/Ch BW | -57.11 +10log ($N_{RB,c}$ /50) | -57.11 +10log ($N_{RB,c}$ /50) | -57.11 +10log ($N_{RB,c}$ /50) | -57.11 +10log ($N_{RB,c}$ /50) | -57.11 +10log ($N_{RB,c}$ /50) | -57.11 +10log ($N_{RB,c}$ /50) | -57.11 +10log ($N_{RB,c}$ /50) | -57.11 +10log ($N_{RB,c}$ /50) | -57.11 +10log ($N_{RB,c}$ /50) | -54.15 +10log ($N_{RB,c}$ /50) | -57.11 +10log ($N_{RB,c}$ /50) | -54.15 +10log ($N_{RB,c}$ /50) | -57.11 +10log ($N_{RB,c}$ /50) | -54.15 +10log ($N_{RB,c}$ /50) | -57.11 +10log ($N_{RB,c}$ /50) | -54.15 +10log ($N_{RB,c}$ /50) |
| Propagation Condition | | AWGN | | | | AWGN | | | | AWGN | | | | AWGN | | | |
| Antenna Configuration | | 1x2 | | | | 1x2 | | | | 1x2 | | | | 1x2 | | | |
| Timing offset to Cell 1 | μ s | - | | | | 0 | | | | 0 | | | | 3 | | | |
| Time alignment error relative to cell 1 ^{Note 5} | μ s | - | | | | \leq TAE | | | | \leq TAE | | | | N/A | | | |
| Time alignment error relative to cell 2 ^{Note 5} | μ s | - | | | | - | | | | \leq TAE | | | | N/A | | | |

Note 1: OCNG shall be used such that all cells are fully allocated and a constant total transmitted power spectral density is achieved for all OFDM symbols.

Note 2: The resources for uplink transmission are assigned to the UE on cell1 prior to the start of time period T2 and on cell2 prior to the start of time period T4.

Note 3: Interference from other cells and noise sources not specified in the test is assumed to be constant over subcarriers and time and shall be modelled as AWGN of appropriate power for N_{oc} to be fulfilled.

Note 4: E_s/I_{ot} , RSRP, SCH_RP and I_o levels have been derived from other parameters for information purposes. They are not settable parameters themselves.

Note 5: Time alignment error (TAE) as specified in TS 36.104 [30] clause 6.5.3.1. The TAE value depends upon the type of carrier aggregation.

A.8.16.31.2 Test Requirements

The UE shall send one Event A6 triggered measurement report, with a measurement reporting delay less than 12.8s ($20 \times \text{scellMeasCycle}$) from the beginning of time period T2.

The UE shall send one Event A6 triggered measurement report, with a measurement reporting delay less than 3.2s ($5 \times \text{scellMeasCycle}$) from the beginning of time period T4.

The UE shall not send event triggered measurement reports, as long as the reporting criteria are not fulfilled.

The UE shall be scheduled on PCell continuously throughout the test. From the start of T1 until the measurement report is received during T2, at least 99.5% of all expected ACK/NACKs shall be transmitted by the UE.

The UE shall be scheduled on Cell2 continuously from the start of T4 to the end. From the start of T4 until the measurement report is received during T4, at least 99.5% of all expected ACK/NACKs shall be transmitted by the UE.

For a test to be considered successful requirements on both event detection and percentage of transmitted ACK/NACKs have to be fulfilled simultaneously.

The rate of correct events observed during repeated tests shall be at least 90%.

NOTE: The actual overall delays measured in the test may be up to $2 \times \text{TTI}_{\text{DCCH}}$ higher than the measurement reporting delays above because of TTI insertion uncertainty of the measurement report in DCCH.

A.8.16.32 E-UTRAN TDD-FDD 3 DL CA Event Triggered Reporting on Deactivated SCell with PCell and SCell Interruptions in Non-DRX and with PCell in TDD

A.8.16.32.1 Test Purpose and Environment

The purpose of this test is to verify that the UE correctly detects event A6 (Neighbour becomes better than SCell) defined in TS 36.331 [2] within the requirements stated in clause 8.3.3.2.1 while at the same time fulfilling the requirement on interruption rate.

The test parameters are given in Table A.8.16.32.1-1 and A.8.16.32.1-2 below. In the test there are four cells: Cell 1, Cell 2, Cell 3 and Cell 4. Cell 1 is PCell on the TDD primary component (RF Channel 1), Cell 2 is SCell on the FDD secondary component (RF Channel 2), and Cell 3 is SCell on the FDD secondary component (RF Channel 3) and Cell 4 is the neighbour cell on the FDD secondary component (RF Channel 3). It is indicated to the UE in the measurement control information that event-triggered reporting with Event A6 is used. The test consists of four successive time periods, with duration of T1, T2, T3 and T4, respectively. During T1 and T2, both Cell2 and Cell3 are deactivated. During T1 the UE shall not have any information of cell 4. Immediately at beginning of T2 the transmission power of cell 4 is increased to same level as for cell 3, and due to usage of an offset this shall result in reporting of Event A6.

At the beginning of T3, the transmission power of Cell 4 is turned off and the test equipment sends a MAC message for activation of Cell 2 to UE but Cell3 remains deactivated. Immediately at beginning of T4 the transmission power of Cell 4 is increased to same level as for Cell 3, and due to usage of an offset this shall result in reporting of Event A6. The UE shall be continuously scheduled in the PCell throughout the whole test and continuously scheduled in Cell2 during T4.

Table A.8.16.32.1-1: General test parameters for E-UTRAN TDD-FDD 3 DL CA Event Triggered Reporting on Deactivated SCell with PCell and SCell Interruptions in Non-DRX and with PCell in TDD

| Parameter | Unit | Value | Comment |
|--------------------------|------|---------|--|
| E-UTRA RF Channel Number | | 1, 2, 3 | Three radio channels are used for this test |
| Active PCell | | Cell 1 | Primary cell on RF channel number 1. |
| Configured SCell | | Cell 2 | Configured secondary cell on RF channel number 2. |
| Configured SCell | | Cell 3 | Configured secondary cell on RF channel number 3. |
| Neighbour cell | | Cell 4 | Neighbor cell to be identified on RF channel number 3. |

| | | | | |
|---|-----------------|----|-----------|---|
| CP length | | | Normal | |
| Special subframe configuration on PCell | | | 6 | As specified in table 4.2.1 in TS 36.211. The same configuration applies to all cells. |
| Uplink-downlink configuration on PCell | | | 1 | |
| DRX | | | OFF | Continuous monitoring of primary cell |
| A6 | Hysteresis | dB | 0 | Hysteresis for evaluation of event A6. |
| | Offset | dB | -3 | Offset parameter for evaluation of event A6. Needs to take relative accuracy tolerance in clause 9.1.11.2 into account plus margin. |
| | Report on leave | | False | |
| | Time To Trigger | s | 0 | |
| Cell-individual offset for cells on RF channel number 1 | | dB | 0 | Individual offset for cells on primary component carrier. |
| Cell-individual offset for cells on RF channel number 2 | | dB | 0 | Individual offset for cells on secondary component carrier. |
| Cell-individual offset for cells on RF channel number 3 | | dB | 0 | Individual offset for cells on secondary component carrier. |
| Filter coefficient | | | 0 | L3 filtering is not used |
| SCell measurement cycle | | ms | 640 | |
| T1 | | s | 4 | During this time the UE shall be aware of cells 1, 2 and 3 but not cell 4. |
| T2 | | s | ≤ 15 | UE should report Event A6 within 12.8s (20xscellMeasCycle) |
| T3 | | s | 4 | During this time the UE shall activate cell 2 |
| T4 | | s | ≤ 4 | UE should report Event A6 within 3.2s (5xscellMeasCycle) |

Table A.8.16.32.1-2: Cell specific test parameters for E-UTRAN TDD-FDD 3 DL CA Event Triggered Reporting on Deactivated SCell with PCell and SCell Interruptions in Non-DRX and with PCell in TDD

| Parameter | Unit | Cell 1 | | | | Cell 2 | | | | Cell 3 | | | | Cell 4 | | | |
|--|------|---|----|----|----|---|--|--|---|---|----|----|----|---|----|----|----|
| | | T1 | T2 | T3 | T4 | T1 | T2 | T3 | T4 | T1 | T2 | T3 | T4 | T1 | T2 | T3 | T4 |
| E-UTRA RF Channel Number | | 1 | | | | 2 | | | | 3 | | | | 3 | | | |
| BW _{channel} | MHz | 5MHz: N _{RB,c} = 25 10MHz: N _{RB,c} = 50 20MHz: N _{RB,c} = 100 | | | | 5MHz: N _{RB,c} = 25 10MHz: N _{RB,c} = 50 20MHz: N _{RB,c} = 100 | | | | 5MHz: N _{RB,c} = 25 10MHz: N _{RB,c} = 50 20MHz: N _{RB,c} = 100 | | | | 5MHz: N _{RB,c} = 25 10MHz: N _{RB,c} = 50 20MHz: N _{RB,c} = 100 | | | |
| PDSCH parameters: DL Reference Measurement Channel | | 5MHz: R.4 TDD 10MHz: R.0 TDD 20MHz: R.3 TDD | | | | N/A | N/A | N/A | 5MHz: R.7 FDD 10MHz: R.3 FDD 20MHz: R.6 FDD | N/A | | | | N/A | | | |
| PCFICH/PDCCH/HICH parameters | | 5MHz: R.11 TDD 10MHz: R.6 TDD 20MHz: R.10 TDD | | | | 5MHz: R.11 FDD 10MHz: R.6 FDD 20MHz: R.10 FDD | | | | 5MHz: R.11 FDD 10MHz: R.6 FDD 20MHz: R.10 FDD | | | | 5MHz: R.11 FDD 10MHz: R.6 FDD 20MHz: R.10 FDD | | | |
| OCNG Pattern defined in A.3.2.1 | | 5MHz: OP.9 TDD 10MHz: OP.1 TDD 20MHz: OP. 7 TDD | | | | 5MHz: OP.19 FDD; 10MHz: OP.6 FDD; 20MHz: OP.14 FDD | 5MHz: OP.19 FDD; 10MHz: OP.6 FDD; 20MHz: OP.14 FDD | 5MHz: OP.19 FDD; 10MHz: OP.6 FDD; 20MHz: OP.14 FDD | 5MHz: OP.20 FDD; 10MHz: OP.10 FDD; 20MHz: OP.17 FDD | 5MHz: OP.16FDD; 10MHz:OP.2 FDD; 20MHz: OP.12FDD | | | | 5MHz: OP.16FDD; 10MHz:OP.2 FDD; 20MHz: OP.12FDD | | | |
| PBCH_RA | dB | 0 | | | | 0 | | | | 0 | | | | 0 | | | |
| PBCH_RB | dB | | | | | | | | | | | | | | | | |
| PSS_RA | dB | | | | | | | | | | | | | | | | |
| SSS_RA | dB | | | | | | | | | | | | | | | | |
| PCFICH_RB | dB | | | | | | | | | | | | | | | | |
| PHICH_RA | dB | | | | | | | | | | | | | | | | |
| PHICH_RB | dB | | | | | | | | | | | | | | | | |
| PDCCH_RA | dB | | | | | | | | | | | | | | | | |
| PDCCH_RB | dB | | | | | | | | | | | | | | | | |
| PDSCH_RA | dB | | | | | | | | | | | | | | | | |
| PDSCH_RB | dB | | | | | | | | | | | | | | | | |
| OCNG_RA ^{Note 1} | dB | | | | | | | | | | | | | | | | |
| OCNG_RB ^{Note 1} | dB | | | | | | | | | | | | | | | | |

| | | | | | | | | | | | | | | | | | | |
|--|------------|--|--|--|--|--|--|--|--|--|--|--|--|--|--|--|--|-----|
| N_{oc} <small>Note 3</small> | dBm/15 kHz | -101 | | | | -101 | | | | -101 | | | | | | | | |
| \hat{E}_s / N_{oc} | dB | 16 | 16 | 16 | 16 | 16 | 16 | 16 | 16 | 16 | 16 | 16 | 16 | -Infinity | 16 | -Infinity | 16 | |
| \hat{E}_s / I_{ot} <small>Note 4</small> | dB | 16 | 16 | 16 | 16 | 16 | 16 | 16 | 16 | 16 | -0.11 | 16 | -0.11 | -Infinity | -0.11 | -Infinity | -0.11 | |
| RSRP <small>Note 4</small> | dBm/15 kHz | -85 | -85 | -85 | -85 | -85 | -85 | -85 | -85 | -85 | -85 | -85 | -85 | -85 | -Infinity | -85 | -Infinity | -85 |
| SCH_RP <small>Note 4</small> | dBm/15 kHz | -85 | -85 | -85 | -85 | -85 | -85 | -85 | -85 | -85 | -85 | -85 | -85 | -85 | -Infinity | -85 | -Infinity | -85 |
| I_o <small>Note 4</small> | dBm/Ch BW | -57.11 +10log ($N_{RB,c}$ /50) | -57.11 +10log ($N_{RB,c}$ /50) | -57.11 +10log ($N_{RB,c}$ /50) | -57.11 +10log ($N_{RB,c}$ /50) | -57.11 +10log ($N_{RB,c}$ /50) | -57.11 +10log ($N_{RB,c}$ /50) | -57.11 +10log ($N_{RB,c}$ /50) | -57.11 +10log ($N_{RB,c}$ /50) | -57.11 +10log ($N_{RB,c}$ /50) | -54.15 +10log ($N_{RB,c}$ /50) | -57.11 +10log ($N_{RB,c}$ /50) | -54.15 +10log ($N_{RB,c}$ /50) | -57.11 +10log ($N_{RB,c}$ /50) | -54.15 +10log ($N_{RB,c}$ /50) | -57.11 +10log ($N_{RB,c}$ /50) | -54.15 +10log ($N_{RB,c}$ /50) | |
| Propagation Condition | | AWGN | | | | AWGN | | | | AWGN | | | | AWGN | | | | |
| Antenna Configuration | | 1x2 | | | | 1x2 | | | | 1x2 | | | | 1x2 | | | | |
| Timing offset to Cell 1 | μ s | - | | | | 0 | | | | 0 | | | | 3 | | | | |
| Time alignment error relative to cell 1 <small>Note5</small> | μ s | - | | | | \leq TAE | | | | \leq TAE | | | | N/A | | | | |
| Time alignment error relative to cell 2 <small>Note5</small> | μ s | - | | | | - | | | | \leq TAE | | | | N/A | | | | |

Note 1: OCNG shall be used such that all cells are fully allocated and a constant total transmitted power spectral density is achieved for all OFDM symbols.

Note 2: The resources for uplink transmission are assigned to the UE on cell1 prior to the start of time period T2 and on cell2 prior to the start of time period T4.

Note 3: Interference from other cells and noise sources not specified in the test is assumed to be constant over subcarriers and time and shall be modelled as AWGN of appropriate power for N_{oc} to be fulfilled.

Note 4: E_s/I_{ot} , RSRP, SCH_RP and I_o levels have been derived from other parameters for information purposes. They are not settable parameters themselves.

Note 5: Time alignment error (TAE) as specified in TS 36.104 [30] clause 6.5.3.1. The TAE value depends upon the type of carrier aggregation.

A.8.16.32.2 Test Requirements

The UE shall send one Event A6 triggered measurement report, with a measurement reporting delay less than 12.8s ($20 \times \text{scellMeasCycle}$) from the beginning of time period T2.

The UE shall send one Event A6 triggered measurement report, with a measurement reporting delay less than 3.2s ($5 \times \text{scellMeasCycle}$) from the beginning of time period T4.

The UE shall not send event triggered measurement reports, as long as the reporting criteria are not fulfilled.

The UE shall be scheduled on PCell continuously throughout the test. From the start of T1 until the measurement report is received during T2, at least 99.5% of all expected ACK/NACKs shall be transmitted by the UE.

The UE shall be scheduled on Cell2 continuously from the beginning of T4 to the end. From the start of T4 until the measurement report is received during T4, at least 99.5% of all expected ACK/NACKs shall be transmitted by the UE.

For a test to be considered successful requirements on both event detection and percentage of transmitted ACK/NACKs have to be fulfilled simultaneously.

The rate of correct events observed during repeated tests shall be at least 90%.

NOTE: The actual overall delays measured in the test may be up to $2 \times \text{TTI}_{\text{DCCH}}$ higher than the measurement reporting delays above because of TTI insertion uncertainty of the measurement report in DCCH.

A.8.16.33 E-UTRAN FDD 3 DL CA Event Triggered Reporting on Deactivated SCell with PCell and SCell Interruptions in Non-DRX

A.8.16.33.1 Test Purpose and Environment

The purpose of this test is to verify that the UE correctly detects event A6 (Neighbour becomes better than SCell) defined in TS 36.331 [2] within the requirements stated in clause 8.3.3.2.1 while at the same time fulfilling the requirement on interruption rate.

The test parameters are given in Table A.8.16.33.1-1 and A.8.16.33.1-2 below. In the test there are four cells: Cell 1, Cell 2, Cell 3 and Cell 4. Cell 1 is PCell on the FDD primary component (RF Channel 1), Cell 2 is SCell on the FDD secondary component (RF Channel 2), and Cell 3 is SCell on the FDD secondary component (RF Channel 3) and Cell 4 is the neighbour cell on the FDD secondary component (RF Channel 3). It is indicated to the UE in the measurement control information that event-triggered reporting with Event A6 is used. The test consists of four successive time periods, with duration of T1, T2, T3 and T4, respectively. During T1 and T2, both Cell2 and Cell3 are deactivated. During T1 the UE shall not have any information of cell 4. Immediately at beginning of T2 the transmission power of cell 4 is increased to same level as for cell 3, and due to usage of an offset this shall result in reporting of Event A6.

At the beginning of T3, the transmission power of Cell 4 is turned off and the test equipment sends a MAC message for activation of Cell 2 to UE but Cell3 remains deactivated. Immediately at beginning of T4 the transmission power of Cell 4 is increased to same level as for Cell 3, and due to usage of an offset this shall result in reporting of Event A6. The UE shall be continuously scheduled in the PCell throughout the whole test and continuously scheduled in Cell2 during T4.

Table A.8.16.33.1-1: General test parameters for E-UTRAN FDD 3 DL CA Event Triggered Reporting on Deactivated SCell with PCell and SCell interruptions in Non-DRX

| Parameter | Unit | Value | Comment |
|------------------------------|------|---------|---|
| E-UTRA RF Channel Number | | 1, 2, 3 | Three radio channels are used for this test |
| Active PCell | | Cell 1 | Primary cell on RF channel number 1. |
| Configured deactivated SCell | | Cell 2 | Configured deactivated secondary cell on RF channel number 2. |
| Configured deactivated SCell | | Cell 3 | Configured deactivated secondary cell on RF channel number 3. |
| Neighbour cell | | Cell 4 | Neighbor cell to be identified on RF channel number 3. |
| CP length | | Normal | |
| DRX | | OFF | Continuous monitoring of primary cell |

| | | | | |
|---|-----------------|----|-----------|---|
| A6 | Hysteresis | dB | 0 | Hysteresis for evaluation of event A6. |
| | Offset | dB | -3 | Offset parameter for evaluation of event A6. Needs to take relative accuracy tolerance in clause 9.1.11.2 into account plus margin. |
| | Report on leave | | False | |
| | Time To Trigger | s | 0 | |
| Cell-individual offset for cells on RF channel number 1 | dB | 0 | | Individual offset for cells on primary component carrier. |
| Cell-individual offset for cells on RF channel number 2 | dB | 0 | | Individual offset for cells on secondary component carrier. |
| Cell-individual offset for cells on RF channel number 3 | dB | 0 | | Individual offset for cells on secondary component carrier. |
| Filter coefficient | | | 0 | L3 filtering is not used |
| SCell measurement cycle | ms | | 640 | |
| T1 | s | | 4 | During this time the UE shall be aware of cells 1, 2 and 3 but not cell 4. |
| T2 | s | | ≤ 15 | UE should report Event A6 within 12.8s (20xscellMeasCycle) |
| T3 | s | | 4 | During this time the UE shall activate cell 2 |
| T4 | s | | ≤ 4 | UE should report Event A6 within 3.2s (5xscellMeasCycle) |

Table A.8.16.33.1-2: Cell specific test parameters for E-UTRAN FDD 3 DL CA Event Triggered Reporting on Deactivated SCell with PCell and SCell interruptions in Non-DRX (Cell #1 and Cell #2)

| Parameter | Unit | Cell 1 | | | | Cell 2 | | | | Cell 3 | | | | Cell 4 | | | |
|--|------|---|----|----|----|---|--|--|---|---|----|----|----|---|----|----|----|
| | | T1 | T2 | T3 | T4 | T1 | T2 | T3 | T4 | T1 | T2 | T3 | T4 | T1 | T2 | T3 | T4 |
| E-UTRA RF Channel Number | | 1 | | | | 2 | | | | 3 | | | | 3 | | | |
| BW _{channel} | | 5MHz: N _{RB,c} = 25 10MHz: N _{RB,c} = 50 20MHz: N _{RB,c} = 100 | | | | 5MHz: N _{RB,c} = 25 10MHz: N _{RB,c} = 50 20MHz: N _{RB,c} = 100 | | | | 5MHz: N _{RB,c} = 25 10MHz: N _{RB,c} = 50 20MHz: N _{RB,c} = 100 | | | | 5MHz: N _{RB,c} = 25 10MHz: N _{RB,c} = 50 20MHz: N _{RB,c} = 100 | | | |
| PDSCH parameters: DL Reference Measurement Channel | | 5MHz: R.7 FDD 10MHz: R.3 FDD 20MHz: R.6 FDD | | | | N/A | N/A | N/A | 5MHz: R.7 FDD 10MHz: R.3 FDD 20MHz: R.6 FDD | N/A | | | | N/A | | | |
| PCFICH/PDCCH/PHICH parameters | | 5MHz: R.11 FDD 10MHz: R.6 FDD 20MHz: R.10 FDD | | | | 5MHz: R.11 FDD 10MHz: R.6 FDD 20MHz: R.10 FDD | | | | 5MHz: R.11 FDD 10MHz: R.6 FDD 20MHz: R.10 FDD | | | | 5MHz: R.11 FDD 10MHz: R.6 FDD 20MHz: R.10 FDD | | | |
| OCNG Pattern defined in A.3.2.1 | | 5MHz: OP.20 FDD 10MHz: OP.10 FDD 20MHz: OP.17 FDD | | | | 5MHz: OP.19 FDD 10MHz: OP.6 FDD 20MHz: OP.14 FDD | 5MHz: OP.19 FDD 10MHz: OP.6FDD 20MHz: OP.14 FDD | 5MHz: OP.19 FDD 10MHz: OP.6 FDD 20MHz: OP.14 FDD | 5MHz: OP.20 FDD 10MHz: OP.10 FDD 20MHz: OP.17 FDD | 5MHz: OP.16 FDD 10MHz: OP.2 FDD 20MHz: OP.12 FDD | | | | 5MHz: OP.16 FDD 10MHz: OP.2 FDD 20MHz: OP.12 FDD | | | |
| PBCH_RA | dB | 0 | | | | 0 | | | | 0 | | | | 0 | | | |
| PBCH_RB | dB | | | | | | | | | | | | | | | | |
| PSS_RA | dB | | | | | | | | | | | | | | | | |
| SSS_RA | dB | | | | | | | | | | | | | | | | |
| PCFICH_RB | dB | | | | | | | | | | | | | | | | |
| PHICH_RA | dB | | | | | | | | | | | | | | | | |
| PHICH_RB | dB | | | | | | | | | | | | | | | | |
| PDCCH_RA | dB | | | | | | | | | | | | | | | | |
| PDCCH_RB | dB | | | | | | | | | | | | | | | | |
| PDSCH_RA | dB | | | | | | | | | | | | | | | | |
| PDSCH_RB | dB | | | | | | | | | | | | | | | | |
| OCNG_RA ^{Note 1} | dB | | | | | | | | | | | | | | | | |
| OCNG_RB ^{Note 1} | dB | | | | | | | | | | | | | | | | |

| | | | | | | | | | | | | | | | | | |
|---|------------|--|--|--|--|--|--|--|--|--|--|--|--|--|--|--|--|
| N_{oc} ^{Note 3} | dBm/15 kHz | -101 | | | | -101 | | | | -101 | | | | | | | |
| \hat{E}_s / N_{oc} | dB | 16 | 16 | 16 | 16 | 16 | 16 | 16 | 16 | 16 | 16 | 16 | 16 | - | 16 | - | 16 |
| \hat{E}_s / I_{ot} ^{Note 4} | dB | 16 | 16 | 16 | 16 | 16 | 16 | 16 | 16 | 16 | -0.11 | 16 | -0.11 | - | -0.11 | - | -0.11 |
| RSRP ^{Note 4} | dBm/15 kHz | -85 | -85 | -85 | -85 | -85 | -85 | -85 | -85 | -85 | -85 | -85 | -85 | - | -85 | - | -85 |
| SCH_RP ^{Note 4} | dBm/15 kHz | -85 | -85 | -85 | -85 | -85 | -85 | -85 | -85 | -85 | -85 | -85 | -85 | - | -85 | - | -85 |
| I_o ^{Note 4} | dBm/Ch BW | -57.11 +10log ($N_{RB,c}$ /50) | -57.11 +10log ($N_{RB,c}$ /50) | -57.11 +10log ($N_{RB,c}$ /50) | -57.11 +10log ($N_{RB,c}$ /50) | -57.11 +10log ($N_{RB,c}$ /50) | -57.11 +10log ($N_{RB,c}$ /50) | -57.11 +10log ($N_{RB,c}$ /50) | -57.11 +10log ($N_{RB,c}$ /50) | -57.11 +10log ($N_{RB,c}$ /50) | -54.15 +10log ($N_{RB,c}$ /50) | -57.11 +10log ($N_{RB,c}$ /50) | -54.15 +10log ($N_{RB,c}$ /50) | -57.11 +10log ($N_{RB,c}$ /50) | -54.15 +10log ($N_{RB,c}$ /50) | -57.11 +10log ($N_{RB,c}$ /50) | -54.15 +10log ($N_{RB,c}$ /50) |
| Propagation Condition | | AWGN | | | | AWGN | | | | AWGN | | | | AWGN | | | |
| Antenna Configuration | | 1x2 | | | | 1x2 | | | | 1x2 | | | | 1x2 | | | |
| Timing offset to Cell 1 | μ s | - | | | | 0 | | | | 0 | | | | 3 | | | |
| Time alignment error relative to cell 1 ^{Note 5} | μ s | - | | | | \leq TAE | | | | \leq TAE | | | | N/A | | | |
| Time alignment error relative to cell 2 ^{Note 5} | μ s | - | | | | - | | | | \leq TAE | | | | N/A | | | |

Note 1: OCNB shall be used such that all cells are fully allocated and a constant total transmitted power spectral density is achieved for all OFDM symbols.

Note 2: The resources for uplink transmission are assigned to the UE on cell1 from the start of time period T2 and on cell2 from the start of time period T4.

Note 3: Interference from other cells and noise sources not specified in the test is assumed to be constant over subcarriers and time and shall be modelled as AWGN of appropriate power for N_{oc} to be fulfilled.

Note 4: E_s/I_{ot} , RSRP, SCH_RP and I_o levels have been derived from other parameters for information purposes. They are not settable parameters themselves.

Note 5: Time alignment error (TAE) as specified in TS 36.104 [30] clause 6.5.3.1. The TAE value depends upon the type of carrier aggregation.

A.8.16.33.2 Test Requirements

The UE shall send one Event A6 triggered measurement report, with a measurement reporting delay less than 12.8s ($20 \times \text{scellMeasCycle}$) from the beginning of time period T2.

The UE shall send one Event A6 triggered measurement report, with a measurement reporting delay less than 3.2s ($5 \times \text{scellMeasCycle}$) from the beginning of time period T4.

The UE shall not send event triggered measurement reports, as long as the reporting criteria are not fulfilled.

The UE shall be scheduled on PCell continuously throughout the test. From the start of T1 until the measurement report is received during T2, at least 99.5% of all expected ACK/NACKs shall be transmitted by the UE.

The UE shall be scheduled on Cell2 continuously from the beginning of T4 to the end. From the start of T4 until the measurement report is received during T4, at least 99.5% of all expected ACK/NACKs shall be transmitted by the UE.

For a test to be considered successful requirements on both event detection and percentage of transmitted ACK/NACKs have to be fulfilled simultaneously.

The rate of correct events observed during repeated tests shall be at least 90%.

NOTE: The actual overall delays measured in the test may be up to $2 \times \text{TTI}_{\text{DCCH}}$ higher than the measurement reporting delays above because of TTI insertion uncertainty of the measurement report in DCCH.

A.8.16.34 E-UTRAN TDD 3 DL CA Event Triggered Reporting on Deactivated SCell with PCell and SCell Interruptions in Non-DRX

A.8.16.34.1 Test Purpose and Environment

The purpose of this test is to verify that the UE correctly detects event A6 (Neighbour becomes better than SCell) defined in TS 36.331 [2] within the requirements stated in clause 8.3.3.2.1 while at the same time fulfilling the requirement on interruption rate.

The test parameters are given in Table A.8.16.34.1-1 and A.8.16.34.1-2 below. In the test there are four cells: Cell 1, Cell 2, Cell 3 and Cell 4. Cell 1 is PCell on the TDD primary component (RF Channel 1), Cell 2 is SCell on the TDD secondary component (RF Channel 2), and Cell 3 is SCell on the TDD secondary component (RF Channel 3) and Cell 4 is the neighbour cell on the TDD secondary component (RF Channel 3). It is indicated to the UE in the measurement control information that event-triggered reporting with Event A6 is used. The test consists of four successive time periods, with duration of T1, T2, T3 and T4, respectively. During T1 and T2, both Cell2 and Cell3 are deactivated. During T1 the UE shall not have any information of cell 4. Immediately at beginning of T2 the transmission power of cell 4 is increased to same level as for cell 3, and due to usage of an offset this shall result in reporting of Event A6.

At the beginning of T3, the transmission power of Cell 4 is turned off and the test equipment sends a MAC message for activation of Cell 2 to UE but Cell3 remains deactivated. Immediately at beginning of T4 the transmission power of cell 4 is increased to same level as for cell 3, and due to usage of an offset this shall result in reporting of Event A6. The UE shall be continuously scheduled in the PCell throughout the whole test and continuously scheduled in Cell 2 during T4.

Table A.8.16.34.1-1: General test parameters for E-UTRAN TDD 3 DL CA Event Triggered Reporting on Deactivated SCell with PCell and SCell interruptions in Non-DRX

| Parameter | Unit | Value | Comment |
|--------------------------------|------|---------|--|
| E-UTRA RF Channel Number | | 1, 2, 3 | three radio channels are used for this test |
| Active PCell | | Cell 1 | Primary cell on RF channel number 1. |
| Configured deactivated SCell | | Cell 2 | Configured deactivated secondary cell on RF channel number 2. |
| Configured deactivated SCell | | Cell 3 | Configured deactivated secondary cell on RF channel number 3. |
| Neighbour cell | | Cell 4 | Neighbor cell to be identified on RF channel number 3. |
| CP length | | Normal | |
| Special subframe configuration | | 6 | As specified in table 4.2-1 in TS 36.211. The same configuration in both cells |

| | | | | |
|---|-----------------|----|-------|---|
| Uplink-downlink configuration | | | 1 | As specified in table 4.2-2 in TS 36.211. The same configuration in both cells |
| DRX | | | OFF | Continuous monitoring of primary cell |
| A6 | Hysteresis | dB | 0 | Hysteresis for evaluation of event A6. |
| | Offset | dB | -3 | Offset parameter for evaluation of event A6. Needs to take relative accuracy tolerance in clause 9.1.11.2 into account plus margin. |
| | Report on leave | | False | |
| | Time To Trigger | s | 0 | |
| Cell-individual offset for cells on RF channel number 1 | | dB | 0 | Individual offset for cells on primary component carrier. |
| Cell-individual offset for cells on RF channel number 2 | | dB | 0 | Individual offset for cells on secondary component carrier. |
| Cell-individual offset for cells on RF channel number 3 | | dB | 0 | Individual offset for cells on secondary component carrier. |
| Filter coefficient | | | 0 | L3 filtering is not used |
| SCell measurement cycle | | ms | 640 | |
| T1 | | s | 4 | During this time the UE shall be aware of cells 1, 2 and 3 but not cell 4. |
| T2 | | s | ≤15 | UE should report Event A6 within 12.8s (20×scellMeasCycle) |
| T3 | | s | 4 | During this time the UE shall activate cell 2 |
| T4 | | s | ≤4 | UE should report Event A6 within 3.2s (5×scellMeasCycle) |

Table A.8.16.34.1-2: Cell specific test parameters for E-UTRAN TDD 3 DL CA Event Triggered Reporting on Deactivated SCell with PCell and SCell interruptions in Non-DRX

| Parameter | Unit | Cell 1 | | | | Cell 2 | | | | Cell 3 | | | | Cell 4 | | | |
|--|------|---|----|----|----|---|-----------------|-----------------|---|---|----|----|----|---|----|----|----|
| | | T1 | T2 | T3 | T4 | T1 | T2 | T3 | T4 | T1 | T2 | T3 | T4 | T1 | T2 | T3 | T4 |
| E-UTRA RF Channel Number | | 1 | | | | 2 | | | | 3 | | | | 3 | | | |
| BW _{channel} | MHz | 5MHz: N _{RB,c} = 25 10MHz: N _{RB,c} = 50 20MHz: N _{RB,c} = 100 | | | | 5MHz: N _{RB,c} = 25 10MHz: N _{RB,c} = 50 20MHz: N _{RB,c} = 100 | | | | 5MHz: N _{RB,c} = 25 10MHz: N _{RB,c} = 50 20MHz: N _{RB,c} = 100 | | | | 5MHz: N _{RB,c} = 25 10MHz: N _{RB,c} = 50 20MHz: N _{RB,c} = 100 | | | |
| PDSCH parameters: DL Reference Measurement Channel | | 5MHz: R.4 TDD 10MHz: R.0 TDD 20MHz: R.3 TDD | | | | N/A | N/A | N/A | 5MHz: R.4 TDD 10MHz: R.0 TDD 20MHz: R.3 TDD | N/A | | | | N/A | | | |
| PCFICH/PDCCH/HICH parameters: DL Reference Measurement Channel | | 5MHz: R.11 TDD 10MHz: R.6 TDD 20MHz: R.10 TDD | | | | 5MHz: R.11 TDD 10MHz: R.6 TDD 20MHz: R.10 TDD | | | | 5MHz: R.11 TDD 10MHz: R.6 TDD 20MHz: R.10 TDD | | | | 5MHz: R.11 TDD 10MHz: R.6 TDD 20MHz: R.10 TDD | | | |
| OCNG Pattern defined in A.3.2.2 | | 5MHz: OP.9 TDD 10MHz: OP.1 TDD 20MHz: OP.7 TDD | | | | 5MHz: OP.10 TDD | 5MHz: OP.10 TDD | 5MHz: OP.10 TDD | 5MHz: OP.9 TDD | 5MHz: OP.10 TDD 10MHz: OP.2 TDD 20MHz: OP.8 TDD | | | | 5MHz: OP.10 TDD 10MHz: OP.2 TDD 20MHz: OP.8 TDD | | | |
| PBCH_RA | dB | 0 | | | | 0 | | | | 0 | | | | 0 | | | |
| PBCH_RB | dB | | | | | | | | | | | | | | | | |
| PSS_RA | dB | | | | | | | | | | | | | | | | |
| SSS_RA | dB | | | | | | | | | | | | | | | | |
| PCFICH_RB | dB | | | | | | | | | | | | | | | | |
| PHICH_RA | dB | | | | | | | | | | | | | | | | |
| PHICH_RB | dB | | | | | | | | | | | | | | | | |
| PDCCH_RA | dB | | | | | | | | | | | | | | | | |
| PDCCH_RB | dB | | | | | | | | | | | | | | | | |
| PDSCH_RA | dB | | | | | | | | | | | | | | | | |
| PDSCH_RB | dB | | | | | | | | | | | | | | | | |
| OCNG_RA ^{Note 1} | dB | | | | | | | | | | | | | | | | |

| | | | | | | | | | | | | | | | | | |
|---|------------|--|--|--|--|--|--|--|--|--|--|--|--|--|--|--|--|
| OCNG_RB ^{Note 1} | dB | | | | | | | | | | | | | | | | |
| N_{oc} ^{Note 3} | dBm/15 kHz | -101 | | | | -101 | | | | -101 | | | | | | | |
| \hat{E}_s / N_{oc} | dB | 16 | 16 | 16 | 16 | 16 | 16 | 16 | 16 | 16 | 16 | 16 | 16 | -Infinity | 16 | -Infinity | 16 |
| \hat{E}_s / I_{ot} ^{Note 4} | dB | 16 | 16 | 16 | 16 | 16 | 16 | 16 | 16 | 16 | -0.11 | 16 | -0.11 | -Infinity | -0.11 | -Infinity | -0.11 |
| RSRP ^{Note 4} | dBm/15 kHz | -85 | -85 | -85 | -85 | -85 | -85 | -85 | -85 | -85 | -85 | -85 | -85 | -85 | -85 | -85 | -85 |
| SCH_RP ^{Note 4} | dBm/15 kHz | -85 | -85 | -85 | -85 | -85 | -85 | -85 | -85 | -85 | -85 | -85 | -85 | -85 | -85 | -85 | -85 |
| I_o ^{Note 4} | dBm/Ch BW | -57.11 +10log ($N_{RB,c}$ /50) | -57.11 +10log ($N_{RB,c}$ /50) | -57.11 +10log ($N_{RB,c}$ /50) | -57.11 +10log ($N_{RB,c}$ /50) | -57.11 +10log ($N_{RB,c}$ /50) | -57.11 +10log ($N_{RB,c}$ /50) | -57.11 +10log ($N_{RB,c}$ /50) | -57.11 +10log ($N_{RB,c}$ /50) | -57.11 +10log ($N_{RB,c}$ /50) | -54.15 +10log ($N_{RB,c}$ /50) | -57.11 +10log ($N_{RB,c}$ /50) | -54.15 +10log ($N_{RB,c}$ /50) | -57.11 +10log ($N_{RB,c}$ /50) | -54.15 +10log ($N_{RB,c}$ /50) | -57.11 +10log ($N_{RB,c}$ /50) | -54.15 +10log ($N_{RB,c}$ /50) |
| Propagation Condition | | AWGN | | | | AWGN | | | | AWGN | | | | | | | |
| Antenna Configuration | | 1x2 | | | | 1x2 | | | | 1x2 | | | | | | | |
| Timing offset to Cell 1 | μ s | - | | | | 0 | | | | 0 | | | | | | | |
| Time alignment error relative to cell 1 ^{Note 5} | μ s | - | | | | \leq TAE | | | | \leq TAE | | | | | | | |
| Time alignment error relative to cell 2 ^{Note 5} | μ s | - | | | | - | | | | \leq TAE | | | | | | | |

Note 1: OCNG shall be used such that all cells are fully allocated and a constant total transmitted power spectral density is achieved for all OFDM symbols.

Note 2: The resources for uplink transmission are assigned to the UE on cell1 prior to the start of time period T2 and on cell2 prior to the start of time period T4.

Note 3: Interference from other cells and noise sources not specified in the test is assumed to be constant over subcarriers and time and shall be modelled as AWGN of appropriate power for N_{oc} to be fulfilled.

Note 4: E_s/I_{ot} , RSRP, SCH_RP and I_o levels have been derived from other parameters for information purposes. They are not settable parameters themselves.

Note 5: Time alignment error (TAE) as specified in TS 36.104 [30] clause 6.5.3.1. The TAE value depends upon the type of carrier aggregation.

A.8.16.34.2 Test Requirements

The UE shall send one Event A6 triggered measurement report, with a measurement reporting delay less than 12.8s ($20 \times \text{scellMeasCycle}$) from the beginning of time period T2.

The UE shall send one Event A6 triggered measurement report, with a measurement reporting delay less than 3.2s ($5 \times \text{scellMeasCycle}$) from the beginning of time period T4.

The UE shall not send event triggered measurement reports, as long as the reporting criteria are not fulfilled.

The UE shall be scheduled on PCell continuously throughout the test. From the start of T1 until the measurement report is received during T2, at least 99.5% of all expected ACK/NACKs shall be transmitted by the UE.

The UE shall be scheduled on Cell2 continuously from the start of T4 to the end. From the start of T4 until the measurement report is received during T4, at least 99.5% of all expected ACK/NACKs shall be transmitted by the UE.

For a test to be considered successful requirements on both event detection and percentage of transmitted ACK/NACKs have to be fulfilled simultaneously.

The rate of correct events observed during repeated tests shall be at least 90%.

NOTE: The actual overall delays measured in the test may be up to $2 \times \text{TTI}_{\text{DCCH}}$ higher than the measurement reporting delays above because of TTI insertion uncertainty of the measurement report in DCCH.

A.8.16.35 3 DL PCell in FDD CA Activation and Deactivation of Known SCell in Non-DRX

A.8.16.35.1 Test Purpose and Environment

The purpose of this test is to verify that the SCell activation and deactivation times are within the requirements stated in section 7.7 for UE configured with two downlink SCells, when the SCell is known by the UE at the time of activation and PCell is in FDD.

The test parameters are given in Tables A.8.16.35.1-1 and cell-specific parameters in A.8.16.35.1-2 below. The test consists of three successive time periods, with duration of T1, T2 and T3, respectively. There are three carriers, each with one cell. All cells have constant signal levels throughout the test. Before the test starts the UE is connected to Cell 1 (PCell) on radio channel 1 (PCC) and deactivated Cell 3 (SCell2) on radio channel 3 (SCC2) but is not aware of Cell 2 (SCell1) on radio channel 2 (SCC1). The UE is only monitoring the PCC and SCC2. The UE shall be continuously scheduled in the PCell throughout the whole test.

At the beginning of T1 the UE receives an RRC message by which the SCell1 (Cell 2) becomes configured on radio channel 2 (SCC1). The UE now starts monitoring also the SCC1. The test equipment sends a MAC message for activation of the SCell1.

The point in time at which the MAC message is received at the UE antenna connector, in a subframe # denoted m which is an even number, defines the start of time period T2. At the beginning of T2 the test equipment sends a MAC message for activation of the SCell1. The UE receives the SCell2 activation command in a subframe ($m+10$) during activation of the SCell1. The UE shall be able to report valid CSI for the activated SCell1 at latest in subframe ($m+29$). The UE shall start reporting CSI for SCell1 in subframe ($m+8$) and shall report CQI index 0 (out-of-range) until the SCell activation has been completed. Any PCell interruption due to activation of SCells shall occur in the subframes ($m+5$) to ($m+9$) and ($m+15$) to ($m+19$).

Time period T3 starts when a MAC message for deactivation of SCell1, sent from the test equipment to the UE in a subframe # denoted n which is an even number, is received at the UE antenna connector. The test equipment sends a MAC message for deactivation of the SCell2 in subframe ($n+10$). The UE shall carry out deactivation of the SCell1 at latest in subframe ($n+8$), and any PCell interruption due to the deactivation of SCells shall occur in the subframes ($n+5$) to ($n+9$) and ($n+15$) to ($n+19$).

The test equipment verifies that potential interruption is carried out in the correct time span by monitoring ACK/NACK sent in PCell during activation and deactivation of SCell1, respectively.

The test equipment verifies the activation time by counting the subframes from the time when the SCell1 activation command is sent until a CSI report with other than CQI index 0 is received.

The test equipment verifies the deactivation time by counting the subframes from the time when the SCell1 deactivation command is sent until CQI reporting for SCell1 is discontinued.

Table A.8.16.35.1-1: General test parameters for known SCell1 activation case

| Parameter | Unit | Value | Comment |
|---|------|---------|--|
| E-UTRA RF Channel Number | | 1, 2, 3 | Three radio channels are used for this test |
| Active PCell | | Cell 1 | Primary cell on RF channel number 1. |
| Deconfigured deactivated SCell1 | | Cell 2 | Deconfigured deactivated secondary cell on RF channel number 2. |
| Configured deactivated SCell2 | | Cell 3 | Configured deactivated secondary cell on RF channel number 3. |
| CP length | | Normal | |
| DRX | | OFF | Continuous monitoring of primary cell |
| CQI/PMI periodicity and offset configuration index | | 0 | CQI reporting for SCell every second subframe |
| Cell-individual offset for cells on RF channel number 1 | dB | 0 | Individual offset for cells on PCC. |
| Cell-individual offset for cells on RF channel number 2 | dB | 0 | Individual offset for cells on SCC1. |
| Cell-individual offset for cells on RF channel number 3 | dB | 0 | Individual offset for cells on SCC2. |
| SCell measurement cycle (measCycleSCell) | ms | 320 | |
| T1 | s | 7 | During this time the PCell and SCell2 shall be known and the SCell1 configured and detected. |
| T2 | s | 1 | During this time the UE shall activate the SCell1. |
| T3 | s | 1 | During this time the UE shall deactivate the SCell1. |

Table A.8.16.35.1-2: Cell specific test parameters for E-UTRAN TDD known SCell1 activation with PCell in FDD

| Parameter | Unit | Cell 1 | | | Cell 2 | | | Cell 3 | | |
|---|------------|---|----|----|---|----|----|---|----|----|
| | | T1 | T2 | T3 | T1 | T2 | T3 | T1 | T2 | T3 |
| E-UTRA RF Channel Number | | 1 | | | 2 | | | 3 | | |
| BW _{channel} | MHz | 5MHz: N _{RB,c} = 25 10MHz: N _{RB,c} = 50 20MHz: N _{RB,c} = 100 | | | 5MHz: N _{RB,c} = 25 10MHz: N _{RB,c} = 50 20MHz: N _{RB,c} = 100 | | | 5MHz: N _{RB,c} = 25 10MHz: N _{RB,c} = 50 20MHz: N _{RB,c} = 100 | | |
| PDSCH parameters: DL Reference Measurement Channel | | 5MHz: R.7 FDD 10MHz: R.3 FDD 20MHz: R.6 FDD | | | - | | | - | | |
| PCFICH/PDCCH/PHICH parameters: DL Reference Measurement Channel | | 5MHz: R.11 FDD 10MHz: R.6 FDD 20MHz: R.10 FDD | | | 5MHz: R.11 TDD 10MHz: R.6 TDD 20MHz: R.10 TDD | | | 5MHz: R.11 TDD 10MHz: R.6 TDD 20MHz: R.10 TDD | | |
| OCNG Patterns | | 5MHz: OP.20 FDD 10MHz: OP.10 FDD 20MHz: OP.17 FDD | | | 5MHz: OP.10 TDD 10MHz: OP.2 TDD 20MHz: OP.8 TDD | | | 5MHz: OP.10 TDD 10MHz: OP.2 TDD 20MHz: OP.8 TDD | | |
| PBCH_RA | dB | 0 | | | 0 | | | 0 | | |
| PBCH_RB | dB | | | | | | | | | |
| PSS_RA | dB | | | | | | | | | |
| SSS_RA | dB | | | | | | | | | |
| PCFICH_RB | dB | | | | | | | | | |
| PHICH_RA | dB | | | | | | | | | |
| PHICH_RB | dB | | | | | | | | | |
| PDCCH_RA | dB | | | | | | | | | |
| PDCCH_RB | dB | | | | | | | | | |
| PDSCH_RA | dB | | | | | | | | | |
| PDSCH_RB | dB | | | | | | | | | |
| OCNG_RA ^{Note 1} | dB | | | | | | | | | |
| OCNG_RB ^{Note 1} | dB | | | | | | | | | |
| N _{oc} ^{Note 2} | dBm/15 kHz | -104 | | | -104 | | | -104 | | |
| \bar{E}_s/N_{oc} | dB | 17 | | | 17 | | | 17 | | |
| \bar{E}_s/I_{ot} | dB | 17 | | | 17 | | | 17 | | |
| RSRP ^{Note 3} | dBm/15 kHz | -87 | | | -87 | | | -87 | | |

| | | | | |
|--|------------|---|---|---|
| SCH_RP ^{Note 3} | dBm/15 kHz | -87 | -87 | -87 |
| Io ^{Note 3} | dBm/Ch BW | -59.13 +10log (N _{RB,c} /50) | -59.13 +10log (N _{RB,c} /50) | -59.13 +10log (N _{RB,c} /50) |
| Propagation Condition | | AWGN | AWGN | AWGN |
| Antenna Configuration | | 1x2 | 1x2 | 1x2 |
| Timing offset to Cell 1 | μs | - | 0 | 0 |
| Time alignment error relative to cell 1 ^{Note 5} | μs | - | ≤ TAE | ≤ TAE |
| Time alignment error relative to cell 2 ^{Note 5} | μs | - | - | ≤ TAE |
| <p>Note 1: OCNG shall be used such that all cells are fully allocated and a constant total transmitted power spectral density is achieved for all OFDM symbols.</p> <p>Note 2: Interference from other cells and noise sources not specified in the test is assumed to be constant over subcarriers and time and shall be modelled as AWGN of appropriate power for N_{oc} to be fulfilled.</p> <p>Note 3: Es/Iot, RSRP, SCH_RP and Io levels have been derived from other parameters for information purposes. They are not settable parameters themselves.</p> <p>Note 4: The uplink resources for CSI reporting are assigned to the UE prior to the start of time period T2.</p> <p>Note 5: Time alignment error (TAE) as specified in TS 36.104 [30] clause 6.5.3.1. The TAE value depends upon the type of carrier aggregation.</p> | | | | |

A.8.16.35.2 Test Requirements

During T2 the UE shall send the first CSI report for SCell1 in a subframe (m+8), or in a subframe (m+10) if the subframe (m+8) was subject to interruption. Whether CSI report in subframe (m+8) was interrupted or not is checked by monitoring ACK/NACK sent in PCell in subframe (m+8).

During T2 the UE shall start sending CSI reports for SCell1 with non-zero CQI index at latest in a subframe (m+29).

During T3 the UE shall stop sending CSI reports for SCell1 at latest in a subframe (n+8).

During T2 interruption of PCell during SCells activation shall not happen outside the subframes (m+5) to (m+9) and outside the subframes (m+15) to (m+19).

During T3 interruption of PCell during SCells deactivation shall not happen outside the subframes (n+5) to (n+9) and outside the subframes (n+15) to (n+19).

The interruption of PCell shall not be more than the values specified for intra-band CA and inter-band CA in Section 7.8.2.

All of the above test requirements shall be fulfilled in order for the observed SCell1 activation delay and SCell1 deactivation delay to be counted as correct. The rate of correct observed SCell1 activation delay and SCell1 deactivation delay during repeated tests shall be at least 90%.

NOTE: During T2 if there are no uplink resources for reporting the valid CSI in a subframe (m+29) then the UE shall use the next available uplink resource for reporting the corresponding valid CSI.

A.8.16.36 3 DL PCell in TDD CA Activation and Deactivation of Known SCell in Non-DRX

A.8.16.36.1 Test Purpose and Environment

The purpose of this test is to verify that the SCell activation and deactivation times are within the requirements stated in section 7.7 for UE configured with two downlink SCells, when the SCell is known by the UE at the time of activation and PCell is in TDD.

The test parameters are given in Tables A.8.16.36.1-1 and cell-specific parameters in A.8.16.36.1-2 below. The test consists of three successive time periods, with duration of T1, T2 and T3, respectively. There are three carriers, each with one cell. All cells have constant signal levels throughout the test. Before the test starts the UE is connected to Cell 1 (PCell) on radio channel 1 (PCC) and deactivated Cell 3 (SCell2) on radio channel 3 (SCC2) but is not aware of Cell 2 (SCell1) on radio channel 2 (SCC1). The UE is only monitoring the PCC and SCC2. The UE shall be continuously scheduled in the PCell throughout the whole test.

At the beginning of T1 the UE receives an RRC message by which the SCell1 (Cell 2) becomes configured on radio channel 2 (SCC1). The UE now starts monitoring also the SCC1. The test equipment sends a MAC message for activation of the SCell1.

The point in time at which the MAC message is received at the UE antenna connector, in a subframe # denoted m , where m is 4 or 9, defines the start of time period T2. At the beginning of T2 the test equipment sends a MAC message for activation of the SCell1. The UE receives the SCell2 activation command in a subframe ($m+15$) during activation of the SCell1. The UE shall be able to report valid CSI for the activated SCell1 at latest in a subframe ($m+29$). The UE shall start reporting CSI for SCell1 in subframe ($m+8$) and shall report CQI index 0 (out-of-range) until the SCell activation has been completed. Any PCell interruption due to activation of SCells shall occur in the subframes ($m+5$) to ($m+11$) and ($m+20$) to ($m+26$).

Time period T3 starts when a MAC message for deactivation of SCell1, sent from the test equipment to the UE in a subframe # denoted n , where n is 4 or 9, is received at the UE antenna connector. The test equipment sends a MAC message for deactivation of the SCell2 in subframe ($n+15$). The UE shall carry out deactivation of the SCell1 at latest in subframe ($n+8$), and any PCell interruption due to the deactivation of SCells shall occur in the subframes ($n+5$) to ($n+11$) and ($n+20$) to ($n+26$).

The test equipment verifies that potential interruption is carried out in the correct time span by monitoring ACK/NACK sent in PCell during activation and deactivation of SCell1, respectively.

The test equipment verifies the activation time by counting the subframes from the time when the SCell1 activation command is sent until a CSI report with other than CQI index 0 is received.

The test equipment verifies the deactivation time by counting the subframes from the time when the SCell1 deactivation command is sent until CQI reporting for SCell1 is discontinued.

Table A.8.16.36.1-1: General test parameters for known SCell1 activation case

| Parameter | Unit | Value | Comment |
|---|------|---------|--|
| E-UTRA RF Channel Number | | 1, 2, 3 | Three radio channels are used for this test |
| Active PCell | | Cell 1 | Primary cell on RF channel number 1. |
| Deconfigured deactivated SCell | | Cell 2 | Deconfigured deactivated secondary cell on RF channel number 2. |
| Configured deactivated SCell2 | | Cell 3 | Configured deactivated secondary cell on RF channel number 3. |
| CP length | | Normal | |
| Special subframe configuration | | 6 | As specified in table 4.2.1 in TS 36.211. The same configuration applies to all cells. |
| Uplink-downlink configuration | | 1 | |
| DRX | | OFF | Continuous monitoring of primary cell |
| CQI/PMI periodicity and offset configuration index | | 0 | CQI reporting for SCell every UL subframe |
| Cell-individual offset for cells on RF channel number 1 | dB | 0 | Individual offset for cells on PCC. |
| Cell-individual offset for cells on RF channel number 2 | dB | 0 | Individual offset for cells on SCC1. |
| Cell-individual offset for cells on RF channel number 3 | dB | 0 | Individual offset for cells on SCC1. |
| SCell measurement cycle (measCycleSCell) | ms | 320 | |
| T1 | s | 7 | During this time the PCell and SCell2 shall be known and the SCell1 configured and detected. |
| T2 | s | 1 | During this time the UE shall activate the SCell1. |
| T3 | s | 1 | During this time the UE shall deactivate the SCell1. |

Table A.8.16.36.1-2: Cell specific test parameters for E-UTRAN FDD known SCell1 activation with PCell in TDD

| Parameter | Unit | Cell 1 | | | Cell 2 | | | Cell 3 | | |
|--------------------------|------|---|----|----|---|----|----|---|----|----|
| | | T1 | T2 | T3 | T1 | T2 | T3 | T1 | T2 | T3 |
| E-UTRA RF Channel Number | | 1 | | | 2 | | | 3 | | |
| BW _{channel} | MHz | 5MHz: N _{RB,c} = 25 10MHz: N _{RB,c} = 50 20MHz: N _{RB,c} = 100 | | | 5MHz: N _{RB,c} = 25 10MHz: N _{RB,c} = 50 20MHz: N _{RB,c} = 100 | | | 5MHz: N _{RB,c} = 25 10MHz: N _{RB,c} = 50 20MHz: N _{RB,c} = 100 | | |

| | | | | |
|--|------------|--|--|--|
| PDSCH parameters: DL Reference Measurement Channel | | 5MHz: R.4 TDD 10MHz: R.0 TDD 20MHz: R.3 TDD | - | - |
| PCFICH/PDCCH/PHICH parameters: DL Reference Measurement Channel | | 5MHz: R.11 TDD 10MHz: R.6 TDD 20MHz: R.10 TDD | 5MHz: R.11 FDD 10MHz: R.6 FDD 20MHz: R.10 FDD | 5MHz: R.11 FDD 10MHz: R.6 FDD 20MHz: R.10 FDD |
| OCNG Patterns | | 5MHz: OP.9 TDD 10MHz: OP.1 TDD 20MHz: OP.7 TDD | 5MHz: OP.16 FDD 10MHz: OP.2 FDD 20MHz: OP.12 FDD | 5MHz: OP.16 FDD 10MHz: OP.2 FDD 20MHz: OP.12 FDD |
| PBCH_RA | dB | 0 | 0 | 0 |
| PBCH_RB | dB | | | |
| PSS_RA | dB | | | |
| SSS_RA | dB | | | |
| PCFICH_RB | dB | | | |
| PHICH_RA | dB | | | |
| PHICH_RB | dB | | | |
| PDCCH_RA | dB | | | |
| PDCCH_RB | dB | | | |
| PDSCH_RA | dB | | | |
| PDSCH_RB | dB | | | |
| OCNG_RA ^{Note 1} | dB | | | |
| OCNG_RB ^{Note 1} | dB | | | |
| N_{oc} ^{Note 2} | dBm/15 kHz | | | |
| \bar{E}_s/N_{oc} | dB | 17 | 17 | 17 |
| \bar{E}_s/I_{ot} | dB | 17 | 17 | 17 |
| RSRP ^{Note 3} | dBm/15 kHz | -87 | -87 | -87 |
| SCH_RP ^{Note 3} | dBm/15 kHz | -87 | -87 | -87 |
| I_o ^{Note 3} | dBm/Ch BW | -59.13 +10log ($N_{RB,c}/50$) | -59.13 +10log ($N_{RB,c}/50$) | -59.13 +10log ($N_{RB,c}/50$) |
| Propagation Condition | | AWGN | AWGN | AWGN |
| Antenna Configuration | | 1x2 | 1x2 | 1x2 |
| Timing offset to Cell 1 | μ s | - | 0 | 0 |
| Time alignment error relative to cell 1 ^{Note 5} | μ s | - | \leq TAE | \leq TAE |
| Time alignment error relative to cell 2 ^{Note 5} | μ s | - | - | \leq TAE |
| <p>Note 1: OCNG shall be used such that all cells are fully allocated and a constant total transmitted power spectral density is achieved for all OFDM symbols.</p> <p>Note 2: Interference from other cells and noise sources not specified in the test is assumed to be constant over subcarriers and time and shall be modelled as AWGN of appropriate power for N_{oc} to be fulfilled.</p> <p>Note 3: \bar{E}_s/I_{ot}, RSRP, SCH_RP and I_o levels have been derived from other parameters for information purposes. They are not settable parameters themselves.</p> <p>Note 4: The uplink resources for CSI reporting are assigned to the UE prior to the start of time period T2.</p> <p>Note 5: Time alignment error (TAE) as specified in TS 36.104 [30] clause 6.5.3.1. The TAE value depends upon the type of carrier aggregation.</p> | | | | |

A.8.16.36.2 Test Requirements

During T2 the UE shall send the first CSI report for SCell1 in a subframe (m+8,) or in a subframe (m+9) if the subframe (m+8) was subject to interruption. Whether CSI report in subframe (m+8) was interrupted or not is checked by monitoring ACK/NACK sent in PCell in subframe (m+8).

During T2 the UE shall start sending CSI reports for SCell1 with non-zero CQI index at latest in a subframe (m+29).

During T3 the UE shall stop sending CSI reports for SCell at latest in a subframe (n+8).

During T2 interruption of PCell during SCells activation shall not happen outside the subframes (m+5) to (m+11) and outside the subframes (m+20) to (m+26).

During T3 interruption of PCell during SCells deactivation shall not happen outside the subframes (n+5) to (n+11) and outside the subframes (n+20) to (n+26).

The interruption of PCell shall not be more than the values specified for intra-band CA and inter-band CA in Section 7.8.2.

All of the above test requirements shall be fulfilled in order for the observed SCell1 activation delay and SCell1 deactivation delay to be counted as correct. The rate of correct observed SCell1 activation delay and SCell1 deactivation delay during repeated tests shall be at least 90%.

NOTE: During T2 if there are no uplink resources for reporting the valid CSI in a subframe (m+29) then the UE shall use the next available uplink resource for reporting the corresponding valid CSI.

A.8.16.37 3 DL FDD CA activation and deactivation of known SCell in non-DRX

A.8.16.37.1 Test Purpose and Environment

The purpose of this test is to verify that SCell activation and deactivation times are within the requirements stated in clause 7.7 for 3DL FDD carrier aggregation, when the SCells are known by the UE at the time of activation.

The test parameters are given in Tables A.8.16.37-1 and cell-specific parameters in A.8.16.37-2 below. The test consists of three successive time periods, with duration of T1, T2 and T3, respectively. There are three carriers, each with one cell. All cells have constant signal levels throughout the test. Before the test starts the UE is connected to Cell 1 (PCell) on radio channel 1 (PCC) and Cell 3 (deactivated SCell2) on radio channel 3 (SCC2), but is not aware of Cell 2 (SCell1) on radio channel 2 (SCC1). The UE is only monitoring the PCC and SCC2. The UE shall be continuously scheduled in the PCell throughout the whole test.

At the beginning of T1 the UE receives an RRC message by which the SCell1 (Cell 2) becomes configured on radio channel 2 (SCC1). The UE now starts monitoring also the SCC1. The test equipment sends a MAC message for activation of the SCell1.

The point in time at which the MAC message is received at the UE antenna connector, in a subframe # denoted m which is an even number, defines the start of time period T2. At the beginning of T2 the test equipment sends a MAC message for activation of the SCell1. The UE receives the SCell2 activation command in a subframe (m+10) during activation of the SCell1. The UE shall be able to report valid CSIs for the activated SCell1 at latest in a subframe (m+29). The UE shall start reporting CSI for SCell1 in subframe (m+8) and shall report CQI index 0 (out-of-range) until the SCell activation has been completed. Any PCell interruption due to activation of SCells shall occur in the subframes (m+5) to (m+9) and (m+15) to (m+19).

Time period T3 starts when a MAC message for deactivation of SCell1, sent from the test equipment to the UE in a subframe # denoted n which is an even number, is received at the UE antenna connector. The test equipment sends a MAC message for deactivation of the SCell2 in subframe (n+10). The UE shall carry out deactivation of the SCell1 at latest in subframe (n+8), and any PCell interruption due to the deactivation of SCells shall occur in the subframes (n+5) to (n+9) and (n+15) to (n+19).

The test equipment verifies that potential interruption is carried out in the correct time span by monitoring ACK/NACK sent in PCell during activation and deactivation of SCells, respectively.

The test equipment verifies the activation time by counting the subframes from the time when the SCell1 activation command is sent until a CSI report with other than CQI index 0 is received.

The test equipment verifies the deactivation time by counting the subframes from the time when the SCell1 deactivation command is sent until CQI reporting for SCell1 is discontinued.

Table A.8.16.37-1: General test parameters for E-UTRAN FDD 3 DL CA activation and deactivation of known SCell in non-DRX

| Parameter | Unit | Value | Comment |
|---|------|---------|---|
| E-UTRA RF Channel Number | | 1, 2, 3 | Three radio channels are used for this test |
| Active PCell | | Cell 1 | Primary cell on RF channel number 1. |
| Deconfigured SCell | | Cell 2 | Deconfigured secondary cell on RF channel number 2. |
| Configured deactivated SCell | | Cell 3 | Configured deactivated secondary cell on RF channel number 3. |
| CP length | | Normal | |
| DRX | | OFF | Continuous monitoring of primary cell |
| CQI/PMI periodicity and offset configuration index | | 0 | CQI reporting for SCells every second subframe |
| Cell-individual offset for cells on RF channel number 1 | dB | 0 | Individual offset for cells on PCC. |
| Cell-individual offset for cells on RF channel number 2 | dB | 0 | Individual offset for cells on SCC1. |
| Cell-individual offset for cells on RF channel number 3 | dB | 0 | Individual offset for cells on SCC2. |
| Filter coefficient | | 0 | L3 filtering is not used |

| | | | |
|--|----|-----|--|
| SCell measurement cycle (measCycleSCell) | ms | 320 | |
| T1 | s | 7 | During this time the PCell and SCell2 shall be known and the SCell1 configured and detected. |
| T2 | s | 1 | During this time the UE shall activate the SCell1 and SCell2. |
| T3 | s | 1 | During this time the UE shall deactivate the SCell1 and SCell2. |

Table A.8.16.37-2: Cell specific test parameters for E-UTRAN FDD 3 DL CA activation and deactivation of known SCell in non-DRX

| Parameter | Unit | Cell 1 | | | Cell 2 | | | Cell 3 | | |
|--|---|---|----|----|---|----|----|---|----|----|
| | | T1 | T2 | T3 | T1 | T2 | T3 | T1 | T2 | T3 |
| E-UTRA RF Channel Number | | 1 | | | 2 | | | 3 | | |
| BW _{channel} | | 5MHz: N _{RB,c} = 25 10MHz: N _{RB,c} = 50 20MHz: N _{RB,c} = 100 | | | 5MHz: N _{RB,c} = 25 10MHz: N _{RB,c} = 50 20MHz: N _{RB,c} = 100 | | | 5MHz: N _{RB,c} = 25 10MHz: N _{RB,c} = 50 20MHz: N _{RB,c} = 100 | | |
| PDSCH parameters: DL Reference Measurement Channel | | 5MHz: R.7 FDD 10MHz: R.3 FDD 20MHz: R.6 FDD | | | - | | | - | | |
| PCFICH/PDCCH/PHICH parameters: DL Reference Measurement Channel | | 5MHz: R.11 FDD 10MHz: R.6 FDD 20MHz: R.10 FDD | | | 5MHz: R.11 FDD 10MHz: R.6 FDD 20MHz: R.10 FDD | | | 5MHz: R.11 FDD 10MHz: R.6 FDD 20MHz: R.10 FDD | | |
| OCNG Patterns | | 5MHz: OP.20 FDD 10MHz: OP.10 FDD 20MHz: OP.17 FDD | | | 5MHz: OP.16 FDD 10MHz: OP.2 FDD 20MHz: OP.12 FDD | | | 5MHz: OP.16 FDD 10MHz: OP.2 FDD 20MHz: OP.12 FDD | | |
| PBCH_RA | dB | 0 | | | 0 | | | 0 | | |
| PBCH_RB | dB | | | | | | | | | |
| PSS_RA | dB | | | | | | | | | |
| SSS_RA | dB | | | | | | | | | |
| PCFICH_RB | dB | | | | | | | | | |
| PHICH_RA | dB | | | | | | | | | |
| PHICH_RB | dB | | | | | | | | | |
| PDCCH_RA | dB | | | | | | | | | |
| PDCCH_RB | dB | | | | | | | | | |
| PDSCH_RA | dB | | | | | | | | | |
| PDSCH_RB | dB | | | | | | | | | |
| OCNG_RA ^{Note 1} | dB | | | | | | | | | |
| OCNG_RB ^{Note 1} | dB | | | | | | | | | |
| N _{oc} ^{Note 2} | dBm/15 kHz | -104 | | | -104 | | | -104 | | |
| E _s /N _{oc} | dB | 17 | | | 17 | | | 17 | | |
| E _s /I _{ot} ^{Note 3} | dB | 17 | | | 17 | | | 17 | | |
| RSRP ^{Note 3} | dBm/15 kHz | -87 | | | -87 | | | -87 | | |
| SCH_RP ^{Note 3} | dBm/15 kHz | -87 | | | -87 | | | -87 | | |
| I _o ^{Note 3} | dBm/Ch BW | -59.13+10log (N _{RB,c} /50) | | | -59.13+10log (N _{RB,c} /50) | | | -59.13+10log (N _{RB,c} /50) | | |
| Propagation Condition | | AWGN | | | AWGN | | | AWGN | | |
| Antenna Configuration | | 1x2 | | | 1x2 | | | 1x2 | | |
| Timing offset to Cell 1 | μs | - | | | 0 | | | 0 | | |
| Time alignment error relative to cell 1 ^{Note 5} | μs | - | | | ≤ TAE | | | ≤ TAE | | |
| Time alignment error relative to cell 2 ^{Note 5} | μs | - | | | - | | | ≤ TAE | | |
| Note 1: | OCNG shall be used such that all cells are fully allocated and a constant total transmitted power spectral density is achieved for all OFDM symbols. | | | | | | | | | |
| Note 2: | Interference from other cells and noise sources not specified in the test is assumed to be constant over subcarriers and time and shall be modelled as AWGN of appropriate power for N _{oc} to be fulfilled. | | | | | | | | | |
| Note 3: | E _s /I _{ot} , RSRP, SCH_RP and I _o have been derived from other parameters for information purposes. They are not settable parameters themselves. | | | | | | | | | |
| Note 4: | The uplink resources for CSI reporting are assigned to the UE prior to the start of time period T2. | | | | | | | | | |
| Note 5: | Time alignment error (TAE) as specified in TS 36.104 [30] clause 6.5.3.1. The TAE value depends upon the type of carrier aggregation. | | | | | | | | | |

A.8.16.37.2 Test Requirements

During T2 the UE shall send the first CSI report for SCell1 in a subframe (m+8), or in a subframe (m+10) if the subframe (m+8) was subject to interruption. Whether CSI report in subframe (m+8) was interrupted or not is checked by monitoring ACK/NACK sent in PCell in subframe (m+8).

During T2 the UE shall start sending CSI reports for SCell1 with non-zero CQI index at latest in a subframe (m+29).

During T3 the UE shall stop sending CSI reports for SCell1 at latest in a subframe (n+8).

During T2 interruption of PCell during SCells activation shall not happen outside the subframes (m+5) to (m+9) and outside the subframes (m+15) to (m+19).

During T3 interruption of PCell during SCells deactivation shall not happen outside the subframes (n+5) to (n+9) and outside the subframes (n+15) to (n+19).

The interruption of PCell shall not be more than the values specified for intra-band CA and inter-band CA in Section 7.8.2.

All of the above test requirements shall be fulfilled in order for the observed SCell1 activation delay and SCell1 deactivation delay to be counted as correct. The rate of correct observed SCell1 activation delay and SCell1 deactivation delay during repeated tests shall be at least 90%.

NOTE: During T2 if there are no uplink resources for reporting the valid CSI in a subframe (m+29) then the UE shall use the next available uplink resource for reporting the corresponding valid CSI.

A.8.16.38 3 DL TDD CA activation and deactivation of known SCell in non-DRX

A.8.16.38.1 Test Purpose and Environment

The purpose of this test is to verify that SCell activation and deactivation times are within the requirements stated in clause 7.7 for 3DL TDD carrier aggregation, when the SCells are known by the UE at the time of activation.

The test parameters are given in Tables A.8.16.38-1 and cell-specific parameters in A.8.16.38-2 below. The test consists of three successive time periods, with duration of T1, T2 and T3, respectively. There are three carriers, each with one cell. All cells have constant signal levels throughout the test. Before the test starts the UE is connected to Cell 1 (PCell) on radio channel 1 (PCC) and Cell 3 (deactivated SCell2) on radio channel 3 (SCC2), but is not aware of Cell 2 (SCell1) on radio channel 2 (SCC1). The UE is only monitoring the PCC and SCC2. The UE shall be continuously scheduled in the PCell throughout the whole test.

At the beginning of T1 the UE receives an RRC message by which the SCell1 (Cell 2) becomes configured on radio channel 2 (SCC1). The UE now starts monitoring also the SCC1. The test equipment sends a MAC message for activation of the SCell1.

The point in time at which the MAC message is received at the UE antenna connector, in a subframe # denoted m, where m is 4 or 9, defines the start of time period T2. At the beginning of T2 the test equipment sends a MAC message for activation of the SCell1. The UE receives the SCell2 activation command in a subframe (m+15) during activation of the SCell1. The UE shall be able to report valid CSIs for the activated SCell1 at latest in a subframe (m+29). The UE shall start reporting CSI for SCell1 for SCell1 in subframe (m+8) and shall report CQI index 0 (out-of-range) until the SCell activation has been completed. Any PCell interruption due to activation of SCells shall occur in the subframes (m+5) to (m+11) and (m+20) to (m+26).

Time period T3 starts when a MAC message for deactivation of SCell1, sent from the test equipment to the UE, in a subframe # denoted n, where n is 4 or 9, is received at the UE antenna connector. The test equipment sends a MAC message for deactivation of the SCell2 in subframe (n+15). The UE shall carry out deactivation of the SCell1 at latest in subframe (n+8), and any PCell interruption due to the deactivation of SCells shall occur in the subframes (n+5) to (n+11) and (n+20) to (n+26).

The test equipment verifies that potential interruption is carried out in the correct time span by monitoring ACK/NACK sent in PCell during activation and deactivation of SCells, respectively.

The test equipment verifies the activation time by counting the subframes from the time when the SCell1 activation command is sent until a CSI report with other than CQI index 0 is received.

The test equipment verifies the deactivation time by counting the subframes from the time when the SCell1 deactivation command is sent until CQI reporting for SCell1 is discontinued.

Table A.8.16.38-1: General test parameters for E-UTRAN TDD 3 DL CA activation and deactivation of known SCell in non-DRX

| Parameter | Unit | Value | Comment |
|-----------|------|-------|---------|
|-----------|------|-------|---------|

| | | | |
|---|----|---------|--|
| E-UTRA RF Channel Number | | 1, 2, 3 | Three radio channels are used for this test |
| Active PCell | | Cell 1 | Primary cell on RF channel number 1. |
| Deconfigured SCell | | Cell 2 | Deconfigured secondary cell on RF channel number 2. |
| Configured deactivated SCell | | Cell 3 | Configured deactivated secondary cell on RF channel number 3. |
| CP length | | Normal | |
| Special subframe configuration | | 6 | As specified in table 4.2-1 in TS 36.211. The same configuration applies to all cells. |
| Uplink-downlink configuration | | 1 | As specified in table 4.2-2 in TS 36.211. The same configuration applies to all cells |
| DRX | | OFF | Continuous monitoring of primary cell |
| CQI/PMI periodicity and offset configuration index | | 0 | CQI reporting for SCells every UL subframe |
| Cell-individual offset for cells on RF channel number 1 | dB | 0 | Individual offset for cells on PCC. |
| Cell-individual offset for cells on RF channel number 2 | dB | 0 | Individual offset for cells on SCC1. |
| Cell-individual offset for cells on RF channel number 3 | dB | 0 | Individual offset for cells on SCC2. |
| Filter coefficient | | 0 | L3 filtering is not used |
| SCell measurement cycle (measCycleSCell) | ms | 320 | |
| T1 | s | 7 | During this time the PCell and SCell2 shall be known and the SCell1 configured and detected. |
| T2 | s | 1 | During this time the UE shall activate the SCell1 and SCell2. |
| T3 | s | 1 | During this time the UE shall deactivate the SCell1 and SCell2 |

Table A.8.16.38-2: Cell specific test parameters for E-UTRAN TDD 3 DL CA activation and deactivation of known SCell in non-DRX

| Parameter | Unit | Cell 1 | | | Cell 2 | | | Cell 3 | | |
|--|------------|---|----|----|---|----|----|---|----|----|
| | | T1 | T2 | T3 | T1 | T2 | T3 | T1 | T2 | T3 |
| E-UTRA RF Channel Number | | 1 | | | 2 | | | 3 | | |
| BW _{channel} | | 5MHz: N _{RB,c} = 25 10MHz: N _{RB,c} = 50 20MHz: N _{RB,c} = 100 | | | 5MHz: N _{RB,c} = 25 10MHz: N _{RB,c} = 50 20MHz: N _{RB,c} = 100 | | | 5MHz: N _{RB,c} = 25 10MHz: N _{RB,c} = 50 20MHz: N _{RB,c} = 100 | | |
| PDSCH parameters: DL Reference Measurement Channel | | 5MHz: R.4 TDD 10MHz: R.0 TDD 20MHz: R.3 TDD | | | - | | | - | | |
| PCFICH/PDCCH/PHICH parameters: DL Reference Measurement Channel | | 5MHz: R.11 TDD 10MHz: R.6 TDD 20MHz: R.10 TDD | | | 5MHz: R.11 TDD 10MHz: R.6 TDD 20MHz: R.10 TDD | | | 5MHz: R.11 TDD 10MHz: R.6 TDD 20MHz: R.10 TDD | | |
| OCNG Patterns | | 5MHz: OP.9 TDD 10MHz: OP.1 TDD 20MHz: OP.7 TDD | | | 5MHz: OP.10 TDD 10MHz: OP.2 TDD 20MHz: OP.8 TDD | | | 5MHz: OP.10 TDD 10MHz: OP.2 TDD 20MHz: OP.8 TDD | | |
| PBCH_RA | dB | 0 | | | 0 | | | 0 | | |
| PBCH_RB | dB | | | | | | | | | |
| PSS_RA | dB | | | | | | | | | |
| SSS_RA | dB | | | | | | | | | |
| PCFICH_RB | dB | | | | | | | | | |
| PHICH_RA | dB | | | | | | | | | |
| PHICH_RB | dB | | | | | | | | | |
| PDCCH_RA | dB | | | | | | | | | |
| PDCCH_RB | dB | | | | | | | | | |
| PDSCH_RA | dB | | | | | | | | | |
| PDSCH_RB | dB | | | | | | | | | |
| OCNG_RA ^{Note 1} | dB | | | | | | | | | |
| OCNG_RB ^{Note 1} | dB | | | | | | | | | |
| N _{oc} ^{Note 2} | dBm/15 kHz | -104 | | | -104 | | | -104 | | |
| \hat{E}_s/N_{oc} | dB | 17 | | | 17 | | | 17 | | |
| \hat{E}_s/I_{ot} ^{Note 3} | dB | 17 | | | 17 | | | 17 | | |

| | | | | |
|---|---------------|------------------------------|------------------------------|------------------------------|
| RSRP ^{Note 3} | dBm/15 kHz | -87 | -87 | -87 |
| SCH_RP ^{Note 3} | dBm/15 kHz | -87 | -87 | -87 |
| I_o ^{Note 3} | dBm/Ch BW | $-59.13+10\log(N_{RB,c}/50)$ | $-59.13+10\log(N_{RB,c}/50)$ | $-59.13+10\log(N_{RB,c}/50)$ |
| Propagation Condition | | AWGN | AWGN | AWGN |
| Antenna Configuration | | 1x2 | 1x2 | 1x2 |
| Timing offset to Cell 1 | μs | - | 0 | 0 |
| Time alignment error relative to cell 1 ^{Note 5} | μs | - | $\leq \text{TAE}$ | $\leq \text{TAE}$ |
| Time alignment error relative to cell 2 ^{Note 5} | μs | - | - | $\leq \text{TAE}$ |
| <p>Note 1: OCNG shall be used such that all cells are fully allocated and a constant total transmitted power spectral density is achieved for all OFDM symbols.</p> <p>Note 2: Interference from other cells and noise sources not specified in the test is assumed to be constant over subcarriers and time and shall be modelled as AWGN of appropriate power for N_{oc} to be fulfilled.</p> <p>Note 3: E_s/I_{ot}, RSRP, SCH_RP and I_o have been derived from other parameters for information purposes. They are not settable parameters themselves.</p> <p>Note 4: The uplink resources for CSI reporting are assigned to the UE prior to the start of time period T2.</p> <p>Note 5: Time alignment error (TAE) as specified in TS 36.104 [30] clause 6.5.3.1. The TAE value depends upon the type of carrier aggregation.</p> | | | | |

A.8.16.38.2 Test Requirements

During T2 the UE shall send the first CSI report for SCell1 in a subframe (m+8), or in a subframe (m+9) if the subframe (m+8) was subject to interruption, or in a subframe (m+13) if the subframe (m+8) and (m+9) were subject to interruption when an intra-band SCell is activated. Whether CSI report in subframe (m+8) and/or (m+9) was interrupted or not is checked by monitoring ACK/NACK sent in PCell in subframe (m+8) and/or (m+9).

During T2 the UE shall start sending CSI reports for SCell1 with non-zero CQI index at latest in a subframe (m+29).

During T3 the UE shall stop sending CSI reports for SCell1 at latest in subframe (n+8).

During T2 interruption of PCell during SCells activation shall not happen outside the subframes (m+5) to (m+11) and outside the subframes (m+20) to (m+26).

During T3 interruption of PCell during SCells deactivation shall not happen outside the subframe (n+5) to (n+11) and outside the subframes (n+20) to (n+26).

The interruption of PCell shall not be more than the values specified for intra-band CA and inter-band CA in Section 7.8.2.

The UE shall not send event triggered measurement reports as long as the reporting criteria are not fulfilled.

All of the above test requirements shall be fulfilled in order for the observed SCell1 activation delay and SCell1 deactivation delay to be counted as correct. The rate of correct observed SCell1 activation delay and SCell1 deactivation delay during repeated tests shall be at least 90%.

NOTE: During T2 if there are no uplink resources for reporting the valid CSI in a subframe (m+29) then the UE shall use the next available uplink resource for reporting the corresponding valid CSI.

A.8.16.39 E-UTRA TDD-FDD 3DL CA Activation and Deactivation of Unknown SCell in Non-DRX with PCell in FDD

A.8.16.39.1 Test Purpose and Environment

The purpose of this test is to verify that the SCell activation and deactivation times are within the requirements stated in section 7.7 for UE configured with two downlink SCells, when the SCell is unknown by the UE at the time of activation.

The test parameters are given in Tables A.8.16.39.1-1 and cell-specific parameters in A.8.16.39.1-2 below. The test consists of three successive time periods, with duration of T1, T2 and T3, respectively. There are three carriers, each with one cell. Cell 1 is FDD cell, and Cell 2 and Cell 3 are TDD cells. Cell 1 and Cell 3 have constant signal levels throughout the test. Before the test starts the UE is connected to Cell 1 (PCell) on radio channel 1 (PCC) and Cell 3 (deactivated SCell2) on radio channel 3 (SCC2) but is not aware of Cell 2 (SCell1) on radio channel 2 (SCC1). The UE is only monitoring the PCC and SCC2. The UE shall be continuously scheduled in the PCell throughout the whole test.

At the beginning of T1 the UE receives an RRC message by which the Cell 2 (SCell1) becomes configured on radio channel 2 (SCC1). During T1 Cell 2 (SCell1) is powered off and UE is not aware of Cell 2 (SCell1).

A MAC message for activation of SCell1 is sent by the test equipment 100ms after the RRC message, in a subframe # denoted m which is an even number. The point in time at which the MAC message for activation of Cell 2 (SCell1) is received at the UE antenna connector defines the start of time period T2. Immediately at beginning of T2 the transmission power of Cell 2 (SCell1) is increased to same level as for Cell 1 (PCell). The test equipment sends a MAC message for activation of the Cell 3 (SCell2) in subframe (m+10). Since UE received SCell2 activation command during activation of SCell1, the UE shall be able to report valid CSI for the activated SCell1 at latest in subframe (m+39) provided the SCell1 can be successfully detected on the first attempt. The UE shall start reporting CSI for SCell1 in subframe (m+8), and shall report CQI index 0 (out-of-range) until the SCell activation has been completed. Any PCell interruption due to activation of SCells shall occur in the subframes (m+5) to (m+9) and (m+15) to (m+19).

Time period T3 starts when a MAC message for deactivation of Cell 2 (SCell1), sent from the test equipment to the UE, in a subframe # denoted n which is an even number, is received at the UE antenna connector. The test equipment sends a MAC message for deactivation of the Cell 3 (SCell2) in subframe (n+10). The UE shall carry out deactivation of the Cell 2 (SCell1) at latest in subframe (n+8), and any PCell interruption due to the deactivation of SCells shall occur in subframes (n+5) to (n+9) and (n+10) to (n+19).

The test equipment verifies that potential interruption is carried out in the correct time span by monitoring ACK/NACK sent in PCell during activation and deactivation of SCell1, respectively.

The test equipment verifies the activation time by counting the subframes from the time when the Cell 2 (SCell1) activation command is sent until a CSI report with other than CQI index 0 is received.

The test equipment verifies the deactivation time by counting the subframes from the time when the Cell 2 (SCell1) deactivation command is sent until CQI reporting for SCell1 is discontinued.

Table A.8.16.39.1-1: General test parameters for unknown SCell1 activation case

| Parameter | Unit | Value | Comment |
|--|------|---------|---|
| E-UTRA RF Channel Number | | 1, 2, 3 | Three radio channels are used for this test |
| Active PCell | | Cell 1 | Primary cell on RF channel number 1. |
| Deconfigured deactivated SCell1 | | Cell 2 | Deconfigured deactivated secondary cell on RF channel number 2. |
| Configured deactivated SCell2 | | Cell 3 | Configured deactivated secondary cell on RF channel number 3. |
| CP length | | Normal | |
| DRX | | OFF | Continuous monitoring of primary cell |
| CQI/PMI periodicity and offset configuration index | | 0 | CQI reporting for SCell every second subframe |
| Cell-individual offset for cells on RF channel number 1 | dB | 0 | Individual offset for cells on PCC. |
| Cell-individual offset for cells on RF channel number 2 | dB | 0 | Individual offset for cells on SCC1. |
| Cell-individual offset for cells on RF channel number 3 | dB | 0 | Individual offset for cells on SCC2. |
| SCell measurement cycle (measCycleSCell) | ms | 320 | |
| T1 | ms | 100 | During this time the PCell and SCell2 shall be known and the SCell1 configured. |
| T2 | s | 1 | During this time the UE shall activate the SCell1 and SCell2. |
| T3 | s | 1 | During this time the UE shall deactivate the SCell1 and SCell2. |
| Note: This test verifies the RRM requirement which is independent of channel bandwidth and is performed according to the principle defined in section A.3.6.1. | | | |

Table A.8.16.39.1-2: Cell specific test parameters for E-UTRAN TDD known SCell1 activation with PCell in FDD

| Parameter | Unit | Cell 1 | | | Cell 2 | | | Cell 3 | | |
|--------------------------|------|--------|----|----|--------|----|----|--------|----|----|
| | | T1 | T2 | T3 | T1 | T2 | T3 | T1 | T2 | T3 |
| E-UTRA RF Channel Number | | 1 | | | 2 | | | 3 | | |

| | | | | |
|---|------------|---|---|---|
| TDD special subframe configuration | | - | 6 | 6 |
| TDD uplink-downlink configuration | | - | 1 | 1 |
| BW _{channel} | MHz | 5MHz: N _{RB,c} = 25 10MHz: N _{RB,c} = 50 20MHz: N _{RB,c} = 100 | 5MHz: N _{RB,c} = 25 10MHz: N _{RB,c} = 50 20MHz: N _{RB,c} = 100 | 5MHz: N _{RB,c} = 25 10MHz: N _{RB,c} = 50 20MHz: N _{RB,c} = 100 |
| PDSCH parameters: DL Reference Measurement Channel | | 5MHz: R.7 FDD 10MHz: R.3 FDD 20MHz: R.6 FDD | - | - |
| PCFICH/PDCCH/PHICH parameters: DL Reference Measurement Channel | | 5MHz: R.11 FDD 10MHz: R.6 FDD 20MHz: R.10 FDD | 5MHz: R.11 TDD 10MHz: R.6 TDD 20MHz: R.10 TDD | 5MHz: R.11 TDD 10MHz: R.6 TDD 20MHz: R.10 TDD |
| OCNG Patterns | | 5MHz: OP.20 FDD 10MHz: OP.10 FDD 20MHz: OP.17 FDD | 5MHz: OP.10 TDD 10MHz: OP.2 TDD 20MHz: OP.8 TDD | 5MHz: OP.10 TDD 10MHz: OP.2 TDD 20MHz: OP.8 TDD |
| PBCH_RA | dB | 0 | 0 | 0 |
| PBCH_RB | dB | | | |
| PSS_RA | dB | | | |
| SSS_RA | dB | | | |
| PCFICH_RB | dB | | | |
| PHICH_RA | dB | | | |
| PHICH_RB | dB | | | |
| PDCCH_RA | dB | | | |
| PDCCH_RB | dB | | | |
| PDSCH_RA | dB | | | |
| PDSCH_RB | dB | | | |
| OCNG_RA ^{Note 1} | dB | | | |
| OCNG_RB ^{Note 1} | dB | | | |
| N _{oc} ^{Note 2} | dBm/15 kHz | | | |
| \bar{E}_s/N_{oc} | dB | 17 | -infinity | 17 |
| \bar{E}_s/I_{ot} | dB | 17 | -infinity | 17 |
| RSRP ^{Note 3} | dBm/15 kHz | -87 | -infinity | -87 |
| SCH_RP ^{Note 3} | dBm/15 kHz | -87 | -infinity | -87 |
| I _o ^{Note 3} | dBm/Ch BW | -59.13 +10log (N _{RB,c} /50) | -76.22 +10log (N _{RB,c} /50) | -59.13 +10log (N _{RB,c} /50) |
| Propagation Condition | | AWGN | AWGN | AWGN |
| Antenna Configuration | | 1x2 | 1x2 | 1x2 |
| Timing offset to Cell 1 | μs | - | 0 | 0 |
| Time alignment error relative to cell 1 ^{Note 5} | μs | - | ≤ TAE | ≤ TAE |
| Time alignment error relative to cell 2 ^{Note 5} | μs | - | - | ≤ TAE |
| <p>Note 1: OCNG shall be used such that all cells are fully allocated and a constant total transmitted power spectral density is achieved for all OFDM symbols.</p> <p>Note 2: Interference from other cells and noise sources not specified in the test is assumed to be constant over subcarriers and time and shall be modelled as AWGN of appropriate power for N_{oc} to be fulfilled.</p> <p>Note 3: Es/I_{ot}, RSRP, SCH_RP and I_o levels have been derived from other parameters for information purposes. They are not settable parameters themselves.</p> <p>Note 4: The uplink resources for CSI reporting are assigned to the UE prior to the start of time period T2.</p> <p>Note 5: Time alignment error (TAE) as specified in TS 36.104 [30] clause 6.5.3.1. The TAE value depends upon the type of carrier aggregation.</p> <p>Note 6: TDD special subframe configuration and uplink-downlink configuration are as specified in Table 4.2-1 and 4.2-2 in TS36.211 [16]. The same configuration applies to all TDD cells.</p> | | | | |

A.8.16.39.2 Test Requirements

During T2 the UE shall send the first CSI report for SCell1 at latest in a subframe (m+8), or in a subframe (m+10) if the subframe (m+8) was subject to interruption. Whether CSI report in subframe (m+8) was interrupted or not is checked by monitoring ACK/NACK sent in PCell in subframe (m+8).

During T2 the UE shall start sending CSI reports for SCell1 with non-zero CQI index at latest in a subframe (m+39).

During T3 the UE shall stop sending CSI reports for SCell1 at latest in a subframe (n+8).

During T2 interruption of PCell during SCells activation shall not happen outside subframes (m+5) to (m+9) and outside the subframes (m+15) to (m+19).

During T3 interruption of PCell during SCells deactivation shall not happen outside subframes (n+5) to (n+9) and outside subframes (n+15) to (n+19).

The interruption of PCell shall not be more than the values specified for intra-band CA and inter-band CA in Section 7.8.2.

All of the above test requirements shall be fulfilled in order for the observed SCell1 activation delay and SCell1 deactivation delay to be counted as correct. The rate of correct observed SCell1 activation delay and SCell1 deactivation delay during repeated tests shall be at least 90%.

NOTE: During T2 if there are no uplink resources for reporting the valid CSI in a subframe (m+39) then the UE shall use the next available uplink resource for reporting the corresponding valid CSI.

A.8.16.40 E-UTRA TDD-FDD 3DL CA Activation and Deactivation of Unknown SCell in Non-DRX with PCell in TDD

A.8.16.40.1 Test Purpose and Environment

The purpose of this test is to verify that the SCell activation and deactivation times are within the requirements stated in section 7.7 for UE configured with two downlink SCells, when the SCell is unknown by the UE at the time of activation.

The test parameters are given in Tables A.8.16.40.1-1 and cell-specific parameters in A.8.16.40.1-2 below. The test consists of three successive time periods, with duration of T1, T2 and T3, respectively. There are three carriers, each with one cell. Cell 1 is TDD cell, and Cell 2 and Cell 3 are FDD cells. Cell 1 and Cell 3 have constant signal levels throughout the test. Before the test starts the UE is connected to Cell 1 (PCell) on radio channel 1 (PCC) and Cell 3 (deactivated SCell2) on radio channel 3 (SCC2) but is not aware of Cell 2 (SCell1) on radio channel 2 (SCC1). The UE is only monitoring the PCC and SCC2. The UE shall be continuously scheduled in the PCell throughout the whole test.

At the beginning of T1 the UE receives an RRC message by which the Cell 2 (SCell1) becomes configured on radio channel 2 (SCC1). During T1 Cell 2 (SCell1) is powered off and UE is not aware of Cell 2 (SCell1).

A MAC message for activation of SCell1 is sent by the test equipment 100ms after the RRC message, in a subframe # denoted m, where m is 4 or 9. The point in time at which the MAC message for activation of Cell 2 (SCell1) is received at the UE antenna connector defines the start of time period T2. Immediately at beginning of T2 the transmission power of Cell 2 (SCell1) is increased to same level as for Cell 1 (PCell). The test equipment sends a MAC message for activation of the Cell 3 (SCell2) in subframe (m+15). Since UE received SCell2 activation command during activation of SCell1, the UE shall be able to report valid CSI for the activated SCell1 at latest in subframe (m+39) provided the SCell1 can be successfully detected on the first attempt. The UE shall start reporting CSI for SCell1 in subframe (m+8), and shall report CQI index 0 (out-of-range) until the SCell activation has been completed. Any PCell interruption due to activation of SCells shall occur in subframes (m+5) to (m+9) and (m+20) to (m+24).

Time period T3 starts when a MAC message for deactivation of Cell 2 (SCell1), sent from the test equipment to the UE in a subframe # denoted n, where n is 4 or 9, is received at the UE antenna connector. The test equipment sends a MAC message for deactivation of the Cell 3 (SCell2) in subframe (n+15). The UE shall carry out deactivation of the Cell 2 (SCell1) at latest in subframe (n+8), and any PCell interruption due to the deactivation of SCells shall occur in subframes (n+5) to (n+9) and (n+20) to (n+24).

The test equipment verifies that potential interruption is carried out in the correct time span by monitoring ACK/NACK sent in PCell during activation and deactivation of SCell1, respectively.

The test equipment verifies the activation time by counting the subframes from the time when the Cell 2 (SCell1) activation command is sent until a CSI report with other than CQI index 0 is received.

The test equipment verifies the deactivation time by counting the subframes from the time when the Cell 2 (SCell1) deactivation command is sent until CQI reporting for SCell1 is discontinued.

Table A.8.16.40.1-1: General test parameters for unknown SCell1 activation case

| Parameter | Unit | Value | Comment |
|--|------|---------|---|
| E-UTRA RF Channel Number | | 1, 2, 3 | Three radio channels are used for this test |
| Active PCell | | Cell 1 | Primary cell on RF channel number 1. |
| Deconfigured deactivated SCell1 | | Cell 2 | Deconfigured deactivated secondary cell on RF channel number 2. |
| Configured deactivated SCell2 | | Cell 3 | Configured deactivated secondary cell on RF channel number 3. |
| CP length | | Normal | |
| DRX | | OFF | Continuous monitoring of primary cell |
| CQI/PMI periodicity and offset configuration index | | 0 | CQI reporting for SCell every second subframe |
| Cell-individual offset for cells on RF channel number 1 | dB | 0 | Individual offset for cells on PCC. |
| Cell-individual offset for cells on RF channel number 2 | dB | 0 | Individual offset for cells on SCC1. |
| Cell-individual offset for cells on RF channel number 3 | dB | 0 | Individual offset for cells on SCC2. |
| SCell measurement cycle (measCycleSCell) | ms | 320 | |
| T1 | ms | 100 | During this time the PCell and SCell2 shall be known and the SCell1 configured. |
| T2 | s | 1 | During this time the UE shall activate the SCell1 and SCell2. |
| T3 | s | 1 | During this time the UE shall deactivate the SCell1 and SCell2. |
| Note: This test verifies the RRM requirement which is independent of channel bandwidth and is performed according to the principle defined in section A.3.6.1. | | | |

Table A.8.16.40.1-2: Cell specific test parameters for E-UTRAN FDD known SCell1 activation with PCell in TDD

| Parameter | Unit | Cell 1 | | | Cell 2 | | | Cell 3 | | |
|---|------|---|----|----|---|----|----|---|----|----|
| | | T1 | T2 | T3 | T1 | T2 | T3 | T1 | T2 | T3 |
| E-UTRA RF Channel Number | | 1 | | | 2 | | | 3 | | |
| TDD special subframe configuration | | 6 | | | - | | | - | | |
| TDD uplink-downlink configuration | | 1 | | | - | | | - | | |
| BW _{channel} | MHz | 5MHz: N _{RB,c} = 25 10MHz: N _{RB,c} = 50 20MHz: N _{RB,c} = 100 | | | 5MHz: N _{RB,c} = 25 10MHz: N _{RB,c} = 50 20MHz: N _{RB,c} = 100 | | | 5MHz: N _{RB,c} = 25 10MHz: N _{RB,c} = 50 20MHz: N _{RB,c} = 100 | | |
| PDSCH parameters: DL Reference Measurement Channel | | 5MHz: R.4 TDD 10MHz: R.0 TDD 20MHz: R.3 TDD | | | - | | | - | | |
| PCFICH/PDCCH/PHICH parameters: DL Reference Measurement Channel | | 5MHz: R.11 TDD 10MHz: R.6 TDD 20MHz: R.10 TDD | | | 5MHz: R.11 FDD 10MHz: R.6 FDD 20MHz: R.10 FDD | | | 5MHz: R.11 FDD 10MHz: R.6 FDD 20MHz: R.10 FDD | | |
| OCNG Patterns | | 5MHz: OP.9 TDD 10MHz: OP.1 TDD 20MHz: OP.7 TDD | | | 5MHz: OP.16 FDD 10MHz: OP.2 FDD 20MHz: OP.12 FDD | | | 5MHz: OP.16 FDD 10MHz: OP.2 FDD 20MHz: OP.12 FDD | | |
| PBCH_RA | dB | 0 | | | 0 | | | 0 | | |
| PBCH_RB | dB | | | | | | | | | |
| PSS_RA | dB | | | | | | | | | |
| SSS_RA | dB | | | | | | | | | |
| PCFICH_RB | dB | | | | | | | | | |
| PHICH_RA | dB | | | | | | | | | |
| PHICH_RB | dB | | | | | | | | | |
| PDCCH_RA | dB | | | | | | | | | |
| PDCCH_RB | dB | | | | | | | | | |

| | | | | | |
|---|------------|---------------------------------------|---------------------------------------|---------------------------------------|---------------------------------------|
| PDSCH_RA | dB | | | | |
| PDSCH_RB | dB | | | | |
| OCNG_RA ^{Note 1} | dB | | | | |
| OCNG_RB ^{Note 1} | dB | | | | |
| N_{oc} ^{Note 2} | dBm/15 kHz | -104 | -104 | -104 | -104 |
| \bar{E}_s/N_{oc} | dB | 17 | -infinity | 17 | 17 |
| \bar{E}_s/I_{ot} | dB | 17 | -infinity | 17 | 17 |
| RSRP ^{Note 3} | dBm/15 kHz | -87 | -infinity | -87 | -87 |
| SCH_RP ^{Note 3} | dBm/15 kHz | -87 | -infinity | -87 | -87 |
| I_o ^{Note 3} | dBm/Ch BW | -59.13 +10log ($N_{RB,c}/50$) | -76.22 +10log ($N_{RB,c}/50$) | -59.13 +10log ($N_{RB,c}/50$) | -59.13 +10log ($N_{RB,c}/50$) |
| Propagation Condition | | AWGN | AWGN | AWGN | AWGN |
| Antenna Configuration | | 1x2 | 1x2 | 1x2 | 1x2 |
| Timing offset to Cell 1 | μ s | - | 0 | 0 | 0 |
| Time alignment error relative to cell 1 ^{Note 5} | μ s | - | \leq TAE | \leq TAE | \leq TAE |
| Time alignment error relative to cell 2 ^{Note 5} | μ s | - | - | - | \leq TAE |
| <p>Note 1: OCNG shall be used such that all cells are fully allocated and a constant total transmitted power spectral density is achieved for all OFDM symbols.</p> <p>Note 2: Interference from other cells and noise sources not specified in the test is assumed to be constant over subcarriers and time and shall be modelled as AWGN of appropriate power for N_{oc} to be fulfilled.</p> <p>Note 3: E_s/I_{ot}, RSRP, SCH_RP and I_o levels have been derived from other parameters for information purposes. They are not settable parameters themselves.</p> <p>Note 4: The uplink resources for CSI reporting are assigned to the UE prior to the start of time period T2.</p> <p>Note 5: Time alignment error (TAE) as specified in TS 36.104 [30] clause 6.5.3.1. The TAE value depends upon the type of carrier aggregation.</p> <p>Note 6: TDD special subframe configuration and uplink-downlink configuration are as specified in Table 4.2-1 and 4.2-2 in TS36.211 [16]. The same configuration applies to all TDD cells.</p> | | | | | |

A.8.16.40.2 Test Requirements

During T2 the UE shall send the first CSI report for SCell12 in a subframe (m+8), or in a subframe (m+9) if the subframe (m+8) was subject to interruption. Whether CSI report in subframe (m+8) was interrupted or not is checked by monitoring ACK/NACK sent in PCell in subframe (m+8).

During T2 the UE shall start sending CSI reports for SCell1 with non-zero CQI index at latest in a subframe (m+39).

During T3 the UE shall stop sending CSI reports for SCell1 at latest in a subframe (n+8).

During T2 interruption of PCell during SCells activation shall not happen outside subframes (m+5) and (m+9) and outside the subframes (m+20) to (m+24).

During T3 interruption of PCell during SCells deactivation shall not happen outside subframes (n+5) to (n+9) and outside subframes (n+20) to (n+24).

The interruption of PCell shall not be more than the values specified for intra-band CA and inter-band CA in Section 7.8.2.

All of the above test requirements shall be fulfilled in order for the observed SCell1 activation delay and SCell1 deactivation delay to be counted as correct. The rate of correct observed SCell1 activation delay and SCell1 deactivation delay during repeated tests shall be at least 90%.

NOTE: During T2 if there are no uplink resources for reporting the valid CSI in subframe (m+39) then the UE shall use the next available uplink resource for reporting the corresponding valid CSI.

A.8.16.41 3 DL FDD CA activation and deactivation of unknown SCell in non-DRX

A.8.16.41.1 Test Purpose and Environment

The purpose of this test is to verify that the SCell activation and deactivation times are within the requirements stated in clause 7.7 for 3DL FDD carrier aggregation, when the SCell is unknown by the UE at the time of activation.

The test parameters are given in Tables A.8.16.41-1 and cell-specific parameters in A.8.16.41-2 below. The test consists of three successive time periods, with duration of T1, T2 and T3, respectively. There are three carriers, each with one cell. Cell 1 and Cell 3 have constant signal levels throughout the test. Before the test starts the UE is connected to Cell 1 (PCell) on radio channel 1 (PCC) and Cell 3 (deactivated SCell2) on radio channel 3 (SCC2), but is not aware of Cell 2 (SCell1) on radio channel 2 (SCC1). The UE is only monitoring the PCC and SCC2. The UE shall be continuously scheduled in the PCell throughout the whole test.

At the beginning of T1 the UE receives an RRC message by which the Cell 2 (SCell1) becomes configured on radio channel 2 (SCC1). During T1 the signal level of Cell 2 (SCell1) is powered off and UE is not aware of Cell 2 (SCell1).

A MAC message for activation of the SCell1 is sent by the test equipment 100ms after the RRC message, in a subframe # denoted m which is an even number. The point in time at which the MAC message for activation of Cell 2 (SCell1) is received at the UE antenna connector defines the start of time period T2. Immediately at beginning of T2 the transmission power of Cell 2 (SCell1) is increased to same level as for Cell 1 (PCell). The test equipment sends a MAC message for activation of Cell 3 (SCell2) in subframe (m+10). Since UE received SCell2 activation command during activation of SCell1, the UE shall be able to report valid CSIs for the activated SCell1 at latest in subframe (m+39) provided the SCell1 can be successfully detected on the first attempt. The UE shall start reporting CSI in subframe (m+8) and shall report CQI index 0 (out-of-range) until the SCell activation has been completed. Any PCell interruption due to activation of SCells shall occur in the subframe (m+5) to (m+9) and (m+15) to (m+19).

Time period T3 starts when a MAC message for deactivation of Cell 2 (SCell1), sent from the test equipment to the UE in a subframe # denoted n, is received at the UE antenna connector. The test equipment sends a MAC message for deactivation of the Cell 3 (SCell2) in subframe (n+10). The UE shall carry out deactivation of Cell 2 (SCell1) at latest in subframe (n+8), and any PCell interruption due to the deactivation shall occur in the subframes (n+5) to (n+9) and (n+15) to (n+19).

The test equipment verifies that potential interruption is carried out in the correct time span by monitoring ACK/NACK sent in PCell during activation and deactivation of SCells, respectively.

The test equipment verifies the activation time by counting the subframes from the time when the Cell 2 (SCell1) activation command is sent until a CSI reports with other than CQI index 0 is received.

The test equipment verifies the deactivation time by counting the subframes from the time when the Cell 2 (SCell1) deactivation command is sent until CQI reporting for SCell1 is discontinued.

Table A.8.16.41-1: General test parameters for E-UTRAN FDD 3 DL CA activation and deactivation of unknown SCell in non-DRX

| Parameter | Unit | Value | Comment |
|---|------|---------|---|
| E-UTRA RF Channel Number | | 1, 2, 3 | Three radio channels are used for this test |
| Active PCell | | Cell 1 | Primary cell on RF channel number 1. |
| Deconfigured SCell1 | | Cell 2 | Deconfigured secondary cell on RF channel number 2. |
| Configured deactivated SCell2 | | Cell 3 | Configured deactivated secondary cell on RF channel number 3. |
| CP length | | Normal | |
| DRX | | OFF | Continuous monitoring of primary cell |
| CQI/PMI periodicity and offset configuration index | | 0 | CQI reporting for SCells every second subframe |
| Cell-individual offset for cells on RF channel number 1 | dB | 0 | Individual offset for cells on PCC. |
| Cell-individual offset for cells on RF channel number 2 | dB | 0 | Individual offset for cells on SCC1. |
| Cell-individual offset for cells on RF channel number 3 | dB | 0 | Individual offset for cells on SCC2. |
| SCell measurement cycle (measCycleSCell) | ms | 320 | |
| T1 | ms | 100 | During this time the PCell and SCell2 shall be known and the SCell1 configured. |
| T2 | s | 1 | During this time the UE shall activate the SCell1 and SCell2. |
| T3 | s | 1 | During this time the UE shall deactivate the SCell1 and SCell2. |

Note: This test verifies the RRM requirement which is independent of channel bandwidth and is performed according to the principle defined in section A.3.6.1.

Table A.8.16.41-2: Cell specific test parameters for E-UTRAN FDD 3 DL CA activation and deactivation of unknown SCell in non-DRX

| Parameter | Unit | Cell 1 | | | Cell 2 | | | Cell 3 | | |
|--|----------------|---|----|----|---|---|---|---|----|----|
| | | T1 | T2 | T3 | T1 | T2 | T3 | T1 | T2 | T3 |
| E-UTRA RF Channel Number | | 1 | | | 2 | | | 3 | | |
| BW _{channel} | | 5MHz: N _{RB,c} = 25 10MHz: N _{RB,c} = 50 20MHz: N _{RB,c} = 100 | | | 5MHz: N _{RB,c} = 25 10MHz: N _{RB,c} = 50 20MHz: N _{RB,c} = 100 | | | 5MHz: N _{RB,c} = 25 10MHz: N _{RB,c} = 50 20MHz: N _{RB,c} = 100 | | |
| PDSCH parameters: DL Reference Measurement Channel | | 5MHz: R.7 FDD 10MHz: R.3 FDD 20MHz: R.6 FDD | | | - | | | - | | |
| PCFICH/PDCCH/PHICH parameters: DL Reference Measurement Channel | | 5MHz: R.11 FDD 10MHz: R.6 FDD 20MHz: R.10 FDD | | | 5MHz: R.11 FDD 10MHz: R.6 FDD 20MHz: R.10 FDD | | | 5MHz: R.11 FDD 10MHz: R.6 FDD 20MHz: R.10 FDD | | |
| OCNG Patterns | | 5MHz: OP.20 FDD 10MHz: OP.10 FDD 20MHz: OP.17 FDD | | | 5MHz: OP.16 FDD 10MHz: OP.2 FDD 20MHz: OP.12 FDD | | | 5MHz: OP.16 FDD 10MHz: OP.2 FDD 20MHz: OP.12 FDD | | |
| PBCH_RA | dB | 0 | | | 0 | | | 0 | | |
| PBCH_RB | dB | | | | | | | | | |
| PSS_RA | dB | | | | | | | | | |
| SSS_RA | dB | | | | | | | | | |
| PCFICH_RB | dB | | | | | | | | | |
| PHICH_RA | dB | | | | | | | | | |
| PHICH_RB | dB | | | | | | | | | |
| PDCCH_RA | dB | | | | | | | | | |
| PDCCH_RB | dB | | | | | | | | | |
| PDSCH_RA | dB | | | | | | | | | |
| PDSCH_RB | dB | | | | | | | | | |
| OCNG_RA ^{Note 1} | dB | | | | | | | | | |
| OCNG_RB ^{Note 1} | dB | | | | | | | | | |
| N _{oc} ^{Note 2} | dBm/ 15 kHz | | | | | | | | | |
| \bar{E}_s/N_{oc} | dB | 17 | | | -infinity | 17 | 17 | | | |
| \bar{E}_s/I_{ot} ^{Note 3} | dB | 17 | | | -infinity | 17 | 17 | | | |
| RSRP ^{Note 3} | dBm/ 15 kHz | -87 | | | -infinity | -87 | -87 | | | |
| SCH_RP ^{Note 3} | dBm/ 15 kHz | -87 | | | -infinity | -87 | -87 | | | |
| I _o ^{Note 3} | dBm/ Ch BW | -59.13+10log (N _{RB,c} /50) | | | -76.22 +10log (N _{RB,c} /50) | -59.13+10log (N _{RB,c} /50) | -59.13+10log (N _{RB,c} /50) | | | |
| Propagation Condition | | AWGN | | | AWGN | | | AWGN | | |
| Antenna Configuration | | 1x2 | | | 1x2 | | | 1x2 | | |
| Timing offset to Cell 1 | μs | - | | | 0 | | | 0 | | |
| Time alignment error relative to cell 1 ^{Note 5} | μs | - | | | ≤ TAE | | | ≤ TAE | | |
| Time alignment error relative to Cell 2 ^{Note 5} | μs | - | | | - | | | ≤ TAE | | |

- Note 1: OCNG shall be used such that all cells are fully allocated and a constant total transmitted power spectral density is achieved for all OFDM symbols.
- Note 2: Interference from other cells and noise sources not specified in the test is assumed to be constant over subcarriers and time and shall be modelled as AWGN of appropriate power for N_{oc} to be fulfilled.
- Note 3: E_s/I_{ot}, RSRP, SCH_RP and I_o have been derived from other parameters for information purposes. They are not settable parameters themselves.
- Note 4: The uplink resources for CSI reporting are assigned to the UE prior to the start of time period T2.
- Note 5: The time alignment error (TAE) between two cells specified in TS36.104 [30] clause 6.5.3.1 (value depends upon the type of carrier aggregation).

A.8.16.41.2 Test Requirements

During T2 the UE shall send the first CSI report for SCell1 in a subframe (m+8), or in a subframe (m+10) if the subframe (m+8) was subject to interruption. Whether CSI report in subframe (m+8) was interrupted or not is checked by monitoring ACK/NACK sent in PCell in subframe (m+8).

During T2 the UE shall start sending CSI reports for SCell1 with non-zero CQI index at latest in a subframe (m+39).

During T3 the UE shall stop sending CSI reports for SCell1 at latest in a subframe (n+8).

During T2 interruption of PCell during SCells activation shall not happen outside the subframes (m+5) to (m+9) and outside the subframes (m+15) to (m+19).

During T2 interruption of PCell during SCells deactivation shall not happen outside the subframes (n+5) to (n+9) and outside the subframes (n+15) to (n+19).

The interruption of PCell shall not be more than the values specified for intra-band CA and inter-band CA in Section 7.8.2.

All of the above test requirements shall be fulfilled in order for the observed SCell1 activation delay and SCell1 deactivation delay to be counted as correct. The rate of correct observed SCell1 activation delay and SCell1 deactivation delay during repeated tests shall be at least 90%.

NOTE: During T2 if there are no uplink resources for reporting the valid CSI in a subframe (m+39) then the UE shall use the next available uplink resource for reporting the corresponding valid CSI.

A.8.16.42 3 DL TDD CA activation and deactivation of unknown SCell in non-DRX

A.8.16.42.1 Test Purpose and Environment

The purpose of this test is to verify that the SCell activation and deactivation times are within the requirements stated in clause 7.7 for 3DL TDD carrier aggregation, when the SCell is unknown by the UE at the time of activation.

The test parameters are given in Tables A.8.16.42-1 and cell-specific parameters in A.8.16.42-2 below. The test consists of three successive time periods, with duration of T1, T2 and T3, respectively. There are three carriers, each with one cell. Cell 1 and cell 3 have constant signal levels throughout the test. Before the test starts the UE is connected to Cell 1 (PCell) on radio channel 1 (PCC) and Cell 3 (deactivated SCell2) on radio channel 3 (SCC2), but is not aware of Cell 2 (SCell1) on radio channel 2 (SCC1). The UE is only monitoring the PCC and SCC2. The UE shall be continuously scheduled in the PCell throughout the whole test.

At the beginning of T1 the UE receives an RRC message by which the Cell 2 (SCell 1) becomes configured on radio channel 2 (SCC1). During T1 the signal level of Cell 2 (SCell 1) is powered off and UE is not aware of Cell 2 (SCell1).

A MAC message for activation of the SCell1 is sent by the test equipment 100ms after the RRC message, in a subframe # denoted m, where m is 4 or 9. The point in time at which the MAC message for activation of Cell 2 (SCell1) is received at the UE antenna connector defines the start of time period T2. Immediately at beginning of T2 the transmission power of Cell 2 (SCell1) is increased to same level as for Cell 1 (PCell). The test equipment sends a MAC message for activation of Cell 3 (SCell2) in subframe (m+15). Since UE received SCell2 activation command during activation of SCell1, the UE shall be able to report valid CSIs for the activated SCell1 at latest in subframe (m+39) provided the SCell1 can be successfully detected on the first attempt. The UE shall start reporting CSI in subframe (m+8) and shall report CQI index 0 (out-of-range) until the SCell activation has been completed. Any PCell interruption due to activation of SCells shall occur in the subframes (m+5) to (m+11) and (m+20) to (m+26).

Time period T3 starts when a MAC message for deactivation of Cell 2 (SCell1), sent from the test equipment to the UE in a subframe # denoted n, where n is 4 or 9, is received at the UE antenna connector. The test equipment sends a MAC message for deactivation of the Cell 3 (SCell2) in subframe (n+15). The UE shall carry out deactivation of Cell 2 (SCell1) at latest in subframe (n+8), and any PCell interruption due to the deactivation of SCells shall occur in the subframes (n+5) to (n+11) and (n+20) to (n+26).

The test equipment verifies that potential interruption is carried out in the correct time span by monitoring ACK/NACK sent in PCell during activation and deactivation of SCells, respectively.

The test equipment verifies the activation time by counting the subframes from the time when the Cell 2 (SCell1) activation command is sent until a CSI reports with other than CQI index 0 is received.

The test equipment verifies the deactivation time by counting the subframes from the time when the Cell 2 (SCell1) deactivation command is sent until CQI reporting for SCell1 is discontinued.

Table A.8.16.42-1: General test parameters for E-UTRAN TDD 3 DL CA activation and deactivation of unknown SCell in non-DRX

| Parameter | Unit | Value | Comment |
|---|--|---------|---|
| E-UTRA RF Channel Number | | 1, 2, 3 | Three radio channels are used for this test |
| Active PCell | | Cell 1 | Primary cell on RF channel number 1. |
| Deconfigured SCell1 | | Cell 2 | Deconfigured secondary cell on RF channel number 2. |
| Configured deactivated SCell2 | | Cell 3 | Configured deactivated secondary cell on RF channel number 3. |
| CP length | | Normal | |
| Special subframe configuration | | 6 | As specified in table 4.2-1 in TS 36.211 [16]. The same configuration applies to all cells. |
| Uplink-downlink configuration | | 1 | As specified in table 4.2-2 in TS 36.211 [16]. The same configuration applies to all cells |
| DRX | | OFF | Continuous monitoring of primary cell |
| CQI/PMI periodicity and offset configuration index | | 0 | CQI reporting for SCells every UL subframe |
| Cell-individual offset for cells on RF channel number 1 | dB | 0 | Individual offset for cells on PCC. |
| Cell-individual offset for cells on RF channel number 2 | dB | 0 | Individual offset for cells on SCC1. |
| Cell-individual offset for cells on RF channel number 3 | dB | 0 | Individual offset for cells on SCC2. |
| Filter coefficient | | 0 | L3 filtering is not used |
| SCell measurement cycle (measCycleSCell) | ms | 320 | |
| T1 | ms | 100 | During this time the PCell and SCell2 shall be known and the SCell1 configured, |
| T2 | s | 1 | During this time the UE shall activate the SCell1 and SCell2. |
| T3 | s | 1 | During this time the UE shall deactivate the SCell1 and SCell2 |
| Note: | This test verifies the RRM requirement which is independent of channel bandwidth and is performed according to the principle defined in section A.3.6.1. | | |

Table A.8.16.42-2: Cell specific test parameters for E-UTRAN TDD 3 DL CA activation and deactivation of unknown SCell in non-DRX

| Parameter | Unit | Cell 1 | | | Cell 2 | | | Cell 3 | | |
|--|------|---|----|----|---|----|----|---|----|----|
| | | T1 | T2 | T3 | T1 | T2 | T3 | T1 | T2 | T3 |
| E-UTRA RF Channel Number | | 1 | | | 2 | | | 3 | | |
| BW _{channel} | | 5MHz: N _{RB,c} = 25 10MHz: N _{RB,c} = 50 20MHz: N _{RB,c} = 100 | | | 5MHz: N _{RB,c} = 25 10MHz: N _{RB,c} = 50 20MHz: N _{RB,c} = 100 | | | 5MHz: N _{RB,c} = 25 10MHz: N _{RB,c} = 50 20MHz: N _{RB,c} = 100 | | |
| PDSCH parameters: DL Reference Measurement Channel | | 5MHz: R.4 TDD 10MHz: R.0 TDD 20MHz: R.3 TDD | | | - | | | - | | |
| PCFICH/PDCCH/PHICH parameters: DL Reference Measurement Channel | | 5MHz: R.11 TDD 10MHz: R.6 TDD 20MHz: R.10 TDD | | | 5MHz: R.11 TDD 10MHz: R.6 TDD 20MHz: R.10 TDD | | | 5MHz: R.11 TDD 10MHz: R.6 TDD 20MHz: R.10 TDD | | |
| OCNG Patterns | | 5MHz: OP.9 TDD 10MHz: OP.1 TDD 20MHz: OP.7 TDD | | | 5MHz: OP.10 TDD 10MHz: OP.2 TDD 20MHz: OP.8 TDD | | | 5MHz: OP.10 TDD 10MHz: OP.2 TDD 20MHz: OP.8 TDD | | |
| PBCH_RA | dB | 0 | | | 0 | | | 0 | | |
| PBCH_RB | dB | | | | | | | | | |
| PSS_RA | dB | | | | | | | | | |
| SSS_RA | dB | | | | | | | | | |
| PCFICH_RB | dB | | | | | | | | | |
| PHICH_RA | dB | | | | | | | | | |
| PHICH_RB | dB | | | | | | | | | |
| PDCCH_RA | dB | | | | | | | | | |
| PDCCH_RB | dB | | | | | | | | | |
| PDSCH_RA | dB | | | | | | | | | |
| PDSCH_RB | dB | | | | | | | | | |
| OCNG_RA ^{Note 1} | dB | | | | | | | | | |

| | | | | | |
|--|----------------|---|---|---|---|
| OCNG_RB ^{Note 1} | dB | | | | |
| N _{oc} ^{Note 2} | dBm/ 15 kHz | -104 | -104 | | -104 |
| \bar{E}_s/N_{oc} | dB | 17 | -infin | 17 | 17 |
| \bar{E}_s/I_{ot} ^{Note 3} | dB | 17 | -infin | 17 | 17 |
| RSRP ^{Note 3} | dBm/ 15 kHz | -87 | -infin | -87 | -87 |
| SCH_RP ^{Note 3} | dBm/ 15 kHz | -87 | -infin | -87 | -87 |
| I _o ^{Note 3} | dBm/ Ch BW | -59.13+10log (N _{RB,c} /50) | -76.22 +10log (N _{RB,c} /50) | -59.13+10log (N _{RB,c} /50) | -59.13+10log (N _{RB,c} /50) |
| Propagation Condition | | AWGN | AWGN | | AWGN |
| Antenna Configuration | | 1x2 | 1x2 | | 1x2 |
| Timing offset to Cell 1 | μs | - | 0 | | 0 |
| Time alignment error relative to cell 1 ^{Note 5} | μs | - | ≤ TAE | | ≤ TAE |
| Time alignment error relative to cell 2 ^{Note 5} | μs | - | - | | ≤ TAE |
| <p>Note 1: OCNG shall be used such that all cells are fully allocated and a constant total transmitted power spectral density is achieved for all OFDM symbols.</p> <p>Note 2: Interference from other cells and noise sources not specified in the test is assumed to be constant over subcarriers and time and shall be modelled as AWGN of appropriate power for N_{oc} to be fulfilled.</p> <p>Note 3: E_s/I_{ot}, RSRP, SCH_RP and I_o have been derived from other parameters for information purposes. They are not settable parameters themselves.</p> <p>Note 4: The uplink resources for CSI reporting are assigned to the UE prior to the start of time period T2.</p> <p>Note 5: The time alignment error (TAE) between two cells specified in TS 36.104 [30] clause 6.5.3.1 (value depends upon the type of carrier aggregation).</p> | | | | | |

A.8.16.42.2 Test Requirements

During T2 the UE shall send the first CSI report for SCell1 in a subframe (m+8), or in a subframe (m+9) if the subframe (m+8) was subject to interruption, or in a subframe (m+13) if the subframes (m+8) and (m+9) were subject to interruption when an intra-band SCell is activated. Whether CSI report in subframe (m+8) and/or (m+9) was interrupted or not is checked by monitoring ACK/NACK sent in PCell in subframe (m+8) and/or (m+9).

During T2 the UE shall start sending CSI reports for SCell1 with non-zero CQI index at latest in a subframe (m+39).

During T3 the UE shall stop sending CSI reports for SCell1 at latest in a subframe (n+8).

During T2 interruption of PCell during SCells activation shall not happen outside the subframes (m+5) to (m+11) and outside the subframes (m+20) to (m+26).

During T3 interruption of PCell during SCells deactivation shall not happen outside the subframes (n+5) to (n+11) and outside the subframes (n+20) to (n+26).

The interruption of PCell shall not be more than the values specified for intra-band CA and inter-band CA in Section 7.8.2.

All of the above test requirements shall be fulfilled in order for the observed SCell1 activation delay and SCell1 deactivation delay to be counted as correct. The rate of correct observed SCell1 activation delay and SCell1 deactivation delay during repeated tests shall be at least 90%.

NOTE: During T2 if there are no uplink resources for reporting the valid CSI in a subframe (m+39) then the UE shall use the next available uplink resource for reporting the corresponding valid CSI.

A.8.16.43 E-UTRAN TDD-FDD CA activation and deactivation of known SCell in non-DRX with PCell in FDD

A.8.16.43.1 Test Purpose and Environment

The purpose of this test is to verify that the SCell activation and deactivation times are within the requirements stated in section 7.7, when the SCell is known by the UE at the time of activation and PCell is in FDD.

The test parameters are given in Tables A.8.16.43.1-1 and cell-specific parameters in A.8.16.43.1-2 below. The test consists of three successive time periods, with duration of T1, T2 and T3, respectively. There are two carriers, each with one cell. Both cells

have constant signal levels throughout the test. Before the test starts the UE is connected to Cell 1 (PCell) on radio channel 1 (PCC) but is not aware of Cell 2 on radio channel 2. The UE is only monitoring the PCC. The UE shall be continuously scheduled in the PCell throughout the whole test.

At the beginning of T1 the UE receives an RRC message by which the SCell (Cell 2) becomes configured on radio channel 2 (SCC). The UE now starts monitoring also the SCC. The test equipment sends a MAC message for activation of the SCell.

The point in time at which the MAC message is received at the UE antenna connector, in a subframe # denoted m which is an even number, defines the start of time period T2. The UE shall be able to report valid CSI for the activated SCell at latest in subframe (m+24). The UE shall start reporting CSI in subframe (m+8) and shall report CQI index 0 (out-of-range) until the SCell activation has been completed. Any PCell interruption due to activation of SCell shall occur in the subframes (m+5) to (m+9).

Time period T3 starts when a MAC message for deactivation of SCell, sent from the test equipment to the UE in a subframe # denoted n which is an even number, received at the UE antenna connector. The UE shall carry out deactivation of the SCell in a subframe (n+8), and any PCell interruption due to the deactivation shall occur in the subframes (n+5) to (n+9).

The test equipment verifies that potential interruption is carried out in the correct time span by monitoring ACK/NACK sent in PCell during activation and deactivation of SCell, respectively.

The test equipment verifies the activation time by counting the subframes from the time when the SCell activation command is sent until a CSI report with other than CQI index 0 is received.

The test equipment verifies the deactivation time by counting the subframes from the time when the SCell deactivation command is sent until CQI reporting for SCell is discontinued.

Table A.8.16.43.1-1: General test parameters for known SCell activation case

| Parameter | Unit | Value | Comment |
|---|------|--------|--|
| E-UTRA RF Channel Number | | 1, 2 | Two radio channels are used for this test |
| Active PCell | | Cell 1 | Primary cell on RF channel number 1. |
| Deconfigured deactivated SCell | | Cell 2 | Deconfigured deactivated secondary cell on RF channel number 2. |
| CP length | | Normal | |
| DRX | | OFF | Continuous monitoring of primary cell |
| CQI/PMI periodicity and offset configuration index | | 0 | CQI reporting for SCell every second subframe |
| Cell-individual offset for cells on RF channel number 1 | dB | 0 | Individual offset for cells on primary component carrier. |
| Cell-individual offset for cells on RF channel number 2 | dB | 0 | Individual offset for cells on secondary component carrier. |
| SCell measurement cycle (measCycleSCell) | ms | 320 | |
| T1 | s | 7 | During this time the PCell shall be known and the SCell configured and detected. |
| T2 | s | 1 | During this time the UE shall activate the SCell. |
| T3 | s | 1 | During this time the UE shall deactivate the SCell. |

Table A.8.16.43.1-2: Cell specific test parameters for E-UTRAN TDD known SCell activation with PCell in FDD

| Parameter | Unit | Cell 1 | | | Cell 2 | | |
|--|------|---|----|----|---|----|----|
| | | T1 | T2 | T3 | T1 | T2 | T3 |
| E-UTRA RF Channel Number | | 1 | | | 2 | | |
| TDD special subframe configuration | | - | | | 6 | | |
| TDD uplink-downlink configuration | | - | | | 1 | | |
| BW _{channel} | MHz | 5MHz: N _{RB,c} = 25 10MHz: N _{RB,c} = 50 20MHz: N _{RB,c} = 100 | | | 5MHz: N _{RB,c} = 25 10MHz: N _{RB,c} = 50 20MHz: N _{RB,c} = 100 | | |
| PDSCH parameters: DL Reference Measurement Channel | | 5MHz: R.7 FDD 10MHz: R.3 FDD 20MHz: R.6 FDD | | | - | | |

| | | | |
|--|------------|---|---|
| PCFICH/PDCCH/PHICH parameters: DL Reference Measurement Channel | | 5MHz: R.11 FDD 10MHz: R.6 FDD 20MHz: R.10 FDD | 5MHz: R.11 TDD 10MHz: R.6 TDD 20MHz: R.10 TDD |
| OCNG Patterns | | 5MHz: OP.20 FDD 10MHz: OP.10 FDD 20MHz: OP.17 FDD | 5MHz: OP.10 TDD 10MHz: OP.2 TDD 20MHz: OP.8 TDD |
| PBCH_RA | dB | 0 | 0 |
| PBCH_RB | dB | | |
| PSS_RA | dB | | |
| SSS_RA | dB | | |
| PCFICH_RB | dB | | |
| PHICH_RA | dB | | |
| PHICH_RB | dB | | |
| PDCCH_RA | dB | | |
| PDCCH_RB | dB | | |
| PDSCH_RA | dB | | |
| PDSCH_RB | dB | | |
| OCNG_RA ^{Note 1} | dB | | |
| OCNG_RB ^{Note 1} | dB | | |
| N_{oc} ^{Note 2} | dBm/15 kHz | -104 | -104 |
| \bar{E}_s/N_{oc} | dB | 17 | 17 |
| \bar{E}_s/I_{ot} | dB | 17 | 17 |
| RSRP ^{Note 3} | dBm/15 kHz | -87 | -87 |
| SCH_RP ^{Note 3} | dBm/15 kHz | -87 | -87 |
| I_o ^{Note 3} | dBm/Ch BW | -59.13 +10log ($N_{RB,c}/50$) | -59.13 +10log ($N_{RB,c}/50$) |
| Propagation Condition | | AWGN | AWGN |
| Antenna Configuration | | 1x2 | 1x2 |
| Timing offset to Cell 1 | μ s | - | 0 |
| Time alignment error relative to cell 1 ^{Note 5} | μ s | - | \leq TAE |
| <p>Note 1: OCNG shall be used such that all cells are fully allocated and a constant total transmitted power spectral density is achieved for all OFDM symbols.</p> <p>Note 2: Interference from other cells and noise sources not specified in the test is assumed to be constant over subcarriers and time and shall be modelled as AWGN of appropriate power for N_{oc} to be fulfilled.</p> <p>Note 3: \bar{E}_s/I_{ot}, RSRP, SCH_RP and I_o levels have been derived from other parameters for information purposes. They are not settable parameters themselves.</p> <p>Note 4: The uplink resources for CSI reporting are assigned to the UE prior to the start of time period T2.</p> <p>Note 5: Time alignment error (TAE) as specified in TS 36.104 [30] clause 6.5.3.1. The TAE value depends upon the type of carrier aggregation.</p> | | | |

A.8.16.43.2 Test Requirements

During T2 the UE shall send the first CSI report for SCell in a subframe (m+8), or in a subframe (m+10) if the subframe (m+8) was subject to interruption. Whether CSI report in subframe (m+8) was interrupted or not is checked by monitoring ACK/NACK sent in PCell in subframe (m+8).

During T2 the UE shall start sending CSI reports for SCell with non-zero CQI index at latest in a subframe (m+24).

During T3 the UE shall stop sending CSI reports for SCell at latest in a subframe (n+8).

During T2 interruption of PCell during SCell activation shall not happen outside the subframes (m+5) to (m+9).

During T3 interruption of PCell during SCell deactivation shall not happen outside the subframes (n+5) to (n+9).

The interruption of PCell shall not be more than the values specified for inter-band CA in Section 7.8.2.

All of the above test requirements shall be fulfilled in order for the observed SCell activation delay and SCell deactivation delay to be counted as correct. The rate of correct observed SCell activation delay and SCell deactivation delay during repeated tests shall be at least 90%.

NOTE: During T2 if there are no uplink resources for reporting the valid CSI in a subframe (m+24) then the UE shall use the next available uplink resource for reporting the corresponding valid CSI.

A.8.16.44 E-UTRAN TDD-FDD CA activation and deactivation of unknown SCell in non-DRX with PCell in FDD

A.8.16.44.1 Test Purpose and Environment

The purpose of this test is to verify that the SCell activation and deactivation times are within the requirements stated in section 7.7, when the SCell is unknown by the UE at the time of activation and PCell is in FDD.

The test parameters are given in Tables A.8.16.44.1-1 and cell-specific parameters in A.8.16.44.1-2 below. The test consists of three successive time periods, with duration of T1, T2 and T3, respectively. There are two carriers, each with one cell. Cell 1 has constant signal level throughout the test. Before the test starts the UE is connected to Cell 1 (PCell) on radio channel 1 (PCC) but is not aware of Cell 2 on radio channel 2. The UE is only monitoring the PCC. The UE shall be continuously scheduled in the PCell throughout the whole test.

At the beginning of T1 the UE receives an RRC message by which the SCell (Cell 2) becomes configured on radio channel 2 (SCC). During T1 the SCell is powered off and UE is not aware of SCell.

A MAC message for activation of SCell is sent by the test equipment 100ms after the RRC message, in a subframe # denoted m which is an even number. The point in time at which the MAC message for activation of SCell is received at the UE antenna connector defines the start of time period T2. Immediately at beginning of T2 the transmission power of cell 2 is increased to same level as for cell 1. The UE shall be able to report valid CSI for the activated SCell at latest in subframe (m+34) provided the SCell can be successfully detected on the first attempt. The UE shall start reporting CSI in subframe (m+8) and shall report CQI index 0 (out-of-range) until the SCell activation has been completed. Any PCell interruption due to activation of SCell shall occur in the subframes (m+5) to (m+9).

Time period T3 starts when a MAC message for deactivation of the SCell, sent from the test equipment to the UE in a subframe # denoted n which is an even number, is received at the UE antenna connector. The UE shall carry out deactivation of the SCell at latest in subframe (n+8), and any PCell interruption due to the deactivation shall occur in the subframes (n+5) to (n+9).

The test equipment verifies that potential interruption is carried out in the correct time span by monitoring ACK/NACK sent in PCell during activation and deactivation of SCell, respectively.

The test equipment verifies the activation time by counting the subframes from the time when the SCell activation command is sent until a CSI report with other than CQI index 0 is received.

The test equipment verifies the deactivation time by counting the subframes from the time when the SCell deactivation command is sent until CQI reporting for SCell1 is discontinued.

Table A.8.16.44.1-1: General test parameters for unknown SCell activation case

| Parameter | Unit | Value | Comment |
|---|------|--------|---|
| E-UTRA RF Channel Number | | 1, 2 | Two radio channels are used for this test |
| Active PCell | | Cell 1 | Primary cell on RF channel number 1. |
| Deconfigured deactivated SCell | | Cell 2 | Deconfigured deactivated secondary cell on RF channel number 2. |
| CP length | | Normal | |
| DRX | | OFF | Continuous monitoring of primary cell |
| CQI/PMI periodicity and offset configuration index | | 0 | CQI reporting for SCell every second subframe |
| Cell-individual offset for cells on RF channel number 1 | dB | 0 | Individual offset for cells on primary component carrier. |
| Cell-individual offset for cells on RF channel number 2 | dB | 0 | Individual offset for cells on secondary component carrier. |
| SCell measurement cycle (measCycleSCell) | ms | 320 | |
| T1 | ms | 100 | During this time the PCell shall be known and the SCell configured, but not detected. |
| T2 | s | 1 | During this time the UE shall activate the SCell. |
| T3 | s | 1 | During this time the UE shall deactivate the SCell. |

Table A.8.16.44.1-2: Cell specific test parameters for E-UTRAN TDD unknown SCell activation

| Parameter | Unit | Cell 1 | | | Cell 2 | | |
|---|---|---|----|----|---|---|----|
| | | T1 | T2 | T3 | T1 | T2 | T3 |
| E-UTRA RF Channel Number | | 1 | | | 2 | | |
| TDD special subframe configuration | | - | | | 6 | | |
| TDD uplink-downlink configuration | | - | | | 1 | | |
| BW _{channel} | MHz | 5MHz: N _{RB,c} = 25 10MHz: N _{RB,c} = 50 20MHz: N _{RB,c} = 100 | | | 5MHz: N _{RB,c} = 25 10MHz: N _{RB,c} = 50 20MHz: N _{RB,c} = 100 | | |
| PDSCH parameters: DL Reference Measurement Channel | | 5MHz: R.7 FDD 10MHz: R.3 FDD 20MHz: R.6 FDD | | | - | | |
| PCFICH/PDCCH/PHICH parameters: DL Reference Measurement Channel | | 5MHz: R.11 FDD 10MHz: R.6 FDD 20MHz: R.10 FDD | | | 5MHz: R.11 TDD 10MHz: R.6 TDD 20MHz: R.10 TDD | | |
| OCNG Patterns | | 5MHz: OP.20 FDD 10MHz: OP.10 FDD 20MHz: OP.17 FDD | | | 5MHz: OP.10 TDD 10MHz: OP.2 TDD 20MHz: OP.8 TDD | | |
| PBCH_RA | dB | 0 | | | 0 | | |
| PBCH_RB | dB | | | | | | |
| PSS_RA | dB | | | | | | |
| SSS_RA | dB | | | | | | |
| PCFICH_RB | dB | | | | | | |
| PHICH_RA | dB | | | | | | |
| PHICH_RB | dB | | | | | | |
| PDCCH_RA | dB | | | | | | |
| PDCCH_RB | dB | | | | | | |
| PDSCH_RA | dB | | | | | | |
| PDSCH_RB | dB | | | | | | |
| OCNG_RA ^{Note 1} | dB | | | | | | |
| OCNG_RB ^{Note 1} | dB | | | | | | |
| N _{oc} ^{Note 2} | dBm/15 kHz | | | | | | |
| \hat{E}_s/N_{oc} | dB | 17 | | | -Infinity | 17 | |
| \hat{E}_s/I_{ot} | dB | 17 | | | -Infinity | 17 | |
| RSRP ^{Note 3} | dBm/15 kHz | -87 | | | -Infinity | -87 | |
| SCH_RP ^{Note 3} | dBm/15 kHz | -87 | | | -Infinity | -87 | |
| I _o ^{Note 3} | dBm/Ch BW | -59.13 +10log (N _{RB,c} /50) | | | -76.22 +10log (N _{RB,c} /50) | -59.13 +10log (N _{RB,c} /50) | |
| Propagation Condition | | AWGN | | | AWGN | | |
| Antenna Configuration | | 1x2 | | | 1x2 | | |
| Timing offset to Cell 1 | μs | - | | | 0 | | |
| Time alignment error relative to cell 1 ^{Note 5} | μs | - | | | ≤ TAE | | |
| Note 1: | OCNG shall be used such that all cells are fully allocated and a constant total transmitted power spectral density is achieved for all OFDM symbols. | | | | | | |
| Note 2: | Interference from other cells and noise sources not specified in the test is assumed to be constant over subcarriers and time and shall be modelled as AWGN of appropriate power for N _{oc} to be fulfilled. | | | | | | |
| Note 3: | Es/I _{ot} , RSRP, SCH_RP and I _o levels have been derived from other parameters for information purposes. They are not settable parameters themselves. | | | | | | |
| Note 4: | The uplink resources for CSI reporting are assigned to the UE prior to the start of time period T2. | | | | | | |
| Note 5: | Time alignment error (TAE) as specified in TS 36.104 [30] clause 6.5.3.1. The TAE value depends upon the type of carrier aggregation. | | | | | | |

A.8.16.44.2 Test Requirements

During T2 the UE shall send the first CSI report for SCell (m+8), or in a subframe (m+10) if the subframe (m+8) was subject to interruption. Whether CSI report in subframe (m+8) was interrupted or not is checked by monitoring ACK/NACK sent in PCell in subframe (m+8).

During T2 the UE shall start sending CSI reports for SCell with non-zero CQI index at latest in a subframe (m+34).

During T3 the UE shall stop sending CSI reports for SCell at latest in a subframe (n+8).

During T2 interruption of PCell during SCell activation shall not happen outside the subframes (m+5) to (m+9).

During T3 interruption of PCell during SCell deactivation shall not happen outside the subframes (n+5) to (n+9).

The interruption of PCell shall not be more than the values specified for inter-band CA in Section 7.8.2.

All of the above test requirements shall be fulfilled in order for the observed SCell activation delay and SCell deactivation delay to be counted as correct. The rate of correct observed SCell activation and deactivation delay during repeated tests shall be at least 90%.

NOTE: During T2 if there are no uplink resources for reporting the valid CSI in a subframe (m+34) then the UE shall use the next available uplink resource for reporting the corresponding valid CSI.

A.8.16.45 E-UTRAN TDD-FDD CA activation and deactivation of known SCell in non-DRX with PCell in TDD

A.8.16.45.1 Test Purpose and Environment

The purpose of this test is to verify that the SCell activation and deactivation times are within the requirements stated in section 7.7, when the SCell is known by the UE at the time of activation and PCell is in TDD.

The test parameters are given in Tables A.8.16.45.1-1 and cell-specific parameters in A.8.16.45.1-2 below. The test consists of three successive time periods, with duration of T1, T2 and T3, respectively. There are two carriers, each with one cell. Both cells have constant signal levels throughout the test. Before the test starts the UE is connected to Cell 1 (PCell) on radio channel 1 (PCC) but is not aware of Cell 2 on radio channel 2. The UE is only monitoring the PCC. The UE shall be continuously scheduled in the PCell throughout the whole test.

At the beginning of T1 the UE receives an RRC message by which the SCell (Cell 2) becomes configured on radio channel 2 (SCC). The UE now starts monitoring also the SCC. The test equipment sends a MAC message for activation of the SCell.

The point in time at which the MAC message is received at the UE antenna connector, in a subframe # denoted m, where m is 4 or 9, defines the start of time period T2. The UE shall be able to report valid CSI for the activated SCell at latest in subframe (m+24). The UE shall start reporting CSI in subframe (m+8) and shall report CQI index 0 (out-of-range) until the SCell activation has been completed. Any PCell interruption due to activation of SCell shall occur in the subframes (m+5) to (m+11).

Time period T3 starts when a MAC message for deactivation of SCell, sent from the test equipment to the UE in a subframe # denoted n where n is 4 or 9, is received at the UE antenna connector. The UE shall carry out deactivation of the SCell at latest in subframe (n+8), and any PCell interruption due to the deactivation shall occur in the subframes (n+5) to (n+11).

The test equipment verifies that potential interruption is carried out in the correct time span by monitoring ACK/NACK sent in PCell during activation and deactivation of SCell, respectively.

The test equipment verifies the activation time by counting the subframes from the time when the SCell activation command is sent until a CSI report with other than CQI index 0 is received.

The test equipment verifies the deactivation time by counting the subframes from the time when the SCell deactivation command is sent until CQI reporting for SCell is discontinued.

Table A.8.16.45.1-1: General test parameters for known SCell activation case

| Parameter | Unit | Value | Comment |
|--------------------------------|------|--------|---|
| E-UTRA RF Channel Number | | 1, 2 | Two radio channels are used for this test |
| Active PCell | | Cell 1 | Primary cell on RF channel number 1. |
| Deconfigured deactivated SCell | | Cell 2 | Deconfigured deactivated secondary cell on RF channel number 2. |

| | | | |
|---|----|--------|--|
| CP length | | Normal | |
| DRX | | OFF | Continuous monitoring of primary cell |
| CQI/PMI periodicity and offset configuration index | | 0 | CQI reporting for SCell every second subframe |
| Cell-individual offset for cells on RF channel number 1 | dB | 0 | Individual offset for cells on primary component carrier. |
| Cell-individual offset for cells on RF channel number 2 | dB | 0 | Individual offset for cells on secondary component carrier. |
| SCell measurement cycle (measCycleSCell) | ms | 320 | |
| T1 | s | 7 | During this time the PCell shall be known and the SCell configured and detected. |
| T2 | s | 1 | During this time the UE shall activate the SCell. |
| T3 | s | 1 | During this time the UE shall deactivate the SCell. |

Table A.8.16.45.1-2: Cell specific test parameters for E-UTRAN FDD known SCell activation with PCell in TDD

| Parameter | Unit | Cell 1 | | | Cell 2 | | |
|---|------------|---|----|----|---|----|----|
| | | T1 | T2 | T3 | T1 | T2 | T3 |
| E-UTRA RF Channel Number | | 1 | | | 2 | | |
| TDD special subframe configuration | | 6 | | | - | | |
| TDD uplink-downlink configuration | | 1 | | | - | | |
| BW _{channel} | MHz | 5MHz: N _{RB,c} = 25 10MHz: N _{RB,c} = 50 20MHz: N _{RB,c} = 100 | | | 5MHz: N _{RB,c} = 25 10MHz: N _{RB,c} = 50 20MHz: N _{RB,c} = 100 | | |
| PDSCH parameters: DL Reference Measurement Channel | | 5MHz: R.4 TDD 10MHz: R.0 TDD 20MHz: R.3 TDD | | | - | | |
| PCFICH/PDCCH/PHICH parameters: DL Reference Measurement Channel | | 5MHz: R.11 TDD 10MHz: R.6 TDD 20MHz: R.10 TDD | | | 5MHz: R.11 FDD 10MHz: R.6 FDD 20MHz: R.10 FDD | | |
| OCNG Patterns | | 5MHz: OP.9 TDD 10MHz: OP.1 TDD 20MHz: OP.7 TDD | | | 5MHz: OP.16 FDD 10MHz: OP.2 FDD 20MHz: OP.12 FDD | | |
| PBCH_RA | dB | 0 | | | 0 | | |
| PBCH_RB | dB | | | | | | |
| PSS_RA | dB | | | | | | |
| SSS_RA | dB | | | | | | |
| PCFICH_RB | dB | | | | | | |
| PHICH_RA | dB | | | | | | |
| PHICH_RB | dB | | | | | | |
| PDCCH_RA | dB | | | | | | |
| PDCCH_RB | dB | | | | | | |
| PDSCH_RA | dB | | | | | | |
| PDSCH_RB | dB | | | | | | |
| OCNG_RA ^{Note 1} | dB | | | | | | |
| OCNG_RB ^{Note 1} | dB | | | | | | |
| N _{oc} ^{Note 2} | dBm/15 kHz | | | | | | |
| \bar{E}_s/N_{oc} | dB | 17 | | | 17 | | |
| \bar{E}_s/I_{ot} | dB | 17 | | | 17 | | |
| RSRP ^{Note 3} | dBm/15 kHz | -87 | | | -87 | | |
| SCH_RP ^{Note 3} | dBm/15 kHz | -87 | | | -87 | | |
| I _o ^{Note 3} | dBm/Ch BW | -59.13 +10log (N _{RB,c} /50) | | | -59.13 +10log (N _{RB,c} /50) | | |
| Propagation Condition | | AWGN | | | AWGN | | |
| Antenna Configuration | | 1x2 | | | 1x2 | | |
| Timing offset to Cell 1 | μs | - | | | 0 | | |

| Time alignment error relative to cell 1 ^{Note 5} | μs | - | $\leq \text{TAE}$ |
|---|--|---|-------------------|
| Note 1: | OCNG shall be used such that all cells are fully allocated and a constant total transmitted power spectral density is achieved for all OFDM symbols. | | |
| Note 2: | Interference from other cells and noise sources not specified in the test is assumed to be constant over subcarriers and time and shall be modelled as AWGN of appropriate power for N_{oc} to be fulfilled. | | |
| Note 3: | E_s/lot , RSRP, SCH_RP and I_0 levels have been derived from other parameters for information purposes. They are not settable parameters themselves. | | |
| Note 4: | The uplink resources for CSI reporting are assigned to the UE prior to the start of time period T2. | | |
| Note 5: | Time alignment error (TAE) as specified in TS 36.104 [30] clause 6.5.3.1. The TAE value depends upon the type of carrier aggregation. | | |

A.8.16.45.2 Test Requirements

During T2 the UE shall send the first CSI report for SCell in a subframe (m+8), or in a subframe (m+9) if the subframe (m+8) was subject to interruption. Whether CSI report in subframe (m+8) was interrupted or not is checked by monitoring ACK/NACK sent in PCell in subframe (m+8).

During T2 the UE shall start sending CSI reports for SCell with non-zero CQI index at latest in a subframe (m+24).

During T3 the UE shall stop sending CSI reports for SCell at latest in a subframe (m+8).

During T2 interruption of PCell during SCell activation shall not happen outside the subframes (m+5) to (m+11).

During T3 interruption of PCell during SCell deactivation shall not happen outside the subframes (n+5) to (n+11).

The interruption of PCell shall not be more than the values specified for inter-band CA in Section 7.8.2.

All of the above test requirements shall be fulfilled in order for the observed SCell activation delay and SCell deactivation delay to be counted as correct. The rate of correct observed SCell activation delay and SCell deactivation delay during repeated tests shall be at least 90%.

NOTE: During T2 if there are no uplink resources for reporting the valid CSI in a subframe (m+24) then the UE shall use the next available uplink resource for reporting the corresponding valid CSI.

A.8.16.46 E-UTRAN TDD-FDD CA activation and deactivation of unknown SCell in non-DRX with PCell in TDD

A.8.16.46.1 Test Purpose and Environment

The purpose of this test is to verify that the SCell activation and deactivation times are within the requirements stated in section 7.7, when the SCell is unknown by the UE at the time of activation and PCell is in FDD.

The test parameters are given in Tables A.8.16.46.1-1 and cell-specific parameters in A.8.16.46.1-2 below. The test consists of three successive time periods, with duration of T1, T2 and T3, respectively. There are two carriers, each with one cell. Cell 1 has constant signal level throughout the test. Before the test starts the UE is connected to Cell 1 (PCell) on radio channel 1 (PCC) but is not aware of Cell 2 on radio channel 2. The UE is only monitoring the PCC. The UE shall be continuously scheduled in the PCell throughout the whole test.

At the beginning of T1 the UE receives an RRC message by which the SCell (Cell 2) becomes configured on radio channel 2 (SCC). During T1 the SCell is powered off and UE is not aware of SCell.

A MAC message for activation of SCell is sent by the test equipment 100ms after the RRC message, in a subframe # denoted m, where m is 4 or 9. The point in time at which the MAC message for activation of SCell is received at the UE antenna connector defines the start of time period T2. Immediately at beginning of T2 the transmission power of cell 2 is increased to same level as for cell 1. The UE shall be able to report valid CSI for the activated SCell at latest in subframe (m+34) provided the SCell can be successfully detected on the first attempt. The UE shall start reporting CSI in subframe (m+8) and shall report CQI index 0 (out-of-range) until the SCell activation has been completed. Any PCell interruption due to activation of SCell shall occur in the subframes (m+5) to (m+11).

Time period T3 starts when a MAC message for deactivation of the SCell, sent from the test equipment to the UE in a subframe # denoted n, where n is 4 or 9, is received at the UE antenna connector. The UE shall carry out deactivation of the SCell at latest in subframe (n+8), and any PCell interruption due to the deactivation shall occur in the subframes (n+5) to (n+11).

The test equipment verifies that potential interruption is carried out in the correct time span by monitoring ACK/NACK sent in PCell during activation of SCell, respectively.

The test equipment verifies the activation time by counting the subframes from the time when the SCell activation command is sent until a CSI report with other than CQI index 0 is received.

The test equipment verifies the deactivation time by counting the subframes from the time when the SCell1 deactivation command is sent until CQI reporting for SCell1 is discontinued.

Table A.8.16.46.1-1: General test parameters for unknown SCell activation case

| Parameter | Unit | Value | Comment |
|---|------|--------|---|
| E-UTRA RF Channel Number | | 1, 2 | Two radio channels are used for this test |
| Active PCell | | Cell 1 | Primary cell on RF channel number 1. |
| Deconfigured deactivated SCell | | Cell 2 | Deconfigured deactivated secondary cell on RF channel number 2. |
| CP length | | Normal | |
| DRX | | OFF | Continuous monitoring of primary cell |
| CQI/PMI periodicity and offset configuration index | | 0 | CQI reporting for SCell every second subframe |
| Cell-individual offset for cells on RF channel number 1 | dB | 0 | Individual offset for cells on primary component carrier. |
| Cell-individual offset for cells on RF channel number 2 | dB | 0 | Individual offset for cells on secondary component carrier. |
| SCell measurement cycle (measCycleSCell) | ms | 320 | |
| T1 | s | 100 | During this time the PCell shall be known and the SCell configured, but not detected. |
| T2 | s | 1 | During this time the UE shall activate the SCell. |
| T3 | s | 1 | During this time the UE shall deactivate the SCell. |

Table A.8.16.46.1-2: Cell specific test parameters for E-UTRAN FDD unknown SCell activation with PCell in TDD

| Parameter | Unit | Cell 1 | | | Cell 2 | | |
|---|------|---|----|----|---|----|----|
| | | T1 | T2 | T3 | T1 | T2 | T3 |
| E-UTRA RF Channel Number | | 1 | | | 2 | | |
| TDD special subframe configuration | | 6 | | | - | | |
| TDD uplink-downlink configuration | | 1 | | | - | | |
| BW _{channel} | MHz | 5MHz: N _{RB,c} = 25 10MHz: N _{RB,c} = 50 20MHz: N _{RB,c} = 100 | | | 5MHz: N _{RB,c} = 25 10MHz: N _{RB,c} = 50 20MHz: N _{RB,c} = 100 | | |
| PDSCH parameters: DL Reference Measurement Channel | | 5MHz: R.4 TDD 10MHz: R.0 TDD 20MHz: R.3 TDD | | | - | | |
| PCFICH/PDCCH/PHICH parameters: DL Reference Measurement Channel | | 5MHz: R.11 TDD 10MHz: R.6 TDD 20MHz: R.10 TDD | | | 5MHz: R.11 FDD 10MHz: R.6 FDD 20MHz: R.10 FDD | | |
| OCNG Patterns | | 5MHz: OP.9 TDD 10MHz: OP.1 TDD 20MHz: OP.7 TDD | | | 5MHz: OP.16 FDD 10MHz: OP.2 FDD 20MHz: OP.12 FDD | | |
| PBCH_RA | dB | 0 | | | 0 | | |
| PBCH_RB | dB | | | | | | |
| PSS_RA | dB | | | | | | |
| SSS_RA | dB | | | | | | |
| PCFICH_RB | dB | | | | | | |
| PHICH_RA | dB | | | | | | |

| | | | | |
|--|------------|---|---|---|
| PHICH_RB | dB | | | |
| PDCCH_RA | dB | | | |
| PDCCH_RB | dB | | | |
| PDSCH_RA | dB | | | |
| PDSCH_RB | dB | | | |
| OCNG_RA ^{Note 1} | dB | | | |
| OCNG_RB ^{Note 1} | dB | | | |
| N _{oc} ^{Note 2} | dBm/15 kHz | -104 | -104 | |
| \bar{E}_s/N_{oc} | dB | 17 | -Infinity | 17 |
| \bar{E}_s/I_{ot} | dB | 17 | -Infinity | 17 |
| RSRP ^{Note 3} | dBm/15 kHz | -87 | -Infinity | -87 |
| SCH_RP ^{Note 3} | dBm/15 kHz | -87 | -Infinity | -87 |
| I _o ^{Note 3} | dBm/Ch BW | -59.13 +10log (N _{RB,c} /50) | -76.22 +10log (N _{RB,c} /50) | -59.13 +10log (N _{RB,c} /50) |
| Propagation Condition | | AWGN | AWGN | |
| Antenna Configuration | | 1x2 | 1x2 | |
| Timing offset to Cell 1 | μs | - | 0 | |
| Time alignment error relative to cell 1 ^{Note 5} | μs | - | ≤ TAE | |
| <p>Note 1: OCNG shall be used such that all cells are fully allocated and a constant total transmitted power spectral density is achieved for all OFDM symbols.</p> <p>Note 2: Interference from other cells and noise sources not specified in the test is assumed to be constant over subcarriers and time and shall be modelled as AWGN of appropriate power for N_{oc} to be fulfilled.</p> <p>Note 3: Es/I_{ot}, RSRP, SCH_RP and I_o levels have been derived from other parameters for information purposes. They are not settable parameters themselves.</p> <p>Note 4: The uplink resources for CSI reporting are assigned to the UE prior to the start of time period T2.</p> <p>Note 5: Time alignment error (TAE) as specified in TS 36.104 [30] clause 6.5.3.1. The TAE value depends upon the type of carrier aggregation.</p> | | | | |

A.8.16.46.2 Test Requirements

During T2 the UE shall send the first CSI report for SCell in a subframe (m+8), or in a subframe (m+9) if the subframe (m+8) was subject to interruption. Whether CSI report in subframe (m+8) was interrupted or not is checked by monitoring ACK/NACK sent in PCell in subframe (m+8).

During T2 the UE shall start sending CSI reports for SCell with non-zero CQI index at latest in a subframe (m+34).

During T3 the UE shall stop sending CSI reports for SCell at latest in a subframe (n+8).

During T2 Interruption of PCell during SCell activation shall not happen outside the subframes (m+5) to (m+11).

During T3 Interruption of PCell during SCell deactivation shall not happen outside the subframes (n+5) to (n+11).

The interruption of PCell shall not be more than the values specified for inter-band CA in Section 7.8.2.

All of the above test requirements shall be fulfilled in order for the observed SCell activation delay and SCell deactivation delay to be counted as correct. The rate of correct observed SCell activation and deactivation delay during repeated tests shall be at least 90%.

NOTE: During T2 if there are no uplink resources for reporting the valid CSI in a subframe (m+34) then the UE shall use the next available uplink resource for reporting the corresponding valid CSI.

A.8.16.47 2DL/2UL FDD CA activation and deactivation of known PUCCH SCell without valid TA in non-DRX

A.8.16.47.1 Test Purpose and Environment

The purpose of this test is to verify that SCell activation and deactivation are done within the required time period defined in clause 7.7 for 2DL/2UL FDD carrier aggregation, when PUCCH for a being activated SCell is configured on the SCell. The SCell is known by a UE and the UE does not have valid TA for an sTAG which the SCell belongs to at the time of activation.

Test parameters are given in Table A.8.16.47.1-1 and Table A.8.16.47.1-2. The test consists of three successive time periods with duration of T1, T2 and T3, respectively. There are two carriers. In each carrier only one cell exists. All cells have constant signal levels throughout the test. The UE shall be continuously scheduled in Cell 1 (PCell) throughout the test.

Before the test starts, the UE is connected to the PCell (Cell 1) on radio channel 1 (PCC), but is not aware of Cell 2 (SCell) on radio channel 2 (SCC). The PCell is in the pTAG and the SCell is in an sTAG. The UE is only monitoring the PCC.

At the beginning of T1, the UE receives an RRC message by which the SCell (Cell 2) gets configured with PUCCH on radio channel 2 (SCC). The UE now starts monitoring the SCC also. Test equipment sends a MAC message for activation of the SCell.

The MAC message for the activation is received at the UE antenna connector at subframe # denoted m, which is defined as the start of time period T2. Subframe m is an even number. The test equipment should send a PDCCH order to the UE to initiate RA procedure on the PUCCH SCell at subframe (m+24). The UE shall be able to report valid CSI for the activated SCell no later than subframe (m+58). Any PCell interruption due to the activation shall not occur outside subframe (m+5) to (m+9).

A MAC message for deactivation of the SCell is received at the UE antenna connector at subframe # denoted n, which is defined as the start of time period T3. The UE shall carry out the deactivation of the SCell no later than subframe (n+8). Any PCell interruption due to the deactivation shall not occur outside subframe (n+5) to (n+9).

The test equipment verifies that potential interruption is carried out in the correct time span by monitoring ACK/NACK sent in PCell during the activation and the deactivation, respectively.

The test equipment verifies the activation time by counting the subframes from the time when the SCell activation command is sent until a CSI report with other than CQI index 0 is received from the PUCCH SCell.

The test equipment verifies the deactivation time by counting the subframes from the time when the SCell deactivation command is sent until CQI reporting from the PUCCH SCell is discontinued.

Table A.8.16.47.1-1: General test parameters for 2DL/2UL FDD CA activation and deactivation of known PUCCH SCell without valid TA in non-DRX

| Parameter | Unit | Value | Comment |
|---|------|--------|---|
| E-UTRA RF Channel Number | | 1, 2 | Two radio channels are used for the test. |
| Active PCell | | Cell 1 | Primary cell on RF channel number 1. |
| Deconfigured SCell | | Cell 2 | Deconfigured secondary cell on RF channel number 2. |
| CP length | | Normal | |
| DRX | | OFF | Continuous monitoring of primary cell. |
| CQI/PMI periodicity and offset configuration index | | 0 | CQI reporting for SCell every second subframe. |
| Cell-individual offset for cells on RF channel number 1 | dB | 0 | Individual offset for cells on PCC. |
| Cell-individual offset for cells on RF channel number 2 | dB | 0 | Individual offset for cells on SCC. |
| Filter coefficient | | 0 | L3 filtering is not used. |
| SCell measurement cycle (measCycleSCell) | ms | 320 | |
| TimeAlignmentTimer | ms | 1280 | Cell 1 in pTAG. |
| TimeAlignmentTimerSTAG | ms | 1280 | Cell 2 in sTAG. |
| T1 | s | 7 | During this time the PCell shall be known and the SCell shall be configured and detected. |
| T2 | s | 1 | During this time the UE shall activate the SCell. |
| T3 | s | 1 | During this time the UE shall deactivate the SCell. |

Table A.8.16.47.1-2: Cell specific test parameters for 2DL/2UL FDD CA activation and deactivation of known PUCCH SCell without valid TA in non-DRX

| Parameter | Unit | Cell 1 | | | Cell 2 | | |
|--|---------------|--|----|----|--|----|----|
| | | T1 | T2 | T3 | T1 | T2 | T3 |
| E-UTRA RF Channel Number | | 1 | | | 2 | | |
| BW_{channel} | | 5MHz: $N_{RB,c} = 25$ 10MHz: $N_{RB,c} = 50$ 20MHz: $N_{RB,c} = 100$ | | | 5MHz: $N_{RB,c} = 25$ 10MHz: $N_{RB,c} = 50$ 20MHz: $N_{RB,c} = 100$ | | |
| PDSCH parameters: DL Reference Measurement Channel | | 5MHz: R.7 FDD 10MHz: R.3 FDD 20MHz: R.6 FDD | | | - | | |
| PCFICH/PDCCH/PHICH parameters: DL Reference Measurement Channel | | 5MHz: R.11 FDD 10MHz: R.6 FDD 20MHz: R.10 FDD | | | 5MHz: R.11 FDD 10MHz: R.6 FDD 20MHz: R.10 FDD | | |
| OCNG Patterns | | 5MHz: OP.20 FDD 10MHz: OP.10 FDD 20MHz: OP.17 FDD | | | 5MHz: OP.16 FDD 10MHz: OP.2 FDD 20MHz: OP.12 FDD | | |
| PBCH_RA | dB | 0 | | | 0 | | |
| PBCH_RB | dB | | | | | | |
| PSS_RA | dB | | | | | | |
| SSS_RA | dB | | | | | | |
| PCFICH_RB | dB | | | | | | |
| PHICH_RA | dB | | | | | | |
| PHICH_RB | dB | | | | | | |
| PDCCH_RA | dB | | | | | | |
| PDCCH_RB | dB | | | | | | |
| PDSCH_RA | dB | | | | | | |
| PDSCH_RB | dB | | | | | | |
| OCNG_RA ^{Note 1} | dB | | | | | | |
| OCNG_RB ^{Note 1} | dB | | | | | | |
| N_{oc} ^{Note 2} | dBm/15 kHz | | | | | | |
| \bar{E}_s/N_{oc} | dB | 17 | | | 17 | | |
| \bar{E}_s/I_{ot} ^{Note 3} | dB | 17 | | | 17 | | |
| RSRP ^{Note 3} | dBm/15 kHz | -87 | | | -87 | | |
| SCH_RP ^{Note 3} | dBm/15 kHz | -87 | | | -87 | | |
| I_o ^{Note 3} | dBm/Ch BW | $-59.13+10\log(N_{RB,c}/50)$ | | | $-59.13+10\log(N_{RB,c}/50)$ | | |
| Propagation Condition | | AWGN | | | AWGN | | |
| Antenna Configuration | | 1x2 | | | 1x2 | | |
| Timing offset to Cell 1 | μs | - | | | 0 | | |
| Time alignment error relative to cell 1 ^{Note 5} | μs | - | | | $\leq \text{TAE}$ | | |
| PRACH Configuration index ^{Note 6} | | - | | | 4 | | |
| <p>Note 1: OCNG shall be used such that all cells are fully allocated and a constant total transmitted power spectral density is achieved for all OFDM symbols.</p> <p>Note 2: Interference from other cells and noise sources not specified in the test is assumed to be constant over subcarriers and time and shall be modelled as AWGN of appropriate power for N_{oc} to be fulfilled.</p> <p>Note 3: \bar{E}_s/I_{ot}, RSRP, SCH_RP and I_o have been derived from other parameters for information purposes. They are not settable parameters themselves.</p> <p>Note 4: The uplink resources for CSI reporting are assigned to the UE prior to the start of time period T2.</p> <p>Note 5: Time alignment error (TAE) as specified in TS 36.104 [30] clause 6.5.3.1. The TAE value depends upon the type of carrier aggregation.</p> <p>Note 6: As specified in table 5.7.1-2 in TS 36.211.</p> | | | | | | | |

A.8.16.47.2 Test Requirements

During T2 the UE shall start sending CSI report for the SCell with non-zero CQI index on the PUCCH SCell no later than subframe (m+58).

During T2 interruption of the PCell during the SCell activation shall not occur outside subframe (m+5) to (m+9).

During T3 the UE shall stop sending CSI reports from the PUCCH SCell no later than subframe (n+8).

During T3 interruption of the PCell during the SCell deactivation shall not occur outside subframe (n+5) to (n+9).

The interruption of the PCell shall not be more than the values specified for intra-band CA and inter-band CA in Section 7.8.2.

All of the above test requirements shall be fulfilled in order for the observed SCell activation and deactivation delay to be counted as correct.

NOTE: During T2 if there are no uplink resources for reporting the valid CSI in the subframe (m+58) then the UE shall use the next available uplink resource for reporting the corresponding valid CSI.

A.8.16.48 2DL/2UL TDD CA activation and deactivation of known PUCCH SCell without valid TA in non-DRX

A.8.16.48.1 Test Purpose and Environment

The purpose of this test is to verify that SCell activation and deactivation are done within the required time period defined in clause 7.7 for 2DL/2UL TDD carrier aggregation, when PUCCH for a being activated SCell is configured on the SCell. The SCell is known by a UE and the UE does not have valid TA for a sTAG which the SCell belongs to at the time of activation.

Test parameters are given in Tables A.8.16.48.1-1 and cell-specific parameters in A.8.16.48.1-2. The test consists of three successive time periods with duration of T1, T2 and T3, respectively. There are two carriers. In each carrier only one cell exists. All cells have constant signal levels throughout the test. The UE shall be continuously scheduled in Cell 1 (PCell) throughout the test.

Before the test starts, the UE is connected to the PCell (Cell 1) on radio channel 1 (PCC), but is not aware of Cell 2 (SCell) on radio channel 2 (SCC). The PCell is in the pTAG and the SCell is in a sTAG. The UE is only monitoring the PCC.

At the beginning of T1, the UE receives an RRC message by which the SCell (Cell 2) gets configured with PUCCH on radio channel 2 (SCC). The UE now starts monitoring the SCC also. A test equipment sends a MAC message for activation of the SCell.

The MAC message for the activation is received at the UE antenna connector at subframe # denoted m, which is defined as the start of time period T2. Subframe m is an even number. The test equipment should send a PDCCH order to the UE to initiate RA procedure on the PUCCH SCell at subframe (m+24). The UE shall be able to report valid CSI for the activated SCell no later than subframe (m+58). Any PCell interruption due to the activation shall not occur outside subframe (m+5) to (m+11).

A MAC message for deactivation of the SCell is received at the UE antenna connector at subframe # denoted n, which is defined as the start of time period T3. The UE shall carry out the deactivation of the SCell no later than subframe (n+8). Any PCell interruption due to the deactivation shall not occur outside subframe (n+5) to (n+11).

The test equipment verifies that potential interruption is carried out in the correct time span by monitoring ACK/NACK sent in PCell during the activation and the deactivation, respectively.

The test equipment verifies the activation time by counting the subframes from the time when the SCell activation command is sent until a CSI report with other than CQI index 0 is received from the PUCCH SCell.

The test equipment verifies the deactivation time by counting the subframes from the time when the SCell deactivation command is sent until CQI reporting from the PUCCH SCell is discontinued.

Table A.8.16.48.1-1: General test parameters for 2DL/2UL TDD CA activation and deactivation of known PUCCH SCell without valid TA in non-DRX

| Parameter | Unit | Value | Comment |
|--------------------------------|------|--------|---|
| E-UTRA RF Channel Number | | 1, 2 | Two radio channels are used for the test. |
| Active PCell | | Cell 1 | Primary cell on RF channel number 1. |
| Deconfigured SCell | | Cell 2 | Deconfigured secondary cell on RF channel number 2. |
| CP length | | Normal | |
| DRX | | OFF | Continuous monitoring of primary cell. |
| Special subframe configuration | | 6 | As specified in table 4.2-1 in TS 36.211 [16]. The same configuration applies to all cells. |
| Uplink-downlink configuration | | 1 | As specified in table 4.2-2 in TS 36.211 [16]. The same configuration applies to all cells. |

| | | | |
|---|----|------|---|
| CQI/PMI periodicity and offset configuration index | | 0 | CQI reporting for SCells every second subframe. |
| Cell-individual offset for cells on RF channel number 1 | dB | 0 | Individual offset for cells on PCC. |
| Cell-individual offset for cells on RF channel number 2 | dB | 0 | Individual offset for cells on SCC. |
| Filter coefficient | | 0 | L3 filtering is not used. |
| SCell measurement cycle (measCycleSCell) | ms | 320 | |
| TimeAlignmentTimer | ms | 1280 | Cell 1 in pTAG. |
| TimeAlignmentTimerSTAG | ms | 1280 | Cell 2 in sTAG. |
| T1 | s | 7 | During this time the PCell shall be known and the SCell shall be configured and detected. |
| T2 | s | 1 | During this time the UE shall activate the SCell. |
| T3 | s | 1 | During this time the UE shall deactivate the SCell. |

Table A.8.16.48.1-2: Cell specific test parameters for 2DL/2UL TDD CA activation and deactivation of known PUCCH SCell without valid TA in non-DRX

| Parameter | Unit | Cell 1 | | | Cell 2 | | |
|--|------------|---|----|----|---|----|----|
| | | T1 | T2 | T3 | T1 | T2 | T3 |
| E-UTRA RF Channel Number | | 1 | | | 2 | | |
| BW _{channel} | | 5MHz: N _{RB,c} = 25 10MHz: N _{RB,c} = 50 20MHz: N _{RB,c} = 100 | | | 5MHz: N _{RB,c} = 25 10MHz: N _{RB,c} = 50 20MHz: N _{RB,c} = 100 | | |
| PDSCH parameters: DL Reference Measurement Channel | | 5MHz: R.4 TDD 10MHz: R.0 TDD 20MHz: R.3 TDD | | | - | | |
| PCFICH/PDCCH/PHICH parameters: DL Reference Measurement Channel | | 5MHz: R.11 TDD 10MHz: R.6 TDD 20MHz: R.10 TDD | | | 5MHz: R.11 TDD 10MHz: R.6 TDD 20MHz: R.10 TDD | | |
| OCNG Patterns | | 5MHz: OP.9 TDD 10MHz: OP.1 TDD 20MHz: OP.7 TDD | | | 5MHz: OP.10 TDD 10MHz: OP.2 TDD 20MHz: OP.8 TDD | | |
| PBCH_RA | dB | 0 | | | 0 | | |
| PBCH_RB | dB | | | | | | |
| PSS_RA | dB | | | | | | |
| SSS_RA | dB | | | | | | |
| PCFICH_RB | dB | | | | | | |
| PHICH_RA | dB | | | | | | |
| PHICH_RB | dB | | | | | | |
| PDCCH_RA | dB | | | | | | |
| PDCCH_RB | dB | | | | | | |
| PDSCH_RA | dB | | | | | | |
| PDSCH_RB | dB | | | | | | |
| OCNG_RA ^{Note 1} | dB | | | | | | |
| OCNG_RB ^{Note 1} | dB | | | | | | |
| N _{oc} ^{Note 2} | dBm/15 kHz | | | | | | |
| \hat{E}_s/N_{oc} | dB | 17 | | | 17 | | |
| \hat{E}_s/I_{ot} ^{Note 3} | dB | 17 | | | 17 | | |
| RSRP ^{Note 3} | dBm/15 kHz | -87 | | | -87 | | |
| SCH_RP ^{Note 3} | dBm/15 kHz | -87 | | | -87 | | |
| I _o ^{Note 3} | dBm/Ch BW | -59.13+10log (N _{RB,c} /50) | | | -59.13+10log (N _{RB,c} /50) | | |
| Propagation Condition | | AWGN | | | AWGN | | |
| Antenna Configuration | | 1x2 | | | 1x2 | | |
| Timing offset to Cell 1 | μs | - | | | 0 | | |
| Time alignment error relative to cell 1 ^{Note 5} | μs | - | | | ≤ TAE | | |
| PRACH Configuration index | | - | | | 4 | | |

| | |
|---------|--|
| Note 1: | OCNG shall be used such that all cells are fully allocated and a constant total transmitted power spectral density is achieved for all OFDM symbols. |
| Note 2: | Interference from other cells and noise sources not specified in the test is assumed to be constant over subcarriers and time and shall be modelled as AWGN of appropriate power for N_{oc} to be fulfilled. |
| Note 3: | E_s/I_{ot} , RSRP, SCH_RP and I_o have been derived from other parameters for information purposes. They are not settable parameters themselves. |
| Note 4: | The uplink resources for CSI reporting are assigned to the UE prior to the start of time period T2. |
| Note 5: | Time alignment error (TAE) as specified in TS 36.104 [30] clause 6.5.3.1. The TAE value depends upon the type of carrier aggregation. |

A.8.16.48.2 Test Requirements

During T2 the UE shall start sending CSI report for the SCell with non-zero CQI index on the PUCCH SCell no later than subframe (m+58).

During T2 interruption of the PCell during the SCell activation shall not occur outside subframe (m+5) to (m+11).

During T3 the UE shall stop sending CSI reports from the PUCCH SCell no later than subframe (n+8).

During T3 interruption of the PCell during the SCell deactivation shall not occur outside subframe (n+5) to (n+11).

The interruption of the PCell shall not be more than the values specified for intra-band CA and inter-band CA in Section 7.8.2.

All of the above test requirements shall be fulfilled in order for the observed SCell activation and deactivation delay to be counted as correct.

NOTE: During T2 if there are no uplink resources for reporting the valid CSI in the subframe (m+58) then the UE shall use the next available uplink resource for reporting the corresponding valid CSI.

A.8.16.49 2DL/2UL TDD-FDD CA (FDD PCell) activation and deactivation of known PUCCH SCell without valid TA in non-DRX

A.8.16.49.1 Test Purpose and Environment

The purpose of this test is to verify that SCell activation and deactivation are done within the required time period defined in clause 7.7 for 2DL/2UL TDD-FDD carrier aggregation with PCell in FDD, when PUCCH for a being activated SCell is configured on the SCell. The SCell is known by a UE and the UE does not have valid TA for an sTAG which the SCell belongs to at the time of activation.

Test parameters are given in Table A.8.16.49.1-1 and Table A.8.16.49.1-2. The test consists of three successive time periods with duration of T1, T2 and T3, respectively. There are two carriers. In each carrier only one cell exists. All cells have constant signal levels throughout the test. The UE shall be continuously scheduled in Cell 1 (PCell) throughout the test.

Before the test starts, the UE is connected to the PCell (Cell 1) on radio channel 1 (PCC), but is not aware of Cell 2 (SCell) on radio channel 2 (SCC). The PCell is in the pTAG and the SCell is in an sTAG. The UE is only monitoring the PCC.

At the beginning of T1, the UE receives an RRC message by which the SCell (Cell 2) gets configured with PUCCH on radio channel 2 (SCC). The UE now starts monitoring the SCC also. Test equipment sends a MAC message for activation of the SCell.

The MAC message for the activation is received at the UE antenna connector at subframe # denoted m, which is defined as the start of time period T2. Subframe m is an even number. The test equipment should send a PDCCH order to the UE to initiate RA procedure on the PUCCH SCell at subframe (m+24). The UE shall be able to report valid CSI for the activated SCell no later than subframe (m+58). Any PCell interruption due to the activation shall not occur outside subframe (m+5) to (m+9).

A MAC message for deactivation of the SCell is received at the UE antenna connector at subframe # denoted n, which is defined as the start of time period T3. The UE shall carry out the deactivation of the SCell no later than subframe (n+8). Any PCell interruption due to the deactivation shall not occur outside subframe (n+5) to (n+9).

The test equipment verifies that potential interruption is carried out in the correct time span by monitoring ACK/NACK sent in PCell during the activation and the deactivation, respectively.

The test equipment verifies the activation time by counting the subframes from the time when the SCell activation command is sent until a CSI report with other than CQI index 0 is received from the PUCCH SCell.

The test equipment verifies the deactivation time by counting the subframes from the time when the SCell deactivation command is sent until CQI reporting from the PUCCH SCell is discontinued.

Table A.8.16.49.1-1: General test parameters for 2DL/2UL TDD-FDD CA (FDD PCell) activation and deactivation of known PUCCH SCell without valid TA in non-DRX

| Parameter | Unit | Value | Comment |
|---|------|--------|---|
| E-UTRA RF Channel Number | | 1, 2 | Two radio channels are used for this test |
| Active PCell | | Cell 1 | Primary cell on RF channel number 1. |
| Deconfigured deactivated SCell | | Cell 2 | Deconfigured deactivated secondary cell on RF channel number 2. |
| CP length | | Normal | |
| DRX | | OFF | Continuous monitoring of primary cell |
| CQI/PMI periodicity and offset configuration index | | 0 | CQI reporting for SCell every second subframe |
| Cell-individual offset for cells on RF channel number 1 | dB | 0 | Individual offset for cells on PCC. |
| Cell-individual offset for cells on RF channel number 2 | dB | 0 | Individual offset for cells on SCC. |
| SCell measurement cycle (measCycleSCell) | ms | 320 | |
| TimeAlignmentTimer | ms | 1280 | Cell 1 in pTAG. |
| TimeAlignmentTimerSTAG | ms | 1280 | Cell 2 in sTAG. |
| T1 | s | 7 | During this time the PCell and SCell shall be known. |
| T2 | s | 1 | During this time the UE shall activate the SCell. |
| T3 | s | 1 | During this time the UE shall deactivate the SCell. |

Table A.8.16.49.1-2: Cell specific test parameters for 2DL/2UL TDD-FDD CA (FDD PCell) activation and deactivation of known PUCCH SCell without valid TA in non-DRX

| Parameter | Unit | Cell 1 | | | Cell 2 | | |
|---|------|---|----|----|---|----|----|
| | | T1 | T2 | T3 | T1 | T2 | T3 |
| E-UTRA RF Channel Number | | 1 | | | 2 | | |
| TDD special subframe configuration | | - | | | 6 | | |
| TDD uplink-downlink configuration | | - | | | 1 | | |
| BW _{channel} | MHz | 5MHz: N _{RB,c} = 25 10MHz: N _{RB,c} = 50 20MHz: N _{RB,c} = 100 | | | 5MHz: N _{RB,c} = 25 10MHz: N _{RB,c} = 50 20MHz: N _{RB,c} = 100 | | |
| PDSCH parameters: DL Reference Measurement Channel | | 5MHz: R.7 FDD 10MHz: R.3 FDD 20MHz: R.6 FDD | | | - | | |
| PCFICH/PDCCH/PHICH parameters: DL Reference Measurement Channel | | 5MHz: R.11 FDD 10MHz: R.6 FDD 20MHz: R.10 FDD | | | 5MHz: R.11 TDD 10MHz: R.6 TDD 20MHz: R.10 TDD | | |
| OCNG Patterns | | 5MHz: OP.20 FDD 10MHz: OP.10 FDD 20MHz: OP.17 FDD | | | 5MHz: OP.10 TDD 10MHz: OP.2 TDD 20MHz: OP.8 TDD | | |
| PBCH_RA | dB | 0 | | | 0 | | |
| PBCH_RB | dB | | | | | | |
| PSS_RA | dB | | | | | | |
| SSS_RA | dB | | | | | | |
| PCFICH_RB | dB | | | | | | |
| PHICH_RA | dB | | | | | | |
| PHICH_RB | dB | | | | | | |
| PDCCH_RA | dB | | | | | | |
| PDCCH_RB | dB | | | | | | |
| PDSCH_RA | dB | | | | | | |

| | | | |
|---|---------------|---------------------------------------|---------------------------------------|
| PDSCH_RB | dB | | |
| OCNG_RA ^{Note 1} | dB | | |
| OCNG_RB ^{Note 1} | dB | | |
| N_{oc} ^{Note 2} | dBm/15 kHz | -104 | -104 |
| \bar{E}_s/N_{oc} | dB | 17 | 17 |
| \bar{E}_s/I_{ot} | dB | 17 | 17 |
| RSRP ^{Note 3} | dBm/15 kHz | -87 | -87 |
| SCH_RP ^{Note 3} | dBm/15 kHz | -87 | -87 |
| I_o ^{Note 3} | dBm/Ch BW | -59.13 +10log ($N_{RB,c}/50$) | -59.13 +10log ($N_{RB,c}/50$) |
| Propagation Condition | | AWGN | AWGN |
| Antenna Configuration | | 1x2 | 1x2 |
| Timing offset to Cell 1 | μ s | - | 0 |
| Time alignment error relative to cell 1 ^{Note 5} | μ s | - | \leq TAE |
| PRACH configuration Index ^{Note 7} | | - | 4 |
| <p>Note 1: OCNG shall be used such that all cells are fully allocated and a constant total transmitted power spectral density is achieved for all OFDM symbols.</p> <p>Note 2: Interference from other cells and noise sources not specified in the test is assumed to be constant over subcarriers and time and shall be modelled as AWGN of appropriate power for N_{oc} to be fulfilled.</p> <p>Note 3: \bar{E}_s/I_{ot}, RSRP, SCH_RP and I_o levels have been derived from other parameters for information purposes. They are not settable parameters themselves.</p> <p>Note 4: The uplink resources for CSI reporting are assigned to the UE prior to the start of time period T2.</p> <p>Note 5: Time alignment error (TAE) as specified in TS 36.104 [30] clause 6.5.3.1. The TAE value depends upon the type of carrier aggregation.</p> <p>Note 6: TDD special subframe configuration and uplink-downlink configuration are as specified in Table 4.2-1 and 4.2-2 in TS36.211 [16].</p> <p>Note 7: As specified in table 5.7.1-2 in TS 36.211.</p> | | | |

A.8.16.49.2 Test Requirements

During T2 the UE shall start sending CSI report for the SCell with non-zero CQI index on the PUCCH SCell no later than subframe (m+58).

During T2 interruption of the PCell during the SCell activation shall not occur outside subframe (m+5) to (m+9).

During T3 the UE shall stop sending CSI reports from the PUCCH SCell no later than subframe (n+8).

During T3 interruption of the PCell during the SCell deactivation shall not occur outside subframe (n+5) to (n+9).

The interruption of the PCell shall not be more than the values specified for intra-band CA and inter-band CA in Section 7.8.2.

All of the above test requirements shall be fulfilled in order for the observed SCell activation delay and SCell deactivation delay to be counted as correct.

NOTE: During T2 if there are no uplink resources for reporting the valid CSI in the subframe (m+58) then the UE shall use the next available uplink resource for reporting the corresponding valid CSI.

A.8.16.50 2DL/2UL TDD-FDD CA (TDD PCell) activation and deactivation of known PUCCH SCell without valid TA in non-DRX

A.8.16.50.1 Test Purpose and Environment

The purpose of this test is to verify that SCell activation and deactivation are done within the required time period defined in clause 7.7 for 2DL/2UL TDD-FDD carrier aggregation with PCell in TDD, when PUCCH for a being activated SCell is configured on the SCell. The SCell is known by a UE and the UE does not have valid TA for an sTAG which the SCell belongs to at the time of activation.

Test parameters are given in Tables A.8.16.50.1-1 and cell-specific parameters in A.8.16.50.1-2. The test consists of three successive time periods with duration of T1, T2 and T3, respectively. There are two carriers. In each carrier only one cell exists. All cells have constant signal levels throughout the test. The UE shall be continuously scheduled in Cell 1 (PCell) throughout the test.

Before the test starts, the UE is connected to the PCell (Cell 1) on radio channel 1 (PCC), but is not aware of Cell 2 (SCell) on radio channel 2 (SCC). The PCell is in the pTAG and the SCell is in an sTAG. The UE is only monitoring the PCC.

At the beginning of T1, the UE receives an RRC message by which the SCell (Cell 2) gets configured with PUCCH on radio channel 2 (SCC). The UE now starts monitoring the SCC also. The test equipment sends a MAC message for activation of the SCell.

The MAC message for the activation is received at the UE antenna connector at subframe # denoted m, which is defined as the start of time period T2. Subframe m is an even number. The test equipment should send a PDCCH order to the UE to initiate RA procedure on the PUCCH SCell at subframe (m+24). The UE shall be able to report valid CSI for the activated SCell no later than subframe (m+58). Any PCell interruption due to the activation shall not occur outside subframe (m+5) to (m+9).

A MAC message for deactivation of the SCell is received at the UE antenna connector at subframe # denoted n, which is defined as the start of time period T3. The UE shall carry out the deactivation of the SCell no later than subframe (n+8). Any PCell interruption due to the deactivation shall not occur outside subframe (n+5) to (n+9).

The test equipment verifies that potential interruption is carried out in the correct time span by monitoring ACK/NACK sent in PCell during activation and deactivation of SCell, respectively.

The test equipment verifies the activation time by counting the subframes from the time when the SCell activation command is sent until a CSI report with other than CQI index 0 is received from the PUCCH SCell.

The test equipment verifies the deactivation time by counting the subframes from the time when the SCell deactivation command is sent until CQI reporting from the PUCCH SCell is discontinued.

Table A.8.16.50.1-1: General test parameters for 2DL/2UL TDD-FDD CA (TDD PCell) activation and deactivation of known PUCCH SCell without valid TA in non-DRX

| Parameter | Unit | Value | Comment |
|---|------|--------|--|
| E-UTRA RF Channel Number | | 1, 2 | Two radio channels are used for this test |
| Active PCell | | Cell 1 | Primary cell on RF channel number 1. |
| Deconfigured SCell | | Cell 2 | Deconfigured secondary cell on RF channel number 2. |
| CP length | | Normal | |
| DRX | | OFF | Continuous monitoring of primary cell |
| CQI/PMI periodicity and offset configuration index | | 0 | CQI reporting for SCell every second subframe |
| Cell-individual offset for cells on RF channel number 1 | dB | 0 | Individual offset for cells on PCC. |
| Cell-individual offset for cells on RF channel number 2 | dB | 0 | Individual offset for cells on SCC. |
| Filter coefficient | | 0 | L3 filtering is not used |
| SCell measurement cycle (measCycleSCell) | ms | 320 | |
| TimeAlignmentTimer | ms | 1280 | Cell 1 in pTAG. |
| TimeAlignmentTimerSTAG | ms | 1280 | Cell 2 in sTAG. |
| T1 | s | 7 | During this time the PCell shall be known and the SCell configured and detected. |
| T2 | s | 1 | During this time the UE shall activate the SCell. |
| T3 | s | 1 | During this time the UE shall deactivate the SCell. |

Table A.8.16.50.1-2: Cell specific test parameters for 2DL/2UL TDD-FDD CA (TDD PCell) activation and deactivation of known PUCCH SCell without valid TA in non-DRX

| Parameter | Unit | Cell 1 | | | Cell 2 | | |
|------------------------------------|------|--------|----|----|--------|----|----|
| | | T1 | T2 | T3 | T1 | T2 | T3 |
| E-UTRA RF Channel Number | | | 1 | | | 2 | |
| TDD special subframe configuration | | | 6 | | | | |
| TDD uplink-downlink configuration | | | 1 | | | | |

| | | | |
|--|------------|---|---|
| BW _{channel} | | 5MHz: N _{RB,c} = 25 10MHz: N _{RB,c} = 50 20MHz: N _{RB,c} = 100 | 5MHz: N _{RB,c} = 25 10MHz: N _{RB,c} = 50 20MHz: N _{RB,c} = 100 |
| PDSCH parameters: DL Reference Measurement Channel | | 5MHz: R.4 TDD 10MHz: R.0 TDD 20MHz: R.3 TDD | - |
| PCFICH/PDCCH/PHICH parameters: DL Reference Measurement Channel | | 5MHz: R.11 TDD 10MHz: R.6 TDD 20MHz: R.10 TDD | 5MHz: R.11 FDD 10MHz: R.6 FDD 20MHz: R.10 FDD |
| OCNG Patterns | | 5MHz: OP.9 TDD 10MHz: OP.1 TDD 20MHz: OP.7 TDD | 5MHz: OP.16 FDD 10MHz: OP.2 FDD 20MHz: OP.12 FDD |
| PBCH_RA | dB | | |
| PBCH_RB | dB | | |
| PSS_RA | dB | | |
| SSS_RA | dB | | |
| PCFICH_RB | dB | | |
| PHICH_RA | dB | | |
| PHICH_RB | dB | 0 | 0 |
| PDCCH_RA | dB | | |
| PDCCH_RB | dB | | |
| PDSCH_RA | dB | | |
| PDSCH_RB | dB | | |
| OCNG_RA ^{Note 1} | dB | | |
| OCNG_RB ^{Note 1} | dB | | |
| N _{oc} ^{Note 2} | dBm/15 kHz | -104 | -104 |
| \bar{E}_s/N_{oc} | dB | 17 | 17 |
| \bar{E}_s/I_{ot} ^{Note 3} | dB | 17 | 17 |
| RSRP ^{Note 3} | dBm/15 kHz | -87 | -87 |
| SCH_RP ^{Note 3} | dBm/15 kHz | -87 | -87 |
| I _o ^{Note 3} | dBm/Ch BW | -59.13+10log (N _{RB,c} /50) | -59.13+10log (N _{RB,c} /50) |
| Propagation Condition | | AWGN | AWGN |
| Antenna Configuration | | 1x2 | 1x2 |
| Timing offset to Cell 1 | μs | - | 0 |
| Time alignment error relative to cell 1 ^{Note 5} | μs | - | ≤ TAE |
| PRACH Configuration index | | - | 4 |
| <p>Note 1: OCNG shall be used such that all cells are fully allocated and a constant total transmitted power spectral density is achieved for all OFDM symbols.</p> <p>Note 2: Interference from other cells and noise sources not specified in the test is assumed to be constant over subcarriers and time and shall be modelled as AWGN of appropriate power for N_{oc} to be fulfilled.</p> <p>Note 3: E_s/I_{ot}, RSRP, SCH_RP and I_o have been derived from other parameters for information purposes. They are not settable parameters themselves.</p> <p>Note 4: The uplink resources for CSI reporting are assigned to the UE prior to the start of time period T2.</p> <p>Note 5: Time alignment error (TAE) as specified in TS 36.104 [30] clause 6.5.3.1. The TAE value depends upon the type of carrier aggregation.</p> <p>Note 6: TDD special subframe configuration and uplink-downlink configuration are as specified in Table 4.2-1 and 4.2-2 in TS36.211 [16].</p> | | | |

A.8.16.50.2 Test Requirements

During T2 the UE shall start sending CSI reports for SCell with non-zero CQI index on the PUCCH SCell at latest in a subframe (m+58).

During T2 interruption of the PCell during the SCell activation shall not occur outside subframe (m+5) to (m+9).

During T3 the UE shall stop sending CSI reports from the PUCCH SCell no later than subframe (n+8).

During T3 interruption of the PCell during the SCell deactivation shall not occur outside subframe (n+5) to (n+9).

The interruption of the PCell shall not be more than the values specified for intra-band CA and inter-band CA in Section 7.8.2.

All of the above test requirements shall be fulfilled in order for the observed SCell activation and deactivation delay to be counted as correct.

NOTE: During T2 if there are no uplink resources for reporting the valid CSI in the subframe (m+58) then the UE shall use the next available uplink resource for reporting the corresponding valid CSI.

A.8.16.51 E-UTRAN 4 DL FDD CA Event Triggered Reporting with 3 deactivated SCells in Non-DRX

A.8.16.51.1 Test Purpose and Environment

The purpose of this test is to verify that the UE correctly detects events A1 (Serving cell becomes better than threshold), A2 (Serving cell becomes worse than threshold) and A6 (Neighbour becomes better than SCell) defined in TS 36.331 [2] within the requirements stated in clause 8.3.3.2.1.

In this test case there are 5 cells. Cell 1 is the PCell on the FDD PCC F1. Cell 2 is the configured and deactivated SCell on the FDD SCC F2. Cell 3 is the configured and deactivated SCell on the FDD SCC F3. Cell 4 is the configured and deactivated SCell on the FDD SCC F4, and cell 5 is the neighbor cell on the FDD SCC F4.

The test parameters are given in Tables A.8.16.51.1-1 and A.8.16.51.1-2 below. It is indicated to the UE in the measurement control information that event-triggered reporting with Events A1 (cell2), A2 (PCell and SCCells) and A6 are used. The test consists of three successive time periods, with duration of T1, T2 and T3, respectively. During T1 the UE shall not have any information on cell 5. At the beginning of T2 the transmission power of cell 5 is increased to the same level as for cell 4, and due to usage of an offset this shall result in reporting of Event A6. Also, at the beginning of T2 the transmission power of cell 2 is increased to the same level as for cell 1, which shall result in reporting of Event A1. At the beginning of T3 the transmission powers of cells 1, 2, 3, 4 and 5 are reduced below a threshold value and this shall result in reporting of Event A2 for Cell 1, for Cell 2, for Cell3 and for Cell 4.

Table A.8.16.51.1-1: General test parameters for E-UTRAN FDD-FDD 4 DL CA event triggered reporting under fading propagation conditions with 3 configured but deactivated SCCells in non-DRX with PCell in FDD

| Parameter | Unit | Value | Comment | |
|---|-----------------|------------|---|--|
| E-UTRA RF Channel Number | | 1, 2, 3, 4 | Three radio channels are used for this test | |
| Active PCell | | Cell 1 | Primary cell on RF channel number 1. | |
| Configured deactivated SCell | | Cell 2 | Configured deactivated secondary cell on RF channel number 2. | |
| Configured deactivated SCell | | Cell 3 | Configured deactivated secondary cell on RF channel number 3. | |
| Configured deactivated SCell | | Cell 4 | Configured deactivated secondary cell on RF channel number 4. | |
| Neighbour cell | | Cell 5 | Neighbour cell to be identified on RF channel number 4. | |
| CP length | | Normal | | |
| DRX | | OFF | Continuous monitoring of primary cell | |
| A1 | Hysteresis | dB | 0 | Hysteresis for evaluation of event A1. |
| | Threshold RSRP | dBm | -98 | Actual RSRP threshold for event A1. Needs to take absolute accuracy tolerance in section 9.1.11.1 into account plus margin. |
| | Time To Trigger | s | 0 | |
| A2 | Hysteresis | dB | 0 | Hysteresis for evaluation of event A2. |
| | Threshold RSRP | dBm | -98 | Actual RSRP threshold for event A2. Needs to take absolute accuracy tolerance in section 9.1.11.1 into account plus margin. |
| | Time To Trigger | s | 0 | |
| A6 | Hysteresis | dB | 0 | Hysteresis for evaluation of event A6. |
| | Offset | dB | -6 | Offset parameter for evaluation of event A6. Needs to take relative accuracy tolerance in section 9.1.11.2 into account plus margin. |
| | Report on leave | | False | |
| | Time To Trigger | s | 0 | |
| Cell-individual offset for cells on RF channel number 1 | dB | 0 | Individual offset for cells on primary component carrier. | |
| Cell-individual offset for cells on RF channel number 2 | dB | 0 | Individual offset for cells on secondary component carrier. | |
| Cell-individual offset for cells on RF channel number 3 | dB | 0 | Individual offset for cells on secondary component carrier. | |
| Cell-individual offset for cells on RF channel number 4 | dB | 0 | Individual offset for cells on secondary component carrier. | |
| Filter coefficient | | 0 | L3 filtering is not used | |
| SCell measurement cycle (measCycleSCell) | ms | 320 | | |

| | | | |
|----|---|-----------|---|
| T1 | s | 5 | During this time the cell1, cell3, cell4 shall be known to the UE; but cell2 and cell 5 shall be unknown to the UE. |
| T2 | s | ≤ 12 | UE should report Event A1 for cell2 and event A6 for cell5 within 6.4s ($20 \times \text{scellMeasCycle}$) |
| T3 | s | 5 | UE should report Event A2 within 200 ms for cell1, and 1.6s for cells 2, 3 and 4. |

Table A.8.16.51.1-2: Cell specific test parameters for E-UTRAN FDD-FDD 4 DL CA event triggered reporting under fading propagation conditions with 3 configured but deactivated SCells in non-DRX

| Parameter | Unit | Cell 1 | | | Cell 2 | | | Cell 3 | | | Cell 4 | | | Cell 5 | | |
|--|------------|---|--|--|---|--|--|---|--|--|---|--|--|--|-------|-------|
| | | T1 | T2 | T3 | T1 | T2 | T3 | T1 | T2 | T3 | T1 | T2 | T3 | T1 | T2 | T3 |
| E-UTRA RF Channel Number | | 1 | | | 2 | | | 3 | | | 4 | | | | | |
| BW _{channel} | | 5MHz: N _{RB,c} = 25 10MHz: N _{RB,c} = 50 20MHz: N _{RB,c} = 100 | | | 5MHz: N _{RB,c} = 25 10MHz: N _{RB,c} = 50 20MHz: N _{RB,c} = 100 | | | 5MHz: N _{RB,c} = 25 10MHz: N _{RB,c} = 50 20MHz: N _{RB,c} = 100 | | | 5MHz: N _{RB,c} = 25 10MHz: N _{RB,c} = 50 20MHz: N _{RB,c} = 100 | | | | | |
| PDSCH parameters: DL Reference Measurement Channel | | 5MHz: R.5 FDD 10MHz: R.0 FDD 20MHz: R.4 FDD | | | - | | | - | | | - | | | - | | |
| PCFICH/PDCCH/PHICH parameters: DL Reference Measurement Channel | | 5MHz: R.11 FDD 10MHz: R.6 FDD 20MHz: R.10 FDD | | | 5MHz: R.11 FDD 10MHz: R.6 FDD 20MHz: R.10 FDD | | | 5MHz: R.11 FDD 10MHz: R.6 FDD 20MHz: R.10 FDD | | | 5MHz: R.11 FDD 10MHz: R.6 FDD 20MHz: R.10 FDD | | | 5MHz: R.11 FDD 10MHz: R.6 FDD 20MHz: R.10 FDD | | |
| OCNG Patterns | | 5MHz: OP.15 FDD 10MHz: OP.1 FDD 20MHz: OP.11 FDD | | | 5MHz: OP.16 FDD 10MHz: OP.2 FDD 20MHz: OP.12 FDD | | | 5MHz: OP.16 FDD 10MHz: OP.2 FDD 20MHz: OP.12 FDD | | | 5MHz: OP.16 FDD 10MHz: OP.2 FDD 20MHz: OP.12 FDD | | | 5MHz: OP.16 FDD 10MHz: OP.2 FDD 20MHz: OP.12 FDD | | |
| PBCH_RA | dB | 0 | | | 0 | | | 0 | | | 0 | | | 0 | | |
| PBCH_RB | dB | | | | | | | | | | | | | | | |
| PSS_RA | dB | | | | | | | | | | | | | | | |
| SSS_RA | dB | | | | | | | | | | | | | | | |
| PCFICH_RB | dB | | | | | | | | | | | | | | | |
| PHICH_RA | dB | | | | | | | | | | | | | | | |
| PHICH_RB | dB | | | | | | | | | | | | | | | |
| PDCCH_RA | dB | | | | | | | | | | | | | | | |
| PDCCH_RB | dB | | | | | | | | | | | | | | | |
| PDSCH_RA | dB | | | | | | | | | | | | | | | |
| PDSCH_RB | dB | | | | | | | | | | | | | | | |
| OCNG_RA ^{Note 1} | dB | | | | | | | | | | | | | | | |
| OCNG_RB ^{Note 1} | dB | | | | | | | | | | | | | | | |
| N _{oc} ^{Note 2} | dBm/15 KHz | | | | | | | | | | | | | | | |
| E _s /N _{oc} | dB | 17 | 17 | -3 | -infinity | 17 | -3 | 17 | 17 | -3 | 17 | 17 | -3 | -infinity | 17 | -3 |
| E _s /I _{ot} ^{Note 3} | dB | 17 | 17 | -3 | -infinity | 17 | -3 | 17 | 17 | -3 | 17 | -0.09 | -4.76 | -infinity | -0.09 | -4.76 |
| RSRP ^{Note 3} | dBm/15 kHz | -87 | -87 | -107 | -infinity | -87 | -107 | -87 | -87 | -107 | -87 | -87 | -107 | -infinity | -87 | -107 |
| SCH_RP ^{Note 3} | dBm/15 kHz | -87 | -87 | -107 | -infinity | -87 | -107 | -87 | -87 | -107 | -87 | -87 | -107 | -infinity | -87 | -107 |
| I _o ^{Note 3} | dBm/Ch BW | -59.13 +10log (N _{RB,c} /50) | -59.13 +10log (N _{RB,c} /50) | -74.45 +10log (N _{RB,c} /50) | -76.22 +10log (N _{RB,c} /50) | -59.13 +10log (N _{RB,c} /50) | -74.45 +10log (N _{RB,c} /50) | -59.13 +10log (N _{RB,c} /50) | -59.13 +10log (N _{RB,c} /50) | -74.45 +10log (N _{RB,c} /50) | -59.13 +10log (N _{RB,c} /50) | -56.17 +10log (N _{RB,c} /50) | -73.20 +10log (N _{RB,c} /50) | Specified in columns for Cell 4 | | |
| Propagation Condition | | AWGN | | | ETU70 | | | ETU70 | | | ETU70 | | | ETU70 | | |
| Correlation Matrix and Antenna Configuration | | 1x2 | | | 1x2 Low | | | 1x2 Low | | | 1x2 Low | | | 1x2 Low | | |
| Timing offset to Cell 1 | μs | - | | | 0 | | | 0 | | | 0 | | | 3 | | |
| Time alignment error relative to cell 1 ^{Note 5} | μs | - | | | ≤ TAE | | | ≤ TAE | | | ≤ TAE | | | N/A | | |
| Time alignment error relative to cell 2 ^{Note 5} | μs | - | | | - | | | ≤ TAE | | | ≤ TAE | | | N/A | | |
| Time alignment error relative to cell 3 ^{Note 5} | μs | - | | | - | | | - | | | ≤ TAE | | | N/A | | |

- Note 1: OCNG shall be used such that all cells are fully allocated and a constant total transmitted power spectral density is achieved for all OFDM symbols.
- Note 2: Interference from other cells and noise sources not specified in the test is assumed to be constant over subcarriers and time and shall be modelled as AWGN of appropriate power for N_{oc} to be fulfilled.
- Note 3: E_s/I_{ot} , RSRP, SCH_RP and I_o have been derived from other parameters for information purposes. They are not settable parameters themselves.
- Note 4: The resources for uplink transmission are assigned to the UE prior to the start of time period T2.
- Note 5: Time alignment error (TAE) as specified in TS 36.104 [30] clause 6.5.3.1. The TAE value depends upon the type of carrier aggregation.

A.8.16.51.2 Test Requirements

The UE shall send one Event A6 triggered measurement report for Cell 5 with a measurement reporting delay of less than 6.4s ($20 \times \text{measCycleSCell}$) from the beginning of time T2.

The UE shall send one Event A1 triggered measurement report for Cell 2 with a measurement reporting delay of less than 6.4s ($20 \times \text{measCycleSCell}$) from beginning of time T2.

The UE shall send one Event A2 triggered measurement report for Cell 1 with a measurement reporting delay of less than 200 ms from beginning of time T3.

The UE shall send one Event A2 triggered measurement report for Cell 2 with a measurement reporting delay of less than 1.6s ($5 \times \text{measCycleSCell}$) from beginning of time T3.

The UE shall send one Event A2 triggered measurement report for Cell 3 with a measurement reporting delay of less than 1.6s ($5 \times \text{measCycleSCell}$) from beginning of time T3.

The UE shall send one Event A2 triggered measurement report for Cell 4 with a measurement reporting delay of less than 1.6s ($5 \times \text{measCycleSCell}$) from beginning of time T3.

The UE shall not send event triggered measurement reports as long as the reporting criteria are not fulfilled.

The rate of correct events observed during repeated tests shall be at least 90% for each of the events.

NOTE: The actual overall delays measured in the tests may be up to $2 \times \text{TTI}_{\text{DCCH}}$ higher than the measurement reporting delays above because of TTI insertion uncertainty of the measurement report in DCCH.

A.8.16.52 E-UTRAN 4 DL TDD CA Event Triggered Reporting with 3 deactivated SCells in Non-DRX

A.8.16.52.1 Test Purpose and Environment

The purpose of this test is to verify that the UE correctly detects events A1 (Serving cell becomes better than threshold), A2 (Serving cell becomes worse than threshold) and A6 (Neighbour becomes better than SCell) defined in TS 36.331 [2] within the requirements stated in clause 8.3.3.2.1.

In this test case there are 5 cells. Cell 1 is the PCell on the TDD PCC F1. Cell 2 is the configured and deactivated SCell on the TDD SCC F2. Cell 3 is the configured and deactivated SCell on the TDD SCC F3. Cell 4 is the configured and deactivated SCell on the TDD SCC F4, and cell 5 is the neighbor cell on the TDD SCC F4.

The test parameters are given in Tables A.8.16.52.1-1 and A.8.16.52.1-2 below. It is indicated to the UE in the measurement control information that event-triggered reporting with Events A1 (cell2), A2 (PCell and SCCells) and A6 are used. The test consists of three successive time periods, with duration of T1, T2 and T3, respectively. During T1 the UE shall not have any information on cell 5. At the beginning of T2 the transmission power of cell 5 is increased to the same level as for cell 4, and due to usage of an offset this shall result in reporting of Event A6. Also, at the beginning of T2 the transmission power of cell 2 is increased to the same level as for cell 1, which shall result in reporting of Event A1. At the beginning of T3 the transmission powers of cells 1, 2, 3, 4 and 5 are reduced below a threshold value and this shall result in reporting of Event A2 for Cell 1, for Cell 2, for Cell3 and for Cell 4.

Table A.8.16.52.1-1: General test parameters for E-UTRAN TDD-TDD 4 DL CA event triggered reporting under fading propagation conditions with 3 configured but deactivated SCells in non-DRX

| Parameter | | Unit | Value | Comment |
|---|-----------------|------|------------|--|
| E-UTRA RF Channel Number | | | 1, 2, 3, 4 | Three radio channels are used for this test |
| Active PCell | | | Cell 1 | Primary cell on RF channel number 1. |
| Configured deactivated SCell | | | Cell 2 | Configured deactivated secondary cell on RF channel number 2. |
| Configured deactivated SCell | | | Cell 3 | Configured deactivated secondary cell on RF channel number 3. |
| Configured deactivated SCell | | | Cell 4 | Configured deactivated secondary cell on RF channel number 4. |
| Neighbour cell | | | Cell 5 | Neighbour cell to be identified on RF channel number 4. |
| CP length | | | Normal | |
| DRX | | | OFF | Continuous monitoring of primary cell |
| Special subframe configuration | | | 6 | As specified in table 4.2-1 in TS 36.211. The same configuration applies to all TDD cells |
| Uplink-downlink configuration | | | 1 | As specified in table 4.2-2 in TS 36.211. The same configuration applies to all TDD cells. |
| A1 | Hysteresis | dB | 0 | Hysteresis for evaluation of event A1. |
| | Threshold RSRP | dBm | -98 | Actual RSRP threshold for event A1. Needs to take absolute accuracy tolerance in section 9.1.11.1 into account plus margin. |
| | Time To Trigger | s | 0 | |
| A2 | Hysteresis | dB | 0 | Hysteresis for evaluation of event A2. |
| | Threshold RSRP | dBm | -98 | Actual RSRP threshold for event A2. Needs to take absolute accuracy tolerance in section 9.1.11.1 into account plus margin. |
| | Time To Trigger | s | 0 | |
| A6 | Hysteresis | dB | 0 | Hysteresis for evaluation of event A6. |
| | Offset | dB | -6 | Offset parameter for evaluation of event A6. Needs to take relative accuracy tolerance in section 9.1.11.2 into account plus margin. |
| | Report on leave | | False | |
| | Time To Trigger | s | 0 | |
| Cell-individual offset for cells on RF channel number 1 | | dB | 0 | Individual offset for cells on primary component carrier. |
| Cell-individual offset for cells on RF channel number 2 | | dB | 0 | Individual offset for cells on secondary component carrier. |
| Cell-individual offset for cells on RF channel number 3 | | dB | 0 | Individual offset for cells on secondary component carrier. |
| Cell-individual offset for cells on RF channel number 4 | | dB | 0 | Individual offset for cells on secondary component carrier. |
| Filter coefficient | | | 0 | L3 filtering is not used |
| SCell measurement cycle (measCycleSCell) | | ms | 320 | |
| T1 | | s | 5 | During this time the cell1 and cell3 shall be known to the UE; but cell2 and cell 5 shall be unknown to the UE. |
| T2 | | s | ≤12 | UE should report Event A1 for cell2 and event A6 for cell5 within 6.4s (20xscellMeasCycle) |
| T3 | | s | 5 | UE should report Event A2 within 200 ms for cell 1, and 1.6s for cells 2, 3 and 4. |

Table A.8.16.52.1-2: Cell specific test parameters for E-UTRAN TDD-TDD 4 DL CA event triggered reporting under fading propagation conditions with 3 configured but deactivated SCells in non-DRX

| Parameter | Unit | Cell 1 | | | Cell 2 | | | Cell 3 | | | Cell 4 | | | Cell 5 | | |
|--|------------|---|--|--|---|--|--|---|--|--|---|--|--|--|-------|-------|
| | | T1 | T2 | T3 | T1 | T2 | T3 | T1 | T2 | T3 | T1 | T2 | T3 | T1 | T2 | T3 |
| E-UTRA RF Channel Number | | 1 | | | 2 | | | 3 | | | 4 | | | | | |
| BW _{channel} | | 5MHz: N _{RB,c} = 25 10MHz: N _{RB,c} = 50 20MHz: N _{RB,c} = 100 | | | 5MHz: N _{RB,c} = 25 10MHz: N _{RB,c} = 50 20MHz: N _{RB,c} = 100 | | | 5MHz: N _{RB,c} = 25 10MHz: N _{RB,c} = 50 20MHz: N _{RB,c} = 100 | | | 5MHz: N _{RB,c} = 25 10MHz: N _{RB,c} = 50 20MHz: N _{RB,c} = 100 | | | | | |
| PDSCH parameters: DL Reference Measurement Channel | | 5MHz: R.5 TDD 10MHz: R.0 TDD 20MHz: R.4 TDD | | | - | | | - | | | - | | | - | | |
| PCFICH/PDCCH/PHI CH parameters: DL Reference Measurement Channel | | 5MHz: R.11 TDD 10MHz: R.6 TDD 20MHz: R.10 TDD | | | 5MHz: R.11 TDD 10MHz: R.6 TDD 20MHz: R.10 TDD | | | 5MHz: R.11 TDD 10MHz: R.6 TDD 20MHz: R.10 TDD | | | 5MHz: R.11 TDD 10MHz: R.6 TDD 20MHz: R.10 TDD | | | 5MHz: R.11 TDD 10MHz: R.6 TDD 20MHz: R.10 TDD | | |
| OCNG Patterns | | 5MHz: OP.15 TDD 10MHz: OP.1 TDD 20MHz: OP.11 TDD | | | 5MHz: OP.16 TDD 10MHz: OP.2 TDD 20MHz: OP.12 TDD | | | 5MHz: OP.16 TDD 10MHz: OP.2 TDD 20MHz: OP.12 TDD | | | 5MHz: OP.16 TDD 10MHz: OP.2 TDD 20MHz: OP.12 TDD | | | 5MHz: OP.16 TDD 10MHz: OP.2 TDD 20MHz: OP.12 TDD | | |
| PBCH_RA | dB | 0 | | | 0 | | | 0 | | | 0 | | | 0 | | |
| PBCH_RB | dB | | | | | | | | | | | | | | | |
| PSS_RA | dB | | | | | | | | | | | | | | | |
| SSS_RA | dB | | | | | | | | | | | | | | | |
| PCFICH_RB | dB | | | | | | | | | | | | | | | |
| PHICH_RA | dB | | | | | | | | | | | | | | | |
| PHICH_RB | dB | | | | | | | | | | | | | | | |
| PDCCH_RA | dB | | | | | | | | | | | | | | | |
| PDCCH_RB | dB | | | | | | | | | | | | | | | |
| PDSCH_RA | dB | | | | | | | | | | | | | | | |
| PDSCH_RB | dB | | | | | | | | | | | | | | | |
| OCNG_RA ^{Note 1} | dB | | | | | | | | | | | | | | | |
| OCNG_RB ^{Note 1} | dB | | | | | | | | | | | | | | | |
| N _{oc} ^{Note 2} | dBm/15 KHz | | | | | | | | | | | | | | | |
| \bar{E}_s/N_{oc} | dB | 17 | 17 | -3 | -infinity | 17 | -3 | 17 | 17 | -3 | 17 | 17 | -3 | -infinity | 17 | -3 |
| \bar{E}_s/I_{ot} ^{Note 3} | dB | 17 | 17 | -3 | -infinity | 17 | -3 | 17 | 17 | -3 | 17 | -0.09 | -4.76 | -infinity | -0.09 | -4.76 |
| RSRP ^{Note 3} | dBm/15 kHz | -87 | -87 | -107 | -infinity | -87 | -107 | -87 | -87 | -107 | -87 | -87 | -107 | -infinity | -87 | -107 |
| SCH_RP ^{Note 3} | dBm/15 kHz | -87 | -87 | -107 | -infinity | -87 | -107 | -87 | -87 | -107 | -87 | -87 | -107 | -infinity | -87 | -107 |
| I _o ^{Note 3} | dBm/Ch BW | -59.13 +10log (N _{RB,c} /50) | -59.13 +10log (N _{RB,c} /50) | -74.45 +10log (N _{RB,c} /50) | -76.22 +10log (N _{RB,c} /50) | -59.13 +10log (N _{RB,c} /50) | -74.45 +10log (N _{RB,c} /50) | -59.13 +10log (N _{RB,c} /50) | -59.13 +10log (N _{RB,c} /50) | -74.45 +10log (N _{RB,c} /50) | -59.13 +10log (N _{RB,c} /50) | -56.17 +10log (N _{RB,c} /50) | -73.20 +10log (N _{RB,c} /50) | Specified in columns for Cell 4 | | |
| Propagation Condition | | AWGN | | | ETU70 | | | ETU70 | | | ETU70 | | | ETU70 | | |
| Correlation Matrix and Antenna Configuration | | 1x2 | | | 1x2 Low | | | 1x2 Low | | | 1x2 Low | | | 1x2 Low | | |

| | | | | | | |
|---|---------------|---|-------------------|-------------------|-------------------|-----|
| Timing offset to Cell 1 | μs | - | 0 | 0 | 0 | 3 |
| Time alignment error relative to cell 1 <small>Note 5</small> | μs | - | $\leq \text{TAE}$ | $\leq \text{TAE}$ | $\leq \text{TAE}$ | N/A |
| Time alignment error relative to cell 2 <small>Note 5</small> | μs | - | - | $\leq \text{TAE}$ | $\leq \text{TAE}$ | N/A |
| Time alignment error relative to cell 3 <small>Note 5</small> | μs | - | - | - | $\leq \text{TAE}$ | N/A |

Note 1: OCNG shall be used such that all cells are fully allocated and a constant total transmitted power spectral density is achieved for all OFDM symbols.

Note 2: Interference from other cells and noise sources not specified in the test is assumed to be constant over subcarriers and time and shall be modelled as AWGN of appropriate power for N_{oc} to be fulfilled.

Note 3: E_s/I_{ot} , RSRP, SCH_RP and I_o have been derived from other parameters for information purposes. They are not settable parameters themselves.

Note 4: The resources for uplink transmission are assigned to the UE prior to the start of time period T2.

Note 5: Time alignment error (TAE) as specified in TS 36.104 [30] clause 6.5.3.1. The TAE value depends upon the type of carrier aggregation.

A.8.16.52.2 Test Requirements

The UE shall send one Event A6 triggered measurement report for Cell 5 with a measurement reporting delay of less than 6.4s ($20 \times \text{measCycleSCell}$) from the beginning of time T2.

The UE shall send one Event A1 triggered measurement report for Cell 2 with a measurement reporting delay of less than 6.4s ($20 \times \text{measCycleSCell}$) from beginning of time T2.

The UE shall send one Event A2 triggered measurement report for Cell 1 with a measurement reporting delay of less than 200 ms from beginning of time T3.

The UE shall send one Event A2 triggered measurement report for Cell 2 with a measurement reporting delay of less than 1.6s ($5 \times \text{measCycleSCell}$) from beginning of time T3.

The UE shall send one Event A2 triggered measurement report for Cell 3 with a measurement reporting delay of less than 1.6s ($5 \times \text{measCycleSCell}$) from beginning of time T3.

The UE shall send one Event A2 triggered measurement report for Cell 4 with a measurement reporting delay of less than 1.6s ($5 \times \text{measCycleSCell}$) from beginning of time T3.

The UE shall not send event triggered measurement reports as long as the reporting criteria are not fulfilled.

The rate of correct events observed during repeated tests shall be at least 90% for each of the events.

NOTE: The actual overall delays measured in the tests may be up to $2 \times \text{TTI}_{\text{DCCH}}$ higher than the measurement reporting delays above because of TTI insertion uncertainty of the measurement report in DCCH.

A.8.16.53 4 DL PCell in FDD CA Event Triggered Reporting with 3 Deactivated SCells in Non-DRX

A.8.16.53.1 Test Purpose and Environment

The purpose of this test is to verify that the UE correctly detects events A1 (Serving cell becomes better than threshold), A2 (Serving cell becomes worse than threshold) and A6 (Neighbour becomes better than SCell) defined in TS 36.331 [2] within the requirements stated in clause 8.3.3.2.1.

The test parameters are given in Tables A.8.16.53.1-1, A.8.16.53.1-2 and A.8.16.53.1-3 below. It is indicated to the UE in the measurement control information that event-triggered reporting with Events A1 (for only SCell1 i.e. cell2), A2 (PCell and SCells) and A6 is used. The test consists of three successive time periods, with duration of T1, T2 and T3, respectively. During T1 the UE shall not have any information on cell 5. At the beginning of T2 the transmission power of cell 5 is increased to the same level as for cell 4, and due to usage of an offset this shall result in reporting of Event A6. Also, at the beginning of T2 the transmission power of cell 2 is increased to the same level as for cell 1, which shall result in reporting of Event A1. At the beginning of T3 the transmission powers of cells 1, 2, 3 and 4 are reduced below a threshold value and this shall result in reporting of Event A2 for Cell 1, for Cell 2, for Cell 3 and for Cell 4.

Table A.8.16.53.1-1: General test parameters for E-UTRAN TDD-FDD 4 DL CA event triggered reporting under fading propagation conditions with 3 configured but deactivated SCells in non-DRX with PCell in FDD

| Parameter | Unit | Value | Comment |
|--------------------------------|------|------------|--|
| E-UTRA RF Channel Number | | 1, 2, 3, 4 | Three radio channels are used for this test |
| Active PCell | | Cell 1 | Primary cell on RF channel number 1. |
| Configured deactivated SCell | | Cell 2 | Configured deactivated secondary cell on RF channel number 2. |
| Configured deactivated SCell | | Cell 3 | Configured deactivated secondary cell on RF channel number 3. |
| Configured deactivated SCell | | Cell 4 | Configured deactivated secondary cell on RF channel number 4. |
| Neighbour cell | | Cell 5 | Neighbour cell to be identified on RF channel number 4. |
| CP length | | Normal | |
| DRX | | OFF | Continuous monitoring of primary cell |
| Special subframe configuration | | 6 | As specified in table 4.2-1 in TS 36.211. The same configuration applies to all TDD cells (cell2, cell3, cell4 and cell5). |

| | | | | |
|---|-----------------|-----|-------|--|
| Uplink-downlink configuration | | | 1 | As specified in table 4.2-2 in TS 36.211. The same configuration applies to all TDD cells (cell2, cell3, cell4 and cell5). |
| A1 | Hysteresis | dB | 0 | Hysteresis for evaluation of event A1. |
| | Threshold RSRP | dBm | -98 | Actual RSRP threshold for event A1. Needs to take absolute accuracy tolerance in section 9.1.11.1 into account plus margin. |
| | Time To Trigger | s | 0 | |
| A2 | Hysteresis | dB | 0 | Hysteresis for evaluation of event A2. |
| | Threshold RSRP | dBm | -98 | Actual RSRP threshold for event A2. Needs to take absolute accuracy tolerance in section 9.1.11.1 into account plus margin. |
| | Time To Trigger | s | 0 | |
| A6 | Hysteresis | dB | 0 | Hysteresis for evaluation of event A6. |
| | Offset | dB | -6 | Offset parameter for evaluation of event A6. Needs to take relative accuracy tolerance in section 9.1.11.2 into account plus margin. |
| | Report on leave | | False | |
| | Time To Trigger | s | 0 | |
| Cell-individual offset for cells on RF channel number 1 | | dB | 0 | Individual offset for cells on primary component carrier. |
| Cell-individual offset for cells on RF channel number 2 | | dB | 0 | Individual offset for cells on secondary component carrier. |
| Cell-individual offset for cells on RF channel number 3 | | dB | 0 | Individual offset for cells on secondary component carrier. |
| Cell-individual offset for cells on RF channel number 4 | | dB | 0 | Individual offset for cells on secondary component carrier. |
| Filter coefficient | | | 0 | L3 filtering is not used |
| SCell measurement cycle (measCycleSCell) | | ms | 320 | For cell2, cell3 and cell4 |
| T1 | | s | 5 | During this time the cell1, cell3 and cell4 shall be known to the UE; but cell2 and cell5 shall be unknown to the UE. |
| T2 | | s | ≤12 | UE should report Event A1 for cell2 and event A6 for cell5 within 6.4s (20xscellMeasCycle) |
| T3 | | s | 5 | UE should report Event A2 within 200 ms for cell1 and within 1.6s for each of cells2, 3 and 4. |

Table A.8.16.53.1-2: Cell specific test parameters for E-UTRAN TDD-FDD 4 DL CA event triggered reporting under fading propagation conditions with 3 configured but deactivated SCells in non-DRX with PCell in FDD

| Parameter | Unit | Cell 1 | | | Cell 2 | | | Cell3 | | |
|--|---|---|--|--|---|--|--|---|--|--|
| | | T1 | T2 | T3 | T1 | T2 | T3 | T1 | T2 | T3 |
| E-UTRA RF Channel Number | | 1 | | | 2 | | | 3 | | |
| BW _{channel} | | 5MHz: N _{RB,c} = 25 10MHz: N _{RB,c} = 50 20MHz: N _{RB,c} = 100 | | | 5MHz: N _{RB,c} = 25 10MHz: N _{RB,c} = 50 20MHz: N _{RB,c} = 100 | | | 5MHz: N _{RB,c} = 25 10MHz: N _{RB,c} = 50 20MHz: N _{RB,c} = 100 | | |
| PDSCH parameters: DL Reference Measurement Channel | | 5MHz: R.5 FDD 10MHz: R.0 FDD 20MHz: R.4 FDD | | | - | | | - | | |
| PCFICH/PDCCH/PHICH parameters: DL Reference Measurement Channel | | 5MHz: R.11 FDD 10MHz: R.6 FDD 20MHz: R.10 FDD | | | 5MHz: R.11 TDD 10MHz: R.6 TDD 20MHz: R.10 TDD | | | 5MHz: R.11 TDD 10MHz: R.6 TDD 20MHz: R.10 TDD | | |
| OCNG Patterns | | 5MHz: OP.15 FDD 10MHz: OP.1 FDD 20MHz: OP.11 FDD | | | 5MHz: OP.10 TDD 10MHz: OP.2 TDD 20MHz: OP.8 TDD | | | 5MHz: OP.10 TDD 10MHz: OP.2 TDD 20MHz: OP.8 TDD | | |
| PBCH_RA | dB | 0 | | | 0 | | | 0 | | |
| PBCH_RB | dB | | | | | | | | | |
| PSS_RA | dB | | | | | | | | | |
| SSS_RA | dB | | | | | | | | | |
| PCFICH_RB | dB | | | | | | | | | |
| PHICH_RA | dB | | | | | | | | | |
| PHICH_RB | dB | | | | | | | | | |
| PDCCH_RA | dB | | | | | | | | | |
| PDCCH_RB | dB | | | | | | | | | |
| PDSCH_RA | dB | | | | | | | | | |
| PDSCH_RB | dB | | | | | | | | | |
| OCNG_RA ^{Note 1} | dB | | | | | | | | | |
| OCNG_RB ^{Note 1} | dB | | | | | | | | | |
| N _{oc} ^{Note 2} | dBm/15 KHz | | | | | | | | | |
| \bar{E}_s/N_{oc} | dB | 17 | 17 | -3 | -infinity | 17 | -3 | 17 | 17 | -3 |
| \bar{E}_s/I_{ot} ^{Note 3} | dB | 17 | 17 | -3 | -infinity | 17 | -3 | 17 | 17 | -3 |
| RSRP ^{Note 3} | dBm/15 kHz | -87 | -87 | -107 | -infinity | -87 | -107 | -87 | -87 | -107 |
| SCH_RP ^{Note 3} | dBm/15 kHz | -87 | -87 | -107 | -infinity | -87 | -107 | -87 | -87 | -107 |
| I _o ^{Note 3} | dBm/Ch BW | -59.13 +10log (N _{RB,c} /50) | -59.13 +10log (N _{RB,c} /50) | -74.45 +10log (N _{RB,c} /50) | -76.22 +10log (N _{RB,c} /50) | -59.13 +10log (N _{RB,c} /50) | -74.45 +10log (N _{RB,c} /50) | -59.13 +10log (N _{RB,c} /50) | -59.13 +10log (N _{RB,c} /50) | -74.45 +10log (N _{RB,c} /50) |
| Propagation Condition | | AWGN | | | ETU70 | | | ETU70 | | |
| Correlation Matrix and Antenna Configuration | | 1x2 Low | | | 1x2 Low | | | 1x2 Low | | |
| Timing offset to cell1 | μs | - | | | 0 | | | 0 | | |
| Time alignment error relative to cell1 ^{Note 5} | μs | - | | | ≤ TAE | | | ≤ TAE | | |
| Time alignment error relative to cell 2 ^{Note 5} | μs | ≤ TAE | | | - | | | ≤ TAE | | |
| Time alignment error relative to cell 3 ^{Note 5} | μs | ≤ TAE | | | ≤ TAE | | | - | | |
| Time alignment error relative to cell 4 ^{Note 5} | μs | ≤ TAE | | | ≤ TAE | | | ≤ TAE | | |
| Note 1: | OCNG shall be used such that all cells are fully allocated and a constant total transmitted power spectral density is achieved for all OFDM symbols. | | | | | | | | | |
| Note 2: | Interference from other cells and noise sources not specified in the test is assumed to be constant over subcarriers and time and shall be modelled as AWGN of appropriate power for N _{oc} to be fulfilled. | | | | | | | | | |
| Note 3: | Es/I _{ot} , RSRP, SCH_RP and I _o have been derived from other parameters for information purposes. They are not settable parameters themselves. | | | | | | | | | |
| Note 4: | The resources for uplink transmission are assigned to the UE prior to the start of time period T2. | | | | | | | | | |
| Note 5: | Time alignment error (TAE) as specified in TS 36.104 [30] clause 6.5.3.1. The TAE value depends upon the type of carrier aggregation. | | | | | | | | | |

Table A.8.16.53.1-3: Cell specific test parameters for E-UTRAN TDD-FDD 4 DL CA event triggered reporting under fading propagation conditions with 3 configured but deactivated SCells in non-DRX with PCell in FDD

| Parameter | Unit | Cell 4 | | | Cell 5 | | |
|--|--|--|--|--|---|-------|-------|
| | | T1 | T2 | T3 | T1 | T2 | T3 |
| E-UTRA RF Channel Number | | 4 | | | | | |
| $BW_{channel}$ | | 5MHz: $N_{RB,c} = 25$ 10MHz: $N_{RB,c} = 50$ 20MHz: $N_{RB,c} = 100$ | | | | | |
| PDSCH parameters: DL Reference Measurement Channel | | - | | | - | | |
| PCFICH/PDCCH/PHICH parameters: DL Reference Measurement Channel | | 5MHz: R.11 TDD 10MHz: R.6 TDD 20MHz: R.10 TDD | | | 5MHz: R.11 TDD 10MHz: R.6 TDD 20MHz: R.10 TDD | | |
| OCNG Patterns | | 5MHz: OP.10 TDD 10MHz: OP.2 TDD 20MHz: OP.8 TDD | | | 5MHz: OP.10 TDD 10MHz: OP.2 TDD 20MHz: OP.8 TDD | | |
| PBCH_RA | dB | 0 | | | 0 | | |
| PBCH_RB | dB | | | | | | |
| PSS_RA | dB | | | | | | |
| SSS_RA | dB | | | | | | |
| PCFICH_RB | dB | | | | | | |
| PHICH_RA | dB | | | | | | |
| PHICH_RB | dB | | | | | | |
| PDCCH_RA | dB | | | | | | |
| PDCCH_RB | dB | | | | | | |
| PDSCH_RA | dB | | | | | | |
| PDSCH_RB | dB | | | | | | |
| OCNG_RA ^{Note 1} | dB | | | | | | |
| OCNG_RB ^{Note 1} | dB | | | | | | |
| N_{oc} ^{Note 2} | dBm/15 KHz | | | | | | |
| \bar{E}_s/N_{oc} | dB | 17 | 17 | -3 | -infinity | 17 | -3 |
| \bar{E}_s/I_{ot} ^{Note 3} | dB | 17 | -0.09 | -4.76 | -infinity | -0.09 | -4.76 |
| RSRP ^{Note 3} | dBm/15 kHz | -87 | -87 | -107 | -infinity | -87 | -107 |
| SCH_RP ^{Note 3} | dBm/15 kHz | -87 | -87 | -107 | -infinity | -87 | -107 |
| I_o ^{Note 3} | dBm/Ch BW | -59.13 +10log ($N_{RB,c}$ /50) | -56.17 +10log ($N_{RB,c}$ /50) | -73.20 +10log ($N_{RB,c}$ /50) | Specified in columns for Cell 4 | | |
| Propagation Condition | | ETU70 | | | ETU70 | | |
| Correlation Matrix and Antenna Configuration | | 1x2 Low | | | 1x2 Low | | |
| Timing offset to Cell 1 | μ s | 0 | | | 3 | | |
| Time alignment error relative to cell 1 ^{Note 5} | μ s | - | | | N/A | | |
| Time alignment error relative to cell 2 ^{Note 5} | μ s | - | | | N/A | | |
| Time alignment error relative to cell 3 ^{Note 5} | μ s | - | | | N/A | | |
| Time alignment error relative to cell 4 ^{Note 5} | μ s | - | | | N/A | | |
| Note 1: | OCNG shall be used such that all cells are fully allocated and a constant total transmitted power spectral density is achieved for all OFDM symbols. | | | | | | |
| Note 2: | Interference from other cells and noise sources not specified in the test is assumed to be constant over subcarriers and time and shall be modelled as AWGN of appropriate power for N_{oc} to be fulfilled. | | | | | | |
| Note 3: | \bar{E}_s/I_{ot} , RSRP, SCH_RP and I_o have been derived from other parameters for information purposes. They are not settable parameters themselves. | | | | | | |
| Note 4: | The resources for uplink transmission are assigned to the UE prior to the start of time period T2. | | | | | | |
| Note 5: | Time alignment error (TAE) as specified in TS 36.104 [30] clause 6.5.3.1. The TAE value depends upon the type of carrier aggregation. | | | | | | |

A.8.16.53.2 Test Requirements

The UE shall send one Event A6 triggered measurement report for Cell 5 with a measurement reporting delay of less than 6.4s ($20 \times \text{measCycleSCell}$) from the beginning of time T2.

The UE shall send one Event A1 triggered measurement report for Cell 2 with a measurement reporting delay of less than 6.4s ($20 \times \text{measCycleSCell}$) from beginning of time T2.

The UE shall send one Event A2 triggered measurement report for Cell 1 with a measurement reporting delay of less than 200 ms from beginning of time T3.

The UE shall send one Event A2 triggered measurement report for Cell 2 with a measurement reporting delay of less than 1.6s ($5 \times \text{measCycleSCell}$) from beginning of time T3.

The UE shall send one Event A2 triggered measurement report for Cell 3 with a measurement reporting delay of less than 1.6s ($5 \times \text{measCycleSCell}$) from beginning of time T3.

The UE shall send one Event A2 triggered measurement report for Cell 4 with a measurement reporting delay of less than 1.6s ($5 \times \text{measCycleSCell}$) from beginning of time T3.

The UE shall not send event triggered measurement reports as long as the reporting criteria are not fulfilled.

The rate of correct events observed during repeated tests shall be at least 90% for each of the events.

NOTE: The actual overall delays measured in the tests may be up to $2 \times \text{TTI}_{\text{DCCH}}$ higher than the measurement reporting delays above because of TTI insertion uncertainty of the measurement report in DCCH.

A.8.16.54 4 DL PCell in TDD CA Event Triggered Reporting with 3 Deactivated SCells in Non-DRX

A.8.16.54.1 Test Purpose and Environment

The purpose of this test is to verify that the UE correctly detects events A1 (Serving cell becomes better than threshold), A2 (Serving cell becomes worse than threshold) and A6 (Neighbour becomes better than SCell) defined in TS 36.331 [2] within the requirements stated in clause 8.3.3.2.1.

The test parameters are given in Tables A.8.16.54.1-1, A.8.16.54.1-2 and A.8.16.54.1-3 below. It is indicated to the UE in the measurement control information that event-triggered reporting with Events A1 (for only SCell1 i.e. cell2), A2 (PCell and SCells) and A6 is used. The test consists of three successive time periods, with duration of T1, T2 and T3, respectively. During T1 the UE shall not have any information on cell 5. At the beginning of T2 the transmission power of cell 5 is increased to the same level as for cell 4, and due to usage of an offset this shall result in reporting of Event A6. Also, at the beginning of T2 the transmission power of cell 2 is increased to the same level as for cell 1, which shall result in reporting of Event A1. At the beginning of T3 the transmission powers of cells 1, 2, 3 and 4 are reduced below a threshold value and this shall result in reporting of Event A2 for Cell 1, for Cell 2, for Cell 3 and for Cell 4.

Table A.8.16.54.1-1: General test parameters for E-UTRAN TDD-FDD 4 DL CA event triggered reporting under fading propagation conditions with 3 configured but deactivated SCells in non-DRX with PCell in TDD

| Parameter | Unit | Value | Comment |
|--------------------------------|------|------------|--|
| E-UTRA RF Channel Number | | 1, 2, 3, 4 | Three radio channels are used for this test |
| Active PCell | | Cell 1 | Primary cell on RF channel number 1. |
| Configured deactivated SCell | | Cell 2 | Configured deactivated secondary cell on RF channel number 2. |
| Configured deactivated SCell | | Cell 3 | Configured deactivated secondary cell on RF channel number 3. |
| Configured deactivated SCell | | Cell 4 | Configured deactivated secondary cell on RF channel number 4. |
| Neighbour cell | | Cell 5 | Neighbour cell to be identified on RF channel number 4. |
| CP length | | Normal | |
| DRX | | OFF | Continuous monitoring of primary cell |
| Special subframe configuration | | 6 | As specified in table 4.2-1 in TS 36.211. The configuration applies to the TDD cell (cell1). |
| Uplink-downlink configuration | | 1 | As specified in table 4.2-2 in TS 36.211. The configuration applies to the TDD cell (cell1). |
| A1 Hysteresis | dB | 0 | Hysteresis for evaluation of event A1. |

| | | | | |
|---|-----------------|-----|-------|--|
| | Threshold RSRP | dBm | -98 | Actual RSRP threshold for event A1. Needs to take absolute accuracy tolerance in section 9.1.11.1 into account plus margin. |
| | Time To Trigger | s | 0 | |
| A2 | Hysteresis | dB | 0 | Hysteresis for evaluation of event A2. |
| | Threshold RSRP | dBm | -98 | Actual RSRP threshold for event A2. Needs to take absolute accuracy tolerance in section 9.1.11.1 into account plus margin. |
| | Time To Trigger | s | 0 | |
| A6 | Hysteresis | dB | 0 | Hysteresis for evaluation of event A6. |
| | Offset | dB | -6 | Offset parameter for evaluation of event A6. Needs to take relative accuracy tolerance in section 9.1.11.2 into account plus margin. |
| | Report on leave | | False | |
| | Time To Trigger | s | 0 | |
| Cell-individual offset for cells on RF channel number 1 | | dB | 0 | Individual offset for cells on primary component carrier. |
| Cell-individual offset for cells on RF channel number 2 | | dB | 0 | Individual offset for cells on secondary component carrier. |
| Cell-individual offset for cells on RF channel number 3 | | dB | 0 | Individual offset for cells on secondary component carrier. |
| Cell-individual offset for cells on RF channel number 4 | | dB | 0 | Individual offset for cells on secondary component carrier. |
| Filter coefficient | | | 0 | L3 filtering is not used |
| SCell measurement cycle (measCycleSCell) | | ms | 320 | For cell2, cell3 and cell4 |
| T1 | | s | 5 | During this time the cell1, cell3 and cell4 shall be known to the UE; but cell2 and cell5 shall be unknown to the UE. |
| T2 | | s | ≤12 | UE should report Event A1 for cell2 and event A6 for cell5 within 6.4s (20xscellMeasCycle) |
| T3 | | s | 5 | UE should report Event A2 within 200 ms for cell1 and within 1.6s for each of cells2, 3 and 4. |

Table A.8.16.54.1-2: Cell specific test parameters for E-UTRAN TDD-FDD 4 DL CA event triggered reporting under fading propagation conditions with 3 configured but deactivated SCells in non-DRX with PCell in TDD

| Parameter | Unit | Cell 1 | | | Cell 2 | | | Cell3 | | |
|--|---|---|--|--|---|--|--|---|--|--|
| | | T1 | T2 | T3 | T1 | T2 | T3 | T1 | T2 | T3 |
| E-UTRA RF Channel Number | | 1 | | | 2 | | | 3 | | |
| BW _{channel} | | 5MHz: N _{RB,c} = 25 10MHz: N _{RB,c} = 50 20MHz: N _{RB,c} = 100 | | | 5MHz: N _{RB,c} = 25 10MHz: N _{RB,c} = 50 20MHz: N _{RB,c} = 100 | | | 5MHz: N _{RB,c} = 25 10MHz: N _{RB,c} = 50 20MHz: N _{RB,c} = 100 | | |
| PDSCH parameters: DL Reference Measurement Channel | | 5MHz: R.4 TDD 10MHz: R.0 TDD 20MHz: R.3 TDD | | | - | | | - | | |
| PCFICH/PDCCH/PHICH parameters: DL Reference Measurement Channel | | 5MHz: R.11 TDD 10MHz: R.6 TDD 20MHz: R.10 TDD | | | 5MHz: R.11 FDD 10MHz: R.6 FDD 20MHz: R.10 FDD | | | 5MHz: R.11 FDD 10MHz: R.6 FDD 20MHz: R.10 FDD | | |
| OCNG Patterns | | 5MHz: OP.9 TDD 10MHz: OP.1 TDD 20MHz: OP.7 TDD | | | 5MHz: OP.16 FDD 10MHz: OP.2 FDD 20MHz: OP.12 FDD | | | 5MHz: OP.16 FDD 10MHz: OP.2 FDD 20MHz: OP.12 FDD | | |
| PBCH_RA | dB | 0 | | | 0 | | | 0 | | |
| PBCH_RB | dB | | | | | | | | | |
| PSS_RA | dB | | | | | | | | | |
| SSS_RA | dB | | | | | | | | | |
| PCFICH_RB | dB | | | | | | | | | |
| PHICH_RA | dB | | | | | | | | | |
| PHICH_RB | dB | | | | | | | | | |
| PDCCH_RA | dB | | | | | | | | | |
| PDCCH_RB | dB | | | | | | | | | |
| PDSCH_RA | dB | | | | | | | | | |
| PDSCH_RB | dB | | | | | | | | | |
| OCNG_RA ^{Note 1} | dB | | | | | | | | | |
| OCNG_RB ^{Note 1} | dB | | | | | | | | | |
| N _{oc} ^{Note 2} | dBm/15 KHz | | | | | | | | | |
| \bar{E}_s/N_{oc} | dB | 17 | 17 | -3 | -infinity | 17 | -3 | 17 | 17 | -3 |
| \bar{E}_s/I_{ot} ^{Note 3} | dB | 17 | 17 | -3 | -infinity | 17 | -3 | 17 | 17 | -3 |
| RSRP ^{Note 3} | dBm/15 kHz | -87 | -87 | -107 | -infinity | -87 | -107 | -87 | -87 | -107 |
| SCH_RP ^{Note 3} | dBm/15 kHz | -87 | -87 | -107 | -infinity | -87 | -107 | -87 | -87 | -107 |
| I _o ^{Note 3} | dBm/Ch BW | -59.13 +10log (N _{RB,c} /50) | -59.13 +10log (N _{RB,c} /50) | -74.45 +10log (N _{RB,c} /50) | -76.22 +10log (N _{RB,c} /50) | -59.13 +10log (N _{RB,c} /50) | -74.45 +10log (N _{RB,c} /50) | -59.13 +10log (N _{RB,c} /50) | -59.13 +10log (N _{RB,c} /50) | -74.45 +10log (N _{RB,c} /50) |
| Propagation Condition | | AWGN | | | ETU70 | | | ETU70 | | |
| Correlation Matrix and Antenna Configuration | | 1x2 Low | | | 1x2 Low | | | 1x2 Low | | |
| Timing offset to cell1 | μs | - | | | 0 | | | 0 | | |
| Time alignment error relative to cell1 ^{Note5} | μs | - | | | ≤ TAE | | | ≤ TAE | | |
| Time alignment error relative to cell 2 ^{Note 5} | μs | ≤ TAE | | | - | | | ≤ TAE | | |
| Time alignment error relative to cell 3 ^{Note 5} | μs | ≤ TAE | | | ≤ TAE | | | - | | |
| Time alignment error relative to cell 4 ^{Note 5} | μs | ≤ TAE | | | ≤ TAE | | | ≤ TAE | | |
| Note 1: | OCNG shall be used such that all cells are fully allocated and a constant total transmitted power spectral density is achieved for all OFDM symbols. | | | | | | | | | |
| Note 2: | Interference from other cells and noise sources not specified in the test is assumed to be constant over subcarriers and time and shall be modelled as AWGN of appropriate power for N _{oc} to be fulfilled. | | | | | | | | | |
| Note 3: | Es/I _{ot} , RSRP, SCH_RP and I _o have been derived from other parameters for information purposes. They are not settable parameters themselves. | | | | | | | | | |
| Note 4: | The resources for uplink transmission are assigned to the UE prior to the start of time period T2. | | | | | | | | | |
| Note 5: | Time alignment error (TAE) as specified in TS 36.104 [30] clause 6.5.3.1. The TAE value depends upon the type of carrier aggregation. | | | | | | | | | |

Table A.8.16.54.1-3: Cell specific test parameters for E-UTRAN TDD-FDD 4 DL CA event triggered reporting under fading propagation conditions with 3 configured but deactivated SCells in non-DRX with PCell in TDD

| Parameter | Unit | Cell 4 | | | Cell 5 | | |
|--|--|--|--|--|--|-------|-------|
| | | T1 | T2 | T3 | T1 | T2 | T3 |
| E-UTRA RF Channel Number | | 4 | | | | | |
| $BW_{channel}$ | | 5MHz: $N_{RB,c} = 25$ 10MHz: $N_{RB,c} = 50$ 20MHz: $N_{RB,c} = 100$ | | | | | |
| PDSCH parameters: DL Reference Measurement Channel | | - | | | - | | |
| PCFICH/PDCCH/PHICH parameters: DL Reference Measurement Channel | | 5MHz: R.11 FDD 10MHz: R.6 FDD 20MHz: R.10 FDD | | | 5MHz: R.11 FDD 10MHz: R.6 FDD 20MHz: R.10 FDD | | |
| OCNG Patterns | | 5MHz: OP.16 FDD 10MHz: OP.2 FDD 20MHz: OP.12 FDD | | | 5MHz: OP.16 FDD 10MHz: OP.2 FDD 20MHz: OP.12 FDD | | |
| PBCH_RA | dB | 0 | | | 0 | | |
| PBCH_RB | dB | | | | | | |
| PSS_RA | dB | | | | | | |
| SSS_RA | dB | | | | | | |
| PCFICH_RB | dB | | | | | | |
| PHICH_RA | dB | | | | | | |
| PHICH_RB | dB | | | | | | |
| PDCCH_RA | dB | | | | | | |
| PDCCH_RB | dB | | | | | | |
| PDSCH_RA | dB | | | | | | |
| PDSCH_RB | dB | | | | | | |
| OCNG_RA ^{Note 1} | dB | | | | | | |
| OCNG_RB ^{Note 1} | dB | | | | | | |
| N_{oc} ^{Note 2} | dBm/15 KHz | | | | | | |
| \bar{E}_s/N_{oc} | dB | 17 | 17 | -3 | -infinity | 17 | -3 |
| \bar{E}_s/I_{ot} ^{Note 3} | dB | 17 | -0.09 | -4.76 | -infinity | -0.09 | -4.76 |
| RSRP ^{Note 3} | dBm/15 kHz | -87 | -87 | -107 | -infinity | -87 | -107 |
| SCH_RP ^{Note 3} | dBm/15 kHz | -87 | -87 | -107 | -infinity | -87 | -107 |
| I_o ^{Note 3} | dBm/Ch BW | -59.13 +10log ($N_{RB,c}$ /50) | -56.17 +10log ($N_{RB,c}$ /50) | -73.20 +10log ($N_{RB,c}$ /50) | Specified in columns for Cell 4 | | |
| Propagation Condition | | ETU70 | | | ETU70 | | |
| Correlation Matrix and Antenna Configuration | | 1x2 Low | | | 1x2 Low | | |
| Timing offset to cell1 | μ s | 0 | | | 3 | | |
| Time alignment error relative to cell1 ^{Note 5} | μ s | - | | | N/A | | |
| Time alignment error relative to cell2 ^{Note 5} | μ s | - | | | N/A | | |
| Time alignment error relative to cell3 ^{Note 5} | μ s | - | | | N/A | | |
| Time alignment error relative to cell4 ^{Note 5} | μ s | - | | | N/A | | |
| Note 1: | OCNG shall be used such that all cells are fully allocated and a constant total transmitted power spectral density is achieved for all OFDM symbols. | | | | | | |
| Note 2: | Interference from other cells and noise sources not specified in the test is assumed to be constant over subcarriers and time and shall be modelled as AWGN of appropriate power for N_{oc} to be fulfilled. | | | | | | |
| Note 3: | E_s/I_{ot} , RSRP, SCH_RP and I_o have been derived from other parameters for information purposes. They are not settable parameters themselves. | | | | | | |
| Note 4: | The resources for uplink transmission are assigned to the UE prior to the start of time period T2. | | | | | | |
| Note 5: | Time alignment error (TAE) as specified in TS 36.104 [30] clause 6.5.3.1. The TAE value depends upon the type of carrier aggregation. | | | | | | |

A.8.16.54.2 Test Requirements

The UE shall send one Event A6 triggered measurement report for Cell 5 with a measurement reporting delay of less than 6.4s ($20 \times \text{measCycleSCell}$) from the beginning of time T2.

The UE shall send one Event A1 triggered measurement report for Cell 2 with a measurement reporting delay of less than 6.4s ($20 \times \text{measCycleSCell}$) from beginning of time T2.

The UE shall send one Event A2 triggered measurement report for Cell 1 with a measurement reporting delay of less than 200 ms from beginning of time T3.

The UE shall send one Event A2 triggered measurement report for Cell 2 with a measurement reporting delay of less than 1.6s ($5 \times \text{measCycleSCell}$) from beginning of time T3.

The UE shall send one Event A2 triggered measurement report for Cell 3 with a measurement reporting delay of less than 1.6s ($5 \times \text{measCycleSCell}$) from beginning of time T3.

The UE shall send one Event A2 triggered measurement report for Cell 4 with a measurement reporting delay of less than 1.6s ($5 \times \text{measCycleSCell}$) from beginning of time T3.

The UE shall not send event triggered measurement reports as long as the reporting criteria are not fulfilled.

The rate of correct events observed during repeated tests shall be at least 90% for each of the events.

NOTE: The actual overall delays measured in the tests may be up to $2 \times \text{TTI}_{\text{DCCH}}$ higher than the measurement reporting delays above because of TTI insertion uncertainty of the measurement report in DCCH.

A.8.16.55 E-UTRAN FDD 4 DL CA Event Triggered Reporting on Deactivated SCell with PCell and SCell Interruptions in Non-DRX

A.8.16.55.1 Test Purpose and Environment

The purpose of this test is to verify that the UE correctly detects event A6 (Neighbour becomes better than SCell) defined in TS 36.331 [2] within the requirements stated in clause 8.3.3.2.1 while at the same time fulfilling the requirement on interruption rate.

The test parameters are given in Table A.8.16.55.1-1, A.8.16.55.1-2 and A.8.16.55.1-3 below. In the test there are five cells: Cell 1, Cell 2, Cell 3, Cell 4 and Cell 5. Cell 1 is PCell on the FDD primary component (RF Channel 1), Cell 2 is SCell on the FDD secondary component (RF Channel 2), Cell 3 is SCell on the FDD secondary component (RF Channel 3), Cell 4 is SCell on the FDD secondary component (RF Channel 4) and Cell 5 is the neighbour cell on the FDD secondary component (RF Channel 4). It is indicated to the UE in the measurement control information that event-triggered reporting with Event A6 is used. The test consists of four successive time periods, with duration of T1, T2, T3 and T4, respectively. During T1 and T2, Cell2, Cell3 and Cell4 are deactivated. During T1 the UE shall not have any information of Cell 5. Immediately at beginning of T2 the transmission power of Cell 5 is increased to same level as for Cell 4, and due to usage of an offset this shall result in reporting of Event A6.

At the beginning of T3, the transmission power of Cell 5 is turned off, and the test equipment sends a MAC message for activation of Cell 2 to UE but Cell3 and Cell4 remains deactivated. Immediately at beginning of T4 the transmission power of Cell 5 is increased to same level as for Cell 4, and due to usage of an offset this shall result in reporting of Event A6. The UE shall be continuously scheduled in the PCell throughout the whole test and continuously scheduled in Cell2 during T4.

Table A.8.16.55.1-1: General test parameters for E-UTRAN FDD 4 DL CA Event Triggered Reporting on Deactivated SCell with PCell and SCell interruptions in Non-DRX

| Parameter | Unit | Value | Comment |
|------------------------------|------|------------|---|
| E-UTRA RF Channel Number | | 1, 2, 3, 4 | Four radio channels are used for this test |
| Active PCell | | Cell 1 | Primary cell on RF channel number 1. |
| Configured deactivated SCell | | Cell 2 | Configured deactivated secondary cell on RF channel number 2. |
| Configured deactivated SCell | | Cell 3 | Configured deactivated secondary cell on RF channel number 3. |

| | | | | |
|---|-----------------|----|--------|---|
| Configured deactivated SCell | | | Cell 4 | Configured deactivated secondary cell on RF channel number 4. |
| Neighbour cell | | | Cell 5 | Neighbor cell to be identified on RF channel number 4. |
| CP length | | | Normal | |
| DRX | | | OFF | Continuous monitoring of primary cell |
| A6 | Hysteresis | dB | 0 | Hysteresis for evaluation of event A6. |
| | Offset | dB | -3 | Offset parameter for evaluation of event A6. Needs to take relative accuracy tolerance in clause 9.1.11.2 into account plus margin. |
| | Report on leave | | False | |
| | Time To Trigger | s | 0 | |
| Cell-individual offset for cells on RF channel number 1 | | dB | 0 | Individual offset for cells on primary component carrier. |
| Cell-individual offset for cells on RF channel number 2 | | dB | 0 | Individual offset for cells on secondary component carrier. |
| Cell-individual offset for cells on RF channel number 3 | | dB | 0 | Individual offset for cells on secondary component carrier. |
| Cell-individual offset for cells on RF channel number 4 | | dB | 0 | Individual offset for cells on secondary component carrier. |
| Filter coefficient | | | 0 | L3 filtering is not used |
| SCell measurement cycle | | ms | 640 | |
| T1 | | s | 4 | During this time the UE shall be aware of cells 1, 2, 3 and 4 but not cell 5. |
| T2 | | s | ≤15 | UE should report Event A6 within 12.8s (20×scellMeasCycle) |
| T3 | | s | 4 | During this time the UE shall activate cell 2 |
| T4 | | s | ≤4 | UE should report Event A6 within 3.2s (5×scellMeasCycle) |

Table A.8.16.55.1-2: Cell specific test parameters for E-UTRAN FDD 4 DL CA Event Triggered Reporting on Deactivated SCell with PCell and SCell interruptions in Non-DRX (Cell #1, Cell #2, Cell #3, Cell #4)

| Parameter | Unit | Cell 1 | | | | Cell 2 | | | | Cell 3 | | | | Cell 4 | | | |
|--|------|---|----|----|----|---|--|--|---|---|----|----|----|---|----|----|----|
| | | T1 | T2 | T3 | T4 | T1 | T2 | T3 | T4 | T1 | T2 | T3 | T4 | T1 | T2 | T3 | T4 |
| E-UTRA RF Channel Number | | 1 | | | | 2 | | | | 3 | | | | 4 | | | |
| BW _{channel} | | 5MHz: N _{RB,c} = 25 10MHz: N _{RB,c} = 50 20MHz: N _{RB,c} = 100 | | | | 5MHz: N _{RB,c} = 25 10MHz: N _{RB,c} = 50 20MHz: N _{RB,c} = 100 | | | | 5MHz: N _{RB,c} = 25 10MHz: N _{RB,c} = 50 20MHz: N _{RB,c} = 100 | | | | 5MHz: N _{RB,c} = 25 10MHz: N _{RB,c} = 50 20MHz: N _{RB,c} = 100 | | | |
| PDSCH parameters: DL Reference Measurement Channel | | 5MHz: R.7 FDD 10MHz: R.3 FDD 20MHz: R.6 FDD | | | | N/A | N/A | N/A | 5MHz: R.7 FDD 10MHz: R.3 FDD 20MHz: R.6 FDD | N/A | | | | N/A | | | |
| PCFICH/PDCCH/PHICH parameters | | 5MHz: R.11 FDD 10MHz: R.6 FDD 20MHz: R.10 FDD | | | | 5MHz: R.11 FDD 10MHz: R.6 FDD 20MHz: R.10 FDD | | | | 5MHz: R.11 FDD 10MHz: R.6 FDD 20MHz: R.10 FDD | | | | 5MHz: R.11 FDD 10MHz: R.6 FDD 20MHz: R.10 FDD | | | |
| OCNG Pattern defined in A.3.2.1 | | 5MHz: OP.20 FDD 10MHz: OP.10 FDD 20MHz: OP.17 FDD | | | | 5MHz: OP. 19 FDD 10MHz: OP.6 FDD 20MHz: OP.14 FDD | 5MHz: OP.19 FDD 10MHz: OP.6 FDD 20MHz: OP.14 FDD | 5MHz: OP.19 FDD 10MHz: OP.6 FDD 20MHz: OP.14 FDD | 5MHz: OP.20 FDD 10MHz: OP.10 FDD 20MHz: OP.17 FDD | 5MHz: OP.16 FDD 10MHz: OP.2 FDD 20MHz: OP.12 FDD | | | | 5MHz: OP.16 FDD 10MHz: OP.2 FDD 20MHz: OP.12 FDD | | | |
| PBCH_RA | dB | 0 | | | | 0 | | | | 0 | | | | 0 | | | |
| PBCH_RB | dB | | | | | | | | | | | | | | | | |
| PSS_RA | dB | | | | | | | | | | | | | | | | |
| SSS_RA | dB | | | | | | | | | | | | | | | | |
| PCFICH_RB | dB | | | | | | | | | | | | | | | | |
| PHICH_RA | dB | | | | | | | | | | | | | | | | |
| PHICH_RB | dB | | | | | | | | | | | | | | | | |
| PDCCH_RA | dB | | | | | | | | | | | | | | | | |
| PDCCH_RB | dB | | | | | | | | | | | | | | | | |
| PDSCH_RA | dB | | | | | | | | | | | | | | | | |
| PDSCH_RB | dB | | | | | | | | | | | | | | | | |
| OCNG_RA ^{Note 1} | dB | | | | | | | | | | | | | | | | |
| OCNG_RB ^{Note 1} | dB | | | | | | | | | | | | | | | | |

| | | | | | | | | | | | | | | | | | |
|--|------------|--|--|--|--|--|--|--|--|--|--|--|--|--|--|--|--|
| N_{oc} <small>Note 3</small> | dBm/15 kHz | -101 | | | | -101 | | | | -101 | | | | -101 | | | |
| \hat{E}_s / N_{oc} | dB | 16 | 16 | 16 | 16 | 16 | 16 | 16 | 16 | 16 | 16 | 16 | 16 | 16 | 16 | 16 | 16 |
| \hat{E}_s / I_{ot} <small>Note 4</small> | dB | 16 | 16 | 16 | 16 | 16 | 16 | 16 | 16 | 16 | 16 | 16 | 16 | 16 | -0.11 | 16 | -0.11 |
| RSRP <small>Note 4</small> | dBm/15 kHz | -85 | -85 | -85 | -85 | -85 | -85 | -85 | -85 | -85 | -85 | -85 | -85 | -85 | -85 | -85 | -85 |
| SCH_RP <small>Note 4</small> | dBm/15 kHz | -85 | -85 | -85 | -85 | -85 | -85 | -85 | -85 | -85 | -85 | -85 | -85 | -85 | -85 | -85 | -85 |
| I_o <small>Note 4</small> | dBm/Ch BW | -57.11 +10log ($N_{RB,c}$ /50) | -57.11 +10log ($N_{RB,c}$ /50) | -57.11 +10log ($N_{RB,c}$ /50) | -57.11 +10log ($N_{RB,c}$ /50) | -57.11 +10log ($N_{RB,c}$ /50) | -57.11 +10log ($N_{RB,c}$ /50) | -57.11 +10log ($N_{RB,c}$ /50) | -57.11 +10log ($N_{RB,c}$ /50) | -57.11 +10log ($N_{RB,c}$ /50) | -57.11 +10log ($N_{RB,c}$ /50) | -57.11 +10log ($N_{RB,c}$ /50) | -57.11 +10log ($N_{RB,c}$ /50) | -57.11 +10log ($N_{RB,c}$ /50) | -54.15 +10log ($N_{RB,c}$ /50) | -57.11 +10log ($N_{RB,c}$ /50) | -54.15 +10log ($N_{RB,c}$ /50) |
| Propagation Condition | | AWGN | | | | AWGN | | | | AWGN | | | | AWGN | | | |
| Antenna Configuration | | 1x2 | | | | 1x2 | | | | 1x2 | | | | 1x2 | | | |
| Timing offset to Cell 1 | μ s | - | | | | 0 | | | | 0 | | | | 0 | | | |
| Time alignment error relative to cell 1 <small>Note 5</small> | μ s | - | | | | \leq TAE | | | | \leq TAE | | | | \leq TAE | | | |
| Time alignment error relative to cell 2 <small>Note 5</small> | μ s | - | | | | - | | | | \leq TAE | | | | \leq TAE | | | |
| Time alignment error relative to cell 3 <small>Note 5</small> | μ s | - | | | | - | | | | - | | | | \leq TAE | | | |
| <p>Note 1: OCNG shall be used such that all cells are fully allocated and a constant total transmitted power spectral density is achieved for all OFDM symbols.</p> <p>Note 2: The resources for uplink transmission are assigned to the UE on cell1 from the start of time period T2 and on cell2 from the start of time period T4.</p> <p>Note 3: Interference from other cells and noise sources not specified in the test is assumed to be constant over subcarriers and time and shall be modelled as AWGN of appropriate power for N_{oc} to be fulfilled.</p> <p>Note 4: E_s/I_{ot}, RSRP, SCH_RP and I_o levels have been derived from other parameters for information purposes. They are not settable parameters themselves.</p> <p>Note 5: Time alignment error (TAE) as specified in TS 36.104 [30] clause 6.5.3.1. The TAE value depends upon the type of carrier aggregation.</p> | | | | | | | | | | | | | | | | | |

Table A.8.16.55.1-3: Cell specific test parameters for E-UTRAN FDD 4 DL CA Event Triggered Reporting on Deactivated SCell with PCell and SCell interruptions in Non-DRX (Cell #5)

| Parameter | Unit | Cell 5 | | | |
|---|--|--|--|--|--|
| | | T1 | T2 | T3 | T4 |
| E-UTRA RF Channel Number | | 4 | | | |
| $BW_{channel}$ | | 5MHz: $N_{RB,c} = 25$ 10MHz: $N_{RB,c} = 50$ 20MHz: $N_{RB,c} = 100$ | | | |
| PDSCH parameters: DL Reference Measurement Channel | | N/A | | | |
| PCFICH/PDCCH/PHICH parameters | | 5MHz: R.11 FDD 10MHz: R.6 FDD 20MHz: R.10 FDD | | | |
| OCNG Pattern defined in A.3.2.1 | | 5MHz: OP.16 FDD 10MHz: OP.2 FDD 20MHz: OP.12 FDD | | | |
| PBCH_RA | dB | 0 | | | |
| PBCH_RB | dB | | | | |
| PSS_RA | dB | | | | |
| SSS_RA | dB | | | | |
| PCFICH_RB | dB | | | | |
| PHICH_RA | dB | | | | |
| PHICH_RB | dB | | | | |
| PDCCH_RA | dB | | | | |
| PDCCH_RB | dB | | | | |
| PDSCH_RA | dB | | | | |
| PDSCH_RB | dB | | | | |
| OCNG_RA ^{Note 1} | dB | | | | |
| OCNG_RB ^{Note 1} | dB | | | | |
| N_{oc} ^{Note 3} | dBm/15 kHz | | | | |
| \hat{E}_s / N_{oc} | dB | -infinity | 16 | -infinity | 16 |
| \hat{E}_s / I_{ot} ^{Note 4} | dB | -infinity | -0.11 | -infinity | -0.11 |
| RSRP ^{Note 4} | dBm/15 kHz | -infinity | -85 | -infinity | -85 |
| SCH_RP ^{Note 4} | dBm/15 kHz | -infinity | -85 | -infinity | -85 |
| I_o ^{Note 4} | dBm/Ch BW | -57.11 +10log ($N_{RB,c}$ /50) | -54.15 +10log ($N_{RB,c}$ /50) | -57.11 +10log ($N_{RB,c}$ /50) | -54.15 +10log ($N_{RB,c}$ /50) |
| Propagation Condition | | AWGN | | | |
| Antenna Configuration | | 1x2 | | | |
| Timing offset to Cell 1 | μ s | 3 | | | |
| Time alignment error relative to cell 1 ^{Note 5} | μ s | N/A | | | |
| Time alignment error relative to cell 2 ^{Note 5} | μ s | N/A | | | |
| Time alignment error relative to cell 3 ^{Note 5} | μ s | N/A | | | |
| Note 1: | OCNG shall be used such that all cells are fully allocated and a constant total transmitted power spectral density is achieved for all OFDM symbols. | | | | |
| Note 2: | Void | | | | |
| Note 3: | Interference from other cells and noise sources not specified in the test is assumed to be constant over subcarriers and time and shall be modelled as AWGN of appropriate power for N_{oc} to be fulfilled. | | | | |
| Note 4: | E_s/I_{ot} , RSRP, SCH_RP and I_o levels have been derived from other parameters for information purposes. They are not settable parameters themselves. | | | | |
| Note 5: | Time alignment error (TAE) as specified in TS 36.104 [30] clause 6.5.3.1. The TAE value depends upon the type of carrier aggregation. | | | | |

A.8.16.55.2 Test Requirements

The UE shall send one Event A6 triggered measurement report, with a measurement reporting delay less than 12.8s ($20 \times \text{scellMeasCycle}$) from the beginning of time period T2.

The UE shall send one Event A6 triggered measurement report, with a measurement reporting delay less than 3.2s ($5 \times \text{scellMeasCycle}$) from the beginning of time period T4.

The UE shall not send event triggered measurement reports, as long as the reporting criteria are not fulfilled.

The UE shall be scheduled on PCell continuously throughout the test. From the start of T1 until the measurement report is received during T2, at least 99.5% of all expected ACK/NACKs shall be transmitted by the UE.

The UE shall be scheduled on Cell2 continuously from the beginning of T4 to the end. From the start of T4 until the measurement report is received during T4, at least 99.5% of all expected ACK/NACKs shall be transmitted by the UE.

For a test to be considered successful requirements on both event detection and percentage of transmitted ACK/NACKs have to be fulfilled simultaneously.

The rate of correct events observed during repeated tests shall be at least 90%.

NOTE: The actual overall delays measured in the test may be up to $2 \times \text{TTI}_{\text{DCCH}}$ higher than the measurement reporting delays above because of TTI insertion uncertainty of the measurement report in DCCH.

A.8.16.56 E-UTRAN TDD 4 DL CA Event Triggered Reporting on Deactivated SCell with PCell and SCell Interruptions in Non-DRX

A.8.16.56.1 Test Purpose and Environment

The purpose of this test is to verify that the UE correctly detects event A6 (Neighbour becomes better than SCell) defined in TS 36.331 [2] within the requirements stated in clause 8.3.3.2.1 while at the same time fulfilling the requirement on interruption rate.

The test parameters are given in Table A.8.16.56.1-1, A.8.16.56.1-2 and A.8.16.56.1-3 below. In the test there are five cells: Cell 1, Cell 2, Cell 3, Cell 4 and Cell 5. Cell 1 is PCell on the TDD primary component (RF Channel 1), Cell 2 is SCell on the TDD secondary component (RF Channel 2), Cell 3 is SCell on the TDD secondary component (RF Channel 3), Cell 4 is SCell on the TDD secondary component (RF Channel 4) and Cell 5 is the neighbour cell on the TDD secondary component (RF Channel 4). It is indicated to the UE in the measurement control information that event-triggered reporting with Event A6 is used. The test consists of four successive time periods, with duration of T1, T2, T3 and T4, respectively. During T1 and T2, Cell2, Cell3 and Cell4 are deactivated. During T1 the UE shall not have any information of Cell 5. Immediately at beginning of T2 the transmission power of Cell 5 is increased to same level as for Cell 3, and due to usage of an offset this shall result in reporting of Event A6.

At the beginning of T3, the transmission power of Cell 5 is turned off, and the test equipment sends a MAC message for activation of Cell 2 to UE but Cell3 and Cell4 remains deactivated. Immediately at beginning of T4 the transmission power of Cell 5 is increased to same level as for Cell 3, and due to usage of an offset this shall result in reporting of Event A6. The UE shall be continuously scheduled in the PCell throughout the whole test and continuously scheduled in Cell2 during T4.

Table A.8.16.56.1-1: General test parameters for E-UTRAN TDD 4 DL CA Event Triggered Reporting on Deactivated SCell with PCell and SCell interruptions in Non-DRX

| Parameter | Unit | Value | Comment |
|------------------------------|------|------------|---|
| E-UTRA RF Channel Number | | 1, 2, 3, 4 | Four radio channels are used for this test |
| Active PCell | | Cell 1 | Primary cell on RF channel number 1. |
| Configured deactivated SCell | | Cell 2 | Configured deactivated secondary cell on RF channel number 2. |
| Configured deactivated SCell | | Cell 3 | Configured deactivated secondary cell on RF channel number 3. |

| | | | | |
|---|-----------------|--------|---|---|
| Configured deactivated SCell | | Cell 4 | Configured deactivated secondary cell on RF channel number 4. | |
| Neighbour cell | | Cell 5 | Neighbor cell to be identified on RF channel number 4. | |
| CP length | | Normal | | |
| Special subframe configuration | | 6 | As specified in table 4.2-1 in TS 36.211. The same configuration in all cells | |
| Uplink-downlink configuration | | 1 | As specified in table 4.2-2 in TS 36.211. The same configuration in all cells | |
| DRX | | OFF | Continuous monitoring of primary cell | |
| A6 | Hysteresis | dB | 0 | Hysteresis for evaluation of event A6. |
| | Offset | dB | -3 | Offset parameter for evaluation of event A6. Needs to take relative accuracy tolerance in clause 9.1.11.2 into account plus margin. |
| | Report on leave | | False | |
| | Time To Trigger | s | 0 | |
| Cell-individual offset for cells on RF channel number 1 | dB | 0 | Individual offset for cells on primary component carrier. | |
| Cell-individual offset for cells on RF channel number 2 | dB | 0 | Individual offset for cells on secondary component carrier. | |
| Cell-individual offset for cells on RF channel number 3 | dB | 0 | Individual offset for cells on secondary component carrier. | |
| Cell-individual offset for cells on RF channel number 3 | dB | 0 | Individual offset for cells on secondary component carrier. | |
| Filter coefficient | | 0 | L3 filtering is not used | |
| SCell measurement cycle | ms | 640 | | |
| T1 | s | 4 | During this time the UE shall be aware of cells 1, 2, 3 and 4 but not cell 5. | |
| T2 | s | ≤15 | UE should report Event A6 within 12.8s (20×scellMeasCycle) | |
| T3 | s | 4 | During this time the UE shall activate cell 2 | |
| T4 | s | ≤4 | UE should report Event A6 within 3.2s (5×scellMeasCycle) | |

Table A.8.16.56.1-2: Cell specific test parameters for E-UTRAN TDD 4 DL CA Event Triggered Reporting on Deactivated SCell with PCell and SCell interruptions in Non-DRX (Cell #1, Cell #2, Cell #3, Cell #4)

| Parameter | Unit | Cell 1 | | | | Cell 2 | | | | Cell 3 | | | | Cell 4 | | | |
|--|------|---|----|----|----|---|---|---|--|---|----|----|----|---|----|----|----|
| | | T1 | T2 | T3 | T4 | T1 | T2 | T3 | T4 | T1 | T2 | T3 | T4 | T1 | T2 | T3 | T4 |
| E-UTRA RF Channel Number | | 1 | | | | 2 | | | | 3 | | | | 4 | | | |
| BW _{channel} | | 5MHz: N _{RB,c} = 25 10MHz: N _{RB,c} = 50 20MHz: N _{RB,c} = 100 | | | | 5MHz: N _{RB,c} = 25 10MHz: N _{RB,c} = 50 20MHz: N _{RB,c} = 100 | | | | 5MHz: N _{RB,c} = 25 10MHz: N _{RB,c} = 50 20MHz: N _{RB,c} = 100 | | | | 5MHz: N _{RB,c} = 25 10MHz: N _{RB,c} = 50 20MHz: N _{RB,c} = 100 | | | |
| PDSCH parameters: DL Reference Measurement Channel | | 5MHz: R.4 TDD 10MHz: R.0 TDD 20MHz: R.3 TDD | | | | N/A | N/A | N/A | 5MHz: R.4 TDD 10MHz: R.0 TDD 20MHz: R.3 TDD | N/A | | | | N/A | | | |
| PCFICH/PDCCH/PHICH parameters | | 5MHz: R.11 TDD 10MHz: R.6 TDD 20MHz: R.10 TDD | | | | 5MHz: R.11 TDD 10MHz: R.6 TDD 20MHz: R.10 TDD | | | | 5MHz: R.11 TDD 10MHz: R.6 TDD 20MHz: R.10 TDD | | | | 5MHz: R.11 TDD 10MHz: R.6 TDD 20MHz: R.10 TDD | | | |
| OCNG Pattern defined in A.3.2.1 | | 5MHz: OP.9 TDD 10MHz: OP.1 TDD 20MHz: OP.7 TDD | | | | 5MHz: OP.10 TDD 10MHz: OP.2 TDD 20MHz: OP.8 TDD | 5MHz: OP.10 TDD 10MHz: OP.2 TDD 20MHz: OP.8 TDD | 5MHz: OP.10 TDD 10MHz: OP.2 TDD 20MHz: OP.8 TDD | 5MHz: OP.9 TDD 10MHz: OP.1 TDD 20MHz: OP.7 FDD | 5MHz: OP.10 TDD 10MHz: OP.2 TDD 20MHz: OP.8 TDD | | | | 5MHz: OP.10 TDD 10MHz: OP.2 TDD 20MHz: OP.8 TDD | | | |
| PBCH_RA | dB | 0 | | | | 0 | | | | 0 | | | | 0 | | | |
| PBCH_RB | dB | | | | | | | | | | | | | | | | |
| PSS_RA | dB | | | | | | | | | | | | | | | | |
| SSS_RA | dB | | | | | | | | | | | | | | | | |
| PCFICH_RB | dB | | | | | | | | | | | | | | | | |
| PHICH_RA | dB | | | | | | | | | | | | | | | | |
| PHICH_RB | dB | | | | | | | | | | | | | | | | |
| PDCCH_RA | dB | | | | | | | | | | | | | | | | |
| PDCCH_RB | dB | | | | | | | | | | | | | | | | |
| PDSCH_RA | dB | | | | | | | | | | | | | | | | |
| PDSCH_RB | dB | | | | | | | | | | | | | | | | |
| OCNG_RA ^{Note 1} | dB | | | | | | | | | | | | | | | | |
| OCNG_RB ^{Note 1} | dB | | | | | | | | | | | | | | | | |

| | | | | | | | | | | | | | | | | | |
|--|------------|--|--|--|--|--|--|--|--|--|--|--|--|--|--|--|--|
| N_{oc} <small>Note 3</small> | dBm/15 kHz | -101 | | | | -101 | | | | -101 | | | | -101 | | | |
| \hat{E}_s/N_{oc} | dB | 16 | 16 | 16 | 16 | 16 | 16 | 16 | 16 | 16 | 16 | 16 | 16 | 16 | 16 | 16 | 16 |
| \hat{E}_s/I_{ot} <small>Note 4</small> | dB | 16 | 16 | 16 | 16 | 16 | 16 | 16 | 16 | 16 | -0.11 | 16 | -0.11 | 16 | -0.11 | 16 | -0.11 |
| RSRP <small>Note 4</small> | dBm/15 kHz | -85 | -85 | -85 | -85 | -85 | -85 | -85 | -85 | -85 | -85 | -85 | -85 | 85 | -85 | 85 | -85 |
| SCH_RP <small>Note 4</small> | dBm/15 kHz | -85 | -85 | -85 | -85 | -85 | -85 | -85 | -85 | -85 | -85 | -85 | -85 | 85 | -85 | 85 | -85 |
| I_o <small>Note 4</small> | dBm/Ch BW | -57.11 +10log ($N_{RB,c}$ /50) | -57.11 +10log ($N_{RB,c}$ /50) | -57.11 +10log ($N_{RB,c}$ /50) | -57.11 +10log ($N_{RB,c}$ /50) | -57.11 +10log ($N_{RB,c}$ /50) | -57.11 +10log ($N_{RB,c}$ /50) | -57.11 +10log ($N_{RB,c}$ /50) | -57.11 +10log ($N_{RB,c}$ /50) | -57.11 +10log ($N_{RB,c}$ /50) | -54.15 +10log ($N_{RB,c}$ /50) | -57.11 +10log ($N_{RB,c}$ /50) | -54.15 +10log ($N_{RB,c}$ /50) | -57.11 +10log ($N_{RB,c}$ /50) | -54.15 +10log ($N_{RB,c}$ /50) | -57.11 +10log ($N_{RB,c}$ /50) | -54.15 +10log ($N_{RB,c}$ /50) |
| Propagation Condition | | AWGN | | | | AWGN | | | | AWGN | | | | AWGN | | | |
| Antenna Configuration | | 1x2 | | | | 1x2 | | | | 1x2 | | | | 1x2 | | | |
| Timing offset to Cell 1 | μ s | - | | | | 0 | | | | 0 | | | | 0 | | | |
| Time alignment error relative to cell 1 <small>Note 5</small> | μ s | - | | | | \leq TAE | | | | \leq TAE | | | | \leq TAE | | | |
| Time alignment error relative to cell 2 <small>Note 5</small> | μ s | - | | | | - | | | | \leq TAE | | | | \leq TAE | | | |
| Time alignment error relative to cell 3 <small>Note 5</small> | μ s | - | | | | - | | | | - | | | | \leq TAE | | | |
| <p>Note 1: OCNG shall be used such that all cells are fully allocated and a constant total transmitted power spectral density is achieved for all OFDM symbols.</p> <p>Note 2: The resources for uplink transmission are assigned to the UE on cell1 from the start of time period T2 and on cell2 from the start of time period T4.</p> <p>Note 3: Interference from other cells and noise sources not specified in the test is assumed to be constant over subcarriers and time and shall be modelled as AWGN of appropriate power for N_{oc} to be fulfilled.</p> <p>Note 4: E_s/I_{ot}, RSRP, SCH_RP and I_o levels have been derived from other parameters for information purposes. They are not settable parameters themselves.</p> <p>Note 5: Time alignment error (TAE) as specified in TS 36.104 [30] clause 6.5.3.1. The TAE value depends upon the type of carrier aggregation.</p> | | | | | | | | | | | | | | | | | |

Table A.8.16.56.1-3: Cell specific test parameters for E-UTRAN TDD 4 DL CA Event Triggered Reporting on Deactivated SCell with PCell and SCell interruptions in Non-DRX (Cell #5)

| Parameter | Unit | Cell 5 | | | |
|--|--|--|--|--|--|
| | | T1 | T2 | T3 | T4 |
| E-UTRA RF Channel Number | | 4 | | | |
| $BW_{channel}$ | | 5MHz: $N_{RB,c} = 25$ 10MHz: $N_{RB,c} = 50$ 20MHz: $N_{RB,c} = 100$ | | | |
| PDSCH parameters: DL Reference Measurement Channel | | N/A | | | |
| PCFICH/PDCCH/PHICH parameters | | 5MHz: R.11 TDD 10MHz: R.6 TDD 20MHz: R.10 TDD | | | |
| OCNG Pattern defined in A.3.2.1 | | 5MHz: OP.10 TDD 10MHz: OP.2 TDD 20MHz: OP.8 TDD | | | |
| PBCH_RA | dB | 0 | | | |
| PBCH_RB | dB | | | | |
| PSS_RA | dB | | | | |
| SSS_RA | dB | | | | |
| PCFICH_RB | dB | | | | |
| PHICH_RA | dB | | | | |
| PHICH_RB | dB | | | | |
| PDCCH_RA | dB | | | | |
| PDCCH_RB | dB | | | | |
| PDSCH_RA | dB | | | | |
| PDSCH_RB | dB | | | | |
| OCNG_RA ^{Note 1} | dB | | | | |
| OCNG_RB ^{Note 1} | dB | | | | |
| N_{oc} ^{Note 3} | dBm/15 kHz | | | | |
| \hat{E}_s / N_{oc} | dB | -infinity | 16 | -infinity | 16 |
| \hat{E}_s / I_{ot} ^{Note 4} | dB | -infinity | -0.11 | -infinity | -0.11 |
| RSRP ^{Note 4} | dBm/15 kHz | -infinity | -85 | -infinity | -85 |
| SCH_RP ^{Note 4} | dBm/15 kHz | -infinity | -85 | -infinity | -85 |
| I_o ^{Note 4} | dBm/Ch BW | -57.11 +10log ($N_{RB,c}$ /50) | -54.15 +10log ($N_{RB,c}$ /50) | -57.11 +10log ($N_{RB,c}$ /50) | -54.15 +10log ($N_{RB,c}$ /50) |
| Propagation Condition | | AWGN | | | |
| Antenna Configuration | | 1x2 | | | |
| Timing offset to Cell 1 | μ s | 3 | | | |
| Time alignment error relative to cell 1 ^{Note 5} | μ s | N/A | | | |
| Time alignment error relative to cell 2 ^{Note 5} | μ s | N/A | | | |
| Time alignment error relative to cell 3 ^{Note 5} | μ s | N/A | | | |
| Note 1: | OCNG shall be used such that all cells are fully allocated and a constant total transmitted power spectral density is achieved for all OFDM symbols. | | | | |
| Note 2: | Void | | | | |
| Note 3: | Interference from other cells and noise sources not specified in the test is assumed to be constant over subcarriers and time and shall be modelled as AWGN of appropriate power for N_{oc} to be fulfilled. | | | | |
| Note 4: | E_s/I_{ot} , RSRP, SCH_RP and I_o levels have been derived from other parameters for information purposes. They are not settable parameters themselves. | | | | |
| Note 5: | Time alignment error (TAE) as specified in TS 36.104 [30] clause 6.5.3.1. The TAE value depends upon the type of carrier aggregation. | | | | |

A.8.16.56.2 Test Requirements

The UE shall send one Event A6 triggered measurement report, with a measurement reporting delay less than 12.8s ($20 \times \text{scellMeasCycle}$) from the beginning of time period T2.

The UE shall send one Event A6 triggered measurement report, with a measurement reporting delay less than 3.2s ($5 \times \text{scellMeasCycle}$) from the beginning of time period T4.

The UE shall not send event triggered measurement reports, as long as the reporting criteria are not fulfilled.

The UE shall be scheduled on PCell continuously throughout the test. From the start of T1 until the measurement report is received during T2, at least 99.5% of all expected ACK/NACKs shall be transmitted by the UE.

The UE shall be scheduled on Cell2 continuously from the beginning of T4 to the end. From the start of T4 until the measurement report is received during T4, at least 99.5% of all expected ACK/NACKs shall be transmitted by the UE.

For a test to be considered successful requirements on both event detection and percentage of transmitted ACK/NACKs have to be fulfilled simultaneously.

The rate of correct events observed during repeated tests shall be at least 90%.

NOTE: The actual overall delays measured in the test may be up to $2 \times \text{TTI}_{\text{DCCH}}$ higher than the measurement reporting delays above because of TTI insertion uncertainty of the measurement report in DCCH.

A.8.16.57 E-UTRAN FDD 4DL CA activation and deactivation of know SCell in non-DRX

A.8.16.57.1 Test Purpose and Environment

The purpose of this test is to verify that the SCell activation and deactivation times are within the requirements stated in section 7.7 for UE configured with three downlink SCells, when the SCell is known by the UE at the time of activation and PCell is in FDD.

The test parameters are given in Tables A.8.16.57.1-1 and cell-specific parameters in A.8.16.57.1-2 below. The test consists of three successive time periods, with duration of T1, T2 and T3, respectively. There are four carriers, each with one cell. All cells have constant signal levels throughout the test. Before the test starts the UE is connected to Cell1 (PCell) on radio channel 1 (PCC), Cell 3 (deactivated SCell2) on radio channel 3 (SCC2) and Cell4 (deactivated SCell3) on radio channel 4 (SCC3), but is not aware of Cell2 (SCell1) on radio channel 2 (SCC1). The UE is only monitoring the PCC, SCC2 and SCC3. The UE shall be continuously scheduled in the PCell throughout the whole test.

At the beginning of T1 the UE receives an RRC message by which the SCell1 (Cell2) becomes configured on radio channel 2 (SCC1). The UE now starts monitoring also the SCC1. The test equipment sends a MAC message for activation of the SCell1.

The point in time at which the MAC message is received at the UE antenna connector, in a subframe #denoted m which is an even number, defines the start of time period T2. At the beginning of T2 the test equipment sends a MAC message for activation of the SCell1. The UE receives the SCell2 activation command in a subframe ($m+10$) and receives the SCell3 activation command in a subframe ($m+20$) during activation of the SCell1. The UE shall be able to report valid CSIs for the activated SCell at latest in a subframe ($m+34$). The UE shall start reporting CSI for SCell1 in subframe in ($m+8$) and shall report CQI index 0 (out-of-range) until the subframe activation has been completed. Any PCell interruption due to activation of SCells shall occur in the subframe ($m+5$) to ($m+9$), ($m+15$) to ($m+19$) and ($m+25$) to ($m+29$).

Time period T3 starts when a MAC message for deactivation of SCell1, send from the test equipment to the UE in a subframe #denoted n , is received at the UE antenna connector. The test equipment sends a MAC message for deactivation of the SCell2 in subframe ($n+10$) and send a MAC message for deactivation of the SCell3 in subframe ($n+20$). The UE shall carry out deactivation of the SCell1 at latest in subframe ($n+8$), and any interruption due to the deactivation of SCells shall occur in the subframe ($n+5$) to ($n+9$), ($n+15$) to ($n+19$) and ($n+25$) to ($n+29$).

The test equipment verifies that potential interruption is carried out in the correct time span by monitoring ACK/NACK sent in PCell during activation and deactivation of SCell1, respectively.

The test equipment verifies the activation time by counting the subframes from the time when the SCell1 activation command is sent until a CSI report with other than CQI index 0 is received.

The test equipment verifies the deactivation time by counting the subframes from the time when the SCell1 deactivation command is sent until CQI reporting for SCell1 is discontinued.

Table A.8.16.57.1-1: General test parameters for known SCell1 activation case

| Parameter | Unit | Value | Comment |
|---|------|-----------|--|
| E-UTRA RF Channel Number | | 1, 2, 3,4 | Four radio channels are used for this test |
| Active PCell | | Cell 1 | Primary cell on RF channel number 1. |
| Deconfigured deactivated SCell1 | | Cell 2 | Deconfigured deactivated secondary cell on RF channel number 2. |
| Configured deactivated SCell2 | | Cell 3 | Configured deactivated secondary cell on RF channel number 3. |
| Configured deactivated SCell3 | | Cell 4 | Configured deactivated secondary cell on RF channel number 4. |
| CP length | | Normal | |
| DRX | | OFF | Continuous monitoring of primary cell |
| CQI/PMI periodicity and offset configuration index | | 0 | CQI reporting for SCell every second subframe |
| Cell-individual offset for cells on RF channel number 1 | dB | 0 | Individual offset for cells on PCC. |
| Cell-individual offset for cells on RF channel number 2 | dB | 0 | Individual offset for cells on SCC1. |
| Cell-individual offset for cells on RF channel number 3 | dB | 0 | Individual offset for cells on SCC2. |
| Cell-individual offset for cells on RF channel number 4 | dB | 0 | Individual offset for cells on SCC3. |
| Filter coefficient | | 0 | L3 filtering is not used |
| SCell measurement cycle (measCycleSCell) | ms | 320 | |
| T1 | s | 7 | During this time the PCell, SCell2 and SCell3 shall be known and the SCell1 configured and detected. |
| T2 | s | 1 | During this time the UE shall activate the SCell1. |
| T3 | s | 1 | During this time the UE shall deactivate the SCell1. |

Table A.8.16.57.1-2: Cell specific test parameters for E-UTRAN FDD 4 DL CA activation and deactivation of known SCell in non-DRX

| Parameter | Unit | Cell 1 | | | Cell 2 | | | Cell 3 | | | Cell 4 | | |
|--|------|---|----|----|---|----|----|---|----|----|---|----|----|
| | | T1 | T2 | T3 | T1 | T2 | T3 | T1 | T2 | T3 | T1 | T2 | T3 |
| E-UTRA RF Channel Number | | 1 | | | 2 | | | 3 | | | 4 | | |
| BW _{channel} | MHz | 5MHz: N _{RB,c} = 25 10MHz: N _{RB,c} = 50 20MHz: N _{RB,c} = 100 | | | 5MHz: N _{RB,c} = 25 10MHz: N _{RB,c} = 50 20MHz: N _{RB,c} = 100 | | | 5MHz: N _{RB,c} = 25 10MHz: N _{RB,c} = 50 20MHz: N _{RB,c} = 100 | | | 5MHz: N _{RB,c} = 25 10MHz: N _{RB,c} = 50 20MHz: N _{RB,c} = 100 | | |
| PDSCH parameters: DL Reference Measurement Channel | | 5MHz: R.7 FDD 10MHz: R.3 FDD 20MHz: R.6 FDD | | | - | | | - | | | - | | |
| PCFICH/PDCCH/PHICH parameters: DL Reference Measurement Channel | | 5MHz: R.11 FDD 10MHz: R.6 FDD 20MHz: R.10 FDD | | | 5MHz: R.11 FDD 10MHz: R.6 FDD 20MHz: R.10 FDD | | | 5MHz: R.11 FDD 10MHz: R.6 FDD 20MHz: R.10 FDD | | | 5MHz: R.11 FDD 10MHz: R.6 FDD 20MHz: R.10 FDD | | |
| OCNG Patterns | | 5MHz: OP.20 FDD 10MHz: OP.10 FDD 20MHz: OP.17 FDD | | | 5MHz: OP.16 FDD 10MHz: OP.2 FDD 20MHz: OP.12 FDD | | | 5MHz: OP.16 FDD 10MHz: OP.2 FDD 20MHz: OP.12 FDD | | | 5MHz: OP.16 FDD 10MHz: OP.2 FDD 20MHz: OP.12 FDD | | |
| PBCH_RA | dB | 0 | | | 0 | | | 0 | | | 0 | | |
| PBCH_RB | dB | | | | | | | | | | | | |
| PSS_RA | dB | | | | | | | | | | | | |
| SSS_RA | dB | | | | | | | | | | | | |
| PCFICH_RB | dB | | | | | | | | | | | | |
| PHICH_RA | dB | | | | | | | | | | | | |
| PHICH_RB | dB | | | | | | | | | | | | |
| PDCCH_RA | dB | | | | | | | | | | | | |
| PDCCH_RB | dB | | | | | | | | | | | | |
| PDSCH_RA | dB | | | | | | | | | | | | |
| PDSCH_RB | dB | | | | | | | | | | | | |
| OCNG_RA ^{Note 1} | dB | | | | | | | | | | | | |
| OCNG_RB ^{Note 1} | dB | | | | | | | | | | | | |

| | | | | | |
|--|------------|---------------------------------------|---------------------------------------|---------------------------------------|---------------------------------------|
| N_{oc} ^{Note 2} | dBm/15 kHz | -104 | -104 | -104 | -104 |
| \hat{E}_s/N_{oc} | dB | 17 | 17 | 17 | 17 |
| \hat{E}_s/I_{ot} | dB | 17 | 17 | 17 | 17 |
| RSRP ^{Note 3} | dBm/15 kHz | -87 | -87 | -87 | -87 |
| SCH_RP ^{Note 3} | dBm/15 kHz | -87 | -87 | -87 | -87 |
| I_o ^{Note 3} | dBm/Ch BW | -59.13 +10log ($N_{RB,c}/50$) | -59.13 +10log ($N_{RB,c}/50$) | -59.13 +10log ($N_{RB,c}/50$) | -59.13 +10log ($N_{RB,c}/50$) |
| Propagation Condition | | AWGN | AWGN | AWGN | AWGN |
| Antenna Configuration | | 1x2 | 1x2 | 1x2 | 1x2 |
| Timing offset to Cell 1 | μ s | - | 0 | 0 | 0 |
| Time alignment error relative to cell 1 ^{Note 5} | μ s | - | \leq TAE | \leq TAE | \leq TAE |
| Time alignment error relative to cell 2 ^{Note 5} | μ s | - | - | \leq TAE | \leq TAE |
| Time alignment error relative to cell 3 ^{Note 5} | μ s | - | - | - | \leq TAE |
| <p>Note 1: OCNG shall be used such that all cells are fully allocated and a constant total transmitted power spectral density is achieved for all OFDM symbols.</p> <p>Note 2: Interference from other cells and noise sources not specified in the test is assumed to be constant over subcarriers and time and shall be modelled as AWGN of appropriate power for N_{oc} to be fulfilled.</p> <p>Note 3: \hat{E}_s/I_{ot}, RSRP, SCH_RP and I_o levels have been derived from other parameters for information purposes. They are not settable parameters themselves.</p> <p>Note 4: The uplink resources for CSI reporting are assigned to the UE prior to the start of time period T2.</p> <p>Note 5: Time alignment error (TAE) as specified in TS 36.104 [30] clause 6.5.3.1. The TAE value depends upon the type of carrier aggregation.</p> | | | | | |

A.8.16.57.2 Test Requirements

During T2, the UE shall send the first CSI report for SCell1 in a subframe (m+8), or in a subframe (m+10) if the subframe (m+8) was subject to interruption. Whether CSI report in subframe (m+8) was interrupted or not is checked by monitoring ACK/NACK sent in PCell in subframe (m+8).

During T2 the UE shall start sending CSI reports for SCell1 with non-zero CQI index at latest in a subframe (m+34).

During T3 the UE shall stop sending CSI reports for SCell1 at latest in a subframe (n+8).

During T2 interruption of PCell during SCells activation shall not happen outside the subframes (m+5) to (m+9), outside the subframes (m+15) to (m+19) and outside the subframes (m+25) to (m+29).

During T3 interruption of PCell during SCells deactivation shall not happen outside the subframes (n+5) to (n+9), outside the subframes (n+15) to (n+19) and outside the subframes (n+25) to (n+29).

The interruption of PCell shall not be more than the values specified for intra-band CA and inter-band CA in Section 7.8.2.

All of the above test requirements shall be fulfilled in order for the observed SCell1 activation delay and SCell1 deactivation delay to be counted as correct. The rate of correct observed SCell1 activation delay and SCell1 deactivation delay during repeated tests shall be at least 90%.

NOTE: During T2 if there are no uplink resources for reporting the valid CSI in a subframe (m+34) then the UE shall use the next available uplink resource for reporting the corresponding valid CSI.

A.8.16.58 E-UTRAN TDD 4DL CA activation and deactivation of know SCell in non-DRX

A.8.16.58.1 Test Purpose and Environment

The purpose of this test is to verify that SCell activation and deactivation times are within the requirements stated in clause 7.7 for 4DL TDD carrier aggregation, when the SCells are known by the UE at the time of activation.

The test parameters are given in Tables A.8.16.58-1 and cell-specific parameters in A.8.16.58-2 below. The test consists of three successive time periods, with duration of T1, T2 and T3, respectively. There are four carriers, each with one cell. All cells have constant signal levels throughout the test. Before the test starts the UE is connected to Cell 1 (PCell) on radio channel 1 (PCC), Cell 3 (deactivated SCell2) on radio channel 3 (SCC2) and Cell 4 (deactivated SCell3) on radio channel 4 (SCC3), but is not aware of Cell 2 (SCell1) on radio channel 2 (SCC1). The UE is only monitoring the PCC, SCC2 and SCC3. The UE shall be continuously scheduled in the PCell throughout the whole test.

At the beginning of T1 the UE receives an RRC message by which the SCell1 (Cell 2) becomes configured on radio channel 2 (SCC1). The UE now starts monitoring also the SCC1. The test equipment sends a MAC message for activation of the SCell1.

The point in time at which the MAC message is received at the UE antenna connector, in a subframe # denoted m , where m is 4 or 9, defines the start of time period T2. At the beginning of T2 the test equipment sends a MAC message for activation of the SCell1. The UE receives the SCell2 and SCell3 activation command in a subframe ($m+15$) during activation of the SCell1. The UE shall be able to report valid CSIs for the activated SCell1 at latest in a subframe ($m+34$). The UE shall start reporting CSI for SCell1 in subframe ($m+8$) and shall report CQI index 0 (out-of-range) until the SCell activation has been completed. Any PCell interruption due to activation of SCells shall occur in the subframes ($m+5$) to ($m+11$) and ($m+20$) to ($m+26$).

Time period T3 starts when a MAC message for deactivation of SCell1, sent from the test equipment to the UE, in a subframe # denoted n , where n is 4 or 9, is received at the UE antenna connector. The test equipment sends a MAC message for deactivation of the SCell2 in subframe ($n+15$) and for deactivation of the SCell3 in subframe ($n+30$). The UE shall carry out deactivation of the SCell1 at latest in subframe ($n+8$), and any PCell interruption due to the deactivation of SCells shall occur in the subframes ($n+5$) to ($n+11$), ($n+20$) to ($n+26$) and ($n+35$) to ($n+41$).

The test equipment verifies that potential interruption is carried out in the correct time span by monitoring ACK/NACK sent in PCell during activation and deactivation of SCells, respectively.

The test equipment verifies the activation time by counting the subframes from the time when the SCell1 activation command is sent until a CSI report with other than CQI index 0 is received.

The test equipment verifies the deactivation time by counting the subframes from the time when the SCell1 deactivation command is sent until CQI reporting for SCell1 is discontinued.

Table A.8.16.58-1: General test parameters for E-UTRAN TDD 4 DL CA activation and deactivation of known SCell in non-DRX

| Parameter | Unit | Value | Comment |
|---|------|-----------|--|
| E-UTRA RF Channel Number | | 1, 2, 3,4 | Four radio channels are used for this test |
| Active PCell | | Cell 1 | Primary cell on RF channel number 1. |
| Deconfigured SCell | | Cell 2 | Deconfigured secondary cell on RF channel number 2. |
| Configured deactivated SCell | | Cell 3 | Configured deactivated secondary cell on RF channel number 3. |
| Configured deactivated SCell | | Cell 4 | Configured deactivated secondary cell on RF channel number 4. |
| CP length | | Normal | |
| Special subframe configuration | | 6 | As specified in table 4.2-1 in TS 36.211. The same configuration applies to all cells. |
| Uplink-downlink configuration | | 1 | As specified in table 4.2-2 in TS 36.211. The same configuration applies to all cells |
| DRX | | OFF | Continuous monitoring of primary cell |
| CQI/PMI periodicity and offset configuration index | | 0 | CQI reporting for SCells every UL subframe |
| Cell-individual offset for cells on RF channel number 1 | dB | 0 | Individual offset for cells on PCC. |
| Cell-individual offset for cells on RF channel number 2 | dB | 0 | Individual offset for cells on SCC1. |
| Cell-individual offset for cells on RF channel number 3 | dB | 0 | Individual offset for cells on SCC2. |
| Cell-individual offset for cells on RF channel number 4 | dB | 0 | Individual offset for cells on SCC3. |
| Filter coefficient | | 0 | L3 filtering is not used |
| SCell measurement cycle (measCycleSCell) | ms | 320 | |
| T1 | s | 7 | During this time the PCell, SCell2 and SCell3 shall be known and the SCell1 configured and detected. |

| | | | |
|----|---|---|--|
| T2 | s | 1 | During this time the UE shall activate the SCell1. |
| T3 | s | 1 | During this time the UE shall deactivate the SCell1. |

Table A.8.16.58-2: Cell specific test parameters for E-UTRAN TDD 4 DL CA activation and deactivation of known SCell in non-DRX

| Parameter | Unit | Cell 1 | | | Cell 2 | | | Cell 3 | | | Cell 4 | | |
|---|------------|---|----|----|---|----|----|---|----|----|---|----|----|
| | | T1 | T2 | T3 | T1 | T2 | T3 | T1 | T2 | T3 | T1 | T2 | T3 |
| E-UTRA RF Channel Number | | 1 | | | 2 | | | 3 | | | 4 | | |
| BW _{channel} | | 5MHz: N _{RB,c} = 25 10MHz: N _{RB,c} = 50 20MHz: N _{RB,c} = 100 | | | 5MHz: N _{RB,c} = 25 10MHz: N _{RB,c} = 50 20MHz: N _{RB,c} = 100 | | | 5MHz: N _{RB,c} = 25 10MHz: N _{RB,c} = 50 20MHz: N _{RB,c} = 100 | | | 5MHz: N _{RB,c} = 25 10MHz: N _{RB,c} = 50 20MHz: N _{RB,c} = 100 | | |
| PDSCH parameters: DL Reference Measurement Channel | | 5MHz: R.4 TDD 10MHz: R.0 TDD 20MHz: R.3 TDD | | | - | | | - | | | - | | |
| PCFICH/PDCCH/PHICH parameters: DL Reference Measurement Channel | | 5MHz: R.11 TDD 10MHz: R.6 TDD 20MHz: R.10 TDD | | | 5MHz: R.11 TDD 10MHz: R.6 TDD 20MHz: R.10 TDD | | | 5MHz: R.11 TDD 10MHz: R.6 TDD 20MHz: R.10 TDD | | | 5MHz: R.11 TDD 10MHz: R.6 TDD 20MHz: R.10 TDD | | |
| OCNG Patterns | | 5MHz: OP.9 TDD 10MHz: OP.1 TDD 20MHz: OP.7 TDD | | | 5MHz: OP.10 TDD 10MHz: OP.2 TDD 20MHz: OP.8 TDD | | | 5MHz: OP.10 TDD 10MHz: OP.2 TDD 20MHz: OP.8 TDD | | | 5MHz: OP.10 TDD 10MHz: OP.2 TDD 20MHz: OP.8 TDD | | |
| PBCH_RA | dB | 0 | | | 0 | | | 0 | | | 0 | | |
| PBCH_RB | dB | | | | | | | | | | | | |
| PSS_RA | dB | | | | | | | | | | | | |
| SSS_RA | dB | | | | | | | | | | | | |
| PCFICH_RB | dB | | | | | | | | | | | | |
| PHICH_RA | dB | | | | | | | | | | | | |
| PHICH_RB | dB | | | | | | | | | | | | |
| PDCCH_RA | dB | | | | | | | | | | | | |
| PDCCH_RB | dB | | | | | | | | | | | | |
| PDSCH_RA | dB | | | | | | | | | | | | |
| PDSCH_RB | dB | | | | | | | | | | | | |
| OCNG_RA ^{Note 1} | dB | | | | | | | | | | | | |
| OCNG_RB ^{Note 1} | dB | | | | | | | | | | | | |
| N _{oc} ^{Note 2} | dBm/15 kHz | | | | | | | | | | | | |
| \bar{E}_s/N_{oc} | dB | 17 | | | 17 | | | 17 | | | 17 | | |
| \bar{E}_s/I_{ot} ^{Note 3} | dB | 17 | | | 17 | | | 17 | | | 17 | | |
| RSRP ^{Note 3} | dBm/15 kHz | -87 | | | -87 | | | -87 | | | -87 | | |
| SCH_RP ^{Note 3} | dBm/15 kHz | -87 | | | -87 | | | -87 | | | -87 | | |
| I _o ^{Note 3} | dBm/C h BW | -59.13+10log (N _{RB,c} /50) | | | -59.13+10log (N _{RB,c} /50) | | | -59.13+10log (N _{RB,c} /50) | | | -59.13+10log (N _{RB,c} /50) | | |
| Propagation Condition | | AWGN | | | AWGN | | | AWGN | | | AWGN | | |
| Antenna Configuration | | 1x2 | | | 1x2 | | | 1x2 | | | 1x2 | | |
| Timing offset to Cell 1 | μs | - | | | 0 | | | 0 | | | 0 | | |
| Time alignment error relative to cell 1 ^{Note 5} | μs | - | | | ≤ TAE | | | ≤ TAE | | | ≤ TAE | | |
| Time alignment error relative to cell 2 ^{Note 5} | μs | - | | | - | | | ≤ TAE | | | ≤ TAE | | |
| Time alignment error relative to cell 3 ^{Note 5} | μs | - | | | - | | | - | | | ≤ TAE | | |

Note 1: OCNG shall be used such that all cells are fully allocated and a constant total transmitted power spectral density is achieved for all OFDM symbols.

Note 2: Interference from other cells and noise sources not specified in the test is assumed to be constant over subcarriers and time and shall be modelled as AWGN of appropriate power for N_{oc} to be fulfilled.

Note 3: E_s/I_{ot}, RSRP, SCH_RP and I_o have been derived from other parameters for information purposes. They are not settable parameters themselves.

Note 4: The uplink resources for CSI reporting are assigned to the UE prior to the start of time period T2.

Note 5: Time alignment error (TAE) as specified in TS 36.104 [30] clause 6.5.3.1. The TAE value depends upon the type of carrier aggregation.

A.8.16.58.2 Test Requirements

During T2 the UE shall send the first CSI report for SCell1 in a subframe (m+8), or in a subframe (m+9) if the subframe (m+8) was subject to interruption, or in a subframe (m+13) if the subframe (m+8) and (m+9) were subject to interruption when an intra-band SCell is activated. Whether CSI report in subframe (m+8) and/or (m+9) was interrupted or not is checked by monitoring ACK/NACK sent in PCell in subframe (m+8) and/or (m+9).

During T2 the UE shall start sending CSI reports for SCell1 with non-zero CQI index at latest in a subframe (m+34).

During T3 the UE shall stop sending CSI reports for SCell1 at latest in subframe (n+8).

During T2 interruption of PCell during SCells activation shall not happen outside the subframes (m+5) to (m+11) and outside the subframes (m+20) to (m+26).

During T3 interruption of PCell during SCells deactivation shall not happen outside the subframes (n+5) to (n+11), outside the subframes (n+20) to (n+26) and outside the subframes (n+35) to (n+41).

The interruption of PCell shall not be more than the values specified for intra-band CA and inter-band CA in Section 7.8.2.

The UE shall not send event triggered measurement reports as long as the reporting criteria are not fulfilled.

All of the above test requirements shall be fulfilled in order for the observed SCell1 activation delay and SCell1 deactivation delay to be counted as correct. The rate of correct observed SCell1 activation delay and SCell1 deactivation delay during repeated tests shall be at least 90%.

NOTE: During T2 if there are no uplink resources for reporting the valid CSI in a subframe (m+34) then the UE shall use the next available uplink resource for reporting the corresponding valid CSI.

A.8.16.59 E-UTRAN PCell in FDD FDD-TDD 4 DL CA activation and deactivation of known SCell in non-DRX

A.8.16.59.1 Test Purpose and Environment

The purpose of this test is to verify that the SCell activation and deactivation times are within the requirements stated in section 7.7 for UE configured with three downlink SCells, when the SCell is known by the UE at the time of activation and PCell is in FDD.

The test parameters are given in Tables A.8.16.59.1-1 and cell-specific parameters in A.8.16.59.1-2 and A.8.16.59.1-3 below. The test consists of three successive time periods, with duration of T1, T2 and T3, respectively. There are four carriers, each with one cell. All cells have constant signal levels throughout the test. Before the test starts the UE is connected to Cell 1 (PCell) on radio channel 1 (PCC), deactivated Cell 3 (SCell2) on radio channel 3 (SCC2) and deactivated Cell 4 (SCell3) on radio channel 4 (SCC3) but is not aware of Cell 2 (SCell1) on radio channel 2 (SCC1). The UE is only monitoring PCC, SCC2 and SCC3. The UE shall be continuously scheduled in PCell throughout the whole test.

At the beginning of T1 the UE receives an RRC message by which the SCell1 becomes configured on SCC1. The UE now starts monitoring also SCC1. The test equipment sends a MAC message for activation of SCell1.

The point in time at which the MAC message is received at the UE antenna connector, in a subframe # denoted m which is an even number, defines the start of time period T2. The UE receives a MAC message for activation of SCell2 in a subframe (m+10) and a MAC message for activation of SCell3 in subframe (m+20) during activation of SCell1. The UE shall be able to report valid CSI for the activated SCell1 at latest in subframe (m+34). The UE shall start reporting CSI for SCell1 in subframe (m+8) and shall report CQI index 0 (out-of-range) until the SCell activation has been completed. Any PCell interruption due to activation of SCells shall not occur outside subframes (m+5) to (m+9), (m+15) to (m+19) and (m+25) to (m+29).

Time period T3 starts when a MAC message for deactivation of SCell1, sent from the test equipment to the UE in a subframe # denoted n, is received at the UE antenna connector. The test equipment sends a MAC message for deactivation of the SCell2 in subframe (n+10) and a MAC message for deactivation of the SCell3 in subframe (n+20). The UE shall carry out deactivation of the SCell1 at latest in subframe (n+8), and any PCell interruption due to the deactivation of SCells shall not occur outside subframes (n+5) to (n+9), (n+15) to (n+19) and (n+25) to (n+29).

The test equipment verifies that potential interruption is carried out in the correct time span by monitoring ACK/NACK sent in PCell during activation and deactivation of SCell1, respectively.

The test equipment verifies the activation time by counting the subframes from the time when SCell1 activation command is sent until a CSI report with other than CQI index 0 is received.

The test equipment verifies the deactivation time by counting the subframes from the time when SCell1 deactivation command is sent until CQI reporting for SCell1 is discontinued.

Table A.8.16.59.1-1: General test parameters for known SCell1 activation case

| Parameter | Unit | Value | Comment |
|---|------|------------|--|
| E-UTRA RF Channel Number | | 1, 2, 3, 4 | Four radio channels are used for this test |
| Active PCell | | Cell 1 | Primary cell on RF channel number 1. |
| Deconfigured deactivated SCell1 | | Cell 2 | Deconfigured deactivated secondary cell on RF channel number 2. |
| Configured deactivated SCell2 | | Cell 3 | Configured deactivated secondary cell on RF channel number 3. |
| Configured deactivated SCell3 | | Cell 4 | Configured deactivated secondary cell on RF channel number 4. |
| CP length | | Normal | |
| DRX | | OFF | Continuous monitoring of primary cell |
| CQI/PMI periodicity and offset configuration index | | 0 | CQI reporting for SCell every second subframe |
| Cell-individual offset for cells on RF channel number 1 | dB | 0 | Individual offset for cells on PCC. |
| Cell-individual offset for cells on RF channel number 2 | dB | 0 | Individual offset for cells on SCC1. |
| Cell-individual offset for cells on RF channel number 3 | dB | 0 | Individual offset for cells on SCC2. |
| Cell-individual offset for cells on RF channel number 4 | dB | 0 | Individual offset for cells on SCC3. |
| SCell measurement cycle (measCycleSCell) | ms | 320 | |
| T1 | s | 7 | During this time the PCell, SCell2 and SCell3 shall be known and the SCell1 configured and detected. |
| T2 | s | 1 | During this time the UE shall activate the SCell1, SCell2, and SCell3. |
| T3 | s | 1 | During this time the UE shall deactivate the SCell1, SCell2, and SCell3. |

Table A.8.16.59.1-2: Cell specific test parameters for E-UTRAN TDD known SCell1 activation with PCell in FDD

| Parameter | Unit | Cell 1 | | | Cell 2 | | | Cell 3 | | |
|---|------|---|----|----|---|----|----|---|----|----|
| | | T1 | T2 | T3 | T1 | T2 | T3 | T1 | T2 | T3 |
| E-UTRA RF Channel Number | | 1 | | | 2 | | | 3 | | |
| BW _{channel} | MHz | 5MHz: N _{RB,c} = 25 10MHz: N _{RB,c} = 50 20MHz: N _{RB,c} = 100 | | | 5MHz: N _{RB,c} = 25 10MHz: N _{RB,c} = 50 20MHz: N _{RB,c} = 100 | | | 5MHz: N _{RB,c} = 25 10MHz: N _{RB,c} = 50 20MHz: N _{RB,c} = 100 | | |
| Special subframe configuration | | - | | | 6 | | | 6 | | |
| Uplink-downlink configuration | | - | | | 1 | | | 1 | | |
| PDSCH parameters: DL Reference Measurement Channel | | 5MHz: R.7 FDD 10MHz: R.3 FDD 20MHz: R.6 FDD | | | - | | | - | | |
| PCFICH/PDCCH/PHICH parameters: DL Reference Measurement Channel | | 5MHz: R.11 FDD 10MHz: R.6 FDD 20MHz: R.10 FDD | | | 5MHz: R.11 TDD 10MHz: R.6 TDD 20MHz: R.10 TDD | | | 5MHz: R.11 TDD 10MHz: R.6 TDD 20MHz: R.10 TDD | | |
| OCNG Patterns | | 5MHz: OP.20 FDD 10MHz: OP.10 FDD 20MHz: OP.17 FDD | | | 5MHz: OP.10 TDD 10MHz: OP.2 TDD 20MHz: OP.8 TDD | | | 5MHz: OP.10 TDD 10MHz: OP.2 TDD 20MHz: OP.8 TDD | | |
| PBCH_RA | dB | 0 | | | 0 | | | 0 | | |
| PBCH_RB | dB | | | | | | | | | |
| PSS_RA | dB | | | | | | | | | |
| SSS_RA | dB | | | | | | | | | |
| PCFICH_RB | dB | | | | | | | | | |
| PHICH_RA | dB | | | | | | | | | |

| | | | | |
|---|------------|--------------------------------------|--------------------------------------|--------------------------------------|
| PHICH_RB | dB | | | |
| PDCCH_RA | dB | | | |
| PDCCH_RB | dB | | | |
| PDSCH_RA | dB | | | |
| PDSCH_RB | dB | | | |
| OCNG_RA ^{Note 1} | dB | | | |
| OCNG_RB ^{Note 1} | dB | | | |
| N _{oc} ^{Note 2} | dBm/15 kHz | -104 | -104 | -104 |
| \bar{E}_s/N_{oc} | dB | 17 | 17 | 17 |
| \bar{E}_s/I_{ot} | dB | 17 | 17 | 17 |
| RSRP ^{Note 3} | dBm/15 kHz | -87 | -87 | -87 |
| SCH_RP ^{Note 3} | dBm/15 kHz | -87 | -87 | -87 |
| I _o ^{Note 3} | dBm/Ch BW | -59.13 +10log(N _{RB,c} /50) | -59.13 +10log(N _{RB,c} /50) | -59.13 +10log(N _{RB,c} /50) |
| Propagation Condition | | AWGN | AWGN | AWGN |
| Antenna Configuration | | 1x2 | 1x2 | 1x2 |
| Timing offset to Cell 1 | μs | - | 0 | 0 |
| Time alignment error relative to cell 1 ^{Note 5} | μs | - | ≤ TAE | ≤ TAE |
| Time alignment error relative to cell 2 ^{Note 5} | μs | - | - | ≤ TAE |
| Time alignment error relative to cell 3 ^{Note 5} | μs | - | - | - |
| <p>Note 1: OCNG shall be used such that all cells are fully allocated and a constant total transmitted power spectral density is achieved for all OFDM symbols.</p> <p>Note 2: Interference from other cells and noise sources not specified in the test is assumed to be constant over subcarriers and time and shall be modelled as AWGN of appropriate power for N_{oc} to be fulfilled.</p> <p>Note 3: Es/lot, RSRP, SCH_RP and I_o levels have been derived from other parameters for information purposes. They are not settable parameters themselves.</p> <p>Note 4: The uplink resources for CSI reporting are assigned to the UE prior to the start of time period T2.</p> <p>Note 5: Time alignment error (TAE) as specified in TS 36.104 [30] clause 6.5.3.1. The TAE value depends upon the type of carrier aggregation.</p> | | | | |

Table A.8.16.59.1-3: Cell specific test parameters for E-UTRAN TDD known SCell1 activation with PCell in FDD

| Parameter | Unit | Cell 4 | | | | | | |
|--|------|---|----|----|--|--|--|--|
| | | T1 | T2 | T3 | | | | |
| E-UTRA RF Channel Number | | 4 | | | | | | |
| BW _{channel} | MHz | 5MHz: N _{RB,c} = 25 10MHz: N _{RB,c} = 50 20MHz: N _{RB,c} = 100 | | | | | | |
| Special subframe configuration | | 6 | | | | | | |
| Uplink-downlink configuration | | 1 | | | | | | |
| PDSCH parameters: DL Reference Measurement Channel | | - | | | | | | |
| PCFICH/PDCCH/PHICH parameters: DL Reference Measurement Channel | | 5MHz: R.11 TDD 10MHz: R.6 TDD 20MHz: R.10 TDD | | | | | | |
| OCNG Patterns | | 5MHz: OP.10 TDD 10MHz: OP.2 TDD 20MHz: OP.8 TDD | | | | | | |
| PBCH_RA | dB | 0 | | | | | | |
| PBCH_RB | dB | | | | | | | |
| PSS_RA | dB | | | | | | | |
| SSS_RA | dB | | | | | | | |
| PCFICH_RB | dB | | | | | | | |
| PHICH_RA | dB | | | | | | | |
| PHICH_RB | dB | | | | | | | |

| | | | | |
|--|---------------|---------------------------------------|--|--|
| PDCCH_RA | dB | | | |
| PDCCH_RB | dB | | | |
| PDSCH_RA | dB | | | |
| PDSCH_RB | dB | | | |
| OCNG_RA ^{Note 1} | dB | | | |
| OCNG_RB ^{Note 1} | dB | | | |
| N_{oc} ^{Note 2} | dBm/15 kHz | -104 | | |
| \bar{E}_s/N_{oc} | dB | 17 | | |
| \bar{E}_s/I_{ot} | dB | 17 | | |
| RSRP ^{Note 3} | dBm/15 kHz | -87 | | |
| SCH_RP ^{Note 3} | dBm/15 kHz | -87 | | |
| I_o ^{Note 3} | dBm/Ch BW | -59.13 +10log ($N_{RB,c}/50$) | | |
| Propagation Condition | | AWGN | | |
| Antenna Configuration | | 1x2 | | |
| Timing offset to Cell 1 | μ s | 0 | | |
| Time alignment error relative to cell 1 ^{Note 5} | μ s | \leq TAE | | |
| Time alignment error relative to cell 2 ^{Note 5} | μ s | \leq TAE | | |
| Time alignment error relative to cell 3 ^{Note 5} | μ s | \leq TAE | | |
| <p>Note 1: OCNG shall be used such that all cells are fully allocated and a constant total transmitted power spectral density is achieved for all OFDM symbols.</p> <p>Note 2: Interference from other cells and noise sources not specified in the test is assumed to be constant over subcarriers and time and shall be modelled as AWGN of appropriate power for N_{oc} to be fulfilled.</p> <p>Note 3: E_s/I_{ot}, RSRP, SCH_RP and I_o levels have been derived from other parameters for information purposes. They are not settable parameters themselves.</p> <p>Note 4: The uplink resources for CSI reporting are assigned to the UE prior to the start of time period T2.</p> <p>Note 5: Time alignment error (TAE) as specified in TS 36.104 [30] clause 6.5.3.1. The TAE value depends upon the type of carrier aggregation.</p> | | | | |

A.8.16.59.2 Test Requirements

During T2 the UE shall send the first CSI report for SCell1 in a subframe (m+8), or in a subframe (m+10) if the subframe (m+8) was subject to interruption. Whether CSI report in subframe (m+8) was interrupted or not is checked by monitoring ACK/NACK sent in PCell in subframe (m+8).

During T2 the UE shall start sending CSI reports for SCell1 with non-zero CQI index at latest in a subframe (m+34).

During T3 the UE shall stop sending CSI reports for SCell1 at latest in a subframe (n+8).

During T2 interruption of PCell during SCells activation shall not happen outside the subframes (m+5) to (m+9), outside the subframes (m+15) to (m+19), and outside the subframes (m+25) to (m+29).

During T3 interruption of PCell during SCells deactivation shall not happen outside the subframes (n+5) to (n+9), outside the subframes (n+15) to (n+19), and (n+25) to (n+29).

The interruption of PCell shall not be more than the values specified for intra-band CA and inter-band CA in Section 7.8.2.

All of the above test requirements shall be fulfilled in order for the observed SCell1 activation delay and SCell1 deactivation delay to be counted as correct. The rate of correct observed SCell1 activation delay and SCell1 deactivation delay during repeated tests shall be at least 90%.

NOTE: During T2 if there are no uplink resources for reporting the valid CSI in a subframe (m+34) then the UE shall use the next available uplink resource for reporting the corresponding valid CSI.

A.8.16.60 E-UTRAN PCell in TDD FDD-TDD 4 DL CA activation and deactivation of known SCell in non-DRX

A.8.16.60.1 Test Purpose and Environment

The purpose of this test is to verify that the SCell activation and deactivation times are within the requirements stated in section 7.7 for UE configured with three downlink SCells, when the SCell is known by the UE at the time of activation and PCell is in TDD.

The test parameters are given in Tables A.8.16.60.1-1 and cell-specific parameters in A.8.16.60.1-2 and A.8.16.60.1-3 below. The test consists of three successive time periods, with duration of T1, T2 and T3, respectively. There are four carriers, each with one cell. All cells have constant signal levels throughout the test. Before the test starts the UE is connected to Cell 1 (PCell) on radio channel 1 (PCC), deactivated Cell 3 (SCell2) on radio channel 3 (SCC2) and deactivated Cell 4 (SCell3) on radio channel 4 (SCC3) but is not aware of Cell 2 (SCell1) on radio channel 2 (SCC1). The UE is only monitoring the PCC, SCC2 and SCC3. The UE shall be continuously scheduled in PCell throughout the whole test.

At the beginning of T1 the UE receives an RRC message by which the SCell1 becomes configured on SCC1. The UE now starts monitoring also SCC1. The test equipment sends a MAC message for activation of the SCell1.

The point in time at which the MAC message is received at the UE antenna connector, in a subframe # denoted m , where m is 4 or 9, defines the start of time period T2. The UE receives a MAC message for activation of SCell 2 and SCell3 in a subframe ($m+15$) during activation of the SCell1. The UE shall be able to report valid CSI for the activated SCell1 at latest in a subframe ($m+34$). The UE shall start reporting CSI for SCell1 in subframe ($m+8$) and shall report CQI index 0 (out-of-range) until the SCell activation has been completed. Any PCell interruption due to activation of SCells shall not occur outside subframes ($m+5$) to ($m+11$) and ($m+20$) to ($m+26$).

Time period T3 starts when a MAC message for deactivation of SCell1, sent from the test equipment to the UE in a subframe # denoted n , where n is 4 or 9, is received at the UE antenna connector. The test equipment sends a MAC message for deactivation of the SCell2 in subframe ($n+15$) and a MAC message for deactivation of the SCell3 in subframe ($n+30$). The UE shall carry out deactivation of the SCell1 at latest in subframe ($n+8$), and any PCell interruption due to the deactivation of SCells shall not occur outside subframes ($n+5$) to ($n+11$), ($n+20$) to ($n+26$) and ($n+35$) to ($n+41$).

The test equipment verifies that potential interruption is carried out in the correct time span by monitoring ACK/NACK sent in PCell during activation and deactivation of SCell1, respectively.

The test equipment verifies the activation time by counting the subframes from the time when SCell1 activation command is sent until a CSI report with other than CQI index 0 is received.

The test equipment verifies the deactivation time by counting the subframes from the time when SCell1 deactivation command is sent until CQI reporting for SCell1 is discontinued.

Table A.8.16.60.1-1: General test parameters for known SCell1 activation case

| Parameter | Unit | Value | Comment |
|---|------|------------|---|
| E-UTRA RF Channel Number | | 1, 2, 3, 4 | Four radio channels are used for this test |
| Active PCell | | Cell 1 | Primary cell on RF channel number 1. |
| Deconfigured deactivated SCell | | Cell 2 | Deconfigured deactivated secondary cell on RF channel number 2. |
| Configured deactivated SCell2 | | Cell 3 | Configured deactivated secondary cell on RF channel number 3. |
| Configured deactivated SCell3 | | Cell 4 | Configured deactivated secondary cell on RF channel number 4. |
| CP length | | Normal | |
| DRX | | OFF | Continuous monitoring of primary cell |
| CQI/PMI periodicity and offset configuration index | | 0 | CQI reporting for SCell every UL subframe |
| Cell-individual offset for cells on RF channel number 1 | dB | 0 | Individual offset for cells on PCC. |
| Cell-individual offset for cells on RF channel number 2 | dB | 0 | Individual offset for cells on SCC1. |
| Cell-individual offset for cells on RF channel number 3 | dB | 0 | Individual offset for cells on SCC2. |
| Cell-individual offset for cells on RF channel number 4 | dB | 0 | Individual offset for cells on SCC3. |

| | | | |
|--|----|-----|--|
| SCell measurement cycle (measCycleSCell) | ms | 320 | |
| T1 | s | 7 | During this time the PCell, SCell2 and SCell3 shall be known and the SCell1 configured and detected. |
| T2 | s | 1 | During this time the UE shall activate the SCell1, SCell2, and SCell3. |
| T3 | s | 1 | During this time the UE shall deactivate the SCell1, SCell2, and SCell3. |

Table A.8.16.60.1-2: Cell specific test parameters for E-UTRAN FDD known SCell1 activation with PCell in TDD

| Parameter | Unit | Cell 1 | | | Cell 2 | | | Cell 3 | | |
|---|------------|---|----|----|---|----|----|---|----|----|
| | | T1 | T2 | T3 | T1 | T2 | T3 | T1 | T2 | T3 |
| E-UTRA RF Channel Number | | 1 | | | 2 | | | 3 | | |
| BW _{channel} | MHz | 5MHz: N _{RB,c} = 25 10MHz: N _{RB,c} = 50 20MHz: N _{RB,c} = 100 | | | 5MHz: N _{RB,c} = 25 10MHz: N _{RB,c} = 50 20MHz: N _{RB,c} = 100 | | | 5MHz: N _{RB,c} = 25 10MHz: N _{RB,c} = 50 20MHz: N _{RB,c} = 100 | | |
| Special subframe configuration | | 6 | | | - | | | - | | |
| Uplink-downlink configuration | | 1 | | | - | | | - | | |
| PDSCH parameters: DL Reference Measurement Channel | | 5MHz: R.4 TDD 10MHz: R.0 TDD 20MHz: R.3 TDD | | | - | | | - | | |
| PCFICH/PDCCH/PHICH parameters: DL Reference Measurement Channel | | 5MHz: R.11 TDD 10MHz: R.6 TDD 20MHz: R.10 TDD | | | 5MHz: R.11 FDD 10MHz: R.6 FDD 20MHz: R.10 FDD | | | 5MHz: R.11 FDD 10MHz: R.6 FDD 20MHz: R.10 FDD | | |
| OCNG Patterns | | 5MHz: OP.9 TDD 10MHz: OP.1 TDD 20MHz: OP.7 TDD | | | 5MHz: OP.16 FDD 10MHz: OP.2 FDD 20MHz: OP.12 FDD | | | 5MHz: OP.16 FDD 10MHz: OP.2 FDD 20MHz: OP.12 FDD | | |
| PBCH_RA | dB | 0 | | | 0 | | | 0 | | |
| PBCH_RB | dB | | | | | | | | | |
| PSS_RA | dB | | | | | | | | | |
| SSS_RA | dB | | | | | | | | | |
| PCFICH_RB | dB | | | | | | | | | |
| PHICH_RA | dB | | | | | | | | | |
| PHICH_RB | dB | | | | | | | | | |
| PDCCH_RA | dB | | | | | | | | | |
| PDCCH_RB | dB | | | | | | | | | |
| PDSCH_RA | dB | | | | | | | | | |
| PDSCH_RB | dB | | | | | | | | | |
| OCNG_RA ^{Note 1} | dB | | | | | | | | | |
| OCNG_RB ^{Note 1} | dB | | | | | | | | | |
| N _{oc} ^{Note 2} | dBm/15 kHz | | | | | | | | | |
| \bar{E}_s/N_{oc} | dB | 17 | | | 17 | | | 17 | | |
| \bar{E}_s/I_{ot} | dB | 17 | | | 17 | | | 17 | | |
| RSRP ^{Note 3} | dBm/15 kHz | -87 | | | -87 | | | -87 | | |
| SCH_RP ^{Note 3} | dBm/15 kHz | -87 | | | -87 | | | -87 | | |
| I _o ^{Note 3} | dBm/Ch BW | -59.13 +10log (N _{RB,c} /50) | | | -59.13 +10log (N _{RB,c} /50) | | | -59.13 +10log (N _{RB,c} /50) | | |
| Propagation Condition | | AWGN | | | AWGN | | | AWGN | | |
| Antenna Configuration | | 1x2 | | | 1x2 | | | 1x2 | | |
| Timing offset to Cell 1 | μs | - | | | 0 | | | 0 | | |
| Time alignment error relative to cell 1 ^{Note 5} | μs | - | | | ≤ TAE | | | ≤ TAE | | |
| Time alignment error relative to cell 2 ^{Note 5} | μs | - | | | - | | | ≤ TAE | | |
| Time alignment error relative to cell 3 ^{Note 5} | μs | - | | | - | | | - | | |

| | |
|---------|--|
| Note 1: | OCNG shall be used such that all cells are fully allocated and a constant total transmitted power spectral density is achieved for all OFDM symbols. |
| Note 2: | Interference from other cells and noise sources not specified in the test is assumed to be constant over subcarriers and time and shall be modelled as AWGN of appropriate power for N_{oc} to be fulfilled. |
| Note 3: | E_s/I_{ot} , RSRP, SCH_RP and I_o levels have been derived from other parameters for information purposes. They are not settable parameters themselves. |
| Note 4: | The uplink resources for CSI reporting are assigned to the UE prior to the start of time period T2. |
| Note 5: | Time alignment error (TAE) as specified in TS 36.104 [30] clause 6.5.3.1. The TAE value depends upon the type of carrier aggregation. |

Table A.8.16.60.1-3: Cell specific test parameters for E-UTRAN FDD known SCell1 activation with PCell in TDD

| Parameter | Unit | Cell 4 | | | | | | | | | | |
|--|------------|--|----|----|------|--|--|--|--|--|--|--|
| | | T1 | T2 | T3 | | | | | | | | |
| E-UTRA RF Channel Number | | 4 | | | | | | | | | | |
| BW _{channel} | MHz | 5MHz: $N_{RB,c} = 25$ 10MHz: $N_{RB,c} = 50$ 20MHz: $N_{RB,c} = 100$ | | | | | | | | | | |
| Special subframe configuration | | - | | | | | | | | | | |
| Uplink-downlink configuration | | - | | | | | | | | | | |
| PDSCH parameters: DL Reference Measurement Channel | | - | | | | | | | | | | |
| PCFICH/PDCCH/PHICH parameters: DL Reference Measurement Channel | | 5MHz: R.11 FDD 10MHz: R.6 FDD 20MHz: R.10 FDD | | | | | | | | | | |
| OCNG Patterns | | 5MHz: OP.16 FDD 10MHz: OP.2 FDD 20MHz: OP.12 FDD | | | | | | | | | | |
| PBCH_RA | dB | 0 | | | | | | | | | | |
| PBCH_RB | dB | | | | | | | | | | | |
| PSS_RA | dB | | | | | | | | | | | |
| SSS_RA | dB | | | | | | | | | | | |
| PCFICH_RB | dB | | | | | | | | | | | |
| PHICH_RA | dB | | | | | | | | | | | |
| PHICH_RB | dB | | | | | | | | | | | |
| PDCCH_RA | dB | | | | | | | | | | | |
| PDCCH_RB | dB | | | | | | | | | | | |
| PDSCH_RA | dB | | | | | | | | | | | |
| PDSCH_RB | dB | | | | | | | | | | | |
| OCNG_RA ^{Note 1} | dB | | | | | | | | | | | |
| OCNG_RB ^{Note 1} | dB | | | | | | | | | | | |
| N_{oc} ^{Note 2} | dBm/15 kHz | | | | -104 | | | | | | | |
| \bar{E}_s/N_{oc} | dB | | | | 17 | | | | | | | |
| \bar{E}_s/I_{ot} | dB | 17 | | | | | | | | | | |
| RSRP ^{Note 3} | dBm/15 kHz | -87 | | | | | | | | | | |
| SCH_RP ^{Note 3} | dBm/15 kHz | -87 | | | | | | | | | | |
| I_o ^{Note 3} | dBm/Ch BW | -59.13 +10log ($N_{RB,c} / 50$) | | | | | | | | | | |
| Propagation Condition | | AWGN | | | | | | | | | | |
| Antenna Configuration | | 1x2 | | | | | | | | | | |
| Timing offset to Cell 1 | μ s | 0 | | | | | | | | | | |
| Time alignment error relative to cell 1 ^{Note 5} | μ s | \leq TAE | | | | | | | | | | |
| Time alignment error relative to cell 2 ^{Note 5} | μ s | \leq TAE | | | | | | | | | | |
| Time alignment error relative to cell 3 ^{Note 5} | μ s | \leq TAE | | | | | | | | | | |

| | |
|---------|--|
| Note 1: | OCNG shall be used such that all cells are fully allocated and a constant total transmitted power spectral density is achieved for all OFDM symbols. |
| Note 2: | Interference from other cells and noise sources not specified in the test is assumed to be constant over subcarriers and time and shall be modelled as AWGN of appropriate power for N_{oc} to be fulfilled. |
| Note 3: | E_s/I_{ot} , RSRP, SCH_RP and I_o levels have been derived from other parameters for information purposes. They are not settable parameters themselves. |
| Note 4: | The uplink resources for CSI reporting are assigned to the UE prior to the start of time period T2. |
| Note 5: | Time alignment error (TAE) as specified in TS 36.104 [30] clause 6.5.3.1. The TAE value depends upon the type of carrier aggregation. |

A.8.16.60.2 Test Requirements

During T2 the UE shall send the first CSI report for SCell1 in a subframe (m+8), or in a subframe (m+9) if the subframe (m+8) was subject to interruption. Whether CSI report in subframe (m+8) was interrupted or not is checked by monitoring ACK/NACK sent in PCell in subframe (m+8).

During T2 the UE shall start sending CSI reports for SCell1 with non-zero CQI index at latest in a subframe (m+34).

During T3 the UE shall stop sending CSI reports for SCell at latest in a subframe (n+8).

During T2 interruption of PCell during SCells activation shall not happen outside the subframes (m+5) to (m+11) and outside the subframes (m+20) to (m+26).

During T3 interruption of PCell during SCells deactivation shall not happen outside the subframes (n+5) to (n+11), outside the subframes (n+20) to (n+26) and outside the subframes (n+35) to (n+41).

The interruption of PCell shall not be more than the values specified for intra-band CA and inter-band CA in Section 7.8.2.

All of the above test requirements shall be fulfilled in order for the observed SCell1 activation delay and SCell1 deactivation delay to be counted as correct. The rate of correct observed SCell1 activation delay and SCell1 deactivation delay during repeated tests shall be at least 90%.

NOTE: During T2 if there are no uplink resources for reporting the valid CSI in a subframe (m+34) then the UE shall use the next available uplink resource for reporting the corresponding valid CSI.

A.8.16.61 E-UTRAN FDD 4DL CA activation and deactivation of unknown SCell in non-DRX

A.8.16.61.1 Test Purpose and Environment

The purpose of this test is to verify that the SCell activation and deactivation times are within the requirements stated in section 7.7 for UE configured with four downlink SCells, when the SCell is unknown by the UE at the time of activation and PCell is in FDD.

The test parameters are given in Tables A.8.16.61.1-1 and cell-specific parameters in A.8.16.61.1-2 below. The test consists of three successive time periods, with duration of T1, T2 and T3, respectively. There are four carriers, each with one cell. Cell 1, Cell 3, and Cell 4 have constant signal levels throughout the test. Before the test starts the UE is connected to Cell1 (PCell) on radio channel 1 (PCC), Cell 3 (deactivated SCell2) on radio channel 3 (SCC2) and Cell4 (deactivated SCell3) on radio channel 4 (SCC3), but is not aware of Cell2 (SCell1) on radio channel 2 (SCC1). The UE is only monitoring the PCC, SCC2 and SCC3. The UE shall be continuously scheduled in the PCell throughout the whole test.

At the beginning of T1 the UE receives an RRC message by which the Cell 2 (SCell1) becomes configured on radio channel 2 (SCC1). During T1 the signal level of Cell 2 (SCell1) is powered off and UE is not aware of Cell 2 (SCell1).

A MAC message for activation of the SCell1 is sent by the test equipment 100ms after the RRC message, in a subframe # denoted m which is an even number. The point in time at which the MAC message for activation of Cell 2 (SCell1) is received at the UE antenna connector defines the start of time period T2. Immediately at beginning of T2 the transmission power of Cell 2 (SCell1) is increased to same level as for Cell 1 (PCell). The test equipment sends a MAC message for activation of Cell 3 (SCell2) and Cell4 (SCell 3) in subframe (m+10) and subframe (m+20), respectively. Since UE received SCell2 activation command during activation of SCell1, the UE shall be able to report valid CSIs for the activated SCell1 at latest in subframe (m+44) provided the SCell1 can be successfully detected on the first attempt. The UE shall start reporting CSI in subframe (m+8) and shall report CQI index 0 (out-of-range) until the SCell activation has been completed. Any PCell interruption due to activation of SCells shall occur in the subframes (m+5) to (m+9), (m+15) to (m+19) and (m+25) to (m+29).

Time period T3 starts when a MAC message for deactivation of Cell 2 (SCell1), sent from the test equipment to the UE in a subframe # denoted n, is received at the UE antenna connector. The test equipment sends a MAC message for deactivation of the

Cell 3 (SCell2) and Cell4 (SCell3) in subframe (n+10) and (n+20), respectively. The UE shall carry out deactivation of Cell 2 (SCell1) at latest in subframe (n+8), and any PCell interruption due to the deactivation of SCells shall occur in the subframes (n+5) to (n+9), (n+15) to (n+19) and (n+25) to (n+29).

The test equipment verifies that potential interruption is carried out in the correct time span by monitoring ACK/NACK sent in PCell during activation and deactivation of SCells, respectively.

The test equipment verifies the activation time by counting the subframes from the time when the Cell 2 (SCell1) activation command is sent until a CSI reports with other than CQI index 0 is received.

The test equipment verifies the deactivation time by counting the subframes from the time when the Cell 2 (SCell1) deactivation command is sent until CQI reporting for SCell1 is discontinued.

Table A.8.16.61.1-1: General test parameters for unknown SCell1 activation case

| Parameter | Unit | Value | Comment |
|---|------|-----------|---|
| E-UTRA RF Channel Number | | 1, 2, 3,4 | Four radio channels are used for this test |
| Active PCell | | Cell 1 | Primary cell on RF channel number 1. |
| Deconfigured SCell1 | | Cell 2 | Deconfigured secondary cell on RF channel number 2. |
| Configured deactivated SCell2 | | Cell 3 | Configured deactivated secondary cell on RF channel number 3. |
| Configured deactivated SCell3 | | Cell 4 | Configured deactivated secondary cell on RF channel number 4. |
| CP length | | Normal | |
| DRX | | OFF | Continuous monitoring of primary cell |
| CQI/PMI periodicity and offset configuration index | | 0 | CQI reporting for SCell every second subframe |
| Cell-individual offset for cells on RF channel number 1 | dB | 0 | Individual offset for cells on PCC. |
| Cell-individual offset for cells on RF channel number 2 | dB | 0 | Individual offset for cells on SCC1. |
| Cell-individual offset for cells on RF channel number 3 | dB | 0 | Individual offset for cells on SCC2. |
| Cell-individual offset for cells on RF channel number 4 | dB | 0 | Individual offset for cells on SCC3. |
| Filter coefficient | | 0 | L3 filtering is not used |
| SCell measurement cycle (measCycleSCell) | ms | 320 | |
| T1 | ms | 100 | During this time the PCell, SCell2 and SCell3 shall be known and the SCell1 configured. |
| T2 | s | 1 | During this time the UE shall activate the SCell1. |
| T3 | s | 1 | During this time the UE shall deactivate the SCell1. |

Table A.8.16.61.1-2: Cell specific test parameters for E-UTRAN FDD 4 DL CA activation and deactivation of known SCell in non-DRX

| Parameter | Unit | Cell 1 | | | Cell 2 | | | Cell 3 | | | Cell 4 | | |
|---|------|---|----|----|---|----|----|---|----|----|---|----|----|
| | | T1 | T2 | T3 | T1 | T2 | T3 | T1 | T2 | T3 | T1 | T2 | T3 |
| E-UTRA RF Channel Number | | 1 | | | 2 | | | 3 | | | 4 | | |
| BW _{channel} | MHz | 5MHz: N _{RB,c} = 25 10MHz: N _{RB,c} = 50 20MHz: N _{RB,c} = 100 | | | 5MHz: N _{RB,c} = 25 10MHz: N _{RB,c} = 50 20MHz: N _{RB,c} = 100 | | | 5MHz: N _{RB,c} = 25 10MHz: N _{RB,c} = 50 20MHz: N _{RB,c} = 100 | | | 5MHz: N _{RB,c} = 25 10MHz: N _{RB,c} = 50 20MHz: N _{RB,c} = 100 | | |
| PDSCH parameters: DL Reference Measurement Channel | | 5MHz: R.7 FDD 10MHz: R.3 FDD 20MHz: R.6 FDD | | | - | | | - | | | - | | |
| PCFICH/PDCCH/PHICH parameters: DL Reference Measurement Channel | | 5MHz: R.11 FDD 10MHz: R.6 FDD 20MHz: R.10 FDD | | | 5MHz: R.11 FDD 10MHz: R.6 FDD 20MHz: R.10 FDD | | | 5MHz: R.11 FDD 10MHz: R.6 FDD 20MHz: R.10 FDD | | | 5MHz: R.11 FDD 10MHz: R.6 FDD 20MHz: R.10 FDD | | |

| OCNG Patterns | | 5MHz: OP.20 FDD 10MHz: OP.10 FDD 20MHz: OP.17 FDD | 5MHz: OP.16 FDD 10MHz: OP.2 FDD 20MHz: OP.12 FDD | 5MHz: OP.16 FDD 10MHz: OP.2 FDD 20MHz: OP.12 FDD | 5MHz: OP.16 FDD 10MHz: OP.2 FDD 20MHz: OP.12 FDD |
|--|------------|---|--|--|--|
| PBCH_RA | dB | 0 | 0 | 0 | 0 |
| PBCH_RB | dB | | | | |
| PSS_RA | dB | | | | |
| SSS_RA | dB | | | | |
| PCFICH_RB | dB | | | | |
| PHICH_RA | dB | | | | |
| PHICH_RB | dB | | | | |
| PDCCH_RA | dB | | | | |
| PDCCH_RB | dB | | | | |
| PDSCH_RA | dB | | | | |
| PDSCH_RB | dB | | | | |
| OCNG_RA ^{Note 1} | dB | | | | |
| OCNG_RB ^{Note 1} | dB | | | | |
| N _{oc} ^{Note 2} | dBm/15 kHz | | | | |
| \hat{E}_s/N_{oc} | dB | 17 | -infinity | 17 | 17 |
| \hat{E}_s/I_{ot} ^{Note 3} | dB | 17 | -infinity | 17 | 17 |
| RSRP ^{Note 3} | dBm/15 kHz | -87 | -infinity | -87 | -87 |
| SCH_RP ^{Note 3} | dBm/15 kHz | -87 | -infinity | -87 | -87 |
| I _o ^{Note 3} | dBm/Ch BW | -59.13 +10log (N _{RB,c} /50) | -76.22 +10log (N _{RB,c} /50) | -59.13 +10log (N _{RB,c} /50) | -59.13 +10log (N _{RB,c} /50) |
| Propagation Condition | | AWGN | AWGN | AWGN | AWGN |
| Antenna Configuration | | 1x2 | 1x2 | 1x2 | 1x2 |
| Timing offset to Cell 1 | μs | - | 0 | 0 | 0 |
| Time alignment error relative to cell 1 ^{Note 5} | μs | - | ≤ TAE | ≤ TAE | ≤ TAE |
| Time alignment error relative to cell 2 ^{Note 5} | μs | - | - | ≤ TAE | ≤ TAE |
| Time alignment error relative to cell 3 ^{Note 5} | μs | - | - | - | ≤ TAE |
| <p>Note 1: OCNG shall be used such that all cells are fully allocated and a constant total transmitted power spectral density is achieved for all OFDM symbols.</p> <p>Note 2: Interference from other cells and noise sources not specified in the test is assumed to be constant over subcarriers and time and shall be modelled as AWGN of appropriate power for N_{oc} to be fulfilled.</p> <p>Note 3: Es/I_{ot}, RSRP, SCH_RP and I_o levels have been derived from other parameters for information purposes. They are not settable parameters themselves.</p> <p>Note 4: The uplink resources for CSI reporting are assigned to the UE prior to the start of time period T2.</p> <p>Note 5: Time alignment error (TAE) as specified in TS 36.104 [30] clause 6.5.3.1. The TAE value depends upon the type of carrier aggregation.</p> | | | | | |

A.8.16.61.2 Test Requirements

During T2, the UE shall send the first CSI report for SCell1 in a subframe (m+8), or in a subframe (m+10) if the subframe (m+8) was subject to interruption. Whether CSI report in subframe (m+8) was interrupted or not is checked by monitoring ACK/NACK sent in PCell in subframe (m+8).

During T2 the UE shall start sending CSI reports for SCell1 with non-zero CQI index at latest in a subframe (m+44).

During T3 the UE shall stop sending CSI reports for SCell1 at latest in a subframe (n+8).

During T2 interruption of PCell during SCells activation shall not happen outside the subframes (m+5) to (m+9), outside the subframes (m+15) to (m+19) and outside the subframes (m+25) to (m+29).

During T3 interruption of PCell during SCells deactivation shall not happen outside the subframes (n+5) to (n+9), outside the subframes (n+15) to (n+19) and outside the subframes (n+25) to (n+29).

The interruption of PCell shall not be more than the values specified for intra-band CA and inter-band CA in Section 7.8.2.

All of the above test requirements shall be fulfilled in order for the observed SCell1 activation delay and SCell1 deactivation delay to be counted as correct. The rate of correct observed SCell1 activation delay and SCell1 deactivation delay during repeated tests shall be at least 90%.

NOTE: During T2 if there are no uplink resources for reporting the valid CSI in a subframe (m+44) then the UE shall use the next available uplink resource for reporting the corresponding valid CSI.

A.8.16.62 E-UTRAN TDD 4DL CA activation and deactivation of unknown SCell in non-DRX

A.8.16.62.1 Test Purpose and Environment

The purpose of this test is to verify that SCell activation and deactivation times are within the requirements stated in clause 7.7 for 4DL TDD carrier aggregation, when the SCells are unknown by the UE at the time of activation.

The test parameters are given in Tables A.8.16.62-1 and cell-specific parameters in A.8.16.62-2 below. The test consists of three successive time periods, with duration of T1, T2 and T3, respectively. There are four carriers, each with one cell. Cell 1, Cell 3, and Cell 4 have constant signal levels throughout the test. Before the test starts the UE is connected to Cell 1 (PCell) on radio channel 1 (PCC), Cell 3 (deactivated SCell2) on radio channel 3 (SCC2) and Cell 4 (deactivated SCell3) on radio channel 4 (SCC3), but is not aware of Cell 2 (SCell1) on radio channel 2 (SCC1). The UE is only monitoring the PCC, SCC2 and SCC3. The UE shall be continuously scheduled in the PCell throughout the whole test.

At the beginning of T1 the UE receives an RRC message by which the Cell 2 (SCell 1) becomes configured on radio channel 2 (SCC1). During T1 the signal level of Cell 2 (SCell 1) is powered off and UE is not aware of Cell 2 (SCell1).

A MAC message for activation of the SCell1 is sent by the test equipment 100ms after the RRC message, in a subframe # denoted m, where m is 4 or 9. The point in time at which the MAC message for activation of Cell 2 (SCell1) is received at the UE antenna connector defines the start of time period T2. Immediately at beginning of T2 the transmission power of Cell 2 (SCell1) is increased to same level as for Cell 1 (PCell). The test equipment sends a MAC message for activation of Cell 3 (SCell2) and Cell 4 (SCell3) in subframe (m+15) and subframe (m+30), respectively. Since UE received SCell2 activation command during activation of SCell1, the UE shall be able to report valid CSIs for the activated SCell1 at latest in subframe (m+44) provided the SCell1 can be successfully detected on the first attempt. The UE shall start reporting CSI in subframe (m+8) and shall report CQI index 0 (out-of-range) until the SCell activation has been completed. Any PCell interruption due to activation of SCells shall occur in the subframes (m+5) to (m+11), (m+20) to (m+26) and (m+35) to (m+41).

Time period T3 starts when a MAC message for deactivation of Cell 2 (SCell1), sent from the test equipment to the UE in a subframe # denoted n, where n is 4 or 9, is received at the UE antenna connector. The test equipment sends a MAC message for deactivation of the Cell 3 (SCell2) and Cell 4 (SCell3) in subframe (n+15) and (n+30), respectively. The UE shall carry out deactivation of Cell 2 (SCell1) at latest in subframe (n+8), and any PCell interruption due to the deactivation of SCells shall occur in the subframes (n+5) to (n+11), (n+20) to (n+26) and (n+35) to (n+41).

The test equipment verifies that potential interruption is carried out in the correct time span by monitoring ACK/NACK sent in PCell during activation and deactivation of SCells, respectively.

The test equipment verifies the activation time by counting the subframes from the time when the Cell 2 (SCell1) activation command is sent until a CSI reports with other than CQI index 0 is received.

The test equipment verifies the deactivation time by counting the subframes from the time when the Cell 2 (SCell1) deactivation command is sent until CQI reporting for SCell1 is discontinued.

Table A.8.16.62-1: General test parameters for E-UTRAN TDD 4 DL CA activation and deactivation of unknown SCell in non-DRX

| Parameter | Unit | Value | Comment |
|------------------------------|------|-----------|---|
| E-UTRA RF Channel Number | | 1, 2, 3,4 | Four radio channels are used for this test |
| Active PCell | | Cell 1 | Primary cell on RF channel number 1. |
| Deconfigured SCell | | Cell 2 | Deconfigured secondary cell on RF channel number 2. |
| Configured deactivated SCell | | Cell 3 | Configured deactivated secondary cell on RF channel number 3. |
| Configured deactivated SCell | | Cell 4 | Configured deactivated secondary cell on RF channel number 4. |
| CP length | | Normal | |

| | | | |
|---|----|-----|---|
| Special subframe configuration | | 6 | As specified in table 4.2-1 in TS 36.211. The same configuration applies to all cells. |
| Uplink-downlink configuration | | 1 | As specified in table 4.2-2 in TS 36.211. The same configuration applies to all cells |
| DRX | | OFF | Continuous monitoring of primary cell |
| CQI/PMI periodicity and offset configuration index | | 0 | CQI reporting for SCells every UL subframe |
| Cell-individual offset for cells on RF channel number 1 | dB | 0 | Individual offset for cells on PCC. |
| Cell-individual offset for cells on RF channel number 2 | dB | 0 | Individual offset for cells on SCC1. |
| Cell-individual offset for cells on RF channel number 3 | dB | 0 | Individual offset for cells on SCC2. |
| Cell-individual offset for cells on RF channel number 4 | dB | 0 | Individual offset for cells on SCC3. |
| Filter coefficient | | 0 | L3 filtering is not used |
| SCell measurement cycle (measCycleSCell) | ms | 320 | |
| T1 | ms | 100 | During this time the PCell, SCell2 and SCell3 shall be known and the SCell1 configured. |
| T2 | s | 1 | During this time the UE shall activate the SCell1. |
| T3 | s | 1 | During this time the UE shall deactivate the SCell1. |

Table A.8.16.62-2: Cell specific test parameters for E-UTRAN TDD 4 DL CA activation and deactivation of unknown SCell in non-DRX

| Parameter | Unit | Cell 1 | | | Cell 2 | | | Cell 3 | | | Cell 4 | | |
|---|------------|---|----|----|---|----|----|---|----|----|---|----|----|
| | | T1 | T2 | T3 | T1 | T2 | T3 | T1 | T2 | T3 | T1 | T2 | T3 |
| E-UTRA RF Channel Number | | 1 | | | 2 | | | 3 | | | 4 | | |
| BW _{channel} | | 5MHz: N _{RB,c} = 25 10MHz: N _{RB,c} = 50 20MHz: N _{RB,c} = 100 | | | 5MHz: N _{RB,c} = 25 10MHz: N _{RB,c} = 50 20MHz: N _{RB,c} = 100 | | | 5MHz: N _{RB,c} = 25 10MHz: N _{RB,c} = 50 20MHz: N _{RB,c} = 100 | | | 5MHz: N _{RB,c} = 25 10MHz: N _{RB,c} = 50 20MHz: N _{RB,c} = 100 | | |
| PDSCH parameters: DL Reference Measurement Channel | | 5MHz: R.4 TDD 10MHz: R.0 TDD 20MHz: R.3 TDD | | | - | | | - | | | - | | |
| PCFICH/PDCCH/PHICH parameters: DL Reference Measurement Channel | | 5MHz: R.11 TDD 10MHz: R.6 TDD 20MHz: R.10 TDD | | | 5MHz: R.11 TDD 10MHz: R.6 TDD 20MHz: R.10 TDD | | | 5MHz: R.11 TDD 10MHz: R.6 TDD 20MHz: R.10 TDD | | | 5MHz: R.11 TDD 10MHz: R.6 TDD 20MHz: R.10 TDD | | |
| OCNG Patterns | | 5MHz: OP.9 TDD 10MHz: OP.1 TDD 20MHz: OP.7 TDD | | | 5MHz: OP.10 TDD 10MHz: OP.2 TDD 20MHz: OP.8 TDD | | | 5MHz: OP.10 TDD 10MHz: OP.2 TDD 20MHz: OP.8 TDD | | | 5MHz: OP.10 TDD 10MHz: OP.2 TDD 20MHz: OP.8 TDD | | |
| PBCH_RA | dB | 0 | | | 0 | | | 0 | | | 0 | | |
| PBCH_RB | dB | | | | | | | | | | | | |
| PSS_RA | dB | | | | | | | | | | | | |
| SSS_RA | dB | | | | | | | | | | | | |
| PCFICH_RB | dB | | | | | | | | | | | | |
| PHICH_RA | dB | | | | | | | | | | | | |
| PHICH_RB | dB | | | | | | | | | | | | |
| PDCCH_RA | dB | | | | | | | | | | | | |
| PDCCH_RB | dB | | | | | | | | | | | | |
| PDSCH_RA | dB | | | | | | | | | | | | |
| PDSCH_RB | dB | | | | | | | | | | | | |
| OCNG_RA ^{Note 1} | dB | | | | | | | | | | | | |
| OCNG_RB ^{Note 1} | dB | | | | | | | | | | | | |
| N _{oc} ^{Note 2} | dBm/15 kHz | | | | | | | | | | | | |
| $\frac{E_s}{N_{oc}}$ | dB | 17 | | | -infinity | | | 17 | | | 17 | | |
| $\frac{E_s}{I_{ot}}$ ^{Note 3} | dB | 17 | | | -infinity | | | 17 | | | 17 | | |
| RSRP ^{Note 3} | dBm/15 kHz | -87 | | | -infinity | | | -87 | | | -87 | | |
| SCH_RP ^{Note 3} | dBm/15 kHz | -87 | | | -infinity | | | -87 | | | -87 | | |

| I_0 ^{Note 3} | dBm/C h BW | $-59.13+10\log$ ($N_{RB,c}/50$) | -76.22 $+10\log$ ($N_{RB,c}$ /50) | $-59.13+10\log$ ($N_{RB,c}/50$) | $-59.13+10\log$ ($N_{RB,c}/50$) | $-59.13+10\log$ ($N_{RB,c}/50$) |
|---|---------------|--------------------------------------|---|--------------------------------------|--------------------------------------|--------------------------------------|
| Propagation Condition | | AWGN | | AWGN | AWGN | AWGN |
| Antenna Configuration | | 1x2 | | 1x2 | 1x2 | 1x2 |
| Timing offset to Cell 1 | μs | - | | 0 | 0 | 0 |
| Time alignment error relative to cell 1 ^{Note 5} | μs | - | | $\leq \text{TAE}$ | $\leq \text{TAE}$ | $\leq \text{TAE}$ |
| Time alignment error relative to cell 2 ^{Note 5} | μs | - | | - | $\leq \text{TAE}$ | $\leq \text{TAE}$ |
| Time alignment error relative to cell 3 ^{Note 5} | μs | - | | - | - | $\leq \text{TAE}$ |
| <p>Note 1: OCNG shall be used such that all cells are fully allocated and a constant total transmitted power spectral density is achieved for all OFDM symbols.</p> <p>Note 2: Interference from other cells and noise sources not specified in the test is assumed to be constant over subcarriers and time and shall be modelled as AWGN of appropriate power for N_{oc} to be fulfilled.</p> <p>Note 3: E_s/I_{ot}, RSRP, SCH_RP and I_0 have been derived from other parameters for information purposes. They are not settable parameters themselves.</p> <p>Note 4: The uplink resources for CSI reporting are assigned to the UE prior to the start of time period T2.</p> <p>Note 5: Time alignment error (TAE) as specified in TS 36.104 [30] clause 6.5.3.1. The TAE value depends upon the type of carrier aggregation.</p> | | | | | | |

A.8.16.62.2 Test Requirements

During T2 the UE shall send the first CSI report for SCell1 in a subframe (m+8), or in a subframe (m+9) if the subframe (m+8) was subject to interruption, or in a subframe (m+13) if the subframe (m+8) and (m+9) were subject to interruption when an intra-band SCell is activated. Whether CSI report in subframe (m+8) and/or (m+9) was interrupted or not is checked by monitoring ACK/NACK sent in PCell in subframe (m+8) and/or (m+9).

During T2 the UE shall start sending CSI reports for SCell1 with non-zero CQI index at latest in a subframe (m+44).

During T3 the UE shall stop sending CSI reports for SCell1 at latest in subframe (n+8).

During T2 interruption of PCell during SCells activation shall not happen outside the subframes (m+5) to (m+11), outside the subframes (m+20) to (m+26), and outside the subframes (n+35) to (n+41).

During T3 interruption of PCell during SCells deactivation shall not happen outside the subframes (n+5) to (n+11), outside the subframes (n+20) to (n+26) and outside the subframes (n+35) to (n+41).

The interruption of PCell shall not be more than the values specified for intra-band CA and inter-band CA in Section 7.8.2.

The UE shall not send event triggered measurement reports as long as the reporting criteria are not fulfilled.

All of the above test requirements shall be fulfilled in order for the observed SCell1 activation delay and SCell1 deactivation delay to be counted as correct. The rate of correct observed SCell1 activation delay and SCell1 deactivation delay during repeated tests shall be at least 90%.

NOTE: During T2 if there are no uplink resources for reporting the valid CSI in a subframe (m+44) then the UE shall use the next available uplink resource for reporting the corresponding valid CSI.

A.8.16.63 E-UTRAN PCell in FDD FDD-TDD 4 DL CA activation and deactivation of unknown SCell in non-DRX

A.8.16.63.1 Test Purpose and Environment

The purpose of this test is to verify that the SCell activation and deactivation times are within the requirements stated in section 7.7 for UE configured with three downlink SCells, when the SCell is unknown by the UE at the time of activation and PCell is in FDD.

The test parameters are given in Tables A.8.16.63.1-1 and cell-specific parameters in A.8.16.63.1-2 and A.8.16.63.1-3 below. The test consists of three successive time periods, with duration of T1, T2 and T3, respectively. There are four carriers, each with one cell. Cell 1, Cell 3 and Cell 4 have constant signal levels throughout the test. Before the test starts the UE is connected to Cell 1 (PCell) on radio channel 1 (PCC), deactivated Cell 3 (SCell2) on radio channel 3 (SCC2) and deactivated Cell 4 (SCell3) on radio channel 4 (SCC3) but is not aware of Cell 2 (SCell1) on radio channel 2 (SCC1). The UE is only monitoring PCC, SCC2 and SCC3. The UE shall be continuously scheduled in PCell throughout the whole test.

At the beginning of T1 the UE receives an RRC message by which SCell1 becomes configured on SCC1. During T1 SCell1 is powered off and the UE is not aware of SCell1.

A MAC message for activation of SCell1 is sent by the test equipment 100ms after the RRC message, in a subframe # denoted m which is an even number. The point in time at which the MAC message for activation of SCell1 is received at the UE antenna connector defines the start of time period T2. Immediately at beginning of T2 transmission power of SCell1 is increased to same level as for PCell. The test equipment sends a MAC message for activation of the SCell2 in subframe (m+10) and a MAC message for activation of the SCell3 in subframe (m+20) during activation of SCell1. The UE shall be able to report valid CSI for the activated SCell1 at latest in subframe (m+44) provided SCell1 can be successfully detected on the first attempt. The UE shall start reporting CSI for SCell1 in subframe (m+8) and shall report CQI index 0 (out-of-range) until the SCell activation has been completed. Any PCell interruption due to activation of SCells shall not occur outside subframes (m+5) to (m+9), (m+15) to (m+19) and (m+25) to (m+29).

Time period T3 starts when a MAC message for deactivation of SCell1, sent from the test equipment to the UE in a subframe # denoted n, is received at the UE antenna connector. The test equipment sends a MAC message for deactivation of the SCell2 in subframe (n+10) and a MAC message for deactivation of the SCell3 in subframe (n+20). The UE shall carry out deactivation of SCell1 at latest in subframe (n+8), and any PCell interruption due to the deactivation of SCells shall not occur outside subframes (n+5) to (n+9), (n+15) to (n+19) and (n+25) to (n+29).

The test equipment verifies that potential interruption is carried out in the correct time span by monitoring ACK/NACK sent in PCell during activation and deactivation of SCell1, respectively.

The test equipment verifies the activation time by counting the subframes from the time when SCell1 activation command is sent until a CSI report with other than CQI index 0 is received.

The test equipment verifies the deactivation time by counting the subframes from the time when SCell1 deactivation command is sent until CQI reporting for SCell1 is discontinued.

Table A.8.16.63.1-1: General test parameters for unknown SCell1 activation case

| Parameter | Unit | Value | Comment |
|---|------|------------|---|
| E-UTRA RF Channel Number | | 1, 2, 3, 4 | Four radio channels are used for this test |
| Active PCell | | Cell 1 | Primary cell on RF channel number 1. |
| Deconfigured deactivated SCell1 | | Cell 2 | Deconfigured deactivated secondary cell on RF channel number 2. |
| Configured deactivated SCell2 | | Cell 3 | Configured deactivated secondary cell on RF channel number 3. |
| Configured deactivated SCell3 | | Cell 4 | Configured deactivated secondary cell on RF channel number 4. |
| CP length | | Normal | |
| DRX | | OFF | Continuous monitoring of primary cell |
| CQI/PMI periodicity and offset configuration index | | 0 | CQI reporting for SCell every second subframe |
| Cell-individual offset for cells on RF channel number 1 | dB | 0 | Individual offset for cells on PCC. |
| Cell-individual offset for cells on RF channel number 2 | dB | 0 | Individual offset for cells on SCC1. |
| Cell-individual offset for cells on RF channel number 3 | dB | 0 | Individual offset for cells on SCC2. |
| Cell-individual offset for cells on RF channel number 4 | dB | 0 | Individual offset for cells on SCC3. |
| SCell measurement cycle (measCycleSCell) | ms | 320 | |
| T1 | ms | 100 | During this time the PCell, SCell2 and SCell3 shall be known and the SCell1 configured. |
| T2 | s | 1 | During this time the UE shall activate the SCell1, SCell2, and SCell3. |
| T3 | s | 1 | During this time the UE shall deactivate the SCell1, SCell2, and SCell3. |

Table A.8.16.63.1-2: Cell specific test parameters for E-UTRAN TDD unknown SCell1 activation with PCell in FDD

| Parameter | Unit | Cell 1 | | | Cell 2 | | | Cell 3 | | |
|--|------------|---|----|----|---|---|---|---|----|----|
| | | T1 | T2 | T3 | T1 | T2 | T3 | T1 | T2 | T3 |
| E-UTRA RF Channel Number | | 1 | | | 2 | | | 3 | | |
| BW _{channel} | MHz | 5MHz: N _{RB,c} = 25 10MHz: N _{RB,c} = 50 20MHz: N _{RB,c} = 100 | | | 5MHz: N _{RB,c} = 25 10MHz: N _{RB,c} = 50 20MHz: N _{RB,c} = 100 | | | 5MHz: N _{RB,c} = 25 10MHz: N _{RB,c} = 50 20MHz: N _{RB,c} = 100 | | |
| Special subframe configuration | | - | | | 6 | | | 6 | | |
| Uplink-downlink configuration | | - | | | 1 | | | 1 | | |
| PDSCH parameters: DL Reference Measurement Channel | | 5MHz: R.7 FDD 10MHz: R.3 FDD 20MHz: R.6 FDD | | | - | | | - | | |
| PCFICH/PDCCH/PHICH parameters: DL Reference Measurement Channel | | 5MHz: R.11 FDD 10MHz: R.6 FDD 20MHz: R.10 FDD | | | 5MHz: R.11 TDD 10MHz: R.6 TDD 20MHz: R.10 TDD | | | 5MHz: R.11 TDD 10MHz: R.6 TDD 20MHz: R.10 TDD | | |
| OCNG Patterns | | 5MHz: OP.20 FDD 10MHz: OP.10 FDD 20MHz: OP.17 FDD | | | 5MHz: OP.10 TDD 10MHz: OP.2 TDD 20MHz: OP.8 TDD | | | 5MHz: OP.10 TDD 10MHz: OP.2 TDD 20MHz: OP.8 TDD | | |
| PBCH_RA | dB | 0 | | | 0 | | | 0 | | |
| PBCH_RB | dB | | | | | | | | | |
| PSS_RA | dB | | | | | | | | | |
| SSS_RA | dB | | | | | | | | | |
| PCFICH_RB | dB | | | | | | | | | |
| PHICH_RA | dB | | | | | | | | | |
| PHICH_RB | dB | | | | | | | | | |
| PDCCH_RA | dB | | | | | | | | | |
| PDCCH_RB | dB | | | | | | | | | |
| PDSCH_RA | dB | | | | | | | | | |
| PDSCH_RB | dB | | | | | | | | | |
| OCNG_RA ^{Note 1} | dB | | | | | | | | | |
| OCNG_RB ^{Note 1} | dB | | | | | | | | | |
| N _{oc} ^{Note 2} | dBm/15 kHz | | | | | | | | | |
| \bar{E}_s/N_{oc} | dB | 17 | | | -infinity | 17 | 17 | | | |
| \bar{E}_s/I_{ot} | dB | 17 | | | -infinity | 17 | 17 | | | |
| RSRP ^{Note 3} | dBm/15 kHz | -87 | | | -infinity | -87 | -87 | | | |
| SCH_RP ^{Note 3} | dBm/15 kHz | -87 | | | -infinity | -87 | -87 | | | |
| I _o ^{Note 3} | dBm/Ch BW | -59.13 +10log (N _{RB,c} /50) | | | -76.22 +10log (N _{RB,c} /50) | -59.13 +10log (N _{RB,c} /50) | -59.13 +10log (N _{RB,c} /50) | | | |
| Propagation Condition | | AWGN | | | AWGN | | | AWGN | | |
| Antenna Configuration | | 1x2 | | | 1x2 | | | 1x2 | | |
| Timing offset to Cell 1 | μs | - | | | 0 | | | 0 | | |
| Time alignment error relative to cell 1 ^{Note 5} | μs | - | | | ≤ TAE | | | ≤ TAE | | |
| Time alignment error relative to cell 2 ^{Note 5} | μs | - | | | - | | | ≤ TAE | | |
| Time alignment error relative to cell 3 ^{Note 5} | μs | - | | | - | | | - | | |
| <p>Note 1: OCNG shall be used such that all cells are fully allocated and a constant total transmitted power spectral density is achieved for all OFDM symbols.</p> <p>Note 2: Interference from other cells and noise sources not specified in the test is assumed to be constant over subcarriers and time and shall be modelled as AWGN of appropriate power for N_{oc} to be fulfilled.</p> <p>Note 3: Es/I_{ot}, RSRP, SCH_RP and I_o levels have been derived from other parameters for information purposes. They are not settable parameters themselves.</p> <p>Note 4: The uplink resources for CSI reporting are assigned to the UE prior to the start of time period T2.</p> <p>Note 5: Time alignment error (TAE) as specified in TS 36.104 [30] clause 6.5.3.1. The TAE value depends upon the type of carrier aggregation.</p> | | | | | | | | | | |

Table A.8.16.63.1-3: Cell specific test parameters for E-UTRAN TDD unknown SCell1 activation with PCell in FDD

| Parameter | Unit | Cell 4 | | | | | | | |
|--|------------|---|----|----|------|--|--|--|--|
| | | T1 | T2 | T3 | | | | | |
| E-UTRA RF Channel Number | | 4 | | | | | | | |
| BW _{channel} | MHz | 5MHz: N _{RB,c} = 25 10MHz: N _{RB,c} = 50 20MHz: N _{RB,c} = 100 | | | | | | | |
| Special subframe configuration | | 6 | | | | | | | |
| Uplink-downlink configuration | | 1 | | | | | | | |
| PDSCH parameters: DL Reference Measurement Channel | | - | | | | | | | |
| PCFICH/PDCCH/PHICH parameters: DL Reference Measurement Channel | | 5MHz: R.11 TDD 10MHz: R.6 TDD 20MHz: R.10 TDD | | | | | | | |
| OCNG Patterns | | 5MHz: OP.10 TDD 10MHz: OP.2 TDD 20MHz: OP.8 TDD | | | | | | | |
| PBCH_RA | dB | 0 | | | | | | | |
| PBCH_RB | dB | | | | | | | | |
| PSS_RA | dB | | | | | | | | |
| SSS_RA | dB | | | | | | | | |
| PCFICH_RB | dB | | | | | | | | |
| PHICH_RA | dB | | | | | | | | |
| PHICH_RB | dB | | | | | | | | |
| PDCCH_RA | dB | | | | | | | | |
| PDCCH_RB | dB | | | | | | | | |
| PDSCH_RA | dB | | | | | | | | |
| PDSCH_RB | dB | | | | | | | | |
| OCNG_RA ^{Note 1} | dB | | | | | | | | |
| OCNG_RB ^{Note 1} | dB | | | | | | | | |
| N _{oc} ^{Note 2} | dBm/15 kHz | | | | -104 | | | | |
| \bar{E}_s/N_{oc} | dB | 17 | | | | | | | |
| \bar{E}_s/I_{ot} | dB | 17 | | | | | | | |
| RSRP ^{Note 3} | dBm/15 kHz | -87 | | | | | | | |
| SCH_RP ^{Note 3} | dBm/15 kHz | -87 | | | | | | | |
| I _o ^{Note 3} | dBm/Ch BW | -59.13 +10log (N _{RB,c} /50) | | | | | | | |
| Propagation Condition | | AWGN | | | | | | | |
| Antenna Configuration | | 1x2 | | | | | | | |
| Timing offset to Cell 1 | μs | 0 | | | | | | | |
| Time alignment error relative to cell 1 ^{Note 5} | μs | ≤ TAE | | | | | | | |
| Time alignment error relative to cell 2 ^{Note 5} | μs | ≤ TAE | | | | | | | |
| Time alignment error relative to cell 3 ^{Note 5} | μs | ≤ TAE | | | | | | | |
| <p>Note 1: OCNG shall be used such that all cells are fully allocated and a constant total transmitted power spectral density is achieved for all OFDM symbols.</p> <p>Note 2: Interference from other cells and noise sources not specified in the test is assumed to be constant over subcarriers and time and shall be modelled as AWGN of appropriate power for N_{oc} to be fulfilled.</p> <p>Note 3: Es/I_{ot}, RSRP, SCH_RP and I_o levels have been derived from other parameters for information purposes. They are not settable parameters themselves.</p> <p>Note 4: The uplink resources for CSI reporting are assigned to the UE prior to the start of time period T2.</p> <p>Note 5: Time alignment error (TAE) as specified in TS 36.104 [30] clause 6.5.3.1. The TAE value depends upon the type of carrier aggregation.</p> | | | | | | | | | |

A.8.16.63.2 Test Requirements

During T2 the UE shall send the first CSI report for SCell1 in a subframe (m+8), or in a subframe (m+10) if the subframe (m+8) was subject to interruption. Whether CSI report in subframe (m+8) was interrupted or not is checked by monitoring ACK/NACK sent in PCell in subframe (m+8).

During T2 the UE shall start sending CSI reports for SCell1 with non-zero CQI index at latest in a subframe (m+44).

During T3 the UE shall stop sending CSI reports for SCell1 at latest in a subframe (n+8).

During T2 interruption of PCell during SCells activation shall not happen outside the subframes (m+5) to (m+9), outside the subframes (m+15) to (m+19), and outside the subframes (m+25) to (m+29).

During T3 interruption of PCell during SCells deactivation shall not happen outside the subframes (n+5) to (n+9), outside the subframes (n+15) to (n+19), and (n+25) to (n+29).

The interruption of PCell shall not be more than the values specified for intra-band CA and inter-band CA in Section 7.8.2.

All of the above test requirements shall be fulfilled in order for the observed SCell1 activation delay and SCell1 deactivation delay to be counted as correct. The rate of correct observed SCell1 activation delay and SCell1 deactivation delay during repeated tests shall be at least 90%.

NOTE: During T2 if there are no uplink resources for reporting the valid CSI in a subframe (m+44) then the UE shall use the next available uplink resource for reporting the corresponding valid CSI.

A.8.16.64 E-UTRAN PCell in TDD FDD-TDD 4 DL CA activation and deactivation of unknown SCell in non-DRX

A.8.16.64.1 Test Purpose and Environment

The purpose of this test is to verify that the SCell activation and deactivation times are within the requirements stated in section 7.7 for UE configured with three downlink SCells, when the SCell is unknown by the UE at the time of activation and PCell is in TDD.

The test parameters are given in Tables A.8.16.64.1-1 and cell-specific parameters in A.8.16.64.1-2 and A.8.16.64.1-3 below. The test consists of three successive time periods, with duration of T1, T2 and T3, respectively. There are four carriers, each with one cell. Cell 1, Cell 3 and Cell 4 have constant signal levels throughout the test. Before the test starts the UE is connected to Cell 1 (PCell) on radio channel 1 (PCC), deactivated Cell 3 (SCell2) on radio channel 3 (SCC2) and deactivated Cell 4 (SCell3) on radio channel 4 (SCC3) but is not aware of Cell 2 (SCell1) on radio channel 2 (SCC1). The UE is only monitoring PCC, SCC2 and SCC3. The UE shall be continuously scheduled in PCell throughout the whole test.

At the beginning of T1 the UE receives an RRC message by which SCell1 becomes configured on SCC1. During T1 SCell1 is powered off and the UE is not aware of SCell1.

A MAC message for activation of SCell1 is sent by the test equipment 100ms after the RRC message, in a subframe # denoted m which is 4 or 9. The point in time at which the MAC message for activation of SCell1 is received at the UE antenna connector defines the start of time period T2. Immediately at beginning of T2 the transmission power of SCell1 is increased to same level as for PCell. The test equipment sends a MAC message for activation of SCell2 in subframe (m+15) and a MAC message for activation of SCell3 in subframe (m+30) during activation of SCell1. The UE shall be able to report valid CSI for the activated SCell1 at latest in subframe (m+44) provided the SCell1 can be successfully detected on the first attempt. The UE shall start reporting CSI for SCell1 in subframe (m+8) and shall report CQI index 0 (out-of-range) until the SCell activation has been completed. Any PCell interruption due to activation of SCells shall not occur outside subframes (m+5) to (m+11), (m+20) to (m+26) and (m+35) to (m+41).

Time period T3 starts when a MAC message for deactivation of SCell1, sent from the test equipment to the UE in a subframe # denoted n, where n is 4 or 9, is received at the UE antenna connector. The test equipment sends a MAC message for deactivation of the SCell2 in subframe (n+15) and a MAC message for deactivation of the SCell3 in subframe (n+30). The UE shall carry out deactivation of SCell1 at latest in subframe (n+8), and any PCell interruption due to the deactivation of SCells shall not occur outside subframes (n+5) to (n+11), (n+20) to (n+26) and (n+35) to (n+41).

The test equipment verifies that potential interruption is carried out in the correct time span by monitoring ACK/NACK sent in PCell during activation and deactivation of SCell1, respectively.

The test equipment verifies the activation time by counting the subframes from time when the SCell1 activation command is sent until a CSI report with other than CQI index 0 is received.

The test equipment verifies the deactivation time by counting the subframes from time when the SCell1 deactivation command is sent until CQI reporting for SCell1 is discontinued.

Table A.8.16.64.1-1: General test parameters for unknown SCell1 activation case

| Parameter | Unit | Value | Comment |
|---|------|------------|---|
| E-UTRA RF Channel Number | | 1, 2, 3, 4 | Four radio channels are used for this test |
| Active PCell | | Cell 1 | Primary cell on RF channel number 1. |
| Deconfigured deactivated SCell | | Cell 2 | Deconfigured deactivated secondary cell on RF channel number 2. |
| Configured deactivated SCell2 | | Cell 3 | Configured deactivated secondary cell on RF channel number 3. |
| Configured deactivated SCell3 | | Cell 4 | Configured deactivated secondary cell on RF channel number 4. |
| CP length | | Normal | |
| DRX | | OFF | Continuous monitoring of primary cell |
| CQI/PMI periodicity and offset configuration index | | 0 | CQI reporting for SCell every UL subframe |
| Cell-individual offset for cells on RF channel number 1 | dB | 0 | Individual offset for cells on PCC. |
| Cell-individual offset for cells on RF channel number 2 | dB | 0 | Individual offset for cells on SCC1. |
| Cell-individual offset for cells on RF channel number 3 | dB | 0 | Individual offset for cells on SCC2. |
| Cell-individual offset for cells on RF channel number 4 | dB | 0 | Individual offset for cells on SCC3. |
| SCell measurement cycle (measCycleSCell) | ms | 320 | |
| T1 | ms | 100 | During this time the PCell, SCell2 and SCell3 shall be known and the SCell1 configured. |
| T2 | s | 1 | During this time the UE shall activate the SCell1, SCell2, and SCell3. |
| T3 | s | 1 | During this time the UE shall deactivate the SCell1, SCell2, and SCell3. |

Table A.8.16.64.1-2: Cell specific test parameters for E-UTRAN FDD unknown SCell1 activation with PCell in TDD

| Parameter | Unit | Cell 1 | | | Cell 2 | | | Cell 3 | | |
|---|------|---|----|----|---|----|----|---|----|----|
| | | T1 | T2 | T3 | T1 | T2 | T3 | T1 | T2 | T3 |
| E-UTRA RF Channel Number | | 1 | | | 2 | | | 3 | | |
| BW _{channel} | MHz | 5MHz: N _{RB,c} = 25 10MHz: N _{RB,c} = 50 20MHz: N _{RB,c} = 100 | | | 5MHz: N _{RB,c} = 25 10MHz: N _{RB,c} = 50 20MHz: N _{RB,c} = 100 | | | 5MHz: N _{RB,c} = 25 10MHz: N _{RB,c} = 50 20MHz: N _{RB,c} = 100 | | |
| Special subframe configuration | | 6 | | | - | | | - | | |
| Uplink-downlink configuration | | 1 | | | - | | | - | | |
| PDSCH parameters: DL Reference Measurement Channel | | 5MHz: R.4 TDD 10MHz: R.0 TDD 20MHz: R.3 TDD | | | - | | | - | | |
| PCFICH/PDCCH/PHICH parameters: DL Reference Measurement Channel | | 5MHz: R.11 TDD 10MHz: R.6 TDD 20MHz: R.10 TDD | | | 5MHz: R.11 FDD 10MHz: R.6 FDD 20MHz: R.10 FDD | | | 5MHz: R.11 FDD 10MHz: R.6 FDD 20MHz: R.10 FDD | | |
| OCNG Patterns | | 5MHz: OP.9 TDD 10MHz: OP.1 TDD 20MHz: OP.7 TDD | | | 5MHz: OP.16 FDD 10MHz: OP.2 FDD 20MHz: OP.12 FDD | | | 5MHz: OP.16 FDD 10MHz: OP.2 FDD 20MHz: OP.12 FDD | | |
| PBCH_RA | dB | 0 | | | 0 | | | 0 | | |
| PBCH_RB | dB | | | | | | | | | |
| PSS_RA | dB | | | | | | | | | |
| SSS_RA | dB | | | | | | | | | |
| PCFICH_RB | dB | | | | | | | | | |

| | | | | | |
|--|------------|---|---|---|---|
| PHICH_RA | dB | | | | |
| PHICH_RB | dB | | | | |
| PDCCH_RA | dB | | | | |
| PDCCH_RB | dB | | | | |
| PDSCH_RA | dB | | | | |
| PDSCH_RB | dB | | | | |
| OCNG_RA ^{Note 1} | dB | | | | |
| OCNG_RB ^{Note 1} | dB | | | | |
| N _{oc} ^{Note 2} | dBm/15 kHz | -104 | -104 | -104 | -104 |
| \hat{E}_s/N_{oc} | dB | 17 | -infinity | 17 | 17 |
| \hat{E}_s/I_{ot} | dB | 17 | -infinity | 17 | 17 |
| RSRP ^{Note 3} | dBm/15 kHz | -87 | -infinity | -87 | -87 |
| SCH_RP ^{Note 3} | dBm/15 kHz | -87 | -infinity | -87 | -87 |
| I _o ^{Note 3} | dBm/Ch BW | -59.13 +10log (N _{RB,c} /50) | -76.22 +10log (N _{RB,c} /50) | -59.13 +10log (N _{RB,c} /50) | -59.13 +10log (N _{RB,c} /50) |
| Propagation Condition | | AWGN | AWGN | AWGN | AWGN |
| Antenna Configuration | | 1x2 | 1x2 | 1x2 | 1x2 |
| Timing offset to Cell 1 | μs | - | 0 | 0 | 0 |
| Time alignment error relative to cell 1 ^{Note 5} | μs | - | ≤ TAE | ≤ TAE | ≤ TAE |
| Time alignment error relative to cell 2 ^{Note 5} | μs | - | - | ≤ TAE | ≤ TAE |
| Time alignment error relative to cell 3 ^{Note 5} | μs | - | - | - | - |
| <p>Note 1: OCNG shall be used such that all cells are fully allocated and a constant total transmitted power spectral density is achieved for all OFDM symbols.</p> <p>Note 2: Interference from other cells and noise sources not specified in the test is assumed to be constant over subcarriers and time and shall be modelled as AWGN of appropriate power for N_{oc} to be fulfilled.</p> <p>Note 3: Es/I_{ot}, RSRP, SCH_RP and I_o levels have been derived from other parameters for information purposes. They are not settable parameters themselves.</p> <p>Note 4: The uplink resources for CSI reporting are assigned to the UE prior to the start of time period T2.</p> <p>Note 5: Time alignment error (TAE) as specified in TS 36.104 [30] clause 6.5.3.1. The TAE value depends upon the type of carrier aggregation.</p> | | | | | |

Table A.8.16.64.1-3: Cell specific test parameters for E-UTRAN FDD unknown SCell1 activation with PCell in TDD

| Parameter | Unit | Cell 4 | | | | | | | |
|---|------|---|----|----|--|--|--|--|--|
| | | T1 | T2 | T3 | | | | | |
| E-UTRA RF Channel Number | | 4 | | | | | | | |
| BW _{channel} | MHz | 5MHz: N _{RB,c} = 25 10MHz: N _{RB,c} = 50 20MHz: N _{RB,c} = 100 | | | | | | | |
| Special subframe configuration | | - | | | | | | | |
| Uplink-downlink configuration | | - | | | | | | | |
| PDSCH parameters: DL Reference Measurement Channel | | - | | | | | | | |
| PCFICH/PDCCH/PHICH parameters: DL Reference Measurement Channel | | 5MHz: R.11 FDD 10MHz: R.6 FDD 20MHz: R.10 FDD | | | | | | | |
| OCNG Patterns | | 5MHz: OP.16 FDD 10MHz: OP.2 FDD 20MHz: OP.12 FDD | | | | | | | |
| PBCH_RA | dB | 0 | | | | | | | |
| PBCH_RB | dB | | | | | | | | |
| PSS_RA | dB | | | | | | | | |
| SSS_RA | dB | | | | | | | | |
| PCFICH_RB | dB | | | | | | | | |
| PHICH_RA | dB | | | | | | | | |
| PHICH_RB | dB | | | | | | | | |
| PDCCH_RA | dB | | | | | | | | |
| PDCCH_RB | dB | | | | | | | | |

| | | | | |
|---|---|---|--|--|
| PDSCH_RA | dB | | | |
| PDSCH_RB | dB | | | |
| OCNG_RA ^{Note 1} | dB | | | |
| OCNG_RB ^{Note 1} | dB | | | |
| N _{oc} ^{Note 2} | dBm/15 kHz | -104 | | |
| \bar{E}_s/N_{oc} | dB | 17 | | |
| \bar{E}_s/I_{ot} | dB | 17 | | |
| RSRP ^{Note 3} | dBm/15 kHz | -87 | | |
| SCH_RP ^{Note 3} | dBm/15 kHz | -87 | | |
| I _o ^{Note 3} | dBm/Ch BW | -59.13 +10log (N _{RB,c} /50) | | |
| Propagation Condition | | AWGN | | |
| Antenna Configuration | | 1x2 | | |
| Timing offset to Cell 1 | μs | 0 | | |
| Time alignment error relative to cell 1 ^{Note 5} | μs | ≤ TAE | | |
| Time alignment error relative to cell 2 ^{Note 5} | μs | ≤ TAE | | |
| Time alignment error relative to cell 3 ^{Note 5} | μs | ≤ TAE | | |
| Note 1: | OCNG shall be used such that all cells are fully allocated and a constant total transmitted power spectral density is achieved for all OFDM symbols. | | | |
| Note 2: | Interference from other cells and noise sources not specified in the test is assumed to be constant over subcarriers and time and shall be modelled as AWGN of appropriate power for N _{oc} to be fulfilled. | | | |
| Note 3: | Es/lot, RSRP, SCH_RP and I _o levels have been derived from other parameters for information purposes. They are not settable parameters themselves. | | | |
| Note 4: | The uplink resources for CSI reporting are assigned to the UE prior to the start of time period T2. | | | |
| Note 5: | Time alignment error (TAE) as specified in TS 36.104 [30] clause 6.5.3.1. The TAE value depends upon the type of carrier aggregation. | | | |

A.8.16.64.2 Test Requirements

During T2 the UE shall send the first CSI report for SCell1 in a subframe (m+8), or in a subframe (m+9) if the subframe (m+8) was subject to interruption. Whether CSI report in subframe (m+8) was interrupted or not is checked by monitoring ACK/NACK sent in PCell in subframe (m+8).

During T2 the UE shall start sending CSI reports for SCell1 with non-zero CQI index at latest in a subframe (m+44).

During T3 the UE shall stop sending CSI reports for SCell at latest in a subframe (n+8).

During T2 interruption of PCell during SCells activation shall not happen outside the subframes (m+5) to (m+11), outside the subframes (m+20) to (m+26), and outside the subframes (m+35) to (m+41).

During T3 interruption of PCell during SCells deactivation shall not happen outside the subframes (n+5) to (n+11), outside the subframes (n+20) to (n+26) and outside the subframes (n+35) to (n+41).

The interruption of PCell shall not be more than the values specified for intra-band CA and inter-band CA in Section 7.8.2.

All of the above test requirements shall be fulfilled in order for the observed SCell1 activation delay and SCell1 deactivation delay to be counted as correct. The rate of correct observed SCell1 activation delay and SCell1 deactivation delay during repeated tests shall be at least 90%.

NOTE: During T2 if there are no uplink resources for reporting the valid CSI in a subframe (m+44) then the UE shall use the next available uplink resource for reporting the corresponding valid CSI.

A.8.16.65 5 DL FDD-TDD with PCell in FDD CA Event Triggered Reporting with 4 Deactivated SCells in Non-DRX

A.8.16.65.1 Test Purpose and Environment

The purpose of this test is to verify that the UE correctly detects events A1 (Serving cell becomes better than threshold), A2 (Serving cell becomes worse than threshold) and A6 (Neighbour becomes better than SCell) defined in TS 36.331 [2] within the requirements stated in clause 8.3.3.2.1.

The test parameters are given in Tables A.8.16.65.1-1, A.8.16.65.1-2 and A.8.16.65.1-3 below. It is indicated to the UE in the measurement control information that event-triggered reporting with Events A1 (for only SCell1 i.e. cell2), A2 (PCell and SCells) and A6 is used. The test consists of three successive time periods, with duration of T1, T2 and T3, respectively. During T1 the UE shall not have any information on cell 6. At the beginning of T2 the transmission power of cell 6 is increased to the same level as for cell 5, and due to usage of an offset this shall result in reporting of Event A6. Also, at the beginning of T2 the transmission power of cell 2 is increased to the same level as for cell 1, which shall result in reporting of Event A1. At the beginning of T3 the transmission powers of cells 1, 2, 3, 4 and 5 are reduced below a threshold value and this shall result in reporting of Event A2 for Cell 1, for Cell 2, for Cell 3, for Cell 4 and for Cell 5.

Table A.8.16.65.1-1: General test parameters for E-UTRAN TDD-FDD 5 DL CA event triggered reporting under fading propagation conditions with 4 configured but deactivated SCells in non-DRX with PCell in FDD

| Parameter | | Unit | Value | Comment |
|---|-----------------|------|---------------|--|
| E-UTRA RF Channel Number | | | 1, 2, 3, 4, 5 | Five radio channels are used for this test |
| Active PCell | | | Cell 1 | Primary cell on RF channel number 1. |
| Configured deactivated SCell | | | Cell 2 | Configured deactivated secondary cell on RF channel number 2. |
| Configured deactivated SCell | | | Cell 3 | Configured deactivated secondary cell on RF channel number 3. |
| Configured deactivated SCell | | | Cell 4 | Configured deactivated secondary cell on RF channel number 4. |
| Configured deactivated SCell | | | Cell 5 | Configured deactivated secondary cell on RF channel number 5. |
| Neighbour cell | | | Cell 6 | Neighbour cell to be identified on RF channel number 5. |
| CP length | | | Normal | |
| DRX | | | OFF | Continuous monitoring of primary cell |
| Special subframe configuration | | | 6 | As specified in table 4.2-1 in TS 36.211. The same configuration applies to all TDD cells (cell2, cell3, cell4, cell5 and cell6). |
| Uplink-downlink configuration | | | 1 | As specified in table 4.2-2 in TS 36.211. The same configuration applies to all TDD cells (cell2, cell3, cell4, cell5 and cell6). |
| A1 | Hysteresis | dB | 0 | Hysteresis for evaluation of event A1. |
| | Threshold RSRP | dBm | -98 | Actual RSRP threshold for event A1. Needs to take absolute accuracy tolerance in section 9.1.11.1 into account plus margin. |
| | Time To Trigger | s | 0 | |
| A2 | Hysteresis | dB | 0 | Hysteresis for evaluation of event A2. |
| | Threshold RSRP | dBm | -98 | Actual RSRP threshold for event A2. Needs to take absolute accuracy tolerance in section 9.1.11.1 into account plus margin. |
| | Time To Trigger | s | 0 | |
| A6 | Hysteresis | dB | 0 | Hysteresis for evaluation of event A6. |
| | Offset | dB | -6 | Offset parameter for evaluation of event A6. Needs to take relative accuracy tolerance in section 9.1.11.2 into account plus margin. |
| | Report on leave | | False | |
| | Time To Trigger | s | 0 | |
| Cell-individual offset for cells on RF channel number 1 | | dB | 0 | Individual offset for cells on primary component carrier. |
| Cell-individual offset for cells on RF channel number 2 | | dB | 0 | Individual offset for cells on secondary component carrier. |
| Cell-individual offset for cells on RF channel number 3 | | dB | 0 | Individual offset for cells on secondary component carrier. |
| Cell-individual offset for cells on RF channel number 4 | | dB | 0 | Individual offset for cells on secondary component carrier. |
| Cell-individual offset for cells on RF channel number 5 | | dB | 0 | Individual offset for cells on secondary component carrier. |
| Filter coefficient | | | 0 | L3 filtering is not used |
| SCell measurement cycle (measCycleSCell) | | ms | 320 | For cell2, cell3, cell4 and cell5 |
| T1 | | s | 5 | During this time the cell1, cell3, cell4 and cell5 shall be known to the UE; but cell2 and cell6 shall be unknown to the UE. |
| T2 | | s | ≤12 | UE should report Event A1 for cell2 and event A6 for cell6 within 6.4s (20xscellMeasCycle) |

| | | | |
|----|---|---|--|
| T3 | s | 5 | UE should report Event A2 within 200 ms for cell1 and within 1.6s for each of cells 2, 3, 4 and 5. |
|----|---|---|--|

Table A.8.16.65.1-2: Cell specific test parameters for E-UTRAN TDD-FDD 5 DL CA event triggered reporting under fading propagation conditions with 4 configured but deactivated SCells in non-DRX with PCell in FDD

| Parameter | Unit | Cell 1 | | | Cell 2 | | | Cell3 | | |
|--|------------|---|--|--|---|--|--|---|--|--|
| | | T1 | T2 | T3 | T1 | T2 | T3 | T1 | T2 | T3 |
| E-UTRA RF Channel Number | | 1 | | | 2 | | | 3 | | |
| BW _{channel} | | 5MHz: N _{RB,c} = 25 10MHz: N _{RB,c} = 50 20MHz: N _{RB,c} = 100 | | | 5MHz: N _{RB,c} = 25 10MHz: N _{RB,c} = 50 20MHz: N _{RB,c} = 100 | | | 5MHz: N _{RB,c} = 25 10MHz: N _{RB,c} = 50 20MHz: N _{RB,c} = 100 | | |
| PDSCH parameters: DL Reference Measurement Channel | | 5MHz: R.5 FDD 10MHz: R.0 FDD 20MHz: R.4 FDD | | | - | | | - | | |
| PCFICH/PDCCH/PHICH parameters: DL Reference Measurement Channel | | 5MHz: R.11 FDD 10MHz: R.6 FDD 20MHz: R.10 FDD | | | 5MHz: R.11 TDD 10MHz: R.6 TDD 20MHz: R.10 TDD | | | 5MHz: R.11 TDD 10MHz: R.6 TDD 20MHz: R.10 TDD | | |
| OCNG Patterns | | 5MHz: OP.15 FDD 10MHz: OP.1 FDD 20MHz: OP.11 FDD | | | 5MHz: OP.10 TDD 10MHz: OP.2 TDD 20MHz: OP.8 TDD | | | 5MHz: OP.10 TDD 10MHz: OP.2 TDD 20MHz: OP.8 TDD | | |
| PBCH_RA | dB | 0 | | | 0 | | | 0 | | |
| PBCH_RB | dB | | | | | | | | | |
| PSS_RA | dB | | | | | | | | | |
| SSS_RA | dB | | | | | | | | | |
| PCFICH_RB | dB | | | | | | | | | |
| PHICH_RA | dB | | | | | | | | | |
| PHICH_RB | dB | | | | | | | | | |
| PDCCH_RA | dB | | | | | | | | | |
| PDCCH_RB | dB | | | | | | | | | |
| PDSCH_RA | dB | | | | | | | | | |
| PDSCH_RB | dB | | | | | | | | | |
| OCNG_RA ^{Note 1} | dB | | | | | | | | | |
| OCNG_RB ^{Note 1} | dB | | | | | | | | | |
| N _{oc} ^{Note 2} | dBm/15 KHz | | | | | | | | | |
| \bar{E}_s/N_{oc} | dB | 17 | 17 | -3 | -infinity | 17 | -3 | 17 | 17 | -3 |
| \bar{E}_s/I_{ot} ^{Note 3} | dB | 17 | 17 | -3 | -infinity | 17 | -3 | 17 | 17 | -3 |
| RSRP ^{Note 3} | dBm/15 kHz | -87 | -87 | -107 | -infinity | -87 | -107 | -87 | -87 | -107 |
| SCH_RP ^{Note 3} | dBm/15 kHz | -87 | -87 | -107 | -infinity | -87 | -107 | -87 | -87 | -107 |
| I _o ^{Note 3} | dBm/Ch BW | -59.13 +10log (N _{RB,c} /50) | -59.13 +10log (N _{RB,c} /50) | -74.45 +10log (N _{RB,c} /50) | -76.22 +10log (N _{RB,c} /50) | -59.13 +10log (N _{RB,c} /50) | -74.45 +10log (N _{RB,c} /50) | -59.13 +10log (N _{RB,c} /50) | -59.13 +10log (N _{RB,c} /50) | -74.45 +10log (N _{RB,c} /50) |
| Propagation Condition | | AWGN | | | ETU70 | | | ETU70 | | |
| Correlation Matrix and Antenna Configuration | | 1x2 Low | | | 1x2 Low | | | 1x2 Low | | |
| Timing offset to Cell 1 | μs | - | | | 0 | | | 0 | | |
| Time alignment error relative to cell1 ^{Note 5} | μs | - | | | ≤ TAE | | | ≤ TAE | | |
| Time alignment error relative to cell 2 ^{Note 5} | μs | ≤ TAE | | | - | | | ≤ TAE | | |
| Time alignment error relative to cell 3 ^{Note 5} | μs | ≤ TAE | | | ≤ TAE | | | - | | |
| Time alignment error relative to cell 4 ^{Note 5} | μs | ≤ TAE | | | ≤ TAE | | | ≤ TAE | | |
| Time alignment error relative to cell 5 ^{Note 5} | μs | ≤ TAE | | | ≤ TAE | | | ≤ TAE | | |

- Note 1: OCNB shall be used such that all cells are fully allocated and a constant total transmitted power spectral density is achieved for all OFDM symbols.
- Note 2: Interference from other cells and noise sources not specified in the test is assumed to be constant over subcarriers and time and shall be modelled as AWGN of appropriate power for N_{oc} to be fulfilled.
- Note 3: E_s/I_{ot} , RSRP, SCH_RP and I_o have been derived from other parameters for information purposes. They are not settable parameters themselves.
- Note 4: The resources for uplink transmission are assigned to the UE prior to the start of time period T2.
- Note 5: Time alignment error (TAE) as specified in TS 36.104 [30] clause 6.5.3.1. The TAE value depends upon the type of carrier aggregation.

Table A.8.16.65.1-3: Cell specific test parameters for E-UTRAN TDD-FDD 5 DL CA event triggered reporting under fading propagation conditions with 4 configured but deactivated SCells in non-DRX with PCell in FDD

| Parameter | Unit | Cell 4 | | | Cell 5 | | | Cell 6 | | |
|--|------------|--|--|--|--|--|--|---|-------|-------|
| | | T1 | T2 | T3 | T1 | T2 | T3 | T1 | T2 | T3 |
| E-UTRA RF Channel Number | | 4 | | | 5 | | | | | |
| $BW_{channel}$ | | 5MHz: $N_{RB,c} = 25$ 10MHz: $N_{RB,c} = 50$ 20MHz: $N_{RB,c} = 100$ | | | 5MHz: $N_{RB,c} = 25$ 10MHz: $N_{RB,c} = 50$ 20MHz: $N_{RB,c} = 100$ | | | | | |
| PDSCH parameters: DL Reference Measurement Channel | | - | | | - | | | - | | |
| PCFICH/PDCCH/PHI CH parameters: DL Reference Measurement Channel | | 5MHz: R.11 TDD 10MHz: R.6 TDD 20MHz: R.10 TDD | | | 5MHz: R.11 TDD 10MHz: R.6 TDD 20MHz: R.10 TDD | | | 5MHz: R.11 TDD 10MHz: R.6 TDD 20MHz: R.10 TDD | | |
| OCNB Patterns | | 5MHz: OP.10 TDD 10MHz: OP.2 TDD 20MHz: OP.8 TDD | | | 5MHz: OP.10 TDD 10MHz: OP.2 TDD 20MHz: OP.8 TDD | | | 5MHz: OP.10 TDD 10MHz: OP.2 TDD 20MHz: OP.8 TDD | | |
| PBCH_RA | dB | 0 | | | 0 | | | 0 | | |
| PBCH_RB | dB | | | | | | | | | |
| PSS_RA | dB | | | | | | | | | |
| SSS_RA | dB | | | | | | | | | |
| PCFICH_RB | dB | | | | | | | | | |
| PHICH_RA | dB | | | | | | | | | |
| PHICH_RB | dB | | | | | | | | | |
| PDCCH_RA | dB | | | | | | | | | |
| PDCCH_RB | dB | | | | | | | | | |
| PDSCH_RA | dB | | | | | | | | | |
| PDSCH_RB | dB | | | | | | | | | |
| OCNB_RA ^{Note 1} | dB | | | | | | | | | |
| OCNB_RB ^{Note 1} | dB | | | | | | | | | |
| N_{oc} ^{Note 2} | dBm/15 KHz | | | | | | | | | |
| \bar{E}_s/N_{oc} | dB | 17 | 17 | -3 | 17 | 17 | -3 | -infinity | 17 | -3 |
| \bar{E}_s/I_{ot} ^{Note 3} | dB | 17 | 17 | -3 | 17 | -0.09 | -4.76 | -infinity | -0.09 | -4.76 |
| RSRP ^{Note 3} | dBm/15 kHz | -87 | -87 | -107 | -87 | -87 | -107 | -infinity | -87 | -107 |
| SCH_RP ^{Note 3} | dBm/15 kHz | -87 | -87 | -107 | -87 | -87 | -107 | -infinity | -87 | -107 |
| I_o ^{Note 3} | dBm/Ch BW | -59.13 +10log ($N_{RB,c}$ /50) | -59.13 +10log ($N_{RB,c}$ /50) | -74.45 +10log ($N_{RB,c}$ /50) | -59.13 +10log ($N_{RB,c}$ /50) | -56.17 +10log ($N_{RB,c}$ /50) | -73.20 +10log ($N_{RB,c}$ /50) | Specified in columns for Cell 5 | | |
| Propagation Condition | | ETU70 | | | ETU70 | | | ETU70 | | |
| Correlation Matrix and Antenna Configuration | | 1x2 Low | | | 1x2 Low | | | 1x2 Low | | |
| Timing offset to Cell 1 | μ s | 0 | | | 0 | | | 3 | | |
| Time alignment error relative to cell1 ^{Note 5} | μ s | - | | | - | | | NA | | |
| Time alignment error relative to cell2 ^{Note 5} | μ s | - | | | - | | | NA | | |
| Time alignment error relative to cell3 ^{Note 5} | μ s | - | | | - | | | NA | | |
| Time alignment error relative to cell4 ^{Note 5} | μ s | - | | | - | | | NA | | |
| Time alignment error relative to cell5 ^{Note 5} | μ s | - | | | - | | | NA | | |

| | |
|---------|--|
| Note 1: | OCNG shall be used such that all cells are fully allocated and a constant total transmitted power spectral density is achieved for all OFDM symbols. |
| Note 2: | Interference from other cells and noise sources not specified in the test is assumed to be constant over subcarriers and time and shall be modelled as AWGN of appropriate power for N_{oc} to be fulfilled. |
| Note 3: | E_s/lot , RSRP, SCH_RP and I_o have been derived from other parameters for information purposes. They are not settable parameters themselves. |
| Note 4: | The resources for uplink transmission are assigned to the UE prior to the start of time period T2. |
| Note 5: | Time alignment error (TAE) as specified in TS 36.104 [30] clause 6.5.3.1. The TAE value depends upon the type of carrier aggregation. |

A.8.16.65.2 Test Requirements

The UE shall send one Event A6 triggered measurement report for Cell 6 with a measurement reporting delay of less than 6.4s ($20 \times \text{measCycleSCell}$) from the beginning of time T2.

The UE shall send one Event A1 triggered measurement report for Cell 2 with a measurement reporting delay of less than 6.4s ($20 \times \text{measCycleSCell}$) from beginning of time T2.

The UE shall send one Event A2 triggered measurement report for Cell 1 with a measurement reporting delay of less than 200 ms from beginning of time T3.

The UE shall send one Event A2 triggered measurement report for Cell 2 with a measurement reporting delay of less than 1.6s ($5 \times \text{measCycleSCell}$) from beginning of time T3.

The UE shall send one Event A2 triggered measurement report for Cell 3 with a measurement reporting delay of less than 1.6s ($5 \times \text{measCycleSCell}$) from beginning of time T3.

The UE shall send one Event A2 triggered measurement report for Cell 4 with a measurement reporting delay of less than 1.6s ($5 \times \text{measCycleSCell}$) from beginning of time T3.

The UE shall send one Event A2 triggered measurement report for Cell 5 with a measurement reporting delay of less than 1.6s ($5 \times \text{measCycleSCell}$) from beginning of time T3.

The UE shall not send event triggered measurement reports as long as the reporting criteria are not fulfilled.

The rate of correct events observed during repeated tests shall be at least 90% for each of the events.

NOTE: The actual overall delays measured in the tests may be up to $2 \times TTI_{DCCH}$ higher than the measurement reporting delays above because of TTI insertion uncertainty of the measurement report in DCCH.

A.8.16.66 5 DL FDD-TDD with PCell in TDD CA Event Triggered Reporting with 4 Deactivated SCells in Non-DRX

A.8.16.66.1 Test Purpose and Environment

The purpose of this test is to verify that the UE correctly detects events A1 (Serving cell becomes better than threshold), A2 (Serving cell becomes worse than threshold) and A6 (Neighbour becomes better than SCell) defined in TS 36.331 [2] within the requirements stated in clause 8.3.3.2.1.

The test parameters are given in Tables A.8.16.66.1-1, Tables A.8.16.66.1-2 and A.8.16.66.1-3 below. It is indicated to the UE in the measurement control information that event-triggered reporting with Events A1 (for only SCell1 i.e. cell2), A2 (PCell and SCells) and A6 is used. The test consists of three successive time periods, with duration of T1, T2 and T3, respectively. During T1 the UE shall not have any information on cell 6. At the beginning of T2 the transmission power of cell 6 is increased to the same level as for cell 5, and due to usage of an offset this shall result in reporting of Event A6. Also, at the beginning of T2 the transmission power of cell 2 is increased to the same level as for cell 1, which shall result in reporting of Event A1. At the beginning of T3 the transmission powers of cells 1, 2, 3, 4 and 5 are reduced below a threshold value and this shall result in reporting of Event A2 for Cell 1, for Cell 2, for Cell 3, for Cell 4 and for Cell 5.

Table A.8.16.66.1-1: General test parameters for E-UTRAN TDD-FDD 5 DL CA event triggered reporting under fading propagation conditions with 4 configured but deactivated SCells in non-DRX with PCell in TDD

| Parameter | Unit | Value | Comment |
|--------------------------|------|---------------|--|
| E-UTRA RF Channel Number | | 1, 2, 3, 4, 5 | Five radio channels are used for this test |
| Active PCell | | Cell 1 | Primary cell on RF channel number 1. |

| | | | | |
|---|-----------------|--------|--|--|
| Configured deactivated SCell | | Cell 2 | Configured deactivated secondary cell on RF channel number 2. | |
| Configured deactivated SCell | | Cell 3 | Configured deactivated secondary cell on RF channel number 3. | |
| Configured deactivated SCell | | Cell 4 | Configured deactivated secondary cell on RF channel number 4. | |
| Configured deactivated SCell | | Cell 5 | Configured deactivated secondary cell on RF channel number 5. | |
| Neighbour cell | | Cell 6 | Neighbour cell to be identified on RF channel number 5. | |
| CP length | | Normal | | |
| DRX | | OFF | Continuous monitoring of primary cell | |
| Special subframe configuration | | 6 | As specified in table 4.2-1 in TS 36.211. The configuration applies to the TDD cell (cell1). | |
| Uplink-downlink configuration | | 1 | As specified in table 4.2-2 in TS 36.211. The configuration applies to the TDD cell (cell1). | |
| A1 | Hysteresis | dB | 0 | Hysteresis for evaluation of event A1. |
| | Threshold RSRP | dBm | -98 | Actual RSRP threshold for event A1. Needs to take absolute accuracy tolerance in section 9.1.11.1 into account plus margin. |
| | Time To Trigger | s | 0 | |
| A2 | Hysteresis | dB | 0 | Hysteresis for evaluation of event A2. |
| | Threshold RSRP | dBm | -98 | Actual RSRP threshold for event A2. Needs to take absolute accuracy tolerance in section 9.1.11.1 into account plus margin. |
| | Time To Trigger | s | 0 | |
| A6 | Hysteresis | dB | 0 | Hysteresis for evaluation of event A6. |
| | Offset | dB | -6 | Offset parameter for evaluation of event A6. Needs to take relative accuracy tolerance in section 9.1.11.2 into account plus margin. |
| | Report on leave | | False | |
| | Time To Trigger | s | 0 | |
| Cell-individual offset for cells on RF channel number 1 | dB | 0 | Individual offset for cells on primary component carrier. | |
| Cell-individual offset for cells on RF channel number 2 | dB | 0 | Individual offset for cells on secondary component carrier. | |
| Cell-individual offset for cells on RF channel number 3 | dB | 0 | Individual offset for cells on secondary component carrier. | |
| Cell-individual offset for cells on RF channel number 4 | dB | 0 | Individual offset for cells on secondary component carrier. | |
| Cell-individual offset for cells on RF channel number 5 | dB | 0 | Individual offset for cells on secondary component carrier. | |
| Filter coefficient | | 0 | L3 filtering is not used | |
| SCell measurement cycle (measCycleSCell) | ms | 320 | For cell2, cell3, cell4 and cell5 | |
| T1 | s | 5 | During this time the cell1, cell3, cell4 and cell5 shall be known to the UE; but cell2 and cell6 shall be unknown to the UE. | |
| T2 | s | ≤12 | UE should report Event A1 for cell2 and event A6 for cell6 within 6.4s (20×sCellMeasCycle) | |
| T3 | s | 5 | UE should report Event A2 within 200 ms for cell1 and within 1.6s for each of cells 2, 3, 4 and 5. | |

Table A.8.16.66.1-2: Cell specific test parameters for E-UTRAN TDD-FDD 5 DL CA event triggered reporting under fading propagation conditions with 4 configured but deactivated SCells in non-DRX with PCell in TDD

| Parameter | Unit | Cell 1 | | | Cell 2 | | | Cell3 | | |
|--|------------|---|--|--|---|--|--|---|--|--|
| | | T1 | T2 | T3 | T1 | T2 | T3 | T1 | T2 | T3 |
| E-UTRA RF Channel Number | | 1 | | | 2 | | | 3 | | |
| BW _{channel} | | 5MHz: N _{RB,c} = 25 10MHz: N _{RB,c} = 50 20MHz: N _{RB,c} = 100 | | | 5MHz: N _{RB,c} = 25 10MHz: N _{RB,c} = 50 20MHz: N _{RB,c} = 100 | | | 5MHz: N _{RB,c} = 25 10MHz: N _{RB,c} = 50 20MHz: N _{RB,c} = 100 | | |
| PDSCH parameters: DL Reference Measurement Channel | | 5MHz: R.4 TDD 10MHz: R.0 TDD 20MHz: R.3 TDD | | | - | | | - | | |
| PCFICH/PDCCH/PHICH parameters: DL Reference Measurement Channel | | 5MHz: R.11 TDD 10MHz: R.6 TDD 20MHz: R.10 TDD | | | 5MHz: R.11 FDD 10MHz: R.6 FDD 20MHz: R.10 FDD | | | 5MHz: R.11 FDD 10MHz: R.6 FDD 20MHz: R.10 FDD | | |
| OCNG Patterns | | 5MHz: OP.9 TDD 10MHz: OP.1 TDD 20MHz: OP.7 TDD | | | 5MHz: OP.16 FDD 10MHz: OP.2 FDD 20MHz: OP.12 FDD | | | 5MHz: OP.16 FDD 10MHz: OP.2 FDD 20MHz: OP.12 FDD | | |
| PBCH_RA | dB | 0 | | | 0 | | | 0 | | |
| PBCH_RB | dB | | | | | | | | | |
| PSS_RA | dB | | | | | | | | | |
| SSS_RA | dB | | | | | | | | | |
| PCFICH_RB | dB | | | | | | | | | |
| PHICH_RA | dB | | | | | | | | | |
| PHICH_RB | dB | | | | | | | | | |
| PDCCH_RA | dB | | | | | | | | | |
| PDCCH_RB | dB | | | | | | | | | |
| PDSCH_RA | dB | | | | | | | | | |
| PDSCH_RB | dB | | | | | | | | | |
| OCNG_RA ^{Note 1} | dB | | | | | | | | | |
| OCNG_RB ^{Note 1} | dB | | | | | | | | | |
| N _{oc} ^{Note 2} | dBm/15 KHz | | | | | | | | | |
| \bar{E}_s/N_{oc} | dB | 17 | 17 | -3 | -infinity | 17 | -3 | 17 | 17 | -3 |
| \bar{E}_s/I_{ot} ^{Note 3} | dB | 17 | 17 | -3 | -infinity | 17 | -3 | 17 | 17 | -3 |
| RSRP ^{Note 3} | dBm/15 kHz | -87 | -87 | -107 | -infinity | -87 | -107 | -87 | -87 | -107 |
| SCH_RP ^{Note 3} | dBm/15 kHz | -87 | -87 | -107 | -infinity | -87 | -107 | -87 | -87 | -107 |
| I _o ^{Note 3} | dBm/Ch BW | -59.13 +10log (N _{RB,c} /50) | -59.13 +10log (N _{RB,c} /50) | -74.45 +10log (N _{RB,c} /50) | -76.22 +10log (N _{RB,c} /50) | -59.13 +10log (N _{RB,c} /50) | -74.45 +10log (N _{RB,c} /50) | -59.13 +10log (N _{RB,c} /50) | -59.13 +10log (N _{RB,c} /50) | -74.45 +10log (N _{RB,c} /50) |
| Propagation Condition | | AWGN | | | ETU70 | | | ETU70 | | |
| Correlation Matrix and Antenna Configuration | | 1x2 Low | | | 1x2 Low | | | 1x2 Low | | |
| Timing offset to Cell 1 | μs | - | | | 0 | | | 0 | | |
| Time alignment error relative to cell1 ^{Note 5} | μs | - | | | ≤ TAE | | | ≤ TAE | | |
| Time alignment error relative to cell 2 ^{Note 5} | μs | ≤ TAE | | | - | | | ≤ TAE | | |
| Time alignment error relative to cell 3 ^{Note 5} | μs | ≤ TAE | | | ≤ TAE | | | - | | |
| Time alignment error relative to cell 4 ^{Note 5} | μs | ≤ TAE | | | ≤ TAE | | | ≤ TAE | | |
| Time alignment error relative to cell 5 ^{Note 5} | μs | ≤ TAE | | | ≤ TAE | | | ≤ TAE | | |

| | |
|---------|--|
| Note 1: | OCNG shall be used such that all cells are fully allocated and a constant total transmitted power spectral density is achieved for all OFDM symbols. |
| Note 2: | Interference from other cells and noise sources not specified in the test is assumed to be constant over subcarriers and time and shall be modelled as AWGN of appropriate power for N_{oc} to be fulfilled. |
| Note 3: | E_s/I_{ot} , RSRP, SCH_RP and I_o have been derived from other parameters for information purposes. They are not settable parameters themselves. |
| Note 4: | The resources for uplink transmission are assigned to the UE prior to the start of time period T2. |
| Note 5: | Time alignment error (TAE) as specified in TS 36.104 [30] clause 6.5.3.1. The TAE value depends upon the type of carrier aggregation. |

Table A.8.16.66.1-3: Cell specific test parameters for E-UTRAN TDD-FDD 5 DL CA event triggered reporting under fading propagation conditions with 4 configured but deactivated SCells in non-DRX with PCell in FDD

| Parameter | Unit | Cell 4 | | | Cell 5 | | | Cell 6 | | |
|--|------------|--|--|--|--|--|--|--|-------|-------|
| | | T1 | T2 | T3 | T1 | T2 | T3 | T1 | T2 | T3 |
| E-UTRA RF Channel Number | | 4 | | | 5 | | | | | |
| $BW_{channel}$ | | 5MHz: $N_{RB,c} = 25$ 10MHz: $N_{RB,c} = 50$ 20MHz: $N_{RB,c} = 100$ | | | 5MHz: $N_{RB,c} = 25$ 10MHz: $N_{RB,c} = 50$ 20MHz: $N_{RB,c} = 100$ | | | | | |
| PDSCH parameters: DL Reference Measurement Channel | | - | | | - | | | - | | |
| PCFICH/PDCCH/PHI CH parameters: DL Reference Measurement Channel | | 5MHz: R.11 FDD 10MHz: R.6 FDD 20MHz: R.10 FDD | | | 5MHz: R.11 FDD 10MHz: R.6 FDD 20MHz: R.10 FDD | | | 5MHz: R.11 FDD 10MHz: R.6 FDD 20MHz: R.10 FDD | | |
| OCNG Patterns | | 5MHz: OP.16 FDD 10MHz: OP.2 FDD 20MHz: OP.12 FDD | | | 5MHz: OP.16 FDD 10MHz: OP.2 FDD 20MHz: OP.12 FDD | | | 5MHz: OP.16 FDD 10MHz: OP.2 FDD 20MHz: OP.12 FDD | | |
| PBCH_RA | dB | 0 | | | 0 | | | 0 | | |
| PBCH_RB | dB | | | | | | | | | |
| PSS_RA | dB | | | | | | | | | |
| SSS_RA | dB | | | | | | | | | |
| PCFICH_RB | dB | | | | | | | | | |
| PHICH_RA | dB | | | | | | | | | |
| PHICH_RB | dB | | | | | | | | | |
| PDCCH_RA | dB | | | | | | | | | |
| PDCCH_RB | dB | | | | | | | | | |
| PDSCH_RA | dB | | | | | | | | | |
| PDSCH_RB | dB | | | | | | | | | |
| OCNG_RA ^{Note 1} | dB | | | | | | | | | |
| OCNG_RB ^{Note 1} | dB | | | | | | | | | |
| N_{oc} ^{Note 2} | dBm/15 KHz | -104 | | | -104 | | | | | |
| \bar{E}_s/N_{oc} | dB | 17 | 17 | -3 | 17 | 17 | -3 | -infinity | 17 | -3 |
| \bar{E}_s/I_{ot} ^{Note 3} | dB | 17 | 17 | -3 | 17 | -0.09 | -4.76 | -infinity | -0.09 | -4.76 |
| RSRP ^{Note 3} | dBm/15 kHz | -87 | -87 | -107 | -87 | -87 | -107 | -infinity | -87 | -107 |
| SCH_RP ^{Note 3} | dBm/15 kHz | -87 | -87 | -107 | -87 | -87 | -107 | -infinity | -87 | -107 |
| I_o ^{Note 3} | dBm/Ch BW | -59.13 +10log ($N_{RB,c}$ /50) | -59.13 +10log ($N_{RB,c}$ /50) | -74.45 +10log ($N_{RB,c}$ /50) | -59.13 +10log ($N_{RB,c}$ /50) | -56.17 +10log ($N_{RB,c}$ /50) | -73.20 +10log ($N_{RB,c}$ /50) | Specified in columns for Cell 5 | | |
| Propagation Condition | | ETU70 | | | ETU70 | | | ETU70 | | |
| Correlation Matrix and Antenna Configuration | | 1x2 Low | | | 1x2 Low | | | 1x2 Low | | |
| Timing offset to Cell 1 | μ s | 0 | | | 0 | | | 3 | | |
| Time alignment error relative to cell1 ^{Note 5} | μ s | - | | | - | | | NA | | |
| Time alignment error relative to cell2 ^{Note 5} | μ s | - | | | - | | | NA | | |
| Time alignment error relative to cell3 ^{Note 5} | μ s | - | | | - | | | NA | | |
| Time alignment error relative to cell4 ^{Note 5} | μ s | - | | | - | | | NA | | |
| Time alignment error relative to cell5 ^{Note 5} | μ s | - | | | - | | | NA | | |

| | |
|---------|--|
| Note 1: | OCNG shall be used such that all cells are fully allocated and a constant total transmitted power spectral density is achieved for all OFDM symbols. |
| Note 2: | Interference from other cells and noise sources not specified in the test is assumed to be constant over subcarriers and time and shall be modelled as AWGN of appropriate power for N_{oc} to be fulfilled. |
| Note 3: | E_s/lot , RSRP, SCH_RP and I_o have been derived from other parameters for information purposes. They are not settable parameters themselves. |
| Note 4: | The resources for uplink transmission are assigned to the UE prior to the start of time period T2. |
| Note 5: | Time alignment error (TAE) as specified in TS 36.104 [30] clause 6.5.3.1. The TAE value depends upon the type of carrier aggregation. |

A.8.16.66.2 Test Requirements

The UE shall send one Event A6 triggered measurement report for Cell 6 with a measurement reporting delay of less than 6.4s ($20 \times \text{measCycleSCell}$) from the beginning of time T2.

The UE shall send one Event A1 triggered measurement report for Cell 2 with a measurement reporting delay of less than 6.4s ($20 \times \text{measCycleSCell}$) from beginning of time T2.

The UE shall send one Event A2 triggered measurement report for Cell 1 with a measurement reporting delay of less than 200 ms from beginning of time T3.

The UE shall send one Event A2 triggered measurement report for Cell 2 with a measurement reporting delay of less than 1.6s ($5 \times \text{measCycleSCell}$) from beginning of time T3.

The UE shall send one Event A2 triggered measurement report for Cell 3 with a measurement reporting delay of less than 1.6s ($5 \times \text{measCycleSCell}$) from beginning of time T3.

The UE shall send one Event A2 triggered measurement report for Cell 4 with a measurement reporting delay of less than 1.6s ($5 \times \text{measCycleSCell}$) from beginning of time T3.

The UE shall send one Event A2 triggered measurement report for Cell 5 with a measurement reporting delay of less than 1.6s ($5 \times \text{measCycleSCell}$) from beginning of time T3.

The UE shall not send event triggered measurement reports as long as the reporting criteria are not fulfilled.

The rate of correct events observed during repeated tests shall be at least 90% for each of the events.

NOTE: The actual overall delays measured in the tests may be up to $2 \times TTI_{DCCH}$ higher than the measurement reporting delays above because of TTI insertion uncertainty of the measurement report in DCCH.

A.8.16.67 5 DL FDD-TDD with PCell in FDD CA activation and deactivation of Unknown SCell in non-DRX

A.8.16.67.1 Test Purpose and Environment

The purpose of this test is to verify that the SCell activation and deactivation times are within the requirements stated in section 7.7 for UE configured with four downlink SCells, when the SCell is unknown by the UE at the time of activation and PCell is in FDD.

The test parameters are given in Tables A.8.16.67.1-1 and cell-specific parameters in A.8.16.67.1-2 and A.8.16.67.1-3 below. The test consists of three successive time periods, with duration of T1, T2 and T3, respectively. There are five carriers, each with one cell. Cell 1, Cell 3, Cell 4 and Cell5 have constant signal levels throughout the test. Before the test starts the UE is connected to Cell 1 (PCell) on radio channel 1 (PCC), deactivated Cell 3 (SCell2) on radio channel 3 (SCC2), deactivated Cell 4 (SCell3) on radio channel 4 (SCC3) and deactivated Cell 5 (SCell4) on radio channel 5 (SCC4) but is not aware of Cell 2 (SCell1) on radio channel 2 (SCC1). The UE is only monitoring PCC, SCC2, SCC3 and SCC4. The UE shall be continuously scheduled in PCell throughout the whole test.

At the beginning of T1 the UE receives an RRC message by which the SCell1 becomes configured on SCC1. During T1 SCell1 is powered off and the UE is not aware of SCell1.

A MAC message for activation of SCell1 is sent by the test equipment 100ms after the RRC message, in a subframe # denoted m which is an even number. The point in time at which the MAC message for activation of SCell1 is received at the UE antenna connector defines the start of time period T2. Immediately at beginning of T2 transmission power of SCell1 is increased to same level as for PCell. The test equipment sends a MAC message for activation of SCell2 in a subframe (m+10), a MAC message for activation of SCell3 in subframe (m+20), and a MAC message for activation of SCell4 in a subframe (m+30) during activation of SCell1. The UE shall be able to report valid CSI for the activated SCell1 at latest in subframe (m+49). The UE shall start reporting

CSI for SCell1 in subframe (m+8) and shall report CQI index 0 (out-of-range) until the SCell activation has been completed. Any PCell interruption due to activation of SCells shall not occur outside subframes (m+5) to (m+9), (m+15) to (m+19), (m+25) to (m+29), and (m+35) to (m+39).

Time period T3 starts when a MAC message for deactivation of SCell1, sent from the test equipment to the UE in a subframe # denoted n, is received at the UE antenna connector. The test equipment sends a MAC message for deactivation of the SCell2 in subframe (n+10), a MAC message for deactivation of the SCell3 in subframe (n+20), and a MAC message for deactivation of the SCell4 in subframe (n+30). The UE shall carry out deactivation of SCell1 at latest in subframe (n+8), and any PCell interruption due to the deactivation of SCells shall not occur outside subframes (n+5) to (n+9), (n+15) to (n+19), (n+25) to (n+29), and (n+35) to (n+39).

The test equipment verifies that potential interruption is carried out in the correct time span by monitoring ACK/NACK sent in PCell during activation and deactivation of SCell1, respectively.

The test equipment verifies the activation time by counting the subframes from the time when SCell1 activation command is sent until a CSI report with other than CQI index 0 is received.

The test equipment verifies the deactivation time by counting the subframes from the time when SCell1 deactivation command is sent until CQI reporting for SCell1 is discontinued.

Table A.8.16.67.1-1: General test parameters for unknown SCell1 activation case

| Parameter | Unit | Value | Comment |
|---|------|---------------|---|
| E-UTRA RF Channel Number | | 1, 2, 3, 4, 5 | Five radio channels are used for this test |
| Active PCell | | Cell 1 | Primary cell on RF channel number 1. |
| Deconfigured deactivated SCell1 | | Cell 2 | Deconfigured deactivated secondary cell on RF channel number 2. |
| Configured deactivated SCell2 | | Cell 3 | Configured deactivated secondary cell on RF channel number 3. |
| Configured deactivated SCell3 | | Cell 4 | Configured deactivated secondary cell on RF channel number 4. |
| Configured deactivated SCell4 | | Cell 5 | Configured deactivated secondary cell on RF channel number 5. |
| CP length | | Normal | |
| DRX | | OFF | Continuous monitoring of primary cell |
| CQI/PMI periodicity and offset configuration index | | 0 | CQI reporting for SCell every second subframe |
| Cell-individual offset for cells on RF channel number 1 | dB | 0 | Individual offset for cells on PCC. |
| Cell-individual offset for cells on RF channel number 2 | dB | 0 | Individual offset for cells on SCC1. |
| Cell-individual offset for cells on RF channel number 3 | dB | 0 | Individual offset for cells on SCC2. |
| Cell-individual offset for cells on RF channel number 4 | dB | 0 | Individual offset for cells on SCC3. |
| Cell-individual offset for cells on RF channel number 5 | dB | 0 | Individual offset for cells on SCC4. |
| SCell measurement cycle (measCycleSCell) | ms | 320 | |
| T1 | ms | 100 | During this time the PCell, SCell2, SCell3 and SCell4 shall be known and the SCell1 configured. |
| T2 | s | 1 | During this time the UE shall activate the SCell1, SCell2, SCell3 and SCell4. |
| T3 | s | 1 | During this time the UE shall deactivate the SCell1, SCell2, SCell3 and SCell4. |

Table A.8.16.67.1-2: Cell specific test parameters for E-UTRAN TDD unknown SCell1 activation with PCell in FDD

| Parameter | Unit | Cell 1 | | | Cell 2 | | | Cell 3 | | |
|--------------------------|------|--------|----|----|--------|----|----|--------|----|----|
| | | T1 | T2 | T3 | T1 | T2 | T3 | T1 | T2 | T3 |
| E-UTRA RF Channel Number | | 1 | | | 2 | | | 3 | | |

| BW _{channel} | MHz | 5MHz: N _{RB,c} = 25 10MHz: N _{RB,c} = 50 20MHz: N _{RB,c} = 100 | 5MHz: N _{RB,c} = 25 10MHz: N _{RB,c} = 50 20MHz: N _{RB,c} = 100 | 5MHz: N _{RB,c} = 25 10MHz: N _{RB,c} = 50 20MHz: N _{RB,c} = 100 |
|--|------------|---|---|---|
| Special subframe configuration | | - | 6 | 6 |
| Uplink-downlink configuration | | - | 1 | 1 |
| PDSCH parameters: DL Reference Measurement Channel | | 5MHz: R.7 FDD 10MHz: R.3 FDD 20MHz: R.6 FDD | - | - |
| PCFICH/PDCCH/PHICH parameters: DL Reference Measurement Channel | | 5MHz: R.11 FDD 10MHz: R.6 FDD 20MHz: R.10 FDD | 5MHz: R.11 TDD 10MHz: R.6 TDD 20MHz: R.10 TDD | 5MHz: R.11 TDD 10MHz: R.6 TDD 20MHz: R.10 TDD |
| OCNG Patterns | | 5MHz: OP.20 FDD 10MHz: OP.10 FDD 20MHz: OP.17 FDD | 5MHz: OP.10 TDD 10MHz: OP.2 TDD 20MHz: OP.8 TDD | 5MHz: OP.10 TDD 10MHz: OP.2 TDD 20MHz: OP.8 TDD |
| PBCH_RA | dB | 0 | 0 | 0 |
| PBCH_RB | dB | | | |
| PSS_RA | dB | | | |
| SSS_RA | dB | | | |
| PCFICH_RB | dB | | | |
| PHICH_RA | dB | | | |
| PHICH_RB | dB | | | |
| PDCCH_RA | dB | | | |
| PDCCH_RB | dB | | | |
| PDSCH_RA | dB | | | |
| PDSCH_RB | dB | | | |
| OCNG_RA ^{Note 1} | dB | | | |
| OCNG_RB ^{Note 1} | dB | | | |
| N _{oc} ^{Note 2} | dBm/15 kHz | | | |
| \bar{E}_s/N_{oc} | dB | 17 | -infinity | 17 |
| \bar{E}_s/I_{ot} | dB | 17 | -infinity | 17 |
| RSRP ^{Note 3} | dBm/15 kHz | -87 | -infinity | -87 |
| SCH_RP ^{Note 3} | dBm/15 kHz | -87 | -infinity | -87 |
| I _o ^{Note 3} | dBm/Ch BW | -59.13 +10log (N _{RB,c} /50) | -76.22 +10log (N _{RB,c} /50) | -59.13 +10log (N _{RB,c} /50) |
| Propagation Condition | | AWGN | AWGN | AWGN |
| Antenna Configuration | | 1x2 | 1x2 | 1x2 |
| Timing offset to Cell 1 | μs | - | 0 | 0 |
| Time alignment error relative to cell 1 ^{Note 5} | μs | - | ≤ TAE | ≤ TAE |
| Time alignment error relative to cell 2 ^{Note 5} | μs | - | - | ≤ TAE |
| Time alignment error relative to cell 3 ^{Note 5} | μs | - | - | - |
| Time alignment error relative to cell 4 ^{Note 5} | μs | - | - | - |
| <p>Note 1: OCNG shall be used such that all cells are fully allocated and a constant total transmitted power spectral density is achieved for all OFDM symbols.</p> <p>Note 2: Interference from other cells and noise sources not specified in the test is assumed to be constant over subcarriers and time and shall be modelled as AWGN of appropriate power for N_{oc} to be fulfilled.</p> <p>Note 3: Es/I_{ot}, RSRP, SCH_RP and I_o levels have been derived from other parameters for information purposes. They are not settable parameters themselves.</p> <p>Note 4: The uplink resources for CSI reporting are assigned to the UE prior to the start of time period T2.</p> <p>Note 5: Time alignment error (TAE) as specified in TS 36.104 [30] clause 6.5.3.1. The TAE value depends upon the type of carrier aggregation.</p> | | | | |

Table A.8.16.67.1-3: Cell specific test parameters for E-UTRAN TDD unknown SCell1 activation with PCell in FDD

| Parameter | Unit | Cell 4 | | | Cell 5 | | | | | |
|--|------------|---|----|----|---|----|----|--|--|--|
| | | T1 | T2 | T3 | T1 | T2 | T3 | | | |
| E-UTRA RF Channel Number | | 4 | | | 5 | | | | | |
| BW _{channel} | MHz | 5MHz: N _{RB,c} = 25 10MHz: N _{RB,c} = 50 20MHz: N _{RB,c} = 100 | | | 5MHz: N _{RB,c} = 25 10MHz: N _{RB,c} = 50 20MHz: N _{RB,c} = 100 | | | | | |
| Special subframe configuration | | 6 | | | 6 | | | | | |
| Uplink-downlink configuration | | 1 | | | 1 | | | | | |
| PDSCH parameters: DL Reference Measurement Channel | | - | | | - | | | | | |
| PCFICH/PDCCH/PHICH parameters: DL Reference Measurement Channel | | 5MHz: R.11 TDD 10MHz: R.6 TDD 20MHz: R.10 TDD | | | 5MHz: R.11 TDD 10MHz: R.6 TDD 20MHz: R.10 TDD | | | | | |
| OCNG Patterns | | 5MHz: OP.10 TDD 10MHz: OP.2 TDD 20MHz: OP.8 TDD | | | 5MHz: OP.10 TDD 10MHz: OP.2 TDD 20MHz: OP.8 TDD | | | | | |
| PBCH_RA | dB | 0 | | | 0 | | | | | |
| PBCH_RB | dB | | | | | | | | | |
| PSS_RA | dB | | | | | | | | | |
| SSS_RA | dB | | | | | | | | | |
| PCFICH_RB | dB | | | | | | | | | |
| PHICH_RA | dB | | | | | | | | | |
| PHICH_RB | dB | | | | | | | | | |
| PDCCH_RA | dB | | | | | | | | | |
| PDCCH_RB | dB | | | | | | | | | |
| PDSCH_RA | dB | | | | | | | | | |
| PDSCH_RB | dB | | | | | | | | | |
| OCNG_RA ^{Note 1} | dB | | | | | | | | | |
| OCNG_RB ^{Note 1} | dB | | | | | | | | | |
| N _{oc} ^{Note 2} | dBm/15 kHz | | | | | | | | | |
| \bar{E}_s/N_{oc} | dB | 17 | | | 17 | | | | | |
| \bar{E}_s/I_{ot} | dB | 17 | | | 17 | | | | | |
| RSRP ^{Note 3} | dBm/15 kHz | -87 | | | -87 | | | | | |
| SCH_RP ^{Note 3} | dBm/15 kHz | -87 | | | -87 | | | | | |
| I _o ^{Note 3} | dBm/Ch BW | -59.13 +10log (N _{RB,c} /50) | | | -59.13 +10log (N _{RB,c} /50) | | | | | |
| Propagation Condition | | AWGN | | | AWGN | | | | | |
| Antenna Configuration | | 1x2 | | | 1x2 | | | | | |
| Timing offset to Cell 1 | μs | 0 | | | 0 | | | | | |
| Time alignment error relative to cell 1 ^{Note 5} | μs | ≤ TAE | | | ≤ TAE | | | | | |
| Time alignment error relative to cell 2 ^{Note 5} | μs | ≤ TAE | | | ≤ TAE | | | | | |
| Time alignment error relative to cell 3 ^{Note 5} | μs | ≤ TAE | | | ≤ TAE | | | | | |
| Time alignment error relative to cell 4 ^{Note 5} | μs | - | | | ≤ TAE | | | | | |
| <p>Note 1: OCNG shall be used such that all cells are fully allocated and a constant total transmitted power spectral density is achieved for all OFDM symbols.</p> <p>Note 2: Interference from other cells and noise sources not specified in the test is assumed to be constant over subcarriers and time and shall be modelled as AWGN of appropriate power for N_{oc} to be fulfilled.</p> <p>Note 3: Es/I_{ot}, RSRP, SCH_RP and I_o levels have been derived from other parameters for information purposes. They are not settable parameters themselves.</p> <p>Note 4: The uplink resources for CSI reporting are assigned to the UE prior to the start of time period T2.</p> <p>Note 5: Time alignment error (TAE) as specified in TS 36.104 [30] clause 6.5.3.1. The TAE value depends upon the type of carrier aggregation.</p> | | | | | | | | | | |

A.8.16.67.2 Test Requirements

During T2 the UE shall send the first CSI report for SCell1 in a subframe (m+8), or in a subframe (m+10) if the subframe (m+8) was subject to interruption. Whether CSI report in subframe (m+8) was interrupted or not is checked by monitoring ACK/NACK sent in PCell in subframe (m+8).

During T2 the UE shall start sending CSI reports for SCell1 with non-zero CQI index at latest in a subframe (m+49).

During T3 the UE shall stop sending CSI reports for SCell1 at latest in a subframe (n+8).

During T2 interruption of PCell during SCells activation shall not happen outside the subframes (m+5) to (m+9), outside the subframes (m+15) to (m+19), outside the subframes (m+25) to (m+29), and outside the subframes (m+35) to (m+39).

During T3 interruption of PCell during SCells deactivation shall not happen outside the subframes (n+5) to (n+9), outside the subframes (n+15) to (n+19), outside the subframes (n+25) to (n+29), and outside the subframes (n+25) to (n+29).

The interruption of PCell shall not be more than the values specified for intra-band CA and inter-band CA in Section 7.8.2.

All of the above test requirements shall be fulfilled in order for the observed SCell1 activation delay and SCell1 deactivation delay to be counted as correct. The rate of correct observed SCell1 activation delay and SCell1 deactivation delay during repeated tests shall be at least 90%.

NOTE: During T2 if there are no uplink resources for reporting the valid CSI in a subframe (m+49) then the UE shall use the next available uplink resource for reporting the corresponding valid CSI.

A.8.16.68 5 DL FDD-TDD with PCell in TDD CA activation and deactivation of Unknown SCell in non-DRX

A.8.16.68.1 Test Purpose and Environment

The purpose of this test is to verify that the SCell activation and deactivation times are within the requirements stated in section 7.7 for UE configured with four downlink SCells, when the SCell is unknown by the UE at the time of activation and PCell is in TDD.

The test parameters are given in Tables A.8.16.68.1-1 and cell-specific parameters in A.8.16.68.1-2 and A.8.16.68.1-3 below. The test consists of three successive time periods, with duration of T1, T2 and T3, respectively. There are five carriers, each with one cell. Cell 1, Cell 3, Cell 4 and Cell 5 have constant signal levels throughout the test. Before the test starts the UE is connected to Cell 1 (PCell) on radio channel 1 (PCC), deactivated Cell 3 (SCell2) on radio channel 3 (SCC2), deactivated Cell 4 (SCell3) on radio channel 4 (SCC3) and deactivated Cell 5 (SCell4) on radio channel 5 (SCC4) but is not aware of Cell 2 (SCell1) on radio channel 2 (SCC1). The UE is only monitoring PCC, SCC2, SCC3 and SCC4. The UE shall be continuously scheduled in the PCell throughout the whole test.

At the beginning of T1 the UE receives an RRC message by which SCell1 becomes configured on SCC1. The UE now starts monitoring also the SCC1. During T1 SCell1 is powered off and the UE is not aware of SCell1.

A MAC message for activation of SCell1 is sent by the test equipment 100ms after the RRC message, in a subframe # denoted m which is 4 or 9. The point in time at which the MAC message for activation of SCell1 is received at the UE antenna connector defines the start of time period T2. Immediately at beginning of T2 transmission power of SCell1 is increased to same level as for PCell. Immediately at beginning of T2 transmission power of SCell1 is increased to same level as for PCell. The test equipment sends a MAC message for activation of SCell2, SCell3 and SCell4 in subframe (m+15) during activation of SCell1. The UE shall be able to report valid CSI for the activated SCell1 at latest in a subframe (m+49). The UE shall start reporting CSI for SCell1 in subframe (m+8) and shall report CQI index 0 (out-of-range) until the SCell activation has been completed. Any PCell interruption due to activation of SCells shall not occur outside subframes (m+5) to (m+11) and (m+20) to (m+26).

Time period T3 starts when a MAC message for deactivation of SCell1, sent from the test equipment to the UE in a subframe # denoted n, where n is 4 or 9, is received at the UE antenna connector. The test equipment sends a MAC message for deactivation of the SCell2 in subframe (n+15), a MAC message for deactivation of the SCell3 in subframe (n+30), and a MAC message for deactivation of the SCell4 in subframe (n+45). The UE shall carry out deactivation of SCell1 at latest in subframe (n+8), and any PCell interruption due to the deactivation of SCells shall not occur outside subframes (n+5) to (n+11), (n+20) to (n+26), (n+35) to (n+41) and (n+50) to (n+56).

The test equipment verifies that potential interruption is carried out in the correct time span by monitoring ACK/NACK sent in PCell during activation and deactivation of SCell1, respectively.

The test equipment verifies the activation time by counting the subframes from the time when SCell1 activation command is sent until a CSI report with other than CQI index 0 is received.

The test equipment verifies the deactivation time by counting the subframes from the time when SCell1 deactivation command is sent until CQI reporting for SCell1 is discontinued.

Table A.8.16.68.1-1: General test parameters for unknown SCell1 activation case

| Parameter | Unit | Value | Comment |
|---|------|---------------|---|
| E-UTRA RF Channel Number | | 1, 2, 3, 4, 5 | Five radio channels are used for this test |
| Active PCell | | Cell 1 | Primary cell on RF channel number 1. |
| Deconfigured deactivated SCell | | Cell 2 | Deconfigured deactivated secondary cell on RF channel number 2. |
| Configured deactivated SCell2 | | Cell 3 | Configured deactivated secondary cell on RF channel number 3. |
| Configured deactivated SCell3 | | Cell 4 | Configured deactivated secondary cell on RF channel number 4. |
| Configured deactivated SCell4 | | Cell 5 | Configured deactivated secondary cell on RF channel number 5. |
| CP length | | Normal | |
| | | | |
| DRX | | OFF | Continuous monitoring of primary cell |
| CQI/PMI periodicity and offset configuration index | | 0 | CQI reporting for SCell every UL subframe |
| Cell-individual offset for cells on RF channel number 1 | dB | 0 | Individual offset for cells on PCC. |
| Cell-individual offset for cells on RF channel number 2 | dB | 0 | Individual offset for cells on SCC1. |
| Cell-individual offset for cells on RF channel number 3 | dB | 0 | Individual offset for cells on SCC2. |
| Cell-individual offset for cells on RF channel number 4 | dB | 0 | Individual offset for cells on SCC3. |
| Cell-individual offset for cells on RF channel number 5 | dB | 0 | Individual offset for cells on SCC4. |
| SCell measurement cycle (measCycleSCell) | ms | 320 | |
| T1 | ms | 100 | During this time the PCell, SCell2, SCell3 and SCell4 shall be known and the SCell1 configured. |
| T2 | s | 1 | During this time the UE shall activate the SCell1, SCell2, SCell3 and SCell4. |
| T3 | s | 1 | During this time the UE shall deactivate the SCell1, SCell2, SCell3 and SCell4. |

Table A.8.16.68.1-2: Cell specific test parameters for E-UTRAN FDD unknown SCell1 activation with PCell in TDD

| Parameter | Unit | Cell 1 | | | Cell 2 | | | Cell 3 | | |
|--|------|---|----|----|---|----|----|---|----|----|
| | | T1 | T2 | T3 | T1 | T2 | T3 | T1 | T2 | T3 |
| E-UTRA RF Channel Number | | 1 | | | 2 | | | 3 | | |
| BW _{channel} | MHz | 5MHz: N _{RB,c} = 25 10MHz: N _{RB,c} = 50 20MHz: N _{RB,c} = 100 | | | 5MHz: N _{RB,c} = 25 10MHz: N _{RB,c} = 50 20MHz: N _{RB,c} = 100 | | | 5MHz: N _{RB,c} = 25 10MHz: N _{RB,c} = 50 20MHz: N _{RB,c} = 100 | | |
| Special subframe configuration | | 6 | | | - | | | - | | |
| Uplink-downlink configuration | | 1 | | | - | | | - | | |
| PDSCH parameters: DL Reference Measurement Channel | | 5MHz: R.4 TDD 10MHz: R.0 TDD 20MHz: R.3 TDD | | | - | | | - | | |
| PCFICH/PDCCH/PHICH parameters: DL Reference Measurement Channel | | 5MHz: R.11 TDD 10MHz: R.6 TDD 20MHz: R.10 TDD | | | 5MHz: R.11 FDD 10MHz: R.6 FDD 20MHz: R.10 FDD | | | 5MHz: R.11 FDD 10MHz: R.6 FDD 20MHz: R.10 FDD | | |

| OCNG Patterns | | 5MHz: OP.9 TDD 10MHz: OP.1 TDD 20MHz: OP.7 TDD | 5MHz: OP.16 FDD 10MHz: OP.2 FDD 20MHz: OP.12 FDD | 5MHz: OP.16 FDD 10MHz: OP.2 FDD 20MHz: OP.12 FDD |
|--|------------|--|--|--|
| PBCH_RA | dB | 0 | 0 | 0 |
| PBCH_RB | dB | | | |
| PSS_RA | dB | | | |
| SSS_RA | dB | | | |
| PCFICH_RB | dB | | | |
| PHICH_RA | dB | | | |
| PHICH_RB | dB | | | |
| PDCCH_RA | dB | | | |
| PDCCH_RB | dB | | | |
| PDSCH_RA | dB | | | |
| PDSCH_RB | dB | | | |
| OCNG_RA ^{Note 1} | dB | | | |
| OCNG_RB ^{Note 1} | dB | | | |
| N _{oc} ^{Note 2} | dBm/15 kHz | -104 | -104 | -104 |
| \hat{E}_s/N_{oc} | dB | 17 | -infinity | 17 |
| \hat{E}_s/I_{ot} | dB | 17 | -infinity | 17 |
| RSRP ^{Note 3} | dBm/15 kHz | -87 | -infinity | -87 |
| SCH_RP ^{Note 3} | dBm/15 kHz | -87 | -infinity | -87 |
| I _o ^{Note 3} | dBm/Ch BW | -59.13 +10log(N _{RB,c} /50) | -76.22 +10log(N _{RB,c} /50) | -59.13 +10log(N _{RB,c} /50) |
| Propagation Condition | | AWGN | AWGN | AWGN |
| Antenna Configuration | | 1x2 | 1x2 | 1x2 |
| Timing offset to Cell 1 | μs | - | 0 | 0 |
| Time alignment error relative to cell 1 ^{Note 5} | μs | - | ≤ TAE | ≤ TAE |
| Time alignment error relative to cell 2 ^{Note 5} | μs | - | - | ≤ TAE |
| Time alignment error relative to cell 3 ^{Note 5} | μs | - | - | - |
| Time alignment error relative to cell 4 ^{Note 5} | μs | - | - | - |
| <p>Note 1: OCNG shall be used such that all cells are fully allocated and a constant total transmitted power spectral density is achieved for all OFDM symbols.</p> <p>Note 2: Interference from other cells and noise sources not specified in the test is assumed to be constant over subcarriers and time and shall be modelled as AWGN of appropriate power for N_{oc} to be fulfilled.</p> <p>Note 3: Es/I_{ot}, RSRP, SCH_RP and I_o levels have been derived from other parameters for information purposes. They are not settable parameters themselves.</p> <p>Note 4: The uplink resources for CSI reporting are assigned to the UE prior to the start of time period T2.</p> <p>Note 5: Time alignment error (TAE) as specified in TS 36.104 [30] clause 6.5.3.1. The TAE value depends upon the type of carrier aggregation.</p> | | | | |

Table A.8.16.68.1-3: Cell specific test parameters for E-UTRAN FDD unknown SCell1 activation with PCell in TDD

| Parameter | Unit | Cell 4 | | | Cell 5 | | | | | |
|--|------|---|----|----|---|----|----|--|--|--|
| | | T1 | T2 | T3 | T1 | T2 | T3 | | | |
| E-UTRA RF Channel Number | | 4 | | | 5 | | | | | |
| BW _{channel} | MHz | 5MHz: N _{RB,c} = 25 10MHz: N _{RB,c} = 50 20MHz: N _{RB,c} = 100 | | | 5MHz: N _{RB,c} = 25 10MHz: N _{RB,c} = 50 20MHz: N _{RB,c} = 100 | | | | | |
| Special subframe configuration | | - | | | - | | | | | |
| Uplink-downlink configuration | | - | | | - | | | | | |
| PDSCH parameters: DL Reference Measurement Channel | | - | | | - | | | | | |

| | | | | |
|---|------------|--|--|--|
| PCFICH/PDCCH/PHICH parameters: DL Reference Measurement Channel | | 5MHz: R.11 FDD 10MHz: R.6 FDD 20MHz: R.10 FDD | 5MHz: R.11 FDD 10MHz: R.6 FDD 20MHz: R.10 FDD | |
| OCNG Patterns | | 5MHz: OP.16 FDD 10MHz: OP.2 FDD 20MHz: OP.12 FDD | 5MHz: OP.16 FDD 10MHz: OP.2 FDD 20MHz: OP.12 FDD | |
| PBCH_RA | dB | 0 | 0 | |
| PBCH_RB | dB | | | |
| PSS_RA | dB | | | |
| SSS_RA | dB | | | |
| PCFICH_RB | dB | | | |
| PHICH_RA | dB | | | |
| PHICH_RB | dB | | | |
| PDCCH_RA | dB | | | |
| PDCCH_RB | dB | | | |
| PDSCH_RA | dB | | | |
| PDSCH_RB | dB | | | |
| OCNG_RA ^{Note 1} | dB | | | |
| OCNG_RB ^{Note 1} | dB | | | |
| N _{oc} ^{Note 2} | dBm/15 kHz | -104 | -104 | |
| \bar{E}_s/N_{oc} | dB | 17 | 17 | |
| \bar{E}_s/I_{ot} | dB | 17 | 17 | |
| RSRP ^{Note 3} | dBm/15 kHz | -87 | -87 | |
| SCH_RP ^{Note 3} | dBm/15 kHz | -87 | -87 | |
| I _o ^{Note 3} | dBm/Ch BW | -59.13 +10log (N _{RB,c} /50) | -59.13 +10log (N _{RB,c} /50) | |
| Propagation Condition | | AWGN | AWGN | |
| Antenna Configuration | | 1x2 | 1x2 | |
| Timing offset to Cell 1 | μs | 0 | 0 | |
| Time alignment error relative to cell 1 ^{Note 5} | μs | ≤ TAE | ≤ TAE | |
| Time alignment error relative to cell 2 ^{Note 5} | μs | ≤ TAE | ≤ TAE | |
| Time alignment error relative to cell 3 ^{Note 5} | μs | ≤ TAE | ≤ TAE | |
| Time alignment error relative to cell 4 ^{Note 5} | μs | - | ≤ TAE | |
| <p>Note 1: OCNG shall be used such that all cells are fully allocated and a constant total transmitted power spectral density is achieved for all OFDM symbols.</p> <p>Note 2: Interference from other cells and noise sources not specified in the test is assumed to be constant over subcarriers and time and shall be modelled as AWGN of appropriate power for N_{oc} to be fulfilled.</p> <p>Note 3: Es/lot, RSRP, SCH_RP and I_o levels have been derived from other parameters for information purposes. They are not settable parameters themselves.</p> <p>Note 4: The uplink resources for CSI reporting are assigned to the UE prior to the start of time period T2.</p> <p>Note 5: Time alignment error (TAE) as specified in TS 36.104 [30] clause 6.5.3.1. The TAE value depends upon the type of carrier aggregation.</p> | | | | |

A.8.16.68.2 Test Requirements

During T2 the UE shall send the first CSI report for SCell1 in a subframe (m+8,) or in a subframe (m+9) if the subframe (m+8) was subject to interruption. Whether CSI report in subframe (m+8) was interrupted or not is checked by monitoring ACK/NACK sent in PCell in subframe (m+8).

During T2 the UE shall start sending CSI reports for SCell1 with non-zero CQI index at latest in a subframe (m+49).

During T3 the UE shall stop sending CSI reports for SCell at latest in a subframe (n+8).

During T2 interruption of PCell during SCells activation shall not happen outside the subframes (m+5) to (m+11) and outside the subframes (m+20) to (m+26).

During T3 interruption of PCell during SCells deactivation shall not happen outside the subframes (n+5) to (n+11), outside the subframes (n+20) to (n+26), outside the subframes (n+35) to (n+41), and outside the subframes (n+50) to (n+56).

The interruption of PCell shall not be more than the values specified for intra-band CA and inter-band CA in Section 7.8.2.

All of the above test requirements shall be fulfilled in order for the observed SCell1 activation delay and SCell1 deactivation delay to be counted as correct. The rate of correct observed SCell1 activation delay and SCell1 deactivation delay during repeated tests shall be at least 90%.

NOTE: During T2 if there are no uplink resources for reporting the valid CSI in a subframe (m+49) then the UE shall use the next available uplink resource for reporting the corresponding valid CSI.

A.8.16.69 5 DL FDD CA activation and deactivation of unknown SCell in non-DRX

A.8.16.69.1 Test Purpose and Environment

The purpose of this test is to verify that the SCell activation and deactivation times are within the requirements stated in section 7.7 for UE configured with five downlink SCells, when the SCell is unknown by the UE at the time of activation and PCell is in FDD.

The test parameters are given in Tables A.8.16.69.1-1 and cell-specific parameters in A.8.16.69.1-2 below. The test consists of three successive time periods, with duration of T1, T2 and T3, respectively. There are five carriers, each with one cell. Cell 1, Cell 3, Cell 4, and Cell 5 have constant signal levels throughout the test. Before the test starts the UE is connected to Cell1 (PCell) on radio channel 1 (PCC), Cell 3 (deactivated SCell2) on radio channel 3 (SCC2), Cell4 (deactivated SCell3) on radio channel 4 (SCC3) and Cell5 (deactivated SCell4) on radio channel 5 (SCC4) but is not aware of Cell2 (SCell1) on radio channel 2 (SCC1). The UE is only monitoring the PCC, SCC2, SCC3 and SCC4. The UE shall be continuously scheduled in the PCell throughout the whole test.

At the beginning of T1 the UE receives an RRC message by which the Cell 2 (SCell1) becomes configured on radio channel 2 (SCC1). During T1 the signal level of Cell 2 (SCell1) is powered off and UE is not aware of Cell 2 (SCell1).

A MAC message for activation of the SCell1 is sent by the test equipment 100ms after the RRC message, in a subframe # denoted m which is an even number. The point in time at which the MAC message for activation of Cell 2 (SCell1) is received at the UE antenna connector defines the start of time period T2. Immediately at beginning of T2 the transmission power of Cell 2 (SCell1) is increased to same level as for Cell 1 (PCell). The test equipment sends a MAC message for activation of Cell 3 (SCell2), Cell4 (SCell 3) and Cell5 (SCell 4) in subframe (m+10), subframe (m+20) and subframe (m+30) respectively. Since UE received SCell2 activation command during activation of SCell1, the UE shall be able to report valid CSIs for the activated SCell1 at latest in subframe (m+49) provided the SCell1 can be successfully detected on the first attempt. The UE shall start reporting CSI in subframe (m+8) and shall report CQI index 0 (out-of-range) until the SCell activation has been completed. Any PCell interruption due to activation of SCells shall occur in the subframes (m+5) to (m+9), (m+15) to (m+19), (m+25) to (m+29) and (m+35) to (m+39).

Time period T3 starts when a MAC message for deactivation of Cell 2 (SCell1), sent from the test equipment to the UE in a subframe # denoted n, is received at the UE antenna connector. The test equipment sends a MAC message for deactivation of the Cell 3 (SCell2), Cell4 (SCell3) and Cell5 (SCell4) in subframe (n+10), subframe (n+20), subframe (n+30), respectively. The UE shall carry out deactivation of Cell 2 (SCell1) at latest in subframe (n+8), and any PCell interruption due to the deactivation of SCells shall occur in the subframes (n+5) to (n+9), (n+15) to (n+19), (n+25) to (n+29) and (n+35) to (n+39).

The test equipment verifies that potential interruption is carried out in the correct time span by monitoring ACK/NACK sent in PCell during activation and deactivation of SCells, respectively.

The test equipment verifies the activation time by counting the subframes from the time when the Cell 2 (SCell1) activation command is sent until a CSI reports with other than CQI index 0 is received.

The test equipment verifies the deactivation time by counting the subframes from the time when the Cell 2 (SCell1) deactivation command is sent until CQI reporting for SCell1 is discontinued.

Table A.8.16.69.1-1: General test parameters for unknown SCell1 activation case

| Parameter | Unit | Value | Comment |
|-------------------------------|------|-------------|---|
| E-UTRA RF Channel Number | | 1, 2, 3,4,5 | Five radio channels are used for this test |
| Active PCell | | Cell 1 | Primary cell on RF channel number 1. |
| Deconfigured SCell1 | | Cell 2 | Deconfigured secondary cell on RF channel number 2. |
| Configured deactivated SCell2 | | Cell 3 | Configured deactivated secondary cell on RF channel number 3. |

| | | | |
|---|----|--------|---|
| Configured deactivated SCell3 | | Cell 4 | Configured deactivated secondary cell on RF channel number 4. |
| Configured deactivated SCell3 | | Cell 5 | Configured deactivated secondary cell on RF channel number 5. |
| CP length | | Normal | |
| DRX | | OFF | Continuous monitoring of primary cell |
| CQI/PMI periodicity and offset configuration index | | 0 | CQI reporting for SCell every second subframe |
| Cell-individual offset for cells on RF channel number 1 | dB | 0 | Individual offset for cells on PCC. |
| Cell-individual offset for cells on RF channel number 2 | dB | 0 | Individual offset for cells on SCC1. |
| Cell-individual offset for cells on RF channel number 3 | dB | 0 | Individual offset for cells on SCC2. |
| Cell-individual offset for cells on RF channel number 4 | dB | 0 | Individual offset for cells on SCC3. |
| Cell-individual offset for cells on RF channel number 5 | dB | 0 | Individual offset for cells on SCC4. |
| Filter coefficient | | 0 | L3 filtering is not used |
| SCell measurement cycle (measCycleSCell) | ms | 320 | |
| T1 | ms | 100 | During this time the PCell, SCell2, SCell3 and SCell4 shall be known and the SCell1 configured. |
| T2 | s | 1 | During this time the UE shall activate the SCell1. |
| T3 | s | 1 | During this time the UE shall deactivate the SCell1. |

Table A.8.16.69.1-2: Cell specific test parameters for E-UTRAN FDD 5 DL CA activation and deactivation of unknown SCell in non-DRX

| Parameter | Unit | Cell 1 | | | Cell 2 | | | Cell 3 | | | Cell 4 | | | Cell 5 | | |
|---|------|---|----|----|---|----|----|---|----|----|---|----|----|---|----|----|
| | | T1 | T2 | T3 | T1 | T2 | T3 | T1 | T2 | T3 | T1 | T2 | T3 | T1 | T2 | T3 |
| E-UTRA RF Channel Number | | 1 | | | 2 | | | 3 | | | 4 | | | 5 | | |
| BW _{channel} | MHz | 5MHz: N _{RB,c} = 25 10MHz: N _{RB,c} = 50 20MHz: N _{RB,c} = 100 | | | 5MHz: N _{RB,c} = 25 10MHz: N _{RB,c} = 50 20MHz: N _{RB,c} = 100 | | | 5MHz: N _{RB,c} = 25 10MHz: N _{RB,c} = 50 20MHz: N _{RB,c} = 100 | | | 5MHz: N _{RB,c} = 25 10MHz: N _{RB,c} = 50 20MHz: N _{RB,c} = 100 | | | 5MHz: N _{RB,c} = 25 10MHz: N _{RB,c} = 50 20MHz: N _{RB,c} = 100 | | |
| PDSCH parameters: DL Reference Measurement Channel | | 5MHz: R.7 FDD 10MHz: R.3 FDD 20MHz: R.6 FDD | | | - | | | - | | | - | | | - | | |
| PCFICH/PDCCH/PHICH parameters: DL Reference Measurement Channel | | 5MHz: R.11 FDD 10MHz: R.6 FDD 20MHz: R.10 FDD | | | 5MHz: R.11 FDD 10MHz: R.6 FDD 20MHz: R.10 FDD | | | 5MHz: R.11 FDD 10MHz: R.6 FDD 20MHz: R.10 FDD | | | 5MHz: R.11 FDD 10MHz: R.6 FDD 20MHz: R.10 FDD | | | 5MHz: R.11 FDD 10MHz: R.6 FDD 20MHz: R.10 FDD | | |
| OCNG Patterns | | 5MHz: OP.20 FDD 10MHz: OP.10 FDD 20MHz: OP.17 FDD | | | 5MHz: OP.16 FDD 10MHz: OP.2 FDD 20MHz: OP.12 FDD | | | 5MHz: OP.16 FDD 10MHz: OP.2 FDD 20MHz: OP.12 FDD | | | 5MHz: OP.16 FDD 10MHz: OP.2 FDD 20MHz: OP.12 FDD | | | 5MHz: OP.16 FDD 10MHz: OP.2 FDD 20MHz: OP.12 FDD | | |
| PBCH_RA | dB | 0 | | | 0 | | | 0 | | | 0 | | | 0 | | |
| PBCH_RB | dB | | | | | | | | | | | | | | | |
| PSS_RA | dB | | | | | | | | | | | | | | | |
| SSS_RA | dB | | | | | | | | | | | | | | | |
| PCFICH_RB | dB | | | | | | | | | | | | | | | |
| PHICH_RA | dB | | | | | | | | | | | | | | | |
| PHICH_RB | dB | | | | | | | | | | | | | | | |
| PDCCH_RA | dB | | | | | | | | | | | | | | | |
| PDCCH_RB | dB | | | | | | | | | | | | | | | |
| PDSCH_RA | dB | | | | | | | | | | | | | | | |
| PDSCH_RB | dB | | | | | | | | | | | | | | | |

| | | | | | | | |
|---|---|---|--|--|---|---|---|
| OCNG_RA ^{Note 1} | dB | | | | | | |
| OCNG_RB ^{Note 1} | dB | | | | | | |
| N _{oc} ^{Note 2} | dBm/ 15 kHz | -104 | -104 | -104 | -104 | -104 | -104 |
| \bar{E}_s/N_{oc} | dB | 17 | -infinity | 17 | 17 | 17 | 17 |
| \bar{E}_s/I_{ot} ^{Note 3} | dB | 17 | -infinity | 17 | 17 | 17 | 17 |
| RSRP ^{Note 3} | dBm/ 15 kHz | -87 | -infinity | -87 | -87 | -87 | -87 |
| SCH_RP ^{Note 3} | dBm/ 15 kHz | -87 | -infinity | -87 | -87 | -87 | -87 |
| I _o ^{Note 3} | dBm/ Ch BW | -59.13 +10log (N _{RB,c} /50) | -76.22 +10log (N _{RB,c} /50) | -59.13 +10log (N _{RB,c} /50) | -59.13 +10log (N _{RB,c} /50) | -59.13 +10log (N _{RB,c} /50) | -59.13 +10log (N _{RB,c} /50) |
| Propagation Condition | | AWGN | AWGN | AWGN | AWGN | AWGN | AWGN |
| Antenna Configuration | | 1x2 | 1x2 | 1x2 | 1x2 | 1x2 | 1x2 |
| Timing offset to Cell 1 | μs | - | 0 | 0 | 0 | 0 | 0 |
| Time alignment error relative to cell 1 ^{Note 5} | μs | - | ≤ TAE | ≤ TAE | ≤ TAE | ≤ TAE | ≤ TAE |
| Time alignment error relative to cell 2 ^{Note 5} | μs | - | - | ≤ TAE | ≤ TAE | ≤ TAE | ≤ TAE |
| Time alignment error relative to cell 3 ^{Note 5} | μs | - | - | - | ≤ TAE | ≤ TAE | ≤ TAE |
| Time alignment error relative to cell 4 ^{Note 5} | μs | - | - | - | - | - | ≤ TAE |
| Note 1: | OCNG shall be used such that all cells are fully allocated and a constant total transmitted power spectral density is achieved for all OFDM symbols. | | | | | | |
| Note 2: | Interference from other cells and noise sources not specified in the test is assumed to be constant over subcarriers and time and shall be modelled as AWGN of appropriate power for N _{oc} to be fulfilled. | | | | | | |
| Note 3: | Es/I _{ot} , RSRP, SCH_RP and I _o levels have been derived from other parameters for information purposes. They are not settable parameters themselves. | | | | | | |
| Note 4: | The uplink resources for CSI reporting are assigned to the UE prior to the start of time period T2. | | | | | | |
| Note 5: | Time alignment error (TAE) as specified in TS 36.104 [30] clause 6.5.3.1. The TAE value depends upon the type of carrier aggregation. | | | | | | |

A.8.16.69.2 Test Requirements

During T2, the UE shall send the first CSI report for SCell1 in a subframe (m+8), or in a subframe (m+10) if the subframe (m+8) was subject to interruption. Whether CSI report in subframe (m+8) was interrupted or not is checked by monitoring ACK/NACK sent in PCell in subframe (m+8).

During T2 the UE shall start sending CSI reports for SCell1 with non-zero CQI index at latest in a subframe (m+49).

During T3 the UE shall stop sending CSI reports for SCell1 at latest in a subframe (n+8).

During T2 interruption of PCell during SCells activation shall not happen outside the subframes (m+5) to (m+9), outside the subframes (m+15) to (m+19), outside the subframes (m+25) to (m+29) and outside the subframes (m+35) to (m+39).

During T3 interruption of PCell during SCells deactivation shall not happen outside the subframes (n+5) to (n+9), outside the subframes (n+15) to (n+19), outside the subframes (n+25) to (n+29) and outside the subframes (n+35) to (n+39).

The interruption of PCell shall not be more than the values specified for intra-band CA and inter-band CA in Section 7.8.2.

All of the above test requirements shall be fulfilled in order for the observed SCell1 activation delay and SCell1 deactivation delay to be counted as correct. The rate of correct observed SCell1 activation delay and SCell1 deactivation delay during repeated tests shall be at least 90%.

NOTE: During T2 if there are no uplink resources for reporting the valid CSI in a subframe (m+49) then the UE shall use the next available uplink resource for reporting the corresponding valid CSI.

A.8.16.70 5 DL TDD CA activation and deactivation of unknown SCell in non-DRX

A.8.16.70.1 Test Purpose and Environment

The purpose of this test is to verify that SCell activation and deactivation times are within the requirements stated in clause 7.7 for 5DL TDD carrier aggregation, when the SCells are unknown by the UE at the time of activation.

The test parameters are given in Tables A.8.16.70.1-1 and cell-specific parameters in A.8.16.70.1-2 below. The test consists of three successive time periods, with duration of T1, T2 and T3, respectively. There are five carriers, each with one cell. Cell 1, Cell 3, Cell 4, and Cell 5 have constant signal levels throughout the test. Before the test starts the UE is connected to Cell 1 (PCell) on radio channel 1 (PCC), Cell 3 (deactivated SCell2) on radio channel 3 (SCC2), Cell 4 (deactivated SCell3) on radio channel 4 (SCC3) and Cell 5 (deactivated SCell4) on radio channel 5 (SCC4), but is not aware of Cell 2 (SCell1) on radio channel 2 (SCC1). The UE is only monitoring the PCC, SCC2, SCC3 and SCC4. The UE shall be continuously scheduled in the PCell throughout the whole test.

At the beginning of T1 the UE receives an RRC message by which the Cell 2 (SCell 1) becomes configured on radio channel 2 (SCC1). During T1 the signal level of Cell 2 (SCell 1) is powered off and UE is not aware of Cell 2 (SCell1).

A MAC message for activation of the SCell1 is sent by the test equipment 100ms after the RRC message, in a subframe # denoted m, where m is 4 or 9. The point in time at which the MAC message for activation of Cell 2 (SCell1) is received at the UE antenna connector defines the start of time period T2. Immediately at beginning of T2 the transmission power of Cell 2 (SCell1) is increased to same level as for Cell 1 (PCell). The test equipment sends a MAC message for activation of Cell 3 (SCell2), Cell 4 (SCell3) and Cell 5 (SCell4) in subframe (m+15). Since UE received SCell2 activation command during activation of SCell1, the UE shall be able to report valid CSIs for the activated SCell1 at latest in subframe (m+49) provided the SCell1 can be successfully detected on the first attempt. The UE shall start reporting CSI in subframe (m+8) and shall report CQI index 0 (out-of-range) until the SCell activation has been completed. Any PCell interruption due to activation of SCells shall occur in the subframes (m+5) to (m+11) and (m+20) to (m+26).

Time period T3 starts when a MAC message for deactivation of Cell 2 (SCell1), sent from the test equipment to the UE in a subframe # denoted n, where n is 4 or 9, is received at the UE antenna connector. The test equipment sends a MAC message for deactivation of the Cell 3 (SCell2), Cell 4 (SCell3) and Cell 5 (SCell4) in subframe (n+15), (n+30) and (n+45), respectively. The UE shall carry out deactivation of Cell 2 (SCell1) at latest in subframe (n+8), and any PCell interruption due to the deactivation of SCells shall occur in the subframes (n+5) to (n+11), (n+20) to (n+26), (n+35) to (n+41) and (n+50) to (n+56).

The test equipment verifies that potential interruption is carried out in the correct time span by monitoring ACK/NACK sent in PCell during activation and deactivation of SCells, respectively.

The test equipment verifies the activation time by counting the subframes from the time when the Cell 2 (SCell1) activation command is sent until a CSI reports with other than CQI index 0 is received.

The test equipment verifies the deactivation time by counting the subframes from the time when the Cell 2 (SCell1) deactivation command is sent until CQI reporting for SCell1 is discontinued.

Table A.8.16.70.1-1: General test parameters for E-UTRAN TDD 5 DL CA activation and deactivation of unknown SCell in non-DRX

| Parameter | Unit | Value | Comment |
|--|------|-------------|--|
| E-UTRA RF Channel Number | | 1, 2, 3,4,5 | Five radio channels are used for this test |
| Active PCell | | Cell 1 | Primary cell on RF channel number 1. |
| Deconfigured SCell | | Cell 2 | Deconfigured secondary cell on RF channel number 2. |
| Configured deactivated SCell | | Cell 3 | Configured deactivated secondary cell on RF channel number 3. |
| Configured deactivated SCell | | Cell 4 | Configured deactivated secondary cell on RF channel number 4. |
| Configured deactivated SCell | | Cell 5 | Configured deactivated secondary cell on RF channel number 5. |
| CP length | | Normal | |
| Special subframe configuration | | 6 | As specified in table 4.2-1 in TS 36.211. The same configuration applies to all cells. |
| Uplink-downlink configuration | | 1 | As specified in table 4.2-2 in TS 36.211. The same configuration applies to all cells |
| DRX | | OFF | Continuous monitoring of primary cell |
| CQI/PMI periodicity and offset configuration index | | 0 | CQI reporting for SCells every UL subframe |

| | | | |
|---|----|-----|---|
| Cell-individual offset for cells on RF channel number 1 | dB | 0 | Individual offset for cells on PCC. |
| Cell-individual offset for cells on RF channel number 2 | dB | 0 | Individual offset for cells on SCC1. |
| Cell-individual offset for cells on RF channel number 3 | dB | 0 | Individual offset for cells on SCC2. |
| Cell-individual offset for cells on RF channel number 4 | dB | 0 | Individual offset for cells on SCC3. |
| Cell-individual offset for cells on RF channel number 5 | dB | 0 | Individual offset for cells on SCC4. |
| Filter coefficient | | 0 | L3 filtering is not used |
| SCell measurement cycle (measCycleSCell) | ms | 320 | |
| T1 | ms | 100 | During this time the PCell, SCell2, SCell3 and SCell4 shall be known and the SCell1 configured. |
| T2 | s | 1 | During this time the UE shall activate the SCell1. |
| T3 | s | 1 | During this time the UE shall deactivate the SCell1. |

Table A.8.16.70.1-2: Cell specific test parameters for E-UTRAN TDD 4 DL CA activation and deactivation of unknown SCell in non-DRX

| Parameter | Unit | Cell 1 | | | Cell 2 | | | Cell 3 | | | Cell 4 | | | Cell5 | | |
|---|------------|---|----|----|---|----|----|---|----|----|---|----|----|---|----|----|
| | | T1 | T2 | T3 | T1 | T2 | T3 | T1 | T2 | T3 | T1 | T2 | T3 | T1 | T2 | T3 |
| E-UTRA RF Channel Number | | 1 | | | 2 | | | 3 | | | 4 | | | 5 | | |
| BW _{channel} | | 5MHz: N _{RB,c} = 25 10MHz: N _{RB,c} = 50 20MHz: N _{RB,c} = 100 | | | 5MHz: N _{RB,c} = 25 10MHz: N _{RB,c} = 50 20MHz: N _{RB,c} = 100 | | | 5MHz: N _{RB,c} = 25 10MHz: N _{RB,c} = 50 20MHz: N _{RB,c} = 100 | | | 5MHz: N _{RB,c} = 25 10MHz: N _{RB,c} = 50 20MHz: N _{RB,c} = 100 | | | 5MHz: N _{RB,c} = 25 10MHz: N _{RB,c} = 50 20MHz: N _{RB,c} = 100 | | |
| PDSCH parameters: DL Reference Measurement Channel | | 5MHz: R.4 TDD 10MHz: R.0 TDD 20MHz: R.3 TDD | | | - | | | - | | | - | | | - | | |
| PCFICH/PDCCH/PHICH parameters: DL Reference Measurement Channel | | 5MHz: R.11 TDD 10MHz: R.6 TDD 20MHz: R.10 TDD | | | 5MHz: R.11 TDD 10MHz: R.6 TDD 20MHz: R.10 TDD | | | 5MHz: R.11 TDD 10MHz: R.6 TDD 20MHz: R.10 TDD | | | 5MHz: R.11 TDD 10MHz: R.6 TDD 20MHz: R.10 TDD | | | 5MHz: R.11 TDD 10MHz: R.6 TDD 20MHz: R.10 TDD | | |
| OCNG Patterns | | 5MHz: OP.9 TDD 10MHz: OP.1 TDD 20MHz: OP.7 TDD | | | 5MHz: OP.10 TDD 10MHz: OP.2 TDD 20MHz: OP.8 TDD | | | 5MHz: OP.10 TDD 10MHz: OP.2 TDD 20MHz: OP.8 TDD | | | 5MHz: OP.10 TDD 10MHz: OP.2 TDD 20MHz: OP.8 TDD | | | 5MHz: OP.10 TDD 10MHz: OP.2 TDD 20MHz: OP.8 TDD | | |
| PBCH_RA | dB | 0 | | | 0 | | | 0 | | | 0 | | | 0 | | |
| PBCH_RB | dB | | | | | | | | | | | | | | | |
| PSS_RA | dB | | | | | | | | | | | | | | | |
| SSS_RA | dB | | | | | | | | | | | | | | | |
| PCFICH_RB | dB | | | | | | | | | | | | | | | |
| PHICH_RA | dB | | | | | | | | | | | | | | | |
| PHICH_RB | dB | | | | | | | | | | | | | | | |
| PDCCH_RA | dB | | | | | | | | | | | | | | | |
| PDCCH_RB | dB | | | | | | | | | | | | | | | |
| PDSCH_RA | dB | | | | | | | | | | | | | | | |
| PDSCH_RB | dB | | | | | | | | | | | | | | | |
| OCNG_RA ^{Note 1} | dB | | | | | | | | | | | | | | | |
| OCNG_RB ^{Note 1} | dB | | | | | | | | | | | | | | | |
| N _{oc} ^{Note 2} | dBm/15 kHz | | | | | | | | | | | | | | | |

| | | | | | | | |
|---|--|--------------------------------------|--|--|--------------------------------------|--------------------------------------|--------------------------------------|
| \hat{E}_s/N_{oc} | dB | 17 | - infinity | 17 | 17 | 17 | 17 |
| \hat{E}_s/I_{ot} ^{Note 3} | dB | 17 | - infinity | 17 | 17 | 17 | 17 |
| RSRP ^{Note 3} | dBm/ 15 kHz | -87 | - infinity | -87 | -87 | -87 | -87 |
| SCH_RP ^{Note 3} | dBm/ 15 kHz | -87 | - infinity | -87 | -87 | -87 | -87 |
| I_o ^{Note 3} | dBm/ Ch BW | $-59.13+10\log$ ($N_{RB,c}/50$) | -76.22 $+10\log$ ($N_{RB,c}/50$) | $-$ $59.13+10\log$ ($N_{RB,c}/50$) | $-59.13+10\log$ ($N_{RB,c}/50$) | $-59.13+10\log$ ($N_{RB,c}/50$) | $-59.13+10\log$ ($N_{RB,c}/50$) |
| Propagation Condition | | AWGN | AWGN | AWGN | AWGN | AWGN | AWGN |
| Antenna Configuration | | 1x2 | 1x2 | 1x2 | 1x2 | 1x2 | 1x2 |
| Timing offset to Cell 1 | μ s | - | 0 | 0 | 0 | 0 | 0 |
| Time alignment error relative to cell 1 ^{Note 5} | μ s | - | \leq TAE | \leq TAE | \leq TAE | \leq TAE | \leq TAE |
| Time alignment error relative to cell 2 ^{Note 5} | μ s | - | - | \leq TAE | \leq TAE | \leq TAE | \leq TAE |
| Time alignment error relative to cell 3 ^{Note 5} | μ s | - | - | - | \leq TAE | \leq TAE | \leq TAE |
| Time alignment error relative to cell 4 ^{Note 5} | μ s | - | - | - | - | - | \leq TAE |
| Note 1: | OCNG shall be used such that all cells are fully allocated and a constant total transmitted power spectral density is achieved for all OFDM symbols. | | | | | | |
| Note 2: | Interference from other cells and noise sources not specified in the test is assumed to be constant over subcarriers and time and shall be modelled as AWGN of appropriate power for N_{oc} to be fulfilled. | | | | | | |
| Note 3: | E_s/I_{ot} , RSRP, SCH_RP and I_o have been derived from other parameters for information purposes. They are not settable parameters themselves. | | | | | | |
| Note 4: | The uplink resources for CSI reporting are assigned to the UE prior to the start of time period T2. | | | | | | |
| Note 5: | Time alignment error (TAE) as specified in TS 36.104 [30] clause 6.5.3.1. The TAE value depends upon the type of carrier aggregation. | | | | | | |

A.8.16.70.2 Test Requirements

During T2 the UE shall send the first CSI report for SCell1 in a subframe (m+8), or in a subframe (m+9) if the subframe (m+8) was subject to interruption, or in a subframe (m+13) if the subframe (m+8) and (m+9) were subject to interruption when an intra-band SCell is activated. Whether CSI report in subframe (m+8) and/or (m+9) was interrupted or not is checked by monitoring ACK/NACK sent in PCell in subframe (m+8) and/or (m+9).

During T2 the UE shall start sending CSI reports for SCell1 with non-zero CQI index at latest in a subframe (m+49).

During T3 the UE shall stop sending CSI reports for SCell1 at latest in subframe (n+8).

During T2 interruption of PCell during SCells activation shall not happen outside the subframes (m+5) to (m+11) and outside the subframes (m+20) to (m+26).

During T3 interruption of PCell during SCells deactivation shall not happen outside the subframes (n+5) to (n+11), outside the subframes (n+20) to (n+26), outside the subframes (n+35) to (n+41) and outside the subframes (n+50) to (n+56).

The interruption of PCell shall not be more than the values specified for intra-band CA and inter-band CA in Section 7.8.2.

The UE shall not send event triggered measurement reports as long as the reporting criteria are not fulfilled.

All of the above test requirements shall be fulfilled in order for the observed SCell1 activation delay and SCell1 deactivation delay to be counted as correct. The rate of correct observed SCell1 activation delay and SCell1 deactivation delay during repeated tests shall be at least 90%.

NOTE: During T2 if there are no uplink resources for reporting the valid CSI in a subframe (m+49) then the UE shall use the next available uplink resource for reporting the corresponding valid CSI.

A.8.16.66 Void

A.8.16.71 5 DL FDD CA Event Triggered Reporting with Deactivated SCells in Non-DRX

A.8.16.71.1 Test Purpose and Environment

The purpose of this test is to verify that the UE correctly detects events A1 (Serving cell becomes better than threshold), A2 (Serving cell becomes worse than threshold) and A6 (Neighbour becomes better than SCell) defined in TS 36.331 [2] within the requirements stated in clause 8.3.3.2.1.

In this test case there are 6 cells. Cell 1 is the PCell on the FDD PCC F1. Cell 2 is the configured and deactivated SCell on the FDD SCC F2. Cell 3 is the configured and deactivated SCell on the FDD SCC F3. Cell 4 is the configured and deactivated SCell on the FDD SCC F4. Cell 5 is the configured and deactivated SCell on the FDD SCC F5, and cell 6 is the neighbor cell on the FDD SCC F5.

The test parameters are given in Tables A.8.16.71.1-1 and A.8.16.71.1-2 below. It is indicated to the UE in the measurement control information that event-triggered reporting with Events A1 (cell2), A2 (PCell and SCells) and A6 are used. The test consists of three successive time periods, with duration of T1, T2 and T3, respectively. During T1 the UE shall not have any information on cell 6. At the beginning of T2 the transmission power of cell 6 is increased to the same level as for cell 5, and due to usage of an offset this shall result in reporting of Event A6. Also, at the beginning of T2 the transmission power of cell 2 is increased to the same level as for cell 1, which shall result in reporting of Event A1. At the beginning of T3 the transmission powers of cells 1, 2, 3, 4, 5 and 6 are reduced below a threshold value and this shall result in reporting of Event A2 for Cell 1, for Cell 2, for Cell3, for Cell 4 and for Cell 5.

Table A.8.16.71.1-1: General test parameters for E-UTRAN FDD-FDD 5 DL CA event triggered reporting under fading propagation conditions with 4 configured but deactivated SCells in non-DRX

| Parameter | | Unit | Value | Comment |
|---|-----------------|------|---------------|--|
| E-UTRA RF Channel Number | | | 1, 2, 3, 4, 5 | Five radio channels are used for this test |
| Active PCell | | | Cell 1 | Primary cell on RF channel number 1. |
| Configured deactivated SCell | | | Cell 2 | Configured deactivated secondary cell on RF channel number 2. |
| Configured deactivated SCell | | | Cell 3 | Configured deactivated secondary cell on RF channel number 3. |
| Configured deactivated SCell | | | Cell 4 | Configured deactivated secondary cell on RF channel number 4. |
| Configured deactivated SCell | | | Cell 5 | Configured deactivated secondary cell on RF channel number 5. |
| Neighbour cell | | | Cell 6 | Neighbour cell to be identified on RF channel number 6. |
| CP length | | | Normal | |
| DRX | | | OFF | Continuous monitoring of primary cell |
| A1 | Hysteresis | dB | 0 | Hysteresis for evaluation of event A1. |
| | Threshold RSRP | dBm | -98 | Actual RSRP threshold for event A1. Needs to take absolute accuracy tolerance in section 9.1.11.1 into account plus margin. |
| | Time To Trigger | s | 0 | |
| A2 | Hysteresis | dB | 0 | Hysteresis for evaluation of event A2. |
| | Threshold RSRP | dBm | -98 | Actual RSRP threshold for event A2. Needs to take absolute accuracy tolerance in section 9.1.11.1 into account plus margin. |
| | Time To Trigger | s | 0 | |
| A6 | Hysteresis | dB | 0 | Hysteresis for evaluation of event A6. |
| | Offset | dB | -6 | Offset parameter for evaluation of event A6. Needs to take relative accuracy tolerance in section 9.1.11.2 into account plus margin. |
| | Report on leave | | False | |
| | Time To Trigger | s | 0 | |
| Cell-individual offset for cells on RF channel number 1 | | dB | 0 | Individual offset for cells on primary component carrier. |

| | | | |
|---|----|-----|---|
| Cell-individual offset for cells on RF channel number 2 | dB | 0 | Individual offset for cells on secondary component carrier. |
| Cell-individual offset for cells on RF channel number 3 | dB | 0 | Individual offset for cells on secondary component carrier. |
| Cell-individual offset for cells on RF channel number 4 | dB | 0 | Individual offset for cells on secondary component carrier. |
| Cell-individual offset for cells on RF channel number 5 | dB | 0 | Individual offset for cells on secondary component carrier. |
| Filter coefficient | | 0 | L3 filtering is not used |
| SCell measurement cycle (measCycleSCell) | ms | 320 | |
| T1 | s | 5 | During this time the cell1 cell3 cell4 cell5 shall be known to the UE; but cell2 and cell 6 shall be unknown to the UE. |
| T2 | s | ≤12 | UE should report Event A1 for cell2 and event A6 for cell6 within 6.4s (20xscellMeasCycle) |
| T3 | s | 5 | UE should report Event A2 within 200 ms for cell1, and 1.6s for cells 2, 3, 4 and 5. |

Table A.8.16.71.1-2: Cell specific test parameters for E-UTRAN FDD-FDD 5 DL CA event triggered reporting under fading propagation conditions with 4 configured but deactivated SCells in non-DRX

| Parameter | Unit | Cell 1 | | | Cell 2 | | | Cell 3 | | | Cell 4 | | | Cell 5 | | | Cell 6 | | |
|--|------------|---|--|--|---|--|--|---|--|--|---|--|--|---|--|--|--|-----------|-----------|
| | | T1 | T2 | T3 | T1 | T2 | T3 | T1 | T2 | T3 | T1 | T2 | T3 | T1 | T2 | T3 | T1 | T2 | T3 |
| E-UTRA RF Channel Number | | 1 | | | 2 | | | 3 | | | 4 | | | 5 | | | | | |
| BW _{channel} | | 5MHz: N _{RB,c} = 25 10MHz: N _{RB,c} = 50 20MHz: N _{RB,c} = 100 | | | 5MHz: N _{RB,c} = 25 10MHz: N _{RB,c} = 50 20MHz: N _{RB,c} = 100 | | | 5MHz: N _{RB,c} = 25 10MHz: N _{RB,c} = 50 20MHz: N _{RB,c} = 100 | | | 5MHz: N _{RB,c} = 25 10MHz: N _{RB,c} = 50 20MHz: N _{RB,c} = 100 | | | 5MHz: N _{RB,c} = 25 10MHz: N _{RB,c} = 50 20MHz: N _{RB,c} = 100 | | | | | |
| PDSCH parameters: DL Reference Measurement Channel | | 5MHz: R.5 FDD 10MHz: R.0 FDD 20MHz: R.4 FDD | | | - | | | - | | | - | | | - | | | - | | |
| PCFICH/PDCCH/PHICH parameters: DL Reference Measurement Channel | | 5MHz: R.11 FDD 10MHz: R.6 FDD 20MHz: R.10 FDD | | | 5MHz: R.11 FDD 10MHz: R.6 FDD 20MHz: R.10 FDD | | | 5MHz: R.11 FDD 10MHz: R.6 FDD 20MHz: R.10 FDD | | | 5MHz: R.11 FDD 10MHz: R.6 FDD 20MHz: R.10 FDD | | | 5MHz: R.11 FDD 10MHz: R.6 FDD 20MHz: R.10 FDD | | | 5MHz: R.11 FDD 10MHz: R.6 FDD 20MHz: R.10 FDD | | |
| OCNG Patterns | | 5MHz: OP.15 FDD 10MHz: OP.1 FDD 20MHz: OP.11 FDD | | | 5MHz: OP.16 FDD 10MHz: OP.2 FDD 20MHz: OP.12 FDD | | | 5MHz: OP.16 FDD 10MHz: OP.2 FDD 20MHz: OP.12 FDD | | | 5MHz: OP.16 FDD 10MHz: OP.2 FDD 20MHz: OP.12 FDD | | | 5MHz: OP.16 FDD 10MHz: OP.2 FDD 20MHz: OP.12 FDD | | | 5MHz: OP.16 FDD 10MHz: OP.2 FDD 20MHz: OP.12 FDD | | |
| PBCH_RA | dB | 0 | | | 0 | | | 0 | | | 0 | | | 0 | | | 0 | | |
| PBCH_RB | dB | | | | | | | | | | | | | | | | | | |
| PSS_RA | dB | | | | | | | | | | | | | | | | | | |
| SSS_RA | dB | | | | | | | | | | | | | | | | | | |
| PCFICH_RB | dB | | | | | | | | | | | | | | | | | | |
| PHICH_RA | dB | | | | | | | | | | | | | | | | | | |
| PHICH_RB | dB | | | | | | | | | | | | | | | | | | |
| PDCCH_RA | dB | | | | | | | | | | | | | | | | | | |
| PDCCH_RB | dB | | | | | | | | | | | | | | | | | | |
| PDSCH_RA | dB | | | | | | | | | | | | | | | | | | |
| PDSCH_RB | dB | | | | | | | | | | | | | | | | | | |
| OCNG_RA ^{Note 1} | dB | | | | | | | | | | | | | | | | | | |
| OCNG_RB ^{Note 1} | dB | | | | | | | | | | | | | | | | | | |
| N _{oc} ^{Note 2} | dBm/15 KHz | -104 | | | -104 | | | -104 | | | -104 | | | -104 | | | | | |
| \hat{E}_g/N_{oc} | dB | 17 | 17 | -3 | - infinity | 17 | -3 | 17 | 17 | -3 | 17 | 17 | -3 | 17 | 17 | -3 | - infinity | 17 | -3 |
| \hat{E}_g/I_{ot} ^{Note 3} | dB | 17 | 17 | -3 | - infinity | 17 | -3 | 17 | 17 | -3 | 17 | 17 | -3 | 17 | -0.09 | -4.76 | - infinity | - 0.05 | - 4.76 |
| RSRP ^{Note 3} | dBm/15 kHz | -87 | -87 | -107 | - infinity | -87 | -107 | -87 | -87 | -107 | -87 | -87 | -107 | -87 | -87 | -107 | - infinity | -87 | -107 |
| SCH_RP ^{Note 3} | dBm/15 kHz | -87 | -87 | -107 | - infinity | -87 | -107 | -87 | -87 | -107 | -87 | -87 | -107 | -87 | -87 | -107 | - infinity | -87 | -107 |
| I _o ^{Note 3} | dBm/Ch BW | -59.13 +10log (N _{RB,c} /50) | -59.13 +10log (N _{RB,c} /50) | -74.45 +10log (N _{RB,c} /50) | -76.22 +10log (N _{RB,c} /50) | -59.13 +10log (N _{RB,c} /50) | -74.45 +10log (N _{RB,c} /50) | -59.13 +10log (N _{RB,c} /50) | -59.13 +10log (N _{RB,c} /50) | -74.45 +10log (N _{RB,c} /50) | -59.13 +10log (N _{RB,c} /50) | -59.13 +10log (N _{RB,c} /50) | -74.45 +10log (N _{RB,c} /50) | -59.13 +10log (N _{RB,c} /50) | -56.17 +10log (N _{RB,c} /50) | -73.20 +10log (N _{RB,c} /50) | Specified in columns for Cell 5 | | |
| Propagation Condition | | AWGN | | | ETU70 | | | ETU70 | | | ETU70 | | | ETU70 | | | ETU70 | | |
| Correlation Matrix and Antenna Configuration | | 1x2 | | | 1x2 Low | | | 1x2 Low | | | 1x2 Low | | | 1x2 Low | | | 1x2 Low | | |
| Timing offset to Cell 1 | μs | - | | | 0 | | | 0 | | | 0 | | | 0 | | | 3 | | |

| | | | | | | | |
|---|---------------|---|-------------------|-------------------|-------------------|-------------------|-----|
| Time alignment error relative to cell 1 <small>Note 5</small> | μs | - | $\leq \text{TAE}$ | $\leq \text{TAE}$ | $\leq \text{TAE}$ | $\leq \text{TAE}$ | N/A |
| Time alignment error relative to cell 2 <small>Note 5</small> | μs | - | - | $\leq \text{TAE}$ | $\leq \text{TAE}$ | $\leq \text{TAE}$ | N/A |
| Time alignment error relative to cell 3 <small>Note 5</small> | μs | - | - | - | $\leq \text{TAE}$ | $\leq \text{TAE}$ | N/A |
| Time alignment error relative to cell 4 <small>Note 5</small> | μs | - | - | - | - | $\leq \text{TAE}$ | N/A |

Note 1: OCNG shall be used such that all cells are fully allocated and a constant total transmitted power spectral density is achieved for all OFDM symbols.

Note 2: Interference from other cells and noise sources not specified in the test is assumed to be constant over subcarriers and time and shall be modelled as AWGN of appropriate power for N_{oc} to be fulfilled.

Note 3: E_s/I_{ot} , RSRP, SCH_RP and I_o have been derived from other parameters for information purposes. They are not settable parameters themselves.

Note 4: The resources for uplink transmission are assigned to the UE prior to the start of time period T2.

Note 5: Time alignment error (TAE) as specified in TS 36.104 [30] clause 6.5.3.1. The TAE value depends upon the type of carrier aggregation.

A.8.16.71.2 Test Requirements

The UE shall send one Event A6 triggered measurement report for cell 6 with a measurement reporting delay of less than 6.4s ($20 \times \text{measCycleSCell}$) from the beginning of time T2.

The UE shall send one Event A1 triggered measurement report for Cell 2 with a measurement reporting delay of less than 6.4s ($20 \times \text{measCycleSCell}$) from beginning of time T2.

The UE shall send one Event A2 triggered measurement report for Cell 1 with a measurement reporting delay of less than 200 ms from beginning of time T3.

The UE shall send one Event A2 triggered measurement report for Cell 2 with a measurement reporting delay of less than 1.6s ($5 \times \text{measCycleSCell}$) from beginning of time T3.

The UE shall send one Event A2 triggered measurement report for Cell 3 with a measurement reporting delay of less than 1.6s ($5 \times \text{measCycleSCell}$) from beginning of time T3.

The UE shall send one Event A2 triggered measurement report for Cell 4 with a measurement reporting delay of less than 1.6s ($5 \times \text{measCycleSCell}$) from beginning of time T3.

The UE shall send one Event A2 triggered measurement report for Cell 5 with a measurement reporting delay of less than 1.6s ($5 \times \text{measCycleSCell}$) from beginning of time T3.

The UE shall not send event triggered measurement reports as long as the reporting criteria are not fulfilled.

The rate of correct events observed during repeated tests shall be at least 90% for each of the events.

NOTE: The actual overall delays measured in the tests may be up to $2 \times \text{TTI}_{\text{DCCH}}$ higher than the measurement reporting delays above because of TTI insertion uncertainty of the measurement report in DCCH.

A.8.16.72 5 DL TDD CA Event Triggered Reporting with Deactivated SCells in Non-DRX

A.8.16.72.1 Test Purpose and Environment

The purpose of this test is to verify that the UE correctly detects events A1 (Serving cell becomes better than threshold), A2 (Serving cell becomes worse than threshold) and A6 (Neighbour becomes better than SCell) defined in TS 36.331 [2] within the requirements stated in clause 8.3.3.2.1.

In this test case there are 6 cells. Cell 1 is the PCell on the TDD PCC F1. Cell 2 is the configured and deactivated SCell on the TDD SCC F2. Cell 3 is the configured and deactivated SCell on the TDD SCC F3. Cell 4 is the configured and deactivated SCell on the TDD SCC F4. Cell 5 is the configured and deactivated SCell on the TDD SCC F5, and cell 6 is the neighbor cell on the TDD SCC F5.

The test parameters are given in Tables A.8.16.72.1-1 and A.8.16.72.1-2 below. It is indicated to the UE in the measurement control information that event-triggered reporting with Events A1 (cell2), A2 (PCell and SCells) and A6 are used. The test consists of three successive time periods, with duration of T1, T2 and T3, respectively. During T1 the UE shall not have any information on cell 6. At the beginning of T2 the transmission power of cell 6 is increased to the same level as for cell 5, and due to usage of an offset this shall result in reporting of Event A6. Also, at the beginning of T2 the transmission power of cell 2 is increased to the same level as for cell 1, which shall result in reporting of Event A1. At the beginning of T3 the transmission powers of cells 1, 2, 3, 4, 5 and 6 are reduced below a threshold value and this shall result in reporting of Event A2 for Cell 1, for Cell 2, for Cell3, for Cell4 and for Cell 5.

Table A.8.16.72.1-1: General test parameters for E-UTRAN TDD-TDD 5 DL CA event triggered reporting under fading propagation conditions with 4 configured but deactivated SCells in non-DRX with PCell in TDD

| Parameter | Unit | Value | Comment |
|------------------------------|------|---------------|---|
| E-UTRA RF Channel Number | | 1, 2, 3, 4, 5 | Five radio channels are used for this test |
| Active PCell | | Cell 1 | Primary cell on RF channel number 1. |
| Configured deactivated SCell | | Cell 2 | Configured deactivated secondary cell on RF channel number 2. |
| Configured deactivated SCell | | Cell 3 | Configured deactivated secondary cell on RF channel number 3. |
| Configured deactivated SCell | | Cell 4 | Configured deactivated secondary cell on RF channel number 4. |

| | | | | |
|---|-----------------|-----|--------|--|
| Configured deactivated SCell | | | Cell 5 | Configured deactivated secondary cell on RF channel number 5. |
| Neighbour cell | | | Cell 6 | Neighbour cell to be identified on RF channel number 5. |
| CP length | | | Normal | |
| DRX | | | OFF | Continuous monitoring of primary cell |
| Special subframe configuration | | | 6 | As specified in table 4.2-1 in TS 36.211. The same configuration applies to all TDD cells |
| Uplink-downlink configuration | | | 1 | As specified in table 4.2-2 in TS 36.211. The same configuration applies to all TDD cells |
| A1 | Hysteresis | dB | 0 | Hysteresis for evaluation of event A1. |
| | Threshold RSRP | dBm | -98 | Actual RSRP threshold for event A1. Needs to take absolute accuracy tolerance in section 9.1.11.1 into account plus margin. |
| | Time To Trigger | s | 0 | |
| A2 | Hysteresis | dB | 0 | Hysteresis for evaluation of event A2. |
| | Threshold RSRP | dBm | -98 | Actual RSRP threshold for event A2. Needs to take absolute accuracy tolerance in section 9.1.11.1 into account plus margin. |
| | Time To Trigger | s | 0 | |
| A6 | Hysteresis | dB | 0 | Hysteresis for evaluation of event A6. |
| | Offset | dB | -6 | Offset parameter for evaluation of event A6. Needs to take relative accuracy tolerance in section 9.1.11.2 into account plus margin. |
| | Report on leave | | False | |
| | Time To Trigger | s | 0 | |
| Cell-individual offset for cells on RF channel number 1 | | dB | 0 | Individual offset for cells on primary component carrier. |
| Cell-individual offset for cells on RF channel number 2 | | dB | 0 | Individual offset for cells on secondary component carrier. |
| Cell-individual offset for cells on RF channel number 3 | | dB | 0 | Individual offset for cells on secondary component carrier. |
| Cell-individual offset for cells on RF channel number 4 | | dB | 0 | Individual offset for cells on secondary component carrier. |
| Cell-individual offset or cells on RF channel number 5 | | dB | 0 | Individual offset for cells on secondary component carrier. |
| Filter coefficient | | | 0 | L3 filtering is not used |
| SCell measurement cycle (measCycleSCell) | | ms | 320 | |
| T1 | | s | 5 | During this time the cell1, cell3, cell 4, cell 5 shall be known to the UE; but cell2 and cell 6 shall be unknown to the UE. |
| T2 | | s | ≤12 | UE should report Event A1 for cell2 and event A6 for cell6 within 6.4s (20xscellMeasCycle) |
| T3 | | s | 5 | UE should report Event A2 within 200 ms for cell 1, and 1.6s for cells 2, 3, 4, 5. |

Table A.8.16.72.1-2: Cell specific test parameters for E-UTRAN TDD-TDD 5 DL CA event triggered reporting under fading propagation conditions with 4 configured but deactivated SCells in non-DRX with PCell in TDD

| Parameter | Unit | Cell 1 | | | Cell 2 | | | Cell 3 | | | Cell 4 | | | Cell 5 | | | Cell 6 | | |
|--|---------------|---|--|--|---|--|--|---|--|--|---|--|--|---|--|--|--|-----------|-----------|
| | | T1 | T2 | T3 | T2 | T2 | T3 | T1 | T2 | T3 | T1 | T2 | T3 | T1 | T2 | T3 | T1 | T2 | T3 |
| E-UTRA RF Channel Number | | 1 | | | 2 | | | 3 | | | 4 | | | 5 | | | | | |
| BW _{channel} | | 5MHz: N _{RB,c} = 25 10MHz: N _{RB,c} = 50 20MHz: N _{RB,c} = 100 | | | 5MHz: N _{RB,c} = 25 10MHz: N _{RB,c} = 50 20MHz: N _{RB,c} = 100 | | | 5MHz: N _{RB,c} = 25 10MHz: N _{RB,c} = 50 20MHz: N _{RB,c} = 100 | | | 5MHz: N _{RB,c} = 25 10MHz: N _{RB,c} = 50 20MHz: N _{RB,c} = 100 | | | 5MHz: N _{RB,c} = 25 10MHz: N _{RB,c} = 50 20MHz: N _{RB,c} = 100 | | | | | |
| PDSCH parameters: DL Reference Measurement Channel | | 5MHz: R.5 TDD 10MHz: R.0 TDD 20MHz: R.4 TDD | | | - | | | - | | | - | | | - | | | - | | |
| PCFICH/PDCCH/PHICH parameters: DL Reference Measurement Channel | | 5MHz: R.11 TDD 10MHz: R.6 TDD 20MHz: R.10 TDD | | | 5MHz: R.11 TDD 10MHz: R.6 TDD 20MHz: R.10 TDD | | | 5MHz: R.11 TDD 10MHz: R.6 TDD 20MHz: R.10 TDD | | | 5MHz: R.11 TDD 10MHz: R.6 TDD 20MHz: R.10 TDD | | | 5MHz: R.11 TDD 10MHz: R.6 TDD 20MHz: R.10 TDD | | | 5MHz: R.11 TDD 10MHz: R.6 TDD 20MHz: R.10 TDD | | |
| OCNG Patterns | | 5MHz: OP.15 TDD 10MHz: OP.1 TDD 20MHz: OP.11 TDD | | | 5MHz: OP.16 TDD 10MHz: OP.2 TDD 20MHz: OP.12 TDD | | | 5MHz: OP.16 TDD 10MHz: OP.2 TDD 20MHz: OP.12 TDD | | | 5MHz: OP.16 TDD 10MHz: OP.2 TDD 20MHz: OP.12 TDD | | | 5MHz: OP.16 TDD 10MHz: OP.2 TDD 20MHz: OP.12 TDD | | | 5MHz: OP.16 TDD 10MHz: OP.2 TDD 20MHz: OP.12 TDD | | |
| PBCH_RA | dB | 0 | | | 0 | | | 0 | | | 0 | | | 0 | | | 0 | | |
| PBCH_RB | dB | | | | | | | | | | | | | | | | | | |
| PSS_RA | dB | | | | | | | | | | | | | | | | | | |
| SSS_RA | dB | | | | | | | | | | | | | | | | | | |
| PCFICH_RB | dB | | | | | | | | | | | | | | | | | | |
| PHICH_RA | dB | | | | | | | | | | | | | | | | | | |
| PHICH_RB | dB | | | | | | | | | | | | | | | | | | |
| PDCCH_RA | dB | | | | | | | | | | | | | | | | | | |
| PDCCH_RB | dB | | | | | | | | | | | | | | | | | | |
| PDSCH_RA | dB | | | | | | | | | | | | | | | | | | |
| PDSCH_RB | dB | | | | | | | | | | | | | | | | | | |
| OCNG_RA ^{Note 1} | dB | | | | | | | | | | | | | | | | | | |
| OCNG_RB ^{Note 1} | dB | | | | | | | | | | | | | | | | | | |
| N _{oc} ^{Note 2} | dBm/15 KHz | -104 | | | -104 | | | -104 | | | -104 | | | -104 | | | | | |
| \hat{E}_g/N_{oc} | dB | 17 | 17 | -3 | - infinity | 17 | -3 | 17 | 17 | -3 | 17 | 17 | -3 | 17 | 17 | -3 | - infinity | 17 | -3 |
| \hat{E}_g/I_{ot} ^{Note 3} | dB | 17 | 17 | -3 | - infinity | 17 | -3 | 17 | 17 | -3 | 17 | 17 | -3 | 17 | -0.09 | -4.76 | - infinity | - 0.09 | - 4.76 |
| RSRP ^{Note 3} | dBm/15 kHz | -87 | -87 | -107 | - infinity | -87 | -107 | -87 | -87 | -107 | -87 | -87 | -107 | -87 | -87 | -107 | - infinity | -87 | -107 |
| SCH_RP ^{Note 3} | dBm/15 kHz | -87 | -87 | -107 | - infinity | -87 | -107 | -87 | -87 | -107 | -87 | -87 | -107 | -87 | -87 | -107 | - infinity | -87 | -107 |
| I _o ^{Note 3} | dBm/Ch BW | -59.13 +10log (N _{RB,c} /50) | -59.13 +10log (N _{RB,c} /50) | -74.45 +10log (N _{RB,c} /50) | -76.22 +10log (N _{RB,c} /50) | -59.13 +10log (N _{RB,c} /50) | -74.45 +10log (N _{RB,c} /50) | -59.13 +10log (N _{RB,c} /50) | -59.13 +10log (N _{RB,c} /50) | -74.45 +10log (N _{RB,c} /50) | -59.13 +10log (N _{RB,c} /50) | -59.13 +10log (N _{RB,c} /50) | -74.45 +10log (N _{RB,c} /50) | -59.13 +10log (N _{RB,c} /50) | -56.17 +10log (N _{RB,c} /50) | -73.20 +10log (N _{RB,c} /50) | Specified in columns for Cell 5 | | |
| Propagation Condition | | AWGN | | | ETU70 | | | ETU70 | | | ETU70 | | | ETU70 | | | ETU70 | | |
| Correlation Matrix and Antenna Configuration | | 1x2 | | | 1x2 Low | | | 1x2 Low | | | 1x2 Low | | | 1x2 Low | | | 1x2 Low | | |
| Timing offset to Cell 1 | μs | - | | | 0 | | | 0 | | | 0 | | | 0 | | | 3 | | |

| | | | | | | | |
|---|---------------|---|-------------------|-------------------|-------------------|-------------------|-----|
| Time alignment error relative to cell 1 <small>Note 5</small> | μs | - | $\leq \text{TAE}$ | $\leq \text{TAE}$ | $\leq \text{TAE}$ | $\leq \text{TAE}$ | N/A |
| Time alignment error relative to cell 2 <small>Note 5</small> | μs | - | - | $\leq \text{TAE}$ | $\leq \text{TAE}$ | $\leq \text{TAE}$ | N/A |
| Time alignment error relative to cell 3 <small>Note 5</small> | μs | - | - | - | $\leq \text{TAE}$ | $\leq \text{TAE}$ | N/A |
| Time alignment error relative to cell 4 <small>Note 5</small> | μs | - | - | - | - | $\leq \text{TAE}$ | N/A |

Note 1: OCNG shall be used such that all cells are fully allocated and a constant total transmitted power spectral density is achieved for all OFDM symbols.

Note 2: Interference from other cells and noise sources not specified in the test is assumed to be constant over subcarriers and time and shall be modelled as AWGN of appropriate power for N_{oc} to be fulfilled.

Note 3: E_s/I_{ot} , RSRP, SCH_RP and I_o have been derived from other parameters for information purposes. They are not settable parameters themselves.

Note 4: The resources for uplink transmission are assigned to the UE prior to the start of time period T2.

Note 5: Time alignment error (TAE) as specified in TS 36.104 [30] clause 6.5.3.1. The TAE value depends upon the type of carrier aggregation.

A.8.16.72.2 Test Requirements

The UE shall send one Event A6 triggered measurement report for cell 6 with a measurement reporting delay of less than 6.4s ($20 \times \text{measCycleSCell}$) from the beginning of time T2.

The UE shall send one Event A1 triggered measurement report for Cell 2 with a measurement reporting delay of less than 6.4s ($20 \times \text{measCycleSCell}$) from beginning of time T2.

The UE shall send one Event A2 triggered measurement report for Cell 1 with a measurement reporting delay of less than 200 ms from beginning of time T3.

The UE shall send one Event A2 triggered measurement report for Cell 2 with a measurement reporting delay of less than 1.6s ($5 \times \text{measCycleSCell}$) from beginning of time T3.

The UE shall send one Event A2 triggered measurement report for Cell 3 with a measurement reporting delay of less than 1.6s ($5 \times \text{measCycleSCell}$) from beginning of time T3.

The UE shall send one Event A2 triggered measurement report for Cell 4 with a measurement reporting delay of less than 1.6s ($5 \times \text{measCycleSCell}$) from beginning of time T3.

The UE shall send one Event A2 triggered measurement report for Cell 5 with a measurement reporting delay of less than 1.6s ($5 \times \text{measCycleSCell}$) from beginning of time T3.

The UE shall not send event triggered measurement reports as long as the reporting criteria are not fulfilled.

The rate of correct events observed during repeated tests shall be at least 90% for each of the events.

NOTE: The actual overall delays measured in the tests may be up to $2 \times \text{TTI}_{\text{DCCH}}$ higher than the measurement reporting delays above because of TTI insertion uncertainty of the measurement report in DCCH.

A.8.16.73 5 DL FDD CA Event Triggered Reporting on Deactivated SCell with PCell and SCell Interruptions in Non-DRX

A.8.16.73.1 Test Purpose and Environment

The purpose of this test is to verify that the UE correctly detects event A6 (Neighbour becomes better than SCell) defined in TS 36.331 [2] within the requirements stated in clause 8.3.3.2.1 while at the same time fulfilling the requirement on interruption rate.

The test parameters are given in Table A.8.16.73.1-1, A.8.16.73.1-2 and A.8.16.73.1-3 below. In the test there are six cells: Cell 1, Cell 2, Cell 3, Cell 4, Cell 5 and Cell 6. Cell 1 is PCell on the FDD primary component (RF Channel 1), Cell 2 is SCell on the FDD secondary component (RF Channel 2), Cell 3 is SCell on the FDD secondary component (RF Channel 3), Cell 4 is SCell on the FDD secondary component (RF Channel 4) and Cell 5 is SCell on the FDD secondary component (RF Channel 5) and Cell 6 is the neighbour cell on the FDD secondary component (RF Channel 5). It is indicated to the UE in the measurement control information that event-triggered reporting with Event A6 is used. The test consists of four successive time periods, with duration of T1, T2, T3 and T4, respectively. During T1 and T2, Cell2, Cell3, Cell4 and Cell5 are deactivated. During T1 the UE shall not have any information of Cell 6. Immediately at beginning of T2 the transmission power of Cell 6 is increased to same level as for Cell 3, and due to usage of an offset this shall result in reporting of Event A6.

At the beginning of T3, the transmission power of Cell 6 is turned off, and the test equipment sends a MAC message for activation of Cell 2 to UE but Cell3, Cell4 and Cell5 remains deactivated. Immediately at beginning of T4 the transmission power of Cell 6 is increased to same level as for Cell 3, and due to usage of an offset this shall result in reporting of Event A6. The UE shall be continuously scheduled in the PCell throughout the whole test and continuously scheduled in Cell2 during T4.

Table A.8.16.73.1-1: General test parameters for E-UTRAN FDD 5 DL CA Event Triggered Reporting on Deactivated SCell with PCell and SCell interruptions in Non-DRX

| Parameter | Unit | Value | Comment |
|--------------------------|------|---------------|--|
| E-UTRA RF Channel Number | | 1, 2, 3, 4, 5 | Five radio channels are used for this test |
| Active PCell | | Cell 1 | Primary cell on RF channel number 1. |

| | | | | |
|---|-----------------|--------|--|---|
| Configured deactivated SCell | | Cell 2 | Configured deactivated secondary cell on RF channel number 2. | |
| Configured deactivated SCell | | Cell 3 | Configured deactivated secondary cell on RF channel number 3. | |
| Configured deactivated SCell | | Cell 4 | Configured deactivated secondary cell on RF channel number 4. | |
| Configured deactivated SCell | | Cell 5 | Configured deactivated secondary cell on RF channel number 5. | |
| Neighbour cell | | Cell 6 | Neighbor cell to be identified on RF channel number 5. | |
| CP length | | Normal | | |
| DRX | | OFF | Continuous monitoring of primary cell | |
| A6 | Hysteresis | dB | 0 | Hysteresis for evaluation of event A6. |
| | Offset | dB | -3 | Offset parameter for evaluation of event A6. Needs to take relative accuracy tolerance in clause 9.1.11.2 into account plus margin. |
| | Report on leave | | False | |
| | Time To Trigger | s | 0 | |
| Cell-individual offset for cells on RF channel number 1 | dB | 0 | Individual offset for cells on primary component carrier. | |
| Cell-individual offset for cells on RF channel number 2 | dB | 0 | Individual offset for cells on secondary component carrier. | |
| Cell-individual offset for cells on RF channel number 3 | dB | 0 | Individual offset for cells on secondary component carrier. | |
| Cell-individual offset for cells on RF channel number 4 | dB | 0 | Individual offset for cells on secondary component carrier. | |
| Cell-individual offset for cells on RF channel number 5 | dB | 0 | Individual offset for cells on secondary component carrier. | |
| Filter coefficient | | 0 | L3 filtering is not used | |
| SCell measurement cycle | ms | 640 | | |
| T1 | s | 4 | During this time the UE shall be aware of cells 1, 2, 3, 4 and 5 but not cell 6. | |
| T2 | s | ≤15 | UE should report Event A6 within 25.6s (20×scellMeasCycle) | |
| T3 | s | 4 | During this time the UE shall activate cell 2 | |
| T4 | s | ≤4 | UE should report Event A6 within 3.2s (5×scellMeasCycle) | |

Table A.8.16.73.1-2: Cell specific test parameters for E-UTRAN FDD 5 DL CA Event Triggered Reporting on Deactivated SCell with PCell and SCell interruptions in Non-DRX (Cell #1, Cell #2, Cell #3, Cell #4)

| Parameter | Unit | Cell 1 | | | | Cell 2 | | | | Cell 3 | | | | Cell 4 | | | |
|--|------|---|----|----|----|---|--|--|---|---|----|----|----|---|----|----|----|
| | | T1 | T2 | T3 | T4 | T1 | T2 | T3 | T4 | T1 | T2 | T3 | T4 | T1 | T2 | T3 | T4 |
| E-UTRA RF Channel Number | | 1 | | | | 2 | | | | 3 | | | | 4 | | | |
| BW _{channel} | | 5MHz: N _{RB,c} = 25 10MHz: N _{RB,c} = 50 20MHz: N _{RB,c} = 100 | | | | 5MHz: N _{RB,c} = 25 10MHz: N _{RB,c} = 50 20MHz: N _{RB,c} = 100 | | | | 5MHz: N _{RB,c} = 25 10MHz: N _{RB,c} = 50 20MHz: N _{RB,c} = 100 | | | | 5MHz: N _{RB,c} = 25 10MHz: N _{RB,c} = 50 20MHz: N _{RB,c} = 100 | | | |
| PDSCH parameters: DL Reference Measurement Channel | | 5MHz: R.7 FDD 10MHz: R.3 FDD 20MHz: R.6 FDD | | | | N/A | N/A | N/A | 5MHz: R.7 FDD 10MHz: R.3 FDD 20MHz: R.6 FDD | N/A | | | | N/A | | | |
| PCFICH/PDCCH/PHICH parameters | | 5MHz: R.11 FDD 10MHz: R.6 FDD 20MHz: R.10 FDD | | | | 5MHz: R.11 FDD 10MHz: R.6 FDD 20MHz: R.10 FDD | | | | 5MHz: R.11 FDD 10MHz: R.6 FDD 20MHz: R.10 FDD | | | | 5MHz: R.11 FDD 10MHz: R.6 FDD 20MHz: R.10 FDD | | | |
| OCNG Pattern defined in A.3.2.1 | | 5MHz: OP.20 FDD 10MHz: OP.10 FDD 20MHz: OP.17 FDD | | | | 5MHz: OP.19 FDD 10MHz: OP.6 FDD 20MHz: OP.14 FDD | 5MHz: OP.19 FDD 10MHz: OP.6 FDD 20MHz: OP.14 FDD | 5MHz: OP.19 FDD 10MHz: OP.6 FDD 20MHz: OP.14 FDD | 5MHz: OP.20 FDD 10MHz: OP.10 FDD 20MHz: OP.17 FDD | 5MHz: OP.16 FDD 10MHz: OP.2 FDD 20MHz: OP.12 FDD | | | | 5MHz: OP.16 FDD 10MHz: OP.2 FDD 20MHz: OP.12 FDD | | | |
| PBCH_RA | dB | 0 | | | | 0 | | | | 0 | | | | 0 | | | |
| PBCH_RB | dB | | | | | | | | | | | | | | | | |
| PSS_RA | dB | | | | | | | | | | | | | | | | |
| SSS_RA | dB | | | | | | | | | | | | | | | | |
| PCFICH_RB | dB | | | | | | | | | | | | | | | | |
| PHICH_RA | dB | | | | | | | | | | | | | | | | |
| PHICH_RB | dB | | | | | | | | | | | | | | | | |
| PDCCH_RA | dB | | | | | | | | | | | | | | | | |
| PDCCH_RB | dB | | | | | | | | | | | | | | | | |
| PDSCH_RA | dB | | | | | | | | | | | | | | | | |
| PDSCH_RB | dB | | | | | | | | | | | | | | | | |
| OCNG_RA ^{Note 1} | dB | | | | | | | | | | | | | | | | |
| OCNG_RB ^{Note 1} | dB | | | | | | | | | | | | | | | | |

| | | | | | | | | | | | | | | | | | |
|---|------------|--|--|--|--|--|--|--|--|--|--|--|--|--|--|--|--|
| N_{oc} ^{Note 3} | dBm/15 kHz | -101 | | | | -101 | | | | -101 | | | | -101 | | | |
| \hat{E}_s / N_{oc} | dB | 16 | 16 | 16 | 16 | 16 | 16 | 16 | 16 | 16 | 16 | 16 | 16 | 16 | 16 | 16 | 16 |
| \hat{E}_s / I_{ot} ^{Note 4} | dB | 16 | 16 | 16 | 16 | 16 | 16 | 16 | 16 | 16 | -0.11 | 16 | -0.11 | 16 | -0.11 | 16 | -0.11 |
| RSRP ^{Note 4} | dBm/15 kHz | -85 | -85 | -85 | -85 | -85 | -85 | -85 | -85 | -85 | -85 | -85 | -85 | 85 | -85 | 85 | -85 |
| SCH_RP ^{Note 4} | dBm/15 kHz | -85 | -85 | -85 | -85 | -85 | -85 | -85 | -85 | -85 | -85 | -85 | -85 | 85 | -85 | 85 | -85 |
| I_o ^{Note 4} | dBm/Ch BW | -57.11 +10log ($N_{RB,c}$ /50) | -57.11 +10log ($N_{RB,c}$ /50) | -57.11 +10log ($N_{RB,c}$ /50) | -57.11 +10log ($N_{RB,c}$ /50) | -57.11 +10log ($N_{RB,c}$ /50) | -57.11 +10log ($N_{RB,c}$ /50) | -57.11 +10log ($N_{RB,c}$ /50) | -57.11 +10log ($N_{RB,c}$ /50) | -57.11 +10log ($N_{RB,c}$ /50) | -54.15 +10log ($N_{RB,c}$ /50) | -57.11 +10log ($N_{RB,c}$ /50) | -54.15 +10log ($N_{RB,c}$ /50) | -57.11 +10log ($N_{RB,c}$ /50) | -54.15 +10log ($N_{RB,c}$ /50) | -57.11 +10log ($N_{RB,c}$ /50) | -54.15 +10log ($N_{RB,c}$ /50) |
| Propagation Condition | | AWGN | | | | AWGN | | | | AWGN | | | | AWGN | | | |
| Antenna Configuration | | 1x2 | | | | 1x2 | | | | 1x2 | | | | 1x2 | | | |
| Timing offset to Cell 1 | μ s | - | | | | 0 | | | | 0 | | | | 0 | | | |
| Time alignment error relative to cell 1 ^{Note 5} | μ s | - | | | | \leq TAE | | | | \leq TAE | | | | \leq TAE | | | |
| Time alignment error relative to cell 2 ^{Note 5} | μ s | - | | | | - | | | | \leq TAE | | | | \leq TAE | | | |
| Time alignment error relative to cell 3 ^{Note 5} | μ s | - | | | | - | | | | - | | | | \leq TAE | | | |
| Time alignment error relative to cell 4 ^{Note 5} | μ s | - | | | | - | | | | - | | | | - | | | |

Note 1: OCNG shall be used such that all cells are fully allocated and a constant total transmitted power spectral density is achieved for all OFDM symbols.

Note 2: The resources for uplink transmission are assigned to the UE on cell1 from the start of time period T2 and on cell2 from the start of time period T4.

Note 3: Interference from other cells and noise sources not specified in the test is assumed to be constant over subcarriers and time and shall be modelled as AWGN of appropriate power for N_{oc} to be fulfilled.

Note 4: Es/Iot, RSRP, SCH_RP and Io levels have been derived from other parameters for information purposes. They are not settable parameters themselves.

Note 5: Time alignment error (TAE) as specified in TS 36.104 [30] clause 6.5.3.1. The TAE value depends upon the type of carrier aggregation.

Table A.8.16.73.1-3: Cell specific test parameters for E-UTRAN FDD 5 DL CA Event Triggered Reporting on Deactivated SCell with PCell and SCell interruptions in Non-DRX (Cell #5 and Cell #6)

| Parameter | Unit | Cell 5 | | | | Cell 6 | | | |
|---|------------|---|--|--|--|---|--|--|--|
| | | T1 | T2 | T3 | T4 | T1 | T2 | T3 | T4 |
| E-UTRA RF Channel Number | | 5 | | | | 5 | | | |
| BW _{channel} | | 5MHz: N _{RB,c} = 25 10MHz: N _{RB,c} = 50 20MHz: N _{RB,c} = 100 | | | | 5MHz: N _{RB,c} = 25 10MHz: N _{RB,c} = 50 20MHz: N _{RB,c} = 100 | | | |
| PDSCH parameters: DL Reference Measurement Channel | | N/A | | | | N/A | | | |
| PCFICH/PDCCH/PHICH parameters | | 5MHz: R.11 FDD 10MHz: R.6 FDD 20MHz: R.10 FDD | | | | 5MHz: R.11 FDD 10MHz: R.6 FDD 20MHz: R.10 FDD | | | |
| OCNG Pattern defined in A.3.2.1 | | 5MHz: OP.16 FDD 10MHz: OP.2 FDD 20MHz: OP.12 FDD | | | | 5MHz: OP.16 FDD 10MHz: OP.2 FDD 20MHz: OP.12 FDD | | | |
| PBCH_RA | dB | 0 | | | | 0 | | | |
| PBCH_RB | dB | | | | | | | | |
| PSS_RA | dB | | | | | | | | |
| SSS_RA | dB | | | | | | | | |
| PCFICH_RB | dB | | | | | | | | |
| PHICH_RA | dB | | | | | | | | |
| PHICH_RB | dB | | | | | | | | |
| PDCCH_RA | dB | | | | | | | | |
| PDCCH_RB | dB | | | | | | | | |
| PDSCH_RA | dB | | | | | | | | |
| PDSCH_RB | dB | | | | | | | | |
| OCNG_RA ^{Note 1} | dB | | | | | | | | |
| OCNG_RB ^{Note 1} | dB | | | | | | | | |
| N _{oc} ^{Note 3} | dBm/15 kHz | | | | | | | | |
| \hat{E}_s/N_{oc} | dB | 16 | 16 | 16 | 16 | -infinity | 16 | -infinity | 16 |
| \hat{E}_s/I_{ot} ^{Note 4} | dB | 16 | -0.11 | 16 | -0.11 | -infinity | -0.11 | -infinity | -0.11 |
| RSRP ^{Note 4} | dBm/15 kHz | -85 | -85 | -85 | -85 | -infinity | -85 | -infinity | -85 |
| SCH_RP ^{Note 4} | dBm/15 kHz | -85 | -85 | -85 | -85 | -infinity | -85 | -infinity | -85 |
| I _o ^{Note 4} | dBm/Ch BW | -57.11 +10log (N _{RB,c} /50) | -54.15 +10log (N _{RB,c} /50) | -57.11 +10log (N _{RB,c} /50) | -54.15 +10log (N _{RB,c} /50) | -57.11 +10log (N _{RB,c} /50) | -54.15 +10log (N _{RB,c} /50) | -57.11 +10log (N _{RB,c} /50) | -54.15 +10log (N _{RB,c} /50) |
| Propagation Condition | | AWGN | | | | AWGN | | | |
| Antenna Configuration | | 1x2 | | | | 1x2 | | | |
| Timing offset to Cell 1 | μs | 0 | | | | 3 | | | |
| Time alignment error relative to cell 1 ^{Note 5} | μs | ≤ TAE | | | | N/A | | | |
| Time alignment error relative to cell 2 ^{Note 5} | μs | ≤ TAE | | | | N/A | | | |
| Time alignment error relative to cell 3 ^{Note 5} | μs | ≤ TAE | | | | N/A | | | |
| Time alignment error relative to cell 4 ^{Note 5} | μs | ≤ TAE | | | | N/A | | | |
| <p>Note 1: OCNG shall be used such that all cells are fully allocated and a constant total transmitted power spectral density is achieved for all OFDM symbols.</p> <p>Note 2: Void</p> <p>Note 3: Interference from other cells and noise sources not specified in the test is assumed to be constant over subcarriers and time and shall be modelled as AWGN of appropriate power for N_{oc} to be fulfilled.</p> <p>Note 4: Es/Iot, RSRP, SCH_RP and Io levels have been derived from other parameters for information purposes. They are not settable parameters themselves.</p> <p>Note 5: Time alignment error (TAE) as specified in TS 36.104 [30] clause 6.5.3.1. The TAE value depends upon the type of carrier aggregation.</p> | | | | | | | | | |

A.8.16.73.2 Test Requirements

The UE shall send one Event A6 triggered measurement report, with a measurement reporting delay less than 12.8s ($20 \times \text{scellMeasCycle}$) from the beginning of time period T2.

The UE shall send one Event A6 triggered measurement report, with a measurement reporting delay less than 3.2s ($5 \times \text{scellMeasCycle}$) from the beginning of time period T4.

The UE shall not send event triggered measurement reports, as long as the reporting criteria are not fulfilled.

The UE shall be scheduled on PCell continuously throughout the test. From the start of T1 until the measurement report is received during T2, at least 99.5% of all expected ACK/NACKs shall be transmitted by the UE.

The UE shall be scheduled on Cell2 continuously from the beginning of T4 to the end. From the start of T4 until the measurement report is received during T4, at least 99.5% of all expected ACK/NACKs shall be transmitted by the UE.

For a test to be considered successful requirements on both event detection and percentage of transmitted ACK/NACKs have to be fulfilled simultaneously.

The rate of correct events observed during repeated tests shall be at least 90%.

NOTE: The actual overall delays measured in the test may be up to $2 \times \text{TTI}_{\text{DCCH}}$ higher than the measurement reporting delays above because of TTI insertion uncertainty of the measurement report in DCCH.

A.8.16.74 5 DL TDD CA Event Triggered Reporting on Deactivated SCell with PCell and SCell Interruptions in Non-DRX

A.8.16.74.1 Test Purpose and Environment

The purpose of this test is to verify that the UE correctly detects event A6 (Neighbour becomes better than SCell) defined in TS 36.331 [2] within the requirements stated in clause 8.3.3.2.1 while at the same time fulfilling the requirement on interruption rate.

The test parameters are given in Table A.8.16.74.1-1, A.8.16.74.1-2 and A.8.16.74.1-3 below. In the test there are six cells: Cell 1, Cell 2, Cell 3, Cell 4, Cell 5 and Cell 6. Cell 1 is PCell on the TDD primary component (RF Channel 1), Cell 2 is SCell on the TDD secondary component (RF Channel 2), Cell 3 is SCell on the TDD secondary component (RF Channel 3), Cell 4 is SCell on the TDD secondary component (RF Channel 4) and Cell 5 is SCell on the TDD secondary component (RF Channel 5) and Cell 6 is the neighbour cell on the TDD secondary component (RF Channel 5). It is indicated to the UE in the measurement control information that event-triggered reporting with Event A6 is used. The test consists of four successive time periods, with duration of T1, T2, T3 and T4, respectively. During T1 and T2, Cell2, Cell3, Cell4 and Cell5 are deactivated. During T1 the UE shall not have any information of Cell 6. Immediately at beginning of T2 the transmission power of Cell 6 is increased to same level as for Cell 3, and due to usage of an offset this shall result in reporting of Event A6.

At the beginning of T3, the transmission power of Cell 6 is turned off, and the test equipment sends a MAC message for activation of Cell 2 to UE but Cell3, Cell4 and Cell5 remains deactivated. Immediately at beginning of T4 the transmission power of Cell 6 is increased to same level as for Cell 3, and due to usage of an offset this shall result in reporting of Event A6. The UE shall be continuously scheduled in the PCell throughout the whole test and continuously scheduled in Cell2 during T4.

Table A.8.16.74.1-1: General test parameters for E-UTRAN TDD 5 DL CA Event Triggered Reporting on Deactivated SCell with PCell and SCell interruptions in Non-DRX

| Parameter | Unit | Value | Comment |
|------------------------------|------|---------------|---|
| E-UTRA RF Channel Number | | 1, 2, 3, 4, 5 | Five radio channels are used for this test |
| Active PCell | | Cell 1 | Primary cell on RF channel number 1. |
| Configured deactivated SCell | | Cell 2 | Configured deactivated secondary cell on RF channel number 2. |
| Configured deactivated SCell | | Cell 3 | Configured deactivated secondary cell on RF channel number 3. |

| | | | | |
|---|-----------------|--------|--|---|
| Configured deactivated SCell | | Cell 4 | Configured deactivated secondary cell on RF channel number 4. | |
| Configured deactivated SCell | | Cell 5 | Configured deactivated secondary cell on RF channel number 5. | |
| Neighbour cell | | Cell 6 | Neighbor cell to be identified on RF channel number 5. | |
| CP length | | Normal | | |
| Special subframe configuration | | 6 | As specified in table 4.2-1 in TS 36.211. The same configuration in all cells | |
| Uplink-downlink configuration | | 1 | As specified in table 4.2-2 in TS 36.211. The same configuration in all cells | |
| DRX | | OFF | Continuous monitoring of primary cell | |
| A6 | Hysteresis | dB | 0 | Hysteresis for evaluation of event A6. |
| | Offset | dB | -3 | Offset parameter for evaluation of event A6. Needs to take relative accuracy tolerance in clause 9.1.11.2 into account plus margin. |
| | Report on leave | | False | |
| | Time To Trigger | s | 0 | |
| Cell-individual offset for cells on RF channel number 1 | dB | 0 | Individual offset for cells on primary component carrier. | |
| Cell-individual offset for cells on RF channel number 2 | dB | 0 | Individual offset for cells on secondary component carrier. | |
| Cell-individual offset for cells on RF channel number 3 | dB | 0 | Individual offset for cells on secondary component carrier. | |
| Cell-individual offset for cells on RF channel number 4 | dB | 0 | Individual offset for cells on secondary component carrier. | |
| Cell-individual offset for cells on RF channel number 5 | dB | 0 | Individual offset for cells on secondary component carrier. | |
| Filter coefficient | | 0 | L3 filtering is not used | |
| SCell measurement cycle | ms | 640 | | |
| T1 | s | 4 | During this time the UE shall be aware of cells 1, 2, 3, 4 and 5 but not cell 6. | |
| T2 | s | ≤15 | UE should report Event A6 within 12.8s (20×scellMeasCycle) | |
| T3 | s | 4 | During this time the UE shall activate cell 2 | |
| T4 | s | ≤4 | UE should report Event A6 within 3.2s (5×scellMeasCycle) | |

Table A.8.16.74.1-2: Cell specific test parameters for E-UTRANTDD 5 DL CA Event Triggered Reporting on Deactivated SCell with PCell and SCell interruptions in Non-DRX (Cell #1, Cell #2, Cell #3 and Cell #4)

| Parameter | Unit | Cell 1 | | | | Cell 2 | | | | Cell 3 | | | | Cell 4 | | | |
|--|------|---|----|----|----|---|---|---|--|---|----|----|----|---|----|----|----|
| | | T1 | T2 | T3 | T4 | T1 | T2 | T3 | T4 | T1 | T2 | T3 | T4 | T1 | T2 | T3 | T4 |
| E-UTRA RF Channel Number | | 1 | | | | 2 | | | | 3 | | | | 4 | | | |
| BW _{channel} | | 5MHz: N _{RB,c} = 25 10MHz: N _{RB,c} = 50 20MHz: N _{RB,c} = 100 | | | | 5MHz: N _{RB,c} = 25 10MHz: N _{RB,c} = 50 20MHz: N _{RB,c} = 100 | | | | 5MHz: N _{RB,c} = 25 10MHz: N _{RB,c} = 50 20MHz: N _{RB,c} = 100 | | | | 5MHz: N _{RB,c} = 25 10MHz: N _{RB,c} = 50 20MHz: N _{RB,c} = 100 | | | |
| PDSCH parameters: DL Reference Measurement Channel | | 5MHz: R.4 TDD 10MHz: R.0 TDD 20MHz: R.3 TDD | | | | N/A | N/A | N/A | 5MHz: R.4 TDD 10MHz: R.0 TDD 20MHz: R.3 TDD | N/A | | | | N/A | | | |
| PCFICH/PDCCH/PHICH parameters | | 5MHz: R.11 TDD 10MHz: R.6 TDD 20MHz: R.10 TDD | | | | 5MHz: R.11 TDD 10MHz: R.6 TDD 20MHz: R.10 TDD | | | | 5MHz: R.11 TDD 10MHz: R.6 TDD 20MHz: R.10 TDD | | | | 5MHz: R.11 TDD 10MHz: R.6 TDD 20MHz: R.10 TDD | | | |
| OCNG Pattern defined in A.3.2.1 | | 5MHz: OP.9 TDD 10MHz: OP.1 TDD 20MHz: OP.7 TDD | | | | 5MHz: OP.10 TDD 10MHz: OP.2 TDD 20MHz: OP.8 TDD | 5MHz: OP.10 TDD 10MHz: OP.2 TDD 20MHz: OP.8 TDD | 5MHz: OP.10 TDD 10MHz: OP.2 TDD 20MHz: OP.8 TDD | 5MHz: OP.9 TDD 10MHz: OP.1 TDD 20MHz: OP.7 FDD | 5MHz: OP.10 TDD 10MHz: OP.2 TDD 20MHz: OP.8 TDD | | | | 5MHz: OP.10 TDD 10MHz: OP.2 TDD 20MHz: OP.8 TDD | | | |
| PBCH_RA | dB | 0 | | | | 0 | | | | 0 | | | | 0 | | | |
| PBCH_RB | dB | | | | | | | | | | | | | | | | |
| PSS_RA | dB | | | | | | | | | | | | | | | | |
| SSS_RA | dB | | | | | | | | | | | | | | | | |
| PCFICH_RB | dB | | | | | | | | | | | | | | | | |
| PHICH_RA | dB | | | | | | | | | | | | | | | | |
| PHICH_RB | dB | | | | | | | | | | | | | | | | |
| PDCCH_RA | dB | | | | | | | | | | | | | | | | |
| PDCCH_RB | dB | | | | | | | | | | | | | | | | |
| PDSCH_RA | dB | | | | | | | | | | | | | | | | |
| PDSCH_RB | dB | | | | | | | | | | | | | | | | |
| OCNG_RA ^{Note 1} | dB | | | | | | | | | | | | | | | | |
| OCNG_RB ^{Note 1} | dB | | | | | | | | | | | | | | | | |

| | | | | | | | | | | | | | | | | | |
|---|------------|--|--|--|--|--|--|--|--|--|--|--|--|--|--|--|--|
| N_{oc} <small>Note 3</small> | dBm/15 kHz | -101 | | | | -101 | | | | -101 | | | | -101 | | | |
| \hat{E}_s / N_{oc} | dB | 16 | 16 | 16 | 16 | 16 | 16 | 16 | 16 | 16 | 16 | 16 | 16 | 16 | 16 | 16 | 16 |
| \hat{E}_s / I_{ot} <small>Note 4</small> | dB | 16 | 16 | 16 | 16 | 16 | 16 | 16 | 16 | 16 | -0.11 | 16 | -0.11 | 16 | -0.11 | 16 | -0.11 |
| RSRP <small>Note 4</small> | dBm/15 kHz | -85 | -85 | -85 | -85 | -85 | -85 | -85 | -85 | -85 | -85 | -85 | -85 | 85 | -85 | 85 | -85 |
| SCH_RP <small>Note 4</small> | dBm/15 kHz | -85 | -85 | -85 | -85 | -85 | -85 | -85 | -85 | -85 | -85 | -85 | -85 | 85 | -85 | 85 | -85 |
| I_o <small>Note 4</small> | dBm/Ch BW | -57.11 +10log ($N_{RB,c}$ /50) | -57.11 +10log ($N_{RB,c}$ /50) | -57.11 +10log ($N_{RB,c}$ /50) | -57.11 +10log ($N_{RB,c}$ /50) | -57.11 +10log ($N_{RB,c}$ /50) | -57.11 +10log ($N_{RB,c}$ /50) | -57.11 +10log ($N_{RB,c}$ /50) | -57.11 +10log ($N_{RB,c}$ /50) | -57.11 +10log ($N_{RB,c}$ /50) | -54.15 +10log ($N_{RB,c}$ /50) | -57.11 +10log ($N_{RB,c}$ /50) | -54.15 +10log ($N_{RB,c}$ /50) | -57.11 +10log ($N_{RB,c}$ /50) | -54.15 +10log ($N_{RB,c}$ /50) | -57.11 +10log ($N_{RB,c}$ /50) | -54.15 +10log ($N_{RB,c}$ /50) |
| Propagation Condition | | AWGN | | | | AWGN | | | | AWGN | | | | AWGN | | | |
| Antenna Configuration | | 1x2 | | | | 1x2 | | | | 1x2 | | | | 1x2 | | | |
| Timing offset to Cell 1 | μ s | - | | | | 0 | | | | 0 | | | | 0 | | | |
| Time alignment error relative to cell 1 <small>Note 5</small> | μ s | - | | | | \leq TAE | | | | \leq TAE | | | | \leq TAE | | | |
| Time alignment error relative to cell 2 <small>Note 5</small> | μ s | - | | | | - | | | | \leq TAE | | | | \leq TAE | | | |
| Time alignment error relative to cell 3 <small>Note 5</small> | μ s | - | | | | - | | | | - | | | | \leq TAE | | | |
| Time alignment error relative to cell 4 <small>Note 5</small> | μ s | - | | | | - | | | | - | | | | - | | | |
| <p>Note 1: OCNG shall be used such that all cells are fully allocated and a constant total transmitted power spectral density is achieved for all OFDM symbols.</p> <p>Note 2: The resources for uplink transmission are assigned to the UE on cell1 from the start of time period T2 and on cell2 from the start of time period T4.</p> <p>Note 3: Interference from other cells and noise sources not specified in the test is assumed to be constant over subcarriers and time and shall be modelled as AWGN of appropriate power for N_{oc} to be fulfilled.</p> <p>Note 4: Es/Iot, RSRP, SCH_RP and Io levels have been derived from other parameters for information purposes. They are not settable parameters themselves.</p> <p>Note 5: Time alignment error (TAE) as specified in TS 36.104 [30] clause 6.5.3.1. The TAE value depends upon the type of carrier aggregation.</p> | | | | | | | | | | | | | | | | | |

Table A.8.16.74.1-3: Cell specific test parameters for E-UTRAN TDD 5 DL CA Event Triggered Reporting on Deactivated SCell with PCell and SCell interruptions in Non-DRX (Cell #5 and Cell #6)

| Parameter | Unit | Cell 5 | | | | Cell 6 | | | |
|---|------------|---|--|--|--|---|--|--|--|
| | | T1 | T2 | T3 | T4 | T1 | T2 | T3 | T4 |
| E-UTRA RF Channel Number | | 5 | | | | 5 | | | |
| BW _{channel} | | 5MHz: N _{RB,c} = 25 10MHz: N _{RB,c} = 50 20MHz: N _{RB,c} = 100 | | | | 5MHz: N _{RB,c} = 25 10MHz: N _{RB,c} = 50 20MHz: N _{RB,c} = 100 | | | |
| PDSCH parameters: DL Reference Measurement Channel | | N/A | | | | N/A | | | |
| PCFICH/PDCCH/PHICH parameters | | 5MHz: R.11 TDD 10MHz: R.6 TDD 20MHz: R.10 TDD | | | | 5MHz: R.11 TDD 10MHz: R.6 TDD 20MHz: R.10 TDD | | | |
| OCNG Pattern defined in A.3.2.1 | | 5MHz: OP.10 TDD 10MHz: OP.2 TDD 20MHz: OP.8 TDD | | | | 5MHz: OP.10 TDD 10MHz: OP.2 TDD 20MHz: OP.8 TDD | | | |
| PBCH_RA | dB | 0 | | | | 0 | | | |
| PBCH_RB | dB | | | | | | | | |
| PSS_RA | dB | | | | | | | | |
| SSS_RA | dB | | | | | | | | |
| PCFICH_RB | dB | | | | | | | | |
| PHICH_RA | dB | | | | | | | | |
| PHICH_RB | dB | | | | | | | | |
| PDCCH_RA | dB | | | | | | | | |
| PDCCH_RB | dB | | | | | | | | |
| PDSCH_RA | dB | | | | | | | | |
| PDSCH_RB | dB | | | | | | | | |
| OCNG_RA ^{Note 1} | dB | | | | | | | | |
| OCNG_RB ^{Note 1} | dB | | | | | | | | |
| N _{oc} ^{Note 3} | dBm/15 kHz | | | | | | | | |
| \hat{E}_s/N_{oc} | dB | 16 | 16 | 16 | 16 | -infinity | 16 | -infinity | 16 |
| \hat{E}_s/I_{ot} ^{Note 4} | dB | 16 | -0.11 | 16 | -0.11 | -infinity | -0.11 | -infinity | -0.11 |
| RSRP ^{Note 4} | dBm/15 kHz | -85 | -85 | -85 | -85 | -infinity | -85 | -infinity | -85 |
| SCH_RP ^{Note 4} | dBm/15 kHz | -85 | -85 | -85 | -85 | -infinity | -85 | -infinity | -85 |
| I _o ^{Note 4} | dBm/Ch BW | -57.11 +10log (N _{RB,c} /50) | -54.15 +10log (N _{RB,c} /50) | -57.11 +10log (N _{RB,c} /50) | -54.15 +10log (N _{RB,c} /50) | -57.11 +10log (N _{RB,c} /50) | -54.15 +10log (N _{RB,c} /50) | -57.11 +10log (N _{RB,c} /50) | -54.15 +10log (N _{RB,c} /50) |
| Propagation Condition | | AWGN | | | | AWGN | | | |
| Antenna Configuration | | 1x2 | | | | 1x2 | | | |
| Timing offset to Cell 1 | μs | 0 | | | | 3 | | | |
| Time alignment error relative to cell 1 ^{Note 5} | μs | ≤ TAE | | | | N/A | | | |
| Time alignment error relative to cell 2 ^{Note 5} | μs | ≤ TAE | | | | N/A | | | |
| Time alignment error relative to cell 3 ^{Note 5} | μs | ≤ TAE | | | | N/A | | | |
| Time alignment error relative to cell 4 ^{Note 5} | μs | ≤ TAE | | | | N/A | | | |
| Note 1: OCNG shall be used such that all cells are fully allocated and a constant total transmitted power spectral density is achieved for all OFDM symbols. | | | | | | | | | |
| Note 2: Void | | | | | | | | | |
| Note 3: Interference from other cells and noise sources not specified in the test is assumed to be constant over subcarriers and time and shall be modelled as AWGN of appropriate power for N _{oc} to be fulfilled. | | | | | | | | | |
| Note 4: Es/I _{ot} , RSRP, SCH_RP and I _o levels have been derived from other parameters for information purposes. They are not settable parameters themselves. | | | | | | | | | |
| Note 5: Time alignment error (TAE) as specified in TS 36.104 [30] clause 6.5.3.1. The TAE value depends upon the type of carrier aggregation. | | | | | | | | | |

A.8.16.74.2 Test Requirements

The UE shall send one Event A6 triggered measurement report, with a measurement reporting delay less than 12.8s ($20 \times \text{scellMeasCycle}$) from the beginning of time period T2.

The UE shall send one Event A6 triggered measurement report, with a measurement reporting delay less than 3.2s ($5 \times \text{scellMeasCycle}$) from the beginning of time period T4.

The UE shall not send event triggered measurement reports, as long as the reporting criteria are not fulfilled.

The UE shall be scheduled on PCell continuously throughout the test. From the start of T1 until the measurement report is received during T2, at least 99.5% of all expected ACK/NACKs shall be transmitted by the UE.

The UE shall be scheduled on Cell2 continuously from the beginning of T4 to the end. From the start of T4 until the measurement report is received during T4, at least 99.5% of all expected ACK/NACKs shall be transmitted by the UE.

For a test to be considered successful requirements on both event detection and percentage of transmitted ACK/NACKs have to be fulfilled simultaneously.

The rate of correct events observed during repeated tests shall be at least 90%.

NOTE: The actual overall delays measured in the test may be up to $2 \times \text{TTI}_{\text{DCCH}}$ higher than the measurement reporting delays above because of TTI insertion uncertainty of the measurement report in DCCH.

A.8.16.75 5 DL FDD-TDD with PCell in FDD CA activation and deactivation of known SCell in non-DRX

A.8.16.75.1 Test Purpose and Environment

The purpose of this test is to verify that the SCell activation and deactivation times are within the requirements stated in section 7.7 for UE configured with four downlink SCells, when the SCell is known by the UE at the time of activation and PCell is in FDD.

The test parameters are given in Tables A.8.16.75.1-1 and cell-specific parameters in A.8.16.75.1-2 and A.8.16.75.1-3 below. The test consists of three successive time periods, with duration of T1, T2 and T3, respectively. There are five carriers, each with one cell. All cells have constant signal levels throughout the test. Before the test starts the UE is connected to Cell 1 (PCell) on radio channel 1 (PCC), deactivated Cell 3 (SCell2) on radio channel 3 (SCC2), deactivated Cell 4 (SCell3) on radio channel 4 (SCC3) and deactivated Cell 5 (SCell4) on radio channel 5 (SCC4) but is not aware of Cell 2 (SCell1) on radio channel 2 (SCC1). The UE is only monitoring PCC, SCC2, SCC3 and SCC4. The UE shall be continuously scheduled in PCell throughout the whole test.

At the beginning of T1 the UE receives an RRC message by which the SCell1 becomes configured on SCC1. The UE now starts monitoring also SCC1. The test equipment sends a MAC message for activation of SCell1.

The point in time at which the MAC message is received at the UE antenna connector, in a subframe # denoted m which is an even number, defines the start of time period T2. The UE receives a MAC message for activation of SCell2 in a subframe (m+10), a MAC message for activation of SCell3 in subframe (m+20), and a MAC message for activation of SCell4 in a subframe (m+30) during activation of SCell1. The UE shall be able to report valid CSI for the activated SCell1 at latest in subframe (m+39). The UE shall start reporting CSI for SCell1 in subframe (m+8) and shall report CQI index 0 (out-of-range) until the SCell activation has been completed. Any PCell interruption due to activation of SCells shall not occur outside subframes (m+5) to (m+9), (m+15) to (m+19), (m+25) to (m+29), and (m+35) to (m+39).

Time period T3 starts when a MAC message for deactivation of SCell1, sent from the test equipment to the UE in a subframe # denoted n, is received at the UE antenna connector. The test equipment sends a MAC message for deactivation of the SCell2 in subframe (n+10), a MAC message for deactivation of the SCell3 in subframe (n+20), and a MAC message for deactivation of the SCell4 in subframe (n+30). The UE shall carry out deactivation of the SCell1 at latest in subframe (n+8), and any PCell interruption due to the deactivation of SCells shall not occur outside subframes (n+5) to (n+9), (n+15) to (n+19), (n+25) to (n+29), and (n+35) to (n+39).

The test equipment verifies that potential interruption is carried out in the correct time span by monitoring ACK/NACK sent in PCell during activation and deactivation of SCell1, respectively.

The test equipment verifies the activation time by counting the subframes from the time when SCell1 activation command is sent until a CSI report with other than CQI index 0 is received.

The test equipment verifies the deactivation time by counting the subframes from the time when SCell1 deactivation command is sent until CQI reporting for SCell1 is discontinued.

Table A.8.16.75.1-1: General test parameters for known SCell1 activation case

| Parameter | Unit | Value | Comment |
|---|------|---------------|--|
| E-UTRA RF Channel Number | | 1, 2, 3, 4, 5 | Five radio channels are used for this test |
| Active PCell | | Cell 1 | Primary cell on RF channel number 1. |
| Deconfigured deactivated SCell1 | | Cell 2 | Deconfigured deactivated secondary cell on RF channel number 2. |
| Configured deactivated SCell2 | | Cell 3 | Configured deactivated secondary cell on RF channel number 3. |
| Configured deactivated SCell3 | | Cell 4 | Configured deactivated secondary cell on RF channel number 4. |
| Configured deactivated SCell4 | | Cell 5 | Configured deactivated secondary cell on RF channel number 5. |
| CP length | | Normal | |
| DRX | | OFF | Continuous monitoring of primary cell |
| CQI/PMI periodicity and offset configuration index | | 0 | CQI reporting for SCell every second subframe |
| Cell-individual offset for cells on RF channel number 1 | dB | 0 | Individual offset for cells on PCC. |
| Cell-individual offset for cells on RF channel number 2 | dB | 0 | Individual offset for cells on SCC1. |
| Cell-individual offset for cells on RF channel number 3 | dB | 0 | Individual offset for cells on SCC2. |
| Cell-individual offset for cells on RF channel number 4 | dB | 0 | Individual offset for cells on SCC3. |
| Cell-individual offset for cells on RF channel number 5 | dB | 0 | Individual offset for cells on SCC4. |
| SCell measurement cycle (measCycleSCell) | ms | 320 | |
| T1 | s | 7 | During this time the PCell, SCell2, SCell3 and SCell4 shall be known and the SCell1 configured and detected. |
| T2 | s | 1 | During this time the UE shall activate the SCell1, SCell2, SCell3 and SCell4. |
| T3 | s | 1 | During this time the UE shall deactivate the SCell1, SCell2, SCell3 and SCell4. |

Table A.8.16.75.1-2: Cell specific test parameters for E-UTRAN TDD known SCell1 activation with PCell in FDD

| Parameter | Unit | Cell 1 | | | Cell 2 | | | Cell 3 | | |
|--|------|---|----|----|---|----|----|---|----|----|
| | | T1 | T2 | T3 | T1 | T2 | T3 | T1 | T2 | T3 |
| E-UTRA RF Channel Number | | 1 | | | 2 | | | 3 | | |
| BW _{channel} | MHz | 5MHz: N _{RB,c} = 25 10MHz: N _{RB,c} = 50 20MHz: N _{RB,c} = 100 | | | 5MHz: N _{RB,c} = 25 10MHz: N _{RB,c} = 50 20MHz: N _{RB,c} = 100 | | | 5MHz: N _{RB,c} = 25 10MHz: N _{RB,c} = 50 20MHz: N _{RB,c} = 100 | | |
| Special subframe configuration | | - | | | 6 | | | 6 | | |
| Uplink-downlink configuration | | - | | | 1 | | | 1 | | |
| PDSCH parameters: DL Reference Measurement Channel | | 5MHz: R.7 FDD 10MHz: R.3 FDD 20MHz: R.6 FDD | | | - | | | - | | |

| | | | | |
|--|------------|---|---|---|
| PCFICH/PDCCH/PHICH parameters: DL Reference Measurement Channel | | 5MHz: R.11 FDD 10MHz: R.6 FDD 20MHz: R.10 FDD | 5MHz: R.11 TDD 10MHz: R.6 TDD 20MHz: R.10 TDD | 5MHz: R.11 TDD 10MHz: R.6 TDD 20MHz: R.10 TDD |
| OCNG Patterns | | 5MHz: OP.20 FDD 10MHz: OP.10 FDD 20MHz: OP.17 FDD | 5MHz: OP.10 TDD 10MHz: OP.2 TDD 20MHz: OP.8 TDD | 5MHz: OP.10 TDD 10MHz: OP.2 TDD 20MHz: OP.8 TDD |
| PBCH_RA | dB | 0 | 0 | 0 |
| PBCH_RB | dB | | | |
| PSS_RA | dB | | | |
| SSS_RA | dB | | | |
| PCFICH_RB | dB | | | |
| PHICH_RA | dB | | | |
| PHICH_RB | dB | | | |
| PDCCH_RA | dB | | | |
| PDCCH_RB | dB | | | |
| PDSCH_RA | dB | | | |
| PDSCH_RB | dB | | | |
| OCNG_RA ^{Note 1} | dB | | | |
| OCNG_RB ^{Note 1} | dB | | | |
| N _{oc} ^{Note 2} | dBm/15 kHz | -104 | -104 | -104 |
| \bar{E}_s/N_{oc} | dB | 17 | 17 | 17 |
| \bar{E}_s/I_{ot} | dB | 17 | 17 | 17 |
| RSRP ^{Note 3} | dBm/15 kHz | -87 | -87 | -87 |
| SCH_RP ^{Note 3} | dBm/15 kHz | -87 | -87 | -87 |
| I _o ^{Note 3} | dBm/Ch BW | -59.13 +10log (N _{RB,c} /50) | -59.13 +10log (N _{RB,c} /50) | -59.13 +10log (N _{RB,c} /50) |
| Propagation Condition | | AWGN | AWGN | AWGN |
| Antenna Configuration | | 1x2 | 1x2 | 1x2 |
| Timing offset to Cell 1 | μs | - | 0 | 0 |
| Time alignment error relative to cell 1 ^{Note 5} | μs | - | ≤ TAE | ≤ TAE |
| Time alignment error relative to cell 2 ^{Note 5} | μs | - | - | ≤ TAE |
| Time alignment error relative to cell 3 ^{Note 5} | μs | - | - | - |
| Time alignment error relative to cell 4 ^{Note 5} | μs | - | - | - |
| <p>Note 1: OCNG shall be used such that all cells are fully allocated and a constant total transmitted power spectral density is achieved for all OFDM symbols.</p> <p>Note 2: Interference from other cells and noise sources not specified in the test is assumed to be constant over subcarriers and time and shall be modelled as AWGN of appropriate power for N_{oc} to be fulfilled.</p> <p>Note 3: Es/I_{ot}, RSRP, SCH_RP and I_o levels have been derived from other parameters for information purposes. They are not settable parameters themselves.</p> <p>Note 4: The uplink resources for CSI reporting are assigned to the UE prior to the start of time period T2.</p> <p>Note 5: Time alignment error (TAE) as specified in TS 36.104 [30] clause 6.5.3.1. The TAE value depends upon the type of carrier aggregation.</p> | | | | |

Table A.8.16.75.1-3: Cell specific test parameters for E-UTRAN TDD known SCell1 activation with PCell in FDD

| Parameter | Unit | Cell 4 | | | Cell 5 | | | | | |
|--------------------------------|------|---|----|----|---|----|----|--|--|--|
| | | T1 | T2 | T3 | T1 | T2 | T3 | | | |
| E-UTRA RF Channel Number | | 4 | | | 5 | | | | | |
| BW _{channel} | MHz | 5MHz: N _{RB,c} = 25 10MHz: N _{RB,c} = 50 20MHz: N _{RB,c} = 100 | | | 5MHz: N _{RB,c} = 25 10MHz: N _{RB,c} = 50 20MHz: N _{RB,c} = 100 | | | | | |
| Special subframe configuration | | 6 | | | 6 | | | | | |

| | | | | |
|--|---------------|---|---|--|
| Uplink-downlink configuration | | 1 | 1 | |
| PDSCH parameters: DL Reference Measurement Channel | | - | - | |
| PCFICH/PDCCH/PHICH H parameters: DL Reference Measurement Channel | | 5MHz: R.11 TDD 10MHz: R.6 TDD 20MHz: R.10 TDD | 5MHz: R.11 TDD 10MHz: R.6 TDD 20MHz: R.10 TDD | |
| OCNG Patterns | | 5MHz: OP.10 TDD 10MHz: OP.2 TDD 20MHz: OP.8 TDD | 5MHz: OP.10 TDD 10MHz: OP.2 TDD 20MHz: OP.8 TDD | |
| PBCH_RA | dB | 0 | 0 | |
| PBCH_RB | dB | | | |
| PSS_RA | dB | | | |
| SSS_RA | dB | | | |
| PCFICH_RB | dB | | | |
| PHICH_RA | dB | | | |
| PHICH_RB | dB | | | |
| PDCCH_RA | dB | | | |
| PDCCH_RB | dB | | | |
| PDSCH_RA | dB | | | |
| PDSCH_RB | dB | | | |
| OCNG_RA ^{Note 1} | dB | | | |
| OCNG_RB ^{Note 1} | dB | | | |
| N_{oc} ^{Note 2} | dBm/15 kHz | | | |
| \bar{E}_s/N_{oc} | dB | 17 | 17 | |
| \bar{E}_s/I_{ot} | dB | 17 | 17 | |
| RSRP ^{Note 3} | dBm/15 kHz | -87 | -87 | |
| SCH_RP ^{Note 3} | dBm/15 kHz | -87 | -87 | |
| I_o ^{Note 3} | dBm/Ch BW | -59.13 +10log ($N_{RB,c}/50$) | -59.13 +10log ($N_{RB,c}/50$) | |
| Propagation Condition | | AWGN | AWGN | |
| Antenna Configuration | | 1x2 | 1x2 | |
| Timing offset to Cell 1 | μ s | 0 | 0 | |
| Time alignment error relative to cell 1 ^{Note 5} | μ s | \leq TAE | \leq TAE | |
| Time alignment error relative to cell 2 ^{Note 5} | μ s | \leq TAE | \leq TAE | |
| Time alignment error relative to cell 3 ^{Note 5} | μ s | \leq TAE | \leq TAE | |
| Time alignment error relative to cell 4 ^{Note 5} | μ s | - | \leq TAE | |
| <p>Note 1: OCNG shall be used such that all cells are fully allocated and a constant total transmitted power spectral density is achieved for all OFDM symbols.</p> <p>Note 2: Interference from other cells and noise sources not specified in the test is assumed to be constant over subcarriers and time and shall be modelled as AWGN of appropriate power for N_{oc} to be fulfilled.</p> <p>Note 3: E_s/I_{ot}, RSRP, SCH_RP and I_o levels have been derived from other parameters for information purposes. They are not settable parameters themselves.</p> <p>Note 4: The uplink resources for CSI reporting are assigned to the UE prior to the start of time period T2.</p> <p>Note 5: Time alignment error (TAE) as specified in TS 36.104 [30] clause 6.5.3.1. The TAE value depends upon the type of carrier aggregation.</p> | | | | |

A.8.16.75.2 Test Requirements

During T2 the UE shall send the first CSI report for SCell1 in a subframe (m+8), or in a subframe (m+10) if the subframe (m+8) was subject to interruption. Whether CSI report in subframe (m+8) was interrupted or not is checked by monitoring ACK/NACK sent in PCell in subframe (m+8).

During T2 the UE shall start sending CSI reports for SCell1 with non-zero CQI index at latest in a subframe (m+39).

During T3 the UE shall stop sending CSI reports for SCell1 at latest in a subframe (n+8).

During T2 interruption of PCell during SCells activation shall not happen outside the subframes (m+5) to (m+9), outside the subframes (m+15) to (m+19), outside the subframes (m+25) to (m+29), and outside the subframes (m+35) to (m+39).

During T3 interruption of PCell during SCells deactivation shall not happen outside the subframes (n+5) to (n+9), outside the subframes (n+15) to (n+19), outside the subframes (n+25) to (n+29), and outside the subframes (n+25) to (n+29).

The interruption of PCell shall not be more than the values specified for intra-band CA and inter-band CA in Section 7.8.2.

All of the above test requirements shall be fulfilled in order for the observed SCell1 activation delay and SCell1 deactivation delay to be counted as correct. The rate of correct observed SCell1 activation delay and SCell1 deactivation delay during repeated tests shall be at least 90%.

NOTE: During T2 if there are no uplink resources for reporting the valid CSI in a subframe (m+39) then the UE shall use the next available uplink resource for reporting the corresponding valid CSI.

A.8.16.76 5 DL FDD-TDD with PCell in TDD CA activation and deactivation of known SCell in non-DRX

A.8.16.76.1 Test Purpose and Environment

The purpose of this test is to verify that the SCell activation and deactivation times are within the requirements stated in section 7.7 for UE configured with four downlink SCells, when the SCell is known by the UE at the time of activation and PCell is in TDD.

The test parameters are given in Tables A.8.16.76.1-1 and cell-specific parameters in A.8.16.76.1-2 and A.8.16.76.1-3 below. The test consists of three successive time periods, with duration of T1, T2 and T3, respectively. There are five carriers, each with one cell. All cells have constant signal levels throughout the test. Before the test starts the UE is connected to Cell 1 (PCell) on radio channel 1 (PCC), deactivated Cell 3 (SCell2) on radio channel 3 (SCC2), deactivated Cell 4 (SCell3) on radio channel 4 (SCC3) and deactivated Cell 5 (SCell4) on radio channel 5 (SCC4) but is not aware of Cell 2 (SCell1) on radio channel 2 (SCC1). The UE is only monitoring PCC, SCC2, SCC3 and SCC4. The UE shall be continuously scheduled in the PCell throughout the whole test.

At the beginning of T1 the UE receives an RRC message by which SCell1 becomes configured on SCC1. The UE now starts monitoring also the SCC1. The test equipment sends a MAC message for activation of SCell1.

The point in time at which the MAC message is received at the UE antenna connector, in a subframe # denoted m, where m is 4 or 9, defines the start of time period T2. The UE receives a MAC message for activation of the SCell 2, SCell3 and SCell4 in a subframe (m+15) during activation of SCell1. The UE shall be able to report valid CSI for the activated SCell1 at latest in a subframe (m+39). The UE shall start reporting CSI for SCell1 in subframe (m+8) and shall report CQI index 0 (out-of-range) until the SCell activation has been completed. Any PCell interruption due to activation of SCells shall not occur outside subframes (m+5) to (m+11) and (m+20) to (m+26).

Time period T3 starts when a MAC message for deactivation of SCell1, sent from the test equipment to the UE in a subframe # denoted n, where n is 4 or 9, is received at the UE antenna connector. The test equipment sends a MAC message for deactivation of the SCell2 in subframe (n+15), a MAC message for deactivation of the SCell3 in subframe (n+30), and a MAC message for deactivation of the SCell4 in subframe (n+45). The UE shall carry out deactivation of SCell1 at latest in subframe (n+8), and any PCell interruption due to the deactivation of SCells shall not occur outside subframes (n+5) to (n+11), (n+20) to (n+26), (n+35) to (n+41) and (n+50) to (n+56).

The test equipment verifies that potential interruption is carried out in the correct time span by monitoring ACK/NACK sent in PCell during activation and deactivation of SCell1, respectively.

The test equipment verifies the activation time by counting the subframes from the time when SCell1 activation command is sent until a CSI report with other than CQI index 0 is received.

The test equipment verifies the deactivation time by counting the subframes from the time when SCell1 deactivation command is sent until CQI reporting for SCell1 is discontinued.

Table A.8.16.76.1-1: General test parameters for known SCell1 activation case

| Parameter | Unit | Value | Comment |
|---|------|---------------|--|
| E-UTRA RF Channel Number | | 1, 2, 3, 4, 5 | Five radio channels are used for this test |
| Active PCell | | Cell 1 | Primary cell on RF channel number 1. |
| Deconfigured deactivated SCell | | Cell 2 | Deconfigured deactivated secondary cell on RF channel number 2. |
| Configured deactivated SCell2 | | Cell 3 | Configured deactivated secondary cell on RF channel number 3. |
| Configured deactivated SCell3 | | Cell 4 | Configured deactivated secondary cell on RF channel number 4. |
| Configured deactivated SCell4 | | Cell 5 | Configured deactivated secondary cell on RF channel number 5. |
| CP length | | Normal | |
| | | | |
| DRX | | OFF | Continuous monitoring of primary cell |
| CQI/PMI periodicity and offset configuration index | | 0 | CQI reporting for SCell every UL subframe |
| Cell-individual offset for cells on RF channel number 1 | dB | 0 | Individual offset for cells on PCC. |
| Cell-individual offset for cells on RF channel number 2 | dB | 0 | Individual offset for cells on SCC1. |
| Cell-individual offset for cells on RF channel number 3 | dB | 0 | Individual offset for cells on SCC2. |
| Cell-individual offset for cells on RF channel number 4 | dB | 0 | Individual offset for cells on SCC3. |
| Cell-individual offset for cells on RF channel number 5 | dB | 0 | Individual offset for cells on SCC4. |
| SCell measurement cycle (measCycleSCell) | ms | 320 | |
| T1 | s | 7 | During this time the PCell, SCell2, SCell3 and SCell4 shall be known and the SCell1 configured and detected. |
| T2 | s | 1 | During this time the UE shall activate the SCell1, SCell2, SCell3 and SCell4. |
| T3 | s | 1 | During this time the UE shall deactivate the SCell1, SCell2, SCell3 and SCell4. |

Table A.8.16.76.1-2: Cell specific test parameters for E-UTRAN FDD known SCell1 activation with PCell in TDD

| Parameter | Unit | Cell 1 | | | Cell 2 | | | Cell 3 | | |
|---|------|---|----|----|---|----|----|---|----|----|
| | | T1 | T2 | T3 | T1 | T2 | T3 | T1 | T2 | T3 |
| E-UTRA RF Channel Number | | 1 | | | 2 | | | 3 | | |
| BW _{channel} | MHz | 5MHz: N _{RB,c} = 25 10MHz: N _{RB,c} = 50 20MHz: N _{RB,c} = 100 | | | 5MHz: N _{RB,c} = 25 10MHz: N _{RB,c} = 50 20MHz: N _{RB,c} = 100 | | | 5MHz: N _{RB,c} = 25 10MHz: N _{RB,c} = 50 20MHz: N _{RB,c} = 100 | | |
| Special subframe configuration | | 6 | | | - | | | - | | |
| Uplink-downlink configuration | | 1 | | | - | | | - | | |
| PDSCH parameters: DL Reference Measurement Channel | | 5MHz: R.4 TDD 10MHz: R.0 TDD 20MHz: R.3 TDD | | | - | | | - | | |
| PCFICH/PDCCH/PHICH parameters: DL Reference Measurement Channel | | 5MHz: R.11 TDD 10MHz: R.6 TDD 20MHz: R.10 TDD | | | 5MHz: R.11 FDD 10MHz: R.6 FDD 20MHz: R.10 FDD | | | 5MHz: R.11 FDD 10MHz: R.6 FDD 20MHz: R.10 FDD | | |

| OCNG Patterns | | 5MHz: OP.9 TDD 10MHz: OP.1 TDD 20MHz: OP.7 TDD | 5MHz: OP.16 FDD 10MHz: OP.2 FDD 20MHz: OP.12 FDD | 5MHz: OP.16 FDD 10MHz: OP.2 FDD 20MHz: OP.12 FDD |
|--|------------|--|--|--|
| PBCH_RA | dB | 0 | 0 | 0 |
| PBCH_RB | dB | | | |
| PSS_RA | dB | | | |
| SSS_RA | dB | | | |
| PCFICH_RB | dB | | | |
| PHICH_RA | dB | | | |
| PHICH_RB | dB | | | |
| PDCCH_RA | dB | | | |
| PDCCH_RB | dB | | | |
| PDSCH_RA | dB | | | |
| PDSCH_RB | dB | | | |
| OCNG_RA ^{Note 1} | dB | | | |
| OCNG_RB ^{Note 1} | dB | | | |
| N _{oc} ^{Note 2} | dBm/15 kHz | -104 | -104 | -104 |
| \bar{E}_s/N_{oc} | dB | 17 | 17 | 17 |
| \bar{E}_s/I_{ot} | dB | 17 | 17 | 17 |
| RSRP ^{Note 3} | dBm/15 kHz | -87 | -87 | -87 |
| SCH_RP ^{Note 3} | dBm/15 kHz | -87 | -87 | -87 |
| I _o ^{Note 3} | dBm/Ch BW | -59.13 +10log (N _{RB,c} /50) | -59.13 +10log (N _{RB,c} /50) | -59.13 +10log (N _{RB,c} /50) |
| Propagation Condition | | AWGN | AWGN | AWGN |
| Antenna Configuration | | 1x2 | 1x2 | 1x2 |
| Timing offset to Cell 1 | μs | - | 0 | 0 |
| Time alignment error relative to cell 1 ^{Note 5} | μs | - | ≤ TAE | ≤ TAE |
| Time alignment error relative to cell 2 ^{Note 5} | μs | - | - | ≤ TAE |
| Time alignment error relative to cell 3 ^{Note 5} | μs | - | - | - |
| Time alignment error relative to cell 4 ^{Note 5} | μs | - | - | - |
| <p>Note 1: OCNG shall be used such that all cells are fully allocated and a constant total transmitted power spectral density is achieved for all OFDM symbols.</p> <p>Note 2: Interference from other cells and noise sources not specified in the test is assumed to be constant over subcarriers and time and shall be modelled as AWGN of appropriate power for N_{oc} to be fulfilled.</p> <p>Note 3: Es/I_{ot}, RSRP, SCH_RP and I_o levels have been derived from other parameters for information purposes. They are not settable parameters themselves.</p> <p>Note 4: The uplink resources for CSI reporting are assigned to the UE prior to the start of time period T2.</p> <p>Note 5: Time alignment error (TAE) as specified in TS 36.104 [30] clause 6.5.3.1. The TAE value depends upon the type of carrier aggregation.</p> | | | | |

Table A.8.16.76.1-3: Cell specific test parameters for E-UTRAN FDD known SCell1 activation with PCell in TDD

| Parameter | Unit | Cell 4 | | | Cell 5 | | | | | |
|--------------------------------|------|---|----|----|---|----|----|--|--|--|
| | | T1 | T2 | T3 | T1 | T2 | T3 | | | |
| E-UTRA RF Channel Number | | 4 | | | 5 | | | | | |
| BW _{channel} | MHz | 5MHz: N _{RB,c} = 25 10MHz: N _{RB,c} = 50 20MHz: N _{RB,c} = 100 | | | 5MHz: N _{RB,c} = 25 10MHz: N _{RB,c} = 50 20MHz: N _{RB,c} = 100 | | | | | |
| Special subframe configuration | | - | | | - | | | | | |
| Uplink-downlink configuration | | - | | | - | | | | | |

| | | | | |
|---|---------------|--|--|--|
| PDSCH parameters: DL Reference Measurement Channel | | - | - | |
| PCFICH/PDCCH/PHICH parameters: DL Reference Measurement Channel | | 5MHz: R.11 FDD 10MHz: R.6 FDD 20MHz: R.10 FDD | 5MHz: R.11 FDD 10MHz: R.6 FDD 20MHz: R.10 FDD | |
| OCNG Patterns | | 5MHz: OP.16 FDD 10MHz: OP.2 FDD 20MHz: OP.12 FDD | 5MHz: OP.16 FDD 10MHz: OP.2 FDD 20MHz: OP.12 FDD | |
| PBCH_RA | dB | 0 | 0 | |
| PBCH_RB | dB | | | |
| PSS_RA | dB | | | |
| SSS_RA | dB | | | |
| PCFICH_RB | dB | | | |
| PHICH_RA | dB | | | |
| PHICH_RB | dB | | | |
| PDCCH_RA | dB | | | |
| PDCCH_RB | dB | | | |
| PDSCH_RA | dB | | | |
| PDSCH_RB | dB | | | |
| OCNG_RA ^{Note 1} | dB | | | |
| OCNG_RB ^{Note 1} | dB | | | |
| N _{oc} ^{Note 2} | dBm/15 kHz | | | |
| \bar{E}_s/N_{oc} | dB | 17 | 17 | |
| \bar{E}_s/I_{ot} | dB | 17 | 17 | |
| RSRP ^{Note 3} | dBm/15 kHz | -87 | -87 | |
| SCH_RP ^{Note 3} | dBm/15 kHz | -87 | -87 | |
| I _o ^{Note 3} | dBm/Ch BW | -59.13 +10log (N _{RB,c} /50) | -59.13 +10log (N _{RB,c} /50) | |
| Propagation Condition | | AWGN | AWGN | |
| Antenna Configuration | | 1x2 | 1x2 | |
| Timing offset to Cell 1 | μs | 0 | 0 | |
| Time alignment error relative to cell 1 ^{Note 5} | μs | ≤ TAE | ≤ TAE | |
| Time alignment error relative to cell 2 ^{Note 5} | μs | ≤ TAE | ≤ TAE | |
| Time alignment error relative to cell 3 ^{Note 5} | μs | ≤ TAE | ≤ TAE | |
| Time alignment error relative to cell 4 ^{Note 5} | μs | - | ≤ TAE | |
| <p>Note 1: OCNG shall be used such that all cells are fully allocated and a constant total transmitted power spectral density is achieved for all OFDM symbols.</p> <p>Note 2: Interference from other cells and noise sources not specified in the test is assumed to be constant over subcarriers and time and shall be modelled as AWGN of appropriate power for N_{oc} to be fulfilled.</p> <p>Note 3: E_s/I_{ot}, RSRP, SCH_RP and I_o levels have been derived from other parameters for information purposes. They are not settable parameters themselves.</p> <p>Note 4: The uplink resources for CSI reporting are assigned to the UE prior to the start of time period T2.</p> <p>Note 5: Time alignment error (TAE) as specified in TS 36.104 [30] clause 6.5.3.1. The TAE value depends upon the type of carrier aggregation.</p> | | | | |

A.8.16.76.2 Test Requirements

During T2 the UE shall send the first CSI report for SCell1 in a subframe (m+8,) or in a subframe (m+9) if the subframe (m+8) was subject to interruption. Whether CSI report in subframe (m+8) was interrupted or not is checked by monitoring ACK/NACK sent in PCell in subframe (m+8).

During T2 the UE shall start sending CSI reports for SCell1 with non-zero CQI index at latest in a subframe (m+39).

During T3 the UE shall stop sending CSI reports for SCell at latest in a subframe (n+8).

During T2 interruption of PCell during SCells activation shall not happen outside the subframes (m+5) to (m+11) and outside the subframes (m+20) to (m+26).

During T3 interruption of PCell during SCells deactivation shall not happen outside the subframes (n+5) to (n+11), outside the subframes (n+20) to (n+26), outside the subframes (n+35) to (n+41), and outside the subframes (n+50) to (n+56).

The interruption of PCell shall not be more than the values specified for intra-band CA and inter-band CA in Section 7.8.2.

All of the above test requirements shall be fulfilled in order for the observed SCell1 activation delay and SCell1 deactivation delay to be counted as correct. The rate of correct observed SCell1 activation delay and SCell1 deactivation delay during repeated tests shall be at least 90%.

NOTE: During T2 if there are no uplink resources for reporting the valid CSI in a subframe (m+39) then the UE shall use the next available uplink resource for reporting the corresponding valid CSI.

A.8.16.77 5 DL FDD CA activation and deactivation of know SCell in non-DRX

A.8.16.77.1 Test Purpose and Environment

The purpose of this test is to verify that the SCell activation and deactivation times are within the requirements stated in section 7.7 for UE configured with four downlink SCells, when the SCell is known by the UE at the time of activation and PCell is in FDD.

The test parameters are given in Tables A.8.16.77.1-1 and cell-specific parameters in A.8.16.77.1-2 below. The test consists of three successive time periods, with duration of T1, T2 and T3, respectively. There are five carriers, each with one cell. All cells have constant signal levels throughout the test. Before the test starts the UE is connected to Cell1 (PCell) on radio channel 1 (PCC), Cell 3 (deactivated SCell2) on radio channel 3 (SCC2), Cell4 (deactivated SCell3) on radio channel 4 (SCC3) and Cell5 (deactivated SCell4) on radio channel 5 (SCC4) but is not aware of Cell2 (SCell1) on radio channel 2 (SCC1). The UE is only monitoring the PCC, SCC2, SCC3 and SCC4. The UE shall be continuously scheduled in the PCell throughout the whole test.

At the beginning of T1 the UE receives an RRC message by which the SCell1 (Cell2) becomes configured on radio channel 2 (SCC1). The UE now starts monitoring also the SCC1. The test equipment sends a MAC message for activation of the SCell1.

The point in time at which the MAC message is received at the UE antenna connector, in a subframe #denoted m which is an even number, defines the start of time period T2. At the beginning of T2 the test equipment sends a MAC message for activation of the SCell1. The UE receives the activation command for SCell2, SCell3 and SCell4 in subframes (m+10), (m+20) and (m+30) during activation of the SCell1. The UE shall be able to report valid CSIs for the activated SCell at latest in a subframe (m+39). The UE shall start reporting CSI for SCell1 in subframe in (m+8) and shall report CQI index 0 (out-of-range) until the subframe activation has been completed. Any PCell interruption due to activation of SCells shall occur in the subframe (m+5) to (m+9), (m+15) to (m+19), (m+25) to (m+29) and (m+35) to (m+39).

Time period T3 starts when a MAC message for deactivation of SCell1, send from the test equipment to the UE in a subframe #denoted n, is received at the UE antenna connector. The test equipment sends a MAC message for deactivation of the SCell2, SCell3 and SCell4 in subframe (n+10), (n+20) and (n+30). The UE shall carry out deactivation of the SCell1 at latest in subframe (n+8), and any interruption due to the deactivation of SCells shall occur in the subframe (n+5) to (n+9), (n+15) to (n+19), (n+25) to (n+29) and (n+35) to (n+39).

The test equipment verifies that potential interruption is carried out in the correct time span by monitoring ACK/NACK sent in PCell during activation and deactivation of SCell1, respectively.

The test equipment verifies the activation time by counting the subframes from the time when the SCell1 activation command is sent until a CSI report with other than CQI index 0 is received.

The test equipment verifies the deactivation time by counting the subframes from the time when the SCell1 deactivation command is sent until CQI reporting for SCell1 is discontinued.

Table A.8.16.77.1-1: General test parameters for known SCell1 activation case

| Parameter | Unit | Value | Comment |
|---|------|---------------|--|
| E-UTRA RF Channel Number | | 1, 2, 3, 4, 5 | Five radio channels are used for this test |
| Active PCell | | Cell 1 | Primary cell on RF channel number 1. |
| Deconfigured deactivated SCell1 | | Cell 2 | Deconfigured deactivated secondary cell on RF channel number 2. |
| Configured deactivated SCell2 | | Cell 3 | Configured deactivated secondary cell on RF channel number 3. |
| Configured deactivated SCell3 | | Cell 4 | Configured deactivated secondary cell on RF channel number 4. |
| Configured deactivated SCell3 | | Cell 5 | Configured deactivated secondary cell on RF channel number 5. |
| CP length | | Normal | |
| DRX | | OFF | Continuous monitoring of primary cell |
| CQI/PMI periodicity and offset configuration index | | 0 | CQI reporting for SCell every second subframe |
| Cell-individual offset for cells on RF channel number 1 | dB | 0 | Individual offset for cells on PCC. |
| Cell-individual offset for cells on RF channel number 2 | dB | 0 | Individual offset for cells on SCC1. |
| Cell-individual offset for cells on RF channel number 3 | dB | 0 | Individual offset for cells on SCC2. |
| Cell-individual offset for cells on RF channel number 4 | dB | 0 | Individual offset for cells on SCC3. |
| Cell-individual offset for cells on RF channel number 5 | dB | 0 | Individual offset for cells on SCC4. |
| Filter coefficient | | 0 | L3 filtering is not used |
| SCell measurement cycle (measCycleSCell) | ms | 320 | |
| T1 | s | 7 | During this time the PCell, SCell2, SCell3 and SCell4 shall be known and the SCell1 configured and detected. |
| T2 | s | 1 | During this time the UE shall activate the SCell1. |
| T3 | s | 1 | During this time the UE shall deactivate the SCell1. |

Table A.8.16.77.1-2: Cell specific test parameters for E-UTRAN FDD 5 DL CA activation and deactivation of known SCell in non-DRX

| Parameter | Unit | Cell 1 | | | Cell 2 | | | Cell 3 | | | Cell 4 | | | Cell 5 | | |
|---|------|---|----|----|---|----|----|---|----|----|---|----|----|---|----|----|
| | | T1 | T2 | T3 | T1 | T3 | T3 | T1 | T2 | T3 | T1 | T2 | T3 | T1 | T2 | T3 |
| E-UTRA RF Channel Number | | 1 | | | 2 | | | 3 | | | 4 | | | 5 | | |
| BW _{channel} | MHz | 5MHz: N _{RB,c} = 25 10MHz: N _{RB,c} = 50 20MHz: N _{RB,c} = 100 | | | 5MHz: N _{RB,c} = 25 10MHz: N _{RB,c} = 50 20MHz: N _{RB,c} = 100 | | | 5MHz: N _{RB,c} = 25 10MHz: N _{RB,c} = 50 20MHz: N _{RB,c} = 100 | | | 5MHz: N _{RB,c} = 25 10MHz: N _{RB,c} = 50 20MHz: N _{RB,c} = 100 | | | 5MHz: N _{RB,c} = 25 10MHz: N _{RB,c} = 50 20MHz: N _{RB,c} = 100 | | |
| PDSCH parameters: DL Reference Measurement Channel | | 5MHz: R.7 FDD 10MHz: R.3 FDD 20MHz: R.6 FDD | | | - | | | - | | | - | | | - | | |
| PCFICH/PDCCH/PHICH parameters: DL Reference Measurement Channel | | 5MHz: R.11 FDD 10MHz: R.6 FDD 20MHz: R.10 FDD | | | 5MHz: R.11 FDD 10MHz: R.6 FDD 20MHz: R.10 FDD | | | 5MHz: R.11 FDD 10MHz: R.6 FDD 20MHz: R.10 FDD | | | 5MHz: R.11 FDD 10MHz: R.6 FDD 20MHz: R.10 FDD | | | 5MHz: R.11 FDD 10MHz: R.6 FDD 20MHz: R.10 FDD | | |

| OCNG Patterns | | 5MHz: OP.20 FDD 10MHz: OP.10 FDD 20MHz: OP.17 FDD | 5MHz: OP.16 FDD 10MHz: OP.2 FDD 20MHz: OP.12 FDD | 5MHz: OP.16 FDD 10MHz: OP.2 FDD 20MHz: OP.12 FDD | 5MHz: OP.16 FDD 10MHz: OP.2 FDD 20MHz: OP.12 FDD | 5MHz: OP.16 FDD 10MHz: OP.2 FDD 20MHz: OP.12 FDD |
|---|--|--|---|---|---|---|
| PBCH_RA | dB | 0 | 0 | 0 | 0 | 0 |
| PBCH_RB | dB | | | | | |
| PSS_RA | dB | | | | | |
| SSS_RA | dB | | | | | |
| PCFICH_RB | dB | | | | | |
| PHICH_RA | dB | | | | | |
| PHICH_RB | dB | | | | | |
| PDCCH_RA | dB | | | | | |
| PDCCH_RB | dB | | | | | |
| PDSCH_RA | dB | | | | | |
| PDSCH_RB | dB | | | | | |
| OCNG_RA ^{Note 1} | dB | | | | | |
| OCNG_RB ^{Note 1} | dB | | | | | |
| N_{oc} ^{Note 2} | dBm/ 15 kHz | | | | | |
| \hat{E}_s/N_{oc} | dB | 17 | 17 | 17 | 17 | 17 |
| \hat{E}_s/I_{ot} | dB | 17 | 17 | 17 | 17 | 17 |
| RSRP ^{Note 3} | dBm/ 15 kHz | -87 | -87 | -87 | -87 | -87 |
| SCH_RP ^{Note 3} | dBm/ 15 kHz | -87 | -87 | -87 | -87 | -87 |
| I_o ^{Note 3} | dBm/ Ch BW | -59.13 +10log ($N_{RB,c}/50$) | -59.13 +10log ($N_{RB,c}/50$) | -59.13 +10log ($N_{RB,c}/50$) | -59.13 +10log ($N_{RB,c}/50$) | -59.13 +10log ($N_{RB,c}/50$) |
| Propagation Condition | | AWGN | AWGN | AWGN | AWGN | AWGN |
| Antenna Configuration | | 1x2 | 1x2 | 1x2 | 1x2 | 1x2 |
| Timing offset to Cell 1 | μ s | - | 0 | 0 | 0 | 0 |
| Time alignment error relative to cell 1 ^{Note 5} | μ s | - | \leq TAE | \leq TAE | \leq TAE | \leq TAE |
| Time alignment error relative to cell 2 ^{Note 5} | μ s | - | - | \leq TAE | \leq TAE | \leq TAE |
| Time alignment error relative to cell 3 ^{Note 5} | μ s | - | - | - | \leq TAE | \leq TAE |
| Time alignment error relative to cell 4 ^{Note 5} | μ s | - | - | - | - | \leq TAE |
| Note 1: | OCNG shall be used such that all cells are fully allocated and a constant total transmitted power spectral density is achieved for all OFDM symbols. | | | | | |
| Note 2: | Interference from other cells and noise sources not specified in the test is assumed to be constant over subcarriers and time and shall be modelled as AWGN of appropriate power for N_{oc} to be fulfilled. | | | | | |
| Note 3: | Es/Iot, RSRP, SCH_RP and Io levels have been derived from other parameters for information purposes. They are not settable parameters themselves. | | | | | |
| Note 4: | The uplink resources for CSI reporting are assigned to the UE prior to the start of time period T2. | | | | | |
| Note 5: | Time alignment error (TAE) as specified in TS 36.104 [30] clause 6.5.3.1. The TAE value depends upon the type of carrier aggregation. | | | | | |

A.8.16.77.2 Test Requirements

During T2, the UE shall send the first CSI report for SCell1 in a subframe (m+8), or in a subframe (m+10) if the subframe (m+8) was subject to interruption. Whether CSI report in subframe (m+8) was interrupted or not is checked by monitoring ACK/NACK sent in PCell in subframe (m+8).

During T2 the UE shall start sending CSI reports for SCell1 with non-zero CQI index at latest in a subframe (m+39).

During T3 the UE shall stop sending CSI reports for SCell1 at latest in a subframe (n+8).

During T2 interruption of PCell during SCells activation shall not happen outside the subframes (m+5) to (m+9), outside the subframes (m+15) to (m+19), outside the subframes (m+25) to (m+29) and outside the subframes (m+35) to (m+39).

During T3 interruption of PCell during SCells deactivation shall not happen outside the subframes (n+5) to (n+9), outside the subframes (n+15) to (n+19), outside the subframes (n+25) to (n+29) and outside the subframes (n+35) to (n+39).

The interruption of PCell shall not be more than the values specified for intra-band CA and inter-band CA in Section 7.8.2.

All of the above test requirements shall be fulfilled in order for the observed SCell1 activation delay and SCell1 deactivation delay to be counted as correct. The rate of correct observed SCell1 activation delay and SCell1 deactivation delay during repeated tests shall be at least 90%.

NOTE: During T2 if there are no uplink resources for reporting the valid CSI in a subframe (m+39) then the UE shall use the next available uplink resource for reporting the corresponding valid CSI.

A.8.16.78 5 DL TDD CA activation and deactivation of know SCell in non-DRX

A.8.16.78.1 Test Purpose and Environment

The purpose of this test is to verify that SCell activation and deactivation times are within the requirements stated in clause 7.7 for 5DL TDD carrier aggregation, when the SCells are known by the UE at the time of activation.

The test parameters are given in Tables A.8.16.78.1-1 and cell-specific parameters in A.8.16.78.1-2 below. The test consists of three successive time periods, with duration of T1, T2 and T3, respectively. There are five carriers, each with one cell. All cells have constant signal levels throughout the test. Before the test starts the UE is connected to Cell 1 (PCell) on radio channel 1 (PCC), Cell 3 (deactivated SCell2) on radio channel 3 (SCC2), Cell 4 (deactivated SCell3) on radio channel 4 (SCC3) and Cell 5 (deactivated SCell4) on radio channel 5 (SCC4), but is not aware of Cell 2 (SCell1) on radio channel 2 (SCC1). The UE is only monitoring the PCC, SCC2, SCC3 and SCC4. The UE shall be continuously scheduled in the PCell throughout the whole test.

At the beginning of T1 the UE receives an RRC message by which the SCell1 (Cell 2) becomes configured on radio channel 2 (SCC1). The UE now starts monitoring also the SCC1. The test equipment sends a MAC message for activation of the SCell1.

The point in time at which the MAC message is received at the UE antenna connector, in a subframe # denoted m, where m is 4 or 9, defines the start of time period T2. At the beginning of T2 the test equipment sends a MAC message for activation of the SCell1. The UE receives the SCell2, SCell3 and SCell4 activation command in a subframe (m+15), during activation of the SCell1. The UE shall be able to report valid CSIs for the activated SCell1 at latest in a subframe (m+39). The UE shall start reporting CSI for SCell1 in subframe (m+8) and shall report CQI index 0 (out-of-range) until the SCell activation has been completed. Any PCell interruption due to activation of SCells shall occur in the subframes (m+5) to (m+12) and (m+20) to (m+26).

Time period T3 starts when a MAC message for deactivation of SCell1, sent from the test equipment to the UE, in a subframe # denoted n, where n is 4 or 9, is received at the UE antenna connector. The test equipment sends MAC message for deactivation of the SCell2 in subframe (n+15), MAC message for deactivation of the SCell3 in subframe (n+30) and MAC message for deactivation of the SCell4 in subframe (n+45). The UE shall carry out deactivation of the SCell1 at latest in subframe (n+8), and any PCell interruption due to the deactivation of SCells shall occur in the subframes (n+5) to (n+12), (n+20) to (n+26), (n+35) to (n+41) and (n+50) to (n+56).

The test equipment verifies that potential interruption is carried out in the correct time span by monitoring ACK/NACK sent in PCell during activation and deactivation of SCells, respectively.

The test equipment verifies the activation time by counting the subframes from the time when the SCell1 activation command is sent until a CSI report with other than CQI index 0 is received.

The test equipment verifies the deactivation time by counting the subframes from the time when the SCell1 deactivation command is sent until CQI reporting for SCell1 is discontinued.

Table A.8.16.78.1-1: General test parameters for E-UTRAN TDD 5 DL CA activation and deactivation of known SCell in non-DRX

| Parameter | Unit | Value | Comment |
|---|------|-------------|--|
| E-UTRA RF Channel Number | | 1, 2, 3,4,5 | Five radio channels are used for this test |
| Active PCell | | Cell 1 | Primary cell on RF channel number 1. |
| Deconfigured SCell | | Cell 2 | Deconfigured secondary cell on RF channel number 2. |
| Configured deactivated SCell | | Cell 3 | Configured deactivated secondary cell on RF channel number 3. |
| Configured deactivated SCell | | Cell 4 | Configured deactivated secondary cell on RF channel number 4. |
| Configured deactivated SCell | | Cell 5 | Configured deactivated secondary cell on RF channel number 5. |
| CP length | | Normal | |
| Special subframe configuration | | 6 | As specified in table 4.2-1 in TS 36.211. The same configuration applies to all cells. |
| Uplink-downlink configuration | | 1 | As specified in table 4.2-2 in TS 36.211. The same configuration applies to all cells |
| DRX | | OFF | Continuous monitoring of primary cell |
| CQI/PMI periodicity and offset configuration index | | 0 | CQI reporting for SCells every UL subframe |
| Cell-individual offset for cells on RF channel number 1 | dB | 0 | Individual offset for cells on PCC. |
| Cell-individual offset for cells on RF channel number 2 | dB | 0 | Individual offset for cells on SCC1. |
| Cell-individual offset for cells on RF channel number 3 | dB | 0 | Individual offset for cells on SCC2. |
| Cell-individual offset for cells on RF channel number 4 | dB | 0 | Individual offset for cells on SCC3. |
| Cell-individual offset for cells on RF channel number 5 | dB | 0 | Individual offset for cells on SCC4. |
| Filter coefficient | | 0 | L3 filtering is not used |
| SCell measurement cycle (measCycleSCell) | ms | 320 | |
| T1 | s | 7 | During this time the PCell, SCell2, SCell3 and SCell4 shall be known and the SCell1 configured and detected. |
| T2 | s | 1 | During this time the UE shall activate the SCell1. |
| T3 | s | 1 | During this time the UE shall deactivate the SCell1. |

Table A.8.16.78.1-2: Cell specific test parameters for E-UTRAN TDD 4 DL CA activation and deactivation of known SCell in non-DRX

| Parameter | Unit | Cell 1 | | | Cell 2 | | | Cell 3 | | | Cell 4 | | | Cell5 | | |
|---|------|---|----|----|---|----|----|---|----|----|---|----|----|---|----|----|
| | | T1 | T2 | T3 | T1 | T2 | T3 | T1 | T2 | T3 | T1 | T2 | T3 | T1 | T2 | T3 |
| E-UTRA RF Channel Number | | 1 | | | 2 | | | 3 | | | 4 | | | 5 | | |
| BW _{channel} | | 5MHz: N _{RB,c} = 25 10MHz: N _{RB,c} = 50 20MHz: N _{RB,c} = 100 | | | 5MHz: N _{RB,c} = 25 10MHz: N _{RB,c} = 50 20MHz: N _{RB,c} = 100 | | | 5MHz: N _{RB,c} = 25 10MHz: N _{RB,c} = 50 20MHz: N _{RB,c} = 100 | | | 5MHz: N _{RB,c} = 25 10MHz: N _{RB,c} = 50 20MHz: N _{RB,c} = 100 | | | 5MHz: N _{RB,c} = 25 10MHz: N _{RB,c} = 50 20MHz: N _{RB,c} = 100 | | |
| PDSCH parameters: DL Reference Measurement Channel | | 5MHz: R.4 TDD 10MHz: R.0 TDD 20MHz: R.3 TDD | | | - | | | - | | | - | | | - | | |
| PCFICH/PDCCH/PHICH parameters: DL Reference Measurement Channel | | 5MHz: R.11 TDD 10MHz: R.6 TDD 20MHz: R.10 TDD | | | 5MHz: R.11 TDD 10MHz: R.6 TDD 20MHz: R.10 TDD | | | 5MHz: R.11 TDD 10MHz: R.6 TDD 20MHz: R.10 TDD | | | 5MHz: R.11 TDD 10MHz: R.6 TDD 20MHz: R.10 TDD | | | 5MHz: R.11 TDD 10MHz: R.6 TDD 20MHz: R.10 TDD | | |

| OCNG Patterns | | 5MHz: OP.9 TDD 10MHz: OP.1 TDD 20MHz: OP.7 TDD | 5MHz: OP.10 TDD 10MHz: OP.2 TDD 20MHz: OP.8 TDD | 5MHz: OP.10 TDD 10MHz: OP.2 TDD 20MHz: OP.8 TDD | 5MHz: OP.10 TDD 10MHz: OP.2 TDD 20MHz: OP.8 TDD | 5MHz: OP.10 TDD 10MHz: OP.2 TDD 20MHz: OP.8 TDD | | | | | |
|---|----------------|--|---|---|---|---|------|------|------|------|------|
| PBCH_RA | dB | 0 | 0 | 0 | 0 | 0 | | | | | |
| PBCH_RB | dB | | | | | | | | | | |
| PSS_RA | dB | | | | | | | | | | |
| SSS_RA | dB | | | | | | | | | | |
| PCFICH_RB | dB | | | | | | | | | | |
| PHICH_RA | dB | | | | | | | | | | |
| PHICH_RB | dB | | | | | | | | | | |
| PDCCH_RA | dB | | | | | | | | | | |
| PDCCH_RB | dB | | | | | | | | | | |
| PDSCH_RA | dB | | | | | | | | | | |
| PDSCH_RB | dB | | | | | | | | | | |
| OCNG_RA ^{Note 1} | dB | | | | | | | | | | |
| OCNG_RB ^{Note 1} | dB | | | | | | | | | | |
| N_{oc} ^{Note 2} | dBm/1 5 kHz | | | | | | -104 | -104 | -104 | -104 | -104 |
| \hat{E}_s/N_{oc} | dB | | | | | | 17 | 17 | 17 | 17 | 17 |
| \hat{E}_s/I_{ot} ^{Note 3} | dB | 17 | 17 | 17 | 17 | 17 | | | | | |
| RSRP ^{Note 3} | dBm/1 5 kHz | -87 | -87 | -87 | -87 | -87 | | | | | |
| SCH_RP ^{Note 3} | dBm/1 5 kHz | -87 | -87 | -87 | -87 | -87 | | | | | |
| I_o ^{Note 3} | dBm/C h BW | -59.13+10log ($N_{RB,c}/50$) | -59.13+10log ($N_{RB,c}/50$) | -59.13+10log ($N_{RB,c}/50$) | -59.13+10log ($N_{RB,c}/50$) | -59.13+10log ($N_{RB,c}/50$) | | | | | |
| Propagation Condition | | AWGN | AWGN | AWGN | AWGN | AWGN | | | | | |
| Antenna Configuration | | 1x2 | 1x2 | 1x2 | 1x2 | 1x2 | | | | | |
| Timing offset to Cell 1 | μ s | - | 0 | 0 | 0 | 0 | | | | | |
| Time alignment error relative to cell 1 ^{Note 5} | μ s | - | \leq TAE | \leq TAE | \leq TAE | \leq TAE | | | | | |
| Time alignment error relative to cell 2 ^{Note 5} | μ s | - | - | \leq TAE | \leq TAE | \leq TAE | | | | | |
| Time alignment error relative to cell 3 ^{Note 5} | μ s | - | - | - | \leq TAE | \leq TAE | | | | | |
| Time alignment error relative to cell 4 ^{Note 5} | μ s | - | - | - | - | \leq TAE | | | | | |
| <p>Note 1: OCNG shall be used such that all cells are fully allocated and a constant total transmitted power spectral density is achieved for all OFDM symbols.</p> <p>Note 2: Interference from other cells and noise sources not specified in the test is assumed to be constant over subcarriers and time and shall be modelled as AWGN of appropriate power for N_{oc} to be fulfilled.</p> <p>Note 3: \hat{E}_s/I_{ot}, RSRP, SCH_RP and I_o have been derived from other parameters for information purposes. They are not settable parameters themselves.</p> <p>Note 4: The uplink resources for CSI reporting are assigned to the UE prior to the start of time period T2.</p> <p>Note 5: Time alignment error (TAE) as specified in TS 36.104 [30] clause 6.5.3.1. The TAE value depends upon the type of carrier aggregation.</p> | | | | | | | | | | | |

A.8.16.78.2 Test Requirements

During T2 the UE shall send the first CSI report for SCell1 in a subframe (m+8), or in a subframe (m+9) if the subframe (m+8) was subject to interruption, or in a subframe (m+13) if the subframe (m+8) and (m+9) were subject to interruption when an intra-band SCell is activated. Whether CSI report in subframe (m+8) and/or (m+9) was interrupted or not is checked by monitoring ACK/NACK sent in PCell in subframe (m+8) and/or (m+9).

During T2 the UE shall start sending CSI reports for SCell1 with non-zero CQI index at latest in a subframe (m+39).

During T3 the UE shall stop sending CSI reports for SCell1 at latest in subframe (n+8).

During T2 interruption of PCell during SCells activation shall not happen outside the subframes (m+5) to (m+12) and outside the subframes (m+20) to (m+26).

During T3 interruption of PCell during SCells deactivation shall not happen outside the subframes (n+5) to (n+11), outside the subframes (n+20) to (n+26), outside the subframes (n+35) to (n+41) and outside the subframes (n+50) to (n+56).

The interruption of PCell shall not be more than the values specified for intra-band CA and inter-band CA in Section 7.8.2.

The UE shall not send event triggered measurement reports as long as the reporting criteria are not fulfilled.

All of the above test requirements shall be fulfilled in order for the observed SCell1 activation delay and SCell1 deactivation delay to be counted as correct. The rate of correct observed SCell1 activation delay and SCell1 deactivation delay during repeated tests shall be at least 90%.

NOTE: During T2 if there are no uplink resources for reporting the valid CSI in a subframe (m+39) then the UE shall use the next available uplink resource for reporting the corresponding valid CSI.

A.8.16.79 E-UTRAN PCell in FDD FDD-TDD 4 DL CA Event Triggered Reporting on Deactivated SCell with PCell and SCell Interruptions in Non-DRX

A.8.16.79.1 Test Purpose and Environment

The purpose of this test is to verify that the UE correctly detects event A6 (Neighbour becomes better than SCell) defined in TS 36.331 [2] within the requirements stated in clause 8.3.3.2.1 while at the same time fulfilling the requirement on interruption rate.

The test parameters are given in Table A.8.16.79.1-1, A.8.16.79.1-2 and A.8.16.79.1-3 below. In the test there are five cells: Cell 1, Cell 2, Cell 3, Cell 4 and Cell 5. Cell 1 is PCell on the FDD primary component (RF Channel 1), Cell 2 is SCell on the TDD secondary component (RF Channel 2), Cell 3 is SCell on the TDD secondary component (RF Channel 3), Cell 4 is SCell on the TDD secondary component (RF Channel 4) and Cell 5 is the neighbour cell on the TDD secondary component (RF Channel 4). It is indicated to the UE in the measurement control information that event-triggered reporting with Event A6 is used. The test consists of four successive time periods, with duration of T1, T2, T3 and T4, respectively. During T1 and T2, Cell2, Cell3 and Cell4 are deactivated. During T1 the UE shall not have any information of Cell 5. Immediately at beginning of T2 the transmission power of Cell 5 is increased to same level as for Cell 3, and due to usage of an offset this shall result in reporting of Event A6.

At the beginning of T3, the transmission power of Cell 5 is turned off, and the test equipment sends a MAC message for activation of Cell 2 to UE but Cell3 and Cell4 remains deactivated. Immediately at beginning of T4 the transmission power of Cell 5 is increased to same level as for Cell 3, and due to usage of an offset this shall result in reporting of Event A6. The UE shall be continuously scheduled in the PCell throughout the whole test and continuously scheduled in Cell2 during T4.

Table A.8.16.79.1-1: General test parameters for E-UTRAN PCell in FDD FDD-TDD 4 DL CA Event Triggered Reporting on Deactivated SCell with PCell and SCell Interruptions in Non-DRX

| Parameter | Unit | Value | Comment | |
|---|-----------------|------------|---|---|
| E-UTRA RF Channel Number | | 1, 2, 3, 4 | Four radio channels are used for this test | |
| Active PCell | | Cell 1 | Primary cell on RF channel number 1. | |
| Configured deactivated SCell | | Cell 2 | Configured deactivated secondary cell on RF channel number 2. | |
| Configured deactivated SCell | | Cell 3 | Configured deactivated secondary cell on RF channel number 3. | |
| Configured deactivated SCell | | Cell 4 | Configured deactivated secondary cell on RF channel number 4. | |
| Neighbour cell | | Cell 5 | Neighbor cell to be identified on RF channel number 4. | |
| CP length | | Normal | | |
| DRX | | OFF | Continuous monitoring of primary cell | |
| A6 | Hysteresis | dB | 0 | Hysteresis for evaluation of event A6. |
| | Offset | dB | -3 | Offset parameter for evaluation of event A6. Needs to take relative accuracy tolerance in clause 9.1.11.2 into account plus margin. |
| | Report on leave | | False | |
| | Time To Trigger | s | 0 | |
| Cell-individual offset for cells on RF channel number 1 | dB | 0 | Individual offset for cells on primary component carrier. | |
| Cell-individual offset for cells on RF channel number 2 | dB | 0 | Individual offset for cells on secondary component carrier. | |
| Cell-individual offset for cells on RF channel number 3 | dB | 0 | Individual offset for cells on secondary component carrier. | |

| | | | |
|---|----|-----------|---|
| Cell-individual offset for cells on RF channel number 4 | dB | 0 | Individual offset for cells on secondary component carrier. |
| Filter coefficient | | 0 | L3 filtering is not used |
| SCell measurement cycle | ms | 640 | |
| T1 | s | 4 | During this time the UE shall be aware of cells 1, 2, 3 and 4 but not cell 5. |
| T2 | s | ≤ 15 | UE should report Event A6 within 12.8s (20×sCellMeasCycle) |
| T3 | s | 4 | During this time the UE shall activate cell 2 |
| T4 | s | ≤ 4 | UE should report Event A6 within 3.2s (5×sCellMeasCycle) |

Table A.8.16.79.1-2: Cell specific test parameters for E-UTRAN PCell in FDD FDD-TDD 4 DL CA Event Triggered Reporting on Deactivated SCell with PCell and SCell Interruptions in Non-DRX (Cell #1, Cell #2, Cell #3, Cell #4)

| Parameter | Unit | Cell 1 | | | | Cell 2 | | | | Cell 3 | | | | Cell 4 | | | |
|--|------|---|----|----|----|---|---|---|--|---|----|----|----|---|----|----|----|
| | | T1 | T2 | T3 | T4 | T1 | T2 | T3 | T4 | T1 | T2 | T3 | T4 | T1 | T2 | T3 | T4 |
| E-UTRA RF Channel Number | | 1 | | | | 2 | | | | 3 | | | | 4 | | | |
| BW _{channel} | | 5MHz: N _{RB,c} = 25 10MHz: N _{RB,c} = 50 20MHz: N _{RB,c} = 100 | | | | 5MHz: N _{RB,c} = 25 10MHz: N _{RB,c} = 50 20MHz: N _{RB,c} = 100 | | | | 5MHz: N _{RB,c} = 25 10MHz: N _{RB,c} = 50 20MHz: N _{RB,c} = 100 | | | | 5MHz: N _{RB,c} = 25 10MHz: N _{RB,c} = 50 20MHz: N _{RB,c} = 100 | | | |
| PDSCH parameters: DL Reference Measurement Channel | | 5MHz: R.7 FDD 10MHz: R.3 FDD 20MHz: R.6 FDD | | | | N/A | N/A | N/A | 5MHz: R.4 TDD 10MHz: R.0 TDD 20MHz: R.3 TDD | N/A | | | | N/A | | | |
| PCFICH/PDCCH/PHICH parameters | | 5MHz: R.11 FDD 10MHz: R.6 FDD 20MHz: R.10 FDD | | | | 5MHz: R.11 TDD 10MHz: R.6 TDD 20MHz: R.10 TDD | | | | 5MHz: R.11 TDD 10MHz: R.6 TDD 20MHz: R.10 TDD | | | | 5MHz: R.11 TDD 10MHz: R.6 TDD 20MHz: R.10 TDD | | | |
| OCNG Pattern defined in A.3.2.1 | | 5MHz: OP.20 FDD 10MHz: OP.10 FDD 20MHz: OP.17 FDD | | | | 5MHz: OP.10 TDD 10MHz: OP.2 TDD 20MHz: OP.8 TDD | 5MHz: OP.10 TDD 10MHz: OP.2 TDD 20MHz: OP.8 TDD | 5MHz: OP.10 TDD 10MHz: OP.2 TDD 20MHz: OP.8 TDD | 5MHz: OP.9 TDD 10MHz: OP.1 TDD 20MHz: OP.7 TDD | 5MHz: OP.10 TDD 10MHz: OP.2 TDD 20MHz: OP.8 TDD | | | | 5MHz: OP.10 TDD 10MHz: OP.2 TDD 20MHz: OP.8 TDD | | | |
| PBCH_RA | dB | 0 | | | | 0 | | | | 0 | | | | 0 | | | |
| PBCH_RB | dB | | | | | | | | | | | | | | | | |
| PSS_RA | dB | | | | | | | | | | | | | | | | |
| SSS_RA | dB | | | | | | | | | | | | | | | | |
| PCFICH_RB | dB | | | | | | | | | | | | | | | | |
| PHICH_RA | dB | | | | | | | | | | | | | | | | |
| PHICH_RB | dB | | | | | | | | | | | | | | | | |
| PDCCH_RA | dB | | | | | | | | | | | | | | | | |
| PDCCH_RB | dB | | | | | | | | | | | | | | | | |
| PDSCH_RA | dB | | | | | | | | | | | | | | | | |
| PDSCH_RB | dB | | | | | | | | | | | | | | | | |
| OCNG_RA ^{Note 1} | dB | | | | | | | | | | | | | | | | |
| OCNG_RB ^{Note 1} | dB | | | | | | | | | | | | | | | | |

| | | | | | | | | | | | | | | | | | |
|--|------------|--|--|--|--|--|--|--|--|--|--|--|--|--|--|--|--|
| N_{oc} ^{Note 3} | dBm/15 kHz | -101 | | | | -101 | | | | -101 | | | | -101 | | | |
| \hat{E}_s / N_{oc} | dB | 16 | 16 | 16 | 16 | 16 | 16 | 16 | 16 | 16 | 16 | 16 | 16 | 16 | 16 | 16 | 16 |
| \hat{E}_s / I_{ot} ^{Note 4} | dB | 16 | 16 | 16 | 16 | 16 | 16 | 16 | 16 | 16 | -0.11 | 16 | -0.11 | 16 | -0.11 | 16 | -0.11 |
| RSRP ^{Note 4} | dBm/15 kHz | -85 | -85 | -85 | -85 | -85 | -85 | -85 | -85 | -85 | -85 | -85 | -85 | 85 | -85 | 85 | -85 |
| SCH_RP ^{Note 4} | dBm/15 kHz | -85 | -85 | -85 | -85 | -85 | -85 | -85 | -85 | -85 | -85 | -85 | -85 | 85 | -85 | 85 | -85 |
| I_o ^{Note 4} | dBm/Ch BW | -57.11 +10log ($N_{RB,c}$ /50) | -57.11 +10log ($N_{RB,c}$ /50) | -57.11 +10log ($N_{RB,c}$ /50) | -57.11 +10log ($N_{RB,c}$ /50) | -57.11 +10log ($N_{RB,c}$ /50) | -57.11 +10log ($N_{RB,c}$ /50) | -57.11 +10log ($N_{RB,c}$ /50) | -57.11 +10log ($N_{RB,c}$ /50) | -57.11 +10log ($N_{RB,c}$ /50) | -54.15 +10log ($N_{RB,c}$ /50) | -57.11 +10log ($N_{RB,c}$ /50) | -54.15 +10log ($N_{RB,c}$ /50) | -57.11 +10log ($N_{RB,c}$ /50) | -54.15 +10log ($N_{RB,c}$ /50) | -57.11 +10log ($N_{RB,c}$ /50) | -54.15 +10log ($N_{RB,c}$ /50) |
| Propagation Condition | | AWGN | | | | AWGN | | | | AWGN | | | | AWGN | | | |
| Antenna Configuration | | 1x2 | | | | 1x2 | | | | 1x2 | | | | 1x2 | | | |
| Timing offset to Cell 1 | μ s | - | | | | 0 | | | | 0 | | | | 0 | | | |
| Time alignment error relative to cell 1 ^{Note 5} | μ s | - | | | | \leq TAE | | | | \leq TAE | | | | \leq TAE | | | |
| Time alignment error relative to cell 2 ^{Note 5} | μ s | - | | | | - | | | | \leq TAE | | | | \leq TAE | | | |
| Time alignment error relative to cell 3 ^{Note 5} | μ s | - | | | | - | | | | - | | | | \leq TAE | | | |
| <p>Note 1: OCNG shall be used such that all cells are fully allocated and a constant total transmitted power spectral density is achieved for all OFDM symbols.</p> <p>Note 2: The resources for uplink transmission are assigned to the UE on cell1 from the start of time period T2 and on cell2 from the start of time period T4.</p> <p>Note 3: Interference from other cells and noise sources not specified in the test is assumed to be constant over subcarriers and time and shall be modelled as AWGN of appropriate power for N_{oc} to be fulfilled.</p> <p>Note 4: E_s/I_{ot}, RSRP, SCH_RP and I_o levels have been derived from other parameters for information purposes. They are not settable parameters themselves.</p> <p>Note 5: Time alignment error (TAE) as specified in TS 36.104 [30] clause 6.5.3.1. The TAE value depends upon the type of carrier aggregation.</p> | | | | | | | | | | | | | | | | | |

Table A.8.16.79.1-3: Cell specific test parameters for E-UTRAN PCell in FDD FDD-TDD 4 DL CA Event Triggered Reporting on Deactivated SCell with PCell and SCell Interruptions in Non-DRX (Cell #5)

| Parameter | Unit | Cell 5 | | | |
|--|------------|--|--|--|--|
| | | T1 | T2 | T3 | T4 |
| E-UTRA RF Channel Number | | 4 | | | |
| $BW_{channel}$ | | 5MHz: $N_{RB,c} = 25$ 10MHz: $N_{RB,c} = 50$ 20MHz: $N_{RB,c} = 100$ | | | |
| PDSCH parameters: DL Reference Measurement Channel | | N/A | | | |
| PCFICH/PDCCH/PHICH parameters | | 5MHz: R.11 TDD 10MHz: R.6 TDD 20MHz: R.10 TDD | | | |
| OCNG Pattern defined in A.3.2.1 | | 5MHz: OP.10 TDD 10MHz: OP.2 TDD 20MHz: OP.8 TDD | | | |
| PBCH_RA | dB | 0 | | | |
| PBCH_RB | dB | | | | |
| PSS_RA | dB | | | | |
| SSS_RA | dB | | | | |
| PCFICH_RB | dB | | | | |
| PHICH_RA | dB | | | | |
| PHICH_RB | dB | | | | |
| PDCCH_RA | dB | | | | |
| PDCCH_RB | dB | | | | |
| PDSCH_RA | dB | | | | |
| PDSCH_RB | dB | | | | |
| OCNG_RA ^{Note 1} | dB | | | | |
| OCNG_RB ^{Note 1} | dB | | | | |
| N_{oc} ^{Note 3} | dBm/15 kHz | | | | |
| \hat{E}_s / N_{oc} | dB | -infinity | 16 | -infinity | 16 |
| \hat{E}_s / I_{ot} ^{Note 4} | dB | -infinity | -0.11 | -infinity | -0.11 |
| RSRP ^{Note 4} | dBm/15 kHz | -infinity | -85 | -infinity | -85 |
| SCH_RP ^{Note 4} | dBm/15 kHz | -infinity | -85 | -infinity | -85 |
| I_o ^{Note 4} | dBm/Ch BW | -57.11 +10log ($N_{RB,c}$ /50) | -54.15 +10log ($N_{RB,c}$ /50) | -57.11 +10log ($N_{RB,c}$ /50) | -54.15 +10log ($N_{RB,c}$ /50) |
| Propagation Condition | | AWGN | | | |
| Antenna Configuration | | 1x2 | | | |
| Timing offset to Cell 1 | μ s | 3 | | | |
| Time alignment error relative to cell 1 ^{Note 5} | μ s | N/A | | | |
| Time alignment error relative to cell 2 ^{Note 5} | μ s | N/A | | | |
| Time alignment error relative to cell 3 ^{Note 5} | μ s | N/A | | | |
| Note 1: OCNG shall be used such that all cells are fully allocated and a constant total transmitted power spectral density is achieved for all OFDM symbols. | | | | | |
| Note 2: Void | | | | | |
| Note 3: Interference from other cells and noise sources not specified in the test is assumed to be constant over subcarriers and time and shall be modelled as AWGN of appropriate power for N_{oc} to be fulfilled. | | | | | |
| Note 4: E_s/I_{ot} , RSRP, SCH_RP and I_o levels have been derived from other parameters for information purposes. They are not settable parameters themselves. | | | | | |
| Note 5: Time alignment error (TAE) as specified in TS 36.104 [30] clause 6.5.3.1. The TAE value depends upon the type of carrier aggregation. | | | | | |

A.8.16.79.2 Test Requirements

The UE shall send one Event A6 triggered measurement report, with a measurement reporting delay less than 12.8s ($20 \times \text{scellMeasCycle}$) from the beginning of time period T2.

The UE shall send one Event A6 triggered measurement report, with a measurement reporting delay less than 3.2s ($5 \times \text{scellMeasCycle}$) from the beginning of time period T4.

The UE shall not send event triggered measurement reports, as long as the reporting criteria are not fulfilled.

The UE shall be scheduled on PCell continuously throughout the test. From the start of T1 until the measurement report is received during T2, at least 99.5% of all expected ACK/NACKs shall be transmitted by the UE.

The UE shall be scheduled on Cell2 continuously from the beginning of T4 to the end. From the start of T4 until the measurement report is received during T4, at least 99.5% of all expected ACK/NACKs shall be transmitted by the UE.

For a test to be considered successful requirements on both event detection and percentage of transmitted ACK/NACKs have to be fulfilled simultaneously.

The rate of correct events observed during repeated tests shall be at least 90%.

NOTE: The actual overall delays measured in the test may be up to $2 \times \text{TTI}_{\text{DCCCH}}$ higher than the measurement reporting delays above because of TTI insertion uncertainty of the measurement report in DCCCH.

A.8.16.80 E-UTRAN PCell in TDD TDD-FDD 4 DL CA Event Triggered Reporting on Deactivated SCell with PCell and SCell Interruptions in Non-DRX

A.8.16.80.1 Test Purpose and Environment

The purpose of this test is to verify that the UE correctly detects event A6 (Neighbour becomes better than SCell) defined in TS 36.331 [2] within the requirements stated in clause 8.3.3.2.1 while at the same time fulfilling the requirement on interruption rate.

The test parameters are given in Table A.8.16.80.1-1, A.8.16.80.1-2 and A.8.16.80.1-3 below. In the test there are five cells: Cell 1, Cell 2, Cell 3, Cell 4 and Cell 5. Cell 1 is PCell on the TDD primary component (RF Channel 1), Cell 2 is SCell on the FDD secondary component (RF Channel 2), Cell 3 is SCell on the FDD secondary component (RF Channel 3), Cell 4 is SCell on the FDD secondary component (RF Channel 4) and Cell 5 is the neighbour cell on the FDD secondary component (RF Channel 4). It is indicated to the UE in the measurement control information that event-triggered reporting with Event A6 is used. The test consists of four successive time periods, with duration of T1, T2, T3 and T4, respectively. During T1 and T2, Cell2, Cell3 and Cell4 are deactivated. During T1 the UE shall not have any information of Cell 5. Immediately at beginning of T2 the transmission power of Cell 5 is increased to same level as for Cell 3, and due to usage of an offset this shall result in reporting of Event A6.

At the beginning of T3, the transmission power of Cell 5 is turned off, and the test equipment sends a MAC message for activation of Cell 2 to UE but Cell3 and Cell4 remains deactivated. Immediately at beginning of T4 the transmission power of Cell 5 is increased to same level as for Cell 3, and due to usage of an offset this shall result in reporting of Event A6. The UE shall be continuously scheduled in the PCell throughout the whole test and continuously scheduled in Cell2 during T4.

Table A.8.16.80.1-1: General test parameters for E-UTRAN PCell in TDD TDD-FDD 4 DL CA Event Triggered Reporting on Deactivated SCell with PCell and SCell Interruptions in Non-DRX

| Parameter | Unit | Value | Comment |
|------------------------------|------|------------|---|
| E-UTRA RF Channel Number | | 1, 2, 3, 4 | Four radio channels are used for this test |
| Active PCell | | Cell 1 | Primary cell on RF channel number 1. |
| Configured deactivated SCell | | Cell 2 | Configured deactivated secondary cell on RF channel number 2. |

| | | | | |
|---|-----------------|--------|---|---|
| Configured deactivated SCell | | Cell 3 | Configured deactivated secondary cell on RF channel number 3. | |
| Configured deactivated SCell | | Cell 4 | Configured deactivated secondary cell on RF channel number 4. | |
| Neighbour cell | | Cell 5 | Neighbor cell to be identified on RF channel number 4. | |
| CP length | | Normal | | |
| Special subframe configuration | | 6 | As specified in table 4.2-1 in TS 36.211. The same configuration in all cells | |
| Uplink-downlink configuration | | 1 | As specified in table 4.2-2 in TS 36.211. The same configuration in all cells | |
| DRX | | OFF | Continuous monitoring of primary cell | |
| A6 | Hysteresis | dB | 0 | Hysteresis for evaluation of event A6. |
| | Offset | dB | -3 | Offset parameter for evaluation of event A6. Needs to take relative accuracy tolerance in clause 9.1.11.2 into account plus margin. |
| | Report on leave | | False | |
| | Time To Trigger | s | 0 | |
| Cell-individual offset for cells on RF channel number 1 | dB | 0 | Individual offset for cells on primary component carrier. | |
| Cell-individual offset for cells on RF channel number 2 | dB | 0 | Individual offset for cells on secondary component carrier. | |
| Cell-individual offset for cells on RF channel number 3 | dB | 0 | Individual offset for cells on secondary component carrier. | |
| Cell-individual offset for cells on RF channel number 3 | dB | 0 | Individual offset for cells on secondary component carrier. | |
| Filter coefficient | | 0 | L3 filtering is not used | |
| SCell measurement cycle | ms | 640 | | |
| T1 | s | 4 | During this time the UE shall be aware of cells 1, 2, 3 and 4 but not cell 5. | |
| T2 | s | ≤15 | UE should report Event A6 within 12.8s (20×scellMeasCycle) | |
| T3 | s | 4 | During this time the UE shall activate cell 2 | |
| T4 | s | ≤4 | UE should report Event A6 within 3.2s (5×scellMeasCycle) | |

Table A.8.16.80.1-2: Cell specific test parameters for E-UTRAN PCell in TDD TDD-FDD 4 DL CA Event Triggered Reporting on Deactivated SCell with PCell and SCell Interruptions in Non-DRX (Cell #1, Cell #2, Cell #3, Cell #4)

| Parameter | Unit | Cell 1 | | | | Cell 2 | | | | Cell 3 | | | | Cell 4 | | | |
|--|------|---|----|----|----|---|--|--|---|---|----|----|----|---|----|----|----|
| | | T1 | T2 | T3 | T4 | T1 | T2 | T3 | T4 | T1 | T2 | T3 | T4 | T1 | T2 | T3 | T4 |
| E-UTRA RF Channel Number | | 1 | | | | 2 | | | | 3 | | | | 4 | | | |
| BW _{channel} | | 5MHz: N _{RB,c} = 25 10MHz: N _{RB,c} = 50 20MHz: N _{RB,c} = 100 | | | | 5MHz: N _{RB,c} = 25 10MHz: N _{RB,c} = 50 20MHz: N _{RB,c} = 100 | | | | 5MHz: N _{RB,c} = 25 10MHz: N _{RB,c} = 50 20MHz: N _{RB,c} = 100 | | | | 5MHz: N _{RB,c} = 25 10MHz: N _{RB,c} = 50 20MHz: N _{RB,c} = 100 | | | |
| PDSCH parameters: DL Reference Measurement Channel | | 5MHz: R.4 TDD 10MHz: R.0 TDD 20MHz: R.3 TDD | | | | N/A | N/A | N/A | 5MHz: R.7 FDD 10MHz: R.3 FDD 20MHz: R.6 FDD | N/A | | | | N/A | | | |
| PCFICH/PDCCH/PHICH parameters | | 5MHz: R.11 TDD 10MHz: R.6 TDD 20MHz: R.10 TDD | | | | 5MHz: R.11 FDD 10MHz: R.6 FDD 20MHz: R.10 FDD | | | | 5MHz: R.11 FDD 10MHz: R.6 FDD 20MHz: R.10 FDD | | | | 5MHz: R.11 FDD 10MHz: R.6 FDD 20MHz: R.10 FDD | | | |
| OCNG Pattern defined in A.3.2.1 | | 5MHz: OP.9 TDD 10MHz: OP.1 TDD 20MHz: OP.7 TDD | | | | 5MHz: OP.16 FDD 10MHz: OP.2 FDD 20MHz: OP.12 FDD | 5MHz: OP.16 FDD 10MHz: OP.2 FDD 20MHz: OP.12 FDD | 5MHz: OP.16 FDD 10MHz: OP.2 FDD 20MHz: OP.12 FDD | 5MHz: OP.20 FDD 10MHz: OP.10 FDD 20MHz: OP.17 FDD | 5MHz: OP.16 FDD 10MHz: OP.2 FDD 20MHz: OP.12 FDD | | | | 5MHz: OP.16 FDD 10MHz: OP.2 FDD 20MHz: OP.12 FDD | | | |
| PBCH_RA | dB | 0 | | | | 0 | | | | 0 | | | | 0 | | | |
| PBCH_RB | dB | | | | | | | | | | | | | | | | |
| PSS_RA | dB | | | | | | | | | | | | | | | | |
| SSS_RA | dB | | | | | | | | | | | | | | | | |
| PCFICH_RB | dB | | | | | | | | | | | | | | | | |
| PHICH_RA | dB | | | | | | | | | | | | | | | | |
| PHICH_RB | dB | | | | | | | | | | | | | | | | |
| PDCCH_RA | dB | | | | | | | | | | | | | | | | |
| PDCCH_RB | dB | | | | | | | | | | | | | | | | |
| PDSCH_RA | dB | | | | | | | | | | | | | | | | |
| PDSCH_RB | dB | | | | | | | | | | | | | | | | |
| OCNG_RA ^{Note 1} | dB | | | | | | | | | | | | | | | | |
| OCNG_RB ^{Note 1} | dB | | | | | | | | | | | | | | | | |

| | | | | | | | | | | | | | | | | | |
|--|------------|--|--|--|--|--|--|--|--|--|--|--|--|--|--|--|--|
| N_{oc} <small>Note 3</small> | dBm/15 kHz | -101 | | | | -101 | | | | -101 | | | | -101 | | | |
| \hat{E}_s / N_{oc} | dB | 16 | 16 | 16 | 16 | 16 | 16 | 16 | 16 | 16 | 16 | 16 | 16 | 16 | 16 | 16 | 16 |
| \hat{E}_s / I_{ot} <small>Note 4</small> | dB | 16 | 16 | 16 | 16 | 16 | 16 | 16 | 16 | 16 | -0.11 | 16 | -0.11 | 16 | -0.11 | 16 | -0.11 |
| RSRP <small>Note 4</small> | dBm/15 kHz | -85 | -85 | -85 | -85 | -85 | -85 | -85 | -85 | -85 | -85 | -85 | -85 | 85 | -85 | 85 | -85 |
| SCH_RP <small>Note 4</small> | dBm/15 kHz | -85 | -85 | -85 | -85 | -85 | -85 | -85 | -85 | -85 | -85 | -85 | -85 | 85 | -85 | 85 | -85 |
| I_o <small>Note 4</small> | dBm/Ch BW | -57.11 +10log ($N_{RB,c}$ /50) | -57.11 +10log ($N_{RB,c}$ /50) | -57.11 +10log ($N_{RB,c}$ /50) | -57.11 +10log ($N_{RB,c}$ /50) | -57.11 +10log ($N_{RB,c}$ /50) | -57.11 +10log ($N_{RB,c}$ /50) | -57.11 +10log ($N_{RB,c}$ /50) | -57.11 +10log ($N_{RB,c}$ /50) | -57.11 +10log ($N_{RB,c}$ /50) | -54.15 +10log ($N_{RB,c}$ /50) | -57.11 +10log ($N_{RB,c}$ /50) | -54.15 +10log ($N_{RB,c}$ /50) | -57.11 +10log ($N_{RB,c}$ /50) | -54.15 +10log ($N_{RB,c}$ /50) | -57.11 +10log ($N_{RB,c}$ /50) | -54.15 +10log ($N_{RB,c}$ /50) |
| Propagation Condition | | AWGN | | | | AWGN | | | | AWGN | | | | AWGN | | | |
| Antenna Configuration | | 1x2 | | | | 1x2 | | | | 1x2 | | | | 1x2 | | | |
| Timing offset to Cell 1 | μ s | - | | | | 0 | | | | 0 | | | | 0 | | | |
| Time alignment error relative to cell 1 <small>Note 5</small> | μ s | - | | | | \leq TAE | | | | \leq TAE | | | | \leq TAE | | | |
| Time alignment error relative to cell 2 <small>Note 5</small> | μ s | - | | | | - | | | | \leq TAE | | | | \leq TAE | | | |
| Time alignment error relative to cell 3 <small>Note 5</small> | μ s | - | | | | - | | | | - | | | | \leq TAE | | | |
| <p>Note 1: OCNG shall be used such that all cells are fully allocated and a constant total transmitted power spectral density is achieved for all OFDM symbols.</p> <p>Note 2: The resources for uplink transmission are assigned to the UE on cell1 from the start of time period T2 and on cell2 from the start of time period T4.</p> <p>Note 3: Interference from other cells and noise sources not specified in the test is assumed to be constant over subcarriers and time and shall be modelled as AWGN of appropriate power for N_{oc} to be fulfilled.</p> <p>Note 4: E_s/I_{ot}, RSRP, SCH_RP and I_o levels have been derived from other parameters for information purposes. They are not settable parameters themselves.</p> <p>Note 5: Time alignment error (TAE) as specified in TS 36.104 [30] clause 6.5.3.1. The TAE value depends upon the type of carrier aggregation.</p> | | | | | | | | | | | | | | | | | |

Table A.8.16.80.1-3: Cell specific test parameters for E-UTRAN PCell in TDD TDD-FDD 4 DL CA Event Triggered Reporting on Deactivated SCell with PCell and SCell Interruptions in Non-DRX (Cell #5)

| Parameter | Unit | Cell 5 | | | |
|---|--|--|----------------------------------|----------------------------------|----------------------------------|
| | | T1 | T2 | T3 | T4 |
| E-UTRA RF Channel Number | | 4 | | | |
| $BW_{channel}$ | | 5MHz: $N_{RB,c} = 25$ 10MHz: $N_{RB,c} = 50$ 20MHz: $N_{RB,c} = 100$ | | | |
| PDSCH parameters: DL Reference Measurement Channel | | N/A | | | |
| PCFICH/PDCCH/PHICH parameters | | 5MHz: R.11 FDD 10MHz: R.6 FDD 20MHz: R.10 FDD | | | |
| OCNG Pattern defined in A.3.2.1 | | 5MHz: OP.20 FDD 10MHz: OP.10 FDD 20MHz: OP.17 FDD | | | |
| PBCH_RA | dB | 0 | | | |
| PBCH_RB | dB | | | | |
| PSS_RA | dB | | | | |
| SSS_RA | dB | | | | |
| PCFICH_RB | dB | | | | |
| PHICH_RA | dB | | | | |
| PHICH_RB | dB | | | | |
| PDCCH_RA | dB | | | | |
| PDCCH_RB | dB | | | | |
| PDSCH_RA | dB | | | | |
| PDSCH_RB | dB | | | | |
| OCNG_RA ^{Note 1} | dB | | | | |
| OCNG_RB ^{Note 1} | dB | | | | |
| N_{oc} ^{Note 3} | dBm/15 kHz | | | | |
| \hat{E}_s / N_{oc} | dB | -infinity | 16 | -infinity | 16 |
| \hat{E}_s / I_{ot} ^{Note 4} | dB | -infinity | -0.11 | -infinity | -0.11 |
| RSRP ^{Note 4} | dBm/15 kHz | -infinity | -85 | -infinity | -85 |
| SCH_RP ^{Note 4} | dBm/15 kHz | -infinity | -85 | -infinity | -85 |
| I_o ^{Note 4} | dBm/Ch BW | -57.11 +10log($N_{RB,c} / 50$) | -54.15 +10log($N_{RB,c} / 50$) | -57.11 +10log($N_{RB,c} / 50$) | -54.15 +10log($N_{RB,c} / 50$) |
| Propagation Condition | | AWGN | | | |
| Antenna Configuration | | 1x2 | | | |
| Timing offset to Cell 1 | μ s | 3 | | | |
| Time alignment error relative to cell 1 ^{Note 5} | μ s | N/A | | | |
| Time alignment error relative to cell 2 ^{Note 5} | μ s | N/A | | | |
| Time alignment error relative to cell 3 ^{Note 5} | μ s | N/A | | | |
| Note 1: | OCNG shall be used such that all cells are fully allocated and a constant total transmitted power spectral density is achieved for all OFDM symbols. | | | | |
| Note 2: | Void | | | | |
| Note 3: | Interference from other cells and noise sources not specified in the test is assumed to be constant over subcarriers and time and shall be modelled as AWGN of appropriate power for N_{oc} to be fulfilled. | | | | |
| Note 4: | E_s/I_{ot} , RSRP, SCH_RP and I_o levels have been derived from other parameters for information purposes. They are not settable parameters themselves. | | | | |
| Note 5: | Time alignment error (TAE) as specified in TS 36.104 [30] clause 6.5.3.1. The TAE value depends upon the type of carrier aggregation. | | | | |

A.8.16.80.2 Test Requirements

The UE shall send one Event A6 triggered measurement report, with a measurement reporting delay less than 12.8s ($20 \times \text{scellMeasCycle}$) from the beginning of time period T2.

The UE shall send one Event A6 triggered measurement report, with a measurement reporting delay less than 3.2s ($5 \times \text{scellMeasCycle}$) from the beginning of time period T4.

The UE shall not send event triggered measurement reports, as long as the reporting criteria are not fulfilled.

The UE shall be scheduled on PCell continuously throughout the test. From the start of T1 until the measurement report is received during T2, at least 99.5% of all expected ACK/NACKs shall be transmitted by the UE.

The UE shall be scheduled on Cell2 continuously from the beginning of T4 to the end. From the start of T4 until the measurement report is received during T4, at least 99.5% of all expected ACK/NACKs shall be transmitted by the UE.

For a test to be considered successful requirements on both event detection and percentage of transmitted ACK/NACKs have to be fulfilled simultaneously.

The rate of correct events observed during repeated tests shall be at least 90%.

NOTE: The actual overall delays measured in the test may be up to $2 \times \text{TTI}_{\text{DCCH}}$ higher than the measurement reporting delays above because of TTI insertion uncertainty of the measurement report in DCCH.

A.8.16.81 E-UTRAN PCell in FDD FDD-TDD 5 DL CA Event Triggered Reporting on Deactivated SCell with PCell and SCell Interruptions in Non-DRX

A.8.16.81.1 Test Purpose and Environment

The purpose of this test is to verify that the UE correctly detects event A6 (Neighbour becomes better than SCell) defined in TS 36.331 [2] within the requirements stated in clause 8.3.3.2.1 while at the same time fulfilling the requirement on interruption rate.

The test parameters are given in Table A.8.16.81.1-1, A.8.16.81.1-2 and A.8.16.81.1-3 below. In the test there are five cells: Cell 1, Cell 2, Cell 3, Cell 4, Cell 5 and Cell 6. Cell 1 is PCell on the FDD primary component (RF Channel 1), Cell 2 is SCell on the TDD secondary component (RF Channel 2), Cell 3 is SCell on the TDD secondary component (RF Channel 3), Cell 4 is SCell on the TDD secondary component (RF Channel 4), Cell 5 is SCell on the TDD secondary component (RF Channel 5) and Cell 6 is the neighbour cell on the TDD secondary component (RF Channel 4). It is indicated to the UE in the measurement control information that event-triggered reporting with Event A6 is used. The test consists of four successive time periods, with duration of T1, T2, T3 and T4, respectively. During T1 and T2, Cell2, Cell3, Cell4 and Cell5 are deactivated. During T1 the UE shall not have any information of Cell 6. Immediately at beginning of T2 the transmission power of Cell 6 is increased to same level as for Cell 5, and due to usage of an offset this shall result in reporting of Event A6.

At the beginning of T3, the transmission power of Cell 6 is turned off, and the test equipment sends a MAC message for activation of Cell 2 to UE but Cell 3, Cell 4 and Cell5 remains deactivated. Immediately at beginning of T4 the transmission power of Cell 6 is increased to same level as for Cell 5, and due to usage of an offset this shall result in reporting of Event A6. The UE shall be continuously scheduled in the PCell throughout the whole test and continuously scheduled in Cell2 during T4.

Table A.8.16.81.1-1: General test parameters for E-UTRAN PCell in FDD FDD-TDD 5 DL CA Event Triggered Reporting on Deactivated SCell with PCell and SCell Interruptions in Non-DRX

| Parameter | Unit | Value | Comment |
|------------------------------|------|---------------|---|
| E-UTRA RF Channel Number | | 1, 2, 3, 4, 5 | Four radio channels are used for this test |
| Active PCell | | Cell 1 | Primary cell on RF channel number 1. |
| Configured deactivated SCell | | Cell 2 | Configured deactivated secondary cell on RF channel number 2. |

| | | | | |
|---|-----------------|----|--------|---|
| Configured deactivated SCell | | | Cell 3 | Configured deactivated secondary cell on RF channel number 3. |
| Configured deactivated SCell | | | Cell 4 | Configured deactivated secondary cell on RF channel number 4. |
| Configured deactivated SCell | | | Cell 5 | Configured deactivated secondary cell on RF channel number 5. |
| Neighbour cell | | | Cell 6 | Neighbor cell to be identified on RF channel number 5. |
| CP length | | | Normal | |
| Special subframe configuration | | | 6 | As specified in table 4.2-1 in TS 36.211. The same configuration in TDD cells |
| Uplink-downlink configuration | | | 1 | As specified in table 4.2-2 in TS 36.211. The same configuration in TDD cells |
| DRX | | | OFF | Continuous monitoring of primary cell |
| A6 | Hysteresis | dB | 0 | Hysteresis for evaluation of event A6. |
| | Offset | dB | -3 | Offset parameter for evaluation of event A6. Needs to take relative accuracy tolerance in clause 9.1.11.2 into account plus margin. |
| | Report on leave | | False | |
| | Time To Trigger | s | 0 | |
| Cell-individual offset for cells on RF channel number 1 | | dB | 0 | Individual offset for cells on primary component carrier. |
| Cell-individual offset for cells on RF channel number 2 | | dB | 0 | Individual offset for cells on secondary component carrier. |
| Cell-individual offset for cells on RF channel number 3 | | dB | 0 | Individual offset for cells on secondary component carrier. |
| Cell-individual offset for cells on RF channel number 4 | | dB | 0 | Individual offset for cells on secondary component carrier. |
| Cell-individual offset for cells on RF channel number 5 | | dB | 0 | Individual offset for cells on secondary component carrier. |
| Filter coefficient | | | 0 | L3 filtering is not used |
| SCell measurement cycle | | ms | 640 | |
| T1 | | s | 4 | During this time the UE shall be aware of cells 1, 2, 3, 4 and 5 but not cell 6. |
| T2 | | s | ≤15 | UE should report Event A6 within 12.8s (20×sCellMeasCycle) |
| T3 | | s | 4 | During this time the UE shall activate cell 2 |
| T4 | | s | ≤4 | UE should report Event A6 within 3.2s (5×sCellMeasCycle) |

Table A.8.16.81.1-2: Cell specific test parameters for E-UTRAN PCell in FDD FDD-TDD 5 DL CA Event Triggered Reporting on Deactivated SCell with PCell and SCell Interruptions in Non-DRX (Cell #1, Cell #2, Cell #3, Cell #4)

| Parameter | Unit | Cell 1 | | | | Cell 2 | | | | Cell 3 | | | | Cell 4 | | | |
|--|------|---|----|----|----|---|---|---|--|---|----|----|----|---|----|----|----|
| | | T1 | T2 | T3 | T4 | T1 | T2 | T3 | T4 | T1 | T2 | T3 | T4 | T1 | T2 | T3 | T4 |
| E-UTRA RF Channel Number | | 1 | | | | 2 | | | | 3 | | | | 4 | | | |
| BW _{channel} | | 5MHz: N _{RB,c} = 25 10MHz: N _{RB,c} = 50 20MHz: N _{RB,c} = 100 | | | | 5MHz: N _{RB,c} = 25 10MHz: N _{RB,c} = 50 20MHz: N _{RB,c} = 100 | | | | 5MHz: N _{RB,c} = 25 10MHz: N _{RB,c} = 50 20MHz: N _{RB,c} = 100 | | | | 5MHz: N _{RB,c} = 25 10MHz: N _{RB,c} = 50 20MHz: N _{RB,c} = 100 | | | |
| PDSCH parameters: DL Reference Measurement Channel | | 5MHz: R.7 FDD 10MHz: R.3 FDD 20MHz: R.6 FDD | | | | N/A | N/A | N/A | 5MHz: R.4 TDD 10MHz: R.0 TDD 20MHz: R.3 TDD | N/A | | | | N/A | | | |
| PCFICH/PDCCH/PHICH parameters | | 5MHz: R.11 FDD 10MHz: R.6 FDD 20MHz: R.10 FDD | | | | 5MHz: R.11 TDD 10MHz: R.6 TDD 20MHz: R.10 TDD | | | | 5MHz: R.11 TDD 10MHz: R.6 TDD 20MHz: R.10 TDD | | | | 5MHz: R.11 TDD 10MHz: R.6 TDD 20MHz: R.10 TDD | | | |
| OCNG Pattern defined in A.3.2.1 | | 5MHz: OP.20 FDD 10MHz: OP.10 FDD 20MHz: OP.17 FDD | | | | 5MHz: OP.10 TDD 10MHz: OP.2 TDD 20MHz: OP.8 TDD | 5MHz: OP.10 TDD 10MHz: OP.2 TDD 20MHz: OP.8 TDD | 5MHz: OP.10 TDD 10MHz: OP.2 TDD 20MHz: OP.8 TDD | 5MHz: OP.9 TDD 10MHz: OP.1 TDD 20MHz: OP.7 TDD | 5MHz: OP.10 TDD 10MHz: OP.2 TDD 20MHz: OP.8 TDD | | | | 5MHz: OP.10 TDD 10MHz: OP.2 TDD 20MHz: OP.8 TDD | | | |
| PBCH_RA | dB | 0 | | | | 0 | | | | 0 | | | | 0 | | | |
| PBCH_RB | dB | | | | | | | | | | | | | | | | |
| PSS_RA | dB | | | | | | | | | | | | | | | | |
| SSS_RA | dB | | | | | | | | | | | | | | | | |
| PCFICH_RB | dB | | | | | | | | | | | | | | | | |
| PHICH_RA | dB | | | | | | | | | | | | | | | | |
| PHICH_RB | dB | | | | | | | | | | | | | | | | |
| PDCCH_RA | dB | | | | | | | | | | | | | | | | |
| PDCCH_RB | dB | | | | | | | | | | | | | | | | |
| PDSCH_RA | dB | | | | | | | | | | | | | | | | |
| PDSCH_RB | dB | | | | | | | | | | | | | | | | |
| OCNG_RA ^{Note 1} | dB | | | | | | | | | | | | | | | | |
| OCNG_RB ^{Note 1} | dB | | | | | | | | | | | | | | | | |

| | | | | | | | | | | | | | | | | | |
|--|------------|--|--|--|--|--|--|--|--|--|--|--|--|--|--|--|--|
| N_{oc} <small>Note 3</small> | dBm/15 kHz | -101 | | | | -101 | | | | -101 | | | | -101 | | | |
| \hat{E}_s / N_{oc} | dB | 16 | 16 | 16 | 16 | 16 | 16 | 16 | 16 | 16 | 16 | 16 | 16 | 16 | 16 | 16 | 16 |
| \hat{E}_s / I_{ot} <small>Note 4</small> | dB | 16 | 16 | 16 | 16 | 16 | 16 | 16 | 16 | 16 | -0.11 | 16 | -0.11 | 16 | -0.11 | 16 | -0.11 |
| RSRP <small>Note 4</small> | dBm/15 kHz | -85 | -85 | -85 | -85 | -85 | -85 | -85 | -85 | -85 | -85 | -85 | -85 | 85 | -85 | 85 | -85 |
| SCH_RP <small>Note 4</small> | dBm/15 kHz | -85 | -85 | -85 | -85 | -85 | -85 | -85 | -85 | -85 | -85 | -85 | -85 | 85 | -85 | 85 | -85 |
| I_o <small>Note 4</small> | dBm/Ch BW | -57.11 +10log ($N_{RB,c}$ /50) | -57.11 +10log ($N_{RB,c}$ /50) | -57.11 +10log ($N_{RB,c}$ /50) | -57.11 +10log ($N_{RB,c}$ /50) | -57.11 +10log ($N_{RB,c}$ /50) | -57.11 +10log ($N_{RB,c}$ /50) | -57.11 +10log ($N_{RB,c}$ /50) | -57.11 +10log ($N_{RB,c}$ /50) | -57.11 +10log ($N_{RB,c}$ /50) | -54.15 +10log ($N_{RB,c}$ /50) | -57.11 +10log ($N_{RB,c}$ /50) | -54.15 +10log ($N_{RB,c}$ /50) | -57.11 +10log ($N_{RB,c}$ /50) | -54.15 +10log ($N_{RB,c}$ /50) | -57.11 +10log ($N_{RB,c}$ /50) | -54.15 +10log ($N_{RB,c}$ /50) |
| Propagation Condition | | AWGN | | | | AWGN | | | | AWGN | | | | AWGN | | | |
| Antenna Configuration | | 1x2 | | | | 1x2 | | | | 1x2 | | | | 1x2 | | | |
| Timing offset to Cell 1 | μ s | - | | | | 0 | | | | 0 | | | | 0 | | | |
| Time alignment error relative to cell 1 <small>Note 5</small> | μ s | - | | | | \leq TAE | | | | \leq TAE | | | | \leq TAE | | | |
| Time alignment error relative to cell 2 <small>Note 5</small> | μ s | - | | | | - | | | | \leq TAE | | | | \leq TAE | | | |
| Time alignment error relative to cell 3 <small>Note 5</small> | μ s | - | | | | - | | | | - | | | | \leq TAE | | | |
| <p>Note 1: OCNG shall be used such that all cells are fully allocated and a constant total transmitted power spectral density is achieved for all OFDM symbols.</p> <p>Note 2: The resources for uplink transmission are assigned to the UE on cell1 from the start of time period T2 and on cell2 from the start of time period T4.</p> <p>Note 3: Interference from other cells and noise sources not specified in the test is assumed to be constant over subcarriers and time and shall be modelled as AWGN of appropriate power for N_{oc} to be fulfilled.</p> <p>Note 4: E_s/I_{ot}, RSRP, SCH_RP and I_o levels have been derived from other parameters for information purposes. They are not settable parameters themselves.</p> <p>Note 5: Time alignment error (TAE) as specified in TS 36.104 [30] clause 6.5.3.1. The TAE value depends upon the type of carrier aggregation.</p> | | | | | | | | | | | | | | | | | |

Table A.8.16.81.1-3: Cell specific test parameters for E-UTRAN PCell in FDD FDD-TDD 5 DL CA Event Triggered Reporting on Deactivated SCell with PCell and SCell Interruptions in Non-DRX (Cell #5, Cell #6)

| Parameter | Unit | Cell 5 | | | | Cell 6 | | | |
|---|------------|--|--|--|--|--|--|--|--|
| | | T1 | T2 | T3 | T4 | T1 | T2 | T3 | T4 |
| E-UTRA RF Channel Number | | 5 | | | | 5 | | | |
| $BW_{channel}$ | | 5MHz: $N_{RB,c} = 25$ 10MHz: $N_{RB,c} = 50$ 20MHz: $N_{RB,c} = 100$ | | | | 5MHz: $N_{RB,c} = 25$ 10MHz: $N_{RB,c} = 50$ 20MHz: $N_{RB,c} = 100$ | | | |
| PDSCH parameters: DL Reference Measurement Channel | | N/A | | | | N/A | | | |
| PCFICH/PDCCH/PHICH parameters | | 5MHz: R.11 TDD 10MHz: R.6 TDD 20MHz: R.10 TDD | | | | 5MHz: R.11 TDD 10MHz: R.6 TDD 20MHz: R.10 TDD | | | |
| OCNG Pattern defined in A.3.2.1 | | 5MHz: OP.10 TDD 10MHz: OP.2 TDD 20MHz: OP.8 TDD | | | | 5MHz: OP.10 TDD 10MHz: OP.2 TDD 20MHz: OP.8 TDD | | | |
| PBCH_RA | dB | 0 | | | | 0 | | | |
| PBCH_RB | dB | | | | | | | | |
| PSS_RA | dB | | | | | | | | |
| SSS_RA | dB | | | | | | | | |
| PCFICH_RB | dB | | | | | | | | |
| PHICH_RA | dB | | | | | | | | |
| PHICH_RB | dB | | | | | | | | |
| PDCCH_RA | dB | | | | | | | | |
| PDCCH_RB | dB | | | | | | | | |
| PDSCH_RA | dB | | | | | | | | |
| PDSCH_RB | dB | | | | | | | | |
| OCNG_RA ^{Note 1} | dB | | | | | | | | |
| OCNG_RB ^{Note 1} | dB | | | | | | | | |
| N_{oc} ^{Note 3} | dBm/15 kHz | | | | | | | | |
| \hat{E}_s / N_{oc} | dB | 16 | 16 | 16 | 16 | -infinity | 16 | -infinity | 16 |
| \hat{E}_s / I_{ot} ^{Note 4} | dB | 16 | -0.11 | 16 | -0.11 | -infinity | -0.11 | -infinity | -0.11 |
| RSRP ^{Note 4} | dBm/15 kHz | 85 | -85 | 85 | -85 | -infinity | -85 | -infinity | -85 |
| SCH_RP ^{Note 4} | dBm/15 kHz | 85 | -85 | 85 | -85 | -infinity | -85 | -infinity | -85 |
| I_o ^{Note 4} | dBm/Ch BW | -57.11 +10log ($N_{RB,c}$ /50) | -54.15 +10log ($N_{RB,c}$ /50) | -57.11 +10log ($N_{RB,c}$ /50) | -54.15 +10log ($N_{RB,c}$ /50) | -57.11 +10log ($N_{RB,c}$ /50) | -54.15 +10log ($N_{RB,c}$ /50) | -57.11 +10log ($N_{RB,c}$ /50) | -54.15 +10log ($N_{RB,c}$ /50) |
| Propagation Condition | | AWGN | | | | AWGN | | | |
| Antenna Configuration | | 1x2 | | | | 1x2 | | | |
| Timing offset to Cell 1 | μ s | 0 | | | | 3 | | | |
| Time alignment error relative to cell 1 ^{Note 5} | μ s | \leq TAE | | | | N/A | | | |
| Time alignment error relative to cell 2 ^{Note 5} | μ s | \leq TAE | | | | N/A | | | |
| Time alignment error relative to cell 3 ^{Note 5} | μ s | \leq TAE | | | | N/A | | | |
| <p>Note 1: OCNG shall be used such that all cells are fully allocated and a constant total transmitted power spectral density is achieved for all OFDM symbols.</p> <p>Note 2: Void</p> <p>Note 3: Interference from other cells and noise sources not specified in the test is assumed to be constant over subcarriers and time and shall be modelled as AWGN of appropriate power for N_{oc} to be fulfilled.</p> <p>Note 4: E_s/I_{ot}, RSRP, SCH_RP and I_o levels have been derived from other parameters for information purposes. They are not settable parameters themselves.</p> <p>Note 5: Time alignment error (TAE) as specified in TS 36.104 [30] clause 6.5.3.1. The TAE value depends upon the type of carrier aggregation.</p> | | | | | | | | | |

A.8.16.81.2 Test Requirements

The UE shall send one Event A6 triggered measurement report, with a measurement reporting delay less than $12.8s$ ($20 \times \text{scellMeasCycle}$) from the beginning of time period T2.

The UE shall send one Event A6 triggered measurement report, with a measurement reporting delay less than $3.2s$ ($5 \times \text{scellMeasCycle}$) from the beginning of time period T4.

The UE shall not send event triggered measurement reports, as long as the reporting criteria are not fulfilled.

The UE shall be scheduled on PCell continuously throughout the test. From the start of T1 until the measurement report is received during T2, at least 99.5% of all expected ACK/NACKs shall be transmitted by the UE.

The UE shall be scheduled on Cell2 continuously from the beginning of T4 to the end. From the start of T4 until the measurement report is received during T4, at least 99.5% of all expected ACK/NACKs shall be transmitted by the UE.

For a test to be considered successful requirements on both event detection and percentage of transmitted ACK/NACKs have to be fulfilled simultaneously.

The rate of correct events observed during repeated tests shall be at least 90%.

NOTE: The actual overall delays measured in the test may be up to $2 \times \text{TTI}_{\text{DCCH}}$ higher than the measurement reporting delays above because of TTI insertion uncertainty of the measurement report in DCCH.

A.8.16.82 E-UTRAN PCell in TDD TDD-FDD 5 DL CA Event Triggered Reporting on Deactivated SCell with PCell and SCell Interruptions in Non-DRX

A.8.16.82.1 Test Purpose and Environment

The purpose of this test is to verify that the UE correctly detects event A6 (Neighbour becomes better than SCell) defined in TS 36.331 [2] within the requirements stated in clause 8.3.3.2.1 while at the same time fulfilling the requirement on interruption rate.

The test parameters are given in Table A.8.16.82.1-1, A.8.16.82.1-2 and A.8.16.82.1-3 below. In the test there are five cells: Cell 1, Cell 2, Cell 3, Cell 4, Cell 5 and Cell 6. Cell 1 is PCell on the TDD primary component (RF Channel 1), Cell 2 is SCell on the FDD secondary component (RF Channel 2), Cell 3 is SCell on the FDD secondary component (RF Channel 3), Cell 4 is SCell on the FDD secondary component (RF Channel 4), Cell 5 is SCell on the FDD secondary component (RF Channel 5) and Cell 6 is the neighbour cell on the FDD secondary component (RF Channel 4). It is indicated to the UE in the measurement control information that event-triggered reporting with Event A6 is used. The test consists of four successive time periods, with duration of T1, T2, T3 and T4, respectively. During T1 and T2, Cell2, Cell3, Cell4 and Cell5 are deactivated. During T1 the UE shall not have any information of Cell 6. Immediately at beginning of T2 the transmission power of Cell 6 is increased to same level as for Cell 5, and due to usage of an offset this shall result in reporting of Event A6.

At the beginning of T3, the transmission power of Cell 6 is turned off, and the test equipment sends a MAC message for activation of Cell 2 to UE but Cell3, Cell4 and Cell5 remains deactivated. Immediately at beginning of T4 the transmission power of Cell 6 is increased to same level as for Cell 5, and due to usage of an offset this shall result in reporting of Event A6. The UE shall be continuously scheduled in the PCell throughout the whole test and continuously scheduled in Cell2 during T4.

Table A.8.16.82.1-1: General test parameters for E-UTRAN PCell in TDD TDD-FDD 5 DL CA Event Triggered Reporting on Deactivated SCell with PCell and SCell Interruptions in Non-DRX

| Parameter | Unit | Value | Comment |
|------------------------------|------|------------|---|
| E-UTRA RF Channel Number | | 1, 2, 3, 4 | Four radio channels are used for this test |
| Active PCell | | Cell 1 | Primary cell on RF channel number 1. |
| Configured deactivated SCell | | Cell 2 | Configured deactivated secondary cell on RF channel number 2. |
| Configured deactivated SCell | | Cell 3 | Configured deactivated secondary cell on RF channel number 3. |

| | | | | |
|---|-----------------|--------|--|---|
| Configured deactivated SCell | | Cell 4 | Configured deactivated secondary cell on RF channel number 4. | |
| Configured deactivated SCell | | Cell 5 | Configured deactivated secondary cell on RF channel number 5. | |
| Neighbour cell | | Cell 6 | Neighbor cell to be identified on RF channel number 5. | |
| CP length | | Normal | | |
| Special subframe configuration | | 6 | As specified in table 4.2-1 in TS 36.211. The same configuration in all cells | |
| Uplink-downlink configuration | | 1 | As specified in table 4.2-2 in TS 36.211. The same configuration in all cells | |
| DRX | | OFF | Continuous monitoring of primary cell | |
| A6 | Hysteresis | dB | 0 | Hysteresis for evaluation of event A6. |
| | Offset | dB | -3 | Offset parameter for evaluation of event A6. Needs to take relative accuracy tolerance in clause 9.1.11.2 into account plus margin. |
| | Report on leave | | False | |
| | Time To Trigger | s | 0 | |
| Cell-individual offset for cells on RF channel number 1 | dB | 0 | Individual offset for cells on primary component carrier. | |
| Cell-individual offset for cells on RF channel number 2 | dB | 0 | Individual offset for cells on secondary component carrier. | |
| Cell-individual offset for cells on RF channel number 3 | dB | 0 | Individual offset for cells on secondary component carrier. | |
| Cell-individual offset for cells on RF channel number 4 | dB | 0 | Individual offset for cells on secondary component carrier. | |
| Cell-individual offset for cells on RF channel number 5 | dB | 0 | Individual offset for cells on secondary component carrier. | |
| Filter coefficient | | 0 | L3 filtering is not used | |
| SCell measurement cycle | ms | 640 | | |
| T1 | s | 4 | During this time the UE shall be aware of cells 1, 2, 3, 4 and 5 but not cell 6. | |
| T2 | s | ≤15 | UE should report Event A6 within 12.8s (20×scellMeasCycle) | |
| T3 | s | 4 | During this time the UE shall activate cell 2 | |
| T4 | s | ≤4 | UE should report Event A6 within 3.2s (5×scellMeasCycle) | |

Table A.8.16.82.1-2: Cell specific test parameters for E-UTRAN PCell in TDD TDD-FDD 5 DL CA Event Triggered Reporting on Deactivated SCell with PCell and SCell Interruptions in Non-DRX (Cell #1, Cell #2, Cell #3, Cell #4)

| Parameter | Unit | Cell 1 | | | | Cell 2 | | | | Cell 3 | | | | Cell 4 | | | |
|--|------|---|----|----|----|---|--|--|---|---|----|----|----|---|----|----|----|
| | | T1 | T2 | T3 | T4 | T1 | T2 | T3 | T4 | T1 | T2 | T3 | T4 | T1 | T2 | T3 | T4 |
| E-UTRA RF Channel Number | | 1 | | | | 2 | | | | 3 | | | | 4 | | | |
| BW _{channel} | | 5MHz: N _{RB,c} = 25 10MHz: N _{RB,c} = 50 20MHz: N _{RB,c} = 100 | | | | 5MHz: N _{RB,c} = 25 10MHz: N _{RB,c} = 50 20MHz: N _{RB,c} = 100 | | | | 5MHz: N _{RB,c} = 25 10MHz: N _{RB,c} = 50 20MHz: N _{RB,c} = 100 | | | | 5MHz: N _{RB,c} = 25 10MHz: N _{RB,c} = 50 20MHz: N _{RB,c} = 100 | | | |
| PDSCH parameters: DL Reference Measurement Channel | | 5MHz: R.4 TDD 10MHz: R.0 TDD 20MHz: R.3 TDD | | | | N/A | N/A | N/A | 5MHz: R.7 FDD 10MHz: R.3 FDD 20MHz: R.6 FDD | N/A | | | | N/A | | | |
| PCFICH/PDCCH/PHICH parameters | | 5MHz: R.11 TDD 10MHz: R.6 TDD 20MHz: R.10 TDD | | | | 5MHz: R.11 FDD 10MHz: R.6 FDD 20MHz: R.10 FDD | | | | 5MHz: R.11 FDD 10MHz: R.6 FDD 20MHz: R.10 FDD | | | | 5MHz: R.11 FDD 10MHz: R.6 FDD 20MHz: R.10 FDD | | | |
| OCNG Pattern defined in A.3.2.1 | | 5MHz: OP.9 TDD 10MHz: OP.1 TDD 20MHz: OP.7 TDD | | | | 5MHz: OP.16 FDD 10MHz: OP.2 FDD 20MHz: OP.12 FDD | 5MHz: OP.16 FDD 10MHz: OP.2 FDD 20MHz: OP.12 FDD | 5MHz: OP.16 FDD 10MHz: OP.2 FDD 20MHz: OP.12 FDD | 5MHz: OP.20 FDD 10MHz: OP.10 FDD 20MHz: OP.17 FDD | 5MHz: OP.16 FDD 10MHz: OP.2 FDD 20MHz: OP.12 FDD | | | | 5MHz: OP.16 FDD 10MHz: OP.2 FDD 20MHz: OP.12 FDD | | | |
| PBCH_RA | dB | 0 | | | | 0 | | | | 0 | | | | 0 | | | |
| PBCH_RB | dB | | | | | | | | | | | | | | | | |
| PSS_RA | dB | | | | | | | | | | | | | | | | |
| SSS_RA | dB | | | | | | | | | | | | | | | | |
| PCFICH_RB | dB | | | | | | | | | | | | | | | | |
| PHICH_RA | dB | | | | | | | | | | | | | | | | |
| PHICH_RB | dB | | | | | | | | | | | | | | | | |
| PDCCH_RA | dB | | | | | | | | | | | | | | | | |
| PDCCH_RB | dB | | | | | | | | | | | | | | | | |
| PDSCH_RA | dB | | | | | | | | | | | | | | | | |
| PDSCH_RB | dB | | | | | | | | | | | | | | | | |
| OCNG_RA ^{Note 1} | dB | | | | | | | | | | | | | | | | |
| OCNG_RB ^{Note 1} | dB | | | | | | | | | | | | | | | | |

| | | | | | | | | | | | | | | | | | |
|--|------------|--|--|--|--|--|--|--|--|--|--|--|--|--|--|--|--|
| N_{oc} <small>Note 3</small> | dBm/15 kHz | -101 | | | | -101 | | | | -101 | | | | -101 | | | |
| \hat{E}_s / N_{oc} | dB | 16 | 16 | 16 | 16 | 16 | 16 | 16 | 16 | 16 | 16 | 16 | 16 | 16 | 16 | 16 | 16 |
| \hat{E}_s / I_{ot} <small>Note 4</small> | dB | 16 | 16 | 16 | 16 | 16 | 16 | 16 | 16 | 16 | 16 | 16 | 16 | 16 | 16 | 16 | 16 |
| RSRP <small>Note 4</small> | dBm/15 kHz | -85 | -85 | -85 | -85 | -85 | -85 | -85 | -85 | -85 | -85 | -85 | -85 | 85 | -85 | 85 | -85 |
| SCH_RP <small>Note 4</small> | dBm/15 kHz | -85 | -85 | -85 | -85 | -85 | -85 | -85 | -85 | -85 | -85 | -85 | -85 | 85 | -85 | 85 | -85 |
| I_o <small>Note 4</small> | dBm/Ch BW | -57.11 +10log ($N_{RB,c}$ /50) | -57.11 +10log ($N_{RB,c}$ /50) | -57.11 +10log ($N_{RB,c}$ /50) | -57.11 +10log ($N_{RB,c}$ /50) | -57.11 +10log ($N_{RB,c}$ /50) | -57.11 +10log ($N_{RB,c}$ /50) | -57.11 +10log ($N_{RB,c}$ /50) | -57.11 +10log ($N_{RB,c}$ /50) | -57.11 +10log ($N_{RB,c}$ /50) | -57.11 +10log ($N_{RB,c}$ /50) | -57.11 +10log ($N_{RB,c}$ /50) | -57.11 +10log ($N_{RB,c}$ /50) | -57.11 +10log ($N_{RB,c}$ /50) | -57.11 +10log ($N_{RB,c}$ /50) | -57.11 +10log ($N_{RB,c}$ /50) | -57.11 +10log ($N_{RB,c}$ /50) |
| Propagation Condition | | AWGN | | | | AWGN | | | | AWGN | | | | AWGN | | | |
| Antenna Configuration | | 1x2 | | | | 1x2 | | | | 1x2 | | | | 1x2 | | | |
| Timing offset to Cell 1 | μ s | - | | | | 0 | | | | 0 | | | | 0 | | | |
| Time alignment error relative to cell 1 <small>Note 5</small> | μ s | - | | | | \leq TAE | | | | \leq TAE | | | | \leq TAE | | | |
| Time alignment error relative to cell 2 <small>Note 5</small> | μ s | - | | | | - | | | | \leq TAE | | | | \leq TAE | | | |
| Time alignment error relative to cell 3 <small>Note 5</small> | μ s | - | | | | - | | | | - | | | | \leq TAE | | | |
| <p>Note 1: OCNG shall be used such that all cells are fully allocated and a constant total transmitted power spectral density is achieved for all OFDM symbols.</p> <p>Note 2: The resources for uplink transmission are assigned to the UE on cell1 from the start of time period T2 and on cell2 from the start of time period T4.</p> <p>Note 3: Interference from other cells and noise sources not specified in the test is assumed to be constant over subcarriers and time and shall be modelled as AWGN of appropriate power for N_{oc} to be fulfilled.</p> <p>Note 4: E_s/I_{ot}, RSRP, SCH_RP and I_o levels have been derived from other parameters for information purposes. They are not settable parameters themselves.</p> <p>Note 5: Time alignment error (TAE) as specified in TS 36.104 [30] clause 6.5.3.1. The TAE value depends upon the type of carrier aggregation.</p> | | | | | | | | | | | | | | | | | |

Table A.8.16.82.1-3: Cell specific test parameters for E-UTRAN PCell in TDD TDD-FDD 5 DL CA Event Triggered Reporting on Deactivated SCell with PCell and SCell Interruptions in Non-DRX (Cell #5, Cell #6)

| Parameter | Unit | Cell 5 | | | | Cell 6 | | | |
|---|------------|--|--|--|--|--|--|--|--|
| | | T1 | T2 | T3 | T4 | T1 | T2 | T3 | T4 |
| E-UTRA RF Channel Number | | 5 | | | | 5 | | | |
| $BW_{channel}$ | | 5MHz: $N_{RB,c} = 25$ 10MHz: $N_{RB,c} = 50$ 20MHz: $N_{RB,c} = 100$ | | | | 5MHz: $N_{RB,c} = 25$ 10MHz: $N_{RB,c} = 50$ 20MHz: $N_{RB,c} = 100$ | | | |
| PDSCH parameters: DL Reference Measurement Channel | | N/A | | | | N/A | | | |
| PCFICH/PDCCH/PHICH parameters | | 5MHz: R.11 FDD 10MHz: R.6 FDD 20MHz: R.10 FDD | | | | 5MHz: R.11 FDD 10MHz: R.6 FDD 20MHz: R.10 FDD | | | |
| OCNG Pattern defined in A.3.2.1 | | 5MHz: OP.16 FDD 10MHz: OP.2 FDD 20MHz: OP.12 FDD | | | | 5MHz: OP.20 FDD 10MHz: OP.10 FDD 20MHz: OP.17 FDD | | | |
| PBCH_RA | dB | 0 | | | | 0 | | | |
| PBCH_RB | dB | | | | | | | | |
| PSS_RA | dB | | | | | | | | |
| SSS_RA | dB | | | | | | | | |
| PCFICH_RB | dB | | | | | | | | |
| PHICH_RA | dB | | | | | | | | |
| PHICH_RB | dB | | | | | | | | |
| PDCCH_RA | dB | | | | | | | | |
| PDCCH_RB | dB | | | | | | | | |
| PDSCH_RA | dB | | | | | | | | |
| PDSCH_RB | dB | | | | | | | | |
| OCNG_RA ^{Note 1} | dB | | | | | | | | |
| OCNG_RB ^{Note 1} | dB | | | | | | | | |
| N_{oc} ^{Note 3} | dBm/15 kHz | | | | | | | | |
| \hat{E}_s / N_{oc} | dB | 16 | 16 | 16 | 16 | -infinity | 16 | -infinity | 16 |
| \hat{E}_s / I_{ot} ^{Note 4} | dB | 16 | -0.11 | 16 | -0.11 | -infinity | -0.11 | -infinity | -0.11 |
| RSRP ^{Note 4} | dBm/15 kHz | 85 | -85 | 85 | -85 | -infinity | -85 | -infinity | -85 |
| SCH_RP ^{Note 4} | dBm/15 kHz | 85 | -85 | 85 | -85 | -infinity | -85 | -infinity | -85 |
| I_o ^{Note 4} | dBm/Ch BW | -57.11 +10log ($N_{RB,c}$ /50) | -54.15 +10log ($N_{RB,c}$ /50) | -57.11 +10log ($N_{RB,c}$ /50) | -54.15 +10log ($N_{RB,c}$ /50) | -57.11 +10log ($N_{RB,c}$ /50) | -54.15 +10log ($N_{RB,c}$ /50) | -57.11 +10log ($N_{RB,c}$ /50) | -54.15 +10log ($N_{RB,c}$ /50) |
| Propagation Condition | | AWGN | | | | AWGN | | | |
| Antenna Configuration | | 1x2 | | | | 1x2 | | | |
| Timing offset to Cell 1 | μs | 0 | | | | 3 | | | |
| Time alignment error relative to cell 1 ^{Note 5} | μs | \leq TAE | | | | N/A | | | |
| Time alignment error relative to cell 2 ^{Note 5} | μs | \leq TAE | | | | N/A | | | |
| Time alignment error relative to cell 3 ^{Note 5} | μs | \leq TAE | | | | N/A | | | |
| <p>Note 1: OCNG shall be used such that all cells are fully allocated and a constant total transmitted power spectral density is achieved for all OFDM symbols.</p> <p>Note 2: Void</p> <p>Note 3: Interference from other cells and noise sources not specified in the test is assumed to be constant over subcarriers and time and shall be modelled as AWGN of appropriate power for N_{oc} to be fulfilled.</p> <p>Note 4: E_s/I_{ot}, RSRP, SCH_RP and I_o levels have been derived from other parameters for information purposes. They are not settable parameters themselves.</p> <p>Note 5: Time alignment error (TAE) as specified in TS 36.104 [30] clause 6.5.3.1. The TAE value depends upon the type of carrier aggregation.</p> | | | | | | | | | |

A.8.16.82.2 Test Requirements

The UE shall send one Event A6 triggered measurement report, with a measurement reporting delay less than 12.8s ($20 \times \text{scellMeasCycle}$) from the beginning of time period T2.

The UE shall send one Event A6 triggered measurement report, with a measurement reporting delay less than 3.2s ($5 \times \text{scellMeasCycle}$) from the beginning of time period T4.

The UE shall not send event triggered measurement reports, as long as the reporting criteria are not fulfilled.

The UE shall be scheduled on PCell continuously throughout the test. From the start of T1 until the measurement report is received during T2, at least 99.5% of all expected ACK/NACKs shall be transmitted by the UE.

The UE shall be scheduled on Cell2 continuously from the beginning of T4 to the end. From the start of T4 until the measurement report is received during T4, at least 99.5% of all expected ACK/NACKs shall be transmitted by the UE.

For a test to be considered successful requirements on both event detection and percentage of transmitted ACK/NACKs have to be fulfilled simultaneously.

The rate of correct events observed during repeated tests shall be at least 90%.

NOTE: The actual overall delays measured in the test may be up to $2 \times \text{TTI}_{\text{DCCH}}$ higher than the measurement reporting delays above because of TTI insertion uncertainty of the measurement report in DCCH.

A.8.17 RSTD Measurements for E-UTRAN Carrier Aggregation

A.8.17.1 E-UTRAN FDD RSTD measurement reporting delay test case

A.8.17.1.1 Test Purpose and Environment

The purpose of the test case is to verify that the RSTD measurements meet the requirements specified in Clause 8.4 in a synchronized network environment with fading propagation conditions. This test case will verify the measurement period requirements specified in Clause 8.4.3 for RSTD measurements performed on the secondary component carrier and also the measurement period requirements for RSTD measurements performed on both the primary and secondary component carriers specified in Clause 8.4.4.

In the tests, there are two configured component carriers: PCC and SCC, and three synchronous cells: Cell 1, Cell 2 and Cell 3. Cell 1 is PCell on the PCC, Cell 2 is an active SCell on the SCC, and Cell 3 is a neighbour cell on the SCC. In all tests, Cell 2 is the OTDOA assistance data reference cell.

The test case includes two tests. Test 1 is designed for the scenario where the UE receives OTDOA assistance data with cells on SCC, and the UE is expected to report RSTD measurements performed on SCC only. Test 2 is designed for the scenario where the UE receives OTDOA assistance data with cells on PCC and SCC, and the UE is expected to report RSTD measurements performed on PCC and on SCC.

Each test consists of three consecutive time intervals, with duration of T1, T2 and T3. Cell 1 is active in T1, T2 and T3, whilst Cell 2 is active only in T2 and T3, and Cell 3 is active only during T2. The beginning of the time interval T2 shall be aligned with the first PRS positioning subframe of a positioning occasion in the OTDOA assistance data reference cell, where the PRS positioning occasion is as defined in Clause 8.1.2.5.1. Cell 1 transmits PRS in T2, while Cell 2 transmits PRS only in T3, and Cell 3 transmits PRS only in T2.

Note: The information on when PRS is muted is conveyed to the UE using PRS muting information.

The OTDOA assistance data as defined in TS 36.355, Clause 6.5.1.1, shall be provided to the UE during T1. The last TTI containing the OTDOA assistance data shall be provided to the UE ΔT ms before the start of T2, where $\Delta T = 150$ ms is the maximum processing time of the OTDOA assistance data.

The test parameters are as given in Table A.8.17.1.1-1, Table A.8.17.1.1-2, Table A.8.17.1.1-3 and Table A.8.17.1.1-4.

Table A.8.17.1.1-1: General test parameters for E-UTRAN FDD RSTD measurement reporting delay under fading propagation conditions for carrier aggregation

| Parameter | Unit | Value | | Comment |
|---|---------|---|---|---|
| | | Test 1 | Test 2 | |
| PCell | | Cell 1 | | PCell is on RF channel 1 (PCC). |
| SCell | | Cell 2 | | SCell on RF channel 2 (SCC). Cell 2 is the assistance data reference cell. |
| Other neighbor cell | | Cell 3 | | Neighbor cell on RF channel 2 (SCC). |
| PCFICH/PDCCH/PHICH parameters | | DL Reference Measurement Channel R.6 FDD | | As specified in clause A.3.1.2.1 |
| Channel Bandwidth ($BW_{channel}$) | MHz | 10 | | |
| PRS Transmission Bandwidth | RB | 50 | | PRS are transmitted over the system bandwidth |
| PRS configuration index I_{PRS} | | 171 for all cells on PCC 181 for all cells on SCC | | This corresponds to periodicity of 320 ms and PRS subframe offset of $I_{PRS} - 160$ DL subframes, as defined in TS 36.211 [16], Table 6.10.4.3-1 |
| Number of consecutive downlink positioning subframes N_{PRS} | | 1 | | As defined in TS 36.211 [16]. The number of subframes in a positioning occasion |
| Physical cell ID PCI | | (PCI of Cell 2 – PCI of Cell 3) mod 6 = 0 | | The PCI of Cell 1 is selected randomly. PCIs of Cell 2 and Cell 3 are selected randomly such that the relative subcarrier shifts of PRS patterns among these cells are as given by the condition |
| CP length | | Normal | | |
| DRX | | ON | | DRX parameters are further specified in Table A.8.17.1.1-3 |
| Radio frame receive time offset between the cells at the UE antenna connector | μs | Cell 1 to Cell 2: 1 Cell 3 to Cell 2: -1 | | PRS are transmitted from synchronous cells |
| Time alignment error between cell2 and cell1 | μs | \leq Time alignment error as specified in 3GPP TS 36.104 [30] clause 6.5.3.1. | | The value of time alignment error depends upon the type of carrier aggregation. |
| Expected RSTD | μs | Cell 3: 2 Other neighbour cells: randomly between -3 and 3 | Cell 1: -2 Cell 3: 2 Other neighbour cells: randomly between -3 and 3 | The expected RSTD is what is expected at the receiver. The corresponding parameter in the OTDOA assistance data specified in TS 36.355 [24] is the expectedRSTD indicator |
| Expected RSTD uncertainty for all neighbour cells | μs | 5 | | The corresponding parameter in the OTDOA assistance data specified in TS 36.355 [24] is the expectedRSTD-Uncertainty index |
| Cells in OTDOA assistance data | | 16 cells in total | | The list includes the reference cell (received in <i>OTDOA-ReferenceCellInfo</i> [24]) and 15 other cells, all received in <i>OTDOA-ProvideAssistanceData</i> [24]. Cell 1 (when included) appears at random places in the first half of the neighbour cell list in the OTDOA assistance data. Cell 3 always appears at random places in the second half of the list. |
| | | OTDOA neighbor cells include Cell 3 and other 14 cells on SCC | OTDOA neighbor cells include Cell 1 and other 7 cells on PCC, and Cell 3 and other 6 cells on SCC | |

| | | | | |
|--------------------|---|---|---|--|
| prs-SubframeOffset | | Cells on PCC: 310 Cells on SCC, except reference cell: 0 | | Subframe offset, counted in full subframes. The corresponding parameter in the OTDOA assistance data is prs-SubframeOffset specified in TS 36.355 [24] |
| slotNumberOffset | | Cells on PCC: 0 Cells on SCC, except reference cell: 0 | | The slot number offset at the transmitter between a neighbour cell and the assistance data reference cell. The corresponding parameter in the OTDOA assistance data is slotNumberOffset specified in TS 36.355 [24]. |
| PRS muting info | | Cell 1: '11110000' Cell 2: '00001111' Cell 3: '11110000' | Cell 1: '1111111100000000' Cell 2: '0000000011111111' Cell 3: '1111111100000000' | Corresponds to prs-MutingInfo defined in TS 36.355 [24] |
| T1 | s | 3 | | The length of the time interval from the beginning of each test |
| T2 | s | 1.28 | 2.48 | The length of the time interval that follows immediately after time interval T1 |
| T3 | s | 1.28 | 2.48 | The length of the time interval that follows immediately after time interval T2 |

Table A.8.17.1.1-2: Cell-specific test parameters for E-UTRAN FDD RSTD measurement reporting delay under fading propagation conditions during T1 for carrier aggregation

| Parameter | Unit | Cell 1 | Cell 2 | Cell 3 | | | | |
|--|-----------|----------|-----------|-----------|------------|-----------|-----------|-----------|
| E-UTRA RF Channel Number | | 1 | N/A | N/A | | | | |
| Correlation Matrix and Antenna Configuration | | 1x2 Low | 1x2 Low | 1x2 Low | | | | |
| OCNG patterns defined in A.3.2.1 | | OP.5 FDD | N/A | N/A | | | | |
| PBCH_RA | dB | 0 | N/A | N/A | | | | |
| PBCH_RB | | | | | | | | |
| PSS_RA | | | | | | | | |
| SSS_RA | | | | | | | | |
| PCFICH_RB | | | | | | | | |
| PHICH_RA | | | | | | | | |
| PHICH_RB | | | | | | | | |
| PDCCH_RA | | | | | | | | |
| PDCCH_RB | | | | | | | | |
| OCNG_RA ^{Note 1} | | | | | | | | |
| OCNG_RB ^{Note 1} | | | | | | | | |
| N_{oc} ^{Note 3} | | | | | dBm/15 kHz | -95 | N/A | N/A |
| PRS \hat{E}_s/N_{oc} | | | | | dB | -Infinity | -Infinity | -Infinity |
| I_0 ^{Note 4} | dBm/9 MHz | -67.22 | N/A | N/A | | | | |
| \hat{E}_s/N_{oc} | dB | 0 | -Infinity | -Infinity | | | | |
| Propagation Condition | | ETU30 | | | | | | |

| | |
|---------|---|
| Note 1: | OCNG shall be used such that active cell (Cell 1) is fully allocated and a constant total transmitted power spectral density is achieved for all OFDM symbols. |
| Note 2: | The resources for uplink transmission are assigned to the UE prior to the start of time period T2. |
| Note 3: | Interference from other cells and noise sources not specified in the test are assumed to be constant over subcarriers and time and shall be modelled as AWGN of appropriate power for N_{oc} to be fulfilled. |
| Note 4: | lo levels have been derived from other parameters and are given for information purpose. These are not settable test parameters. |

Table A.8.17.1.1-3: Cell-specific test parameters for E-UTRAN FDD RSTD measurement reporting delay under fading propagation conditions during T2 and T3 for carrier aggregation

| Parameter | Unit | Cell 1 | | Cell 2 | | Cell 3 | |
|--|------------|----------|-----------|-----------|--------|----------|-----------|
| | | T2 | T3 | T2 | T3 | T2 | T3 |
| E-UTRA RF Channel Number | | 1 | | 2 | | 2 | |
| Correlation Matrix and Antenna Configuration | | 1x2 Low | | 1x2 Low | | 1x2 Low | |
| OCNG patterns defined in A.3.2.1 | | OP.5 FDD | | OP.6 FDD | | OP.6 FDD | N/A |
| PBCH_RA | dB | 0 | | 0 | | 0 | N/A |
| PBCH_RB | | | | | | | |
| PSS_RA | | | | | | | |
| SSS_RA | | | | | | | |
| PCFICH_RB | | | | | | | |
| PHICH_RA | | | | | | | |
| PHICH_RB | | | | | | | |
| PDCCH_RA | | | | | | | |
| PDCCH_RB | | | | | | | |
| OCNG_RA ^{Note 1} | | | | | | | |
| OCNG_RB ^{Note 1} | | | | | | | |
| PRS_RA | dB | -6 | N/A | N/A | 3 | 3 | N/A |
| N_{oc} ^{Note 3} | dBm/15 kHz | -98 | -98 | -98 | -95 | -98 | -95 |
| $PRS \hat{E}_s / N_{oc}$ | dB | -4 | -Infinity | -Infinity | -1 | -8 | -Infinity |
| $PRS \hat{E}_s / I_{ot}$ ^{Note 4} | dB | -4 | -Infinity | -Infinity | -1 | -8 | -Infinity |
| I_o ^{Note 4} | dBm/9 MHz | -69.94 | N/A | N/A | -66.68 | -70.11 | N/A |
| PRP ^{Note 4} | dBm/15 kHz | -102 | -Infinity | -Infinity | -96 | -106 | -Infinity |
| RSRP ^{Note 4} | dBm/15 kHz | -96 | -96 | -105 | -99 | -109 | -Infinity |
| \hat{E}_s / N_{oc} ^{Note 4} | dB | 2 | 2 | -7 | -4 | -11 | -Infinity |
| Propagation Condition | | ETU30 | | | | | |

| | |
|---------|--|
| Note 1: | OCNG shall be used such that active cells (all, except Cell 3 in T3) are fully allocated and a constant total transmitted power spectral density is achieved for all OFDM symbols other than those in the subframes with transmitted PRS. |
| Note 2: | The resources for uplink transmission are assigned to the UE prior to the start of time period T2. |
| Note 3: | Interference from other cells and noise sources not specified in the test are assumed to be constant over subcarriers and time and shall be modelled as AWGN of appropriate power for N_{oc} to be fulfilled. |
| Note 4: | If PRS_RA is not "N/A", \hat{E}_s/N_{oc} , PRS \hat{E}_s/I_{ot} , I_o , RSRP and PRP levels have been derived from other parameters and are given for information purpose. If PRS_RA is "N/A", I_o and RSRP levels have been derived from other parameters and are given for information purpose. These are not settable test parameters. Interference conditions shall be applied to all PRS symbols of DL positioning subframes. |

Table A.8.17.1.1-4: DRX parameters for the test of E-UTRAN FDD intra-frequency RSTD measurement reporting delay under fading propagation conditions for carrier aggregation

| Field | Value | Comment |
|--------------------------|---------|---|
| onDurationTimer | psf1 | As specified in TS 36.331 [2], Clause 6.3.2 |
| Drx-InactivityTimer | psf1 | |
| drx-RetransmissionTimer | sf1 | |
| longDRX-CycleStartOffset | sf320 | |
| shortDRX | Disable | |

A.8.17.1.2 Test Requirements

The RSTD measurement time fulfils the requirements specified in Clause 8.4.

In Test 1, the UE shall perform and report the RSTD measurements from Cell 2 and Cell 3 within 2560 ms starting from the beginning of time interval T2.

In Test 2, the UE shall perform and report the RSTD measurements from Cell 1 and Cell 2, and RSTD measurements from Cell 2 and Cell 3 within 4960 ms starting from the beginning of time interval T2.

The rate of the correct events for each neighbour cell observed during repeated tests shall be at least 90%, where the reported RSTD measurement for each correct event shall be within the RSTD reporting range specified in Clause 9.1.10.3, i.e., between RSTD_0000 and RSTD_12711.

NOTE: The RSTD measurement times in the tests are derived from the following expression,

$$T_{PRS} (M - 1) + 160 \left\lceil \frac{n}{M} \right\rceil,$$

where $M = 8$ and $n = 16$ for Test 1, and $M = 16$ and $n = 16$ for Test 2. For Test 1, the M and n parameters specified in Clause 8.1.2.5.1, Table 8.1.2.5.1-1, under Note 1, which gives the total RSTD measurement time of 2560 ms for Cell 3 with respect to the reference cell Cell 2. For Test 2, the M and n parameters are specified in Clause 8.1.2.6.1, Table 8.1.2.6.1-1, under Note 1, which gives the total RSTD measurement time of 4960 ms for reporting the RSTD measurements of Cell 1 and Cell 3 with respect to the reference cell Cell 2.

A.8.17.2 E-UTRAN TDD RSTD measurement reporting delay test case

A.8.17.2.1 Test Purpose and Environment

The purpose of the test case is to verify that the RSTD measurements meet the requirements specified in Clause 8.4 in a synchronized network environment with fading propagation conditions. This test case will verify the measurement period requirements specified in Clause 8.4.3 for RSTD measurements performed on the secondary component carrier and also the measurement period requirements for RSTD measurements performed on both the primary and secondary component carriers specified in Clause 8.4.4.

In the tests, there are two configured component carriers: PCC and SCC, and three synchronous cells: Cell 1, Cell 2 and Cell 3. Cell 1 is PCell on the PCC, Cell 2 is an active SCell on the SCC, and Cell 3 is a neighbour cell on the SCC. In all tests, Cell 2 is the OTDOA assistance data reference cell.

The test case includes two tests. Test 1 is designed for the scenario where the UE receives OTDOA assistance data with cells on SCC, and the UE is expected to report RSTD measurements performed on SCC only. Test 2 is designed for the scenario where the UE receives OTDOA assistance data with cells on PCC and SCC, and the UE is expected to report RSTD measurements performed on PCC and on SCC.

Each test consists of three consecutive time intervals, with duration of T1, T2 and T3. Cell 1 is active in T1, T2 and T3, whilst Cell 2 is active only in T2 and T3, and Cell 3 is active only during T2. The beginning of the time interval T2 shall be aligned with the first PRS positioning subframe of a positioning occasion in the OTDOA assistance data reference cell, where the PRS positioning occasion is as defined in Clause 8.1.2.5.1. Cell 1 transmits PRS in T2, while Cell 2 transmits PRS only in T3, and Cell 3 transmits PRS only in T2.

Note: The information on when PRS is muted is conveyed to the UE using PRS muting information.

The OTDOA assistance data as defined in TS 36.355, Clause 6.5.1.1, shall be provided to the UE during T1. The last TTI containing the OTDOA assistance data shall be provided to the UE ΔT ms before the start of T2, where $\Delta T = 150$ ms is the maximum processing time of the OTDOA assistance data.

The test parameters are as given in Table A.8.17.2.1-1, Table A.8.17.2.1-2, Table A.8.17.2.1-3 and Table A.8.17.2.1-4.

Table A.8.17.2.1-1: General test parameters for E-UTRAN TDD RSTD measurement reporting delay under fading propagation conditions for carrier aggregation

| Parameter | Unit | Value | | Comment |
|---|------|--|--------|--|
| | | Test 1 | Test 2 | |
| PCell | | Cell 1 | | PCell is on RF channel 1 (PCC). |
| SCell | | Cell 2 | | SCell on RF channel 2 (SCC). Cell 2 is the assistance data reference cell. |
| Other neighbor cell | | Cell 3 | | Neighbor cell on RF channel 2 (SCC). |
| PCFICH/PDCCH/PHICH parameters | | DL Reference Measurement Channel R.6 TDD | | As specified in clause A.3.1.2.2 |
| Channel Bandwidth (BW_{channel}) | MHz | 10 | | |
| PRS Transmission Bandwidth | RB | 50 | | PRS are transmitted over the system bandwidth |
| PRS configuration index I_{PRS} | | 174 for all cells on PCC 184 for all cells on SCC | | This corresponds to periodicity of 320 ms and PRS subframe offset of $I_{\text{PRS}} - 160$ DL subframes, as defined in TS 36.211 [16], Table 6.10.4.3-1 |
| Number of consecutive downlink positioning subframes N_{PRS} | | 1 | | As defined in TS 36.211 [16]. The number of subframes in a positioning occasion |
| Physical cell ID PCI | | (PCI of Cell 2 – PCI of Cell 3) mod 6 = 0 | | The PCI of Cell 1 is selected randomly. PCIs of Cell 2 and Cell 3 are selected randomly such that the relative subcarrier shifts of PRS patterns among these cells are as given by the condition |
| TDD uplink-downlink configuration | | 1 | | As specified in TS 36.211 [16], Clause 4.2; corresponds to a configuration with 5 ms switch-point periodicity and two downlink consecutive subframes |
| TDD special subframe configuration | | 6 | | As specified in TS 36.211 [16], Clause 4.2; corresponds to DwPTS of $19760 \cdot T_s$ and UpPTS of $4384 \cdot T_s$ |

| | | | | |
|---|---------------|---|---|--|
| CP length | | Normal | | |
| DRX | | ON | | DRX parameters are further specified in Table A.8.17.2.1-3 |
| Radio frame receive time offset between the cells at the UE antenna connector | μs | Cell 1 to Cell 2: 1 Cell 3 to Cell 2: -1 | | PRS are transmitted from synchronous cells |
| Time alignment error between cell2 and cell1 | μs | \leq Time alignment error as specified in 3GPP TS 36.104 [30] clause 6.5.3.1. | | The value of time alignment error depends upon the type of carrier aggregation. |
| Expected RSTD | μs | Cell 3: 2 Other neighbour cells: randomly between -3 and 3 | Cell 1: -2 Cell 3: 2 Other neighbour cells: randomly between -3 and 3 | The expected RSTD is what is expected at the receiver. The corresponding parameter in the OTDOA assistance data specified in TS 36.355 [24] is the expectedRSTD indicator |
| Expected RSTD uncertainty for all neighbour cells | μs | 5 | | The corresponding parameter in the OTDOA assistance data specified in TS 36.355 [24] is the expectedRSTD-Uncertainty index |
| Cells in OTDOA assistance data | | 16 cells in total | | The list includes the reference cell (received in <i>OTDOA-ReferenceCellInfo</i> [24]) and 15 other cells, all received in <i>OTDOA-ProvideAssistanceData</i> [24]. Cell 1 (when included) appears at random places in the first half of the neighbour cell list in the OTDOA assistance data. Cell 3 always appears at random places in the second half of the list. |
| | | OTDOA neighbor cells include Cell 3 and other 14 cells on SCC | OTDOA neighbor cells include Cell 1 and other 7 cells on PCC, and Cell 3 and other 6 cells on SCC | |
| prs-SubframeOffset | | Cells on PCC: 310 Cells on SCC, except reference cell: 0 | | Subframe offset, counted in full subframes. The corresponding parameter in the OTDOA assistance data is prs-SubframeOffset specified in TS 36.355 [24] |
| slotNumberOffset | | Cells on PCC: 0 Cells on SCC, except reference cell: 0 | | The slot number offset at the transmitter between a neighbour cell and the assistance data reference cell. The corresponding parameter in the OTDOA assistance data is slotNumberOffset specified in TS 36.355 [24]. |
| PRS muting info | | Cell 1: '11110000' Cell 2: '00001111' Cell 3: '11110000' | Cell 1: '1111111100000000' Cell 2: '0000000011111111' Cell 3: '1111111100000000' | Corresponds to prs-MutingInfo defined in TS 36.355 [24] |
| T1 | s | 3 | | The length of the time interval from the beginning of each test |
| T2 | s | 1.28 | 2.48 | The length of the time interval that follows immediately after time interval T1 |
| T3 | s | 1.28 | 2.48 | The length of the time interval that follows immediately after time interval T2 |

Table A.8.17.2.1-2: Cell-specific test parameters for E-UTRAN TDD RSTD measurement reporting delay under fading propagation conditions during T1 for carrier aggregation

| Parameter | Unit | Cell 1 | Cell 2 | Cell 3 |
|---|------------|-----------|-----------|-----------|
| E-UTRA RF Channel Number | | 1 | N/A | N/A |
| Correlation Matrix and Antenna Configuration | | 1x2 Low | 1x2 Low | 1x2 Low |
| OCNG patterns defined in A.3.2.2 | | OP.1 TDD | N/A | N/A |
| PBCH_RA | dB | 0 | N/A | N/A |
| PBCH_RB | | | | |
| PSS_RA | | | | |
| SSS_RA | | | | |
| PCFICH_RB | | | | |
| PHICH_RA | | | | |
| PHICH_RB | | | | |
| PDCCH_RA | | | | |
| PDCCH_RB | | | | |
| OCNG_RA ^{Note 1} | | | | |
| OCNG_RB ^{Note 1} | | | | |
| N_{oc} ^{Note 3} | dBm/15 kHz | -95 | N/A | N/A |
| $PR_S \hat{E}_s / N_{oc}$ | dB | -Infinity | -Infinity | -Infinity |
| I_o ^{Note 4} | dBm/9 MHz | -67.22 | N/A | N/A |
| \hat{E}_s / N_{oc} | dB | 0 | -Infinity | -Infinity |
| Propagation Condition | | ETU30 | | |
| <p>Note 1: OCNG shall be used such that active cell (Cell 1) is fully allocated and a constant total transmitted power spectral density is achieved for all OFDM symbols.</p> <p>Note 2: The resources for uplink transmission are assigned to the UE prior to the start of time period T2.</p> <p>Note 3: Interference from other cells and noise sources not specified in the test are assumed to be constant over subcarriers and time and shall be modelled as AWGN of appropriate power for N_{oc} to be fulfilled.</p> <p>Note 4: I_o levels have been derived from other parameters and are given for information purpose. These are not settable test parameters.</p> | | | | |

Table A.8.17.2.1-3: Cell-specific test parameters for E-UTRAN TDD RSTD measurement reporting delay under fading propagation conditions during T2 and T3 for carrier aggregation

| Parameter | Unit | Cell 1 | | Cell 2 | | Cell 3 | |
|--|------|----------|----|----------|----|----------|-----|
| | | T2 | T3 | T2 | T3 | T2 | T3 |
| E-UTRA RF Channel Number | | 1 | | 2 | | 2 | |
| Correlation Matrix and Antenna Configuration | | 1x2 Low | | 1x2 Low | | 1x2 Low | |
| OCNG patterns defined in A.3.2.2 | | OP.1 TDD | | OP.2 TDD | | OP.2 TDD | N/A |
| PBCH_RA | dB | 0 | 0 | 0 | 0 | 0 | N/A |
| PBCH_RB | | | | | | | |
| PSS_RA | | | | | | | |
| SSS_RA | | | | | | | |
| PCFICH_RB | | | | | | | |
| PHICH_RA | | | | | | | |
| PHICH_RB | | | | | | | |
| PDCCH_RA | | | | | | | |

| | | | | | | | |
|---|----------------|--------|-----------|-----------|--------|--------|-----------|
| PDCCH_RB | | | | | | | |
| OCNG_RA ^{Note 1} | | | | | | | |
| OCNG_RB ^{Note 1} | | | | | | | |
| PRS_RA | dB | -6 | N/A | N/A | 3 | 3 | N/A |
| N_{oc} ^{Note 3} | dBm/ 15 kHz | -98 | -98 | -98 | -95 | -98 | -95 |
| PRS \hat{E}_s/N_{oc} | dB | -4 | -Infinity | -Infinity | -1 | -8 | -Infinity |
| PRS \hat{E}_s/I_{ot} ^{Note 4} | dB | -4 | -Infinity | -Infinity | -1 | -8 | -Infinity |
| I_o ^{Note 4} | dBm/ 9 MHz | -69.94 | N/A | N/A | -66.68 | -70.11 | N/A |
| PRP ^{Note 4} | dBm/ 15 kHz | -102 | -Infinity | -Infinity | -96 | -106 | -Infinity |
| RSRP | dBm/ 15 kHz | -96 | -96 | -105 | -99 | -109 | -Infinity |
| \hat{E}_s/N_{oc} ^{Note 4} | dB | 2 | 2 | -7 | -4 | -11 | -Infinity |
| Propagation Condition | | ETU30 | | | | | |
| <p>Note 1: OCNG shall be used such that active cells (all, except Cell 3 in T3) are fully allocated and a constant total transmitted power spectral density is achieved for all OFDM symbols other than those in the subframes with transmitted PRS.</p> <p>Note 2: The resources for uplink transmission are assigned to the UE prior to the start of time period T2.</p> <p>Note 3: Interference from other cells and noise sources not specified in the test are assumed to be constant over subcarriers and time and shall be modelled as AWGN of appropriate power for N_{oc} to be fulfilled.</p> <p>Note 4: If PRS_RA is not "N/A", \hat{E}_s/N_{oc}, PRS \hat{E}_s/I_{ot}, I_o, RSRP and PRP levels have been derived from other parameters and are given for information purpose. If PRS_RA is "N/A", I_o and RSRP levels have been derived from other parameters and are given for information purpose. These are not settable test parameters. Interference conditions shall be applied to all PRS symbols of DL positioning subframes.</p> | | | | | | | |

Table A.8.17.2.1-4: DRX parameters for the test of E-UTRAN TDD intra-frequency RSTD measurement reporting delay under fading propagation conditions for carrier aggregation

| Field | Value | Comment |
|--------------------------|---------|--|
| onDurationTimer | psf1 | As specified in TS 36.331 [2], Clause 6.3.2 |
| Drx-InactivityTimer | psf1 | |
| drx-RetransmissionTimer | sf1 | |
| longDRX-CycleStartOffset | sf320 | |
| shortDRX | Disable | |

A.8.17.2.2 Test Requirements

The RSTD measurement time fulfils the requirements specified in Clause 8.4.

In Test 1, the UE shall perform and report the RSTD measurements from Cell 2 and Cell 3 within 2560 ms starting from the beginning of time interval T2.

In Test 2, the UE shall perform and report the RSTD measurements from Cell 1 and Cell 2, and RSTD measurements from Cell 2 and Cell 3 within 4960 ms starting from the beginning of time interval T2.

The rate of the correct events for each neighbour cell observed during repeated tests shall be at least 90%, where the reported RSTD measurement for each correct event shall be within the RSTD reporting range specified in Clause 9.1.10.3, i.e., between RSTD_0000 and RSTD_12711.

NOTE: The RSTD measurement times in the tests are derived from the following expression,

$$T_{PRS} (M - 1) + 160 \left\lceil \frac{n}{M} \right\rceil,$$

where $M = 8$ and $n = 16$ for Test 1, and $M = 16$ and $n = 16$ for Test 2. For Test 1, the M and n parameters specified in Clause 8.1.2.5.1, Table 8.1.2.5.1-1, under Note 1, which gives the total RSTD measurement time of 2560 ms for Cell 3 with respect to the reference cell Cell 2. For Test 2, the M and n parameters are specified in Clause 8.1.2.6.1, Table 8.1.2.6.1-1, under Note 1, which gives the total RSTD measurement time of 4960 ms for reporting the RSTD measurements of Cell 1 and Cell 3 with respect to the reference cell Cell 2.

A.8.17.3 E-UTRAN FDD RSTD Measurement Reporting Test Case for 20 MHz

A.8.17.3.1 Test Purpose and Environment

The purpose of this test is the same as defined in Subclause A.8.17.1.1.

The parameters of this test are the same as defined in Subclause A.8.17.1.1 except that the values of the parameters in Table A.8.17.3.1-1, Table A.8.17.3.1-2 and Table A.8.17.3.1-3 will replace the values of the corresponding parameters in Table A.8.17.1.1-1, Table A.8.17.1.1-2 and Table A.8.17.1.1-3, respectively.

Note: This test verifies the RRM requirement which is independent of channel bandwidth and is performed according to the principle defined in section A.3.6.1.

Table A.8.17.3.1-1: General test parameters for E-UTRAN FDD RSTD measurement reporting delay under fading propagation conditions for carrier aggregation

| Parameter | Unit | Value | | Comment |
|--|------|---|--------|---|
| | | Test 1 | Test 2 | |
| PCFICH/PDCCH/PHICH parameters | | DL Reference Measurement Channel R.10 FDD | | As specified in section A.3.1.2.1 |
| Channel Bandwidth ($BW_{channel}$) | MHz | 20 | | |
| PRS Transmission Bandwidth | RB | 100 | | PRS are transmitted over the system bandwidth |
| Note 1: See Table A.8.17.1.1-1 for the other parameters. | | | | |
| Note 2: This test verifies the RRM requirement which is independent of channel bandwidth and is performed according to the principle defined in section A.3.6.1. | | | | |

Table A.8.17.3.1-2: Cell-specific test parameters for E-UTRAN FDD RSTD measurement reporting delay under fading propagation conditions during T1 for carrier aggregation

| Parameter | Unit | Cell 1 | Cell 2 | Cell 3 |
|---|------------|-----------|--------|--------|
| OCNG patterns defined in A.3.2.1 | | OP.13 FDD | N/A | N/A |
| I_0 Note 1 | dBm/18 MHz | -64.21 | N/A | N/A |
| Note 1: I_0 levels have been derived from other parameters for information purposes. They are not settable parameters themselves. | | | | |
| Note 2: See Table A.8.17.1.1-2 for the other parameters. | | | | |

Table A.8.17.3.1-3: Cell-specific test parameters for E-UTRAN FDD RSTD measurement reporting delay under fading propagation conditions during T2 and T3 for carrier aggregation

| Parameter | Unit | Cell 1 | | Cell 2 | | Cell 3 | |
|----------------------------------|------|-----------|----|-----------|----|-----------|-----|
| | | T2 | T3 | T2 | T3 | T2 | T3 |
| OCNG patterns defined in A.3.2.1 | | OP.13 FDD | | OP.14 FDD | | OP.14 FDD | N/A |

| | | | | | | | |
|---|----------------|--------|-----|-----|--------|--------|-----|
| I_0 ^{Note 1} | dBm/ 18 MHz | -66.93 | N/A | N/A | -63.67 | -67.09 | N/A |
| Note 1: I_0 levels have been derived from other parameters for information purposes. They are not settable parameters themselves. | | | | | | | |
| Note 2: See Table A.8.17.1.1-3 for the other parameters. | | | | | | | |

A.8.17.3.2 Test Requirements

The test requirements defined in section A.8.17.1.2 shall apply in this test case.

A.8.17.4 E-UTRAN TDD RSTD Measurement Reporting Test Case for 20 MHz

A.8.17.4.1 Test Purpose and Environment

The purpose of this test is the same as defined in Subclause A.8.17.2.1.

The parameters of this test are the same as defined in Subclause A.8.17.2.1 except that the values of the parameters in Table A.8.17.4.1-1, Table A.8.17.4.1-2 and Table A.8.17.4.1-3 will replace the values of the corresponding parameters in Table A.8.17.2.1-1, Table A.8.17.2.1-2 and Table A.8.17.2.1-3, respectively.

Note: This test verifies the RRM requirement which is independent of channel bandwidth and is performed according to the principle defined in section A.3.6.1.

Table A.8.17.4.1-1: General test parameters for E-UTRAN TDD RSTD measurement reporting delay under fading propagation conditions for carrier aggregation

| Parameter | Unit | Value | | Comment |
|--|------|---|--------|---|
| | | Test 1 | Test 2 | |
| PCFICH/PDCCH/PHICH parameters | | DL Reference Measurement Channel R.10 TDD | | As specified in section A.3.1.2.2 |
| Channel Bandwidth (BW_{channel}) | MHz | 20 | | |
| PRS Transmission Bandwidth | RB | 100 | | PRS are transmitted over the system bandwidth |
| Note 1: See Table A.8.17.2.1-1 for the other parameters. | | | | |
| Note 2: This test verifies the RRM requirement which is independent of channel bandwidth and is performed according to the principle defined in section A.3.6.1. | | | | |

Table A.8.17.4.1-2: Cell-specific test parameters for E-UTRAN TDD RSTD measurement reporting delay under fading propagation conditions during T1 for carrier aggregation

| Parameter | Unit | Cell 1 | Cell 2 | Cell 3 |
|---|----------------|----------|--------|--------|
| OCNG patterns defined in A.3.2.2 | | OP.7 TDD | N/A | N/A |
| I_0 ^{Note 1} | dBm/ 18 MHz | -64.21 | N/A | N/A |
| Note 1: I_0 levels have been derived from other parameters for information purposes. They are not settable parameters themselves. | | | | |
| Note 2: See Table A.8.17.2.1-2 for the other parameters. | | | | |

Table A.8.17.4.1-3: Cell-specific test parameters for E-UTRAN TDD RSTD measurement reporting delay under fading propagation conditions during T2 and T3 for carrier aggregation

| Parameter | Unit | Cell 1 | | Cell 2 | | Cell 3 | |
|----------------------------------|------|----------|----|----------|----|----------|-----|
| | | T2 | T3 | T2 | T3 | T2 | T3 |
| OCNG patterns defined in A.3.2.2 | | OP.7 TDD | | OP.8 TDD | | OP.8 TDD | N/A |

| | | | | | | | |
|---|----------------|--------|-----|-----|--------|--------|-----|
| I_0 ^{Note 1} | dBm/ 18 MHz | -66.93 | N/A | N/A | -63.67 | -67.09 | N/A |
| Note 1: I_0 levels have been derived from other parameters for information purposes. They are not settable parameters themselves. | | | | | | | |
| Note 2: See Table A.8.17.2.1-3 for the other parameters. | | | | | | | |

A.8.17.4.2 Test Requirements

The test requirements defined in section A.8.17.2.2 shall apply in this test case.

A.8.17.5 E-UTRAN FDD RSTD Measurement Reporting Test Case for 10MHz+5MHz

A.8.17.5.1 Test Purpose and Environment

The purpose of this test is the same as defined in Subclause A.8.17.1.1.

The parameters of this test are the same as defined in Subclause A.8.17.1.1 except that the values of the parameters in Table A.8.17.5.1-1, Table A.8.17.5.1-2 and Table A.8.17.5.1-1 will replace the values of the corresponding parameters in Table A.8.17.1.1-1, Table A.8.17.1.1-2 and Table A.8.17.1.1-3, respectively.

Note: This test verifies the RRM requirement which is independent of channel bandwidth and is performed according to the principle defined in section A.3.6.1.

Table A.8.17.5.1-1: General test parameters for E-UTRAN FDD RSTD measurement reporting delay under fading propagation conditions for carrier aggregation

| Parameter | Unit | Value | | Comment |
|--|------|---|---|---|
| | | Test 1 | Test 2 | |
| PCFICH/PDCCH/PHICH parameters | | Cell 1: R.6 FDD Cell 2: R.11 FDD Cell 3: R.11 FDD | Cell 1: R.6 FDD Cell 2: R.11 FDD Cell 3: R.11 FDD | As specified in section A.3.1.2.1 |
| Channel Bandwidth (BW_{channel}) | MHz | Cell 1: 10 Cell 2: 5 Cell 3: 5 | Cell 1: 10 Cell 2: 5 Cell 3: 5 | |
| PRS Transmission Bandwidth | RB | Cell 1: 50 Cell 2: 25 Cell 3: 25 | Cell 1: 50 Cell 2: 25 Cell 3: 25 | PRS are transmitted over the system bandwidth |
| PRS occasion length N_{PRS} | | Cell 1: 1 Cell 2: 2 Cell 3: 2 | Cell 1: 1 Cell 2: 2 Cell 3: 2 | |
| Note 1: See Table A.8.17.1.1-1 for the other parameters. | | | | |
| Note 2: This test verifies the RRM requirement which is independent of channel bandwidth and is performed according to the principle defined in section A.3.6.1. | | | | |

Table A.8.17.5.1-2: Cell-specific test parameters for E-UTRAN FDD RSTD measurement reporting delay under fading propagation conditions during T1 for carrier aggregation

| Parameter | Unit | Cell 1 | Cell 2 | Cell 3 |
|---|----------------|--------|--------|--------|
| I_0 ^{Note 1} | dBm/ 9 MHz | -67.22 | N/A | N/A |
| | dBm/ 4.5MHz | N/A | N/A | N/A |
| Note 1: I_0 levels have been derived from other parameters for information purposes. They are not settable parameters themselves. | | | | |
| Note 2: See Table A.8.17.1.1-2 for the other parameters. | | | | |

Table A.8.17.5.1-3: Cell-specific test parameters for E-UTRAN FDD RSTD measurement reporting delay under fading propagation conditions during T2 and T3 for carrier aggregation

| Parameter | Unit | Cell 1 | | Cell 2 | | Cell 3 | |
|---|------------|----------|-----|-----------|--------|-----------|-----|
| | | T2 | T3 | T2 | T3 | T2 | T3 |
| OCNG patterns defined in A.3.2.1 | | OP.5 FDD | | OP.19 FDD | | OP.19 FDD | N/A |
| I_0 ^{Note 1} | dBm/9 MHz | -69.94 | N/A | N/A | N/A | N/A | N/A |
| | dBm/4.5MHz | N/A | N/A | N/A | -69.69 | -73.12 | N/A |
| Note 1: I_0 levels have been derived from other parameters for information purposes. They are not settable parameters themselves. | | | | | | | |
| Note 2: See Table A.8.17.1.1-3 for the other parameters. | | | | | | | |

A.8.17.5.2 Test Requirements

The test requirements defined in section A.8.17.1.2 shall apply in this test case.

A.8.17.6 E-UTRAN TDD RSTD Measurement Reporting Test Case for 10MHz+5MHz

A.8.17.6.1 Test Purpose and Environment

The purpose of this test is the same as defined in Subclause A.8.17.2.1.

The parameters of this test are the same as defined in Subclause A.8.17.2.1 except that the values of the parameters in Table A.8.17.6.1-1, Table A.8.17.6.1-2 and Table A.8.17.6.1-1 will replace the values of the corresponding parameters in Table A.8.17.2.1-1, Table A.8.17.2.1-2 and Table A.8.17.2.1-3, respectively.

Note: This test verifies the RRM requirement which is independent of channel bandwidth and is performed according to the principle defined in section A.3.6.1.

Table A.8.17.6.1-1: General test parameters for E-UTRAN TDD RSTD measurement reporting delay under fading propagation conditions for carrier aggregation

| Parameter | Unit | Value | | Comment |
|--|------|---|---|---|
| | | Test 1 | Test 2 | |
| PCFICH/PDCCH/PHICH parameters | | Cell 1: R.6 TDD Cell 2: R.11 TDD Cell 3: R.11 TDD | Cell 1: R.6 TDD Cell 2: R.11 TDD Cell 3: R.11 TDD | As specified in section A.3.1.2.2 |
| Channel Bandwidth ($BW_{channel}$) | MHz | Cell 1: 10 Cell 2: 5 Cell 3: 5 | Cell 1: 10 Cell 2: 5 Cell 3: 5 | |
| PRS Transmission Bandwidth | RB | Cell 1: 50 Cell 2: 25 Cell 3: 25 | Cell 1: 50 Cell 2: 25 Cell 3: 25 | PRS are transmitted over the system bandwidth |
| PRS occasion length N_{PRS} | | Cell 1: 1 Cell 2: 2 Cell 3: 2 | Cell 1: 1 Cell 2: 2 Cell 3: 2 | |
| Note 1: See Table A.8.17.2.1-1 for the other parameters. | | | | |
| Note 2: This test verifies the RRM requirement which is independent of channel bandwidth and is performed according to the principle defined in section A.3.6.1. | | | | |

Table A.8.17.6.1-2: Cell-specific test parameters for E-UTRAN TDD RSTD measurement reporting delay under fading propagation conditions during T1 for carrier aggregation

| Parameter | Unit | Cell 1 | Cell 2 | Cell 3 |
|-------------------------|-----------|--------|--------|--------|
| I_0 ^{Note 1} | dBm/9 MHz | -67.22 | N/A | N/A |

| | | | | |
|---------|--|-----|-----|-----|
| | dBm/ 4.5MHz | N/A | N/A | N/A |
| Note 1: | Io levels have been derived from other parameters for information purposes. They are not settable parameters themselves. | | | |
| Note 2: | See Table A.8.17.1.1-2 for the other parameters. | | | |

Table A.8.17.6.1-3: Cell-specific test parameters for E-UTRAN TDD RSTD measurement reporting delay under fading propagation conditions during T2 and T3 for carrier aggregation

| Parameter | Unit | Cell 1 | | Cell 2 | | Cell 3 | |
|----------------------------------|--|----------|-----|-----------|--------|-----------|-----|
| | | T2 | T3 | T2 | T3 | T2 | T3 |
| OCNG patterns defined in A.3.2.1 | | OP.1 TDD | | OP.10 TDD | | OP.10 TDD | N/A |
| Io ^{Note 1} | dBm/ 9 MHz | -69.94 | N/A | N/A | N/A | N/A | N/A |
| | dBm/ 4.5MHz | N/A | N/A | N/A | -69.69 | -73.12 | N/A |
| Note 1: | Io levels have been derived from other parameters for information purposes. They are not settable parameters themselves. | | | | | | |
| Note 2: | See Table A.8.17.1.1-3 for the other parameters. | | | | | | |

A.8.17.6.2 Test Requirements

The test requirements defined in section A.8.17.2.2 shall apply in this test case.

A.8.17.7 E-UTRAN FDD RSTD Measurement Reporting Test Case for 5 + 5 MHz Bandwidth

A.8.17.7.1 Test Purpose and Environment

The purpose of this test is the same as defined in Subclause A.8.17.1.1.

The parameters of this test are the same as defined in Subclause A.8.17.1.1 except that the values of the parameters in Table A.8.17.7.1-1, Table A.8.17.7.1-2 and Table A.8.17.7.1-1 will replace the values of the corresponding parameters in Table A.8.17.1.1-1, Table A.8.17.1.1-2 and Table A.8.17.1.1-3, respectively.

Note: This test verifies the RRM requirement which is independent of channel bandwidth and is performed according to the principle defined in section A.3.6.1.

Table A.8.17.7.1-1: General test parameters for E-UTRAN FDD RSTD measurement reporting delay under fading propagation conditions for carrier aggregation

| Parameter | Unit | Value | | Comment |
|--|--|---|--------|---|
| | | Test 1 | Test 2 | |
| PCFICH/PDCCH/PHICH parameters | | DL Reference Measurement Channel R.11 FDD | | As specified in section A.3.1.2.1 |
| Channel Bandwidth (BW _{channel}) | MHz | 5 | | |
| PRS Transmission Bandwidth | RB | 25 | | PRS are transmitted over the system bandwidth |
| PRS occasion length N_{PRS} | | 2 | | |
| Note 1: | See Table A.8.17.1.1-1 for the other parameters. | | | |
| Note 2: | This test verifies the RRM requirement which is independent of channel bandwidth and is performed according to the principle defined in section A.3.6.1. | | | |

Table A.8.17.7.1-2: Cell-specific test parameters for E-UTRAN FDD RSTD measurement reporting delay under fading propagation conditions during T1 for carrier aggregation

| Parameter | Unit | Cell 1 | Cell 2 | Cell 3 |
|---|--------------------|-----------|--------|--------|
| OCNG patterns defined in A.3.2.1 | | OP.18 FDD | N/A | N/A |
| I_o ^{Note 1} | dBm/ 4.5 MHz | -70.23 | N/A | N/A |
| Note 1: I_o levels have been derived from other parameters for information purposes. They are not settable parameters themselves. | | | | |
| Note 2: See Table A.8.17.1.1-2 for the other parameters. | | | | |

Table A.8.17.7.1-3: Cell-specific test parameters for E-UTRAN FDD RSTD measurement reporting delay under fading propagation conditions during T2 and T3 for carrier aggregation

| Parameter | Unit | Cell 1 | | Cell 2 | | Cell 3 | |
|---|--------------------|-----------|-----|-----------|--------|-----------|-----|
| | | T2 | T3 | T2 | T3 | T2 | T3 |
| OCNG patterns defined in A.3.2.1 | | OP.18 FDD | | OP.19 FDD | | OP.19 FDD | N/A |
| I_o ^{Note 1} | dBm/ 4.5 MHz | -72.95 | N/A | N/A | -69.69 | -73.12 | N/A |
| Note 1: I_o levels have been derived from other parameters for information purposes. They are not settable parameters themselves. | | | | | | | |
| Note 2: See Table A.8.17.1.1-3 for the other parameters. | | | | | | | |

A.8.17.7.2 Test Requirements

The test requirements defined in section A.8.17.1.2 shall apply in this test case.

A.8.17.8 E-UTRAN TDD RSTD Measurement Reporting Test Case for 5+5 MHz bandwidth

A.8.17.8.1 Test Purpose and Environment

The purpose of this test is the same as defined in Subclause A.8.17.2.1.

The parameters of this test are the same as defined in Subclause A.8.17.2.1 except that the values of the parameters in Table A.8.17.8.1-1, Table A.8.17.8.1-2 and Table A.8.17.8.1-1 will replace the values of the corresponding parameters in Table A.8.17.2.1-1, Table A.8.17.2.1-2 and Table A.8.17.2.1-3, respectively.

Note: This test verifies the RRM requirement which is independent of channel bandwidth and is performed according to the principle defined in section A.3.6.1.

Table A.8.17.8.1-1: General test parameters for E-UTRAN TDD RSTD measurement reporting delay under fading propagation conditions for carrier aggregation

| Parameter | Unit | Value | | Comment |
|--------------------------------------|------|---|--------|---|
| | | Test 1 | Test 2 | |
| PCFICH/PDCCH/PHICH parameters | | DL Reference Measurement Channel R.11 TDD | | As specified in section A.3.1.2.1 |
| Channel Bandwidth ($BW_{channel}$) | MHz | 5 | | |
| PRS Transmission Bandwidth | RB | 25 | | PRS are transmitted over the system bandwidth |
| PRS occasion length N_{PRS} | | 2 | | |

Note 1: See Table A.8.17.2.1-1 for the other parameters.
 Note 2: This test verifies the RRM requirement which is independent of channel bandwidth and is performed according to the principle defined in section A.3.6.1.

Table A.8.17.8.1-2: Cell-specific test parameters for E-UTRAN TDD RSTD measurement reporting delay under fading propagation conditions during T1 for carrier aggregation

| Parameter | Unit | Cell 1 | Cell 2 | Cell 3 |
|---|--------------------|----------|--------|--------|
| OCNG patterns defined in A.3.2.1 | | OP.9 TDD | N/A | N/A |
| I_0 ^{Note 1} | dBm/ 4.5 MHz | -70.23 | N/A | N/A |
| Note 1: I_0 levels have been derived from other parameters for information purposes. They are not settable parameters themselves. | | | | |
| Note 2: See Table A.8.17.2.1-2 for the other parameters. | | | | |

Table A.8.17.8.1-3: Cell-specific test parameters for E-UTRAN TDD RSTD measurement reporting delay under fading propagation conditions during T2 and T3 for carrier aggregation

| Parameter | Unit | Cell 1 | | Cell 2 | | Cell 3 | |
|---|--------------------|----------|-----|-----------|--------|-----------|-----|
| | | T2 | T3 | T2 | T3 | T2 | T3 |
| OCNG patterns defined in A.3.2.1 | | OP.9 TDD | | OP.10 TDD | | OP.10 TDD | N/A |
| I_0 ^{Note 1} | dBm/ 4.5 MHz | -72.95 | N/A | N/A | -69.69 | -73.12 | N/A |
| Note 1: I_0 levels have been derived from other parameters for information purposes. They are not settable parameters themselves. | | | | | | | |
| Note 2: See Table A.8.17.2.1-3 for the other parameters. | | | | | | | |

A.8.17.8.2 Test Requirements

The test requirements defined in section A.8.17.2.2 shall apply in this test case.

A.8.17.9 E-UTRAN TDD RSTD Measurement Reporting Test Case for 20MHz+10MHz

A.8.17.9.1 Test Purpose and Environment

The purpose of this test is the same as defined in Subclause A.8.17.2.1.

The parameters of this test are the same as defined in Subclause A.8.17.2.1 except that the values of the parameters in Table A.8.17.9.1-1, Table A.8.17.9.1-2 and Table A.8.17.9.1-1 will replace the values of the corresponding parameters in Table A.8.17.2.1-1, Table A.8.17.2.1-2 and Table A.8.17.2.1-3, respectively.

Note: This test verifies the RRM requirement which is independent of channel bandwidth and is performed according to the principle defined in section A.3.6.1.

Table A.8.17.9.1-1: General test parameters for E-UTRAN TDD RSTD measurement reporting delay under fading propagation conditions for carrier aggregation

| Parameter | Unit | Value | | Comment |
|-------------------------------|------|--|--|-----------------------------------|
| | | Test 1 | Test 2 | |
| PCFICH/PDCCH/PHICH parameters | | Cell 1: R.10 TDD Cell 2: R.6 TDD Cell 3: R.6 TDD | Cell 1: R.10 TDD Cell 2: R.6 TDD Cell 3: R.6 TDD | As specified in section A.3.1.2.2 |

| | | | | |
|--|-----|---|---|--|
| Channel Bandwidth (BW_{channel}) | MHz | Cell 1: 20 Cell 2: 10 Cell 3: 10 | Cell 1: 20 Cell 2: 10 Cell 3: 10 | |
| PRS Transmission Bandwidth | RB | Cell 1: 100 Cell 2: 50 Cell 3: 50 | Cell 1: 100 Cell 2: 50 Cell 3: 50 | PRS are transmitted over the system bandwidth |
| Note 1: See Table A.8.17.2.1-1 for the other parameters. | | | | |
| Note 2: This test verifies the RRM requirement which is independent of channel bandwidth and is performed according to the principle defined in section A.3.6.1. | | | | |

Table A.8.17.9.1-2: Cell-specific test parameters for E-UTRAN TDD RSTD measurement reporting delay under fading propagation conditions during T1 for carrier aggregation

| Parameter | Unit | Cell 1 | Cell 2 | Cell 3 |
|---|----------------|--------|--------|--------|
| I_0 Note 1 | dBm/ 18 MHz | -64.21 | N/A | N/A |
| | dBm/ 9 MHz | N/A | N/A | N/A |
| Note 1: I_0 levels have been derived from other parameters for information purposes. They are not settable parameters themselves. | | | | |
| Note 2: See Table A.8.17.1.1-2 for the other parameters. | | | | |

Table A.8.17.9.1-3: Cell-specific test parameters for E-UTRAN TDD RSTD measurement reporting delay under fading propagation conditions during T2 and T3 for carrier aggregation

| Parameter | Unit | Cell 1 | | Cell 2 | | Cell 3 | |
|---|----------------|----------|-----|----------|--------|-------------|-----|
| | | T2 | T3 | T2 | T3 | T2 | T3 |
| OCNG patterns defined in A.3.2.1 | | OP.7 TDD | | OP.2 TDD | | OP.2 TDD | N/A |
| I_0 Note 1 | dBm/ 18 MHz | -66.93 | N/A | N/A | N/A | N/A | N/A |
| | dBm/ 9MHz | N/A | N/A | N/A | -66.68 | -70.11 | N/A |
| Note 1: I_0 levels have been derived from other parameters for information purposes. They are not settable parameters themselves. | | | | | | | |
| Note 2: See Table A.8.17.1.1-3 for the other parameters. | | | | | | | |

A.8.17.9.2 Test Requirements

The test requirements defined in section A.8.17.2.2 shall apply in this test case.

A.8.17.10 E-UTRAN 3 DL FDD CA RSTD Measurement Reporting Delay Test Case

A.8.17.10.1 Test Purpose and Environment

The purpose of the test case is to verify that the RSTD measurements meet the requirements specified in Clause 8.4 in a synchronized network environment with fading propagation conditions. This test case will verify the measurement period requirements specified in Clause 8.4.3 for RSTD measurements performed on the same secondary component carrier, the measurement period requirements for RSTD measurements performed on both the primary and secondary component carriers specified in Clause 8.4.4, and also the measurement period requirements for RSTD measurements performed on different secondary component carriers specified in Clause 8.4.5.

In the tests, there are three configured component carriers: PCC, SCC1 and SCC2, and four synchronous cells: Cell 1, Cell 2, Cell 3 and Cell 4. Cell 1 is PCell on the PCC, Cell 2 is SCell on the SCC1, Cell 3 is SCell on the SCC2 and Cell 4 is a neighbour cell on the SCC2. In all tests, Cell 3 is the OTDOA assistance data reference cell.

The test case includes two tests. Test 1 is designed for the scenario where the UE receives OTDOA assistance data with cells only on SCC2, and the UE is expected to report RSTD measurements performed on SCC2 only. Test 2 is designed

for the scenario where the UE receives OTDOA assistance data with cells on PCC, SCC1 and SCC2, and the UE is expected to report RSTD measurements performed on PCC, SCC1 and SCC2.

Each test consists of three consecutive time intervals, with duration of T1, T2 and T3. Cell 1 is active in T1, T2 and T3, Cell 2 is active only in T2 and T3, Cell 3 is active only during T2 and T3, and Cell 4 is active only during T2. The beginning of the time interval T2 shall be aligned with the first PRS positioning subframe of a positioning occasion in the OTDOA assistance data reference cell, where the PRS positioning occasion is as defined in Clause 8.1.2.5.1. Cell 1 transmits PRS in T2, Cell 2 transmits PRS only in T3, and Cell 3 transmits PRS only in T3, and Cell 4 transmits PRS only in T2.

Note: The information on when PRS is muted is conveyed to the UE using PRS muting information.

The OTDOA assistance data as defined in TS 36.355, Clause 6.5.1.1, shall be provided to the UE during T1. The last TTI containing the OTDOA assistance data shall be provided to the UE ΔT ms before the start of T2, where $\Delta T = 150$ ms is the maximum processing time of the OTDOA assistance data.

The test parameters are as given in Table A.8.17.10.1-1, Table A.8.17.10.1-2, Table A.8.17.10.1-3 and Table A.8.17.10.1-4.

Table A.8.17.10.1-1: General test parameters for E-UTRAN FDD RSTD measurement reporting delay under fading propagation conditions for carrier aggregation

| Parameter | Unit | Value | | Comment |
|---|---------------|--|--|---|
| | | Test 1 | Test 2 | |
| PCell | | Cell 1 | | PCell is on RF channel 1 (PCC). |
| SCell 1 | | Cell 2 | | SCell 1 on RF channel 2 (SCC1). |
| SCell 2 | | Cell 3 | | SCell 2 on RF channel 3 (SCC2). Cell 3 is the assistance data reference cell. |
| Other neighbor cell | | Cell 4 | | Neighbor cell on RF channel 3 (SCC2). |
| PRS configuration index I_{PRS} | | 171 for all cells on PCC 181 for all cells on SCC1 191 for all cells on SCC2 | | This corresponds to periodicity of 320 ms and PRS subframe offset of $I_{PRS} - 160$ DL subframes, as defined in TS 36.211 [16], Table 6.10.4.3-1 |
| Physical cell ID PCI | | $(\text{PCI of Cell 3} - \text{PCI of Cell 4}) \bmod 6 = 0$ | | The PCIs of Cell 1 and Cell 2 are selected randomly. PCIs of Cell 3 and Cell 4 are selected randomly such that the relative subcarrier shifts of PRS patterns among these cells are as given by the condition |
| CP length | | Normal | | |
| DRX | | ON | | DRX parameters are further specified in Table A.8.17.10.1-3 |
| Radio frame receive time offset between the cells at the UE antenna connector | μs | Cell 1 to Cell 3: 1 Cell 2 to Cell 3: -1 Cell 4 to Cell 3: 3 | | PRS are transmitted from synchronous cells |
| Time alignment errors between cell1, cell2 and cell3 | μs | \leq Time alignment error as specified in 3GPP TS 36.104 [30] clause 6.5.3.1. | | The value of time alignment error depends upon the type of carrier aggregation. |
| Expected RSTD | μs | Cell 4: 2 Other neighbour cells: randomly between -3 and 3 | Cell 1: -2 Cell 2: 0 Cell 4: 2 Other neighbour cells: randomly between -3 and 3 | The expected RSTD is what is expected at the receiver. The corresponding parameter in the OTDOA assistance data specified in TS 36.355 [24] is the expectedRSTD indicator |
| Expected RSTD uncertainty for all neighbour cells | μs | 5 | | The corresponding parameter in the OTDOA assistance data specified in TS 36.355 [24] is the expectedRSTD-Uncertainty index |

| | | | | |
|--------------------------------|---|--|---|--|
| Cells in OTDOA assistance data | | 16 cells in total | | The list includes the reference cell (received in <i>OTDOA-ReferenceCellInfo</i> [24]) and 15 other cells, all received in <i>OTDOA-ProvideAssistanceData</i> [24]. Cell 1 and Cell 2 (when included) appears at random places in the first half of the neighbour cell list in the OTDOA assistance data. Cell 4 always appears at random places in the second half of the list. |
| | | OTDOA neighbor cells include Cell 4 and other 14 cells on SCC2 | OTDOA neighbor cells include Cell 1 and other 3 cells on PCC, Cell 2 and other 3 cells on SCC1 and Cell 4 and other 6 cells on SCC2 | |
| 'prs-SubframeOffset | | Cells on PCC: 300 Cells on SCC1: 310 Cells on SCC2, except reference cell: 0 | | Subframe offset, counted in full subframes. The corresponding parameter in the OTDOA assistance data is prs-SubframeOffset specified in TS 36.355 [24] |
| slotNumberOffset | | Cells on PCC: 0 Cells on SCC1: 0 Cells on SCC2, except reference cell: 0 | | The slot number offset at the transmitter between a neighbour cell and the assistance data reference cell. The corresponding parameter in the OTDOA assistance data is slotNumberOffset specified in TS 36.355 [24]. |
| PRS muting info | | Cell 1: '11110000' Cell 2: '00001111' Cell 3: '11110000' Cell 4: '00001111' | Cell 1: '1111111100000000' Cell 2: '0000000011111111' Cell 3: '1111111100000000' Cell 4: 0000000011111111' | Corresponds to prs-MutingInfo defined in TS 36.355 [24] |
| T1 | s | 3 | | The length of the time interval from the beginning of each test |
| T2 | s | 1.28 | 2.48 | The length of the time interval that follows immediately after time interval T1 |
| T3 | s | 1.28 | 2.48 | The length of the time interval that follows immediately after time interval T2 |

Table A.8.17.10.1-2: Cell-specific test parameters for E-UTRAN FDD RSTD measurement reporting delay under fading propagation conditions during T1 for carrier aggregation

| Parameter | Unit | Cell 1 | Cell 2 | Cell 3 | Cell 4 |
|--|------|---|---------|---------|---------|
| E-UTRA RF Channel Number | | 1 | N/A | N/A | N/A |
| Channel Bandwidth (BW _{channel}) | MHz | 5,10,20 | N/A | N/A | N/A |
| Correlation Matrix and Antenna Configuration | | 1x2 Low | 1x2 Low | 1x2 Low | 1x2 Low |
| PCFICH/PDCCH/PHICH parameters as specified in clause A.3.1.2.1 | | 5MHz: R.11 FDD 10MHz: R.6 FDD 20MHz: R.10 FDD | N/A | N/A | N/A |

| | | | | | |
|---|----------------|--|-----------|-----------|-----------|
| OCNG patterns defined in A.3.2.1 | | 5MHz: OP.18 FDD 10MHz: OP.5 FDD 20MHz: OP.13 FDD | N/A | N/A | N/A |
| PBCH_RA | dB | 0 | N/A | N/A | N/A |
| PBCH_RB | | | | | |
| PSS_RA | | | | | |
| SSS_RA | | | | | |
| PCFICH_RB | | | | | |
| PHICH_RA | | | | | |
| PHICH_RB | | | | | |
| PDCCH_RA | | | | | |
| PDCCH_RB | | | | | |
| OCNG_RA ^{Note 1} | | | | | |
| OCNG_RB ^{Note 1} | | | | | |
| N_{oc} ^{Note 3} | dBm/ 15 kHz | -95 | N/A | N/A | N/A |
| PRS \hat{E}_s/N_{oc} | dB | -Infinity | -Infinity | -Infinity | -Infinity |
| I_o ^{Note 4} | dBm/ 9 MHz | -67.22 +10log ($N_{RB,c}/50$) | N/A | N/A | N/A |
| \hat{E}_s/N_{oc} | dB | 0 | -Infinity | -Infinity | -Infinity |
| Propagation Condition | | ETU30 | | | |
| <p>Note 1: OCNG shall be used such that active cell (Cell 1) is fully allocated and a constant total transmitted power spectral density is achieved for all OFDM symbols.</p> <p>Note 2: The resources for uplink transmission are assigned to the UE prior to the start of time period T2.</p> <p>Note 3: Interference from other cells and noise sources not specified in the test are assumed to be constant over subcarriers and time and shall be modelled as AWGN of appropriate power for N_{oc} to be fulfilled.</p> <p>Note 4: I_o levels have been derived from other parameters and are given for information purpose. These are not settable test parameters.</p> | | | | | |

Table A.8.17.10.1-3: Cell-specific test parameters for E-UTRAN FDD RSTD measurement reporting delay under fading propagation conditions during T2 and T3 for carrier aggregation

| Parameter | Unit | Cell 1 | | Cell 2 | | Cell 3 | | Cell 4 | |
|---|------|--|----|--|----|--|----|--|-----|
| | | T2 | T3 | T2 | T3 | T2 | T3 | T2 | T3 |
| E-UTRA RF Channel Number | | 1 | | 2 | | 3 | | 3 | |
| Channel Bandwidth ($BW_{channel}$) | MHz | 5,10,20 | | 5,10,20 | | 5,10,20 | | 5,10,20 | |
| Correlation Matrix and Antenna Configuration | | 1x2 Low | | 1x2 Low | | 1x2 Low | | 1x2 Low | |
| PCFICH/PDCCH/PHICH parameters as specified in clause A.3.1.2.1 | | 5MHz: R.11 FDD 10MHz: R.6 FDD 20MHz: R.10 FDD | | 5MHz: R.11 FDD 10MHz: R.6 FDD 20MHz: R.10 FDD | | 5MHz: R.11 FDD 10MHz: R.6 FDD 20MHz: R.10 FDD | | 5MHz: R.11 FDD 10MHz: R.6 FDD 20MHz: R.10 FDD | N/A |
| OCNG patterns defined in A.3.2.1 (There is no PDSCH allocated in the subframe transmitting PRS) | | 5MHz: OP.18 FDD 10MHz: OP.5 FDD 20MHz: OP.13 FDD | | 5MHz: OP.19 FDD 10MHz: OP.6 FDD 20MHz: OP.14 FDD | | 5MHz: OP.19 FDD 10MHz: OP.6 FDD 20MHz: OP.14 FDD | | 5MHz: OP.19 FDD 10MHz: OP.6 FDD 20MHz: OP.14 FDD | N/A |

| | | | | | | | | | |
|---|-------------------|--|------------------------------------|------------------------------------|--|------------------------------------|--|--|-----|
| PRS Transmission Bandwidth (PRS transmission bandwidth depends on selected channel bandwidth. PRS are transmitted over the system bandwidth) | RB | 5MHz: 25 10MHz: 50 20MHz:100 | 5MHz: 25 10MHz: 50 20MHz:100 | 5MHz: 25 10MHz: 50 20MHz:100 | 5MHz: 25 10MHz: 50 20MHz:100 | 5MHz: 25 10MHz: 50 20MHz:100 | N/A | | |
| Number of consecutive downlink positioning subframes N_{PRS} . N_{PRS} also depends on selected channel bandwidth. As defined in TS 36.211 [16]. The number of subframes in a positioning occasion | | 5MHz: 2 10MHz: 1 20MHz:1 | 5MHz: 2 10MHz: 1 20MHz:1 | 5MHz: 2 10MHz: 1 20MHz:1 | 5MHz: 2 10MHz: 1 20MHz:1 | 5MHz: 2 10MHz: 1 20MHz:1 | N/A | | |
| PBCH_RA | dB | 0 | 0 | 0 | 0 | 0 | N/A | | |
| PBCH_RB | | | | | | | | | |
| PSS_RA | | | | | | | | | |
| SSS_RA | | | | | | | | | |
| PCFICH_RB | | | | | | | | | |
| PHICH_RA | | | | | | | | | |
| PHICH_RB | | | | | | | | | |
| PDCCH_RA | | | | | | | | | |
| PDCCH_RB | | | | | | | | | |
| OCNG_RA ^{Note 1} | | | | | | | | | |
| OCNG_RB ^{Note 1} | | | | | | | | | |
| PRS_RA | dB | -6 | N/A | N/A | 3 | N/A | 3 | 3 | N/A |
| N_{oc} ^{Note 3} | dBm/ 15 kHz | -98 | -98 | -98 | -95 | -98 | -95 | -98 | -95 |
| PRS \hat{E}_s/N_{oc} | dB | -4 | - | - | -1 | - | -1 | -8 | - |
| PRS \hat{E}_s/I_{ot} ^{Note 4} | dB | -4 | - | - | -1 | - | -1 | -8 | - |
| I_o ^{Note 4} | dBm/ 9 MHz | -69.94 +10log ($N_{RB,c}$ /50) | N/A | N/A | -66.68 +10log ($N_{RB,c}$ /50) | N/A | -66.68 +10log ($N_{RB,c}$ /50) | -70.11 +10log ($N_{RB,c}$ /50) | N/A |
| PRP ^{Note 4} | dBm/ 15 kHz | -102 | - | - | -96 | - | -96 | -106 | - |
| RSRP ^{Note 4} | dBm/ 15 kHz | -96 | -96 | -105 | -99 | -105 | -99 | -109 | - |
| \hat{E}_s/N_{oc} ^{Note 4} | dB | 2 | 2 | -7 | -4 | -7 | -4 | -11 | - |
| Propagation Condition | | ETU30 | | | | | | | |
| <p>Note 1: OCNG shall be used such that active cells (all, except Cell 3 in T3) are fully allocated and a constant total transmitted power spectral density is achieved for all OFDM symbols other than those in the subframes with transmitted PRS.</p> <p>Note 2: The resources for uplink transmission are assigned to the UE prior to the start of time period T2.</p> <p>Note 3: Interference from other cells and noise sources not specified in the test are assumed to be constant over subcarriers and time and shall be modelled as AWGN of appropriate power for N_{oc} to be fulfilled.</p> <p>Note 4: If PRS_RA is not "N/A", \hat{E}_s/N_{oc}, PRS \hat{E}_s/I_{ot}, I_o, RSRP and PRP levels have been derived from other parameters and are given for information purpose. If PRS_RA is "N/A", I_o and RSRP levels have been derived from other parameters and are given for information purpose. These are not settable test parameters. Interference conditions shall be applied to all PRS symbols of DL positioning subframes.</p> | | | | | | | | | |

Table A.8.17.10.1-4: DRX parameters for the test of E-UTRAN FDD intra-frequency RSTD measurement reporting delay under fading propagation conditions for carrier aggregation

| Field | Value | Comment |
|--------------------------|---------|---|
| onDurationTimer | psf1 | As specified in TS 36.331 [2], Clause 6.3.2 |
| Drx-InactivityTimer | psf1 | |
| drx-RetransmissionTimer | sf1 | |
| longDRX-CycleStartOffset | sf320 | |
| shortDRX | Disable | |

A.8.17.10.2 Test Requirements

The RSTD measurement time fulfils the requirements specified in Clause 8.4.

In Test 1, the UE shall perform and report the RSTD measurements from Cell 4 and Cell 3 within 2560 ms starting from the beginning of time interval T2.

In Test 2, the UE shall perform and report the RSTD measurements from Cell 1 and Cell 3, RSTD measurements from Cell 2 and Cell 3, and RSTD measurements from Cell 4 and Cell 3 within 4960 ms starting from the beginning of time interval T2.

The rate of the correct events for each neighbour cell observed during repeated tests shall be at least 90%, where the reported RSTD measurement for each correct event shall be within the RSTD reporting range specified in Clause 9.1.10.3, i.e., between RSTD_0000 and RSTD_12711.

NOTE: The RSTD measurement times in the tests are derived from the following expression,

$$T_{PRS} (M - 1) + 160 \left\lceil \frac{n}{M} \right\rceil,$$

where $M=8$ and $n=16$ for Test 1, and $M=16$ and $n=16$ for Test 2. For Test 1, the M and n parameters specified in Clause 8.1.2.5.1, Table 8.1.2.5.1-1, under Note 1, which gives the total RSTD measurement time of 2560 ms for Cell 4 with respect to the reference cell Cell 3. For Test 2, the M and n parameters are specified in Clause 8.1.2.6.1, Table 8.1.2.6.1-1, under Note 1, which gives the total RSTD measurement time of 4960 ms for reporting the RSTD measurements of Cell 1, Cell 2 and Cell 4 with respect to the reference cell Cell 3.

A.8.17.11 E-UTRAN 3 DL TDD CA RSTD Measurement Reporting Delay Test Case

A.8.17.11.1 Test Purpose and Environment

The purpose of the test case is to verify that the RSTD measurements meet the requirements specified in Clause 8.4 in a synchronized network environment with fading propagation conditions. This test case will verify the measurement period requirements specified in Clause 8.4.3 for RSTD measurements performed on the same secondary component carrier, the measurement period requirements for RSTD measurements performed on both the primary and secondary component carriers specified in Clause 8.4.4, and also the measurement period requirements for RSTD measurements performed on different secondary component carriers specified in Clause 8.4.5.

In the tests, there are three configured component carriers: PCC, SCC1 and SCC2, and four synchronous cells: Cell 1, Cell 2, Cell 3 and Cell 4. Cell 1 is PCell on the PCC, Cell 2 is SCell on the SCC1, Cell 3 is SCell on the SCC2 and Cell 4 is a neighbour cell on the SCC2. In all tests, Cell 3 is the OTDOA assistance data reference cell.

The test case includes two tests. Test 1 is designed for the scenario where the UE receives OTDOA assistance data with cells only on SCC2, and the UE is expected to report RSTD measurements performed on SCC2 only. Test 2 is designed for the scenario where the UE receives OTDOA assistance data with cells on PCC, SCC1 and SCC2, and the UE is expected to report RSTD measurements performed on PCC, SCC1 and SCC2.

Each test consists of three consecutive time intervals, with duration of T1, T2 and T3. Cell 1 is active in T1, T2 and T3, Cell 2 is active only in T2 and T3, Cell 3 is active only during T2 and T3, and Cell 4 is active only during T2. The beginning of the time interval T2 shall be aligned with the first PRS positioning subframe of a positioning occasion in the OTDOA assistance data reference cell, where the PRS positioning occasion is as defined in Clause 8.1.2.5.1. Cell 1 transmits PRS in T2, Cell 2 transmits PRS only in T3, and Cell 3 transmits PRS only in T3, and Cell 4 transmits PRS only in T2.

Note: The information on when PRS is muted is conveyed to the UE using PRS muting information.

The OTDOA assistance data as defined in TS 36.355, Clause 6.5.1.1, shall be provided to the UE during T1. The last TTI containing the OTDOA assistance data shall be provided to the UE ΔT ms before the start of T2, where $\Delta T = 150$ ms is the maximum processing time of the OTDOA assistance data.

The test parameters are as given in Table A.8.17.11.1-1, Table A.8.17.11.1-2, Table A.8.17.11.1-3 and Table A.8.17.11.1-4.

Table A.8.17.11.1-1: General test parameters for E-UTRAN TDD RSTD measurement reporting delay under fading propagation conditions for carrier aggregation

| Parameter | Unit | Value | | Comment |
|---|---------------|--|--------|---|
| | | Test 1 | Test 2 | |
| PCell | | Cell 1 | | PCell is on RF channel 1 (PCC). |
| SCell 1 | | Cell 2 | | SCell 1 on RF channel 2 (SCC1). |
| SCell 2 | | Cell 3 | | SCell 2 on RF channel 3 (SCC2). Cell 3 is the assistance data reference cell. |
| Other neighbor cell | | Cell 4 | | Neighbor cell on RF channel 3 (SCC2). |
| Channel Bandwidth (BW_{channel}) | MHz | 5MHz or 10MHz or 20MHz | | All channels in a test have the same bandwidth. |
| PRS configuration index I_{PRS} | | 174 for all cells on PCC 184 for all cells on SCC1 194 for all cells on SCC2 | | This corresponds to periodicity of 320 ms and PRS subframe offset of $I_{\text{PRS}} - 160$ DL subframes, as defined in TS 36.211 [16], Table 6.10.4.3-1 |
| Physical cell ID PCI | | $(\text{PCI of Cell 3} - \text{PCI of Cell 4}) \bmod 6 = 0$ | | The PCIs of Cell 1 and Cell 2 are selected randomly. PCIs of Cell 3 and Cell 4 are selected randomly such that the relative subcarrier shifts of PRS patterns among these cells are as given by the condition |
| TDD uplink-downlink configuration | | 1 | | As specified in TS 36.211 [16], Clause 4.2; corresponds to a configuration with 5 ms switch-point periodicity and two downlink consecutive subframes |
| TDD special subframe configuration | | 6 | | As specified in TS 36.211 [16], Clause 4.2; corresponds to DwPTS of $19760 \cdot T_s$ and UpPTS of $4384 \cdot T_s$ |
| CP length | | Normal | | |
| DRX | | ON | | DRX parameters are further specified in Table A.8.17.11.1-3 |
| Radio frame receive time offset between the cells at the UE antenna connector | μs | Cell 1 to Cell 3: 1 Cell 2 to Cell 3: -1 Cell 4 to Cell 3: 3 | | PRS are transmitted from synchronous cells |

| | | | | |
|--|----|--|---|--|
| Time alignment errors among cell1, cell2 and cell3 | μs | ≤ Time alignment error as specified in 3GPP TS 36.104 [30] clause 6.5.3.1. | | The value of time alignment error depends upon the type of carrier aggregation. |
| Expected RSTD | μs | Cell 4: 2 Other neighbour cells: randomly between -3 and 3 | Cell 1: -2 Cell 2: 0 Cell 4: 2 Other neighbour cells: randomly between -3 and 3 | The expected RSTD is what is expected at the receiver. The corresponding parameter in the OTDOA assistance data specified in TS 36.355 [24] is the expectedRSTD indicator |
| Expected RSTD uncertainty for all neighbour cells | μs | 5 | | The corresponding parameter in the OTDOA assistance data specified in TS 36.355 [24] is the expectedRSTD-Uncertainty index |
| Cells in OTDOA assistance data | | 16 cells in total | | The list includes the reference cell (received in <i>OTDOA-ReferenceCellInfo</i> [24]) and 15 other cells, all received in <i>OTDOA-ProvideAssistanceData</i> [24]. Cell 1 and Cell 2 (when included) appears at random places in the first half of the neighbour cell list in the OTDOA assistance data. Cell 4 always appears at random places in the second half of the list. |
| | | OTDOA neighbor cells include Cell 4 and other 14 cells on SCC2 | OTDOA neighbor cells include Cell 1 and other 3 cells on PCC, Cell 2 and other 3 cells on SCC1 and Cell 4 and other 6 cells on SCC2 | |
| prs-SubframeOffset | | Cells on PCC: 300 Cells on SCC1: 310 Cells on SCC2, except reference cell: 0 | | Subframe offset, counted in full subframes. The corresponding parameter in the OTDOA assistance data is prs-SubframeOffset specified in TS 36.355 [24] |
| slotNumberOffset | | Cells on PCC: 0 Cells on SCC1: 0 Cells on SCC2, except reference cell: 0 | | The slot number offset at the transmitter between a neighbour cell and the assistance data reference cell. The corresponding parameter in the OTDOA assistance data is slotNumberOffset specified in TS 36.355 [24]. |
| PRS muting info | | Cell 1: '11110000' Cell 2: '00001111' Cell 3: '11110000' Cell 4: '00001111' | Cell 1: '11111110000000' Cell 2: '00000001111111' Cell 3: '11111110000000' Cell 4: '00000001111111' | Corresponds to prs-MutingInfo defined in TS 36.355 [24] |
| T1 | s | 3 | | The length of the time interval from the beginning of each test |
| T2 | s | 1.28 | 2.48 | The length of the time interval that follows immediately after time interval T1 |

| | | | | |
|----|---|------|------|---|
| T3 | s | 1.28 | 2.48 | The length of the time interval that follows immediately after time interval T2 |
|----|---|------|------|---|

Table A.8.17.11.1-2: Cell-specific test parameters for E-UTRAN TDD RSTD measurement reporting delay under fading propagation conditions during T1 for carrier aggregation

| Parameter | Unit | Cell 1 | Cell 2 | Cell 3 | Cell 4 |
|---|---------------|---|-----------|-----------|-----------|
| E-UTRA RF Channel Number | | 1 | N/A | N/A | N/A |
| Channel Bandwidth (BW_{channel}) | MHz | 5,10,20 | N/A | N/A | N/A |
| Correlation Matrix and Antenna Configuration | | 1x2 Low | 1x2 Low | 1x2 Low | 1x2 Low |
| PCFICH/PDCCH/PHICH parameters as specified in clause A.3.1.2.1 | | 5MHz: R11 TDD 10MHz: R6 TDD 20MHz: R10 TDD | N/A | N/A | N/A |
| OCNG patterns defined in A.3.2.2 | | 5MHz: OP.10 TDD 10MHz: OP.1 TDD 20MHz: OP.7 TDD | N/A | N/A | N/A |
| PBCH_RA | dB | 0 | N/A | N/A | N/A |
| PBCH_RB | | | | | |
| PSS_RA | | | | | |
| SSS_RA | | | | | |
| PCFICH_RB | | | | | |
| PHICH_RA | | | | | |
| PHICH_RB | | | | | |
| PDCCH_RA | | | | | |
| PDCCH_RB | | | | | |
| OCNG_RA ^{Note 1} | | | | | |
| OCNG_RB ^{Note 1} | | | | | |
| N_{oc} ^{Note 3} | | | | | |
| $\text{PRS } \hat{E}_s / N_{oc}$ | dB | -Infinity | -Infinity | -Infinity | -Infinity |
| I_o ^{Note 4} | dBm/ 9 MHz | -67.22 +10log ($N_{RB,c} / 50$) | N/A | N/A | N/A |
| \hat{E}_s / N_{oc} | dB | 0 | -Infinity | -Infinity | -Infinity |
| Propagation Condition | | ETU30 | | | |
| <p>Note 1: OCNG shall be used such that active cell (Cell 1) is fully allocated and a constant total transmitted power spectral density is achieved for all OFDM symbols.</p> <p>Note 2: The resources for uplink transmission are assigned to the UE prior to the start of time period T2.</p> <p>Note 3: Interference from other cells and noise sources not specified in the test are assumed to be constant over subcarriers and time and shall be modelled as AWGN of appropriate power for N_{oc} to be fulfilled.</p> <p>Note 4: I_o levels have been derived from other parameters and are given for information purpose. These are not settable test parameters.</p> | | | | | |

Table A.8.17.11.1-3: Cell-specific test parameters for E-UTRAN TDD RSTD measurement reporting delay under fading propagation conditions during T2 and T3 for carrier aggregation

| Parameter | Unit | Cell 1 | | Cell 2 | | Cell 3 | | Cell 4 | |
|--|-------------------|---|-----|---|-----|---|-----|---|-----|
| | | T2 | T3 | T2 | T3 | T2 | T3 | T2 | T3 |
| E-UTRA RF Channel Number | | 1 | | 2 | | 3 | | 3 | |
| Correlation Matrix and Antenna Configuration | | 1x2 Low | | 1x2 Low | | 1x2 Low | | 1x2 Low | |
| Channel Bandwidth (BW _{channel}) | MHz | 5,10,20 | | 5,10,20 | | 5,10,20 | | 5,10,20 | |
| PCFICH/PDCCH/PHICH parameters as specified in clause A.3.1.2.1 | | 5MHz: R11 TDD 10MHz: R6 TDD 20MHz: R10 TDD | | 5MHz: R11 TDD 10MHz: R6 TDD 20MHz: R10 TDD | | 5MHz: R11 TDD 10MHz: R6 TDD 20MHz: R10 TDD | | 5MHz: R11 TDD 10MHz: R6 TDD 20MHz: R10 TDD | N/A |
| OCNG patterns defined in A.3.2.1 | | 5MHz: OP.10 TDD 10MHz: OP.1 TDD 20MHz: OP.7 TDD | | 5MHz: OP.10 TDD 10MHz: OP.1 TDD 20MHz: OP.7 TDD | | 5MHz: OP.10 TDD 10MHz: OP.1 TDD 20MHz: OP.7 TDD | | 5MHz: OP.10 TDD 10MHz: OP.1 TDD 20MHz: OP.7 TDD | N/A |
| PRS Transmission Bandwidth (PRS transmission bandwidth depends on selected channel bandwidth. PRS are transmitted over the system bandwidth) | RB | 5MHz: 25 10MHz: 50 20MHz:100 | | 5MHz: 25 10MHz: 50 20MHz:100 | | 5MHz: 25 10MHz: 50 20MHz:100 | | 5MHz: 25 10MHz: 50 20MHz:100 | N/A |
| Number of consecutive downlink positioning subframes N_{PRS} . N_{PRS} also depends on selected channel bandwidth. As defined in TS 36.211 [16]. The number of subframes in a positioning occasion | | 5MHz: 2 10MHz: 1 20MHz:1 | | 5MHz: 2 10MHz: 1 20MHz:1 | | 5MHz: 2 10MHz: 1 20MHz:1 | | 5MHz: 2 10MHz: 1 20MHz:1 | N/A |
| PBCH_RA | dB | | | | | | | | |
| PBCH_RB | | | | | | | | | |
| PSS_RA | | | | | | | | | |
| SSS_RA | | | | | | | | | |
| PCFICH_RB | | | | | | | | | |
| PHICH_RA | | 0 | | 0 | | 0 | | 0 | |
| PHICH_RB | | | | | | | | | |
| PDCCH_RA | | | | | | | | | |
| PDCCH_RB | | | | | | | | | |
| OCNG_RA ^{Note 1} | | | | | | | | | |
| OCNG_RB ^{Note 1} | | | | | | | | | |
| PRS_RA | | dB | -6 | N/A | N/A | 3 | N/A | 3 | 3 |
| N_{oc} ^{Note 3} | dBm/ 15 kHz | -98 | -98 | -98 | -95 | -98 | -95 | -98 | -95 |

| | | | | | | | | | |
|---|-------------------|--|-----|------|--|------|--|--|-----|
| $\text{PRS } \hat{E}_s/N_{oc}$ | dB | -4 | - | - | -1 | - | -1 | -8 | - |
| $\text{PRS } \hat{E}_s/I_{ot}$ ^{Note 4} | dB | -4 | - | - | -1 | - | -1 | -8 | - |
| I_o ^{Note 4} | dBm/ 9 MHz | -69.94 +10log ($N_{RB,c}$ /50) | N/A | N/A | -66.68 +10log ($N_{RB,c}$ /50) | N/A | -66.68 +10log ($N_{RB,c}$ /50) | -70.11 +10log ($N_{RB,c}$ /50) | N/A |
| PRP ^{Note 4} | dBm/ 15 kHz | -102 | - | - | -96 | - | -96 | -106 | - |
| RSRP ^{Note 4} | dBm/ 15 kHz | -96 | -96 | -105 | -99 | -105 | -99 | -109 | - |
| \hat{E}_s/N_{oc} ^{Note 4} | dB | 2 | 2 | -7 | -4 | -7 | -4 | -11 | - |
| Propagation Condition | | ETU30 | | | | | | | |
| <p>Note 1: OCNG shall be used such that active cells (all, except Cell 3 in T3) are fully allocated and a constant total transmitted power spectral density is achieved for all OFDM symbols other than those in the subframes with transmitted PRS.</p> <p>Note 2: The resources for uplink transmission are assigned to the UE prior to the start of time period T2.</p> <p>Note 3: Interference from other cells and noise sources not specified in the test are assumed to be constant over subcarriers and time and shall be modelled as AWGN of appropriate power for N_{oc} to be fulfilled.</p> <p>Note 4: If PRS_RA is not "N/A", \hat{E}_s/N_{oc}, $\text{PRS } \hat{E}_s/I_{ot}$, I_o, RSRP and PRP levels have been derived from other parameters and are given for information purpose. If PRS_RA is "N/A", I_o and RSRP levels have been derived from other parameters and are given for information purpose. These are not settable test parameters. Interference conditions shall be applied to all PRS symbols of DL positioning subframes.</p> | | | | | | | | | |

Table A.8.17.11.1-4: DRX parameters for the test of E-UTRAN TDD intra-frequency RSTD measurement reporting delay under fading propagation conditions for carrier aggregation

| Field | Value | Comment |
|--------------------------|---------|--|
| onDurationTimer | psf1 | As specified in TS 36.331 [2], Clause 6.3.2 |
| Drx-InactivityTimer | psf1 | |
| drx-RetransmissionTimer | sf1 | |
| longDRX-CycleStartOffset | sf320 | |
| shortDRX | Disable | |

A.8.17.11.2 Test Requirements

The RSTD measurement time fulfils the requirements specified in Clause 8.4.

In Test 1, the UE shall perform and report the RSTD measurements from Cell 4 and Cell 3 within 2560 ms starting from the beginning of time interval T2.

In Test 2, the UE shall perform and report the RSTD measurements from Cell 1 and Cell 3, RSTD measurements from Cell 2 and Cell 3, and RSTD measurements from Cell 4 and Cell 3 within 4960 ms starting from the beginning of time interval T2.

The rate of the correct events for each neighbour cell observed during repeated tests shall be at least 90%, where the reported RSTD measurement for each correct event shall be within the RSTD reporting range specified in Clause 9.1.10.3, i.e., between RSTD_0000 and RSTD_12711.

NOTE: The RSTD measurement times in the tests are derived from the following expression,

$$T_{PRS} (M - 1) + 160 \left\lceil \frac{n}{M} \right\rceil,$$

where $M = 8$ and $n = 16$ for Test 1, and $M = 16$ and $n = 16$ for Test 2. For Test 1, the M and n parameters specified in Clause 8.1.2.5.1, Table 8.1.2.5.1-1, under Note 1, which gives the total RSTD measurement time of 2560 ms for Cell 4 with respect to the reference cell Cell 3. For Test 2, the M and n parameters are specified in Clause 8.1.2.6.1, Table 8.1.2.6.1-1, under Note 1, which gives the total RSTD measurement time of 4960 ms for reporting the RSTD measurements of Cell 1, Cell 2 and Cell 4 with respect to the reference cell Cell 3.

A.8.18 E-UTRAN TDD – HRPD Measurements

A.8.18.1 E-UTRAN TDD-HRPD event triggered reporting under fading propagation conditions

A.8.18.1.1 Test Purpose and Environment

The purpose of this test is to verify that the UE makes correct reporting of an event. This test will partly verify the E-UTRAN TDD- HRPD cell search requirements in clause 8.1.2.4.12.

The test parameters are given in Tables A.8.18.1.1-1, A.8.18.1.1-2 and A.8.18.1.1-3 below. In the measurement control information it is indicated to the UE that event-triggered reporting with Event B1 is used. The test consists of two successive time periods, with time duration of T1, and T2 respectively. During time duration T1, the UE shall not have any timing information of cell 2.

Table A.8.18.1.1-1: General test parameters for E-UTRAN TDD to HRPD event triggered reporting under fading propagation conditions

| Parameter | Unit | Value | Comment |
|---|------|--|--|
| PDSCH parameters | | DL Reference Measurement Channel R.0 TDD | As specified in clause A.3.1.1.2 |
| PCFICH/PDCCH/PHICH parameters | | DL Reference Measurement Channel R.6 TDD | As specified in clause A.3.1.2.2 |
| Active cell | | Cell 1 | E-UTRAN TDD cell |
| Neighbouring cell | | Cell 2 | HRPD cell |
| Gap Pattern Id | | 1 | As specified in TS 36.133 clause 8.1.2.1. |
| E-UTRAN TDD measurement quantity | | RSRP | |
| Inter-RAT (HRPD) measurement quantity | | CDMA2000 HRPD Pilot Strength | |
| b1-ThresholdCDMA2000 | dB | -7 | Absolute 'CDMA2000 HRPD Pilot Strength' threshold for event B1 |
| Hysteresis | dB | 0 | |
| TimeToTrigger | s | 0 | |
| Filter coefficient | | 0 | L3 filtering is not used |
| DRX | | OFF | Non-DRX test |
| Access Barring Information | - | Not sent | No additional delays in random access procedure |
| E-UTRA RF Channel Number | | 1 | One E-UTRA TDD carrier frequency is used. |
| E-UTRA Channel Bandwidth (BW _{channel}) | MHz | 10 | |
| Uplink-downlink configuration of cell 1 | | 1 | As specified in table 4.2.2 in TS 36.211 |
| Special subframe configuration of cell 1 | | 6 | As specified in table 4.2.1 in TS 36.211 |
| HRPD RF Channel Number | | 1 | One HRPD carrier frequency is used. |

| | | | |
|-------------------------------|---|-----------------|--|
| HRPD neighbour cell list size | | 8 | HRPD cells on HRPD RF channel 1 provided in the cell list before T2. |
| cdma2000-SearchWindowSize | | 8 (60 PN chips) | Search window size as defined in clause 6.3.5 in TS 36.331 |
| T1 | s | 5 | |
| T2 | s | 3 | |

Table A.8.18.1.1-2: Cell specific test parameters for E-UTRAN TDD cell#1 for event triggered reporting under fading propagation conditions

| Parameter | Unit | Cell 1 (E-UTRA) | |
|---|------------|-----------------|-----|
| | | T1 | T2 |
| E-UTRA RF Channel number | | 1 | |
| BW _{channel} | MHz | 10 | |
| Correlation Matrix and Antenna Configuration | | 1x2 Low | |
| OCNG Patterns defined in TS36.133 A.3.2.2.1 (OP.1 TDD) | | OP.1 TDD | |
| PBCH_RA | dB | 0 | |
| PBCH_RB | dB | | |
| PSS_RA | dB | | |
| SSS_RA | dB | | |
| PCFICH_RB | dB | | |
| PHICH_RA | dB | | |
| PHICH_RB | dB | | |
| PDCCH_RA | dB | | |
| PDCCH_RB | dB | | |
| PDSCH_RA | dB | | |
| PDSCH_RB | dB | | |
| OCNG_RA ^{Note 1} | dB | | |
| OCNG_RB ^{Note 1} | dB | | |
| N_{oc} ^{Note 2} | dBm/15 kHz | | |
| RSRP ^{Note 3} | dBm/15 KHz | -98 | -98 |
| \hat{E}_s / N_{oc} | dB | 0 | 0 |
| \hat{E}_s / I_{ot} | dB | 0 | 0 |
| Propagation Condition | | ETU70 | |
| <p>Note 1: OCNG shall be used such that both cells are fully allocated and a constant total transmitted power spectral density is achieved for all OFDM symbols.</p> <p>Note 2: Interference from other cells and noise sources not specified in the test is assumed to be constant over subcarriers and time and shall be modelled as AWGN of appropriate power for N_{oc} to be fulfilled.</p> <p>Note 3: RSRP levels have been derived from other parameters for information purposes. They are not settable parameters themselves.</p> | | | |

Table A.8.18.1.1-3: Cell specific test parameters for HRPD (cell # 2) for event triggered reporting under fading propagation conditions

| Parameter | Unit | Cell 2 (HRPD) | |
|---|------|---------------|----|
| | | T1 | T2 |
| $\frac{\text{Control } E_b}{N_t}$ (38.4 kbps) | dB | 21 | |
| $\frac{\text{Control } E_b}{N_t}$ (76.8 kbps) | dB | 18 | |
| \hat{I}_{or} / I_{oc} | dB | -infinity | 0 |

| | | | |
|------------------------------|----------------|-----------|----|
| I_{oc} | dBm/1.2288 MHz | -55 | |
| CDMA2000 HRPD Pilot Strength | dB | -infinity | -3 |
| Propagation Condition | | ETU70 | |

A.8.18.1.2 Test Requirements

The UE shall send one Event B1 triggered measurement report, with a measurement reporting delay less than 2134 ms from the beginning of time period T2.

The UE shall not send event triggered measurement reports, as long as the reporting criteria are not fulfilled.

The rate of correct events observed during repeated tests shall be at least 90%.

NOTE: The actual overall delays measured in the test may be up to $2 \times TTI_{DCCH}$ higher than the measurement reporting delays above because of I TTI insertion uncertainty of the measurement report in DCCH.

A.8.19 E-UTRAN TDD – CDMA2000 1X Measurements

A.8.19.1 E-UTRAN TDD – CDMA2000 1X event triggered reporting under fading propagation conditions

A.8.19.1.1 Test Purpose and Environment

The purpose of this test is to verify that the UE makes correct reporting of an event. This test will partly verify the E-UTRAN TDD- CDMA2000 1X cell search requirements in clause 8.1.2.4.10.

The test parameters are given in Tables A.8.19.1.1-1, A.8.19.1.1-2 and A.8.19.1.1-3 below. In the measurement control information it is indicated to the UE that event-triggered reporting with Event B1 is used. The test consists of two successive time periods, with time duration of T1, and T2 respectively. During time duration T1, the UE shall not have any timing information of cell 2.

Table A.8.19.1.1-1: General test parameters for E-UTRAN TDD-CDMA2000 1X event triggered reporting in fading propagation conditions

| Parameter | Unit | Value | Comment |
|--|------|--|---|
| PDSCH parameters (E-UTRAN TDD) | | DL Reference Measurement Channel R.0 TDD | As specified in clause A.3.1.1.2. |
| PCFICH/PDCCH/PHICH parameters (E-UTRAN TDD) | | DL Reference Measurement Channel R.6 TDD | As specified in clause A.3.1.2.2. |
| Gap Pattern Id | | 1 | As specified in TS 36.133 clause 8.1.2.1. |
| Active cell | | Cell 1 | Cell 1 is on E-UTRA RF channel number 1. |
| Neighbour cell | | Cell 2 | Cell 2 is on CDMA2000 1X RF channel number 1. |
| Special subframe configuration | | 6 | As specified in table 4.2-1 in TS 36.211. Applicable to cell 1. |
| Uplink-downlink configuration | | 1 | As specified in table 4.2-2 in TS 36.211. Applicable to cell 1. |
| CP length | | Normal | Applicable to cell 1. |
| E-UTRA RF Channel Number | | 1 | One E-UTRA TDD carrier frequency is used. |
| E-UTRA Channel Bandwidth ($BW_{channel}$) | MHz | 10 | |
| CDMA2000 1X Channel Number | | 1 | One CDMA2000 1X carrier frequency is used. |
| Inter-RAT (CDMA2000 1X) measurement quantity | | CDMA2000 1xRTT Pilot Strength | |
| B1-Threshold-CDMA2000 | dB | -14 | Absolute 'CDMA2000 1xRTT Pilot Strength' threshold for event B1 |
| Hysteresis | dB | 0 | |
| Time To Trigger | ms | 0 | |
| Filter coefficient | | 0 | L3 filtering is not used. |

| | | | |
|--------------------------------------|---|-----------------|--|
| DRX | | OFF | |
| cdma2000 1X neighbour cell list size | | 8 | cdma2000 1X cells on cdma2000 1X RF channel 1 provided in the cell list before T2. |
| cdma2000-SearchWindowSize | | 8 (60 PN chips) | Search window size as defined in clause 6.3.5 in TS 36.331 |
| T1 | s | 5 | |
| T2 | s | 3 | |

Table A.8.19.1.1-2: Cell specific test parameters for E-UTRAN TDD (cell # 1) for event triggered reporting of CDMA2000 1X cell under fading propagation conditions

| Parameter | Unit | Cell 1 | |
|---|------------|----------|-----|
| | | T1 | T2 |
| E-UTRA RF Channel Number | | 1 | |
| BW _{channel} | MHz | 10 | |
| Correlation Matrix and Antenna Configuration | | 1x2 Low | |
| OCNG Pattern defined in A.3.2.2.1 (OP.1 TDD) | | OP.1 TDD | |
| PBCH_RA | dB | 0 | |
| PBCH_RB | dB | | |
| PSS_RA | dB | | |
| SSS_RA | dB | | |
| PCFICH_RB | dB | | |
| PHICH_RA | dB | | |
| PHICH_RB | dB | | |
| PDCCH_RA | dB | | |
| PDCCH_RB | dB | | |
| PDSCH_RA | dB | | |
| PDSCH_RB | dB | | |
| OCNG_RA ^{Note 1} | dB | | |
| OCNG_RB ^{Note 1} | dB | | |
| \hat{E}_s / I_{ot} | dB | 4 | 4 |
| \hat{E}_s / N_{oc} | dB | 4 | 4 |
| N_{oc} | dBm/15 kHz | -98 | |
| RSRP | dBm/15 kHz | -94 | -94 |
| SCH_RP | dBm/15 kHz | -94 | -94 |
| Propagation Condition | | ETU70 | |
| Note 1: OCNG shall be used such that both cells are fully allocated and a constant total transmitted power spectral density is achieved for all OFDM symbols. Note 2: The resources for uplink transmission are assigned to the UE prior to the start of time period T2. | | | |

Table A.8.19.1.1-3: Cell specific test parameters for CDMA2000 1X (cell # 2) for event triggered reporting of CDMA2000 1X cell under fading propagation conditions

| Parameter | Unit | Cell 2 (cdma2000 1X) | |
|--|----------------|----------------------|-----|
| | | T1 | T2 |
| $\frac{\text{Pilot } E_c}{I_{or}}$ | dB | -7 | |
| $\frac{\text{Sync } E_c}{I_{or}}$ | dB | -16 | |
| $\frac{\text{Paging } E_c}{I_{or}}$ (4.8 kbps) | dB | -12 | |
| \hat{I}_{or} / I_{oc} | dB | -infinity | 0 |
| I_{oc} | dBm/1.2288 MHz | -55 | |
| CDMA2000 1xRTT Pilot Strength | dB | -infinity | -10 |
| Propagation Condition | | ETU70 | |

A.8.19.1.2 Test Requirements

The UE shall send one Event B1 triggered measurement report, with a measurement reporting delay less than 2134 ms from the beginning of time period T2.

The UE shall not send event triggered measurement reports, as long as the reporting criteria are not fulfilled.

The rate of correct events observed during repeated tests shall be at least 90%.

NOTE: The actual overall delays measured in the test may be up to $2 \times T_{TTIDCCH}$ higher than the measurement reporting delays above because of TTI insertion uncertainty of the measurement report in DCCH.

A.8.20 Inter-frequency/RAT Measurements in CA mode

A.8.20.1 E-UTRAN FDD-FDD Inter-frequency event triggered reporting under fading propagation conditions in asynchronous cells

It is not necessary for CA UEs to be tested in A.8.3.1 if this case is done.

A.8.20.1.1 Test Purpose and Environment

The purpose of this test is to verify that the UE makes correct reporting of an event. This test will partly verify the FDD-FDD inter-frequency cell search requirements in clause 8.1.2.3.

The test parameters are given in Tables A.8.20.1.1-1 and A.8.20.1.1-2. In this test, there are three cells on different carrier frequencies and gap pattern configuration # 0 as defined in Table 8.1.2.1-1 is provided.

In the measurement control information, it is indicated to the UE that event-triggered reporting with Event A3 is used. The test consists of two successive time periods, with time duration of T1, and T2 respectively. During time duration T1, the UE shall not have any timing information of cell 2.

Table A.8.20.1.1-1: General test parameters for E-UTRAN FDD-FDD inter-frequency event triggered reporting in fading propagation conditions

| Parameter | Unit | Value | Comment |
|--|------|--|---|
| PDSCH parameters | | DL Reference Measurement Channel R.0 FDD | As specified in clause A.3.1.1.1 |
| PCFICH/PDCCH/PHICH parameters | | DL Reference Measurement Channel R.6 FDD | As specified in clause A.3.1.2.1 |
| E-UTRA RF Channel Number | | 1, 2 | Two FDD carrier frequencies are used. |
| E-UTRA RF Channel Number for Scell | | 3 | One FDD carrier frequencies is used |
| Channel Bandwidth (BW _{channel}) | MHz | 10 | |
| Active cell | | Cell 1 | Cell 1 is on RF channel number 1 |
| Neighbour cell | | Cell 2 | Cell 2 is on RF channel number 2 |
| Configured active Scell | | Cell 3 | Cell 3 is on RF channel number 3 |
| Gap Pattern Id | | 0 | As specified in TS 36.133 clause 8.1.2.1. |
| A3-Offset | dB | -6 | |
| Hysteresis | dB | 0 | |
| CP length | | Normal | |
| TimeToTrigger | s | 0 | |
| Filter coefficient | | 0 | L3 filtering is not used |
| DRX | | OFF | OFF |
| Cell2 timing offset to cell1 | ms | 3 | Asynchronous cells |
| Cell3 timing offset to cell1 | μs | 0 | Synchronous cells |
| Time alignment error between cell3 and cell1 | μs | ≤ Time alignment error as specified in 3GPP TS 36.104 [30] | The value of time alignment error depends upon the type of carrier aggregation. |

| | | | |
|----|---|-----------------|--|
| | | clause 6.5.3.1. | |
| T1 | s | 5 | |
| T2 | s | 5 | |

Table A.8.20.1.1-2: Cell specific test parameters for E-UTRAN FDD-FDD inter-frequency event triggered reporting under fading propagation conditions in synchronous cells

| Parameter | Unit | Cell 1 | | Cell 2 | | Cell 3 | |
|--|------------|----------|-----|-----------|-----|----------|-----|
| | | T1 | T2 | T1 | T2 | T1 | T2 |
| E-UTRA RF Channel Number | | 1 | | 2 | | 3 | |
| BW _{channel} | MHz | 10 | | 10 | | 10 | |
| Correlation Matrix and Antenna Configuration | | 1x2 Low | | 1x2 Low | | 1x2 Low | |
| OCNG Patterns defined in A.3.2.1.1 (OP.1 FDD) and in A.3.2.1.2 (OP.2 FDD) | | OP.1 FDD | | OP.2 FDD | | OP.1 FDD | |
| PBCH_RA | dB | 0 | | 0 | | 0 | |
| PBCH_RB | dB | | | | | | |
| PSS_RA | dB | | | | | | |
| SSS_RA | dB | | | | | | |
| PCFICH_RB | dB | | | | | | |
| PHICH_RA | dB | | | | | | |
| PHICH_RB | dB | | | | | | |
| PDCCH_RA | dB | | | | | | |
| PDCCH_RB | dB | | | | | | |
| PDSCH_RA | dB | | | | | | |
| PDSCH_RB | dB | | | | | | |
| OCNG_RA ^{Note 1} | dB | | | | | | |
| OCNG_RB ^{Note 1} | dB | | | | | | |
| N_{oc} ^{Note 3} | dBm/15 kHz | | | | | | |
| RSRP ^{Note 4} | dBm/15 kHz | -94 | -94 | -Infinity | -91 | -94 | -94 |
| \hat{E}_s / I_{ot} | dB | 4 | 4 | -Infinity | 7 | 4 | 4 |
| SCH_RP ^{Note 4} | dBm/15 kHz | -94 | -94 | -Infinity | -91 | -94 | -94 |
| \hat{E}_s / N_{oc} | dB | 4 | 4 | -Infinity | 7 | 4 | 4 |
| Propagation Condition | | ETU70 | | | | | |
| <p>Note 1: OCNG shall be used such that both cells are fully allocated and a constant total transmitted power spectral density is achieved for all OFDM symbols.</p> <p>Note 2: The resources for uplink transmission are assigned to the UE prior to the start of time period T2.</p> <p>Note 3: Interference from other cells and noise sources not specified in the test is assumed to be constant over subcarriers and time and shall be modelled as AWGN of appropriate power for N_{oc} to be fulfilled.</p> <p>Note 4: RSRP and SCH_RP levels have been derived from other parameters for information purposes. They are not settable parameters themselves.</p> | | | | | | | |

A.8.20.1.2 Test Requirements

The UE shall send one Event A3 triggered measurement report, with a measurement reporting delay less than 3840 ms from the beginning of time period T2.

The UE shall not send event triggered measurement reports, as long as the reporting criteria are not fulfilled.

The rate of correct events observed during repeated tests shall be at least 90%.

NOTE: The actual overall delays measured in the test may be up to $2 \times TTI_{DCCH}$ higher than the measurement reporting delays above because of TTI insertion uncertainty of the measurement report in DCCH.

A.8.20.2 E-UTRAN TDD-TDD Inter-frequency event triggered reporting under fading propagation conditions in synchronous cells

It is not necessary for CA UEs to be tested in A.8.4.1 if this case is done.

A.8.20.2.1 Test Purpose and Environment

The purpose of this test is to verify that the UE makes correct reporting of an event. This test will partly verify the TDD-TDD inter-frequency cell search requirements in clause 8.1.2.3.4.

The test parameters are given in Table A.8.20.2.1-1 and A.8.20.2.1-2 below. In the measurement control information it is indicated to the UE that event-triggered reporting with Event A3 is used. The test consists of two successive time periods, with time duration of T1, and T2 respectively. During time duration T1, the UE shall not have any timing information of cell 2.

Table A.8.20.2.1-1: General test parameters for E-UTRAN TDD-TDD inter-frequency event triggered reporting in fading propagation conditions

| Parameter | Unit | Value | Comment |
|--|---------|---|---|
| PDSCH parameters | | DL Reference Measurement Channel R.0 TDD | As specified in clause A.3.1.1.2 |
| PCFICH/PDCCH/PHICH parameters | | DL Reference Measurement Channel R.6 TDD | As specified in clause A.3.1.2.2 |
| Gap Pattern Id | | 1 | As specified in TS 36.133 clause 8.1.2.1. |
| Special subframe configuration | | 6 | As specified in table 4.2-1 in TS 36.211. The same configuration in both cells |
| Uplink-downlink configuration | | 1 | As specified in TS 36.211 clause 4.2 Table 4.2-2 |
| CP length | | Normal | |
| E-UTRA RF Channel Number | | 1, 2 | Two TDD carrier frequencies are used. |
| E-UTRA RF Channel Number for Scell | | 3 | One TDD carrier frequencies is used |
| Channel Bandwidth ($BW_{channel}$) | MHz | 10 | |
| Active cell | | Cell 1 | Cell 1 is on RF channel number 1 |
| Neighbour cell | | Cell 2 | Cell 2 is on RF channel number 2 |
| Configured active Scell | | Cell 3 | Cell 3 is on RF channel number 3 |
| A3-Offset | dB | -6 | |
| Hysteresis | dB | 0 | |
| TimeToTrigger | s | 0 | |
| Filter coefficient | | 0 | L3 filtering is not used |
| DRX | | OFF | |
| Cell2 timing offset to cell1 | μ s | 3 | Synchronous cells |
| Cell3 timing offset to cell1 | μ s | 0 | Synchronous cells |
| Time alignment error between cell3 and cell1 | μ s | \leq Time alignment error as specified in 3GPP TS 36.104 [30] clause 6.5.3.1. | The value of time alignment error depends upon the type of carrier aggregation. |
| T1 | s | 5 | |
| T2 | s | 10 | |

Table A.8.20.2.1-2: Cell specific test parameters for E-UTRAN TDD-TDD inter-frequency event triggered reporting under fading propagation conditions in synchronous cells

| Parameter | Unit | Cell 1 | | Cell 2 | | Cell 3 | |
|---|------------|----------|-----|-----------|-----|----------|-----|
| | | T1 | T2 | T1 | T2 | T1 | T2 |
| E-UTRA RF Channel Number | | 1 | | 2 | | 3 | |
| BW_{channel} | MHz | 10 | | 10 | | 10 | |
| Correlation Matrix and Antenna Configuration | | 1x2 Low | | 1x2 Low | | 1x2 Low | |
| OCNG Pattern defined in A.3.2.2.1 (OP.1 TDD) and in A.3.2.2.2 (OP.2) | | OP.1 TDD | | OP.2 TDD | | OP.1 TDD | |
| PBCH_RA | dB | 0 | | 0 | | 0 | |
| PBCH_RB | dB | | | | | | |
| PSS_RA | dB | | | | | | |
| SSS_RA | dB | | | | | | |
| PCFICH_RB | dB | | | | | | |
| PHICH_RA | dB | | | | | | |
| PHICH_RB | dB | | | | | | |
| PDCCH_RA | dB | | | | | | |
| PDCCH_RB | dB | | | | | | |
| PDSCH_RA | dB | | | | | | |
| PDSCH_RB | dB | | | | | | |
| OCNG_RA ^{Note 1} | dB | | | | | | |
| OCNG_RB ^{Note 1} | dB | | | | | | |
| $\hat{E}_s / I_{\text{ot}}$ | dB | | | | | | |
| N_{oc} ^{Note 3} | dBm/15 kHz | -98 | | | | | |
| RSRP ^{Note 4} | dBm/15 kHz | -94 | -94 | -Infinity | -91 | -94 | -94 |
| SCH_RP ^{Note 4} | dBm/15 kHz | -94 | -94 | -infinity | -91 | -94 | -94 |
| $\hat{E}_s / N_{\text{oc}}$ | dB | 4 | 4 | -Infinity | 7 | 4 | 4 |
| Propagation Condition | | ETU70 | | | | | |
| <p>Note 1: OCNG shall be used such that both cells are fully allocated and a constant total transmitted power spectral density is achieved for all OFDM symbols.</p> <p>Note 2: The resources for uplink transmission are assigned to the UE prior to the start of time period T2.</p> <p>Note 3: Interference from other cells and noise sources not specified in the test is assumed to be constant over subcarriers and time and shall be modelled as AWGN of appropriate power for N_{oc} to be fulfilled.</p> <p>Note 4: RSRP and SCH_RP levels have been derived from other parameters for information purposes. They are not settable parameters themselves.</p> | | | | | | | |

A.8.20.2.2 Test Requirements

The UE shall send one Event A3 triggered measurement report, with a measurement reporting delay less than 7680 ms from the beginning of time period T2.

The UE shall not send event triggered measurement reports, as long as the reporting criteria are not fulfilled.

The rate of correct events observed during repeated tests shall be at least 90%.

NOTE: The actual overall delays measured in the test may be up to $2 \times TTI_{\text{DCCH}}$ higher than the measurement reporting delays above because of TTI insertion uncertainty of the measurement report in DCCH.

A.8.20.2A E-UTRAN TDD-TDD Inter-frequency event triggered reporting under fading propagation conditions in synchronous cells for 20 MHz +20 MHz bandwidth.

A.8.20.2A.1 Test Purpose and Environment

The purpose of this test case is the same as for the test defined in subclause A.8.20.2. The test parameters are the same except those described in the following section. The listed parameter values in Tables A.8.20.2A.1-1 and A.8.20.2A.1-2 will replace the values of corresponding parameters in Tables A.8.20.2.1-1 and A.8.20.2.1-2.

Table A.8.20.2A.1-1: General test parameters for E-UTRAN TDD-TDD Inter-frequency event triggered reporting under fading propagation conditions in synchronous cells for 20 MHz +20 MHz bandwidth

| Parameter | Unit | Value | Comment |
|--|------|---|----------------------------------|
| PDSCH parameters | | DL Reference Measurement Channel R.3 TDD | As specified in clause A.3.1.1.2 |
| PCFICH/PDCCH/PHICH parameters | | DL Reference Measurement Channel R.10 TDD | As specified in clause A.3.1.2.2 |
| Channel Bandwidth (BW_{channel}) | MHz | 20 | |
| Note 1: See Table A.8.20.2.1-1 for other general test parameters. | | | |
| Note 2: This test verifies the RRM requirement which is independent of channel bandwidth and is performed according to the principle defined in section A.3.6.1. | | | |

Table A.8.20.2A.1-2: Cell specific test parameters for E-UTRAN TDD-TDD Inter-frequency event triggered reporting under fading propagation conditions in synchronous cells for 20 MHz +20 MHz bandwidth

| Parameter | Unit | Cell 1 | | Cell 2 | | Cell 3 | |
|---|------|----------|----|----------|----|----------|----|
| | | T1 | T2 | T1 | T2 | T1 | T2 |
| BW_{channel} | MHz | 20 | | 20 | | 20 | |
| OCNG Pattern defined in A.3.2.2 | | OP.7 TDD | | OP.8 TDD | | OP.7 TDD | |
| Note 1: See Table A.8.20.2.1-1 for other general test parameters. | | | | | | | |

A.8.20.2A.2 Test Requirements

The test requirements defined in section A.8.20.2.2 shall apply to this test case.

A.8.20.2B E-UTRAN TDD-TDD Inter-frequency event triggered reporting under fading propagation conditions in synchronous cells for 20 MHz +10 MHz bandwidth.

A.8.20.2B.1 Test Purpose and Environment

The purpose of this test case is the same as for the test defined in subclause A.8.20.2.

The test parameters are given in Tables A.8.20.2B.1-1 and A.8.20.2B.1-2 below. In the measurement control information it is indicated to the UE that event-triggered reporting with Event A3 is used. The test consists of two successive time periods, with time duration of T1, and T2 respectively. During time duration T, the UE shall not have any timing information of cell 2.

Table A.8.20.2B.1-1: General test parameters for E-UTRAN TDD-TDD Inter-frequency event triggered reporting under fading propagation conditions in synchronous cells for 20 MHz +10 MHz bandwidth

| Parameter | Unit | Value | Comment |
|--------------------------------|------|-------|--|
| Gap Pattern Id | | 1 | As specified in TS 36.133 clause 8.1.2.1. |
| Special subframe configuration | | 6 | As specified in table 4.2-1 in TS 36.211. The same configuration in both cells |

| | | | |
|--|----|--|---|
| Uplink-downlink configuration | | 1 | As specified in TS 36.211 clause 4.2 Table 4.2-2 |
| CP length | | Normal | |
| E-UTRA RF Channel Number | | 1, 2 | Two TDD carrier frequencies are used. |
| E-UTRA RF Channel Number for Scell | | 3 | One TDD carrier frequencies is used |
| Active cell | | Cell 1 | Cell 1 is on RF channel number 1 |
| Neighbour cell | | Cell 2 | Cell 2 is on RF channel number 2 |
| Configured active Scell | | Cell 3 | Cell 3 is on RF channel number 3 |
| A3-Offset | dB | -6 | |
| Hysteresis | dB | 0 | |
| TimeToTrigger | s | 0 | |
| Filter coefficient | | 0 | L3 filtering is not used |
| DRX | | OFF | |
| Cell2 timing offset to cell1 | μs | 3 | Synchronous cells |
| Cell3 timing offset to cell1 | μs | 0 | Synchronous cells |
| Time alignment error between cell3 and cell1 | μs | ≤ Time alignment error as specified in 3GPP TS 36.104 [30] clause 6.5.3.1. | The value of time alignment error depends upon the type of carrier aggregation. |
| T1 | s | 5 | |
| T2 | s | 10 | |
| Note 1: This test verifies the RRM requirement which is independent of channel bandwidth and is performed according to the principle defined in section A.3.6.1. | | | |

Table A.8.20.2B.1-2: Cell specific test parameters for E-UTRAN TDD-TDD Inter-frequency event triggered reporting under fading propagation conditions in synchronous cells for 20 MHz +10 MHz bandwidth

| Parameter | Unit | Combination | Cell 1 | | Cell 2 | | Cell 3 | |
|---|------|-------------|---|----|---|----|---|----|
| | | | T1 | T2 | T1 | T2 | T1 | T2 |
| E-UTRA RF Channel Number | | All | 1 | | 2 | | 3 | |
| BW _{channel} | MHz | 20MHz+10MHz | 20MHz: N _{RB,c} = 100 | | 10MHz: N _{RB,c} = 50 | | 10MHz: N _{RB,c} = 50 | |
| | | 10MHz+20MHz | 10MHz: N _{RB,c} = 50 | | 20MHz: N _{RB,c} = 100 | | 20MHz: N _{RB,c} = 100 | |
| Correlation Matrix and Antenna Configuration | | All | 1x2 Low | | 1x2 Low | | 1x2 Low | |
| PDSCH Reference measurement channel defined in A.3.1.1.2 | | 20MHz+10MHz | DL Reference Measurement Channel R.3 TDD | | N/A | | DL Reference Measurement Channel R.0 TDD | |
| | | 10MHz+20MHz | DL Reference Measurement Channel R.0 TDD | | N/A | | DL Reference Measurement Channel R.3 TDD | |
| PDCCH/PCFICH/PHICH Reference measurement channel defined in A.3.1.2.2 | | 20MHz+10MHz | DL Reference Measurement Channel R.10 TDD | | DL Reference Measurement Channel R.6 TDD | | DL Reference Measurement Channel R.6 TDD | |
| | | 10MHz+20MHz | DL Reference Measurement Channel R.6 TDD | | DL Reference Measurement Channel R.10 TDD | | DL Reference Measurement Channel R.10 TDD | |
| OCNG Pattern defined in A.3.2.2 (TDD) | | 20MHz+10MHz | OP.7 TDD | | OP.2 TDD | | OP.1 TDD | |
| | | 10MHz+20MHz | OP.1 TDD | | OP.8 TDD | | OP.7 TDD | |
| PBCH_RA | dB | All | 0 | | 0 | | 0 | |
| PBCH_RB | dB | | | | | | | |
| PSS_RA | dB | | | | | | | |
| SSS_RA | dB | | | | | | | |
| PCFICH_RB | dB | | | | | | | |
| PHICH_RA | dB | | | | | | | |
| PHICH_RB | dB | | | | | | | |
| PDCCH_RA | dB | | | | | | | |

| | | | | | | | |
|--|------------|-----|-------|-----|-----------|-----|---------|
| PDCCH_RB | dB | | | | | | |
| PDSCH_RA | dB | | | | | | |
| PDSCH_RB | dB | | | | | | |
| OCNG_RA ^{Note 1} | dB | | | | | | |
| OCNG_RB ^{Note 1} | dB | | | | | | |
| \hat{E}_s / I_{ot} | dB | All | 4 | 4 | -Infinity | 7 | 4 4 |
| N_{oc} ^{Note 3} | dBm/15 kHz | All | -98 | | -98 | | -98 |
| RSRP ^{Note 4} | dBm/15 kHz | All | -94 | -94 | -Infinity | -91 | -94 -94 |
| SCH_RP ^{Note 4} | dBm/15 kHz | All | -94 | -94 | -infinity | -91 | -94 -94 |
| \hat{E}_s / N_{oc} | dB | All | 4 | 4 | -Infinity | 7 | 4 4 |
| Propagation Condition | | All | ETU70 | | ETU70 | | ETU70 |
| <p>Note 1: OCNG shall be used such that both cells are fully allocated and a constant total transmitted power spectral density is achieved for all OFDM symbols.</p> <p>Note 2: The resources for uplink transmission are assigned to the UE priori to the start of time period T2.</p> <p>Note 3: Interference from other cells and noise sources not specified in the test is assumed to be constant over subcarriers and time and shall be modelled as AWGN of appropriate power for N_{oc} to be fulfilled.</p> <p>Note 4: E_s/I_{ot}, RSRP and SCH_RP levels have been derived from other parameters for information purposes. They are not settable parameters themselves.</p> | | | | | | | |

A.8.20.2B.2 Test Requirements

The test requirements defined in section A.8.20.2.2 shall apply to this test case.

A.8.20.3 E-UTRAN FDD - UTRAN FDD event triggered reporting under fading propagation conditions

It is not necessary for CA UEs to be tested in A.8.5.1 if this case is done.

A.8.20.3.1 Test Purpose and Environment

The purpose of this test is to verify that the UE makes correct reporting of an event. This test will partly verify the E-UTRAN FDD- UTRAN FDD cell search requirements in clause 8.1.2.4.1.

The test parameters are given in Tables A.8.20.3.1-1, A.8.20.3.1-2 and A.8.20.3.1-3 below. In the measurement control information it is indicated to the UE that event-triggered reporting with Event B1 is used. The test consists of two successive time periods, with time duration of T1, and T2 respectively. During time duration T1, the UE shall not have any timing information of cell 2.

Table A.8.20.3.1-1: General test parameters for E-UTRAN FDD-UTRAN FDD event triggered reporting in fading propagation conditions

| Parameter | Unit | Value | Comment |
|---|------|--|---|
| PDSCH parameters (E-UTRAN FDD) | | DL Reference Measurement Channel R.0 FDD | As specified in clause A.3.1.1.1. |
| PCFICH/PDCCH/PHICH parameters (E-UTRAN FDD) | | DL Reference Measurement Channel R.6 FDD | As specified in clause A.3.1.2.1. |
| Gap Pattern Id | | 1 | As specified in TS 36.133 clause 8.1.2.1. |
| Active cell | | Cell 1 | Cell 1 is on E-UTRA RF channel number 1. |
| Neighbour cell | | Cell 2 | Cell 2 is on UTRA RF channel number 1. |
| Configured active Scell | | Cell 3 | Cell 3 is on E-UTRA RF channel number 2. |
| CP length | | Normal | Applicable to cell 1 |
| E-UTRA RF Channel Number | | 1 | One E-UTRA FDD carrier frequency is used. |

| | | | |
|---|-----|-------------|--|
| E-UTRA RF Channel Number for Scell | | 2 | One E-UTRA FDD carrier frequency is used. |
| E-UTRA Channel Bandwidth ($BW_{channel}$) | MHz | 10 | |
| UTRA RF Channel Number | | 1 | One UTRA FDD carrier frequency is used. |
| Inter-RAT (UTRA FDD) measurement quantity | | CPICH Ec/Io | |
| b1-Threshold-UTRA | dB | -18 | CPICH Ec/Io threshold for event B1. |
| Hysteresis | dB | 0 | |
| Time To Trigger | ms | 0 | |
| Filter coefficient | | 0 | L3 filtering is not used. |
| DRX | | OFF | |
| Monitored UTRA FDD cell list size | | 12 | UTRA cells on UTRA RF channel 1 provided in the cell list. |
| T1 | s | 5 | |
| T2 | s | 6 | |

Table A.8.20.3.1-2: Cell specific test parameters for E-UTRAN FDD (cell # 1, cell # 3) for event triggered reporting of UTRAN FDD cell under fading propagation conditions

| Parameter | Unit | Cell 1 | | Cell 3 | |
|---|------------|----------|-----|----------|----|
| | | T1 | T2 | T1 | T2 |
| E-UTRA RF Channel Number | | 1 | | 2 | |
| $BW_{channel}$ | MHz | 10 | | 10 | |
| Correlation Matrix and Antenna Configuration | | 1x2 Low | | 1x2 Low | |
| OCNG Pattern defined in A.3.2.1.1 (OP.1 FDD) | | OP.1 FDD | | OP.1 FDD | |
| PBCH_RA | dB | 0 | | 0 | |
| PBCH_RB | dB | | | | |
| PSS_RA | dB | | | | |
| SSS_RA | dB | | | | |
| PCFICH_RB | dB | | | | |
| PHICH_RA | dB | | | | |
| PHICH_RB | dB | | | | |
| PDCCH_RA | dB | | | | |
| PDCCH_RB | dB | | | | |
| PDSCH_RA | dB | | | | |
| PDSCH_RB | dB | | | | |
| OCNG_RA ^{Note 1} | dB | | | | |
| OCNG_RB ^{Note 1} | dB | | | | |
| \hat{E}_s / I_{ot} | dB | | | | |
| \hat{E}_s / N_{oc} | dB | 4 | 4 | 4 | |
| N_{oc} | dBm/15 kHz | -98 | | | |
| RSRP | dBm/15 kHz | -94 | -94 | -94 | |
| SCH_RP | dBm/15 kHz | -94 | -94 | -94 | |
| Propagation Condition | | ETU70 | | | |
| Note 1: OCNG shall be used such that both cells are fully allocated and a constant total transmitted power spectral density is achieved for all OFDM symbols. | | | | | |
| Note 2: The resources for uplink transmission are assigned to the UE prior to the start of time period T2. | | | | | |

Table A.8.20.3.1-3: Cell specific test parameters for UTRAN FDD (cell # 2) for event triggered reporting of UTRAN FDD cell under fading propagation conditions

| Parameter | Unit | Cell 2 |
|-----------|------|--------|
|-----------|------|--------|

| | | T1 | T2 |
|---|--------------|-----------------|------|
| UTRA RF Channel Number | | 1 | |
| CPICH_Ec/I _{or} | dB | -10 | |
| PCCPCH_Ec/I _{or} | dB | -12 | |
| SCH_Ec/I _{or} | dB | -12 | |
| PICH_Ec/I _{or} | dB | -15 | |
| DPCH_Ec/I _{or} | dB | N/A | |
| OCNS | | -0.941 | |
| \hat{I}_{or}/I_{oc} | dB | -Infinity | -1.8 |
| I_{oc} | dBm/3.84 MHz | -70 | |
| CPICH_Ec/I _o | dB | -Infinity | -14 |
| Propagation Condition | | Case 5 (Note 3) | |
| Note 1: The DPCH level is controlled by the power control loop. | | | |
| Note 2: The power of the OCNS channel that is added shall make the total power from the cell to be equal to I _{or} | | | |
| Note 3: Case 5 propagation conditions are defined in Annex A of 3GPP TS 25.101. | | | |

A.8.20.3.2 Test Requirements

The UE shall send one Event B1 triggered measurement report, with a measurement reporting delay less than 4800 ms from the beginning of time period T2.

The UE shall not send event triggered measurement reports, as long as the reporting criteria are not fulfilled.

The rate of correct events observed during repeated tests shall be at least 90%.

NOTE: The actual overall delays measured in the test may be up to $2 \times TTI_{DCCH}$ higher than the measurement reporting delays above because of TTI insertion uncertainty of the measurement report in DCCH.

A.8.20.4 E-UTRAN TDD to UTRAN TDD cell search under fading propagation conditions

It is not necessary for CA UEs to be tested in A.8.7.1 if this case is done.

A.8.20.4.1 Test Purpose and Environment

A.8.20.4.1.1 1.28 Mcps TDD option

The purpose of this test is to verify that the UE makes correct reporting of an event. This test will partly verify the E-UTRA TDD to UTRA TDD cell search requirements in clause 8.1.2.4.3 under fading propagation conditions.

This test scenario comprised of 1 E-UTRA TDD PCell, 1 E-UTRA TDD SCell and 1 UTRA TDD cell to be searched. Test parameters are given in Table A.8.20.4.1.2-1, A.8.20.4.1.2-2, and A.8.20.4.1.2-3. Gap pattern configuration #0 as defined in table 8.1.2.1-1 is provided.

In the measurement control information, it is indicated to the UE that event-triggered reporting with Event B1 is used. The test consists of two successive time periods, with time duration of T1 and T2 respectively. During time duration T1, the UE shall not have any timing information of cell 2.

Table A.8.20.4.1.1-1: General test parameters for E-UTRA TDD to UTRA(1.28 Mcps TDD OPTION) cell search in fading propagation conditions

| Parameter | Unit | Value | Comment |
|------------------------------------|------|--|---|
| PDSCH parameters | | DL Reference Measurement Channel R.0 TDD | As specified in clause A.3.1.1.2 |
| PCFICH/PDCCH/PHICH parameters | | DL Reference Measurement Channel R.6 TDD | As specified in clause A.3.1.2.2 |
| E-UTRA RF Channel Number | | 1 | One E-UTRA TDD carrier frequency is used. |
| E-UTRA RF Channel Number for Scell | | 2 | One E-UTRA TDD carrier frequency is used. |

| | | | |
|--|-----|--------|---|
| Active cell | | Cell 1 | E-UTRA TDD cell |
| Neighbour cell | | Cell 2 | UTRA 1.28Mcps TDD Cell |
| Configured active SCell | | Cell 3 | E-UTRA TDD cell |
| Gap Pattern Id | | 0 | As specified in TS 36.133 clause 8.1.2.1. |
| Uplink-downlink configuration of cell 1 | | 1 | As specified in table 4.2.2 in TS 36.211 |
| Special subframe configuration of cell 1 | | 6 | As specified in table 4.2.1 in TS 36.211 |
| CP length of cell 1 | | normal | |
| Hysteresis | dB | 0 | |
| TimeToTrigger | s | 0 | |
| Filter coefficient | | 0 | L3 filtering is not used |
| DRX | | OFF | |
| Time offset between cells | | 3 ms | Asynchronous cells |
| Ofn | dB | 0 | |
| Thresh | dBm | -87 | |
| T1 | s | 5 | |
| T2 | s | 10 | |

Table A.8.20.4.1.1-2: Cell specific test parameters for cell search E-UTRA TDD to UTRA TDD test case (cell 1, cell3)

| Parameter | Unit | Cell 1 | | Cell 3 | |
|--|-----------|----------|-----|----------|-----|
| | | T1 | T2 | T1 | T2 |
| E-UTRA RF Channel Number | | 1 | | 2 | |
| BW _{channel} | MHz | 10 | | 10 | |
| Correlation Matrix and Antenna Configuration | | 1x2 Low | | 1x2 Low | |
| OCNG Pattern defined in A.3.2.2.1 (OP.1 TDD) | | OP.1 TDD | | OP.1 TDD | |
| PBCH_RA | dB | 0 | 0 | 0 | 0 |
| PBCH_RB | dB | | | | |
| PSS_RA | dB | | | | |
| SSS_RA | dB | | | | |
| PCFICH_RB | dB | | | | |
| PHICH_RA | dB | | | | |
| PHICH_RB | dB | | | | |
| PDCCH_RA | dB | | | | |
| PDCCH_RB | dB | | | | |
| PDSCH_RA | dB | | | | |
| PDSCH_RB | dB | | | | |
| OCNG_RA ^{Note1} | dB | | | | |
| OCNG_RB ^{Note1} | dB | | | | |
| \hat{E}_s / I_{ot} | dB | | | | |
| \hat{E}_s / N_{oc} | dB | 9 | 9 | 9 | 9 |
| N_{oc} | dBm/15kHz | -98 | | | |
| RSRP | dBm/15kHz | -89 | -89 | -89 | -89 |
| SCH_RP | dBm/15kHz | -89 | -89 | -89 | -89 |
| Propagation Condition | | ETU70 | | | |
| Note 1: OCNG shall be used such that cell is fully allocated and a constant total transmitted power spectral density is achieved for all OFDM symbols. | | | | | |
| Note 2: The resources for uplink transmission are assigned to the UE prior to the start of time period T2. | | | | | |

Table A.8.20.4.1.1-3: Cell specific test parameters for cell search E-UTRA TDD to UTRA TDD test case (cell 2)

| Parameter | Unit | Cell 2 (UTRA) | | | |
|-----------------|------|---------------|----|-------|----|
| Timeslot Number | | 0 | | DwPTS | |
| | | T1 | T2 | T1 | T2 |

| UTRA RF Channel Number ^{NOTE1} | | Channel 2 | | | |
|--|---|-------------------------|-----|------|------|
| PCCPCH_Ec/I _{or} | dB | -3 | -3 | | |
| DwPCH_Ec/I _{or} | dB | | | 0 | 0 |
| OCNS_Ec/I _{or} ^{NOTE2} | dB | -3 | -3 | | |
| \hat{I}_{or}/I_{oc} | dB | -inf | 5 | -inf | 5 |
| I_{oc} | dBm/1.2 8 MHz | -80 | | | |
| PCCPCH RSCP | dBm | -inf | -78 | n.a. | n.a. |
| Propagation Condition | | Case 3 ^{NOTE3} | | | |
| Note 1: | In the case of multi-frequency cell, the UTRA RF Channel Number is the primary frequency's channel number. | | | | |
| Note 2: | The power of the OCNS channel that is added shall make the total power from the cell to be equal to I _{or} . | | | | |
| Note 3: | Case 3 propagation conditions are defined in Annex B of TS 25.102 | | | | |

A.8.20.4.2 Test Requirements

A.8.20.4.2.1 1.28 Mcps TDD option

The UE shall send one Event B1 triggered measurement report, with a measurement reporting delay less than 6400 ms from the beginning of time period T2.

The UE shall not send event triggered measurement reports, as long as the reporting criteria are not fulfilled.

The rate of correct events observed during repeated tests shall be at least 90%.

NOTE: The actual overall delays measured in the test may be up to $2 \times TTI_{DCCH}$ higher than the measurement reporting delays above because of TTI insertion uncertainty of the measurement report in DCCH.

A.8.20.4A E-UTRAN TDD with 20 MHz +20 MHz bandwidth to UTRAN TDD cell search under fading propagation conditions

A.8.20.4A.1 Test Purpose and Environment

A.8.20.4A.1.1 1.28 Mcps TDD option

The purpose of this test case is the same as for the test defined in subclause A.8.20.4. The test parameters are the same except those described in the following section. The listed parameter values in Tables A.8. 20.4A.1.1-1 and A.8. 20.4A.1.1-2 will replace the values of corresponding parameters in Tables A.8. 20.4.1.1-1 and A.8. 20.4.1.1-2.

Table A.8.20.4A.1.1-1: General test parameters for E-UTRA TDD with 20MHz +20MHz bandwidth to UTRA(1.28 Mcps TDD OPTION) cell search in fading propagation conditions

| Parameter | Unit | Value | Comment |
|-------------------------------|--|---|-----------------------------------|
| PDSCH parameters | | DL Reference Measurement Channel R.3 TDD | As specified in section A.3.1.1.2 |
| PCFICH/PDCCH/PHICH parameters | | DL Reference Measurement Channel R.10 TDD | As specified in section A.3.1.2.2 |
| Note 1: | See Table A.8.20.4.1.1-1 for other general test parameters. | | |
| Note 2: | This test verifies the RRM requirement which is independent of channel bandwidth and is performed according to the principle defined in section A.3.6.1. | | |

Table A.8.20.4A.1.1-2: Cell specific test parameters for cell search E-UTRA TDD with 20MHz +20MHz bandwidth to UTRA TDD test case (cell 1, cell3)

| Parameter | Unit | Cell 1 | | Cell 3 | |
|-----------|------|--------|----|--------|----|
| | | T1 | T2 | T1 | T2 |
| | | | | | |

| | | | |
|---------------------------------|--|----------|----------|
| BW _{channel} | MHz | 20 | 20 |
| OCNG Pattern defined in A.3.2.2 | | OP.7 TDD | OP.7 TDD |
| Propagation Condition | | ETU70 | |
| Note 1: | See Table A.8.20.4.1.1-2 for other general test parameters. | | |
| Note 2: | This test verifies the RRM requirement which is independent of channel bandwidth and is performed according to the principle defined in section A.3.6.1. | | |

A.8.20.4A.2 Test Requirements

A.8.20.4A.2.1 1.28 Mcps TDD option

The test requirements defined in section A.8.20.4.2.1 shall apply to this test case.

A.8.20.4B E-UTRAN TDD with 20 MHz +10 MHz bandwidth to UTRAN TDD cell search under fading propagation conditions

A.8.20.4B.1 Test Purpose and Environment

A.8.20.4B.1.1 1.28 Mcps TDD option

The purpose of this test case is the same as for the test defined in subclause A.8.20.4.

This test scenario comprised of 1 E-UTRA TDD PCell, 1 E-UTRA TDD SCell and 1 UTRA TDD cell to be searched. The test parameters are given in Tables A.8. 20.4B.1.1-1, A.8. 20.4B.1.1-2 and A.8.20.4B.1.1-3. Gap pattern configuration #0 as defined in table 8.1.2.1-1 is provided.

In the measurement control information, it is indicated to the UE that event-triggered reporting with Event B1 is used. The test consists of two successive time periods, with time duration of T1 and T2 respectively. During time duration T1, the UE shall not have any timing information of cell 2.

Table A.8.20.4B.1.1-1: General test parameters for E-UTRA TDD with 20MHz +10MHz bandwidth to UTRA(1.28 Mcps TDD OPTION) cell search in fading propagation conditions

| Parameter | Unit | Value | Comment |
|--|------|--------|---|
| E-UTRA RF Channel Number | | 1 | One E-UTRA TDD carrier frequency is used. |
| E-UTRA RF Channel Number for Scell | | 2 | One E-UTRA TDD carrier frequency is used. |
| Active cell | | Cell 1 | E-UTRA TDD cell |
| Neighbour cell | | Cell 2 | UTRA 1.28Mcps TDD Cell |
| Configured active SCell | | Cell 3 | E-UTRA TDD cell |
| Gap Pattern Id | | 0 | As specified in TS 36.133 clause 8.1.2.1. |
| Uplink-downlink configuration of cell 1 | | 1 | As specified in table 4.2.2 in TS 36.211 |
| Special subframe configuration of cell 1 | | 6 | As specified in table 4.2.1 in TS 36.211 |
| CP length of cell 1 | | normal | |
| Hysteresis | dB | 0 | |
| TimeToTrigger | s | 0 | |
| Filter coefficient | | 0 | L3 filtering is not used |
| DRX | | OFF | |
| Time offset between cells | | 3 ms | Asynchronous cells |
| Ofn | dB | 0 | |
| Thresh | dBm | -87 | |
| T1 | s | 5 | |
| T2 | s | 10 | |

Table A.8.20.4B.1.1-2: Cell specific test parameters for cell search E-UTRA TDD with 20MHz +10MHz bandwidth to UTRA TDD test case (cell 1, cell3)

| Parameter | Unit | Combination | Cell 1 | | Cell 3 | |
|--------------------------|------|-------------|--------|----|--------|----|
| | | | T1 | T2 | T1 | T2 |
| E-UTRA RF Channel Number | | All | 1 | | 2 | |
| BW _{channel} | | 20MHz+10MHz | 20 | | 10 | |

| | | | | | | | | | | | |
|--|-----------|-------------|----------|----------|-----|-----|-----|-----|---|---|---|
| | | 10MHz+20MHz | 10 | 20 | | | | | | | |
| Correlation Matrix and Antenna Configuration | | All | 1x2 Low | 1x2 Low | | | | | | | |
| PDSCH Reference measurement channel defined in A.3.1.1.2 | | 20MHz+10MHz | R.3 TDD | R.0 TDD | | | | | | | |
| | | 10MHz+20MHz | R.0 TDD | R.3 TDD | | | | | | | |
| PDCCH/PCFICH/PHICH Reference measurement channel defined in A.3.1.2.2 | | 20MHz+10MHz | R.10 TDD | R.6 TDD | | | | | | | |
| | | 10MHz+20MHz | R.6 TDD | R.10 TDD | | | | | | | |
| OCNG Pattern defined in A.3.2.2 | | 20MHz+10MHz | OP.7 TDD | OP.1 TDD | | | | | | | |
| | | 10MHz+20MHz | OP.1 TDD | OP.7 TDD | | | | | | | |
| PBCH_RA | dB | All | 0 | 0 | 0 | 0 | | | | | |
| PBCH_RB | dB | | | | | | | | | | |
| PSS_RA | dB | | | | | | | | | | |
| SSS_RA | dB | | | | | | | | | | |
| PCFICH_RB | dB | | | | | | | | | | |
| PHICH_RA | dB | | | | | | | | | | |
| PHICH_RB | dB | | | | | | | | | | |
| PDCCH_RA | dB | | | | | | | | | | |
| PDCCH_RB | dB | | | | | | | | | | |
| PDSCH_RA | dB | | | | | | | | | | |
| PDSCH_RB | dB | | | | | | | | | | |
| OCNG_RA ^{Note1} | dB | | | | | | | | | | |
| OCNG_RB ^{Note1} | dB | | | | | | | | | | |
| \hat{E}_s / I_{ot} | dB | | | | | | All | 9 | 9 | 9 | 9 |
| \hat{E}_s / N_{oc} | dB | | | | | | All | 9 | 9 | 9 | 9 |
| N_{oc} | dBm/15kHz | | | | | | All | -98 | | | |
| RSRP | dBm/15kHz | All | -89 | -89 | -89 | -89 | | | | | |
| SCH_RP | dBm/15kHz | All | -89 | -89 | -89 | -89 | | | | | |
| Propagation Condition | | All | ETU70 | | | | | | | | |
| Note 1: OCNG shall be used such that cell is fully allocated and a constant total transmitted power spectral density is achieved for all OFDM symbols. | | | | | | | | | | | |
| Note 2: The resources for uplink transmission are assigned to the UE prior to the start of time period T2. | | | | | | | | | | | |

Table A.8.20.4B.1.1-3: Cell specific test parameters for cell search E-UTRA TDD with 20MHz +10MHz bandwidth to UTRA TDD test case (cell 2)

| Parameter | Unit | Cell 2 (UTRA) | | | |
|---|--------------|-------------------------|-----|-------|------|
| Timeslot Number | | 0 | | DwPTS | |
| | | T1 | T2 | T1 | T2 |
| UTRA RF Channel Number ^{NOTE1} | | Channel 2 | | | |
| PCCPCH_Ec/I _{or} | dB | -3 | -3 | | |
| DwPCH_Ec/I _{or} | dB | | | 0 | 0 |
| OCNS_Ec/I _{or} ^{NOTE2} | dB | -3 | -3 | | |
| \hat{I}_{or} / I_{oc} | dB | -inf | 5 | -inf | 5 |
| I_{oc} | dBm/1.28 MHz | -80 | | | |
| PCCPCH RSCP | dBm | -inf | -78 | n.a. | n.a. |
| Propagation Condition | | Case 3 ^{NOTE3} | | | |
| Note 1: In the case of multi-frequency cell, the UTRA RF Channel Number is the primary frequency's channel number. | | | | | |
| Note 2: The power of the OCNS channel that is added shall make the total power from the cell to be equal to I _{or} . | | | | | |
| Note 3: Case 3 propagation conditions are defined in Annex B of TS 25.102 | | | | | |

A.8.20.4B.2 Test Requirements

A.8.20.4B.2.1 1.28 Mcps TDD option

The test requirements defined in section A.8.20.4.2.1 shall apply to this test case.

A.8.21 CSG Proximity Indication Testing Case for E-UTRAN FDD – FDD Inter frequency

Note : The test case in this section forms the basis for a signalling test for CSG proximity detection.

A.8.21.1 Test Purpose and Environment

The purpose of this test is to verify the UE has implemented properly the feature for indicating that the UE is entering or leaving the proximity of one or more CSG member cells based on proximity detection with an autonomous search function, as defined by the requirements in Section 6.4.

The test case consists of three successive segments: Test Preparation, Negative Test, and Positive Test. The test scenario comprises of three E-UTRAN FDD cells on different carriers. Cell 1 represents the serving cell in the proximity of the CSG cell, Cell 2 the CSG cell, and Cell 3 the serving cell not in the proximity of the CSG cell. The description of the test procedure is shown in Table A.8.21-1. The general test parameters and cell specific test parameters are presented in Table A.8.21-2 and Table A.8.21-3 respectively.

Table A.8.21-1: Description of the test procedures

| Parameter | Cell Status | Comment |
|-------------------------|------------------------------|--|
| Test Preparation | | |
| Initial Condition | Cell 1 is active | Clean up the UE memory to be free from previously stored cell information for proximity detection. Turn on the UE and allow sufficient time for the UE to select to Cell 1. |
| Time duration T1 | Cell 1 and Cell 2 are active | Turn on Cell 2 at the start of T1. Perform manual CSG selection towards Cell 2. The UE is expected to store necessary information for later proximity detection. |
| End condition | | Turn off the UE. Turn off Cell 1 and Cell 2. |
| Negative Test | | |
| Initial Condition | Cell 3 is active | Turn on Cell 3. Turn on the UE and set up the UE in connected mode with Cell 3.. |
| Time duration T2 | Cell 3 is active | Configure the UE with proximity indication control by sending the Reconfiguration message with ReportProximityConfig at the start of T2. The UE is not expected to report "entering" proximity in the negative test. |
| End condition | | Turn off the UE. Turn off Cell 3. |
| Positive Test | | |
| Initial Condition | Cell 1 is active | Turn on Cell 1. Turn on the UE and set up the UE in connected mode with Cell 1. |
| Time duration T3 | Cell 1 and Cell 2 are active | Turn on Cell 2 at the start of T3. Configure the UE with proximity indication control by sending the Reconfiguration message with reportProximityConfig at the start of T3. The UE is expected to report "entering" proximity before end of T3. |
| End condition | | Turn off the UE. Turn off Cell 1 and Cell 2. |

Table A.8.21-2: General test parameters for E-UTRAN FDD-FDD inter frequency cell proximity detection test case

| Parameter | Unit | Value | Comment |
|------------------|-----------|--|-----------------------------------|
| PDSCH parameters | | DL Reference Measurement Channel R.0 FDD | As specified in section A.3.1.1.1 |
| PDSCH allocation | n_{PRB} | 2—3 | 13—36 |

| | | | |
|--|----|--|---|
| PCFICH/PDCCH/PHICH parameters | | DL Reference Measurement Channel R.6 FDD | As specified in section A.3.1.2.1 |
| A3-Offset | dB | -4 | |
| Hysteresis | dB | 0 | |
| TimeToTrigger | s | 0 | |
| Filter coefficient | | 0 | L3 filtering is not used |
| DRX | | off | As specified in section A.3.3 |
| PRACH configuration | | 4 | As specified in table 5.7.1-2 in 3GPP TS 36.211 |
| Access Barring Information | - | Not sent | No additional delays in random access procedure |
| Time offset between cells | | 3 ms | Asynchronous cells |
| Gap pattern configuration Id | | 0 | As specified in Table 8.1.2.1-1 started before T1 starts |
| Time duration T1 | s | [10] | Defined to give enough time for the UE to complete the manual reselection to Cell 2. |
| Time duration T2 | s | [360] | Defined to be longer enough to see whether the UE will report enter "proximity" indication. |
| Time duration T3 ^{Note 1} | s | [<=360] | The time duration for a UE to report enters "proximity" when the UE is near a CSG cell. |
| <p>Note 1: The maximum allowed time duration for the UE to decide either entering or leaving "proximity" is 360s. To reduce test time, T3 may end once UE reports entering "proximity".</p> <p>Note 2: The test case assumes an environment where CSG proximity detection results not being impact by non-3GPP signals, such as GPS and WiFi. When the test case is being executed, the UE may ignore any radio signals which are not provided by the test setup which it would otherwise use in proximity estimation.</p> | | | |

Table A.8.21-3: Cell specific test parameters for E-UTRAN FDD-FDD inter frequency cell proximity detection test case

| Parameter | Unit | Cell 1 | | | Cell 2 | | |
|---|------------|-----------|------|----------|-----------|------|----------|
| | | T1 | T2 | T3 | T1 | T2 | T3 |
| E-UARFCN | | Channel 1 | | | Channel 2 | | |
| CSG indicator | | False | | | True | N/A | True |
| Physical cell global identity | | 1 | 1 | 1 | 2 | N/A | 2 |
| CSG identity | | Not sent | | | Sent | N/A | Sent |
| BW _{channel} | MHz | 10 | | | 10 | | |
| OCNG Patterns defined in A.3.2.1.1 (OP.1 FDD) and in A.3.2.1.2 (OP.2 FDD) | | OP.1 FDD | N/A | OP.2 FDD | OP.2 FDD | N/A | OP.2 FDD |
| PBCH_RA | dB | 0 | | | 0 | | |
| PBCH_RB | dB | | | | | | |
| PSS_RA | dB | | | | | | |
| SSS_RA | dB | | | | | | |
| PCFICH_RB | dB | | | | | | |
| PHICH_RA | dB | | | | | | |
| PHICH_RB | dB | | | | | | |
| PDCCH_RA | dB | | | | | | |
| PDCCH_RB | dB | | | | | | |
| PDSCH_RA | dB | | | | | | |
| PDSCH_RB | dB | | | | | | |
| OCNG_RA ^{Note 1} | dB | | | | | | |
| OCNG_RB ^{Note 1} | dB | | | | | | |
| \hat{E}_s / I_{ot} | dB | | | | | | |
| N_{oc} ^{Note 2} | dBm/15 kHz | -98 | | | -98 | | |
| \hat{E}_s / N_{oc} | dB | 0 | -inf | 4 | 7 | -inf | 7 |
| RSRP ^{Note 3} | dBm/15 KHz | -98 | -inf | -94 | -91 | -inf | -91 |
| Propagation Condition | | AWGN | | | AWGN | | |

| | |
|---------|--|
| Note 1: | OCNG shall be used such that both cells are fully allocated and a constant total transmitted power spectral density is achieved for all OFDM symbols. |
| Note 2: | Interference from other cells and noise sources not specified in the test is assumed to be constant over subcarriers and time and shall be modelled as AWGN of appropriate power for N_{oc} to be fulfilled. |
| Note 3: | RSRP levels have been derived from other parameters for information purposes. They are not settable parameters themselves. |

Table A.8.21-4: Cell specific test parameters for E-UTRAN FDD-FDD inter frequency cell proximity detection test case (Cell 3)

| Parameter | Unit | Cell 3 | | |
|--|------------|-----------|----|----|
| | | T1 | T2 | T3 |
| E-UARFCN | | Channel 1 | | |
| CSG indicator | | False | | |
| Physical cell global identity | | 3 | | |
| CSG identity | | Not sent | | |
| $BW_{channel}$ | MHz | 10 | | |
| OCNG Patterns defined in A.3.2.1.1 (OP.1 FDD) and in A.3.2.1.2 (OP.2 FDD) | | N/A | | |
| PBCH_RA | dB | 0 | | |
| PBCH_RB | dB | | | |
| PSS_RA | dB | | | |
| SSS_RA | dB | | | |
| PCFICH_RB | dB | | | |
| PHICH_RA | dB | | | |
| PHICH_RB | dB | | | |
| PDCCH_RA | dB | | | |
| PDCCH_RB | dB | | | |
| PDSCH_RA | dB | | | |
| PDSCH_RB | dB | | | |
| OCNG_RA ^{Note 1} | dB | | | |
| OCNG_RB ^{Note 1} | dB | | | |
| \hat{E}_s / I_{ot} | dB | | | |
| N_{oc} ^{Note 2} | dBm/15 kHz | -98 | | |
| \hat{E}_s / N_{oc} | dB | -inf | | |
| RSRP ^{Note 3} | dBm/15 KHz | -inf | | |
| Propagation Condition | | AWGN | | |
| <p>Note 1: OCNG shall be used such that both cells are fully allocated and a constant total transmitted power spectral density is achieved for all OFDM symbols.</p> <p>Note 2: Interference from other cells and noise sources not specified in the test is assumed to be constant over subcarriers and time and shall be modelled as AWGN of appropriate power for N_{oc} to be fulfilled.</p> <p>Note 3: RSRP levels have been derived from other parameters for information purposes. They are not settable parameters themselves</p> | | | | |

A.8.21.2 Test Requirements

The UE shall not send an "entering" proximity indication in T2 during Negative Test.

The UE shall send an "entering" proximity indication in T3 during Positive Test.

A.8.22 E-UTRAN Discovery Signal Measurements

A.8.22.1 E-UTRAN FDD-FDD intra-frequency event triggered reporting under fading propagation conditions in synchronous cells in DRX based on CRS based discovery signal

A.8.22.1.1 Test Purpose and Environment

The purpose of the test is to verify that the UE makes correct reporting of an event when discovery signal is configured in DRX. The test will partly verify the FDD-FDD intra-frequency cell search in DRX requirements in clause 8.6.2.1.1.

The test parameters are given in Tables A.8.22.1.1-1, A.8.22.1.1-2, A.8.22.1.1-3 and A.8.22.1.1-4. In the measurement control information, it is indicated to the UE performing CRS based discovery signals measurement and event-triggered reporting with Event A3 is configured. The test consists of two successive time periods, with time duration of T1, and T2 respectively. During time duration T1, the UE shall not have any timing information of cell 2.

UE needs to be provided at least once every 500ms with new Timing Advance Command MAC control element to restart the Time alignment timer to keep UE uplink time alignment. Furthermore UE is allocated with PUSCH resource at every DRX cycle.

Table A.8.22.1.1-1: General test parameters for E-UTRAN FDD-FDD intra-frequency event triggered reporting under fading propagation conditions in synchronous cells in DRX based on CRS based discovery signal

| Parameter | Unit | Value | Comment |
|------------------------------------|------|--------|--|
| Active cell | | Cell 1 | |
| Neighbour cell | | Cell 2 | Cell to be identified. |
| E-UTRA RF Channel Number | | 1 | One FDD carrier frequency is used. |
| DMTC period | ms | 160 | As specified in IE MeasDS-Config in TS 36.331 |
| dmtc-PeriodOffset | ms | 10 | As specified in IE MeasDS-Config in TS 36.331 |
| Discovery signal occasion duration | ms | 1 | As specified in IE MeasDS-Config in TS 36.331 |
| A3-Offset | dB | -6 | |
| CP length | | Normal | |
| Hysteresis | dB | 0 | |
| Time To Trigger | s | 0 | |
| Filter coefficient | | 0 | L3 filtering is not used |
| DRX | | ON | DRX related parameters are defined in Table A.8.22.1.1-3 |
| T1 | s | 5 | |
| T2 | s | 10 | |

Table A.8.22.1.1-2: Cell specific test parameters for E-UTRAN FDD-FDD intra-frequency event triggered reporting under fading propagation conditions in synchronous cells in DRX based on CRS based discovery signal

| Parameter | Unit | Cell 1 | | Cell 2 | |
|--|-----------|---------|----|--------|----|
| | | T1 | T2 | T1 | T2 |
| E-UTRA RF Channel Number | | 1 | | 1 | |
| BW _{channel} | MHz | 10 | | 10 | |
| Measurement bandwidth | n_{PRB} | 13-37 | | 13-37 | |
| PDSCH parameters: DL Reference Measurement Channel | | R.0 FDD | | - | |

| | | | | | |
|--|------------|----------|--------|---------------------------------|-------|
| PCFICH/PDCCH/PHICH parameters: DL Reference Measurement Channel | | R.6 FDD | | R.6 FDD | |
| OCNG Patterns defined in A.3.2.1.1 (OP.1 FDD) and in A.3.2.1.2 (OP.2 FDD) | | OP.1 FDD | | OP.2 FDD | |
| PBCH_RA | dB | 0 | | 0 | |
| PBCH_RB | dB | | | | |
| PSS_RA | dB | | | | |
| SSS_RA | dB | | | | |
| PCFICH_RB | dB | | | | |
| PHICH_RA | dB | | | | |
| PHICH_RB | dB | | | | |
| PDCCH_RA | dB | | | | |
| PDCCH_RB | dB | | | | |
| PDSCH_RA | dB | | | | |
| PDSCH_RB | dB | | | | |
| OCNG_RA ^{Note 1} | dB | | | | |
| OCNG_RB ^{Note 1} | dB | | | | |
| N_{oc} ^{Note 2} | dBm/15 KHz | | | | |
| \hat{E}_s / N_{oc} | dB | 4 | 4 | -Infinity | 4 |
| \hat{E}_s / I_{ot} | dB | 4 | -1.46 | -Infinity | -1.46 |
| RSRP ^{Note 3} | dBm/15 KHz | -94 | -94 | -Infinity | -94 |
| SCH_RP ^{Note 3} | dBm/15 KHz | -94 | -94 | -Infinity | -94 |
| I_o ^{Note 3} | dBm/9MHz | -64.76 | -62.42 | Specified in columns for Cell 1 | |
| Propagation Condition | | ETU30 | | ETU30 | |
| Correlation Matrix and Antenna Configuration | | 1x2 Low | | 1x2 Low | |
| Timing offset to Cell 1 | μ s | - | | 2.3 (CP/2) | |
| <p>Note 1: OCNG shall be used such that both cells are fully allocated and a constant total transmitted power spectral density is achieved for all OFDM symbols.</p> <p>Note 2: Interference from other cells and noise sources not specified in the test is assumed to be constant over subcarriers and time and shall be modelled as AWGN of appropriate power for N_{oc} to be fulfilled.</p> <p>Note 3: E_s/I_{ot}, RSRP and SCH_RP and I_o levels have been derived from other parameters for information purposes. They are not settable parameters themselves.</p> | | | | | |

Table A.8.22.1.1-3: DRX-Configuration for E-UTRAN FDD-FDD intra-frequency event triggered reporting under fading propagation conditions in synchronous cells in DRX based on CRS based discovery signal

| Field | Value | Comment |
|--------------------------|---------|---|
| onDurationTimer | psf1 | As specified in clause 6.3.2 in TS 36.331 |
| drx-InactivityTimer | psf1 | |
| drx-RetransmissionTimer | psf1 | |
| longDRX-CycleStartOffset | sf256 | |
| shortDRX | disable | |

Table A.8.22.1.1-4: TimeAlignmentTimer-Configuration for E-UTRAN FDD-FDD intra-frequency event triggered reporting under fading propagation conditions in synchronous cells in DRX based on CRS based discovery signal

| Field | Value | Comment |
|--------------------|-------|---|
| TimeAlignmentTimer | sf500 | As specified in clause 6.3.2 in TS 36.331 |
| sr-ConfigIndex | 0 | For further information see |

| | | |
|--|--|--|
| | | clause 6.3.2 in TS 36.331 and section 10.1 in TS 36.213. |
|--|--|--|

A.8.22.1.2 Test Requirements

The UE shall send one Event A3 triggered measurement report, with a measurement reporting delay less than 4864ms from the beginning of time period T2. The measurement reporting delay is defined as the time from the beginning of time period T2 to the moment when the UE send the measurement report on PUSCH.

The UE shall not send event triggered measurement reports, as long as the reporting criteria are not fulfilled.

The rate of correct events observed during repeated tests shall be at least 90%.

NOTE 1: The actual overall delays measured in the test may be up to one DRX cycle higher than the measurement reporting delays above because UE is allowed to delay the initiation of the measurement reporting procedure to the next until the Active Time.

NOTE 2: In order to calculate the rate of correct events the system simulator shall verify that it has received correct Event A3 measurement report.

A.8.22.2 E-UTRAN TDD-TDD intra-frequency event triggered reporting under fading propagation conditions in synchronous cells in DRX based on CRS based discovery signal

A.8.22.2.1 Test Purpose and Environment

The purpose of the test is to verify that the UE makes correct reporting of an event when discovery signal is configured in DRX. The test will partly verify the TDD-TDD intra-frequency cell search in DRX requirements in clause 8.6.2.1.1.

The test parameters are given in Tables A.8.22.2.1-1, A.8.22.2.1-2, A.8.22.2.1-3 and A.8.22.2.1-4. In the measurement control information, it is indicated to the UE performing CRS based discovery signals measurement and event-triggered reporting with Event A3 is configured. The test consists of two successive time periods, with time duration of T1, and T2 respectively. During time duration T1, the UE shall not have any timing information of cell 2.

UE needs to be provided at least once every 500ms with new Timing Advance Command MAC control element to restart the Time alignment timer to keep UE uplink time alignment. Furthermore UE is allocated with PUSCH resource at every DRX cycle.

Table A.8.22.2.1-1: General test parameters for E-UTRAN TDD-TDD intra-frequency event triggered reporting under fading propagation conditions in synchronous cells in DRX based on CRS based discovery signal

| Parameter | Unit | Value | Comment |
|------------------------------------|------|--------|--|
| Active cell | | Cell 1 | |
| Neighbour cell | | Cell 2 | Cell to be identified. |
| E-UTRA RF Channel Number | | 1 | One TDD carrier frequency is used. |
| Special subframe configuration | | 6 | As specified in table 4.2-1 in TS 36.211. The same configuration in both cells |
| Uplink-downlink configuration | | 1 | As specified in table 4.2-2 in TS 36.211. The same configuration in both cells |
| DMTC period | ms | 160 | As specified in IE MeasDS-Config in TS 36.331 |
| dmtc-PeriodOffset | ms | 10 | As specified in IE MeasDS-Config in TS 36.331 |
| Discovery signal occasion duration | ms | 2 | As specified in IE MeasDS-Config in TS 36.331 |
| A3-Offset | dB | -6 | |

| | | | |
|--------------------|----|--------|--|
| CP length | | Normal | |
| Hysteresis | dB | 0 | |
| Time To Trigger | s | 0 | |
| Filter coefficient | | 0 | L3 filtering is not used |
| DRX | | ON | DRX related parameters are defined in Table A.8.22.2.1-3 |
| T1 | s | 5 | |
| T2 | s | 10 | |

Table A.8.22.2.1-2: Cell specific test parameters for E-UTRAN TDD-TDD intra-frequency event triggered reporting under fading propagation conditions in synchronous cells in DRX based on CRS based discovery signal

| Parameter | Unit | Cell 1 | | Cell 2 | |
|--|------------|----------|--------|---------------------------------|-------|
| | | T1 | T2 | T1 | T2 |
| E-UTRA RF Channel Number | | 1 | | 1 | |
| BW _{channel} | MHz | 10 | | 10 | |
| Measurement bandwidth | n_{PRB} | 13-37 | | 13-37 | |
| PDSCH parameters: DL Reference Measurement Channel | | R.0 TDD | | - | |
| PCFICH/PDCCH/PHICH parameters: DL Reference Measurement Channel | | R.6 TDD | | R.6 TDD | |
| OCNG Patterns defined in A.3.2.2.1 (OP.1 TDD) and in A.3.2.2.2 (OP.2 TDD) | | OP.1 TDD | | OP.2 TDD | |
| PBCH_RA | dB | 0 | | 0 | |
| PBCH_RB | dB | | | | |
| PSS_RA | dB | | | | |
| SSS_RA | dB | | | | |
| PCFICH_RB | dB | | | | |
| PHICH_RA | dB | | | | |
| PHICH_RB | dB | | | | |
| PDCCH_RA | dB | | | | |
| PDCCH_RB | dB | | | | |
| PDSCH_RA | dB | | | | |
| PDSCH_RB | dB | | | | |
| OCNG_RA ^{Note 1} | dB | | | | |
| OCNG_RB ^{Note 1} | dB | | | | |
| N_{oc} ^{Note 2} | dBm/15 KHz | | | | |
| \hat{E}_s/N_{oc} | dB | 4 | 4 | -Infinity | 4 |
| \hat{E}_s/I_{ot} | dB | 4 | -1.46 | -Infinity | -1.46 |
| RSRP ^{Note 3} | dBm/15 KHz | -94 | -94 | -Infinity | -94 |
| SCH_RP ^{Note 3} | dBm/15 KHz | -94 | -94 | -Infinity | -94 |
| I_o ^{Note 3} | dBm/9MHz | -64.76 | -62.42 | Specified in columns for Cell 1 | |
| Propagation Condition | | ETU30 | | ETU30 | |
| Correlation Matrix and Antenna Configuration | | 1x2 Low | | 1x2 Low | |
| Timing offset to Cell 1 | μ s | - | | 2.3 (CP/2) | |
| <p>Note 1: OCNG shall be used such that both cells are fully allocated and a constant total transmitted power spectral density is achieved for all OFDM symbols.</p> <p>Note 2: Interference from other cells and noise sources not specified in the test is assumed to be constant over subcarriers and time and shall be modelled as AWGN of appropriate power for N_{oc} to be fulfilled.</p> <p>Note 3: E_s/I_{ot}, RSRP and SCH_RP and I_o levels have been derived from other parameters for information purposes. They are not settable parameters themselves.</p> | | | | | |

Table A.8.22.2.1-3: DRX-Configuration for E-UTRAN TDD-TDD intra-frequency event triggered reporting under fading propagation conditions in synchronous cells in DRX based on CRS based discovery signal

| Field | Value | Comment |
|--------------------------|---------|---|
| onDurationTimer | psf1 | As specified in clause 6.3.2 in TS 36.331 |
| drx-InactivityTimer | psf1 | |
| drx-RetransmissionTimer | psf1 | |
| longDRX-CycleStartOffset | sf256 | |
| shortDRX | disable | |

Table A.8.22.2.1-4: TimeAlignmentTimer -Configuration for E-UTRAN TDD-TDD intra-frequency event triggered reporting under fading propagation conditions in synchronous cells in DRX based on CRS based discovery signal

| Field | Value | Comment |
|--------------------|-------|--|
| TimeAlignmentTimer | sf500 | As specified in clause 6.3.2 in TS 36.331 |
| sr-ConfigIndex | 0 | For further information see clause 6.3.2 in TS 36.331 and section 10.1 in TS 36.213. |

A.8.22.2.2 Test Requirements

The UE shall send one Event A3 triggered measurement report, with a measurement reporting delay less than 4864ms from the beginning of time period T2. The measurement reporting delay is defined as the time from the beginning of time period T2 to the moment when the UE send the measurement report on PUSCH.

The UE shall not send event triggered measurement reports, as long as the reporting criteria are not fulfilled.

The rate of correct events observed during repeated tests shall be at least 90%.

NOTE 1: The actual overall delays measured in the test may be up to one DRX cycle higher than the measurement reporting delays above because UE is allowed to delay the initiation of the measurement reporting procedure to the next until the Active Time.

NOTE 2: In order to calculate the rate of correct events the system simulator shall verify that it has received correct Event A3 measurement report.

A.8.22.3 E-UTRAN FDD-FDD inter-frequency event triggered reporting under fading propagation conditions in DRX based on CRS based discovery signal

A.8.22.3.1 Test Purpose and Environment

The purpose of the test is to verify that the UE makes correct reporting of an event when discovery signal is configured in DRX. The test will partly verify the FDD-FDD inter-frequency measurement requirements in clause 8.6.2.2.1.

The test parameters are given in Tables A.8.22.3.1-1, A.8.22.3.1-2, A.8.22.3.1-3 and A.8.22.3.1-4. In the measurement control information, it is indicated to the UE performing CRS based discovery signals measurement and event-triggered reporting with Event A3 is configured. Entire discovery signal occasion should be contained in the measurement gap. The subframe contained discovery signal for the measurement is not overlapped with the first 0.5ms period and the last 0.5ms period in every gap.

UE needs to be provided at least once every 500ms with new Timing Advance Command MAC control element to restart the Time alignment timer to keep UE uplink time alignment. Furthermore UE is allocated with PUSCH resource at every DRX cycle.

The test consists of two successive time periods, with time duration of T1, and T2 respectively. During time duration T1, the UE shall not have any timing information of cell 2.

Table A.8.22.3.1-1: General test parameters for E-UTRAN FDD-FDD inter-frequency event triggered reporting under fading propagation conditions in DRX based on CRS based discovery signal

| Parameter | Unit | Value | Comment |
|------------------------------------|------|----------|--|
| E-UTRA RF Channel Number | | 1, 2 | Two FDD carrier frequencies are used. |
| Active cell | | Cell 1 | Cell 1 is on RF channel number 1 |
| Neighbour cell | | Cell 2 | Cell 1 is on RF channel number 2 |
| Gap Pattern Id | | 0 | As specified in TS 36.133 clause 8.1.2.1. |
| Gap Offset | | 9 | As specified in TS 36.331 clause 6.3.5 |
| DMTC period | ms | 160 | As specified in IE MeasDS-Config in TS 36.331 |
| dmtc-PeriodOffset | ms | 10 | As specified in IE MeasDS-Config in TS 36.331 |
| Discovery signal occasion duration | ms | 1 | As specified in IE MeasDS-Config in TS 36.331 |
| A3-Offset | dB | -6 | |
| Hysteresis | dB | 0 | |
| CP length | | Normal | |
| Time To Trigger | s | 0 | |
| Filter coefficient | | 0 | L3 filtering is not used |
| PRACH configuration | | 4 | As specified in table 5.7.1-2 in TS 36.211 |
| Access Barring Information | - | Not Sent | No additional delays in random access procedure. |
| DRX | | ON | DRX related parameters are defined in Table A.8.22.3.1-3 |
| T1 | s | 5 | |
| T2 | s | 10 | |

Table A.8.22.3.1-2: Cell specific test parameters for E-UTRAN FDD-FDD inter-frequency event triggered reporting under fading propagation conditions in DRX based on CRS based discovery signal

| Parameter | Unit | Cell 1 | | Cell 2 | |
|---|-----------|----------|----|----------|----|
| | | T1 | T2 | T1 | T2 |
| E-UTRA RF Channel Number | | 1 | | 2 | |
| BW _{channel} | MHz | 10 | | 10 | |
| Measurement bandwidth | n_{PRB} | 13-37 | | 13-37 | |
| PDSCH parameters: DL Reference Measurement Channel | | R.0 FDD | | - | |
| PCFICH/PDCCH/PHICH parameters: DL Reference Measurement Channel | | R.6 FDD | | R.6 FDD | |
| OCNG Patterns defined in A.3.2.1.1 (OP.1 FDD) and in A.3.2.1.2 (OP.2 FDD) | | OP.1 FDD | | OP.2 FDD | |
| PBCH_RA | dB | 0 | | 0 | |
| PBCH_RB | dB | | | | |
| PSS_RA | dB | | | | |
| SSS_RA | dB | | | | |
| PCFICH_RB | dB | | | | |
| PHICH_RA | dB | | | | |
| PHICH_RB | dB | | | | |
| PDCCH_RA | dB | | | | |
| PDCCH_RB | dB | | | | |
| PDSCH_RA | dB | | | | |

| | | | | | |
|--|------------|---------|--------|-----------|--------|
| PDSCH_RB | dB | | | | |
| OCNG_RA ^{Note 1} | dB | | | | |
| OCNG_RB ^{Note 1} | dB | | | | |
| N_{oc} ^{Note 2} | dBm/15 kHz | | | -98 | |
| \hat{E}_s / N_{oc} | dB | 4 | 4 | -Infinity | 7 |
| \hat{E}_s / I_{ot} | dB | 4 | 4 | -Infinity | 7 |
| RSRP ^{Note 3} | dBm/15 kHz | -94 | -94 | -Infinity | -91 |
| SCH_RP ^{Note 3} | dBm/15 kHz | -94 | -94 | -Infinity | -91 |
| I_o ^{Note 3} | dBm/9MHz | -64.76 | -64.76 | -70.22 | -62.43 |
| Propagation Condition | | ETU30 | | ETU30 | |
| Correlation Matrix and Antenna Configuration | | 1x2 Low | | 1x2 Low | |
| Timing offset to Cell 1 | μ s | - | | 3 | |
| <p>Note 1: OCNG shall be used such that both cells are fully allocated and a constant total transmitted power spectral density is achieved for all OFDM symbols.</p> <p>Note 2: Interference from other cells and noise sources not specified in the test is assumed to be constant over subcarriers and time and shall be modelled as AWGN of appropriate power for N_{oc} to be fulfilled.</p> <p>Note 3: E_s/I_{ot}, RSRP and SCH_RP and I_o levels have been derived from other parameters for information purposes. They are not settable parameters themselves.</p> | | | | | |

Table A.8.22.3.1-3: DRX-Configuration for E-UTRAN FDD-FDD inter-frequency event triggered reporting under fading propagation conditions in DRX based on CRS based discovery signal

| Field | Value | Comment |
|--------------------------|---------|---|
| onDurationTimer | psf1 | As specified in clause 6.3.2 in TS 36.331 |
| drx-InactivityTimer | psf1 | |
| drx-RetransmissionTimer | psf1 | |
| longDRX-CycleStartOffset | sf256 | |
| shortDRX | disable | |

Table A.8.22.3.1-4: TimeAlignmentTimer -Configuration for E-UTRAN FDD-FDD inter-frequency event triggered reporting under fading propagation conditions in DRX based on CRS based discovery signal

| Field | Value | Comment |
|--------------------|-------|--|
| TimeAlignmentTimer | sf500 | As specified in clause 6.3.2 in TS 36.331 |
| sr-ConfigIndex | 0 | For further information see clause 6.3.2 in TS 36.331 and section 10.1 in TS 36.213. |

A.8.22.3.2 Test Requirements

UE shall send one Event A3 triggered measurement report, with a measurement reporting delay less than 5120 ms from the beginning of time period T2. The measurement reporting delay is defined as the time from the beginning of time period T2, to the moment when the UE starts to send preambles on the PRACH for scheduling request (SR) to obtain allocation to send the measurement report on PUSCH.

The UE shall not send event triggered measurement reports, as long as the reporting criteria are not fulfilled.

The rate of correct events observed during repeated tests shall be at least 90%.

NOTE 1: The actual overall delays measured in the test may be up to one DRX cycle higher than the measurement reporting delays above because UE is allowed to delay the initiation of the measurement reporting procedure to the next until the Active Time.

NOTE 2: In order to calculate the rate of correct events the system simulator shall verify that it has received correct Event A3 measurement report.

A.8.22.4 E-UTRAN TDD-TDD inter-frequency event triggered reporting under fading propagation conditions in DRX based on CRS based discovery signal

A.8.22.4.1 Test Purpose and Environment

The purpose of the test is to verify that the UE makes correct reporting of an event when discovery signal is configured in DRX. The test will partly verify the FDD-FDD inter-frequency measurement requirements in clause 8.6.2.2.1.

The test parameters are given in Tables A.8.22.4.1-1, A.8.22.4.1-2, A.8.22.4.1-3 and A.8.22.4.1-4. In the measurement control information, it is indicated to the UE performing CRS based discovery signals measurement and event-triggered reporting with Event A3 is configured. Entire discovery signal occasion should be contained in the measurement gap. The subframe contained discovery signal for the measurement is not overlapped with the first 0.5ms period and the last 0.5ms period in every gap.

UE needs to be provided at least once every 500ms with new Timing Advance Command MAC control element to restart the Time alignment timer to keep UE uplink time alignment. Furthermore UE is allocated with PUSCH resource at every DRX cycle.

The test consists of two successive time periods, with time duration of T1, and T2 respectively. During time duration T1, the UE shall not have any timing information of cell 2.

Table A.8.22.4.1-1: General test parameters for E-UTRAN TDD-TDD inter-frequency event triggered reporting under fading propagation conditions in DRX based on CRS based discovery signal

| Parameter | Unit | Value | Comment |
|------------------------------------|------|----------|--|
| E-UTRA RF Channel Number | | 1, 2 | Two TDD carrier frequencies are used. |
| Active cell | | Cell 1 | Cell 1 is on RF channel number 1 |
| Neighbour cell | | Cell 2 | Cell 2 is on RF channel number 2 |
| Gap Pattern Id | | 0 | As specified in TS 36.133 clause 8.1.2.1. |
| Gap Offset | | 9 | As specified in TS 36.331 clause 6.3.5 |
| Uplink-downlink configuration | | 1 | As specified in table 4.2-2 in TS 36.211. The same configuration in both cells |
| Special subframe configuration | | 6 | As specified in table 4.2-1 in TS 36.211. The same configuration in both cells |
| DMTC period | ms | 160 | As specified in IE MeasDS-Config in TS 36.331 |
| dmtc-PeriodOffset | ms | 10 | As specified in IE MeasDS-Config in TS 36.331 |
| Discovery signal occasion duration | ms | 2 | As specified in IE MeasDS-Config in TS 36.331 |
| A3-Offset | dB | -6 | |
| Hysteresis | dB | 0 | |
| CP length | | Normal | |
| Time To Trigger | s | 0 | |
| Filter coefficient | | 0 | L3 filtering is not used |
| PRACH configuration | | 4 | As specified in table 5.7.1-2 in TS 36.211 |
| Access Barring Information | - | Not Sent | No additional delays in random access procedure. |
| DRX | | ON | DRX related parameters are defined in Table A.8.22.4.1-3 |
| T1 | s | 5 | |
| T2 | s | 10 | |

Table A.8.22.4.1-2: Cell specific test parameters for E-UTRAN TDD-TDD inter-frequency event triggered reporting under fading propagation conditions in DRX based on CRS based discovery signal

| Parameter | Unit | Cell 1 | Cell 2 |
|-----------|------|--------|--------|
|-----------|------|--------|--------|

| | | T1 | T2 | T1 | T2 |
|--|------------|----------|--------|-----------------------|--------|
| E-UTRA RF Channel Number | | 1 | | 2 | |
| BW _{channel} | MHz | 10 | | 10 | |
| Measurement bandwidth | n_{PRB} | 13-37 | | 13-37 | |
| PDSCH parameters: DL Reference Measurement Channel | | R.0 TDD | | - | |
| PCFICH/PDCCH/PHICH parameters: DL Reference Measurement Channel | | R.6 TDD | | R.6 TDD | |
| OCNG Patterns defined in A.3.2.2.1 (OP.1 TDD) and in A.3.2.2.2 (OP.2 TDD) | | OP.1 TDD | | OP.2 TDD | |
| PBCH_RA | dB | 0 | | 0 | |
| PBCH_RB | dB | | | | |
| PSS_RA | dB | | | | |
| SSS_RA | dB | | | | |
| PCFICH_RB | dB | | | | |
| PHICH_RA | dB | | | | |
| PHICH_RB | dB | | | | |
| PDCCH_RA | dB | | | | |
| PDCCH_RB | dB | | | | |
| PDSCH_RA | dB | | | | |
| PDSCH_RB | dB | | | | |
| OCNG_RA ^{Note 1} | dB | | | | |
| OCNG_RB ^{Note 1} | dB | | | | |
| N_{oc} ^{Note 2} | dBm/15 kHz | | | | |
| \hat{E}_s/N_{oc} | dB | 4 | 4 | -Infinity | 7 |
| \hat{E}_s/I_{ot} | dB | 4 | 4 | -Infinity | 7 |
| RSRP ^{Note 3} | dBm/15 kHz | -94 | -94 | -Infinity | -91 |
| SCH_RP ^{Note 3} | dBm/15 kHz | -94 | -94 | -Infinity | -91 |
| I_o ^{Note 3} | dBm/9MHz | -64.76 | -64.76 | -70.22 | -62.43 |
| Propagation Condition | | ETU30 | | ETU30 | |
| Correlation Matrix and Antenna Configuration | | 1x2 Low | | 1x2 Low | |
| Timing offset to Cell 1 | μ s | - | | 3 (Synchronous cells) | |
| <p>Note 1: OCNG shall be used such that both cells are fully allocated and a constant total transmitted power spectral density is achieved for all OFDM symbols.</p> <p>Note 2: Interference from other cells and noise sources not specified in the test is assumed to be constant over subcarriers and time and shall be modelled as AWGN of appropriate power for N_{oc} to be fulfilled.</p> <p>Note 3: E_s/I_{ot}, RSRP and SCH_RP and I_o levels have been derived from other parameters for information purposes. They are not settable parameters themselves.</p> | | | | | |

Table A.8.22.4.1-3: DRX-Configuration for E-UTRAN TDD-TDD inter-frequency event triggered reporting under fading propagation conditions in DRX based on CRS based discovery signal

| Field | Value | Comment |
|--------------------------|---------|---|
| onDurationTimer | psf1 | As specified in clause 6.3.2 in TS 36.331 |
| drx-InactivityTimer | psf1 | |
| drx-RetransmissionTimer | psf1 | |
| longDRX-CycleStartOffset | sf256 | |
| shortDRX | disable | |

Table A.8.22.4.1-4: *TimeAlignmentTimer* -Configuration for E-UTRAN TDD-TDD inter-frequency event triggered reporting under fading propagation conditions in DRX based on CRS based discovery signal

| Field | Value | Comment |
|--------------------|-------|--|
| TimeAlignmentTimer | sf500 | As specified in clause 6.3.2 in TS 36.331 |
| sr-ConfigIndex | 0 | For further information see clause 6.3.2 in TS 36.331 and section 10.1 in TS 36.213. |

A.8.22.4.2 Test Requirements

UE shall send one Event A3 triggered measurement report, with a measurement reporting delay less than 5120 ms from the beginning of time period T2. The measurement reporting delay is defined as the time from the beginning of time period T2, to the moment when the UE starts to send preambles on the PRACH for scheduling request (SR) to obtain allocation to send the measurement report on PUSCH.

The UE shall not send event triggered measurement reports, as long as the reporting criteria are not fulfilled.

The rate of correct events observed during repeated tests shall be at least 90%.

NOTE 1: The actual overall delays measured in the test may be up to one DRX cycle higher than the measurement reporting delays above because UE is allowed to delay the initiation of the measurement reporting procedure to the next until the Active Time.

NOTE 2: In order to calculate the rate of correct events the system simulator shall verify that it has received correct Event A3 measurement report.

A.8.22.5 E-UTRAN FDD-FDD intra-frequency event triggered reporting in DRX based on CSI-RS based discovery signal

A.8.22.5.1 Test Purpose and Environment

The purpose of the test is to verify that the UE makes correct reporting of an event in DRX. The test will partly verify the FDD-FDD intra-frequency cell search in DRX requirements in clause 8.6.3.1.1.2.

The test parameters are given in Tables A.8.22.5.1-1, A.8.22.5.1-2, A.8.22.5.1-3 and A.8.22.5.1-4. In the measurement control information, it is indicated to the UE that event-triggered reporting with Event C2 is used. The test consists of two successive time periods, with time duration of T1, and T2 respectively. During time duration T1, the UE shall not have any timing information of cell 2.

The UE needs to be provided at least once every 500ms with new Timing Advance Command MAC control element to restart the Time alignment timer to keep UE uplink time alignment. Furthermore UE is allocated with PUSCH resource at every DRX cycle.

Table A.8.22.5.1-1: General test parameters for E-UTRAN FDD-FDD intra-frequency event triggered reporting for DRS measurement based on CSI-RS with DRX

| Parameter | Unit | Value | Comment |
|------------------------------------|------|--------|------------------------------------|
| | | Test 1 | |
| Active cell | | Cell 1 | |
| Neighbour cell | | Cell 2 | Cell to be identified. |
| E-UTRA RF Channel Number | | 1 | One FDD carrier frequency is used. |
| DMTC period [2] | ms | 160 | |
| DMTC period offset [2] | ms | 10 | |
| Discovery signal occasion duration | ms | 1 | |
| c2-Offset | dB | -6 | |
| CP length | | Normal | |
| Hysteresis | dB | 0 | |
| Time To Trigger | s | 0 | |
| Filter coefficient | | 0 | L3 filtering is not used |

| | | | |
|---------------------------|---|-------------|--|
| DRX | | ON | DRX related parameters are defined in Table A.8.22.5.1-3 |
| Time offset between cells | | 2.3 μ s | CP/2 or Synchronous cells |
| T1 | s | 5 | |
| T2 | s | 10 | |

Table A.8.22.5.1-2: Cell specific test parameters for E-UTRAN FDD-FDD intra-frequency event triggered reporting for DRS measurement based on CSI-RS with DRX

| Parameter | Unit | Cell 1 | | Cell 2 | |
|---|--------------|--|--------|--|-------|
| | | T1 | T2 | T1 | T2 |
| E-UTRA RF Channel Number | | 1 | | 1 | |
| BW _{channel} | MHz | 10 | | 10 | |
| Measurement bandwidth | <i>n</i> PRB | 13-37 | | 13-37 | |
| PDSCH parameters | | DL Reference Measurement Channel R.0 FDD as in A.3.1.1.1 | | | |
| PCFICH/PDCCH/PHICH parameters | | DL Reference Measurement Channel R.6 FDD as in A.3.1.2.1 | | DL Reference Measurement Channel R.6 FDD as in A.3.1.2.1 | |
| Correlation Matrix and Antenna Configuration | | 1x2 Low | | 1x2 Low | |
| OCNG Patterns defined in A.3.2.1.1 (OP.1 FDD) and in A.3.2.1.2 (OP.2 FDD) | | OP.1 FDD | | OP.2 FDD | |
| PBCH_RA | dB | 0 | | 0 | |
| PBCH_RB | dB | | | | |
| PSS_RA | dB | | | | |
| SSS_RA | dB | | | | |
| PCFICH_RB | dB | | | | |
| PHICH_RA | dB | | | | |
| PHICH_PB | dB | | | | |
| PDCCH_RA | dB | | | | |
| PDCCH_PB | dB | | | | |
| PDSCH_RA | dB | | | | |
| PDSCH_RB | dB | | | | |
| OCNG_RA ^{Note 1} | dB | | | | |
| OCNG_RB ^{Note 1} | dB | | | | |
| p-C-r10 [2] | dB | | | | |
| N_{oc} ^{Note 3} | dBm/15 KHz | -98 | | | |
| CRS \hat{E}_s / N_{oc} | dB | 4 | 4 | -Infinity | 4 |
| CSI-RS \hat{E}_s / N_{oc} | dB | 10 | 10 | -Infinity | 10 |
| CRS \hat{E}_s / I_{ot} | dB | 4 | -1.46 | -Infinity | -1.46 |
| CSI-RS \hat{E}_s / I_{ot} | dB | 10 | 4.54 | -Infinity | 4.54 |
| RSRP ^{Note 4} | dBm/15 KHz | -94 | -94 | -Infinity | -94 |
| CSI-RSRP ^{Note 4} | dBm/15 KHz | -88 | -88 | -Infinity | -88 |
| SCH_RP ^{Note 4} | dBm/15 KHz | -94 | -94 | -Infinity | -94 |
| I_o ^{Note 4} | dBm/9 MHz | -64.76 | -62.42 | Specied in columns for cell1 | |
| CSI reference signal configurations [16] | | 2 | | 4 | |
| CSI-RS periodicity | ms | 10 | | 10 | |
| CSI-RS subframe offset | | 0 | | 0 | |
| CSI-RS individual offset [2] | dB | 0 | | 0 | |
| CSI-RS muting | | Enable | | Enable | |
| Propagation Condition | | ETU30 | | ETU30 | |
| Timing offset to cell 1 | us | - | | 2.3 (CP/2) | |

| | |
|---------|--|
| Note 1: | OCNG shall be used such that both cells are fully allocated and a constant total transmitted power spectral density is achieved for all OFDM symbols. |
| Note 2: | The resources for uplink transmission are assigned to the UE prior to the start of time period T2. |
| Note 3: | Interference from other cells and noise sources not specified in the test is assumed to be constant over subcarriers and time and shall be modelled as AWGN of appropriate power for N_{oc} to be fulfilled. |
| Note 4: | RSRP, CSI-RSRP, SCH_RP and Io levels have been derived from other parameters for information purposes. They are not settable parameters themselves. |

Table A.8.22.5.1-3: DRX-Configuration for E-UTRAN FDD-FDD intra-frequency event triggered reporting in DRX under fading propagation conditions in synchronous cells

| Field | Value | Comment |
|--------------------------|---------|---|
| onDurationTimer | psf1 | As specified in clause 6.3.2 in TS 36.331 |
| drx-InactivityTimer | psf1 | |
| drx-RetransmissionTimer | psf1 | |
| longDRX-CycleStartOffset | Sf256 | |
| shortDRX | disable | |

Table A.8.22.5.1-4: TimeAlignmentTimer-Configuration for E-UTRAN FDD-FDD intra-frequency event triggered reporting in DRX under fading propagation conditions in synchronous cells

| Field | Value | Comment |
|--------------------|-------|--|
| TimeAlignmentTimer | sf500 | As specified in clause 6.3.2 in TS 36.331 |
| sr-ConfigIndex | 0 | For further information see clause 6.3.2 in TS 36.331 and section 10.1 in TS 36.213. |

A.8.22.5.2 Test Requirements

In Test 1, the UE shall send one Event C2 triggered measurement report, with a measurement reporting delay less than 5632ms ($T_{\text{identify_intra_SCE_DRX}} + T_{\text{Measurement_Period_intra_FDD_CSI-RS_DRX}} = 16 * \max\{T_{\text{DMTC_periodicity}}, \text{DRX cycle length}\} + 3 * \max\{T_{\text{DMTC_periodicity}}, \text{DRX cycle length}\} + 3 * \max\{T_{\text{DMTC_periodicity}}, \text{DRX cycle length}\} = 22 * \max\{T_{\text{DMTC_periodicity}}, \text{DRX cycle length}\}$) from the beginning of time period T2. The measurement reporting delay is defined as the time from the beginning of time period T2 to the moment when the UE send the measurement report on PUSCH.

The UE shall not send event triggered measurement reports, as long as the reporting criteria are not fulfilled.

The rate of correct events observed during repeated tests shall be at least 90%.

NOTE 1: The actual overall delays measured in the test may be up to one DRX cycle higher than the measurement reporting delays above because UE is allowed to delay the initiation of the measurement reporting procedure to the next until the Active Time.

NOTE 2: In order to calculate the rate of correct events the system simulator shall verify that it has received correct Event C2 measurement report.

A.8.22.6 E-UTRAN TDD-TDD intra-frequency event triggered reporting in DRX based on CSI-RS based discovery signal

A.8.22.6.1 Test Purpose and Environment

The purpose of the test is to verify that the UE makes correct reporting of an event in DRX. The test will partly verify the TDD-TDD intra-frequency cell search in DRX requirements in clause 8.6.3.1.2.2.

The test parameters are given in Tables A.8.22.6.1-1, A.8.22.6.1-2, A.8.22.6.1-3 and A.8.22.6.1-4. In the measurement control information, it is indicated to the UE that event-triggered reporting with Event C2 is used. The test consists of two successive time periods, with time duration of T1, and T2 respectively. During time duration T1, the UE shall not have any timing information of cell 2.

UE needs to be provided at least once every 500ms with new Timing Advance Command MAC control element to restart the Time alignment timer to keep UE uplink time alignment. Furthermore UE is allocated with PUSCH resource at every DRX cycle.

Table A.8.22.6.1-1: General test parameters for E-UTRAN TDD-TDD intra-frequency event triggered reporting for DRS measurement based on CSI-RS with DRX

| Parameter | Unit | Value | Comment |
|------------------------------------|------|--------|--|
| | | Test 1 | |
| Active cell | | Cell 1 | |
| Neighbour cell | | Cell 2 | Cell to be identified. |
| E-UTRA RF Channel Number | | 1 | One TDD carrier frequency is used. |
| DMTC period [2] | ms | 160 | |
| DMTC period offset [2] | ms | 10 | |
| Discovery signal occasion duration | ms | 2 | |
| c2-Offset | dB | -6 | |
| CP length | | Normal | |
| Special subframe configuration | | 6 | As specified in table 4.2-1 in TS 36.211. The same configuration in both cells |
| Uplink-downlink configuration | | 1 | As specified in table 4.2-2 in TS 36.211. The same configuration in both cells |
| Hysteresis | dB | 0 | |
| Time To Trigger | s | 0 | |
| Filter coefficient | | 0 | L3 filtering is not used |
| DRX | | ON | DRX related parameters are defined in Table A.8.22.6.1-3 |
| T1 | s | 5 | |
| T2 | s | 10 | |

Table A.8.22.6.1-2: Cell specific test parameters for E-UTRAN TDD-TDD intra-frequency event triggered reporting for DRS measurement based on CSI-RS with DRX

| Parameter | Unit | Cell 1 | | Cell 2 | |
|---|------------------------|--|----|--|----|
| | | T1 | T2 | T1 | T2 |
| E-UTRA RF Channel Number | | 1 | | 1 | |
| BW _{channel} | MHz | 10 | | 10 | |
| Measurement bandwidth | <i>n_{PRB}</i> | 13-37 | | 13-37 | |
| PDSCH parameters | | DL Reference Measurement Channel R.0 TDD as in A.3.1.1.2 | | | |
| PCFICH/PDCCH/PHICH parameters | | DL Reference Measurement Channel R.6 TDD as in A.3.1.2.2 | | DL Reference Measurement Channel R.6 TDD as in A.3.1.2.2 | |
| Correlation Matrix and Antenna Configuration | | 1x2 Low | | 1x2 Low | |
| OCNG Patterns defined in A.3.2.1.1 (OP.1 TDD) and in A.3.2.1.2 (OP.2 TDD) | | OP.1 TDD | | OP.2 TDD | |
| PBCH_RA | dB | 0 | | 0 | |
| PBCH_RB | dB | | | | |
| PSS_RA | dB | | | | |
| SSS_RA | dB | | | | |
| PCFICH_RB | dB | | | | |
| PHICH_RA | dB | | | | |
| PHICH_PB | dB | | | | |

| | | | | | |
|--|------------|--------|--------|------------------------------|-------|
| PDCCH_RA | dB | | | | |
| PDCCH_PB | dB | | | | |
| PDSCH_RA | dB | | | | |
| PDSCH_RB | dB | | | | |
| OCNG_RA ^{Note 1} | dB | | | | |
| OCNG_RB ^{Note 1} | dB | | | | |
| p-C-r10 [2] | dB | -6 | -6 | -6 | -6 |
| N_{oc} ^{Note 3} | dBm/15 KHz | -98 | | | |
| CRS \hat{E}_s/N_{oc} | dB | 4 | 4 | -Infinity | 4 |
| CSI-RS \hat{E}_s/N_{oc} | dB | 10 | 10 | -Infinity | 10 |
| CRS \hat{E}_s/I_{ot} | dB | 4 | -1.46 | -Infinity | -1.46 |
| CSI-RS \hat{E}_s/I_{ot} | dB | 10 | 4.54 | -Infinity | 4.54 |
| RSRP ^{Note 4} | dBm/15 KHz | -94 | -94 | -Infinity | -94 |
| CSI-RSRP ^{Note 4} | dBm/15 KHz | -88 | -88 | -Infinity | -88 |
| I_o ^{Note 4} | dBm/9 MHz | -64.76 | -62.42 | Specied in columns for cell1 | |
| SCH_RP ^{Note 4} | dBm/15 KHz | -94 | -94 | -Infinity | -94 |
| Propagation Condition | | ETU30 | | | |
| CSI reference signal configurations [16] | | 2 | | 4 | |
| CSI-RS periodicity | ms | 10 | | 10 | |
| CSI-RS subframe offset | | 0 | | 0 | |
| CSI-RS individual offset [2] | dB | 0 | | 0 | |
| CSI-RS muting | | Enable | | Enable | |
| Timing offset to cell 1 | us | 0 | | 2.3 (CP/2) | |
| <p>Note 1: OCNG shall be used such that both cells are fully allocated and a constant total transmitted power spectral density is achieved for all OFDM symbols.</p> <p>Note 2: The resources for uplink transmission are assigned to the UE prior to the start of time period T2.</p> <p>Note 3: Interference from other cells and noise sources not specified in the test is assumed to be constant over subcarriers and time and shall be modelled as AWGN of appropriate power for N_{oc} to be fulfilled.</p> <p>Note 4: RSRP, CSI-RSRP, SCH_RP and I_o levels have been derived from other parameters for information purposes. They are not settable parameters themselves.</p> | | | | | |

Table A.8.22.6.1-3: DRX-Configuration for E-UTRAN TDD-TDD intra-frequency event triggered reporting in DRX under fading propagation conditions in synchronous cells

| Field | Value | Comment |
|--------------------------|---------|---|
| onDurationTimer | psf1 | As specified in clause 6.3.2 in TS 36.331 |
| drx-InactivityTimer | psf1 | |
| drx-RetransmissionTimer | psf1 | |
| longDRX-CycleStartOffset | Sf256 | |
| shortDRX | disable | |

Table A.8.22.6.1-4: TimeAlignmentTimer-Configuration for E-UTRAN TDD-TDD intra-frequency event triggered reporting in DRX under fading propagation conditions in synchronous cells

| Field | Value | Comment |
|--------------------|-------|--|
| TimeAlignmentTimer | sf500 | As specified in clause 6.3.2 in TS 36.331 |
| sr-ConfigIndex | 0 | For further information see clause 6.3.2 in TS 36.331 and section 10.1 in TS 36.213. |

A.8.22.6.2 Test Requirements

The UE shall send one Event C2 triggered measurement report, with a measurement reporting delay less than 5632 ms from the beginning of time period T2. The measurement reporting delay is defined as the time from the beginning of time period T2 to the moment when the UE send the measurement report on PUSCH.

The UE shall not send event triggered measurement reports, as long as the reporting criteria are not fulfilled.

The rate of correct events observed during repeated tests shall be at least 90%.

NOTE 1: The actual overall delays measured in the test may be up to one DRX cycle higher than the measurement reporting delays above because UE is allowed to delay the initiation of the measurement reporting procedure to the next until the Active Time.

NOTE 2: In order to calculate the rate of correct events the system simulator shall verify that it has received correct Event C2 measurement report.

A.8.22.7 E-UTRAN FDD-FDD Inter-frequency event triggered reporting in DRX based on CSI-RS based discovery signal

A.8.22.7.1 Test Purpose and Environment

The purpose of the test is to verify that the UE makes correct reporting of an event in DRX. The test will partly verify the FDD-FDD inter-frequency cell search in DRX requirements in clause 8.6.3.2.1.2.

The test parameters are given in Tables A.8.22.7.1-1, A.8.22.7.1-2, A.8.22.7.1-3 and A.8.22.7.1-4. In the measurement control information, it is indicated to the UE that event-triggered reporting with Event C1 is used. Entire discovery signal occasion should be contained in the measurement gap. The subframe contained discovery signal for the measurement is not overlapped with the first 0.5ms period and the last 0.5ms period in every gap.

The test consists of two successive time periods, with time duration of T1, and T2 respectively. During time duration T1, the UE shall not have any timing information of cell 2.

The UE needs to be provided at least once every 500ms with new Timing Advance Command MAC control element to restart the Time alignment timer to keep UE uplink time alignment. Furthermore UE is allocated with PUSCH resource at every DRX cycle.

Table A.8.22.7.1-1: General test parameters for E-UTRAN FDD-FDD inter-frequency event triggered reporting for DRS measurement based on CSI-RS with DRX

| Parameter | Unit | Value | Comment |
|------------------------------------|------|--------|--|
| | | Test 1 | |
| Active cell | | Cell 1 | |
| Neighbour cell | | Cell 2 | Cell to be identified. |
| E-UTRA RF Channel Number | | 1,2 | Two FDD carrier frequency is used. |
| Gap Pattern Id | | 0 | As specified in TS 36.133 clause 8.1.2.1. |
| Gap Offset | | 9 | As specified in TS 36.331 clause 6.3.5 |
| DMTC period [2] | ms | 160 | |
| DMTC period offset [2] | ms | 10 | |
| Discovery signal occasion duration | ms | 1 | |
| C1 Threshold | dB | -96 | |
| CP length | | Normal | |
| Hysteresis | dB | 0 | |
| Time To Trigger | s | 0 | |
| Filter coefficient | | 0 | L3 filtering is not used |
| DRX | | ON | DRX related parameters are defined in Table A.8.22.7.1-3 |
| T1 | s | 5 | |
| T2 | s | 10 | |

Table A.8.22.7.1-2: Cell specific test parameters for E-UTRAN FDD-FDD inter-frequency event triggered reporting for DRS measurement based on CSI-RS with DRX

| Parameter | Unit | Cell 1 | | Cell 2 | |
|---|-------------|--|--------|--|--------|
| | | T1 | T2 | T1 | T2 |
| E-UTRA RF Channel Number | | 1 | | 2 | |
| BW _{channel} | MHz | 10 | | 10 | |
| Measurement bandwidth | <i>nPRB</i> | 13-37 | | 13-37 | |
| PDSCH parameters | | DL Reference Measurement Channel R.0 FDD as in A.3.1.1.1 | | | |
| PCFICH/PDCCH/PHICH parameters | | DL Reference Measurement Channel R.6 FDD as in A.3.1.2.1 | | DL Reference Measurement Channel R.6 FDD as in A.3.1.2.1 | |
| Correlation Matrix and Antenna Configuration | | 1x2 Low | | 1x2 Low | |
| OCNG Patterns defined in A.3.2.1.1 (OP.1 FDD) and in A.3.2.1.2 (OP.2 FDD) | | OP.1 FDD | | OP.2 FDD | |
| PBCH_RA | dB | 0 | | 0 | |
| PBCH_RB | dB | | | | |
| PSS_RA | dB | | | | |
| SSS_RA | dB | | | | |
| PCFICH_RB | dB | | | | |
| PHICH_RA | dB | | | | |
| PHICH_PB | dB | | | | |
| PDCCH_RA | dB | | | | |
| PDCCH_PB | dB | | | | |
| PDSCH_RA | dB | | | | |
| PDSCH_RB | dB | | | | |
| OCNG_RA ^{Note 1} | dB | | | | |
| OCNG_RB ^{Note 1} | dB | | | | |
| p-C-r10 [2] | dB | | | | |
| N_{oc} ^{Note 3} | dBm/15 KHz | -98 | | | |
| CRS \hat{E}_s/N_{oc} | dB | 4 | 4 | -Infinity | 7 |
| CSI-RS \hat{E}_s/N_{oc} | dB | 10 | 10 | -Infinity | 13 |
| CRS \hat{E}_s/I_{ot} | dB | 4 | 4 | -Infinity | 7 |
| CSI-RS \hat{E}_s/I_{ot} | dB | 10 | 10 | -Infinity | 13 |
| RSRP ^{Note 4} | dBm/15 KHz | -94 | -94 | -Infinity | -91 |
| CSI-RSRP ^{Note 4} | dBm/15 KHz | -88 | -88 | -Infinity | -85 |
| SCH_RP ^{Note 4} | dBm/15 KHz | -94 | -94 | -Infinity | -91 |
| I_o ^{Note 4} | dBm/9 MHz | -64.76 | -64.76 | -70.22 | -62.43 |
| Propagation Condition | | ETU30 | | | |
| CSI reference signal configurations [16] | | 2 | | 4 | |
| CSI-RS periodicity | ms | 10 | | 10 | |
| CSI-RS subframe offset | | 0 | | 0 | |
| CSI-RS individual offset [2] | dB | 0 | | 0 | |
| CSI-RS muting | | Enable | | Enable | |
| Timing offset to cell 1 | us | - | | 3us | |

| | |
|---------|--|
| Note 1: | OCNG shall be used such that both cells are fully allocated and a constant total transmitted power spectral density is achieved for all OFDM symbols. |
| Note 2: | The resources for uplink transmission are assigned to the UE prior to the start of time period T2. |
| Note 3: | Interference from other cells and noise sources not specified in the test is assumed to be constant over subcarriers and time and shall be modelled as AWGN of appropriate power for N_{oc} to be fulfilled. |
| Note 4: | RSRP, CSI-RSRP, SCH_RP and Io levels have been derived from other parameters for information purposes. They are not settable parameters themselves. |

Table A.8.22.7.1-3: DRX-Configuration for E-UTRAN FDD-FDD inter-frequency event triggered reporting in DRX under fading propagation conditions in synchronous cells

| Field | Value | Comment |
|--------------------------|---------|---------|
| onDurationTimer | psf1 | |
| drx-InactivityTimer | psf1 | |
| drx-RetransmissionTimer | psf1 | |
| longDRX-CycleStartOffset | Sf256 | |
| shortDRX | disable | |

Table A.8.22.7.1-4: TimeAlignmentTimer -Configuration for E-UTRAN FDD-FDD inter-frequency event triggered reporting in DRX under fading propagation conditions in synchronous cells

| Field | Value | Comment |
|--------------------|-------|---|
| TimeAlignmentTimer | sf500 | For further information see clause 6.3.2 in TS 36.331. |
| sr-ConfigIndex | 0 | For further information see clause 6.3.2 in TS 36.331 and section 10.1 in TS 36.213.. |

A.8.22.7.2 Test Requirements

The UE shall send one Event C1 triggered measurement report, with a measurement reporting delay less than 5888ms from the beginning of time period T2. The measurement reporting delay is defined as the time from the beginning of time period T2, to the moment when the UE send the measurement report on PUSCH.

The UE shall not send event triggered measurement reports, as long as the reporting criteria are not fulfilled.

The rate of correct events observed during repeated tests shall be at least 90%.

NOTE 1: The actual overall delays measured in the test may be up to one DRX cycle higher than the measurement reporting delays above because UE is allowed to delay the initiation of the measurement reporting procedure to the next until the Active Time.

NOTE 2: In order to calculate the rate of correct events the system simulator shall verify that it has received correct Event C1 measurement report

A.8.22.8 E-UTRAN TDD-TDD inter-frequency event triggered reporting under fading propagation condition in DRX based on CSI-RS based discovery signal

A.8.22.8.1 Test Purpose and Environment

The purpose of the test is to verify that the UE makes correct reporting of an event in DRX. The test will partly verify the TDD-TDD inter-frequency cell search in DRX requirements in clause 8.6.3.2.2.2.

The test parameters are given in Tables A.8.22.8.1-1, A.8.22.8.1-2, A.8.22.8.1-3 and A.8.22.8.1-4. In the measurement control information, it is indicated to the UE that event-triggered reporting with Event C1 is used. Entire discovery

signal occasion should be contained in the measurement gap. The subframe contained discovery signal for the measurement is not overlapped with the first 0.5ms period and the last 0.5ms period in every gap.

The test consists of two successive time periods, with time duration of T1, and T2 respectively. During time duration T1, the UE shall not have any timing information of cell 2.

The UE needs to be provided at least once every 500ms with new Timing Advance Command MAC control element to restart the Time alignment timer to keep UE uplink time alignment. Furthermore UE is allocated with PUSCH resource at every DRX cycle.

Table A.8.22.8.1-1: General test parameters for E-UTRAN TDD-TDD inter-frequency event triggered reporting for DRS measurement based on CSI-RS with DRX

| Parameter | Unit | Test 1 | Comment |
|--|------|----------|--|
| | | Value | |
| E-UTRA RF Channel Number | | 1, 2 | Two TDD carrier frequencies are used. |
| Channel Bandwidth (BW _{channel}) | MHz | 10 | |
| Active cell | | Cell 1 | Cell 1 is on RF channel number 1 |
| Neighbour cell | | Cell 2 | Cell 2 is on RF channel number 2 |
| Gap Pattern Id | | 0 | As specified in TS 36.133 clause 8.1.2.1. |
| Gap Offset | | 9 | As specified in TS 36.331 clause 6.3.5 |
| Uplink-downlink configuration | | 1 | As specified in TS 36.211 clause 4.2 Table 4.2-2 |
| Special subframe configuration | | 6 | As specified in table 4.2-1 in TS 36.211. The same configuration in both cells |
| DMTC period [2] | ms | 160 | |
| DMTC period offset [2] | ms | 10 | |
| Discovery signal occasion duration | ms | 2 | |
| C1 Threshold | dB | -96 | |
| Hysteresis | dB | 0 | |
| CP length | | Normal | |
| TimeToTrigger | s | 0 | |
| Filter coefficient | | 0 | L3 filtering is not used |
| PRACH configuration | | 4 | As specified in table 5.7.1-3 in TS 36.211 |
| Access Barring Information | - | Not Sent | No additional delays in random access procedure. |
| DRX | | ON | DRX related parameters are defined in Table A.8.22.8.1-3 |
| T1 | s | 5 | |
| T2 | s | 10 | |

Table A.8.22.8.1-2: Cell specific test parameters for E-UTRAN TDD-TDD inter-frequency event triggered reporting for DRS measurement based on CSI-RS with DRX

| Parameter | Unit | Cell 1 | | Cell 2 | |
|--|-------------|---|----|---|----|
| | | T1 | T2 | T1 | T2 |
| E-UTRA RF Channel Number | | 1 | | 2 | |
| BW _{channel} | MHz | 10 | | 10 | |
| Measurement bandwidth | <i>nPRB</i> | 13-37 | | 13-37 | |
| PDSCH parameters | | DL Reference Measurement Channel R.0 TDD as in A.3.1.1.2 | | | |
| PCFICH/PDCCH/PHICH parameters | | DL Reference Measurement Channel R.6 TDD as in A.3.1.2.2. | | DL Reference Measurement Channel R.6 TDD as in A.3.1.2.2. | |
| Correlation Matrix and Antenna Configuration | | 1x2 Low | | 1x2 Low | |

| OCNG Patterns defined in A.3.2.1.1 (OP.1 TDD) and in A.3.2.1.2 (OP.2 TDD) | | OP.1 TDD | | OP.2 TDD | |
|--|------------|----------|--------|-----------|--------|
| | | PBCH_RA | dB | 0 | |
| PBCH_RB | dB | | | | |
| PSS_RA | dB | | | | |
| SSS_RA | dB | | | | |
| PCFICH_RB | dB | | | | |
| PHICH_RA | dB | | | | |
| PHICH_PB | dB | | | | |
| PDCCH_RA | dB | | | | |
| PDCCH_PB | dB | | | | |
| PDSCH_RA | dB | | | | |
| PDSCH_RB | dB | | | | |
| OCNG_RA ^{Note 1} | dB | | | | |
| OCNG_RB ^{Note 1} | dB | | | | |
| p-C-r10 [2] | dB | -6 | -6 | -6 | -6 |
| N_{oc} ^{Note 3} | dBm/15 KHz | -98 | | | |
| CRS \hat{E}_s/N_{oc} | dB | 4 | 4 | -Infinity | 7 |
| CSI-RS \hat{E}_s/N_{oc} | dB | 10 | 10 | -Infinity | 13 |
| CRS \hat{E}_s/I_{ot} | dB | 4 | 4 | -Infinity | 7 |
| CSI-RS \hat{E}_s/I_{ot} | dB | 10 | 10 | -Infinity | 13 |
| RSRP ^{Note 4} | dBm/15 KHz | -94 | -94 | -Infinity | -91 |
| CSI-RSRP ^{Note 4} | dBm/15 KHz | -88 | -88 | -Infinity | -85 |
| SCH_RP ^{Note 4} | dBm/15 KHz | -94 | -94 | -Infinity | -91 |
| I_o ^{Note 4} | dBm/9 MHz | -64.76 | -64.76 | -70.22 | -62.43 |
| Propagation Condition | | ETU30 | | | |
| CSI reference signal configurations [16] | | 2 | | 4 | |
| CSI-RS periodicity | ms | 10 | | 10 | |
| CSI-RS subframe offset | | 0 | | 0 | |
| CSI-RS individual offset [2] | dB | 0 | | 0 | |
| CSI-RS muting | | Enable | | Enable | |
| Timing offset to cell 1 | us | - | | 3 | |
| <p>Note 1: OCNG shall be used such that both cells are fully allocated and a constant total transmitted power spectral density is achieved for all OFDM symbols.</p> <p>Note 2: The resources for uplink transmission are assigned to the UE prior to the start of time period T2.</p> <p>Note 3: Interference from other cells and noise sources not specified in the test is assumed to be constant over subcarriers and time and shall be modelled as AWGN of appropriate power for N_{oc} to be fulfilled.</p> <p>Note 4: RSRP, CSI-RSRP, SCH_RP and I_o levels have been derived from other parameters for information purposes. They are not settable parameters themselves.</p> | | | | | |

Table A.8.22.8.1-3: DRX-Configuration for E-UTRAN TDD-TDD inter-frequency event triggered reporting in DRX under fading propagation conditions in synchronous cells

| Field | Value | Comment |
|--------------------------|---------|---|
| onDurationTimer | psf1 | As specified in clause 6.3.2 in TS 36.331 |
| drx-InactivityTimer | psf1 | |
| drx-RetransmissionTimer | psf1 | |
| longDRX-CycleStartOffset | Sf256 | |
| shortDRX | disable | |

Table A.8.22.8.1-4: TimeAlignmentTimer -Configuration for E-UTRAN TDD-TDD inter-frequency event triggered reporting in DRX under fading propagation conditions in synchronous cells

| Field | Value | Comment |
|--------------------|-------|--|
| TimeAlignmentTimer | sf500 | As specified in clause 6.3.2 in TS 36.331 |
| sr-ConfigIndex | 0 | For further information see clause 6.3.2 in TS 36.331 and section 10.1 in TS 36.213. |

A.8.22.8.2 Test Requirements

In Test 1, the UE shall send one Event C1 triggered measurement report, with a measurement reporting delay less than 5888ms from the beginning of time period T2. The measurement reporting delay is defined as the time from the beginning of time period T2 to the moment when the UE send the measurement report on PUSCH.

The UE shall not send event triggered measurement reports, as long as the reporting criteria are not fulfilled.

The rate of correct events observed during repeated tests shall be at least 90%.

NOTE 1: The actual overall delays measured in the test may be up to one DRX cycle higher than the measurement reporting delays above because UE is allowed to delay the initiation of the measurement reporting procedure to the next until the Active Time.

NOTE 2: In order to calculate the rate of correct events the system simulator shall verify that it has received correct Event C1 measurement report.

A.8.22.9 E-UTRAN FDD event triggered reporting under deactivated SCell in non-DRX based on CRS based discovery signal

A.8.22.9.1 Test Purpose and Environment

The purpose of this test is to verify that the UE correctly detects events A2 (Serving cell becomes worse than threshold) and A6 (Neighbour becomes better than SCell) defined in TS 36.331 [2] when CRS based discovery signal is configured within the requirements stated in clause 8.7.2.4.1.

The test parameters are given in Tables A.8.22.9.1-1 and A.8.22.9.1-2 below. It is indicated to the UE in the measurement control information that event-triggered reporting with Events A2 (PCell and SCell) and A6 is used. The test consists of three successive time periods, with duration of T1, T2 and T3, respectively. During T1 the UE shall not have any information on cell 3. Immediately at beginning of T2 the transmission power of cell 3 is increased to same level as for cell 2, and due to usage of an offset this shall result in reporting of Event A6. At beginning of T3 the transmission powers of cells 1, 2 and 3 are reduced below a threshold value and this shall result in reporting of Event A2 for PCell and SCell, respectively.

Table A.8.22.9.1-1: General test parameters for E-UTRAN FDD event triggered reporting under deactivated SCell in non-DRX based on CRS based discovery signal

| Parameter | Unit | Value | Comment |
|-------------------------------------|------|--------|---|
| E-UTRA RF Channel Number | | 1, 2 | Two radio channels are used for this test |
| Active PCell | | Cell 1 | Primary cell on RF channel number 1. |
| Configured deactivated SCell | | Cell 2 | Configured deactivated secondary cell on RF channel number 2. |
| Neighbour cell | | Cell 3 | Neighbor cell to be identified on RF channel number 2. |
| CP length | | Normal | |
| DRX | | OFF | Continuous monitoring of primary cell |
| DMTC period | ms | 160 | As specified in IE MeasDS-Config in TS 36.331 |
| dmtc-PeriodOffset for cells 2 and 3 | ms | 10 | As specified in IE MeasDS-Config in TS 36.331 |

| | | | |
|--|-----------------|-----|---|
| Discovery signal occasion duration | ms | 1 | As specified in IE MeasDS-Config in TS 36.331 |
| A2 | Hysteresis | dB | 0 |
| | Threshold RSRP | dBm | -93 |
| | Time To Trigger | s | 0 |
| A6 | Hysteresis | dB | 0 |
| | Offset | dB | -6 |
| | Report on leave | | False |
| | Time To Trigger | s | 0 |
| Cell-individual offset for cells on RF channel number 1 | dB | 0 | Individual offset for cells on primary component carrier. |
| Cell-individual offset for cells on RF channel number 2 | dB | 0 | Individual offset for cells on secondary component carrier. |
| Filter coefficient | | 0 | L3 filtering is not used |
| SCell measurement cycle (measCycleSCell) | ms | 320 | |
| T1 | s | 10 | |
| T2 | s | 10 | |
| T3 | s | 5 | |
| NOTE: This test verifies the RRM requirement which is independent of channel bandwidth and is performed according to the principle defined in section A.3.6.1. | | | |

Table A.8.22.9.1-2: Cell specific test parameters for E-UTRAN FDD event triggered reporting under deactivated SCell in non-DRX based on CRS based discovery signal

| Parameter | Unit | Cell 1 | | | Cell 2 | | | Cell 3 | | |
|---|------------------------|----------|----|----|----------|-------|-------|-----------|-------|-------|
| | | T1 | T2 | T3 | T1 | T2 | T3 | T1 | T2 | T3 |
| E-UTRA RF Channel Number | | 1 | | | 2 | | | 2 | | |
| BW _{channel} | MHz | 10 | | | 10 | | | 10 | | |
| Measurement bandwidth | <i>n_{PRB}</i> | 13-37 | | | 13-37 | | | 13-37 | | |
| PDSCH parameters: DL Reference Measurement Channel | | R.0 FDD | | | - | | | - | | |
| PCFICH/PDCCH/PHICH parameters: DL Reference Measurement Channel | | R.6 FDD | | | R.6 FDD | | | R.6 FDD | | |
| OCNG Patterns defined in A.3.2.1.1 (OP.1 FDD) and in A.3.2.1.2 (OP.2 FDD) | | OP.1 FDD | | | OP.2 FDD | | | OP.2 FDD | | |
| PBCH_RA | dB | 0 | | | 0 | | | 0 | | |
| PBCH_RB | dB | | | | | | | | | |
| PSS_RA | dB | | | | | | | | | |
| SSS_RA | dB | | | | | | | | | |
| PCFICH_RB | dB | | | | | | | | | |
| PHICH_RA | dB | | | | | | | | | |
| PHICH_RB | dB | | | | | | | | | |
| PDCCH_RA | dB | | | | | | | | | |
| PDCCH_RB | dB | | | | | | | | | |
| PDSCH_RA | dB | | | | | | | | | |
| PDSCH_RB | dB | | | | | | | | | |
| OCNG_RA ^{Note 1} | dB | | | | | | | | | |
| OCNG_RB ^{Note 1} | dB | | | | | | | | | |
| N _{oc} ^{Note 2} | dBm/15 kHz | | | | | | | | | |
| \bar{E}_s/N_{oc} | dB | 19 | 19 | -3 | 19 | 19 | -3 | -infinity | 19 | -3 |
| \bar{E}_s/I_{ot} | dB | 19 | 19 | -3 | 19 | -0.05 | -4.76 | -infinity | -0.05 | -4.76 |

| | | | | | | | | | | |
|---|------------|---------|--------|------|---------|--------|------|------------|---------------------------------|------|
| RSRP ^{Note 3} | dBm/15 kHz | -82 | -82 | -104 | -82 | -82 | -104 | -infinity | -82 | -104 |
| SCH_RP ^{Note 3} | dBm/15 kHz | -82 | -82 | -104 | -82 | -82 | -104 | -infinity | -82 | -104 |
| Io ^{Note 3} | dBm/9MHz | -54.16 | -54.16 | - | -54.16 | -51.18 | - | 70.20 | Specified in columns for Cell 2 | |
| Propagation Condition | | ETU30 | | | ETU30 | | | ETU30 | | |
| Correlation Matrix and Antenna Configuration | | 1x2 Low | | | 1x2 Low | | | 1x2 Low | | |
| Timing offset to Cell 1 | μs | - | | | 0 | | | - | | |
| Time alignment error relative to cell 1 ^{Note 5} | μs | - | | | ≤ TAE | | | N/A | | |
| Timing offset to Cell 2 | μs | - | | | - | | | 2.3 (CP/2) | | |
| <p>Note 1: OCNG shall be used such that all cells are fully allocated and a constant total transmitted power spectral density is achieved for all OFDM symbols.</p> <p>Note 2: Interference from other cells and noise sources not specified in the test is assumed to be constant over subcarriers and time and shall be modelled as AWGN of appropriate power for N_{oc} to be fulfilled.</p> <p>Note 3: Es/lot, RSRP and SCH_RP and Io levels have been derived from other parameters for information purposes. They are not settable parameters themselves.</p> <p>Note 4: The resources for uplink transmission are assigned to the UE prior to the start of time period T2.</p> <p>Note 5: Time alignment error (TAE) as specified in TS 36.104 [30] clause 6.5.3.1. The TAE value depends upon the type of carrier aggregation.</p> | | | | | | | | | | |

A.8.22.9.2 Test Requirements

The UE shall send one Event A6 triggered measurement report with a measurement reporting delay of less than $5.12s (13 \times measCycleSCell + T_{measure_scc_CRS})$ from the beginning of time T2.

The UE shall send one Event A2 triggered measurement report for Cell 1 with a measurement reporting delay of less than $480 (3 \times T_{DMTC_periodicity})$ ms from beginning of time T3.

The UE shall send one Event A2 triggered measurement report for Cell 2 with a measurement reporting delay of less than 960ms ($3 \times measCycleSCell$) from beginning of time T3.

The UE shall not send event triggered measurement reports as long as the reporting criteria are not fulfilled.

The rate of correct events observed during repeated tests shall be at least 90% for each of the events.

NOTE: The actual overall delays measured in the tests may be up to $2 \times TTI_{DCCH}$ higher than the measurement reporting delays above because of TTI insertion uncertainty of the measurement report in DCCH.

A.8.22.10 E-UTRAN TDD event triggered reporting under deactivated SCell in non-DRX based on CRS based discovery signal

A.8.22.10.1 Test Purpose and Environment

The purpose of this test is to verify that the UE correctly detects events A2 (Serving cell becomes worse than threshold) and A6 (Neighbour becomes better than SCell) defined in TS 36.331 [2] when CRS based discovery signal is configured within the requirements stated in clause 8.7.2.4.1.

The test parameters are given in Tables A.8.22.10.1-1 and A.8.22.10.1-2 below. It is indicated to the UE in the measurement control information that event-triggered reporting with Events A2 (PCell and SCell) and A6 is used. The test consists of three successive time periods, with duration of T1, T2 and T3, respectively. During T1 the UE shall not have any information on cell 3. Immediately at beginning of T2 the transmission power of cell 3 is increased to same level as for cell 2, and due to usage of an offset this shall result in reporting of Event A6. At beginning of T3 the transmission powers of cells 1, 2 and 3 are reduced below a threshold value and this shall result in reporting of Event A2 for PCell and SCell, respectively.

Table A.8.22.10.1-1: General test parameters for E-UTRAN TDD event triggered reporting under deactivated SCell in non-DRX based on CRS based discovery signal

| Parameter | Unit | Value | Comment |
|--------------------------|------|-------|---|
| E-UTRA RF Channel Number | | 1, 2 | Two radio channels are used for this test |

| | | | | |
|--|-----------------|--------|--|---|
| Active PCell | | Cell 1 | Primary cell on RF channel number 1. | |
| Configured deactivated SCell | | Cell 2 | Configured deactivated secondary cell on RF channel number 2. | |
| Neighbour cell | | Cell 3 | Neighbor cell to be identified on RF channel number 2. | |
| CP length | | Normal | | |
| Special subframe configuration | | 6 | As specified in table 4.2.1 in TS 36.211. The same configuration applies to all cells. | |
| Uplink-downlink configuration | | 1 | | |
| DRX | | OFF | Continuous monitoring of primary cell | |
| DMTC period | ms | 160 | As specified in IE MeasDS-Config in TS 36.331 | |
| dmtc-PeriodOffset for cells 2 and 3 | ms | 10 | As specified in IE MeasDS-Config in TS 36.331 | |
| Discovery signal occasion duration | ms | 2 | As specified in IE MeasDS-Config in TS 36.331 | |
| A2 | Hysteresis | dB | 0 | Hysteresis for evaluation of event A2. |
| | Threshold RSRP | dBm | -93 | Actual RSRP threshold for event A2. Needs to take absolute accuracy tolerance in clause 9.1.14.2 into account plus margin. |
| | Time To Trigger | s | 0 | |
| A6 | Hysteresis | dB | 0 | Hysteresis for evaluation of event A6. |
| | Offset | dB | -6 | Offset parameter for evaluation of event A6. Needs to take relative accuracy tolerance in clause 9.1.14.2 into account plus margin. |
| | Report on leave | | False | |
| | Time To Trigger | s | 0 | |
| Cell-individual offset for cells on RF channel number 1 | dB | 0 | Individual offset for cells on primary component carrier. | |
| Cell-individual offset for cells on RF channel number 2 | dB | 0 | Individual offset for cells on secondary component carrier. | |
| Filter coefficient | | 0 | L3 filtering is not used | |
| SCell measurement cycle (measCycleSCell) | ms | 320 | | |
| T1 | s | 10 | | |
| T2 | s | 10 | | |
| T3 | s | 5 | | |
| NOTE: This test verifies the RRM requirement which is independent of channel bandwidth and is performed according to the principle defined in section A.3.6.1. | | | | |

Table A.8.22.10.1-2: Cell specific test parameters for E-UTRAN TDD event triggered reporting under deactivated SCell in non-DRX based on CRS based discovery signal

| Parameter | Unit | Cell 1 | | | Cell 2 | | | Cell 3 | | |
|---|-----------|----------|----|----|----------|----|----|----------|----|----|
| | | T1 | T2 | T3 | T1 | T2 | T3 | T1 | T2 | T3 |
| E-UTRA RF Channel Number | | 1 | | | 2 | | | 2 | | |
| BW _{channel} | MHz | 10 | | | 10 | | | 10 | | |
| Measurement bandwidth | n_{PRB} | 13-37 | | | 13-37 | | | 13-37 | | |
| PDSCH parameters: DL Reference Measurement Channel | | R.0 TDD | | | - | | | - | | |
| PCFICH/PDCCH/PHICH parameters: DL Reference Measurement Channel | | R.6 TDD | | | R.6 TDD | | | R.6 TDD | | |
| OCNG Patterns defined in A.3.2.2.1 (OP.1 TDD) and in A.3.2.2.2 (OP.2 TDD) | | OP.1 TDD | | | OP.2 TDD | | | OP.2 TDD | | |
| PBCH_RA | dB | 0 | | | 0 | | | 0 | | |

| | | | | | | | | | | |
|--|------------|---------|--------|------|------------|--------|-------|------------|---------------------------------|-------|
| PBCH_RB | dB | | | | | | | | | |
| PSS_RA | dB | | | | | | | | | |
| SSS_RA | dB | | | | | | | | | |
| PCFICH_RB | dB | | | | | | | | | |
| PHICH_RA | dB | | | | | | | | | |
| PHICH_RB | dB | | | | | | | | | |
| PDCCH_RA | dB | | | | | | | | | |
| PDCCH_RB | dB | | | | | | | | | |
| PDSCH_RA | dB | | | | | | | | | |
| PDSCH_RB | dB | | | | | | | | | |
| OCNG_RA ^{Note 1} | dB | | | | | | | | | |
| OCNG_RB ^{Note 1} | dB | | | | | | | | | |
| N_{oc} ^{Note 2} | dBm/15 kHz | -101 | | | -101 | | | | | |
| \bar{E}_s/N_{oc} | dB | 19 | 19 | -3 | 19 | 19 | -3 | -infinity | 19 | -3 |
| \bar{E}_s/I_{ot} | dB | 19 | 19 | -3 | 19 | -0.05 | -4.76 | -infinity | -0.05 | -4.76 |
| RSRP ^{Note 3} | dBm/15 kHz | -82 | -82 | -104 | -82 | -82 | -104 | -infinity | -82 | -104 |
| SCH_RP ^{Note 3} | dBm/15 kHz | -82 | -82 | -104 | -82 | -82 | -104 | -infinity | -82 | -104 |
| I_o ^{Note 3} | dBm/9MHz | -54.16 | -54.16 | - | -54.16 | -51.18 | - | 70.20 | Specified in columns for Cell 2 | |
| Propagation Condition | | ETU30 | | | ETU30 | | | ETU30 | | |
| Correlation Matrix and Antenna Configuration | | 1x2 Low | | | 1x2 Low | | | 1x2 Low | | |
| Timing offset to Cell 1 | μ s | - | | | 0 | | | - | | |
| Time alignment error relative to cell 1 ^{Note 5} | μ s | - | | | \leq TAE | | | N/A | | |
| Timing offset to Cell 2 | μ s | - | | | - | | | 2.3 (CP/2) | | |
| Note 1: OCNG shall be used such that all cells are fully allocated and a constant total transmitted power spectral density is achieved for all OFDM symbols. | | | | | | | | | | |
| Note 2: Interference from other cells and noise sources not specified in the test is assumed to be constant over subcarriers and time and shall be modelled as AWGN of appropriate power for N_{oc} to be fulfilled. | | | | | | | | | | |
| Note 3: \bar{E}_s/I_{ot} , RSRP and SCH_RP and I_o levels have been derived from other parameters for information purposes. They are not settable parameters themselves. | | | | | | | | | | |
| Note 4: The resources for uplink transmission are assigned to the UE prior to the start of time period T2. | | | | | | | | | | |
| Note 5: Time alignment error (TAE) as specified in TS 36.104 [30] clause 6.5.3.1. The TAE value depends upon the type of carrier aggregation. | | | | | | | | | | |

A.8.22.10.2 Test Requirements

The UE shall send one Event A6 triggered measurement report with a measurement reporting delay of less than $5.12s (13 \times measCycleSCell + T_{measure_scc_CRS})$ from the beginning of time T2.

The UE shall send one Event A2 triggered measurement report for Cell 1 with a measurement reporting delay of less than $480 (3 \times T_{DMTC_periodicity})$ ms from beginning of time T3.

The UE shall send one Event A2 triggered measurement report for Cell 2 with a measurement reporting delay of less than $960ms (3 \times measCycleSCell)$ from beginning of time T3.

The UE shall not send event triggered measurement reports as long as the reporting criteria are not fulfilled.

The rate of correct events observed during repeated tests shall be at least 90% for each of the events.

NOTE: The actual overall delays measured in the tests may be up to $2 \times TTI_{DCCH}$ higher than the measurement reporting delays above because of TTI insertion uncertainty of the measurement report in DCCH.

A.8.22.11 E-UTRAN FDD event triggered reporting under deactivated SCell in non-DRX based on CSI-RS based discovery signal

A.8.22.11.1 Test Purpose and Environment

The purpose of this test is to verify that the UE correctly detects event C1 (CSI-RS resource becomes better than threshold) defined in TS 36.331 [2] within the requirements stated in clause 8.7.3.4.1.

The test parameters are given in Tables A.8.22.11.1-1 and A.8.22.11.1-2 below. It is indicated to the UE in the measurement control information that event-triggered reporting with Events C1 is used. The test consists of three successive time periods, with duration of T1, T2 and T3, respectively. During T1 and T2 the UE shall not have any information on cell 3. Immediately at beginning of T3 the transmission power of cell 3 is increased above a threshold value and this shall result in reporting of Event C1. At beginning of T2 the transmission powers of cells 1 and 2 are increased above a threshold value and this shall result in reporting of Event C1 for PCell and SCell, respectively.

Table A.8.22.11.1-1: General test parameters for E-UTRAN FDD event triggered reporting on configured but deactivated SCell in non-DRX under fading propagation conditions for CSI-RS based measurements under discovery signal

| Parameter | | Unit | Value | Comment |
|--|--------------------|------|--------|--|
| E-UTRA RF Channel Number | | | 1, 2 | Two radio channels are used for this test |
| Active PCell | | | Cell 1 | Primary cell on RF channel number 1. |
| Configured deactivated SCell | | | Cell 2 | Configured deactivated secondary cell on RF channel number 2. |
| Neighbour cell | | | Cell 3 | Neighbor cell to be identified on RF channel number 2. |
| DMTC period | | ms | 160 | As specified in IE MeasDS-Config in TS 36.331 |
| dmtc-PeriodOffset for cells 2 and 3 | | ms | 10 | As specified in IE MeasDS-Config in TS 36.331 |
| Discovery signal occasion duration | | ms | 1 | As specified in IE MeasDS-Config in TS 36.331 |
| CP length | | | Normal | |
| DRX | | | OFF | Continuous monitoring of primary cell |
| C1 | Hysteresis | dB | 0 | Hysteresis for evaluation of event C1. |
| | Threshold CSI-RSRP | dBm | -90 | Actual RSRP threshold for event C1. Needs to take absolute accuracy tolerance in clause 9.1.14.3 into account plus margin. |
| | Time To Trigger | s | 0 | |
| Cell-individual offset for cells on RF channel number 1 | | dB | 0 | Individual offset for cells on primary component carrier. |
| Cell-individual offset for cells on RF channel number 2 | | dB | 0 | Individual offset for cells on secondary component carrier. |
| Filter coefficient | | | 0 | L3 filtering is not used |
| SCell measurement cycle (measCycleSCell) | | ms | 320 | |
| T1 | | s | 5 | |
| T2 | | s | 5 | |
| T3 | | s | 10 | |
| NOTE: This test verifies the RRM requirement which is independent of channel bandwidth and is performed according to the principle defined in section A.3.6.1. | | | | |

Table A.8.22.11.1-2: Cell specific test parameters for E-UTRAN FDD event triggered reporting on configured but deactivated SCell in non-DRX under fading propagation conditions for CSI-RS based measurements under discovery signal

| Parameter | Unit | Cell 1 | | | Cell 2 | | | Cell 3 | | |
|--|------------------------|--|----|----|--|----|----|--|----|----|
| | | T1 | T2 | T3 | T1 | T2 | T3 | T1 | T2 | T3 |
| E-UTRA RF Channel Number | | 1 | | | 2 | | | 2 | | |
| BW _{channel} | MHz | 10 | | | 10 | | | 10 | | |
| Measurement bandwidth | <i>n_{PRB}</i> | 13-37 | | | 13-37 | | | 13-37 | | |
| PDSCH parameters | | DL Reference Measurement Channel R.0 FDD as in A.3.1.1.1 | | | | | | | | |
| PCFICH/PDCCH/PHICH parameters | | DL Reference Measurement Channel R.6 FDD as in A.3.1.2.1 | | | DL Reference Measurement Channel R.6 FDD as in A.3.1.2.1 | | | DL Reference Measurement Channel R.6 FDD as in A.3.1.2.1 | | |
| Correlation Matrix and Antenna Configuration | | 1x2 Low | | | 1x2 Low | | | 1x2 Low | | |

| OCNG Patterns defined in A.3.2.1.1 (OP.1 FDD) and in A.3.2.1.2 (OP.2 FDD) | | OP.1 FDD | | | OP.2 FDD | | | OP.2 FDD | | |
|---|------------|----------|-----|-----|----------|-----|-------|------------|-----------|-------|
| PBCH_RA | dB | 0 | | | 0 | | | 0 | | |
| PBCH_RB | dB | | | | | | | | | |
| PSS_RA | dB | | | | | | | | | |
| SSS_RA | dB | | | | | | | | | |
| PCFICH_RB | dB | | | | | | | | | |
| PHICH_RA | dB | | | | | | | | | |
| PHICH_RB | dB | | | | | | | | | |
| PDCCH_RA | dB | | | | | | | | | |
| PDCCH_RB | dB | | | | | | | | | |
| PDSCH_RA | dB | | | | | | | | | |
| PDSCH_RB | dB | | | | | | | | | |
| OCNG_RA ^{Note 1} | dB | | | | | | | | | |
| OCNG_RB ^{Note 1} | dB | | | | | | | | | |
| N_{oc} ^{Note 2} | dBm/15 kHz | -101 | | | -101 | | | | | |
| RSRP ^{Note 3} | dBm/15 kHz | -104 | -84 | -84 | -104 | -84 | -84 | -infinity | -infinity | -84 |
| CSI-RSRP ^{Note 3} | dBm/15 kHz | -98 | -78 | -78 | -98 | -78 | -78 | -infinity | -infinity | -78 |
| SCH_RP ^{Note 3} | dBm/15 kHz | -104 | -84 | -84 | -104 | -84 | -84 | -infinity | -infinity | -84 |
| $CRS \hat{E}_s/N_{oc}$ | dB | -3 | 17 | 17 | -3 | 17 | 17 | -infinity | -infinity | 17 |
| $CSI-RS \hat{E}_s/N_{oc}$ | dB | 3 | 23 | 23 | 3 | 23 | 23 | -infinity | -infinity | 23 |
| $CRS \hat{E}_s/I_{ot}$ | dB | -3 | 17 | 17 | -3 | 17 | -0.09 | -infinity | -infinity | -0.09 |
| $CSI-RS \hat{E}_s/I_{ot}$ | dB | 3 | 23 | 23 | 3 | 23 | 5.91 | -infinity | -infinity | 5.91 |
| CSI-RS resource configurations [16] | | 2 | | | 4 | | | 6 | | |
| p-C-r10 [2] | dB | -6 | | | -6 | | | -6 | | |
| CSI-RS periodicity | ms | 10 | | | 10 | | | 10 | | |
| CSI-RS subframe offset | | 0 | | | 0 | | | 0 | | |
| CSI-RS individual offset [2] | [dB] | 0 | | | 0 | | | 0 | | |
| CSI-RS muting | | Enable | | | Enable | | | Enable | | |
| Propagation Condition | | ETU30 | | | ETU30 | | | ETU30 | | |
| Time offset to cell 1 | us | 0 | | | 0 | | | 2.3 (CP/2) | | |
| Time alignment error relative to cell1 ^{Note 5} | us | - | | | ≤ TAE | | | N/A | | |
| Timing offset to Cell 2 | μs | - | | | - | | | 2.3 (CP/2) | | |

Note 1: OCNG shall be used such that all cells are fully allocated and a constant total transmitted power spectral density is achieved for all OFDM symbols.

Note 2: Interference from other cells and noise sources not specified in the test is assumed to be constant over subcarriers and time and shall be modelled as AWGN of appropriate power for N_{oc} to be fulfilled.

Note 3: RSRP, CSI-RSRP and SCH_RP levels have been derived from other parameters for information purposes. They are not settable parameters themselves.

Note 4: The resources for uplink transmission are assigned to the UE prior to the start of time period T2.

Note 5: Time alignment error (TAE) as specified in TS 36.104 [30] clause 6.5.3.1. The TAE value depends upon the type of carrier aggregation.

A.8.22.11.2 Test Requirements

The UE shall send one Event C1 triggered measurement report for Cell 3 with a measurement reporting delay of less than 6.08s ($T_{\text{identify_scc_SCE}} + T_{\text{measure_scc_CSI-RS}} = 13 * \text{measCycleSCell} + T_{\text{measure_scc_CRS}} + T_{\text{measure_scc_CSI-RS}} = 13 * \text{measCycleSCell} + 3 * \text{measCycleSCell} + 3 * \text{measCycleSCell}$) from the beginning of time T3.

The UE shall send one Event C1 triggered measurement report for Cell 1 with a measurement reporting delay of less than 480 ms ($3 * T_{\text{DMTC_periodicity}}$) from beginning of time T2.

The UE shall send one Event C1 triggered measurement report for Cell 2 with a measurement reporting delay of less than 960ms ($3 * \text{measCycleSCell}$) from beginning of time T2.

The UE shall not send event triggered measurement reports as long as the reporting criteria are not fulfilled.

The rate of correct events observed during repeated tests shall be at least 90% for each of the events.

NOTE: The actual overall delays measured in the tests may be up to $2 * TTI_{\text{DCCH}}$ higher than the measurement reporting delays above because of TTI insertion uncertainty of the measurement report in DCCH.

A.8.22.12 E-UTRAN TDD event triggered reporting under deactivated SCell in non-DRX based on CSI-RS based discovery signal

A.8.22.12.1 Test Purpose and Environment

The purpose of this test is to verify that the UE correctly detects event C1 (CSI-RS resource becomes better than threshold) defined in TS 36.331 [2] within the requirements stated in clause 8.7.3.4.1.

The test parameters are given in Tables A.8.22.12.1-1 and A.8.22.12.1-2 below. It is indicated to the UE in the measurement control information that event-triggered reporting with Events C1 is used. The test consists of three successive time periods, with duration of T1, T2 and T3, respectively. During T1 and T2 the UE shall not have any information on cell 3. Immediately at beginning of T3 the transmission power of cell 3 is increased above a threshold value and this shall result in reporting of Event C1. At beginning of T2 the transmission powers of cells 1 and 2 are increased above a threshold value and this shall result in reporting of Event C1 for PCell and SCell, respectively.

Table A.8.22.12.1-1: General test parameters for E-UTRAN TDD event triggered reporting on configured but deactivated SCell in non-DRX under fading propagation conditions for CSI-RS based measurements under discovery signal

| Parameter | Unit | Value | Comment |
|---|------|--------|--|
| E-UTRA RF Channel Number | | 1, 2 | Two radio channels are used for this test |
| Active PCell | | Cell 1 | Primary cell on RF channel number 1. |
| Configured deactivated SCell | | Cell 2 | Configured deactivated secondary cell on RF channel number 2. |
| Neighbour cell | | Cell 3 | Neighbor cell to be identified on RF channel number 2. |
| DMTC period | ms | 160 | As specified in IE MeasDS-Config in TS 36.331 |
| dmtc-PeriodOffset for cells 2 and 3 | ms | 10 | As specified in IE MeasDS-Config in TS 36.331 |
| Discovery signal occasion duration | ms | 1 | As specified in IE MeasDS-Config in TS 36.331 |
| Channel Bandwidth (BW_{channel}) | MHz | 10 | Channel bandwidth for cells on primary and secondary component carriers |
| CP length | | Normal | |
| Special subframe configuration | | 6 | As specified in table 4.2.1 in TS 36.211. The same configuration applies to all cells. |
| Uplink-downlink configuration | | 1 | |
| DRX | | OFF | Continuous monitoring of primary cell |
| C1 Hysteresis | dB | 0 | Hysteresis for evaluation of event C1. |

| | | | |
|--|-----|-----|--|
| Threshold CSI-RSRP | dBm | -90 | Actual RSRP threshold for event C1. Needs to take absolute accuracy tolerance in clause 9.1.14.3 into account plus margin. |
| Time To Trigger | s | 0 | |
| Cell-individual offset for cells on RF channel number 1 | dB | 0 | Individual offset for cells on primary component carrier. |
| Cell-individual offset for cells on RF channel number 2 | dB | 0 | Individual offset for cells on secondary component carrier. |
| Filter coefficient | | 0 | L3 filtering is not used |
| SCell measurement cycle (measCycleSCell) | ms | 320 | |
| T1 | s | 5 | |
| T2 | s | 5 | |
| T3 | s | 10 | |
| NOTE: This test verifies the RRM requirement which is independent of channel bandwidth and is performed according to the principle defined in section A.3.6.1. | | | |

Table A.8.22.12.1-2: Cell specific test parameters for E-UTRAN TDD event triggered reporting on configured but deactivated SCell in non-DRX under fading propagation conditions for CSI-RS based measurements under discovery signal

| Parameter | Unit | Cell 1 | | | Cell 2 | | | Cell 3 | | |
|---|------------------------|--|-----|-----|--|-----|-----|--|-----------|-----|
| | | T1 | T2 | T3 | T1 | T2 | T3 | T1 | T2 | T3 |
| E-UTRA RF Channel Number | | 1 | | | 2 | | | 2 | | |
| BW _{channel} | MHz | 10 | | | 10 | | | 10 | | |
| Measurement bandwidth | <i>n_{PRB}</i> | 13-37 | | | 13-37 | | | 13-37 | | |
| PDSCH parameters | | DL Reference Measurement Channel R.0 TDD As in A.3.1.1.2 | | | | | | | | |
| PCFICH/PDCCH/PHICH parameters | | DL Reference Measurement Channel R.6 TDD as in A.3.1.2.2 | | | DL Reference Measurement Channel R.6 TDD as in A.3.1.2.2 | | | DL Reference Measurement Channel R.6 TDD as in A.3.1.2.2 | | |
| Correlation Matrix and Antenna Configuration | | 1x2 Low | | | 1x2 Low | | | 1x2 Low | | |
| OCNG Patterns defined in A.3.2.1.1 (OP.1 TDD) and in A.3.2.1.2 (OP.2 TDD) | | OP.1 TDD | | | OP.2 TDD | | | OP.2 TDD | | |
| PBCH_RA | dB | 0 | | | 0 | | | 0 | | |
| PBCH_RB | dB | | | | | | | | | |
| PSS_RA | dB | | | | | | | | | |
| SSS_RA | dB | | | | | | | | | |
| PCFICH_RB | dB | | | | | | | | | |
| PHICH_RA | dB | | | | | | | | | |
| PHICH_RB | dB | | | | | | | | | |
| PDCCH_RA | dB | | | | | | | | | |
| PDCCH_RB | dB | | | | | | | | | |
| PDSCH_RA | dB | | | | | | | | | |
| PDSCH_RB | dB | | | | | | | | | |
| OCNG_RA ^{Note 1} | dB | | | | | | | | | |
| OCNG_RB ^{Note 1} | dB | | | | | | | | | |
| N _{oc} ^{Note 2} | dBm/15 kHz | | | | | | | | | |
| RSRP ^{Note 3} | dBm/15 kHz | -104 | -84 | -84 | -104 | -84 | -84 | -infinity | -infinity | -84 |
| CSI-RSRP ^{Note 3} | dBm/15 kHz | -98 | -78 | -78 | -98 | -78 | -78 | -infinity | -infinity | -78 |
| SCH_RP ^{Note 3} | dBm/15 kHz | -104 | -84 | -84 | -104 | -84 | -84 | -infinity | -infinity | -84 |

| | | | | | | | | | | |
|--|--|--------|----|----|--------|----|-------|------------|-----------|-------|
| CRS \bar{E}_s/N_{oc} | dB | -3 | 17 | 17 | -3 | 17 | 17 | -infinity | -infinity | 17 |
| CSI-RS \bar{E}_s/N_{oc} | dB | 3 | 23 | 23 | 3 | 23 | 23 | -infinity | -infinity | 23 |
| CRS \bar{E}_s/I_{ot} | dB | -3 | 17 | 17 | -3 | 17 | -0.09 | -infinity | -infinity | -0.09 |
| CSI-RS \bar{E}_s/I_{ot} | dB | 3 | 23 | 23 | 3 | 23 | 5.91 | -infinity | -infinity | 5.91 |
| Propagation Condition | | ETU30 | | | ETU30 | | | ETU30 | | |
| CSI-RS resource configurations [16] | | 0 | | | 2 | | | 4 | | |
| CSI-RS periodicity | 10 | 10 | | | 10 | | | 10 | | |
| CSI-RS subframe offset | | 0 | | | 0 | | | 0 | | |
| CSI-RS individual offset [2] | [dB] | 0 | | | 0 | | | 0 | | |
| CSI-RS muting | | Enable | | | Enable | | | Enable | | |
| p-C-r10 [2] | dB | -6 | | | -6 | | | -6 | | |
| Time offset to cell 1 | us | 0 | | | 0 | | | 2.3 (CP/2) | | |
| Time alignment error relative to cell1 ^{Note 5} | us | - | | | ≤ TAE | | | N/A | | |
| Timing offset to Cell 2 | μs | - | | | - | | | 2.3 (CP/2) | | |
| Note 1: | OCNG shall be used such that all cells are fully allocated and a constant total transmitted power spectral density is achieved for all OFDM symbols. | | | | | | | | | |
| Note 2: | Interference from other cells and noise sources not specified in the test is assumed to be constant over subcarriers and time and shall be modelled as AWGN of appropriate power for N_{oc} to be fulfilled. | | | | | | | | | |
| Note 3: | RSRP, CSI-RSRP and SCH_RP levels have been derived from other parameters for information purposes. They are not settable parameters themselves. | | | | | | | | | |
| Note 4: | The resources for uplink transmission are assigned to the UE prior to the start of time period T2. | | | | | | | | | |
| Note 5: | Time alignment error (TAE) as specified in TS 36.104 [30] clause 6.5.3.1. The TAE value depends upon the type of carrier aggregation. | | | | | | | | | |

A.8.22.12.2 Test Requirements

The UE shall send one Event C1 triggered measurement report for Cell 3 with a measurement reporting delay of less than 6.08s ($T_{identify_scc_SCE} + T_{measure_scc_CSI-RS} = 13 * measCycleSCell + T_{measure_scc_CRS} + T_{measure_scc_CSI-RS} = 13 * measCycleSCell + 3 * measCycleSCell + 3 * measCycleSCell$) from the beginning of time T3.

The UE shall send one Event C1 triggered measurement report for Cell 1 with a measurement reporting delay of less than 480 ms ($3 * T_{DMTC_periodicity}$) from beginning of time T2.

The UE shall send one Event C1 triggered measurement report for Cell 2 with a measurement reporting delay of less than 960ms ($3 * measCycleSCell$) from beginning of time T2.

The UE shall not send event triggered measurement reports as long as the reporting criteria are not fulfilled.

The rate of correct events observed during repeated tests shall be at least 90% for each of the events.

NOTE: The actual overall delays measured in the tests may be up to $2 * TTI_{DCCH}$ higher than the measurement reporting delays above because of TTI insertion uncertainty of the measurement report in DCCH.

A.8.23 E-UTRAN Dual Connectivity Measurements

A.8.23.1 E-UTRAN FDD-FDD DC intra-frequency event triggered reporting with DRX in synchronous DC

A.8.23.1.1 Test Purpose and Environment

The purpose of this test is to verify that the UE makes correct reporting of intra frequency measurement. This test will partly verify the FDD intra-frequency cell search requirements in clause 8.8.2 and 8.8.3.

The test parameters are given in Table A.8.23.1.1-1, A.8.23.1.1-2, A.8.23.1.1-3 and A.8.23.1.1-4 below. In the test there are two cells: Cell1 and Cell2. Cell1 is PCell and Cell2 is PSCell. In the measurement control information it is indicated to the UE that event-triggered reporting with Events A1 (PCell and PSCell) and A2 (PCell and PSCell) is used. The test consists of three successive time periods, with duration of T1, T2 and T3, respectively. Prior to the start of the time duration T1, the UE shall be fully synchronized to Cell1 and Cell2. Prior to the start of the time duration T1, DRX configurations on MCG and SCG are enabled and DRX inactivity timers for MCG and SCG have already been expired. Immediately at beginning of T2 the transmission powers of Cell1 and Cell2 are reduced below a threshold value of event A2 and this shall result in reporting of Event A2 for PCell and PSCell, respectively. Immediately after receiving the reporting of event A2 for both PCell and PSCell, PDCCH indicating a new transmission on Cell1 shall be sent continuously to ensure that the UE would not enter the DRX state on MCG throughout T3. At beginning of T3 the transmission powers of Cell1 and Cell2 are increased above a threshold value of event A1 and this shall result in reporting of Event A1 for PCell and PSCell, respectively.

When MCG DRX is used, the uplink time alignment of Cell1 is not maintained and UE needs to use RACH to obtain UL allocation for measurement reporting in Cell1. When SCG DRX is used, the UE needs to be provided at least once every 500ms with new Timing Advance Command MAC control element to restart the Time alignment timer to keep UE uplink time alignment in Cell2. Furthermore UE is allocated with PUSCH resource at every DRX cycle.

Table A.8.23.1.1-1: General test parameters for E-UTRAN FDD-FDD DC intra-frequency event triggered reporting with DRX in synchronous DC

| Parameter | Unit | Value | Comment | |
|---|-----------------|--------|--|---|
| E-UTRA RF Channel Number | | 1, 2 | Two radio channels are used for this test. | |
| Active PCell | | Cell1 | PCell on RF channel number 1. | |
| Configured PSCell | | Cell2 | PSCell on RF channel number 2. | |
| A1 | Hysteresis | dB | 0 | Hysteresis for evaluation of event A1. |
| | Threshold RSRP | dBm | -95 | Actual RSRP threshold for event A1. Needs to take absolute accuracy tolerance in clause 9.1.11.1 and 9.1.11.2 into account plus margin. |
| | Time To Trigger | s | 0 | |
| A2 | Hysteresis | dB | 0 | Hysteresis for evaluation of event A2. |
| | Threshold RSRP | dBm | -99 | Actual RSRP threshold for event A2. Needs to take absolute accuracy tolerance in clause 9.1.11.1 and 9.1.11.2 into account plus margin. |
| | Time To Trigger | s | 0 | |
| CP length | | Normal | | |
| DRX | | ON | DRX related parameters are defined in Table A.8.23.1.1-3 | |
| Cell-individual offset for cells on RF channel number 1 | dB | 0 | Individual offset for cells on primary component carrier. | |
| Cell-individual offset for cells on RF channel number 2 | dB | 0 | Individual offset for cells on carrier frequency of Cell2. | |
| Filter coefficient | | 0 | L3 filtering is not used | |
| T1 | s | 2 | | |
| T2 | s | 10 | | |
| T3 | s | 1 | | |

Note 1: Void
 Note 2: A UE capable of both synchronous and asynchronous DC operations is not required to pass this test case in accordance with the principle defined in section A.3.11.

Table A.8.23.1.1-2: Cell specific test parameters for E-UTRAN FDD-FDD DC intra-frequency event triggered reporting with DRX in synchronous DC

| Parameter | Unit | Cell 1 | | | Cell 2 | | |
|--|---|---|--|--|---|--|--|
| | | T1 | T2 | T3 | T1 | T2 | T3 |
| E-UTRA RF Channel Number | | 1 | | | 2 | | |
| BW _{channel} | MHz | 5MHz: N _{RB,c} = 25 10MHz: N _{RB,c} = 50 20MHz: N _{RB,c} = 100 | | | 5MHz: N _{RB,c} = 25 10MHz: N _{RB,c} = 50 20MHz: N _{RB,c} = 100 | | |
| PDSCH parameters: DL Reference Measurement Channel | | 5MHz: R.5 FDD 10MHz: R.0 FDD 20MHz: R.4 FDD | | | 5MHz: R.5 FDD 10MHz: R.0 FDD 20MHz: R.4 FDD | | |
| PCFICH/PDCCH/PHICH parameters: DL Reference Measurement Channel | | 5MHz: R.11 FDD 10MHz: R.6 FDD 20MHz: R.10 FDD | | | 5MHz: R.11 FDD 10MHz: R.6 FDD 20MHz: R.10 FDD | | |
| OCNG Patterns | | 5MHz: OP.15 FDD 10MHz: OP.1 FDD 20MHz: OP.11 FDD | | | 5MHz: OP.15 FDD 10MHz: OP.1 FDD 20MHz: OP.11 FDD | | |
| PBCH_RA | dB | 0 | | | 0 | | |
| PBCH_RB | dB | | | | | | |
| PSS_RA | dB | | | | | | |
| SSS_RA | dB | | | | | | |
| PCFICH_RB | dB | | | | | | |
| PHICH_RA | dB | | | | | | |
| PHICH_PB | dB | | | | | | |
| PDCCH_RA | dB | | | | | | |
| PDCCH_PB | dB | | | | | | |
| PDSCH_RA | dB | | | | | | |
| PDSCH_RB | dB | | | | | | |
| OCNG_RA ^{Note 1} | dB | | | | | | |
| OCNG_RB ^{Note 1} | dB | | | | | | |
| N _{oc} ^{Note 2} | dBm/15 KHz | | | | | | |
| \hat{E}_s / N_{oc} | dB | 16 | -2.5 | 20 | 16 | -2.5 | 20 |
| \hat{E}_s / I_{ot} ^{Note 3} | dB | 16 | -2.5 | 20 | 16 | -2.5 | 20 |
| RSRP ^{Note 3} | dBm/15 KHz | -88 | -106.5 | -84 | -88 | -106.5 | -84 |
| SCH_RP ^{Note 3} | dBm/15 KHz | -88 | -106.5 | -84 | -88 | -106.5 | -84 |
| I _o ^{Note 3} | dBm/Ch BW | -60.11 +10log (N _{RB,c} /50) | -74.28 +10log (N _{RB,c} /50) | -56.18 +10log (N _{RB,c} /50) | -60.11 +10log (N _{RB,c} /50) | -74.28 +10log (N _{RB,c} /50) | -56.18 +10log (N _{RB,c} /50) |
| Propagation Condition | | ETU70 | | | ETU70 | | |
| Correlation Matrix and Antenna Configuration | | 1x2 Low | | | 1x2 Low | | |
| Receive Time offset to cell1 ^{Note 5} | μs | - | | | 33 | | |
| Note 1: | OCNG shall be used such that both cells are fully allocated and a constant total transmitted power spectral density is achieved for all OFDM symbols. | | | | | | |
| Note 2: | Interference from other cells and noise sources not specified in the test is assumed to be constant over subcarriers and time and shall be modelled as AWGN of appropriate power for N _{oc} to be fulfilled. | | | | | | |
| Note 3: | Es/I _{ot} , RSRP, SCH_RP and I _o levels have been derived from other parameters for information purposes. They are not settable parameters themselves. | | | | | | |
| Note 4: | The resources for uplink transmission in Cell1 are assigned to the UE prior to the start of time period T3. | | | | | | |
| Note 5: | Receive time difference between subframe boundaries of signals received from the two cells at the UE antenna connector including time alignment error between the two cells. | | | | | | |

Table A.8.23.1.1-3: DRX-Configuration for E-UTRAN FDD-FDD DC intra-frequency event triggered reporting with DRX in synchronous DC

| Field | Cell1 | Cell2 | Comment |
|--------------------------|---------|---------|---|
| | Value | Value | |
| onDurationTimer | psf1 | psf1 | As specified in clause 6.3.2 in TS 36.331 |
| drx-InactivityTimer | psf1 | psf1 | |
| drx-RetransmissionTimer | psf1 | psf1 | |
| longDRX-CycleStartOffset | sf1280 | sf80 | |
| shortDRX | disable | disable | |

Table A.8.23.1.1-4: TimeAlignmentTimer -Configuration for E-UTRAN FDD-FDD DC intra-frequency event triggered reporting with DRX in synchronous DC

| Field | Cell1 | Cell2 | Comment |
|--------------------|-------|-------|---|
| | Value | Value | |
| TimeAlignmentTimer | sf500 | sf500 | As specified in clause 6.3.2 in TS 36.331 |
| sr-ConfigIndex | 0 | 0 | For further information see clause 6.3.2 in TS 36.331 and section10.1 in TS 36.213. |

A.8.23.1.2 Test Requirements

The UE shall send one Event A2 triggered report for PCell on PCell with a measurement reporting delay less than 6.4s (5*MCG_DRX cycle) from the beginning of time period T2. The measurement reporting delay is defined as the time from the beginning of time period T2 to the moment when the UE starts to send preambles on the PRACH to obtain allocation to send the measurement report on PUSCH.

The UE shall send one Event A2 triggered report for PSCell on PCell with a measurement reporting delay less than 400ms (5*SCG_DRX cycle) from the beginning of time period T2. The measurement reporting delay is defined as the time from the beginning of time period T2 to the moment when the UE starts to send preambles on the PRACH to obtain allocation to send the measurement report on PUSCH.

The UE shall send one Event A1 triggered report for PCell on PCell with a measurement reporting delay less than 200ms from the beginning of time period T3. The measurement reporting delay is defined as the time from the beginning of time period T3 to the moment when the UE sends the measurement report on PUSCH.

The UE shall send one Event A1 triggered report for PSCell on PCell with a measurement reporting delay less than 400ms (5*SCG_DRX cycle) from the beginning of time period T3. The measurement reporting delay is defined as the time from the beginning of time period T3 to the moment when the UE sends the measurement report on PUSCH.

The UE shall not send event triggered measurement reports, as long as the reporting criteria are not fulfilled.

The rate of correct events observed during repeated tests shall be at least 90%.

A.8.23.2 E-UTRAN FDD-FDD DC intra-frequency event triggered reporting with DRX in asynchronous DC

A.8.23.2.1 Test Purpose and Environment

The purpose of this test is to verify that the UE makes correct reporting of intra frequency measurement. This test will partly verify the FDD intra-frequency cell search requirements in clause 8.8.2 and 8.8.3.

The test parameters are given in Table A.8.23.2.1-1, A.8.23.2.1-2, A.8.23.2.1-3 and A.8.23.2.1-4 below. In the test there are two cells: Cell1 and Cell2. Cell1 is PCell and Cell2 is PSCell. In the measurement control information it is indicated to the UE that event-triggered reporting with Events A1 (PCell and PSCell) and A2 (PCell and PSCell) is used. The test consists of three successive time periods, with duration of T1, T2 and T3, respectively. Prior to the start of the time duration T1, the UE shall be fully synchronized to Cell1 and Cell2. Prior to the start of the time duration T1, DRX configurations on MCG and SCG are enabled and DRX inactivity timers for MCG and SCG have already been expired.

Immediately at beginning of T2 the transmission powers of Cell1 and Cell2 are reduced below a threshold value of event A2 and this shall result in reporting of Event A2 for PCell and PSCell, respectively. Immediately after receiving the reporting of event A2 for both PCell and PSCell, PDCCH indicating a new transmission on Cell1 shall be sent continuously to ensure UE would not enter DRX state on MCG throughout T3. At beginning of T3 the transmission powers of Cell1 and Cell2 are increased above a threshold value of event A1 and this shall result in reporting of Event A1 for PCell and PSCell, respectively.

When MCG DRX is used, the uplink time alignment of Cell1 is not maintained and UE needs to use RACH to obtain UL allocation for measurement reporting in Cell1. When SCG DRX is used, the UE needs to be provided at least once every 500ms with new Timing Advance Command MAC control element to restart the Time alignment timer to keep UE uplink time alignment in Cell2. Furthermore UE is allocated with PUSCH resource at every DRX cycle.

Table A.8.23.2.1-1: General test parameters for E-UTRAN FDD-FDD DC intra-frequency event triggered reporting with DRX in asynchronous DC

| Parameter | Unit | Value | Comment | |
|---|---|--------|--|---|
| E-UTRA RF Channel Number | | 1, 2 | Two radio channels are used for this test. | |
| Active PCell | | Cell1 | PCell on RF channel number 1. | |
| Configured PSCell | | Cell2 | PSCell on RF channel number 2. | |
| A1 | Hysteresis | dB | 0 | Hysteresis for evaluation of event A1. |
| | Threshold RSRP | dBm | -95 | Actual RSRP threshold for event A1. Needs to take absolute accuracy tolerance in clause 9.1.11.1 and 9.1.11.2 into account plus margin. |
| | Time To Trigger | s | 0 | |
| A2 | Hysteresis | dB | 0 | Hysteresis for evaluation of event A2. |
| | Threshold RSRP | dBm | -99 | Actual RSRP threshold for event A2. Needs to take absolute accuracy tolerance in clause 9.1.11.1 and 9.1.11.2 into account plus margin. |
| | Time To Trigger | s | 0 | |
| CP length | | Normal | | |
| DRX | | ON | DRX related parameters are defined in Table A.8.23.2.1-3 | |
| Cell-individual offset for cells on RF channel number 1 | dB | 0 | Individual offset for cells on primary component carrier. | |
| Cell-individual offset for cells on RF channel number 2 | dB | 0 | Individual offset for cells on carrier frequency of Cell2. | |
| Filter coefficient | | 0 | L3 filtering is not used | |
| T1 | s | 2 | | |
| T2 | s | 10 | | |
| T3 | s | 1 | | |
| Note 1: | Void | | | |
| Note 2: | Even a UE capable of both synchronous and asynchronous DC operations is required to pass this test case in accordance with the principle defined in section A.3.11. | | | |

Table A.8.23.2.1-2: Cell specific test parameters for E-UTRAN FDD-FDD DC intra-frequency event triggered reporting with DRX in asynchronous DC

| Parameter | Unit | Cell 1 | | | Cell 2 | | |
|--|------|---|----|----|---|----|----|
| | | T1 | T2 | T3 | T1 | T2 | T3 |
| E-UTRA RF Channel Number | | 1 | | | 2 | | |
| BW _{channel} | MHz | 5MHz: N _{RB,c} = 25 10MHz: N _{RB,c} = 50 20MHz: N _{RB,c} = 100 | | | 5MHz: N _{RB,c} = 25 10MHz: N _{RB,c} = 50 20MHz: N _{RB,c} = 100 | | |
| PDSCH parameters: DL Reference Measurement Channel | | 5MHz: R.5 FDD 10MHz: R.0 FDD 20MHz: R.4 FDD | | | 5MHz: R.5 FDD 10MHz: R.0 FDD 20MHz: R.4 FDD | | |

| | | | | | | | |
|--|------------|--|--|--|--|--|--|
| PCFICH/PDCCH/PHICH parameters: DL Reference Measurement Channel | | 5MHz: R.11 FDD 10MHz: R.6 FDD 20MHz: R.10 FDD | | | 5MHz: R.11 FDD 10MHz: R.6 FDD 20MHz: R.10 FDD | | |
| OCNG Patterns | | 5MHz: OP.15 FDD 10MHz: OP.1 FDD 20MHz: OP.11 FDD | | | 5MHz: OP.15 FDD 10MHz: OP.1 FDD 20MHz: OP.11 FDD | | |
| PBCH_RA | dB | 0 | | | 0 | | |
| PBCH_RB | dB | | | | | | |
| PSS_RA | dB | | | | | | |
| SSS_RA | dB | | | | | | |
| PCFICH_RB | dB | | | | | | |
| PHICH_RA | dB | | | | | | |
| PHICH_PB | dB | | | | | | |
| PDCCH_RA | dB | | | | | | |
| PDCCH_PB | dB | | | | | | |
| PDSCH_RA | dB | | | | | | |
| PDSCH_RB | dB | | | | | | |
| OCNG_RA ^{Note 1} | dB | | | | | | |
| OCNG_RB ^{Note 1} | dB | | | | | | |
| N_{oc} ^{Note 2} | dBm/15 KHz | | | | | | |
| \hat{E}_s / N_{oc} | dB | 16 | -2.5 | 20 | 16 | -2.5 | 20 |
| \hat{E}_s / I_{ot} ^{Note 3} | dB | 16 | -2.5 | 20 | 16 | -2.5 | 20 |
| RSRP ^{Note 3} | dBm/15 KHz | -88 | -106.5 | -84 | -88 | -106.5 | -84 |
| SCH_RP ^{Note 3} | dBm/15 KHz | -88 | -106.5 | -84 | -88 | -106.5 | -84 |
| I_o ^{Note 3} | dBm/Ch BW | -60.11 +10log ($N_{RB,c}$ /50) | -74.28 +10log ($N_{RB,c}$ /50) | -56.18 +10log ($N_{RB,c}$ /50) | -60.11 +10log ($N_{RB,c}$ /50) | -74.28 +10log ($N_{RB,c}$ /50) | -56.18 +10log ($N_{RB,c}$ /50) |
| Propagation Condition | | ETU70 | | | ETU70 | | |
| Correlation Matrix and Antenna Configuration | | 1x2 Low | | | 1x2 Low | | |
| Receive Time offset to cell1 ^{Note 5} | μ s | - | | | 500 | | |
| <p>Note 1: OCNG shall be used such that both cells are fully allocated and a constant total transmitted power spectral density is achieved for all OFDM symbols.</p> <p>Note 2: Interference from other cells and noise sources not specified in the test is assumed to be constant over subcarriers and time and shall be modelled as AWGN of appropriate power for N_{oc} to be fulfilled.</p> <p>Note 3: E_s/I_{ot}, RSRP, SCH_RP and I_o levels have been derived from other parameters for information purposes. They are not settable parameters themselves.</p> <p>Note 4: The resources for uplink transmission in Cell1 are assigned to the UE prior to the start of time period T3.</p> <p>Note 5: Receive time difference between subframe boundaries of signals received from the two cells at the UE antenna connector including time alignment error between the two cells.</p> | | | | | | | |

Table A.8.23.2.1-3: DRX-Configuration for E-UTRAN FDD-FDD DC intra-frequency event triggered reporting with DRX in asynchronous DC

| Field | Cell1 | Cell2 | Comment |
|--------------------------|---------|---------|---|
| | Value | Value | |
| onDurationTimer | psf1 | psf1 | As specified in clause 6.3.2 in TS 36.331 |
| drx-InactivityTimer | psf1 | psf1 | |
| drx-RetransmissionTimer | psf1 | psf1 | |
| longDRX-CycleStartOffset | sf1280 | sf80 | |
| shortDRX | disable | disable | |

Table A.8.23.2.1-4: TimeAlignmentTimer -Configuration for E-UTRAN FDD-FDD DC intra-frequency event triggered reporting with DRX in asynchronous DC

| Field | Cell1 | Cell2 | Comment |
|-------|-------|-------|---------|
|-------|-------|-------|---------|

| | Value | Value | |
|--------------------|-------|-------|--|
| TimeAlignmentTimer | sf500 | sf500 | As specified in clause 6.3.2 in TS 36.331 |
| sr-ConfigIndex | 0 | 0 | For further information see clause 6.3.2 in TS 36.331 and section 10.1 in TS 36.213. |

A.8.23.2.2 Test Requirements

The UE shall send one Event A2 triggered report for PCell on PCell with a measurement reporting delay less than 6.4s (5*MCG_DRX cycle) from the beginning of time period T2. The measurement reporting delay is defined as the time from the beginning of time period T2 to the moment when the UE starts to send preambles on the PRACH to obtain allocation to send the measurement report on PUSCH.

The UE shall send one Event A2 triggered report for PSCell on PCell with a measurement reporting delay less than 400ms (5*SCG_DRX cycle) from the beginning of time period T2. The measurement reporting delay is defined as the time from the beginning of time period T2 to the moment when the UE starts to send preambles on the PRACH to obtain allocation to send the measurement report on PUSCH.

The UE shall send one Event A1 triggered report for PCell on PCell with a measurement reporting delay less than 200ms from the beginning of time period T3. The measurement reporting delay is defined as the time from the beginning of time period T3 to the moment when the UE sends the measurement report on PUSCH.

The UE shall send one Event A1 triggered report for PSCell on PCell with a measurement reporting delay less than 400ms (5*SCG_DRX cycle) from the beginning of time period T3. The measurement reporting delay is defined as the time from the beginning of time period T3 to the moment when the UE sends the measurement report on PUSCH.

The UE shall not send event triggered measurement reports, as long as the reporting criteria are not fulfilled.

The rate of correct events observed during repeated tests shall be at least 90%.

A.8.23.3 E-UTRAN TDD-TDD DC intra-frequency event triggered reporting with DRX in synchronous DC

A.8.23.3.1 Test Purpose and Environment

The purpose of this test is to verify that the UE makes correct reporting of intra frequency measurement. This test will partly verify the TDD intra-frequency cell search requirements in clause 8.8.2 and 8.8.3.

The test parameters are given in Table A.8.23.3.1-1, A.8.23.3.1-2, A.8.23.3.1-3 and A.8.23.3.1-4 below. In the test there are two cells: Cell1 and Cell2. Cell1 is PCell and Cell2 is PSCell. In the measurement control information it is indicated to the UE that event-triggered reporting with Events A1 (PCell and PSCell) and A2 (PCell and PSCell) is used. The test consists of three successive time periods, with duration of T1, T2 and T3, respectively. Prior to the start of the time duration T1, the UE shall be fully synchronized to Cell1 and Cell2. Prior to the start of the time duration T1, DRX configurations on MCG and SCG are enabled and DRX inactivity timers for MCG and SCG have already been expired. Immediately at beginning of T2 the transmission powers of Cell1 and Cell2 are reduced below a threshold value of event A2 and this shall result in reporting of Event A2 for PCell and PSCell, respectively. Immediately after receiving the reporting of event A2 for both PCell and PSCell, PDCCH indicating a new transmission on Cell1 shall be sent continuously to ensure UE would not enter DRX state on MCG throughout T3. At beginning of T3 the transmission powers of Cell1 and Cell2 are increased above a threshold value of event A1 and this shall result in reporting of Event A1 for PCell and PSCell, respectively.

When MCG DRX is used, the uplink time alignment of Cell1 is not maintained and UE needs to use RACH to obtain UL allocation for measurement reporting in Cell1. When SCG DRX is used, the UE needs to be provided at least once every 500ms with new Timing Advance Command MAC control element to restart the Time alignment timer to keep UE uplink time alignment in Cell2. Furthermore UE is allocated with PUSCH resource at every DRX cycle.

Table A.8.23.3.1-1: General test parameters for E-UTRAN TDD-TDD DC intra-frequency event triggered reporting with DRX in synchronous DC

| Parameter | Unit | Value | Comment |
|-----------|------|-------|---------|
|-----------|------|-------|---------|

| | | | | |
|---|-----------------|-----|--------|---|
| E-UTRA RF Channel Number | | | 1, 2 | Two radio channels are used for this test. |
| Active PCell | | | Cell1 | PCell on RF channel number 1. |
| Configured PSCell | | | Cell2 | PSCell on RF channel number 2. |
| A1 | Hysteresis | dB | 0 | Hysteresis for evaluation of event A1. |
| | Threshold RSRP | dBm | -95 | Actual RSRP threshold for event A1. Needs to take absolute accuracy tolerance in clause 9.1.11.1 and 9.1.11.2 into account plus margin. |
| | Time To Trigger | s | 0 | |
| A2 | Hysteresis | dB | 0 | Hysteresis for evaluation of event A2. |
| | Threshold RSRP | dBm | -99 | Actual RSRP threshold for event A2. Needs to take absolute accuracy tolerance in clause 9.1.11.1 and 9.1.11.2 into account plus margin. |
| | Time To Trigger | s | 0 | |
| CP length | | | Normal | |
| DRX | | | ON | DRX related parameters are defined in Table A.8.23.3.1-3 |
| Cell-individual offset for cells on RF channel number 1 | | dB | 0 | Individual offset for cells on primary component carrier. |
| Cell-individual offset for cells on RF channel number 2 | | dB | 0 | Individual offset for cells on carrier frequency of Cell2. |
| Filter coefficient | | | 0 | L3 filtering is not used |
| T1 | | s | 5 | |
| T2 | | s | 10 | |
| T3 | | s | 1 | |
| NOTE1: Void | | | | |

Table A.8.23.3.1-2: Cell specific test parameters for E-UTRAN TDD-TDD DC intra-frequency event triggered reporting with DRX in synchronous DC

| Parameter | Unit | Cell 1 | | | Cell 2 | | |
|---|------|---|----|----|---|----|----|
| | | T1 | T2 | T3 | T1 | T2 | T3 |
| E-UTRA RF Channel Number | | 1 | | | 2 | | |
| BW _{channel} | MHz | 5MHz: N _{RB,c} = 25 10MHz: N _{RB,c} = 50 20MHz: N _{RB,c} = 100 | | | 5MHz: N _{RB,c} = 25 10MHz: N _{RB,c} = 50 20MHz: N _{RB,c} = 100 | | |
| Special subframe configuration ^{Note 6} | | 6 | | | 6 | | |
| Uplink-downlink configuration ^{Note 6} | | 1 | | | 1 | | |
| PDSCH parameters: DL Reference Measurement Channel | | 5MHz: R.4 TDD 10MHz: R.0 TDD 20MHz: R.3 TDD | | | 5MHz: R.4 TDD 10MHz: R.0 TDD 20MHz: R.3 TDD | | |
| PCFICH/PDCCH/PHICH parameters: DL Reference Measurement Channel | | 5MHz: R.11 TDD 10MHz: R.6 TDD 20MHz: R.10 TDD | | | 5MHz: R.11 TDD 10MHz: R.6 TDD 20MHz: R.10 TDD | | |
| OCNG Patterns | | 5MHz: OP.9 TDD 10MHz: OP.1 TDD 20MHz: OP.7 TDD | | | 5MHz: OP.9 TDD 10MHz: OP.1 TDD 20MHz: OP.7 TDD | | |
| PBCH_RA | dB | 0 | | | 0 | | |
| PBCH_RB | dB | | | | | | |
| PSS_RA | dB | | | | | | |
| SSS_RA | dB | | | | | | |
| PCFICH_RB | dB | | | | | | |
| PHICH_RA | dB | | | | | | |
| PHICH_PB | dB | | | | | | |
| PDCCH_RA | dB | | | | | | |
| PDCCH_PB | dB | | | | | | |
| PDSCH_RA | dB | | | | | | |

| | | | | | | | |
|---|------------|--|--|--|--|--|--|
| PDSCH_RB | dB | | | | | | |
| OCNG_RA ^{Note 1} | dB | | | | | | |
| OCNG_RB ^{Note 1} | dB | | | | | | |
| N_{oc} ^{Note 2} | dBm/15 KHz | -104 | | | -104 | | |
| \hat{E}_s/N_{oc} | dB | 16 | -2.5 | 20 | 16 | -2.5 | 20 |
| \hat{E}_s/I_{ot} ^{Note 3} | dB | 16 | -2.5 | 20 | 16 | -2.5 | 20 |
| RSRP ^{Note 3} | dBm/15 KHz | -88 | -106.5 | -84 | -88 | -106.5 | -84 |
| SCH_RP ^{Note 3} | dBm/15 KHz | -88 | -106.5 | -84 | -88 | -106.5 | -84 |
| I_o ^{Note 3} | dBm/Ch BW | -60.11 +10log ($N_{RB,c}$ /50) | -74.28 +10log ($N_{RB,c}$ /50) | -56.18 +10log ($N_{RB,c}$ /50) | -60.11 +10log ($N_{RB,c}$ /50) | -74.28 +10log ($N_{RB,c}$ /50) | -56.18 +10log ($N_{RB,c}$ /50) |
| Propagation Condition | | ETU70 | | | ETU70 | | |
| Correlation Matrix and Antenna Configuration | | 1x2 Low | | | 1x2 Low | | |
| Receive Time offset to cell1 ^{Note 5} | µs | - | | | 33 | | |
| <p>Note 1: OCNG shall be used such that both cells are fully allocated and a constant total transmitted power spectral density is achieved for all OFDM symbols.</p> <p>Note 2: Interference from other cells and noise sources not specified in the test is assumed to be constant over subcarriers and time and shall be modelled as AWGN of appropriate power for N_{oc} to be fulfilled.</p> <p>Note 3: E_s/I_{ot}, RSRP, SCH_RP and I_o levels have been derived from other parameters for information purposes. They are not settable parameters themselves.</p> <p>Note 4: The resources for uplink transmission in Cell1 are assigned to the UE prior to the start of time period T3.</p> <p>Note 5: Receive time difference between subframe boundaries of signals received from the two cells at the UE antenna connector including time alignment error between the two cells.</p> <p>Note 6: For special subframe and uplink-downlink configurations see Tables 4.2-1 and 4.2-2 in TS 36.211 [16].</p> | | | | | | | |

Table A.8.23.3.1-3: DRX-Configuration for E-UTRAN TDD-TDD DC intra-frequency event triggered reporting with DRX in synchronous DC

| Field | Cell1 | Cell2 | Comment |
|--------------------------|---------|---------|---|
| | Value | Value | |
| onDurationTimer | psf1 | psf1 | As specified in clause 6.3.2 in TS 36.331 |
| drx-InactivityTimer | psf1 | psf1 | |
| drx-RetransmissionTimer | psf1 | psf1 | |
| longDRX-CycleStartOffset | sf1280 | sf80 | |
| shortDRX | disable | disable | |

Table A.8.23.3.1-4: TimeAlignmentTimer-Configuration for E-UTRAN TDD-TDD DC intra-frequency event triggered reporting with DRX in synchronous DC

| Field | Cell1 | Cell2 | Comment |
|--------------------|-------|-------|--|
| | Value | Value | |
| TimeAlignmentTimer | sf500 | sf500 | As specified in clause 6.3.2 in TS 36.331 |
| sr-ConfigIndex | 0 | 0 | For further information see clause 6.3.2 in TS 36.331 and section 10.1 in TS 36.213. |

A.8.23.3.2 Test Requirements

The UE shall send one Event A2 triggered report for PCell on PCell with a measurement reporting delay less than 6.4s (5*MCG_DRX cycle) from the beginning of time period T2. The measurement reporting delay is defined as the time from the beginning of time period T2 to the moment when the UE starts to send preambles on the PRACH to obtain allocation to send the measurement report on PUSCH.

The UE shall send one Event A2 triggered report for PSCell on PCell with a measurement reporting delay less than 400ms (5*SCG_DRX cycle) from the beginning of time period T2. The measurement reporting delay is defined as the time from the beginning of time period T2 to the moment when the UE starts to send preambles on the PRACH to obtain allocation to send the measurement report on PUSCH.

The UE shall send one Event A1 triggered report for PCell on PCell with a measurement reporting delay less than 200ms from the beginning of time period T3. The measurement reporting delay is defined as the time from the beginning of time period T3 to the moment when the UE sends the measurement report on PUSCH.

The UE shall send one Event A1 triggered report for PSCell on PCell with a measurement reporting delay less than 400ms (5*SCG_DRX cycle) from the beginning of time period T3. The measurement reporting delay is defined as the time from the beginning of time period T3 to the moment when the UE sends the measurement report on PUSCH.

The UE shall not send event triggered measurement reports, as long as the reporting criteria are not fulfilled.

The rate of correct events observed during repeated tests shall be at least 90%.

A.8.23.4 E-UTRAN FDD-FDD DC inter-frequency event triggered reporting with DRX in synchronous DC

A.8.23.4.1 Test Purpose and Environment

The purpose of this test is to verify that the UE makes correct reporting of inter frequency measurement. This test will partly verify the FDD inter-frequency cell search requirements in clause 8.8.4.

The test parameters are given in Table A.8.23.4.1-1, A.8.23.4.1-2, A.8.23.4.1-3 and A.8.23.4.1-4 below. In the test there are three cells: Cell1, Cell2 and Cell3. Cell1 is PCell, Cell2 is PSCell and Cell3 is a neighbour cell. In the measurement control information it is indicated to the UE that event-triggered reporting with Events A3 (PCell) is used. The test consists of two successive time periods, with duration of T1 and T2, respectively. Prior to the start of the time duration T1, the UE shall be fully synchronized to Cell1 and Cell2. During T1 the UE shall not have any information on Cell3. Prior to the start of the time duration T1, DRX configurations on MCG and SCG are enabled and DRX inactivity timers for MCG and SCG have already been expired.

In this test, UE needs to be provided at least once every 500ms with new Timing Advance Command MAC control element to restart the Time alignment timer to keep UE uplink time alignment in Cell1. Furthermore UE is allocated with PUSCH resource at every DRX cycle.

Table A.8.23.4.1-1: General test parameters for E-UTRAN FDD-FDD DC inter-frequency event triggered reporting with DRX in synchronous DC

| Parameter | | Unit | Value | Comment |
|---|-----------------|------|---------|--|
| E-UTRA RF Channel Number | | | 1, 2, 3 | Three radio channels are used for this test. |
| Active PCell | | | Cell1 | PCell on RF channel number 1. |
| Configured PSCell | | | Cell2 | PSCell on RF channel number 2. |
| Neighbour cell | | | Cell3 | Neighbour cell on RF channel number 3. |
| A3 | Hysteresis | dB | 0 | Hysteresis for evaluation of event A3. |
| | A3-offset | dB | -6 | |
| | Time To Trigger | s | 0 | |
| CP length | | | Normal | |
| DRX | | | ON | DRX related parameters are defined in Table A.8.23.4.1-3 |
| Measurement gap pattern Id | | | 0 | |
| Cell-individual offset for cells on RF channel number 1 | | dB | 0 | Individual offset for cells on primary component carrier. |
| Cell-individual offset for cells on RF channel number 2 | | dB | 0 | Individual offset for cells on carrier frequency of Cell2. |
| Cell-individual offset for cells on RF channel number 3 | | dB | 0 | Individual offset for cells on carrier frequency of Cell3. |

| | | | |
|--|---|---|--------------------------|
| Filter coefficient | | 0 | L3 filtering is not used |
| T1 | s | 5 | |
| T2 | s | 5 | |
| Note 1: Void | | | |
| Note 2: A UE capable of both synchronous and asynchronous DC operations is not required to pass this test case in accordance with the principle defined in section A.3.11. | | | |

Table A.8.23.4.1-2: Cell specific test parameters for E-UTRAN FDD-FDD DC inter-frequency event triggered reporting with DRX in synchronous DC

| Parameter | Unit | Cell1 | | Cell2 | | Cell3 | |
|---|------------|---|--------------------------------------|---|--------------------------------------|---|--------------------------------------|
| | | T1 | T2 | T1 | T2 | T1 | T2 |
| E-UTRA RF Channel Number | | 1 | | 2 | | 3 | |
| BW _{channel} | MHz | 5MHz: N _{RB,c} = 25 10MHz: N _{RB,c} = 50 20MHz: N _{RB,c} = 100 | | 5MHz: N _{RB,c} = 25 10MHz: N _{RB,c} = 50 20MHz: N _{RB,c} = 100 | | 5MHz: N _{RB,c} = 25 10MHz: N _{RB,c} = 50 20MHz: N _{RB,c} = 100 | |
| PDSCH parameters: DL Reference Measurement Channel | | 5MHz: R.5 FDD 10MHz: R.0 FDD 20MHz: R.4 FDD | | 5MHz: R.5 FDD 10MHz: R.0 FDD 20MHz: R.4 FDD | | - | |
| PCFICH/PDCCH/PHICH parameters: DL Reference Measurement Channel | | 5MHz: R.11 FDD 10MHz: R.6 FDD 20MHz: R.10 FDD | | 5MHz: R.11 FDD 10MHz: R.6 FDD 20MHz: R.10 FDD | | 5MHz: R.11 FDD 10MHz: R.6 FDD 20MHz: R.10 FDD | |
| OCNG Patterns | | 5MHz: OP.15 FDD 10MHz: OP.1 FDD 20MHz: OP.11 FDD | | 5MHz: OP.15 FDD 10MHz: OP.1 FDD 20MHz: OP.11 FDD | | 5MHz: OP.16 FDD 10MHz: OP.2 FDD 20MHz: OP.12 FDD | |
| PBCH_RA | dB | 0 | | 0 | | 0 | |
| PBCH_RB | dB | | | | | | |
| PSS_RA | dB | | | | | | |
| SSS_RA | dB | | | | | | |
| PCFICH_RB | dB | | | | | | |
| PHICH_RA | dB | | | | | | |
| PHICH_PB | dB | | | | | | |
| PDCCH_RA | dB | | | | | | |
| PDCCH_PB | dB | | | | | | |
| PDSCH_RA | dB | | | | | | |
| PDSCH_RB | dB | | | | | | |
| OCNG_RA ^{Note 1} | dB | | | | | | |
| OCNG_RB ^{Note 1} | dB | | | | | | |
| N _{oc} ^{Note 2} | dBm/15 KHz | -101 | | -101 | | -101 | |
| \hat{E}_s / N_{oc} | dB | 4 | 4 | 4 | 4 | -infinity | 7 |
| \hat{E}_s / I_{ot} ^{Note 3} | dB | 4 | 4 | 4 | 4 | -infinity | 7 |
| RSRP ^{Note 3} | dBm/15 KHz | -97 | -97 | -97 | -97 | -infinity | -94 |
| SCH_RP ^{Note 3} | dBm/15 KHz | -97 | -97 | -97 | -97 | -infinity | -94 |
| I _o ^{Note 3} | dBm/Ch BW | -67.76 +10log(N _{RB,c} /50) | -67.76 +10log(N _{RB,c} /50) | -67.76 +10log(N _{RB,c} /50) | -67.76 +10log(N _{RB,c} /50) | -73.22 +10log(N _{RB,c} /50) | -65.43 +10log(N _{RB,c} /50) |
| Propagation Condition | | ETU70 | | ETU70 | | ETU70 | |
| Correlation Matrix and Antenna Configuration | | 1x2 Low | | 1x2 Low | | 1x2 Low | |
| Receive Time offset to cell1 ^{Note 4} | µs | - | | 33 | | - | |
| Time offset to cell1 | µs | - | | - | | 3 | |

| | |
|---------|--|
| Note 1: | OCNG shall be used such that both cells are fully allocated and a constant total transmitted power spectral density is achieved for all OFDM symbols. |
| Note 2: | Interference from other cells and noise sources not specified in the test is assumed to be constant over subcarriers and time and shall be modelled as AWGN of appropriate power for N_{oc} to be fulfilled. |
| Note 3: | Es/lot, RSRP, SCH_RP and lo levels have been derived from other parameters for information purposes. They are not settable parameters themselves. |
| Note 4: | Receive time difference between subframe boundaries of signals received from the two cells at the UE antenna connector including time alignment error between the two cells. |

Table A.8.23.4.1-3: DRX-Configuration for E-UTRAN FDD-FDD DC inter-frequency event triggered reporting with DRX in synchronous DC

| Field | Cell1 | Cell2 | Comment |
|--------------------------|---------|---------|---|
| | Value | Value | |
| onDurationTimer | psf1 | psf1 | As specified in clause 6.3.2 in TS 36.331 |
| drx-InactivityTimer | psf1 | psf1 | |
| drx-RetransmissionTimer | psf1 | psf1 | |
| longDRX-CycleStartOffset | sf80 | sf1280 | |
| shortDRX | disable | disable | |

Table A.8.23.4.1-4: TimeAlignmentTimer -Configuration for E-UTRAN FDD-FDD DC inter-frequency event triggered reporting with DRX in synchronous DC

| Field | Cell1 | Cell2 | Comment |
|--------------------|-------|-------|--|
| | Value | Value | |
| TimeAlignmentTimer | sf500 | sf500 | As specified in clause 6.3.2 in TS 36.331 |
| sr-ConfigIndex | 0 | 0 | For further information see clause 6.3.2 in TS 36.331 and section 10.1 in TS 36.213. |

A.8.23.4.2 Test Requirements

The UE shall send one Event A3 triggered measurement report for Cell 3 on PCell, with a measurement reporting delay less than 3.84s from the beginning of time period T2. The measurement reporting delay is defined as the time from the beginning of time period T2 to the moment when the UE sends the measurement report on PUSCH.

The UE shall not send event triggered measurement reports, as long as the reporting criteria are not fulfilled.

The rate of correct events observed during repeated tests shall be at least 90%.

A.8.23.5 E-UTRAN FDD-FDD DC inter-frequency event triggered reporting with DRX in asynchronous DC

A.8.23.5.1 Test Purpose and Environment

The purpose of this test is to verify that the UE makes correct reporting of inter frequency measurement. This test will partly verify the FDD inter-frequency cell search requirements in clause 8.8.4.

The test parameters are given in Table A.8.23.5.1-1, A.8.23.5.1-2, A.8.23.5.1-3 and A.8.23.5.1-4 below. In the test there are three cells: Cell1, Cell2 and Cell3. Cell1 is PCell, Cell2 is PSCell and Cell3 is a neighbour cell. In the measurement control information it is indicated to the UE that event-triggered reporting with Events A3 (PCell) is used. The test consists of two successive time periods, with duration of T1 and T2, respectively. Prior to the start of the time duration T1, the UE shall be fully synchronized to Cell1 and Cell2. During T1 the UE shall not have any information on Cell3. Prior to the start of the time duration T1, DRX configurations on MCG and SCG are enabled and DRX inactivity timers for MCG and SCG have already been expired.

In this test, UE needs to be provided at least once every 500ms with new Timing Advance Command MAC control element to restart the Time alignment timer to keep UE uplink time alignment in Cell1. Furthermore UE is allocated with PUSCH resource at every DRX cycle.

Table A.8.23.5.1-1: General test parameters for E-UTRAN FDD-FDD DC inter-frequency event triggered reporting with DRX in asynchronous DC

| Parameter | | Unit | Value | Comment |
|---|-----------------|------|---------|--|
| E-UTRA RF Channel Number | | | 1, 2, 3 | Three radio channels are used for this test. |
| Active PCell | | | Cell1 | PCell on RF channel number 1. |
| Configured PSCell | | | Cell2 | PSCell on RF channel number 2. |
| Neighbour cell | | | Cell3 | Neighbour cell on RF channel number 3. |
| A3 | Hysteresis | dB | 0 | Hysteresis for evaluation of event A3. |
| | A3-offset | dB | -6 | |
| | Time To Trigger | s | 0 | |
| CP length | | | Normal | |
| DRX | | | ON | DRX related parameters are defined in Table A.8.23.4.1-3 |
| Measurement gap pattern Id | | | 0 | |
| Cell-individual offset for cells on RF channel number 1 | | dB | 0 | Individual offset for cells on primary component carrier. |
| Cell-individual offset for cells on RF channel number 2 | | dB | 0 | Individual offset for cells on carrier frequency of Cell2. |
| Cell-individual offset for cells on RF channel number 3 | | dB | 0 | Individual offset for cells on carrier frequency of Cell3. |
| Filter coefficient | | | 0 | L3 filtering is not used |
| T1 | | s | 5 | |
| T2 | | s | 5 | |
| Note 1: Void | | | | |
| Note 2: Even a UE capable of both synchronous and asynchronous DC operations is required to pass this test case in accordance with the principle defined in section A.3.11. | | | | |

Table A.8.23.5.1-2: Cell specific test parameters for E-UTRAN FDD-FDD DC inter-frequency event triggered reporting with DRX in asynchronous DC

| Parameter | Unit | Cell1 | | Cell2 | | Cell3 | |
|--|------|---|----|---|----|---|----|
| | | T1 | T2 | T1 | T2 | T1 | T2 |
| E-UTRA RF Channel Number | | 1 | | 2 | | 3 | |
| BW _{channel} | MHz | 5MHz: N _{RB,c} = 25 10MHz: N _{RB,c} = 50 20MHz: N _{RB,c} = 100 | | 5MHz: N _{RB,c} = 25 10MHz: N _{RB,c} = 50 20MHz: N _{RB,c} = 100 | | 5MHz: N _{RB,c} = 25 10MHz: N _{RB,c} = 50 20MHz: N _{RB,c} = 100 | |
| PDSCH parameters: DL Reference Measurement Channel | | 5MHz: R.5 FDD 10MHz: R.0 FDD 20MHz: R.4 FDD | | 5MHz: R.5 FDD 10MHz: R.0 FDD 20MHz: R.4 FDD | | - | |
| PCFICH/PDCCH/PHICH parameters: DL Reference Measurement Channel | | 5MHz: R.11 FDD 10MHz: R.6 FDD 20MHz: R.10 FDD | | 5MHz: R.11 FDD 10MHz: R.6 FDD 20MHz: R.10 FDD | | 5MHz: R.11 FDD 10MHz: R.6 FDD 20MHz: R.10 FDD | |
| OCNG Patterns | | 5MHz: OP.15 FDD 10MHz: OP.1 FDD 20MHz: OP.11 FDD | | 5MHz: OP.15 FDD 10MHz: OP.1 FDD 20MHz: OP.11 FDD | | 5MHz: OP.16 FDD 10MHz: OP.2 FDD 20MHz: OP.12 FDD | |
| PBCH_RA | dB | 0 | | 0 | | 0 | |
| PBCH_RB | dB | | | | | | |
| PSS_RA | dB | | | | | | |
| SSS_RA | dB | | | | | | |
| PCFICH_RB | dB | | | | | | |
| PHICH_RA | dB | | | | | | |
| PHICH_PB | dB | | | | | | |
| PDCCH_RA | dB | | | | | | |
| PDCCH_PB | dB | | | | | | |
| PDSCH_RA | dB | | | | | | |
| PDSCH_RB | dB | | | | | | |
| OCNG_RA ^{Note 1} | dB | | | | | | |

| | | | | | | | |
|---|------------|--|--|--|--|--|--|
| OCNG_RB ^{Note 1} | dB | | | | | | |
| N_{oc} ^{Note 2} | dBm/15 KHz | -101 | | -101 | | -101 | |
| \hat{E}_s / N_{oc} | dB | 4 | 4 | 4 | 4 | -infinity | 7 |
| \hat{E}_s / I_{ot} ^{Note 3} | dB | 4 | 4 | 4 | 4 | -infinity | 7 |
| RSRP ^{Note 3} | dBm/15 KHz | -97 | -97 | -97 | -97 | -infinity | -94 |
| SCH_RP ^{Note 3} | dBm/15 KHz | -97 | -97 | -97 | -97 | -infinity | -94 |
| I_o ^{Note 3} | dBm/Ch BW | -67.76 +10log ($N_{RB,c}$ /50) | -67.76 +10log ($N_{RB,c}$ /50) | -67.76 +10log ($N_{RB,c}$ /50) | -67.76 +10log ($N_{RB,c}$ /50) | -73.22 +10log ($N_{RB,c}$ /50) | -65.43 +10log ($N_{RB,c}$ /50) |
| Propagation Condition | | ETU70 | | ETU70 | | ETU70 | |
| Correlation Matrix and Antenna Configuration | | 1x2 Low | | 1x2 Low | | 1x2 Low | |
| Receive time offset to cell1 ^{Note 4} | μ s | - | | 500 | | - | |
| Time offset to cell1 | μ s | - | | - | | 400 | |
| <p>Note 1: OCNG shall be used such that both cells are fully allocated and a constant total transmitted power spectral density is achieved for all OFDM symbols.</p> <p>Note 2: Interference from other cells and noise sources not specified in the test is assumed to be constant over subcarriers and time and shall be modelled as AWGN of appropriate power for N_{oc} to be fulfilled.</p> <p>Note 3: E_s/I_{ot}, RSRP, SCH_RP and I_o levels have been derived from other parameters for information purposes. They are not settable parameters themselves.</p> <p>Note 4: Receive time difference between subframe boundaries of signals received from the two cells at the UE antenna connector including time alignment error between the two cells.</p> | | | | | | | |

Table A.8.23.5.1-3: DRX-Configuration for E-UTRAN FDD-FDD DC inter-frequency event triggered reporting with DRX in asynchronous DC

| Field | Cell1 | Cell2 | Comment |
|--------------------------|---------|---------|---|
| | Value | Value | |
| onDurationTimer | psf1 | psf1 | As specified in clause 6.3.2 in TS 36.331 |
| drx-InactivityTimer | psf1 | psf1 | |
| drx-RetransmissionTimer | psf1 | psf1 | |
| longDRX-CycleStartOffset | sf80 | sf1280 | |
| shortDRX | disable | disable | |

Table A.8.23.5.1-4: TimeAlignmentTimer-Configuration for E-UTRAN FDD-FDD DC inter-frequency event triggered reporting with DRX in asynchronous DC

| Field | Cell1 | Cell2 | Comment |
|--------------------|-------|-------|--|
| | Value | Value | |
| TimeAlignmentTimer | sf500 | sf500 | As specified in clause 6.3.2 in TS 36.331 |
| sr-ConfigIndex | 0 | 0 | For further information see clause 6.3.2 in TS 36.331 and section 10.1 in TS 36.213. |

A.8.23.5.2 Test Requirements

The UE shall send one Event A3 triggered measurement report for Cell 3 on PCell, with a measurement reporting delay less than 3.84s from the beginning of time period T2. The measurement reporting delay is defined as the time from the beginning of time period T2 to the moment when the UE sends the measurement report on PUSCH.

The UE shall not send event triggered measurement reports, as long as the reporting criteria are not fulfilled.

The rate of correct events observed during repeated tests shall be at least 90%.

A.8.23.6 E-UTRAN TDD-TDD DC inter-frequency event triggered reporting with DRX in synchronous DC

A.8.23.6.1 Test Purpose and Environment

The purpose of this test is to verify that the UE makes correct reporting of inter frequency measurement. This test will partly verify the TDD inter-frequency cell search requirements in clause 8.8.4.

The test parameters are given in Table A.8.23.6.1-1, A.8.23.6.1-2, A.8.23.6.1-3 and A.8.23.6.1-4 below. In the test there are three cells: Cell1, Cell2 and Cell3. Cell1 is PCell, Cell2 is PSCell and Cell3 is a neighbour cell. In the measurement control information it is indicated to the UE that event-triggered reporting with Events A3 (PCell) is used. The test consists of two successive time periods, with duration of T1 and T2, respectively. Prior to the start of the time duration T1, the UE shall be fully synchronized to Cell1 and Cell2. During T1 the UE shall not have any information on Cell3. Prior to the start of the time duration T1, DRX configurations on MCG and SCG are enabled and DRX inactivity timers for MCG and SCG have already been expired.

In this test, UE needs to be provided at least once every 500ms with new Timing Advance Command MAC control element to restart the Time alignment timer to keep UE uplink time alignment in Cell1. Furthermore UE is allocated with PUSCH resource at every DRX cycle.

Table A.8.23.6.1-1: General test parameters for E-UTRAN TDD-TDD DC inter-frequency event triggered reporting with DRX in synchronous DC

| Parameter | Unit | Value | Comment | |
|---|-----------------|---------|--|--|
| E-UTRA RF Channel Number | | 1, 2, 3 | Three radio channels are used for this test. | |
| Active PCell | | Cell1 | PCell on RF channel number 1. | |
| Configured PSCell | | Cell2 | PSCell on RF channel number 2. | |
| Neighbour cell | | Cell3 | Neighbour cell on RF channel number 3. | |
| A3 | Hysteresis | dB | 0 | Hysteresis for evaluation of event A3. |
| | A3-offset | dB | -6 | |
| | Time To Trigger | s | 0 | |
| CP length | | Normal | | |
| DRX | | ON | DRX related parameters are defined in Table A.8.23.4.1-3 | |
| Measurement gap pattern Id | | 0 | | |
| Cell-individual offset for cells on RF channel number 1 | dB | 0 | Individual offset for cells on primary component carrier. | |
| Cell-individual offset for cells on RF channel number 2 | dB | 0 | Individual offset for cells on carrier frequency of Cell2. | |
| Cell-individual offset for cells on RF channel number 3 | dB | 0 | Individual offset for cells on carrier frequency of Cell3. | |
| Filter coefficient | | 0 | L3 filtering is not used | |
| T1 | s | 5 | | |
| T2 | s | 5 | | |
| Note 1: | Void | | | |

Table A.8.23.6.1-2: Cell specific test parameters for E-UTRAN TDD-TDD DC inter-frequency event triggered reporting with DRX in synchronous DC

| Parameter | Unit | Cell1 | | Cell2 | | Cell3 | |
|--|------|---|----|---|----|---|----|
| | | T1 | T2 | T1 | T2 | T1 | T2 |
| E-UTRA RF Channel Number | | 1 | | 2 | | 3 | |
| BW _{channel} | MHz | 5MHz: N _{RB,c} = 25 10MHz: N _{RB,c} = 50 20MHz: N _{RB,c} = 100 | | 5MHz: N _{RB,c} = 25 10MHz: N _{RB,c} = 50 20MHz: N _{RB,c} = 100 | | 5MHz: N _{RB,c} = 25 10MHz: N _{RB,c} = 50 20MHz: N _{RB,c} = 100 | |
| Special subframe configuration ^{Note 5} | | 6 | | 6 | | 6 | |

| | | | | | | | |
|--|---------------|--|--|--|--|---|--|
| Uplink-downlink configuration ^{Note 5} | | 1 | | 1 | | 1 | |
| PDSCH parameters: DL Reference Measurement Channel | | 5MHz: R.4 TDD 10MHz: R.0 TDD 20MHz: R.3 TDD | | 5MHz: R.4 TDD 10MHz: R.0 TDD 20MHz: R.3 TDD | | - | |
| PCFICH/PDCCH/PHICH parameters: DL Reference Measurement Channel | | 5MHz: R.11 TDD 10MHz: R.6 TDD 20MHz: R.10 TDD | | 5MHz: R.11 TDD 10MHz: R.6 TDD 20MHz: R.10 TDD | | 5MHz: R.11 TDD 10MHz: R.6 TDD 20MHz: R.10 TDD | |
| OCNG Patterns | | 5MHz: OP.9 TDD 10MHz: OP.1 TDD 20MHz: OP.7 TDD | | 5MHz: OP.9 TDD 10MHz: OP.1 TDD 20MHz: OP.7 TDD | | 5MHz: OP.10 TDD 10MHz: OP.2 TDD 20MHz: OP.8 TDD | |
| PBCH_RA | dB | 0 | | 0 | | 0 | |
| PBCH_RB | dB | | | | | | |
| PSS_RA | dB | | | | | | |
| SSS_RA | dB | | | | | | |
| PCFICH_RB | dB | | | | | | |
| PHICH_RA | dB | | | | | | |
| PHICH_PB | dB | | | | | | |
| PDCCH_RA | dB | | | | | | |
| PDCCH_PB | dB | | | | | | |
| PDSCH_RA | dB | | | | | | |
| PDSCH_RB | dB | | | | | | |
| OCNG_RA ^{Note 1} | dB | | | | | | |
| OCNG_RB ^{Note 1} | dB | | | | | | |
| N_{oc} ^{Note 2} | dBm/15 KHz | -101 | | -101 | | -101 | |
| \hat{E}_s / N_{oc} | dB | 4 | 4 | 4 | 4 | -infinity | 7 |
| \hat{E}_s / I_{ot} ^{Note 3} | dB | 4 | 4 | 4 | 4 | -infinity | 7 |
| RSRP ^{Note 3} | dBm/15 KHz | -97 | -97 | -97 | -97 | -infinity | -94 |
| SCH_RP ^{Note 3} | dBm/15 KHz | -97 | -97 | -97 | -97 | -infinity | -94 |
| I_o ^{Note 3} | dBm/Ch BW | -67.76 +10log ($N_{RB,c}$ /50) | -67.76 +10log ($N_{RB,c}$ /50) | -67.76 +10log ($N_{RB,c}$ /50) | -67.76 +10log ($N_{RB,c}$ /50) | -73.22 +10log ($N_{RB,c}$ /50) | -65.43 +10log ($N_{RB,c}$ /50) |
| Propagation Condition | | ETU70 | | ETU70 | | ETU70 | |
| Correlation Matrix and Antenna Configuration | | 1x2 Low | | 1x2 Low | | 1x2 Low | |
| Receive Time offset to cell1 ^{Note 4} | μ s | - | | 33 | | - | |
| Time offset to cell1 | μ s | - | | - | | 3 | |
| <p>Note 1: OCNG shall be used such that both cells are fully allocated and a constant total transmitted power spectral density is achieved for all OFDM symbols.</p> <p>Note 2: Interference from other cells and noise sources not specified in the test is assumed to be constant over subcarriers and time and shall be modelled as AWGN of appropriate power for N_{oc} to be fulfilled.</p> <p>Note 3: E_s/I_{ot}, RSRP, SCH_RP and I_o levels have been derived from other parameters for information purposes. They are not settable parameters themselves.</p> <p>Note 4: Receive time difference between subframe boundaries of signals received from the two cells at the UE antenna connector including time alignment error between the two cells.</p> <p>Note 5: For special subframe and uplink-downlink configurations see Tables 4.2-1 and 4.2-2 in TS 36.211 [16].</p> | | | | | | | |

Table A.8.23.6.1-3: DRX-Configuration for E-UTRAN TDD-TDD DC inter-frequency event triggered reporting with DRX in synchronous DC

| Field | Cell1 | Cell2 | Comment |
|--------------------------|---------|---------|---|
| | Value | Value | |
| onDurationTimer | psf1 | psf1 | As specified in clause 6.3.2 in TS 36.331 |
| drx-InactivityTimer | psf1 | psf1 | |
| drx-RetransmissionTimer | psf1 | psf1 | |
| longDRX-CycleStartOffset | sf80 | sf1280 | |
| shortDRX | disable | disable | |

Table A.8.23.6.1-4: TimeAlignmentTimer -Configuration for E-UTRAN TDD-TDD DC inter-frequency event triggered reporting with DRX in synchronous DC

| Field | Cell1 | Cell2 | Comment |
|--------------------|-------|-------|---|
| | Value | Value | |
| TimeAlignmentTimer | sf500 | sf500 | As specified in clause 6.3.2 in TS 36.331 |
| sr-ConfigIndex | 0 | 0 | For further information see clause 6.3.2 in TS 36.331 and section10.1 in TS 36.213. |

A.8.23.6.2 Test Requirements

The UE shall send one Event A3 triggered measurement report for Cell 3 on PCell, with a measurement reporting delay less than 3.84s from the beginning of time period T2. The measurement reporting delay is defined as the time from the beginning of time period T2 to the moment when the UE sends the measurement report on PUSCH.

The UE shall not send event triggered measurement reports, as long as the reporting criteria are not fulfilled.

The rate of correct events observed during repeated tests shall be at least 90%.

A.8.23.7 E-UTRAN FDD-FDD Addition and Release Delay of known PSCell in Synchronous DC

A.8.23.7.1 Test Purpose and Environment

The purpose of this test is to verify that the PSCell addition and release delays under synchronous dual connectivity are within the requirements stated in section 7.14 for the case when the PSCell is known by the UE at the time of addition.

The test parameters are given in Tables A.8.23.7.1-1 and cell-specific parameters in A.8.23.7.1-2 below. The test consists of five successive time periods with duration of T1, T2, T3, T4 and T5 respectively. There are two carriers each with one cell. Before the test starts the UE is connected to Cell 1 (PCell) on radio channel 1 (PCC) but is not aware of Cell 2 on radio channel 2. The UE is only monitoring the PCC. During T1 only Cell1 is known to the UE.

Before the start of T2 it is indicated to the UE in the measurement control information that event-triggered reporting with Event A4 is configured for neighbour cell (Cell2). Before the start of T2 the UE is configured with the measurement gaps (gap pattern Id # 0). The Cell2 becomes known to the UE during T2. Therefore during T2 the UE shall report Event A4. After receiving the Event A4, the test system shall send a RRC message to the UE to release the measurement gaps.

The test system shall send a RRC message to the UE to add PSCell (Cell 2) on radio channel 2. The RRC message (to add PSCell) also includes a request for the UE to start periodic CSI reporting for the PSCell after the PSCell has been successfully added. The RRC message to add PSCell shall be sent to the UE during period T2, after the measurement gaps are released by the test system. The point in time at which the RRC message to add PSCell (Cell2) is received at the UE antenna connector defines the start of time period T3.

The test system shall observe the periodic reporting of CSI for PSCell during T4. The point in time at which the UE has sent PRACH to the PSCell (Cell 2) defines the start of time period T4.

The test system shall send a RRC message to the UE to release PSCell (Cell 2) on radio channel 2. The RRC message to release PSCell (Cell2) shall be sent to the UE during time period T4, after the UE has sent at least one CQI report with non-zero CQI index for PSCell (Cell 2). The point in time at which the RRC message to release PSCell (Cell2) is received at the UE antenna connector defines the start of time period T5.

Table A.8.23.7.1-1: General test parameters for known PSCell addition and release case

| Parameter | | Unit | Value | Comment |
|--------------------------|----------------|------|-------|---|
| E-UTRA RF Channel Number | | | 1, 2 | Two radio channels are used for this test |
| Initial Condition | Active PCell | | Cell1 | PCell on RF channel number 1. |
| | Neighbour cell | | Cell2 | Neighbour cell on RF channel number 2. |
| Final Condition | Active PCell | | Cell1 | PCell on RF channel number 1. |
| | PSCell | | Cell2 | PSCell on RF channel number 2. |

| | | | | |
|--|-----------------|-----|--------|---|
| A4 | Hysteresis | dB | 0 | Hysteresis for evaluation of event A4. |
| | Threshold RSRP | dBm | -93 | Actual RSRP threshold for event A4. Needs to take absolute accuracy tolerance in section 9.1.11.1 into account plus margin. |
| | Time To Trigger | s | 0 | |
| CP length | | | Normal | |
| DRX | | | OFF | Continuous monitoring of primary cell |
| Measurement gap pattern Id | | | 0 | Gaps are configured before T2 and released before T3. |
| CQI/PMI periodicity and offset configuration index on cell2 | | | 0 | CQI reporting for PSCell every second subframe |
| Cell-individual offset for cells on RF channel number 1 | | dB | 0 | Individual offset for cells on primary component carrier. |
| Cell-individual offset for cells on RF channel number 2 | | dB | 0 | Individual offset for cells on carrier frequency of cell2. |
| T1 | | s | 5 | During this time the PCell shall be known and cell2 shall be unknown. |
| T2 | | s | ≤ 5 | During this time the UE shall identify neighbour cell (cell2) and report event A4. |
| T3 | | s | 1 | During this time the UE adds the PSCell. |
| T4 | | s | 1 | During this time the UE sends CSI reports for PSCell. |
| T5 | | s | 1 | During this time the UE releases the PSCell. |
| Note 1: Void | | | | |
| Note 2: A UE capable of both synchronous and asynchronous DC operations is not required to pass this test case in accordance with the principle defined in section A.3.11. | | | | |

Table A.8.23.7.1-2: Cell specific test parameters for E-UTRAN FDD known PSCell addition and release

| Parameter | Unit | Cell 1 | | | | | Cell 2 | | | | |
|---|------------|---|----|----|----|----|---|----|----|----|----|
| | | T1 | T2 | T3 | T4 | T5 | T1 | T2 | T3 | T4 | T5 |
| E-UTRA RF Channel Number | | 1 | | | | | 2 | | | | |
| BW _{channel} | MHz | 5MHz: N _{RB,c} = 25 10MHz: N _{RB,c} = 50 20MHz: N _{RB,c} = 100 | | | | | 5MHz: N _{RB,c} = 25 10MHz: N _{RB,c} = 50 20MHz: N _{RB,c} = 100 | | | | |
| PDSCH parameters: DL Reference Measurement Channel | | 5MHz: R.5 FDD 10MHz: R.0 FDD 20MHz: R.4 FDD | | | | | - | | | | |
| PCFICH/PDCCH/PHICH parameters: DL Reference Measurement Channel | | 5MHz: R.11 FDD 10MHz: R.6 FDD 20MHz: R.10 FDD | | | | | 5MHz: R.11 FDD 10MHz: R.6 FDD 20MHz: R.10 FDD | | | | |
| OCNG Patterns | | 5MHz: OP.15 FDD 10MHz: OP.1 FDD 20MHz: OP.11 FDD | | | | | 5MHz: OP.16 FDD 10MHz: OP.2 FDD 20MHz: OP.12 FDD | | | | |
| PBCH_RA | dB | 0 | | | | | 0 | | | | |
| PBCH_RB | dB | | | | | | | | | | |
| PSS_RA | dB | | | | | | | | | | |
| SSS_RA | dB | | | | | | | | | | |
| PCFICH_RB | dB | | | | | | | | | | |
| PHICH_RA | dB | | | | | | | | | | |
| PHICH_RB | dB | | | | | | | | | | |
| PDCCH_RA | dB | | | | | | | | | | |
| PDCCH_RB | dB | | | | | | | | | | |
| PDSCH_RA | dB | | | | | | | | | | |
| PDSCH_RB | dB | | | | | | | | | | |
| OCNG_RA ^{Note 1} | dB | | | | | | | | | | |
| OCNG_RB ^{Note 1} | dB | | | | | | | | | | |
| N _{oc} ^{Note 2} | dBm/15 kHz | | | | | | | | | | |
| \hat{E}_s/N_{oc} | dB | 19 | 19 | 19 | 19 | 19 | -infinity | 0 | 0 | 0 | 0 |
| \hat{E}_s/I_{ot} ^{Note 3} | dB | 19 | 19 | 19 | 19 | 19 | infinity | 0 | 0 | 0 | 0 |

| | | | | | | | | | | | |
|---|------------|--------------------------------------|--------------------------------------|--------------------------------------|--------------------------------------|--------------------------------------|-----------|--------------------------------------|--------------------------------------|--------------------------------------|--------------------------------------|
| RSRP ^{Note 3} | dBm/15 kHz | -82 | -82 | -82 | -82 | -82 | -infinity | -85 | -85 | -85 | -85 |
| SCH_RP ^{Note 3} | dBm/15 kHz | -82 | -82 | -82 | -82 | -82 | -infinity | -85 | -85 | -85 | -85 |
| Io ^{Note 3} | dBm/Ch BW | -54.16 +10log(N _{RB,c} /50) | -54.16 +10log(N _{RB,c} /50) | -54.16 +10log(N _{RB,c} /50) | -54.16 +10log(N _{RB,c} /50) | -54.16 +10log(N _{RB,c} /50) | N/A | -54.21 +10log(N _{RB,c} /50) | -54.21 +10log(N _{RB,c} /50) | -54.21 +10log(N _{RB,c} /50) | -54.21 +10log(N _{RB,c} /50) |
| Propagation Condition | | AWGN | | | | | AWGN | | | | |
| Antenna Configuration | | 1x2 | | | | | 1x2 | | | | |
| Receive time offset to cell1 ^{Note 4} | µs | - | | | | | 33 | | | | |
| PRACH configuration Index ^{Note 5} | | 4 | | | | | 2 | | | | |
| <p>Note 1: OCNG shall be used such that all cells are fully allocated and a constant total transmitted power spectral density is achieved for all OFDM symbols.</p> <p>Note 2: Interference from other cells and noise sources not specified in the test is assumed to be constant over subcarriers and time and shall be modelled as AWGN of appropriate power for N_{oc} to be fulfilled.</p> <p>Note 3: Ê_s/I_{ot}, RSRP, SCH_RP and I_o levels have been derived from other parameters for information purposes. They are not settable parameters themselves.</p> <p>Note 4: Receive time difference between subframe boundaries of signals received from the two cells at the UE antenna connector including time alignment error between the two cells.</p> <p>Note 5: As specified in table 5.7.1-2 in TS 36.211.</p> <p>Note 6: The uplink resources for CSI reporting are assigned to the UE prior to the start of time period T4.</p> | | | | | | | | | | | |

A.8.23.7.2 Test Requirements

The UE shall transmit the PRACH to PSCell at latest 115 ms into T3.

The UE shall send at least one CSI report for PSCell with non-zero CQI index during T4.

The UE shall periodically send CSI reports for PSCell after the UE has sent first CQI report with non-zero CQI index during T4

The UE shall stop sending CSI reports for PSCell in at latest 16ms into T5.

All of the above test requirements shall be fulfilled in order for the observed PSCell addition delay and PSCell release delay to be counted as correct. The rate of correct observed PSCell addition delay and PSCell release delay during repeated tests shall be at least 90%.

NOTE: The PSCell addition delay can be expressed as follows as specified in Clause 7.14.2:

$$T_{\text{config_PSCell}} = 15\text{ms} + T_{\text{activation_time}} + 50\text{ms} + T_{\text{PCell_DU}} + T_{\text{PSCell_DU}}$$

Where:

T_{activation_time} = 20 ms (cell2 is known to the UE);

T_{PCell_DU} = 0 (due to PRACH configurations in cell1 and cell2 being orthogonal in time, i.e. non-overlapping in time);

T_{PSCell_DU} = 30 ms (delay due to PRACH transmission to cell2).

This gives a total of 115 ms.

A.8.23.8 E-UTRAN FDD-FDD Addition and Release Delay of known PSCell in Asynchronous DC

A.8.23.8.1 Test Purpose and Environment

The purpose of this test is to verify that the PSCell addition and release delays under asynchronous dual connectivity are within the requirements stated in section 7.14 for the case when the PSCell is known by the UE at the time of addition.

The test parameters are given in Tables A.8.23.8.1-1 and cell-specific parameters in A.8.23.8.1-2 below. The test consists of five successive time periods with duration of T1, T2, T3, T4 and T5 respectively. There are two carriers each with one cell. Before the test starts the UE is connected to Cell 1 (PCell) on radio channel 1 (PCC) but is not aware of Cell 2 on radio channel 2. The UE is only monitoring the PCC. During T1 only Cell1 is known to the UE.

Before the start of T2 it is indicated to the UE in the measurement control information that event-triggered reporting with Event A4 is configured for neighbour cell (Cell2). Before the start of T2 the UE is configured with the measurement gaps (gap pattern Id # 0). The Cell2 becomes known to the UE during T2. Therefore during T2 the UE shall report Event A4. After receiving the Event A4, the test system shall send a RRC message to the UE to release the measurement gaps.

The test system shall send a RRC message to the UE to add PSCell (Cell 2) on radio channel 2. The RRC message (to add PSCell) also includes a request for the UE to start periodic CSI reporting for the PSCell after the PSCell has been successfully added. The RRC message to add PSCell shall be sent to the UE during period T2, after the measurement gaps are released by the test system. The point in time at which the RRC message to add PSCell (Cell2) is received at the UE antenna connector defines the start of time period T3.

The test system shall observe the periodic reporting of CSI for PSCell during T4. The point in time at which the UE has sent PRACH to the PSCell (Cell 2) defines the start of time period T4.

The test system shall send a RRC message to the UE to release PSCell (Cell 2) on radio channel 2. The RRC message to release PSCell (Cell2) shall be sent to the UE during time period T4, after the UE has sent at least one CQI report with non-zero CQI index for PSCell (Cell 2). The point in time at which the RRC message to release PSCell (Cell2) is received at the UE antenna connector defines the start of time period T5.

Table A.8.23.8.1-1: General test parameters for known PSCell addition and release case

| Parameter | | Unit | Value | Comment |
|---|-----------------|------|--------|---|
| E-UTRA RF Channel Number | | | 1, 2 | Two radio channels are used for this test |
| Initial Condition | Active PCell | | Cell1 | PCell on RF channel number 1. |
| | Neighbour cell | | Cell2 | Neighbour cell on RF channel number 2. |
| Final Condition | Active PCell | | Cell1 | PCell on RF channel number 1. |
| | PSCell | | Cell2 | PSCell on RF channel number 2. |
| A4 | Hysteresis | dB | 0 | Hysteresis for evaluation of event A4. |
| | Threshold RSRP | dBm | -93 | Actual RSRP threshold for event A4. Needs to take absolute accuracy tolerance in section 9.1.11.1 into account plus margin. |
| | Time To Trigger | s | 0 | |
| CP length | | | Normal | |
| DRX | | | OFF | Continuous monitoring of primary cell |
| Measurement gap pattern Id | | | 0 | Gaps are configured before T2 and released before T3. |
| CQI/PMI periodicity and offset configuration index on cell2 | | | 0 | CQI reporting for PSCell every second subframe |
| Cell-individual offset for cells on RF channel number 1 | | dB | 0 | Individual offset for cells on primary component carrier. |
| Cell-individual offset for cells on RF channel number 2 | | dB | 0 | Individual offset for cells on carrier frequency of cell2. |
| T1 | | s | 5 | During this time the PCell shall be known and cell2 shall be unknown. |
| T2 | | s | ≤ 5 | During this time the UE shall identify neighbour cell (cell2) and report event A4. |
| T3 | | s | 1 | During this time the UE adds the PSCell. |
| T4 | | s | 1 | During this time the UE sends CSI reports for PSCell. |
| T5 | | s | 1 | During this time the UE releases the PSCell. |
| Note 1: Void | | | | |
| Note 2: Even a UE capable of both synchronous and asynchronous DC operations is required to pass this test case in accordance with the principle defined in section A.3.11. | | | | |

Table A.8.22.8.1-2: Cell specific test parameters for E-UTRAN FDD known PSCell addition and release

| Parameter | Unit | Cell 1 | | | | | Cell 2 | | | | | |
|---|------------|---|---------------------------------------|---------------------------------------|---------------------------------------|---------------------------------------|---|---------------------------------------|---------------------------------------|---------------------------------------|---------------------------------------|------|
| | | T1 | T2 | T3 | T4 | T5 | T1 | T2 | T3 | T4 | T5 | |
| E-UTRA RF Channel Number | | 1 | | | | | 2 | | | | | |
| BW _{channel} | MHz | 5MHz: N _{RB,c} = 25 10MHz: N _{RB,c} = 50 20MHz: N _{RB,c} = 100 | | | | | 5MHz: N _{RB,c} = 25 10MHz: N _{RB,c} = 50 20MHz: N _{RB,c} = 100 | | | | | |
| PDSCH parameters: DL Reference Measurement Channel | | 5MHz: R.5 FDD 10MHz: R.0 FDD 20MHz: R.4 FDD | | | | | - | | | | | |
| PCFICH/PDCCH/PHICH parameters: DL Reference Measurement Channel | | 5MHz: R.11 FDD 10MHz: R.6 FDD 20MHz: R.10 FDD | | | | | 5MHz: R.11 FDD 10MHz: R.6 FDD 20MHz: R.10 FDD | | | | | |
| OCNG Patterns | | 5MHz: OP.15 FDD 10MHz: OP.1 FDD 20MHz: OP.11 FDD | | | | | 5MHz: OP.16 FDD 10MHz: OP.2 FDD 20MHz: OP.12 FDD | | | | | |
| PBCH_RA | dB | 0 | | | | | 0 | | | | | |
| PBCH_RB | dB | | | | | | | | | | | |
| PSS_RA | dB | | | | | | | | | | | |
| SSS_RA | dB | | | | | | | | | | | |
| PCFICH_RB | dB | | | | | | | | | | | |
| PHICH_RA | dB | | | | | | | | | | | |
| PHICH_RB | dB | | | | | | | | | | | |
| PDCCH_RA | dB | | | | | | | | | | | |
| PDCCH_RB | dB | | | | | | | | | | | |
| PDSCH_RA | dB | | | | | | | | | | | |
| PDSCH_RB | dB | | | | | | | | | | | |
| OCNG_RA ^{Note 1} | dB | | | | | | | | | | | |
| OCNG_RB ^{Note 1} | dB | | | | | | | | | | | |
| N _{oc} ^{Note 2} | dBm/15 kHz | | | | | | | | | | | -101 |
| \hat{E}_s/N_{oc} | dB | 19 | 19 | 19 | 19 | 19 | - infinity | 0 | 0 | 0 | 0 | |
| \hat{E}_s/I_{ot} ^{Note 3} | dB | 19 | 19 | 19 | 19 | 19 | infinity | 0 | 0 | 0 | 0 | |
| RSRP ^{Note 3} | dBm/15 kHz | -82 | -82 | -82 | -82 | -82 | - infinity | -85 | -85 | -85 | -85 | |
| SCH_RP ^{Note 3} | dBm/15 kHz | -82 | -82 | -82 | -82 | -82 | - infinity | -85 | -85 | -85 | -85 | |
| I _o ^{Note 3} | dBm/C h BW | -54.16 +10log (N _{RB,c} /50) | -54.16 +10log (N _{RB,c} /50) | -54.16 +10log (N _{RB,c} /50) | -54.16 +10log (N _{RB,c} /50) | -54.16 +10log (N _{RB,c} /50) | N/A | -54.21 +10log (N _{RB,c} /50) | -54.21 +10log (N _{RB,c} /50) | -54.21 +10log (N _{RB,c} /50) | -54.21 +10log (N _{RB,c} /50) | |
| Propagation Condition | | AWGN | | | | | AWGN | | | | | |
| Antenna Configuration | | 1x2 | | | | | 1x2 | | | | | |
| Receive time offset to cell1 ^{Note 4} | μs | - | | | | | 500 | | | | | |
| PRACH configuration Index ^{Note 5} | | 4 | | | | | 2 | | | | | |

- Note 1: OCNG shall be used such that all cells are fully allocated and a constant total transmitted power spectral density is achieved for all OFDM symbols.
- Note 2: Interference from other cells and noise sources not specified in the test is assumed to be constant over subcarriers and time and shall be modelled as AWGN of appropriate power for N_{oc} to be fulfilled.
- Note 3: \hat{E}_s/I_{ot} , RSRP, SCH_RP and I_o levels have been derived from other parameters for information purposes. They are not settable parameters themselves.
- Note 4: Receive time difference between subframe boundaries of signals received from the two cells at the UE antenna connector including time alignment error between the two cells.
- Note 5: As specified in table 5.7.1-2 in TS 36.211
- Note 6: The uplink resources for CSI reporting are assigned to the UE prior to the start of time period T4.

A.8.23.8.2 Test Requirements

The UE shall transmit the PRACH to PSCell at latest 115 ms into T3.

The UE shall send at least one CSI report for PSCell with non-zero CQI index during T4.

The UE shall periodically send CSI reports for PSCell after the UE has sent first CQI report with non-zero CQI index during T4

The UE shall stop sending CSI reports for PSCell in at latest 16ms into T5.

All of the above test requirements shall be fulfilled in order for the observed PSCell addition delay and PSCell release delay to be counted as correct. The rate of correct observed PSCell addition delay and PSCell release delay during repeated tests shall be at least 90%.

NOTE: The PSCell addition delay can be expressed as follows as specified in Clause 7.14.2:

$$T_{\text{config_PSCell}} = 15\text{ms} + T_{\text{activation_time}} + 50\text{ms} + T_{\text{PCell_DU}} + T_{\text{PSCell_DU}}$$

Where:

$T_{\text{activation_time}} = 20 \text{ ms}$ (cell2 is known to the UE);

$T_{\text{PCell_DU}} = 0$ (due to PRACH configurations in cell1 and cell2 being orthogonal in time, i.e. non-overlapping in time);

$T_{\text{PSCell_DU}} = 30 \text{ ms}$ (delay due to PRACH transmission to cell2).

This gives a total of 115 ms.

A.8.23.9 E-UTRAN TDD Addition and Release Delay of known PSCell in Synchronous DC

A.8.23.9.1 Test Purpose and Environment

The purpose of this test is to verify that the PSCell addition and release delays under synchronous dual connectivity are within the requirements stated in section 7.14 for the case when the PSCell is known by the UE at the time of addition.

The test parameters are given in Tables A.8.23.9.1-1 and cell-specific parameters in A.8.23.9.1-2 below. The test consists of five successive time periods, with duration of T1, T2, T3, T4 and T5 respectively. There are two carriers each with one cell. Before the test starts the UE is connected to Cell 1 (PCell) on radio channel 1 (PCC) but is not aware of Cell 2 on radio channel 2. The UE is only monitoring the PCC. During T1 only Cell1 is known to the UE.

Before the start of T2 it is indicated to the UE in the measurement control information that event-triggered reporting with Event A4 is configured for neighbour cell (Cell2). Before the start of T2 the UE is configured with the measurement gaps (gap pattern Id # 0). The Cell2 becomes known to the UE during T2. Therefore during T2 the UE shall report Event A4. After receiving the Event A4, the test system shall send a RRC message to the UE to release the measurement gaps.

The test system shall send a RRC message to the UE to add PSCell (Cell 2) on radio channel 2. The RRC message (to add PSCell) also includes a request for the UE to start periodic CSI reporting for the PSCell after the PSCell has been successfully added. The RRC message to add PSCell shall be sent to the UE during period T2, after the measurement gaps are released by the test system. The point in time at which the RRC message to add PSCell (Cell2) is received at the UE antenna connector defines the start of time period T3.

The test system shall observe the periodic reporting of CSI for PSCell during T4. The point in time at which the UE has sent PRACH to the PSCell (Cell 2) defines the start of time period T4.

The test system shall send a RRC message to the UE to release PSCell (Cell 2) on radio channel 2. The RRC message to release PSCell (Cell2) shall be sent to the UE during time period T4, after the UE has sent at least one CQI report with non-zero CQI index for PSCell (Cell 2). The point in time at which the RRC message to release PSCell (Cell2) is received at the UE antenna connector defines the start of time period T5.

Table A.8.23.9.1-1: General test parameters for known PSCell addition and release case

| Parameter | Unit | Value | Comment |
|--------------------------|------|-------|---|
| E-UTRA RF Channel Number | | 1, 2 | Two radio channels are used for this test |
| Initial Active PCell | | Cell1 | PCell on RF channel number 1. |

| | | | | |
|---|-----------------|-----|--------|---|
| Condition | Neighbour cell | | Cell2 | Neighbour cell on RF channel number 2. |
| Final Condition | Active PCell | | Cell1 | PCell on RF channel number 1. |
| | PSCell | | Cell2 | PSCell on RF channel number 2. |
| A4 | Hysteresis | dB | 0 | Hysteresis for evaluation of event A4. |
| | Threshold RSRP | dBm | -93 | Actual RSRP threshold for event A4. Needs to take absolute accuracy tolerance in section 9.1.11.1 into account plus margin. |
| | Time To Trigger | s | 0 | |
| CP length | | | Normal | |
| DRX | | | OFF | Continuous monitoring of primary cell |
| Measurement gap pattern Id | | | 0 | Gaps are configured before T2 and released before T3. |
| PRACH configuration on cell2 | | | 53 | As specified in table 5.7.1-3 in TS 36.211 |
| CQI/PMI periodicity and offset configuration index on cell2 | | | 0 | CQI reporting for PSCell every uplink subframe |
| Cell-individual offset for cells on RF channel number 1 | | dB | 0 | Individual offset for cells on primary component carrier. |
| Cell-individual offset for cells on RF channel number 2 | | dB | 0 | Individual offset for cells on carrier frequency of cell2. |
| T1 | | s | 5 | During this time the PCell shall be known and cell2 shall be unknown. |
| T2 | | s | ≤ 5 | During this time the UE shall identify neighbour cell (cell2) and report event A4. |
| T3 | | s | 1 | During this time the UE adds the PSCell. |
| T4 | | s | 1 | During this time the UE sends CSI reports for PSCell. |
| T5 | | s | 1 | During this time the UE releases the PSCell. |
| Note 1: Void | | | | |

Table A.8.23.9.1-2: Cell specific test parameters for E-UTRAN TDD known PSCell addition and release

| Parameter | Unit | Cell 1 | | | | | Cell 2 | | | | |
|---|------|---|----|----|----|----|---|----|----|----|----|
| | | T1 | T2 | T3 | T4 | T5 | T1 | T2 | T3 | T4 | T5 |
| E-UTRA RF Channel Number | | 1 | | | | | 2 | | | | |
| BW _{channel} | MHz | 5MHz: N _{RB,c} = 25 10MHz: N _{RB,c} = 50 20MHz: N _{RB,c} = 100 | | | | | 5MHz: N _{RB,c} = 25 10MHz: N _{RB,c} = 50 20MHz: N _{RB,c} = 100 | | | | |
| Special subframe configuration <small>Note 7</small> | | 6 | | | | | 6 | | | | |
| Uplink-downlink configuration <small>Note 7</small> | | 1 | | | | | 1 | | | | |
| PDSCH parameters: DL Reference Measurement Channel | | 5MHz: R.4 TDD 10MHz: R.0 TDD 20MHz: R.3 TDD | | | | | - | | | | |
| PCFICH/PDCCH/PHICH parameters: DL Reference Measurement Channel | | 5MHz: R.11 TDD 10MHz: R.6 TDD 20MHz: R.10 TDD | | | | | 5MHz: R.11 TDD 10MHz: R.6 TDD 20MHz: R.10 TDD | | | | |
| OCNG Patterns | | 5MHz: OP.9 TDD 10MHz: OP.1 TDD 20MHz: OP.7 TDD | | | | | 5MHz: OP.10 TDD 10MHz: OP.2 TDD 20MHz: OP.8 TDD | | | | |
| PBCH_RA | dB | 0 | | | | | 0 | | | | |
| PBCH_RB | dB | | | | | | | | | | |
| PSS_RA | dB | | | | | | | | | | |
| SSS_RA | dB | | | | | | | | | | |
| PCFICH_RB | dB | | | | | | | | | | |
| PHICH_RA | dB | | | | | | | | | | |
| PHICH_RB | dB | | | | | | | | | | |
| PDCCH_RA | dB | | | | | | | | | | |
| PDCCH_RB | dB | | | | | | | | | | |
| PDSCH_RA | dB | | | | | | | | | | |
| PDSCH_RB | dB | | | | | | | | | | |
| OCNG_RA <small>Note 1</small> | dB | | | | | | | | | | |

| OCNG_RB ^{Note 1} | dB | | | | | | | | | | |
|--|------------|--|--|--|--|--|---------------|--|--|--|--|
| N _{oc} ^{Note 2} | dBm/15 kHz | -101 | | | | | N/A | -85 | | | |
| \hat{E}_s/N_{oc} | dB | 19 | 19 | 19 | 19 | 19 | - infinity | 0 | 0 | 0 | 0 |
| \hat{E}_s/I_{ot} ^{Note 3} | dB | 19 | 19 | 19 | 19 | 19 | infinity | 0 | 0 | 0 | 0 |
| RSRP ^{Note 3} | dBm/15 kHz | -82 | -82 | -82 | -82 | -82 | - infinity | -85 | -85 | -85 | -85 |
| SCH_RP ^{Note 3} | dBm/15 kHz | -82 | -82 | -82 | -82 | -82 | - infinity | -85 | -85 | -85 | -85 |
| I _o ^{Note 3} | dBm/C h BW | -54.16 +10log (N _{RB,c} /50) | -54.16 +10log (N _{RB,c} /50) | -54.16 +10log (N _{RB,c} /50) | -54.16 +10log (N _{RB,c} /50) | -54.16 +10log (N _{RB,c} /50) | N/A | -54.21 +10log (N _{RB,c} /50) | -54.21 +10log (N _{RB,c} /50) | -54.21 +10log (N _{RB,c} /50) | -54.21 +10log (N _{RB,c} /50) |
| Propagation Condition | | AWGN | | | | | AWGN | | | | |
| Antenna Configuration | | 1x2 | | | | | 1x2 | | | | |
| Receive time offset to cell1 ^{Note 4} | μs | - | | | | | 33 | | | | |
| PRACH configuration Index ^{Note 5} | | 56 | | | | | 50 | | | | |
| <p>Note 1: OCNG shall be used such that all cells are fully allocated and a constant total transmitted power spectral density is achieved for all OFDM symbols.</p> <p>Note 2: Interference from other cells and noise sources not specified in the test is assumed to be constant over subcarriers and time and shall be modelled as AWGN of appropriate power for N_{oc} to be fulfilled.</p> <p>Note 3: \hat{E}_s/I_{ot}, RSRP, SCH_RP and I_o levels have been derived from other parameters for information purposes. They are not settable parameters themselves.</p> <p>Note 4: Receive time difference between subframe boundaries of signals received from the two cells at the UE antenna connector including time alignment error between the two cells.</p> <p>Note 5: As specified in table 5.7.1-3 in TS 36.211</p> <p>Note 6: The uplink resources for CSI reporting are assigned to the UE prior to the start of time period T4.</p> <p>Note 7: For special subframe and uplink-downlink configurations see Tables 4.2-1 and 4.2-2 in TS 36.211 [16].</p> | | | | | | | | | | | |

A.8.23.9.2 Test Requirements

The UE shall transmit the PRACH to PSCell at latest 115 ms into T3.

The UE shall send at least one CSI report for PSCell with non-zero CQI index during T4.

The UE shall periodically send CSI reports for PSCell after the UE has sent first CQI report with non-zero CQI index during T4

The UE shall stop sending CSI reports for PSCell in at latest 16ms into T5.

All of the above test requirements shall be fulfilled in order for the observed PSCell addition delay and PSCell release delay to be counted as correct. The rate of correct observed PSCell addition delay and PSCell release delay during repeated tests shall be at least 90%.

NOTE: The PSCell addition delay can be expressed as follows as specified in Clause 7.14.2:

$$T_{\text{config_PSCell}} = 15\text{ms} + T_{\text{activation_time}} + 50\text{ms} + T_{\text{PCell_DU}} + T_{\text{PSCell_DU}}$$

Where:

T_{activation_time} = 20 ms (cell2 is known to the UE);

T_{PCell_DU} = 0 (due to PRACH configurations in cell1 and cell2 being orthogonal in time, i.e. non-overlapping in time);

T_{PSCell_DU} = 30 ms (delay due to PRACH transmission to cell2).

This gives a total of 115 ms.

A.8.23.10 E-UTRAN TDD-FDD DC intra-frequency event triggered reporting with DRX in synchronous DC with PCell in FDD

A.8.23.10.1 Test Purpose and Environment

The purpose of this test is to verify that the UE makes correct reporting of PCell and PSCell intra frequency measurement. This test will partly verify the intra-frequency measurement requirements in clause 8.8.2 and clause 8.8.3.

The test parameters are given in Table A.8.23.10.1-1, A.8.23.10.1-2, A.8.23.10.1-3 and A.8.23.10.1-4 below. In the test there are two cells: Cell1 and Cell2. Cell1 is PCell and Cell2 is PSCell. In the measurement control information it is indicated to the UE that event-triggered reporting with Events A1 (PCell and PSCell) and A2 (PCell and PSCell) is used. The test consists of three successive time periods, with duration of T1, T2 and T3, respectively. Prior to the start of the time duration T1, the UE shall be fully synchronized to Cell1 and Cell2. Prior to the start of the time duration T1, DRX configurations on MCG and SCG are enabled and DRX inactivity timers for MCG and SCG have expired. Immediately at beginning of T2 the transmission powers of Cell1 and Cell2 are reduced below a threshold value of event A2 and this shall result in reporting of Event A2 for PCell and PSCell, respectively. Immediately after receiving the reporting of event A2 for both PCell and PSCell, PDCCH indicating a new transmission on Cell1 shall be sent continuously to ensure that the UE would not enter the DRX state on MCG throughout T3. At beginning of T3 the transmission powers of Cell1 and Cell2 are increased above a threshold value of event A1 and this shall result in reporting of Event A1 for PCell and PSCell, respectively.

When MCG DRX is used, the uplink time alignment of Cell1 is not maintained and UE needs to use RACH to obtain UL allocation for measurement reporting in Cell1. When SCG DRX is used, the UE needs to be provided at least once every 500ms with new Timing Advance Command MAC control element to restart the Time alignment timer to keep UE uplink time alignment in Cell2. Furthermore UE is allocated with PUSCH resource at every DRX cycle.

Table A.8.23.10.1-1: General test parameters for E-UTRAN TDD-FDD DC intra-frequency event triggered reporting with DRX in synchronous DC with PCell in FDD

| Parameter | Unit | Value | Comment | |
|---|-----------------|--------|---|---|
| E-UTRA RF Channel Number | | 1, 2 | Two radio channels are used for this test. | |
| Active PCell | | Cell1 | PCell on RF channel number 1. | |
| Configured PSCell | | Cell2 | PSCell on RF channel number 2. | |
| A1 | Hysteresis | dB | 0 | Hysteresis for evaluation of event A1. |
| | Threshold RSRP | dBm | -95 | Actual RSRP threshold for event A1. Needs to take absolute accuracy tolerance in clause 9.1.11.1 and 9.1.11.2 into account plus margin. |
| | Time To Trigger | s | 0 | |
| A2 | Hysteresis | dB | 0 | Hysteresis for evaluation of event A2. |
| | Threshold RSRP | dBm | -99 | Actual RSRP threshold for event A2. Needs to take absolute accuracy tolerance in clause 9.1.11.1 and 9.1.11.2 into account plus margin. |
| | Time To Trigger | s | 0 | |
| CP length | | Normal | | |
| Special subframe configuration | | 6 | As specified in table 4.2-1 in TS 36.211. This configuration is for the TDD PSCell. | |
| Uplink-downlink configuration | | 1 | As specified in table 4.2-2 in TS 36.211. The configuration is for the TDD PSCell. | |
| DRX | | ON | DRX related parameters are defined in Table A.8.23.10.1-3 | |
| Cell-individual offset for cells on RF channel number 1 | dB | 0 | Individual offset for cells on primary component carrier. | |
| Cell-individual offset for cells on RF channel number 2 | dB | 0 | Individual offset for cells on carrier frequency of Cell2. | |
| Filter coefficient | | 0 | L3 filtering is not used | |
| T1 | s | 2 | | |
| T2 | s | 10 | | |
| T3 | s | 1 | | |

Note 1: This test verifies the RRM requirement which is independent of channel bandwidth and is performed according to the principle defined in section A.3.6.1.
 Note 2: A UE capable of both synchronous and asynchronous DC operations is not required to pass this test case in accordance with the principle defined in section A.3.6.11.

Table A.8.23.10.1-2: Cell specific test parameters for E-UTRAN TDD-FDD DC intra-frequency event triggered reporting with DRX in synchronous DC with PCell in FDD

| Parameter | Unit | Cell 1 | | | Cell 2 | | |
|--|---|---|--|--|---|--|--|
| | | T1 | T2 | T3 | T1 | T2 | T3 |
| E-UTRA RF Channel Number | | 1 | | | 2 | | |
| BW _{channel} | MHz | 5MHz: N _{RB,c} = 25 10MHz: N _{RB,c} = 50 20MHz: N _{RB,c} = 100 | | | 5MHz: N _{RB,c} = 25 10MHz: N _{RB,c} = 50 20MHz: N _{RB,c} = 100 | | |
| PDSCH parameters: DL Reference Measurement Channel | | 5MHz: R.5 FDD 10MHz: R.0 FDD 20MHz: R.4 FDD | | | 5MHz: R.4 TDD 10MHz: R.0 TDD 20MHz: R.3 TDD | | |
| PCFICH/PDCCH/PHICH parameters: DL Reference Measurement Channel | | 5MHz: R.11 FDD 10MHz: R.6 FDD 20MHz: R.10 FDD | | | 5MHz: R.11 TDD 10MHz: R.6 TDD 20MHz: R.10 TDD | | |
| OCNG Patterns | | 5MHz: OP.15 FDD 10MHz: OP.1 FDD 20MHz: OP.11 FDD | | | 5MHz: OP.9 TDD 10MHz: OP.1 TDD 20MHz: OP.7 TDD | | |
| PBCH_RA | dB | 0 | | | 0 | | |
| PBCH_RB | dB | | | | | | |
| PSS_RA | dB | | | | | | |
| SSS_RA | dB | | | | | | |
| PCFICH_RB | dB | | | | | | |
| PHICH_RA | dB | | | | | | |
| PHICH_PB | dB | | | | | | |
| PDCCH_RA | dB | | | | | | |
| PDCCH_PB | dB | | | | | | |
| PDSCH_RA | dB | | | | | | |
| PDSCH_RB | dB | | | | | | |
| OCNG_RA ^{Note 1} | dB | | | | | | |
| OCNG_RB ^{Note 1} | dB | | | | | | |
| N _{oc} ^{Note 2} | dBm/15 KHz | | | | | | |
| \hat{E}_s / N_{oc} | dB | 16 | -2.5 | 20 | 16 | -2.5 | 20 |
| \hat{E}_s / I_{ot} | dB | 16 | -2.5 | 20 | 16 | -2.5 | 20 |
| RSRP ^{Note 3} | dBm/15 KHz | -88 | -106.5 | -84 | -88 | -106.5 | -84 |
| SCH_RP ^{Note 3} | dBm/15 KHz | -88 | -106.5 | -84 | -88 | -106.5 | -84 |
| I _o ^{Note 3} | dBm/Ch BW | -60.11 +10log (N _{RB,c} /50) | -74.28 +10log (N _{RB,c} /50) | -56.18 +10log (N _{RB,c} /50) | -60.11 +10log (N _{RB,c} /50) | -74.28 +10log (N _{RB,c} /50) | -56.18 +10log (N _{RB,c} /50) |
| Propagation Condition | | ETU70 | | | ETU70 | | |
| Correlation Matrix and Antenna Configuration | | 1x2 Low | | | 1x2 Low | | |
| Receive Time offset to cell1 ^{Note 5} | µs | - | | | 33 | | |
| Note 1: | OCNG shall be used such that both cells are fully allocated and a constant total transmitted power spectral density is achieved for all OFDM symbols. | | | | | | |
| Note 2: | Interference from other cells and noise sources not specified in the test is assumed to be constant over subcarriers and time and shall be modelled as AWGN of appropriate power for N _{oc} to be fulfilled. | | | | | | |
| Note 3: | RSRP, SCH_RP and I _o levels have been derived from other parameters for information purposes. They are not settable parameters themselves. | | | | | | |
| Note 4: | The resources for uplink transmission in Cell1 are assigned to the UE prior to the start of time period T3. | | | | | | |
| Note 5: | Receive time difference between subframe boundaries of signals received from the two cells at the UE antenna connector including time alignment error between the two cells. | | | | | | |

Table A.8.23.10.1-3: DRX-Configuration for E-UTRAN TDD-FDD DC intra-frequency event triggered reporting with DRX in synchronous DC with PCell in FDD

| Field | Cell1 | Cell2 | Comment |
|--------------------------|---------|---------|---|
| | Value | Value | |
| onDurationTimer | psf1 | psf1 | As specified in clause 6.3.2 in TS 36.331 |
| drx-InactivityTimer | psf1 | psf1 | |
| drx-RetransmissionTimer | psf1 | psf1 | |
| longDRX-CycleStartOffset | sf1280 | sf80 | |
| shortDRX | disable | disable | |

Table A.8.23.10.1-4: *TimeAlignmentTimer* -Configuration for E-UTRAN TDD-FDD DC intra-frequency event triggered reporting with DRX in synchronous DC with PCell in FDD

| Field | Cell1 | Cell2 | Comment |
|--------------------|-------|-------|--|
| | Value | Value | |
| TimeAlignmentTimer | sf500 | sf500 | As specified in clause 6.3.2 in TS 36.331 |
| sr-ConfigIndex | 0 | 0 | For further information see clause 6.3.2 in TS 36.331 and section 10.1 in TS 36.213. |

A.8.23.10.2 Test Requirements

The UE shall send one Event A2 triggered report for PCell on PCell with a measurement reporting delay less than 6.4s (5*MCG_DRX cycle) from the beginning of time period T2. The measurement reporting delay is defined as the time from the beginning of time period T2 to the moment when the UE starts to send preambles on the PRACH to obtain allocation to send the measurement report on PUSCH.

The UE shall send one Event A2 triggered report for PSCell on PCell with a measurement reporting delay less than 400ms (5*SCG_DRX cycle) from the beginning of time period T2. The measurement reporting delay is defined as the time from the beginning of time period T2 to the moment when the UE starts to send preambles on the PRACH to obtain allocation to send the measurement report on PUSCH.

The UE shall send one Event A1 triggered report for PCell on PCell with a measurement reporting delay less than 200ms from the beginning of time period T3. The measurement reporting delay is defined as the time from the beginning of time period T3 to the moment when the UE sends the measurement report on PUSCH.

The UE shall send one Event A1 triggered report for PSCell on PCell with a measurement reporting delay less than 400ms (5*SCG_DRX cycle) from the beginning of time period T3. The measurement reporting delay is defined as the time from the beginning of time period T3 to the moment when the UE sends the measurement report on PUSCH.

The UE shall not send event triggered measurement reports, as long as the reporting criteria are not fulfilled.

The rate of correct events observed during repeated tests shall be at least 90%.

A.8.23.11 E-UTRAN TDD-FDD DC intra-frequency event triggered reporting with DRX in synchronous DC with PCell in TDD

A.8.23.11.1 Test Purpose and Environment

The purpose of this test is to verify that the UE makes correct reporting of PCell and PSCell intra frequency measurement. This test will partly verify the intra-frequency measurement requirements in clause 8.8.2 and clause 8.8.3.

The test parameters are given in Table A.8.23.11.1-1, A.8.23.11.1-2, A.8.23.11.1-3 and A.8.23.11.1-4 below. In the test there are two cells: Cell1 and Cell2. Cell1 is PCell and Cell2 is PSCell. In the measurement control information it is indicated to the UE that event-triggered reporting with Events A1 (PCell and PSCell) and A2 (PCell and PSCell) is used. The test consists of three successive time periods, with duration of T1, T2 and T3, respectively. Prior to the start

of the time duration T1, the UE shall be fully synchronized to Cell1 and Cell2. Prior to the start of the time duration T1, DRX configurations on MCG and SCG are enabled and DRX inactivity timers for MCG and SCG have already been expired. Immediately at beginning of T2 the transmission powers of Cell1 and Cell2 are reduced below a threshold value of event A2 and this shall result in reporting of Event A2 for PCell and PSCell, respectively. Immediately after receiving the reporting of event A2 for both PCell and PSCell, PDCCH indicating a new transmission on Cell1 shall be sent continuously to ensure UE would not enter DRX state on MCG throughout T3. At beginning of T3 the transmission powers of Cell1 and Cell2 are increased above a threshold value of event A1 and this shall result in reporting of Event A1 for PCell and PSCell, respectively.

When MCG DRX is used, the uplink time alignment of Cell1 is not maintained and UE needs to use RACH to obtain UL allocation for measurement reporting in Cell1. When SCG DRX is used, the UE needs to be provided at least once every 500ms with new Timing Advance Command MAC control element to restart the Time alignment timer to keep UE uplink time alignment in Cell2. Furthermore UE is allocated with PUSCH resource at every DRX cycle.

Table A.8.23.11.1-1: General test parameters for E-UTRAN TDD-FDD DC intra-frequency event triggered reporting with DRX in synchronous DC with PCell in TDD

| Parameter | | Unit | Value | Comment |
|--|-----------------|------|--------|---|
| E-UTRA RF Channel Number | | | 1, 2 | Two radio channels are used for this test. |
| Active PCell | | | Cell1 | PCell on RF channel number 1. |
| Configured PSCell | | | Cell2 | PSCell on RF channel number 2. |
| A1 | Hysteresis | dB | 0 | Hysteresis for evaluation of event A1. |
| | Threshold RSRP | dBm | -95 | Actual RSRP threshold for event A1. Needs to take absolute accuracy tolerance in clause 9.1.11.1 and 9.1.11.2 into account plus margin. |
| | Time To Trigger | s | 0 | |
| A2 | Hysteresis | dB | 0 | Hysteresis for evaluation of event A2. |
| | Threshold RSRP | dBm | -99 | Actual RSRP threshold for event A2. Needs to take absolute accuracy tolerance in clause 9.1.11.1 and 9.1.11.2 into account plus margin. |
| | Time To Trigger | s | 0 | |
| CP length | | | Normal | |
| Special subframe configuration | | | 6 | As specified in table 4.2-1 in TS 36.211. The configuration is the TDD PCell |
| Uplink-downlink configuration | | | 1 | As specified in table 4.2-2 in TS 36.211. The configuration is for TDD PCell |
| DRX | | | ON | DRX related parameters are defined in Table A.8.23.3.1-3 |
| Cell-individual offset for cells on RF channel number 1 | | dB | 0 | Individual offset for cells on primary component carrier. |
| Cell-individual offset for cells on RF channel number 2 | | dB | 0 | Individual offset for cells on carrier frequency of Cell2. |
| Filter coefficient | | | 0 | L3 filtering is not used |
| T1 | | s | 5 | |
| T2 | | s | 10 | |
| T3 | | s | 1 | |
| NOTE 1: This test verifies the RRM requirement which is independent of channel bandwidth and is performed according to the principle defined in section A.3.6.1. | | | | |

Table A.8.23.11.1-2: Cell specific test parameters for E-UTRAN TDD-FDD DC intra-frequency event triggered reporting with DRX in synchronous DC with PCell in TDD

| Parameter | Unit | Cell 1 | | | Cell 2 | | |
|--------------------------|------|---|----|----|---|----|----|
| | | T1 | T2 | T3 | T1 | T2 | T3 |
| E-UTRA RF Channel Number | | 1 | | | 2 | | |
| BW _{channel} | MHz | 5MHz: N _{RB,c} = 25 10MHz: N _{RB,c} = 50 20MHz: N _{RB,c} = 100 | | | 5MHz: N _{RB,c} = 25 10MHz: N _{RB,c} = 50 20MHz: N _{RB,c} = 100 | | |

| | | | | | | | |
|---|---------------|--|--|--|--|--|--|
| PDSCH parameters: DL Reference Measurement Channel | | 5MHz: R.4 TDD 10MHz: R.0 TDD 20MHz: R.3 TDD | | | 5MHz: R.5 FDD 10MHz: R.0 FDD 20MHz: R.4 FDD | | |
| PCFICH/PDCCH/PHICH parameters: DL Reference Measurement Channel | | 5MHz: R.11 TDD 10MHz: R.6 TDD 20MHz: R.10 TDD | | | 5MHz: R.11 FDD 10MHz: R.6 FDD 20MHz: R.10 FDD | | |
| OCNG Patterns | | 5MHz: OP.9 TDD 10MHz: OP.1 TDD 20MHz: OP.7 TDD | | | 5MHz: OP.15 FDD 10MHz: OP.1 FDD 20MHz: OP.11 FDD | | |
| PBCH_RA | dB | 0 | | | 0 | | |
| PBCH_RB | dB | | | | | | |
| PSS_RA | dB | | | | | | |
| SSS_RA | dB | | | | | | |
| PCFICH_RB | dB | | | | | | |
| PHICH_RA | dB | | | | | | |
| PHICH_PB | dB | | | | | | |
| PDCCH_RA | dB | | | | | | |
| PDCCH_PB | dB | | | | | | |
| PDSCH_RA | dB | | | | | | |
| PDSCH_RB | dB | | | | | | |
| OCNG_RA ^{Note 1} | dB | | | | | | |
| OCNG_RB ^{Note 1} | dB | | | | | | |
| N_{oc} ^{Note 2} | dBm/15 KHz | | | | | | |
| \hat{E}_s / N_{oc} | dB | 16 | -2.5 | 20 | 16 | -2.5 | 20 |
| \hat{E}_s / I_{ot} | dB | 16 | -2.5 | 20 | 16 | -2.5 | 20 |
| RSRP ^{Note 3} | dBm/15 KHz | -88 | -106.5 | -84 | -88 | -106.5 | -84 |
| SCH_RP ^{Note 3} | dBm/15 KHz | -88 | -106.5 | -84 | -88 | -106.5 | -84 |
| I_o ^{Note 3} | dBm/Ch BW | -60.11 +10log ($N_{RB,c}$ /50) | -74.28 +10log ($N_{RB,c}$ /50) | -56.18 +10log ($N_{RB,c}$ /50) | -60.11 +10log ($N_{RB,c}$ /50) | -74.28 +10log ($N_{RB,c}$ /50) | -56.18 +10log ($N_{RB,c}$ /50) |
| Propagation Condition | | ETU70 | | | ETU70 | | |
| Correlation Matrix and Antenna Configuration | | 1x2 Low | | | 1x2 Low | | |
| Receive Time offset to cell1 ^{Note 5} | μ s | - | | | 33 | | |
| <p>Note 1: OCNG shall be used such that both cells are fully allocated and a constant total transmitted power spectral density is achieved for all OFDM symbols.</p> <p>Note 2: Interference from other cells and noise sources not specified in the test is assumed to be constant over subcarriers and time and shall be modelled as AWGN of appropriate power for N_{oc} to be fulfilled.</p> <p>Note 3: RSRP, SCH_RP and I_o levels have been derived from other parameters for information purposes. They are not settable parameters themselves.</p> <p>Note 4: The resources for uplink transmission in Cell1 are assigned to the UE prior to the start of time period T3.</p> <p>Note 5: Receive time difference between subframe boundaries of signals received from the two cells at the UE antenna connector including time alignment error between the two cells.</p> | | | | | | | |

Table A.8.23.11-3: DRX-Configuration for E-UTRAN TDD-FDD DC intra-frequency event triggered reporting with DRX in synchronous DC with PCell in TDD

| Field | Cell1 | Cell2 | Comment |
|--------------------------|---------|---------|---|
| | Value | Value | |
| onDurationTimer | psf1 | psf1 | As specified in clause 6.3.2 in TS 36.331 |
| drx-InactivityTimer | psf1 | psf1 | |
| drx-RetransmissionTimer | psf1 | psf1 | |
| longDRX-CycleStartOffset | sf1280 | sf80 | |
| shortDRX | disable | disable | |

Table A.8.23.11.1-4: TimeAlignmentTimer -Configuration for E-UTRAN TDD-FDD DC intra-frequency event triggered reporting with DRX in synchronous DC with PCell in TDD

| Field | Cell1 | Cell2 | Comment |
|--------------------|-------|-------|--|
| | Value | Value | |
| TimeAlignmentTimer | sf500 | sf500 | As specified in clause 6.3.2 in TS 36.331 |
| sr-ConfigIndex | 0 | 0 | For further information see clause 6.3.2 in TS 36.331 and section 10.1 in TS 36.213. |

A.8.23.11.2 Test Requirements

The UE shall send one Event A2 triggered report for PCell on PCell with a measurement reporting delay less than 6.4s (5*MCG_DRX cycle) from the beginning of time period T2. The measurement reporting delay is defined as the time from the beginning of time period T2 to the moment when the UE starts to send preambles on the PRACH to obtain allocation to send the measurement report on PUSCH.

The UE shall send one Event A2 triggered report for PSCell on PCell with a measurement reporting delay less than 400ms (5*SCG_DRX cycle) from the beginning of time period T2. The measurement reporting delay is defined as the time from the beginning of time period T2 to the moment when the UE starts to send preambles on the PRACH to obtain allocation to send the measurement report on PUSCH.

The UE shall send one Event A1 triggered report for PCell on PCell with a measurement reporting delay less than 200ms from the beginning of time period T3. The measurement reporting delay is defined as the time from the beginning of time period T3 to the moment when the UE sends the measurement report on PUSCH.

The UE shall send one Event A1 triggered report for PSCell on PCell with a measurement reporting delay less than 400ms (5*SCG_DRX cycle) from the beginning of time period T3. The measurement reporting delay is defined as the time from the beginning of time period T3 to the moment when the UE sends the measurement report on PUSCH.

The UE shall not send event triggered measurement reports, as long as the reporting criteria are not fulfilled.

The rate of correct events observed during repeated tests shall be at least 90%.

A.8.23.12 E-UTRAN TDD-FDD DC inter-frequency event triggered reporting with DRX in synchronous DC with PCell in FDD

A.8.23.12.1 Test Purpose and Environment

The purpose of this test is to verify that the UE makes correct reporting of inter frequency measurement. This test will partly verify the inter-frequency cell search requirements in clause 8.8.4.

The test parameters are given in Tables A.8.23.12.1-1, A.8.23.12.1-2, A.8.23.12.1-3 and A.8.23.12.1-4 below. In the test there are three cells: Cell1, Cell2 and Cell3. Cell1 is PCell, Cell2 is PSCell and Cell3 is a neighbour cell. In the measurement control information it is indicated to the UE that event-triggered reporting with Event A3 (PCell) is used. The test consists of two successive time periods, with duration of T1 and T2, respectively. Prior to the start of the time duration T1, the UE shall be fully synchronized to Cell1 and Cell2. During T1 the UE shall not have any information on Cell3. Prior to the start of the time duration T1, DRX configurations on MCG and SCG are enabled and DRX inactivity timers for MCG and SCG have already been expired.

In this test, UE needs to be provided at least once every 500ms with new Timing Advance Command MAC control element to restart the Time alignment timer to keep UE uplink time alignment in Cell1. Furthermore the UE is allocated with PUSCH resource at every DRX cycle.

Table A.8.23.12.1-1: General test parameters for E-UTRAN TDD-FDD DC inter-frequency event triggered reporting with DRX in synchronous DC with PCell in FDD

| Parameter | Unit | Value | Comment |
|--------------------------|------|---------|--|
| E-UTRA RF Channel Number | | 1, 2, 3 | Three radio channels are used for this test. |
| Active PCell | | Cell1 | PCell on RF channel number 1. |

| | | | | |
|--|-----------------|----|--------|--|
| Configured PSCell | | | Cell2 | PSCell on RF channel number 2. |
| Neighbour cell | | | Cell3 | Neighbour cell on RF channel number 3. |
| A3 | Hysteresis | dB | 0 | Hysteresis for evaluation of event A3. |
| | A3-offset | dB | -6 | |
| | Time To Trigger | s | 0 | |
| CP length | | | Normal | |
| DRX | | | ON | DRX related parameters are defined in Table A.8.23.12.1-3 |
| Measurement gap pattern Id | | | 0 | |
| Cell-individual offset for cells on RF channel number 1 | | dB | 0 | Individual offset for cells on primary component carrier. |
| Cell-individual offset for cells on RF channel number 2 | | dB | 0 | Individual offset for cells on carrier frequency of Cell2. |
| Cell-individual offset for cells on RF channel number 3 | | dB | 0 | Individual offset for cells on carrier frequency of Cell3. |
| Filter coefficient | | | 0 | L3 filtering is not used |
| T1 | s | | 5 | |
| T2 | s | | 5 | |
| Note 1: A UE capable of both synchronous and asynchronous DC operations is not required to pass this test case in accordance with the principle defined in section A.3.11. | | | | |

Table A.8.23.12.1-2: Cell specific test parameters for E-UTRAN TDD-FDD DC inter-frequency event triggered reporting with DRX in synchronous DC with PCell in FDD

| Parameter | Unit | Cell1 | | Cell2 | | Cell3 | |
|--|------------|---|----|---|----|---|----|
| | | T1 | T2 | T1 | T2 | T1 | T2 |
| E-UTRA RF Channel Number | | 1 | | 2 | | 3 | |
| BW _{channel} | MHz | 5MHz: N _{RB,c} = 25 10MHz: N _{RB,c} = 50 20MHz: N _{RB,c} = 100 | | 5MHz: N _{RB,c} = 25 10MHz: N _{RB,c} = 50 20MHz: N _{RB,c} = 100 | | 5MHz: N _{RB,c} = 25 10MHz: N _{RB,c} = 50 20MHz: N _{RB,c} = 100 | |
| Special subframe configuration ^{Note5} | | - | | 6 | | 6 | |
| Uplink-downlink configuration ^{Note5} | | - | | 1 | | 1 | |
| PDSCH parameters: DL Reference Measurement Channel | | 5MHz: R.5 FDD 10MHz: R.0 FDD 20MHz: R.4 FDD | | 5MHz: R.4 TDD 10MHz: R.0 TDD 20MHz: R.3 TDD | | - | |
| PCFICH/PDCCH/PHICH parameters: DL Reference Measurement Channel | | 5MHz: R.11 FDD 10MHz: R.6 FDD 20MHz: R.10 FDD | | 5MHz: R.11 TDD 10MHz: R.6 TDD 20MHz: R.10 TDD | | 5MHz: R.11 TDD 10MHz: R.6 TDD 20MHz: R.10 TDD | |
| OCNG Patterns | | 5MHz: OP.15 FDD 10MHz: OP.1 FDD 20MHz: OP.11 FDD | | 5MHz: OP.9 TDD 10MHz: OP.1 TDD 20MHz: OP.7 TDD | | 5MHz: OP.10 TDD 10MHz: OP.2 TDD 20MHz: OP.8 TDD | |
| PBCH_RA | dB | 0 | | 0 | | 0 | |
| PBCH_RB | dB | | | | | | |
| PSS_RA | dB | | | | | | |
| SSS_RA | dB | | | | | | |
| PCFICH_RB | dB | | | | | | |
| PHICH_RA | dB | | | | | | |
| PHICH_PB | dB | | | | | | |
| PDCCH_RA | dB | | | | | | |
| PDCCH_PB | dB | | | | | | |
| PDSCH_RA | dB | | | | | | |
| PDSCH_RB | dB | | | | | | |
| OCNG_RA ^{Note 1} | dB | | | | | | |
| OCNG_RB ^{Note 1} | dB | | | | | | |
| N _{oc} ^{Note 2} | dBm/15 KHz | | | | | | |

| | | | | | | | |
|--|---------------|--|--|--|--|-----------|--|
| \hat{E}_s / N_{oc} | dB | 4 | 4 | 4 | 4 | -infinity | 7 |
| \hat{E}_s / I_{ot} | dB | 4 | 4 | 4 | 4 | -infinity | 7 |
| RSRP ^{Note 3} | dBm/15 KHz | -97 | -97 | -97 | -97 | -infinity | -94 |
| SCH_RP ^{Note 3} | dBm/15 KHz | -97 | -97 | -97 | -97 | -infinity | -94 |
| I_o ^{Note 3} | dBm/Ch BW | -67.76 +10log ($N_{RB,c}$ /50) | -67.76 +10log ($N_{RB,c}$ /50) | -67.76 +10log ($N_{RB,c}$ /50) | -67.76 +10log ($N_{RB,c}$ /50) | N/A | -65.43 +10log ($N_{RB,c}$ /50) |
| Propagation Condition | | ETU70 | | ETU70 | | ETU70 | |
| Correlation Matrix and Antenna Configuration | | 1x2 Low | | 1x2 Low | | 1x2 Low | |
| Receive Time offset to cell1 ^{Note 4} | μ s | - | | 33 | | - | |
| Time offset to cell1 | μ s | - | | - | | 3 | |
| <p>Note 1: OCNG shall be used such that both cells are fully allocated and a constant total transmitted power spectral density is achieved for all OFDM symbols.</p> <p>Note 2: Interference from other cells and noise sources not specified in the test is assumed to be constant over subcarriers and time and shall be modelled as AWGN of appropriate power for N_{oc} to be fulfilled.</p> <p>Note 3: E_s/I_{ot}, RSRP, SCH_RP and I_o levels have been derived from other parameters for information purposes. They are not settable parameters themselves.</p> <p>Note 4: Receive time difference between subframe boundaries of signals received from the two cells at the UE antenna connector including time alignment error between the two cells.</p> <p>Note 5: For special subframe and uplink-downlink configurations see Tables 4.2-1 and 4.2-2 in TS 36.211 [16].</p> | | | | | | | |

Table A.8.23.12.1-3: DRX-Configuration for E-UTRAN TDD-FDD DC inter-frequency event triggered reporting with DRX in synchronous DC with PCell in FDD

| Field | Cell1 | Cell2 | Comment |
|--------------------------|---------|---------|---|
| | Value | Value | |
| onDurationTimer | psf1 | psf1 | As specified in clause 6.3.2 in TS 36.331 [2] |
| drx-InactivityTimer | psf1 | psf1 | |
| drx-RetransmissionTimer | psf1 | psf1 | |
| longDRX-CycleStartOffset | sf80 | sf1280 | |
| shortDRX | disable | disable | |

Table A.8.23.12.1-4: TimeAlignmentTimer-Configuration for E-UTRAN TDD-FDD DC inter-frequency event triggered reporting with DRX in synchronous DC with PCell in FDD

| Field | Cell1 | Cell2 | Comment |
|--------------------|-------|-------|--|
| | Value | Value | |
| TimeAlignmentTimer | sf500 | sf500 | As specified in clause 6.3.2 in TS 36.331 [2] |
| sr-ConfigIndex | 0 | 0 | For further information see clause 6.3.2 in TS 36.331 [2] and section 10.1 in TS 36.213 [3]. |

A.8.23.12.2 Test Requirements

The UE shall send one Event A3 triggered measurement report for Cell 3 on PCell, with a measurement reporting delay less than 3.84s from the beginning of time period T2. The measurement reporting delay is defined as the time from the beginning of time period T2 to the moment when the UE sends the measurement report on PUSCH.

The UE shall not send event triggered measurement reports, as long as the reporting criteria are not fulfilled.

The rate of correct events observed during repeated tests shall be at least 90%.

A.8.23.13 E-UTRAN TDD-FDD DC inter-frequency event triggered reporting with DRX in synchronous DC with PCell in TDD

A.8.23.13.1 Test Purpose and Environment

The purpose of this test is to verify that the UE makes correct reporting of inter frequency measurement. This test will partly verify the inter-frequency cell search requirements in clause 8.8.4.

The test parameters are given in Table A.8.23.13.1-1, A.8.23.13.1-2, A.8.23.13.1-3 and A.8.23.13.1-4 below. In the test there are three cells: Cell1, Cell2 and Cell3. Cell1 is PCell, Cell2 is PSCell and Cell3 is a neighbour cell. In the measurement control information it is indicated to the UE that event-triggered reporting with Events A3 (PCell) is used. The test consists of two successive time periods, with duration of T1 and T2, respectively. Prior to the start of the time duration T1, the UE shall be fully synchronized to Cell1 and Cell2. During T1 the UE shall not have any information on Cell3. Prior to the start of the time duration T1, DRX configurations on MCG and SCG are enabled and DRX inactivity timers for MCG and SCG have already been expired.

In this test, UE needs to be provided at least once every 500ms with new Timing Advance Command MAC control element to restart the Time alignment timer to keep UE uplink time alignment in Cell1. Furthermore the UE is allocated with PUSCH resource at every DRX cycle.

Table A.8.23.13.1-1: General test parameters for E-UTRAN TDD-FDD DC inter-frequency event triggered reporting with DRX in synchronous DC with PCell in TDD

| Parameter | Unit | Value | Comment | |
|--|-----------------|---------|--|--|
| E-UTRA RF Channel Number | | 1, 2, 3 | Three radio channels are used for this test. | |
| Active PCell | | Cell1 | PCell on RF channel number 1. | |
| Configured PSCell | | Cell2 | PSCell on RF channel number 2. | |
| Neighbour cell | | Cell3 | Neighbour cell on RF channel number 3. | |
| A3 | Hysteresis | dB | 0 | Hysteresis for evaluation of event A3. |
| | A3-offset | dB | -6 | |
| | Time To Trigger | s | 0 | |
| CP length | | Normal | | |
| DRX | | ON | DRX related parameters are defined in Table A.8.23.13.1-3 | |
| Measurement gap pattern Id | | 0 | | |
| Cell-individual offset for cells on RF channel number 1 | dB | 0 | Individual offset for cells on primary component carrier. | |
| Cell-individual offset for cells on RF channel number 2 | dB | 0 | Individual offset for cells on carrier frequency of Cell2. | |
| Cell-individual offset for cells on RF channel number 3 | dB | 0 | Individual offset for cells on carrier frequency of Cell3. | |
| Filter coefficient | | 0 | L3 filtering is not used | |
| T1 | s | 5 | | |
| T2 | s | 5 | | |
| Note 1: A UE capable of both synchronous and asynchronous DC operations is not required to pass this test case in accordance with the principle defined in section A.3.11. | | | | |

Table A.8.23.13.1-2: Cell specific test parameters for E-UTRAN TDD-FDD DC inter-frequency event triggered reporting with DRX in synchronous DC with PCell in TDD

| Parameter | Unit | Cell1 | | Cell2 | | Cell3 | |
|--------------------------|------|---|----|---|----|---|----|
| | | T1 | T2 | T1 | T2 | T1 | T2 |
| E-UTRA RF Channel Number | | 1 | | 2 | | 3 | |
| BW _{channel} | MHz | 5MHz: N _{RB,c} = 25 10MHz: N _{RB,c} = 50 20MHz: N _{RB,c} = 100 | | 5MHz: N _{RB,c} = 25 10MHz: N _{RB,c} = 50 20MHz: N _{RB,c} = 100 | | 5MHz: N _{RB,c} = 25 10MHz: N _{RB,c} = 50 20MHz: N _{RB,c} = 100 | |

| | | | | | | | |
|--|------------|--|--|--|--|--|--|
| Special subframe configuration ^{Note5} | | 6 | | - | | - | |
| Uplink-downlink configuration ^{Note5} | | 1 | | - | | - | |
| PDSCH parameters: DL Reference Measurement Channel | | 5MHz: R.4 TDD 10MHz: R.0 TDD 20MHz: R.3 TDD | | 5MHz: R.5 FDD 10MHz: R.0 FDD 20MHz: R.4 FDD | | - | |
| PCFICH/PDCCH/PHICH parameters: DL Reference Measurement Channel | | 5MHz: R.11 TDD 10MHz: R.6 TDD 20MHz: R.10 TDD | | 5MHz: R.11 FDD 10MHz: R.6 FDD 20MHz: R.10 FDD | | 5MHz: R.11 FDD 10MHz: R.6 FDD 20MHz: R.10 FDD | |
| OCNG Patterns | | 5MHz: OP.9 TDD 10MHz: OP.1 TDD 20MHz: OP.7 TDD | | 5MHz: OP.15 FDD 10MHz: OP.1 FDD 20MHz: OP.11 FDD | | 5MHz: OP.16 FDD 10MHz: OP.2 FDD 20MHz: OP.12 FDD | |
| PBCH_RA | dB | 0 | | 0 | | 0 | |
| PBCH_RB | dB | | | | | | |
| PSS_RA | dB | | | | | | |
| SSS_RA | dB | | | | | | |
| PCFICH_RB | dB | | | | | | |
| PHICH_RA | dB | | | | | | |
| PHICH_PB | dB | | | | | | |
| PDCCH_RA | dB | | | | | | |
| PDCCH_PB | dB | | | | | | |
| PDSCH_RA | dB | | | | | | |
| PDSCH_RB | dB | | | | | | |
| OCNG_RA ^{Note 1} | dB | | | | | | |
| OCNG_RB ^{Note 1} | dB | | | | | | |
| N_{oc} ^{Note 2} | dBm/15 KHz | | | | | | |
| \hat{E}_s / N_{oc} | dB | 4 | 4 | 4 | 4 | -infinity | 7 |
| \hat{E}_s / I_{ot} | dB | 4 | 4 | 4 | 4 | -infinity | 7 |
| RSRP ^{Note 3} | dBm/15 KHz | -97 | -97 | -97 | -97 | -infinity | -94 |
| SCH_RP ^{Note 3} | dBm/15 KHz | -97 | -97 | -97 | -97 | -infinity | -94 |
| I_o ^{Note 3} | dBm/Ch BW | -67.76 +10log ($N_{RB,c}$ /50) | -67.76 +10log ($N_{RB,c}$ /50) | -67.76 +10log ($N_{RB,c}$ /50) | -67.76 +10log ($N_{RB,c}$ /50) | N/A | -65.43 +10log ($N_{RB,c}$ /50) |
| Propagation Condition | | ETU70 | | ETU70 | | ETU70 | |
| Correlation Matrix and Antenna Configuration | | 1x2 Low | | 1x2 Low | | 1x2 Low | |
| Receive Time offset to cell1 ^{Note 4} | μ s | - | | 33 | | - | |
| Time offset to cell1 | μ s | - | | - | | 3 | |
| <p>Note 1: OCNG shall be used such that both cells are fully allocated and a constant total transmitted power spectral density is achieved for all OFDM symbols.</p> <p>Note 2: Interference from other cells and noise sources not specified in the test is assumed to be constant over subcarriers and time and shall be modelled as AWGN of appropriate power for N_{oc} to be fulfilled.</p> <p>Note 3: E_s/I_{ot}, RSRP, SCH_RP and I_o levels have been derived from other parameters for information purposes. They are not settable parameters themselves.</p> <p>Note 4: Receive time difference between subframe boundaries of signals received from the two cells at the UE antenna connector including time alignment error between the two cells.</p> <p>Note 5: For special subframe and uplink-downlink configurations see Tables 4.2-1 and 4.2-2 in TS 36.211 [16].</p> | | | | | | | |

Table A.8.23.13.1-3: DRX-Configuration for E-UTRAN TDD-FDD DC inter-frequency event triggered reporting with DRX in synchronous DC with PCell in TDD

| Field | Cell1 | Cell2 | Comment |
|--------------------------|-------|--------|---|
| | Value | Value | |
| onDurationTimer | psf1 | psf1 | As specified in clause 6.3.2 in TS 36.331 [2] |
| drx-InactivityTimer | psf1 | psf1 | |
| drx-RetransmissionTimer | psf1 | psf1 | |
| longDRX-CycleStartOffset | sf80 | sf1280 | |

| | | | |
|----------|---------|---------|--|
| shortDRX | disable | disable | |
|----------|---------|---------|--|

Table A.8.23.13.1-4: TimeAlignmentTimer -Configuration for E-UTRAN TDD-FDD DC inter-frequency event triggered reporting with DRX in synchronous DC with PCell in TDD

| Field | Cell1 | Cell2 | Comment |
|--------------------|-------|-------|--|
| | Value | Value | |
| TimeAlignmentTimer | sf500 | sf500 | As specified in clause 6.3.2 in TS 36.331 [2] |
| sr-ConfigIndex | 0 | 0 | For further information see clause 6.3.2 in TS 36.331 [2] and section 10.1 in TS 36.213 [3]. |

A.8.23.13.2 Test Requirements

The UE shall send one Event A3 triggered measurement report for Cell 3 on PCell, with a measurement reporting delay less than 3.84s from the beginning of time period T2. The measurement reporting delay is defined as the time from the beginning of time period T2 to the moment when the UE sends the measurement report on PUSCH.

The UE shall not send event triggered measurement reports, as long as the reporting criteria are not fulfilled.

The rate of correct events observed during repeated tests shall be at least 90%.

A.8.23.14 E-UTRAN TDD-FDD Addition and Release Delay of known PSCell in Synchronous DC with PCell in FDD

A.8.23.14.1 Test Purpose and Environment

The purpose of this test is to verify that the PSCell addition and release delays under synchronous dual connectivity are within the requirements stated in section 7.14 for the case when the PSCell is known by the UE at the time of addition.

The test parameters are given in Tables A.8.23.14.1-1 and cell-specific parameters in A.8.23.14.1-2 below. The test consists of five successive time periods with duration of T1, T2, T3, T4 and T5 respectively. There are two carriers each with one cell. Before the test starts the UE is connected to Cell 1 (PCell) on radio channel 1 (PCC) but is not aware of Cell 2 on radio channel 2. The UE is only monitoring the PCC. During T1 only Cell1 is known to the UE.

Before the start of T2 it is indicated to the UE in the measurement control information that event-triggered reporting with Event A4 is configured for neighbour cell (Cell2). Before the start of T2 the UE is configured with the measurement gaps (gap pattern Id # 0). The Cell2 becomes known to the UE during T2. Therefore during T2 the UE shall report Event A4. After receiving the Event A4, the test system shall send a RRC message to the UE to release the measurement gaps.

The test system shall send a RRC message to the UE to add PSCell (Cell 2) on radio channel 2. The RRC message (to add PSCell) also includes a request for the UE to start periodic CSI reporting for the PSCell after the PSCell has been successfully added. The RRC message to add PSCell shall be sent to the UE during period T2, after the measurement gaps are released by the test system. The point in time at which the RRC message to add PSCell (Cell2) is received at the UE antenna connector defines the start of time period T3.

The test system shall observe the periodic reporting of CSI for PSCell during T4. The point in time at which the UE has sent PRACH to the PSCell (Cell 2) defines the start of time period T4.

The test system shall send a RRC message to the UE to release PSCell (Cell 2) on radio channel 2. The RRC message to release PSCell (Cell2) shall be sent to the UE during time period T4, after the UE has sent at least one CQI report with non-zero CQI index for PSCell (Cell 2). The point in time at which the RRC message to release PSCell (Cell2) is received at the UE antenna connector defines the start of time period T5.

Table A.8.23.14.1-1: General test parameters for known PSCell addition and release case

| Parameter | Unit | Value | Comment |
|--------------------------|------|-------|---|
| E-UTRA RF Channel Number | | 1, 2 | Two radio channels are used for this test |

| | | | | |
|--|-----------------|-----|--------|---|
| Initial Condition | Active PCell | | Cell1 | PCell on RF channel number 1. |
| | Neighbour cell | | Cell2 | Neighbour cell on RF channel number 2. |
| Final Condition | Active PCell | | Cell1 | PCell on RF channel number 1. |
| | PSCell | | Cell2 | PSCell on RF channel number 2. |
| A4 | Hysteresis | dB | 0 | Hysteresis for evaluation of event A4. |
| | Threshold RSRP | dBm | -93 | Actual RSRP threshold for event A4. Needs to take absolute accuracy tolerance in section 9.1.11.1 into account plus margin. |
| | Time To Trigger | s | 0 | |
| CP length | | | Normal | |
| DRX | | | OFF | Continuous monitoring of primary cell |
| Measurement gap pattern Id | | | 0 | Gaps are configured before T2 and released before T3. |
| CQI/PMI periodicity and offset configuration index on cell2 | | | 0 | CQI reporting for PSCell every second subframe |
| Cell-individual offset for cells on RF channel number 1 | | dB | 0 | Individual offset for cells on primary component carrier. |
| Cell-individual offset for cells on RF channel number 2 | | dB | 0 | Individual offset for cells on carrier frequency of cell2. |
| T1 | | s | 5 | During this time the PCell shall be known and cell2 shall be unknown. |
| T2 | | s | ≤ 5 | During this time the UE shall identify neighbour cell (cell2) and report event A4. |
| T3 | | s | 1 | During this time the UE adds the PSCell. |
| T4 | | s | 1 | During this time the UE sends CSI reports for PSCell. |
| T5 | | s | 1 | During this time the UE releases the PSCell. |
| Note 1: This test verifies the RRM requirement which is independent of channel bandwidth and is performed according to the principle defined in section A.3.6.1. | | | | |
| Note 2: A UE capable of both synchronous and asynchronous DC operations is not required to pass this test case in accordance with the principle defined in section A.3.6.11. | | | | |

Table A.8.23.14.1-2: Cell specific test parameters for E-UTRAN known PSCell addition and release

| Parameter | Unit | Cell 1 | | | | | Cell 2 | | | | |
|---|------|---|----|----|----|----|---|----|----|----|----|
| | | T1 | T2 | T3 | T4 | T5 | T1 | T2 | T3 | T4 | T5 |
| E-UTRA RF Channel Number | | 1 | | | | | 2 | | | | |
| Special subframe configuration | | N/A | | | | | 6 | | | | |
| Uplink-downlink configuration | | N/A | | | | | 1 | | | | |
| BW _{channel} | MHz | 5MHz: N _{RB,c} = 25 10MHz: N _{RB,c} = 50 20MHz: N _{RB,c} = 100 | | | | | 5MHz: N _{RB,c} = 25 10MHz: N _{RB,c} = 50 20MHz: N _{RB,c} = 100 | | | | |
| PDSCH parameters: DL Reference Measurement Channel | | 5MHz: R.5 FDD 10MHz: R.0 FDD 20MHz: R.4 FDD | | | | | - | | | | |
| PCFICH/PDCCH/PHICH parameters: DL Reference Measurement Channel | | 5MHz: R.11 FDD 10MHz: R.6 FDD 20MHz: R.10 FDD | | | | | 5MHz: R.11 TDD 10MHz: R.6 TDD 20MHz: R.10 TDD | | | | |
| OCNG Patterns | | 5MHz: OP.15 FDD 10MHz: OP.1 FDD 20MHz: OP.11 FDD | | | | | 5MHz: OP.10 TDD 10MHz: OP.2 TDD 20MHz: OP.8 TDD | | | | |
| PBCH_RA | dB | 0 | | | | | 0 | | | | |
| PBCH_RB | dB | | | | | | | | | | |
| PSS_RA | dB | | | | | | | | | | |
| SSS_RA | dB | | | | | | | | | | |
| PCFICH_RB | dB | | | | | | | | | | |
| PHICH_RA | dB | | | | | | | | | | |
| PHICH_RB | dB | | | | | | | | | | |
| PDCCH_RA | dB | | | | | | | | | | |

| | | | | | | | | | | | | |
|--|---|--|--|--|--|--|-----------|--|--|--|--|--|
| PDCCH_RB | dB | | | | | | | | | | | |
| PDSCH_RA | dB | | | | | | | | | | | |
| PDSCH_RB | dB | | | | | | | | | | | |
| OCNG_RA ^{Note 1} | dB | | | | | | | | | | | |
| OCNG_RB ^{Note 1} | dB | | | | | | | | | | | |
| N _{oc} ^{Note 2} | dBm/15 kHz | -101 | | | | | N/A | -85 | | | | |
| \hat{E}_s/N_{oc} | dB | 19 | 19 | 19 | 19 | 19 | -infinity | 0 | 0 | 0 | 0 | |
| \hat{E}_s/I_{ot} | dB | 19 | 19 | 19 | 19 | 19 | infinity | 0 | 0 | 0 | 0 | |
| RSRP ^{Note 3} | dBm/15 kHz | -82 | -82 | -82 | -82 | -82 | -infinity | -85 | -85 | -85 | -85 | |
| SCH_RP ^{Note 3} | dBm/15 kHz | -82 | -82 | -82 | -82 | -82 | -infinity | -85 | -85 | -85 | -85 | |
| I _o ^{Note 3} | dBm/C h BW | -54.16 +10log (N _{RB,c} /50) | -54.16 +10log (N _{RB,c} /50) | -54.16 +10log (N _{RB,c} /50) | -54.16 +10log (N _{RB,c} /50) | -54.16 +10log (N _{RB,c} /50) | N/A | -54.21 +10log (N _{RB,c} /50) | -54.21 +10log (N _{RB,c} /50) | -54.21 +10log (N _{RB,c} /50) | -54.21 +10log (N _{RB,c} /50) | |
| Propagation Condition | | AWGN | | | | | AWGN | | | | | |
| Antenna Configuration | | 1x2 | | | | | 1x2 | | | | | |
| Receive time offset to cell1 ^{Note 4} | µs | - | | | | | 33 | | | | | |
| PRACH configuration Index ^{Note 5} | | 4 | | | | | 50 | | | | | |
| Note 1: | OCNG shall be used such that all cells are fully allocated and a constant total transmitted power spectral density is achieved for all OFDM symbols. | | | | | | | | | | | |
| Note 2: | Interference from other cells and noise sources not specified in the test is assumed to be constant over subcarriers and time and shall be modelled as AWGN of appropriate power for N _{oc} to be fulfilled. | | | | | | | | | | | |
| Note 3: | \hat{E}_s/I_{ot} , RSRP, SCH_RP and I _o levels have been derived from other parameters for information purposes. They are not settable parameters themselves. | | | | | | | | | | | |
| Note 4: | Receive time difference between subframe boundaries of signals received from the two cells at the UE antenna connector including time alignment error between the two cells. | | | | | | | | | | | |
| Note 5: | As specified in table 5.7.1-2 in TS 36.211. | | | | | | | | | | | |
| Note 6: | The uplink resources for CSI reporting are assigned to the UE prior to the start of time period T4. | | | | | | | | | | | |

A.8.23.14.2 Test Requirements

The UE shall transmit the PRACH to PSCell at latest 115 ms into T3.

The UE shall send at least one CSI report for PSCell with non-zero CQI index during T4.

The UE shall stop sending CSI reports for PSCell in at latest 16ms into T5.

All of the above test requirements shall be fulfilled in order for the observed PSCell addition delay and PSCell release delay to be counted as correct. The rate of correct observed PSCell addition delay and PSCell release delay during repeated tests shall be at least 90%.

NOTE: The PSCell addition delay can be expressed as follows as specified in Clause 7.14.2:

$$T_{\text{config_PSCell}} = 15\text{ms} + T_{\text{activation_time}} + 50\text{ms} + T_{\text{PCell_DU}} + T_{\text{PSCell_DU}}$$

Where:

T_{activation_time} = 20 ms (cell2 is known to the UE);

T_{PCell_DU} = 0 (due to PRACH configurations in cell1 and cell2 being orthogonal in time, i.e. non-overlapping in time);

T_{PSCell_DU} = 30 ms (delay due to PRACH transmission to cell2).

This gives a total of 115 ms.

A.8.23.15 E-UTRAN TDD-FDD Addition and Release Delay of known PSCell in Synchronous DC with PCell in TDD

A.8.23.15.1 Test Purpose and Environment

The purpose of this test is to verify that the PSCell addition and release delays under synchronous dual connectivity are within the requirements stated in section 7.14 for the case when the PSCell is known by the UE at the time of addition.

The test parameters are given in Tables A.8.23.15.1-1 and cell-specific parameters in A.8.23.15.1-2 below. The test consists of five successive time periods with duration of T1, T2, T3, T4 and T5 respectively. There are two carriers each with one cell. Before the test starts the UE is connected to Cell 1 (PCell) on radio channel 1 (PCC) but is not aware of Cell 2 on radio channel 2. The UE is only monitoring the PCC. During T1 only Cell1 is known to the UE.

Before the start of T2 it is indicated to the UE in the measurement control information that event-triggered reporting with Event A4 is configured for neighbour cell (Cell2). Before the start of T2 the UE is configured with the measurement gaps (gap pattern Id # 0). The Cell2 becomes known to the UE during T2. Therefore during T2 the UE shall report Event A4. After receiving the Event A4, the test system shall send a RRC message to the UE to release the measurement gaps.

The test system shall send a RRC message to the UE to add PSCell (Cell 2) on radio channel 2. The RRC message (to add PSCell) also includes a request for the UE to start periodic CSI reporting for the PSCell after the PSCell has been successfully added. The RRC message to add PSCell shall be sent to the UE during period T2, after the measurement gaps are released by the test system. The point in time at which the RRC message to add PSCell (Cell2) is received at the UE antenna connector defines the start of time period T3.

The test system shall observe the periodic reporting of CSI for PSCell during T4. The point in time at which the UE has sent PRACH to the PSCell (Cell 2) defines the start of time period T4.

The test system shall send a RRC message to the UE to release PSCell (Cell 2) on radio channel 2. The RRC message to release PSCell (Cell2) shall be sent to the UE during time period T4, after the UE has sent at least one CQI report with non-zero CQI index for PSCell (Cell 2). The point in time at which the RRC message to release PSCell (Cell2) is received at the UE antenna connector defines the start of time period T5.

Table A.8.23.15.1-1: General test parameters for known PSCell addition and release case

| Parameter | | Unit | Value | Comment |
|---|-----------------|------|--------|---|
| E-UTRA RF Channel Number | | | 1, 2 | Two radio channels are used for this test |
| Initial Condition | Active PCell | | Cell1 | PCell on RF channel number 1. |
| | Neighbour cell | | Cell2 | Neighbour cell on RF channel number 2. |
| Final Condition | Active PCell | | Cell1 | PCell on RF channel number 1. |
| | PSCell | | Cell2 | PSCell on RF channel number 2. |
| A4 | Hysteresis | dB | 0 | Hysteresis for evaluation of event A4. |
| | Threshold RSRP | dBm | -93 | Actual RSRP threshold for event A4. Needs to take absolute accuracy tolerance in section 9.1.11.1 into account plus margin. |
| | Time To Trigger | s | 0 | |
| CP length | | | Normal | |
| DRX | | | OFF | Continuous monitoring of primary cell |
| Measurement gap pattern Id | | | 0 | Gaps are configured before T2 and released before T3. |
| CQI/PMI periodicity and offset configuration index on cell2 | | | 0 | CQI reporting for PSCell every second subframe |
| Cell-individual offset for cells on RF channel number 1 | | dB | 0 | Individual offset for cells on primary component carrier. |
| Cell-individual offset for cells on RF channel number 2 | | dB | 0 | Individual offset for cells on carrier frequency of cell2. |
| T1 | | s | 5 | During this time the PCell shall be known and cell2 shall be unknown. |
| T2 | | s | ≤ 5 | During this time the UE shall identify neighbour cell (cell2) and report event A4. |
| T3 | | s | 1 | During this time the UE adds the PSCell. |
| T4 | | s | 1 | During this time the UE sends CSI reports for PSCell. |
| T5 | | s | 1 | During this time the UE releases the PSCell. |

Note 1: This test verifies the RRM requirement which is independent of channel bandwidth and is performed according to the principle defined in section A.3.6.1.
 Note 2: A UE capable of both synchronous and asynchronous DC operations is not required to pass this test case in accordance with the principle defined in section A.3.6.11.

Table A.8.23.15.1-2: Cell specific test parameters for E-UTRAN known PSCell addition and release

| Parameter | Unit | Cell 1 | | | | | Cell 2 | | | | |
|---|------------|---|--------------------------------------|--------------------------------------|--------------------------------------|--------------------------------------|---|--------------------------------------|--------------------------------------|--------------------------------------|--------------------------------------|
| | | T1 | T2 | T3 | T4 | T5 | T1 | T2 | T3 | T4 | T5 |
| E-UTRA RF Channel Number | | 1 | | | | | 2 | | | | |
| Special subframe configuration | | 6 | | | | | N/A | | | | |
| Uplink-downlink configuration | | 1 | | | | | N/A | | | | |
| BW _{channel} | MHz | 5MHz: N _{RB,c} = 25 10MHz: N _{RB,c} = 50 20MHz: N _{RB,c} = 100 | | | | | 5MHz: N _{RB,c} = 25 10MHz: N _{RB,c} = 50 20MHz: N _{RB,c} = 100 | | | | |
| PDSCH parameters: DL Reference Measurement Channel | | 5MHz: R.4 TDD 10MHz: R.0 TDD 20MHz: R.3 TDD | | | | | - | | | | |
| PCFICH/PDCCH/PHICH parameters: DL Reference Measurement Channel | | 5MHz: R.11 TDD 10MHz: R.6 TDD 20MHz: R.10 TDD | | | | | 5MHz: R.11 FDD 10MHz: R.6 FDD 20MHz: R.10 FDD | | | | |
| OCNG Patterns | | 5MHz: OP.9 TDD 10MHz: OP.1 TDD 20MHz: OP.7 TDD | | | | | 5MHz: OP.16 FDD 10MHz: OP.2 FDD 20MHz: OP.12 FDD | | | | |
| PBCH_RA | dB | 0 | | | | | 0 | | | | |
| PBCH_RB | dB | | | | | | | | | | |
| PSS_RA | dB | | | | | | | | | | |
| SSS_RA | dB | | | | | | | | | | |
| PCFICH_RB | dB | | | | | | | | | | |
| PHICH_RA | dB | | | | | | | | | | |
| PHICH_RB | dB | | | | | | | | | | |
| PDCCH_RA | dB | | | | | | | | | | |
| PDCCH_RB | dB | | | | | | | | | | |
| PDSCH_RA | dB | | | | | | | | | | |
| PDSCH_RB | dB | | | | | | | | | | |
| OCNG_RA ^{Note 1} | dB | | | | | | | | | | |
| OCNG_RB ^{Note 1} | dB | | | | | | | | | | |
| N _{oc} ^{Note 2} | dBm/15 kHz | | | | | | | | | | |
| \bar{E}_s/N_{oc} | dB | 19 | 19 | 19 | 19 | 19 | -infinity | 0 | 0 | 0 | 0 |
| \bar{E}_s/I_{ot} | dB | 19 | 19 | 19 | 19 | 19 | infinity | 0 | 0 | 0 | 0 |
| RSRP ^{Note 3} | dBm/15 kHz | -82 | -82 | -82 | -82 | -82 | -infinity | -85 | -85 | -85 | -85 |
| SCH_RP ^{Note 3} | dBm/15 kHz | -82 | -82 | -82 | -82 | -82 | -infinity | -85 | -85 | -85 | -85 |
| I _o ^{Note 3} | dBm/C h BW | -54.16 +10log(N _{RB,c} /50) | -54.16 +10log(N _{RB,c} /50) | -54.16 +10log(N _{RB,c} /50) | -54.16 +10log(N _{RB,c} /50) | -54.16 +10log(N _{RB,c} /50) | N/A | -54.21 +10log(N _{RB,c} /50) | -54.21 +10log(N _{RB,c} /50) | -54.21 +10log(N _{RB,c} /50) | -54.21 +10log(N _{RB,c} /50) |
| Propagation Condition | | AWGN | | | | | AWGN | | | | |
| Antenna Configuration | | 1x2 | | | | | 1x2 | | | | |
| Receive time offset to cell1 ^{Note 4} | μs | - | | | | | 33 | | | | |
| PRACH configuration Index ^{Note 5} | | 56 | | | | | 2 | | | | |

| | |
|---------|--|
| Note 1: | OCNG shall be used such that all cells are fully allocated and a constant total transmitted power spectral density is achieved for all OFDM symbols. |
| Note 2: | Interference from other cells and noise sources not specified in the test is assumed to be constant over subcarriers and time and shall be modelled as AWGN of appropriate power for N_{oc} to be fulfilled. |
| Note 3: | \hat{E}_s/I_{ot} , RSRP, SCH_RP and I_o levels have been derived from other parameters for information purposes. They are not settable parameters themselves. |
| Note 4: | Receive time difference between subframe boundaries of signals received from the two cells at the UE antenna connector including time alignment error between the two cells. |
| Note 5: | As specified in table 5.7.1-2 in TS 36.211. |
| Note 6: | The uplink resources for CSI reporting are assigned to the UE prior to the start of time period T4. |

A.8.23.15.2 Test Requirements

The UE shall transmit the PRACH to PSCell at latest 115 ms into T3.

The UE shall send at least one CSI report for PSCell with non-zero CQI index during T4.

The UE shall stop sending CSI reports for PSCell in at latest 16ms into T5.

All of the above test requirements shall be fulfilled in order for the observed PSCell addition delay and PSCell release delay to be counted as correct. The rate of correct observed PSCell addition delay and PSCell release delay during repeated tests shall be at least 90%.

NOTE: The PSCell addition delay can be expressed as follows as specified in Clause 7.14.2:

$$T_{\text{config_PSCell}} = 15\text{ms} + T_{\text{activation_time}} + 50\text{ms} + T_{\text{PCell_DU}} + T_{\text{PSCell_DU}}$$

Where:

$T_{\text{activation_time}} = 20 \text{ ms}$ (cell2 is known to the UE);

$T_{\text{PCell_DU}} = 0$ (due to PRACH configurations in cell1 and cell2 being orthogonal in time, i.e. non-overlapping in time);

$T_{\text{PSCell_DU}} = 30 \text{ ms}$ (delay due to PRACH transmission to cell2).

This gives a total of 115 ms.

A.8.23.16 E-UTRAN FDD-FDD DC SSTD measurement reporting delay with no DRX in asynchronous DC

A.8.23.16.1 Test Purpose and Environment

The purpose of this test is to verify that the UE makes correct reporting of SSTD measurements. The test partially verifies the requirement in SSTD Measurements for E-UTRA Dual Connectivity, section 8.8.7. This test is applicable to UEs which support asynchronous dual connectivity and support SSTD measurements.

The test parameters are given in Tables A.8.23.16.1-1 and A.8.23.16.1-2. In this test there are 2 cells, a PCell and a PSCell, on different frequencies.

The test consists of two time phases, T1 and T2. During T1 a dual connectivity connection is established. At the end of T1 a measurement with the IE reportSSTD-Meas set to TRUE is configured by the test equipment, such that the measurement configuration is available to the UE at the transition from T1 to T2. The SSTD reporting delay is the time from the start of T2 until an SSTD measurement report is transmitted by the UE.

Table A.8.23.16.1-1: General test parameters for E-UTRAN FDD-FDD DC SSTD measurement reporting delay with no DRX in asynchronous DC

| Parameter | Unit | Value | Comment |
|--------------------------|------|-------|--|
| E-UTRA RF Channel Number | | 1, 2 | Two radio channels are used for this test. |
| Active PCell | | Cell1 | PCell on RF channel number 1. |
| Configured PSCell | | Cell2 | PSCell on RF channel number 2. |

| | | | |
|--|---|--------|--|
| CP length | | Normal | |
| DRX | | OFF | |
| T1 | s | 2 | |
| T2 | s | 10 | |
| Note 1: This test verifies the RRM requirement which is independent of channel bandwidth and is performed according to the principle defined in section A.3.6.1. | | | |

Table A.8.23.16.1-2: Cell specific test parameters for E-UTRAN FDD-FDD DC SSTD measurement reporting delay with no DRX in asynchronous DC

| Parameter | Unit | Cell 1 | | Cell 2 | |
|---|---------------|---|---|---|---|
| | | T1 | T2 | T1 | T2 |
| E-UTRA RF Channel Number | | 1 | | 2 | |
| BW _{channel} | MHz | 5MHz: N _{RB,c} = 25 10MHz: N _{RB,c} = 50 20MHz: N _{RB,c} = 100 | | 5MHz: N _{RB,c} = 25 10MHz: N _{RB,c} = 50 20MHz: N _{RB,c} = 100 | |
| PDSCH parameters: DL Reference Measurement Channel | | 5MHz: R.5 FDD 10MHz: R.0 FDD 20MHz: R.4 FDD | | 5MHz: R.5 FDD 10MHz: R.0 FDD 20MHz: R.4 FDD | |
| PCFICH/PDCCH/PHICH parameters: DL Reference Measurement Channel | | 5MHz: R.11 FDD 10MHz: R.6 FDD 20MHz: R.10 FDD | | 5MHz: R.11 FDD 10MHz: R.6 FDD 20MHz: R.10 FDD | |
| OCNG Patterns | | 5MHz: OP.15 FDD 10MHz: OP.1 FDD 20MHz: OP.11 FDD | | 5MHz: OP.15 FDD 10MHz: OP.1 FDD 20MHz: OP.11 FDD | |
| PBCH_RA | dB | 0 | | 0 | |
| PBCH_RB | dB | | | | |
| PSS_RA | dB | | | | |
| SSS_RA | dB | | | | |
| PCFICH_RB | dB | | | | |
| PHICH_RA | dB | | | | |
| PHICH_PB | dB | | | | |
| PDCCH_RA | dB | | | | |
| PDCCH_PB | dB | | | | |
| PDSCH_RA | dB | | | | |
| PDSCH_RB | dB | | | | |
| OCNG_RA ^{Note 1} | dB | | | | |
| OCNG_RB ^{Note 1} | dB | | | | |
| N_{oc} ^{Note 2} | dBm/15 KHz | | | | |
| \hat{E}_s / N_{oc} | dB | -3 | -3 | -3 | -3 |
| \hat{E}_s / I_{ot} | dB | -3 | -3 | -3 | -3 |
| RSRP ^{Note 3} | dBm/15 KHz | -107 | -107 | -107 | -74.28 |
| SCH_RP ^{Note 3} | dBm/15 KHz | -107 | -107 | -107 | -107 |
| I_o ^{Note 3} | dBm/Ch BW | -74.45 +10log (N _{RB,c} /50) | -74.45 +10log (N _{RB,c} /50) | -74.45 +10log (N _{RB,c} /50) | -74.45 +10log (N _{RB,c} /50) |
| Propagation Condition | | ETU70 | | ETU70 | |
| Correlation Matrix and Antenna Configuration | | 1x2 Low | | 1x2 Low | |
| Receive Time offset to cell1 ^{Note 4} | µs | - | | 33 | |
| Note 1: OCNG shall be used such that both cells are fully allocated and a constant total transmitted power spectral density is achieved for all OFDM symbols. | | | | | |
| Note 2: Interference from other cells and noise sources not specified in the test is assumed to be constant over subcarriers and time and shall be modelled as AWGN of appropriate power for N _{oc} to be fulfilled. | | | | | |
| Note 3: RSRP, SCH_RP and I _o levels have been derived from other parameters for information purposes. They are not settable parameters themselves. | | | | | |
| Note 4: Receive time difference between subframe boundaries of signals received from the two cells at the UE antenna connector including time alignment error between the two cells. | | | | | |

A.8.23.16.2 Test Requirements

The UE shall send a measurement report containing a *MeasResultSSTD* IE within RRC procedure delay + 200ms + 2 x $TTI_{DCCH} = 217$ ms from the start of T2.

A.8.23.17 E-UTRAN FDD-FDD DC SSTD measurement reporting delay with DRX in asynchronous DC

A.8.23.17.1 Test Purpose and Environment

The purpose of this test is to verify that the UE makes correct reporting of SSTD measurements. The test partially verifies the requirement in SSTD Measurements for E-UTRA Dual Connectivity, section 8.8.7. This test is applicable to UEs which support asynchronous dual connectivity and support SSTD measurements.

The test parameters are given in Tables A.8.23.17.1-1, A.8.23.17.1-2 and A.8.23.17.1-3. In this test there are 2 cells, a PCell and a PScell, on different frequencies.

The test consists of two time phases, T1 and T2. During T1 a dual connectivity connection is established. At the end of T1 a measurement with the IE reportSSTD-Meas set to TRUE is configured by the test equipment, such that the measurement configuration is available to the UE at the transition from T1 to T2. The SSTD reporting delay is the time from the start of T2 until an SSTD measurement report is transmitted by the UE.

Table A.8.23.17.1-1: General test parameters for E-UTRAN FDD-FDD DC SSTD measurement reporting delay with DRX in asynchronous DC

| Parameter | Unit | Value | Comment |
|--|------|--------|---|
| E-UTRA RF Channel Number | | 1, 2 | Two radio channels are used for this test. |
| Active PCell | | Cell1 | PCell on RF channel number 1. |
| Configured PSCell | | Cell2 | PSCell on RF channel number 2. |
| CP length | | Normal | |
| DRX | | ON | DRX related parameters are defined in Table A.8.23.17.1-3 |
| T1 | s | 2 | |
| T2 | s | 10 | |
| Note 1: This test verifies the RRM requirement which is independent of channel bandwidth and is performed according to the principle defined in section A.3.6.1. | | | |

Table A.8.23.17.1-2: Cell specific test parameters for E-UTRAN FDD-FDD DC SSTD measurement reporting delay with DRX in asynchronous DC

| Parameter | Unit | Cell 1 | | Cell 2 | |
|--|------|---|----|---|----|
| | | T1 | T2 | T1 | T2 |
| E-UTRA RF Channel Number | | 1 | | 2 | |
| BW _{channel} | MHz | 5MHz: N _{RB,c} = 25 10MHz: N _{RB,c} = 50 20MHz: N _{RB,c} = 100 | | 5MHz: N _{RB,c} = 25 10MHz: N _{RB,c} = 50 20MHz: N _{RB,c} = 100 | |
| PDSCH parameters: DL Reference Measurement Channel | | 5MHz: R.5 FDD 10MHz: R.0 FDD 20MHz: R.4 FDD | | 5MHz: R.5 FDD 10MHz: R.0 FDD 20MHz: R.4 FDD | |
| PCFICH/PDCCH/PHICH parameters: DL Reference Measurement Channel | | 5MHz: R.11 FDD 10MHz: R.6 FDD 20MHz: R.10 FDD | | 5MHz: R.11 FDD 10MHz: R.6 FDD 20MHz: R.10 FDD | |
| OCNG Patterns | | 5MHz: OP.15 FDD 10MHz: OP.1 FDD 20MHz: OP.11 FDD | | 5MHz: OP.15 FDD 10MHz: OP.1 FDD 20MHz: OP.11 FDD | |
| PBCH_RA | dB | 0 | | 0 | |
| PBCH_RB | dB | | | | |

| | | | | | |
|--|---------------|---|---|---|---|
| PSS_RA | dB | | | | |
| SSS_RA | dB | | | | |
| PCFICH_RB | dB | | | | |
| PHICH_RA | dB | | | | |
| PHICH_PB | dB | | | | |
| PDCCH_RA | dB | | | | |
| PDCCH_PB | dB | | | | |
| PDSCH_RA | dB | | | | |
| PDSCH_RB | dB | | | | |
| OCNG_RA ^{Note 1} | dB | | | | |
| OCNG_RB ^{Note 1} | dB | | | | |
| N_{oc} ^{Note 2} | dBm/15 KHz | -104 | | -104 | |
| \hat{E}_s / N_{oc} | dB | -3 | -3 | -3 | -3 |
| \hat{E}_s / I_{ot} | dB | -3 | -3 | -3 | -3 |
| RSRP ^{Note 3} | dBm/15 KHz | -107 | -107 | -107 | -74.28 |
| SCH_RP ^{Note 3} | dBm/15 KHz | -107 | -107 | -107 | -107 |
| I_o ^{Note 3} | dBm/Ch BW | -74.45 +10log ($N_{RB,c} / 50$) | -74.45 +10log ($N_{RB,c} / 50$) | -74.45 +10log ($N_{RB,c} / 50$) | -74.45 +10log ($N_{RB,c} / 50$) |
| Propagation Condition | | ETU70 | | ETU70 | |
| Correlation Matrix and Antenna Configuration | | 1x2 Low | | 1x2 Low | |
| Receive Time offset to cell1 ^{Note 4} | μ s | - | | 500 | |
| Note 1: OCNG shall be used such that both cells are fully allocated and a constant total transmitted power spectral density is achieved for all OFDM symbols. | | | | | |
| Note 2: Interference from other cells and noise sources not specified in the test is assumed to be constant over subcarriers and time and shall be modelled as AWGN of appropriate power for N_{oc} to be fulfilled. | | | | | |
| Note 3: RSRP, SCH_RP and I_o levels have been derived from other parameters for information purposes. They are not settable parameters themselves. | | | | | |
| Note 4: Receive time difference between subframe boundaries of signals received from the two cells at the UE antenna connector including time alignment error between the two cells. | | | | | |

Table A.8.23.17.1-3: DRX-Configuration for E-UTRAN FDD-FDD DC SSTD measurement reporting delay with DRX in asynchronous DC

| Field | PCell Value | PSCell Value | Comment |
|--|----------------|-----------------|---------|
| onDurationTimer | psf1 | psf1 | |
| drx-InactivityTimer | psf1 | psf1 | |
| drx-RetransmissionTimer | psf1 | psf1 | |
| longDRX-CycleStartOffset | sf320 | sf320 | |
| shortDRX | disable | disable | |
| Note 1: For further information see clause 6.3.2 in TS 36.331. | | | |

A.8.23.17.2 Test Requirements

The UE shall send a measurement report containing a *MeasResultSSTD* IE within RRC procedure delay + 5*320ms + 2 x $TTI_{DCH} = 1617$ ms from the start of T2.

A.8.23.18 E-UTRAN FDD - FDD DC Intra-frequency identification of a new CGI of E-UTRA cell using autonomous gaps in synchronous DC

A.8.23.18.1 Test Purpose and Environment

This test is to verify the requirement for identification of a new CGI of E-UTRA cell with autonomous gaps in clause 8.8.5.1.

The test scenario comprises of two E-UTRA FDD carriers and three cells as given in tables A.8.23.18.1-1 and A.8.23.18.1-2. Cell 1 is PCell, Cell 2 is PSCell and Cell 3 is neighbour cell. PDCCHs indicating new transmissions shall be sent continuously on PCell and PSCell to ensure that the UE would have ACK/NACK sending during identifying a new CGI of E-UTRAN cell. The test consists of three successive time periods, with time durations of T1, T2 and T3 respectively. At the start of time duration T1, the UE does not have any timing information of cell 3. Starting T2, cell 2 becomes detectable and the UE is expected to detect and send a measurement report.

A RRC message implying SI reading shall be sent to the UE during period T2, after the UE has reported Event A3. The RRC message shall create a measurement report configuration with purpose *reportCGI* and *si-RequestForHO* set to TRUE. The start of T3 is the instant when the last TTI containing the RRC message implying SI reading is sent to the UE.

Table A.8.23.18.1-1: General test parameters for E-UTRAN FDD - FDD DC Intra-frequency identification of a new CGI of E-UTRA cell using autonomous gaps in synchronous DC

| Parameter | | Unit | Value | Comment |
|---|-----------------|------|--------|--|
| E-UTRA RF Channel Number | | | 1, 2 | Two radio channels are used for this test. |
| Active PCell | | | Cell1 | PCell on RF channel number 1. |
| Active PSCell | | | Cell2 | PSCell on RF channel number 2. |
| Neighbour cell | | | Cell3 | Neighbour cell on RF channel number 2. |
| A3 | Hysteresis | dB | 0 | Hysteresis for evaluation of event A3. |
| | A3-offset | dB | -3 | |
| | Time To Trigger | s | 0 | |
| CP length | | | Normal | |
| DRX | | | OFF | DRX related parameters are defined in Table A.8.23.4.1-3 |
| si-RequestForHO | | | TRUE | As specified in clause 5.5.3.1 in TS 36.331. |
| Cell-individual offset for cells on RF channel number 1 | | dB | 0 | Individual offset for cells on primary component carrier. |
| Cell-individual offset for cells on RF channel number 2 | | dB | 0 | Individual offset for cells on carrier frequency of Cell2. |
| Filter coefficient | | | 0 | L3 filtering is not used |
| T1 | | s | 5 | |
| T2 | | s | ≤10 | |
| T3 | | s | 5 | |

Table A.8.23.18.1-2: Cell specific test parameters for E-UTRAN FDD - FDD DC Intra-frequency identification of a new CGI of E-UTRA cell using autonomous gaps in synchronous DC

| Parameter | Unit | Cell 1 | | | Cell 2 | | | Cell 3 | | |
|----------------------------------|------|---|----|----|---|----|----|---|----|----|
| | | T1 | T2 | T3 | T1 | T2 | T3 | T1 | T2 | T3 |
| E-UTRA RF Channel Number | | 1 | | | 2 | | | | | |
| BW _{channel} | MHz | 5MHz: N _{RB,c} = 25 10MHz: N _{RB,c} = 50 20MHz: N _{RB,c} = 100 | | | 5MHz: N _{RB,c} = 25 10MHz: N _{RB,c} = 50 20MHz: N _{RB,c} = 100 | | | 5MHz: N _{RB,c} = 25 10MHz: N _{RB,c} = 50 20MHz: N _{RB,c} = 100 | | |
| PDSCH parameters: | | 5MHz: R.7 FDD 10MHz: R.3 FDD 20MHz: R.6 FDD | | | 5MHz: R.7 FDD 10MHz: R.3 FDD 20MHz: R.6 FDD | | | - | | |
| PCFICH/PDCCH/PHICH parameters: | | 5MHz: R.11 FDD 10MHz: R.6 FDD 20MHz: R.10 FDD | | | 5MHz: R.11 FDD 10MHz: R.6 FDD 20MHz: R.10 FDD | | | 5MHz: R.11 FDD 10MHz: R.6 FDD 20MHz: R.10 FDD | | |
| OCNG Patterns defined in A.3.2.1 | | 5MHz: OP.20 FDD 10MHz: OP.10 FDD 20MHz: OP.17 FDD | | | 5MHz: OP.20 FDD 10MHz: OP.10 FDD 20MHz: OP.17 FDD | | | 5MHz: OP.16 FDD 10MHz: OP.2 FDD 20MHz: OP.12 FDD | | |
| PBCH_RA | dB | 0 | | | 0 | | | 0 | | |
| PBCH_RB | dB | | | | | | | | | |
| PSS_RA | dB | | | | | | | | | |
| SSS_RA | dB | | | | | | | | | |
| PCFICH_RB | dB | | | | | | | | | |
| PHICH_RA | dB | | | | | | | | | |

| | | | | | | | | | | |
|--|--|--|--|--|--|--|--|---------------------------------|------|------|
| PHICH_PB | dB | | | | | | | | | |
| PDCCH_RA | dB | | | | | | | | | |
| PDCCH_PB | dB | | | | | | | | | |
| PDSCH_RA | dB | | | | | | | | | |
| PDSCH_RB | dB | | | | | | | | | |
| OCNG_RA ^{Note 1} | dB | | | | | | | | | |
| OCNG_RB ^{Note 1} | dB | | | | | | | | | |
| N_{oc} ^{Note 2} | dBm/15 KHz | -98 | | | -98 | | | | | |
| \hat{E}_s/N_{oc} | dB | 8 | 8 | 8 | 8 | 8 | 8 | -Infinity | 11 | 11 |
| \hat{E}_s/I_{ot} | dB | 8 | 8 | 8 | 8 | -3.3 | -3.3 | -Infinity | 2.36 | 2.36 |
| RSRP ^{Note 3} | dBm/15 KHz | -90 | -90 | -90 | -90 | -90 | -90 | -Infinity | -87 | -87 |
| SCH_RP ^{Note3} | dBm/15 KHz | -90 | -90 | -90 | -90 | -90 | -90 | -Infinity | -87 | -87 |
| I_o ^{Note 3} | dBm/Ch BW | -61.58 +10log ($N_{RB,c}$ /50) | -61.58 +10log ($N_{RB,c}$ /50) | -61.58 +10log ($N_{RB,c}$ /50) | -61.58 +10log ($N_{RB,c}$ /50) | -57.23 +10log ($N_{RB,c}$ /50) | -57.23 +10log ($N_{RB,c}$ /50) | Specified in columns for Cell 2 | | |
| Propagation Condition | | AWGN | | | AWGN | | | AWGN | | |
| Correlation Matrix and Antenna Configuration | | 1x2 Low | | | 1x2 Low | | | 1x2 Low | | |
| Time offset to cell1 | μ s | - | | | 33 | | | 3 | | |
| Note 1: | OCNG shall be used such that both cells are fully allocated and a constant total transmitted power spectral density is achieved for all OFDM symbols. | | | | | | | | | |
| Note 2: | Interference from other cells and noise sources not specified in the test is assumed to be constant over subcarriers and time and shall be modelled as AWGN of appropriate power for N_{oc} to be fulfilled. | | | | | | | | | |
| Note 3: | \hat{E}_s/I_{ot} , RSRP, I_o and SCH_RP levels have been derived from other parameters for information purposes. They are not settable parameters themselves. | | | | | | | | | |

A.8.23.18.2 Test Requirements

The UE shall transmit a measurement report containing the cell global identifier of cell 2 within 170 milliseconds from the start of T3.

Test requirement = RRC Procedure delay + $T_{\text{identify_CGI, intra}}$ + reporting delay

$$= 15 + 150 + 2\text{ms from the start of T3}$$

$$= 167 \text{ ms, allow 170 ms.}$$

The UE shall be scheduled continuously throughout the test, and from the start of T3 until 170 ms at least 80 ACK/NACK shall be detected as being transmitted by the UE.

The rate of correct events observed during repeated tests shall be at least 90%.

NOTE: The overall 80 ACK/NACK number is caused by two parts. Firstly, at least 60 ACK/NACK shall be sent during identifying the cell global identifier of cell 2 according to the requirement in Clause 8.1.2.2.3.1. Secondly, given that continuous DL data allocation, additional 20 ACK/NACK shall be sent from the start of T3 until 170 ms excludes 150 ms for identifying the cell global identifier of cell 2.

A.8.23.19 E-UTRAN FDD - FDD DC Intra-frequency identification of a new CGI of E-UTRA cell using autonomous gaps in asynchronous DC

A.8.23.19.1 Test Purpose and Environment

This test is to verify the requirement for identification of a new CGI of E-UTRA cell with autonomous gaps in clause 8.8.5.1.

The test scenario comprises of two E-UTRA FDD carriers and three cells as given in tables A.8.23.19.1-1 and A.8.23.19.1-2. Cell 1 is PCell, Cell 2 is PSCell and Cell 3 is neighbour cell. PDCCHs indicating new transmissions shall be sent continuously on PCell and PSCell to ensure that the UE would have ACK/NACK sending during identifying a new CGI of E-UTRAN cell. The test consists of three successive time periods, with time durations of T1, T2 and T3 respectively. At the start of time duration T1, the UE does not have any timing information of cell 3. Starting T2, cell 2 becomes detectable and the UE is expected to detect and send a measurement report.

A RRC message implying SI reading shall be sent to the UE during period T2, after the UE has reported Event A3. The RRC message shall create a measurement report configuration with purpose *reportCGI* and *si-RequestForHO* set to TRUE. The start of T3 is the instant when the last TTI containing the RRC message implying SI reading is sent to the UE.

Table A.8.23.19.1-1: General test parameters for E-UTRAN FDD - FDD DC Intra-frequency identification of a new CGI of E-UTRA cell using autonomous gaps in asynchronous DC

| Parameter | | Unit | Value | Comment |
|---|-----------------|------|--------|--|
| E-UTRA RF Channel Number | | | 1, 2 | Two radio channels are used for this test. |
| Active PCell | | | Cell1 | PCell on RF channel number 1. |
| Active PSCell | | | Cell2 | PSCell on RF channel number 2. |
| Neighbour cell | | | Cell3 | Neighbour cell on RF channel number 2. |
| A3 | Hysteresis | dB | 0 | Hysteresis for evaluation of event A3. |
| | A3-offset | dB | -3 | |
| | Time To Trigger | s | 0 | |
| CP length | | | Normal | |
| DRX | | | OFF | DRX related parameters are defined in Table A.8.23.4.1-3 |
| si-RequestForHO | | | TRUE | As specified in clause 5.5.3.1 in TS 36.331. |
| Cell-individual offset for cells on RF channel number 1 | | dB | 0 | Individual offset for cells on primary component carrier. |
| Cell-individual offset for cells on RF channel number 2 | | dB | 0 | Individual offset for cells on carrier frequency of Cell2. |
| Filter coefficient | | | 0 | L3 filtering is not used |
| T1 | | s | 5 | |
| T2 | | s | ≤10 | |
| T3 | | s | 5 | |

Table A.8.23.19.1-2: Cell specific test parameters for E-UTRAN FDD - FDD DC Intra-frequency identification of a new CGI of E-UTRA cell using autonomous gaps in asynchronous DC

| Parameter | Unit | Cell 1 | | | Cell 2 | | | Cell 3 | | |
|----------------------------------|------|---|----|----|---|----|----|---|----|----|
| | | T1 | T2 | T3 | T1 | T2 | T3 | T1 | T2 | T3 |
| E-UTRA RF Channel Number | | 1 | | | 2 | | | | | |
| BW _{channel} | MHz | 5MHz: N _{RB,c} = 25 10MHz: N _{RB,c} = 50 20MHz: N _{RB,c} = 100 | | | 5MHz: N _{RB,c} = 25 10MHz: N _{RB,c} = 50 20MHz: N _{RB,c} = 100 | | | 5MHz: N _{RB,c} = 25 10MHz: N _{RB,c} = 50 20MHz: N _{RB,c} = 100 | | |
| PDSCH parameters: | | 5MHz: R.7 FDD 10MHz: R.3 FDD 20MHz: R.6 FDD | | | 5MHz: R.7 FDD 10MHz: R.3 FDD 20MHz: R.6 FDD | | | - | | |
| PCFICH/PDCCH/PHICH parameters: | | 5MHz: R.11 FDD 10MHz: R.6 FDD 20MHz: R.10 FDD | | | 5MHz: R.11 FDD 10MHz: R.6 FDD 20MHz: R.10 FDD | | | 5MHz: R.11 FDD 10MHz: R.6 FDD 20MHz: R.10 FDD | | |
| OCNG Patterns defined in A.3.2.1 | | 5MHz: OP.20 FDD 10MHz: OP.10 FDD 20MHz: OP.17 FDD | | | 5MHz: OP.20 FDD 10MHz: OP.10 FDD 20MHz: OP.17 FDD | | | 5MHz: OP.16 FDD 10MHz: OP.2 FDD 20MHz: OP.12 FDD | | |
| PBCH_RA | dB | 0 | | | 0 | | | 0 | | |
| PBCH_RB | dB | | | | | | | | | |
| PSS_RA | dB | | | | | | | | | |
| SSS_RA | dB | | | | | | | | | |
| PCFICH_RB | dB | | | | | | | | | |
| PHICH_RA | dB | | | | | | | | | |

| | | | | | | | | | | |
|--|--|--------------------------------|--------------------------------|--------------------------------|--------------------------------|--------------------------------|--------------------------------|---------------------------------|------|------|
| PHICH_PB | dB | | | | | | | | | |
| PDCCH_RA | dB | | | | | | | | | |
| PDCCH_PB | dB | | | | | | | | | |
| PDSCH_RA | dB | | | | | | | | | |
| PDSCH_RB | dB | | | | | | | | | |
| OCNG_RA ^{Note 1} | dB | | | | | | | | | |
| OCNG_RB ^{Note 1} | dB | | | | | | | | | |
| N_{oc} ^{Note 2} | dBm/15 KHz | -98 | | | -98 | | | | | |
| \hat{E}_s/N_{oc} | dB | 8 | 8 | 8 | 8 | 8 | 8 | -Infinity | 11 | 11 |
| \hat{E}_s/I_{ot} ^{Note 3} | dB | 8 | 8 | 8 | 8 | -3.3 | -3.3 | -Infinity | 2.36 | 2.36 |
| RSRP ^{Note 3} | dBm/15 KHz | -90 | -90 | -90 | -90 | -90 | -90 | -Infinity | -87 | -87 |
| SCH_RP ^{Note 3} | dBm/15 KHz | -90 | -90 | -90 | -90 | -90 | -90 | -Infinity | -87 | -87 |
| I_o ^{Note 3} | dBm/Ch BW | -61.58 +10log($N_{RB,c}/50$) | -61.58 +10log($N_{RB,c}/50$) | -61.58 +10log($N_{RB,c}/50$) | -61.58 +10log($N_{RB,c}/50$) | -57.23 +10log($N_{RB,c}/50$) | -57.23 +10log($N_{RB,c}/50$) | Specified in columns for Cell 2 | | |
| Propagation Condition | | AWGN | | | AWGN | | | AWGN | | |
| Correlation Matrix and Antenna Configuration | | 1x2 Low | | | 1x2 Low | | | 1x2 Low | | |
| Time offset to cell1 | μ s | - | | | 500 | | | 3 | | |
| Note 1: | OCNG shall be used such that both cells are fully allocated and a constant total transmitted power spectral density is achieved for all OFDM symbols. | | | | | | | | | |
| Note 2: | Interference from other cells and noise sources not specified in the test is assumed to be constant over subcarriers and time and shall be modelled as AWGN of appropriate power for N_{oc} to be fulfilled. | | | | | | | | | |
| Note 3: | \hat{E}_s/I_{ot} , RSRP, I_o and SCH_RP levels have been derived from other parameters for information purposes. They are not settable parameters themselves. | | | | | | | | | |

A.8.23.19.2 Test Requirements

The UE shall transmit a measurement report containing the cell global identifier of cell 2 within 170 milliseconds from the start of T3.

Test requirement = RRC Procedure delay + $T_{\text{identify_CGI, intra}}$ + reporting delay

$$= 15 + 150 + 2\text{ms from the start of T3}$$

$$= 167 \text{ ms, allow 170 ms.}$$

The UE shall be scheduled continuously throughout the test, and from the start of T3 until 170 ms at least 80 ACK/NACK shall be detected as being transmitted by the UE.

The rate of correct events observed during repeated tests shall be at least 90%.

NOTE: The overall 80 ACK/NACK number is caused by two parts. Firstly, at least 60 ACK/NACK shall be sent during identifying the cell global identifier of cell 2 according to the requirement in Clause 8.1.2.2.3.1. Secondly, given that continuous DL data allocation, additional 20 ACK/NACK shall be sent from the start of T3 until 170 ms excludes 150 ms for identifying the cell global identifier of cell 2.

A.8.23.20 E-UTRAN TDD - TDD DC Intra-frequency identification of a new CGI of E-UTRA cell using autonomous gaps in synchronous DC

A.8.23.20.1 Test Purpose and Environment

This test is to verify the requirement for identification of a new CGI of E-UTRA cell with autonomous gaps in clause 8.8.5.1.

The test scenario comprises of two E-UTRA TDD carriers and three cells as given in tables A.8.23.20.1-1 and A.8.23.20.1-2. Cell 1 is PCell, Cell 2 is PSCell and Cell 3 is neighbour cell. PDCCHs indicating new transmissions shall be sent continuously on PCell and PSCell to ensure that the UE would have ACK/NACK sending during identifying a new CGI of E-UTRAN cell. The test consists of three successive time periods, with time durations of T1, T2 and T3 respectively. At the start of time duration T1, the UE does not have any timing information of cell 3. Starting T2, cell 2 becomes detectable and the UE is expected to detect and send a measurement report.

A RRC message implying SI reading shall be sent to the UE during period T2, after the UE has reported Event A3. The RRC message shall create a measurement report configuration with purpose *reportCGI* and *si-RequestForHO* set to TRUE. The start of T3 is the instant when the last TTI containing the RRC message implying SI reading is sent to the UE.

Table A.8.23.20.1-1: General test parameters for E-UTRAN TDD - TDD DC Intra-frequency identification of a new CGI of E-UTRA cell using autonomous gaps in synchronous DC

| Parameter | | Unit | Value | Comment |
|---|-----------------|------|--------|--|
| E-UTRA RF Channel Number | | | 1, 2 | Two radio channels are used for this test. |
| Active PCell | | | Cell1 | PCell on RF channel number 1. |
| Active PSCell | | | Cell2 | PSCell on RF channel number 2. |
| Neighbour cell | | | Cell3 | Neighbour cell on RF channel number 2. |
| A3 | Hysteresis | dB | 0 | Hysteresis for evaluation of event A3. |
| | A3-offset | dB | -3 | |
| | Time To Trigger | s | 0 | |
| CP length | | | Normal | |
| DRX | | | OFF | DRX related parameters are defined in Table A.8.23.4.1-3 |
| Special subframe configuration | | | 6 | As specified in table 4.2-1 in TS 36.211. The same configuration applies to all cells. |
| Uplink-downlink configuration | | | 1 | As specified in table 4.2-2 in TS 36.211. The same configuration applies to all cells. |
| si-RequestForHO | | | TRUE | As specified in clause 5.5.3.1 in TS 36.331. |
| Cell-individual offset for cells on RF channel number 1 | | dB | 0 | Individual offset for cells on primary component carrier. |
| Cell-individual offset for cells on RF channel number 2 | | dB | 0 | Individual offset for cells on carrier frequency of Cell2. |
| Filter coefficient | | | 0 | L3 filtering is not used |
| T1 | | s | 5 | |
| T2 | | s | ≤10 | |
| T3 | | s | 5 | |

Table A.8.23.20.1-2: Cell specific test parameters for E-UTRAN TDD - TDD DC Intra-frequency identification of a new CGI of E-UTRA cell using autonomous gaps in synchronous DC

| Parameter | Unit | Cell 1 | | | Cell 2 | | | Cell 3 | | |
|----------------------------------|------|---|----|----|---|----|----|---|----|----|
| | | T1 | T2 | T3 | T1 | T2 | T3 | T1 | T2 | T3 |
| E-UTRA RF Channel Number | | 1 | | | 2 | | | | | |
| BW _{channel} | MHz | 5MHz: N _{RB,c} = 25 10MHz: N _{RB,c} = 50 5MHz: N _{RB,c} = 25 | | | 5MHz: N _{RB,c} = 25 10MHz: N _{RB,c} = 50 5MHz: N _{RB,c} = 25 | | | 5MHz: N _{RB,c} = 25 10MHz: N _{RB,c} = 50 5MHz: N _{RB,c} = 25 | | |
| PDSCH parameters: | | 5MHz: R.4 TDD 10MHz: R.0 TDD 20MHz: R.3 TDD | | | 5MHz: R.4 TDD 10MHz: R.0 TDD 20MHz: R.3 TDD | | | - | | |
| PCFICH/PDCCH/PHICH parameters: | | 5MHz: R.11 TDD 10MHz: R.6 TDD 20MHz: R.10 TDD | | | 5MHz: R.11 TDD 10MHz: R.6 TDD 20MHz: R.10 TDD | | | 5MHz: R.11 TDD 10MHz: R.6 TDD 20MHz: R.10 TDD | | |
| OCNG Patterns defined in A.3.2.2 | | 5MHz: OP.9 TDD 10MHz: OP.1 TDD 20MHz: OP.7 TDD | | | 5MHz: OP.9 TDD 10MHz: OP.1 TDD 20MHz: OP.7 TDD | | | 5MHz: OP.10 TDD 10MHz: OP.2 TDD 20MHz: OP.8 TDD | | |

| | | | | | | | | | | |
|--|------------|--------------------------------------|--------------------------------------|--------------------------------------|--------------------------------------|--------------------------------------|--------------------------------------|---------------------------------|------|------|
| PBCH_RA | dB | 0 | | | 0 | | | 0 | | |
| PBCH_RB | dB | | | | | | | | | |
| PSS_RA | dB | | | | | | | | | |
| SSS_RA | dB | | | | | | | | | |
| PCFICH_RB | dB | | | | | | | | | |
| PHICH_RA | dB | | | | | | | | | |
| PHICH_PB | dB | | | | | | | | | |
| PDCCH_RA | dB | | | | | | | | | |
| PDCCH_PB | dB | | | | | | | | | |
| PDSCH_RA | dB | | | | | | | | | |
| PDSCH_RB | dB | | | | | | | | | |
| OCNG_RA ^{Note 1} | dB | | | | | | | | | |
| OCNG_RB ^{Note 1} | dB | | | | | | | | | |
| N_{oc} ^{Note 2} | dBm/15 KHz | | | | | | | | | |
| \hat{E}_s/N_{oc} | dB | 8 | 8 | 8 | 8 | 8 | 8 | -Infinity | 11 | 11 |
| \hat{E}_s/I_{ot} ^{Note 3} | dB | 8 | 8 | 8 | 8 | -3.3 | -3.3 | -Infinity | 2.36 | 2.36 |
| RSRP ^{Note 3} | dBm/15 KHz | -90 | -90 | -90 | -90 | -90 | -90 | -Infinity | -87 | -87 |
| SCH_RP ^{Note 3} | dBm/15 KHz | -90 | -90 | -90 | -90 | -90 | -90 | -Infinity | -87 | -87 |
| I_o ^{Note 3} | dBm/Ch BW | -61.58 +10log(N _{RB,c} /50) | -61.58 +10log(N _{RB,c} /50) | -61.58 +10log(N _{RB,c} /50) | -61.58 +10log(N _{RB,c} /50) | -57.23 +10log(N _{RB,c} /50) | -57.23 +10log(N _{RB,c} /50) | Specified in columns for Cell 2 | | |
| Propagation Condition | | AWGN | | | AWGN | | | AWGN | | |
| Correlation Matrix and Antenna Configuration | | 1x2 Low | | | 1x2 Low | | | 1x2 Low | | |
| Time offset to cell1 | μs | - | | | 33 | | | 3 | | |
| <p>Note 1: OCNG shall be used such that both cells are fully allocated and a constant total transmitted power spectral density is achieved for all OFDM symbols.</p> <p>Note 2: Interference from other cells and noise sources not specified in the test is assumed to be constant over subcarriers and time and shall be modelled as AWGN of appropriate power for N_{oc} to be fulfilled.</p> <p>Note 3: \hat{E}_s/I_{ot}, RSRP, I_o and SCH_RP levels have been derived from other parameters for information purposes. They are not settable parameters themselves..</p> | | | | | | | | | | |

A.8.23.20.2 Test Requirements

The UE shall transmit a measurement report containing the cell global identifier of cell 2 within 170 milliseconds from the start of T3.

$$\text{Test requirement} = \text{RRC Procedure delay} + T_{\text{identify_CGI, intra}} + \text{reporting delay}$$

$$= 15 + 150 + 2\text{ms from the start of T3}$$

$$= 167 \text{ ms, allow 170 ms.}$$

The UE shall be scheduled continuously throughout the test, and from the start of T3 until 170 ms at least 80 ACK/NACK shall be detected as being transmitted by the UE.

The rate of correct events observed during repeated tests shall be at least 90%.

NOTE: The overall 80 ACK/NACK number is caused by two parts. Firstly, at least 60 ACK/NACK shall be sent during identifying the cell global identifier of cell 2 according to the requirement in Clause 8.1.2.2.3.1. Secondly, given that continuous DL data allocation, additional 20 ACK/NACK shall be sent from the start of T3 until 170 ms excludes 150 ms for identifying the cell global identifier of cell 2.

A.8.23.21 E-UTRAN FDD - FDD DC Inter-frequency identification of a new CGI of E-UTRA cell using autonomous gaps in synchronous DC

A.8.23.21.1 Test Purpose and Environment

This test is to verify the requirement for identification of a new CGI of E-UTRA cell using autonomous gaps in synchronous DC in clause 8.8.6.1.

The test scenario comprises of three E-UTRA FDD cells, PCell (Cell 1), PSCell (Cell 2) and neighbour cell (Cell 3) and each cell on one carrier as given in tables A.8.23.21.1-1 and A.8.23.21.1-2. PDCCHs indicating new transmissions shall be sent continuously to ensure that the UE would have ACK/NACK sending during identifying a new CGI of E-UTRAN cell. The test consists of three successive time periods, with time durations of T1, T2 and T3 respectively. At the start of time duration T1, the UE does not have any timing information of cell 3. Starting T2, cell 3 becomes detectable and the UE is expected to detect and send a measurement report. Gap pattern configuration with id #0 as specified in Table 8.1.2.1-1 is configured before T2 begins to enable inter-frequency monitoring.

A RRC message implying SI reading shall be sent to the UE during period T2, after the UE has reported Event A3. The RRC message shall create a measurement report configuration with purpose *reportCGI* and *si-RequestForHO* set to UE. The start of T3 is the instant when the last TTI containing the RRC message implying SI reading is sent to the UE. Measurement gaps shall be deconfigured before the start of T3.

Table A.8.23.21.1-1: General test parameters for E-UTRAN FDD - FDD Inter-frequency identification of a new CGI of E-UTRA cell using autonomous gaps in synchronous DC

| Parameter | Unit | Value | Comment |
|--------------------------|------|----------------|--|
| E-UTRA RF channel number | | 1, 2, 3 | Three FDD carrier frequencies are used. |
| Active cell | | Cell 1, Cell 2 | Cell 1 is on RF channel number 1 Cell 2 is on RF channel number 2 |
| Neighbour cell | | Cell 3 | Cell 3 is on RF channel number 3. |
| CP length | | Normal | |
| Gap Pattern Id | | 0 | As specified in TS 36.133 clause 8.1.2.1. |
| A3-Offset | dB | -6 | |
| Hysteresis | dB | 0 | |
| TimeToTrigger | s | 0 | |
| Filter coefficient | | 0 | L3 filtering is not used |
| DRX | | OFF | |
| si-RequestForHO | | TRUE | As specified in clause 5.5.3.1 in TS 36.331. |
| T1 | s | 5 | |
| T2 | s | ≤10 | |
| T3 | s | 5 | |

Table A.8.23.21.1-2: Cell specific test parameters for E-UTRAN FDD - FDD Inter-frequency identification of a new CGI of E-UTRA cell using autonomous gaps in synchronous DC

| Parameter | Unit | Cell 1 | | | Cell 2 | | | Cell 3 | | |
|--|------|---|----|----|---|----|----|---|----|----|
| | | T1 | T2 | T3 | T1 | T2 | T3 | T1 | T2 | T3 |
| E-UTRA RF Channel Number | | 1 | | | 2 | | | 3 | | |
| BW _{channel} | MHz | 5MHz: N _{RB,c} = 25 10MHz: N _{RB,c} = 50 20MHz: N _{RB,c} = 100 | | | 5MHz: N _{RB,c} = 25 10MHz: N _{RB,c} = 50 20MHz: N _{RB,c} = 100 | | | 5MHz: N _{RB,c} = 25 10MHz: N _{RB,c} = 50 20MHz: N _{RB,c} = 100 | | |
| PDSCH parameters defined in A.3.1.1.1 | | 5MHz: R.7 FDD 10MHz: R.3 FDD 20MHz: R.6 FDD | | | 5MHz: R.7 FDD 10MHz: R.3 FDD 20MHz: R.6 FDD | | | - | | |
| PCFICH/PDCCH/PHICH parameters defined in A.3.1.2.1 | | 5MHz: R.11 FDD 10MHz: R.6 FDD 20MHz: R.10 FDD | | | 5MHz: R.11 FDD 10MHz: R.6 FDD 20MHz: R.10 FDD | | | 5MHz: R.11 FDD 10MHz: R.6 FDD 20MHz: R.10 FDD | | |
| OCNG Patterns defined in A.3.2.1 | | 5MHz: OP.20 FDD 10MHz: OP.10 FDD 20MHz: OP.17 FDD | | | 5MHz: OP.20 FDD 10MHz: OP.10 FDD 20MHz: OP.17 FDD | | | 5MHz: OP.16 FDD 10MHz: OP.2 FDD 20MHz: OP.12 FDD | | |

| | | | | | | | | | | |
|--|------------|--------------------------------------|--------------------------------------|--------------------------------------|--------------------------------------|--------------------------------------|--------------------------------------|--------------------------------------|--------------------------------------|--------------------------------------|
| PBCH_RA | dB | 0 | | | 0 | | | 0 | | |
| PBCH_RB | dB | | | | | | | | | |
| PSS_RA | dB | | | | | | | | | |
| SSS_RA | dB | | | | | | | | | |
| PCFICH_RB | dB | | | | | | | | | |
| PHICH_RA | dB | | | | | | | | | |
| PHICH_PB | dB | | | | | | | | | |
| PDCCH_RA | dB | | | | | | | | | |
| PDCCH_PB | dB | | | | | | | | | |
| PDSCH_RA | dB | | | | | | | | | |
| PDSCH_RB | dB | | | | | | | | | |
| OCNG_RA ^{Note 1} | dB | | | | | | | | | |
| OCNG_RB ^{Note 1} | dB | | | | | | | | | |
| N_{oc} ^{Note 2} | dBm/15 KHz | | | | | | | | | |
| \hat{E}_s/N_{oc} | dB | 4 | 4 | 4 | 4 | 4 | 4 | -Infinity | 7 | 7 |
| \hat{E}_s/I_{ot} ^{Note 3} | dB | 4 | 4 | 4 | 4 | 4 | 4 | -Infinity | 7 | 7 |
| RSRP ^{Note 3} | dBm/15 KHz | -94 | -94 | -94 | -94 | -94 | -94 | -Infinity | -91 | -91 |
| SCH_RP ^{Note 3} | dBm/15 KHz | -94 | -94 | -94 | -94 | -94 | -94 | -Infinity | -91 | -91 |
| I_o ^{Note 3} | dBm/Ch BW | -64.76 +10log(N _{RB,c} /50) | -64.76 +10log(N _{RB,c} /50) | -64.76 +10log(N _{RB,c} /50) | -64.76 +10log(N _{RB,c} /50) | -64.76 +10log(N _{RB,c} /50) | -64.76 +10log(N _{RB,c} /50) | -70.22 +10log(N _{RB,c} /50) | -62.42 +10log(N _{RB,c} /50) | -62.42 +10log(N _{RB,c} /50) |
| Propagation Condition | | AWGN | | | AWGN | | | AWGN | | |
| Correlation Matrix and Antenna Configuration | | 1x2 Low | | | 1x2 Low | | | 1x2 Low | | |
| timing offset to cell1 | μs | - | | | 33 | | | 3 | | |
| Note 1: OCNG shall be used such that both cells are fully allocated and a constant total transmitted power spectral density is achieved for all OFDM symbols. | | | | | | | | | | |
| Note 2: Interference from other cells and noise sources not specified in the test is assumed to be constant over subcarriers and time and shall be modelled as AWGN of appropriate power for N_{oc} to be fulfilled. | | | | | | | | | | |
| Note 3: \hat{E}_s/I_{ot} , RSRP, I_o and SCH_RP levels have been derived from other parameters for information purposes. They are not settable parameters themselves. | | | | | | | | | | |

A.8.23.21.2 Test Requirements

The UE shall transmit a measurement report containing the cell global identifier of cell 3 within 170 milliseconds from the start of T3.

Test requirement = RRC Procedure delay + $T_{\text{identify_CGI, inter}}$ + reporting delay

$$= 15 + 150 + 2\text{ms from the start of T3}$$

$$= 167 \text{ ms, allow 170 ms.}$$

The UE shall be scheduled continuously throughout the test, and from the start of T3 until 170 ms at least 80 ACK/NACK shall be detected both on cells in MCG and SCG as being transmitted by the UE.

The rate of correct events observed during repeated tests shall be at least 90%.

NOTE: The overall 80 ACK/NACK number is caused by two parts. Firstly, at least 60 ACK/NACK shall be sent both on cells in MCG and SCG during identifying the cell global identifier of cell 3 according to the requirement in Clause 8.8.6.1. Secondly, given that continuous DL data allocation, and the measurement gaps have been deconfigured before the start of T3, additional 20 ACK/NACK shall be sent both on cells in MCG and SCG from the start of T3 until 170 ms excludes 150 ms for identifying the cell global identifier of cell 3.

A.8.23.22 E-UTRAN FDD - FDD DC Inter-frequency identification of a new CGI of E-UTRA cell using autonomous gaps in asynchronous DC

A.8.23.22.1 Test Purpose and Environment

This test is to verify the requirement for identification of a new CGI of E-UTRA cell using autonomous gaps in asynchronous DC in clause 8.8.6.1.

The test scenario comprises of three E-UTRA FDD cells, PCell (Cell 1), PSCell (Cell 2) and neighbour cell (Cell 3) and each cell on one carrier as given in tables A.8.23.22.1-1 and A.8.23.22.1-2. PDCCHs indicating new transmissions shall be sent continuously to ensure that the UE would have ACK/NACK sending during identifying a new CGI of E-UTRAN cell. The test consists of three successive time periods, with time durations of T1, T2 and T3 respectively. At the start of time duration T1, the UE does not have any timing information of cell 3. Starting T2, cell 3 becomes detectable and the UE is expected to detect and send a measurement report. Gap pattern configuration with id #0 as specified in Table 8.1.2.1-1 is configured before T2 begins to enable inter-frequency monitoring.

A RRC message implying SI reading shall be sent to the UE during period T2, after the UE has reported Event A3. The RRC message shall create a measurement report configuration with purpose *reportCGI* and *si-RequestForHO* set to TRUE. The start of T3 is the instant when the last TTI containing the RRC message implying SI reading is sent to the UE. Measurement gaps shall be deconfigured before the start of T3.

Table A.8.23.22.1-1: General test parameters for E-UTRAN FDD - FDD Inter-frequency identification of a new CGI of E-UTRA cell using autonomous gaps in asynchronous DC

| Parameter | Unit | Value | Comment |
|--------------------------|------|----------------|--|
| E-UTRA RF channel number | | 1, 2, 3 | Three FDD carrier frequencies are used. |
| Active cell | | Cell 1, Cell 2 | Cell 1 is on RF channel number 1 Cell 2 is on RF channel number 2 |
| Neighbour cell | | Cell 3 | Cell 3 is on RF channel number 3. |
| CP length | | Normal | |
| Gap Pattern Id | | 0 | As specified in TS 36.133 clause 8.1.2.1. |
| A3-Offset | dB | -6 | |
| Hysteresis | dB | 0 | |
| TimeToTrigger | s | 0 | |
| Filter coefficient | | 0 | L3 filtering is not used |
| DRX | | OFF | |
| si-RequestForHO | | TRUE | As specified in clause 5.5.3.1 in TS 36.331. |
| T1 | s | 5 | |
| T2 | s | ≤10 | |
| T3 | s | 5 | |

Table A.8.23.22.1-2: Cell specific test parameters for E-UTRAN FDD - FDD Inter-frequency identification of a new CGI of E-UTRA cell using autonomous gaps in asynchronous DC

| Parameter | Unit | Cell 1 | | | Cell 2 | | | Cell 3 | | |
|--|------|---|----|----|---|----|----|---|----|----|
| | | T1 | T2 | T3 | T1 | T2 | T3 | T1 | T2 | T3 |
| E-UTRA RF Channel Number | | 1 | | | 2 | | | 3 | | |
| BW _{channel} | MHz | 5MHz: N _{RB,c} = 25 10MHz: N _{RB,c} = 50 20MHz: N _{RB,c} = 100 | | | 5MHz: N _{RB,c} = 25 10MHz: N _{RB,c} = 50 20MHz: N _{RB,c} = 100 | | | 5MHz: N _{RB,c} = 25 10MHz: N _{RB,c} = 50 20MHz: N _{RB,c} = 100 | | |
| PDSCH parameters defined in A.3.1.1.1 | | 5MHz: R.7 FDD 10MHz: R.3 FDD 20MHz: R.6 FDD | | | 5MHz: R.7 FDD 10MHz: R.3 FDD 20MHz: R.6 FDD | | | - | | |
| PCFICH/PDCCH/PHICH parameters defined in A.3.1.2.1 | | 5MHz: R.11 FDD 10MHz: R.6 FDD 20MHz: R.10 FDD | | | 5MHz: R.11 FDD 10MHz: R.6 FDD 20MHz: R.10 FDD | | | 5MHz: R.11 FDD 10MHz: R.6 FDD 20MHz: R.10 FDD | | |
| OCNG Patterns defined in A.3.2.1 | | 5MHz: OP.20 FDD 10MHz: OP.10 FDD 20MHz: OP.17 FDD | | | 5MHz: OP.20 FDD 10MHz: OP.10 FDD 20MHz: OP.17 FDD | | | 5MHz: OP.16 FDD 10MHz: OP.2 FDD 20MHz: OP.12 FDD | | |

| | | | | | | | | | | |
|---|----------------|--|--|--|--|--|--|--|--|--|
| PBCH_RA | dB | 0 | | | 0 | | | 0 | | |
| PBCH_RB | dB | | | | | | | | | |
| PSS_RA | dB | | | | | | | | | |
| SSS_RA | dB | | | | | | | | | |
| PCFICH_RB | dB | | | | | | | | | |
| PHICH_RA | dB | | | | | | | | | |
| PHICH_PB | dB | | | | | | | | | |
| PDCCH_RA | dB | | | | | | | | | |
| PDCCH_PB | dB | | | | | | | | | |
| PDSCH_RA | dB | | | | | | | | | |
| PDSCH_RB | dB | | | | | | | | | |
| OCNG_RANote 1 | dB | | | | | | | | | |
| OCNG_RBNote 1 | dB | | | | | | | | | |
| N_{oc} Note 2 | dBm/1 5 KHz | | | | | | | | | |
| \hat{E}_s/N_{oc} | dB | 4 | 4 | 4 | 4 | 4 | 4 | - Infinity | 7 | 7 |
| \hat{E}_s/I_{ot} Note 3 | dB | 4 | 4 | 4 | 4 | 4 | 4 | - Infinity | 7 | 7 |
| RSRP Note 3 | dBm/1 5 KHz | -94 | -94 | -94 | -94 | -94 | -94 | - Infinity | -91 | -91 |
| SCH_RP Note3 | dBm/1 5 KHz | -94 | -94 | -94 | -94 | -94 | -94 | - Infinity | -91 | -91 |
| I_o Note 3 | dBm/C h BW | -64.76 +10log ($N_{RB,c}$ /50) | -64.76 +10log ($N_{RB,c}$ /50) | -64.76 +10log ($N_{RB,c}$ /50) | -64.76 +10log ($N_{RB,c}$ /50) | -64.76 +10log ($N_{RB,c}$ /50) | -64.76 +10log ($N_{RB,c}$ /50) | -70.22 +10log ($N_{RB,c}$ /50) | -62.42 +10log ($N_{RB,c}$ /50) | -62.42 +10log ($N_{RB,c}$ /50) |
| Propagation Condition | | AWGN | | | AWGN | | | AWGN | | |
| Correlation Matrix and Antenna Configuration | | 1x2 Low | | | 1x2 Low | | | 1x2 Low | | |
| timing offset to cell1 | μ s | - | | | 500 | | | 3 | | |
| <p>Note 1: OCNG shall be used such that both cells are fully allocated and a constant total transmitted power spectral density is achieved for all OFDM symbols.</p> <p>Note 2: Interference from other cells and noise sources not specified in the test is assumed to be constant over subcarriers and time and shall be modelled as AWGN of appropriate power for N_{oc} to be fulfilled.</p> <p>Note 3: \hat{E}_s/I_{ot}, RSRP, I_o and SCH_RP levels have been derived from other parameters for information purposes. They are not settable parameters themselves.</p> | | | | | | | | | | |

A.8.23.22.2 Test Requirements

The UE shall transmit a measurement report containing the cell global identifier of cell 3 within 170 milliseconds from the start of T3.

$$\begin{aligned}
 \text{Test requirement} &= \text{RRC Procedure delay} + T_{\text{identify_CGL_inter}} + \text{reporting delay} \\
 &= 15 + 150 + 2\text{ms from the start of T3} \\
 &= 167 \text{ ms, allow 170 ms.}
 \end{aligned}$$

The UE shall be scheduled continuously throughout the test, and from the start of T3 until 170 ms at least 80 ACK/NACK shall be detected both on cells in MCG and SCG as being transmitted by the UE.

The rate of correct events observed during repeated tests shall be at least 90%.

NOTE: The overall 80 ACK/NACK number is caused by two parts. Firstly, at least 60 ACK/NACK shall be sent both on cells in MCG and SCG during identifying the cell global identifier of cell 3 according to the requirement in Clause 8.8.6.1. Secondly, given that continuous DL data allocation, and the measurement gaps have been deconfigured before the start of T3, additional 20 ACK/NACK shall be sent both on cells in MCG and SCG from the start of T3 until 170 ms excludes 150 ms for identifying the cell global identifier of cell 3.

A.8.23.23 E-UTRAN TDD - TDD DC Inter-frequency identification of a new CGI of E-UTRA cell using autonomous gaps in synchronous DC

A.8.23.23.1 Test Purpose and Environment

This test is to verify the requirement for identification of a new CGI of E-UTRA cell using autonomous gaps in synchronous DC in clause 8.8.6.1.

The test scenario comprises of three E-UTRA TDD cells, PCell (Cell 1), PSCell (Cell 2) and neighbour cell (Cell 3) and each cell on one carrier as given in tables A.8.23.23.1-1 and A.8.23.23.1-2. PDCCHs indicating new transmissions shall be sent continuously to ensure that the UE would have ACK/NACK sending during identifying a new CGI of E-UTRAN cell. The test consists of three successive time periods, with time durations of T1, T2 and T3 respectively. At the start of time duration T1, the UE does not have any timing information of cell 3. Starting T2, cell 3 becomes detectable and the UE is expected to detect and send a measurement report. Gap pattern configuration with id #0 as specified in Table 8.1.2.1-1 is configured before T2 begins to enable inter-frequency monitoring.

A RRC message implying SI reading shall be sent to the UE during period T2, after the UE has reported Event A3. The RRC message shall create a measurement report configuration with purpose *reportCGI* and *si-RequestForHO* set to TRUE. The start of T3 is the instant when the last TTI containing the RRC message implying SI reading is sent to the UE. Measurement gaps shall be deconfigured before the start of T3.

Table A.8.23.23.1-1: General test parameters for E-UTRAN TDD - TDD Inter-frequency identification of a new CGI of E-UTRA cell using autonomous gaps in synchronous DC

| Parameter | Unit | Value | Comment |
|--------------------------------|------|----------------|--|
| E-UTRA RF channel number | | 1, 2, 3 | Three TDD carrier frequencies are used. |
| Active cell | | Cell 1, Cell 2 | Cell 1 is on RF channel number 1 Cell 2 is on RF channel number 2. |
| Neighbour cell | | Cell 3 | Cell 3 is on RF channel number 3. |
| CP length | | Normal | |
| Special subframe configuration | | 6 | As specified in table 4.2-1 in TS 36.211. The same configuration in both cells |
| Uplink-downlink configuration | | 1 | As specified in table 4.2-2 in TS 36.211. The same configuration in both cells |
| Gap Pattern Id | | 0 | As specified in TS 36.133 clause 8.1.2.1. |
| A3-Offset | dB | -6 | |
| Hysteresis | dB | 0 | |
| TimeToTrigger | s | 0 | |
| Filter coefficient | | 0 | L3 filtering is not used |
| DRX | | OFF | |
| si-RequestForHO | | TRUE | As specified in clause 5.5.3.1 in TS 36.331. |
| T1 | s | 5 | |
| T2 | s | ≤10 | |
| T3 | s | 5 | |

Table A.8.23.23.1-2: Cell specific test parameters for E-UTRAN TDD - TDD Inter-frequency identification of a new CGI of E-UTRA cell using autonomous gaps in synchronous DC

| Parameter | Unit | Cell 1 | | | Cell 2 | | | Cell 3 | | |
|---------------------------------------|------|---|----|----|---|----|----|---|----|----|
| | | T1 | T2 | T3 | T1 | T2 | T3 | T1 | T2 | T3 |
| E-UTRA RF Channel Number | | 1 | | | 2 | | | 3 | | |
| BW _{channel} | MHz | 5MHz: N _{RB,c} = 25 10MHz: N _{RB,c} = 50 20MHz: N _{RB,c} = 100 | | | 5MHz: N _{RB,c} = 25 10MHz: N _{RB,c} = 50 20MHz: N _{RB,c} = 100 | | | 5MHz: N _{RB,c} = 25 10MHz: N _{RB,c} = 50 20MHz: N _{RB,c} = 100 | | |
| PDSCH parameters defined in A.3.1.1.2 | | 5MHz: R.4 TDD 10MHz: R.0 TDD 20MHz: R.3 TDD | | | 5MHz: R.4 TDD 10MHz: R.0 TDD 20MHz: R.3 TDD | | | - | | |

| | | | | | | | | | | |
|---|------------|--|---|---|--|---|--|---|---|---|
| PCFICH/PDCCH/PHICH parameters defined in A.3.1.2.2 | | 5MHz: R.11 TDD 10MHz: R.6 TDD 20MHz: R.10 TDD | | | 5MHz: R.11 TDD 10MHz: R.6 TDD 20MHz: R.10 TDD | | | 5MHz: R.11 TDD 10MHz: R.6 TDD 20MHz: R.10 TDD | | |
| OCNG Patterns defined in A.3.2.2 | | 5MHz: OP.9 TDD 10MHz: OP.1 TDD 20MHz: OP.7 TDD | | | 5MHz: OP.9 TDD 10MHz: OP.1 TDD 20MHz: OP.7 TDD | | | 5MHz: OP.10 TDD 10MHz: OP.2 TDD 20MHz: OP.8 TDD | | |
| PBCH_RA | dB | 0 | | | 0 | | | 0 | | |
| PBCH_RB | dB | | | | | | | | | |
| PSS_RA | dB | | | | | | | | | |
| SSS_RA | dB | | | | | | | | | |
| PCFICH_RB | dB | | | | | | | | | |
| PHICH_RA | dB | | | | | | | | | |
| PHICH_RB | dB | | | | | | | | | |
| PDCCH_RA | dB | | | | | | | | | |
| PDCCH_RB | dB | | | | | | | | | |
| PDSCH_RA | dB | | | | | | | | | |
| PDSCH_RB | dB | | | | | | | | | |
| OCNG_RA ^{Note 1} | dB | | | | | | | | | |
| OCNG_RB ^{Note 1} | dB | | | | | | | | | |
| N_{oc} ^{Note 2} | dBm/15 KHz | -98 | | | -98 | | | -98 | | |
| \hat{E}_s/N_{oc} | dB | 4 | 4 | 4 | 4 | 4 | 4 | - Infinity | 7 | 7 |
| \hat{E}_s/I_{ot} ^{Note 3} | dB | 4 | 4 | 4 | 4 | 4 | 4 | - Infinity | 7 | 7 |
| RSRP ^{Note 3} | dBm/15 KHz | -94 | -94 | -94 | -94 | -94 | -94 | - Infinity | -91 | -91 |
| SCH_RP ^{Note 3} | dBm/15 KHz | -94 | -94 | -94 | -94 | -94 | -94 | - Infinity | -91 | -91 |
| I_o ^{Note 3} | dBm/Ch BW | - 64.76 +10log g ($N_{RB,c}$ /50) | - 64.76 +10log g ($N_{RB,c}$ /50) | - 64.76 +10log g ($N_{RB,c}$ /50) | - 64.76 +10log g ($N_{RB,c}$ /50) | - 64.76 +10log g ($N_{RB,c}$ /50) | -64.76 +10log ($N_{RB,c}$ /50) | -70.22 +10log g ($N_{RB,c}$ /50) | - 62.42 +10log g ($N_{RB,c}$ /50) | - 62.42 +10log g ($N_{RB,c}$ /50) |
| Propagation Condition | | AWGN | | | AWGN | | | AWGN | | |
| Correlation Matrix and Antenna Configuration | | 1x2 Low | | | 1x2 Low | | | 1x2 Low | | |
| timing offset to cell1 | μ s | - | | | 33 | | | 3 | | |
| <p>Note 1: OCNG shall be used such that both cells are fully allocated and a constant total transmitted power spectral density is achieved for all OFDM symbols.</p> <p>Note 2: Interference from other cells and noise sources not specified in the test is assumed to be constant over subcarriers and time and shall be modelled as AWGN of appropriate power for N_{oc} to be fulfilled.</p> <p>Note 3: \hat{E}_s/I_{ot}, RSRP, I_o and SCH_RP levels have been derived from other parameters for information purposes. They are not settable parameters themselves.</p> | | | | | | | | | | |

A.8.23.23.2 Test Requirements

The UE shall transmit a measurement report containing the cell global identifier of cell 3 within 170 milliseconds from the start of T3.

$$\begin{aligned}
 \text{Test requirement} &= \text{RRC Procedure delay} + T_{\text{identify_CGI, inter}} + \text{reporting delay} \\
 &= 15 + 150 + 2\text{ms from the start of T3} \\
 &= 167 \text{ ms, allow 170 ms.}
 \end{aligned}$$

The UE shall be scheduled continuously throughout the test, and from the start of T3 until 170 ms at least 42 ACK/NACK shall be detected both on cells in MCG and SCG as being transmitted by the UE.

The rate of correct events observed during repeated tests shall be at least 90%.

NOTE: The overall 42 ACK/NACK number is caused by two parts. Firstly, at least 30 ACK/NACK shall be sent both on cells in MCG and SCG during identifying the cell global identifier of cell 3 according to the requirement in Clause 8.8.6.1. Secondly, given that continuous DL data allocation and the measurement gaps have been deconfigured before the start of T3, additional 12 ACK/NACK shall be sent both on cells in MCG and SCG from the start of T3 until 170 ms excludes 150 ms for identifying the cell global identifier of cell 3.

A.8.23.24 E-UTRAN FDD-FDD DC activation and deactivation of known SCell in Non-DRX in synchronous DC

A.8.23.24.1 Test Purpose and Environment

The purpose of this test is to verify that SCell activation and deactivation requirements specified in clause 7.18 for Dual Connectivity, when the SCell is known by the UE at the time of activation.

The test parameters are given in Tables A.8.23.24-1 and cell-specific parameters in A.8.23.24-2 below. The test consists of three successive time periods, with duration of T1, T2 and T3, respectively. There are three carriers, each with one cell. All cells have constant signal levels throughout the test. Before the test starts the UE is connected to Cell 1 (PCell) on radio channel 1 (PCC) and Cell 2 (PSCell) on radio channel 2, but is not aware of Cell 3 (SCell1 in MCG) on radio channel 3 (SCC1). The UE is only monitoring the PCC and the frequency of PSCell. The UE shall be continuously scheduled in the PCell and PSCell throughout the whole test.

At the beginning of T1 the UE receives an RRC message by which the SCell1 becomes configured on SCC1. The UE now starts monitoring also the SCC1. The test equipment sends a MAC message for activation of the SCell1.

The point in time at which a MAC message is received at the UE antenna connector, in a subframe # denoted m which is an even number, defines the start of time period T2. The UE shall be able to report valid CSI for the activated SCell1 at latest in a subframe $(m+24)$. The UE shall start reporting CSI for SCell1 in subframe $(m+8)$ and shall report CQI index 0 (out-of-range) until the SCell activation has been completed. Any PCell and PSCell interruption due to activation of SCell1 shall not occur outside subframes $(m+5)$ to $(m+9)$.

Time period T3 starts when a MAC message for deactivation of SCell1, sent from the test equipment to the UE in a subframe # denoted n , is received at the UE antenna connector. The UE shall carry out deactivation of SCell1 at latest in subframe $(n+8)$, and any PCell and PSCell interruption due to the deactivation of SCell1 shall not occur outside subframes $(n+5)$ to $(n+9)$.

The test equipment verifies that potential interruption is carried out in the correct time span by monitoring ACK/NACK sent in PCell and PSCell during activation and deactivation of the SCell1, respectively.

The test equipment verifies the activation time by counting the subframes from the time when the SCell1 activation command is sent until a CSI report with other than CQI index 0 is received.

The test equipment verifies the deactivation time by counting the subframes from the time when the SCell1 deactivation command is sent until CQI reporting for SCell1 is discontinued.

Table A.8.23.24-1: General test parameters for E-UTRAN FDD-FDD DC activation and deactivation of known SCell in non-DRX

| Parameter | Unit | Value | Comment |
|---|------|---------|---|
| E-UTRA RF Channel Number | | 1, 2, 3 | Three radio channels are used for this test |
| Active PCell | | Cell 1 | PCell on RF channel number 1. |
| Configured PSCell | | Cell 2 | PSCell on RF channel number 2. |
| Deconfigured SCell in MCG | | Cell 3 | Deconfigured SCell in MCG on RF channel number 3. |
| CP length | | Normal | |
| DRX | | OFF | Continuous monitoring of primary cell |
| CQI/PMI periodicity and offset configuration index | | 0 | CQI reporting for SCells every second subframe |
| Cell-individual offset for cells on RF channel number 1 | dB | 0 | Individual offset for cells on PCC. |
| Cell-individual offset for cells on RF channel number 2 | dB | 0 | Individual offset for cells on the frequency of PSCell. |

| | | | |
|---|----|-----|--|
| Cell-individual offset for cells on RF channel number 3 | dB | 0 | Individual offset for cells on SCC1. |
| Filter coefficient | | 0 | L3 filtering is not used |
| SCell measurement cycle (measCycleSCell) | ms | 320 | |
| T1 | s | 7 | During this time the PCell and PSCell shall be known and the SCell1 configured and detected. |
| T2 | s | 1 | During this time the UE shall activate the SCell1. |
| T3 | s | 1 | During this time the UE shall deactivate the SCell1. |

Table A.8.23.24-2: Cell specific test parameters for E-UTRAN FDD-FDD DC activation and deactivation of known SCell in non-DRX

| Parameter | Unit | Cell 1 | | | Cell 2 | | | Cell 3 | | |
|---|------------|---|----|----|---|----|----|---|----|----|
| | | T1 | T2 | T3 | T1 | T2 | T3 | T1 | T2 | T3 |
| E-UTRA RF Channel Number | | 1 | | | 2 | | | 3 | | |
| BW _{channel} | | 5MHz: N _{RB,c} = 25 10MHz: N _{RB,c} = 50 20MHz: N _{RB,c} = 100 | | | 5MHz: N _{RB,c} = 25 10MHz: N _{RB,c} = 50 20MHz: N _{RB,c} = 100 | | | 5MHz: N _{RB,c} = 25 10MHz: N _{RB,c} = 50 20MHz: N _{RB,c} = 100 | | |
| PDSCH parameters: DL Reference Measurement Channel | | 5MHz: R.7 FDD 10MHz: R.3 FDD 20MHz: R.6 FDD | | | 5MHz: R.7 FDD 10MHz: R.3 FDD 20MHz: R.6 FDD | | | N/A | | |
| PCFICH/PDCCH/PHICH parameters: DL Reference Measurement Channel | | 5MHz: R.11 FDD 10MHz: R.6 FDD 20MHz: R.10 FDD | | | 5MHz: R.11 FDD 10MHz: R.6 FDD 20MHz: R.10 FDD | | | 5MHz: R.11 FDD 10MHz: R.6 FDD 20MHz: R.10 FDD | | |
| OCNG Patterns | | 5MHz: OP.20 FDD 10MHz: OP.10 FDD 20MHz: OP.17 FDD | | | 5MHz: OP.20 FDD 10MHz: OP.10 FDD 20MHz: OP.17 FDD | | | 5MHz: OP.16 FDD 10MHz: OP.2 FDD 20MHz: OP.12 FDD | | |
| PBCH_RA | dB | 0 | | | 0 | | | 0 | | |
| PBCH_RB | dB | | | | | | | | | |
| PSS_RA | dB | | | | | | | | | |
| SSS_RA | dB | | | | | | | | | |
| PCFICH_RB | dB | | | | | | | | | |
| PHICH_RA | dB | | | | | | | | | |
| PHICH_RB | dB | | | | | | | | | |
| PDCCH_RA | dB | | | | | | | | | |
| PDCCH_RB | dB | | | | | | | | | |
| PDSCH_RA | dB | | | | | | | | | |
| PDSCH_RB | dB | | | | | | | | | |
| OCNG_RA ^{Note 1} | dB | | | | | | | | | |
| OCNG_RB ^{Note 1} | dB | | | | | | | | | |
| N _{oc} ^{Note 2} | dBm/15 kHz | -104 | | | -104 | | | -104 | | |
| E _s /N _{oc} | dB | 17 | | | 17 | | | 17 | | |
| E _s /I _{ot} ^{Note 3} | dB | 17 | | | 17 | | | 17 | | |
| RSRP ^{Note 3} | dBm/15 kHz | -87 | | | -87 | | | -87 | | |
| SCH_RP ^{Note 3} | dBm/15 kHz | -87 | | | -87 | | | -87 | | |
| I _o ^{Note 3} | dBm/Ch BW | -59.13+10log(N _{RB,c} /50) | | | -59.13+10log(N _{RB,c} /50) | | | -59.13+10log(N _{RB,c} /50) | | |
| Propagation Condition | | AWGN | | | AWGN | | | AWGN | | |
| Antenna Configuration | | 1x2 | | | 1x2 | | | 1x2 | | |
| Receive timing offset to Cell1 ^{Note 5} | µs | - | | | 33 | | | ≤ TAE | | |
| Receive timing offset to Cell2 ^{Note 5} | µs | - | | | - | | | 33 | | |

| | |
|---------|--|
| Note 1: | OCNG shall be used such that all cells are fully allocated and a constant total transmitted power spectral density is achieved for all OFDM symbols. |
| Note 2: | Interference from other cells and noise sources not specified in the test is assumed to be constant over subcarriers and time and shall be modelled as AWGN of appropriate power for N_{oc} to be fulfilled. |
| Note 3: | E_s/I_{ot} , RSRP, SCH_RP and I_o have been derived from other parameters for information purposes. They are not settable parameters themselves. |
| Note 4: | The uplink resources for CSI reporting are assigned to the UE prior to the start of time period T2. |
| Note 5: | Receive time difference between subframe boundaries of signals received from the two cells at the UE antenna connector including time alignment error between the two cells. |

A.8.23.24.2 Test Requirements

During T2 the UE shall send the first CSI report for SCell1 in a subframe (m+8), or in a subframe (m+10) if the subframe (m+8) was subject to interruption. Whether CSI report in subframe (m+8) was interrupted or not is checked by monitoring ACK/NACK sent in PCell in subframe (m+8).

During T2 the UE shall start sending CSI reports for SCell1 with non-zero CQI index at latest in a subframe (m+24).

During T3 the UE shall stop sending CSI reports for SCell1 at latest in a subframe (n+8).

During T2 interruption of PCell during the SCell activation shall not happen outside the subframes (m+5) to (m+9).

During T2 interruption of PSCell during the SCell activation shall not happen outside the subframes (m+5) to (m+9).

During T3 interruption of PCell during the SCell deactivation shall not happen outside the subframes (n+5) to (n+9).

During T3 interruption of PSCell during the SCell deactivation shall not happen outside the subframes (n+5) to (n+9).

The interruption of PCell shall not be more than 1ms.

The interruption of PSCell shall not be more than 1ms.

All of the above test requirements shall be fulfilled in order for the observed SCell1 activation delay and SCell1 deactivation delay to be counted as correct. The rate of correct observed SCell1 activation delay and SCell1 deactivation delay during repeated tests shall be at least 90%.

NOTE: During T2 if there are no uplink resources for reporting the valid CSI in a subframe (m+24) then the UE shall use the next available uplink resource for reporting the corresponding valid CSI.

A.8.23.25 E-UTRAN FDD-FDD DC activation and deactivation of known SCell in Non-DRX in asynchronous DC

A.8.23.25.1 Test Purpose and Environment

The purpose of this test is to verify that SCell activation and deactivation requirements specified in clause 7.18 for Dual Connectivity, when the SCell is known by the UE at the time of activation.

The test parameters are given in Tables A.8.23.25-1 and cell-specific parameters in A.8.23.25-2 below. The test consists of three successive time periods, with duration of T1, T2 and T3, respectively. There are three carriers, each with one cell. All cells have constant signal levels throughout the test. Before the test starts the UE is connected to Cell 1 (PCell) on radio channel 1 (PCC) and Cell 2 (PSCell) on radio channel 2, but is not aware of Cell 3 (SCell1 in MCG) on radio channel 3 (SCC1). The UE is only monitoring the PCC and the frequency of PSCell. The UE shall be continuously scheduled in the PCell and PSCell throughout the whole test.

At the beginning of T1 the UE receives an RRC message by which the SCell1 becomes configured on SCC1. The UE now starts monitoring also the SCC1. The test equipment sends a MAC message for activation of SCell1.

The point in time at which a MAC message is received at the UE antenna connector, in a subframe # denoted m which is an even number, defines the start of time period T2. The UE shall be able to report valid CSI for the activated SCell1 at latest in a subframe (m+24). The UE shall start reporting CSI for SCell1 in subframe in (m+8) and shall report CQI index 0 (out-of-range) until the SCell activation has been completed. Any PCell and PSCell interruption due to activation of SCell1 shall not occur outside subframes (m+5) to (m+9).

Time period T3 starts when a MAC message for deactivation of SCell1, sent from the test equipment to the UE in a subframe # denoted n, where n is 4 or 9. is received at the UE antenna connector. The UE shall carry out deactivation of SCell1 at latest in subframe (n+8), and any PCell and PSCell interruption due to the deactivation of the SCell shall not occur outside subframes (n+5) to (n+9).

The test equipment verifies that potential interruption is carried out in the correct time span by monitoring ACK/NACK sent in PCell and PSCell during activation and deactivation of SCell1, respectively.

The test equipment verifies the activation time by counting the subframes from the time when the SCell1 activation command is sent until a CSI report with other than CQI index 0 is received.

The test equipment verifies the deactivation time by counting the subframes from the time when the SCell1 deactivation command is sent until CQI reporting for SCell1 is discontinued.

Table A.8.23.25-1: General test parameters for E-UTRAN FDD-FDD DC activation and deactivation of known SCell in non-DRX

| Parameter | Unit | Value | Comment |
|---|------|---------|--|
| E-UTRA RF Channel Number | | 1, 2, 3 | Three radio channels are used for this test |
| Active PCell | | Cell 1 | PCell on RF channel number 1. |
| Configured PSCell | | Cell 2 | PSCell on RF channel number 2. |
| Deconfigured SCell in MCG | | Cell 3 | Deconfigured SCell in MCG on RF channel number 3. |
| CP length | | Normal | |
| DRX | | OFF | Continuous monitoring of primary cell |
| CQI/PMI periodicity and offset configuration index | | 0 | CQI reporting for SCells every second subframe |
| Cell-individual offset for cells on RF channel number 1 | dB | 0 | Individual offset for cells on PCC. |
| Cell-individual offset for cells on RF channel number 2 | dB | 0 | Individual offset for cells on the frequency of PSCell. |
| Cell-individual offset for cells on RF channel number 3 | dB | 0 | Individual offset for cells on SCC1. |
| Filter coefficient | | 0 | L3 filtering is not used |
| SCell measurement cycle (measCycleSCell) | ms | 320 | |
| T1 | s | 7 | During this time the PCell and PSCell shall be known and the SCell1 configured and detected. |
| T2 | s | 1 | During this time the UE shall activate the SCell1. |
| T3 | s | 1 | During this time the UE shall deactivate the SCell1. |

Table A.8.23.25-2: Cell specific test parameters for E-UTRAN FDD-FDD DC activation and deactivation of known SCell in non-DRX

| Parameter | Unit | Cell 1 | | | Cell 2 | | | Cell 3 | | |
|--|------|---|----|----|---|----|----|---|----|----|
| | | T1 | T2 | T3 | T1 | T2 | T3 | T1 | T2 | T3 |
| E-UTRA RF Channel Number | | 1 | | | 2 | | | 3 | | |
| BW _{channel} | | 5MHz: N _{RB,c} = 25 10MHz: N _{RB,c} = 50 20MHz: N _{RB,c} = 100 | | | 5MHz: N _{RB,c} = 25 10MHz: N _{RB,c} = 50 20MHz: N _{RB,c} = 100 | | | 5MHz: N _{RB,c} = 25 10MHz: N _{RB,c} = 50 20MHz: N _{RB,c} = 100 | | |
| PDSCH parameters: DL Reference Measurement Channel | | 5MHz: R.7 FDD 10MHz: R.3 FDD 20MHz: R.6 FDD | | | 5MHz: R.7 FDD 10MHz: R.3 FDD 20MHz: R.6 FDD | | | N/A | | |
| PCFICH/PDCCH/PHICH parameters: DL Reference Measurement Channel | | 5MHz: R.11 FDD 10MHz: R.6 FDD 20MHz: R.10 FDD | | | 5MHz: R.11 FDD 10MHz: R.6 FDD 20MHz: R.10 FDD | | | 5MHz: R.11 FDD 10MHz: R.6 FDD 20MHz: R.10 FDD | | |
| OCNG Patterns | | 5MHz: OP.20 FDD 10MHz: OP.10 FDD 20MHz: OP.17 FDD | | | 5MHz: OP.20 FDD 10MHz: OP.10 FDD 20MHz: OP.17 FDD | | | 5MHz: OP.16 FDD 10MHz: OP.2 FDD 20MHz: OP.12 FDD | | |

| | | | | |
|---|------------|---|---|---|
| PBCH_RA | dB | | | |
| PBCH_RB | dB | | | |
| PSS_RA | dB | | | |
| SSS_RA | dB | | | |
| PCFICH_RB | dB | | | |
| PHICH_RA | dB | | | |
| PHICH_RB | dB | 0 | 0 | 0 |
| PDCCH_RA | dB | | | |
| PDCCH_RB | dB | | | |
| PDSCH_RA | dB | | | |
| PDSCH_RB | dB | | | |
| OCNG_RA ^{Note 1} | dB | | | |
| OCNG_RB ^{Note 1} | dB | | | |
| N _{oc} ^{Note 2} | dBm/15 kHz | -104 | -104 | -104 |
| E _s /N _{oc} | dB | 17 | 17 | 17 |
| E _s /I _{ot} ^{Note 3} | dB | 17 | 17 | 17 |
| RSRP ^{Note 3} | dBm/15 kHz | -87 | -87 | -87 |
| SCH_RP ^{Note 3} | dBm/15 kHz | -87 | -87 | -87 |
| I _o ^{Note 3} | dBm/Ch BW | -59.13+10log (N _{RB,c} /50) | -59.13+10log (N _{RB,c} /50) | -59.13+10log (N _{RB,c} /50) |
| Propagation Condition | | AWGN | AWGN | AWGN |
| Antenna Configuration | | 1x2 | 1x2 | 1x2 |
| Receive timing offset to Cell1 ^{Note 5} | μs | - | 500 | ≤ TAE |
| Receive timing offset to Cell2 ^{Note 5} | μs | - | - | 500 |
| Note 1: OCNG shall be used such that all cells are fully allocated and a constant total transmitted power spectral density is achieved for all OFDM symbols. | | | | |
| Note 2: Interference from other cells and noise sources not specified in the test is assumed to be constant over subcarriers and time and shall be modelled as AWGN of appropriate power for N _{oc} to be fulfilled. | | | | |
| Note 3: E _s /I _{ot} , RSRP, SCH_RP and I _o have been derived from other parameters for information purposes. They are not settable parameters themselves. | | | | |
| Note 4: The uplink resources for CSI reporting are assigned to the UE prior to the start of time period T2. | | | | |
| Note 5: Receive time difference between subframe boundaries of signals received from the two cells at the UE antenna connector including time alignment error between the two cells. | | | | |

A.8.23.25.2 Test Requirements

During T2 the UE shall send the first CSI report for SCell1 in a subframe (m+8), or in a subframe (m+10) if the subframe (m+8) was subject to interruption. Whether CSI report in subframe (m+8) was interrupted or not is checked by monitoring ACK/NACK sent in PCell in subframe (m+8).

During T2 the UE shall start sending CSI reports for SCell1 with non-zero CQI index at latest in a subframe (m+24).

During T3 the UE shall stop sending CSI reports for SCell1 at latest in a subframe (n+8).

During T2 interruption of PCell during the SCell activation shall not happen outside the subframes (m+5) to (m+9).

During T2 interruption of PSCell during the SCell activation shall not happen outside the subframes (m+5) to (m+9).

During T3 interruption of PCell during the SCell deactivation shall not happen outside the subframes (n+5) to (n+9).

During T3 interruption of PSCell during the SCell deactivation shall not happen outside the subframes (n+5) to (n+9).

The interruption of PCell shall not be more than 1ms.

The interruption of PSCell shall not be more than 2ms.

All of the above test requirements shall be fulfilled in order for the observed SCell1 activation delay and SCell1 deactivation delay to be counted as correct. The rate of correct observed SCell1 activation delay and SCell1 deactivation delay during repeated tests shall be at least 90%.

NOTE: During T2 if there are no uplink resources for reporting the valid CSI in a subframe (m+24) then the UE shall use the next available uplink resource for reporting the corresponding valid CSI.

A.8.23.26 E-UTRAN TDD-TDD DC activation and deactivation of known SCell in Non-DRX in synchronous DC

A.8.23.26.1 Test Purpose and Environment

The purpose of this test is to verify that SCell activation and deactivation requirements specified in clause 7.18 for Dual Connectivity, when the SCell is known by the UE at the time of activation.

The test parameters are given in Tables A.8.23.26-1 and cell-specific parameters in A.8.23.26-2 below. The test consists of three successive time periods, with duration of T1, T2 and T3, respectively. There are three carriers, each with one cell. All cells have constant signal levels throughout the test. Before the test starts the UE is connected to Cell 1 (PCell) on radio channel 1 (PCC) and Cell 2 (PSCell) on radio channel 2, but is not aware of Cell 3 (SCell1 in MCG) on radio channel 3 (SCC1). The UE is only monitoring the PCC and the frequency of PSCell. The UE shall be continuously scheduled in the PCell and PSCell throughout the whole test.

At the beginning of T1 the UE receives an RRC message by which the SCell1 becomes configured on SCC1. The UE now starts monitoring also the SCC1. The test equipment sends a MAC message for activation of the SCell1.

The point in time at which a MAC message is received at the UE antenna connector, in a subframe # denoted m , where m is 4 or 9, defines the start of time period T2. The UE shall be able to report valid CSI for the activated SCell1 at latest in subframe $(m+24)$. The UE shall start reporting CSI for SCell1 in subframe $(m+8)$ and shall report CQI index 0 (out-of-range) until the SCell activation has been completed. Any PCell and PSCell interruption due to activation of the SCell shall not occur outside subframes $(m+5)$ to $(m+11)$.

Time period T3 starts when a MAC message for deactivation of SCell1, sent from the test equipment to the UE in a subframe # denoted n , is received at the UE antenna connector. The UE shall carry out deactivation of the SCell1 at latest in subframe $(n+8)$, and any PCell and PSCell interruption due to the deactivation of the SCell shall not occur outside subframes $(n+5)$ to $(n+11)$.

The test equipment verifies that potential interruption is carried out in the correct time span by monitoring ACK/NACK sent in PCell and PSCell during activation and deactivation of SCell1, respectively.

The test equipment verifies the activation time by counting the subframes from the time when the SCell1 activation command is sent until a CSI report with other than CQI index 0 is received.

The test equipment verifies the deactivation time by counting the subframes from the time when the SCell1 deactivation command is sent until CQI reporting for SCell1 is discontinued.

Table A.8.23.26-1: General test parameters for E-UTRAN TDD-TDD DC activation and deactivation of known SCell in non-DRX

| Parameter | Unit | Value | Comment |
|---|------|---------|--|
| E-UTRA RF Channel Number | | 1, 2, 3 | Three radio channels are used for this test |
| Active PCell | | Cell 1 | PCell on RF channel number 1. |
| Configured PSCell | | Cell 2 | PSCell on RF channel number 2. |
| Deconfigured SCell in MCG | | Cell 3 | Deconfigured SCell in MCG on RF channel number 3. |
| CP length | | Normal | |
| DRX | | OFF | Continuous monitoring of primary cell |
| CQI/PMI periodicity and offset configuration index | | 0 | CQI reporting for SCells every second subframe |
| Cell-individual offset for cells on RF channel number 1 | dB | 0 | Individual offset for cells on PCC. |
| Cell-individual offset for cells on RF channel number 2 | dB | 0 | Individual offset for cells on the frequency of PSCell. |
| Cell-individual offset for cells on RF channel number 3 | dB | 0 | Individual offset for cells on SCC1. |
| Filter coefficient | | 0 | L3 filtering is not used |
| SCell measurement cycle (measCycleSCell) | ms | 320 | |
| T1 | s | 7 | During this time the PCell and PSCell shall be known and the SCell1 configured and detected. |

| | | | |
|----|---|---|--|
| T2 | s | 1 | During this time the UE shall activate the SCell1. |
| T3 | s | 1 | During this time the UE shall deactivate the SCell1. |

Table A.8.23.26-2: Cell specific test parameters for E-UTRAN TDD-TDD DC activation and deactivation of known SCell in non-DRX

| Parameter | Unit | Cell 1 | | | Cell 2 | | | Cell 3 | | |
|--|------------|---|----|----|---|----|----|---|----|----|
| | | T1 | T2 | T3 | T1 | T2 | T3 | T1 | T2 | T3 |
| E-UTRA RF Channel Number | | 1 | | | 2 | | | 3 | | |
| BW _{channel} | | 5MHz: N _{RB,c} = 25 10MHz: N _{RB,c} = 50 20MHz: N _{RB,c} = 100 | | | 5MHz: N _{RB,c} = 25 10MHz: N _{RB,c} = 50 20MHz: N _{RB,c} = 100 | | | 5MHz: N _{RB,c} = 25 10MHz: N _{RB,c} = 50 20MHz: N _{RB,c} = 100 | | |
| PDSCH parameters: DL Reference Measurement Channel | | 5MHz: R.4 TDD 10MHz: R.0 TDD 20MHz: R.3 TDD | | | 5MHz: R.4 TDD 10MHz: R.0 TDD 20MHz: R.3 TDD | | | N/A | | |
| PCFICH/PDCCH/PHICH parameters: DL Reference Measurement Channel | | 5MHz: R.11 TDD 10MHz: R.6 TDD 20MHz: R.10 TDD | | | 5MHz: R.11 TDD 10MHz: R.6 TDD 20MHz: R.10 TDD | | | 5MHz: R.11 TDD 10MHz: R.6 TDD 20MHz: R.10 TDD | | |
| OCNG Patterns | | 5MHz: OP.9 TDD 10MHz: OP.1 TDD 20MHz: OP. 7 TDD | | | 5MHz: OP.9 TDD 10MHz: OP.1 TDD 20MHz: OP. 7 TDD | | | 5MHz: OP.10 TDD 10MHz: OP.2 TDD 20MHz: OP. 8 TDD | | |
| PBCH_RA | dB | 0 | | | 0 | | | 0 | | |
| PBCH_RB | dB | | | | | | | | | |
| PSS_RA | dB | | | | | | | | | |
| SSS_RA | dB | | | | | | | | | |
| PCFICH_RB | dB | | | | | | | | | |
| PHICH_RA | dB | | | | | | | | | |
| PHICH_RB | dB | | | | | | | | | |
| PDCCH_RA | dB | | | | | | | | | |
| PDCCH_RB | dB | | | | | | | | | |
| PDSCH_RA | dB | | | | | | | | | |
| PDSCH_RB | dB | | | | | | | | | |
| OCNG_RA ^{Note 1} | dB | | | | | | | | | |
| OCNG_RB ^{Note 1} | dB | | | | | | | | | |
| N _{oc} ^{Note 2} | dBm/15 kHz | | | | | | | | | |
| E _s /N _{oc} | dB | 17 | | | 17 | | | 17 | | |
| E _s /I _{ot} ^{Note 3} | dB | 17 | | | 17 | | | 17 | | |
| RSRP ^{Note 3} | dBm/15 kHz | -87 | | | -87 | | | -87 | | |
| SCH_RP ^{Note 3} | dBm/15 kHz | -87 | | | -87 | | | -87 | | |
| I _o ^{Note 3} | dBm/Ch BW | -59.13+10log(N _{RB,c} /50) | | | -59.13+10log(N _{RB,c} /50) | | | -59.13+10log(N _{RB,c} /50) | | |
| Propagation Condition | | AWGN | | | AWGN | | | AWGN | | |
| Antenna Configuration | | 1x2 | | | 1x2 | | | 1x2 | | |
| Receive timing offset to Cell1 ^{Note 5} | µs | - | | | 33 | | | 0 | | |
| Time alignment error relative to cell 1 ^{Note 5} | µs | - | | | N/A | | | ≤ TAE | | |
| <p>Note 1: OCNG shall be used such that all cells are fully allocated and a constant total transmitted power spectral density is achieved for all OFDM symbols.</p> <p>Note 2: Interference from other cells and noise sources not specified in the test is assumed to be constant over subcarriers and time and shall be modelled as AWGN of appropriate power for N_{oc} to be fulfilled.</p> <p>Note 3: E_s/I_{ot}, RSRP, SCH_RP and I_o have been derived from other parameters for information purposes. They are not settable parameters themselves.</p> <p>Note 4: The uplink resources for CSI reporting are assigned to the UE prior to the start of time period T2.</p> <p>Note 5: Time alignment error (TAE) as specified in TS 36.104 [30] clause 6.5.3.1. The TAE value depends upon the type of carrier aggregation.</p> | | | | | | | | | | |

A.8.23.26.2 Test Requirements

During T2 the UE shall send the first CSI report for SCell1 in a subframe (m+8), or in a subframe (m+9) if the subframe (m+8) was subject to interruption. Whether CSI report in subframe (m+8) was interrupted or not is checked by monitoring ACK/NACK sent in PCell in subframe (m+8).

During T2 the UE shall start sending CSI reports for SCell1 with non-zero CQI index at latest in a subframe (m+24).

During T3 the UE shall stop sending CSI reports for SCell1 at latest in a subframe (n+8).

During T2 interruption of PCell during the SCell activation shall not happen outside the subframes (m+5) to (m+11).

During T2 interruption of PSCell during the SCell activation shall not happen outside the subframes (m+5) to (m+11).

During T3 interruption of PCell during the SCell deactivation shall not happen outside the subframes (n+5) to (n+11).

During T3 interruption of PSCell during the SCell deactivation shall not happen outside the subframes (n+5) to (n+11).

The interruption of PCell shall not be more than 1ms.

The interruption of PSCell shall not be more than 1ms.

All of the above test requirements shall be fulfilled in order for the observed SCell1 activation delay and SCell1 deactivation delay to be counted as correct. The rate of correct observed SCell1 activation delay and SCell1 deactivation delay during repeated tests shall be at least 90%.

NOTE: During T2 if there are no uplink resources for reporting the valid CSI in a subframe (m+24) then the UE shall use the next available uplink resource for reporting the corresponding valid CSI.

A.8.23.27 E-UTRAN FDD-FDD DC event triggered reporting under deactivated SCell with PCell and PSCell interruption in non-DRX in synchronous DC

A.8.23.27.1 Test Purpose and Environment

The purpose of this test is to verify that in FDD-FDD DC the UE correctly detects event A6 (Neighbour becomes better than SCell) defined in TS 36.331 [2] within the requirements stated in clause 8.8.8 while at the same time fulfilling the requirement on interruption rate stated in clause 7.12.

In this test case there are three cells: Cell1, Cell2, Cell3 and Cell4. Cell 1 is the PCell on the FDD primary component carrier, Cell 2 is the configured PSCell on the FDD carrier 2, Cell 3 is the configured deactivated SCell on the FDD carrier 3 in MCG, and Cell 4 is the neighbour cell on carrier 3. It is indicated to the UE in the measurement control information that event-triggered reporting with Event A6 is used. The test consists of two successive time periods, with duration of T1 and T2, respectively. During T1 the UE shall not have any information of Cell 4. Immediately at beginning of T2 the transmission power of cell 4 is increased to same level as for cell 3, and due to usage of an offset this shall result in reporting of Event A6. PDCCH indicating a new transmission on the PCell and PSCell shall be sent continuously to ensure that the UE sends ACK/NACKs throughout the test.

The test parameters are given in Table A.8.23.27.1-1 and Table A.8.23.27.1-2 below.

Table A.8.23.27.1-1: General test parameters for E-UTRAN FDD-FDD CA Event triggered reporting on configured but deactivated SCell with PCell interruption in non-DRX with PCell in FDD

| Parameter | Unit | Value | Comment |
|------------------------------|------|---------|--|
| E-UTRA RF Channel Number | | 1, 2, 3 | Three radio channels are used for this test |
| Active PCell | | Cell 1 | Primary cell on RF channel number 1. |
| Configured PSCell | | Cell 2 | Configured PSCell on RF channel number 2. |
| Configured deactivated SCell | | Cell 3 | Configured deactivated secondary cell on RF channel number 3 |
| Neighbour cell | | Cell 4 | Neighbor cell to be identified on RF channel number 3. |

| | | | | |
|---|-----------------|----|--------|---|
| CP length | | | Normal | |
| DRX | | | OFF | Continuous monitoring of primary cell |
| A6 | Hysteresis | dB | 0 | Hysteresis for evaluation of event A6. |
| | Offset | dB | -3 | Offset parameter for evaluation of event A6. Needs to take relative accuracy tolerance in clause 9.1.11.2 into account plus margin. |
| | Report on leave | | False | |
| | Time To Trigger | s | 0 | |
| Cell-individual offset for cells on RF channel number 1 | | dB | 0 | Individual offset for cells on primary component carrier. |
| Cell-individual offset for cells on RF channel number 2 | | dB | 0 | Individual offset for cells on secondary component carrier. |
| Filter coefficient | | | 0 | L3 filtering is not used |
| SCell measurement cycle (measCycleSCell) | | ms | 1280 | |
| T1 | | s | 5 | During this time the UE shall be aware of cells 1, 2 and 3 but not cell 4. |
| T2 | | s | ≤30 | UE shall report Event A6 within 25.6s (20×scellMeasCycle) |

Table A.8.23.27.1-2: Cell specific test parameters for E-UTRAN FDD-FDD CA Event triggered reporting on configured but deactivated SCell with PCell interruption in non-DRX with PCell in FDD

| Parameter | Unit | Cell 1 | | Cell 2 | | Cell 3 | | Cell 4 | |
|---|------|---|----|---|----|---|----|---|----|
| | | T1 | T2 | T1 | T2 | T1 | T2 | T1 | T2 |
| E-UTRA RF Channel Number | | 1 | | 2 | | 3 | | | |
| BW _{channel} | | 5MHz: N _{RB,c} = 25 10MHz: N _{RB,c} = 50 20MHz: N _{RB,c} = 100 | | 5MHz: N _{RB,c} = 25 10MHz: N _{RB,c} = 50 20MHz: N _{RB,c} = 100 | | 5MHz: N _{RB,c} = 25 10MHz: N _{RB,c} = 50 20MHz: N _{RB,c} = 100 | | 5MHz: N _{RB,c} = 25 10MHz: N _{RB,c} = 50 20MHz: N _{RB,c} = 100 | |
| PDSCH parameters: DL Reference Measurement Channel | | 5MHz: R.7 FDD 10MHz: R.3 FDD 20MHz: R.6 FDD | | 5MHz: R.7 FDD 10MHz: R.3 FDD 20MHz: R.6 FDD | | - | | - | |
| PCFICH/PDCCH/PHICH parameters: DL Reference Measurement Channel | | 5MHz: R.11 FDD 10MHz: R.6 FDD 20MHz: R.10 FDD | | 5MHz: R.11 FDD 10MHz: R.6 FDD 20MHz: R.10 FDD | | 5MHz: R.11 FDD 10MHz: R.6 FDD 20MHz: R.10 FDD | | 5MHz: R.11 FDD 10MHz: R.6 FDD 20MHz: R.10 FDD | |
| OCNG Patterns defined | | 5MHz: OP.20 FDD 10MHz: OP.10 FDD 20MHz: OP.17 FDD | | 5MHz: OP.20 FDD 10MHz: OP.10 FDD 20MHz: OP.17 FDD | | 5MHz: OP.16 FDD 10MHz: OP.2 FDD 20MHz: OP.12 FDD | | 5MHz: OP.16 FDD 10MHz: OP.2 FDD 20MHz: OP.12 FDD | |
| PBCH_RA | dB | 0 | | 0 | | 0 | | 0 | |
| PBCH_RB | dB | | | | | | | | |
| PSS_RA | dB | | | | | | | | |
| SSS_RA | dB | | | | | | | | |
| PCFICH_RB | dB | | | | | | | | |
| PHICH_RA | dB | | | | | | | | |
| PHICH_RB | dB | | | | | | | | |
| PDCCH_RA | dB | | | | | | | | |
| PDCCH_RB | dB | | | | | | | | |
| PDSCH_RA | dB | | | | | | | | |
| PDSCH_RB | dB | | | | | | | | |
| OCNG_RA ^{Note 1} | dB | | | | | | | | |

| | | | | | | | |
|---|---|---|---|---|---|---------------------------------|-------|
| OCNG_RB ^{Note 1} | dB | | | | | | |
| N _{oc} ^{Note 2} | dBm/15 kHz | -101 | -101 | -101 | | | |
| E _s /N _{oc} | dB | 16 | 16 | 16 | 16 | -infinity | 16 |
| E _s /I _{ot} ^{Note 3} | dB | 16 | 16 | 16 | -0.11 | -infinity | -0.11 |
| RSRP ^{Note 3} | dBm/15 kHz | -85 | -85 | -85 | -85 | -infinity | -85 |
| SCH_RP ^{Note 3} | dBm/15 kHz | -85 | -85 | -85 | -85 | -infinity | -85 |
| I _o ^{Note 3} | dBm/Ch BW | -57.11 +10log (N _{RB,c} /50) | -57.11 +10log (N _{RB,c} /50) | -57.11 +10log (N _{RB,c} /50) | -54.15 +10log (N _{RB,c} /50) | Specified in columns for Cell 3 | |
| Propagation Condition | | ETU70 | ETU70 | ETU70 | | ETU70 | |
| Correlation Matrix and Antenna Configuration | | 1x2 Low | 1x2 Low | 1x2 Low | | 1x2 Low | |
| Timing offset to Cell 1 | μs | - | 33 | 0 | | 3 | |
| Time alignment error relative to cell 1 ^{Note 5} | μs | - | N/A | ≤ TAE | | N/A | |
| Note 1: | OCNG shall be used such that all cells are fully allocated and a constant total transmitted power spectral density is achieved for all OFDM symbols. | | | | | | |
| Note 2: | Interference from other cells and noise sources not specified in the test is assumed to be constant over subcarriers and time and shall be modelled as AWGN of appropriate power for N _{oc} to be fulfilled. | | | | | | |
| Note 3: | Es/lot, RSRP, SCH_RP and I _o levels have been derived from other parameters for information purposes. They are not settable parameters themselves. | | | | | | |
| Note 4: | The resources for uplink transmission are assigned to the UE prior to the start of time period T2. | | | | | | |
| Note 5: | Time alignment error (TAE) as specified in TS 36.104 [30] clause 6.5.3.1. The TAE value depends upon the type of carrier aggregation. | | | | | | |

A.8.23.27.2 Test Requirements

The UE shall send one Event A6 triggered measurement report for cell 3, with a measurement reporting delay less than 25.6s from the beginning of time period T2.

The UE shall not send event triggered measurement reports, as long as the reporting criteria are not fulfilled.

The UE shall be scheduled on PCell and PSCell continuously throughout the test. From the start of T1 until the measurement report is received during T2, at least 99.5% of all expected ACK/NACKs on the PCell and at least 99.5% of all expected ACK/NACKs on the PSCell shall be transmitted by the UE. Each interruption length shall not exceed 1 subframe.

For a test to be considered successful requirements on both event detection and percentage of transmitted ACK/NACKs have to be fulfilled simultaneously.

The rate of correct events observed during repeated tests shall be at least 90%.

NOTE: The actual overall delays measured in the test may be up to 2xTTIDCCH higher than the measurement reporting delays above because of TTI insertion uncertainty of the measurement report in DCCH.

A.8.23.28 E-UTRAN FDD-FDD DC event triggered reporting under deactivated SCell with PCell and PSCell interruption in non-DRX in asynchronous DC

A.8.23.28.1 Test Purpose and Environment

The purpose of this test is to verify that in FDD-FDD DC the UE correctly detects event A6 (Neighbour becomes better than SCell) defined in TS 36.331 [2] within the requirements stated in clause 8.8.8 while at the same time fulfilling the requirement on interruption rate stated in clause 7.12.

In this test case there are three cells: Cell1, Cell2, Cell3 and Cell4. Cell 1 is the PCell on the FDD primary component carrier, Cell 2 is the configured PSCell on the FDD carrier 2, Cell 3 is the configured deactivated SCell on the FDD carrier 3 in MCG, and Cell 4 is the neighbour cell on carrier 3. It is indicated to the UE in the measurement control information that event-triggered reporting with Event A6 is used. The test consists of two successive time periods, with

duration of T1 and T2, respectively. During T1 the UE shall not have any information of Cell 4. Immediately at beginning of T2 the transmission power of cell 4 is increased to same level as for cell 3, and due to usage of an offset this shall result in reporting of Event A6. PDCCH indicating a new transmission on the PCell and PSCell shall be sent continuously to ensure that the UE sends ACK/NACKs throughout the test.

The test parameters are given in Table A.8.23.28.1-1 and Table A.8.23.28.1-2 below.

Table A.8.23.28.1-1: General test parameters for E-UTRAN FDD-FDD CA Event triggered reporting on configured but deactivated SCell with PCell interruption in non-DRX with PCell in FDD

| Parameter | | Unit | Value | Comment |
|---|-----------------|------|---------|---|
| E-UTRA RF Channel Number | | | 1, 2, 3 | Three radio channels are used for this test |
| Active PCell | | | Cell 1 | Primary cell on RF channel number 1. |
| Configured PSCell | | | Cell 2 | Configured PSCell on RF channel number 2. |
| Configured deactivated SCell | | | Cell 3 | Configured deactivated secondary cell on RF channel number 3 |
| Neighbour cell | | | Cell 4 | Neighbor cell to be identified on RF channel number 3. |
| CP length | | | Normal | |
| DRX | | | OFF | Continuous monitoring of primary cell |
| A6 | Hysteresis | dB | 0 | Hysteresis for evaluation of event A6. |
| | Offset | dB | -3 | Offset parameter for evaluation of event A6. Needs to take relative accuracy tolerance in clause 9.1.11.2 into account plus margin. |
| | Report on leave | | False | |
| | Time To Trigger | s | 0 | |
| Cell-individual offset for cells on RF channel number 1 | | dB | 0 | Individual offset for cells on primary component carrier. |
| Cell-individual offset for cells on RF channel number 2 | | dB | 0 | Individual offset for cells on secondary component carrier. |
| Filter coefficient | | | 0 | L3 filtering is not used |
| SCell measurement cycle (measCycleSCell) | | ms | 1280 | |
| T1 | | s | 5 | During this time the UE shall be aware of cells 1, 2 and 3 but not cell 4. |
| T2 | | s | ≤30 | UE shall report Event A6 within 25.6s (20×scellMeasCycle) |

Table A.8.23.28.1-2: Cell specific test parameters for E-UTRAN FDD-FDD CA Event triggered reporting on configured but deactivated SCell with PCell interruption in non-DRX with PCell in FDD

| Parameter | Unit | Cell 1 | | Cell 2 | | Cell 3 | | Cell 4 | |
|--|------|---|----|---|----|---|----|---|----|
| | | T1 | T2 | T1 | T2 | T1 | T2 | T1 | T2 |
| E-UTRA RF Channel Number | | 1 | | 2 | | 3 | | | |
| BW _{channel} | | 5MHz: N _{RB,c} = 25 10MHz: N _{RB,c} = 50 20MHz: N _{RB,c} = 100 | | 5MHz: N _{RB,c} = 25 10MHz: N _{RB,c} = 50 20MHz: N _{RB,c} = 100 | | 5MHz: N _{RB,c} = 25 10MHz: N _{RB,c} = 50 20MHz: N _{RB,c} = 100 | | 5MHz: N _{RB,c} = 25 10MHz: N _{RB,c} = 50 20MHz: N _{RB,c} = 100 | |
| PDSCH parameters: DL Reference Measurement Channel | | 5MHz: R.7 FDD 10MHz: R.3 FDD 20MHz: R.6 FDD | | 5MHz: R.7 FDD 10MHz: R.3 FDD 20MHz: R.6 FDD | | - | | - | |

| | | | | | | | |
|--|------------|---|---|--|--|---------------------------------|-------|
| PCFICH/PDCCH/PHICH parameters: DL Reference Measurement Channel | | 5MHz: R.11 FDD 10MHz: R.6 FDD 20MHz: R.10 FDD | 5MHz: R.11 FDD 10MHz: R.6 FDD 20MHz: R.10 FDD | 5MHz: R.11 FDD 10MHz: R.6 FDD 20MHz: R.10 FDD | 5MHz: R.11 FDD 10MHz: R.6 FDD 20MHz: R.10 FDD | | |
| OCNG Patterns defined | | 5MHz: OP.20 FDD 10MHz: OP.10 FDD 20MHz: OP.17 FDD | 5MHz: OP.20 FDD 10MHz: OP.10 FDD 20MHz: OP.17 FDD | 5MHz: OP.16 FDD 10MHz: OP.2 FDD 20MHz: OP.12 FDD | 5MHz: OP.16 FDD 10MHz: OP.2 FDD 20MHz: OP.12 FDD | | |
| PBCH_RA | dB | 0 | 0 | 0 | 0 | | |
| PBCH_RB | dB | | | | | | |
| PSS_RA | dB | | | | | | |
| SSS_RA | dB | | | | | | |
| PCFICH_RB | dB | | | | | | |
| PHICH_RA | dB | | | | | | |
| PHICH_RB | dB | | | | | | |
| PDCCH_RA | dB | | | | | | |
| PDCCH_RB | dB | | | | | | |
| PDSCH_RA | dB | | | | | | |
| PDSCH_RB | dB | | | | | | |
| OCNG_RA ^{Note 1} | dB | | | | | | |
| OCNG_RB ^{Note 1} | dB | | | | | | |
| N _{oc} ^{Note 2} | dBm/15 kHz | | | | | -101 | -101 |
| \bar{E}_s/N_{oc} | dB | 16 | 16 | 16 | 16 | -infinity | 16 |
| \bar{E}_s/I_{ot} ^{Note 3} | dB | 16 | 16 | 16 | -0.11 | -infinity | -0.11 |
| RSRP ^{Note 3} | dBm/15 kHz | -85 | -85 | -85 | -85 | -infinity | -85 |
| SCH_RP ^{Note 3} | dBm/15 kHz | -85 | -85 | -85 | -85 | -infinity | -85 |
| I _o ^{Note 3} | dBm/Ch BW | -57.11 +10log (N _{RB,c} /50) | -57.11 +10log (N _{RB,c} /50) | -57.11 +10log (N _{RB,c} /50) | -54.15 +10log (N _{RB,c} /50) | Specified in columns for Cell 3 | |
| Propagation Condition | | ETU70 | ETU70 | ETU70 | | ETU70 | |
| Correlation Matrix and Antenna Configuration | | 1x2 Low | 1x2 Low | 1x2 Low | | 1x2 Low | |
| Timing offset to Cell 1 | μs | - | 500 | 0 | | 3 | |
| Time alignment error relative to cell 1 ^{Note 5} | μs | - | N/A | ≤ TAE | | N/A | |
| <p>Note 1: OCNG shall be used such that all cells are fully allocated and a constant total transmitted power spectral density is achieved for all OFDM symbols.</p> <p>Note 2: Interference from other cells and noise sources not specified in the test is assumed to be constant over subcarriers and time and shall be modelled as AWGN of appropriate power for N_{oc} to be fulfilled.</p> <p>Note 3: E_s/I_{ot}, RSRP, SCH_RP and I_o levels have been derived from other parameters for information purposes. They are not settable parameters themselves.</p> <p>Note 4: The resources for uplink transmission are assigned to the UE prior to the start of time period T2.</p> <p>Note 5: Time alignment error (TAE) as specified in TS 36.104 [30] clause 6.5.3.1. The TAE value depends upon the type of carrier aggregation.</p> | | | | | | | |

A.8.23.28.2 Test Requirements

The UE shall send one Event A6 triggered measurement report for cell 3, with a measurement reporting delay less than 25.6s from the beginning of time period T2.

The UE shall not send event triggered measurement reports, as long as the reporting criteria are not fulfilled.

The UE shall be scheduled on PCell and PSCell continuously throughout the test. From the start of T1 until the measurement report is received during T2, at least 99.5% of all expected ACK/NACKs on the PCell and at least 99.5% of all expected ACK/NACKs on the PSCell shall be transmitted by the UE. Each interruption length shall not exceed 1 subframes on PCell and 2 subframes on PSCell, respectively.

For a test to be considered successful requirements on both event detection and percentage of transmitted ACK/NACKs have to be fulfilled simultaneously.

The rate of correct events observed during repeated tests shall be at least 90%.

NOTE: The actual overall delays measured in the test may be up to $2 \times \text{TTIDCCH}$ higher than the measurement reporting delays above because of TTI insertion uncertainty of the measurement report in DCCH.

A.8.23.29 E-UTRAN TDD-TDD DC event triggered reporting under deactivated SCell with PCell and PSCell interruption in non-DRX in synchronous DC

A.8.23.29.1 Test Purpose and Environment

The purpose of this test is to verify that in TDD-TDD DC the UE correctly detects event A6 (Neighbour becomes better than SCell) defined in TS 36.331 [2] within the requirements stated in clause 8.8.8 while at the same time fulfilling the requirement on interruption rate stated in clause 7.12.

In this test case there are three cells: Cell1, Cell2, Cell3 and Cell4. Cell 1 is the PCell on the TDD primary component carrier, Cell 2 is the configured PSCell on the TDD carrier 2, Cell 3 is the configured deactivated SCell on the TDD carrier 3 in MCG, and Cell 4 is the neighbour cell on carrier 3. It is indicated to the UE in the measurement control information that event-triggered reporting with Event A6 is used. The test consists of two successive time periods, with duration of T1 and T2, respectively. During T1 the UE shall not have any information of Cell 4. Immediately at beginning of T2 the transmission power of cell 4 is increased to same level as for cell 3, and due to usage of an offset this shall result in reporting of Event A6. PDCCH indicating a new transmission on the PCell and PSCell shall be sent continuously to ensure that the UE sends ACK/NACKs throughout the test.

The test parameters are given in Table A.8.23.29.1-1 and Table A.8.23.29.1-2 below.

Table A.8.23.29.1-1: General test parameters for E-UTRAN TDD-TDD CA Event triggered reporting on configured but deactivated SCell with PCell interruption in non-DRX with PCell in FDD

| Parameter | Unit | Value | Comment | |
|---|-----------------|---------|---|---|
| E-UTRA RF Channel Number | | 1, 2, 3 | Three radio channels are used for this test | |
| Active PCell | | Cell 1 | Primary cell on RF channel number 1. | |
| Configured PSCell | | Cell 2 | Configured PSCell on RF channel number 2. | |
| Configured deactivated SCell | | Cell 3 | Configured deactivated secondary cell on RF channel number 3 | |
| Neighbour cell | | Cell 4 | Neighbor cell to be identified on RF channel number 3. | |
| CP length | | Normal | | |
| Special subframe configuration | | 6 | As specified in table 4.2-1 in TS 36.211. The same configuration in TDD cells | |
| Uplink-downlink configuration | | 1 | As specified in table 4.2-2 in TS 36.211. The same configuration in TDD cells | |
| DRX | | OFF | Continuous monitoring of primary cell | |
| A6 | Hysteresis | dB | 0 | Hysteresis for evaluation of event A6. |
| | Offset | dB | -3 | Offset parameter for evaluation of event A6. Needs to take relative accuracy tolerance in clause 9.1.11.2 into account plus margin. |
| | Report on leave | | False | |
| | Time To Trigger | s | 0 | |
| Cell-individual offset for cells on RF channel number 1 | dB | 0 | Individual offset for cells on primary component carrier. | |
| Cell-individual offset for cells on RF channel number 2 | dB | 0 | Individual offset for cells on secondary component carrier. | |
| Filter coefficient | | 0 | L3 filtering is not used | |
| SCell measurement cycle (measCycleSCell) | ms | 1280 | | |

| | | | |
|----|---|-----|--|
| T1 | s | 5 | During this time the UE shall be aware of cells 1, 2 and 3 but not cell 4. |
| T2 | s | ≤30 | UE shall report Event A6 within 25.6s (20xscellMeasCycle) |

Table A.8.23.29.1-2: Cell specific test parameters for E-UTRAN TDD-TDD CA Event triggered reporting on configured but deactivated SCell with PCell interruption in non-DRX with PCell in FDD

| Parameter | Unit | Cell 1 | | Cell 2 | | Cell 3 | | Cell 4 | |
|---|------------|---|---|---|---|---|---|---|---|
| | | T1 | T2 | T1 | T2 | T1 | T2 | T1 | T2 |
| E-UTRA RF Channel Number | | 1 | | 2 | | 3 | | | |
| BW _{channel} | | 5MHz: N _{RB,c} = 25 10MHz: N _{RB,c} = 50 20MHz: N _{RB,c} = 100 | 5MHz: N _{RB,c} = 25 10MHz: N _{RB,c} = 50 20MHz: N _{RB,c} = 100 | 5MHz: N _{RB,c} = 25 10MHz: N _{RB,c} = 50 20MHz: N _{RB,c} = 100 | 5MHz: N _{RB,c} = 25 10MHz: N _{RB,c} = 50 20MHz: N _{RB,c} = 100 | 5MHz: N _{RB,c} = 25 10MHz: N _{RB,c} = 50 20MHz: N _{RB,c} = 100 | 5MHz: N _{RB,c} = 25 10MHz: N _{RB,c} = 50 20MHz: N _{RB,c} = 100 | 5MHz: N _{RB,c} = 25 10MHz: N _{RB,c} = 50 20MHz: N _{RB,c} = 100 | 5MHz: N _{RB,c} = 25 10MHz: N _{RB,c} = 50 20MHz: N _{RB,c} = 100 |
| PDSCH parameters: DL Reference Measurement Channel | | 5MHz: R.4 TDD 10MHz: R.0 TDD 20MHz: R.3 TDD | 5MHz: R.4 TDD 10MHz: R.0 TDD 20MHz: R.3 TDD | - | - | - | - | - | - |
| PCFICH/PDCCH/PHICH parameters: DL Reference Measurement Channel | | 5MHz: R.11 TDD 10MHz: R.6 TDD 20MHz: R.10 TDD | 5MHz: R.11 TDD 10MHz: R.6 TDD 20MHz: R.10 TDD | 5MHz: R.11 TDD 10MHz: R.6 TDD 20MHz: R.10 TDD | 5MHz: R.11 TDD 10MHz: R.6 TDD 20MHz: R.10 TDD | 5MHz: R.11 TDD 10MHz: R.6 TDD 20MHz: R.10 TDD | 5MHz: R.11 TDD 10MHz: R.6 TDD 20MHz: R.10 TDD | 5MHz: R.11 TDD 10MHz: R.6 TDD 20MHz: R.10 TDD | 5MHz: R.11 TDD 10MHz: R.6 TDD 20MHz: R.10 TDD |
| OCNG Patterns defined | | 5MHz: OP.9 TDD 10MHz: OP.1 TDD 20MHz: OP.7 TDD | 5MHz: OP.9 TDD 10MHz: OP.1 TDD 20MHz: OP.7 TDD | 5MHz: OP.10 TDD 10MHz: OP.2 TDD 20MHz: OP.8 TDD | 5MHz: OP.10 TDD 10MHz: OP.2 TDD 20MHz: OP.8 TDD | 5MHz: OP.10 TDD 10MHz: OP.2 TDD 20MHz: OP.8 TDD | 5MHz: OP.10 TDD 10MHz: OP.2 TDD 20MHz: OP.8 TDD | 5MHz: OP.10 TDD 10MHz: OP.2 TDD 20MHz: OP.8 TDD | 5MHz: OP.10 TDD 10MHz: OP.2 TDD 20MHz: OP.8 TDD |
| PBCH_RA | dB | 0 | 0 | 0 | 0 | 0 | 0 | 0 | 0 |
| PBCH_RB | dB | | | | | | | | |
| PSS_RA | dB | | | | | | | | |
| SSS_RA | dB | | | | | | | | |
| PCFICH_RB | dB | | | | | | | | |
| PHICH_RA | dB | | | | | | | | |
| PHICH_RB | dB | | | | | | | | |
| PDCCH_RA | dB | | | | | | | | |
| PDCCH_RB | dB | | | | | | | | |
| PDSCH_RA | dB | | | | | | | | |
| PDSCH_RB | dB | | | | | | | | |
| OCNG_RA ^{Note 1} | dB | | | | | | | | |
| OCNG_RB ^{Note 1} | dB | | | | | | | | |
| N _{oc} ^{Note 2} | dBm/15 kHz | | | | | | | | |
| \bar{E}_s/N_{oc} | dB | 16 | 16 | 16 | 16 | -infinity | 16 | -infinity | 16 |
| \bar{E}_s/I_{ot} ^{Note 3} | dB | 16 | 16 | 16 | -0.11 | -infinity | -0.11 | -infinity | -0.11 |
| RSRP ^{Note 3} | dBm/15 kHz | -85 | -85 | -85 | -85 | -infinity | -85 | -infinity | -85 |
| SCH_RP ^{Note 3} | dBm/15 kHz | -85 | -85 | -85 | -85 | -infinity | -85 | -infinity | -85 |
| I _o ^{Note 3} | dBm/Ch BW | -57.11 +10log (N _{RB,c} /50) | -57.11 +10log (N _{RB,c} /50) | -57.11 +10log (N _{RB,c} /50) | -54.15 +10log (N _{RB,c} /50) | Specified in columns for Cell 3 | | | |
| Propagation Condition | | ETU70 | ETU70 | ETU70 | | ETU70 | | | |
| Correlation Matrix and Antenna Configuration | | 1x2 Low | 1x2 Low | 1x2 Low | | 1x2 Low | | | |
| Timing offset to Cell 1 | μs | - | 33 | 0 | | 3 | | | |

| | | | | | |
|---|--|---|-----|-------------------|-----|
| Time alignment error relative to cell 1 ^{Note 5} | μs | - | N/A | $\leq \text{TAE}$ | N/A |
| Note 1: | OCNG shall be used such that all cells are fully allocated and a constant total transmitted power spectral density is achieved for all OFDM symbols. | | | | |
| Note 2: | Interference from other cells and noise sources not specified in the test is assumed to be constant over subcarriers and time and shall be modelled as AWGN of appropriate power for N_{oc} to be fulfilled. | | | | |
| Note 3: | Es/lot, RSRP, SCH_RP and lo levels have been derived from other parameters for information purposes. They are not settable parameters themselves. | | | | |
| Note 4: | The resources for uplink transmission are assigned to the UE prior to the start of time period T2. | | | | |
| Note 5: | Time alignment error (TAE) as specified in TS 36.104 [30] clause 6.5.3.1. The TAE value depends upon the type of carrier aggregation. | | | | |

A.8.23.29.2 Test Requirements

The UE shall send one Event A6 triggered measurement report for cell 3, with a measurement reporting delay less than 25.6s from the beginning of time period T2.

The UE shall not send event triggered measurement reports, as long as the reporting criteria are not fulfilled.

The UE shall be scheduled on PCell and PSCell continuously throughout the test. From the start of T1 until the measurement report is received during T2, at least 99.5% of all expected ACK/NACKs on the PCell and at least 99.5% of all expected ACK/NACKs on the PSCell shall be transmitted by the UE. Each interruption length shall not exceed 1 subframe.

For a test to be considered successful requirements on both event detection and percentage of transmitted ACK/NACKs have to be fulfilled simultaneously.

The rate of correct events observed during repeated tests shall be at least 90%.

NOTE: The actual overall delays measured in the test may be up to $2xTTIDCCH$ higher than the measurement reporting delays above because of TTI insertion uncertainty of the measurement report in DCCH.

A.8.24 Proximity-based Services

A.8.24.1 E-UTRAN FDD - Initiation/Cease of SLSS Transmission with ProSe Direct Discovery

The purpose of this test is to verify the requirements related to the maximum evaluation time allowed to initiate and cease SLSS transmissions defined in clause 8.10.2.1. In the test the UE under test is configured for ProSe operation only on PCell and also the UE is configured only for PCell for WAN. This test is applicable for a UE capable of ProSe Direct Discovery and also SLSS transmission and reception (indicated using *disc-SLSS*).

For this test, the UE is triggered by the test loop function or the upper layers to announce ProSe Direct Discovery.

The test parameters are given in Table A.8.24.1.1-1, Table A.8.24.1.1-2 and Table A.8.24.1.1-3 below. There is one active cell (PCell) in this test. The test consists of three successive time periods, with time duration of T1, T2 and T3 respectively. During T1, the RSRP of the PCell is above *syncTxThreshIC* and the UE is not expected to be transmitting SLSS. During T2, the RSRP of the PCell is lowered below *syncTxThreshIC* and the UE is expected to initiate SLSS transmissions. During T3, the RSRP of the PCell is increased back to be above *syncTxThreshIC* and the UE is expected to cease SLSS transmissions.

A.8.24.1.1 Test Purpose and Environment

Table A.8.24.1.1-1: Test parameters for initiation/cease of SLSS transmissions test for E-UTRAN FDD

| Parameter | Unit | Value | Comment |
|--------------------------------------|------|--------|---|
| E-UTRA RF Channel Number | | 1 | Only one FDD carrier frequency is used. |
| Channel Bandwidth ($BW_{channel}$) | MHz | 5 | |
| Active cell | | Cell 1 | E-UTRA FDD Cell1 on RF channel number 1 |

| | | | |
|---------------------|---|----------|----------------------------------|
| CP length of Cell 1 | | Normal | |
| Layer 3 filtering | | Disabled | L3 filtering is not used |
| drx-Configuration | | DRX_P1 | As specified in Table A.3.12.2-1 |
| T1 | s | 3 | |
| T2 | s | 5.24 | |
| T3 | s | 5.24 | |

Table A.8.24.1.1-2: ProSe Direct Discovery configuration for initiation/cease of SLSS transmissions test for E-UTRAN FDD

| Parameter | Unit | Value | Comment |
|--|------------|---|--|
| E-UTRA RF Channel Number | | 1 | UL carrier frequency |
| Channel Bandwidth ($BW_{channel}$) | MHz | 5 | |
| ProSe Direct Discovery resource pool configuration | | As specified in Table A.3.12.4-1 (Configuration #1) | IE values unless specified otherwise in this test. |
| networkControlledSyncTx | | Not configured | |
| syncTxThreshIC | dBm/15 kHz | -95 | In SIB19 |

Table A.8.24.1.1-3: Cell specific test parameters for initiation/cease of SLSS transmissions test for E-UTRAN FDD

| Parameter | Unit | Cell 1 | | |
|--|------------|-----------|-------|-------|
| | | T1 | T2 | T3 |
| E-UTRA RF Channel Number | | 1 | | |
| $BW_{channel}$ | MHz | 5 | | |
| OCNG Pattern (defined in clause A.3.2) | | OP.16 FDD | | |
| PBCH_RA | dB | 0 | | |
| PBCH_RB | | | | |
| PSS_RA | | | | |
| SSS_RA | | | | |
| PCFICH_RB | | | | |
| PHICH_RA | | | | |
| PHICH_RB | | | | |
| PDCCH_RA | | | | |
| PDCCH_RB | | | | |
| PDSCH_RA | | | | |
| PDSCH_RB | | | | |
| OCNG_RA ^{Note 1} | | | | |
| OCNG_RB ^{Note 1} | | | | |
| N_{oc} ^{Note 2} | | | | |
| \hat{E}_s / N_{oc} | dB | 4.5 | -4.5 | 4.5 |
| RSRP ^{Note 3} | dBm/15 kHz | -90.5 | -99.5 | -90.5 |
| SCH_RP ^{Note 3} | dBm/15 kHz | -90.5 | -99.5 | -90.5 |
| Propagation Condition | | AWGN | | |
| <p>Note 1: OCNG shall be used such that cell is fully allocated and a constant total transmitted power spectral density is achieved for all OFDM symbols.</p> <p>Note 2: Interference from other cells and noise sources not specified in the test is assumed to be constant over subcarriers and time and shall be modelled as AWGN of appropriate power for N_{oc} to be fulfilled.</p> <p>Note 3: RSRP levels have been derived from other parameters for information purposes. They are not settable parameters themselves.</p> | | | | |

A.8.24.1.2 Test Requirements

The SLSS transmission initiation delay is defined as the time from the beginning of time period T2 up to the moment when the UE initiates the SLSS transmission.

The SLSS transmission initiation delay shall be less than 2.24 s.

The SLSS transmission cease delay is defined as the time from the beginning of time period T3 up to the moment when the UE ceases the SLSS transmission.

The SLSS transmission cease delay shall be less than 2.24 s.

The rate of correct initiation/cease delay of SLSS transmissions observed during repeated tests shall be at least 90%.

NOTE: The initiation/cease delay of SLSS transmissions can be expressed as: $T_{\text{evaluate,SLSS}} + \text{discPeriod}$,

Where:

$T_{\text{evaluate,SLSS}}$ is the evaluation time for initiate/cease of SLSS, and is 1.92 sec (see Table 8.10.2.1-1 in clause 8.10.2.1) for the parameters in this test;

discPeriod is the discovery period (set as 320ms in this test).

A.8.24.2 E-UTRAN TDD - Initiation/Cease of SLSS Transmission with ProSe Direct Discovery

The purpose of this test is to verify the requirements related to the maximum evaluation time allowed to initiate and cease SLSS transmissions defined in clause 8.10.2.1. In the test the UE under test is configured for ProSe operation only on PCell and also the UE is configured only for PCell for WAN. This test is applicable for a UE capable of ProSe Direct Discovery and also SLSS transmission and reception (indicated using *disc-SLSS*).

For this test, the UE is triggered by the test loop function or the upper layers to announce ProSe Direct Discovery.

The test parameters are given in Table A.8.24.2.1-1, Table A.8.24.2.1-2 and Table A.8.24.2.1-3 below. There is one active cell (PCell) in this test. The test consists of three successive time periods, with time duration of T1, T2 and T3 respectively. During T1, the RSRP of the PCell is above *syncTxThreshIC* and the UE is not expected to be transmitting SLSS. During T2, the RSRP of the PCell is lowered below *syncTxThreshIC* and the UE is expected to initiate SLSS transmissions. During T3, the RSRP of the PCell is increased back to be above *syncTxThreshIC* and the UE is expected to cease SLSS transmissions.

A.8.24.2.1 Test Purpose and Environment

Table A.8.24.2.1-1: Test parameters for initiation/cease of SLSS transmissions test for E-UTRAN TDD

| Parameter | Unit | Value | Comment |
|---|------|----------|---|
| E-UTRA RF Channel Number | | 1 | Only one TDD carrier frequency is used. |
| Channel Bandwidth (BW_{channel}) | MHz | 5 | |
| Active cell | | Cell 1 | E-UTRA TDD Cell1 on RF channel number 1 |
| Uplink/Downlink Configuration | | Config 0 | |
| Special Subframe Configuration | | 6 | |
| CP length of Cell 1 | | Normal | |
| Layer 3 filtering | | Disabled | L3 filtering is not used |
| drx-Configuration | | DRX_P1 | As specified in Table A.3.12.2-1 |
| T1 | s | 3 | |
| T2 | s | 5.24 | |
| T3 | s | 5.24 | |

Table A.8.24.1.1-2: ProSe Direct Discovery configuration for initiation/cease of SLSS transmissions test for E-UTRAN TDD

| Parameter | Unit | Value | Comment |
|--|------|----------------------------------|--|
| E-UTRA RF Channel Number | | 1 | |
| Channel Bandwidth (BW_{channel}) | MHz | 5 | |
| ProSe Direct Discovery resource pool configuration | | As specified in Table A.3.12.4-3 | IE values unless specified otherwise in this test. |

| | | | |
|-------------------------|------------|--------------------|----------|
| | | (Configuration #3) | |
| networkControlledSyncTx | | Not configured | |
| syncTxThreshIC | dBm/15 kHz | -95 | In SIB19 |

Table A.8.24.2.1-3: Cell specific test parameters for initiation/cease of SLSS transmissions test for E-UTRAN TDD

| Parameter | Unit | Cell 1 | | |
|--|------------|-----------|-------|-------|
| | | T1 | T2 | T3 |
| E-UTRA RF Channel Number | | 1 | | |
| BW _{channel} | MHz | 5 | | |
| OCNG Pattern (defined in clause A.3.2) | | OP.10 TDD | | |
| PBCH_RA | dB | 0 | | |
| PBCH_RB | | | | |
| PSS_RA | | | | |
| SSS_RA | | | | |
| PCFICH_RB | | | | |
| PHICH_RA | | | | |
| PHICH_RB | | | | |
| PDCCH_RA | | | | |
| PDCCH_RB | | | | |
| PDSCH_RA | | | | |
| PDSCH_RB | | | | |
| OCNG_RA ^{Note 1} | | | | |
| OCNG_RB ^{Note 1} | | | | |
| N_{oc} ^{Note2} | | | | |
| \hat{E}_s / N_{oc} | dB | 4.5 | -4.5 | 4.5 |
| RSRP ^{Note3} | dBm/15 kHz | -90.5 | -99.5 | -90.5 |
| SCH_RP ^{Note 3} | dBm/15 kHz | -90.5 | -99.5 | -90.5 |
| Propagation Condition | | AWGN | | |
| Note 1: OCNG shall be used such that cell is fully allocated and a constant total transmitted power spectral density is achieved for all OFDM symbols. | | | | |
| Note 2: Interference from other cells and noise sources not specified in the test is assumed to be constant over subcarriers and time and shall be modelled as AWGN of appropriate power for N_{oc} to be fulfilled. | | | | |
| Note 3: RSRP levels have been derived from other parameters for information purposes. They are not settable parameters themselves. | | | | |

A.8.24.2.2 Test Requirements

The SLSS transmission initiation delay is defined as the time from the beginning of time period T2 up to the moment when the UE initiates the SLSS transmission.

The SLSS transmission initiation delay shall be less than 2.24 s.

The SLSS transmission cease delay is defined as the time from the beginning of time period T3 up to the moment when the UE ceases the SLSS transmission.

The SLSS transmission cease delay shall be less than 2.24 s.

The rate of correct initiation/cease delay of SLSS transmissions observed during repeated tests shall be at least 90%.

NOTE: The initiation/cease delay of SLSS transmissions can be expressed as: $T_{\text{evaluate,SLSS}} + \text{discPeriod}$,

Where:

$T_{\text{evaluate,SLSS}}$ is the evaluation time for initiate/cease of SLSS, and is 1.92 sec (see Table 8.10.2.1-1 in clause 8.10.2.1) for the parameters in this test;

discPeriod is the discovery period (set as 320ms in this test).

A.8.24.3 E-UTRAN FDD - Initiation/Cease of SLSS Transmission with ProSe Direct Communication

The purpose of this test is to verify that the ProSe UE meets the requirements related to the maximum evaluation time allowed to initiate and cease SLSS transmissions defined in clause 8.10.2.2. This test is applicable for a UE capable of ProSe Direct Communication. In the test the UE under test is configured for ProSe operation only on PCell and also the UE is configured only for PCell for WAN.

For this test, the UE is triggered by the test loop function or the upper layers to transmit for ProSe Direct Communication.

The test parameters are given in Table A.8.24.3.1-1, Table A.8.24.3.1-2 and Table A.8.24.3.1-3 below. There is one active cell (PCell) in this test. The test consists of three successive time periods, with time duration of T1, T2 and T3 respectively. During T1, the RSRP of the PCell is above *syncTxThreshIC* and the UE is not expected to be transmitting SLSS. During T2, the RSRP of the PCell is lowered below *syncTxThreshIC* and the UE is expected to initiate SLSS transmissions. During T3, the RSRP of the PCell is increased back to be above *syncTxThreshIC* and the UE is expected to cease SLSS transmissions.

A.8.24.3.1 Test Purpose and Environment

Table A.8.24.3.1-1: Test parameters for initiation/cease of SLSS transmissions test for E-UTRAN FDD

| Parameter | Unit | Value | Comment |
|--------------------------------------|------|----------|---|
| E-UTRA RF Channel Number | | 1 | Only one FDD carrier frequency is used. |
| Channel Bandwidth ($BW_{channel}$) | MHz | 5 or 10 | According to principle defined in clause A.3.12.3 |
| Active cell | | Cell 1 | E-UTRA FDD Cell1 on RF channel number 1 |
| CP length of Cell 1 | | Normal | |
| Layer 3 filtering | | Disabled | L3 filtering is not used |
| drx-Configuration | | DRX_P1 | As specified in Table A.3.12.2-1 |
| T1 | s | 3 | |
| T2 | s | 5.24 | |
| T3 | s | 5.24 | |

Table A.8.24.3.1-2: ProSe Direct Communication configuration for initiation/cease of SLSS transmissions test for E-UTRAN FDD

| Parameter | Unit | Value | Comment |
|--|------------|---|--|
| E-UTRA RF Channel Number | | 1 | UL carrier frequency |
| Channel Bandwidth ($BW_{channel}$) | MHz | 5 or 10 | According to principle defined in clause A.3.12.3 |
| ProSe Direct Communication configuration | | As specified in Table A.3.12.5-1 (Configuration #1) | IE values unless specified otherwise in this test. |
| networkControlledSyncTx | | Not configured | |
| syncTxThreshIC | dBm/15 kHz | -95 | In SIB18 |

Table A.8.24.3.1-3: Cell specific test parameters for initiation/cease of SLSS transmissions test for E-UTRAN FDD

| Parameter | Unit | Cell 1 | | |
|----------------------------------|------|---------|----|----|
| | | T1 | T2 | T3 |
| E-UTRA RF Channel Number | | 1 | | |
| $BW_{channel}$ ^{Note 4} | MHz | 5 or 10 | | |

| | | | | |
|--|------------|-------------------------------------|-------|-------|
| OCNG Patterns defined in A.3.2.1.2 ^{Note 4} | | 5MHz: OP.16 FDD 10 MHz: OP.2 FDD | | |
| PBCH_RA | dB | 0 | | |
| PBCH_RB | | | | |
| PSS_RA | | | | |
| SSS_RA | | | | |
| PCFICH_RB | | | | |
| PHICH_RA | | | | |
| PHICH_RB | | | | |
| PDCCH_RA | | | | |
| PDCCH_RB | | | | |
| PDSCH_RA | | | | |
| PDSCH_RB | | | | |
| OCNG_RA ^{Note 1} | | | | |
| OCNG_RB ^{Note 1} | | | | |
| N_{oc} ^{Note2} | dBm/15 kHz | -95 | | |
| \hat{E}_s / N_{oc} | dB | 4.5 | -4.5 | 4.5 |
| RSRP ^{Note3} | dBm/15 kHz | -90.5 | -99.5 | -90.5 |
| SCH_RP ^{Note 3} | dBm/15 kHz | -90.5 | -99.5 | -90.5 |
| Propagation Condition | | AWGN | | |
| <p>Note 1: OCNG shall be used such that cell is fully allocated and a constant total transmitted power spectral density is achieved for all OFDM symbols.</p> <p>Note 2: Interference from other cells and noise sources not specified in the test is assumed to be constant over subcarriers and time and shall be modelled as AWGN of appropriate power for N_{oc} to be fulfilled.</p> <p>Note 3: RSRP levels have been derived from other parameters for information purposes. They are not settable parameters themselves.</p> <p>Note 4: This test is according to the principle defined in section A.3.12.3.</p> | | | | |

A.8.24.3.2 Test Requirements

The SLSS transmission initiation delay is defined as the time from the beginning of time period T2 up to the moment when the UE initiates the SLSS transmission.

The SLSS transmission initiation delay shall be less than 1.96 s.

The SLSS transmission cease delay is defined as the time from the beginning of time period T3 up to the moment when the UE ceases the SLSS transmission.

The SLSS transmission cease delay shall be less than 1.96 s.

The rate of correct initiation/cease delay of SLSS transmissions observed during repeated tests shall be at least 90%.

NOTE: The initiation/cease delay of SLSS transmissions can be expressed as: $T_{evaluate,SLSS} + SLSS \text{ period}$,

Where:

$T_{evaluate,SLSS}$ is the evaluation time for initiate/cease of SLSS, and is 1.92 sec (see Table 8.10.2.1-1 in clause 8.10.2.1) for the parameters in this test;

SLSS period is set to 40ms.

A.8.25 E-UTRAN-WLAN Measurements

A.8.25.1 E-UTRAN FDD-WLAN Event Triggered Reporting in non-DRX under AWGN

A.8.25.1.1 Test Purpose and Environment

The purpose of this test is to verify that the UE correctly detects event W1 (WLAN becomes better than a threshold) for unknown cell (unknown neighbour AP) and event W3 (All WLAN inside WLAN mobility set becomes worse than a threshold) for known cell (serving AP) defined in TS 36.331 [2] within the requirements stated in clause 8.1.2.4.19.

The test parameters are given in Tables A.8.25.1.1-1 and A.8.25.1.1-2 below. In the tests there are two cells, cell1 (E-UTRAN FDD) and cell2 (WLAN AP). It is indicated to the UE in the measurement control information that event-triggered reporting with Events W1 (for cell2) and W3 (for cell2) are used. The test consists of three successive time periods, with duration of T1, T2 and T3, respectively. During T1 the UE shall not have any information on cell1. At the beginning of T2 the transmission power of cell 2 is increased to a level, which shall result in reporting of Event W1. At the beginning of T3 the transmission power of cell 2 is decreased to a level, which shall result in reporting of Event W3.

Table A.8.25.1.1-1: General test parameters for E-UTRAN FDD-WLAN event triggered reporting under AWGN in non-DRX

| Parameter | | Unit | Value | Comment |
|---------------------------------------|---------------------|------|-------------|---|
| Active cell | | | Cell 1 | Cell 1 is on E-UTRA RF channel number 1. |
| Neighbour cell | | | Cell 2 (AP) | Cell 2 (WLAN AP) is on WLAN RF channel number 1. |
| CP length | | | Normal | Applicable to cell 1 |
| E-UTRA RF Channel Number | | | 1 | One E-UTRA FDD carrier frequency is used. |
| WLAN Channel Number | | | 1 | One WLAN carrier frequency is used. |
| WLAN measurement quantity | | | WLAN RSSI | |
| WLAN beacon frame transmission period | | ms | 102.5 | |
| DRX | | | OFF | |
| W1 | Hysteresis | dB | 0 | Hysteresis for evaluation of event W1. |
| | Threshold WLAN RSSI | dBm | -70 | Actual WLAN RSSI threshold for event W1. Needs to take absolute accuracy tolerance in section 9.7.1 into account plus margin. |
| | Time To Trigger | s | 0 | |
| W3 | Hysteresis | dB | 0 | Hysteresis for evaluation of event W3. |
| | Threshold WLAN RSSI | dBm | -65 | Actual WLAN RSSI threshold for event W3. Needs to take absolute accuracy tolerance in section 9.7.1 into account plus margin. |
| | Time To Trigger | s | 0 | |
| T1 | | s | 5 | During this time the cell1 shall be known to the UE; but cell2 shall be unknown to the UE. |
| T2 | | s | ≤ 40 | UE should report Event W1 for cell2 within 30 s. |
| T3 | | s | 3 | UE should report Event W3 for cell2 within 0.5 s. |

Table A.8.25.1.1-2: Cell specific test parameters for E-UTRAN FDD-WLAN event triggered reporting under AWGN in non-DRX

| Parameter | Unit | Cell 1 | | | Cell 2 (WLAN AP) | | |
|--|------|---------|----|----|------------------|----|----|
| | | T1 | T2 | T3 | T1 | T2 | T3 |
| E-UTRA RF Channel Number | | 1 | | | N/A | | |
| WLAN RF channel Number | | N/A | | | 1 | | |
| BW _{channel} | | 10MHz | | | 20 MHz | | |
| PDSCH parameters: DL Reference Measurement Channel | | R.0 FDD | | | N/A | | |

| | | | | | | | |
|---|------------|----------|-------|-------|-----------|------|------|
| PCFICH/PDCCH/PHICH parameters: DL Reference Measurement Channel | | R.6 FDD | | | N/A | | |
| OCNG Patterns | | OP.1 FDD | | | N/A | | |
| PBCH_RA | dB | 0 | | | N/A | | |
| PBCH_RB | dB | | | | | | |
| PSS_RA | dB | | | | | | |
| SSS_RA | dB | | | | | | |
| PCFICH_RB | dB | | | | | | |
| PHICH_RA | dB | | | | | | |
| PHICH_RB | dB | | | | | | |
| PDCCH_RA | dB | | | | | | |
| PDCCH_RB | dB | | | | | | |
| PDSCH_RA | dB | | | | | | |
| PDSCH_RB | dB | | | | | | |
| OCNG_RA ^{Note 1} | dB | | | | | | |
| OCNG_RB ^{Note 1} | dB | | | | | | |
| N_{oc1} ^{Note 2} | dBm/15 KHz | | | | | | |
| N_{oc2} ^{Note 3} | dBm/20 MHz | N/A | | | -75 | | |
| \bar{E}_s/N_{oc1} | dB | 3 | 3 | 3 | N/A | | |
| \bar{E}_s/I_{ot} ^{Note 4} | dB | 3 | 3 | 3 | | | |
| RSRP ^{Note 4} | dBm/15 kHz | -95 | -95 | -95 | | | |
| SCH_RP ^{Note 4} | dBm/15 kHz | -95 | -95 | -95 | | | |
| I_o ^{Note 3} | dBm/Ch BW | -65.5 | -65.5 | -65.5 | | | |
| WLAN RSSI ^{Note 4} | dBm/20 MHz | | | | -infinity | -65 | -70 |
| WLAN SNR | dB | | | | -infinity | 9.54 | 3.35 |
| Propagation Condition | | AWGN | | | AWGN | | |
| Antenna Configuration | | 1x2 | | | - | | |
| Timing offset to Cell 1 | ms | 0 | | | 3 | | |
| <p>Note 1: OCNG shall be used such that all cells are fully allocated and a constant total transmitted power spectral density is achieved for all OFDM symbols.</p> <p>Note 2: Interference from other cells and noise sources not specified in the test is assumed to be constant over subcarriers and time and shall be modelled as AWGN of appropriate power for N_{oc1} to be fulfilled.</p> <p>Note 3: Interference from other cells and noise sources not specified in the test is assumed to be constant over the bandwidth and time and shall be modelled as AWGN of appropriate power for N_{oc2} to be fulfilled.</p> <p>Note 4: \bar{E}_s/I_{ot}, RSRP, SCH_RP, I_o and WLAN RSSI have been derived from other parameters for information purposes. They are not settable parameters themselves.</p> <p>Note 5: The resources for uplink transmission are assigned to the UE prior to the start of time period T2.</p> | | | | | | | |

A.8.25.1.2 Test Requirements

The UE shall send one Event W1 triggered measurement report, with a measurement reporting delay less than 30 seconds from the beginning of time period T2.

The UE shall send one Event W3 triggered measurement report, with a measurement reporting delay less than 500 ms from the beginning of time period T3.

The UE shall not send event triggered measurement reports as long as the reporting criteria are not fulfilled.

The rate of correct events observed during repeated tests shall be at least 90% for each of the events.

NOTE: The actual overall delays measured in the tests may be up to $2 \times TTI_{DCCH}$ higher than the measurement reporting delays above because of TTI insertion uncertainty of the measurement report in DCCH.

A.8.25.2 E-UTRAN TDD-WLAN Event Triggered Reporting in non-DRX under AWGN

A.8.25.2.1 Test Purpose and Environment

The purpose of this test is to verify that the UE correctly detects event W1 (WLAN becomes better than a threshold) for unknown cell (unknown neighbour AP) and event W3 (All WLAN inside WLAN mobility set becomes worse than a threshold) for known cell (serving AP) defined in TS 36.331 [2] within the requirements stated in clause 8.1.2.4.19.

The test parameters are given in Tables A.8.25.2.1-1 and A.8.25.2.1-2 below. In the tests there are two cells, cell1 (E-UTRAN TDD) and cell2 (WLAN AP). It is indicated to the UE in the measurement control information that event-triggered reporting with Events W1 (for cell2) and W3 (for cell2) are used. The test consists of three successive time periods, with duration of T1, T2 and T3, respectively. During T1 the UE shall not have any information on cell1. At the beginning of T2 the transmission power of cell 2 is increased to a level, which shall result in reporting of Event W1. At the beginning of T3 the transmission power of cell 2 is decreased to a level, which shall result in reporting of Event W3.

Table A.8.25.2.1-1: General test parameters for E-UTRAN TDD-WLAN event triggered reporting under AWGN in non-DRX

| Parameter | | Unit | Value | Comment |
|---------------------------------------|---------------------|------|-------------|---|
| Active cell | | | Cell 1 | Cell 1 is on E-UTRA RF channel number 1. |
| Neighbour cell | | | Cell 2 (AP) | Cell 2 (WLAN AP) is on WLAN RF channel number 1. |
| CP length | | | Normal | Applicable to cell 1 |
| E-UTRA RF Channel Number | | | 1 | One E-UTRA TDD carrier frequency is used. |
| WLAN Channel Number | | | 1 | One WLAN carrier frequency is used. |
| WLAN measurement quantity | | | WLAN RSSI | |
| WLAN beacon frame transmission period | | ms | 102.5 | |
| DRX | | | OFF | |
| Special subframe configuration | | | 6 | As specified in table 4.2-1 in TS 36.211 [16]. The same configuration applies to all cells. |
| Uplink-downlink configuration | | | 1 | As specified in table 4.2-2 in TS 36.211 [16]. The same configuration applies to all cells |
| W1 | Hysteresis | dB | 0 | Hysteresis for evaluation of event W1. |
| | Threshold WLAN RSSI | dBm | -70 | Actual WLAN RSSI threshold for event W1. Needs to take absolute accuracy tolerance in section 9.7.1 into account plus margin. |
| | Time To Trigger | s | 0 | |
| W3 | Hysteresis | dB | 0 | Hysteresis for evaluation of event W3. |
| | Threshold WLAN RSSI | dBm | -65 | Actual WLAN RSSI threshold for event W3. Needs to take absolute accuracy tolerance in section 9.7.1 into account plus margin. |
| | Time To Trigger | s | 0 | |
| T1 | | s | 5 | During this time the cell1 shall be known to the UE; but cell2 shall be unknown to the UE. |
| T2 | | s | ≤ 40 | UE should report Event W1 for cell2 within 30 s. |
| T3 | | s | 3 | UE should report Event W3 for cell2 within 0.5 s. |

Table A.8.25.2.1-2: Cell specific test parameters for E-UTRAN TDD-WLAN event triggered reporting under AWGN in non-DRX

| Parameter | Unit | Cell 1 | | | Cell 2 (WLAN AP) | | |
|---|------|---------|----|----|------------------|----|----|
| | | T1 | T2 | T3 | T1 | T2 | T3 |
| E-UTRA RF Channel Number | | 1 | | | N/A | | |
| WLAN RF channel Number | | N/A | | | 1 | | |
| BW _{channel} | | 10MHz | | | 20 MHz | | |
| PDSCH parameters: DL Reference Measurement Channel | | R.0 TDD | | | N/A | | |

| | | | | | | | |
|---|------------|----------|-------|-------|-----------|------|------|
| PCFICH/PDCCH/PHI CH parameters: DL Reference Measurement Channel | | R.6 TDD | | | N/A | | |
| OCNG Patterns | | OP.1 TDD | | | N/A | | |
| PBCH_RA | dB | 0 | | | N/A | | |
| PBCH_RB | dB | | | | | | |
| PSS_RA | dB | | | | | | |
| SSS_RA | dB | | | | | | |
| PCFICH_RB | dB | | | | | | |
| PHICH_RA | dB | | | | | | |
| PHICH_RB | dB | | | | | | |
| PDCCH_RA | dB | | | | | | |
| PDCCH_RB | dB | | | | | | |
| PDSCH_RA | dB | | | | | | |
| PDSCH_RB | dB | | | | | | |
| OCNG_RA ^{Note 1} | dB | | | | | | |
| OCNG_RB ^{Note 1} | dB | | | | | | |
| N_{oc1} ^{Note 2} | dBm/15 KHz | | | | | | |
| N_{oc2} ^{Note 3} | dBm/20 MHz | N/A | | | -75 | | |
| \bar{E}_s/N_{oc1} | dB | 3 | 3 | 3 | N/A | | |
| \bar{E}_s/I_{ot} ^{Note 4} | dB | 3 | 3 | 3 | | | |
| RSRP ^{Note 4} | dBm/15 kHz | -95 | -95 | -95 | | | |
| SCH_RP ^{Note 4} | dBm/15 kHz | -95 | -95 | -95 | | | |
| I_o ^{Note 3} | dBm/Ch BW | -65.5 | -65.5 | -65.5 | | | |
| WLAN RSSI ^{Note 4} | dBm/20 MHz | N/A | N/A | N/A | -infinity | -65 | -70 |
| WLAN SNR | dB | N/A | N/A | N/A | -infinity | 9.54 | 3.35 |
| Propagation Condition | | AWGN | | | AWGN | | |
| Antenna Configuration | | 1x2 | | | - | | |
| Timing offset to Cell 1 | ms | 0 | | | 3 | | |
| <p>Note 1: OCNG shall be used such that all cells are fully allocated and a constant total transmitted power spectral density is achieved for all OFDM symbols.</p> <p>Note 2: Interference from other cells and noise sources not specified in the test is assumed to be constant over subcarriers and time and shall be modelled as AWGN of appropriate power for N_{oc1} to be fulfilled.</p> <p>Note 3: Interference from other cells and noise sources not specified in the test is assumed to be constant over the bandwidth and time and shall be modelled as AWGN of appropriate power for N_{oc2} to be fulfilled.</p> <p>Note 4: \bar{E}_s/I_{ot}, RSRP, SCH_RP, I_o and WLAN RSSI have been derived from other parameters for information purposes. They are not settable parameters themselves.</p> <p>Note 5: The resources for uplink transmission are assigned to the UE prior to the start of time period T2.</p> | | | | | | | |

A.8.25.2.2 Test Requirements

The UE shall send one Event W1 triggered measurement report, with a measurement reporting delay less than 30 seconds from the beginning of time period T2.

The UE shall send one Event W3 triggered measurement report, with a measurement reporting delay less than 500 ms from the beginning of time period T3.

The UE shall not send event triggered measurement reports as long as the reporting criteria are not fulfilled.

The rate of correct events observed during repeated tests shall be at least 90% for each of the events.

NOTE: The actual overall delays measured in the tests may be up to $2 \times TTI_{DCCH}$ higher than the measurement reporting delays above because of TTI insertion uncertainty of the measurement report in DCCH.

A.8.26 Frame Structure 3 (FS3)

A.8.26.1 E-UTRAN FDD-FS3 Activation and deactivation of known FS3 SCell with FDD PCell in non-DRX

A.8.26.1.1 Test Purpose and Environment

The purpose of this test is to verify that the LAA SCell activation and deactivation times are within the requirements stated in section 7.7, when the SCell is known by the UE at the time of activation.

The test parameters are given in Tables A.8.26.1.1-1 and cell-specific parameters in A.8.26.1.1-2 below. In the test there are two cells: Cell1 and Cell2. Cell1 is PCell on the FDD primary component (RF Channel 1), Cell2 is deactivated SCell on the secondary component (RF Channel 2) for frame structure 3. Cell 1 has constant signal levels throughout the test, and Cell 2 transmits discovery signal with LBT model.

The test consists of three successive time periods, with duration of T1, T2 and T3, respectively. Before the test starts the UE is connected to Cell1 on radio channel 1 (PCC) but is not aware of Cell 2 on radio channel 2. The UE is only monitoring the PCC. The UE shall be continuously scheduled in the PCell throughout the whole test.

At the beginning of T1 the UE receives an RRC message by which the SCell (Cell 2) becomes configured on radio channel 2 (SCC). The UE now starts monitoring also the SCC. The test equipment sends a MAC message for activation of the SCell.

The point in time at which the MAC message is received at the UE antenna connector, in a subframe # denoted m which is an even number, defines the start of time period T2. The UE shall be able to report valid CSI for the activated SCell at latest in subframe $m + T_{\text{activate_basic_FS3}}$, where $T_{\text{activate_basic_FS3}}$ is specified in section 7.7.10. The UE shall start reporting CSI in subframe $(m+8)$ and shall report CQI index 0 (out-of-range) until the SCell activation has been completed. Any PCell interruption due to activation of SCell shall occur in the subframes $(m+5)$ to $(m+9)$.

Time period T3 starts when a MAC message for deactivation of SCell, sent from the test equipment to the UE in a subframe # denoted n , is received at the UE antenna connector. The UE shall carry out deactivation of the SCell in a subframe $(n+8)$, and any PCell interruption due to the deactivation shall occur in the subframes $(n+5)$ to $(n+9)$.

The test equipment verifies that potential interruption is carried out in the correct time span by monitoring ACK/NACK sent in PCell during activation and deactivation of SCell, respectively.

The test equipment verifies the activation time by counting the subframes from the time when the SCell activation command is sent until a CSI report with other than CQI index 0 is received.

The test equipment verifies the deactivation time by counting the subframes from the time when the SCell deactivation command is sent until CQI reporting for SCell is discontinued.

Table A.8.26.1.1-1: General test parameters for known LAA SCell activation case

| Parameter | Unit | Value | Comment |
|--|------|--|---|
| E-UTRA RF Channel Number | | 1, 2 | Two radio channels are used for this test |
| Active PCell | | Cell 1 | Primary cell on RF channel number 1. |
| Configured deactivated LAA FS3 SCell | | Cell 2 | Configured deactivated secondary cell on RF channel number 2. |
| CP length | | Normal | |
| DRX | | OFF | Continuous monitoring of primary cell |
| CQI/PMI periodicity and offset configuration index | | 0 | CQI reporting for SCell every second subframe |
| Discovery signal occasion duration | ms | 1 | As specified in IE MeasDS-Config in TS 36.331 |
| SCell measurement cycle (measCycleSCell) | ms | 320 | |
| DMTC period | ms | 40 | As specified in IE MeasDS-Config in TS 36.331 |
| dmtc-PeriodOffset | | 10 | As specified in IE MeasDS-Config in TS 36.331 |
| laa-SCellSubframeConfig | | 00000000 | No MBSFN subframe. |
| T1 | s | 7 | During this time the PCell shall be known and the SCell configured and detected. |
| T2 | s | > $T_{\text{activate_basic_FS3}}$ | During this time the UE shall activate the SCell, $T_{\text{activate_basic_FS3}}$ is specified in section 7.7.10. |

| | | | |
|----|---|---|---|
| T3 | s | 1 | During this time the UE shall deactivate the SCell. |
|----|---|---|---|

Table A.8.26.1.1-2: Cell specific test parameters for E-UTRAN FDD known LAA SCell activation

| Parameter | Unit | Cell 1 | | | Cell 2 | | |
|---|------------|---|----|----|-----------|----|----|
| | | T1 | T2 | T3 | T1 | T2 | T3 |
| E-UTRA RF Channel Number | | 1 | | | 2 | | |
| BW _{channel} | MHz | 5MHz: N _{RB,c} = 25 10MHz: N _{RB,c} = 50 20MHz: N _{RB,c} = 100 | | | 20 | | |
| LBT model | | - | | | A.3.17 | | |
| PDSCH parameters defined in A.3.1.1.1 | | 5MHz: R.7 FDD 10MHz: R.3 FDD 20MHz: R.6 FDD | | | - | | |
| PCFICH/PDCCH/PHICH parameters defined in A.3.1.2.1 | | 5MHz: R.11 FDD 10MHz: R.6 FDD 20MHz: R.10 FDD | | | - | | |
| OCNG Patterns defined in A.3.2.1 | | 5MHz: OP.20 FDD 10MHz: OP.10 FDD 20MHz: OP.17 FDD | | | OP.14 FDD | | |
| PBCH_RA | dB | 0 | | | 0 | | |
| PBCH_RB | dB | | | | | | |
| PSS_RA | dB | | | | | | |
| SSS_RA | dB | | | | | | |
| PCFICH_RB | dB | | | | | | |
| PHICH_RA | dB | | | | | | |
| PHICH_RB | dB | | | | | | |
| PDCCH_RA | dB | | | | | | |
| PDCCH_RB | dB | | | | | | |
| PDSCH_RA | dB | | | | | | |
| PDSCH_RB | dB | | | | | | |
| OCNG_RA ^{Note 1} | dB | | | | | | |
| OCNG_RB ^{Note 1} | dB | | | | | | |
| N _{oc} ^{Note 2} | dBm/15 kHz | | | | | | |
| \bar{E}_s/N_{oc} | dB | 17 | | | 17 | | |
| RSRP ^{Note 3} | dBm/15 kHz | -87 | | | -87 | | |
| \bar{E}_s/I_{ot} ^{Note 3} | dB | 17 | | | 17 | | |
| SCH_RP ^{Note 3} | dBm/15 kHz | -87 | | | -87 | | |
| I _o ^{Note 3} | dBm/Ch BW | -59.1+10log(N _{RB,c} /50) | | | -56.1 | | |
| Propagation Condition | | AWGN | | | AWGN | | |
| Antenna Configuration | | 1x2 | | | 1x2 | | |
| timing offset to cell1 | μs | - | | | 0 | | |
| Time alignment error relative to cell 1 ^{Note 5} | μs | - | | | ≤ TAE | | |
| <p>Note 1: OCNG shall be used such that cells are fully allocated and a constant total transmitted power spectral density is achieved for all OFDM symbols. For cells with LBT model, OCNG is transmitted only in subframes with downlink transmission bursts, and is not transmitted during muted subframes or during DMTC windows.</p> <p>Note 2: Interference from other cells and noise sources not specified in the test is assumed to be constant over subcarriers and time and shall be modelled as AWGN of appropriate power for N_{oc} to be fulfilled.</p> <p>Note 3: Es/I_{ot}, RSRP, SCH_RP and I_o levels have been derived from other parameters for information purposes. They are not settable parameters themselves.</p> <p>Note 4: The uplink resources for CSI reporting are assigned to the UE prior to the start of time period T2.</p> <p>Note 5: Time alignment error (TAE) as specified in TS 36.104 [30] clause 6.5.3.1.</p> | | | | | | | |

A.8.26.1.2 Test Requirements

During T2 the UE shall send the first CSI report for SCell in a subframe (m+8), or in a subframe (m+10) if the subframe (m+8) was subject to interruption. Whether CSI report in subframe (m+8) was interrupted or not is checked by monitoring ACK/NACK sent in PCell in subframe (m+8).

During T2 the UE shall start sending CSI reports for SCell with non-zero CQI index at latest in a subframe (m+T_{activate_basic_FS3}) ms, L is the number of times the discovery signal occasion is not available at the UE during the SCell activation time.

During T3 the UE shall stop sending CSI reports for SCell at latest in a subframe (n+8).

During T2 interruption of PCell during SCell activation shall not happen outside the subframes (m+5) to (m+9).

During T3 interruption of PCell during SCell deactivation shall not happen outside the subframes (n+5) to (n+9).

The interruption of PCell shall not be more than the values specified for intra-band CA and inter-band CA in Section 7.8.2.

All of the above test requirements shall be fulfilled in order for the observed SCell activation delay and SCell deactivation delay to be counted as correct. The rate of correct observed SCell activation delay and SCell deactivation delay during repeated tests shall be at least 90%.

NOTE: During T2 if there are no uplink resources for reporting the valid CSI in a subframe (m+ $T_{\text{activate_basic_FS3}}$)ms, L is the number of times the discovery signal occasion is not available at the UE during the SCell activation time, then the UE shall use the next available uplink resource for reporting the corresponding valid CSI.

A.8.26.2 E-UTRAN TDD-FS3 Activation and deactivation of known FS3 SCell with TDD PCell in non-DRX

A.8.26.2.1 Test Purpose and Environment

The purpose of this test is to verify that the LAA SCell activation and deactivation times are within the requirements stated in section 7.7, when the SCell is known by the UE at the time of activation.

The test parameters are given in Tables A.8.26.2.1-1 and cell-specific parameters in A.8.26.2.1-2 below. In the test there are two cells: Cell1 and Cell2. Cell1 is PCell on the TDD primary component (RF Channel 1), Cell2 is deactivated SCell on the secondary component (RF Channel 2) for frame structure 3. Cell 1 has constant signal levels throughout the test, and Cell 2 transmits discovery signal with LBT model.

The test consists of three successive time periods, with duration of T1, T2 and T3, respectively. Before the test starts the UE is connected to Cell1 on radio channel 1 (PCC) but is not aware of Cell 2 on radio channel 2. The UE is only monitoring the PCC. The UE shall be continuously scheduled in the PCell throughout the whole test.

At the beginning of T1 the UE receives an RRC message by which the SCell (Cell 2) becomes configured on radio channel 2 (SCC). The UE now starts monitoring also the SCC. The test equipment sends a MAC message for activation of the SCell.

The point in time at which the MAC message is received at the UE antenna connector, in a subframe # denoted m , where m is 4 or 9, defines the start of time period T2. The UE shall be able to report valid CSI for the activated SCell at latest in subframe $m+T_{\text{activate_basic_FS3}}$, where $T_{\text{activate_basic_FS3}}$ is specified in section 7.7.10. The UE shall start reporting CSI in subframe (m+8) and shall report CQI index 0 (out-of-range) until the SCell activation has been completed. Any PCell interruption due to activation of SCell shall occur in the subframes (m+5) to (m+11).

Time period T3 starts when a MAC message for deactivation of SCell, sent from the test equipment to the UE in a subframe # denoted n , is received at the UE antenna connector. The UE shall carry out deactivation of the SCell and any PCell interruption due to the deactivation shall occur in the subframes (n+5) to (n+11).

The test equipment verifies that potential interruption is carried out in the correct time span by monitoring ACK/NACK sent in PCell during activation and deactivation of SCell, respectively.

The test equipment verifies the activation time by counting the subframes from the time when the SCell activation command is sent until a CSI report with other than CQI index 0 is received.

The test equipment verifies the deactivation time by counting the subframes from the time when the SCell deactivation command is sent until CQI reporting for SCell is discontinued.

Table A.8.26.2.1-1: General test parameters for known LAA SCell activation case

| Parameter | Unit | Value | Comment |
|--------------------------|------|--------|---|
| E-UTRA RF Channel Number | | 1, 2 | Two radio channels are used for this test |
| Active PCell | | Cell 1 | Primary cell on RF channel number 1. |

| | | | |
|--|----|--|--|
| Configured deactivated LAA FS3 SCell | | Cell 2 | Configured deactivated secondary cell on RF channel number 2. |
| CP length | | Normal | |
| DRX | | OFF | Continuous monitoring of primary cell |
| CQI/PMI periodicity and offset configuration index | | 0 | CQI reporting for SCell every UL subframe |
| Discovery signal occasion duration | ms | 1 | As specified in IE MeasDS-Config in TS 36.331 |
| SCell measurement cycle (measCycleSCell) | ms | 320 | |
| DMTC period | ms | 40 | As specified in IE MeasDS-Config in TS 36.331 |
| dmtc-PeriodOffset | | 10 | As specified in IE MeasDS-Config in TS 36.331 |
| laa-SCellConfiguration | | 00000000 | No MBSFN subframe. |
| T1 | s | 7 | During this time the PCell shall be known and the SCell configured and detected. |
| T2 | s | > $T_{\text{activate_basic_FS3}}$ | During this time the UE shall activate the SCell. |
| T3 | s | 1 | During this time the UE shall deactivate the SCell. |

Table A.8.26.2.1-2: Cell specific test parameters for E-UTRAN TDD known LAA SCell activation

| Parameter | Unit | Cell 1 | | | Cell 2 | | |
|---|------------|---|----|----|-----------|----|----|
| | | T1 | T2 | T3 | T1 | T2 | T3 |
| E-UTRA RF Channel Number | | 1 | | | 2 | | |
| BW _{channel} | MHz | 5MHz: N _{RB,c} = 25 10MHz: N _{RB,c} = 50 20MHz: N _{RB,c} = 100 | | | 20 | | |
| Uplink-downlink configuration ^{Note1} | | 1 | | | - | | |
| Special subframe configuration ^{Note2} | | 6 | | | - | | |
| LBT model | | - | | | A.3.17 | | |
| PDSCH parameters defined in A.3.1.1.2 | | 5MHz: R.4 TDD 10MHz: R.0 TDD 20MHz: R.3 TDD | | | - | | |
| PCFICH/PDCCH/PHICH parameters defined in A.3.1.2.2 | | 5MHz: R.11 TDD 10MHz: R.6 TDD 20MHz: R.10 TDD | | | - | | |
| OCNG Patterns defined in A.3.2.1 and A.3.2.2. | | 5MHz: OP.9 TDD 10MHz: OP.1 TDD 20MHz: OP.7 TDD | | | OP.14 FDD | | |
| PBCH_RA | dB | 0 | | | 0 | | |
| PBCH_RB | dB | | | | | | |
| PSS_RA | dB | | | | | | |
| SSS_RA | dB | | | | | | |
| PCFICH_RB | dB | | | | | | |
| PHICH_RA | dB | | | | | | |
| PHICH_RB | dB | | | | | | |
| PDCCH_RA | dB | | | | | | |
| PDCCH_RB | dB | | | | | | |
| PDSCH_RA | dB | | | | | | |
| PDSCH_RB | dB | | | | | | |
| OCNG_RA ^{Note 3} | dB | | | | | | |
| OCNG_RB ^{Note 3} | dB | | | | | | |
| N _{oc} ^{Note 4} | dBm/15 kHz | | | | | | |
| \bar{E}_s/N_{oc} | dB | 17 | | | 17 | | |
| RSRP ^{Note 5} | dBm/15 kHz | -87 | | | -87 | | |
| \bar{E}_s/I_{ot} ^{Note 5} | dB | 17 | | | 17 | | |
| SCH_RP ^{Note 5} | dBm/15 kHz | -87 | | | -87 | | |
| I _o ^{Note 5} | dBm/Ch BW | $-59.1+10\log(N_{RB,c}/50)$ | | | -56.1 | | |
| Propagation Condition | | AWGN | | | AWGN | | |
| Antenna Configuration | | 1x2 | | | 1x2 | | |
| timing offset to cell1 | μs | - | | | 0 | | |
| Time alignment error relative to cell 1 ^{Note 7} | μs | - | | | ≤ TAE | | |

| | |
|---------|---|
| Note 1: | For the uplink-downlink configuration see table 4.2-2 in TS 36.211. |
| Note 2: | For the special subframe configuration see table 4.2-1 in TS 36.211. |
| Note 3: | OCNG shall be used such that cells are fully allocated and a constant total transmitted power spectral density is achieved for all OFDM symbols. For cells with LBT model, OCNG is transmitted only in subframes with downlink transmission bursts, and is not transmitted during muted subframes or during DMTC windows. |
| Note 4: | Interference from other cells and noise sources not specified in the test is assumed to be constant over subcarriers and time and shall be modelled as AWGN of appropriate power for N_{oc} to be fulfilled. |
| Note 5: | E_s/lot , RSRP, SCH_RP and I_o levels have been derived from other parameters for information purposes. They are not settable parameters themselves. |
| Note 6: | The uplink resources for CSI reporting are assigned to the UE prior to the start of time period T2. |
| Note 7: | Time alignment error (TAE) as specified in TS 36.104 [30] clause 6.5.3.1. |

A.8.26.2.2 Test Requirements

During T2 the UE shall send the first CSI report for SCell in a subframe (m+8), or in a subframe (m+9) if the subframe (m+8) was subject to interruption, or in a subframe (m+13) if the subframes (m+8) and (m+9) were subject to interruption when an intra-band SCell is activated. Whether first CSI report was interrupted or not is checked by monitoring ACK/NACK sent in PCell at the same time as the first CSI report.

During T2 the UE shall start sending CSI reports for SCell with non-zero CQI index at latest in a subframe (m+ $T_{activate_basic_FS3}$) ms, L is the number of times the discovery signal occasion is not available at the UE during the SCell activation time.

During T3 the UE shall stop sending CSI reports for SCell at latest in a subframe (m+8).

During T2 interruption of PCell during SCell activation shall not happen outside the subframes (m+5) to (m+11).

During T3 interruption of PCell during SCell deactivation shall not happen outside the subframes (n+5) to (n+11).

The interruption of PCell shall not be more than the values specified for intra-band CA and inter-band CA in Section 7.8.2.

All of the above test requirements shall be fulfilled in order for the observed SCell activation delay and SCell deactivation delay to be counted as correct. The rate of correct observed SCell activation delay and SCell deactivation delay during repeated tests shall be at least 90%.

NOTE: During T2 if there are no uplink resources for reporting the valid CSI in a subframe (m+ $T_{activate_basic_FS3}$) ms, L is the number of times the discovery signal occasion is not available at the UE during the SCell activation time, then the UE shall use the next available uplink resource for reporting the corresponding valid CSI.

A.8.26.3 E-UTRAN FDD-FS3 Event triggered reporting on deactivated FS3 SCell and FDD PCell interruption in non-DRX

A.8.26.3.1 Test Purpose and Environment

The purpose of this test is to verify that the UE correctly detects event A6 (Neighbour becomes better than SCell) defined in TS 36.331 [2] within the requirements stated in clause 8.12.2.4 while at the same time fulfilling the requirement on interruption rate.

The test parameters are given in Table A.8.26.3.1-1 and A.8.26.3.1-2. It is indicated to the UE in the measurement control information that event-triggered reporting with Event A6 is used.

In the test there are three synchronous cells: Cell1, Cell2 and Cell3. Cell1 is PCell on the FDD primary component (RF Channel 1), Cell2 is deactivated SCell on the secondary component (RF Channel 2) for frame structure 3, and Cell3 is the neighbour cell on the secondary component (RF Channel 3) for frame structure 3. Cell 2 and Cell 3 transmit discovery signal with LBT model.

The test consists of two successive time periods, with duration of T1 and T2, respectively. During T1 the UE shall not have any information of cell 3. Immediately at beginning of T2 the transmission power of cell 3 is increased to same level as for cell 2, and due to usage of an offset this shall result in reporting of Event A6. PCell is indicated by the

network using IE allowInterruptions and PDCCH indicating a new transmission on the PCell shall be sent continuously to ensure that the UE sends ACK/ NACKs throughout the test.

Table A.8.26.3.1-1: General test parameters for Event triggered reporting on LAA deactivated SCell with E-UTRAN FDD PCell interruption in non-DRX

| Parameter | | Unit | Value | Comment |
|------------------------------------|-----------------|------|----------|---|
| E-UTRA RF Channel Number | | | 1, 2 | Two radio channels are used for this test |
| Active PCell | | | Cell 1 | Primary cell on RF channel number 1. |
| Configured deactivated SCell | | | Cell 2 | Configured deactivated secondary cell on RF channel number 2 for frame structure 3. |
| Neighbour cell | | | Cell 3 | Neighbor cell to be identified on RF channel number 2 for frame structure 3. |
| CP length | | | Normal | |
| DRX | | | OFF | Continuous monitoring of primary cell |
| A6 | Hysteresis | dB | 0 | Hysteresis for evaluation of event A6. |
| | Offset | dB | -3 | Offset parameter for evaluation of event A6. Needs to take relative accuracy tolerance in clause 9.1.18.2 into account plus margin. |
| | Report on leave | | False | |
| | Time To Trigger | s | 0 | |
| Discovery signal occasion duration | | ms | 1 | As specified in IE MeasDS-Config in TS 36.331 |
| Filter coefficient | | | 0 | L3 filtering is not used |
| SCell measurement cycle | | ms | 160 | <i>measCycleSCell</i> as specified in TS 36.331 |
| DMTC period | | ms | 40 | As specified in IE MeasDS-Config in TS 36.331 |
| dmtc-PeriodOffset | | | 10 | As specified in IE MeasDS-Config in TS 36.331 |
| subframeStartPosition | | | s0 | Discovery signal starts from subframe #0 |
| laa-SCellSubframeConfig | | | 00000000 | No MBSFN subframe. |
| T1 | | s | 5 | During this time the UE shall be aware of cells 1 and 2 but not cell 3. |
| T2 | | s | ≤5 | UE should report Event A6 within 4s (25x <i>measCycleSCell</i>) |

Table A.8.26.3.1-2: Cell specific test parameters for Event triggered reporting on LAA deactivated SCell with E-UTRAN FDD PCell interruption in non-DRX

| Parameter | Unit | Cell 1 | | Cell 2 | | Cell 3 | |
|--|-------------------------|---|----|-----------|----|-----------|----|
| | | T1 | T2 | T1 | T2 | T1 | T2 |
| E-UTRA RF Channel Number | | 1 | | 2 | | 2 | |
| BW _{channel} | MHz | 5MHz: N _{RB,c} = 25 10MHz: N _{RB,c} = 50 20MHz: N _{RB,c} = 100 | | 20 | | 20 | |
| Measurement bandwidth | <i>n</i> _{PRB} | 5MHz: 10-15 10MHz: 22-27 20MHz: 47-52 | | 47-52 | | 47-52 | |
| PDSCH parameters defined in A.3.1.1.1 | | 5MHz: R.7 FDD 10MHz: R.3 FDD 20MHz: R.6 FDD | | - | | - | |
| PCFICH/PDCCH/PHICH parameters defined in A.3.1.2.1 | | 5MHz: R.11 FDD 10MHz: R.6 FDD 20MHz: R.10 FDD | | - | | - | |
| OCNG Patterns defined in A.3.2.1 | | 5MHz: OP.20 FDD 10MHz: OP.10 FDD 20MHz: OP.17 FDD | | OP.14 FDD | | OP.14 FDD | |
| IE allowInterruptions | | True | | - | | - | |
| PBCH_RA | dB | 0 | | 0 | | 0 | |
| PBCH_RB | dB | | | | | | |
| PSS_RA | dB | | | | | | |
| SSS_RA | dB | | | | | | |
| PCFICH_RB | dB | | | | | | |
| PHICH_RA | dB | | | | | | |
| PHICH_RB | dB | | | | | | |
| PDCCH_RA | dB | | | | | | |
| PDCCH_RB | dB | | | | | | |

| | | | | | | | |
|---|------------|------------------------------|-----|------------|--------|---------------------------------|-------|
| PDSCH_RA | dB | | | | | | |
| PDSCH_RB | dB | | | | | | |
| OCNG_RA ^{Note 1} | dB | | | | | | |
| OCNG_RB ^{Note 1} | dB | | | | | | |
| N_{oc} ^{Note 3} | dBm/15 kHz | -98 | | -98 | | | |
| \hat{E}_s/N_{oc} | dB | 13 | 13 | 13 | 13 | -Infinity | 13 |
| RSRP ^{Note 4} | dBm/15 kHz | -85 | -85 | -85 | -85 | -Infinity | -85 |
| \hat{E}_s/I_{ot} ^{Note 4} | dB | 13 | 13 | 13 | -0.21 | -Infinity | -0.21 |
| SCH_RP ^{Note 4} | dBm/15 kHz | -85 | -85 | -85 | -85 | -Infinity | -85 |
| I_o ^{Note 4} | dBm/Ch BW | $-57.01+10\log(N_{RB,c}/50)$ | | -54.00 | -51.09 | Specified in columns for Cell 2 | |
| Propagation Condition | | AWGN | | AWGN | | AWGN | |
| Antenna Configuration | | 1x2 | | 1x2 | | 1x2 | |
| timing offset to cell1 | μ s | - | | 0 | | 0 | |
| timing offset to cell2 | μ s | - | | - | | 0 | |
| Time alignment error relative to cell 1 ^{Note 5} | μ s | - | | \leq TAE | | \leq TAE | |
| Time alignment error relative to cell 2 ^{Note 5} | μ s | - | | - | | \leq TAE | |
| <p>Note 1: OCNG shall be used such that all cells are fully allocated and a constant total transmitted power spectral density is achieved for all OFDM symbols.</p> <p>Note 2: The resources for uplink transmission are assigned to the UE prior to the start of time period T2.</p> <p>Note 3: Interference from other cells and noise sources not specified in the test is assumed to be constant over subcarriers and time and shall be modelled as AWGN of appropriate power for N_{oc} to be fulfilled.</p> <p>Note 4: E_s/I_{ot}, RSRP, SCH_RP and I_o levels have been derived from other parameters for information purposes. They are not settable parameters themselves.</p> <p>Note 5: Time alignment error (TAE) as specified in TS 36.104 [30] clause 6.5.3.1.</p> | | | | | | | |

A.8.26.3.2 Test Requirements

The UE shall send one Event A6 triggered measurement report, with a measurement reporting delay less than 4s from the beginning of time period T2.

The UE shall not send event triggered measurement reports, as long as the reporting criteria are not fulfilled.

The UE shall be scheduled on PCell continuously throughout the test. From the start of T1 until the measurement report is received during T2, at least 99.5% of all expected ACK/NACKs shall be transmitted by the UE.

For a test to be considered successful requirements on both event detection and percentage of transmitted ACK/NACKs have to be fulfilled simultaneously.

The rate of correct events observed during repeated tests shall be at least 90%.

NOTE: The actual overall delays measured in the test may be up to $2xTTI_{DCCH}$ higher than the measurement reporting delays above because of TTI insertion uncertainty of the measurement report in DCCH.

A.8.26.4 E-UTRAN TDD-FS3 Event triggered reporting on deactivated FS3 SCell and TDD PCell interruption in non-DRX

A.8.26.4.1 Test Purpose and Environment

The purpose of this test is to verify that the UE correctly detects event A6 (Neighbour becomes better than SCell) defined in TS 36.331 [2] within the requirements stated in clause 8.12.2.4 while at the same time fulfilling the requirement on interruption rate.

The test parameters are given in Table A.8.26.4.1-1 and A.8.26.4.1-2. It is indicated to the UE in the measurement control information that event-triggered reporting with Event A6 is used.

In the test there are three synchronous cells: Cell1, Cell2 and Cell3. Cell1 is PCell on the TDD primary component (RF Channel 1), Cell2 is deactivated SCell on the secondary component (RF Channel 2) for frame structure 3, and Cell3 is

the neighbour cell on the secondary component (RF Channel 3) for frame structure 3. Cell 2 and Cell 3 transmit discovery signal with LBT model.

The test consists of two successive time periods, with duration of T1 and T2, respectively. During T1 the UE shall not have any information of cell 3. Immediately at beginning of T2 the transmission power of cell 3 is increased to same level as for cell 2, and due to usage of an offset this shall result in reporting of Event A6. PCell is indicated by the network using IE allowInterruptions and PDCCH indicating a new transmission on the PCell shall be sent continuously to ensure that the UE sends ACK/ NACKs throughout the test.

Table A.8.26.4.1-1: General test parameters for Event triggered reporting on LAA deactivated SCell with E-UTRAN TDD PCell interruption in non-DRX

| Parameter | | Unit | Value | Comment |
|------------------------------------|-----------------|------|----------|---|
| E-UTRA RF Channel Number | | | 1, 2 | Two radio channels are used for this test |
| Active PCell | | | Cell 1 | Primary cell on RF channel number 1. |
| Configured deactivated SCell | | | Cell 2 | Configured deactivated secondary cell on RF channel number 2 for frame structure 3. |
| Neighbour cell | | | Cell 3 | Neighbor cell to be identified on RF channel number 2 for frame structure 3. |
| CP length | | | Normal | |
| DRX | | | OFF | Continuous monitoring of primary cell |
| A6 | Hysteresis | dB | 0 | Hysteresis for evaluation of event A6. |
| | Offset | dB | -3 | Offset parameter for evaluation of event A6. Needs to take relative accuracy tolerance in clause 9.1.18.2 into account plus margin. |
| | Report on leave | | False | |
| | Time To Trigger | s | 0 | |
| Discovery signal occasion duration | | ms | 1 | As specified in IE MeasDS-Config in TS 36.331 |
| Filter coefficient | | | 0 | L3 filtering is not used |
| SCell measurement cycle | | ms | 160 | <i>measCycleSCell</i> as specified in TS 36.331 |
| DMTC period | | ms | 40 | As specified in IE MeasDS-Config in TS 36.331 |
| dmtc-PeriodOffset | | | 10 | As specified in IE MeasDS-Config in TS 36.331 |
| subframeStartPosition | | | s0 | Discovery signal starts from subframe #0 |
| laa-SCellSubframeConfig | | | 00000000 | No MBSFN subframe. |
| T1 | | s | 5 | During this time the UE shall be aware of cells 1 and 2 but not cell 3. |
| T2 | | s | ≤5 | UE should report Event A6 within 4s (25xscellMeasCycle) |

Table A.8.26.4.1-2: Cell specific test parameters for E-UTRAN TDD-TDD Event triggered reporting on configured but deactivated SCell with PCell interruption in non-DRX

| Parameter | Unit | Cell 1 | | Cell 2 | | Cell 3 | |
|--|------------------------|---|----|-----------|----|-----------|----|
| | | T1 | T2 | T1 | T2 | T1 | T2 |
| E-UTRA RF Channel Number | | 1 | | 2 | | 2 | |
| BW _{channel} | MHz | 5MHz: N _{RB,c} = 25 10MHz: N _{RB,c} = 50 20MHz: N _{RB,c} = 100 | | 20 | | 20 | |
| Uplink-downlink configuration ^{Note1} | | 1 | | - | | - | |
| Special subframe configuration ^{Note2} | | 6 | | - | | - | |
| Measurement bandwidth | <i>n_{PRB}</i> | 5MHz: 10-15 10MHz: 22-27 20MHz: 47-52 | | 47-52 | | 47-52 | |
| PDSCH parameters defined in A.3.1.1.2 | | 5MHz: R.4 TDD 10MHz: R.0 TDD 20MHz: R.3 TDD | | - | | - | |
| PCFICH/PDCCH/PHICH parameters defined in A.3.1.2.2 | | 5MHz: R.11 TDD 10MHz: R.6 TDD 20MHz: R.10 TDD | | - | | - | |
| OCNG Patterns defined in A.3.2.1 and A.3.2.2 | | 5MHz: OP.9 TDD 10MHz: OP.1 TDD 20MHz: OP.7 TDD | | OP.14 FDD | | OP.14 FDD | |

| | | | | | | | |
|--|------------|------------------------------|-----|------------|--------|---------------------------------|-------|
| IE allowInterruptions | | True | | - | | - | |
| PBCH_RA | dB | 0 | | 0 | | 0 | |
| PBCH_RB | dB | | | | | | |
| PSS_RA | dB | | | | | | |
| SSS_RA | dB | | | | | | |
| PCFICH_RB | dB | | | | | | |
| PHICH_RA | dB | | | | | | |
| PHICH_RB | dB | | | | | | |
| PDCCH_RA | dB | | | | | | |
| PDCCH_RB | dB | | | | | | |
| PDSCH_RA | dB | | | | | | |
| PDSCH_RB | dB | | | | | | |
| OCNG_RA ^{Note 3} | dB | | | | | | |
| OCNG_RB ^{Note 3} | dB | | | | | | |
| N_{oc} ^{Note 5} | dBm/15 kHz | | | | | | |
| \hat{E}_s / N_{oc} | dB | 13 | 13 | 13 | 13 | -Infinity | 13 |
| RSRP ^{Note 6} | dBm/15 kHz | -85 | -85 | -85 | -85 | -Infinity | -85 |
| \hat{E}_s / I_{ot} ^{Note 6} | dB | 13 | 13 | 13 | -0.21 | -Infinity | -0.21 |
| SCH_RP ^{Note 6} | dBm/15 kHz | -85 | -85 | -85 | -85 | -Infinity | -85 |
| I_o ^{Note 6} | dBm/Ch BW | $-57.01+10\log(N_{RB,c}/50)$ | | -54.00 | -51.09 | Specified in columns for Cell 2 | |
| Propagation Condition | | AWGN | | AWGN | | AWGN | |
| Antenna Configuration | | 1x2 | | 1x2 | | 1x2 | |
| timing offset to cell1 | μ s | - | | 0 | | 0 | |
| timing offset to cell2 | μ s | - | | - | | 0 | |
| Time alignment error relative to cell 1 ^{Note 7} | μ s | - | | \leq TAE | | \leq TAE | |
| Time alignment error relative to cell 2 ^{Note 7} | μ s | - | | - | | \leq TAE | |
| <p>Note 1: For the uplink-downlink configuration see table 4.2-2 in TS 36.211.</p> <p>Note 2: For the special subframe configuration see table 4.2-1 in TS 36.211.</p> <p>Note 3: OCNG shall be used such that all cells are fully allocated and a constant total transmitted power spectral density is achieved for all OFDM symbols.</p> <p>Note 4: The resources for uplink transmission are assigned to the UE prior to the start of time period T2.</p> <p>Note 5: Interference from other cells and noise sources not specified in the test is assumed to be constant over subcarriers and time and shall be modelled as AWGN of appropriate power for N_{oc} to be fulfilled.</p> <p>Note 6: E_s/I_{ot}, RSRP, SCH_RP and I_o levels have been derived from other parameters for information purposes. They are not settable parameters themselves.</p> <p>Note 7: Time alignment error (TAE) as specified in TS 36.104 [30] clause 6.5.3.1.</p> | | | | | | | |

A.8.26.4.2 Test Requirements

The UE shall send one Event A6 triggered measurement report, with a measurement reporting delay less than 4s from the beginning of time period T2.

The UE shall not send event triggered measurement reports, as long as the reporting criteria are not fulfilled.

The UE shall be scheduled on PCell continuously throughout the test. From the start of T1 until the measurement report is received during T2, at least 99.5% of all expected ACK/NACKs shall be transmitted by the UE.

For a test to be considered successful requirements on both event detection and percentage of transmitted ACK/NACKs have to be fulfilled simultaneously.

The rate of correct events observed during repeated tests shall be at least 90%.

NOTE: The actual overall delays measured in the test may be up to $2xTTI_{DCCH}$ higher than the measurement reporting delays above because of TTI insertion uncertainty of the measurement report in DCCH.

A.8.26.5 E-UTRAN FDD-FS3 Intra-frequency event triggered reporting in non-DRX for CRS based discovery signal

A.8.26.5.1 Test Purpose and Environment

The purpose of the test is to verify that the UE makes correct reporting of an event under operation with frame structure 3. The test will partly verify new intra-frequency FS3 cells in non-DRX requirements in clause 8.11.2.

The test parameters are given in Tables A.8.26.5.1-1 and A.8.26.5.1-2. In the measurement control information, it is indicated to the UE performing CRS based discovery signals measurement and event-triggered reporting with Event A6 is configured.

There are three cells: Cell 1, Cell 2, and Cell 3. Cell 1 is PCell on the FDD primary component (RF Channel 1), Cell 2 is activated SCell on the secondary component (RF Channel 2) for Frame Structure 3, and Cell 3 is the neighbour cell on the secondary component (RF Channel 2) frame structure 3. LBT model is applied on cell 3.

The test consists of two successive time periods, with time duration of T1 and T2 respectively. During time duration T1, the UE shall not have any timing information of cell 3. Immediately at beginning of T2 the transmission power of cell 3 is increased, and due to usage of an offset this shall result in reporting of Event A6.

Table A.8.26.5.1-1: General test parameters for E-UTRAN FDD-FS3 intra-frequency event triggered reporting in non-DRX for CRS based discovery signal measurement under Operation with Frame Structure 3

| Parameter | Unit | Value | Comment |
|------------------------------------|------|--------|---|
| E-UTRA RF Channel Number | | 1, 2 | Two radio channels are used for this test |
| Active PCell | | Cell 1 | Primary cell on RF channel number 1. |
| Active SCell | | Cell 2 | Configured activated secondary cell on RF channel number 2. |
| Neighbour cell | | Cell 3 | Neighbour cell to be identified on RF channel number 2. |
| DMTC period | ms | 40 | As specified in IE MeasDS-Config in TS 36.331 |
| dmtc-PeriodOffset | ms | 10 | As specified in IE MeasDS-Config in TS 36.331 |
| Discovery signal occasion duration | ms | 1 | As specified in IE MeasDS-Config in TS 36.331 |
| CP length | | Normal | |
| A6-Offset | dB | -6 | |
| Time To Trigger | s | 0 | |
| Filter coefficient | | 0 | L3 filtering is not used |
| DRX | | OFF | |
| T1 | s | 5 | |
| T2 | s | 5 | |

Table A.8.26.5.1-2: Cell specific test parameters for E-UTRAN FDD-FS3 intra-frequency event triggered reporting in non-DRX for CRS based discovery signal measurement under Operation with Frame Structure 3

| Parameter | Unit | Cell1 | | Cell2 | | Cell3 | |
|--------------------------|-----------|---|----|-------|----|--------|----|
| | | T1 | T2 | T1 | T2 | T1 | T2 |
| E-UTRA RF Channel Number | | 1 | | 2 | | 2 | |
| BW _{channel} | MHz | 5MHz: NRB,c = 25 10MHz: NRB,c = 50 20MHz: NRB,c = 100 | | 20 | | 20 | |
| LBT model | | - | | - | | A.3.17 | |
| Measurement bandwidth | n_{PRB} | 5MHz: 10-15 10MHz: 22-27 20MHz: 47-52 | | 47-52 | | 47-52 | |

| | | | | | | | |
|--|----------------|--|------|------------|------------|------------------------------------|--------|
| PDSCH parameters: DL Reference Measurement Channel | | 5MHz: R.5 FDD 10MHz: R.0 FDD 20MHz: R.4 FDD | | R.1 FS3 | | - | |
| PCFICH/PDCCH/PHICH parameters: DL Reference Measurement Channel | | 5MHz: R.11 FDD 10MHz: R.6 FDD 20MHz: R.10 FDD | | R.0 FS3 | | R.0 FS3 | |
| OCNG Patterns | | 5MHz: OP.15 FDD 10MHz: OP.1 FDD 20MHz: OP.11 FDD | | OP.13 FDD | | OP.14 FDD | |
| PBCH_RA | dB | 0 | | 0 | | 0 | |
| PBCH_RB | dB | | | | | | |
| PSS_RA | dB | | | | | | |
| SSS_RA | dB | | | | | | |
| PCFICH_RB | dB | | | | | | |
| PHICH_RA | dB | | | | | | |
| PHICH_RB | dB | | | | | | |
| PDCCH_RA | dB | | | | | | |
| PDCCH_RB | dB | | | | | | |
| PDSCH_RA | dB | | | | | | |
| PDSCH_RB | dB | | | | | | |
| OCNG_RA ^{Note 1} | dB | | | | | | |
| OCNG_RB ^{Note 1} | dB | | | | | | |
| N_{oc} ^{Note 2} | dBm/ 15 kHz | | | | | | |
| \hat{E}_s / N_{oc} | dB | 4 | 4 | 4 | 4 | -infinity | 4 |
| \hat{E}_s / I_{ot} | dB | 4 | 4 | 4 | -1.455 | -infinity | -1.455 |
| RSRP ^{Note 3} | dBm/ 15 kHz | -100 | -100 | -100 | -100 | -infinity | -100 |
| SCH_RP ^{Note 3} | dBm/ 15 kHz | -100 | -100 | -100 | -100 | -infinity | -100 |
| I_o ^{Note 3} | dBm/ Ch BW | - | - | -67.75 | -65.41 | Specified in columns for Cell 2 | |
| Propagation Condition | | ETU30 | | ETU30 | | ETU30 | |
| Correlation Matrix and Antenna Configuration | | 1x2 Low | | 1x2 Low | | 1x2 Low | |
| Timing offset to Cell 1 | μ s | - | - | 0 | 0 | - | 3 |
| Time alignment error relative to cell 1 ^{Note 5} | μ s | - | - | \leq TAE | \leq TAE | N/A | N/A |
| <p>Note 1: OCNG shall be used such that cells are fully allocated and a constant total transmitted power spectral density is achieved for all OFDM symbols. For cells with LBT model, OCNG is transmitted only in subframes with downlink transmission bursts, and is not transmitted during muted subframes or during DMTC windows.</p> <p>Note 2: Interference from other cells and noise sources not specified in the test is assumed to be constant over subcarriers and time and shall be modelled as AWGN of appropriate power for N_{oc} to be fulfilled.</p> <p>Note 3: RSRP, SCH_RP, E_s/I_{ot} and I_o levels have been derived from other parameters for information purposes. They are not settable parameters themselves.</p> <p>Note 4: The resources for uplink transmission are assigned to the UE prior to the start of time period T2.</p> <p>Note 5: Time alignment error (TAE) as specified in TS 36.104 [30] clause 6.5.3.1.</p> | | | | | | | |

A.8.26.5.2 Test Requirements

In the test, the UE shall send one Event A6 triggered measurement report, with a measurement reporting delay less than $(24+L)*40$ ms from the beginning of time period T2, where L is the number of configured discovery signal occasions which are not available due to the absence of the necessary radio signals from cell3.

The measurement reporting delay is defined as the time from the beginning of time period T2 to the moment when the UE send the measurement report on PUSCH.

The UE shall not send event triggered measurement reports, as long as the reporting criteria are not fulfilled.

The rate of correct events observed during repeated tests shall be at least 90%.

NOTE: The actual overall delays measured in the test may be up to $2 \times TTI_{DCCH}$ higher than the measurement reporting delays above because of TTI insertion uncertainty of the measurement report in DCCH.

A.8.26.6 E-UTRAN TDD-FS3 Intra-frequency event triggered reporting in non-DRX for CRS based discovery signal

A.8.26.6.1 Test Purpose and Environment

The purpose of the test is to verify that the UE makes correct reporting of an event under operation with frame structure 3. The test will partly verify new intra-frequency FS3 cells in non-DRX requirements in clause 8.11.2.

The test parameters are given in Tables A.8.26.6.1-1 and A.8.26.6.1-2. In the measurement control information, it is indicated to the UE performing CRS based discovery signals measurement and event-triggered reporting with Event A6 is configured.

There are three cells: Cell 1, Cell 2, and Cell 3. Cell 1 is PCell on the TDD primary component (RF Channel 1), Cell 2 is activated SCell on the secondary component (RF Channel 2) for Frame Structure 3, and Cell 3 is the neighbour cell on the secondary component (RF Channel 2) frame structure 3. LBT model is applied on cell 3.

The test consists of two successive time periods, with time duration of T1, and T2 respectively. During time duration T1, the UE shall not have any timing information of cell 3. Immediately at beginning of T2 the transmission power of cell 3 is increased, and due to usage of an offset this shall result in reporting of Event A6.

Table A.8.26.6.1-1: General test parameters for E-UTRAN TDD-TDD intra-frequency event triggered reporting in non-DRX for CRS based discovery signal measurement under Operation with Frame Structure 3

| Parameter | Unit | Value | Comment |
|------------------------------------|------|--------|---|
| E-UTRA RF Channel Number | | 1, 2 | Two radio channels are used for this test |
| Active PCell | | Cell 1 | Primary cell on RF channel number 1. |
| Active SCell | | Cell 2 | Configured activated secondary cell on RF channel number 2. |
| Neighbour cell | | Cell 3 | Neighbor cell to be identified on RF channel number 2. |
| DMTC period | ms | 40 | As specified in IE MeasDS-Config in TS 36.331 |
| dmtc-PeriodOffset | ms | 10 | As specified in IE MeasDS-Config in TS 36.331 |
| Discovery signal occasion duration | ms | 1 | As specified in IE MeasDS-Config in TS 36.331 |
| CP length | | Normal | |
| A6-Offset | dB | -6 | |
| Time To Trigger | s | 0 | |
| Filter coefficient | | 0 | L3 filtering is not used |
| DRX | | OFF | |
| T1 | s | 5 | |
| T2 | s | 5 | |

Table A.8.26.6.1-2: Cell specific test parameters for E-UTRAN TDD-TDD intra-frequency event triggered reporting in non-DRX for CRS based discovery signal measurement under Operation with Frame Structure 3

| Parameter | Unit | Cell1 | | Cell2 | | Cell3 | |
|--------------------------------|------|-------|----|-------|----|-------|----|
| | | T1 | T2 | T1 | T2 | T1 | T2 |
| E-UTRA RF Channel Number | | 1 | | 2 | | 2 | |
| Special subframe configuration | | 6 | | - | | - | |
| Uplink-downlink | | 1 | | - | | - | |

| | | | | | | | |
|--|----------------|---|------|------------|------------|------------------------------------|-----------|
| configuration | | | | | | | |
| LBT model | | | - | - | | | A.3.17 |
| BW _{channel} | MHz | 5MHz: NRB,c = 25 10MHz: NRB,c = 50 20MHz: NRB,c = 100 | | 20 | | | 20 |
| Measurement bandwidth | n_{PRB} | 5MHz: 10-15 10MHz: 22-27 20MHz: 47-52 | | 47-52 | | | 47-52 |
| PDSCH parameters: DL Reference Measurement Channel | | 5MHz: R.4 TDD 10MHz: R.0 TDD 20MHz: R.3 TDD | | R.0 FS3 | | | - |
| PCFICH/PDCCH/PHICH parameters: DL Reference Measurement Channel | | 5MHz: R.11 TDD 10MHz: R.6 TDD 20MHz: R.10 TDD | | R.0 FS3 | | | R.0 FS3 |
| OCNG Patterns | | 5MHz: OP.15 TDD 10MHz: OP.1 TDD 20MHz: OP.11 TDD | | OP.13 FDD | | | OP.14 FDD |
| PBCH_RA | dB | 0 | | 0 | | 0 | |
| PBCH_RB | dB | | | | | | |
| PSS_RA | dB | | | | | | |
| SSS_RA | dB | | | | | | |
| PCFICH_RB | dB | | | | | | |
| PHICH_RA | dB | | | | | | |
| PHICH_RB | dB | | | | | | |
| PDCCH_RA | dB | | | | | | |
| PDCCH_RB | dB | | | | | | |
| PDSCH_RA | dB | | | | | | |
| PDSCH_RB | dB | | | | | | |
| OCNG_RA ^{Note 1} | dB | | | | | | |
| OCNG_RB ^{Note 1} | dB | | | | | | |
| N_{oc} ^{Note 2} | dBm/ 15 kHz | | | | | | |
| \hat{E}_s / N_{oc} | dB | 4 | 4 | 4 | 4 | -infinity | 4 |
| \hat{E}_s / I_{ot} | dB | 4 | 4 | 4 | -1.46 | -infinity | -1.46 |
| RSRP ^{Note 3} | dBm/ 15 kHz | -100 | -100 | -100 | -100 | -infinity | -100 |
| SCH_RP ^{Note 3} | dBm/ 15 kHz | -100 | -100 | -100 | -100 | -infinity | -100 |
| I_o ^{Note 3} | dBm/ Ch BW | - | - | -67.75 | -65.41 | Specified in columns for Cell 2 | |
| Propagation Condition | | ETU30 | | ETU30 | | ETU30 | |
| Correlation Matrix and Antenna Configuration | | 1x2 Low | | 1x2 Low | | 1x2 Low | |
| Timing offset to Cell 1 | μ s | - | - | 0 | 0 | - | 3 |
| Time alignment error relative to cell 1 ^{Note 5} | μ s | - | - | \leq TAE | \leq TAE | N/A | N/A |
| <p>Note 1: OCNG shall be used such that cells are fully allocated and a constant total transmitted power spectral density is achieved for all OFDM symbols. For cells with LBT model, OCNG is transmitted only in subframes with downlink transmission bursts, and is not transmitted during muted subframes or during DMTC windows.</p> <p>Note 2: Interference from other cells and noise sources not specified in the test is assumed to be constant over subcarriers and time and shall be modelled as AWGN of appropriate power for N_{oc} to be fulfilled.</p> <p>Note 3: RSRP, SCH_RP, E_s/I_{ot} and I_o levels have been derived from other parameters for information purposes. They are not settable parameters themselves.</p> <p>Note 4: The resources for uplink transmission are assigned to the UE prior to the start of time period T2.</p> <p>Note 5: Time alignment error (TAE) as specified in TS 36.104 [30] clause 6.5.3.1.</p> | | | | | | | |

A.8.26.6.2 Test Requirements

In the test, the UE shall send one Event A6 triggered measurement report, with a measurement reporting delay less than $(24+L)*40$ ms from the beginning of time period T2, where L is the number of configured discovery signal occasions which are not available due to the absence of the necessary radio signals from cell3.

The measurement reporting delay is defined as the time from the beginning of time period T2 to the moment when the UE send the measurement report on PUSCH.

The UE shall not send event triggered measurement reports, as long as the reporting criteria are not fulfilled.

The rate of correct events observed during repeated tests shall be at least 90%.

NOTE: The actual overall delays measured in the test may be up to $2 \times TTI_{DCCH}$ higher than the measurement reporting delays above because of TTI insertion uncertainty of the measurement report in DCCH.

A.8.26.7 E-UTRAN FDD-FS3 Intra-frequency event triggered reporting in DRX for CRS based discovery signal

A.8.26.7.1 Test Purpose and Environment

The purpose of the test is to verify that the UE makes correct reporting of an event under operation with frame structure 3. The test will partly verify new intra-frequency FS3 cells in DRX requirements in clause 8.11.2.

The test parameters are given in Tables A.8.26.7.1-1 and A.8.26.7.1-2. In the measurement control information, it is indicated to the UE performing CRS based discovery signals measurement and event-triggered reporting with Event A6 is configured.

There are three cells: Cell 1, Cell 2, and Cell 3. Cell 1 is PCell on the FDD primary component (RF Channel 1), Cell 2 is activated SCell on the secondary component (RF Channel 2) for Frame Structure 3, and Cell 3 is the neighbour cell on the secondary component (RF Channel 2) frame structure 3. LBT model is applied on cell 3.

The test consists of two successive time periods, with time duration of T1, and T2 respectively. During time duration T1, the UE shall not have any timing information of cell 2. Immediately at beginning of T2 the transmission power of cell 3 is increased, and due to usage of an offset this shall result in reporting of Event A6.

Table A.8.26.7.1-1: General test parameters for E-UTRAN FDD-FS3 intra-frequency event triggered reporting in DRX for CRS based discovery signal under Operation with Frame Structure 3

| Parameter | Unit | Value | Comment |
|------------------------------------|------|--------|---|
| E-UTRA RF Channel Number | | 1, 2 | Two radio channels are used for this test |
| Active PCell | | Cell 1 | Primary cell on RF channel number 1. |
| Active SCell | | Cell 2 | Configured activated secondary cell on RF channel number 2. |
| Neighbour cell | | Cell 3 | Neighbor cell to be identified on RF channel number 2. |
| DMTC period | ms | 40 | As specified in IE MeasDS-Config in TS 36.331 |
| dmtc-PeriodOffset | ms | 10 | As specified in IE MeasDS-Config in TS 36.331 |
| Discovery signal occasion duration | ms | 1 | As specified in IE MeasDS-Config in TS 36.331 |
| CP length | | Normal | |
| A6-Offset | dB | -6 | |
| Time To Trigger | s | 0 | |
| Filter coefficient | | 0 | L3 filtering is not used |
| DRX | | ON | DRX related parameters are defined in Table A.8.26.7.1-3 |
| T1 | s | 5 | |
| T2 | s | 15 | During this time the UE identify a new detectable FS3 intra-frequency cell. $T_{\text{identify_intra_FS3_DRX}}$ is specified in section 8.11.2.1.1.2. |

Table A.8.26.7.1-2: Cell specific test parameters for E-UTRAN FDD-FS3 intra-frequency event triggered reporting in DRX for CRS based discovery signal under Operation with Frame Structure 3

| Parameter | Unit | Cell1 | | Cell2 | | Cell3 | |
|---|----------------|---|---|------------|------------|---------------------------------|--------|
| | | T1 | T2 | T1 | T2 | T1 | T2 |
| E-UTRA RF Channel Number | | 1 | | 2 | | 2 | |
| BW _{channel} | MHz | 5MHz: NRB,c = 25 10MHz: NRB,c = 50 20MHz: NRB,c = 100 | | 20 | | 20 | |
| LBT model | | - | | - | | A.3.17 | |
| Measurement bandwidth | n_{PRB} | 5MHz: 10-15 10MHz: 22-27 20MHz: 47-52 | | 47-52 | | 47-52 | |
| PDSCH parameters: DL Reference Measurement Channel | | 5MHz: R.5 FDD 10MHz: R.0 FDD 20MHz: R.4 FDD | | R.1 FS3 | | - | |
| PCFICH/PDCCH/PHICH parameters: DL Reference Measurement Channel | | 5MHz: R.11 FDD 10MHz: R.6 FDD 20MHz: R.10 FDD | | R.0 FS3 | | R.0 FS3 | |
| OCNG Patterns defined in A.3.2 | | 5MHz: OP.15 FDD 10MHz: OP.1 FDD 20MHz: OP.11 FDD | | OP.13 FDD | | OP.14 FDD | |
| PBCH_RA | dB | 0 | | 0 | | 0 | |
| PBCH_RB | dB | | | | | | |
| PSS_RA | dB | | | | | | |
| SSS_RA | dB | | | | | | |
| PCFICH_RB | dB | | | | | | |
| PHICH_RA | dB | | | | | | |
| PHICH_RB | dB | | | | | | |
| PDCCH_RA | dB | | | | | | |
| PDCCH_RB | dB | | | | | | |
| PDSCH_RA | dB | | | | | | |
| PDSCH_RB | dB | | | | | | |
| OCNG_RA ^{Note 1} | dB | | | | | | |
| OCNG_RB ^{Note 1} | dB | | | | | | |
| N_{oc} ^{Note 2} | dBm/ 15 kHz | | | | | | |
| \hat{E}_s / N_{oc} | dB | 4 | 4 | 4 | 4 | -infinity | 4 |
| \hat{E}_s / I_{ot} | dB | 4 | 4 | 4 | -1.455 | -infinity | -1.455 |
| RSRP ^{Note 3} | dBm/ 15 kHz | -100 | -100 | -100 | -100 | -infinity | -100 |
| SCH_RP ^{Note 3} | dBm/ 15 kHz | -100 | -100 | -100 | -100 | -infinity | -100 |
| I_o ^{Note 3} | dBm/ Ch BW | - 70.76+10log ($N_{RB,c} / 50$) | - 70.76+10log ($N_{RB,c} / 50$) | -67.76 | -65.42 | Specified in columns for Cell 2 | |
| Propagation Condition | | ETU30 | | ETU30 | | ETU30 | |
| Correlation Matrix and Antenna Configuration | | 1x2 Low | | 1x2 Low | | 1x2 Low | |
| Timing offset to Cell 1 | μ s | - | - | 0 | 0 | - | 3 |
| Time alignment error relative to cell 1 ^{Note 5} | μ s | - | - | \leq TAE | \leq TAE | N/A | N/A |
| <p>Note 1: OCNG shall be used such that cells are fully allocated and a constant total transmitted power spectral density is achieved for all OFDM symbols. For cells with LBT model, OCNG is transmitted only in subframes with downlink transmission bursts, and is not transmitted during muted subframes or during DMTC windows.</p> <p>Note 2: Interference from other cells and noise sources not specified in the test is assumed to be constant over subcarriers and time and shall be modelled as AWGN of appropriate power for N_{oc} to be fulfilled.</p> <p>Note 3: RSRP SCH_RP and E_s/I_{ot} levels have been derived from other parameters for information purposes. They are not settable parameters themselves.</p> <p>Note 4: The resources for uplink transmission are assigned to the UE prior to the start of time period T2.</p> <p>Note 5: Time alignment error (TAE) as specified in TS 36.104 [30] clause 6.5.3.1.</p> | | | | | | | |

Table A.8.26.7.1-3: DRX-Configuration for E-UTRAN FDD-FS3 intra-frequency event triggered reporting in DRX for CRS based discovery signal under Operation with Frame Structure 3

| Field | Value | Comment |
|--------------------------|------------|---|
| onDurationTimer | psf6 | As specified in clause 6.3.2 in TS 36.331 |
| drx-InactivityTimer | psf1 | |
| drx-RetransmissionTimer | psf1 | |
| longDRX-CycleStartOffset | sf320 : 10 | |
| shortDRX | disable | |

Table A.8.26.7.1-4: TimeAlignmentTimer -Configuration for E-UTRAN FDD-FS3 intra-frequency event triggered reporting in DRX for CRS based discovery signal under Operation with Frame Structure 3

| Field | Value | Comment |
|--------------------|-------|--|
| TimeAlignmentTimer | sf500 | As specified in clause 6.3.2 in TS 36.331 |
| sr-ConfigIndex | 0 | For further information see clause 6.3.2 in TS 36.331 and section 10.1 in TS 36.213. |

A.8.26.7.2 Test Requirements

In the test, the UE shall send one Event A6 triggered measurement report, with a measurement reporting delay less than $(24+L)*320\text{ms}$ from the beginning of time period T2, where L is the number of configured discovery signal occasions during ON DURATION which are not available due to the absence of the necessary radio signals from cell3.

The measurement reporting delay is defined as the time from the beginning of time period T2 to the moment when the UE send the measurement report on PUSCH.

The UE shall not send event triggered measurement reports, as long as the reporting criteria are not fulfilled.

The rate of correct events observed during repeated tests shall be at least 90%.

NOTE: The actual overall delays measured in the test may be up to $2xTTI_{\text{DCCH}}$ higher than the measurement reporting delays above because of TTI insertion uncertainty of the measurement report in DCCH.

A.8.26.8 E-UTRAN TDD-FS3 Intra-frequency event triggered reporting in DRX for CRS based discovery signal

A.8.26.8.1 Test Purpose and Environment

The purpose of the test is to verify that the UE makes correct reporting of an event under operation with frame structure 3. The test will partly verify new intra-frequency FS3 cells in DRX requirements in clause 8.11.2.

The test parameters are given in Tables A.8.26.8.1-1 and A.8.26.8.1-2. In the measurement control information, it is indicated to the UE performing CRS based discovery signals measurement and event-triggered reporting with Event A6 is configured.

There are three cells: Cell 1, Cell 2, and Cell 3. Cell 1 is PCell on the TDD primary component (RF Channel 1), Cell 2 is activated SCell on the secondary component (RF Channel 2) for Frame Structure 3, and Cell 3 is the neighbour cell on the secondary component (RF Channel 2) frame structure 3. LBT model is applied on cell 3.

The test consists of two successive time periods, with time duration of T1, and T2 respectively. During time duration T1, the UE shall not have any timing information of cell 2. Immediately at beginning of T2 the transmission power of cell 3 is increased, and due to usage of an offset this shall result in reporting of Event A6.

Table A.8.26.8.1-1: General test parameters for E-UTRAN TDD-TDD intra-frequency event triggered reporting in DRX for CRS based discovery signal under Operation with Frame Structure 3

| Parameter | Unit | Value | Comment |
|------------------------------------|------|--------|---|
| E-UTRA RF Channel Number | | 1, 2 | Two radio channels are used for this test |
| Active PCell | | Cell 1 | Primary cell on RF channel number 1. |
| Active SCell | | Cell 2 | Configured activated secondary cell on RF channel number 2. |
| Neighbour cell | | Cell 3 | Neighbor cell to be identified on RF channel number 2. |
| DMTC period | ms | 40 | As specified in IE MeasDS-Config in TS 36.331 |
| dmtc-PeriodOffset | ms | 10 | As specified in IE MeasDS-Config in TS 36.331 |
| Discovery signal occasion duration | ms | 1 | As specified in IE MeasDS-Config in TS 36.331 |
| CP length | | Normal | |
| A6-Offset | dB | -6 | |
| Time To Trigger | s | 0 | |
| Filter coefficient | | 0 | L3 filtering is not used |
| DRX | | ON | DRX related parameters are defined in Table A.8.26.8.1-3 |
| T1 | s | 5 | |
| T2 | s | 15 | |

Table A.8.26.8.1-2: Cell specific test parameters for E-UTRAN TDD-TDD intra-frequency event triggered reporting in DRX for CRS based discovery signal under Operation with Frame Structure 3

| Parameter | Unit | Cell1 | | Cell2 | | Cell3 | |
|--|-----------|---|----|-----------|----|-----------|----|
| | | T1 | T2 | T1 | T2 | T1 | T2 |
| E-UTRA RF Channel Number | | 1 | | 2 | | 2 | |
| Special subframe configuration | | 6 | | - | | - | |
| Uplink-downlink configuration | | 1 | | - | | - | |
| LBT model | | - | | - | | A.3.17 | |
| BW _{channel} | MHz | 5MHz: NRB,c = 25 10MHz: NRB,c = 50 20MHz: NRB,c = 100 | | 20 | | 20 | |
| Measurement bandwidth | n_{PRB} | 5MHz: 10-15 10MHz: 22-27 20MHz: 47-52 | | 47-52 | | 47-52 | |
| PDSCH parameters: DL Reference Measurement Channel | | 5MHz: R.4 TDD 10MHz: R.0 TDD 20MHz: R.3 TDD | | R.0 FS3 | | - | |
| PCFICH/PDCCH/PHICH parameters: DL Reference Measurement Channel | | 5MHz: R.11 TDD 10MHz: R.6 TDD 20MHz: R.10 TDD | | R.0 FS3 | | R.0 FS3 | |
| OCNG Patterns defined in A.3.2 | | 5MHz: OP.15 TDD 10MHz: OP.1 TDD 20MHz: OP.11 TDD | | OP.13 FDD | | OP.14 FDD | |
| PBCH_RA | dB | 0 | | 0 | | 0 | |
| PBCH_RB | dB | | | | | | |
| PSS_RA | dB | | | | | | |
| SSS_RA | dB | | | | | | |
| PCFICH_RB | dB | | | | | | |
| PHICH_RA | dB | | | | | | |
| PHICH_RB | dB | | | | | | |
| PDCCH_RA | dB | | | | | | |
| PDCCH_RB | dB | | | | | | |

| | | | | | | | |
|--|----------------|-----------------------------|-----------------------------|------------|------------|---------------------------------|-------|
| PDSCH_RA | dB | | | | | | |
| PDSCH_RB | dB | | | | | | |
| OCNG_RA ^{Note 1} | dB | | | | | | |
| OCNG_RB ^{Note 1} | dB | | | | | | |
| N_{oc} ^{Note 2} | dBm/ 15 kHz | -104 | | -104 | | | |
| \hat{E}_s/N_{oc} | dB | 4 | 4 | 4 | 4 | -infinity | 4 |
| \hat{E}_s/I_{ot} | dB | 4 | 4 | 4 | -1.46 | -infinity | -1.46 |
| RSRP ^{Note 3} | dBm/ 15 kHz | -100 | -100 | -100 | -100 | -infinity | -100 |
| SCH_RP ^{Note 3} | dBm/ 15 kHz | -100 | -100 | -100 | -100 | -infinity | -100 |
| I_o ^{Note 3} | dBm/ Ch BW | - | - | -67.76 | -65.42 | Specified in columns for Cell 2 | |
| | | $70.76+10\log(N_{RB,c}/50)$ | $70.76+10\log(N_{RB,c}/50)$ | | | | |
| Propagation Condition | | ETU30 | | ETU30 | | ETU30 | |
| Correlation Matrix and Antenna Configuration | | 1x2 Low | | 1x2 Low | | 1x2 Low | |
| Timing offset to Cell 1 | μ s | - | - | 0 | 0 | - | 3 |
| Time alignment error relative to cell 1 ^{Note 5} | μ s | - | - | \leq TAE | \leq TAE | N/A | N/A |
| <p>Note 1: OCNG shall be used such that cells are fully allocated and a constant total transmitted power spectral density is achieved for all OFDM symbols. For cells with LBT model, OCNG is transmitted only in subframes with downlink transmission bursts, and is not transmitted during muted subframes or during DMTC windows.</p> <p>Note 2: Interference from other cells and noise sources not specified in the test is assumed to be constant over subcarriers and time and shall be modelled as AWGN of appropriate power for N_{oc} to be fulfilled.</p> <p>Note 3: RSRP, SCH_RP, E_s/I_{ot} and I_o levels have been derived from other parameters for information purposes. They are not settable parameters themselves.</p> <p>Note 4: The resources for uplink transmission are assigned to the UE prior to the start of time period T2.</p> <p>Note 5: Time alignment error (TAE) as specified in TS 36.104 [30] clause 6.5.3.1.</p> | | | | | | | |

Table A.8.26.8.1-3: DRX-Configuration for E-UTRAN TDD-TDD intra-frequency event triggered reporting in DRX for CRS based discovery signal under Operation with Frame Structure 3

| Field | Value | Comment |
|--------------------------|---------|---|
| onDurationTimer | psf1 | As specified in clause 6.3.2 in TS 36.331 |
| drx-InactivityTimer | psf1 | |
| drx-RetransmissionTimer | psf1 | |
| longDRX-CycleStartOffset | Sf320 | |
| shortDRX | disable | |

Table A.8.26.8.1-4: TimeAlignmentTimer -Configuration for E-UTRAN TDD-TDD intra-frequency event triggered reporting in DRX for CRS based discovery signal under Operation with Frame Structure 3

| Field | Value | Comment |
|--------------------|-------|--|
| TimeAlignmentTimer | sf500 | As specified in clause 6.3.2 in TS 36.331 |
| sr-ConfigIndex | 0 | For further information see clause 6.3.2 in TS 36.331 and section 10.1 in TS 36.213. |

A.8.26.8.2 Test Requirements

In the test, the UE shall send one Event A6 triggered measurement report, with a measurement reporting delay less than $(24+L)*320$ ms from the beginning of time period T2, where L is the number of configured discovery signal occasions which are not available due to the absence of the necessary radio signals from cell3.

The measurement reporting delay is defined as the time from the beginning of time period T2 to the moment when the UE send the measurement report on PUSCH.

The UE shall not send event triggered measurement reports, as long as the reporting criteria are not fulfilled.

The rate of correct events observed during repeated tests shall be at least 90%.

NOTE: The actual overall delays measured in the test may be up to $2 \times TTI_{DCCH}$ higher than the measurement reporting delays above because of TTI insertion uncertainty of the measurement report in DCCH.

A.8.26.9 E-UTRAN FDD-FS3 Inter-frequency event triggered reporting under fading propagation conditions in synchronous cells

A.8.26.9.1 Test Purpose and Environment

The purpose of this test is to verify that the UE correctly detects event A4 (Neighbour becomes better than threshold) defined in TS 36.331 [2] within the requirements stated in clause 8.11.2.2.1.1.

The test parameters are given in Tables A.8.26.9.1-1 and A.8.26.9.1-2 below. In this test, there are two cells on different carrier frequencies. Cell 1 is an FDD cell and neighbouring Cell 2 is an FS3 cell.

In the measurement control information it is indicated to the UE that event-triggered reporting with Event A4 is used. The test consists of two successive time periods, with time duration of T1, and T2 respectively. During time duration T1, the UE shall not have any timing information of Cell 2.

Table A.8.26.9.1-1: General test parameters for E-UTRAN FDD-FS3 inter-frequency event triggered reporting in fading propagation conditions

| Parameter | | Unit | Value | Comment |
|------------------------------------|-----------------|------|--------|---|
| E-UTRA RF Channel Number | | | 1, 2 | One FDD carrier frequency is used for active cell and one FS3 carrier frequency is used for neighbour cell. |
| Active cell | | | Cell 1 | Cell 1 is on RF channel number 1 |
| Neighbour cell | | | Cell 2 | Cell 2 is on RF channel number 2 |
| DMTC period | | | 40 | As specified in IE MeasDS-Config in TS 36.331 [2] |
| dmtc-PeriodOffset | | | 10 | As specified in IE MeasDS-Config in TS 36.331 [2] |
| Discovery signal occasion duration | | | 1 | As specified in IE MeasDS-Config in TS 36.331 [2] |
| Gap Pattern Id | | | 0 | As specified in TS 36.133 [2] clause 8.1.2.1. |
| Gap Offset | | | 8 | As specified in IE MeasGapConfig in TS 36.331 [2] |
| A4 | Hysteresis | dB | 0 | Hysteresis for evaluation of event A4. |
| | Threshold RSRP | dBm | -105 | Actual RSRP threshold for event A4. Needs to take absolute accuracy tolerance in section 9.1.11.1 into account plus margin. |
| | Time To Trigger | s | 0 | |
| CP length | | | Normal | |
| TimeToTrigger | | s | 0 | |
| Filter coefficient | | | 0 | L3 filtering is not used |
| DRX | | | OFF | OFF |
| Time offset between cells | | | 0 ms | Synchronous cells |
| T1 | | s | 5 | |
| T2 | | s | 1 | |

Table A.8.26.9.1-2: Cell specific test parameters for E-UTRAN FDD-FS3 inter-frequency event triggered reporting under fading propagation conditions in synchronous cells

| Parameter | Unit | Cell 1 | | Cell 2 | |
|-----------------|------|--------|----|--------|----|
| | | T1 | T2 | T1 | T2 |
| Frame Structure | | FDD | | FS3 | |

| E-UTRA RF Channel Number | | 1 | 2 | | |
|---|------------------|--|---|--------|--------|
| BW _{channel} | MHz | 5 MHz: N _{RB,c} = 25 10 MHz: N _{RB,c} = 50 20 MHz: N _{RB,c} = 100 | 20 MHz: N _{RB,c} = 100 | | |
| LBT model | | - | A.3.17 | | |
| Correlation Matrix and Antenna Configuration | | 1x2 Low | 1x2 Low | | |
| Measurement bandwidth | n _{PRB} | 5MHz: 10-15 10MHz: 22-27 20MHz: 47-52 | 47-52 | | |
| PDSCH Reference measurement channel defined in A.3.1.1.1 and A.3.1.1.6 | | 5 MHz: R.5 FDD 10 MHz: R.0 FDD 20 MHz: R.4 FDD | - | | |
| PDCCH/PCFICH/PHICH Reference measurement channel defined in A.3.1.2.1 and A.3.1.2.3 | | 5 MHz: R.11 FDD 10 MHz: R.6 FDD 20 MHz: R.10 FDD | R.0 FS3 | | |
| OCNG Patterns defined in A.3.2 | | 5 MHz: OP.15 FDD 10 MHz: OP.1 FDD 20 MHz: OP.11 FDD | OP.14 FDD | | |
| PBCH_RA | dB | 0 | 0 | | |
| PBCH_RB | dB | | | | |
| PSS_RA | dB | | | | |
| SSS_RA | dB | | | | |
| PCFICH_RB | dB | | | | |
| PHICH_RA | dB | | | | |
| PHICH_RB | dB | | | | |
| PDCCH_RA | dB | | | | |
| PDCCH_RB | dB | | | | |
| PDSCH_RA | dB | | | | |
| PDSCH_RB | dB | | | | |
| OCNG_RA ^{Note 1} | dB | | | | |
| OCNG_RB ^{Note 1} | dB | | | | |
| N _{oc} ^{Note 3} | dBm/15 kHz | | | -98 | -98 |
| RSRP ^{Note 4} | dBm/15 kHz | | | -94 | -94 |
| \hat{E}_s/I_{ot} | dB | 4 | 4 | -inf | 7 |
| SCH_RP ^{Note 4} | dBm/15 kHz | -94 | -94 | -inf | -91 |
| \hat{E}_s/N_{oc} | dB | 4 | 4 | -inf | 7 |
| Io | dBm/Ch BW | -64.76 +10log (N _{RB,c} /50) | -64.76 +10log (N _{RB,c} /50) | -70.22 | -62.43 |
| Propagation Condition | | ETU30 | | ETU30 | |
| <p>Note 1: OCNG shall be used such that cells are fully allocated and a constant total transmitted power spectral density is achieved for all OFDM symbols. For cells with LBT model, OCNG is transmitted only in subframes with downlink transmission bursts, and is not transmitted during muted subframes or during DMTC windows.</p> <p>Note 2: The resources for uplink transmission are assigned to the UE prior to the start of time period T2.</p> <p>Note 3: Interference from other cells and noise sources not specified in the test is assumed to be constant over subcarriers and time and shall be modelled as AWGN of appropriate power for N_{oc} to be fulfilled.</p> <p>Note 4: Es/Iot, RSRP, SCH_RP and Io levels have been derived from other parameters for information purposes. They are not settable parameters themselves.</p> <p>Note 5: Void</p> | | | | | |

A.8.26.9.2 Test Requirements

The UE shall send one Event A4 triggered measurement report, with a measurement reporting delay less than (3 +L)*40 ms from the beginning of time period T2. L is the number of configured discovery signal occasions which are not

available during the time for cell identification at the UE during measurement gaps due to the absence of the necessary radio signals from the measured cell,

The UE shall not send event triggered measurement reports, as long as the reporting criteria are not fulfilled.

The rate of correct events observed during repeated tests shall be at least 90%.

NOTE: The actual overall delays measured in the test may be up to $2 \times TTI_{DCCH}$ higher than the measurement reporting delays above because of TTI insertion uncertainty of the measurement report in DCCH.

A.8.26.10 E-UTRAN TDD-FS3 Inter-frequency event triggered reporting under fading propagation conditions in synchronous cells

A.8.26.10.1 Test Purpose and Environment

The purpose of this test is to verify that the UE correctly detects event A4 (Neighbour becomes better than threshold) defined in TS 36.331 [2] within the requirements stated in clause 8.11.2.2.2.1.

The test parameters are given in Tables A.8.26.10.1-1 and A.8.26.10.1-2 below. In this test, there are two cells on different carrier frequencies. Cell 1 is an TDD cell and neighbouring Cell 2 is an FS3 cell.

In the measurement control information it is indicated to the UE that event-triggered reporting with Event A4 is used. The test consists of two successive time periods, with time duration of T1, and T2 respectively. During time duration T1, the UE shall not have any timing information of Cell 2.

Table A.8.26.10.1-1: General test parameters for E-UTRAN TDD-FS3 inter-frequency event triggered reporting in fading propagation conditions

| Parameter | | Unit | Value | Comment |
|------------------------------------|-----------------|------|--------|---|
| E-UTRA RF Channel Number | | | 1, 2 | One TDD carrier frequency is used for active cell and one FS3 carrier frequency is used for neighbour cell. |
| Active cell | | | Cell 1 | Cell 1 is on RF channel number 1 |
| Neighbour cell | | | Cell 2 | Cell 2 is on RF channel number 2 |
| DMTC period | | | 40 | As specified in IE MeasDS-Config in TS 36.331 [2] |
| dmtc-PeriodOffset | | | 10 | As specified in IE MeasDS-Config in TS 36.331 [2] |
| Discovery signal occasion duration | | | 1 | As specified in IE MeasDS-Config in TS 36.331 [2] |
| Gap Pattern Id | | | 0 | As specified in TS 36.133 [2] clause 8.1.2.1. |
| Gap Offset | | | 8 | As specified in IE MeasGapConfig in TS 36.331 [2] |
| A4 | Hysteresis | dB | 0 | Hysteresis for evaluation of event A4. |
| | Threshold RSRP | dBm | -105 | Actual RSRP threshold for event A4. Needs to take absolute accuracy tolerance in section 9.1.11.1 into account plus margin. |
| | Time To Trigger | s | 0 | |
| CP length | | | Normal | |
| TimeToTrigger | | s | 0 | |
| Filter coefficient | | | 0 | L3 filtering is not used |
| DRX | | | OFF | OFF |
| Time offset between cells | | | 0 ms | Synchronous cells |
| T1 | | s | 5 | |
| T2 | | s | 1 | |

Table A.8.26.10.1-2: Cell specific test parameters for E-UTRAN TDD-FS3 inter-frequency event triggered reporting under fading propagation conditions in synchronous cells

| Parameter | Unit | Cell 1 | Cell 2 |
|-----------|------|--------|--------|
|-----------|------|--------|--------|

| | | T1 | T2 | T1 | T2 | | | | |
|---|------------------------|--|---|---------------------------------|--------|-----|-----|------|-----|
| Frame Structure | | TDD | | FS3 | | | | | |
| E-UTRA RF Channel Number | | 1 | | 2 | | | | | |
| BW _{channel} | MHz | 5 MHz: N _{RB,c} = 25 10 MHz: N _{RB,c} = 50 20 MHz: N _{RB,c} = 100 | | 20 MHz: N _{RB,c} = 100 | | | | | |
| Special subframe configuration | | 6 | | - | | | | | |
| Uplink-downlink configuration | | 1 | | - | | | | | |
| LBT model | | - | | A.3.17 | | | | | |
| Correlation Matrix and Antenna Configuration | | 1x2 Low | | 1x2 Low | | | | | |
| Measurement bandwidth | <i>n_{PRB}</i> | 5MHz: 10-15 10MHz: 22-27 20MHz: 47-52 | | 47-52 | | | | | |
| PDSCH Reference measurement channel defined in A.3.1.1.2 and A.3.1.1.6 | | 5MHz: R.4 TDD 10MHz: R.0 TDD 20MHz: R.3 TDD | | - | | | | | |
| PDCCH/PCFICH/PHICH Reference measurement channel defined in A.3.1.2.2 and A.3.1.2.4 | | 5MHz: R.11 TDD 10MHz: R.6 TDD 20MHz: R.10 TDD | | R.0 FS3 | | | | | |
| OCNG Patterns defined in A.3.2 | | 5MHz: OP.10 TDD 10MHz: OP.2 TDD 20MHz: OP.8 TDD | | OP.14 FDD | | | | | |
| PBCH_RA | dB | 0 | | 0 | | | | | |
| PBCH_RB | dB | | | | | | | | |
| PSS_RA | dB | | | | | | | | |
| SSS_RA | dB | | | | | | | | |
| PCFICH_RB | dB | | | | | | | | |
| PHICH_RA | dB | | | | | | | | |
| PHICH_RB | dB | | | | | | | | |
| PDCCH_RA | dB | | | | | | | | |
| PDCCH_RB | dB | | | | | | | | |
| PDSCH_RA | dB | | | | | | | | |
| PDSCH_RB | dB | | | | | | | | |
| OCNG_RA ^{Note 1} | dB | | | | | | | | |
| OCNG_RB ^{Note 1} | dB | | | | | | | | |
| <i>N_{oc}</i> ^{Note 3} | dBm/15 kHz | | | | | -98 | | -98 | |
| RSRP ^{Note 4} | dBm/15 kHz | | | | | -94 | -94 | -inf | -91 |
| \hat{E}_s/I_{ot} | dB | 4 | 4 | -inf | 7 | | | | |
| SCH_RP ^{Note 4} | dBm/15 kHz | -94 | -94 | -inf | -91 | | | | |
| \hat{E}_s/N_{oc} | dB | 4 | 4 | -inf | 7 | | | | |
| Io | dBm/Ch BW | -64.76 +10log (N _{RB,c} /50) | -64.76 +10log (N _{RB,c} /50) | -70.22 | -62.43 | | | | |
| Propagation Condition | | ETU30 | | ETU30 | | | | | |
| <p>Note 1: OCNG shall be used such that cells are fully allocated and a constant total transmitted power spectral density is achieved for all OFDM symbols. For cells with LBT model, OCNG is transmitted only in subframes with downlink transmission bursts, and is not transmitted during muted subframes or during DMTC windows.</p> <p>Note 2: The resources for uplink transmission are assigned to the UE prior to the start of time period T2.</p> <p>Note 3: Interference from other cells and noise sources not specified in the test is assumed to be constant over subcarriers and time and shall be modelled as AWGN of appropriate power for <i>N_{oc}</i> to be fulfilled.</p> <p>Note 4: <i>E_s/I_{ot}</i>, RSRP, SCH_RP and Io levels have been derived from other parameters for information purposes. They are not settable parameters themselves.</p> <p>Note 5: Void</p> | | | | | | | | | |

A.8.26.10.2 Test Requirements

The UE shall send one Event A4 triggered measurement report, with a measurement reporting delay less than $(3 + L) \cdot 40$ ms from the beginning of time period T2. L is the number of configured discovery signal occasions which are not available during the time for cell identification at the UE during measurement gaps due to the absence of the necessary radio signals from the measured cell,

The UE shall not send event triggered measurement reports, as long as the reporting criteria are not fulfilled.

The rate of correct events observed during repeated tests shall be at least 90%.

NOTE: The actual overall delays measured in the test may be up to $2 \times TTI_{DCCH}$ higher than the measurement reporting delays above because of TTI insertion uncertainty of the measurement report in DCCH.

A.9 Measurement Performance Requirements

Unless explicitly stated otherwise:

- Reported measurements shall be within defined range of accuracy limits defined in Clause 9 for at least 90 % of the reported cases. If multiple measurement performance requirements are verified in the same test, the reported measurements for each requirement shall be within defined range of accuracy limits of the corresponding requirement defined in Clause 9 for at least 90% of the reported cases.
- Cell 1 is the PCell.
- Measurements are performed in RRC_CONNECTED state.
- The reference channels assume transmission of PDSCH with a maximum number of 5 HARQ transmissions unless otherwise specified.

A.9.1 RSRP

A.9.1.1 FDD Intra frequency case

A.9.1.1.1 Test Purpose and Environment

The purpose of this test is to verify that the RSRP measurement accuracy is within the specified limits. This test will verify the requirements in Sections 9.1.2.1 and 9.1.2.2 for FDD intra frequency measurements.

A.9.1.1.2 Test parameters

In this set of test cases all cells are on the same carrier frequency. Both absolute and relative accuracy of RSRP intra frequency measurements are tested by using the parameters in Table A.9.1.1.2-1. In all test cases, Cell 1 is the PCell and Cell 2 the target cell.

Table A.9.1.1.2-1: RSRP FDD Intra frequency test parameters

| Parameter | Unit | Test 1 | | Test 2 | | Test 3 | |
|--|-----------|----------|----------|----------|----------|----------|----------|
| | | Cell 1 | Cell 2 | Cell 1 | Cell 2 | Cell 1 | Cell 2 |
| E-UTRA RF Channel Number | | 1 | | 1 | | 1 | |
| BW _{channel} | MHz | 10 | | 10 | | 10 | |
| Measurement bandwidth | n_{PRB} | 22—27 | | 22—27 | | 22—27 | |
| PDSCH Reference measurement channel defined in A.3.1.1.1 | | R.0 FDD | - | R.0 FDD | - | R.0 FDD | - |
| PDSCH allocation | n_{PRB} | 13—36 | - | 13—36 | - | 13—36 | - |
| PDCCH/PCFICH/PHICH Reference measurement channel defined in A.3.1.2.1 | | R.6 FDD | | R.6 FDD | | R.6 FDD | |
| OCNG Patterns defined in A.3.2.1.1 (OP.1 FDD) and A.3.2.1.2 (OP.2 FDD) | | OP.1 FDD | OP.2 FDD | OP.1 FDD | OP.2 FDD | OP.1 FDD | OP.2 FDD |
| PBCH_RA | dB | 0 | 0 | 0 | 0 | 0 | 0 |
| PBCH_RB | | | | | | | |
| PSS_RA | | | | | | | |
| SSS_RA | | | | | | | |
| PCFICH_RB | | | | | | | |
| PHICH_RA | | | | | | | |
| PHICH_RB | | | | | | | |
| PDCCH_RA | | | | | | | |
| PDCCH_RB | | | | | | | |
| PDSCH_RA | | | | | | | |
| PDSCH_RB | | | | | | | |
| OCNG_RA ^{Note1} | | | | | | | |
| OCNG_RB ^{Note1} | | | | | | | |
| N ^{Note2} | | | | | | | |

| | | | | | | | | |
|---|---|------------|--------|--------|--------|--------|--------|--------|
| | Bands FDD_B | | | | | | | -115.5 |
| | Bands FDD_C | | | | | | | -115 |
| | Bands FDD_D | | | | | | | -114.5 |
| | Bands FDD_E, FDD_F ^{Note 5} | | | | | | | -114 |
| | Bands FDD_G ^{Note 7} | | | | | | | -113 |
| | Bands FDD_H | | | | | | | |
| \hat{E}_s / I_{ot} | | dB | 2.5 | -6 | 2.5 | -6 | 0.46 | -5.76 |
| RSRP ^{Note3} | Bands FDD_A ^{Note 8} | dBm/15 kHz | -100 | -105 | -82 | -87 | -113 | -117 |
| | Bands FDD_B | | | | | | -112.5 | -116.5 |
| | Bands FDD_C | | | | | | -112 | -116 |
| | Bands FDD_D | | | | | | -111.5 | -115.5 |
| | Bands FDD_E, FDD_F ^{Note 5} | | | | | | -111 | -115 |
| | Bands FDD_G ^{Note 7} | | | | | | -110 | -114 |
| Bands FDD_H | -109.5 | -113.5 | | | | | | |
| I _o ^{Note3} | Bands FDD_A ^{Note 8} | dBm/9 MHz | -70.27 | -70.27 | -52.27 | -52.27 | -82.43 | |
| | Bands FDD_B | | | | | | -81.93 | |
| | Bands FDD_C | | | | | | -81.43 | |
| | Bands FDD_D | | | | | | -80.93 | |
| | Bands FDD_E, FDD_F ^{Note 5} | | | | | | -80.43 | |
| | Bands FDD_G ^{Note 7} | | | | | | -79.43 | |
| Bands FDD_H | -78.93 | | | | | | | |
| \hat{E}_s / N_{oc} | | dB | 6 | 1 | 6 | 1 | 3 | -1 |
| Propagation condition | | - | AWGN | | AWGN | | AWGN | |
| <p>Note 1: OCNG shall be used such that both cells are fully allocated and a constant total transmitted power spectral density is achieved for all OFDM symbols.</p> <p>Note 2: Interference from other cells and noise sources not specified in the test is assumed to be constant over subcarriers and time and shall be modelled as AWGN of appropriate power for N_{oc} to be fulfilled.</p> <p>Note 3: RSRP and I_o levels have been derived from other parameters for information purposes. They are not settable parameters themselves.</p> <p>Note 4: RSRP minimum requirements are specified assuming independent interference and noise at each receiver antenna port.</p> <p>Note 5: For Band 26, the tests shall be performed with the carrier frequency of the assigned E-UTRA channel bandwidth within 865-894 MHz.</p> <p>Note 6: E-UTRA operating band groups are as defined in Section 3.5.</p> <p>Note 7: Except Band 29.</p> <p>Note 8: Except Band 32.</p> | | | | | | | | |

A.9.1.1.3 Test Requirements

The RSRP measurement accuracy shall fulfil the requirements in sections 9.1.2.1 and 9.1.2.2.

A.9.1.2 TDD Intra frequency case

A.9.1.2.1 Test Purpose and Environment

The purpose of this test is to verify that the RSRP measurement accuracy is within the specified limits. This test will verify the requirements in Sections 9.1.2.1 and 9.1.2.2 for TDD intra frequency measurements.

A.9.1.2.2 Test parameters

In this set of test cases all cells are on the same carrier frequency. Both absolute and relative accuracy of RSRP intra frequency measurements are tested by using the parameters in Table A.9.1.2.2-1. In all test cases, Cell 1 is the PCell and Cell 2 the target cell.

Table A.9.1.2.2-1: RSRP TDD Intra frequency test parameters

| Parameter | Unit | Test 1 | Test 2 | Test 3 |
|-----------|------|--------|--------|--------|
|-----------|------|--------|--------|--------|

A.9.1.3 FDD—FDD Inter frequency case

A.9.1.3.1 Test Purpose and Environment

The purpose of this test is to verify that the RSRP measurement accuracy is within the specified limits. This test will verify the requirements in Sections 9.1.3.1 and 9.1.3.2 for FDD—FDD inter frequency measurements.

A.9.1.3.2 Test parameters

In this set of test cases the cells are on different carrier frequencies. Both absolute and relative accuracy of RSRP inter-frequency measurements are tested by using the parameters in Table A.9.1.3.2-1 In all test cases, Cell 1 is the PCell and Cell 2 the target cell. The inter frequency measurements are supported by a measurement gap.

Table A.9.1.3.2-1: RSRP FDD—FDD Inter frequency test parameters

| Parameter | Unit | Test 1 | | Test 2 | | | | | | |
|--|---------------------------|----------|----------|---|----------|--------------------|--------|--------|-------------------------------|--------|
| | | Cell 1 | Cell 2 | Cell 1 | Cell 2 | | | | | |
| E-UTRA RF Channel Number | | 1 | 2 | 1 | 2 | | | | | |
| BW _{channel} | MHz | 10 | 10 | 10 | 10 | | | | | |
| Gap Pattern Id | | 0 | - | 0 | - | | | | | |
| Measurement bandwidth | n_{PRB} | 22—27 | | 22—27 | | | | | | |
| PDSCH Reference measurement channel defined in A.3.1.1.1 | | R.0 FDD | - | R.0 FDD | - | | | | | |
| PDSCH allocation | n_{PRB} | 13—36 | - | 13—36 | - | | | | | |
| PDCCH/PCFICH/PHICH Reference measurement channel defined in A.3.1.2.1 | | R.6 FDD | | R.6 FDD | | | | | | |
| OCNG Patterns defined in A.3.2.1.1 (OP.1 FDD) and A.3.2.1.2 (OP.2 FDD) | | OP.1 FDD | OP.2 FDD | OP.1 FDD | OP.2 FDD | | | | | |
| PBCH_RA | dB | 0 | 0 | 0 | 0 | | | | | |
| PBCH_RB | | | | | | | | | | |
| PSS_RA | | | | | | | | | | |
| SSS_RA | | | | | | | | | | |
| PCFICH_RB | | | | | | | | | | |
| PHICH_RA | | | | | | | | | | |
| PHICH_RB | | | | | | | | | | |
| PDCCH_RA | | | | | | | | | | |
| PDCCH_RB | | | | | | | | | | |
| PDSCH_RA | | | | | | | | | | |
| PDSCH_RB | | | | | | | | | | |
| OCNG_RANote1 | | | | | | | | | | |
| OCNG_RBNote | | | | | | | | | | |
| N_{oc} Note2 | | | | | | Bands FDD_A Note 8 | -88.65 | -88.65 | $(N_{oc}$ for Channel 2 +8dB) | -117 |
| | | | | | | Bands FDD_B | | | | -116.5 |
| | | | | | | Bands FDD_C | | | | -116 |
| | Bands FDD_D | -115.5 | | | | | | | | |
| | Bands FDD_E, FDD_F Note 5 | -115 | | | | | | | | |
| | Bands FDD_G Note 7 | -114 | | | | | | | | |
| | Bands FDD_H | -113.5 | | | | | | | | |
| \hat{E}_s / I_{ot} | dB | 10 | 10 | 13 | -4 | | | | | |
| RSRP Note3 | Bands FDD_A Note 8 | -78.65 | -78.65 | (RSRP for Cell 2 +25dB) | -121 | | | | | |
| | Bands FDD_B | | | | -120.5 | | | | | |
| | Bands FDD_C | | | | -120 | | | | | |
| | Bands FDD_D | | | | -119.5 | | | | | |
| | Bands FDD_E, FDD_F Note 5 | | | | -119 | | | | | |
| | Bands FDD_G Note 7 | | | | -118 | | | | | |
| | Bands FDD_H | | | | -117.5 | | | | | |
| I_o Note3 | Bands FDD_A Note 8 | -50.45 | -50.45 | (I _o for Channel 2 +19.75dB) | -87.76 | | | | | |
| | Bands FDD_B | | | | -87.26 | | | | | |
| | Bands FDD_C | | | | -86.76 | | | | | |
| | Bands FDD_D | | | | -86.26 | | | | | |

| | | | | | | |
|-----------------------|--|----|------|----|------|--------|
| | Bands FDD_E, FDD_F ^{Note 5} | | | | B) | -85.76 |
| | Bands FDD_G ^{Note 7} | | | | | -84.76 |
| | Bands FDD_H | | | | | -84.26 |
| \hat{E}_s / N_{oc} | | dB | 10 | 10 | 13 | -4 |
| Propagation condition | | - | AWGN | | AWGN | |
| Note 1: | OCNG shall be used such that both cells are fully allocated and a constant total transmitted power spectral density is achieved for all OFDM symbols. | | | | | |
| Note 2: | Interference from other cells and noise sources not specified in the test is assumed to be constant over subcarriers and time and shall be modelled as AWGN of appropriate power for N_{oc} to be fulfilled. | | | | | |
| Note 3: | RSRP and I_o levels have been derived from other parameters for information purposes. They are not settable parameters themselves. | | | | | |
| Note 4: | RSRP minimum requirements are specified assuming independent interference and noise at each receiver antenna port. | | | | | |
| Note 5: | For Band 26, the tests shall be performed with the carrier frequency of assigned E-UTRA channel bandwidth within 865-894 MHz. | | | | | |
| Note 6: | E-UTRA operating band groups are as defined in Section 3.5. | | | | | |
| Note 7: | Except Band 29. | | | | | |
| Note 8: | Except Band 32. | | | | | |

A.9.1.3.3 Test Requirements

The RSRP measurement accuracy shall fulfil the requirements in sections 9.1.3.1 and 9.1.3.2.

A.9.1.4 TDD—TDD Inter frequency case

A.9.1.4.1 Test Purpose and Environment

The purpose of this test is to verify that the RSRP measurement accuracy is within the specified limits. This test will verify the requirements in Sections 9.1.3.1 and 9.1.3.2 for TDD—TDD inter frequency measurements.

A.9.1.4.2 Test parameters

In this set of test cases the cells are on different carrier frequencies. Both absolute and relative accuracy of RSRP inter-frequency measurements are tested by using the parameters in Table A.9.1.4.2-1 for TDD configuration 1 and in Table A.9.1.4.2-2 for TDD configuration 0. In all test cases, Cell 1 is the PCell and Cell 2 the target cell. The inter frequency measurements are supported by a measurement gap.

Table A.9.1.4.2-1: RSRP TDD—TDD Inter frequency test parameters for TDD configuration 1

| Parameter | Unit | Test 1 | | Test 2 | |
|--|-----------|----------|----------|----------|----------|
| | | Cell 1 | Cell 2 | Cell 1 | Cell 2 |
| E-UTRA RF Channel Number | | 1 | 2 | 1 | 2 |
| $BW_{channel}$ | MHz | 10 | 10 | 10 | 10 |
| Special subframe configuration ^{Note1} | | 6 | | 6 | |
| Uplink-downlink configuration ^{Note1} | | 1 | | 1 | |
| Gap Pattern Id | | 0 | - | 0 | - |
| Measurement bandwidth | n_{PRB} | 22—27 | | 22—27 | |
| PDSCH Reference measurement channel defined in A.3.1.1.2 | | R.0 TDD | - | R.0 TDD | - |
| PDSCH allocation | n_{PRB} | 13—36 | - | 13—36 | - |
| PDCCH/PCFICH/PHICH Reference measurement channel defined in A.3.1.2.2 | | R.6 TDD | | R.6 TDD | |
| OCNG Patterns defined in A.3.2.2.1 (OP.1 TDD) and A.3.2.2.2 (OP.2 TDD) | | OP.1 TDD | OP.2 TDD | OP.1 TDD | OP.2 TDD |
| PBCH_RA | dB | 0 | 0 | 0 | 0 |
| PBCH_RB | | | | | |
| PSS_RA | | | | | |
| SSS_RA | | | | | |

| | | | | | | |
|--|-------------|------------|--------|--------|--|--------|
| PCFICH_RB | | | | | | |
| PHICH_RA | | | | | | |
| PHICH_RB | | | | | | |
| PDCCH_RA | | | | | | |
| PDCCH_RB | | | | | | |
| PDSCH_RA | | | | | | |
| PDSCH_RB | | | | | | |
| OCNG_RA ^{Note2} | | | | | | |
| OCNG_RB ^{Note2} | | | | | | |
| N_{oc} ^{Note3} | Bands TDD_A | dBm/15 kHz | -88.65 | -88.65 | $(N_{oc}$ for Channel 2 +8dB) | -117 |
| | Bands TDD_C | | | | | -116 |
| | Bands TDD_E | | | | | -115 |
| \hat{E}_s/I_{ot} | | dB | 10 | 10 | 13 | -4 |
| RSRP ^{Note4} | Bands TDD_A | dBm/15 kHz | -78.65 | -78.65 | (RSRP for Cell 2 +25dB) | -121 |
| | Bands TDD_C | | | | | -120 |
| | Bands TDD_E | | | | | -119 |
| I_o ^{Note4} | Bands TDD_A | dBm/9 MHz | -50.45 | -50.45 | (I _o for Channel 2 +19.75d B) | -87.76 |
| | Bands TDD_C | | | | | -86.76 |
| | Bands TDD_E | | | | | -85.76 |
| \hat{E}_s/N_{oc} | | dB | 10 | 10 | 13 | -4 |
| Propagation condition | | - | AWGN | | AWGN | |
| <p>Note 1: For special subframe and uplink-downlink configurations see Tables 4.2-1 and 4.2-2 in TS 36.211.</p> <p>Note 2: OCNG shall be used such that both cells are fully allocated and a constant total transmitted power spectral density is achieved for all OFDM symbols.</p> <p>Note 3: Interference from other cells and noise sources not specified in the test is assumed to be constant over subcarriers and time and shall be modelled as AWGN of appropriate power for N_{oc} to be fulfilled.</p> <p>Note 4: RSRP and I_o levels have been derived from other parameters for information purposes. They are not settable parameters themselves.</p> <p>Note 5: RSRP minimum requirements are specified assuming independent interference and noise at each receiver antenna port.</p> <p>Note 6: E-UTRA operating band groups are as defined in Section 3.5.</p> | | | | | | |

Table A.9.1.4.2-2: RSRP TDD—TDD Inter frequency test parameters for TDD configuration 0

| Parameter | Unit | Test 1 | | Test 2 | |
|--|-----------|----------|----------|----------|----------|
| | | Cell 1 | Cell 2 | Cell 1 | Cell 2 |
| E-UTRA RF Channel Number | | 1 | 2 | 1 | 2 |
| $BW_{channel}$ | MHz | 10 | 10 | 10 | 10 |
| Special subframe configuration ^{Note1} | | 6 | | 6 | |
| Uplink-downlink configuration ^{Note1} | | 0 | | 0 | |
| Gap Pattern Id | | 0 | - | 0 | - |
| Measurement bandwidth | n_{PRB} | 22—27 | | 22—27 | |
| PDSCH Reference measurement channel defined in A.3.1.1.2 | | R.5 TDD | - | R.5 TDD | - |
| PDSCH allocation | n_{PRB} | 13—36 | - | 13—36 | - |
| PDCCH/PCFICH/PHICH Reference measurement channel defined in A.3.1.2.2 | | R.6 TDD | | R.6 TDD | |
| OCNG Patterns defined in A.3.2.2.1 (OP.1 TDD) and A.3.2.2.2 (OP.2 TDD) | | OP.1 TDD | OP.2 TDD | OP.1 TDD | OP.2 TDD |
| PBCH_RA | dB | 0 | 0 | 0 | 0 |
| PBCH_RB | | | | | |
| PSS_RA | | | | | |
| SSS_RA | | | | | |
| PCFICH_RB | | | | | |
| PHICH_RA | | | | | |
| PHICH_RB | | | | | |
| PDCCH_RA | | | | | |

| | | | | | | |
|---|-------------|------------|--------|--------|---|--------|
| PDCCH_RB | | | | | | |
| PDSCH_RA | | | | | | |
| PDSCH_RB | | | | | | |
| OCNG_RA ^{Note2} | | | | | | |
| OCNG_RB ^{Note2} | | | | | | |
| N_{oc} ^{Note3} | Bands TDD_A | dBm/15 kHz | -88.65 | -88.65 | $(N_{oc}$ for Channel 2 +8dB) | -117 |
| | Bands TDD_C | | | | | -116 |
| | Bands TDD_E | | | | | -115 |
| \hat{E}_s / I_{ot} | | dB | 10 | 10 | 13 | -4 |
| RSRP ^{Note4} | Bands TDD_A | dBm/15 kHz | -78.65 | -78.65 | (RSRP for Cell 2 +25dB) | -121 |
| | Bands TDD_C | | | | | -120 |
| | Bands TDD_E | | | | | -119 |
| I_o ^{Note4} | Bands TDD_A | dBm/9 MHz | -50.45 | -50.45 | (I _o for Channel 2 +19.75dB) | -87.76 |
| | Bands TDD_C | | | | | -86.76 |
| | Bands TDD_E | | | | | -85.76 |
| \hat{E}_s / N_{oc} | | dB | 10 | 10 | 13 | -4 |
| Propagation condition | | - | AWGN | | AWGN | |
| <p>Note 1: For special subframe and uplink-downlink configurations see Tables 4.2-1 and 4.2-2 in TS 36.211.</p> <p>Note 2: OCNG shall be used such that both cells are fully allocated and a constant total transmitted power spectral density is achieved for all OFDM symbols.</p> <p>Note 3: Interference from other cells and noise sources not specified in the test is assumed to be constant over subcarriers and time and shall be modelled as AWGN of appropriate power for N_{oc} to be fulfilled.</p> <p>Note 4: RSRP and I_o levels have been derived from other parameters for information purposes. They are not settable parameters themselves.</p> <p>Note 5: RSRP minimum requirements are specified assuming independent interference and noise at each receiver antenna port.</p> <p>Note 6: E-UTRA operating band groups are as defined in Section 3.5.</p> | | | | | | |

A.9.1.4.3 Test Requirements

The RSRP measurement accuracy shall fulfil the requirements in sections 9.1.3.1 and 9.1.3.2.

A.9.1.5 FDD—TDD Inter frequency case

A.9.1.5.1 Test Purpose and Environment

The purpose of this test is to verify that the RSRP measurement accuracy is within the specified limits. This test will verify the requirements in Sections 9.1.3.1 and 9.1.3.2 for FDD—TDD inter frequency measurements.

A.9.1.5.2 Test parameters

In this set of test cases the cells are on different carrier frequencies. Both absolute and relative accuracy of RSRP inter frequency measurements are tested by using the parameters in Table A.9.1.5.2-1 and Table A.9.1.5.2-2. In all test cases, Cell 1 is the serving cell and Cell 2 the target cell. Cell 1 is FDD cell and Cell 2 is TDD cell. The inter frequency measurements are supported by a measurement gap.

Table A.9.1.5.2-1: RSRP FDD—TDD Inter frequency test parameters (FDD Cell1)

| Parameter | Unit | Test 1 | Test 2 |
|--------------------------|-----------|--------|--------|
| | | Cell 1 | Cell 1 |
| E-UTRA RF Channel Number | | 1 | 1 |
| $BW_{channel}$ | MHz | 10 | 10 |
| Gap Pattern Id | | 0 | 0 |
| Measurement bandwidth | n_{PRB} | 22—27 | 22—27 |

| | | | |
|--|------------|----------|----------|
| PDSCH Reference measurement channel defined in A.3.1.1.1 | | R.0 FDD | R.0 FDD |
| PDSCH allocation | n_{PRB} | 13—36 | 13—36 |
| PDCCH/PCFICH/PHICH Reference measurement channel defined in A.3.1.2.1 | | R.6 FDD | R.6 FDD |
| OCNG Patterns defined in A.3.2.1.1 (OP.1 FDD) and A.3.2.1.2 (OP.2 FDD) | | OP.1 FDD | OP.1 FDD |
| PBCH_RA | dB | 0 | 0 |
| PBCH_RB | | | |
| PSS_RA | | | |
| SSS_RA | | | |
| PCFICH_RB | | | |
| PHICH_RA | | | |
| PHICH_RB | | | |
| PDCCH_RA | | | |
| PDCCH_RB | | | |
| PDSCH_RA | | | |
| PDSCH_RB | | | |
| OCNG_RANote1 | | | |
| OCNG_RBNote | | | |
| N_{oc} Note2 | | | |
| \hat{E}_s / I_{ot} | dB | 10 | 13 |
| RSRPNote3 | dBm/15 kHz | -78.65 | -91 |
| I_o Note3 | dBm/9 MHz | -50.45 | -63.01 |
| \hat{E}_s / N_{oc} | dB | 10 | 13 |
| Propagation condition | - | AWGN | AWGN |
| <p>Note 1: OCNG shall be used such that both cells are fully allocated and a constant total transmitted power spectral density is achieved for all OFDM symbols.</p> <p>Note 2: Interference from other cells and noise sources not specified in the test is assumed to be constant over subcarriers and time and shall be modelled as AWGN of appropriate power for N_{oc} to be fulfilled.</p> <p>Note 3: RSRP and I_o levels have been derived from other parameters for information purposes. They are not settable parameters themselves.</p> <p>Note 4: RSRP minimum requirements are specified assuming independent interference and noise at each receiver antenna port.</p> | | | |

Table A.9.1.5.2-2: RSRP FDD—TDD Inter frequency test parameters (TDD cell2)

| Parameter | Unit | Test 1 | Test 2 |
|--|-----------|----------|----------|
| | | Cell 2 | Cell 2 |
| E-UTRA RF Channel Number | | 2 | 2 |
| $BW_{channel}$ | MHz | 10 | 10 |
| Special subframe configurationNote1 | | 6 | 6 |
| Uplink-downlink configurationNote1 | | 1 | 1 |
| Gap Pattern Id | | - | - |
| Measurement bandwidth | n_{PRB} | 22—27 | 22—27 |
| PDSCH Reference measurement channel defined in A.3.1.1.2 | | - | - |
| PDSCH allocation | n_{PRB} | - | - |
| PDCCH/PCFICH/PHICH Reference measurement channel defined in A.3.1.2.2 | | R.6 TDD | R.6 TDD |
| OCNG Patterns defined in A.3.2.2.1 (OP.1 TDD) and A.3.2.2.2 (OP.2 TDD) | | OP.2 TDD | OP.2 TDD |
| PBCH_RA | dB | 0 | 0 |
| PBCH_RB | | | |

| | | | |
|--|------------|--------|--------|
| PSS_RA | | | |
| SSS_RA | | | |
| PCFICH_RB | | | |
| PHICH_RA | | | |
| PHICH_RB | | | |
| PDCCH_RA | | | |
| PDCCH_RB | | | |
| PDSCH_RA | | | |
| PDSCH_RB | | | |
| OCNG_RA ^{Note2} | | | |
| OCNG_RB ^{Note2} | | | |
| N_{oc} ^{Note3} | dBm/15 kHz | -88.65 | -112 |
| \hat{E}_s/I_{ot} | dB | 10 | -4 |
| RSRP ^{Note4} | dBm/15 kHz | -78.65 | -116 |
| I_o ^{Note4} | dBm/9 MHz | -50.45 | -82.76 |
| \hat{E}_s/N_{oc} | dB | 10 | -4 |
| Propagation condition | - | AWGN | AWGN |
| <p>Note 1: For special subframe and uplink-downlink configurations see Tables 4.2-1 and 4.2-2 in TS 36.211.</p> <p>Note 2: OCNG shall be used such that both cells are fully allocated and a constant total transmitted power spectral density is achieved for all OFDM symbols.</p> <p>Note 3: Interference from other cells and noise sources not specified in the test is assumed to be constant over subcarriers and time and shall be modelled as AWGN of appropriate power for N_{oc} to be fulfilled.</p> <p>Note 4: RSRP and I_o levels have been derived from other parameters for information purposes. They are not settable parameters themselves.</p> <p>Note 5: RSRP minimum requirements are specified assuming independent interference and noise at each receiver antenna port.</p> | | | |

A.9.1.5.3 Test Requirements

The RSRP measurement accuracy shall fulfil the requirements in sections 9.1.3.1 and 9.1.3.2.

A.9.1.6 FDD RSRP for E-UTRAN Carrier Aggregation

A.9.1.6.1 Test Purpose and Environment

The purpose of this test is to verify that the FDD RSRP absolute and relative accuracy requirements in carrier aggregation are within the specified limits. This test will verify the absolute RSRP accuracy requirements of the primary component carrier defined in clause 9.1.11.1, the absolute RSRP accuracy requirements of the secondary component carrier defined in clause 9.1.11.2, and the relative RSRP accuracy requirements of the secondary component carrier defined in clause 9.1.11.2. The test will also verify the primary and secondary component carrier relative RSRP accuracy requirement defined in Clause 9.1.11.3.

A.9.1.6.2 Test parameters

In this set of cases cell1 is PCell on the primary component carrier, cell2 is SCell on the secondary component carrier and activated, and cell3 is the neighboring cell on the secondary component carrier. The test parameters are given in Table A.9.1.6.2-1.

Table A.9.1.6.2-1: RSRP FDD carrier aggregation test parameters

| Parameter | Unit | Test 1 | | |
|--------------------------|---------|--------|--------|-------|
| | | Cell 1 | Cell 2 | Cell3 |
| E-UTRA RF Channel Number | | 1 | 2 | 2 |
| $BW_{channel}$ | MHz | 10 | 10 | 10 |
| Timing offset to cell1 | μ s | - | 0 | 3 |

| | | | | |
|---|---------------------------|----------|--|------------------------|
| Time alignment error between cell 2 and cell 1 | | - | ≤ Time alignment error as specified in 3GPP TS 36.104 [30] clause 6.5.3.1. | - |
| Measurement bandwidth | n_{PRB} | 22—27 | | |
| PDSCH Reference measurement channel defined in A.3.1.1.1 | | R.0 FDD | R.0 FDD | - |
| PDSCH allocation | n_{PRB} | 13—36 | 13—36 | - |
| PDCCH/PCFICH/PHICH Reference measurement channel defined in A.3.1.2.1 | | R.6 FDD | | |
| OCNG Patterns defined in A.3.2.1.1 (OP.1 FDD) and A.3.2.1.2 (OP.2 FDD) | | OP.1 FDD | OP.1 FDD | OP.2 FDD |
| PBCH_RA | dB | 0 | 0 | 0 |
| PBCH_RB | | | | |
| PSS_RA | | | | |
| SSS_RA | | | | |
| PCFICH_RB | | | | |
| PHICH_RA | | | | |
| PHICH_RB | | | | |
| PDCCH_RA | | | | |
| PDCCH_RB | | | | |
| PDSCH_RA | | | | |
| PDSCH_RB | | | | |
| OCNG_RANote1 | | | | |
| OCNG_RBNote | | | | |
| N_{oc} Note2 | | | | |
| | Bands FDD_B | -116.5 | | |
| | Bands FDD_C | -116 | | |
| | Bands FDD_D | -115.5 | | |
| | Bands FDD_E, FDD_F Note 6 | -115 | | |
| | Bands FDD_G | -114 | | |
| | Bands FDD_H | -113.5 | | |
| \hat{E}_s/I_{ot} | dB | -4 | 0.46 | -5.76 |
| RSRPNote3 | Bands FDD_A | -121 | (RSRP for Cell 1 +8dB) | (RSRP for Cell 1 +4dB) |
| | Bands FDD_B | -120.5 | | |
| | Bands FDD_C | -120 | | |
| | Bands FDD_D | -119.5 | | |
| | Bands FDD_E, FDD_F Note 6 | -119 | | |
| | Bands FDD_G | -118 | | |
| | Bands FDD_H | -117.5 | | |
| I_o Note3 | Bands FDD_A | -87.76 | $(I_o$ for Channel 1 +5.33dB) | |
| | Bands FDD_B | -87.26 | | |
| | Bands FDD_C | -86.76 | | |
| | Bands FDD_D | -86.26 | | |
| | Bands FDD_E, FDD_F Note 6 | -85.76 | | |
| | Bands FDD_G | -84.76 | | |
| | Bands FDD_H | -84.26 | | |
| \hat{E}_s/N_{oc} | dB | -4 | 3 | -1 |
| Propagation condition | - | AWGN | | |
| <p>Note 1: OCNG shall be used such that both cells are fully allocated and a constant total transmitted power spectral density is achieved for all OFDM symbols.</p> <p>Note 2: Interference from other cells and noise sources not specified in the test is assumed to be constant over subcarriers and time and shall be modelled as AWGN of appropriate power for N_{oc} to be fulfilled.</p> | | | | |

| | |
|---------|--|
| Note 3: | RSRP and Io levels have been derived from other parameters for information purposes. They are not settable parameters themselves. |
| Note 4: | RSRP minimum requirements are specified assuming independent interference and noise at each receiver antenna port. |
| Note 5: | The selection of the bands for testing depends on the configuration of the carrier aggregation supported by the UEs. |
| Note 6: | For Band 26, the tests shall be performed with the carrier frequency of the assigned E-UTRA channel bandwidth within 865-894 MHz. |
| Note 7: | This test verifies the RRM requirement which is independent of channel bandwidth and is performed according to the principle defined in section A.3.6.1. |
| Note 8: | E-UTRA operating band groups are as defined in Section 3.5. |

A.9.1.6.3 Test Requirements

In the test, the performance of RSRP measurements is verified from following four perspectives:

- The absolute accuracy of intra-frequency RSRP measurements for Cell 1 on the primary component carrier shall fulfil the requirements defined in clause 9.1.11.1.
- The absolute accuracy of intra-frequency RSRP measurements for Cell 2 on the secondary component carrier shall fulfil the requirements defined in clause 9.1.11.2.
- The relative accuracy of intra-frequency RSRP measurements for Cell 3 relative to Cell 2 on the secondary component carrier shall fulfil the requirements defined in clause 9.1.11.2.
- The relative accuracy of inter-frequency RSRP measurements between the primary and secondary component carriers for Cell 2 relative to Cell 1 shall fulfil the requirements defined in clause 9.1.11.3.

A.9.1.7 TDD RSRP for E-UTRAN Carrier Aggregation

The test case in this clause are applicable to carrier aggregation capable UEs which have been configured with a downlink Scell.

A.9.1.7.1 Test Purpose and Environment

The purpose of this test is to verify that the RSRP measurement accuracy is within the specified limits. This test will verify the absolute RSRP accuracy on PCell defined in clause 9.1.11.1, the absolute RSRP accuracy on Scell defined in clause 9.1.11.2, the relative RSRP accuracy between SCell and Cell 3 defined in clause 9.1.11.2, and the relative RSRP accuracy between PCell and SCell defined in clause 9.1.11.3.

A.9.1.7.2 Test parameters

In this set of test cases there are three cells on two carrier frequencies. Cell 1 is PCell on channel 1, Cell 2 is activated SCell on channel 2, and Cell 3 is neighbour cell which is also on channel 2. The parameters for the test are listed in Table A.9.1.7.2-1.

Table A.9.1.7.2-1: Carrier aggregation RSRP test parameters for TDD

| Parameter | Unit | Test 1 | | |
|---|------|--------|--|--------|
| | | Cell 1 | Cell 2 | Cell 3 |
| E-UTRA RF Channel Number | | 1 | 2 | |
| BW _{channel} | MHz | 10 | | |
| Special subframe configuration ^{Note1} | | 6 | | |
| Uplink/downlink configuration ^{Note1} | | 1 | | |
| Timing offset to Cell 1 | μs | - | 0 | 3 |
| Time alignment error between cell 2 and cell 1 | | - | ≤ Time alignment error as specified in 3GPP TS 36.104 [30] | - |

| | | | | | | | | |
|---|-------------|----------|-------------------------------|------------------------|-------------|------|-------------------------------|--|
| | | | clause 6.5.3.1 | | | | | |
| Measurement bandwidth | n_{PRB} | 22–27 | | | | | | |
| PDSCH Reference measurement channel defined in A.3.1.1.2 | | R.0 TDD | R.0 TDD | - | | | | |
| PDSCH allocation | n_{PRB} | 13–36 | 13–36 | - | | | | |
| PDCCH/PCFICH/PHICH Reference measurement channel defined in A.3.1.2.2 | | R.6 TDD | | | | | | |
| OCNG Patterns defined in A.3.2.2.1 (OP.1 TDD) and A.3.2.2.2 (OP.2 TDD) | | OP.1 TDD | OP.1 TDD | OP.2 TDD | | | | |
| PBCH_RA | dB | 0 | 0 | 0 | | | | |
| PBCH_RB | | | | | | | | |
| PSS_RA | | | | | | | | |
| SSS_RA | | | | | | | | |
| PCFICH_RB | | | | | | | | |
| PHICH_RA | | | | | | | | |
| PHICH_RB | | | | | | | | |
| PDCCH_RA | | | | | | | | |
| PDCCH_RB | | | | | | | | |
| PDSCH_RA | | | | | | | | |
| PDSCH_RB | | | | | | | | |
| OCNG_RA ^{Note2} | | | | | | | | |
| OCNG_RB ^{Note2} | | | | | | | | |
| N_{oc} ^{Note3} | | | | | Bands TDD_A | -117 | $(N_{oc}$ for Channel 1 +1dB) | |
| | | | | | Bands TDD_C | -116 | | |
| | | | | | Bands TDD_E | -115 | | |
| \hat{E}_s / I_{ot} | dB | -4 | 0.5 | -5.76 | | | | |
| RSRP ^{Note4} | Bands TDD_A | -121 | (RSRP for Cell 1 +8dB) | (RSRP for Cell 1 +4dB) | | | | |
| | Bands TDD_C | -120 | | | | | | |
| | Bands TDD_E | -119 | | | | | | |
| I_o ^{Note4} | Bands TDD_A | -87.76 | $(I_o$ for Channel 1 +5.33dB) | | | | | |
| | Bands TDD_C | -86.76 | | | | | | |
| | Bands TDD_E | -85.76 | | | | | | |
| \hat{E}_s / N_{oc} | dB | -4 | 3 | -1 | | | | |
| Propagation condition | - | AWGN | | | | | | |
| <p>Note 1: For special subframe and uplink-downlink configurations see Tables 4.2-1 and 4.2-2 in TS 36.211.</p> <p>Note 2: OCNG shall be used such that both cells are fully allocated and a constant total transmitted power spectral density is achieved for all OFDM symbols.</p> <p>Note 3: Interference from other cells and noise sources not specified in the test is assumed to be constant over subcarriers and time and shall be modelled as AWGN of appropriate power for N_{oc} to be fulfilled.</p> <p>Note 4: RSRP and I_o levels have been derived from other parameters for information purposes. They are not settable parameters themselves.</p> <p>Note 5: RSRP minimum requirements are specified assuming independent interference and noise at each receiver antenna port.</p> <p>Note 6: The selection of the bands for testing depends on the configuration of the carrier aggregation supported by the UEs.</p> <p>Note 7: This test verifies the RRM requirement which is independent of channel bandwidth and is performed according to the principle defined in section A.3.6.1.</p> <p>Note 8: E-UTRA operating band groups are as defined in Section 3.5.</p> | | | | | | | | |

A.9.1.7.3 Test Requirements

In the test, the performance of RSRP measurements is verified from following four perspectives:

- The absolute accuracy of intra-frequency RSRP measurements for Cell 1 on the primary component carrier shall fulfil the requirements defined in clause 9.1.11.1.
- The absolute accuracy of intra-frequency RSRP measurements for Cell 2 on the secondary component carrier shall fulfil the requirements defined in clause 9.1.11.2.

- The relative accuracy of intra-frequency RSRP measurements for Cell 3 relative to Cell 2 on the secondary component carrier shall fulfil the requirements defined in clause 9.1.11.2.
- The relative accuracy of inter-frequency RSRP measurements between the primary and secondary component carriers for Cell 2 relative to Cell 1 shall fulfil the requirements defined in clause 9.1.11.3

A.9.1.8 FDD RSRP under Time-Domain Measurement Resource Restriction with Non-MBSFN ABS

A.9.1.8.1 Test Purpose and Environment

The purpose of this test is to verify that the RSRP measurement accuracy is within the specified limits. This test will verify the requirements in Sections 9.1.2.3 and 9.1.2.4 for FDD intra-frequency RSRP measurements under time-domain measurement resource restriction with non-MBSFN ABS configured in the aggressor cell.

A.9.1.8.2 Test parameters

In this set of test cases all cells are on the same carrier frequency as PCell. Both absolute and relative accuracy of RSRP intra-frequency measurements are tested, with test parameters specified in Tables A.9.1.8.2-1 and A.9.1.8.2-2.

In the tests there are two synchronous cells, Cell 1 and Cell 2, on the same RF channel. In all test cases, Cell 1 is the serving cell (PCell) and also the aggressor cell to Cell 2. Cell 2 is the cell to be measured for RSRP absolute accuracy, whilst both Cell 1 and Cell 2 are measured for RSRP relative accuracy. Non-MBSFN ABS pattern is configured for Cell 1 during the test. The UE is configured by higher layers via Cell 1 with a time-domain measurement resource restriction pattern for performing E-UTRAN FDD intra-frequency measurements on neighbour cells and provided with a neighbour cell list associated with the pattern, where the cell list includes Cell 2. The UE is also configured with a time-domain measurement resource restriction pattern for the serving cell measurements. The information for both patterns shall be provided to the UE before the measurements start.

Table A.9.1.8.2-1: General test parameters for E-UTRAN FDD RSRP intra frequency test parameters under time-domain measurement resource restriction with non-MBSFN ABS

| Parameter | Unit | Value | Comment |
|--|------|---|--|
| Serving cell (PCell) | | Cell 1 | The aggressor cell to Cell 2 |
| Neighbour cell | | Cell 2 | Cell to be measured |
| PCell ABS configuration | | Non-MBSFN ABS | As defined in Table A.3.4.1.1-1 |
| CP length | | Normal | For both cells in the test |
| DRX | | | OFF |
| Time offset between cells | | 3 μ s | Synchronous cells |
| Physical cell ID PCI | | $(PCI_{cell1} - PCI_{cell2}) \bmod 6 \neq 0$ | Cell PCIs for Cell 1 and Cell 2 are selected randomly so that the condition is met |
| ABS pattern | | '1000000010000000100000000000100000000010000000100000000' | Non-MBSFN ABS. FDD ABS Pattern Info IE, as defined in TS 36.423 [28], clause 9.2.54. Configured in Cell 1. The first/leftmost bit corresponds to the subframe #0 of a radio frame satisfying $SFN \bmod x = 0$, where x is the size of the bit string (40) divided by 10. No MBSFN subframes are configured in the ABS subframes in Cell 1. |
| Time-domain measurement resource restriction pattern for neighbour cell measurements on RF Channel 1 | | '1000000010000000100000000000100000000010000000100000000' | Configured for Cell 2 measurements by measSubframePattern-Neigh IE in measSubframePatternConfig-Neigh, as defined in TS 36.331 [2], clause 6.3.5. measSubframeCellList contains Cell 2. |
| Time-domain measurement resource restriction pattern for serving cell measurements | | '01000000010000000100000000000000010000000010000000' | Configured for measurements on Cell 1. |

Table A.9.1.8.2-2: Cell-specific test parameters for E-UTRAN FDD RSRP intra-frequency test parameters under time-domain measurement resource restriction with non-MBSFN ABS

| Parameter | Unit | Test 1 | | Test 2 | | Test 3 | | | | | | | | |
|--|--------------------------------------|------------|----------|----------|----------|----------|----------|--------------------------------|------------|------|---|-----|--------|--|
| | | Cell 1 | Cell 2 | Cell 1 | Cell 2 | Cell 1 | Cell 2 | | | | | | | |
| E-UTRA RF Channel Number | | 1 | | 1 | | 1 | | | | | | | | |
| $BW_{channel}$ | MHz | 10 | | 10 | | 10 | | | | | | | | |
| Measurement bandwidth | n_{PRB} | 22–27 | | 22–27 | | 22–27 | | | | | | | | |
| PDSCH Reference measurement channel defined in A.3.1.1.1 | | R.0 FDD | - | R.0 FDD | - | R.0 FDD | - | | | | | | | |
| PDSCH allocation | n_{PRB} | 13–36 | - | 13–36 | - | 13–36 | - | | | | | | | |
| PDCCH/PCFICH/PHICH Reference measurement channel defined in A.3.1.2.1 | | R.6 FDD | | R.6 FDD | | R.6 FDD | | | | | | | | |
| OCNG Patterns defined in A.3.2.1.5 (OP.5 FDD) and A.3.2.1.6 (OP.6 FDD) | | OP.5 FDD | OP.6 FDD | OP.5 FDD | OP.6 FDD | OP.5 FDD | OP.6 FDD | | | | | | | |
| PBCH_RA | | | | | | | | | | | | | | |
| PBCH_RB | | | | | | | | | | | | | | |
| PCFICH_RB | | | | | | | | | | | | | | |
| PHICH_RA | | | | | | | | | | | | | | |
| PHICH_RB | | | | | | | | | | | | | | |
| PDCCH_RA | dB | Note 6 | 0 | Note 6 | 0 | Note 6 | 0 | | | | | | | |
| PDCCH_RB | | | | | | | | | | | | | | |
| PDSCH_RA | | | | | | | | | | | | | | |
| PDSCH_RB | | | | | | | | | | | | | | |
| OCNG_RA ^{Note1} | | | | | | | | | | | | | | |
| OCNG_RB ^{Note1} | | | | | | | | | | | | | | |
| PSS_RA | | | | | | | | -4 | 0 | -4 | 0 | -4 | 0 | |
| SSS_RA | | | | | | | | -4 | 0 | -4 | 0 | -4 | 0 | |
| N_{oc} ^{Note2} | | | | | | | | Bands FDD_A ^{Note 10} | dBm/15 kHz | -106 | | -88 | -116 | |
| | | | | | | | | Bands FDD_B | | | | | -115.5 | |
| | Bands FDD_C | -115 | | | | | | | | | | | | |
| | Bands FDD_D | -114.5 | | | | | | | | | | | | |
| | Bands FDD_E, FDD_F ^{Note 7} | -114 | | | | | | | | | | | | |
| | Bands FDD_G ^{Note 9} | -113 | | | | | | | | | | | | |
| | Bands FDD_H | -112.5 | | | | | | | | | | | | |
| $CRS \hat{E}_s / N_{oc}$ | dB | 5 | -2 | 5 | -4 | 5 | -4 | | | | | | | |
| $CRS (\hat{E}_s / I_{ot})_{meas}$ ^{Note 5} | dB | 2.88 | -2 | 3.54 | -4 | 3.54 | -4 | | | | | | | |
| $SCH \hat{E}_s / I_{ot}$ | dB | -1.12 | -5.54 | -0.46 | -7.54 | -0.46 | -7.54 | | | | | | | |
| RSRP ^{Note3,4,5} | Bands FDD_A ^{Note 10} | dBm/15 kHz | -101 | -108 | -83 | -92 | -111 | -120 | | | | | | |
| | Bands FDD_B | | | | | | -110.5 | -119.5 | | | | | | |
| | Bands FDD_C | | | | | | -110 | -119 | | | | | | |
| | Bands FDD_D | | | | | | -109.5 | -118.5 | | | | | | |
| | Bands FDD_E, FDD_F ^{Note 7} | | | | | | -109 | -118 | | | | | | |
| | Bands FDD_G ^{Note 9} | | | | | | -108 | -117 | | | | | | |
| | Bands FDD_H | | | | | | -107.5 | -116.5 | | | | | | |
| $(I_o)_{meas}$ ^{Note 3} | Bands FDD_A ^{Note 10} | dBm/9 MHz | -71.41 | -74.88 | -53.63 | -57.37 | -81.63 | -85.37 | | | | | | |
| | Bands FDD_B | | | | | | -81.13 | -84.87 | | | | | | |
| | Bands FDD_C | | | | | | -80.63 | -84.37 | | | | | | |
| | Bands FDD_D | | | | | | -80.13 | -83.87 | | | | | | |
| | Bands FDD_E, FDD_F ^{Note 7} | | | | | | -79.63 | -83.37 | | | | | | |
| | Bands FDD_G ^{Note 9} | | | | | | -78.63 | -82.37 | | | | | | |
| Bands FDD_H | -78.13 | -81.87 | | | | | | | | | | | | |
| Propagation condition | | AWGN | | AWGN | | AWGN | | | | | | | | |

| | |
|----------|--|
| Note 1: | OCNG shall be used such that both cells are fully allocated and a constant total transmitted power spectral density is achieved for all OFDM symbols. |
| Note 2: | Interference from other cells and noise sources not specified in the test is assumed to be constant over subcarriers and time and shall be modelled as AWGN of appropriate power for N_{oc} to be fulfilled. Applies to all subframes. |
| Note 3: | RSRP and I_0 levels have been derived from other parameters for information purposes. They are not settable parameters themselves. I_0 levels are calculated in CRS symbols of measurement restricted subframes. |
| Note 4: | RSRP minimum requirements are specified assuming independent interference and noise at each receiver antenna port. |
| Note 5: | Applies to restricted measurement subframes of the respective cell. |
| Note 6: | Non-ABS and ABS subframe channel powers defined in Table A.3.4.1.1-1. |
| Note 7: | For Band 26, the tests shall be performed with the carrier frequency of the assigned E-UTRA channel bandwidth within 865-894 MHz. |
| Note 8: | E-UTRA operating band groups are as defined in Section 3.5. |
| Note 9: | Except Band 29. |
| Note 10: | Except Band 32. |

A.9.1.8.3 Test Requirements

The absolute RSRP measurement accuracy and relative RSRP measurement accuracy shall fulfill the requirements in Sections 9.1.2.3 and 9.1.2.4, respectively.

A.9.1.9 TDD RSRP under Time-Domain Measurement Resource Restriction with Non-MBSFN ABS

A.9.1.9.1 Test Purpose and Environment

The purpose of this test is to verify that the RSRP measurement accuracy is within the specified limits. This test will verify the requirements in Sections 9.1.2.3 and 9.1.2.4 for TDD intra-frequency RSRP measurements under time-domain measurement resource restriction with non-MBSFN ABS configured in the aggressor cell.

A.9.1.9.2 Test parameters

In this set of test cases all cells are on the same carrier frequency as PCell. Both absolute and relative accuracy of RSRP intra-frequency measurements are tested, with test parameters specified in Tables A.9.1.9.2-1 and A.9.1.9.2-2.

In the tests there are two synchronous cells, Cell 1 and Cell 2, on the same RF channel. In all test cases, Cell 1 is the serving cell (PCell) and also the aggressor cell to Cell 2. Cell 2 is the cell to be measured for RSRP absolute accuracy, whilst both Cell 1 and Cell 2 are measured for RSRP relative accuracy. Non-MBSFN ABS pattern is configured for Cell 1 during the test. The UE is configured by higher layers via Cell 1 with a time-domain measurement resource restriction pattern for performing E-UTRAN TDD intra-frequency measurements on neighbour cells and provided with a neighbour cell list associated with the pattern, where the cell list includes Cell 2. The UE is also configured with a time-domain measurement resource restriction pattern for the serving cell measurements. The information for both patterns shall be provided to the UE before the measurements start.

Table A.9.1.9.2-1: General test parameters for E-UTRAN TDD RSRP intra frequency test parameters under time-domain measurement resource restriction with non-MBSFN ABS

| Parameter | Unit | Value | Comment |
|--|------|--|---|
| Serving cell (PCell) | | Cell 1 | Also the aggressor cell. |
| Neighbour cell | | Cell 2 | Cell to be measured |
| PCell ABS configuration | | Non-MBSFN ABS | As defined in Table A.3.4.1.1-1 |
| Special subframe configuration | | 6 | For Cell 1 and Cell 2. For special subframe configurations see Table 4.2-1 in [16]. |
| Uplink/downlink subframe configuration | | 1 | For Cell 1 and Cell 2. For uplink-downlink subframe configurations see Table 4.2-2 in [16]. |
| CP length | | Normal | For both cells in the test |
| DRX | | | OFF |
| Time offset between cells | | 3 μ s | Synchronous cells |
| Physical cell ID PCI | | $(PCI_{cell1} - PCI_{cell2}) \bmod 6 \neq 0$ | Cell PCIs for Cell 1 and Cell 2 are randomly selected so that the condition is met |

| | | | |
|--|--|------------------------|--|
| ABS pattern | | '00000000010000000001' | Non-MBSFN ABS. TDD ABS Pattern Info IE, as defined in TS 36.423 [28], clause 9.2.54. Configured in Cell 1. The first/leftmost bit corresponds to the subframe #0 of a radio frame satisfying SFN mod x = 0, where x is the size of the bit string (20) divided by 10. No MBSFN subframes are configured in the ABS subframes in Cell 1. |
| Time-domain measurement resource restriction pattern for neighbour cell measurements on RF Channel 1 | | '00000000010000000001' | Configured for Cell 2 measurements by measSubframePattern-Neigh IE in measSubframePatternConfig-Neigh, as defined in TS 36.331 [2], clause 6.3.5. measSubframeCellList contains Cell 2. |
| Time-domain measurement resource restriction pattern for serving cell measurements | | '10000000001000000000' | Configured for Cell 1 measurements. |

Table A.9.1.9.2-2: Cell-specific test parameters for E-UTRAN TDD RSRP intra-frequency test parameters under time-domain measurement resource restriction with non-MBSFN ABS

| Parameter | Unit | Test 1 | | Test 2 | | Test 3 | |
|--|-------------|------------|----------|----------|----------|----------|----------|
| | | Cell 1 | Cell 2 | Cell 1 | Cell 2 | Cell 1 | Cell 2 |
| E-UTRA RF Channel Number | | 1 | | 1 | | 1 | |
| BW _{channel} | MHz | 10 | | 10 | | 10 | |
| Measurement bandwidth | n_{PRB} | 22–27 | | 22–27 | | 22–27 | |
| PDSCH Reference measurement channel defined in A.3.1.1.2 | | R.0 TDD | - | R.0 TDD | - | R.0 TDD | - |
| PDSCH allocation | n_{PRB} | 13–36 | - | 13–36 | - | 13–36 | - |
| PDCCH/PCFICH/PHICH Reference measurement channel defined in A.3.1.2.2 | | R.6 TDD | | R.6 TDD | | R.6 TDD | |
| OCNG Patterns defined in A.3.2.2.1 (OP.1 TDD) and A.3.2.2.2 (OP.2 TDD) | | OP.1 TDD | OP.2 TDD | OP.1 TDD | OP.2 TDD | OP.1 TDD | OP.2 TDD |
| PBCH_RA | dB | Note 6 | 0 | Note 6 | 0 | Note 6 | 0 |
| PBCH_RB | | | | | | | |
| PCFICH_RB | | | | | | | |
| PHICH_RA | | | | | | | |
| PHICH_RB | | | | | | | |
| PDCCH_RA | | | | | | | |
| PDCCH_RB | | | | | | | |
| PDSCH_RA | | | | | | | |
| PDSCH_RB | | | | | | | |
| OCNG_RA ^{Note1} | | | | | | | |
| OCNG_RB ^{Note1} | | | | | | | |
| PSS_RA | | | | | | | |
| SSS_RA | dB | -4 | 0 | -4 | 0 | -4 | 0 |
| N_{oc} ^{Note 2} | Bands TDD_A | dBm/15 kHz | -106 | -88 | -116 | | |
| | Bands TDD_C | | | | -115 | | |
| | Bands TDD_E | | | | -114 | | |
| CRS \hat{E}_s / N_{oc} | dB | 5 | -2 | 5 | -4 | 5 | -4 |
| CRS $(\hat{E}_s / I_{ot})_{meas}$ ^{Note 5} | dB | 2.88 | -2 | 3.54 | -4 | 5 | -4 |
| SCH \hat{E}_s / I_{ot} | dB | -1.12 | -5.54 | -0.46 | -7.54 | -0.46 | -7.54 |
| RSRP ^{Note3,4,5} | Bands TDD_A | dBm/15 kHz | -101 | -108 | -83 | -92 | -111 |
| | Bands TDD_C | | | | | | -120 |
| | Bands TDD_E | | | | | | -119 |
| $(I_o)_{meas}$ ^{Note 3} | Bands TDD_A | dBm/9 MHz | -71.41 | -74.88 | -53.63 | -57.37 | -81.6 |
| | Bands TDD_C | | | | | | -85.4 |
| | Bands TDD_E | | | | | | -84.4 |
| Propagation condition | | AWGN | | AWGN | | AWGN | |

| | |
|---------|---|
| Note 1: | OCNG shall be used such that both cells are fully allocated and a constant total transmitted power spectral density is achieved for all OFDM symbols. |
| Note 2: | Interference from other cells and noise sources not specified in the test is assumed to be constant over subcarriers and time and shall be modelled as AWGN of appropriate power for N_{oc} to be fulfilled. Applies to all subframes. |
| Note 3: | RSRP and I_o levels have been derived from other parameters for information purposes. They are not settable parameters themselves. I_o levels are calculated in CRS symbols of measurement restricted subframes. |
| Note 4: | RSRP minimum requirements are specified assuming independent interference and noise at each receiver antenna port. |
| Note 5: | Applies to restricted measurement subframes of the respective cell. |
| Note 6: | Non-ABS and ABS subframe channel powers defined in Table A.3.4.1.1-1. |
| Note 7: | E-UTRA operating band groups are as defined in Section 3.5. |

A.9.1.9.3 Test Requirements

The absolute RSRP measurement accuracy and relative RSRP measurement accuracy shall fulfill the requirements in Sections 9.1.2.3 and 9.1.2.4, respectively.

A.9.1.10 FDD RSRP under Time-Domain Measurement Resource Restriction with MBSFN ABS

A.9.1.10.1 Test Purpose and Environment

The purpose of this test is to verify that the RSRP measurement accuracy is within the specified limits. This test will verify the requirements in Sections 9.1.2.3 and 9.1.2.4 for FDD intra-frequency RSRP measurements under time-domain measurement resource restriction with MBSFN ABS configured in the aggressor cell.

A.9.1.10.2 Test parameters

In this set of test cases all cells are on the same carrier frequency as PCell. Both absolute and relative accuracy of RSRP intra-frequency measurements are tested, with test parameters specified in Tables A.9.1.10.2-1 and A.9.1.10.2-2.

In the tests there are two synchronous cells, Cell 1 and Cell 2, on the same RF channel. In all test cases, Cell 1 is the serving cell (PCell) and also the aggressor cell to Cell 2. Cell 2 is the cell to be measured for RSRP absolute accuracy, whilst both Cell 1 and Cell 2 are measured for RSRP relative accuracy. MBSFN ABS pattern is configured in Cell 1 during the test. The UE is configured by higher layers via Cell 1 with a time-domain measurement resource restriction pattern for performing E-UTRAN FDD intra-frequency measurements on neighbour cells and provided with a neighbour cell list associated with the pattern, where the cell list includes Cell 2. The UE is also configured with a time-domain measurement resource restriction pattern for the serving cell measurements. The information for both patterns shall be provided to the UE before the measurements start.

Table A.9.1.10.2-1: General test parameters for E-UTRAN FDD RSRP intra-frequency test parameters under time-domain measurement resource restriction with MBSFN ABS

| Parameter | Unit | Value | Comment |
|---------------------------|------|--|--|
| Serving cell (PCell) | | Cell 1 | The aggressor cell to Cell 2 |
| Neighbour cell | | Cell 2 | Cell to be measured |
| PCell ABS configuration | | MBSFN ABS | As defined in Table A.3.4.2.1-1 |
| CP length | | Normal | For both cells in the test |
| DRX | | | OFF |
| Time offset between cells | | 3 μ s | Synchronous cells |
| Physical cell ID PCI | | $(PCI_{cell1} - PCI_{cell2}) \bmod 6 = 0$, PCI_{cell1} not equal to PCI_{cell2} | Cell PCIs for Cell 1 and Cell 2 are selected randomly so that the condition is met |

| | | | |
|--|--|--|---|
| ABS pattern | | '01000000100000001000 00000010000001000000' | MBSFN ABS pattern. FDD ABS Pattern Info IE, as defined in TS 36.423 [28], clause 9.2.54. Configured in Cell 1. The first/leftmost bit corresponds to the subframe #0 of a radio frame satisfying SFN mod x = 0, where x is the size of the bit string (40) divided by 10. All ABS subframes are MBSFN subframes. |
| Time-domain measurement resource restriction pattern for neighbour cell measurements on RF Channel 1 | | '01000000100000001000 00000010000001000000' | Configured for Cell 2 measurements by measSubframePatternNeigh IE in measSubframePatternConfigNeigh, as defined in TS 36.331 [2], clause 6.3.5. measSubframeCellList contains Cell 2. |
| Time-domain measurement resource restriction pattern for serving cell measurements | | '00010000000100000001 00000001000000010000' | Configured for measurements on Cell 1. |

Table A.9.1.10.2-2: Cell-specific test parameters for E-UTRAN FDD RSRP intra-frequency test parameters under time-domain measurement resource restriction with MBSFN ABS

| Parameter | Unit | Test 1 | | Test 2 | | Test 3 | | | | | | | | |
|--|--------------------------------------|------------|----------|----------|----------|----------|----------|----|----|---|----|---|----|---|
| | | Cell 1 | Cell 2 | Cell 1 | Cell 2 | Cell 1 | Cell 2 | | | | | | | |
| E-UTRA RF Channel Number | | 1 | | 1 | | 1 | | | | | | | | |
| BW _{channel} | MHz | 10 | | 10 | | 10 | | | | | | | | |
| Measurement bandwidth | n_{PRB} | 22–27 | | 22–27 | | 22–27 | | | | | | | | |
| PDSCH Reference measurement channel defined in A.3.1.1.1 | | R.0 FDD | - | R.0 FDD | - | R.0 FDD | - | | | | | | | |
| PDSCH allocation | n_{PRB} | 13–36 | - | 13–36 | - | 13–36 | - | | | | | | | |
| PDCCH/PCFICH/PHICH Reference measurement channel defined in A.3.1.2.1 | | R.6 FDD | | R.6 FDD | | R.6 FDD | | | | | | | | |
| OCNG Patterns defined in A.3.2.1.8 (OP.8 FDD) and A.3.2.1.6 (OP.6 FDD) | | OP.8 FDD | OP.6 FDD | OP.8 FDD | OP.6 FDD | OP.8 FDD | OP.6 FDD | | | | | | | |
| PBCH_RA | dB | Note 6 | 0 | Note 6 | 0 | Note 6 | 0 | | | | | | | |
| PBCH_RB | | | | | | | | | | | | | | |
| PCFICH_RB | | | | | | | | | | | | | | |
| PHICH_RA | | | | | | | | | | | | | | |
| PHICH_RB | | | | | | | | | | | | | | |
| PDCCH_RA | | | | | | | | | | | | | | |
| PDCCH_RB | | | | | | | | | | | | | | |
| PDSCH_RA | | | | | | | | | | | | | | |
| PDSCH_RB | | | | | | | | | | | | | | |
| OCNG_RA ^{Note1} | | | | | | | | | | | | | | |
| OCNG_RB ^{Note1} | | | | | | | | | | | | | | |
| PSS_RA | | | | | | | | dB | -4 | 0 | -4 | 0 | -4 | 0 |
| SSS_RA | | | | | | | | dB | -4 | 0 | -4 | 0 | -4 | 0 |
| N_{oc} ^{Note 2} | Bands FDD_A ^{Note 11} | dBm/15 kHz | -106 | -88 | -116 | | | | | | | | | |
| | Bands FDD_B | | | | -115.5 | | | | | | | | | |
| | Bands FDD_C | | | | -115 | | | | | | | | | |
| | Bands FDD_D | | | | -114.5 | | | | | | | | | |
| | Bands FDD_E, FDD_F ^{Note 8} | | | | -114 | | | | | | | | | |
| | Bands FDD_G ^{Note 10} | | | | -113 | | | | | | | | | |
| Bands FDD_H | -112.5 | | | | | | | | | | | | | |
| CRS \hat{E}_s / N_{oc} | dB | 5 | -2 | 5 | -4 | 5 | -4 | | | | | | | |
| CRS $(\hat{E}_s / I_{ot})_{meas}$ ^{Note 5, 7 in the 1st OFDM symbol} | dB | 2.88 | -8.19 | 3.54 | -10.19 | 3.54 | -10.19 | | | | | | | |
| CRS $(\hat{E}_s / I_{ot})_{meas}$ ^{Note 5 in OFDM} | dB | 2.88 | -2 | 3.54 | -4 | 3.54 | -4 | | | | | | | |

| | | | | | | | | |
|---|---------------------------|------------|--------|--------|--------|--------|--------|--------|
| symbols 4,7,11 | | | | | | | | |
| SCH \hat{E}_s / I_{ot} | | dB | -1.12 | -5.54 | -0.46 | -7.54 | -0.46 | -7.54 |
| RSRP Note 3,4 | Bands FDD_A Note 11 | dBm/15 kHz | -101 | -108 | -83 | -92 | -111 | -120 |
| | Bands FDD_B | | | | | | -110.5 | -119.5 |
| | Bands FDD_C | | | | | | -110 | -119 |
| | Bands FDD_D | | | | | | -109.5 | -118.5 |
| | Bands FDD_E, FDD_F Note 8 | | | | | | -109 | -118 |
| | Bands FDD_G Note 10 | | | | | | -108 | -117 |
| | Bands FDD_H | | | | | | -107.5 | -116.5 |
| $(I_o)_{meas}$ Note 3 in the 1 st OFDM symbol | Bands FDD_A Note 11 | dBm/9 MHz | -71.41 | -74.88 | -53.63 | -57.37 | -81.63 | -85.37 |
| | Bands FDD_B | | | | | | -81.13 | -84.87 |
| | Bands FDD_C | | | | | | -80.63 | -84.37 |
| | Bands FDD_D | | | | | | -80.13 | -83.87 |
| | Bands FDD_E, FDD_F Note 8 | | | | | | -79.63 | -83.37 |
| | Bands FDD_G Note 10 | | | | | | -78.63 | -82.37 |
| | Bands FDD_H | | | | | | -78.13 | -81.87 |
| $(I_o)_{meas}$ Note 3 in OFDM symbols other than the 1 st one | Bands FDD_A Note 11 | dBm/9 MHz | -71.41 | -76.09 | -53.63 | -58.76 | -81.63 | -86.76 |
| | Bands FDD_B | | | | | | -81.13 | -86.26 |
| | Bands FDD_C | | | | | | -80.63 | -85.76 |
| | Bands FDD_D | | | | | | -80.13 | -85.26 |
| | Bands FDD_E, FDD_F Note 8 | | | | | | -79.63 | -84.76 |
| | Bands FDD_G Note 10 | | | | | | -78.63 | -83.76 |
| | Bands FDD_H | | | | | | -78.13 | -83.26 |
| Propagation condition | | | AWGN | | AWGN | | AWGN | |
| <p>Note 1: OCNG shall be used such that both cells are fully allocated and a constant total transmitted power spectral density is achieved for all OFDM symbols.</p> <p>Note 2: Interference from other cells and noise sources not specified in the test is assumed to be constant over subcarriers and time and shall be modelled as AWGN of appropriate power for N_{oc} to be fulfilled. Applies to all subframes.</p> <p>Note 3: RSRP and I_o levels have been derived from other parameters for information purposes. They are not settable parameters themselves. I_o levels are calculated in CRS symbols of measurement restricted subframes.</p> <p>Note 4: RSRP minimum requirements are specified assuming independent interference and noise at each receiver antenna port.</p> <p>Note 5: Applies to restricted measurement subframes of the respective cell.</p> <p>Note 6: Non-ABS and ABS subframe channel powers defined in Table A.3.4.2.1-1.</p> <p>Note 7: In the 1st OFDM symbol, Cell 2 is not expected to meet the E_s/I_{ot} side condition in 9.1.2.3 and 9.1.2.4.</p> <p>Note 8: For Band 26, the tests shall be performed with the carrier frequency of the assigned E-UTRA channel bandwidth within 865-894 MHz.</p> <p>Note 9: E-UTRA operating band groups are as defined in Section 3.5.</p> <p>Note 10: Except Band 29.</p> <p>Note 11: Except Band 32.</p> | | | | | | | | |

A.9.1.10.3 Test Requirements

The absolute RSRP measurement accuracy and relative RSRP measurement accuracy shall fulfill the requirements in Sections 9.1.2.3 and 9.1.2.4, respectively.

A.9.1.11 TDD RSRP under Time-Domain Measurement Resource Restriction with MBSFN ABS

A.9.1.11.1 Test Purpose and Environment

The purpose of this test is to verify that the RSRP measurement accuracy is within the specified limits. This test will verify the requirements in Sections 9.1.2.3 and 9.1.2.4 for TDD intra-frequency RSRP measurements under time-domain measurement resource restriction with MBSFN ABS configured in the aggressor cell.

A.9.1.11.2 Test parameters

In this set of test cases all cells are on the same carrier frequency as PCell. Both absolute and relative accuracy of RSRP intra-frequency measurements are tested, with test parameters specified in Tables A.9.1.11.2-1 and A.9.1.11.2-2.

In the tests there are two synchronous cells, Cell 1 and Cell 2, on the same RF channel. In all test cases, Cell 1 is the serving cell (PCell) and also the aggressor cell to Cell 2. Cell 2 is the cell to be measured for RSRP absolute accuracy, whilst both Cell 1 and Cell 2 are measured for RSRP relative accuracy. MBSFN ABS pattern is configured in Cell 1 during the test. The UE is configured by higher layers via Cell 1 with a time-domain measurement resource restriction pattern for performing E-UTRAN TDD intra-frequency measurements on neighbour cells and provided with a neighbour cell list associated with the pattern, where the cell list includes Cell 2. The UE is also configured with a time-domain measurement resource restriction pattern for the serving cell measurements. The information for both patterns shall be provided to the UE before the measurements start.

Table A.9.1.11.2-1: General test parameters for E-UTRAN TDD RSRP intra-frequency test parameters under time-domain measurement resource restriction with MBSFN ABS

| Parameter | Unit | Value | Comment |
|--|------|--|---|
| Serving cell (PCell) | | Cell 1 | The aggressor cell to Cell 2 |
| Neighbour cell | | Cell 2 | Cell to be measured |
| PCell ABS configuration | | MBSFN ABS | As defined in Table A.3.4.2.1-1 |
| Special subframe configuration | | 6 | For Cell 1 and Cell 2. For special subframe configurations see Table 4.2-1 in [16]. |
| Uplink/downlink subframe configuration | | 1 | For Cell 1 and Cell 2. For uplink-downlink subframe configurations see Table 4.2-2 in [16]. |
| CP length | | Normal | For both cells in the test |
| DRX | | | OFF |
| Time offset between cells | | 3 μ s | Synchronous cells |
| Physical cell ID PCI | | $(PCI_{cell1} - PCI_{cell2}) \bmod 6 = 0$, PCI_{cell1} not equal to PCI_{cell2} | Cell PCIs for Cell 1 and Cell 2 are selected randomly so that the condition is met |
| ABS pattern | | '00001000000000100000' | MBSFN ABS pattern. TDD ABS Pattern Info IE, as defined in TS 36.423 [28], clause 9.2.54. Configured in Cell 1. The first/leftmost bit corresponds to the subframe #0 of a radio frame satisfying $SFN \bmod x = 0$, where x is the size of the bit string (20) divided by 10. All ABS subframes are MBSFN subframes. |
| Time-domain measurement resource restriction pattern for neighbour cell measurements on RF Channel 1 | | '00001000000000100000' | Configured for Cell 2 measurements by measSubframePatternNeigh IE in measSubframePatternConfigNeigh, as defined in TS 36.331 [2], clause 6.3.5. measSubframeCellList contains Cell 2. |
| Time-domain measurement resource restriction pattern for serving cell measurements | | '10000000001000000000' | Configured for measurements on Cell 1. |

Table A.9.1.11.2-2: Cell-specific test parameters for E-UTRAN TDD RSRP intra-frequency test parameters under time-domain measurement resource restriction with MBSFN ABS

| Parameter | Unit | Test 1 | | Test 2 | | Test 3 | |
|-----------|------|--------|--------|--------|--------|--------|--------|
| | | Cell 1 | Cell 2 | Cell 1 | Cell 2 | Cell 1 | Cell 2 |
| | | | | | | | |

| | | | | | | | | |
|---|-------------|------------|----------|----------|----------|----------|----------|----------|
| E-UTRA RF Channel Number | | | 1 | | 1 | | 1 | |
| BW _{channel} | | MHz | 10 | | 10 | | 10 | |
| Measurement bandwidth | | n_{PRB} | 22–27 | | 22–27 | | 22–27 | |
| PDSCH Reference measurement channel defined in A.3.1.1.2 | | | R.0 TDD | - | R.0 TDD | - | R.0 TDD | - |
| PDSCH allocation | | n_{PRB} | 13–36 | - | 13–36 | - | 13–36 | - |
| PDCCH/PCFICH/PHICH Reference measurement channel defined in A.3.1.2.2 | | | R.6 TDD | | R.6 TDD | | R.6 TDD | |
| OCNG Patterns defined in A.3.2.2.5 (OP.5 TDD) and A.3.2.2.2 (OP.2 TDD) | | | OP.5 TDD | OP.2 TDD | OP.5 TDD | OP.2 TDD | OP.5 TDD | OP.2 TDD |
| PBCH_RA | | dB | Note 6 | 0 | Note 6 | 0 | Note 6 | 0 |
| PBCH_RB | | | | | | | | |
| PCFICH_RB | | | | | | | | |
| PHICH_RA | | | | | | | | |
| PHICH_RB | | | | | | | | |
| PDCCH_RA | | | | | | | | |
| PDCCH_RB | | | | | | | | |
| PDSCH_RA | | | | | | | | |
| PDSCH_RB | | | | | | | | |
| OCNG_RA ^{Note1} | | | | | | | | |
| OCNG_RB ^{Note1} | | | | | | | | |
| PSS_RA | | | | | | | | |
| SSS_RA | | dB | -4 | 0 | -4 | 0 | -4 | 0 |
| N_{oc} ^{Note 2} | Bands TDD_A | dBm/15 kHz | -106 | | -88 | | -116 | |
| | Bands TDD_C | | | | | | -115 | |
| | Bands TDD_E | | | | | | -114 | |
| CRS \hat{E}_s / N_{oc} | | dB | 5 | -2 | 5 | -4 | 5 | -4 |
| CRS $(\hat{E}_s / I_{ot})_{meas}$ ^{note 5, note 7} in the 1 st OFDM symbol | | dB | 2.88 | -8.19 | 3.54 | -10.19 | 3.54 | -10.19 |
| CRS $(\hat{E}_s / I_{ot})_{meas}$ ^{note 5} in OFDM symbols 4,7,11 | | dB | 2.88 | -2 | 3.54 | -4 | 3.54 | -4 |
| SCH \hat{E}_s / I_{ot} | | dB | -1.12 | -5.54 | -0.46 | -7.54 | -0.46 | -7.54 |
| RSRP ^{Note 3,4} | Bands TDD_A | dBm/15 kHz | -101 | -108 | -83 | -92 | -111 | |
| | Bands TDD_C | | | | | | -110 | |
| | Bands TDD_E | | | | | | -109 | |
| $(I_o)_{meas}$ ^{Note 3} in the 1 st OFDM symbol | Bands TDD_A | dBm/9 MHz | -71.41 | -74.88 | -53.63 | -57.37 | -81.63 | |
| | Bands TDD_C | | | | | | -85.37 | |
| | Bands TDD_E | | | | | | -80.63 | |
| $(I_o)_{meas}$ ^{Note 3} in OFDM symbols other than the 1 st one | Bands TDD_A | dBm/9 MHz | -71.41 | -76.09 | -53.63 | -58.76 | -81.63 | |
| | Bands TDD_C | | | | | | -86.76 | |
| | Bands TDD_E | | | | | | -80.63 | |
| Propagation condition | | | AWGN | | AWGN | | AWGN | |
| <p>Note 1: OCNG shall be used such that both cells are fully allocated and a constant total transmitted power spectral density is achieved for all OFDM symbols.</p> <p>Note 2: Interference from other cells and noise sources not specified in the test is assumed to be constant over subcarriers and time and shall be modelled as AWGN of appropriate power for N_{oc} to be fulfilled. Applies to all subframes.</p> <p>Note 3: RSRP and I_o levels have been derived from other parameters for information purposes. They are not settable parameters themselves. I_o levels are calculated in CRS symbols of measurement restricted subframes.</p> <p>Note 4: RSRP minimum requirements are specified assuming independent interference and noise at each receiver antenna port</p> <p>Note 5: Applies to restricted measurement subframes of the respective cell.</p> <p>Note 6: Non-ABS and ABS subframe channel powers defined in Table A.3.4.2.1-1.</p> <p>Note 7: In the 1st OFDM symbol, Cell 2 is not expected to meet the E_s/I_{ot} side condition in 9.1.2.3 and 9.1.2.4.</p> <p>Note 8: E-UTRA operating band groups are as defined in Section 3.5.</p> | | | | | | | | |

A.9.1.11.3 Test Requirements

The absolute RSRP measurement accuracy and relative RSRP measurement accuracy shall fulfill the requirements in Sections 9.1.2.3 and 9.1.2.4, respectively.

A.9.1.12 FDD RSRP for E-UTRAN Carrier Aggregation for 20MHz

The test case in this section are applicable to carrier aggregation capable UEs which have been configured with a downlink Scell.

A.9.1.12.1 Test Purpose and Environment

The purpose of this test case is the same as for the test defined in subclause A.9.1.6.1.

A.9.1.12.2 Test parameters

The test parameters are the same except those described in the following section. The listed parameter values in Tables A.9.1.12.2-1 will replace the values of corresponding parameters in Tables A.9.1.6.2-1.

Table A.9.1.12.2-1: RSRP FDD carrier aggregation test parameters

| Parameter | | Unit | Test 1 | | |
|---|-------------------------------|------------|-----------|--|-----------|
| | | | Cell 1 | Cell 2 | Cell 3 |
| BW _{channel} ^{Note 1} | | MHz | 20 | 20 | 20 |
| Measurement bandwidth | | n_{PRB} | 47—52 | | |
| PDSCH Reference measurement channel defined in A.3.1.1.1 | | | R.4 FDD | R.4 FDD | N/A |
| PDSCH allocation | | n_{PRB} | 38—61 | 38—61 | N/A |
| PDCCH/PCFICH/PHICH Reference measurement channel defined in A.3.1.2.1 | | | R.10 FDD | | |
| OCNG Patterns defined in A.3.2.1.11 (OP.11 FDD) and A.3.2.1.12 (OP.12 FDD) | | | OP.11 FDD | OP.11 FDD | OP.12 FDD |
| I _o ^{Note2} | Bands FDD_A ^{Note 5} | dBm/18 MHz | -84.75 | (I _o for Channel 1 +5.33dB) | |
| | Bands FDD_B ^{Note 5} | | -84.25 | | |
| | Bands FDD_C ^{Note 5} | | -83.75 | | |
| | Bands FDD_D ^{Note 5} | | -83.25 | | |
| | Bands FDD_E ^{Note 5} | | -82.75 | | |
| | Bands FDD_G ^{Note 5} | | -81.75 | | |
| | Bands FDD_H ^{Note 5} | | -81.25 | | |
| <p>Note 1: This test verifies the RRM requirement which is independent of channel bandwidth and is performed according to the principle defined in section A.3.6.1.</p> <p>Note 2: I_o levels have been derived from other parameters for information purposes. They are not settable parameters themselves.</p> <p>Note 3: See Table A.9.1.6.2-1 for the other parameters.</p> <p>Note 4: E-UTRA operating band groups are as defined in Section 3.5.</p> <p>Note 5: The test applies for E-UTRA operating bands in this band group which are supporting 20 MHz channel bandwidth.</p> | | | | | |

A.9.1.12.3 Test Requirements

The test requirements defined in section A.9.1.6.3 shall apply to this test case.

A.9.1.13 TDD RSRP for E-UTRAN Carrier Aggregation for 20MHz

The test case in this section are applicable to carrier aggregation capable UEs which have been configured with a downlink Scell.

A.9.1.13.1 Test Purpose and Environment

The purpose of this test case is the same as for the test defined in subclause A.9.1.7.1.

A.9.1.13.2 Test parameters

The test parameters are the same except those described in the following section. The listed parameter values in Tables A.9.1.13.2-1 will replace the values of corresponding parameters in Tables A.9.1.7.2-1.

Table A.9.1.13.2-1: Carrier aggregation RSRP test parameters for TDD

| Parameter | Unit | Test 1 | | |
|---|------------|-----------------------------------|----------|--|
| | | Cell 1 | Cell 2 | Cell 3 |
| BW_{channel} <small>Note 1</small> | MHz | 20 | | |
| Measurement bandwidth | n_{PRB} | 47–52 | | |
| PDSCH Reference measurement channel defined in A.3.1.1.2 | | R.3 TDD | R.3 TDD | N/A |
| PDSCH allocation | n_{PRB} | 38–61 | 38–61 | N/A |
| PDCCH/PCFICH/PHICH Reference measurement channel defined in A.3.1.2.2 | | R.10 TDD | | |
| OCNG Patterns defined in A.3.2.2.7 (OP.7 TDD) and A.3.2.2.8 (OP.8 TDD) | | OP.7 TDD | OP.7 TDD | OP.8 TDD |
| I_0 <small>Note 2</small> | dBm/18 MHz | Bands TDD_A <small>Note 5</small> | -84.75 | (I ₀ for Channel 1 +5.33dB) |
| | | Bands TDD_C <small>Note 5</small> | -83.75 | |
| | | Bands TDD_E <small>Note 5</small> | -82.75 | |
| Note 1: This test verifies the RRM requirement which is independent of channel bandwidth and is performed according to the principle defined in section A.3.6.1. Note 2: I ₀ levels have been derived from other parameters for information purposes. They are not settable parameters themselves. Note 3: See Table A.9.1.7.2-1 for the other parameters. Note 4: E-UTRA operating band groups are as defined in Section 3.5. Note 5: The test applies for E-UTRA operating bands in this band group which are supporting 20 MHz channel bandwidth. | | | | |

A.9.1.13.3 Test Requirements

The test requirements defined in section A.9.1.7.3 shall apply to this test case.

A.9.1.14 FDD RSRP under Time-Domain Measurement Resource Restriction with CRS Assistance Information and Non-MBSFN ABS

A.9.1.14.1 Test Purpose and Environment

The purpose of this test is to verify that the RSRP measurement accuracy is within the specified limits. This test will verify the requirements in Sections 9.1.2.5 and 9.1.2.6 for FDD intra-frequency RSRP measurements under time-domain measurement resource restriction with CRS Assistance Information and non-MBSFN ABS configured in the aggressor cells.

A.9.1.14.2 Test parameters

In this set of test cases all cells are on the same carrier frequency as PCell. Both absolute and relative accuracy of RSRP intra-frequency measurements are tested, with test parameters specified in Tables A.9.1.14.2-1 and A.9.1.14.2-2.

In the tests there are three synchronous cells, Cell 1, Cell2 and Cell 3, on the same RF channel. In all test cases, Cell 1 is the serving cell (PCell) and also the aggressor cell to Cell 3. Cell 2 is the neighbour aggressor cell without CRS colliding to Cell 3. Cell 3 is the cell to be measured for RSRP absolute accuracy, whilst both Cell 1 and Cell 3 are measured for RSRP relative accuracy. Non-MBSFN ABS pattern is configured for Cell 1 and Cell 2 during the test.

The UE is configured by higher layers with a time domain measurement resource restriction pattern for performing E-UTRAN FDD intra-frequency measurements on neighbour cells, namely Cell 3 measurements. The UE is also provided via higher layers with the CRS assistance information for Cell 2. The information for both measurement pattern and the CRS assistance information shall be provided via RRC to the UE before the measurements start.

Note: It's up to eNB's implementation whether the time domain measurement resource restriction pattern for PCell measurements is configured or not.

Table A.9.1.14.2-1: General test parameters for FDD RSRP under Time-Domain Measurement Resource Restriction with CRS Assistance Information and Non-MBSFN ABS

| Parameter | | Unit | Value | Comment |
|--|--------------------------|------|--|---|
| Serving cell (PCell) | | | Cell 1 | The aggressor cell to Cell 3 |
| Neighbour cell | | | Cell 2 | The aggressor cell to Cell 3 |
| Neighbour cell | | | Cell 3 | Cell to be measured |
| PCell ABS configuration | | | Non-MBSFN ABS | As defined in Table A.3.4.1.1-1 |
| CP length | | | Normal | For three cells in the test |
| DRX | | | | OFF |
| Cell 2 time offset with respect to Cell 1 | | | 0µs | Synchronous cells |
| Cell 3 time offset with respect to Cell 1 | | | -2.5 µs | Synchronous cells |
| Physical cell ID PCI | | | Colliding CRS: $(PCI_{cell1} - PCI_{cell3}) \bmod 6 = 0$, PCI_{cell1} not equal to PCI_{cell3} Non-colliding CRS: $(PCI_{cell2} - PCI_{cell3}) \bmod 6 \neq 0$ | Cell PCIs for three cells are selected randomly so that all conditions are met |
| ABS pattern | | | '10000000100000001000 00001000000010000000' | Non-MBSFN ABS. FDD ABS Pattern Info IE, as defined in TS 36.423 [28], clause 9.2.54. Configured in Cell 1. The first/leftmost bit corresponds to the Pcell subframe #0 of a radio frame satisfying $SN \bmod x = 0$, where x is the size of the bit string (40) divided by 10. No MBSFN subframes are configured in the ABS subframes in Cell 1. |
| Time-domain measurement resource restriction pattern for neighbour cell measurements on RF Channel 1 | | | '10000000100000001000 00001000000010000000' | Time domain measurement resource restriction pattern for neighbor cell measurement signalled to the UE in measSubframePatternNeigh IE in measSubframePatternConfigNeigh, as defined in TS 36.331, clause 6.3.5. Configured before the measurements start. The cell list in measSubframeCellList IE shall contain Cell 3 but not Cell 2. |
| Time-domain measurement resource restriction pattern for serving cell measurements | | | '01000000010000000100 00000100000001000000' | Configured for measurements on Cell 1. |
| CRS assistance information | physCellId | | see PCI conditions above | The CRS assistance information is provided for Cell 2 only in CRS-AssistanceInfo. It includes a single MBSFN-SubframeConfig element with subframe allocation <i>one Frame</i> ='000000'. |
| | antennaPortsCount | | 1 | |
| | mbsfn-SubframeConfigList | | <i>oneFrame</i> = '000000' | |

Table A.9.1.14.2-2: Cell-specific test parameters for FDD RSRP under Time-Domain Measurement Resource Restriction with CRS Assistance Information and Non-MBSFN ABS

| Parameter | Unit | Test 1 | Test 2 | Test 3 |
|-----------|------|--------|--------|--------|
|-----------|------|--------|--------|--------|

| | | Cell 1 | Cell 2 | Cell 3 | Cell 1 | Cell 2 | Cell 3 | Cell 1 | Cell 2 | Cell 3 | |
|--|--------------------------------------|-----------------|----------|----------|----------|----------|----------|----------|----------|----------|--------------------------------|
| E-UTRA RF Channel Number | | 1 | | | 1 | | | 1 | | | |
| BW _{channel} | | 10 | | | 10 | | | 10 | | | |
| Measurement bandwidth | | 22—27 | | | 22—27 | | | 22—27 | | | |
| PDSCH Reference measurement channel defined in A.3.1.1.1 | | R.0 FDD | - | - | R.0 FDD | - | - | R.0 FDD | - | - | |
| PDSCH allocation | | n_{PRB} 13—36 | - | - | 13—36 | - | - | 13—36 | - | - | |
| PDCCH/PCFICH/PHICH Reference measurement channel defined in A.3.1.2.1 | | R.6 FDD | | | R.6 FDD | | | R.6 FDD | | | |
| OCNG Patterns defined in A.3.2.1.5 (OP.5 FDD) and A.3.2.1.6 (OP.6 FDD) | | OP.5 FDD | OP.6 FDD | OP.6 FDD | OP.5 FDD | OP.6 FDD | OP.6 FDD | OP.5 FDD | OP.6 FDD | OP.6 FDD | |
| PBCH_RA | dB | Note 6 | Note 6 | 0 | Note 6 | Note 6 | 0 | Note 6 | Note 6 | 0 | |
| PBCH_RB | | | | | | | | | | | |
| PSS_RA | | | | | | | | | | | |
| SSS_RA | | | | | | | | | | | |
| PCFICH_RB | | | | | | | | | | | |
| PHICH_RA | | | | | | | | | | | |
| PHICH_RB | | | | | | | | | | | |
| PDCCH_RA | | | | | | | | | | | |
| PDCCH_RB | | | | | | | | | | | |
| PDSCH_RA | | | | | | | | | | | |
| PDSCH_RB | | | | | | | | | | | |
| OCNG_RA ^{Note1} | | | | | | | | | | | |
| OCNG_RB ^{Note1} | | | | | | | | | | | |
| N_{oc} ^{Note2} | | | | | | | | | | | Bands FDD_A ^{Note 10} |
| | Bands FDD_B | -115.5 | | | | | | | | | |
| | Bands FDD_C | -115 | | | | | | | | | |
| | Bands FDD_D | -114.5 | | | | | | | | | |
| | Bands FDD_E, FDD_F ^{Note 7} | -114 | | | | | | | | | |
| | Bands FDD_G ^{Note 9} | -113 | | | | | | | | | |
| Bands FDD_H | -112.5 | | | | | | | | | | |
| CRS \hat{E}_s / N_{oc} | dB | 4 | 2 | -1.5 | 4 | 2 | -4 | 4 | 2 | -4 | |
| CRS $(\hat{E}_s / I_{ot})_{meas}$ ^{Note 5} | dB | -1.18 | -0.32 | -6.96 | -0.75 | 0.54 | -9.46 | -0.75 | 0.54 | -9.46 | |
| RSRP ^{Note3,4,5} | Bands FDD_A ^{Note 10} | dBm/15 kHz | -102 | -104 | -107.5 | -84 | -86 | -92 | -112 | -114 | -120 |
| | Bands FDD_B | | | | | | | | -111.5 | -113.5 | 119.5 |
| | Bands FDD_C | | | | | | | | -111 | -113 | -119 |
| | Bands FDD_D | | | | | | | | -110.5 | -112.5 | -118.5 |
| | Bands FDD_E, FDD_F ^{Note 7} | | | | | | | | -110 | -112 | -118 |
| | Bands FDD_G ^{Note 9} | | | | | | | | -109 | -111 | -117 |
| Bands FDD_H | -108.5 | -110.5 | -116.5 | | | | | | | | |
| $(I_o)_{meas}$ ^{Note 3,5} | Bands FDD_A ^{Note 10} | dBm/9 MHz | -70.58 | -74.43 | -52.82 | -57.04 | -80.82 | -85.04 | | | |
| | Bands FDD_B | | | | | | -80.32 | -84.54 | | | |
| | Bands FDD_C | | | | | | -79.82 | -84.04 | | | |
| | Bands FDD_D | | | | | | -79.32 | -83.54 | | | |
| | Bands FDD_E, FDD_F ^{Note 7} | | | | | | -78.82 | -83.04 | | | |
| | Bands FDD_G ^{Note 9} | | | | | | -77.82 | -82.04 | | | |
| Bands FDD_H | -77.32 | -81.54 | | | | | | | | | |
| Propagation condition | | AWGN | | | AWGN | | | AWGN | | | |

| | |
|----------|---|
| Note 1: | OCNG shall be used such that both cells are fully allocated and a constant total transmitted power spectral density is achieved for all OFDM symbols. |
| Note 2: | Interference from other cells and noise sources not specified in the test is assumed to be constant over subcarriers and time and shall be modelled as AWGN of appropriate power for N_{oc} to be fulfilled. Applies to all subframes. |
| Note 3: | RSRP and I_o levels have been derived from other parameters for information purposes. They are not settable parameters themselves. I_o levels are calculated in CRS symbols of measurement restricted subframes. |
| Note 4: | RSRP minimum requirements are specified assuming independent interference and noise at each receiver antenna port. |
| Note 5: | Applies to restricted measurement subframes for only Cell 2 and Cell 3. For Cell 1, the corresponding value is derived from the normal subframes other than the subframes indicated in the time domain measurement resource restriction pattern for intra-frequency measurements. |
| Note 6: | Non-ABS and ABS subframe channel powers defined in Table A.3.4.1.1-1. |
| Note 7: | For Band 26, the tests shall be performed with the carrier frequency of the assigned E-UTRA channel bandwidth within 865-894 MHz. |
| Note 8: | E-UTRA operating band groups are as defined in Section 3.5. |
| Note 9: | Except Band 29. |
| Note 10: | Except Band 32. |

A.9.1.14.3 Test Requirements

The absolute RSRP measurement accuracy and relative RSRP measurement accuracy shall fulfill the requirements in Sections 9.1.2.5 and 9.1.2.6, respectively.

A.9.1.15 TDD RSRP under Time-Domain Measurement Resource Restriction with CRS Assistance Information and Non-MBSFN ABS

A.9.1.15.1 Test Purpose and Environment

The purpose of this test is to verify that the RSRP measurement accuracy is within the specified limits. This test will verify the requirements in Sections 9.1.2.5 and 9.1.2.6 for TDD intra-frequency RSRP measurements under time-domain measurement resource restriction with CRS Assistance Information and non-MBSFN ABS configured in the aggressor cells.

A.9.1.15.2 Test parameters

In this set of test cases all cells are on the same carrier frequency as PCell. Both absolute and relative accuracy of RSRP intra-frequency measurements are tested, with test parameters specified in Tables A.9.1.15.2-1 and A.9.1.15.2-2.

In the tests there are three synchronous cells, Cell 1, Cell2 and Cell 3, on the same RF channel. In all test cases, Cell 1 is the serving cell (PCell) and also the aggressor cell to Cell 3. Cell 2 is the neighbour aggressor cell without CRS colliding to Cell 3. Cell 3 is the cell to be measured for RSRP absolute accuracy, whilst both Cell 1 and Cell 3 are measured for RSRP relative accuracy. Non-MBSFN ABS pattern is configured for Cell 1 and Cell 2 during the test.

The UE is configured by higher layers with a time domain measurement resource restriction pattern for performing E-UTRAN TDD intra-frequency measurements on neighbour cells, namely Cell 3 measurements. The UE is also provided via higher layers with the CRS assistance information for Cell 2. The information for both measurement pattern and the CRS assistance information shall be provided via RRC to the UE before the measurements start.

Note: It's up to eNB's implementation whether the time domain measurement resource restriction pattern for PCell measurements is configured or not.

Table A.9.1.15.2-1: General test parameters for TDD RSRP under Time-Domain Measurement Resource Restriction with CRS Assistance Information and Non-MBSFN ABS

| Parameter | Unit | Value | Comment |
|--------------------------------|------|---------------|--|
| Serving cell (PCell) | | Cell 1 | The aggressor cell to Cell 3 |
| Neighbour cell | | Cell 2 | The aggressor cell to Cell 3 |
| Neighbour cell | | Cell 3 | Cell to be measured |
| PCell ABS configuration | | Non-MBSFN ABS | As defined in Table A.3.4.1.1-1 |
| CP length | | Normal | For three cells in the test |
| Special subframe configuration | | 6 | As specified in table 4.2-1 in TS 36.211. The same configuration in both cells |

| | | | |
|--|--------------------------|--|---|
| Uplink-downlink configuration | | 1 | As specified in table 4.2-2 in TS 36.211. The same configuration in both cells |
| DRX | | | OFF |
| Cell 2 time offset with respect to Cell 1 | | 0µs | Synchronous cells |
| Cell 3 time offset with respect to Cell 1 | | -2.5 µs | Synchronous cells |
| Physical cell ID PCI | | Colliding CRS: $(PCI_{cell1} - PCI_{cell3}) \bmod 6 = 0$, PCI_{cell1} not equal to PCI_{cell3} Non-colliding CRS: $(PCI_{cell2} - PCI_{cell3}) \bmod 6 \neq 0$ | Cell PCIs for three cells are selected randomly so that all conditions are met |
| ABS pattern | | '000000001000000001' | TDD ABS Pattern Info IE, as defined in TS 36.423 [28], clause 9.2.54. The first/leftmost bit corresponds to the Pcell subframe #0 of the radio frame satisfying $SFN \bmod x = 0$, where x is the size of the bit string (20) divided by 10. No MBSFN subframes are configured in the ABS subframes. Provided to the UE for Cell 1 and Cell 2 before the measurements start. |
| Time-domain measurement resource restriction pattern for neighbour cell measurements on RF Channel 1 | | '000000001000000001' | Time domain measurement resource restriction pattern for neighbor cell measurement signalled to the UE in measSubframePatternNeigh IE in measSubframePatternConfigNeigh, as defined in TS 36.331, clause 6.3.5. Configured before the measurements start. The cell list in measSubframeCellList IE shall contain Cell 3 but not Cell 2. |
| Time-domain measurement resource restriction pattern for serving cell measurements | | '1000000001000000000' | Configured for Cell 1 measurements. |
| CRS assistance information | physCellId | see PCI conditions above | The CRS assistance information is provided for Cell 2 only in CRS-AssistanceInfo. It includes a single MBSFN-SubframeConfig element with subframe allocation <i>one Frame</i> ='000000'. |
| | antennaPortsCount | 1 | |
| | mbsfn-SubframeConfigList | <i>oneFrame</i> = '000000' | |

Table A.9.1.15.2-2: Cell-specific test parameters for TDD RSRP under Time-Domain Measurement Resource Restriction with CRS Assistance Information and Non-MBSFN ABS

| Parameter | Unit | Test 1 | | | Test 2 | | | Test 3 | | |
|---|-----------|----------|----------|----------|----------|----------|----------|----------|----------|----------|
| | | Cell 1 | Cell 2 | Cell 3 | Cell 1 | Cell 2 | Cell 3 | Cell 1 | Cell 2 | Cell 3 |
| E-UTRA RF Channel Number | | 1 | | | 1 | | | 1 | | |
| BW _{channel} | MHz | 10 | | | 10 | | | 10 | | |
| Measurement bandwidth | n_{PRB} | 22—27 | | | 22—27 | | | 22—27 | | |
| PDSCH Reference measurement channel defined in A.3.1.1.2 | | R.0 TDD | - | - | R.0 TDD | - | - | R.0 TDD | - | - |
| PDSCH allocation | n_{PRB} | 13—36 | - | - | 13—36 | - | - | 13—36 | - | - |
| PDCCH/PCFICH/PHICH Reference measurement channel defined in A.3.1.2.2 | | R.6 TDD | | | R.6 TDD | | | R.6 TDD | | |
| OCNG Patterns defined in A.3.2.2 | | OP.1 TDD | OP.2 TDD | OP.2 TDD | OP.1 TDD | OP.2 TDD | OP.2 TDD | OP.1 TDD | OP.2 TDD | OP.2 TDD |
| PBCH_RA | dB | Note 6 | | 0 | Note 6 | | 0 | Note 6 | | 0 |
| PBCH_RB | | | | | | | | | | |
| PSS_RA | | | | | | | | | | |
| SSS_RA | | | | | | | | | | |

| | | | | | | | | | | | |
|--|-------------|------------|--------|--------|--------|--------|--------|--------|--------|-------|------|
| PCFICH_RB | | | | | | | | | | | |
| PHICH_RA | | | | | | | | | | | |
| PHICH_RB | | | | | | | | | | | |
| PDCCH_RA | | | | | | | | | | | |
| PDCCH_RB | | | | | | | | | | | |
| PDSCH_RA | | | | | | | | | | | |
| PDSCH_RB | | | | | | | | | | | |
| OCNG_RA ^{Note1} | | | | | | | | | | | |
| OCNG_RB ^{Note1} | | | | | | | | | | | |
| N_{oc} ^{Note2} | Bands TDD_A | dBm/15 kHz | -106 | | | -88 | | | -116 | | |
| | Bands TDD_C | | | | | | | | -115 | | |
| | Bands TDD_E | | | | | | | | -114 | | |
| CRS \hat{E}_s / N_{oc} | dB | 4 | 2 | -1.5 | 4 | 2 | -4 | 4 | 2 | -4 | |
| CRS $(\hat{E}_s / I_{ot})_{meas}$ ^{Note 5} | dB | -1.18 | -0.32 | -6.96 | -0.75 | 0.54 | -9.46 | -0.75 | 0.54 | -9.46 | |
| RSRP ^{Note3,4,5} | Bands TDD_A | dBm/15 kHz | -102 | -104 | -107.5 | -84 | -86 | -92 | -112 | -114 | -120 |
| | Bands TDD_C | | | | | | | | -111 | -113 | -119 |
| | Bands TDD_E | | | | | | | | -110 | -112 | -118 |
| $(I_o)_{meas}$ ^{Note 3, 5} | Bands TDD_A | dBm/9 MHz | -70.58 | -74.43 | -52.82 | -57.04 | -57.04 | -80.82 | -85.04 | | |
| | Bands TDD_C | | | | | | | -79.82 | -84.04 | | |
| | Bands TDD_E | | | | | | | -78.82 | -83.04 | | |
| Propagation condition | | AWGN | | | AWGN | | | AWGN | | | |
| <p>Note 1: OCNG shall be used such that both cells are fully allocated and a constant total transmitted power spectral density is achieved for all OFDM symbols.</p> <p>Note 2: Interference from other cells and noise sources not specified in the test is assumed to be constant over subcarriers and time and shall be modelled as AWGN of appropriate power for N_{oc} to be fulfilled. Applies to all subframes.</p> <p>Note 3: RSRP and I_o levels have been derived from other parameters for information purposes. They are not settable parameters themselves. I_o levels are calculated in CRS symbols of measurement restricted subframes.</p> <p>Note 4: RSRP minimum requirements are specified assuming independent interference and noise at each receiver antenna port.</p> <p>Note 5: Applies to restricted measurement subframes for only Cell 2 and Cell 3. For Cell 1, the corresponding value is derived from the normal subframes other than the subframes indicated in the time domain measurement resource restriction pattern for intra-frequency measurements.</p> <p>Note 6: Non-ABS and ABS subframe channel powers defined in Table A.3.4.1.1-1.</p> <p>Note 7: E-UTRA operating band groups are as defined in Section 3.5.</p> | | | | | | | | | | | |

A.9.1.15.3 Test Requirements

The absolute RSRP measurement accuracy and relative RSRP measurement accuracy shall fulfill the requirements in Sections 9.1.2.5 and 9.1.2.6, respectively.

A.9.1.16 FDD Intra frequency case for 5MHz Bandwidth

A.9.1.16.1 Test Purpose and Environment

The purpose of this test is to verify that the RSRP measurement accuracy is within the specified limits. This test will verify the requirements in Sections 9.1.2.1 and 9.1.2.2 for FDD intra frequency measurements.

A.9.1.16.2 Test parameters

In this set of test cases all cells are on the same carrier frequency. Both absolute and relative accuracy of RSRP intra frequency measurements are tested by using the parameters in Table A.9.1.16.2-1. In all test cases, Cell 1 is the PCell and Cell 2 the target cell.

Table A.9.1.16.2-1: RSRP FDD Intra frequency test parameters for 5MHz Bandwidth

| Parameter | Unit | Test 1 | | Test 2 | | Test 3 | |
|--------------------------|-----------|--------|--------|--------|--------|--------|--------|
| | | Cell 1 | Cell 2 | Cell 1 | Cell 2 | Cell 1 | Cell 2 |
| E-UTRA RF Channel Number | | 1 | | 1 | | 1 | |
| BW _{channel} | MHz | 5 | | 5 | | 5 | |
| Measurement bandwidth | n_{PRB} | 10—15 | | 10—15 | | 10—15 | |

| | | | | | | | | |
|--|-------------|-------------|-----------|-----------|-----------|-----------|-----------|-----------|
| PDSCH Reference measurement channel defined in A.3.1.1.1-1 | | | R.5 FDD | - | R.5 FDD | - | R.5 FDD | - |
| PDSCH allocation | | n_{PRB} | 7—17 | - | 7-17 | - | 7-17 | - |
| PDCCH/PCFICH/PHICH Reference measurement channel defined in A.3.1.2.1-1 | | | R.11 FDD | | R.11 FDD | | R.11 FDD | |
| OCNG Patterns defined in A.3.2.1.15 (OP.15 FDD) and A.3.2.1.16 (OP.16 FDD) | | | OP.15 FDD | OP.16 FDD | OP.15 FDD | OP.16 FDD | OP.15 FDD | OP.16 FDD |
| PBCH_RA | | dB | 0 | 0 | 0 | 0 | 0 | 0 |
| PBCH_RB | | | | | | | | |
| PSS_RA | | | | | | | | |
| SSS_RA | | | | | | | | |
| PCFICH_RB | | | | | | | | |
| PHICH_RA | | | | | | | | |
| PHICH_RB | | | | | | | | |
| PDCCH_RA | | | | | | | | |
| PDCCH_RB | | | | | | | | |
| PDSCH_RA | | | | | | | | |
| PDSCH_RB | | | | | | | | |
| OCNG_RA ^{Note1} | | | | | | | | |
| OCNG_RB ^{Note1} | | | | | | | | |
| N_{oc} ^{Note2} | Bands FDD_N | | | | | | | |
| \hat{E}_s / I_{ot} | | dB | 2.46 | -5.97 | 2.46 | -5.97 | 0.46 | -5.76 |
| RSRP ^{Note3} | Bands FDD_N | dBm/15 kHz | -97 | -102 | -77 | -82 | -106.5 | -110.5 |
| I_o ^{Note3} | Bands FDD_N | dBm/4.5 MHz | -70.28 | | -50.28 | | -78.94 | |
| \hat{E}_s / N_{oc} | | dB | 6 | 1 | 6 | 1 | 3 | -1 |
| Propagation condition | | - | AWGN | | AWGN | | AWGN | |
| <p>Note 1: OCNG shall be used such that both cells are fully allocated and a constant total transmitted power spectral density is achieved for all OFDM symbols.</p> <p>Note 2: Interference from other cells and noise sources not specified in the test is assumed to be constant over subcarriers and time and shall be modelled as AWGN of appropriate power for N_{oc} to be fulfilled.</p> <p>Note 3: RSRP and I_o levels have been derived from other parameters for information purposes. They are not settable parameters themselves.</p> <p>Note 4: RSRP minimum requirements are specified assuming independent interference and noise at each receiver antenna port.</p> | | | | | | | | |

A.9.1.16.3 Test Requirements

The RSRP measurement accuracy shall fulfil the requirements in sections 9.1.2.1 and 9.1.2.2.

A.9.1.17 FDD—FDD Inter frequency case for 5MHz Bandwidth

A.9.1.17.1 Test Purpose and Environment

The purpose of this test is to verify that the RSRP measurement accuracy is within the specified limits. This test will verify the requirements in Sections 9.1.3.1 and 9.1.3.2 for FDD—FDD inter frequency measurements.

A.9.1.17.2 Test parameters

In this set of test cases the cells are on different carrier frequencies. Both absolute and relative accuracy of RSRP inter-frequency measurements are tested by using the parameters in Table A.9.1.17.2-1. In all test cases, Cell 1 is the PCell and Cell 2 the target cell. The inter frequency measurements are supported by a measurement gap.

Table A.9.1.17.2-1: RSRP FDD—FDD Inter frequency test parameters for 5MHz Bandwidth

| Parameter | Unit | Test 1 | | Test 2 | | | | | | | |
|---|---------------------|-------------|-----------|-----------|-----------|---------------------|------------|--------|--------|--------|--------|
| | | Cell 1 | Cell 2 | Cell 1 | Cell 2 | | | | | | |
| E-UTRA RF Channel Number | | 1 | 2 | 1 | 2 | | | | | | |
| BW_{channel} | MHz | 5 | 5 | 5 | 5 | | | | | | |
| Gap Pattern Id | | 0 | - | 0 | - | | | | | | |
| Measurement bandwidth | n_{PRB} | 10—15 | | 10—15 | | | | | | | |
| PDSCH Reference measurement channel defined in A.3.1.1.1 | | R.5 FDD | - | R.5 FDD | - | | | | | | |
| PDSCH allocation | n_{PRB} | 7—17 | - | 7-17 | - | | | | | | |
| PDCCH/PCFICH/PHICH Reference measurement channel defined in A.3.1.2.1 | | R.11 FDD | | R.11 FDD | | | | | | | |
| OCNG Patterns defined in A.3.2.1.15 (OP.15 FDD) and A.3.2.1.16 (OP.16 FDD) | | OP.15 FDD | OP.16 FDD | OP.15 FDD | OP.16 FDD | | | | | | |
| PBCH_RA | dB | 0 | 0 | 0 | 0 | | | | | | |
| PBCH_RB | | | | | | | | | | | |
| PSS_RA | | | | | | | | | | | |
| SSS_RA | | | | | | | | | | | |
| PCFICH_RB | | | | | | | | | | | |
| PHICH_RA | | | | | | | | | | | |
| PHICH_RB | | | | | | | | | | | |
| PDCCH_RA | | | | | | | | | | | |
| PDCCH_RB | | | | | | | | | | | |
| PDSCH_RA | | | | | | | | | | | |
| PDSCH_RB | | | | | | | | | | | |
| OCNG_RA ^{Note1} | | | | | | | | | | | |
| OCNG_RB ^{Note1} | | | | | | | | | | | |
| N_{oc} ^{Note2} | | | | | | Cell 2: Bands FDD_N | dBm/15 kHz | -85.65 | -85.65 | -102.5 | -110.5 |
| \hat{E}_s / I_{ot} | | | | | | | | 10 | 10 | 13 | -4 |
| RSRP ^{Note3} | Cell 2: Bands FDD_N | dBm/15 kHz | -75.65 | -75.65 | -89.5 | -114.5 | | | | | |
| I_o ^{Note3} | Cell 2: Bands FDD_N | dBm/4.5 MHz | -50.46 | -50.46 | -64.52 | -84.27 | | | | | |
| \hat{E}_s / N_{oc} | | | 10 | 10 | 13 | -4 | | | | | |
| Propagation condition | | - | AWGN | | AWGN | | | | | | |
| <p>Note 1: OCNG shall be used such that both cells are fully allocated and a constant total transmitted power spectral density is achieved for all OFDM symbols.</p> <p>Note 2: Interference from other cells and noise sources not specified in the test is assumed to be constant over subcarriers and time and shall be modelled as AWGN of appropriate power for N_{oc} to be fulfilled.</p> <p>Note 3: RSRP and I_o levels have been derived from other parameters for information purposes. They are not settable parameters themselves.</p> <p>Note 4: RSRP minimum requirements are specified assuming independent interference and noise at each receiver antenna port.</p> <p>Note 5: For Band 26, the tests shall be performed with the assigned E-UTRA channel bandwidth within 865-894 MHz.</p> <p>Note 6: This test is only applicable for testing inter-frequency requirements for Bands FDD_N. Cell 2 is on the Band under test, and Cell 1 is on another band supported by the UE.</p> | | | | | | | | | | | |

Table A.9.1.17.2-1: Void**A.9.1.17.3 Test Requirements**

The RSRP measurement accuracy shall fulfil the requirements in sections 9.1.3.1 and 9.1.3.2.

A.9.1.18 FDD RSRP for E-UTRAN Carrier Aggregation for 10MHz + 5MHz

The test case in this section are applicable to carrier aggregation capable UEs which have been configured with a downlink Scell.

A.9.1.18.1 Test Purpose and Environment

The purpose of this test case is the same as for the test defined in subclause A.9.1.6.1.

A.9.1.18.2 Test parameters

The test parameters are the same except those described in the following section. The listed parameter values in Tables A.9.1.18.2-1 will replace the values of corresponding parameters in Tables A.9.1.6.2-1.

Table A.9.1.18.2-1: RSRP FDD carrier aggregation test parameters

| Parameter | | Unit | Test 1 | | |
|---|--------------------|------------|----------|-------------------------------|------------------------|
| | | | Cell 1 | Cell 2 | Cell 3 |
| BW_{channel} ^{Note 1} | | MHz | 10 | 5 | |
| Measurement bandwidth | | n_{PRB} | 22-27 | 10-15 | |
| PDSCH Reference measurement channel defined in A.3.1.1.1 | | | R.0 FDD | R.5 FDD | N/A |
| PDSCH allocation | | n_{PRB} | 13-36 | 7-17 | N/A |
| PDCCH/PCFICH/PHICH Reference measurement channel defined in A.3.1.2.1 | | | R.6 FDD | R.11 FDD | |
| OCNG Patterns defined in A.3.2.1 (FDD) | | | OP.1 FDD | OP.15 FDD | OP.16 FDD |
| N_{oc} ^{Note2} | Bands FDD_A | dBm/15 kHz | -117 | $(N_{oc}$ for Channel 1 +1dB) | |
| | Bands FDD_B | | -116.5 | | |
| | Bands FDD_C | | -116 | | |
| | Bands FDD_D | | -115.5 | | |
| | Bands FDD_E, FDD_F | | -115 | | |
| | Bands FDD_G | | -114 | | |
| | Bands FDD_H | | -113.5 | | |
| | Bands FDD_N | | N/A | | |
| RSRP ^{Note2} | Bands FDD_A | dBm/15 kHz | -121 | (RSRP for Cell 1 +8dB) | (RSRP for Cell 1 +4dB) |
| | Bands FDD_B | | -120.5 | | |
| | Bands FDD_C | | -120 | | |
| | Bands FDD_D | | -119.5 | | |
| | Bands FDD_E, FDD_F | | -119 | | |
| | Bands FDD_G | | -118 | | |
| | Bands FDD_H | | -117.5 | | |
| | Bands FDD_N | | N/A | | |
| I_o ^{Note2} | Bands FDD_A | dBm/9 MHz | -87.76 | N/A | |
| | Bands FDD_B | | -87.26 | | |
| | Bands FDD_C | | -86.76 | | |
| | Bands FDD_D | | -86.26 | | |
| | Bands FDD_E, FDD_F | | -85.76 | | |
| | Bands FDD_G | | -84.76 | | |
| | Bands FDD_H | | -84.26 | | |

| | | | | |
|--|--------------------|-------------|-----|--|
| | Bands FDD_A | dBm/4.5 MHz | N/A | (I _o for Channel 1 +2.32dB) |
| | Bands FDD_B | | | |
| | Bands FDD_C | | | |
| | Bands FDD_D | | | |
| | Bands FDD_E, FDD_F | | | |
| | Bands FDD_G | | | |
| | Bands FDD_H | | | |
| | Bands FDD_N | | | -80.94 |
| <p>Note 1: This test verifies the RRM requirement which is independent of channel bandwidth and is performed according to the principle defined in section A.3.6.1.</p> <p>Note 2: RSRP and I_o levels have been derived from other parameters for information purposes. They are not settable parameters themselves.</p> <p>Note 3: See Table A.9.1.6.2-1 for the other parameters.</p> | | | | |

A.9.1.18.3 Test Requirements

The test requirements defined in section A.9.1.6.3 shall apply to this test case.

A.9.1.19 TDD RSRP for E-UTRAN Carrier Aggregation for 10MHz + 5MHz

The test case in this section are applicable to carrier aggregation capable UEs which have been configured with a downlink Scell.

A.9.1.19.1 Test Purpose and Environment

The purpose of this test case is the same as for the test defined in subclause A.9.1.7.1.

A.9.1.19.2 Test parameters

The test parameters are the same except those described in the following section. The listed parameter values in Tables A.9.1.19.2-1 will replace the values of corresponding parameters in Tables A.9.1.7.2-1.

Table A.9.1.19.2-1: Carrier aggregation RSRP test parameters for TDD

| Parameter | Unit | Test 1 | | |
|---|-------------------------|------------|----------|--|
| | | Cell 1 | Cell 2 | Cell 3 |
| BW _{channel} ^{Note 1} | MHz | 10 | 5 | |
| Measurement bandwidth | <i>n</i> _{PRB} | 22-27 | 10-15 | |
| PDSCH Reference measurement channel defined in A.3.1.1.2 | | R.0 TDD | R.4 TDD | N/A |
| PDSCH allocation | <i>n</i> _{PRB} | 13-36 | 7-17 | N/A |
| PDCCH/PCFICH/PHICH Reference measurement channel defined in A.3.1.2.2 | | R.6 TDD | R.11 TDD | |
| OCNG Patterns defined in A.3.2.2 (TDD) | | OP.1 TDD | OP.9 TDD | OP.10 TDD |
| I _o ^{Note2} | Bands TDD_A | dBm/9 MHz | -87.76 | N/A |
| | Bands TDD_C | | -86.76 | |
| | Bands TDD_E | | -85.76 | |
| | Bands TDD_A | dBm/4.5MHz | N/A | (I _o for Channel 1 +2.32dB) |
| | Bands TDD_C | | | |
| | Bands TDD_E | | | |
| <p>Note 1: This test verifies the RRM requirement which is independent of channel bandwidth and is performed according to the principle defined in section A.3.6.1.</p> <p>Note 2: I_o levels have been derived from other parameters for information purposes. They are not settable parameters themselves.</p> <p>Note 3: See Table A.9.1.7.2-1 for the other parameters.</p> | | | | |

A.9.1.19.3 Test Requirements

The test requirements defined in section A.9.1.7.3 shall apply to this test case.

A.9.1.20 FDD RSRP for E-UTRAN Carrier Aggregation for 5MHz + 5MHz bandwidth

The test case in this section are applicable to carrier aggregation capable UEs which have been configured with a downlink Scell.

A.9.1.20.1 Test Purpose and Environment

The purpose of this test case is the same as for the test defined in subclause A.9.1.6.1.

A.9.1.20.2 Test parameters

The test parameters are the same except those described in the following section. The listed parameter values in Tables A.9.1.20.2-1 will replace the values of corresponding parameters in Tables A.9.1.6.2-1.

Table A.9.1.20.2-1: RSRP FDD carrier aggregation test parameters

| Parameter | | Unit | Test 1 | | |
|--|--------------------------------------|-------------|-----------|-------------------------------|------------------------|
| | | | Cell 1 | Cell 2 | Cell 3 |
| BW _{channel} ^{Note 1} | | MHz | 5 | 5 | 5 |
| Measurement bandwidth | | n_{PRB} | 10-15 | 10-15 | 10-15 |
| PDSCH Reference measurement channel defined in A.3.1.1.1 | | | R.5 FDD | R.5 FDD | N/A |
| PDSCH allocation | | n_{PRB} | 7-17 | 7-17 | - |
| PDCCH/PCFICH/PHICH Reference measurement channel defined in A.3.1.2.1 | | | R.11 FDD | R.11 FDD | R.11 FDD |
| OCNG Patterns defined in A.3.2.1.15 (OP.15 FDD) and A.3.2.1.26 (OP.16 FDD) | | | OP.15 FDD | OP.15 FDD | OP.16 FDD |
| N_{oc} ^{Note2} | Bands FDD_A | dBm/15 kHz | -117 | $(N_{oc}$ for Channel 1 +1dB) | |
| | Bands FDD_B | | -116.5 | | |
| | Bands FDD_C | | -116 | | |
| | Bands FDD_D | | -115.5 | | |
| | Bands FDD_E, FDD_F | | -115 | | |
| | Bands FDD_G | | -114 | | |
| | Bands FDD_H | | -113.5 | | |
| | Bands FDD_N | | -110.5 | | |
| RSRP ^{Note2} | Bands FDD_A | dBm/15 kHz | -121 | (RSRP for Cell 1 +8dB) | (RSRP for Cell 1 +4dB) |
| | Bands FDD_B | | -120.5 | | |
| | Bands FDD_C | | -120 | | |
| | Bands FDD_D | | -119.5 | | |
| | Bands FDD_E, FDD_F | | -119 | | |
| | Bands FDD_G | | -118 | | |
| | Bands FDD_H | | -117.5 | | |
| | Bands FDD_N | | -114.5 | | |
| I_o ^{Note2} | Bands FDD_A ^{Note 5} | dBm/4.5 MHz | -90.76 | $(I_o$ for Channel 1 +5.33dB) | |
| | Bands FDD_B ^{Note 5} | | -90.26 | | |
| | Bands FDD_C ^{Note 5} | | -89.76 | | |
| | Bands FDD_D ^{Note 5} | | -89.26 | | |
| | Bands FDD_E, FDD_F ^{Note 5} | | -88.76 | | |

| | | | | |
|--|-----------------------|--|--------|--|
| | Bands FDD_G Note 5 | | -87.76 | |
| | Bands FDD_H Note 5 | | -87.26 | |
| | Bands FDD_N Note 5 | | -84.26 | |
| <p>Note 1: This test verifies the RRM requirement which is independent of channel bandwidth and is performed according to the principle defined in section A.3.6.1.</p> <p>Note 2: RSRP and Io levels have been derived from other parameters for information purposes. They are not settable parameters themselves.</p> <p>Note 3: See Table A.9.1.6.2-1 for the other parameters.</p> <p>Note 4: E-UTRA operating band groups are as defined in Section 3.5.</p> <p>Note 5: The test applies for E-UTRA operating bands in this band group which are supporting 5MHz + 5MHz channel bandwidth.</p> | | | | |

A.9.1.20.3 Test Requirements

The test requirements defined in section A.9.1.6.3 shall apply to this test case.

A.9.1.21 TDD RSRP for E-UTRAN Carrier Aggregation for 5MHz + 5MHz bandwidth

The test case in this section are applicable to carrier aggregation capable UEs which have been configured with a downlink Scell.

A.9.1.21.1 Test Purpose and Environment

The purpose of this test case is the same as for the test defined in subclause A.9.1.7.1.

A.9.1.21.2 Test parameters

The test parameters are the same except those described in the following section. The listed parameter values in Tables A.9.1.21.2-1 will replace the values of corresponding parameters in Tables A.9.1.7.2-1.

Table A.9.1.21.2-1: Carrier aggregation RSRP test parameters for TDD

| Parameter | Unit | Test 1 | | |
|---|--------------------|------------|----------|----------------------------|
| | | Cell 1 | Cell 2 | Cell 3 |
| BW_{channel} Note 1 | MHz | 5 | 5 | 5 |
| Measurement bandwidth | n_{PRB} | 10-15 | 10-15 | 10-15 |
| PDSCH Reference measurement channel defined in A.3.1.1.2 | | R.4 TDD | R.4 TDD | N/A |
| PDSCH allocation | n_{PRB} | 7-17 | 7-17 | N/A |
| PDCCH/PCFICH/PHICH Reference measurement channel defined in A.3.1.2.2 | | R.11 TDD | | |
| OCNG Patterns defined in A.3.1.2.9 (OP.9 TDD) and A.3.2.2.10 (OP.10 TDD) | | OP.9 TDD | OP.9 TDD | OP.10 TDD |
| I_o Note 2 | Bands TDD_A Note 5 | dBm/4.5MHz | -90.76 | (Io for Channel 1 +5.33dB) |
| | Bands TDD_C Note 5 | | -89.76 | |
| | Bands TDD_E Note 5 | | -88.76 | |
| <p>Note 1: This test verifies the RRM requirement which is independent of channel bandwidth and is performed according to the principle defined in section A.3.6.1.</p> <p>Note 2: Io levels have been derived from other parameters for information purposes. They are not settable parameters themselves.</p> <p>Note 3: See Table A.9.1.7.2-1 for the other parameters.</p> <p>Note 4: E-UTRA operating band groups are as defined in Section 3.5.</p> <p>Note 5: The test applies for E-UTRA operating bands in this band group which are supporting 5MHz + 5MHz channel bandwidth.</p> | | | | |

A.9.1.21.3 Test Requirements

The test requirements defined in section A.9.1.7.3 shall apply to this test case.

A.9.1.22 RSRP for E-UTRAN TDD-FDD Carrier Aggregation with PCell in FDD

A.9.1.22.1 Test Purpose and Environment

The test case is applicable for TDD-FDD carrier aggregation capable UEs which have been configured with a downlink PCell in FDD and a downlink SCell in TDD.

The purpose of this test is to verify that the RSRP absolute and relative measurements accuracy in TDD-FDD carrier aggregation is within the specified limits. This test will verify the absolute RSRP accuracy requirements of the primary component carrier defined in clause 9.1.11.1, the absolute RSRP accuracy requirements of the secondary component carrier defined in clause 9.1.11.2, the relative RSRP accuracy requirements of the secondary component carrier defined in clause 9.1.11.2 between the SCell and a neighbour cell, and the relative RSRP accuracy requirements of the PCell compared to the SCell defined in Clause 9.1.11.3.

A.9.1.22.2 Test parameters

In this test case, Cell 1 is the PCell on the FDD primary component carrier, Cell 2 is the configured and activated SCell on the TDD secondary component carrier, and Cell 3 is the neighboring cell on the TDD secondary component carrier. The test parameters are given in Table A.9.1.22.2-1.

Table A.9.1.22.2-1: RSRP TDD-FDD carrier aggregation test parameters

| Parameter | Unit | Test 1 | | |
|---|-----------|--|--|--|
| | | Cell 1 | Cell 2 | Cell3 |
| E-UTRA RF Channel Number | | 1 | 2 | 2 |
| BW _{channel} | | 5MHz: N _{RB,c} = 25 10MHz: N _{RB,c} = 50 20MHz: N _{RB,c} = 100 | 5MHz: N _{RB,c} = 25 10MHz: N _{RB,c} = 50 20MHz: N _{RB,c} = 100 | 5MHz: N _{RB,c} = 25 10MHz: N _{RB,c} = 50 20MHz: N _{RB,c} = 100 |
| Special subframe configuration ^{Note9} | | - | 6 | 6 |
| Uplink-downlink configuration ^{Note9} | | - | 1 | 1 |
| Measurement bandwidth | n_{PRB} | 5MHz: 10-15 10MHz: 22-27 20MHz: 47-52 | 5MHz: 10-15 10MHz: 22-27 20MHz: 47-52 | 5MHz: 10-15 10MHz: 22-27 20MHz: 47-52 |
| PDSCH Reference measurement channel defined in A.3.1.1.1 and A.3.1.1.2 | | 5MHz: R.5 FDD 10MHz: R.0 FDD 20MHz: R.4 FDD | 5MHz: R.4 TDD 10MHz: R.0 TDD 20MHz: R.3 TDD | - |
| PDSCH allocation | n_{PRB} | 5MHz: 7-17 10MHz: 13-36 20MHz: 38-61 | 5MHz: 7-17 10MHz: 13-36 20MHz: 38-61 | - |
| PDCCH/PCFICH/PHICH Reference measurement channel defined in A.3.1.2.1 and A.3.1.2.2 | | 5MHz: R.11 FDD 10MHz: R.6 FDD 20MHz: R.10 FDD | 5MHz: R.11 TDD 10MHz: R.6 TDD 20MHz: R.10 TDD | 5MHz: R.11 TDD 10MHz: R.6 TDD 20MHz: R.10 TDD |

| | | | | | | |
|---|---|----------------------------|---|---|--|------------|
| OCNG Patterns defined in A.3.2.1.1 (OP.1 FDD), A.3.2.2.1 (OP.1 TDD), and A.3.2.2.2 (OP.2 TDD) | | | 5MHz: OP.15 FDD 10MHz: OP.1 FDD 20MHz: OP.11 FDD | 5MHz: OP.9 TDD 10MHz: OP.1 TDD 20MHz: OP.7 TDD | 5MHz: OP.10 TDD 10MHz: OP.2 TDD 20MHz: OP.8 TDD | |
| PBCH_RA | | dB | 0 | 0 | 0 | |
| PBCH_RB | | | | | | |
| PSS_RA | | | | | | |
| SSS_RA | | | | | | |
| PCFICH_RB | | | | | | |
| PHICH_RA | | | | | | |
| PHICH_RB | | | | | | |
| PDCCH_RA | | | | | | |
| PDCCH_RB | | | | | | |
| PDSCH_RA | | | | | | |
| PDSCH_RB | | | | | | |
| OCNG_RA ^{Note 2} | | | | | | |
| OCNG_RB ^{Note 2} | | | | | | |
| N_{oc} ^{Note 2} | Bands FDD_A | | | | | dBm/15 kHz |
| | Bands FDD_B | -116.5 | - | - | | |
| | Bands FDD_C | -116 | - | - | | |
| | Bands FDD_D | -115.5 | - | - | | |
| | Bands FDD_E, FDD_F ^{Note 6} | -115 | - | - | | |
| | Bands FDD_G | -114 | - | - | | |
| | Bands FDD_H | -113.5 | - | - | | |
| | Bands TDD_A | - | $(N_{oc}$ for Channel 1 +1dB) | - | - | |
| | Bands TDD_C | - | | - | - | |
| | Bands TDD_E | - | | - | - | |
| \hat{E}_s / N_{oc} | | dB | -4 | 3 | -1 | |
| \hat{E}_s / I_{ot} | | dB | -4 | 0.46 | -5.76 | |
| RSRP ^{Note 3} | Bands FDD_A | dBm/15 kHz | -121 | - | - | |
| | Bands FDD_B | | -120.5 | - | - | |
| | Bands FDD_C | | -120 | - | - | |
| | Bands FDD_D | | -119.5 | - | - | |
| | Bands FDD_E, FDD_F ^{Note 6} | | -119 | - | - | |
| | Bands FDD_G | | -118 | - | - | |
| | Bands FDD_H | | -117.5 | - | - | |
| | Bands TDD_A | | - | (RSRP for Cell 1 +8dB) | - | - |
| | Bands TDD_C | | - | | - | - |
| | Bands TDD_E | | - | | - | - |
| I_o ^{Note 3} | Bands FDD_A | dBm/ BW _{channel} | -87.76 + 10log(N _{RB} , √50) | - | - | |
| | Bands FDD_B | | -87.26 + 10log(N _{RB} , √50) | - | - | |
| | Bands FDD_C | | -86.76 + 10log(N _{RB} , √50) | - | - | |
| | Bands FDD_D | | -86.26 + 10log(N _{RB} , √50) | - | - | |
| | Bands FDD_E, FDD_F ^{Note 6} | | -85.76 + 10log(N _{RB} , √50) | - | - | |
| | Bands FDD_G | | -84.76 + 10log(N _{RB} , √50) | - | - | |

| | | | | | |
|---|---|------|--|---|------|
| | Bands FDD_H | | -84.26+ 10log(N _{RB} , √50) | - | |
| | Bands TDD_A | | - | (10 for Channel 1 +5.33dB +10log (N _{RB channel2} / N _{RB channel 1})) | |
| | Bands TDD_C | | - | | |
| | Bands TDD_E | | - | | |
| Propagation condition | - | AWGN | AWGN | AWGN | AWGN |
| Antenna Configuration | - | 1x2 | 1x2 | 1x2 | 1x2 |
| Timing offset to cell 1 | μs | - | 0 | 3 | |
| Time alignment error relative to cell 1 <small>Note 8</small> | - | - | ≤ TAE | - | |
| Note 1: | For special subframe and uplink-downlink configurations see Tables 4.2-1 and 4.2-2 in TS 36.211. | | | | |
| Note 2: | OCNG shall be used such that all cells are fully allocated and a constant total transmitted power spectral density is achieved for all OFDM symbols. | | | | |
| Note 3: | Interference from other cells and noise sources not specified in the test is assumed to be constant over subcarriers and time and shall be modelled as AWGN of appropriate power for to be fulfilled. | | | | |
| Note 4: | Es/Iot, RSRP and I _o levels have been derived from other parameters for information purposes. They are not settable parameters themselves. | | | | |
| Note 5: | RSRP minimum requirements are specified assuming independent interference and noise at each receiver antenna port. | | | | |
| Note 6: | The selection of the bands for testing depends on the configuration of the carrier aggregation supported by the UEs. | | | | |
| Note 7: | For Band 26, the tests shall be performed with the carrier frequency of the assigned E-UTRA channel bandwidth within 865-894 MHz. | | | | |
| Note 8: | Time alignment error (TAE) as specified in TS 36.104 [30] clause 6.5.3.1. The TAE value depends upon the type of carrier aggregation. | | | | |
| Note 9: | E-UTRA operating band groups are as defined in Section 3.5. | | | | |

A.9.1.22.3 Test Requirements

In the test, the performance of RSRP measurements is verified from following four perspectives:

- The absolute accuracy of intra-frequency RSRP measurements for Cell 1 on the primary component carrier shall fulfil the requirements defined in clause 9.1.11.1.
- The absolute accuracy of intra-frequency RSRP measurements for Cell 2 on the secondary component carrier shall fulfil the requirements defined in clause 9.1.11.2.
- The relative accuracy of intra-frequency RSRP measurements for Cell 3 relative to Cell 2 on the secondary component carrier shall fulfil the requirements defined in clause 9.1.11.2.
- The relative accuracy of inter-frequency RSRP measurements between the primary and secondary component carriers for Cell 2 relative to Cell 1 shall fulfil the requirements defined in clause 9.1.11.3.

A.9.1.23 RSRP for E-UTRAN TDD-FDD Carrier Aggregation with PCell in TDD

A.9.1.23.1 Test Purpose and Environment

The test case is applicable for TDD-FDD carrier aggregation capable UEs which have been configured with a downlink PCell in TDD and a downlink SCell in FDD.

The purpose of this test is to verify that the RSRP absolute and relative measurements accuracy in TDD-FDD carrier aggregation is within the specified limits. This test will verify the absolute RSRP accuracy requirements of the primary component carrier defined in clause 9.1.11.1, the absolute RSRP accuracy requirements of the secondary component carrier defined in clause 9.1.11.2, the relative RSRP accuracy requirements of the secondary component carrier defined in clause 9.1.11.2 between the SCell and a neighbour cell, and the relative RSRP accuracy requirements of the PCell compared to the SCell defined in Clause 9.1.11.3.

A.9.1.23.2 Test parameters

In this test case, Cell 1 is the PCell on the TDD primary component carrier, Cell 2 is the configured and activated SCell on the FDD secondary component carrier, and Cell 3 is the neighboring cell on the FDD secondary component carrier. The test parameters are given in Table A.9.1.23.2-1.

Table A.9.1.23.2-1: RSRP TDD-FDD carrier aggregation test parameters

| Parameter | Unit | Test 1 | | |
|---|-----------|---|---|--|
| | | Cell 1 | Cell 2 | Cell3 |
| E-UTRA RF Channel Number | | 1 | 2 | 2 |
| $BW_{channel}$ | | 5MHz: $N_{RB,c} = 25$ 10MHz: $N_{RB,c} = 50$ 20MHz: $N_{RB,c} = 100$ | 5MHz: $N_{RB,c} = 25$ 10MHz: $N_{RB,c} = 50$ 20MHz: $N_{RB,c} = 100$ | 5MHz: $N_{RB,c} = 25$ 10MHz: $N_{RB,c} = 50$ 20MHz: $N_{RB,c} = 100$ |
| Special subframe configuration ^{Note1} | | 6 | - | - |
| Uplink-downlink configuration ^{Note1} | | 1 | - | - |
| Measurement bandwidth | n_{PRB} | 5MHz: 10-15 10MHz: 22-27 20MHz: 47-52 | 5MHz: 10-15 10MHz: 22-27 20MHz: 47-52 | 5MHz: 10-15 10MHz: 22-27 20MHz: 47-52 |
| PDSCH Reference measurement channel defined in A.3.1.1.1 and A.3.1.1.2 | | 5MHz: R.4 TDD 10MHz: R.0 TDD 20MHz: R.3 TDD | 5MHz: R.5 FDD 10MHz: R.0 FDD 20MHz: R.4 FDD | - |
| PDSCH allocation | n_{PRB} | 5MHz: 7-17 10MHz: 13-36 20MHz: 38-61 | 5MHz: 7-17 10MHz: 13-36 20MHz: 38-61 | - |
| PDCCH/PCFICH/PHICH Reference measurement channel defined in A.3.1.2.1 and A.3.1.2.2 | | 5MHz: R.11 TDD 10MHz: R.6 TDD 20MHz: R.10 TDD | 5MHz: R.11 FDD 10MHz: R.6 FDD 20MHz: R.10 FDD | 5MHz: R.11 FDD 10MHz: R.6 FDD 20MHz: R.10 FDD |
| OCNG Patterns defined in A.3.2.1.1 (OP.1 FDD), A.3.2.2.1 (OP.1 TDD), and A.3.2.1.2 (OP.2 FDD) | | 5MHz: OP.9 TDD 10MHz: OP.1 TDD 20MHz: OP.7 TDD | 5MHz: OP.15 FDD 10MHz: OP.1 FDD 20MHz: OP.11 FDD | 5MHz: OP.16 FDD 10MHz: OP.2 FDD 20MHz: OP.12 FDD |
| PBCH_RA | dB | 0 | 0 | 0 |
| PBCH_RB | | | | |
| PSS_RA | | | | |
| SSS_RA | | | | |
| PCFICH_RB | | | | |
| PHICH_RA | | | | |
| PHICH_RB | | | | |
| PDCCH_RA | | | | |
| PDCCH_RB | | | | |
| PDSCH_RA | | | | |
| PDSCH_RB | | | | |
| OCNG_RA ^{Note 2} | | | | |
| OCNG_RB ^{Note 2} | | | | |
| N ^{Note 3} | | | | |

| | | | | | | |
|--|---|----------------------------|---------------------------------------|--|------------------------|---|
| | Bands FDD_B | | - | | | |
| | Bands FDD_C | | - | | | |
| | Bands FDD_D | | - | | | |
| | Bands FDD_E, FDD_F ^{Note 9} | | - | | | |
| | Bands FDD_G | | - | | | |
| | Bands FDD_H | | - | | | |
| | Bands TDD_A | | -117 | | | - |
| | Bands TDD_C | | -116 | | | - |
| Bands TDD_E | -115 | - | - | | | |
| \hat{E}_s / N_{oc} | | dB | -4 | 3 | -1 | |
| \hat{E}_s / I_{ot} | | dB | -4 | 0.46 | -5.76 | |
| RSRP ^{Note 4} | Bands FDD_A | dBm/15 kHz | - | (RSRP for Cell 1 +8dB) | (RSRP for Cell 1 +4dB) | |
| | Bands FDD_B | | - | | | |
| | Bands FDD_C | | - | | | |
| | Bands FDD_D | | - | | | |
| | Bands FDD_E, FDD_F ^{Note 9} | | - | | | |
| | Bands FDD_G | | - | | | |
| | Bands FDD_H | | - | | | |
| | Bands TDD_A | | -121 | - | - | |
| | Bands TDD_C | | -120 | - | - | |
| | Bands TDD_E | | -119 | - | - | |
| Io ^{Note 4} | Bands FDD_A | dBm/ BW _{channel} | - | (Io for Channel 1 +5.33dB+10log (N _{RB channel2} / N _{RB channel 1})) | | |
| | Bands FDD_B | | - | | | |
| | Bands FDD_C | | - | | | |
| | Bands FDD_D | | - | | | |
| | Bands FDD_E, FDD_F ^{Note 9} | | - | | | |
| | Bands FDD_G | | - | | | |
| | Bands FDD_H | | - | | | |
| | Bands TDD_A | | -87.76 + 10log(N _{RB, √50}) | - | - | |
| | Bands TDD_C | | -86.76 + 10log(N _{RB, √50}) | - | - | |
| | Bands TDD_E | | -85.76 + 10log(N _{RB, √50}) | - | - | |
| Propagation condition | | - | AWGN | AWGN | AWGN | |
| Antenna Configuration | | - | 1x2 | 1x2 | 1x2 | |
| Timing offset to cell 1 | | μs | - | 0 | 3 | |
| Time alignment error relative to cell 1 ^{Note 8} | | - | - | ≤ TAE | - | |
| <p>Note 1: For special subframe and uplink-downlink configurations see Tables 4.2-1 and 4.2-2 in TS 36.211.</p> <p>Note 2: OCNB shall be used such that all cells are fully allocated and a constant total transmitted power spectral density is achieved for all OFDM symbols.</p> <p>Note 3: Interference from other cells and noise sources not specified in the test is assumed to be constant over subcarriers and time and shall be modelled as AWGN of appropriate power for N_{oc} to be fulfilled.</p> <p>Note 4: Es/Iot, RSRP and Io levels have been derived from other parameters for information purposes. They are not settable parameters themselves.</p> <p>Note 5: RSRP minimum requirements are specified assuming independent interference and noise at each receiver antenna port.</p> <p>Note 6: The selection of the bands for testing depends on the configuration of the carrier aggregation supported by the UEs.</p> <p>Note 7: For Band 26, the tests shall be performed with the carrier frequency of the assigned E-UTRA channel bandwidth within 865-894 MHz.</p> <p>Note 8: Time alignment error (TAE) as specified in TS 36.104 [30] clause 6.5.3.1. The TAE value depends upon the type of carrier aggregation.</p> <p>Note 9: E-UTRA operating band groups are as defined in Section 3.5.</p> | | | | | | |

A.9.1.23.3 Test Requirements

In the test, the performance of RSRP measurements is verified from following four perspectives:

- The absolute accuracy of intra-frequency RSRP measurements for Cell 1 on the primary component carrier shall fulfil the requirements defined in clause 9.1.11.1.
- The absolute accuracy of intra-frequency RSRP measurements for Cell 2 on the secondary component carrier shall fulfil the requirements defined in clause 9.1.11.2.
- The relative accuracy of intra-frequency RSRP measurements for Cell 3 relative to Cell 2 on the secondary component carrier shall fulfil the requirements defined in clause 9.1.11.2.
- The relative accuracy of inter-frequency RSRP measurements between the primary and secondary component carriers for Cell 2 relative to Cell 1 shall fulfil the requirements defined in clause 9.1.11.3.

A.9.1.24 TDD RSRP for E-UTRAN Carrier Aggregation for 20MHz + 10MHz

The test case in this section are applicable to carrier aggregation capable UEs which have been configured with a downlink Scell.

A.9.1.24.1 Test Purpose and Environment

The purpose of this test case is the same as for the test defined in subclause A.9.1.7.1.

A.9.1.24.2 Test parameters

The test parameters are the same except those described in the following section. The listed parameter values in Tables A.9.1.24.2-1 will replace the values of corresponding parameters in Tables A.9.1.7.2-1.

Table A.9.1.24.2-1: Carrier aggregation RSRP test parameters for TDD

| Parameter | Unit | Combination | Test 1 | | | |
|--|----------------------------|-------------|---------------------------------------|-------------------------------|---|--|
| | | | Cell 1 | Cell 2 | Cell 3 | |
| BW _{channel} ^{Note 1} | MHz | 20MHz+10MHz | 20MHz: N _{RB,c} = 100 | 10MHz: N _{RB,c} = 50 | | |
| | | 10MHz+20MHz | 10MHz: N _{RB,c} = 50 | | 20MHz: N _{RB,c} = 100 | |
| Measurement bandwidth | n _{PRB} | 20MHz+10MHz | 47-52 | 22-27 | | |
| | | 10MHz+20MHz | 22-27 | | 47-52 | |
| PDSCH Reference measurement channel defined in A.3.1.1.2 | | 20MHz+10MHz | R.3 TDD | R.0 TDD | N/A | |
| | | 10MHz+20MHz | R.0 TDD | R3.TDD | | |
| PDSCH allocation | n _{PRB} | 20MHz+10MHz | 38-61 | 13-36 | | |
| | | 10MHz+20MHz | 13-36 | | 38-61 | |
| PDCCH/PCFICH/PHICH Reference measurement channel defined in A.3.1.2.2 | | 20MHz+10MHz | R.10 TDD | R.6 TDD | | |
| | | 10MHz+20MHz | R.6 TDD | R.10 TDD | | |
| OCNG Patterns defined in A.3.2.2 (TDD) | | 20MHz+10MHz | OP.7 TDD | OP.1 TDD | OP.2 TDD | |
| | | 10MHz+20MHz | OP.1 TDD | OP.7 TDD | OP.8 TDD | |
| I _o ^{Note 2} | dBm/BW _{channel} | All | -87.76 + 10log(N _{RB,c} /50) | N/A | | |
| | | | -86.76 + 10log(N _{RB,c} /50) | | | |
| | | | -85.76 + 10log(N _{RB,c} /50) | | | |
| | dBm/ BW _{channel} | All | N/A | | (I _o for Channel 1 +5.33dB) +10log (N _{RB channel2} / N _{RB channel 1}) | |
| | | | | | | |
| | | | | | | |
| Note 1: This test verifies the RRM requirement which is independent of channel bandwidth and is performed according to the principle defined in section A.3.6.1. | | | | | | |
| Note 2: I _o levels have been derived from other parameters for information purposes. They are not settable parameters themselves. | | | | | | |
| Note 3: See Table A.9.1.7.2-1 for the other parameters. | | | | | | |
| Note 4: For each parameter, the allowed combinations are shown in separate rows. | | | | | | |

A.9.1.24.3 Test Requirements

The test requirements defined in section A.9.1.7.3 shall apply to this test case.

A.9.1.25 FDD intra-frequency absolute and relative RSRP accuracies in CRS based discovery signal

A.9.1.25.1 Test Purpose and Environment

The purpose of this test is to verify that the FDD RSRP absolute and relative measurement accuracies in CRS based discovery signal are within the specified limits. This test will verify the requirements in Sections 9.1.14.2.

A.9.1.25.2 Test parameters

In this test case, all cells are on the same carrier frequency. Both absolute and relative accuracies of RSRP intra frequency measurements are tested by using the parameters in Table A.9.1.25.2-1. In this test case, Cell 1 is the PCell and Cell 2 is the target cell. The Cell 2 DMTC configuration is provided to the UE in the *measDS-Config* before the start of the test.

Table A.9.1.25.2-1: RSRP FDD Intra frequency test parameters

| Parameter | Unit | Test 1 | |
|--|--------------------------------------|----------|----------|
| | | Cell 1 | Cell 2 |
| E-UTRA RF Channel Number | | 1 | |
| BW _{channel} | MHz | 10 | |
| Measurement bandwidth | n_{PRB} | 22—27 | |
| DTMC period | ms | N/A | 160 |
| DTMC period offset | | N/A | 10 |
| Discovery signal occasion duration | ms | N/A | 1 |
| Time offset between cells | μs | 2.3 | |
| PDSCH Reference measurement channel defined in A.3.1.1.1 | | R.0 FDD | - |
| PDSCH allocation | n_{PRB} | 13—36 | - |
| PDCCH/PCFICH/PHICH Reference measurement channel defined in A.3.1.2.1 | | R.6 FDD | |
| OCNG Patterns defined in A.3.2.1.1 (OP.1 FDD) and A.3.2.1.2 (OP.2 FDD) | | OP.1 FDD | OP.2 FDD |
| PBCH_RA | dB | 0 | 0 |
| PBCH_RB | | | |
| PSS_RA | | | |
| SSS_RA | | | |
| PCFICH_RB | | | |
| PHICH_RA | | | |
| PHICH_RB | | | |
| PDCCH_RA | | | |
| PDCCH_RB | | | |
| PDSCH_RA | | | |
| PDSCH_RB | | | |
| OCNG_RA ^{Note1} | | | |
| OCNG_RB ^{Note1} | | | |
| N_{oc} ^{Note2} | | | |
| | Bands FDD_B | | |
| | Bands FDD_C | | |
| | Bands FDD_D | | |
| | Bands FDD_E, FDD_F ^{Note 5} | | |
| | Bands FDD_G ^{Note 7} | | |
| | Bands FDD_H | | |
| \hat{E}_s / I_{ot} | dB | 2.5 | -6 |

| | | | | |
|---|---|------------|--------|--------|
| RSRP ^{Note3} | Bands FDD_A ^{Note 8} | dBm/15 kHz | -100 | -105 |
| | Bands FDD_B | | | |
| | Bands FDD_C | | | |
| | Bands FDD_D | | | |
| | Bands FDD_E, FDD_F ^{Note 5} | | | |
| | Bands FDD_G ^{Note 7} | | | |
| | Bands FDD_H | | | |
| I _o ^{Note3} | Bands FDD_A ^{Note 8} | dBm/9 MHz | -70.27 | -70.27 |
| | Bands FDD_B | | | |
| | Bands FDD_C | | | |
| | Bands FDD_D | | | |
| | Bands FDD_E, FDD_F ^{Note 5} | | | |
| | Bands FDD_G ^{Note 7} | | | |
| | Bands FDD_H | | | |
| \hat{E}_s / N_{oc} | | dB | 6 | 1 |
| Propagation condition | | - | AWGN | |
| <p>Note 1: OCNG shall be used such that both cells are fully allocated and a constant total transmitted power spectral density is achieved for all OFDM symbols.</p> <p>Note 2: Interference from other cells and noise sources not specified in the test is assumed to be constant over subcarriers and time and shall be modelled as AWGN of appropriate power for N_{oc} to be fulfilled.</p> <p>Note 3: RSRP and I_o levels have been derived from other parameters for information purposes. They are not settable parameters themselves.</p> <p>Note 4: RSRP minimum requirements are specified assuming independent interference and noise at each receiver antenna port.</p> <p>Note 5: For Band 26, the tests shall be performed with the carrier frequency of the assigned E-UTRA channel bandwidth within 865-894 MHz.</p> <p>Note 6: E-UTRA operating band groups are as defined in Section 3.5.</p> <p>Note 7: Except Band 29.</p> <p>Note 8: Except Band 32.</p> | | | | |

A.9.1.25.3 Test Requirements

The RSRP measurement accuracy shall fulfil the requirements in sections 9.1.14.2.

A.9.1.26 TDD intra-frequency absolute and relative RSRP accuracies in CRS based discovery signal

A.9.1.26.1 Test Purpose and Environment

The purpose of this test is to verify that the RSRP absolute and relative measurement accuracies in CRS based discovery signal are within the specified limits. This test will verify the requirements in Sections 9.1.14.2.

A.9.1.26.2 Test parameters

In this test case all cells are on the same carrier frequency. Both absolute and relative accuracies of RSRP intra frequency measurements are tested by using the parameters in Table A.9.1.26.2-1. In this test case, Cell 1 is the PCell and Cell 2 is the target cell. The Cell 2 DMTC configuration is provided to the UE in the *measDS-Config* before the start of the test.

Table A.9.1.26.2-1: RSRP TDD Intra frequency test parameters

| Parameter | Unit | Test 1 |
|-----------|------|--------|
|-----------|------|--------|

| | | Cell 1 | Cell 2 |
|---|-------------|------------|----------|
| E-UTRA RF Channel Number | | 1 | |
| $BW_{channel}$ | MHz | 10 | |
| Special subframe configuration ^{Note1} | | 6 | |
| Uplink/downlink configuration ^{Note1} | | 1 | |
| Measurement bandwidth | n_{PRB} | 22–27 | |
| DTMC period | ms | N/A | 160 |
| DTMC period offset | | N/A | 10 |
| Discovery signal occasion duration | ms | N/A | 2 |
| Time offset between cells | μs | 2.3 | |
| PDSCH Reference measurement channel defined in A.3.1.1.2 | | R.0 TDD | - |
| PDSCH allocation | n_{PRB} | 13–36 | - |
| PDCCH/PCFICH/PHICH Reference measurement channel defined in A.3.1.2.2 | | R.6 TDD | |
| OCNG Patterns defined in A.3.2.2.1 (OP.1 TDD) and A.3.2.2.2 (OP.2 TDD) | | OP.1 TDD | OP.2 TDD |
| PBCH_RA | dB | 0 | 0 |
| PBCH_RB | | | |
| PSS_RA | | | |
| SSS_RA | | | |
| PCFICH_RB | | | |
| PHICH_RA | | | |
| PHICH_RB | | | |
| PDCCH_RA | | | |
| PDCCH_RB | | | |
| PDSCH_RA | | | |
| PDSCH_RB | | | |
| OCNG_RA ^{Note2} | | | |
| OCNG_RB ^{Note2} | | | |
| N_{oc} ^{Note3} | | | |
| | Bands TDD_C | | |
| | Bands TDD_E | | |
| \hat{E}_s / I_{ot} | | dB | 2.5 |
| RSRP ^{Note4} | Bands TDD_A | dBm/15 kHz | -100 |
| | Bands TDD_C | | |
| | Bands TDD_E | | |
| I_o ^{Note4} | Bands TDD_A | dBm/9 MHz | -70.27 |
| | Bands TDD_C | | |
| | Bands TDD_E | | |
| \hat{E}_s / N_{oc} | | dB | 6 |
| Propagation condition | - | AWGN | |
| <p>Note 1: For special subframe and uplink-downlink configurations see Tables 4.2-1 and 4.2-2 in TS 36.211.</p> <p>Note 2: OCNG shall be used such that both cells are fully allocated and a constant total transmitted power spectral density is achieved for all OFDM symbols.</p> <p>Note 3: Interference from other cells and noise sources not specified in the test is assumed to be constant over subcarriers and time and shall be modelled as AWGN of appropriate power for N_{oc} to be fulfilled.</p> <p>Note 4: RSRP and I_o levels have been derived from other parameters for information purposes. They are not settable parameters themselves.</p> <p>Note 5: RSRP minimum requirements are specified assuming independent interference and noise at each receiver antenna port.</p> <p>Note 6: E-UTRA operating band groups are as defined in Section 3.5.</p> | | | |

A.9.1.26.3 Test Requirements

The RSRP measurement accuracy shall fulfil the requirements in sections 9.1.14. 2.

A.9.1.27 FDD—FDD inter-frequency absolute and relative RSRP accuracies in CRS based discovery signal

A.9.1.27.1 Test Purpose and Environment

The purpose of this test is to verify that the CRS RSRP measurement accuracy is within the specified limits. This test will verify the requirements in Sections 9.1.14.2 for FDD—FDD inter frequency measurements.

A.9.1.27.2 Test parameters

In this set of test case the cells are on different carrier frequencies. Both absolute and relative accuracy of CRS RSRP inter-frequency measurements are tested by using the parameters in Table A.9.1.27.2-1. In this test case, Cell 1 is the PCell and Cell 2 the target cell. The inter frequency measurements are supported by a measurement gap and a DMTC configuration.

Table A.9.1.27.2-1: CRS RSRP FDD—FDD Inter frequency test parameters

| Parameter | Unit | Test 1 | |
|--|-------------|----------|----------|
| | | Cell 1 | Cell 2 |
| E-UTRA RF Channel Number | | 1 | 2 |
| $BW_{channel}$ | MHz | 10 | 10 |
| Gap Pattern Id | | 0 | - |
| gapOffset | ms | 9 | |
| DMTC period | ms | - | 160 |
| DMTC period offset | ms | - | 10 |
| Discovery signal occasion duration | ms | - | 1 |
| Time offset between cells | μs | - | 3 |
| Measurement bandwidth | n_{PRB} | 22—27 | |
| PDSCH Reference measurement channel defined in A.3.1.1.1 | | R.0 FDD | - |
| PDSCH allocation | n_{PRB} | 13—36 | - |
| PDCCH/PCFICH/PHICH Reference measurement channel defined in A.3.1.2.1 | | R.6 FDD | |
| OCNG Patterns defined in A.3.2.1.1 (OP.1 FDD) and A.3.2.1.2 (OP.2 FDD) | | OP.1 FDD | OP.2 FDD |
| PBCH_RA | dB | 0 | 0 |
| PBCH_RB | | | |
| PSS_RA | | | |
| SSS_RA | | | |
| PCFICH_RB | | | |
| PHICH_RA | | | |
| PHICH_RB | | | |
| PDCCH_RA | | | |
| PDCCH_RB | | | |
| PDSCH_RA | | | |
| PDSCH_RB | | | |
| OCNG_RA ^{Note1} | | | |
| OCNG_RB ^{Note1} | | | |
| N_{oc} ^{Note2} | | | |
| | Bands FDD_B | -114.5 | |
| | Bands FDD_C | -114 | |
| | Bands FDD_D | -113.5 | |

| | | | | |
|---------------------------------|--|------------|---|--------|
| | Bands FDD_E, FDD_F <small>Note 5</small> | | | -113 |
| | Bands FDD_G <small>Note 7</small> | | | -112 |
| | Bands FDD_H | | | -111.5 |
| \hat{E}_s / I_{ot} | | dB | 13 | -6 |
| RSRP ^{Note3} | Bands FDD_A <small>Note 9</small> | dBm/15 kHz | (RSRP for Cell 2 +25dB) | -121 |
| | Bands FDD_B | | | -120.5 |
| | Bands FDD_C | | | -120 |
| | Bands FDD_D | | | -119.5 |
| | Bands FDD_E, FDD_F <small>Note 5</small> | | | -119 |
| | Bands FDD_G <small>Note 7</small> | | | -118 |
| | Bands FDD_H | | | -117.5 |
| I _o ^{Note3} | Bands FDD_A <small>Note 9</small> | dBm/9 MHz | (I _o for Channel 2 +18.24dB) | -86.25 |
| | Bands FDD_B | | | -85.75 |
| | Bands FDD_C | | | -85.25 |
| | Bands FDD_D | | | -84.75 |
| | Bands FDD_E, FDD_F <small>Note 5</small> | | | -84.25 |
| | Bands FDD_G <small>Note 7</small> | | | -83.25 |
| | Bands FDD_H | | | -82.75 |
| \hat{E}_s / N_{oc} | | dB | 13 | -6 |
| Propagation condition | | - | AWGN | |
| Note 1: | OCNG shall be used such that both cells are fully allocated and a constant total transmitted power spectral density is achieved for all OFDM symbols. | | | |
| Note 2: | Interference from other cells and noise sources not specified in the test is assumed to be constant over subcarriers and time and shall be modelled as AWGN of appropriate power for N_{oc} to be fulfilled. | | | |
| Note 3: | RSRP and I _o levels have been derived from other parameters for information purposes. They are not settable parameters themselves. | | | |
| Note 4: | RSRP minimum requirements are specified assuming independent interference and noise at each receiver antenna port. | | | |
| Note 5: | For Band 26, the tests shall be performed with the carrier frequency of assigned E-UTRA channel bandwidth within 865-894 MHz. | | | |
| Note 6: | E-UTRA operating band groups are as defined in Section 3.5. | | | |
| Note 7: | Except Band 29. | | | |
| Note 8: | DMTC is provided to the UE in the <i>measDS-Config</i> (in TS36.331) before the beginning of the test. | | | |
| Note 9: | Except Band 32. | | | |

A.9.1.27.3 Test Requirements

The CRS RSRP measurement accuracy shall fulfil the requirements in sections 9.1.14.2.

A.9.1.28 TDD—TDD inter-frequency absolute and relative RSRP accuracies in CRS based discovery signal

A.9.1.28.1 Test Purpose and Environment

The purpose of this test is to verify that the CRS RSRP measurement accuracy is within the specified limits. This test will verify the requirements in Sections 9.1.14.2 for TDD—TDD inter frequency measurements.

A.9.1.28.2 Test parameters

In this set of test case the cells are on different carrier frequencies. Both absolute and relative accuracy of CRS RSRP inter-frequency measurements are tested by using the parameters in Table A.9.1.28.2-1. In this test case, Cell 1 is the PCell and Cell 2 the target cell. The inter frequency measurements are supported by a measurement gap and a DMTC configuration.

Table A.9.1.28.2-1: CRS RSRP TDD—TDD Inter frequency test parameters

| Parameter | Unit | Test 1 | |
|--|-------------|--------------------------------|----------|
| | | Cell 1 | Cell 2 |
| E-UTRA RF Channel Number | | 1 | 2 |
| BW _{channel} | MHz | 10 | 10 |
| Special subframe configuration ^{Note1} | | 6 | |
| Uplink-downlink configuration ^{Note1} | | 1 | |
| Gap Pattern Id | | 0 | - |
| gapOffset | ms | 9 | |
| DMTC period | ms | - | 160 |
| DMTC period offset | ms | - | 10 |
| Discovery signal occasion duration | ms | - | 2 |
| Time offset between cells | µs | - | 3 |
| Measurement bandwidth | n_{PRB} | 22—27 | |
| PDSCH Reference measurement channel defined in A.3.1.1.2 | | R.0 TDD | - |
| PDSCH allocation | n_{PRB} | 13—36 | - |
| PDCCH/PCFICH/PHICH Reference measurement channel defined in A.3.1.2.2 | | R.6 TDD | |
| OCNG Patterns defined in A.3.2.2.1 (OP.1 TDD) and A.3.2.2.2 (OP.2 TDD) | | OP.1 TDD | OP.2 TDD |
| PBCH_RA | dB | 0 | 0 |
| PBCH_RB | | | |
| PSS_RA | | | |
| SSS_RA | | | |
| PCFICH_RB | | | |
| PHICH_RA | | | |
| PHICH_RB | | | |
| PDCCH_RA | | | |
| PDCCH_RB | | | |
| PDSCH_RA | | | |
| PDSCH_RB | | | |
| OCNG_RA ^{Note2} | | | |
| OCNG_RB ^{Note2} | | | |
| N_{oc} ^{Note3} | | | |
| | Bands TDD_C | -114 | |
| | Bands TDD_E | -113 | |
| \hat{E}_s/I_{ot} | dB | 13 | -6 |
| RSRP ^{Note4} | Bands TDD_A | $(RSRP$ for Cell 2 +25dB) | -121 |
| | Bands TDD_C | | -120 |
| | Bands TDD_E | | -119 |
| I_o ^{Note4} | Bands TDD_A | $(I_o$ for Channel 2 +18.24dB) | -86.25 |
| | Bands TDD_C | | -85.25 |
| | Bands TDD_E | | -84.25 |
| \hat{E}_s/N_{oc} | dB | 13 | -6 |
| Propagation condition | - | AWGN | |
| Note 1: For special subframe and uplink-downlink configurations see Tables 4.2-1 and 4.2-2 in TS 36.211. | | | |

| | |
|---------|--|
| Note 2: | OCNG shall be used such that both cells are fully allocated and a constant total transmitted power spectral density is achieved for all OFDM symbols. |
| Note 3: | Interference from other cells and noise sources not specified in the test is assumed to be constant over subcarriers and time and shall be modelled as AWGN of appropriate power for N_{oc} to be fulfilled. |
| Note 4: | RSRP and Io levels have been derived from other parameters for information purposes. They are not settable parameters themselves. |
| Note 5: | RSRP minimum requirements are specified assuming independent interference and noise at each receiver antenna port. |
| Note 6: | E-UTRA operating band groups are as defined in Section 3.5. |
| Note 7: | DMTC is provided to the UE in the measDS-Config (in TS36.331) before the beginning of test |

A.9.1.28.3 Test Requirements

The CRS RSRP measurement accuracy shall fulfil the requirements in sections 9.1.14.2.

A.9.1.29 FDD intra frequency absolute and relative CSI-RSRP accuracies in CSI-RS based discovery signal

A.9.1.29.1 Test Purpose and Environment

The purpose of this test is to verify that the CSI- RSRP measurement accuracy is within the specified limits. This test will verify the requirements in Sections 9.1.14.3 for FDD intra frequency measurements.

A.9.1.29.2 Test parameters

In this set of test case all cells are on the same carrier frequencies. Both absolute and relative accuracy of CSI- RSRP intra frequency measurements are tested by using the parameters in Table A.9.1.29.2-1. In this test case, Cell 1 is the PCell and Cell 2 the target cell. The intra frequency measurements are supported by a DMTC configuration.

Table A.9.1.29.2-1: CSI-RSRP FDD Intra frequency test parameters

| Parameter | Unit | Test 1 | |
|--|-----------|----------|----------|
| | | Cell 1 | Cell 2 |
| E-UTRA RF Channel Number | | 1 | |
| $BW_{channel}$ | MHz | 10 | |
| DMTC period | ms | 160 | |
| DMTC period offset | ms | 10 | |
| Discovery signal occasion duration | ms | 1 | |
| CSI-RS resource configuration | | 2 | 4 |
| CSI-RS periodicity | ms | 10 | |
| CSI-RS subframe offset | ms | 0 | |
| CSI-RS individual offset[2] | dB | 0 | 0 |
| CSI-RS muting | | Enable | Enable |
| Time offset between cells | μ s | - | 2.3 |
| Measurement bandwidth | n_{PRB} | 22—27 | |
| PDSCH Reference measurement channel defined in A.3.1.1.1 | | R.0 FDD | - |
| PDSCH allocation | n_{PRB} | 13—36 | - |
| PDCCH/PCFICH/PHICH Reference measurement channel defined in A.3.1.2.1 | | R.6 FDD | |
| OCNG Patterns defined in A.3.2.1.1 (OP.1 FDD) and A.3.2.1.2 (OP.2 FDD) | | OP.1 FDD | OP.2 FDD |

| | | | | |
|--|---|------------|------------------------------|------------------------------|
| PBCH_RA | | dB | 0 | 0 |
| PBCH_RB | | | | |
| PSS_RA | | | | |
| SSS_RA | | | | |
| PCFICH_RB | | | | |
| PHICH_RA | | | | |
| PHICH_RB | | | | |
| PDCCH_RA | | | | |
| PDCCH_RB | | | | |
| PDSCH_RA | | | | |
| PDSCH_RB | | | | |
| OCNG_RA ^{Note1} | | | | |
| OCNG_RB ^{Note1} | | | | |
| p-C-r10[2] | | | | |
| N_{oc} ^{Note2} | Bands FDD_A <small>Note 9</small> | dBm/15 kHz | -116 | |
| | Bands FDD_B | | -115.5 | |
| | Bands FDD_C | | -115 | |
| | Bands FDD_D | | -114.5 | |
| | Bands FDD_E, FDD_F ^{Note 5} | | -114 | |
| | Bands FDD_G <small>Note 7</small> | | -113 | |
| | Bands FDD_H | | -112.5 | |
| $CRS \hat{E}_s / I_{ot}$ | | dB | 0.46 | -5.76 |
| $CSI-RS \hat{E}_s / I_{ot}$ | | dB | 6.46 | 0.24 |
| RSRP ^{Note3} | Bands FDD_A <small>Note 9</small> | dBm/15 kHz | -113 | -117 |
| | Bands FDD_B | | -112.5 | -116.5 |
| | Bands FDD_C | | -112 | -116 |
| | Bands FDD_D | | -111.5 | -115.5 |
| | Bands FDD_E, FDD_F ^{Note 5} | | -111 | -115 |
| | Bands FDD_G <small>Note 7</small> | | -110 | -114 |
| | Bands FDD_H | | -109.5 | -113.5 |
| CSI-RSRP ^{Note3} | Bands FDD_A <small>Note 9</small> | dBm/15 kHz | (RSRP for Cell 1 +6dB) | (RSRP for Cell 2 +6dB) |
| | Bands FDD_B | | | |
| | Bands FDD_C | | | |
| | Bands FDD_D | | | |
| | Bands FDD_E, FDD_F ^{Note 5} | | | |
| | Bands FDD_G <small>Note 7</small> | | | |
| | Bands FDD_H | | | |
| I_o ^{Note3} | Bands FDD_A <small>Note 9</small> | dBm/9 MHz | -82.43 | |
| | Bands FDD_B | | -81.93 | |
| | Bands FDD_C | | -81.43 | |
| | Bands FDD_D | | -80.93 | |
| | Bands FDD_E, FDD_F ^{Note 5} | | -80.43 | |
| | Bands FDD_G <small>Note 7</small> | | -79.43 | |
| | Bands FDD_H | | -78.93 | |
| $CRS \hat{E}_s / N_{oc}$ | | dB | 3 | -1 |
| $CSI-RS \hat{E}_s / N_{oc}$ | | dB | 9 | 5 |
| Propagation condition | | - | AWGN | |
| <p>Note 1: OCNG shall be used such that both cells are fully allocated and a constant total transmitted power spectral density is achieved for all OFDM symbols.</p> <p>Note 2: Interference from other cells and noise sources not specified in</p> | | | | |

| | |
|---------|--|
| | the test is assumed to be constant over subcarriers and time and shall be modelled as AWGN of appropriate power for N_{oc} to be fulfilled. |
| Note 3: | RSRP, CSI-RSRP and I_0 levels have been derived from other parameters for information purposes. They are not settable parameters themselves. I_0 levels are calculated in CRS symbols of measurement subframe. |
| Note 4: | RSRP minimum requirements are specified assuming independent interference and noise at each receiver antenna port. |
| Note 5: | For Band 26, the tests shall be performed with the carrier frequency of assigned E-UTRA channel bandwidth within 865-894 MHz. |
| Note 6: | E-UTRA operating band groups are as defined in Section 3.5. |
| Note 7: | Except Band 29. |
| Note 8: | DMTC is provided to the UE in the <i>measDS-Config</i> (in TS36.331) before the beginning of the test. |
| Note 9: | Except Band 32. |

A.9.1.29.3 Test Requirements

The CSI- RSRP measurement accuracy shall fulfil the requirements in sections 9.1.14.3.

A.9.1.30 TDD intra frequency absolute and relative CSI-RSRP accuracies in CSI-RS based discovery signal

A.9.1.30.1 Test Purpose and Environment

The purpose of this test is to verify that the CSI- RSRP measurement accuracy is within the specified limits. This test will verify the requirements in Sections 9.1.14.3 for TDD intra frequency measurements.

A.9.1.30.2 Test parameters

In this set of test case all cells are on the same carrier frequencies. Both absolute and relative accuracy of CSI- RSRP intra frequency measurements are tested by using the parameters in Table A.9.1.30.2-1. In this test case, Cell 1 is the PCell and Cell 2 the target cell. The intra frequency measurements are supported by a DMTC configuration.

Table A.9.1.30.2-1: CSI-RSRP TDD Intra frequency test parameters

| Parameter | Unit | Test 1 | |
|--|-----------|---------|--------|
| | | Cell 1 | Cell 2 |
| E-UTRA RF Channel Number | | 1 | |
| $BW_{channel}$ | MHz | 10 | |
| Special subframe configuration ^{Note1} | | 6 | |
| Uplink-downlink configuration ^{Note1} | | 1 | |
| DMTC period | ms | 160 | |
| DMTC period offset | ms | 10 | |
| Discovery signal occasion duration | ms | 2 | |
| CSI-RS resource configuration | | 2 | 4 |
| CSI-RS periodicity | ms | 10 | |
| CSI-RS subframe offset | ms | 0 | |
| CSI-RS individual offset[2] | dB | 0 | 0 |
| CSI-RS muting | | Enable | Enable |
| Time offset between cells | μ s | - | 2.3 |
| Measurement bandwidth | n_{PRB} | 22—27 | |
| PDSCH Reference measurement channel defined in A.3.1.1.1 | | R.0 TDD | - |
| PDSCH allocation | n_{PRB} | 13—36 | - |

| PDCCH/PCFICH/PHICH Reference measurement channel defined in A.3.1.2.1 | | R.6 TDD | | |
|--|-------------|--|------------------------------|------------------------------|
| OCNG Patterns defined in A.3.2.2.1 (OP.1 TDD) and A.3.2.2.2 (OP.2 TDD) | | OP.1 TDD | OP.2 TDD | |
| PBCH_RA | dB | 0 | 0 | |
| PBCH_RB | | | | |
| PSS_RA | | | | |
| SSS_RA | | | | |
| PCFICH_RB | | | | |
| PHICH_RA | | | | |
| PHICH_RB | | | | |
| PDCCH_RA | | | | |
| PDCCH_RB | | | | |
| PDSCH_RA | | | | |
| PDSCH_RB | | | | |
| OCNG_RA ^{Note1} | | | | |
| OCNG_RB ^{Note1} | | | | |
| p-C-r10[2] | | | | dB |
| N_{oc} ^{Note3} | Bands TDD_A | -116 | | |
| | Bands TDD_C | -115 | | |
| | Bands TDD_E | -114 | | |
| $CRS \hat{E}_s / I_{ot}$ | dB | 0.46 | -5.76 | |
| CSI-RS \hat{E}_s / I_{ot} | dB | 6.46 | 0.24 | |
| RSRP ^{Note4} | Bands TDD_A | dBm/15 kHz | -113 | -117 |
| | Bands TDD_C | | -112 | -116 |
| | Bands TDD_E | | -111 | -115 |
| CSI-RSRP ^{Note4} | Bands TDD_A | dBm/15 kHz | (RSRP for Cell 1 +6dB) | (RSRP for Cell 2 +6dB) |
| | Bands TDD_C | | | |
| | Bands TDD_E | | | |
| I_o ^{Note4} | Bands TDD_A | dBm/9 MHz | -82.43 | |
| | Bands TDD_C | | -81.43 | |
| | Bands TDD_E | | -80.43 | |
| $CRS \hat{E}_s / N_{oc}$ | dB | 3 | -1 | |
| CSI-RS \hat{E}_s / N_{oc} | dB | 9 | 5 | |
| Propagation condition | | - | AWGN | |
| Note 1: | | For special subframe and uplink-downlink configurations see Tables 4.2-1 and 4.2-2 in TS 36.211. | | |
| Note 2: | | OCNG shall be used such that both cells are fully allocated and a constant total transmitted power spectral density is achieved for all OFDM symbols. | | |
| Note 3: | | Interference from other cells and noise sources not specified in the test is assumed to be constant over subcarriers and time and shall be modelled as AWGN of appropriate power for N_{oc} to be fulfilled. | | |
| Note 4: | | RSRP, CSI-RSRP and I_o levels have been derived from other parameters for information purposes. They are not settable parameters themselves. I_o levels are calculated in CRS symbols of measurement subframe. | | |
| Note 5: | | RSRP minimum requirements are specified assuming independent interference and noise at each receiver antenna port. | | |
| Note 6: | | E-UTRA operating band groups are as defined in Section 3.5. | | |
| Note 7: | | DMTC is provided to the UE in the <i>measDS-Config</i> (in TS36.331) before the beginning of the test. | | |

A.9.1.30.3 Test Requirements

The CSI- RSRP measurement accuracy shall fulfil the requirements in sections 9.1.14.3.

A.9.1.31 FDD—FDD inter-frequency absolute and relative CSI-RSRP accuracies in CSI-RS based discovery signal

A.9.1.31.1 Test Purpose and Environment

The purpose of this test is to verify that the CSI-RSRP measurement accuracy is within the specified limits. This test will verify the requirements in Sections 9.1.14.3 for FDD—FDD inter frequency measurements.

A.9.1.31.2 Test parameters

In this set of test case the cells are on different carrier frequencies. Both absolute and relative accuracy of CSI-RSRP inter-frequency measurements are tested by using the parameters in Table A.9.1.31.2-1. In this test case, Cell 1 is the PCell and Cell 2 the target cell. The inter frequency measurements are supported by a measurement gap and two DMTC configurations which one is for cell1 and the other is for cell2.

Table A.9.1.31.2-1: CSI-RSRP FDD—FDD Inter frequency test parameters

| Parameter | Unit | Test 1 | | |
|--|-------------------------------|------------|--------------------------------|--------|
| | | Cell 1 | Cell 2 | |
| E-UTRA RF Channel Number | | 1 | 2 | |
| BW _{channel} | MHz | 10 | 10 | |
| Gap Pattern Id | | 0 | - | |
| gapOffset | ms | 9 | | |
| DMTC period | ms | 160 | 160 | |
| DMTC period offset | ms | 0 | 10 | |
| Discovery signal occasion duration | ms | 1 | 1 | |
| CSI-RS resource configuration | | 2 | 4 | |
| CSI-RS periodicity | ms | 10 | | |
| CSI-RS subframe offset | ms | 0 | | |
| CSI-RS individual offset[2] | dB | 0 | 0 | |
| CSI-RS muting | | Enable | Enable | |
| Time offset between cells | µs | - | 3 | |
| Measurement bandwidth | n_{PRB} | 22—27 | | |
| PDSCH Reference measurement channel defined in A.3.1.1.1 | | R.0 FDD | - | |
| PDSCH allocation | n_{PRB} | 13—36 | - | |
| PDCCH/PCFICH/PHICH Reference measurement channel defined in A.3.1.2.1 | | R.6 FDD | | |
| OCNG Patterns defined in A.3.2.1.1 (OP.1 FDD) and A.3.2.1.2 (OP.2 FDD) | | OP.1 FDD | OP.2 FDD | |
| PBCH_RA | dB | 0 | 0 | |
| PBCH_RB | | | | |
| PSS_RA | | | | |
| SSS_RA | | | | |
| PCFICH_RB | | | | |
| PHICH_RA | | | | |
| PHICH_RB | | | | |
| PDCCH_RA | | | | |
| PDCCH_RB | | | | |
| PDSCH_RA | | | | |
| PDSCH_RB | | | | |
| OCNG_RA ^{Note1} | | | | |
| OCNG_RB ^{Note1} | | | | |
| p-C-r10[2] | | | | dB |
| N_{oc} ^{Note2} | Bands FDD_A ^{Note 9} | dBm/15 kHz | (N_{oc} for Channel 2 +6dB) | -115 |
| | Bands FDD_B | | | -114.5 |
| | Bands FDD_C | | | -114 |
| | Bands FDD_D | | | -113.5 |

| | | | | |
|---------------------------------|--|------------|---|------------------------------|
| | Bands FDD_E, FDD_F <small>Note 5</small> | | | -113 |
| | Bands FDD_G <small>Note 7</small> | | | -112 |
| | Bands FDD_H | | | -111.5 |
| | $CRS \hat{E}_s / I_{ot}$ | dB | 13 | -6 |
| | $CSI-RS \hat{E}_s / I_{ot}$ | dB | 13 | 0 |
| RSRP ^{Note3} | Bands FDD_A <small>Note 9</small> | dBm/15 kHz | (RSRP for Cell 2 +25dB) | -121 |
| | Bands FDD_B | | | -120.5 |
| | Bands FDD_C | | | -120 |
| | Bands FDD_D | | | -119.5 |
| | Bands FDD_E, FDD_F <small>Note 5</small> | | | -119 |
| | Bands FDD_G <small>Note 7</small> | | | -118 |
| | Bands FDD_H | | | -117.5 |
| CSI-RSRP ^{Note3} | Bands FDD_A <small>Note 9</small> | dBm/15 kHz | (RSRP for Cell 1 +0dB) | (RSRP for Cell 2 +6dB) |
| | Bands FDD_B | | | |
| | Bands FDD_C | | | |
| | Bands FDD_D | | | |
| | Bands FDD_E, FDD_F <small>Note 5</small> | | | |
| | Bands FDD_G <small>Note 7</small> | | | |
| I _o ^{Note3} | Bands FDD_A <small>Note 9</small> | dBm/9 MHz | (I _o for Channel 2 +18.24dB) | -86.25 |
| | Bands FDD_B | | | -85.75 |
| | Bands FDD_C | | | -85.25 |
| | Bands FDD_D | | | -84.75 |
| | Bands FDD_E, FDD_F <small>Note 5</small> | | | -84.25 |
| | Bands FDD_G <small>Note 7</small> | | | -83.25 |
| | Bands FDD_H | | | -82.75 |
| | $CRS \hat{E}_s / N_{oc}$ | dB | 13 | -6 |
| | $CSI-RS \hat{E}_s / N_{oc}$ | dB | 13 | 0 |
| Propagation condition | | - | AWGN | |
| Note 1: | OCNG shall be used such that both cells are fully allocated and a constant total transmitted power spectral density is achieved for all OFDM symbols. | | | |
| Note 2: | Interference from other cells and noise sources not specified in the test is assumed to be constant over subcarriers and time and shall be modelled as AWGN of appropriate power for N_{oc} to be fulfilled. | | | |
| Note 3: | RSRP, CSI-RSRP and I _o levels have been derived from other parameters for information purposes. They are not settable parameters themselves. I _o levels are calculated in CRS symbols of measurement subframe. | | | |
| Note 4: | RSRP minimum requirements are specified assuming independent interference and noise at each receiver antenna port. | | | |
| Note 5: | For Band 26, the tests shall be performed with the carrier frequency of assigned E-UTRA channel bandwidth within 865-894 MHz. | | | |
| Note 6: | E-UTRA operating band groups are as defined in Section 3.5. | | | |
| Note 7: | Except Band 29. | | | |
| Note 8: | DMTC is provided to the UE in the <i>measDS-Config</i> (in TS36.331) before the beginning of the test. | | | |
| Note 9: | Except Band 32. | | | |

A.9.1.31.3 Test Requirements

The CSI-RSRP measurement accuracy shall fulfil the requirements in sections 9.1.14.3.

A.9.1.32 TDD—TDD inter-frequency absolute and relative CSI-RSRP accuracies in CSI-RS based discovery signal

A.9.1.32.1 Test Purpose and Environment

The purpose of this test is to verify that the CSI-RSRP measurement accuracy is within the specified limits. This test will verify the requirements in Sections 9.1.14.3 for TDD—TDD inter frequency measurements.

A.9.1.32.2 Test parameters

In this set of test case the cells are on different carrier frequencies. Both absolute and relative accuracy of CSI-RSRP inter-frequency measurements are tested by using the parameters in Table A.9.1.32.2-1. In this test case, Cell 1 is the PCell and Cell 2 the target cell. The inter frequency measurements are supported by a measurement gap and two DMTC configurations which one is for cell 1 and the other is for cell2.

Table A.9.1.32.2-1: CSI-RSRP TDD—TDD Inter frequency test parameters

| Parameter | Unit | Test 1 | |
|--|-----------|----------|----------|
| | | Cell 1 | Cell 2 |
| E-UTRA RF Channel Number | | 1 | 2 |
| $BW_{channel}$ | MHz | 10 | 10 |
| Special subframe configuration ^{Note1} | | 6 | |
| Uplink-downlink configuration ^{Note1} | | 1 | |
| Gap Pattern Id | | 0 | - |
| gapOffset | ms | 9 | |
| DMTC period | ms | 160 | 160 |
| DMTC period offset | ms | 0 | 10 |
| Discovery signal occasion duration | ms | 2 | 2 |
| CSI-RS resource configuration | | 2 | 4 |
| CSI-RS periodicity | ms | 10 | |
| CSI-RS subframe offset | ms | 0 | |
| CSI-RS individual offset[2] | dB | 0 | 0 |
| CSI-RS muting | | Enable | Enable |
| Time offset between cells | μ s | - | 3 |
| Measurement bandwidth | n_{PRB} | 22—27 | |
| PDSCH Reference measurement channel defined in A.3.1.1.2 | | R.0 TDD | - |
| PDSCH allocation | n_{PRB} | 13—36 | - |
| PDCCH/PCFICH/PHICH Reference measurement channel defined in A.3.1.2.2 | | R.6 TDD | |
| OCNG Patterns defined in A.3.2.2.1 (OP.1 TDD) and A.3.2.2.2 (OP.2 TDD) | | OP.1 TDD | OP.2 TDD |
| PBCH_RA | dB | 0 | 0 |
| PBCH_RB | | | |
| PSS_RA | | | |
| SSS_RA | | | |
| PCFICH_RB | | | |
| PHICH_RA | | | |
| PHICH_RB | | | |
| PDCCH_RA | | | |
| PDCCH_RB | | | |
| PDSCH_RA | | | |

| | | | | |
|---|-------------|------------|--------------------------------|------------------------|
| PDSCH_RB | | | | |
| OCNG_RA ^{Note2} | | | | |
| OCNG_RB ^{Note2} | | | | |
| p-C-r10[2] | | dB | 0 | -6 |
| N_{oc} ^{Note3} | Bands TDD_A | dBm/15 kHz | $(N_{oc}$ for Channel 2 +6dB) | -115 |
| | Bands TDD_C | | | -114 |
| | Bands TDD_E | | | -113 |
| CRS \hat{E}_s/I_{ot} | | dB | 13 | -6 |
| CSI-RS \hat{E}_s/I_{ot} | | dB | 13 | 0 |
| RSRP ^{Note4} | Bands TDD_A | dBm/15 kHz | (RSRP for Cell 2 +25dB) | -121 |
| | Bands TDD_C | | | -120 |
| | Bands TDD_E | | | -119 |
| CSI-RSRP ^{Note4} | Bands TDD_A | dBm/15 kHz | (RSRP for Cell 1 +0dB) | (RSRP for Cell 2 +6dB) |
| | Bands TDD_C | | | |
| | Bands TDD_E | | | |
| I_o ^{Note4} | Bands TDD_A | dBm/9 MHz | $(I_o$ for Channel 2 +18.24dB) | -86.25 |
| | Bands TDD_C | | | -85.25 |
| | Bands TDD_E | | | -84.25 |
| CRS \hat{E}_s/N_{oc} | | dB | 13 | -6 |
| CSI-RS \hat{E}_s/N_{oc} | | dB | 13 | 0 |
| Propagation condition | | - | AWGN | |
| <p>Note 1: For special subframe and uplink-downlink configurations see Tables 4.2-1 and 4.2-2 in TS 36.211.</p> <p>Note 2: OCNG shall be used such that both cells are fully allocated and a constant total transmitted power spectral density is achieved for all OFDM symbols.</p> <p>Note 3: Interference from other cells and noise sources not specified in the test is assumed to be constant over subcarriers and time and shall be modelled as AWGN of appropriate power for N_{oc} to be fulfilled.</p> <p>Note 4: RSRP, CSI-RSRP and I_o levels have been derived from other parameters for information purposes. They are not settable parameters themselves. I_o levels are calculated in CRS symbols of measurement subframe.</p> <p>Note 5: RSRP minimum requirements are specified assuming independent interference and noise at each receiver antenna port.</p> <p>Note 6: E-UTRA operating band groups are as defined in Section 3.5.</p> <p>Note 7: DMTC is provided to the UE in the measDS-Config (in TS36.331) before the beginning of test.</p> | | | | |

A.9.1.32.3 Test Requirements

The CSI-RSRP measurement accuracy shall fulfil the requirements in sections 9.1.14.3.

A.9.1.33 FDD absolute and relative RSRP accuracies for E-UTRAN Carrier Aggregation in CRS based discovery signal

A.9.1.33.1 Test Purpose and Environment

The purpose of this test is to verify that the FDD RSRP absolute and relative measurement accuracies in carrier aggregation in CRS based discovery signal are within the specified limits. This test will verify the absolute RSRP accuracy requirement of the secondary component carrier defined in clause 9.1.15.1.2, and the relative RSRP accuracy

requirement of the secondary component carrier defined in clause 9.1.15.1.2. The test will also verify the primary and secondary component carrier relative RSRP accuracy requirement defined in Clause 9.1.15.1.3.

A.9.1.33.2 Test parameters

In this test case, Cell1 is PCell on the primary component carrier, Cell2 is SCell on the secondary component carrier and activated, and Cell3 is the neighboring cell on the secondary component carrier. The test parameters are given in Table A.9.1.33.2-1. The Cell 3 DMTC configuration is provided to the UE in the *measDS-Config* before the start of the test.

Table A.9.1.33.2-1: RSRP FDD carrier aggregation test parameters

| Parameter | Unit | Test 1 | | |
|--|---------------------------|----------|--|------------------------|
| | | Cell 1 | Cell 2 | Cell3 |
| E-UTRA RF Channel Number | | 1 | 2 | 2 |
| BW _{channel} | MHz | 10 | 10 | 10 |
| DMTC period | ms | N/A | N/A | 160 |
| DMTC period offset | | N/A | N/A | 10 |
| Discovery signal occasion duration | ms | N/A | N/A | 1 |
| Timing offset to cell1 | μs | - | 0 | 3 |
| Time alignment error between cell 2 and cell 1 | | - | ≤ Time alignment error as specified in 3GPP TS 36.104 [30] clause 6.5.3.1. | - |
| Measurement bandwidth | n_{PRB} | 22—27 | | |
| PDSCH Reference measurement channel defined in A.3.1.1.1 | | R.0 FDD | R.0 FDD | - |
| PDSCH allocation | n_{PRB} | 13—36 | 13—36 | - |
| PDCCH/PCFICH/PHICH Reference measurement channel defined in A.3.1.2.1 | | R.6 FDD | | |
| OCNG Patterns defined in A.3.2.1.1 (OP.1 FDD) and A.3.2.1.2 (OP.2 FDD) | | OP.1 FDD | OP.1 FDD | OP.2 FDD |
| PBCH_RA | dB | 0 | 0 | 0 |
| PBCH_RB | | | | |
| PSS_RA | | | | |
| SSS_RA | | | | |
| PCFICH_RB | | | | |
| PHICH_RA | | | | |
| PHICH_RB | | | | |
| PDCCH_RA | | | | |
| PDCCH_RB | | | | |
| PDSCH_RA | | | | |
| PDSCH_RB | | | | |
| OCNG_RANote1 | | | | |
| OCNG_RBNote | | | | |
| N_{oc} Note2 | | | | |
| | Bands FDD_B | -116.5 | | |
| | Bands FDD_C | -116 | | |
| | Bands FDD_D | -115.5 | | |
| | Bands FDD_E, FDD_F Note 6 | -115 | | |
| | Bands FDD_G | -114 | | |
| | Bands FDD_H | -113.5 | | |
| \hat{E}_s/I_{ot} | dB | -4 | 0.46 | -5.76 |
| RSRPNote3 | Bands FDD_A | -121 | (RSRP for Cell 1 +8dB) | (RSRP for Cell 1 +4dB) |
| | Bands FDD_B | -120.5 | | |
| | Bands FDD_C | -120 | | |

| | | | | | |
|---|---|-----------|--------|--|----|
| | Bands FDD_D | | -119.5 | | |
| | Bands FDD_E, FDD_F <small>Note 6</small> | | -119 | | |
| | Bands FDD_G | | -118 | | |
| | Bands FDD_H | | -117.5 | | |
| I_o <small>Note3</small> | Bands FDD_A | dBm/9 MHz | -87.76 | (I _o for Channel 1 +5.33dB) | |
| | Bands FDD_B | | -87.26 | | |
| | Bands FDD_C | | -86.76 | | |
| | Bands FDD_D | | -86.26 | | |
| | Bands FDD_E, FDD_F <small>Note 6</small> | | -85.76 | | |
| | Bands FDD_G | | -84.76 | | |
| | Bands FDD_H | | -84.26 | | |
| \hat{E}_s / N_{oc} | | dB | -4 | 3 | -1 |
| Propagation condition | | - | AWGN | | |
| <p>Note 1: OCNG shall be used such that both cells are fully allocated and a constant total transmitted power spectral density is achieved for all OFDM symbols.</p> <p>Note 2: Interference from other cells and noise sources not specified in the test is assumed to be constant over subcarriers and time and shall be modelled as AWGN of appropriate power for N_{oc} to be fulfilled.</p> <p>Note 3: RSRP and I_o levels have been derived from other parameters for information purposes. They are not settable parameters themselves.</p> <p>Note 4: RSRP minimum requirements are specified assuming independent interference and noise at each receiver antenna port.</p> <p>Note 5: The selection of the bands for testing depends on the configuration of the carrier aggregation supported by the UEs.</p> <p>Note 6: For Band 26, the tests shall be performed with the carrier frequency of the assigned E-UTRA channel bandwidth within 865-894 MHz.</p> <p>Note 7: This test verifies the RRM requirement which is independent of channel bandwidth and is performed according to the principle defined in section A.3.6.1.</p> <p>Note 8: E-UTRA operating band groups are as defined in Section 3.5.</p> | | | | | |

A.9.1.33.3 Test Requirements

In the test, the performance of RSRP measurements is verified from following three perspectives:

- The absolute accuracy of intra-frequency RSRP measurements for Cell 3 on the secondary component carrier shall fulfil the requirements defined in clause 9.1.15.1.2.
- The relative accuracy of intra-frequency RSRP measurements for Cell 3 relative to Cell 2 on the secondary component carrier shall fulfil the requirements defined in clause 9.1.15.1.2
- The relative accuracy of inter-frequency RSRP measurements between the primary and secondary component carriers for Cell 3 relative to Cell 1 shall fulfil the requirements defined in clause 9.1.15.1.3.

A.9.1.34 TDD absolute and relative RSRP accuracies for E-UTRAN Carrier Aggregation in CRS based discovery signal

A.9.1.34.1 Test Purpose and Environment

The purpose of this test is to verify that the TDD RSRP absolute and relative measurement accuracies in carrier aggregation in CRS based discovery signal are within the specified limits. This test will verify the absolute RSRP accuracy requirement of the secondary component carrier defined in clause 9.1.15.1.2, and the relative RSRP accuracy requirement of the secondary component carrier defined in clause 9.1.15.1.2. The test will also verify the primary and secondary component carrier relative RSRP accuracy requirement defined in Clause 9.1.15.1.3.

A.9.1.34.2 Test parameters

In this test case, Cell1 is PCell on the primary component carrier, Cell2 is SCell on the secondary component carrier and activated, and Cell3 is the neighboring cell on the secondary component carrier. The test parameters are given in

Table A.9.1.34.2-1. The Cell 3 DMTC configuration is provided to the UE in the *measDS-Config* before the start of the test.

Table A.9.1.34.2-1: Carrier aggregation RSRP test parameters for TDD

| Parameter | Unit | Test 1 | | |
|--|-------------|----------|--|------------------------|
| | | Cell 1 | Cell 2 | Cell 3 |
| E-UTRA RF Channel Number | | 1 | 2 | 2 |
| $BW_{channel}$ | MHz | 10 | 10 | 10 |
| DMTC period | ms | N/A | N/A | 160 |
| DMTC period offset | | N/A | N/A | 10 |
| Discovery signal occasion duration | ms | N/A | N/A | 2 |
| Special subframe configuration ^{Note1} | | 6 | | |
| Uplink/downlink configuration ^{Note1} | | 1 | | |
| Timing offset to Cell 1 | μs | - | 0 | 3 |
| Time alignment error between cell 2 and cell 1 | | - | \leq Time alignment error as specified in 3GPP TS 36.104 [30] clause 6.5.3.1 | - |
| Measurement bandwidth | n_{PRB} | 22–27 | | |
| PDSCH Reference measurement channel defined in A.3.1.1.2 | | R.0 TDD | R.0 TDD | - |
| PDSCH allocation | n_{PRB} | 13–36 | 13–36 | - |
| PDCCH/PCFICH/PHICH Reference measurement channel defined in A.3.1.2.2 | | R.6 TDD | | |
| OCNG Patterns defined in A.3.2.2.1 (OP.1 TDD) and A.3.2.2.2 (OP.2 TDD) | | OP.1 TDD | OP.1 TDD | OP.2 TDD |
| PBCH_RA | dB | 0 | 0 | 0 |
| PBCH_RB | | | | |
| PSS_RA | | | | |
| SSS_RA | | | | |
| PCFICH_RB | | | | |
| PHICH_RA | | | | |
| PHICH_RB | | | | |
| PDCCH_RA | | | | |
| PDCCH_RB | | | | |
| PDSCH_RA | | | | |
| PDSCH_RB | | | | |
| OCNG_RA ^{Note2} | | | | |
| OCNG_RB ^{Note2} | | | | |
| N_{oc} ^{Note3} | | | | |
| | Bands TDD_C | -116 | | |
| | Bands TDD_E | -115 | | |
| \hat{E}_s/I_{ot} | dB | -4 | 0.46 | -5.76 |
| RSRP ^{Note4} | Bands TDD_A | -121 | (RSRP for Cell 1 +8dB) | (RSRP for Cell 1 +4dB) |
| | Bands TDD_C | -120 | | |
| | Bands TDD_E | -119 | | |
| I_o ^{Note4} | Bands TDD_A | -87.76 | (I _o for Channel 1 +5.33dB) | |
| | Bands TDD_C | -86.76 | | |
| | Bands TDD_E | -85.76 | | |
| \hat{E}_s/N_{oc} | dB | -4 | 3 | -1 |
| Propagation condition | - | AWGN | | |
| Note 1: For special subframe and uplink-downlink configurations see Tables 4.2-1 and 4.2-2 in TS 36.211. | | | | |
| Note 2: OCNG shall be used such that both cells are fully allocated and a constant total transmitted power spectral density is achieved for all OFDM symbols. | | | | |
| Note 3: Interference from other cells and noise sources not specified in the test is assumed to be constant over subcarriers and time and shall be modelled as AWGN of appropriate power | | | | |

| | |
|---------|--|
| | for N_{oc} to be fulfilled. |
| Note 4: | RSRP and I_0 levels have been derived from other parameters for information purposes. They are not settable parameters themselves. |
| Note 5: | RSRP minimum requirements are specified assuming independent interference and noise at each receiver antenna port. |
| Note 6: | The selection of the bands for testing depends on the configuration of the carrier aggregation supported by the UEs. |
| Note 7: | This test verifies the RRM requirement which is independent of channel bandwidth and is performed according to the principle defined in section A.3.6.1. |
| Note 8: | E-UTRA operating band groups are as defined in Section 3.5. |

A.9.1.34.3 Test Requirements

In the test, the performance of RSRP measurements is verified from following three perspectives:

- The absolute accuracy of intra-frequency RSRP measurements for Cell 3 on the secondary component carrier shall fulfil the requirements defined in clause 9.1.15.1.2.
- The relative accuracy of intra-frequency RSRP measurements for Cell 3 relative to Cell 2 on the secondary component carrier shall fulfil the requirements defined in clause 9.1.15.1.2
- The relative accuracy of inter-frequency RSRP measurements between the primary and secondary component carriers for Cell 3 relative to Cell 1 shall fulfil the requirements defined in clause 9.1.15.1.3.

A.9.1.35 FDD absolute and relative CSI-RSRP accuracies for E-UTRAN Carrier Aggregation in CSI-RS based discovery signal

A.9.1.35.1 Test Purpose and Environment

The purpose of this test is to verify that the FDD CSI-RSRP absolute and relative accuracy requirements in carrier aggregation are within the specified limits. This test will verify the absolute CSI-RSRP accuracy requirements of the primary component carrier defined in clause 9.1.15.2.1, the absolute CSI-RSRP accuracy requirements of the secondary component carrier defined in clause 9.1.15.2.2, and the relative CSI-RSRP accuracy requirements of the secondary component carrier defined in clause 9.1.15.2.2. The test will also verify the primary and secondary component carrier relative CSI-RSRP accuracy requirement defined in Clause 9.1.15.2.3.

A.9.1.35.2 Test parameters

In this set of cases cell1 is PCell on the primary component carrier, cell2 is SCell on the secondary component carrier and activated, and cell3 is the neighboring cell on the secondary component carrier. The test parameters are given in Table A.9.1.35.2-1. This set is supported by two DMTC configurations which one is for cell1 and the other is for cell2 and cell3.

Table A.9.1.35.2-1: CSI-RSRP FDD carrier aggregation test parameters

| Parameter | Unit | Test 1 | | |
|--|---------|--------|---|-------|
| | | Cell 1 | Cell 2 | Cell3 |
| E-UTRA RF Channel Number | | 1 | 2 | 2 |
| $BW_{channel}$ | MHz | 10 | 10 | 10 |
| Timing offset to cell1 | μ s | - | 0 | 3 |
| Time alignment error between cell 2 and cell 1 | | - | \leq Time alignment error as specified in 3GPP TS 36.104 [30] clause 6.5.3.1. | - |
| DMTC period | ms | 160 | 160 | |
| DMTC period offset | ms | 0 | 10 | |
| Discovery signal occasion duration | ms | 1 | 1 | |

| | | | | | |
|--|---------------------------|------------|----------|--|----------------------------|
| CSI-RS resource configuration | | | 2 | 4 | 6 |
| CSI-RS periodicity | | ms | 10 | 10 | 10 |
| CSI-RS subframe offset | | ms | 0 | 0 | 0 |
| CSI-RS individual offset[2] | | dB | 0 | 0 | 0 |
| CSI-RS muting | | | Enable | Enable | Enable |
| Measurement bandwidth | | n_{PRB} | 22—27 | | |
| PDSCH Reference measurement channel defined in A.3.1.1.1 | | | R.0 FDD | R.0 FDD | - |
| PDSCH allocation | | n_{PRB} | 13—36 | 13—36 | - |
| PDCCH/PCFICH/PHICH Reference measurement channel defined in A.3.1.2.1 | | | R.6 FDD | | |
| OCNG Patterns defined in A.3.2.1.1 (OP.1 FDD) and A.3.2.1.2 (OP.2 FDD) | | | OP.1 FDD | OP.1 FDD | OP.2 FDD |
| PBCH_RA | | dB | 0 | 0 | 0 |
| PBCH_RB | | | | | |
| PSS_RA | | | | | |
| SSS_RA | | | | | |
| PCFICH_RB | | | | | |
| PHICH_RA | | | | | |
| PHICH_RB | | | | | |
| PDCCH_RA | | | | | |
| PDCCH_RB | | | | | |
| PDSCH_RA | | | | | |
| PDSCH_RB | | | | | |
| OCNG_RANote1 | | | | | |
| OCNG_RBNote | | | | | |
| p-C-r10[2] | | | | | |
| N_{oc} Note2 | Bands FDD_A | dBm/15 kHz | -117 | $(N_{oc}$ for Channel 1 +1dB) | |
| | Bands FDD_B | | -116.5 | | |
| | Bands FDD_C | | -116 | | |
| | Bands FDD_D | | -115.5 | | |
| | Bands FDD_E, FDD_F Note 6 | | -115 | | |
| | Bands FDD_G | | -114 | | |
| | Bands FDD_H | | -113.5 | | |
| $CRS \hat{E}_s / I_{ot}$ | | dB | -4 | 0.46 | -5.76 |
| $CSI-RS \hat{E}_s / I_{ot}$ | | dB | 2 | 6.46 | 0.24 |
| RSRPNote3 | Bands FDD_A | dBm/15 kHz | -121 | (RSRP for Cell 1 +8dB) | (RSRP for Cell 1 +4dB) |
| | Bands FDD_B | | -120.5 | | |
| | Bands FDD_C | | -120 | | |
| | Bands FDD_D | | -119.5 | | |
| | Bands FDD_E, FDD_F Note 6 | | -119 | | |
| | Bands FDD_G | | -118 | | |
| | Bands FDD_H | | -117.5 | | |
| CSI-RSRPNote3 | Bands FDD_A | dBm/15 kHz | -115 | (CSI-RSRP for Cell 1 +8dB) | (CSI-RSRP for Cell 1 +4dB) |
| | Bands FDD_B | | -114.5 | | |
| | Bands FDD_C | | -114 | | |
| | Bands FDD_D | | -113.5 | | |
| | Bands FDD_E, FDD_F Note 6 | | -113 | | |
| | Bands FDD_G | | -112 | | |
| | Bands FDD_H | | -111.5 | | |
| I_o Note3 | Bands FDD_A | dBm/9 MHz | -87.76 | (I _o for Channel 1 +5.33dB) | |
| | Bands FDD_B | | -87.26 | | |
| | Bands FDD_C | | -86.76 | | |
| | Bands FDD_D | | -86.26 | | |
| | Bands FDD_E, FDD_F Note 6 | | -85.76 | | |
| | Bands FDD_G | | -84.76 | | |
| | Bands FDD_H | | -84.26 | | |

| | | | | |
|-----------------------------|--|------|---|----|
| CRS \hat{E}_s / N_{oc} | dB | -4 | 3 | -1 |
| CSI-RS \hat{E}_s / N_{oc} | dB | 2 | 9 | 5 |
| Propagation condition | - | AWGN | | |
| Note 1: | OCNG shall be used such that both cells are fully allocated and a constant total transmitted power spectral density is achieved for all OFDM symbols. | | | |
| Note 2: | Interference from other cells and noise sources not specified in the test is assumed to be constant over subcarriers and time and shall be modelled as AWGN of appropriate power for N_{oc} to be fulfilled. | | | |
| Note 3: | RSRP, CSI-RSRP and Io levels have been derived from other parameters for information purposes. They are not settable parameters themselves. Io levels are calculated in CRS symbols of measurement subframe. | | | |
| Note 4: | RSRP minimum requirements are specified assuming independent interference and noise at each receiver antenna port. | | | |
| Note 5: | The selection of the bands for testing depends on the configuration of the carrier aggregation supported by the UEs. | | | |
| Note 6: | For Band 26, the tests shall be performed with the carrier frequency of the assigned E-UTRA channel bandwidth within 865-894 MHz. | | | |
| Note 7: | This test verifies the RRM requirement which is independent of channel bandwidth and is performed according to the principle defined in section A.3.6.1. | | | |
| Note 8: | E-UTRA operating band groups are as defined in Section 3.5. | | | |
| Note 9: | DMTC configurations are provided to the UE in the <i>measDS-Config</i> (in TS36.331) before the beginning of the test. | | | |

A.9.1.35.3 Test Requirements

In the test, the performance of CSI-RSRP measurements is verified from following four perspectives:

- The absolute accuracy of intra-frequency CSI-RSRP measurements for Cell 1 on the primary component carrier shall fulfil the requirements defined in clause 9.1.15.2.1.
- The absolute accuracy of intra-frequency CSI-RSRP measurements for Cell 2 on the secondary component carrier shall fulfil the requirements defined in clause 9.1.15.2.2.
- The relative accuracy of intra-frequency CSI-RSRP measurements for Cell 3 relative to Cell 2 on the secondary component carrier shall fulfil the requirements defined in clause 9.1.15.2.2.
- The relative accuracy of inter-frequency CSI-RSRP measurements between the primary and secondary component carriers for Cell 2 relative to Cell 1 shall fulfil the requirements defined in clause 9.1.15.2.3.

A.9.1.36 TDD absolute and relative CSI-RSRP accuracies for E-UTRAN Carrier Aggregation in CSI-RS based discovery signal

A.9.1.36.1 Test Purpose and Environment

The purpose of this test is to verify that the TDD CSI-RSRP absolute and relative accuracy requirements in carrier aggregation are within the specified limits. This test will verify the absolute CSI-RSRP accuracy requirements of the primary component carrier defined in clause 9.1.15.2.1, the absolute CSI-RSRP accuracy requirements of the secondary component carrier defined in clause 9.1.15.2.2, and the relative CSI-RSRP accuracy requirements of the secondary component carrier defined in clause 9.1.15.2.2. The test will also verify the primary and secondary component carrier relative CSI-RSRP accuracy requirement defined in Clause 9.1.15.2.3.

A.9.1.36.2 Test parameters

In this set of cases cell1 is PCell on the primary component carrier, cell2 is SCell on the secondary component carrier and activated, and cell3 is the neighboring cell on the secondary component carrier. The test parameters are given in Table A.9.1.36.2-1. This set is supported by two DMTC configurations which one is for cell1 and the other is for cell2 and cell3.

Table A.9.1.36.2-1: CSI-RSRP TDD carrier aggregation test parameters

| Parameter | Unit | Test 1 | | |
|--|-------------|----------|---|----------------------------|
| | | Cell 1 | Cell 2 | Cell 3 |
| E-UTRA RF Channel Number | | 1 | 2 | |
| BW _{channel} | MHz | 10 | | |
| Special subframe configuration ^{Note1} | | 6 | | |
| Uplink/downlink configuration ^{Note1} | | 1 | | |
| Timing offset to Cell 1 | μs | - | 0 | 3 |
| Time alignment error between cell 2 and cell 1 | | - | ≤ Time alignment error as specified in 3GPP TS 36.104 [30] clause 6.5.3.1 | - |
| DMTC period | ms | 160 | 160 | |
| DMTC period offset | ms | 0 | 10 | |
| Discovery signal occasion duration | ms | 2 | 2 | |
| CSI-RS resource configuration | | 2 | 4 | 6 |
| CSI-RS periodicity | ms | 10 | 10 | 10 |
| CSI-RS subframe offset | ms | 0 | 0 | 0 |
| CSI-RS individual offset[2] | dB | 0 | 0 | 0 |
| CSI-RS muting | | Enable | Enable | Enable |
| Measurement bandwidth | n_{PRB} | 22–27 | | |
| PDSCH Reference measurement channel defined in A.3.1.1.2 | | R.0 TDD | R.0 TDD | - |
| PDSCH allocation | n_{PRB} | 13–36 | 13–36 | - |
| PDCCH/PCFICH/PHICH Reference measurement channel defined in A.3.1.2.2 | | R.6 TDD | | |
| OCNG Patterns defined in A.3.2.2.1 (OP.1 TDD) and A.3.2.2.2 (OP.2 TDD) | | OP.1 TDD | OP.1 TDD | OP.2 TDD |
| PBCH_RA | dB | 0 | 0 | 0 |
| PBCH_RB | | | | |
| PSS_RA | | | | |
| SSS_RA | | | | |
| PCFICH_RB | | | | |
| PHICH_RA | | | | |
| PHICH_RB | | | | |
| PDCCH_RA | | | | |
| PDCCH_RB | | | | |
| PDSCH_RA | | | | |
| PDSCH_RB | | | | |
| OCNG_RA ^{Note2} | | | | |
| OCNG_RB ^{Note2} | | | | |
| p-C-r10[2] | | | | |
| N_{oc} ^{Note3} | Bands TDD_A | -117 | $(N_{oc}$ for Channel 1 +1dB) | |
| | Bands TDD_C | -116 | | |
| | Bands TDD_E | -115 | | |
| $CRS \hat{E}_s / I_{ot}$ | dB | -4 | 0.46 | -5.76 |
| $CSI-RS \hat{E}_s / I_{ot}$ | dB | 2 | 6.46 | 0.24 |
| RSRP ^{Note4} | Bands TDD_A | -121 | (RSRP for Cell 1 +8dB) | (RSRP for Cell 1 +4dB) |
| | Bands TDD_C | -120 | | |
| | Bands TDD_E | -119 | | |
| CSI-RSRP ^{Note4} | Bands TDD_A | -115 | (CSI-RSRP for Cell 1 +8dB) | (CSI-RSRP for Cell 1 +4dB) |
| | Bands TDD_C | -114 | | |
| | Bands TDD_E | -113 | | |
| I_o ^{Note4} | Bands TDD_A | -87.76 | $(I_o$ for Channel 1 +5.33dB) | |
| | Bands TDD_C | -86.76 | | |
| | Bands TDD_E | -85.76 | | |

| | | | | |
|-----------------------------|--|------|---|----|
| CRS \hat{E}_s / N_{oc} | dB | -4 | 3 | -1 |
| CSI-RS \hat{E}_s / N_{oc} | dB | 2 | 9 | 5 |
| Propagation condition | - | AWGN | | |
| Note 1: | For special subframe and uplink-downlink configurations see Tables 4.2-1 and 4.2-2 in TS 36.211. | | | |
| Note 2: | OCNG shall be used such that both cells are fully allocated and a constant total transmitted power spectral density is achieved for all OFDM symbols. | | | |
| Note 3: | Interference from other cells and noise sources not specified in the test is assumed to be constant over subcarriers and time and shall be modelled as AWGN of appropriate power for N_{oc} to be fulfilled. | | | |
| Note 4: | RSRP, CSI-RSRP and Io levels have been derived from other parameters for information purposes. They are not settable parameters themselves. Io levels are calculated in CRS symbols of measurement subframe. | | | |
| Note 5: | RSRP minimum requirements are specified assuming independent interference and noise at each receiver antenna port. | | | |
| Note 6: | The selection of the bands for testing depends on the configuration of the carrier aggregation supported by the UEs. | | | |
| Note 7: | This test verifies the RRM requirement which is independent of channel bandwidth and is performed according to the principle defined in section A.3.6.1. | | | |
| Note 8: | E-UTRA operating band groups are as defined in Section 3.5. | | | |
| Note 9: | DMTC configurations are provided to the UE in the <i>measDS-Config</i> (in TS36.331) before the beginning of the test | | | |

A.9.1.36.3 Test Requirements

In the test, the performance of CSI-RSRP measurements is verified from following four perspectives:

- The absolute accuracy of intra-frequency CSI-RSRP measurements for Cell 1 on the primary component carrier shall fulfil the requirements defined in clause 9.1.15.2.1.
- The absolute accuracy of intra-frequency CSI-RSRP measurements for Cell 2 on the secondary component carrier shall fulfil the requirements defined in clause 9.1.15.2.2.
- The relative accuracy of intra-frequency CSI-RSRP measurements for Cell 3 relative to Cell 2 on the secondary component carrier shall fulfil the requirements defined in clause 9.1.15.2.2.
- The relative accuracy of inter-frequency CSI-RSRP measurements between the primary and secondary component carriers for Cell 2 relative to Cell 1 shall fulfil the requirements defined in clause 9.1.15.2.3.

A.9.1.37 3 DL PCell in FDD RSRP for E-UTRAN in Carrier Aggregation

A.9.1.37.1 Test Purpose and Environment

The purpose of this test is to verify that the TDD-FDD RSRP absolute and relative accuracy requirements in carrier aggregation with PCell in FDD are within the specified limits. This test will verify the absolute RSRP accuracy requirements of the primary component carrier defined in clause 9.1.11.1, the absolute RSRP accuracy requirements of the secondary component carriers defined in clause 9.1.11.2, and the relative RSRP accuracy requirements of the secondary component carriers defined in clause 9.1.11.2. The test will also verify the primary and secondary component carriers' relative RSRP accuracy requirement defined in Clause 9.1.11.3.

A.9.1.37.2 Test parameters

In this set of cases cell 1 is PCell on the primary component carrier, and cell 2 and cell 4 are activated SCells on secondary component carriers SCC1 and SCC2 respectively. Cell 3 and cell 5 are neighbouring cells on secondary component carriers SCC1 and SCC2 respectively. The test parameters are given in Table A.9.1.37.2-1.

Table A.9.1.37.2-1: 3 Downlink PCell in FDD RSRP carrier aggregation test parameters

| Parameter | Unit | Cell 1 | Cell 2 | Cell 3 | Cell 4 | Cell 5 |
|--------------------------|------|--------|--------|--------|--------|--------|
| E-UTRA RF Channel Number | | 1 | 2 | | 3 | |

| | | | | | | | |
|--|--|------------------|--|---|---|---|------------------------|
| BW _{channel} | | MHz | 5MHz: N _{RB,c} = 25 10MHz: N _{RB,c} = 50 20MHz: N _{RB,c} = 100 | 5MHz: N _{RB,c} = 25 10MHz: N _{RB,c} = 50 20MHz: N _{RB,c} = 100 | 5MHz: N _{RB,c} = 25 10MHz: N _{RB,c} = 50 20MHz: N _{RB,c} = 100 | | |
| Special subframe configuration ^{Note1} | | | - | 6 | 6 | | |
| Uplink/downlink configuration ^{Note1} | | | - | 1 | 1 | | |
| Measurement bandwidth | | n _{PRB} | 5MHz: 10-15 10MHz: 22-27 20MHz: 47-52 | 5MHz: 10-15 10MHz: 22-27 20MHz: 47-52 | 5MHz: 10-15 10MHz: 22-27 20MHz: 47-52 | | |
| PDSCH Reference measurement channel defined in A.3.1.1. | | | 5MHz: R.5 FDD 10MHz: R.0 FDD 20MHz: R.4 FDD | 5MHz: R.4 TDD 10MHz: R.0 TDD 20MHz: R.3 TDD | - | 5MHz: R.4 TDD 10MHz: R.0 TDD 20MHz: R.3 TDD | |
| PDSCH allocation | | n _{PRB} | 5MHz: 7-17 10MHz: 13-36 20MHz: 38-61 | 5MHz: 7-17 10MHz: 13-36 20MHz: 38-61 | - | 5MHz: 7-17 10MHz: 13-36 20MHz: 38-61 | |
| PDCCH/PCFICH/PHICH Reference measurement channel defined in A.3.1.2. | | | 5MHz: R.11 FDD 10MHz: R.6 FDD 20MHz: R.10 FDD | 5MHz: R.11 TDD 10MHz: R.6 TDD 20MHz: R.10 TDD | 5MHz: R.11 TDD 10MHz: R.6 TDD 20MHz: R.10 TDD | 5MHz: R.11 TDD 10MHz: R.6 TDD 20MHz: R.10 TDD | |
| OCNG Patterns defined in A.3.2. | | | 5MHz: OP.15 FDD 10MHz: OP.1 FDD 20MHz: OP.11 FDD | 5MHz: OP.9 TDD 10MHz: OP.1 TDD 20MHz: OP.7 TDD | 5MHz: OP.10 TDD 10MHz: OP.2 TDD 20MHz: OP.8 TDD | 5MHz: OP.9 TDD 10MHz: OP.1 TDD 20MHz: OP.7 TDD | |
| PBCH_RA | | dB | 0 | 0 | 0 | 0 | |
| PBCH_RB | | | | | | | |
| PSS_RA | | | | | | | |
| SSS_RA | | | | | | | |
| PCFICH_RB | | | | | | | |
| PHICH_RA | | | | | | | |
| PHICH_RB | | | | | | | |
| PDCCH_RA | | | | | | | |
| PDCCH_RB | | | | | | | |
| PDSCH_RA | | | | | | | |
| PDSCH_RB | | | | | | | |
| OCNG_RA ^{Note2} | | | | | | | |
| OCNG_RB ^{Note2} | | | | | | | |
| N _{oc} ^{Note3} | Bands TDD_A | | | | | | dBm/15 kHz |
| | Bands TDD_C | -117 | | | | | |
| | Bands TDD_E | -116.5 | | | | | |
| | Bands FDD_A | -116 | | | | | |
| | Bands FDD_B | -115.5 | | | | | |
| | Bands FDD_C | -115 | | | | | |
| | Bands FDD_D | -114 | | | | | |
| | Bands FDD_E, FDD_F ^{Note7} | -113.5 | | | | | |
| | Bands FDD_G | | | | | | |
| Bands FDD_H | | | | | | | |
| \hat{E}_s/N_{oc} | | dB | -4 | 3 | -1 | 3 | -1 |
| \hat{E}_s/I_{ot} | | dB | -4 | 0.46 | -5.76 | 0.46 | -5.76 |
| RSRP ^{Note4} | Bands TDD_A | dBm/15 | - | (RSRP for Cell 1 +8dB) | (RSRP for Cell 1 +4dB) | (RSRP for Cell 1 +8dB) | (RSRP for Cell 1 +4dB) |
| | Bands TDD_C | | -121 | - | - | - | - |
| | Bands FDD_A | | -120.5 | - | - | - | - |
| | Bands FDD_B | | | - | - | - | - |

| | | | | | | | |
|---|---|-------------------------------|--------------------------------------|---|---|-------|------|
| | Bands FDD_C | kHz | -120 | | | | |
| | Bands FDD_D | | -119.5 | | | | |
| | Bands FDD_E, FDD_F ^{Note 7} | | -119 | | | | |
| | Bands FDD_G | | -118 | | | | |
| | Bands FDD_H | | -117.5 | | | | |
| I _o ^{Note 4} | Bands TDD_A | dBm/ BW _{channel} | - | (I _o for Channel 1 +5.33dB +10log (N _{RB channel2} / N _{RB channel 1})) | (I _o for Channel 1 +5.33dB +10log (N _{RB channel3} / N _{RB channel 1})) | | |
| | Bands TDD_C | | | | | | |
| | Bands TDD_E | | | | | | |
| | Bands FDD_A | | -87.76+10log(N _{RB,c} /50) | | | | |
| | Bands FDD_B | | -87.26+10log(N _{RB,c} /50) | | | | |
| | Bands FDD_C | | -86.76+10log(N _{RB,c} /50) | | | | |
| | Bands FDD_D | | -86.26+10log(N _{RB,c} /50) | | | | |
| | Bands FDD_E, FDD_F ^{Note 7} | | -85.76 +10log(N _{RB,c} /50) | | | | |
| | Bands FDD_G | | -84.76 +10log(N _{RB,c} /50) | | | | |
| Bands FDD_H | -84.26 +10log(N _{RB,c} /50) | | | | | | |
| Propagation condition | | - | AWGN | AWGN | AWGN | AWGN | AWGN |
| Antenna Configuration | | - | 1x2 | 1x2 | 1x2 | 1x2 | 1x2 |
| Timing offset to cell 1 | | μs | - | 0 | 3 | 0 | 3 |
| Time alignment error relative to cell 1 ^{Note 8} | | | - | ≤ TAE | - | ≤ TAE | - |
| Time alignment error relative to cell 2 ^{Note 8} | | | - | - | - | ≤ TAE | - |
| <p>Note 1: For special subframe and uplink-downlink configurations see Tables 4.2-1 and 4.2-2 in TS 36.211.</p> <p>Note 2: OCNG shall be used such that all cells are fully allocated and a constant total transmitted power spectral density is achieved for all OFDM symbols.</p> <p>Note 3: Interference from other cells and noise sources not specified in the test is assumed to be constant over subcarriers and time and shall be modelled as AWGN of appropriate power for N_{oc} to be fulfilled.</p> <p>Note 4: RSRP and I_o levels have been derived from other parameters for information purposes. They are not settable parameters themselves.</p> <p>Note 5: RSRP minimum requirements are specified assuming independent interference and noise at each receiver antenna port.</p> <p>Note 6: The selection of the bands for testing depends on the configuration of the carrier aggregation supported by the UEs.</p> <p>Note 7: For Band 26, the tests shall be performed with the carrier frequency of the assigned E-UTRA channel bandwidth within 865-894 MHz.</p> <p>Note 8: Time alignment error (TAE) as specified in TS 36.104 [30] clause 6.5.3.1. The TAE value depends upon the type of carrier aggregation.</p> <p>Note 9: E-UTRA operating band groups are as defined in Section 3.5.</p> | | | | | | | |

A.9.1.37.3 Test Requirements

In the test, the performance of RSRP measurements is verified from the following 7 perspectives:

- The absolute accuracy of intra-frequency RSRP measurements for Cell 1 on the primary component carrier shall fulfil the requirements defined in clause 9.1.11.1.
- The absolute accuracy of intra-frequency RSRP measurements for Cell 2 on SCC1 shall fulfil the requirements defined in clause 9.1.11.2.
- The absolute accuracy of intra-frequency RSRP measurements for Cell 4 on SCC2 shall fulfil the requirements defined in clause 9.1.11.2.
- The relative accuracy of intra-frequency RSRP measurements for Cell 3 relative to Cell 2 on SCC1 shall fulfil the requirements defined in clause 9.1.11.2.
- The relative accuracy of intra-frequency RSRP measurements for Cell 5 relative to Cell 4 on SCC2 shall fulfil the requirements defined in clause 9.1.11.2.
- The relative accuracy of inter-frequency RSRP measurements between SCC1 and the primary component carriers for Cell 2 relative to Cell 1 shall fulfil the requirements defined in clause 9.1.11.3.
- The relative accuracy of inter-frequency RSRP measurements between SCC2 and the primary component carriers for Cell 4 relative to Cell 1 shall fulfil the requirements defined in clause 9.1.11.3.

A.9.1.38 3 DL PCell in TDD RSRP for E-UTRAN in Carrier Aggregation

A.9.1.38.1 Test Purpose and Environment

The purpose of this test is to verify that the TDD-FDD RSRP absolute and relative accuracy requirements in carrier aggregation with PCell in TDD are within the specified limits. This test will verify the absolute RSRP accuracy requirements of the primary component carrier defined in clause 9.1.11.1, the absolute RSRP accuracy requirements of the secondary component carriers defined in clause 9.1.11.2, and the relative RSRP accuracy requirements of the secondary component carriers defined in clause 9.1.11.2. The test will also verify the primary and secondary component carriers' relative RSRP accuracy requirement defined in Clause 9.1.11.3.

A.9.1.38.2 Test parameters

In this set of cases cell 1 is PCell on the primary component carrier, and cell 2 and cell 4 are activated SCells on secondary component carriers SCC1 and SCC2 respectively. Cell 3 and cell 5 are neighbouring cells on secondary component carriers SCC1 and SCC2 respectively. The test parameters are given in Table A.9.1.38.2-1.

Table A.9.1.38.2-1: 3 Downlink PCell in TDD RSRP carrier aggregation test parameters

| Parameter | Unit | Cell 1 | Cell 2 | Cell 3 | Cell 4 | Cell 5 |
|--|------------------|--|---|---|---|---|
| E-UTRA RF Channel Number | | 1 | 2 | | 3 | |
| BW _{channel} | MHz | 5MHz: N _{RB,c} = 25 10MHz: N _{RB,c} = 50 20MHz: N _{RB,c} = 100 | 5MHz: N _{RB,c} = 25 10MHz: N _{RB,c} = 50 20MHz: N _{RB,c} = 100 | | 5MHz: N _{RB,c} = 25 10MHz: N _{RB,c} = 50 20MHz: N _{RB,c} = 100 | |
| Special subframe configuration ^{Note1} | | 6 | - | | - | |
| Uplink/downlink configuration ^{Note1} | | 1 | - | | - | |
| Measurement bandwidth | n _{PRB} | 5MHz: 10-15 10MHz: 22-27 20MHz: 47-52 | 5MHz: 10-15 10MHz: 22-27 20MHz: 47-52 | | 5MHz: 10-15 10MHz: 22-27 20MHz: 47-52 | |
| PDSCH Reference measurement channel defined in A.3.1.1. | | 5MHz: R.4 TDD 10MHz: R.0 TDD 20MHz: R.3 TDD | 5MHz: R.5 FDD 10MHz: R.0 FDD 20MHz: R.4 FDD | - | 5MHz: R.5 FDD 10MHz: R.0 FDD 20MHz: R.4 FDD | - |
| PDSCH allocation | n _{PRB} | 5MHz: 7-17 10MHz: 13-36 20MHz: 38-61 | 5MHz: 7-17 10MHz: 13-36 20MHz: 38-61 | - | 5MHz: 7-17 10MHz: 13-36 20MHz: 38-61 | - |
| PDCCH/PCFICH/PHICH Reference measurement channel defined in A.3.1.2. | | 5MHz: R.11 TDD 10MHz: R.6 TDD 20MHz: R.10 TDD | 5MHz: R.11 FDD 10MHz: R.6 FDD 20MHz: R.10 FDD | 5MHz: R.11 FDD 10MHz: R.6 FDD 20MHz: R.10 FDD | 5MHz: R.11 FDD 10MHz: R.6 FDD 20MHz: R.10 FDD | 5MHz: R.11 FDD 10MHz: R.6 FDD 20MHz: R.10 FDD |
| OCNG Patterns defined in A.3.2. | | 5MHz: OP.9 TDD 10MHz: OP.1 TDD 20MHz: OP.7 TDD | 5MHz: OP.15 FDD 10MHz: OP.1 FDD 20MHz: OP.11 FDD | 5MHz: OP.16 FDD 10MHz: OP.2 FDD 20MHz: OP.12 FDD | 5MHz: OP.15 FDD 10MHz: OP.1 FDD 20MHz: OP.11 FDD | 5MHz: OP.16 FDD 10MHz: OP.2 FDD 20MHz: OP.12 FDD |
| PBCH_RA | dB | 0 | 0 | 0 | 0 | 0 |
| PBCH_RB | | | | | | |
| PSS_RA | | | | | | |
| SSS_RA | | | | | | |
| PCFICH_RB | | | | | | |
| PHICH_RA | | | | | | |
| PHICH_RB | | | | | | |
| PDCCH_RA | | | | | | |

| | | | | | | | |
|---|--------------------------------------|---------------------------|------------------------------|---|------------------------|---|------------------------|
| PDCCH_RB | | | | | | | |
| PDSCH_RA | | | | | | | |
| PDSCH_RB | | | | | | | |
| OCNG_RA ^{Note1} | | | | | | | |
| OCNG_RB ^{Note1} | | | | | | | |
| N_{oc} ^{Note3} | Bands FDD_A | dBm/15 kHz | - | $(N_{oc}$ for Channel 1 +1dB) | | $(N_{oc}$ for Channel 1 +1dB) | |
| | Bands FDD_B | | | | | | |
| | Bands FDD_C | | | | | | |
| | Bands FDD_D | | | | | | |
| | Bands FDD_E, FDD_F ^{Note 7} | | | | | | |
| | Bands FDD_G | | | | | | |
| | Bands FDD_H | | | | | | |
| | Bands TDD_A | | -117 | | | | |
| | Bands TDD_C | | -116 | | | | |
| | Bands TDD_E | | -115 | | | | |
| \hat{E}_s / N_{oc} | | dB | -4 | 3 | -1 | 3 | -1 |
| \hat{E}_s / I_{ot} | | dB | -4 | 0.46 | -5.76 | 0.46 | -5.76 |
| RSRP ^{Note4} | Bands FDD_A | dBm/15 kHz | - | (RSRP for Cell 1 +8dB) | (RSRP for Cell 1 +4dB) | (RSRP for Cell 1 +8dB) | (RSRP for Cell 1 +4dB) |
| | Bands FDD_B | | | | | | |
| | Bands FDD_C | | | | | | |
| | Bands FDD_D | | | | | | |
| | Bands FDD_E, FDD_F ^{Note 7} | | | | | | |
| | Bands FDD_G | | | | | | |
| | Bands FDD_H | | | | | | |
| | Bands TDD_A | | -121 | | | | |
| | Bands TDD_C | | -120 | | | | |
| | Bands TDD_E | | -119 | | | | |
| I_o ^{Note4} | Bands FDD_A | dBm/BW _{channel} | - | (I _o for Channel 1 +5.33dB +10log (N _{RB channel2} / N _{RB channel 1})) | | (I _o for Channel 1 +5.33dB +10log (N _{RB channel3} / N _{RB channel 1})) | |
| | Bands FDD_B | | | | | | |
| | Bands FDD_C | | | | | | |
| | Bands FDD_D | | | | | | |
| | Bands FDD_E, FDD_F ^{Note 7} | | | | | | |
| | Bands FDD_G | | | | | | |
| | Bands FDD_H | | | | | | |
| | Bands TDD_A | | $-87.76+10\log(N_{RB,c}/50)$ | | | | |
| | Bands TDD_C | | $-86.76+10\log(N_{RB,c}/50)$ | | | | |
| | Bands TDD_E | | $-85.76+10\log(N_{RB,c}/50)$ | | | | |
| Propagation condition | | - | AWGN | AWGN | AWGN | AWGN | AWGN |
| Antenna Configuration | | - | 1x2 | 1x2 | 1x2 | 1x2 | 1x2 |
| Timing offset to cell 1 | | μs | - | 0 | 3 | 0 | 3 |
| Time alignment error relative to cell 1 ^{Note 8} | | | - | ≤ TAE | - | ≤ TAE | - |
| Time alignment error relative to cell 2 ^{Note8} | | | - | - | - | ≤ TAE | - |
| <p>Note 1: For special subframe and uplink-downlink configurations see Tables 4.2-1 and 4.2-2 in TS 36.211.</p> <p>Note 2: OCNG shall be used such that all cells are fully allocated and a constant total transmitted power spectral density is achieved for all OFDM symbols.</p> <p>Note 3: Interference from other cells and noise sources not specified in the test is assumed to be constant over subcarriers and time and shall be modelled as AWGN of appropriate power for N_{oc} to be fulfilled.</p> <p>Note 4: RSRP and I_o levels have been derived from other parameters for information purposes. They are not settable parameters themselves.</p> <p>Note 5: RSRP minimum requirements are specified assuming independent interference and noise at each receiver antenna port.</p> <p>Note 6: The selection of the bands for testing depends on the configuration of the carrier aggregation supported by the UEs.</p> <p>Note 7: For Band 26, the tests shall be performed with the carrier frequency of the assigned E-UTRA channel bandwidth within 865-894 MHz.</p> <p>Note 8: Time alignment error (TAE) as specified in TS 36.104 [30] clause 6.5.3.1. The TAE value depends upon the type of carrier aggregation.</p> <p>Note 9: E-UTRA operating band groups are as defined in Section 3.5.</p> | | | | | | | |

A.9.1.38.3 Test Requirements

In the test, the performance of RSRP measurements is verified from the following 7 perspectives:

- The absolute accuracy of intra-frequency RSRP measurements for Cell 1 on the primary component carrier shall fulfil the requirements defined in clause 9.1.11.1.
- The absolute accuracy of intra-frequency RSRP measurements for Cell 2 on SCC1 shall fulfil the requirements defined in clause 9.1.11.2.
- The absolute accuracy of intra-frequency RSRP measurements for Cell 4 on SCC2 shall fulfil the requirements defined in clause 9.1.11.2.
- The relative accuracy of intra-frequency RSRP measurements for Cell 3 relative to Cell 2 on SCC1 shall fulfil the requirements defined in clause 9.1.11.2.
- The relative accuracy of intra-frequency RSRP measurements for Cell 5 relative to Cell 4 on SCC2 shall fulfil the requirements defined in clause 9.1.11.2.
- The relative accuracy of inter-frequency RSRP measurements between SCC1 and the primary component carriers for Cell 2 relative to Cell 1 shall fulfil the requirements defined in clause 9.1.11.3. The relative accuracy of inter-frequency RSRP measurements between SCC2 and the primary component carriers for Cell 4 relative to Cell 1 shall fulfil the requirements defined in clause 9.1.11.3.

A.9.1.39 3 DL FDD RSRP for E-UTRAN in Carrier Aggregation

A.9.1.39.1 Test Purpose and Environment

The purpose of this test is to verify that the FDD RSRP absolute and relative accuracy requirements in carrier aggregation are within the specified limits. This test will verify the absolute RSRP accuracy requirements of the primary component carrier defined in clause 9.1.11.1, the absolute RSRP accuracy requirements of the secondary component carriers defined in clause 9.1.11.2, and the relative RSRP accuracy requirements of the secondary component carriers defined in clause 9.1.11.2. The test will also verify the primary and secondary component carriers' relative RSRP accuracy requirement defined in Clause 9.1.11.3.

A.9.1.39.2 Test parameters

In this set of test cases there are five cells on three carrier frequencies. Cell 1 is PCell on channel 1, and cell 2 and cell 4 are activated SCells on secondary component carriers SCC1 and SCC2 respectively. Cell 3 and cell 5 are neighbouring cells on secondary component carriers SCC1 and SCC2 respectively. The parameters for the test are listed in Table A.9.1.39.2-1.

Table A.9.1.39.2-1: 3 DL FDD RSRP test parameters for E-UTRAN Carrier aggregation (cell #1, cell #2 and cell #3)

| Parameter | Unit | Cell 1 | Cell 2 | Cell 3 |
|---|-----------|--|--|--|
| E-UTRA RF Channel Number | | 1 | 2 | |
| $BW_{channel}$ | MHz | 5MHz: $N_{RB,c} = 25$ 10MHz: $N_{RB,c} = 50$ 20MHz: $N_{RB,c} = 100$ | 5MHz: $N_{RB,c} = 25$ 10MHz: $N_{RB,c} = 50$ 20MHz: $N_{RB,c} = 100$ | |
| Measurement bandwidth | n_{PRB} | 5MHz: 10-15 10MHz: 22-27 20MHz: 47-52 | 5MHz: 10-15 10MHz: 22-27 20MHz: 47-52 | |
| PDSCH Reference measurement channel defined in A.3.1.1.1 | | 5MHz: R.5 FDD 10MHz: R.0 FDD 20MHz: R.4 FDD | 5MHz: R.5 FDD 10MHz: R.0 FDD 20MHz: R.4 FDD | - |
| PDSCH allocation | n_{PRB} | 5MHz: 7-17 10MHz: 13-36 20MHz: 38-61 | 5MHz: 7-17 10MHz: 13-36 20MHz: 38-61 | - |
| PDCCH/PCFICH/PHICH Reference measurement channel defined in A.3.1.2.1 | | 5MHz: R.11 FDD 10MHz: R.6 FDD 20MHz: R.10 FDD | 5MHz: R.11 FDD 10MHz: R.6 FDD 20MHz: R.10 FDD | 5MHz: R.11 FDD 10MHz: R.6 FDD 20MHz: R.10 FDD |
| OCNG Patterns defined in A.3.2.1 | | 5MHz: OP.15 FDD 10MHz: OP.1 FDD 20MHz: OP.11 FDD | 5MHz: OP.15 FDD 10MHz: OP.1 FDD 20MHz: OP.11 FDD | 5MHz: OP.16 FDD 10MHz: OP.2 FDD 20MHz: OP.12 FDD |

| | | | | | |
|--|---|-------------------------------|-----------------------------------|--|---------------------------|
| PBCH_RA | | dB | 0 | 0 | 0 |
| PBCH_RB | | | | | |
| PSS_RA | | | | | |
| SSS_RA | | | | | |
| PCFICH_RB | | | | | |
| PHICH_RA | | | | | |
| PHICH_RB | | | | | |
| PDCCH_RA | | | | | |
| PDCCH_RB | | | | | |
| PDSCH_RA | | | | | |
| PDSCH_RB | | | | | |
| OCNG_RA ^{Note1} | | | | | |
| OCNG_RB ^{Note1} | | | | | |
| N_{oc} ^{Note2} | Bands FDD_A | | | | |
| | Bands FDD_B | -116.5 | | | |
| | Bands FDD_C | -116 | | | |
| | Bands FDD_D | -115.5 | | | |
| | Bands FDD_E, FDD_F ^{Note 6} | -115 | | | |
| | Bands FDD_G | -114 | | | |
| | Bands FDD_H | -113.5 | | | |
| \hat{E}_s / N_{oc} | | dB | -4 | 3 | -1 |
| \hat{E}_s / I_{ot} | | dB | -4 | 0.46 | -5.76 |
| RSRP ^{Note3} | Bands FDD_A | dBm/ 15kHz | -121 | (RSRP for Cell 1 +8dB) | (RSRP for Cell 1 +4dB) |
| | Bands FDD_B | | -120.5 | | |
| | Bands FDD_C | | -120 | | |
| | Bands FDD_D | | -119.5 | | |
| | Bands FDD_E, FDD_F ^{Note 6} | | -119 | | |
| | Bands FDD_G | | -118 | | |
| | Bands FDD_H | | -117.5 | | |
| I_o ^{Note3} | Bands FDD_A | dBm/ BW _{channel} | -87.76 +10log($N_{RB,c}/50$) | $(I_o$ for Channel 1 +5.33dB +10log ($N_{RB channel2} / N_{RB channel 1}$)) | |
| | Bands FDD_B | | -87.26 +10log($N_{RB,c}/50$) | | |
| | Bands FDD_C | | -86.76 +10log($N_{RB,c}/50$) | | |
| | Bands FDD_D | | -86.26 +10log($N_{RB,c}/50$) | | |
| | Bands FDD_E, FDD_F ^{Note 6} | | -85.76 +10log($N_{RB,c}/50$) | | |
| | Bands FDD_G | | -84.76 +10log($N_{RB,c}/50$) | | |
| | Bands FDD_H | | -84.26 +10log($N_{RB,c}/50$) | | |
| Propagation Condition | | | AWGN | AWGN | AWGN |
| Antenna Configuration | | | 1x2 | 1x2 | 1x2 |
| Timing offset to Cell 1 | | μ s | - | 0 | 3 |
| Time alignment error relative to cell 1 ^{Note 7} | | | - | \leq TAE | |
| <p>Note 1: OCNG shall be used such that both cells are fully allocated and a constant total transmitted power spectral density is achieved for all OFDM symbols.</p> <p>Note 2: Interference from other cells and noise sources not specified in the test is assumed to be constant over subcarriers and time and shall be modelled as AWGN of appropriate power for N_{oc} to be fulfilled.</p> <p>Note 3: RSRP and I_o levels have been derived from other parameters for information purposes. They are not settable parameters themselves.</p> <p>Note 4: RSRP minimum requirements are specified assuming independent interference and noise at each receiver antenna port.</p> <p>Note 5: The selection of the bands for testing depends on the configuration of the carrier aggregation supported by the UEs.</p> <p>Note 6: For Band 26, the tests shall be performed with the carrier frequency of the assigned E-UTRA channel bandwidth within 865-894 MHz.</p> <p>Note 7: Time alignment error (TAE) as specified in TS 36.104 [30] clause 6.5.3.1. The TAE value depends</p> | | | | | |

upon the type of carrier aggregation.
 Note 8: E-UTRA operating band groups are as defined in Section 3.5.

Table A.9.1.39.2-2: 3 DL FDD RSRP test parameters for E-UTRAN Carrier aggregation (cell #4 and cell #5)

| Parameter | Unit | Cell 4 | Cell 5 | | | |
|---|--------------------------------------|---|---|-------------|---------------|--|
| E-UTRA RF Channel Number | | 3 | | | | |
| BW _{channel} | MHz | 5MHz: N _{RB,c} = 25 10MHz: N _{RB,c} = 50 20MHz: N _{RB,c} = 100 | | | | |
| Measurement bandwidth | <i>n</i> _{PRB} | 5MHz: 10-15 10MHz: 22-27 20MHz: 47-52 | | | | |
| PDSCH Reference measurement channel defined in A.3.1.1.1 | | 5MHz: R.5 FDD 10MHz: R.0 FDD 20MHz: R.4 FDD | - | | | |
| PDSCH allocation | <i>n</i> _{PRB} | 5MHz: 7-17 10MHz: 13-36 20MHz: 38-61 | - | | | |
| PDCCH/PCFICH/PHICH Reference measurement channel defined in A.3.1.2.1 | | 5MHz: R.11 FDD 10MHz: R.6 FDD 20MHz: R.10 FDD | 5MHz: R.11 FDD 10MHz: R.6 FDD 20MHz: R.10 FDD | | | |
| OCNG Patterns defined in A.3.2.1 | | 5MHz: OP.15 FDD 10MHz: OP.1 FDD 20MHz: OP.11 FDD | 5MHz: OP.16 FDD 10MHz: OP.2 FDD 20MHz: OP.12 FDD | | | |
| PBCH_RA | dB | 0 | 0 | | | |
| PBCH_RB | | | | | | |
| PSS_RA | | | | | | |
| SSS_RA | | | | | | |
| PCFICH_RB | | | | | | |
| PHICH_RA | | | | | | |
| PHICH_RB | | | | | | |
| PDCCH_RA | | | | | | |
| PDCCH_RB | | | | | | |
| PDSCH_RA | | | | | | |
| PDSCH_RB | | | | | | |
| OCNG_RA ^{Note1} | | | | | | |
| OCNG_RB ^{Note1} | | | | | | |
| <i>N</i> _{oc} ^{Note2} | | | | Bands FDD_A | dBm/ 15kHz | (<i>N</i> _{oc} for Channel 1 +1dB) |
| | | | | Bands FDD_B | | |
| | Bands FDD_C | | | | | |
| | Bands FDD_D | | | | | |
| | Bands FDD_E, FDD_F ^{Note 6} | | | | | |
| | Bands FDD_G | | | | | |
| | Bands FDD_H | | | | | |
| \hat{E}_s / N_{oc} | dB | 3 | -1 | | | |
| \hat{E}_s / I_{ot} | dB | 0.46 | -5.76 | | | |
| RSRP ^{Note3} | Bands FDD_A | dBm/ 15kHz | (RSRP for Cell 1 +8dB) | | | |
| | Bands FDD_B | | | | | |
| | Bands FDD_C | | | | | |
| | Bands FDD_D | | | | | |
| | Bands FDD_E, FDD_F ^{Note 6} | | | | | |
| | Bands FDD_G | | | | | |
| | Bands FDD_H | | | | | |
| <i>I</i> _o ^{Note3} | Bands FDD_A | dBm/ BW _{channel} | (<i>I</i> _o for Channel 1 +5.33dB +10log (N _{RB channel3} / N _{RB channel 1})) | | | |
| | Bands FDD_B | | | | | |
| | Bands FDD_C | | | | | |
| | Bands FDD_D | | | | | |

| | | | |
|---|--|-------------------|------|
| | Bands FDD_E, FDD_F ^{Note 6} | | |
| | Bands FDD_G | | |
| | Bands FDD_H | | |
| Propagation Condition | | AWGN | AWGN |
| Antenna Configuration | | 1x2 | 1x2 |
| Timing offset to Cell 1 | μs | 0 | 3 |
| Time alignment error relative to cell 1 ^{Note 7} | | $\leq \text{TAE}$ | - |
| Time alignment error relative to cell 2 ^{Note 7} | | $\leq \text{TAE}$ | - |
| Note 1: | OCNG shall be used such that both cells are fully allocated and a constant total transmitted power spectral density is achieved for all OFDM symbols. | | |
| Note 2: | Interference from other cells and noise sources not specified in the test is assumed to be constant over subcarriers and time and shall be modelled as AWGN of appropriate power for N_{oc} to be fulfilled. | | |
| Note 3: | RSRP and I_0 levels have been derived from other parameters for information purposes. They are not settable parameters themselves. | | |
| Note 4: | RSRP minimum requirements are specified assuming independent interference and noise at each receiver antenna port. | | |
| Note 5: | The selection of the bands for testing depends on the configuration of the carrier aggregation supported by the UEs. | | |
| Note 6: | For Band 26, the tests shall be performed with the carrier frequency of the assigned E-UTRA channel bandwidth within 865-894 MHz. | | |
| Note 7: | Time alignment error (TAE) as specified in TS 36.104 [30] clause 6.5.3.1. The TAE value depends upon the type of carrier aggregation. | | |
| Note 8: | E-UTRA operating band groups are as defined in Section 3.5. | | |

A.9.1.39.3 Test Requirements

In the test, the performance of RSRP measurements is verified from following four perspectives:

- The absolute accuracy of intra-frequency RSRP measurements for Cell 1 on the primary component carrier shall fulfil the requirements defined in clause 9.1.11.1.
- The absolute accuracy of intra-frequency RSRP measurements for Cell 2 on SCC1 shall fulfil the requirements defined in clause 9.1.11.2.
- The absolute accuracy of intra-frequency RSRP measurements for Cell 4 on SCC2 shall fulfil the requirements defined in clause 9.1.11.2.
- The relative accuracy of intra-frequency RSRP measurements for Cell 3 relative to Cell 2 on SCC1 shall fulfil the requirements defined in clause 9.1.11.2.
- The relative accuracy of intra-frequency RSRP measurements for Cell 5 relative to Cell 4 on SCC2 shall fulfil the requirements defined in clause 9.1.11.2.
- The relative accuracy of inter-frequency RSRP measurements between SCC1 and the primary component carriers for Cell 2 relative to Cell 1 shall fulfil the requirements defined in clause 9.1.11.3.
- The relative accuracy of inter-frequency RSRP measurements between SCC2 and the primary component carriers for Cell 4 relative to Cell 1 shall fulfil the requirements defined in clause 9.1.11.3.

A.9.1.40 3 DL TDD RSRP for E-UTRAN in Carrier Aggregation

A.9.1.40.1 Test Purpose and Environment

The purpose of this test is to verify that the FDD RSRP absolute and relative accuracy requirements in carrier aggregation are within the specified limits. This test will verify the absolute RSRP accuracy requirements of the primary component carrier defined in clause 9.1.11.1, the absolute RSRP accuracy requirements of the secondary component carriers defined in clause 9.1.11.2, and the relative RSRP accuracy requirements of the secondary

component carriers defined in clause 9.1.11.2. The test will also verify the primary and secondary component carriers' relative RSRP accuracy requirement defined in Clause 9.1.11.3.

A.9.1.40.2 Test parameters

In this set of test cases there are five cells on three carrier frequencies. Cell 1 is PCell on channel 1, and cell 2 and cell 4 are activated SCells on secondary component carriers SCC1 and SCC2 respectively. Cell 3 and cell 5 are neighbouring cells on secondary component carriers SCC1 and SCC2 respectively. The parameters for the test are listed in Table A.9.1.40.2-1.

Table A.9.1.40.2-1: 3 DL TDD RSRP test parameters for E-UTRAN Carrier aggregation (cell #1, cell #2 and cell #3)

| Parameter | | Unit | Cell 1 | Cell 2 | Cell 3 |
|---|-------------|-------------------------------|---|--|---|
| E-UTRA RF Channel Number | | | 1 | 2 | |
| BW _{channel} | | | 5MHz: N _{RB,c} = 25 10MHz: N _{RB,c} = 50 20MHz: N _{RB,c} = 100 | 5MHz: N _{RB,c} = 25 10MHz: N _{RB,c} = 50 20MHz: N _{RB,c} = 100 | |
| Special subframe configuration ^{Note1} | | | 6 | | |
| Uplink/downlink configuration ^{Note1} | | | 1 | | |
| Measurement bandwidth | | <i>n</i> _{PRB} | 5MHz: 10-15 10MHz: 22-27 20MHz: 47-52 | 5MHz: 10-15 10MHz: 22-27 20MHz: 47-52 | |
| PDSCH Reference measurement channel defined in A.3.1.1.2 | | | 5MHz: R.4 TDD 10MHz: R.0 TDD 20MHz: R.3 TDD | 5MHz: R.4 TDD 10MHz: R.0 TDD 20MHz: R.3 TDD | - |
| PDSCH allocation | | <i>n</i> _{PRB} | 5MHz: 7-17 10MHz: 13-36 20MHz: 38-61 | 5MHz: 7-17 10MHz: 13-36 20MHz: 38-61 | - |
| PDCCH/PCFICH/PHICH Reference measurement channel defined in A.3.1.2.2 | | | 5MHz: R.11 TDD 10MHz: R.6 TDD 20MHz: R.10 TDD | 5MHz: R.11 TDD 10MHz: R.6 TDD 20MHz: R.10 TDD | 5MHz: R.11 TDD 10MHz: R.6 TDD 20MHz: R.10 TDD |
| OCNG Patterns defined in A.3.2.2 | | | 5MHz: OP.9 TDD 10MHz: OP.1 TDD 20MHz: OP.7 TDD | 5MHz: OP.9 TDD 10MHz: OP.1 TDD 20MHz: OP.7 TDD | 5MHz: OP.10 TDD 10MHz: OP.2 TDD 20MHz: OP.8 TDD |
| PBCH_RA | | dB | 0 | 0 | 0 |
| PBCH_RB | | | | | |
| PSS_RA | | | | | |
| SSS_RA | | | | | |
| PCFICH_RB | | | | | |
| PHICH_RA | | | | | |
| PHICH_RB | | | | | |
| PDCCH_RA | | | | | |
| PDCCH_RB | | | | | |
| PDSCH_RA | | | | | |
| PDSCH_RB | | | | | |
| OCNG_RA ^{Note2} | | | | | |
| OCNG_RB ^{Note2} | | | | | |
| <i>N</i> _{oc} ^{Note3} | Bands TDD_A | | | | |
| | Bands TDD_C | -116 | | | |
| | Bands TDD_E | -115 | | | |
| \hat{E}_s / N_{oc} | | dB | -4 | 3 | -1 |
| \hat{E}_s / I_{ot} | | dB | -4 | 0.46 | -5.76 |
| RSRP ^{Note4} | Bands TDD_A | dBm/ 15kHz | -121 | (RSRP for Cell 1 +8dB) | (RSRP for Cell 1 +4dB) |
| | Bands TDD_C | | -120 | | |
| | Bands TDD_E | | -119 | | |
| I _o ^{Note4} | Bands TDD_A | dBm/ BW _{channel} | -87.76 + 10log(N _{RB,c} /50) | (I _o for Channel 1 +5.33dB +10log (N _{RB channel2} / N _{RB channel 1})) | |
| | Bands TDD_C | | -86.76 + 10log(N _{RB,c} /50) | | |
| | Bands TDD_E | | -85.76 + | | |

| | | | | |
|---|--|--|-----------------------|-------------------|
| | | | $10\log(N_{RB,c}/50)$ | |
| Propagation Condition | | | AWGN | AWGN |
| Antenna Configuration | | | 1x2 | 1x2 |
| Timing offset to Cell 1 | μs | | - | 0 |
| Time alignment error relative to cell 1 ^{Note 7} | | | - | $\leq \text{TAE}$ |
| Note 1: | For special subframe and uplink-downlink configurations see Tables 4.2-1 and 4.2-2 in TS 36.211. | | | |
| Note 2: | OCNG shall be used such that both cells are fully allocated and a constant total transmitted power spectral density is achieved for all OFDM symbols. | | | |
| Note 3: | Interference from other cells and noise sources not specified in the test is assumed to be constant over subcarriers and time and shall be modelled as AWGN of appropriate power for N_{oc} to be fulfilled. | | | |
| Note 4: | RSRP and I_o levels have been derived from other parameters for information purposes. They are not settable parameters themselves. | | | |
| Note 5: | RSRP minimum requirements are specified assuming independent interference and noise at each receiver antenna port. | | | |
| Note 6: | The selection of the bands for testing depends on the configuration of the carrier aggregation supported by the UEs. | | | |
| Note 7: | Time alignment error (TAE) as specified in TS 36.104 [30] clause 6.5.3.1. The TAE value depends upon the type of carrier aggregation. | | | |
| Note 8: | E-UTRA operating band groups are as defined in Section 3.5. | | | |

Table A.9.1.40.2-2: 3 DL TDD RSRP test parameters for E-UTRAN Carrier aggregation (cell #4 and cell #5)

| Parameter | Unit | Cell 4 | Cell 5 |
|---|-----------|--|---|
| E-UTRA RF Channel Number | | 3 | |
| $BW_{channel}$ | MHz | 5MHz: $N_{RB,c} = 25$ 10MHz: $N_{RB,c} = 50$ 20MHz: $N_{RB,c} = 100$ | |
| Special subframe configuration ^{Note1} | | 6 | |
| Uplink/downlink configuration ^{Note1} | | 1 | |
| Measurement bandwidth | n_{PRB} | 5MHz: 10-15 10MHz: 22-27 20MHz: 47-52 | |
| PDSCH Reference measurement channel defined in A.3.1.1.2 | | 5MHz: R.4 TDD 10MHz: R.0 TDD 20MHz: R.3 TDD | N/A |
| PDSCH allocation | n_{PRB} | 5MHz: 7-17 10MHz: 13-36 20MHz: 38-61 | N/A |
| PDCCH/PCFICH/PHICH Reference measurement channel defined in A.3.1.2.2 | | 5MHz: R.11 TDD 10MHz: R.6 TDD 20MHz: R.10 TDD | 5MHz: R.11 TDD 10MHz: R.6 TDD 20MHz: R.10 TDD |
| OCNG Patterns defined in A.3.2.2 | | 5MHz: OP.9 TDD 10MHz: OP.1 TDD 20MHz: OP.7 TDD | 5MHz: OP.10 TDD 10MHz: OP.2 TDD 20MHz: OP.8 TDD |
| PBCH_RA | dB | 0 | 0 |
| PBCH_RB | | | |
| PSS_RA | | | |
| SSS_RA | | | |
| PCFICH_RB | | | |
| PHICH_RA | | | |
| PHICH_RB | | | |
| PDCCH_RA | | | |
| PDCCH_RB | | | |
| PDSCH_RA | | | |
| PDSCH_RB | | | |
| OCNG_RA ^{Note2} | | | |
| OCNG_RB ^{Note2} | | | |
| N ^{Note3} Bands TDD_A | | | |

| | | | | |
|---|--|-------------------------------|--|---------------------------|
| | Bands TDD_C | 15kHz | | |
| | Bands TDD_E | | | |
| \hat{E}_s / N_{oc} | | dB | 3 | -1 |
| \hat{E}_s / I_{ot} | | dB | 0.46 | -5.76 |
| RSRP ^{Note4} | Bands TDD_A | dBm/ 15kHz | (RSRP for Cell 1 +8dB) | (RSRP for Cell 1 +4dB) |
| | Bands TDD_C | | | |
| | Bands TDD_E | | | |
| I _o ^{Note4} | Bands TDD_A | dBm/ BW _{channel} | (I _o for Channel 1 +5.33dB +10log (N _{RB channel3} / N _{RB channel 1})) | |
| | Bands TDD_C | | | |
| | Bands TDD_E | | | |
| Propagation Condition | | | AWGN | AWGN |
| Antenna Configuration | | | 1x2 | 1x2 |
| Timing offset to Cell 1 | | μs | 0 | 3 |
| Time alignment error relative to cell 1 ^{Note 7} | | | ≤ TAE | - |
| Time alignment error relative to cell 2 ^{Note 7} | | | ≤ TAE | |
| Note 1: | For special subframe and uplink-downlink configurations see Tables 4.2-1 and 4.2-2 in TS 36.211. | | | |
| Note 2: | OCNG shall be used such that both cells are fully allocated and a constant total transmitted power spectral density is achieved for all OFDM symbols. | | | |
| Note 3: | Interference from other cells and noise sources not specified in the test is assumed to be constant over subcarriers and time and shall be modelled as AWGN of appropriate power for N_{oc} to be fulfilled. | | | |
| Note 4: | RSRP and I _o levels have been derived from other parameters for information purposes. They are not settable parameters themselves. | | | |
| Note 5: | RSRP minimum requirements are specified assuming independent interference and noise at each receiver antenna port. | | | |
| Note 6: | The selection of the bands for testing depends on the configuration of the carrier aggregation supported by the UEs. | | | |
| Note 7: | Time alignment error (TAE) as specified in TS 36.104 [30] clause 6.5.3.1. The TAE value depends upon the type of carrier aggregation. | | | |
| Note 8: | E-UTRA operating band groups are as defined in Section 3.5. | | | |

A.9.1.40.3 Test Requirements

In the test, the performance of RSRP measurements is verified from following four perspectives:

- The absolute accuracy of intra-frequency RSRP measurements for Cell 1 on the primary component carrier shall fulfil the requirements defined in clause 9.1.11.1.
- The absolute accuracy of intra-frequency RSRP measurements for Cell 2 on SCC1 shall fulfil the requirements defined in clause 9.1.11.2.
- The absolute accuracy of intra-frequency RSRP measurements for Cell 4 on SCC2 shall fulfil the requirements defined in clause 9.1.11.2.
- The relative accuracy of intra-frequency RSRP measurements for Cell 3 relative to Cell 2 on SCC1 shall fulfil the requirements defined in clause 9.1.11.2.
- The relative accuracy of intra-frequency RSRP measurements for Cell 5 relative to Cell 4 on SCC2 shall fulfil the requirements defined in clause 9.1.11.2.
- The relative accuracy of inter-frequency RSRP measurements between SCC1 and the primary component carriers for Cell 2 relative to Cell 1 shall fulfil the requirements defined in clause 9.1.11.3.
- The relative accuracy of inter-frequency RSRP measurements between SCC2 and the primary component carriers for Cell 4 relative to Cell 1 shall fulfil the requirements defined in clause 9.1.11.3.

A.9.1.41 FD-FDD RSRP Intra frequency case for UE category 0

A.9.1.41.1 Test Purpose and Environment

The purpose of this test is to verify that the RSRP measurement accuracy is within the specified limits. This test will verify the requirements in Sections 9.1.13.1 and 9.1.13.2 for FD-FDD intra frequency RSRP measurements for UE category 0.

A.9.1.41.2 Test parameters

In this set of test cases all cells are on the same carrier frequency. Both absolute and relative accuracy of RSRP intra frequency measurements are tested by using the parameters in Table A.9.1.41.2-1. In all test cases, Cell 1 is the PCell and Cell 2 the target cell.

Table A.9.1.41.2-1: FD-FDD RSRP Intra frequency test parameters for UE category 0

| Parameter | Unit | Test 1 | | Test 2 | | Test 3 | | | | | | | |
|---|--|------------|----------|----------|----------|----------|----------|---------------------------------|------------|------|-----|--------|--|
| | | Cell 1 | Cell 2 | Cell 1 | Cell 2 | Cell 1 | Cell 2 | | | | | | |
| E-UTRA RF Channel Number | | 1 | | 1 | | 1 | | | | | | | |
| BW _{channel} | MHz | 10 | | 10 | | 10 | | | | | | | |
| Measurement bandwidth | n_{PRB} | 22—27 | | 22—27 | | 22—27 | | | | | | | |
| PDSCH Reference measurement channel defined in A.3.1.1.3 | | R.13 FDD | - | R.13 FDD | - | R.13 FDD | - | | | | | | |
| PDSCH allocation | n_{PRB} | 13—36 | - | 13—36 | - | 13—36 | - | | | | | | |
| PDCCH/PCFICH/PHICH Reference measurement channel defined in A.3.1.2.1 | | R.6 FDD | | R.6 FDD | | R.6 FDD | | | | | | | |
| OCNG Patterns defined in A.3.2.1 | | OP.1 FDD | OP.2 FDD | OP.1 FDD | OP.2 FDD | OP.1 FDD | OP.2 FDD | | | | | | |
| PBCH_RA | dB | 0 | 0 | 0 | 0 | 0 | 0 | | | | | | |
| PBCH_RB | | | | | | | | | | | | | |
| PSS_RA | | | | | | | | | | | | | |
| SSS_RA | | | | | | | | | | | | | |
| PCFICH_RB | | | | | | | | | | | | | |
| PHICH_RA | | | | | | | | | | | | | |
| PHICH_RB | | | | | | | | | | | | | |
| PDCCH_RA | | | | | | | | | | | | | |
| PDCCH_RB | | | | | | | | | | | | | |
| PDSCH_RA | | | | | | | | | | | | | |
| PDSCH_RB | | | | | | | | | | | | | |
| OCNG_RA ^{Note1} | | | | | | | | | | | | | |
| OCNG_RB ^{Note1} | | | | | | | | | | | | | |
| N_{oc} ^{Note2} | | | | | | | | Bands FDD-0_A ^{Note 7} | dBm/15 kHz | -106 | -86 | -116 | |
| | | | | | | | | Bands FDD-0_B | | | | -115.5 | |
| | Bands FDD-0_C | -115 | | | | | | | | | | | |
| | Bands FDD-0_D | -114.5 | | | | | | | | | | | |
| | Bands FDD-0_E, FDD-0_F ^{Note 4} | -114 | | | | | | | | | | | |
| | Bands FDD-0_G ^{Note 6} | -113 | | | | | | | | | | | |
| | Bands FDD-0_H | -112.5 | | | | | | | | | | | |
| \hat{E}_s / N_{oc} | dB | 6 | 1 | 6 | 1 | 3 | -1 | | | | | | |
| \hat{E}_s / I_{ot} ^{Note3} | dB | 2.5 | -6 | 2.5 | -6 | 0.46 | -5.76 | | | | | | |
| RSRP ^{Note3} | Bands FDD-0_A ^{Note 7} | dBm/15 kHz | -100 | -105 | -80 | -85 | -113 | -117 | | | | | |
| | Bands FDD-0_B | | | | | | -112.5 | -116.5 | | | | | |
| | Bands FDD-0_C | | | | | | -112 | -116 | | | | | |
| | Bands FDD-0_D | | | | | | -111.5 | -115.5 | | | | | |
| | Bands FDD-0_E, FDD-0_F ^{Note 4} | | | | | | -111 | -115 | | | | | |

| | | | | | | | | |
|---|-------------------------------------|-----------|--------|--------|------|--|--------|--------|
| | Bands FDD-0_G Note 6 | | | | | | -110 | -114 |
| | Bands FDD-0_H | | | | | | -109.5 | -113.5 |
| I _o ^{Note3} | Bands FDD-0_A Note 7 | dBm/9 MHz | -70.27 | -50.27 | | | -82.43 | |
| | Bands FDD-0_B | | | | | | -81.93 | |
| | Bands FDD-0_C | | | | | | -81.43 | |
| | Bands FDD-0_D | | | | | | -80.93 | |
| | Bands FDD-0_E, FDD-0_F Note 4 | | | | | | -80.43 | |
| | Bands FDD-0_G Note 6 | | | | | | -79.43 | |
| | Bands FDD-0_H | | | | | | -78.93 | |
| Propagation condition | | - | AWGN | AWGN | AWGN | | | |
| Correlation Matrix and Antenna Configuration | | | 1x1 | 1x1 | 1x1 | | | |
| <p>Note 1: OCNG shall be used such that both cells are fully allocated and a constant total transmitted power spectral density is achieved for all OFDM symbols.</p> <p>Note 2: Interference from other cells and noise sources not specified in the test is assumed to be constant over subcarriers and time and shall be modelled as AWGN of appropriate power for N_{oc} to be fulfilled.</p> <p>Note 3: Es/lot, RSRP and I_o levels have been derived from other parameters for information purposes. They are not settable parameters themselves.</p> <p>Note 4: For Band 26, the tests shall be performed with the carrier frequency of the assigned E-UTRA channel bandwidth within 865-894 MHz.</p> <p>Note 5: E-UTRA operating band groups are as defined in Section 3.5.</p> <p>Note 6: Except Band 29.</p> <p>Note 7: Except Band 32.</p> | | | | | | | | |

A.9.1.41.3 Test Requirements

The RSRP measurement accuracy shall fulfil the requirements in sections 9.1.13.1 and 9.1.13.2.

A.9.1.42 HD-FDD RSRP Intra frequency case for UE category 0

A.9.1.42.1 Test Purpose and Environment

The purpose of this test is to verify that the RSRP measurement accuracy is within the specified limits. This test will verify the requirements in Sections 9.1.13.1 and 9.1.13.2 for HD-FDD intra frequency RSRP measurements for UE category 0.

A.9.1.42.2 Test parameters

In this set of test cases all cells are on the same carrier frequency. Both absolute and relative accuracy of RSRP intra frequency measurements are tested by using the parameters in Table A.9.1.42.2-1. In all test cases, Cell 1 is the PCell and Cell 2 the target cell.

Table A.9.1.42.2-1: HD-FDD RSRP Intra frequency test parameters for UE category 0

| Parameter | Unit | Test 1 | | Test 2 | | Test 3 | |
|---|-----------|------------|--------|------------|--------|------------|--------|
| | | Cell 1 | Cell 2 | Cell 1 | Cell 2 | Cell 1 | Cell 2 |
| E-UTRA RF Channel Number | | 1 | | 1 | | 1 | |
| BW _{channel} | MHz | 10 | | 10 | | 10 | |
| Measurement bandwidth | n_{PRB} | 22—27 | | 22—27 | | 22—27 | |
| PDSCH Reference measurement channel defined in A.3.1.1.4 | | R.1 HD-FDD | - | R.1 HD-FDD | - | R.1 HD-FDD | - |
| PDSCH allocation | n_{PRB} | 13—36 | - | 13—36 | - | 13—36 | - |
| PDCCH/PCFICH/PHICH Reference measurement channel defined in A.3.1.2.3 | | R.3 HD-FDD | | R.3 HD-FDD | | R.3 HD-FDD | |

| OCNG Patterns defined in A.3.2.1 | | | OP.1 FDD | OP.2 FDD | OP.1 FDD | OP.2 FDD | OP.1 FDD | OP.2 FDD |
|---|---|------------|-------------|-------------|-------------|-------------|-------------|-------------|
| PBCH_RA | | dB | 0 | 0 | 0 | 0 | 0 | 0 |
| PBCH_RB | | | | | | | | |
| PSS_RA | | | | | | | | |
| SSS_RA | | | | | | | | |
| PCFICH_RB | | | | | | | | |
| PHICH_RA | | | | | | | | |
| PHICH_RB | | | | | | | | |
| PDCCH_RA | | | | | | | | |
| PDCCH_RB | | | | | | | | |
| PDSCH_RA | | | | | | | | |
| PDSCH_RB | | | | | | | | |
| OCNG_RA ^{Note1} | | | | | | | | |
| OCNG_RB ^{Note1} | | | | | | | | |
| N_{oc} ^{Note2} | Bands FDD-0_A <small>Note 7</small> | | | | | | | |
| | Bands FDD-0_B | -115.5 | | | | | | |
| | Bands FDD-0_C | -115 | | | | | | |
| | Bands FDD-0_D | -114.5 | | | | | | |
| | Bands FDD-0_E, FDD-0_F ^{Note 5} | -114 | | | | | | |
| | Bands FDD-0_G <small>Note 6</small> | -113 | | | | | | |
| | Bands FDD-0_H | -112.5 | | | | | | |
| \hat{E}_s/N_{oc} | | dB | 6 | 1 | 6 | 1 | 3 | -1 |
| \hat{E}_s/I_{ot} ^{Note3} | | dB | 2.5 | -6 | 2.5 | -6 | 0.46 | -5.76 |
| RSRP ^{Note3} | Bands FDD-0_A <small>Note 7</small> | dBm/15 kHz | -100 | -105 | -80 | -85 | -113 | -117 |
| | Bands FDD-0_B | | | | | | -112.5 | -116.5 |
| | Bands FDD-0_C | | | | | | -112 | -116 |
| | Bands FDD-0_D | | | | | | -111.5 | -115.5 |
| | Bands FDD-0_E, FDD-0_F ^{Note 4} | | | | | | -111 | -115 |
| | Bands FDD-0_G <small>Note 6</small> | | | | | | -110 | -114 |
| | Bands FDD-0_H | | | | | | -109.5 | -113.5 |
| I_o ^{Note3} | Bands FDD-0_A <small>Note 7</small> | dBm/9 MHz | -70.27 | -50.27 | -82.43 | | | |
| | Bands FDD-0_B | | | | -81.93 | | | |
| | Bands FDD-0_C | | | | -81.43 | | | |
| | Bands FDD-0_D | | | | -80.93 | | | |
| | Bands FDD-0_E, FDD-0_F ^{Note 4} | | | | -80.43 | | | |
| | Bands FDD-0_G <small>Note 6</small> | | | | -79.43 | | | |
| | Bands FDD-0_H | | | | -78.93 | | | |
| Propagation condition | | - | AWGN | | AWGN | | AWGN | |
| Correlation Matrix and Antenna Configuration | | | 1x1 | | 1x1 | | 1x1 | |
| <p>Note 1: OCNG shall be used such that both cells are fully allocated and a constant total transmitted power spectral density is achieved for all OFDM symbols.</p> <p>Note 2: Interference from other cells and noise sources not specified in the test is assumed to be constant over subcarriers and time and shall be modelled as AWGN of appropriate power for N_{oc} to be fulfilled.</p> <p>Note 3: E_s/I_{ot}, RSRP and I_o levels have been derived from other parameters for information purposes. They are not settable parameters themselves.</p> <p>Note 4: For Band 26, the tests shall be performed with the carrier frequency of the assigned E-UTRA channel bandwidth within 865-894 MHz.</p> <p>Note 5: E-UTRA operating band groups are as defined in Section 3.5.</p> <p>Note 6: Except Band 29.</p> <p>Note 7: Except Band 32.</p> | | | | | | | | |

A.9.1.42.3 Test Requirements

The RSRP measurement accuracy shall fulfil the requirements in sections 9.1.13.1 and 9.1.13.2.

A.9.1.43 TDD RSRP Intra frequency case for UE category 0

A.9.1.43.1 Test Purpose and Environment

The purpose of this test is to verify that the RSRP measurement accuracy is within the specified limits. This test will verify the requirements in Sections 9.1.13.1 and 9.1.13.2 for TDD intra frequency RSRP measurements for UE category 0.

A.9.1.43.2 Test parameters

In this set of test cases all cells are on the same carrier frequency. Both absolute and relative accuracy of RSRP intra frequency measurements are tested by using the parameters in Table A.9.1.43.2-1. In all test cases, Cell 1 is the PCell and Cell 2 the target cell.

Table A.9.1.43.2-1: TDD RSRP Intra frequency test parameters for UE category 0

| Parameter | Unit | Test 1 | | Test 2 | | Test 3 | | | | | | | | |
|--|------------------|----------|----------|----------|----------|-----------|----------|---------------|------|--|-----|--|------|--|
| | | Cell 1 | Cell 2 | Cell 1 | Cell 2 | Cell 1 | Cell 2 | | | | | | | |
| E-UTRA RF Channel Number | | 1 | | 1 | | 1 | | | | | | | | |
| BW_{channel} | MHz | 10 | | 10 | | 10 | | | | | | | | |
| Special subframe configuration ^{Note1} | | 6 | | 6 | | 6 | | | | | | | | |
| Uplink/downlink configuration ^{Note1} | | 1 | | 1 | | 1 | | | | | | | | |
| Measurement bandwidth | n_{PRB} | 22—27 | | 22—27 | | 22—27 | | | | | | | | |
| PDSCH Reference measurement channel defined in A.3.1.1.5 | | R.12 TDD | - | R.12 TDD | - | R.12 TDD | - | | | | | | | |
| PDSCH allocation | n_{PRB} | 13—36 | - | 13—36 | - | 13—36 | - | | | | | | | |
| PDCCH/PCFICH/PHICH Reference measurement channel defined in A.3.1.2.2 | | R.6 TDD | | R.6 TDD | | R.6 TDD | | | | | | | | |
| OCNG Patterns defined in A.3.2.2.1 (OP.1 TDD) and A.3.2.2.2 (OP.2 TDD) | | OP.1 TDD | OP.2 TDD | OP.1 TDD | OP.2 TDD | OP.1 TDD | OP.2 TDD | | | | | | | |
| PBCH_RA | dB | 0 | 0 | 0 | 0 | 0 | 0 | | | | | | | |
| PBCH_RB | | | | | | | | | | | | | | |
| PSS_RA | | | | | | | | | | | | | | |
| SSS_RA | | | | | | | | | | | | | | |
| PCFICH_RB | | | | | | | | | | | | | | |
| PHICH_RA | | | | | | | | | | | | | | |
| PHICH_RB | | | | | | | | | | | | | | |
| PDCCH_RA | | | | | | | | | | | | | | |
| PDCCH_RB | | | | | | | | | | | | | | |
| PDSCH_RA | | | | | | | | | | | | | | |
| PDSCH_RB | | | | | | | | | | | | | | |
| OCNG_RA ^{Note2} | | | | | | | | | | | | | | |
| OCNG_RB ^{Note2} | | | | | | | | | | | | | | |
| N_{oc} ^{Note3} | | | | | | | | Bands TDD-0_A | -106 | | -86 | | -116 | |
| | | | | | | | | Bands TDD-0_C | | | | | -115 | |
| | Bands TDD-0_E | -114 | | | | | | | | | | | | |
| \hat{E}_s / N_{oc} | dB | 6 | 1 | 6 | 1 | 3 | -1 | | | | | | | |
| \hat{E}_s / I_{ot} ^{Note4} | dB | 2.5 | -6 | 2.5 | -6 | 0.5 | -5.76 | | | | | | | |
| RSRP ^{Note4} | Bands TDD-0_A | -100 | -105 | -80 | -85 | -113 -117 | | | | | | | | |
| | Bands TDD-0_C | | | | | -112 -116 | | | | | | | | |
| | Bands TDD-0_E | | | | | -111 -115 | | | | | | | | |
| I_o ^{Note4} | Bands TDD-0_A | -70.27 | | -50.27 | | -82.43 | | | | | | | | |

| | | | | | |
|---|---------------|---|------|------|--------|
| | Bands TDD-0_C | | | | -81.43 |
| | Bands TDD-0_E | | | | -80.43 |
| Propagation condition | | - | AWGN | AWGN | AWGN |
| Correlation Matrix and Antenna Configuration | | | 1x1 | 1x1 | 1x1 |
| <p>Note 1: For special subframe and uplink-downlink configurations see Tables 4.2-1 and 4.2-2 in TS 36.211.</p> <p>Note 2: OCNG shall be used such that both cells are fully allocated and a constant total transmitted power spectral density is achieved for all OFDM symbols.</p> <p>Note 3: Interference from other cells and noise sources not specified in the test is assumed to be constant over subcarriers and time and shall be modelled as AWGN of appropriate power for N_{oc} to be fulfilled.</p> <p>Note 4: Es/lot, RSRP and Io levels have been derived from other parameters for information purposes. They are not settable parameters themselves.</p> <p>Note 5: E-UTRA operating band groups are as defined in Section 3.5.</p> | | | | | |

A.9.1.43.3 Test Requirements

The RSRP measurement accuracy shall fulfil the requirements in sections 9.1.13.1 and 9.1.13.2.

A.9.1.44 4 DL CA PCell in FDD FDD-TDD RSRP for E-UTRAN in Carrier Aggregation

A.9.1.44.1 Test Purpose and Environment

The purpose of this test is to verify that the FDD-TDD RSRP absolute and relative accuracy requirements in carrier aggregation with PCell in FDD are within the specified limits. This test will verify the absolute RSRP accuracy requirements of the primary component carrier defined in clause 9.1.11.1, the absolute RSRP accuracy requirements of the secondary component carriers defined in clause 9.1.11.2, and the relative RSRP accuracy requirements of the secondary component carriers defined in clause 9.1.11.2. The test will also verify the primary and secondary component carriers' relative RSRP accuracy requirement defined in Clause 9.1.11.3.

A.9.1.44.2 Test parameters

In this set of cases cell 1 is PCell on the primary component carrier, and cell 2, cell 4 and cell 6 are activated SCells on secondary component carriers SCC1, SCC2 and SCC3 respectively. Cell 3, cell 5 and cell 7 are neighbouring cells on secondary component carriers SCC1, SCC2 and SCC3 respectively. The test parameters are given in Table A.9.1.44.2-1.

Table A.9.1.44.2-1: 4 Downlink PCell in FDD-TDD RSRP carrier aggregation test parameters

| Parameter | Unit | Cell 1 | Cell 2 | Cell 3 | Cell 4 | Cell 5 | Cell 6 | Cell 7 |
|--|-------------------------|--|---|--|---|--|---|--|
| E-UTRA RF Channel Number | | 1 | 2 | 3 | 3 | 4 | 4 | 4 |
| BW _{channel} | MHz | 5MHz: N _{RB,c} = 25 10MHz: N _{RB,c} = 50 20MHz: N _{RB,c} = 100 | 5MHz: N _{RB,c} = 25 10MHz: N _{RB,c} = 50 20MHz: N _{RB,c} = 100 | | 5MHz: N _{RB,c} = 25 10MHz: N _{RB,c} = 50 20MHz: N _{RB,c} = 100 | | 5MHz: N _{RB,c} = 25 10MHz: N _{RB,c} = 50 20MHz: N _{RB,c} = 100 | |
| Special subframe configuration ^{Note1} | | - | 6 | 6 | 6 | 6 | 6 | 6 |
| Uplink/downlink configuration ^{Note1} | | - | 1 | 1 | 1 | 1 | 1 | 1 |
| Measurement bandwidth | <i>n</i> _{PRB} | 5MHz: 10-15 10MHz: 22-27 20MHz: 47-52 | 5MHz: 10-15 10MHz: 22-27 20MHz: 47-52 | | 5MHz: 10-15 10MHz: 22-27 20MHz: 47-52 | | 5MHz: 10-15 10MHz: 22-27 20MHz: 47-52 | |
| PDSCH Reference measurement channel | | 5MHz: R.5 FDD 10MHz: R.0 FDD 20MHz: R.4 FDD | 5MHz: R.4 TDD 10MHz: R.0 TDD 20MHz: R.3 TDD | - | 5MHz: R.4 TDD 10MHz: R.0 TDD 20MHz: R.3 TDD | - | 5MHz: R.4 TDD 10MHz: R.0 TDD 20MHz: R.3 TDD | - |
| PDSCH allocation | <i>n</i> _{PRB} | 5MHz: 7-17 10MHz: 13-36 20MHz: 38-61 | 5MHz: 7-17 10MHz: 13-36 20MHz: 38-61 | - | 5MHz: 7-17 10MHz: 13-36 20MHz: 38-61 | - | 5MHz: 7-17 10MHz: 13-36 20MHz: 38-61 | - |
| PDCCH/PCFICH/PHICH Reference measurement channel | | 5MHz: R.11 FDD 10MHz: R.6 FDD 20MHz: R.10 FDD | 5MHz: R.11 TDD 10MHz: R.6 TDD 20MHz: R.10 TDD | 5MHz: R.11 TDD 10MHz: R.6 TDD 20MHz: R.10 TDD | 5MHz: R.11 TDD 10MHz: R.6 TDD 20MHz: R.10 TDD | 5MHz: R.11 TDD 10MHz: R.6 TDD 20MHz: R.10 TDD | 5MHz: R.11 TDD 10MHz: R.6 TDD 20MHz: R.10 TDD | 5MHz: R.11 TDD 10MHz: R.6 TDD 20MHz: R.10 TDD |
| OCNG Patterns | | 5MHz: OP.15 FDD 10MHz: OP.1 FDD 20MHz: OP.11 FDD | 5MHz: OP.9 TDD 10MHz: OP.1 TDD 20MHz: OP.7 TDD | 5MHz: OP.10 TDD 10MHz: OP.2 TDD 20MHz: OP.8 TDD | 5MHz: OP.9 TDD 10MHz: OP.1 TDD 20MHz: OP.7 TDD | 5MHz: OP.10 TDD 10MHz: OP.2 TDD 20MHz: OP.8 TDD | 5MHz: OP.9 TDD 10MHz: OP.1 TDD 20MHz: OP.7 TDD | 5MHz: OP.10 TDD 10MHz: OP.2 TDD 20MHz: OP.8 TDD |
| PBCH_RA | dB | 0 | 0 | 0 | 0 | 0 | 0 | 0 |
| PBCH_RB | | | | | | | | |
| PSS_RA | | | | | | | | |
| SSS_RA | | | | | | | | |
| PCFICH_RB | | | | | | | | |
| PHICH_RA | | | | | | | | |
| PHICH_RB | | | | | | | | |
| PDCCH_RA | | | | | | | | |
| PDCCH_RB | | | | | | | | |
| PDSCH_RA | | | | | | | | |
| PDSCH_RB | | | | | | | | |

| | | | | | | | | | |
|--|-------------------------------------|-------------------------------|------------------------------|---|------------------------|---|------------------------|---|------------------------|
| OCNG_RA ^{Note2} | | | | | | | | | |
| OCNG_RB ^{Note2} | | | | | | | | | |
| N_{oc} ^{Note3} | Bands TDD_A | dBm/15 kHz | - | $(N_{oc}$ for Channel 1 +1dB) | | $(N_{oc}$ for Channel 1 +1dB) | | $(N_{oc}$ for Channel 1 +1dB) | |
| | Bands TDD_C | | | | | | | | |
| | Bands TDD_E | | | | | | | | |
| | Bands FDD_A | | -117 | | | | | | |
| | Bands FDD_B | | -116.5 | | | | | | |
| | Bands FDD_C | | -116 | | | | | | |
| | Bands FDD_D | | -115.5 | | | | | | |
| | Bands FDD_E, FDD_F ^{Note7} | | -115 | | | | | | |
| | Bands FDD_G | | -114 | | | | | | |
| Bands FDD_H | -113.5 | | | | | | | | |
| \hat{E}_s / N_{oc} | | dB | -4 | 3 | -1 | 3 | -1 | 3 | -1 |
| \hat{E}_s / I_{ot} | | dB | -4 | 0.46 | -5.76 | 0.46 | -5.76 | 0.46 | -5.76 |
| RSRP ^{Note4} | Bands TDD_A | dBm/15 kHz | - | (RSRP for Cell 1 +8dB) | (RSRP for Cell 1 +4dB) | (RSRP for Cell 1 +8dB) | (RSRP for Cell 1 +4dB) | (RSRP for Cell 1 +8dB) | (RSRP for Cell 1 +4dB) |
| | Bands TDD_C | | | | | | | | |
| | Bands TDD_E | | | | | | | | |
| | Bands FDD_A | | -121 | | | | | | |
| | Bands FDD_B | | -120.5 | | | | | | |
| | Bands FDD_C | | -120 | | | | | | |
| | Bands FDD_D | | -119.5 | | | | | | |
| | Bands FDD_E, FDD_F ^{Note7} | | -119 | | | | | | |
| | Bands FDD_G | | -118 | | | | | | |
| Bands FDD_H | -117.5 | | | | | | | | |
| I_o ^{Note4} | Bands TDD_A | dBm/ BW _{channel} | - | $(I_o$ for Channel 1 +5.33dB +10log($N_{RB,channel2} / N_{RB,channel1}$)) | | $(I_o$ for Channel 1 +5.33dB +10log($N_{RB,channel3} / N_{RB,channel1}$)) | | $(I_o$ for Channel 1 +5.33dB +10log($N_{RB,channel4} / N_{RB,channel1}$)) | |
| | Bands TDD_C | | | | | | | | |
| | Bands TDD_E | | | | | | | | |
| | Bands FDD_A | | $-87.76+10\log(N_{RB,c}/50)$ | | | | | | |
| | Bands FDD_B | | $-87.26+10\log(N_{RB,c}/50)$ | | | | | | |
| | Bands FDD_C | | $-86.76+10\log(N_{RB,c}/50)$ | | | | | | |
| | Bands FDD_D | | $-86.26+10\log(N_{RB,c}/50)$ | | | | | | |
| | Bands FDD_E, FDD_F ^{Note7} | | -85.76 | | | | | | |
| | | | $+10\log(N_{RB,c}/50)$ | | | | | | |
| | Bands FDD_G | | -84.76 | | | | | | |
| | | | $+10\log(N_{RB,c}/50)$ | | | | | | |
| | Bands FDD_H | | -84.26 | | | | | | |
| | $+10\log(N_{RB,c}/50)$ | | | | | | | | |
| Propagation condition | | - | AWGN | AWGN | AWGN | AWGN | AWGN | AWGN | AWGN |
| Antenna Configuration | | - | 1x2 | 1x2 | 1x2 | 1x2 | 1x2 | 1x2 | 1x2 |
| Timing offset to cell 1 | | μ s | - | 0 | 3 | 0 | 3 | 0 | 3 |
| Time alignment error relative to cell 1 ^{Note8} | | | - | \leq TAE | - | \leq TAE | - | \leq TAE | - |
| Time alignment error relative to cell 2 ^{Note8} | | | - | - | - | \leq TAE | - | \leq TAE | - |
| Time alignment error relative to cell 4 ^{Note8} | | | - | - | - | - | - | \leq TAE | - |

Note 1: For special subframe and uplink-downlink configurations see Tables 4.2-1 and 4.2-2 in TS 36.211.

Note 2: OCNG shall be used such that all cells are fully allocated and a constant total transmitted power spectral density is achieved for all OFDM symbols.

- Note 3: Interference from other cells and noise sources not specified in the test is assumed to be constant over subcarriers and time and shall be modelled as AWGN of appropriate power for N_{oc} to be fulfilled.
- Note 4: RSRP and I_o levels have been derived from other parameters for information purposes. They are not settable parameters themselves.
- Note 5: RSRP minimum requirements are specified assuming independent interference and noise at each receiver antenna port.
- Note 6: The selection of the bands for testing depends on the configuration of the carrier aggregation supported by the UEs.
- Note 7: For Band 26, the tests shall be performed with the carrier frequency of the assigned E-UTRA channel bandwidth within 865-894 MHz.
- Note 8: Time alignment error (TAE) as specified in TS 36.104 [30] clause 6.5.3.1. The TAE value depends upon the type of carrier aggregation.
- Note 9: E-UTRA operating band groups are as defined in Section 3.5.

A.9.1.44.3 Test Requirements

In the test, the performance of RSRP measurements is verified from the following 10 perspectives:

- The absolute accuracy of intra-frequency RSRP measurements for Cell 1 on the primary component carrier shall fulfil the requirements defined in clause 9.1.11.1.
- The absolute accuracy of intra-frequency RSRP measurements for Cell 2 on SCC1 shall fulfil the requirements defined in clause 9.1.11.2.
- The absolute accuracy of intra-frequency RSRP measurements for Cell 4 on SCC2 shall fulfil the requirements defined in clause 9.1.11.2.
- The absolute accuracy of intra-frequency RSRP measurements for Cell 6 on SCC3 shall fulfil the requirements defined in clause 9.1.11.2.
- The relative accuracy of intra-frequency RSRP measurements for Cell 3 relative to Cell 2 on SCC1 shall fulfil the requirements defined in clause 9.1.11.2.
- The relative accuracy of intra-frequency RSRP measurements for Cell 5 relative to Cell 4 on SCC2 shall fulfil the requirements defined in clause 9.1.11.2.
- The relative accuracy of intra-frequency RSRP measurements for Cell 7 relative to Cell 6 on SCC3 shall fulfil the requirements defined in clause 9.1.11.2.
- The relative accuracy of inter-frequency RSRP measurements between SCC1 and the primary component carriers for Cell 2 relative to Cell 1 shall fulfil the requirements defined in clause 9.1.11.3.
- The relative accuracy of inter-frequency RSRP measurements between SCC2 and the primary component carriers for Cell 4 relative to Cell 1 shall fulfil the requirements defined in clause 9.1.11.3.
- The relative accuracy of inter-frequency RSRP measurements between SCC3 and the primary component carriers for Cell 6 relative to Cell 1 shall fulfil the requirements defined in clause 9.1.11.3.

A.9.1.45 4 DL CA PCell in TDD FDD-TDD RSRP for E-UTRAN in Carrier Aggregation

A.9.1.45.1 Test Purpose and Environment

The purpose of this test is to verify that the TDD-FDD RSRP absolute and relative accuracy requirements in carrier aggregation with PCell in TDD are within the specified limits. This test will verify the absolute RSRP accuracy requirements of the primary component carrier defined in clause 9.1.11.1, the absolute RSRP accuracy requirements of the secondary component carriers defined in clause 9.1.11.2, and the relative RSRP accuracy requirements of the secondary component carriers defined in clause 9.1.11.2. The test will also verify the primary and secondary component carriers' relative RSRP accuracy requirement defined in Clause 9.1.11.3.

A.9.1.45.2 Test parameters

In this set of cases cell 1 is PCell on the primary component carrier, and cell 2, cell 4 and cell 6 are activated SCells on secondary component carriers SCC1, SCC2 and SCC3 respectively. Cell 3, cell 5 and cell 7 are neighbouring cells on secondary component carriers SCC1, SCC2 and SCC3 respectively. The test parameters are given in Table A.9.1.45.2-1.

Table A.9.1.45.2-1: 4 Downlink PCell in TDD-FDD RSRP carrier aggregation test parameters

| Parameter | Unit | Cell 1 | Cell 2 | Cell 3 | Cell 4 | Cell 5 | Cell 6 | Cell 7 |
|--|-------------------------|---|---|--|---|--|---|--|
| E-UTRA RF Channel Number | | 1 | 2 | 3 | 4 | | | |
| BW _{channel} | MHz | 5MHz: N _{RB,c} = 25 10MHz: N _{RB,c} = 50 20MHz: N _{RB,c} = 100 | 5MHz: N _{RB,c} = 25 10MHz: N _{RB,c} = 50 20MHz: N _{RB,c} = 100 | | 5MHz: N _{RB,c} = 25 10MHz: N _{RB,c} = 50 20MHz: N _{RB,c} = 100 | | 5MHz: N _{RB,c} = 25 10MHz: N _{RB,c} = 50 20MHz: N _{RB,c} = 100 | |
| Special subframe configuration ^{Note1} | | 6 | - | - | - | - | - | - |
| Uplink/downlink configuration ^{Note1} | | 1 | - | - | - | - | - | - |
| Measurement bandwidth | <i>n</i> _{PRB} | 5MHz: 10-15 10MHz: 22-27 20MHz: 47-52 | 5MHz: 10-15 10MHz: 22-27 20MHz: 47-52 | | 5MHz: 10-15 10MHz: 22-27 20MHz: 47-52 | | 5MHz: 10-15 10MHz: 22-27 20MHz: 47-52 | |
| PDSCH Reference measurement channel defined in A.3.1.1. | | 5MHz: R.4 TDD 10MHz: R.0 TDD 20MHz: R.3 TDD | 5MHz: R.5 FDD 10MHz: R.0 FDD 20MHz: R.4 FDD | - | 5MHz: R.5 FDD 10MHz: R.0 FDD 20MHz: R.4 FDD | - | 5MHz: R.5 FDD 10MHz: R.0 FDD 20MHz: R.4 FDD | - |
| PDSCH allocation | <i>n</i> _{PRB} | 5MHz: 7-17 10MHz: 13-36 20MHz: 38-61 | 5MHz: 7-17 10MHz: 13-36 20MHz: 38-61 | - | 5MHz: 7-17 10MHz: 13-36 20MHz: 38-61 | - | 5MHz: 7-17 10MHz: 13-36 20MHz: 38-61 | - |
| PDCCH/PCFICH/PHICH Reference measurement channel defined in A.3.1.2. | | 5MHz: R.11 TDD 10MHz: R.6 TDD 20MHz: R.10 TDD | 5MHz: R.11 FDD 10MHz: R.6 FDD 20MHz: R.10 FDD | 5MHz: R.11 FDD 10MHz: R.6 FDD 20MHz: R.10 FDD | 5MHz: R.11 FDD 10MHz: R.6 FDD 20MHz: R.10 FDD | 5MHz: R.11 FDD 10MHz: R.6 FDD 20MHz: R.10 FDD | 5MHz: R.11 FDD 10MHz: R.6 FDD 20MHz: R.10 FDD | 5MHz: R.11 FDD 10MHz: R.6 FDD 20MHz: R.10 FDD |
| OCNG Patterns defined in A.3.2. | | 5MHz: OP.9 TDD 10MHz: OP.1 TDD 20MHz: OP.7 TDD | 5MHz: OP.15 FDD 10MHz: OP.1 FDD 20MHz: OP.11 FDD | 5MHz: OP.16 FDD 10MHz: OP.2 FDD 20MHz: OP.12 FDD | 5MHz: OP.15 FDD 10MHz: OP.1 FDD 20MHz: OP.11 FDD | 5MHz: OP.16 FDD 10MHz: OP.2 FDD 20MHz: OP.12 FDD | 5MHz: OP.15 FDD 10MHz: OP.1 FDD 20MHz: OP.11 FDD | 5MHz: OP.16 FDD 10MHz: OP.2 FDD 20MHz: OP.12 FDD |
| PBCH_RA | dB | 0 | 0 | 0 | 0 | 0 | 0 | 0 |
| PBCH_RB | | | | | | | | |
| PSS_RA | | | | | | | | |
| SSS_RA | | | | | | | | |
| PCFICH_RB | | | | | | | | |
| PHICH_RA | | | | | | | | |
| PHICH_RB | | | | | | | | |
| PDCCH_RA | | | | | | | | |
| PDCCH_RB | | | | | | | | |
| PDSCH_RA | | | | | | | | |

| | | | | | | | | | | | | | | | |
|--|-------------------------------------|-------------------------------|------|---|------------------------|---|------------------------|---|-------------------------------|-----------------------------|--|--|--|--|--|
| PDSCH_RB | | | | | | | | | | | | | | | |
| OCNG_RA ^{Note1} | | | | | | | | | | | | | | | |
| OCNG_RB ^{Note1} | | | | | | | | | | | | | | | |
| N_{oc} ^{Note3} | Bands FDD_A | dBm/15 kHz | - | $(N_{oc}$ for Channel 1 +1dB) | | $(N_{oc}$ for Channel 1 +1dB) | | $(N_{oc}$ for Channel 1 +1dB) | $(N_{oc}$ for Channel 1 +1dB) | | | | | | |
| | Bands FDD_B | | | | | | | | | | | | | | |
| | Bands FDD_C | | | | | | | | | | | | | | |
| | Bands FDD_D | | | | | | | | | | | | | | |
| | Bands FDD_E, FDD_F ^{Note7} | | | | | | | | | | | | | | |
| | Bands FDD_G | | | | | | | | | | | | | | |
| | Bands FDD_H | | | | | | | | | | | | | | |
| | Bands TDD_A | | | | | | | | | | | | | | |
| Bands TDD_C | -117 | | | | | | | | | | | | | | |
| Bands TDD_E | -116 | | | | | | | | | | | | | | |
| | -115 | | | | | | | | | | | | | | |
| \hat{E}_s / N_{oc} | | dB | -4 | 3 | -1 | 3 | -1 | 3 | -1 | | | | | | |
| \hat{E}_s / I_{ot} | | dB | -4 | 0.46 | -5.76 | 0.46 | -5.76 | 0.46 | -5.76 | | | | | | |
| RSRP ^{Note4} | Bands FDD_A | dBm/15 kHz | - | (RSRP for Cell 1 +8dB) | (RSRP for Cell 1 +4dB) | (RSRP for Cell 1 +8dB) | (RSRP for Cell 1 +4dB) | (RSRP for Cell 1 +8dB) | (RSRP for Cell 1 +4dB) | | | | | | |
| | Bands FDD_B | | | | | | | | | | | | | | |
| | Bands FDD_C | | | | | | | | | | | | | | |
| | Bands FDD_D | | | | | | | | | | | | | | |
| | Bands FDD_E, FDD_F ^{Note7} | | | | | | | | | | | | | | |
| | Bands FDD_G | | | | | | | | | | | | | | |
| | Bands FDD_H | | | | | | | | | | | | | | |
| | Bands TDD_A | | | | | | | | | -121 | | | | | |
| Bands TDD_C | -120 | | | | | | | | | | | | | | |
| Bands TDD_E | -119 | | | | | | | | | | | | | | |
| I_o ^{Note4} | Bands FDD_A | dBm/ BW _{channel} | - | $(I_o$ for Channel 1 +5.33dB +10log $(N_{RB,channel2} / N_{RB,channel1})$) | | $(I_o$ for Channel 1 +5.33dB +10log $(N_{RB,channel3} / N_{RB,channel1})$) | | $(I_o$ for Channel 1 +5.33dB +10log $(N_{RB,channel4} / N_{RB,channel1})$) | | | | | | | |
| | Bands FDD_B | | | | | | | | | | | | | | |
| | Bands FDD_C | | | | | | | | | | | | | | |
| | Bands FDD_D | | | | | | | | | | | | | | |
| | Bands FDD_E, FDD_F ^{Note7} | | | | | | | | | | | | | | |
| | Bands FDD_G | | | | | | | | | | | | | | |
| | Bands FDD_H | | | | | | | | | | | | | | |
| | Bands TDD_A | | | | | | | | | $87.76+10\log(N_{RB,c}/50)$ | | | | | |
| | Bands TDD_C | | | | | | | | | $86.76+10\log(N_{RB,c}/50)$ | | | | | |
| | Bands TDD_E | | | | | | | | | $85.76+10\log(N_{RB,c}/50)$ | | | | | |
| Propagation condition | | - | AWGN | AWGN | AWGN | AWGN | AWGN | AWGN | AWGN | | | | | | |
| Antenna Configuration | | - | 1x2 | 1x2 | 1x2 | 1x2 | 1x2 | 1x2 | 1x2 | | | | | | |
| Timing offset to cell 1 | | μ s | - | 0 | 3 | 0 | 3 | 0 | 3 | | | | | | |
| Time alignment error relative to cell 1 ^{Note8} | | - | - | \leq TAE | - | \leq TAE | - | \leq TAE | - | | | | | | |
| Time alignment error relative to cell 2 ^{Note8} | | - | - | - | - | \leq TAE | - | \leq TAE | - | | | | | | |
| Time alignment error relative to cell 4 ^{Note8} | | - | - | - | - | - | - | \leq TAE | - | | | | | | |

Note 1: For special subframe and uplink-downlink configurations see Tables 4.2-1 and 4.2-2 in TS 36.211.

Note 2: OCNG shall be used such that all cells are fully allocated and a constant total transmitted power spectral density is achieved for all OFDM symbols.

- Note 3: Interference from other cells and noise sources not specified in the test is assumed to be constant over subcarriers and time and shall be modelled as AWGN of appropriate power for N_{oc} to be fulfilled.
- Note 4: RSRP and I_o levels have been derived from other parameters for information purposes. They are not settable parameters themselves.
- Note 5: RSRP minimum requirements are specified assuming independent interference and noise at each receiver antenna port.
- Note 6: The selection of the bands for testing depends on the configuration of the carrier aggregation supported by the UEs.
- Note 7: For Band 26, the tests shall be performed with the carrier frequency of the assigned E-UTRA channel bandwidth within 865-894 MHz.
- Note 8: Time alignment error (TAE) as specified in TS 36.104 [30] clause 6.5.3.1. The TAE value depends upon the type of carrier aggregation.
- Note 9: E-UTRA operating band groups are as defined in Section 3.5.

A.9.1.45.3 Test Requirements

In the test, the performance of RSRP measurements is verified from the following perspectives:

- The absolute accuracy of intra-frequency RSRP measurements for Cell 1 on the primary component carrier shall fulfil the requirements defined in clause 9.1.11.1.
- The absolute accuracy of intra-frequency RSRP measurements for Cell 2 on SCC1 shall fulfil the requirements defined in clause 9.1.11.2.
- The absolute accuracy of intra-frequency RSRP measurements for Cell 4 on SCC2 shall fulfil the requirements defined in clause 9.1.11.2.
- The absolute accuracy of intra-frequency RSRP measurements for Cell 6 on SCC3 shall fulfil the requirements defined in clause 9.1.11.2.
- The relative accuracy of intra-frequency RSRP measurements for Cell 3 relative to Cell 2 on SCC1 shall fulfil the requirements defined in clause 9.1.11.2.
- The relative accuracy of intra-frequency RSRP measurements for Cell 5 relative to Cell 4 on SCC2 shall fulfil the requirements defined in clause 9.1.11.2.
- The relative accuracy of intra-frequency RSRP measurements for Cell 7 relative to Cell 6 on SCC3 shall fulfil the requirements defined in clause 9.1.11.2.
- The relative accuracy of inter-frequency RSRP measurements between SCC1 and the primary component carriers for Cell 2 relative to Cell 1 shall fulfil the requirements defined in clause 9.1.11.3.
- The relative accuracy of inter-frequency RSRP measurements between SCC2 and the primary component carriers for Cell 4 relative to Cell 1 shall fulfil the requirements defined in clause 9.1.11.3.
- The relative accuracy of inter-frequency RSRP measurements between SCC3 and the primary component carriers for Cell 6 relative to Cell 1 shall fulfil the requirements defined in clause 9.1.11.3.

A.9.1.46 4 DL FDD RSRP for E-UTRAN in Carrier Aggregation

A.9.1.46.1 Test Purpose and Environment

The purpose of this test is to verify that the RSRP absolute and relative accuracy requirements in FDD-FDD carrier aggregation are within the specified limits. This test will verify the absolute RSRP accuracy requirements of the primary component carrier defined in clause 9.1.11.1, the absolute RSRP accuracy requirements of the secondary component carriers defined in clause 9.1.11.2, and the relative RSRP accuracy requirements of the secondary component carriers defined in clause 9.1.11.2. The test will also verify the primary and secondary component carriers' relative RSRP accuracy requirement defined in Clause 9.1.11.3.

A.9.1.46.2 Test parameters

In this set of test cases cell 1 is PCell on the primary component carrier, and cell 2, cell 4 and cell 6 are activated SCells on secondary component carriers SCC1, SCC2 and SCC3 respectively. Cell 3, cell 5 and cell 7 are neighbouring cells on secondary component carriers SCC1, SCC2 and SCC3 respectively. The test parameters are given in Table A.9.1.46.2-1, Table A.9.1.46.2-2 and Table A.9.1.46.2-3.

Table A.9.1.46.2-1: 4 DL FDD RSRP carrier aggregation test parameters for cell 1, cell 2 and cell 3

| Parameter | Unit | Cell 1 | Cell 2 | Cell 3 |
|--------------------------|-----------|--|--|--------|
| E-UTRA RF Channel Number | | 1 | 2 | |
| BW_{channel} | MHz | 5MHz: $N_{RB,c} = 25$ 10MHz: $N_{RB,c} = 50$ 20MHz: $N_{RB,c} = 100$ | 5MHz: $N_{RB,c} = 25$ 10MHz: $N_{RB,c} = 50$ 20MHz: $N_{RB,c} = 100$ | |
| Measurement bandwidth | n_{PRB} | 5MHz: 10-15 10MHz: 22-27 20MHz: 47-52 | 5MHz: 10-15 10MHz: 22-27 20MHz: 47-52 | |

| | | | | | |
|---|--------------------------------------|------------------------|--|---|--|
| PDSCH Reference measurement channel defined in A.3.1.1.1 | | | 5MHz: R.5 FDD 10MHz: R.0 FDD 20MHz: R.4 FDD | 5MHz: R.5 FDD 10MHz: R.0 FDD 20MHz: R.4 FDD | - |
| PDSCH allocation | | n_{PRB} | 5MHz: 7-17 10MHz: 13-36 20MHz: 38-61 | 5MHz: 7-17 10MHz: 13-36 20MHz: 38-61 | - |
| PDCCH/PCFICH/PHICH Reference measurement channel defined in A.3.1.2.1 | | | 5MHz: R.11 FDD 10MHz: R.6 FDD 20MHz: R.10 FDD | 5MHz: R.11 FDD 10MHz: R.6 FDD 20MHz: R.10 FDD | 5MHz: R.11 FDD 10MHz: R.6 FDD 20MHz: R.10 FDD |
| OCNG Patterns defined in A.3.2.1 | | | 5MHz: OP.15 FDD 10MHz: OP.1 FDD 20MHz: OP.11 FDD | 5MHz: OP.15 FDD 10MHz: OP.1 FDD 20MHz: OP.11 FDD | 5MHz: OP.16 FDD 10MHz: OP.2 FDD 20MHz: OP.12 FDD |
| PBCH_RA | | dB | 0 | 0 | 0 |
| PBCH_RB | | | | | |
| PSS_RA | | | | | |
| SSS_RA | | | | | |
| PCFICH_RB | | | | | |
| PHICH_RA | | | | | |
| PHICH_RB | | | | | |
| PDCCH_RA | | | | | |
| PDCCH_RB | | | | | |
| PDSCH_RA | | | | | |
| PDSCH_RB | | | | | |
| OCNG_RA ^{Note1} | | | | | |
| OCNG_RB ^{Note1} | | | | | |
| N_{oc} ^{Note2} | Bands FDD_A | dBm/ 15kHz | -117 | $(N_{oc}$ for Channel 1 +1dB) | |
| | Bands FDD_B | | -116.5 | | |
| | Bands FDD_C | | -116 | | |
| | Bands FDD_D | | -115.5 | | |
| | Bands FDD_E, FDD_F ^{Note 6} | | -115 | | |
| | Bands FDD_G | | -114 | | |
| | Bands FDD_H | | -113.5 | | |
| \hat{E}_s / N_{oc} | | dB | -4 | 3 | -1 |
| \hat{E}_s / I_{ot} | | dB | -4 | 0.46 | -5.76 |
| RSRP ^{Note3} | Bands FDD_A | dBm/ 15kHz | -121 | (RSRP for Cell 1 +8dB) | (RSRP for Cell 1 +4dB) |
| | Bands FDD_B | | -120.5 | | |
| | Bands FDD_C | | -120 | | |
| | Bands FDD_D | | -119.5 | | |
| | Bands FDD_E, FDD_F ^{Note 6} | | -119 | | |
| | Bands FDD_G | | -118 | | |
| | Bands FDD_H | | -117.5 | | |
| I_o ^{Note3} | Bands FDD_A | dBm/ $BW_{channel}$ | -87.76 $+10\log(N_{RB,c}/50)$ | $(I_o$ for Channel 1 +5.33dB +10log(N_{RB} channel2 / N_{RB} channel 1)) | |
| | Bands FDD_B | | -87.26 $+10\log(N_{RB,c}/50)$ | | |
| | Bands FDD_C | | -86.76 $+10\log(N_{RB,c}/50)$ | | |
| | Bands FDD_D | | -86.26 $+10\log(N_{RB,c}/50)$ | | |
| | Bands FDD_E, FDD_F ^{Note 6} | | -85.76 $+10\log(N_{RB,c}/50)$ | | |
| | Bands FDD_G | | -84.76 $+10\log(N_{RB,c}/50)$ | | |
| | Bands FDD_H | | -84.26 $+10\log(N_{RB,c}/50)$ | | |
| Propagation Condition | | | AWGN | AWGN | AWGN |
| Antenna Configuration | | | 1x2 | 1x2 | 1x2 |
| Timing offset to Cell 1 | | μ s | - | 0 | 3 |
| Time alignment error relative to cell 1 ^{Note 7} | | | - | \leq TAE | |
| Note 1: OCNG shall be used such that both cells are fully allocated and a constant total transmitted power spectral density is achieved for all OFDM symbols. | | | | | |

- Note 2: Interference from other cells and noise sources not specified in the test is assumed to be constant over subcarriers and time and shall be modelled as AWGN of appropriate power for N_{oc} to be fulfilled.
- Note 3: RSRP and I_o levels have been derived from other parameters for information purposes. They are not settable parameters themselves.
- Note 4: RSRP minimum requirements are specified assuming independent interference and noise at each receiver antenna port.
- Note 5: The selection of the bands for testing depends on the configuration of the carrier aggregation supported by the UEs.
- Note 6: For Band 26, the tests shall be performed with the carrier frequency of the assigned E-UTRA channel bandwidth within 865-894 MHz.
- Note 7: Time alignment error (TAE) as specified in TS 36.104 [30] clause 6.5.3.1. The TAE value depends upon the type of carrier aggregation.
- Note 8: E-UTRA operating band groups are as defined in Section 3.5.

Table A.9.1.46.2-2: 4 DL FDD RSRP carrier aggregation test parameters for cell 4 and cell 5

| Parameter | Unit | Cell 4 | Cell 5 | |
|---|--------------------------------------|--|--|-------------------|
| E-UTRA RF Channel Number | | 3 | | |
| $BW_{channel}$ | MHz | 5MHz: $N_{RB,c} = 25$ 10MHz: $N_{RB,c} = 50$ 20MHz: $N_{RB,c} = 100$ | | |
| Measurement bandwidth | n_{PRB} | 5MHz: 10-15 10MHz: 22-27 20MHz: 47-52 | | |
| PDSCH Reference measurement channel defined in A.3.1.1.1 | | 5MHz: R.5 FDD 10MHz: R.0 FDD 20MHz: R.4 FDD | - | |
| PDSCH allocation | n_{PRB} | 5MHz: 7-17 10MHz: 13-36 20MHz: 38-61 | - | |
| PDCCH/PCFICH/PHICH Reference measurement channel defined in A.3.1.2.1 | | 5MHz: R.11 FDD 10MHz: R.6 FDD 20MHz: R.10 FDD | 5MHz: R.11 FDD 10MHz: R.6 FDD 20MHz: R.10 FDD | |
| OCNG Patterns defined in A.3.2.1 | | 5MHz: OP.15 FDD 10MHz: OP.1 FDD 20MHz: OP.11 FDD | 5MHz: OP.16 FDD 10MHz: OP.2 FDD 20MHz: OP.12 FDD | |
| PBCH_RA | dB | 0 | 0 | |
| PBCH_RB | | | | |
| PSS_RA | | | | |
| SSS_RA | | | | |
| PCFICH_RB | | | | |
| PHICH_RA | | | | |
| PHICH_RB | | | | |
| PDCCH_RA | | | | |
| PDCCH_RB | | | | |
| PDSCH_RA | | | | |
| PDSCH_RB | | | | |
| OCNG_RA ^{Note1} | | | | |
| OCNG_RB ^{Note1} | | | | |
| N_{oc} ^{Note2} | | | | Bands FDD_A |
| | Bands FDD_B | | | |
| | Bands FDD_C | | | |
| | Bands FDD_D | | | |
| | Bands FDD_E, FDD_F ^{Note 6} | | | |
| | Bands FDD_G | | | |
| | Bands FDD_H | | | |
| \hat{E}_s / N_{oc} | dB | 3 | -1 | |
| \hat{E}_s / I_{ot} | dB | 0.46 | -5.76 | |
| RSRP ^{Note3} | Bands FDD_A | dBm/ | (RSRP for Cell 1) | (RSRP for Cell 1) |

| | | | | |
|---|---|------------------------|---|-------|
| | Bands FDD_B Bands FDD_C Bands FDD_D Bands FDD_E, FDD_F ^{Note 6} Bands FDD_G Bands FDD_H | 15kHz | +8dB) | +4dB) |
| I_o ^{Note3} | Bands FDD_A Bands FDD_B Bands FDD_C Bands FDD_D Bands FDD_E, FDD_F ^{Note 6} Bands FDD_G Bands FDD_H | dBm/ $BW_{channel}$ | $(I_o \text{ for Channel 1 } +5.33\text{dB} +10\log(N_{RB \text{ channel3}} / N_{RB \text{ channel 1}}))$ | |
| Propagation Condition | | | AWGN | AWGN |
| Antenna Configuration | | | 1x2 | 1x2 |
| Timing offset to Cell 1 | | μs | 0 | 3 |
| Time alignment error relative to cell 1 ^{Note 7} | | | $\leq \text{TAE}$ | - |
| Time alignment error relative to cell 2 ^{Note 7} | | | $\leq \text{TAE}$ | - |
| <p>Note 1: OCNB shall be used such that both cells are fully allocated and a constant total transmitted power spectral density is achieved for all OFDM symbols.</p> <p>Note 2: Interference from other cells and noise sources not specified in the test is assumed to be constant over subcarriers and time and shall be modelled as AWGN of appropriate power for N_{oc} to be fulfilled.</p> <p>Note 3: RSRP and I_o levels have been derived from other parameters for information purposes. They are not settable parameters themselves.</p> <p>Note 4: RSRP minimum requirements are specified assuming independent interference and noise at each receiver antenna port.</p> <p>Note 5: The selection of the bands for testing depends on the configuration of the carrier aggregation supported by the UEs.</p> <p>Note 6: For Band 26, the tests shall be performed with the carrier frequency of the assigned E-UTRA channel bandwidth within 865-894 MHz.</p> <p>Note 7: Time alignment error (TAE) as specified in TS 36.104 [30] clause 6.5.3.1. The TAE value depends upon the type of carrier aggregation.</p> <p>Note 8: E-UTRA operating band groups are as defined in Section 3.5.</p> | | | | |

Table A.9.1.46.2-3: 4 DL FDD RSRP carrier aggregation test parameters for cell 6 and cell 7

| Parameter | Unit | Cell 6 | Cell 7 |
|---|-----------|--|--|
| E-UTRA RF Channel Number | | 4 | |
| $BW_{channel}$ | MHz | 5MHz: $N_{RB,c} = 25$ 10MHz: $N_{RB,c} = 50$ 20MHz: $N_{RB,c} = 100$ | |
| Measurement bandwidth | n_{PRB} | 5MHz: 10-15 10MHz: 22-27 20MHz: 47-52 | |
| PDSCH Reference measurement channel defined in A.3.1.1.1 | | 5MHz: R.5 FDD 10MHz: R.0 FDD 20MHz: R.4 FDD | - |
| PDSCH allocation | n_{PRB} | 5MHz: 7-17 10MHz: 13-36 20MHz: 38-61 | |
| PDCCH/PCFICH/PHICH Reference measurement channel defined in A.3.1.2.1 | | 5MHz: R.11 FDD 10MHz: R.6 FDD 20MHz: R.10 FDD | 5MHz: R.11 FDD 10MHz: R.6 FDD 20MHz: R.10 FDD |
| OCNB Patterns defined in A.3.2.1 | | 5MHz: OP.15 FDD 10MHz: OP.1 FDD 20MHz: OP.11 FDD | 5MHz: OP.16 FDD 10MHz: OP.2 FDD 20MHz: OP.12 FDD |
| PBCH_RA | dB | 0 | 0 |
| PBCH_RB | | | |

| | | | | |
|---|---|-------------------------------|---|---------------------------|
| PSS_RA | | | | |
| SSS_RA | | | | |
| PCFICH_RB | | | | |
| PHICH_RA | | | | |
| PHICH_RB | | | | |
| PDCCH_RA | | | | |
| PDCCH_RB | | | | |
| PDSCH_RA | | | | |
| PDSCH_RB | | | | |
| OCNG_RA ^{Note1} | | | | |
| OCNG_RB ^{Note1} | | | | |
| N_{oc} ^{Note2} | Bands FDD_A | dBm/ 15kHz | $(N_{oc}$ for Channel 1 +1dB) | |
| | Bands FDD_B | | | |
| | Bands FDD_C | | | |
| | Bands FDD_D | | | |
| | Bands FDD_E, FDD_F ^{Note 6} | | | |
| | Bands FDD_G | | | |
| | Bands FDD_H | | | |
| \hat{E}_s / N_{oc} | | dB | 3 | -1 |
| \hat{E}_s / I_{ot} | | dB | 0.46 | -5.76 |
| RSRP ^{Note3} | Bands FDD_A | dBm/ 15kHz | (RSRP for Cell 1 +8dB) | (RSRP for Cell 1 +4dB) |
| | Bands FDD_B | | | |
| | Bands FDD_C | | | |
| | Bands FDD_D | | | |
| | Bands FDD_E, FDD_F ^{Note 6} | | | |
| | Bands FDD_G | | | |
| | Bands FDD_H | | | |
| I_o ^{Note3} | Bands FDD_A | dBm/ BW _{channel} | $(I_o$ for Channel 1 +5.33dB +10log (N_{RB} channel3 / N_{RB} channel 1)) | |
| | Bands FDD_B | | | |
| | Bands FDD_C | | | |
| | Bands FDD_D | | | |
| | Bands FDD_E, FDD_F ^{Note 6} | | | |
| | Bands FDD_G | | | |
| | Bands FDD_H | | | |
| Propagation Condition | | | AWGN | AWGN |
| Antenna Configuration | | | 1x2 | 1x2 |
| Timing offset to Cell 1 | μ s | | 0 | 3 |
| Time alignment error relative to cell 1 ^{Note 7} | | | \leq TAE | - |
| Time alignment error relative to cell 2 ^{Note 7} | | | \leq TAE | - |
| Time alignment error relative to cell 4 ^{Note 7} | | | \leq TAE | - |
| <p>Note 1: OCNG shall be used such that both cells are fully allocated and a constant total transmitted power spectral density is achieved for all OFDM symbols.</p> <p>Note 2: Interference from other cells and noise sources not specified in the test is assumed to be constant over subcarriers and time and shall be modelled as AWGN of appropriate power for N_{oc} to be fulfilled.</p> <p>Note 3: RSRP and I_o levels have been derived from other parameters for information purposes. They are not settable parameters themselves.</p> <p>Note 4: RSRP minimum requirements are specified assuming independent interference and noise at each receiver antenna port.</p> <p>Note 5: The selection of the bands for testing depends on the configuration of the carrier aggregation supported by the UEs.</p> <p>Note 6: For Band 26, the tests shall be performed with the carrier frequency of the assigned E-UTRA channel bandwidth within 865-894 MHz.</p> <p>Note 7: Time alignment error (TAE) as specified in TS 36.104 [30] clause 6.5.3.1. The TAE value depends upon the type of carrier aggregation.</p> <p>Note 8: E-UTRA operating band groups are as defined in Section 3.5.</p> | | | | |

A.9.1.46.3 Test Requirements

In the test, the performance of RSRP measurements is verified from the following 10 perspectives:

- The absolute accuracy of intra-frequency RSRP measurements for Cell 1 on the primary component carrier shall fulfil the requirements defined in clause 9.1.11.1.
- The absolute accuracy of intra-frequency RSRP measurements for Cell 2 on SCC1 shall fulfil the requirements defined in clause 9.1.11.2.
- The absolute accuracy of intra-frequency RSRP measurements for Cell 4 on SCC2 shall fulfil the requirements defined in clause 9.1.11.2.
- The absolute accuracy of intra-frequency RSRP measurements for Cell 6 on SCC3 shall fulfil the requirements defined in clause 9.1.11.2.
- The relative accuracy of intra-frequency RSRP measurements for Cell 3 relative to Cell 2 on SCC1 shall fulfil the requirements defined in clause 9.1.11.2.
- The relative accuracy of intra-frequency RSRP measurements for Cell 5 relative to Cell 4 on SCC2 shall fulfil the requirements defined in clause 9.1.11.2.
- The relative accuracy of intra-frequency RSRP measurements for Cell 7 relative to Cell 6 on SCC3 shall fulfil the requirements defined in clause 9.1.11.2.
- The relative accuracy of inter-frequency RSRP measurements between SCC1 and the primary component carriers for Cell 2 relative to Cell 1 shall fulfil the requirements defined in clause 9.1.11.3.
- The relative accuracy of inter-frequency RSRP measurements between SCC2 and the primary component carriers for Cell 4 relative to Cell 1 shall fulfil the requirements defined in clause 9.1.11.3.
- The relative accuracy of inter-frequency RSRP measurements between SCC3 and the primary component carriers for Cell 6 relative to Cell 1 shall fulfil the requirements defined in clause 9.1.11.3.

A.9.1.47 4 DL TDD RSRP for E-UTRAN in Carrier Aggregation

A.9.1.47.1 Test Purpose and Environment

The purpose of this test is to verify that the RSRP absolute and relative accuracy requirements in TDD-TDD carrier aggregation are within the specified limits. This test will verify the absolute RSRP accuracy requirements of the primary component carrier defined in clause 9.1.11.1, the absolute RSRP accuracy requirements of the secondary component carriers defined in clause 9.1.11.2, and the relative RSRP accuracy requirements of the secondary component carriers defined in clause 9.1.11.2. The test will also verify the primary and secondary component carriers' relative RSRP accuracy requirement defined in Clause 9.1.11.3.

A.9.1.47.2 Test parameters

In this set of test cases cell 1 is PCell on the primary component carrier, and cell 2, cell 4 and cell 6 are activated SCells on secondary component carriers SCC1, SCC2 and SCC3 respectively. Cell 3, cell 5 and cell 7 are neighbouring cells on secondary component carriers SCC1, SCC2 and SCC3 respectively. The test parameters are given in Table A.9.1.47.2-1, Table A.9.1.47.2-2 and Table A.9.1.47.2-3.

Table A.9.1.47.2-1: 4 DL TDD RSRP carrier aggregation test parameters for cell 1, cell 2 and cell 3

| Parameter | Unit | Cell 1 | Cell 2 | Cell 3 |
|---|------|---|---|--------|
| E-UTRA RF Channel Number | | 1 | 2 | |
| BW _{channel} | | 5MHz: N _{RB,c} = 25 10MHz: N _{RB,c} = 50 20MHz: N _{RB,c} = 100 | 5MHz: N _{RB,c} = 25 10MHz: N _{RB,c} = 50 20MHz: N _{RB,c} = 100 | |
| Special subframe configuration ^{Note1} | | 6 | | |
| Uplink/downlink | | 1 | | |

| | | | | |
|--|-------------|--|--|---|
| configuration ^{Note1} | | | | |
| Measurement bandwidth | n_{PRB} | 5MHz: 10-15 10MHz: 22-27 20MHz: 47-52 | 5MHz: 10-15 10MHz: 22-27 20MHz: 47-52 | - |
| PDSCH Reference measurement channel defined in A.3.1.1.2 | | 5MHz: R.4 TDD 10MHz: R.0 TDD 20MHz: R.3 TDD | 5MHz: R.4 TDD 10MHz: R.0 TDD 20MHz: R.3 TDD | - |
| PDSCH allocation | n_{PRB} | 5MHz: 7-17 10MHz: 13-36 20MHz: 38-61 | 5MHz: 7-17 10MHz: 13-36 20MHz: 38-61 | - |
| PDCCH/PCFICH/PHICH Reference measurement channel defined in A.3.1.2.2 | | 5MHz: R.11 TDD 10MHz: R.6 TDD 20MHz: R.10 TDD | 5MHz: R.11 TDD 10MHz: R.6 TDD 20MHz: R.10 TDD | 5MHz: R.11 TDD 10MHz: R.6 TDD 20MHz: R.10 TDD |
| OCNG Patterns defined in A.3.2.2 | | 5MHz: OP.9 TDD 10MHz: OP.1 TDD 20MHz: OP.7 TDD | 5MHz: OP.9 TDD 10MHz: OP.1 TDD 20MHz: OP.7 TDD | 5MHz: OP.10 TDD 10MHz: OP.2 TDD 20MHz: OP.8 TDD |
| PBCH_RA | dB | 0 | 0 | 0 |
| PBCH_RB | | | | |
| PSS_RA | | | | |
| SSS_RA | | | | |
| PCFICH_RB | | | | |
| PHICH_RA | | | | |
| PHICH_RB | | | | |
| PDCCH_RA | | | | |
| PDCCH_RB | | | | |
| PDSCH_RA | | | | |
| PDSCH_RB | | | | |
| OCNG_RA ^{Note2} | | | | |
| OCNG_RB ^{Note2} | | | | |
| N_{oc} ^{Note3} | | | | |
| | Bands TDD_C | -116 | | |
| | Bands TDD_E | -115 | | |
| \hat{E}_s / N_{oc} | dB | -4 | 3 | -1 |
| \hat{E}_s / I_{ot} | dB | -4 | 0.46 | -5.76 |
| RSRP ^{Note4} | Bands TDD_A | -121 | (RSRP for Cell 1 +8dB) | (RSRP for Cell 1 +4dB) |
| | Bands TDD_C | -120 | | |
| | Bands TDD_E | -119 | | |
| I_o ^{Note4} | Bands TDD_A | -87.76 + $10\log(N_{RB,c}/50)$ | (I _o for Channel 1 +5.33dB +10log ($N_{RB,channel2} / N_{RB,channel1}$)) | |
| | Bands TDD_C | -86.76 + $10\log(N_{RB,c}/50)$ | | |
| | Bands TDD_E | -85.76 + $10\log(N_{RB,c}/50)$ | | |
| Propagation Condition | | AWGN | AWGN | AWGN |
| Antenna Configuration | | 1x2 | 1x2 | 1x2 |
| Timing offset to Cell 1 | μ s | - | 0 | 3 |
| Time alignment error relative to cell 1 ^{Note 7} | | - | \leq TAE | - |
| <p>Note 1: For special subframe and uplink-downlink configurations see Tables 4.2-1 and 4.2-2 in TS 36.211.</p> <p>Note 2: OCNG shall be used such that both cells are fully allocated and a constant total transmitted power spectral density is achieved for all OFDM symbols.</p> <p>Note 3: Interference from other cells and noise sources not specified in the test is assumed to be constant over subcarriers and time and shall be modelled as AWGN of appropriate power for N_{oc} to be fulfilled.</p> <p>Note 4: RSRP and I_o levels have been derived from other parameters for information purposes. They are not settable parameters themselves.</p> <p>Note 5: RSRP minimum requirements are specified assuming independent interference and noise at each receiver antenna port.</p> <p>Note 6: The selection of the bands for testing depends on the configuration of the carrier aggregation supported by the UEs.</p> <p>Note 7: Time alignment error (TAE) as specified in TS 36.104 [30] clause 6.5.3.1. The TAE value depends upon the type of carrier aggregation.</p> <p>Note 8: E-UTRA operating band groups are as defined in Section 3.5.</p> | | | | |

Table A.9.1.47.2-2: 4 DL TDD RSRP carrier aggregation test parameters for cell 4 and cell 5

| Parameter | | Unit | Cell 4 | Cell 5 |
|---|---|------------------------------|--|---|
| E-UTRA RF Channel Number | | | 3 | |
| BW _{channel} | | MHz | 5MHz: N _{RB,c} = 25 10MHz: N _{RB,c} = 50 20MHz: N _{RB,c} = 100 | |
| Special subframe configuration ^{Note1} | | | 6 | |
| Uplink/downlink configuration ^{Note1} | | | 1 | |
| Measurement bandwidth | | <i>n</i> _{PRB} | 5MHz: 10-15 10MHz: 22-27 20MHz: 47-52 | |
| PDSCH Reference measurement channel defined in A.3.1.1.2 | | | 5MHz: R.4 TDD 10MHz: R.0 TDD 20MHz: R.3 TDD | N/A |
| PDSCH allocation | | <i>n</i> _{PRB} | 5MHz: 7-17 10MHz: 13-36 20MHz: 38-61 | N/A |
| PDCCH/PCFICH/PHICH Reference measurement channel defined in A.3.1.2.2 | | | 5MHz: R.11 TDD 10MHz: R.6 TDD 20MHz: R.10 TDD | 5MHz: R.11 TDD 10MHz: R.6 TDD 20MHz: R.10 TDD |
| OCNG Patterns defined in A.3.2.2 | | | 5MHz: OP.9 TDD 10MHz: OP.1 TDD 20MHz: OP.7 TDD | 5MHz: OP.10 TDD 10MHz: OP.2 TDD 20MHz: OP.8 TDD |
| PBCH_RA | | dB | 0 | 0 |
| PBCH_RB | | | | |
| PSS_RA | | | | |
| SSS_RA | | | | |
| PCFICH_RB | | | | |
| PHICH_RA | | | | |
| PHICH_RB | | | | |
| PDCCH_RA | | | | |
| PDCCH_RB | | | | |
| PDSCH_RA | | | | |
| PDSCH_RB | | | | |
| OCNG_RA ^{Note2} | | | | |
| OCNG_RB ^{Note2} | | | | |
| <i>N</i> _{oc} ^{Note3} | Bands TDD_A Bands TDD_C Bands TDD_E | | | |
| \hat{E}_s / N_{oc} | | dB | 3 | -1 |
| \hat{E}_s / I_{ot} | | dB | 0.46 | -5.76 |
| RSRP ^{Note4} | Bands TDD_A Bands TDD_C Bands TDD_E | dB/ 15kHz | (RSRP for Cell 1 +8dB) | (RSRP for Cell 1 +4dB) |
| <i>I</i> _o ^{Note4} | Bands TDD_A Bands TDD_C Bands TDD_E | dB/ BW _{channel} | (I _o for Channel 1 +5.33dB +10log (N _{RB channel3} / N _{RB channel1})) | |
| Propagation Condition | | | AWGN | AWGN |
| Antenna Configuration | | | 1x2 | 1x2 |
| Timing offset to Cell 1 | | μs | 0 | 3 |
| Time alignment error relative to cell 1 ^{Note7} | | | ≤ TAE | - |
| Time alignment error relative to cell 2 ^{Note7} | | | ≤ TAE | |
| Note 1: For special subframe and uplink-downlink configurations see Tables 4.2-1 and 4.2-2 in TS 36.211. | | | | |
| Note 2: OCNG shall be used such that both cells are fully allocated and a constant total transmitted power spectral density is achieved for all OFDM symbols. | | | | |

| | |
|---------|--|
| Note 3: | Interference from other cells and noise sources not specified in the test is assumed to be constant over subcarriers and time and shall be modelled as AWGN of appropriate power for N_{oc} to be fulfilled. |
| Note 4: | RSRP and I_o levels have been derived from other parameters for information purposes. They are not settable parameters themselves. |
| Note 5: | RSRP minimum requirements are specified assuming independent interference and noise at each receiver antenna port. |
| Note 6: | The selection of the bands for testing depends on the configuration of the carrier aggregation supported by the UEs. |
| Note 7: | Time alignment error (TAE) as specified in TS 36.104 [30] clause 6.5.3.1. The TAE value depends upon the type of carrier aggregation. |
| Note 8: | E-UTRA operating band groups are as defined in Section 3.5. |

Table A.9.1.47.2-3: 4 DL TDD RSRP carrier aggregation test parameters for cell 6 and cell 7

| Parameter | Unit | Cell 6 | Cell 7 |
|---|---------------|---|---|
| E-UTRA RF Channel Number | | 4 | |
| BW _{channel} | MHz | 5MHz: N _{RB,c} = 25 10MHz: N _{RB,c} = 50 20MHz: N _{RB,c} = 100 | |
| Special subframe configuration ^{Note1} | | 6 | |
| Uplink/downlink configuration ^{Note1} | | 1 | |
| Measurement bandwidth | n_{PRB} | 5MHz: 10-15 10MHz: 22-27 20MHz: 47-52 | |
| PDSCH Reference measurement channel defined in A.3.1.1.2 | | 5MHz: R.4 TDD 10MHz: R.0 TDD 20MHz: R.3 TDD | N/A |
| PDSCH allocation | n_{PRB} | 5MHz: 7-17 10MHz: 13-36 20MHz: 38-61 | N/A |
| PDCCH/PCFICH/PHICH Reference measurement channel defined in A.3.1.2.2 | | 5MHz: R.11 TDD 10MHz: R.6 TDD 20MHz: R.10 TDD | 5MHz: R.11 TDD 10MHz: R.6 TDD 20MHz: R.10 TDD |
| OCNG Patterns defined in A.3.2.2 | | 5MHz: OP.9 TDD 10MHz: OP.1 TDD 20MHz: OP.7 TDD | 5MHz: OP.10 TDD 10MHz: OP.2 TDD 20MHz: OP.8 TDD |
| PBCH_RA | dB | 0 | 0 |
| PBCH_RB | | | |
| PSS_RA | | | |
| SSS_RA | | | |
| PCFICH_RB | | | |
| PHICH_RA | | | |
| PHICH_RB | | | |
| PDCCH_RA | | | |
| PDCCH_RB | | | |
| PDSCH_RA | | | |
| PDSCH_RB | | | |
| OCNG_RA ^{Note2} | | | |
| OCNG_RB ^{Note2} | | | |
| N_{oc} ^{Note3} | | | |
| Bands TDD_A | | | |
| Bands TDD_C | | | |
| Bands TDD_E | | | |
| \hat{E}_s / N_{oc} | dB | 3 | -1 |
| \hat{E}_s / I_{ot} | dB | 0.46 | -5.76 |
| RSRP ^{Note4} | dBm/ 15kHz | (RSRP for Cell 1 +8dB) | (RSRP for Cell 1 +4dB) |
| Bands TDD_A | | | |
| Bands TDD_C | | | |

| | Bands TDD_E | | | |
|--|-------------|-------------------------------|--|------|
| I _o ^{Note4} | Bands TDD_A | dBm/ BW _{channel} | (I _o for Channel 1 +5.33dB +10log (N _{RB channel3} / N _{RB channel 1})) | |
| | Bands TDD_C | | | |
| | Bands TDD_E | | | |
| | | | | |
| Propagation Condition | | | AWGN | AWGN |
| Antenna Configuration | | | 1x2 | 1x2 |
| Timing offset to Cell 1 | | μs | 0 | 3 |
| Time alignment error relative to cell 1 ^{Note 7} | | | ≤ TAE | - |
| Time alignment error relative to cell 2 ^{Note 7} | | | ≤ TAE | |
| Time alignment error relative to cell 4 ^{Note 7} | | | ≤ TAE | |
| <p>Note 1: For special subframe and uplink-downlink configurations see Tables 4.2-1 and 4.2-2 in TS 36.211.</p> <p>Note 2: OCN_G shall be used such that both cells are fully allocated and a constant total transmitted power spectral density is achieved for all OFDM symbols.</p> <p>Note 3: Interference from other cells and noise sources not specified in the test is assumed to be constant over subcarriers and time and shall be modelled as AWGN of appropriate power for N_{oc} to be fulfilled.</p> <p>Note 4: RSRP and I_o levels have been derived from other parameters for information purposes. They are not settable parameters themselves.</p> <p>Note 5: RSRP minimum requirements are specified assuming independent interference and noise at each receiver antenna port.</p> <p>Note 6: The selection of the bands for testing depends on the configuration of the carrier aggregation supported by the UEs.</p> <p>Note 7: Time alignment error (TAE) as specified in TS 36.104 [30] clause 6.5.3.1. The TAE value depends upon the type of carrier aggregation.</p> <p>Note 8: E-UTRA operating band groups are as defined in Section 3.5.</p> | | | | |

A.9.1.47.3 Test Requirements

In the test, the performance of RSRP measurements is verified from the following 10 perspectives:

- The absolute accuracy of intra-frequency RSRP measurements for Cell 1 on the primary component carrier shall fulfil the requirements defined in clause 9.1.11.1.
- The absolute accuracy of intra-frequency RSRP measurements for Cell 2 on SCC1 shall fulfil the requirements defined in clause 9.1.11.2.
- The absolute accuracy of intra-frequency RSRP measurements for Cell 4 on SCC2 shall fulfil the requirements defined in clause 9.1.11.2.
- The absolute accuracy of intra-frequency RSRP measurements for Cell 6 on SCC3 shall fulfil the requirements defined in clause 9.1.11.2.
- The relative accuracy of intra-frequency RSRP measurements for Cell 3 relative to Cell 2 on SCC1 shall fulfil the requirements defined in clause 9.1.11.2.
- The relative accuracy of intra-frequency RSRP measurements for Cell 5 relative to Cell 4 on SCC2 shall fulfil the requirements defined in clause 9.1.11.2.
- The relative accuracy of intra-frequency RSRP measurements for Cell 7 relative to Cell 6 on SCC3 shall fulfil the requirements defined in clause 9.1.11.2.
- The relative accuracy of inter-frequency RSRP measurements between SCC1 and the primary component carriers for Cell 2 relative to Cell 1 shall fulfil the requirements defined in clause 9.1.11.3.
- The relative accuracy of inter-frequency RSRP measurements between SCC2 and the primary component carriers for Cell 4 relative to Cell 1 shall fulfil the requirements defined in clause 9.1.11.3.
- The relative accuracy of inter-frequency RSRP measurements between SCC3 and the primary component carriers for Cell 6 relative to Cell 1 shall fulfil the requirements defined in clause 9.1.11.3.

A.9.1.48 5 DL FDD-TDD with PCell in FDD RSRP for E-UTRAN in Carrier Aggregation

A.9.1.48.1 Test Purpose and Environment

The purpose of this test is to verify that the TDD-FDD RSRP absolute and relative accuracy requirements in carrier aggregation with PCell in FDD are within the specified limits. This test will verify the absolute RSRP accuracy requirements of the primary component carrier defined in clause 9.1.11.1, the absolute RSRP accuracy requirements of the secondary component carriers defined in clause 9.1.11.2, and the relative RSRP accuracy requirements of the secondary component carriers defined in clause 9.1.11.2. The test will also verify the primary and secondary component carriers' relative RSRP accuracy requirement defined in Clause 9.1.11.3.

A.9.1.48.2 Test parameters

In this set of test cases cell 1 is PCell on the primary component carrier, and cell 2, cell 4, cell 6 and cell 8 are activated SCells on secondary component carriers SCC1, SCC2, SCC3 and SCC4 respectively. Cell 3, cell 5, cell 7 and cell 9 are neighbouring cells on secondary component carriers SCC1, SCC2, SCC3 and SCC4 respectively. The test parameters are given in Table A.9.1.48.2-1, Table A.9.1.48.2-2 and Table A.9.1.48.2-3.

Table A.9.1.48.2-1: 5 Downlink PCell in FDD RSRP carrier aggregation test parameters for cell 1, cell 2, cell 3, cell 4 and cell 5

| Parameter | Unit | Cell 1 | Cell 2 | Cell 3 | Cell 4 | Cell 5 |
|--|-----------|---|--|--|--|--|
| E-UTRA RF Channel Number | | 1 | 2 | | 3 | |
| $BW_{channel}$ | MHz | 5MHz: $N_{RB,c} = 25$ 10MHz: $N_{RB,c} = 50$ 20MHz: $N_{RB,c} = 100$ | 5MHz: $N_{RB,c} = 25$ 10MHz: $N_{RB,c} = 50$ 20MHz: $N_{RB,c} = 100$ | | 5MHz: $N_{RB,c} = 25$ 10MHz: $N_{RB,c} = 50$ 20MHz: $N_{RB,c} = 100$ | |
| Special subframe configuration ^{Note1} | | - | 6 | | 6 | |
| Uplink/downlink configuration ^{Note1} | | - | 1 | | 1 | |
| Measurement bandwidth | n_{PRB} | 5MHz: 10-15 10MHz: 22-27 20MHz: 47-52 | 5MHz: 10-15 10MHz: 22-27 20MHz: 47-52 | | 5MHz: 10-15 10MHz: 22-27 20MHz: 47-52 | |
| PDSCH Reference measurement channel defined in A.3.1.1. | | 5MHz: R.5 FDD 10MHz: R.0 FDD 20MHz: R.4 FDD | 5MHz: R.4 TDD 10MHz: R.0 TDD 20MHz: R.3 TDD | - | 5MHz: R.4 TDD 10MHz: R.0 TDD 20MHz: R.3 TDD | - |
| PDSCH allocation | n_{PRB} | 5MHz: 7-17 10MHz: 13-36 20MHz: 38-61 | 5MHz: 7-17 10MHz: 13-36 20MHz: 38-61 | - | 5MHz: 7-17 10MHz: 13-36 20MHz: 38-61 | - |
| PDCCH/PCFICH/PHICH Reference measurement channel defined in A.3.1.2. | | 5MHz: R.11 FDD 10MHz: R.6 FDD 20MHz: R.10 FDD | 5MHz: R.11 TDD 10MHz: R.6 TDD 20MHz: R.10 TDD | 5MHz: R.11 TDD 10MHz: R.6 TDD 20MHz: R.10 TDD | 5MHz: R.11 TDD 10MHz: R.6 TDD 20MHz: R.10 TDD | 5MHz: R.11 TDD 10MHz: R.6 TDD 20MHz: R.10 TDD |
| OCNG Patterns defined in A.3.2. | | 5MHz: OP.15 FDD 10MHz: OP.1 FDD 20MHz: OP.11 FDD | 5MHz: OP.9 TDD 10MHz: OP.1 TDD 20MHz: OP.7 TDD | 5MHz: OP.10 TDD 10MHz: OP.2 TDD 20MHz: OP.2 TDD | 5MHz: OP.7 TDD 10MHz: OP.1 TDD | 5MHz: OP.10 TDD 10MHz: OP.2 TDD 20MHz: OP.2 TDD |

| | | | | | | | |
|---------------------------|--------------------------------------|------------|------|------------------------|------------------------|------------------------|------------------------|
| | | | | | OP.8 TDD | 20MHz: OP.7 TDD | OP.8 TDD |
| PBCH_RA | dB | 0 | 0 | 0 | 0 | 0 | 0 |
| PBCH_RB | | | | | | | |
| PSS_RA | | | | | | | |
| SSS_RA | | | | | | | |
| PCFICH_RB | | | | | | | |
| PHICH_RA | | | | | | | |
| PHICH_RB | | | | | | | |
| PDCCH_RA | | | | | | | |
| PDCCH_RB | | | | | | | |
| PDSCH_RA | | | | | | | |
| PDSCH_RB | | | | | | | |
| OCNG_RA ^{Note2} | | | | | | | |
| OCNG_RB ^{Note2} | | | | | | | |
| N_{oc} ^{Note3} | | | | | | | |
| | Bands TDD_C | | | | | | |
| | Bands TDD_E | | | | | | |
| | Bands FDD_A | | | | | | |
| | Bands FDD_B | | | | | | |
| | Bands FDD_C | | | | | | |
| | Bands FDD_D | | | | | | |
| | Bands FDD_E, FDD_F ^{Note 7} | | | | | | |
| | Bands FDD_G | | | | | | |
| | Bands FDD_H | | | | | | |
| | \hat{E}_s/N_{oc} | dB | -4 | 3 | -1 | 3 | -1 |
| \hat{E}_s/I_{ot} | dB | -4 | 0.46 | -5.76 | 0.46 | -5.76 | |
| RSRP ^{Note4} | Bands TDD_A | dBm/15 kHz | - | (RSRP for Cell 1 +8dB) | (RSRP for Cell 1 +4dB) | (RSRP for Cell 1 +8dB) | (RSRP for Cell 1 +4dB) |
| | Bands TDD_C | | | | | | |
| | Bands TDD_E | | | | | | |
| | Bands FDD_A | | | | | | |
| | Bands FDD_B | | | | | | |
| | Bands FDD_C | | | | | | |
| | Bands FDD_D | | | | | | |
| | Bands FDD_E, FDD_F ^{Note 7} | | | | | | |
| | Bands FDD_G | | | | | | |
| | Bands FDD_H | | | | | | |
| | I_o ^{Note4} | | | | | | |

| | | | | | | |
|--|--|--|---|-------|------|-------|
| | TDD_C | | | | | 1)) |
| | Bands TDD_E | | | | | |
| | Bands FDD_A | | - | | | |
| | Bands FDD_B | | 87.76+10log(N _{RB,c} /50) | | | |
| | Bands FDD_C | | - | | | |
| | Bands FDD_D | | 87.26+10log(N _{RB,c} /50) | | | |
| | Bands FDD_E, FDD_F <small>Note 7</small> | | - | | | |
| | Bands FDD_G | | 86.76+10log(N _{RB,c} /50) | | | |
| | Bands FDD_H | | - | | | |
| | | | 86.26+10log(N _{RB,c} /50) | | | |
| | | | -85.76 +10log(N _{RB,c} /50) | | | |
| | | | -84.76 +10log(N _{RB,c} /50) | | | |
| | | | -84.26 +10log(N _{RB,c} /50) | | | |
| Propagation condition | - | | AWGN | AWGN | AWGN | AWGN |
| Antenna Configuration | - | | 1x2 | 1x2 | 1x2 | 1x2 |
| Timing offset to cell 1 | μs | | - | 0 | 3 | 3 |
| Time alignment error relative to cell 1 <small>Note 8</small> | | | - | ≤ TAE | - | ≤ TAE |
| Time alignment error relative to cell 2 <small>Note 8</small> | | | - | - | - | ≤ TAE |
| <p>Note 1: For special subframe and uplink-downlink configurations see Tables 4.2-1 and 4.2-2 in TS 36.211.</p> <p>Note 2: OCNG shall be used such that all cells are fully allocated and a constant total transmitted power spectral density is achieved for all OFDM symbols.</p> <p>Note 3: Interference from other cells and noise sources not specified in the test is assumed to be constant over subcarriers and time and shall be modelled as AWGN of appropriate power for N_{oc} to be fulfilled.</p> <p>Note 4: RSRP and Io levels have been derived from other parameters for information purposes. They are not settable parameters themselves.</p> <p>Note 5: RSRP minimum requirements are specified assuming independent interference and noise at each receiver antenna port.</p> <p>Note 6: The selection of the bands for testing depends on the configuration of the carrier aggregation supported by the UEs.</p> <p>Note 7: For Band 26, the tests shall be performed with the carrier frequency of the assigned E-UTRA channel bandwidth within 865-894 MHz.</p> <p>Note 8: Time alignment error (TAE) as specified in TS 36.104 [30] clause 6.5.3.1. The TAE value depends upon the type of carrier aggregation.</p> <p>Note 9: E-UTRA operating band groups are as defined in Section 3.5.</p> | | | | | | |

Table A.9.1.48.2-2: 5 Downlink PCell in FDD RSRP carrier aggregation test parameters for cell 6 and cell 7

| Parameter | Unit | Cell 6 | Cell 7 |
|--|-----------|---|----------------------------------|
| E-UTRA RF Channel Number | | 4 | |
| BW _{channel} | MHz | 5MHz: N _{RB,c} = 25 10MHz: N _{RB,c} = 50 20MHz: N _{RB,c} = 100 | |
| Special subframe configuration <small>Note1</small> | | 6 | |
| Uplink/downlink configuration <small>Note1</small> | | 1 | |
| Measurement bandwidth | n_{PRB} | 5MHz: 10-15 10MHz: 22-27 20MHz: 47-52 | |
| PDSCH Reference measurement channel defined in A.3.1.1.2 | | 5MHz: R.4 TDD 10MHz: R.0 TDD 20MHz: R.3 TDD | N/A |
| PDSCH allocation | n_{PRB} | 5MHz: 7-17 10MHz: 13-36 20MHz: 38-61 | N/A |
| PDCCH/PCFICH/PHICH Reference measurement | | 5MHz: R.11 TDD 10MHz: R.6 TDD | 5MHz: R.11 TDD 10MHz: R.6 TDD |

| | | | | |
|--|-------------|---|--|---------------------------|
| channel defined in A.3.1.2.2 | | 20MHz: R.10 TDD | 20MHz: R.10 TDD | |
| OCNG Patterns defined in A.3.2.2 | | 5MHz: OP.9 TDD 10MHz: OP.1 TDD 20MHz: OP.7 TDD | 5MHz: OP.10 TDD 10MHz: OP.2 TDD 20MHz: OP.8 TDD | |
| PBCH_RA | dB | 0 | 0 | |
| PBCH_RB | | | | |
| PSS_RA | | | | |
| SSS_RA | | | | |
| PCFICH_RB | | | | |
| PHICH_RA | | | | |
| PHICH_RB | | | | |
| PDCCH_RA | | | | |
| PDCCH_RB | | | | |
| PDSCH_RA | | | | |
| PDSCH_RB | | | | |
| OCNG_RA ^{Note2} | | | | |
| OCNG_RB ^{Note2} | | | | |
| N_{oc} ^{Note3} | | | | Bands TDD_A |
| | Bands TDD_C | | | |
| | Bands TDD_E | | | |
| \hat{E}_s / N_{oc} | | | 3 | -1 |
| \hat{E}_s / I_{ot} | | | 0.46 | -5.76 |
| RSRP ^{Note4} | Bands TDD_A | dBm/ 15kHz | (RSRP for Cell 1 +8dB) | (RSRP for Cell 1 +4dB) |
| | Bands TDD_C | | | |
| | Bands TDD_E | | | |
| Io ^{Note4} | Bands TDD_A | dBm/ BW _{channel} | (Io for Channel 1 +5.33dB +10log (N _{RB channel3} / N _{RB channel 1})) | |
| | Bands TDD_C | | | |
| | Bands TDD_E | | | |
| Propagation Condition | | | AWGN | AWGN |
| Antenna Configuration | | | 1x2 | 1x2 |
| Timing offset to Cell 1 | μs | | 0 | 3 |
| Time alignment error relative to cell 1 ^{Note 7} | | | ≤ TAE | - |
| Time alignment error relative to cell 2 ^{Note 7} | | | ≤ TAE | |
| Time alignment error relative to cell 4 ^{Note 7} | | | ≤ TAE | |
| <p>Note 1: For special subframe and uplink-downlink configurations see Tables 4.2-1 and 4.2-2 in TS 36.211.</p> <p>Note 2: OCNG shall be used such that both cells are fully allocated and a constant total transmitted power spectral density is achieved for all OFDM symbols.</p> <p>Note 3: Interference from other cells and noise sources not specified in the test is assumed to be constant over subcarriers and time and shall be modelled as AWGN of appropriate power for N_{oc} to be fulfilled.</p> <p>Note 4: RSRP and Io levels have been derived from other parameters for information purposes. They are not settable parameters themselves.</p> <p>Note 5: RSRP minimum requirements are specified assuming independent interference and noise at each receiver antenna port.</p> <p>Note 6: The selection of the bands for testing depends on the configuration of the carrier aggregation supported by the UEs.</p> <p>Note 7: Time alignment error (TAE) as specified in TS 36.104 [30] clause 6.5.3.1. The TAE value depends upon the type of carrier aggregation.</p> <p>Note 8: E-UTRA operating band groups are as defined in Section 3.5.</p> | | | | |

Table A.9.1.48.2-3: 5 Downlink PCell in FDD RSRP carrier aggregation test parameters for cell 8 and cell 9

| Parameter | Unit | Cell 8 | Cell 9 |
|--------------------------|------|--------|--------|
| E-UTRA RF Channel Number | | | 5 |

| | | | |
|--|-------------------------------|---|---|
| BW _{channel} | MHz | 5MHz: N _{RB,c} = 25 10MHz: N _{RB,c} = 50 20MHz: N _{RB,c} = 100 | |
| Special subframe configuration ^{Note1} | | 6 | |
| Uplink/downlink configuration ^{Note1} | | 1 | |
| Measurement bandwidth | <i>n</i> _{PRB} | 5MHz: 10-15 10MHz: 22-27 20MHz: 47-52 | |
| PDSCH Reference measurement channel defined in A.3.1.1.2 | | 5MHz: R.4 TDD 10MHz: R.0 TDD 20MHz: R.3 TDD | N/A |
| PDSCH allocation | <i>n</i> _{PRB} | 5MHz: 7-17 10MHz: 13-36 20MHz: 38-61 | N/A |
| PDCCH/PCFICH/PHICH Reference measurement channel defined in A.3.1.2.2 | | 5MHz: R.11 TDD 10MHz: R.6 TDD 20MHz: R.10 TDD | 5MHz: R.11 TDD 10MHz: R.6 TDD 20MHz: R.10 TDD |
| OCNG Patterns defined in A.3.2.2 | | 5MHz: OP.9 TDD 10MHz: OP.1 TDD 20MHz: OP.7 TDD | 5MHz: OP.10 TDD 10MHz: OP.2 TDD 20MHz: OP.8 TDD |
| PBCH_RA | dB | 0 | 0 |
| PBCH_RB | | | |
| PSS_RA | | | |
| SSS_RA | | | |
| PCFICH_RB | | | |
| PHICH_RA | | | |
| PHICH_RB | | | |
| PDCCH_RA | | | |
| PDCCH_RB | | | |
| PDSCH_RA | | | |
| PDSCH_RB | | | |
| OCNG_RA ^{Note2} | | | |
| OCNG_RB ^{Note2} | | | |
| <i>N</i> _{oc} ^{Note3} | | | |
| Bands TDD_A | | | |
| Bands TDD_C | | | |
| \hat{E}_s / N_{oc} | | 3 | -1 |
| \hat{E}_s / I_{ot} | | 0.46 | -5.76 |
| RSRP ^{Note4} | dBm/ 15kHz | (RSRP for Cell 1 +8dB) | (RSRP for Cell 1 +4dB) |
| Bands TDD_A | | | |
| Bands TDD_C | | | |
| <i>I</i> _o ^{Note4} | dBm/ BW _{channel} | (I _o for Channel 1 +5.33dB +10log (N _{RB channel3} / N _{RB channel 1})) | |
| Bands TDD_A | | | |
| Bands TDD_C | | | |
| Propagation Condition | | AWGN | AWGN |
| Antenna Configuration | | 1x2 | 1x2 |
| Timing offset to Cell 1 | μs | 0 | 3 |
| Time alignment error relative to cell 1 ^{Note 7} | | ≤ TAE | - |
| Time alignment error relative to cell 2 ^{Note 7} | | ≤ TAE | |
| Time alignment error relative to cell 4 ^{Note 7} | | ≤ TAE | |
| Time alignment error relative to cell 6 ^{Note 7} | | ≤ TAE | |
| <p>Note 1: For special subframe and uplink-downlink configurations see Tables 4.2-1 and 4.2-2 in TS 36.211.</p> <p>Note 2: OCNG shall be used such that both cells are fully allocated and a constant total transmitted power spectral density is achieved for all OFDM symbols.</p> | | | |

| | |
|---------|--|
| Note 3: | Interference from other cells and noise sources not specified in the test is assumed to be constant over subcarriers and time and shall be modelled as AWGN of appropriate power for N_{oc} to be fulfilled. |
| Note 4: | RSRP and I_0 levels have been derived from other parameters for information purposes. They are not settable parameters themselves. |
| Note 5: | RSRP minimum requirements are specified assuming independent interference and noise at each receiver antenna port. |
| Note 6: | The selection of the bands for testing depends on the configuration of the carrier aggregation supported by the UEs. |
| Note 7: | Time alignment error (TAE) as specified in TS 36.104 [30] clause 6.5.3.1. The TAE value depends upon the type of carrier aggregation. |
| Note 8: | E-UTRA operating band groups are as defined in Section 3.5. |

A.9.1.48.3 Test Requirements

In the test, the performance of RSRP measurements is verified from the following 13 perspectives:

- The absolute accuracy of intra-frequency RSRP measurements for Cell 1 on the primary component carrier shall fulfil the requirements defined in clause 9.1.11.1.
- The absolute accuracy of intra-frequency RSRP measurements for Cell 2 on SCC1 shall fulfil the requirements defined in clause 9.1.11.2.
- The absolute accuracy of intra-frequency RSRP measurements for Cell 4 on SCC2 shall fulfil the requirements defined in clause 9.1.11.2.
- The absolute accuracy of intra-frequency RSRP measurements for Cell 6 on SCC3 shall fulfil the requirements defined in clause 9.1.11.2.
- The absolute accuracy of intra-frequency RSRP measurements for Cell 8 on SCC4 shall fulfil the requirements defined in clause 9.1.11.2.
- The relative accuracy of intra-frequency RSRP measurements for Cell 3 relative to Cell 2 on SCC1 shall fulfil the requirements defined in clause 9.1.11.2.
- The relative accuracy of intra-frequency RSRP measurements for Cell 5 relative to Cell 4 on SCC2 shall fulfil the requirements defined in clause 9.1.11.2.
- The relative accuracy of intra-frequency RSRP measurements for Cell 7 relative to Cell 6 on SCC3 shall fulfil the requirements defined in clause 9.1.11.2.
- The relative accuracy of intra-frequency RSRP measurements for Cell 9 relative to Cell 8 on SCC3 shall fulfil the requirements defined in clause 9.1.11.2.
- The relative accuracy of inter-frequency RSRP measurements between SCC1 and the primary component carriers for Cell 2 relative to Cell 1 shall fulfil the requirements defined in clause 9.1.11.3.
- The relative accuracy of inter-frequency RSRP measurements between SCC2 and the primary component carriers for Cell 4 relative to Cell 1 shall fulfil the requirements defined in clause 9.1.11.3.
- The relative accuracy of inter-frequency RSRP measurements between SCC3 and the primary component carriers for Cell 6 relative to Cell 1 shall fulfil the requirements defined in clause 9.1.11.3.
- The relative accuracy of inter-frequency RSRP measurements between SCC4 and the primary component carriers for Cell 8 relative to Cell 1 shall fulfil the requirements defined in clause 9.1.11.3.

A.9.1.49 5 DL FDD-TDD with PCell in TDD RSRP for E-UTRAN in Carrier Aggregation

A.9.1.49.1 Test Purpose and Environment

The purpose of this test is to verify that the TDD-FDD RSRP absolute and relative accuracy requirements in carrier aggregation with PCell in TDD are within the specified limits. This test will verify the absolute RSRP accuracy requirements of the primary component carrier defined in clause 9.1.11.1, the absolute RSRP accuracy requirements of the secondary component carriers defined in clause 9.1.11.2, and the relative RSRP accuracy requirements of the secondary component carriers defined in clause 9.1.11.2. The test will also verify the primary and secondary component carriers' relative RSRP accuracy requirement defined in Clause 9.1.11.3.

A.9.1.49.2 Test parameters

In this set of test cases cell 1 is PCell on the primary component carrier, and cell 2, cell 4, cell 6 and cell 8 are activated SCells on secondary component carriers SCC1, SCC2, SCC3 and SCC4 respectively. Cell 3, cell 5, cell 7 and cell 9 are neighbouring cells on secondary component carriers SCC1, SCC2, SCC3 and SCC4 respectively. The test parameters are given in Table A.9.1.49.2-1, Table A.9.1.49.2-2 and Table A.9.1.49.2-3.

Table A.9.1.49.2-1: 5 Downlink PCell in TDD RSRP carrier aggregation test parameters for cell 1, cell 2, cell 3, cell 4 and cell 5

| Parameter | Unit | Cell 1 | Cell 2 | Cell 3 | Cell 4 | Cell 5 |
|--|-----------|---|--|---|--|---|
| E-UTRA RF Channel Number | | 1 | 2 | | 3 | |
| $BW_{channel}$ | MHz | 5MHz: $N_{RB,c} = 25$ 10MHz: $N_{RB,c} = 50$ 20MHz: $N_{RB,c} = 100$ | 5MHz: $N_{RB,c} = 25$ 10MHz: $N_{RB,c} = 50$ 20MHz: $N_{RB,c} = 100$ | | 5MHz: $N_{RB,c} = 25$ 10MHz: $N_{RB,c} = 50$ 20MHz: $N_{RB,c} = 100$ | |
| Special subframe configuration ^{Note1} | | 6 | - | | - | |
| Uplink/downlink configuration ^{Note1} | | 1 | - | | - | |
| Measurement bandwidth | n_{PRB} | 5MHz: 10-15 10MHz: 22-27 20MHz: 47-52 | 5MHz: 10-15 10MHz: 22-27 20MHz: 47-52 | | 5MHz: 10-15 10MHz: 22-27 20MHz: 47-52 | |
| PDSCH Reference measurement channel defined in A.3.1.1. | | 5MHz: R.4 TDD 10MHz: R.0 TDD 20MHz: R.3 TDD | 5MHz: R.5 FDD 10MHz: R.0 FDD 20MHz: R.4 FDD | - | 5MHz: R.5 FDD 10MHz: R.0 FDD 20MHz: R.4 FDD | - |
| PDSCH allocation | n_{PRB} | 5MHz: 7-17 10MHz: 13-36 20MHz: 38-61 | 5MHz: 7-17 10MHz: 13-36 20MHz: 38-61 | - | 5MHz: 7-17 10MHz: 13-36 20MHz: 38-61 | - |
| PDCCH/PCFICH/PHICH Reference measurement channel defined in A.3.1.2. | | 5MHz: R.11 TDD 10MHz: R.6 TDD 20MHz: R.10 TDD | 5MHz: R.11 FDD 10MHz: R.6 FDD 20MHz: R.10 FDD | 5MHz: R.11 FDD 10MHz: R.6 FDD 20MHz: R.10 FDD | 5MHz: R.11 FDD 10MHz: R.6 FDD 20MHz: R.10 FDD | 5MHz: R.11 FDD 10MHz: R.6 FDD 20MHz: R.10 FDD |
| OCNG Patterns defined in A.3.2. | | 5MHz: OP.9 TDD 10MHz: OP.1 TDD 20MHz: OP.7 TDD | 5MHz: OP.15 FDD 10MHz: OP.1 FDD 20MHz: OP.11 FDD | 5MHz: OP.16 FDD 10MHz: OP.2 FDD 20MHz: OP.12 FDD | 5MHz: OP.15 FDD 10MHz: OP.1 FDD | 5MHz: OP.16 FDD 10MHz: OP.2 FDD 20MHz: OP.12 FDD |

| | | | | | | | | | | |
|---------------------------|--------------------------------------|-----------------------------------|------|---|--|------------------------|------------------------|------------|---|-------------------------------|
| | | | | | 20MHz: OP.11 FDD | | | | | |
| PBCH_RA | dB | 0 | 0 | 0 | 0 | 0 | | | | |
| PBCH_RB | | | | | | | | | | |
| PSS_RA | | | | | | | | | | |
| SSS_RA | | | | | | | | | | |
| PCFICH_RB | | | | | | | | | | |
| PHICH_RA | | | | | | | | | | |
| PHICH_RB | | | | | | | | | | |
| PDCCH_RA | | | | | | | | | | |
| PDCCH_RB | | | | | | | | | | |
| PDSCH_RA | | | | | | | | | | |
| PDSCH_RB | | | | | | | | | | |
| OCNG_RA ^{Note1} | | | | | | | | | | |
| OCNG_RB ^{Note1} | | | | | | | | | | |
| N_{oc} ^{Note3} | | | | | | | Bands FDD_A | dBm/15 kHz | - | $(N_{oc}$ for Channel 1 +1dB) |
| | Bands FDD_B | | | | | | | | | |
| | Bands FDD_C | | | | | | | | | |
| | Bands FDD_D | | | | | | | | | |
| | Bands FDD_E, FDD_F ^{Note 7} | | | | | | | | | |
| | Bands FDD_G | | | | | | | | | |
| | Bands FDD_H | | | | | | | | | |
| | Bands TDD_A | -117 | - | - | | | | | | |
| | Bands TDD_C | -116 | | | | | | | | |
| | Bands TDD_E | -115 | | | | | | | | |
| \hat{E}_s / N_{oc} | dB | -4 | 3 | -1 | 3 | -1 | | | | |
| \hat{E}_s / I_{ot} | dB | -4 | 0.46 | -5.76 | 0.46 | -5.76 | | | | |
| RSRP ^{Note4} | Bands FDD_A | dBm/15 kHz | - | (RSRP for Cell 1 +8dB) | (RSRP for Cell 1 +4dB) | (RSRP for Cell 1 +8dB) | (RSRP for Cell 1 +4dB) | | | |
| | Bands FDD_B | | | | | | | | | |
| | Bands FDD_C | | | | | | | | | |
| | Bands FDD_D | | | | | | | | | |
| | Bands FDD_E, FDD_F ^{Note 7} | | | | | | | | | |
| | Bands FDD_G | | | | | | | | | |
| | Bands FDD_H | | | | | | | | | |
| | Bands TDD_A | | | | | | | -121 | - | - |
| | Bands TDD_C | | | | | | | -120 | | |
| | Bands TDD_E | | | | | | | -119 | | |
| I_o ^{Note4} | Bands FDD_A | dBm/ BW _{chann} el | - | (I _o for Channel 1 +5.33dB +10log (N _{RB channel2} / N _{RB channel 1})) | (I _o for Channel 1 +5.33dB +10log (N _{RB channel3} / N _{RB channel} | | | | | |
| | Bands | | | | | | | | | |

| | | | | | | | | |
|---|--------------------------------------|------|-------|------|-------|------|---|---|
| | FDD_B | | | | 1)) | | | |
| | Bands FDD_C | | | | | | | |
| | Bands FDD_D | | | | | | | |
| | Bands FDD_E, FDD_F ^{Note 7} | | | | | | | |
| | Bands FDD_G | | | | | | | |
| | Bands FDD_H | | | | | | | |
| | Bands TDD_A | | | | - | - | - | - |
| | Bands TDD_C | | | | - | - | - | - |
| Bands TDD_E | - | - | - | - | | | | |
| Propagation condition | - | AWGN | AWGN | AWGN | AWGN | AWGN | | |
| Antenna Configuration | - | 1x2 | 1x2 | 1x2 | 1x2 | 1x2 | | |
| Timing offset to cell 1 | μs | - | 0 | 3 | 0 | 3 | | |
| Time alignment error relative to cell 1 ^{Note 8} | | - | ≤ TAE | - | ≤ TAE | - | | |
| Time alignment error relative to cell 2 ^{Note 8} | | - | - | - | ≤ TAE | - | | |
| <p>Note 1: For special subframe and uplink-downlink configurations see Tables 4.2-1 and 4.2-2 in TS 36.211.</p> <p>Note 2: OCNNG shall be used such that all cells are fully allocated and a constant total transmitted power spectral density is achieved for all OFDM symbols.</p> <p>Note 3: Interference from other cells and noise sources not specified in the test is assumed to be constant over subcarriers and time and shall be modelled as AWGN of appropriate power for N_{oc} to be fulfilled.</p> <p>Note 4: RSRP and I_0 levels have been derived from other parameters for information purposes. They are not settable parameters themselves.</p> <p>Note 5: RSRP minimum requirements are specified assuming independent interference and noise at each receiver antenna port.</p> <p>Note 6: The selection of the bands for testing depends on the configuration of the carrier aggregation supported by the UEs.</p> <p>Note 7: For Band 26, the tests shall be performed with the carrier frequency of the assigned E-UTRA channel bandwidth within 865-894 MHz.</p> <p>Note 8: Time alignment error (TAE) as specified in TS 36.104 [30] clause 6.5.3.1. The TAE value depends upon the type of carrier aggregation.</p> <p>Note 9: E-UTRA operating band groups are as defined in Section 3.5.</p> | | | | | | | | |

Table A.9.1.49.2-2: 5 Downlink PCell in TDD RSRP carrier aggregation test parameters for cell 6 and cell 7

| Parameter | Unit | Cell 6 | Cell 7 |
|--|-----------|---|----------------------------------|
| E-UTRA RF Channel Number | | 4 | |
| BW _{channel} | MHz | 5MHz: N _{RB,c} = 25 10MHz: N _{RB,c} = 50 20MHz: N _{RB,c} = 100 | |
| Measurement bandwidth | n_{PRB} | 5MHz: 10-15 10MHz: 22-27 20MHz: 47-52 | |
| PDSCH Reference measurement channel defined in A.3.1.1.1 | | 5MHz: R.5 FDD 10MHz: R.0 FDD 20MHz: R.4 FDD | - |
| PDSCH allocation | n_{PRB} | 5MHz: 7-17 10MHz: 13-36 20MHz: 38-61 | - |
| PDCCH/PCFICH/PHICH Reference measurement | | 5MHz: R.11 FDD 10MHz: R.6 FDD | 5MHz: R.11 FDD 10MHz: R.6 FDD |

| | | | | |
|--|---|-------------------------------|---|--|
| channel defined in A.3.1.2.1 | | | 20MHz: R.10 FDD | 20MHz: R.10 FDD |
| OCNG Patterns defined in A.3.2.1 | | | 5MHz: OP.15 FDD 10MHz: OP.1 FDD 20MHz: OP.11 FDD | 5MHz: OP.16 FDD 10MHz: OP.2 FDD 20MHz: OP.12 FDD |
| PBCH_RA | dB | 0 | 0 | 0 |
| PBCH_RB | | | | |
| PSS_RA | | | | |
| SSS_RA | | | | |
| PCFICH_RB | | | | |
| PHICH_RA | | | | |
| PHICH_RB | | | | |
| PDCCH_RA | | | | |
| PDCCH_RB | | | | |
| PDSCH_RA | | | | |
| PDSCH_RB | | | | |
| OCNG_RA ^{Note1} | | | | |
| OCNG_RB ^{Note1} | | | | |
| N_{oc} ^{Note2} | Bands FDD_A | dBm/ 15kHz | $(N_{oc}$ for Channel 1 +1dB) | |
| | Bands FDD_B | | | |
| | Bands FDD_C | | | |
| | Bands FDD_D | | | |
| | Bands FDD_E, FDD_F ^{Note 6} | | | |
| | Bands FDD_G Bands FDD_H | | | |
| \hat{E}_s / N_{oc} | dB | 3 | -1 | |
| \hat{E}_s / I_{ot} | dB | 0.46 | -5.76 | |
| RSRP ^{Note3} | Bands FDD_A | dBm/ 15kHz | (RSRP for Cell 1 +8dB) | (RSRP for Cell 1 +4dB) |
| | Bands FDD_B | | | |
| | Bands FDD_C | | | |
| | Bands FDD_D | | | |
| | Bands FDD_E, FDD_F ^{Note 6} | | | |
| | Bands FDD_G Bands FDD_H | | | |
| I_o ^{Note3} | Bands FDD_A | dBm/ BW _{channel} | $(I_o$ for Channel 1 +5.33dB +10log (N_{RB} channel3 / N_{RB} channel 1)) | |
| | Bands FDD_B | | | |
| | Bands FDD_C | | | |
| | Bands FDD_D | | | |
| | Bands FDD_E, FDD_F ^{Note 6} | | | |
| | Bands FDD_G Bands FDD_H | | | |
| Propagation Condition | | | AWGN | AWGN |
| Antenna Configuration | | | 1x2 | 1x2 |
| Timing offset to Cell 1 | | μ s | 0 | 3 |
| Time alignment error relative to cell 1 ^{Note 7} | | | \leq TAE | - |
| Time alignment error relative to cell 2 ^{Note 7} | | | \leq TAE | - |
| Time alignment error relative to cell 4 ^{Note 7} | | | \leq TAE | - |
| <p>Note 1: OCNG shall be used such that both cells are fully allocated and a constant total transmitted power spectral density is achieved for all OFDM symbols.</p> <p>Note 2: Interference from other cells and noise sources not specified in the test is assumed to be constant over subcarriers and time and shall be modelled as AWGN of appropriate power for N_{oc} to be fulfilled.</p> <p>Note 3: RSRP and I_o levels have been derived from other parameters for information purposes. They are not settable parameters themselves.</p> <p>Note 4: RSRP minimum requirements are specified assuming independent interference and noise at each receiver antenna port.</p> <p>Note 5: The selection of the bands for testing depends on the configuration of the carrier aggregation supported by the UEs.</p> | | | | |

| | |
|---------|---|
| Note 6: | For Band 26, the tests shall be performed with the carrier frequency of the assigned E-UTRA channel bandwidth within 865-894 MHz. |
| Note 7: | Time alignment error (TAE) as specified in TS 36.104 [30] clause 6.5.3.1. The TAE value depends upon the type of carrier aggregation. |
| Note 8: | E-UTRA operating band groups are as defined in Section 3.5. |

Table A.9.1.49.2-3: 5 Downlink PCell in TDD RSRP carrier aggregation test parameters for cell 8 and cell 9

| Parameter | Unit | Cell 8 | Cell 9 | |
|---|--------------------------------------|--|--|------------------------|
| E-UTRA RF Channel Number | | 5 | | |
| $BW_{channel}$ | MHz | 5MHz: $N_{RB,c} = 25$ 10MHz: $N_{RB,c} = 50$ 20MHz: $N_{RB,c} = 100$ | | |
| Measurement bandwidth | n_{PRB} | 5MHz: 10-15 10MHz: 22-27 20MHz: 47-52 | | |
| PDSCH Reference measurement channel defined in A.3.1.1.1 | | 5MHz: R.5 FDD 10MHz: R.0 FDD 20MHz: R.4 FDD | - | |
| PDSCH allocation | n_{PRB} | 5MHz: 7-17 10MHz: 13-36 20MHz: 38-61 | - | |
| PDCCH/PCFICH/PHICH Reference measurement channel defined in A.3.1.2.1 | | 5MHz: R.11 FDD 10MHz: R.6 FDD 20MHz: R.10 FDD | 5MHz: R.11 FDD 10MHz: R.6 FDD 20MHz: R.10 FDD | |
| OCNG Patterns defined in A.3.2.1 | | 5MHz: OP.15 FDD 10MHz: OP.1 FDD 20MHz: OP.11 FDD | 5MHz: OP.16 FDD 10MHz: OP.2 FDD 20MHz: OP.12 FDD | |
| PBCH_RA | dB | 0 | 0 | |
| PBCH_RB | | | | |
| PSS_RA | | | | |
| SSS_RA | | | | |
| PCFICH_RB | | | | |
| PHICH_RA | | | | |
| PHICH_RB | | | | |
| PDCCH_RA | | | | |
| PDCCH_RB | | | | |
| PDSCH_RA | | | | |
| PDSCH_RB | | | | |
| OCNG_RA ^{Note1} | | | | |
| OCNG_RB ^{Note1} | | | | |
| N_{oc} ^{Note2} | | | | Bands FDD_A |
| | Bands FDD_B | | | |
| | Bands FDD_C | | | |
| | Bands FDD_D | | | |
| | Bands FDD_E, FDD_F ^{Note 6} | | | |
| | Bands FDD_G | | | |
| | Bands FDD_H | | | |
| \hat{E}_s / N_{oc} | dB | 3 | -1 | |
| \hat{E}_s / I_{ot} | dB | 0.46 | -5.76 | |
| RSRP ^{Note3} | Bands FDD_A | dBm/ 15kHz | (RSRP for Cell 1 +8dB) | (RSRP for Cell 1 +4dB) |
| | Bands FDD_B | | | |
| | Bands FDD_C | | | |
| | Bands FDD_D | | | |
| | Bands FDD_E, FDD_F ^{Note 6} | | | |
| | Bands FDD_G | | | |
| | Bands FDD_H | | | |
| I_o ^{Note3} | dBm/ | (I _o for Channel 1 +5.33dB +10log | | |

| | | | | |
|---|---|-----------------------|---------------------------------|------|
| | Bands FDD_B | BW _{channel} | (NRB channel3 / NRB channel 1)) | |
| | Bands FDD_C | | | |
| | Bands FDD_D | | | |
| | Bands FDD_E, FDD_F ^{Note 6} | | | |
| | Bands FDD_G | | | |
| | Bands FDD_H | | | |
| Propagation Condition | | | AWGN | AWGN |
| Antenna Configuration | | | 1x2 | 1x2 |
| Timing offset to Cell 1 | | μs | 0 | 3 |
| Time alignment error relative to cell 1 ^{Note 7} | | | ≤ TAE | - |
| Time alignment error relative to cell 2 ^{Note 7} | | | ≤ TAE | - |
| Time alignment error relative to cell 4 ^{Note 7} | | | ≤ TAE | - |
| Time alignment error relative to cell 6 ^{Note 7} | | | ≤ TAE | - |
| Note 1: | OCNG shall be used such that both cells are fully allocated and a constant total transmitted power spectral density is achieved for all OFDM symbols. | | | |
| Note 2: | Interference from other cells and noise sources not specified in the test is assumed to be constant over subcarriers and time and shall be modelled | | | |
| | as AWGN of appropriate power for N_{oc} to be fulfilled. | | | |
| Note 3: | RSRP and I _o levels have been derived from other parameters for information purposes. They are not settable parameters themselves. | | | |
| Note 4: | RSRP minimum requirements are specified assuming independent interference and noise at each receiver antenna port. | | | |
| Note 5: | The selection of the bands for testing depends on the configuration of the carrier aggregation supported by the UEs. | | | |
| Note 6: | For Band 26, the tests shall be performed with the carrier frequency of the assigned E-UTRA channel bandwidth within 865-894 MHz. | | | |
| Note 7: | Time alignment error (TAE) as specified in TS 36.104 [30] clause 6.5.3.1. The TAE value depends upon the type of carrier aggregation. | | | |
| Note 8: | E-UTRA operating band groups are as defined in Section 3.5. | | | |

A.9.1.49.3 Test Requirements

In the test, the performance of RSRP measurements is verified from the following 13 perspectives:

- The absolute accuracy of intra-frequency RSRP measurements for Cell 1 on the primary component carrier shall fulfil the requirements defined in clause 9.1.11.1.
- The absolute accuracy of intra-frequency RSRP measurements for Cell 2 on SCC1 shall fulfil the requirements defined in clause 9.1.11.2.
- The absolute accuracy of intra-frequency RSRP measurements for Cell 4 on SCC2 shall fulfil the requirements defined in clause 9.1.11.2.
- The absolute accuracy of intra-frequency RSRP measurements for Cell 6 on SCC3 shall fulfil the requirements defined in clause 9.1.11.2.
- The absolute accuracy of intra-frequency RSRP measurements for Cell 8 on SCC4 shall fulfil the requirements defined in clause 9.1.11.2.
- The relative accuracy of intra-frequency RSRP measurements for Cell 3 relative to Cell 2 on SCC1 shall fulfil the requirements defined in clause 9.1.11.2.
- The relative accuracy of intra-frequency RSRP measurements for Cell 5 relative to Cell 4 on SCC2 shall fulfil the requirements defined in clause 9.1.11.2.
- The relative accuracy of intra-frequency RSRP measurements for Cell 7 relative to Cell 6 on SCC3 shall fulfil the requirements defined in clause 9.1.11.2.

- The relative accuracy of intra-frequency RSRP measurements for Cell 9 relative to Cell 8 on SCC3 shall fulfil the requirements defined in clause 9.1.11.2.
- The relative accuracy of inter-frequency RSRP measurements between SCC1 and the primary component carriers for Cell 2 relative to Cell 1 shall fulfil the requirements defined in clause 9.1.11.3.
- The relative accuracy of inter-frequency RSRP measurements between SCC2 and the primary component carriers for Cell 4 relative to Cell 1 shall fulfil the requirements defined in clause 9.1.11.3.
- The relative accuracy of inter-frequency RSRP measurements between SCC3 and the primary component carriers for Cell 6 relative to Cell 1 shall fulfil the requirements defined in clause 9.1.11.3.
- The relative accuracy of inter-frequency RSRP measurements between SCC4 and the primary component carriers for Cell 8 relative to Cell 1 shall fulfil the requirements defined in clause 9.1.11.3.

A.9.1.50 5 DL FDD RSRP for E-UTRAN in Carrier Aggregation

A.9.1.50.1 Test Purpose and Environment

The purpose of this test is to verify that the FDD-FDD RSRP absolute and relative accuracy requirements in carrier aggregation with PCell in FDD are within the specified limits. This test will verify the absolute RSRP accuracy requirements of the primary component carrier defined in clause 9.1.11.1, the absolute RSRP accuracy requirements of the secondary component carriers defined in clause 9.1.11.2, and the relative RSRP accuracy requirements of the secondary component carriers defined in clause 9.1.11.2. The test will also verify the primary and secondary component carriers' relative RSRP accuracy requirement defined in Clause 9.1.11.3.

A.9.1.50.2 Test parameters

In this set of cases cell 1 is PCell on the primary component carrier, and cell 2, cell 4, cell6 and cell8 are activated SCells on secondary component carriers SCC1, SCC2, SCC3 and SCC4 respectively. Cell 3, cell 5, cell7 and cell9 are neighbouring cells on secondary component carriers SCC1, SCC2, SCC3 and SCC4 respectively. The test parameters are given in Table A.9.1.50.2-1.

Table A.9.1.50.2-1: 5 DL FDD RSRP test parameters for E-UTRAN Carrier aggregation (cell #1, cell #2 and cell #3)

| Parameter | Unit | Cell 1 | Cell 2 | Cell 3 |
|---|-----------|--|--|--|
| E-UTRA RF Channel Number | | 1 | 2 | |
| $BW_{channel}$ | MHz | 5MHz: $N_{RB,c} = 25$ 10MHz: $N_{RB,c} = 50$ 20MHz: $N_{RB,c} = 100$ | 5MHz: $N_{RB,c} = 25$ 10MHz: $N_{RB,c} = 50$ 20MHz: $N_{RB,c} = 100$ | |
| Measurement bandwidth | n_{PRB} | 5MHz: 10-15 10MHz: 22-27 20MHz: 47-52 | 5MHz: 10-15 10MHz: 22-27 20MHz: 47-52 | |
| PDSCH Reference measurement channel defined in A.3.1.1.1 | | 5MHz: R.5 FDD 10MHz: R.0 FDD 20MHz: R.4 FDD | 5MHz: R.5 FDD 10MHz: R.0 FDD 20MHz: R.4 FDD | - |
| PDSCH allocation | n_{PRB} | 5MHz: 7-17 10MHz: 13-36 20MHz: 38-61 | 5MHz: 7-17 10MHz: 13-36 20MHz: 38-61 | - |
| PDCCH/PCFICH/PHICH Reference measurement channel defined in A.3.1.2.1 | | 5MHz: R.11 FDD 10MHz: R.6 FDD 20MHz: R.10 FDD | 5MHz: R.11 FDD 10MHz: R.6 FDD 20MHz: R.10 FDD | 5MHz: R.11 FDD 10MHz: R.6 FDD 20MHz: R.10 FDD |
| OCNG Patterns defined in A.3.2.1 | | 5MHz: OP.15 FDD 10MHz: OP.1 FDD 20MHz: OP.11 FDD | 5MHz: OP.15 FDD 10MHz: OP.1 FDD 20MHz: OP.11 FDD | 5MHz: OP.16 FDD 10MHz: OP.2 FDD 20MHz: OP.12 FDD |
| PBCH_RA | dB | 0 | 0 | 0 |
| PBCH_RB | | | | |
| PSS_RA | | | | |
| SSS_RA | | | | |
| PCFICH_RB | | | | |
| PHICH_RA | | | | |

| | | | | | |
|--|---|------------------------|----------------------------------|--|---------------------------|
| PHICH_RB | | | | | |
| PDCCH_RA | | | | | |
| PDCCH_RB | | | | | |
| PDSCH_RA | | | | | |
| PDSCH_RB | | | | | |
| OCNG_RA ^{Note1} | | | | | |
| OCNG_RB ^{Note1} | | | | | |
| N_{oc} ^{Note2} | Bands FDD_A | dBm/ 15kHz | -117 | $(N_{oc}$ for Channel 1 +1dB) | |
| | Bands FDD_B | | -116.5 | | |
| | Bands FDD_C | | -116 | | |
| | Bands FDD_D | | -115.5 | | |
| | Bands FDD_E, FDD_F ^{Note 6} | | -115 | | |
| | Bands FDD_G | | -114 | | |
| | Bands FDD_H | | -113.5 | | |
| \hat{E}_s / N_{oc} | | dB | -4 | 3 | -1 |
| \hat{E}_s / I_{ot} | | dB | -4 | 0.46 | -5.76 |
| RSRP ^{Note3} | Bands FDD_A | dBm/ 15kHz | -121 | (RSRP for Cell 1 +8dB) | (RSRP for Cell 1 +4dB) |
| | Bands FDD_B | | -120.5 | | |
| | Bands FDD_C | | -120 | | |
| | Bands FDD_D | | -119.5 | | |
| | Bands FDD_E, FDD_F ^{Note 6} | | -119 | | |
| | Bands FDD_G | | -118 | | |
| | Bands FDD_H | | -117.5 | | |
| I_o ^{Note3} | Bands FDD_A | dBm/ $BW_{channel}$ | -87.76 $+10\log(N_{RB,c}/50)$ | $(I_o$ for Channel 1 +5.33dB +10log ($N_{RB channel2} / N_{RB channel 1}$)) | |
| | Bands FDD_B | | -87.26 $+10\log(N_{RB,c}/50)$ | | |
| | Bands FDD_C | | -86.76 $+10\log(N_{RB,c}/50)$ | | |
| | Bands FDD_D | | -86.26 $+10\log(N_{RB,c}/50)$ | | |
| | Bands FDD_E, FDD_F ^{Note 6} | | -85.76 $+10\log(N_{RB,c}/50)$ | | |
| | Bands FDD_G | | -84.76 $+10\log(N_{RB,c}/50)$ | | |
| | Bands FDD_H | | -84.26 $+10\log(N_{RB,c}/50)$ | | |
| Propagation Condition | | | AWGN | AWGN | AWGN |
| Antenna Configuration | | | 1x2 | 1x2 | 1x2 |
| Timing offset to Cell 1 | | μ s | - | 0 | 3 |
| Time alignment error relative to cell 1 ^{Note 7} | | | - | \leq TAE | - |
| Time alignment error relative to cell 2 ^{Note 7} | | | - | - | - |
| Time alignment error relative to cell 4 ^{Note 7} | | | - | - | - |
| Time alignment error relative to cell 6 ^{Note 7} | | | - | - | - |
| <p>Note 1: OCNG shall be used such that both cells are fully allocated and a constant total transmitted power spectral density is achieved for all OFDM symbols.</p> <p>Note 2: Interference from other cells and noise sources not specified in the test is assumed to be constant over subcarriers and time and shall be modelled as AWGN of appropriate power for N_{oc} to be fulfilled.</p> <p>Note 3: RSRP and I_o levels have been derived from other parameters for information purposes. They are not settable parameters themselves.</p> <p>Note 4: RSRP minimum requirements are specified assuming independent interference and noise at each receiver antenna port.</p> <p>Note 5: The selection of the bands for testing depends on the configuration of the carrier aggregation supported by the UEs.</p> <p>Note 6: For Band 26, the tests shall be performed with the carrier frequency of the assigned E-UTRA channel bandwidth within 865-894 MHz.</p> <p>Note 7: Time alignment error (TAE) as specified in TS 36.104 [30] clause 6.5.3.1. The TAE value depends</p> | | | | | |

upon the type of carrier aggregation.
 Note 8: E-UTRA operating band groups are as defined in Section 3.5.

Table A.9.1.50.2-2: 5 DL FDD RSRP test parameters for E-UTRAN Carrier aggregation (cell #4 – cell #9)

| Parameter | Unit | Cell 4 | Cell 5 | Cell 6 | Cell 7 | Cell 8 | Cell 9 |
|---|--------------------------------------|---|--|---|--|---|--|
| E-UTRA RF Channel Number | | 3 | | 4 | | 5 | |
| BW _{channel} | MHz | 5MHz: N _{RB,c} = 25 10MHz: N _{RB,c} = 50 20MHz: N _{RB,c} = 100 | | 5MHz: N _{RB,c} = 25 10MHz: N _{RB,c} = 50 20MHz: N _{RB,c} = 100 | | 5MHz: N _{RB,c} = 25 10MHz: N _{RB,c} = 50 20MHz: N _{RB,c} = 100 | |
| Measurement bandwidth | n _{PRB} | 5MHz: 10-15 10MHz: 22-27 20MHz: 47-52 | | 5MHz: 10-15 10MHz: 22-27 20MHz: 47-52 | | 5MHz: 10-15 10MHz: 22-27 20MHz: 47-52 | |
| PDSCH Reference measurement channel defined in A.3.1.1.1 | | 5MHz: R.5 FDD 10MHz: R.0 FDD 20MHz: R.4 FDD | - | 5MHz: R.5 FDD 10MHz: R.0 FDD 20MHz: R.4 FDD | - | 5MHz: R.5 FDD 10MHz: R.0 FDD 20MHz: R.4 FDD | - |
| PDSCH allocation | n _{PRB} | 5MHz: 7-17 10MHz: 13-36 20MHz: 38-61 | - | 5MHz: 7-17 10MHz: 13-36 20MHz: 38-61 | - | 5MHz: 7-17 10MHz: 13-36 20MHz: 38-61 | - |
| PDCCH/PCFICH/PHICH Reference measurement channel defined in A.3.1.2.1 | | 5MHz: R.11 FDD 10MHz: R.6 FDD 20MHz: R.10 FDD | 5MHz: R.11 FDD 10MHz: R.6 FDD 20MHz: R.10 FDD | 5MHz: R.11 FDD 10MHz: R.6 FDD 20MHz: R.10 FDD | 5MHz: R.11 FDD 10MHz: R.6 FDD 20MHz: R.10 FDD | 5MHz: R.11 FDD 10MHz: R.6 FDD 20MHz: R.10 FDD | 5MHz: R.11 FDD 10MHz: R.6 FDD 20MHz: R.10 FDD |
| OCNG Patterns defined in A.3.2.1 | | 5MHz: OP.15 FDD 10MHz: OP.1 FDD 20MHz: OP.11 FDD | 5MHz: OP.16 FDD 10MHz: OP.2 FDD 20MHz: OP.12 FDD | 5MHz: OP.15 FDD 10MHz: OP.1 FDD 20MHz: OP.11 FDD | 5MHz: OP.16 FDD 10MHz: OP.2 FDD 20MHz: OP.12 FDD | 5MHz: OP.15 FDD 10MHz: OP.1 FDD 20MHz: OP.11 FDD | 5MHz: OP.16 FDD 10MHz: OP.2 FDD 20MHz: OP.12 FDD |
| PBCH_RA | dB | 0 | 0 | 0 | 0 | 0 | 0 |
| PBCH_RB | | | | | | | |
| PSS_RA | | | | | | | |
| SSS_RA | | | | | | | |
| PCFICH_RB | | | | | | | |
| PHICH_RA | | | | | | | |
| PHICH_RB | | | | | | | |
| PDCCH_RA | | | | | | | |
| PDCCH_RB | | | | | | | |
| PDSCH_RA | | | | | | | |
| PDSCH_RB | | | | | | | |
| OCNG_RA ^{Note1} | | | | | | | |
| OCNG_RB ^{Note1} | | | | | | | |
| N _{oc} ^{Note2} | | | | | | | |
| | Bands FDD_B | | | | | | |
| | Bands FDD_C | | | | | | |
| | Bands FDD_D | | | | | | |
| | Bands FDD_E, FDD_F ^{Note 6} | | | | | | |

| | | | | | | | | |
|--|--|-------------------------------|---|---|---|---|---|---|
| | Bands FDD_G | | | | | | | |
| | Bands FDD_H | | | | | | | |
| \hat{E}_s / N_{oc} | | dB | 3 | -1 | 3 | -1 | 3 | -1 |
| \hat{E}_s / I_{ot} | | dB | 0.46 | -5.76 | 0.46 | -5.76 | 0.46 | -5.76 |
| RSRP ^{Note3} | Bands FDD_A | dBm/ 15kHz | (RSRP for Cell 1 +8dB) | (RSRP for Cell 1 +4dB) | (RSRP for Cell 1 +8dB) | (RSRP for Cell 1 +4dB) | (RSRP for Cell 1 +8dB) | (RSRP for Cell 1 +4dB) |
| | Bands FDD_B | | | | | | | |
| | Bands FDD_C | | | | | | | |
| | Bands FDD_D | | | | | | | |
| | Bands FDD_E, FDD_F ^{Note 6} | | | | | | | |
| | Bands FDD_G | | | | | | | |
| | Bands FDD_H | | | | | | | |
| I _o ^{Note3} | Bands FDD_A | dBm/ BW _{channel} | (I _o for Channel 1 +5.33dB +10log (N _{RB channel3} / N _{RB channel 1})) | (I _o for Channel 1 +5.33dB +10log (N _{RB channel4} / N _{RB channel 1})) | (I _o for Channel 1 +5.33dB +10log (N _{RB channel5} / N _{RB channel 1})) | (I _o for Channel 1 +5.33dB +10log (N _{RB channel5} / N _{RB channel 1})) | (I _o for Channel 1 +5.33dB +10log (N _{RB channel5} / N _{RB channel 1})) | (I _o for Channel 1 +5.33dB +10log (N _{RB channel5} / N _{RB channel 1})) |
| | Bands FDD_B | | | | | | | |
| | Bands FDD_C | | | | | | | |
| | Bands FDD_D | | | | | | | |
| | Bands FDD_E, FDD_F ^{Note 6} | | | | | | | |
| | Bands FDD_G | | | | | | | |
| | Bands FDD_H | | | | | | | |
| Propagation Condition | | | AWGN | AWGN | AWGN | AWGN | AWGN | AWGN |
| Antenna Configuration | | | 1x2 | 1x2 | 1x2 | 1x2 | 1x2 | 1x2 |
| Timing offset to Cell 1 | | μs | 0 | 3 | 0 | 3 | 0 | 3 |
| Time alignment error relative to cell 1 ^{Note 7} | | | ≤ TAE | - | ≤ TAE | - | ≤ TAE | - |
| Time alignment error relative to cell 2 ^{Note 7} | | | ≤ TAE | - | ≤ TAE | - | ≤ TAE | - |
| Time alignment error relative to cell 4 ^{Note 7} | | | - | - | ≤ TAE | - | ≤ TAE | - |
| Time alignment error relative to cell 6 ^{Note 7} | | | - | - | - | - | ≤ TAE | - |
| <p>Note 1: OCNG shall be used such that both cells are fully allocated and a constant total transmitted power spectral density is achieved for all OFDM symbols.</p> <p>Note 2: Interference from other cells and noise sources not specified in the test is assumed to be constant over subcarriers and time and shall be modelled as AWGN of appropriate power for N_{oc} to be fulfilled.</p> <p>Note 3: RSRP and I_o levels have been derived from other parameters for information purposes. They are not settable parameters themselves.</p> <p>Note 4: RSRP minimum requirements are specified assuming independent interference and noise at each receiver antenna port.</p> <p>Note 5: The selection of the bands for testing depends on the configuration of the carrier aggregation supported by the UEs.</p> <p>Note 6: For Band 26, the tests shall be performed with the carrier frequency of the assigned E-UTRA channel bandwidth within 865-894 MHz.</p> <p>Note 7: Time alignment error (TAE) as specified in TS 36.104 [30] clause 6.5.3.1. The TAE value depends upon the type of carrier aggregation.</p> <p>Note 8: E-UTRA operating band groups are as defined in Section 3.5.</p> | | | | | | | | |

A.9.1.50.3 Test Requirements

In the test, the performance of RSRP measurements is verified from following perspectives:

- The absolute accuracy of intra-frequency RSRP measurements for Cell 1 on the primary component carrier shall fulfil the requirements defined in clause 9.1.11.1.
- The absolute accuracy of intra-frequency RSRP measurements for Cell 2 on SCC1 shall fulfil the requirements defined in clause 9.1.11.2.
- The absolute accuracy of intra-frequency RSRP measurements for Cell 4 on SCC2 shall fulfil the requirements defined in clause 9.1.11.2.
- The absolute accuracy of intra-frequency RSRP measurements for Cell 6 on SCC3 shall fulfil the requirements defined in clause 9.1.11.2.
- The absolute accuracy of intra-frequency RSRP measurements for Cell 8 on SCC4 shall fulfil the requirements defined in clause 9.1.11.2.
- The relative accuracy of intra-frequency RSRP measurements for Cell 3 relative to Cell 2 on SCC1 shall fulfil the requirements defined in clause 9.1.11.2.
- The relative accuracy of intra-frequency RSRP measurements for Cell 5 relative to Cell 4 on SCC2 shall fulfil the requirements defined in clause 9.1.11.2.
- The relative accuracy of intra-frequency RSRP measurements for Cell 7 relative to Cell 6 on SCC3 shall fulfil the requirements defined in clause 9.1.11.2.
- The relative accuracy of intra-frequency RSRP measurements for Cell 9 relative to Cell 8 on SCC4 shall fulfil the requirements defined in clause 9.1.11.2.
- The relative accuracy of inter-frequency RSRP measurements between SCC1 and the primary component carriers for Cell 2 relative to Cell 1 shall fulfil the requirements defined in clause 9.1.11.3.
- The relative accuracy of inter-frequency RSRP measurements between SCC2 and the primary component carriers for Cell 4 relative to Cell 1 shall fulfil the requirements defined in clause 9.1.11.3.
- The relative accuracy of inter-frequency RSRP measurements between SCC3 and the primary component carriers for Cell 6 relative to Cell 1 shall fulfil the requirements defined in clause 9.1.11.3.
- The relative accuracy of inter-frequency RSRP measurements between SCC4 and the primary component carriers for Cell 8 relative to Cell 1 shall fulfil the requirements defined in clause 9.1.11.3.

A.9.1.51 5 DL TDD RSRP for E-UTRAN in Carrier Aggregation

A.9.1.51.1 Test Purpose and Environment

The purpose of this test is to verify that the TDD RSRP absolute and relative accuracy requirements in carrier aggregation with PCell in TDD are within the specified limits. This test will verify the absolute RSRP accuracy requirements of the primary component carrier defined in clause 9.1.11.1, the absolute RSRP accuracy requirements of the secondary component carriers defined in clause 9.1.11.2, and the relative RSRP accuracy requirements of the secondary component carriers defined in clause 9.1.11.2. The test will also verify the primary and secondary component carriers' relative RSRP accuracy requirement defined in Clause 9.1.11.3.

A.9.1.51.2 Test parameters

In this set of cases cell 1 is PCell on the primary component carrier, and cell 2, cell 4, cell6 and cell8 are activated SCells on secondary component carriers SCC1, SCC2, SCC3 and SCC4 respectively. Cell 3, cell 5, cell7 and cell9 are neighbouring cells on secondary component carriers SCC1, SCC2, SCC3 and SCC4 respectively. The test parameters are given in Table A.9.1.51.2-1.

Table A.9.1.51.2-1: 5 DL TDD RSRP test parameters for E-UTRAN Carrier aggregation (cell #1, cell #2 and cell #3)

| Parameter | | Unit | Cell 1 | Cell 2 | Cell 3 |
|---|-------------|-------------------------------|---|---|---|
| E-UTRA RF Channel Number | | | 1 | 2 | |
| BW _{channel} | | | 5MHz: N _{RB,c} = 25 10MHz: N _{RB,c} = 50 20MHz: N _{RB,c} = 100 | 5MHz: N _{RB,c} = 25 10MHz: N _{RB,c} = 50 20MHz: N _{RB,c} = 100 | |
| Special subframe configuration ^{Note1} | | | 6 | | |
| Uplink/downlink configuration ^{Note1} | | | 1 | | |
| Measurement bandwidth | | <i>n</i> _{PRB} | 5MHz: 10-15 10MHz: 22-27 20MHz: 47-52 | 5MHz: 10-15 10MHz: 22-27 20MHz: 47-52 | |
| PDSCH Reference measurement channel defined in A.3.1.1.2 | | | 5MHz: R.4 TDD 10MHz: R.0 TDD 20MHz: R.3 TDD | 5MHz: R.4 TDD 10MHz: R.0 TDD 20MHz: R.3 TDD | - |
| PDSCH allocation | | <i>n</i> _{PRB} | 5MHz: 7-17 10MHz: 13-36 20MHz: 38-61 | 5MHz: 7-17 10MHz: 13-36 20MHz: 38-61 | - |
| PDCCH/PCFICH/PHICH Reference measurement channel defined in A.3.1.2.2 | | | 5MHz: R.11 TDD 10MHz: R.6 TDD 20MHz: R.10 TDD | 5MHz: R.11 TDD 10MHz: R.6 TDD 20MHz: R.10 TDD | 5MHz: R.11 TDD 10MHz: R.6 TDD 20MHz: R.10 TDD |
| OCNG Patterns defined in A.3.2.2 | | | 5MHz: OP.9 TDD 10MHz: OP.1 TDD 20MHz: OP.7 TDD | 5MHz: OP.9 TDD 10MHz: OP.1 TDD 20MHz: OP.7 TDD | 5MHz: OP.10 TDD 10MHz: OP.2 TDD 20MHz: OP.8 TDD |
| PBCH_RA | | dB | 0 | 0 | 0 |
| PBCH_RB | | | | | |
| PSS_RA | | | | | |
| SSS_RA | | | | | |
| PCFICH_RB | | | | | |
| PHICH_RA | | | | | |
| PHICH_RB | | | | | |
| PDCCH_RA | | | | | |
| PDCCH_RB | | | | | |
| PDSCH_RA | | | | | |
| PDSCH_RB | | | | | |
| OCNG_RA ^{Note2} | | | | | |
| OCNG_RB ^{Note2} | | | | | |
| <i>N</i> _{oc} ^{Note3} | Bands TDD_A | | | | |
| | Bands TDD_C | -116 | | | |
| | Bands TDD_E | -115 | | | |
| \hat{E}_s / N_{oc} | | dB | -4 | 3 | -1 |
| \hat{E}_s / I_{ot} | | dB | -4 | 0.46 | -5.76 |
| RSRP ^{Note4} | Bands TDD_A | dBm/ 15kHz | -121 | (RSRP for Cell 1 +8dB) | (RSRP for Cell 1 +4dB) |
| | Bands TDD_C | | -120 | | |
| | Bands TDD_E | | -119 | | |
| <i>I</i> _o ^{Note4} | Bands TDD_A | dBm/ BW _{channel} | -87.76 + 10log(N _{RB,c} /50) | (I _o for Channel 1 +5.33dB +10log (N _{RB channel2} / N _{RB channel 1})) | |
| | Bands TDD_C | | -86.76 + 10log(N _{RB,c} /50) | | |
| | Bands TDD_E | | -85.76 + 10log(N _{RB,c} /50) | | |
| Propagation Condition | | | AWGN | AWGN | AWGN |
| Antenna Configuration | | | 1x2 | 1x2 | 1x2 |
| Timing offset to Cell 1 | | μs | - | 0 | 3 |
| Time alignment error relative to cell 1 ^{Note 7} | | | - | ≤ TAE | - |
| <p>Note 1: For special subframe and uplink-downlink configurations see Tables 4.2-1 and 4.2-2 in TS 36.211.</p> <p>Note 2: OCNG shall be used such that both cells are fully allocated and a constant total transmitted power spectral density is achieved for all OFDM symbols.</p> <p>Note 3: Interference from other cells and noise sources not specified in the test is assumed to be constant</p> | | | | | |

over subcarriers and time and shall be modelled as AWGN of appropriate power for N_{oc} to be fulfilled.

Note 4: RSRP and I_o levels have been derived from other parameters for information purposes. They are not settable parameters themselves.

Note 5: RSRP minimum requirements are specified assuming independent interference and noise at each receiver antenna port.

Note 6: The selection of the bands for testing depends on the configuration of the carrier aggregation supported by the UEs.

Note 7: Time alignment error (TAE) as specified in TS 36.104 [30] clause 6.5.3.1. The TAE value depends upon the type of carrier aggregation.

Note 8: E-UTRA operating band groups are as defined in Section 3.5.

Table A.9.1.51.2-2: 5 DL TDD RSRP test parameters for E-UTRAN Carrier aggregation (cell #4 – cell #9)

| Parameter | Unit | Cell 4 | Cell 5 | Cell 6 | Cell 7 | Cell 8 | Cell 9 |
|---|-----------|---|---|---|---|---|---|
| E-UTRA RF Channel Number | | 3 | | 4 | | 5 | |
| BW _{channel} | MHz | 5MHz: N _{RB,c} = 25 10MHz: N _{RB,c} = 50 20MHz: N _{RB,c} = 100 | - | 5MHz: N _{RB,c} = 25 10MHz: N _{RB,c} = 50 20MHz: N _{RB,c} = 100 | - | 5MHz: N _{RB,c} = 25 10MHz: N _{RB,c} = 50 20MHz: N _{RB,c} = 100 | - |
| Special subframe configuration ^{Note1} | | 6 | | | | | |
| Uplink/downlink configuration ^{Note1} | | 1 | | | | | |
| Measurement bandwidth | n_{PRB} | 5MHz: 10-15 10MHz: 22-27 20MHz: 47-52 | - | 5MHz: 10-15 10MHz: 22-27 20MHz: 47-52 | - | 5MHz: 10-15 10MHz: 22-27 20MHz: 47-52 | - |
| PDSCH Reference measurement channel defined in A.3.1.1.2 | | 5MHz: R.4 TDD 10MHz: R.0 TDD 20MHz: R.3 TDD | - | 5MHz: R.4 TDD 10MHz: R.0 TDD 20MHz: R.3 TDD | - | 5MHz: R.4 TDD 10MHz: R.0 TDD 20MHz: R.3 TDD | - |
| PDSCH allocation | n_{PRB} | 5MHz: 7-17 10MHz: 13-36 20MHz: 38-61 | - | 5MHz: 7-17 10MHz: 13-36 20MHz: 38-61 | - | 5MHz: 7-17 10MHz: 13-36 20MHz: 38-61 | - |
| PDCCH/PCFICH/PHICH Reference measurement channel defined in A.3.1.2.2 | | 5MHz: R.11 TDD 10MHz: R.6 TDD 20MHz: R.10 TDD | 5MHz: R.11 TDD 10MHz: R.6 TDD 20MHz: R.10 TDD | 5MHz: R.11 TDD 10MHz: R.6 TDD 20MHz: R.10 TDD | 5MHz: R.11 TDD 10MHz: R.6 TDD 20MHz: R.10 TDD | 5MHz: R.11 TDD 10MHz: R.6 TDD 20MHz: R.10 TDD | 5MHz: R.11 TDD 10MHz: R.6 TDD 20MHz: R.10 TDD |
| OCNG Patterns defined in A.3.2.2 | | 5MHz: OP.9 TDD 10MHz: OP.1 TDD 20MHz: OP.7 TDD | 5MHz: OP.10 TDD 10MHz: OP.2 TDD 20MHz: OP.8 TDD | 5MHz: OP.9 TDD 10MHz: OP.1 TDD 20MHz: OP.7 TDD | 5MHz: OP.10 TDD 10MHz: OP.2 TDD 20MHz: OP.8 TDD | 5MHz: OP.9 TDD 10MHz: OP.1 TDD 20MHz: OP.7 TDD | 5MHz: OP.10 TDD 10MHz: OP.2 TDD 20MHz: OP.8 TDD |
| PBCH_RA | dB | 0 | 0 | 0 | 0 | 0 | 0 |
| PBCH_RB | | | | | | | |
| PSS_RA | | | | | | | |
| SSS_RA | | | | | | | |
| PCFICH_RB | | | | | | | |
| PHICH_RA | | | | | | | |
| PHICH_RB | | | | | | | |
| PDCCH_RA | | | | | | | |
| PDCCH_RB | | | | | | | |
| PDSCH_RA | | | | | | | |

| | | | | | | | | |
|---|-------------|-------------------------------|---|------------------------------|---|------------------------------|---|------------------------------|
| PDSCH_RB | | | | | | | | |
| OCNG_RA ^{Note2} | | | | | | | | |
| OCNG_RB ^{Note2} | | | | | | | | |
| N_{oc} ^{Note3} | Bands TDD_A | dBm/ 15kHz | $(N_{oc}$ for Channel 1 +1dB) | | $(N_{oc}$ for Channel 1 +1dB) | | $(N_{oc}$ for Channel 1 +1dB) | |
| | Bands TDD_C | | | | | | | |
| | Bands TDD_E | | | | | | | |
| \hat{E}_s / N_{oc} | | dB | 3 | -1 | 3 | -1 | 3 | -1 |
| \hat{E}_s / I_{ot} | | dB | 0.46 | -5.76 | 0.46 | -5.76 | 0.46 | -5.76 |
| RSRP ^{Note4} | Bands TDD_A | dBm/ 15kHz | (RSRP1 +8dB for Cell) | (RSRP for Cell 1 +4dB) | (RSRP for Cell 1 +8dB) | (RSRP for Cell 1 +4dB) | (RSRP for Cell 1 +8dB) | (RSRP for Cell 1 +4dB) |
| | Bands TDD_C | | | | | | | |
| | Bands TDD_E | | | | | | | |
| I_o ^{Note4} | Bands TDD_A | dBm/ BW _{channel} | (I _o for Channel 1 +5.33dB +10log (N _{RB channel3} / N _{RB channel 1})) | | (I _o for Channel 1 +5.33dB +10log (N _{RB channel4} / N _{RB channel 1})) | | (I _o for Channel 1 +5.33dB +10log (N _{RB channel5} / N _{RB channel 1})) | |
| | Bands TDD_C | | | | | | | |
| | Bands TDD_E | | | | | | | |
| Propagation Condition | | | AWGN | AWGN | AWGN | AWGN | AWGN | AWGN |
| Antenna Configuration | | | 1x2 | 1x2 | 1x2 | 1x2 | 1x2 | 1x2 |
| Timing offset to Cell 1 | | μs | 0 | 3 | 0 | 3 | 0 | 3 |
| Time alignment error relative to cell 1 ^{Note 7} | | | ≤ TAE | - | ≤ TAE | - | ≤ TAE | - |
| Time alignment error relative to cell 2 ^{Note 7} | | | ≤ TAE | - | ≤ TAE | - | ≤ TAE | - |
| Time alignment error relative to cell 4 ^{Note 7} | | | - | - | ≤ TAE | - | ≤ TAE | - |
| Time alignment error relative to cell 6 ^{Note 7} | | | - | - | - | - | ≤ TAE | - |
| <p>Note 1: For special subframe and uplink-downlink configurations see Tables 4.2-1 and 4.2-2 in TS 36.211.</p> <p>Note 2: OCNG shall be used such that both cells are fully allocated and a constant total transmitted power spectral density is achieved for all OFDM symbols.</p> <p>Note 3: Interference from other cells and noise sources not specified in the test is assumed to be constant over subcarriers and time and shall be modelled as AWGN of appropriate power for N_{oc} to be fulfilled.</p> <p>Note 4: RSRP and I_o levels have been derived from other parameters for information purposes. They are not settable parameters themselves.</p> <p>Note 5: RSRP minimum requirements are specified assuming independent interference and noise at each receiver antenna port.</p> <p>Note 6: The selection of the bands for testing depends on the configuration of the carrier aggregation supported by the UEs.</p> <p>Note 7: Time alignment error (TAE) as specified in TS 36.104 [30] clause 6.5.3.1. The TAE value depends upon the type of carrier aggregation.</p> <p>Note 8: E-UTRA operating band groups are as defined in Section 3.5.</p> | | | | | | | | |

A.9.1.51.3 Test Requirements

In the test, the performance of RSRP measurements is verified from following perspectives:

- The absolute accuracy of intra-frequency RSRP measurements for Cell 1 on the primary component carrier shall fulfil the requirements defined in clause 9.1.11.1.
- The absolute accuracy of intra-frequency RSRP measurements for Cell 2 on SCC1 shall fulfil the requirements defined in clause 9.1.11.2.
- The absolute accuracy of intra-frequency RSRP measurements for Cell 4 on SCC2 shall fulfil the requirements defined in clause 9.1.11.2.

- The absolute accuracy of intra-frequency RSRP measurements for Cell 6 on SCC3 shall fulfil the requirements defined in clause 9.1.11.2.
- The absolute accuracy of intra-frequency RSRP measurements for Cell 8 on SCC4 shall fulfil the requirements defined in clause 9.1.11.2.
- The relative accuracy of intra-frequency RSRP measurements for Cell 3 relative to Cell 2 on SCC1 shall fulfil the requirements defined in clause 9.1.11.2.
- The relative accuracy of intra-frequency RSRP measurements for Cell 5 relative to Cell 4 on SCC2 shall fulfil the requirements defined in clause 9.1.11.2.
- The relative accuracy of intra-frequency RSRP measurements for Cell 7 relative to Cell 6 on SCC3 shall fulfil the requirements defined in clause 9.1.11.2.
- The relative accuracy of intra-frequency RSRP measurements for Cell 9 relative to Cell 8 on SCC4 shall fulfil the requirements defined in clause 9.1.11.2.
- The relative accuracy of inter-frequency RSRP measurements between SCC1 and the primary component carriers for Cell 2 relative to Cell 1 shall fulfil the requirements defined in clause 9.1.11.3.
- The relative accuracy of inter-frequency RSRP measurements between SCC2 and the primary component carriers for Cell 4 relative to Cell 1 shall fulfil the requirements defined in clause 9.1.11.3.
- The relative accuracy of inter-frequency RSRP measurements between SCC3 and the primary component carriers for Cell 6 relative to Cell 1 shall fulfil the requirements defined in clause 9.1.11.3.
- The relative accuracy of inter-frequency RSRP measurements between SCC4 and the primary component carriers for Cell 8 relative to Cell 1 shall fulfil the requirements defined in clause 9.1.11.3.

A.9.1.52 FD-FDD RSRP Intra frequency case for Cat-M1 UE in CEModeA

A.9.1.52.1 Test Purpose and Environment

The purpose of this test is to verify that the RSRP measurement accuracy is within the specified limits. This test will verify the requirements in Sections 9.1.21.1 and 9.1.21.2 for FD-FDD intra frequency RSRP measurements for Cat-M1 UE in CEModeA.

A.9.1.52.2 Test parameters

In this set of test cases all cells are on the same carrier frequency. Both absolute and relative accuracy of RSRP intra frequency measurements are tested by using the parameters in Table A.9.1.52.2-1. In all test cases, Cell 1 is the PCell and Cell 2 the target cell.

Table A.9.1.52.2-1: FD-FDD RSRP Intra frequency test parameters for Cat-M1 UE in CEModeA

| Parameter | Unit | Test 1 | | Test 2 | | Test 3 | |
|--------------------------------------|-----------|------------------------|-------------|------------------------|-------------|------------------------|-------------|
| | | Cell 1 | Cell 2 | Cell 1 | Cell 2 | Cell 1 | Cell 2 |
| E-UTRA RF Channel Number | | 1 | | 1 | | 1 | |
| BW_{channel} | MHz | 10 | | 10 | | 10 | |
| Measurement bandwidth | n_{PRB} | 22—27 | | 22—27 | | 22—27 | |
| PDSCH Reference measurement channel | | R.20 FDD | - | R.20 FDD | - | R.20 FDD | - |
| PDSCH allocation | n_{PRB} | Follows R.20 FDD | - | Follows R.20 FDD | - | Follows R.20 FDD | - |
| MPDCCH Reference measurement channel | | R.16 FDD | | R.16 FDD | | R.16 FDD | |
| OCNG Patterns | | OP.21 FDD | OP.6 FDD | OP.21 FDD | OP.6 FDD | OP.21 FDD | OP.6 FDD |
| PBCH_RA | dB | 0 | 0 | 0 | 0 | 0 | 0 |
| PBCH_RB | | | | | | | |
| PSS_RA | | | | | | | |

| | | | | | | | | |
|---|--|------------|--------|------|--------|-----|---------------|-------|
| SSS_RA | | | | | | | | |
| PCFICH_RB | | | | | | | | |
| PHICH_RA | | | | | | | | |
| PHICH_RB | | | | | | | | |
| MPDCCH_RA | | | | | | | | |
| MPDCCH_RB | | | | | | | | |
| PDSCH_RA | | | | | | | | |
| PDSCH_RB | | | | | | | | |
| OCNG_RA ^{Note1} | | | | | | | | |
| OCNG_RB ^{Note1} | | | | | | | | |
| N_{oc} ^{Note2} | Bands FDD-M1_A | dBm/15 kHz | -106 | | -86 | | -116 | |
| | Bands FDD-M1_B | | | | | | -115.5 | |
| | Bands FDD-M1_C | | | | | | -115 | |
| | Bands FDD-M1_D | | | | | | -114.5 | |
| | Bands FDD-M1_E, FDD-M1_F ^{Note 4} | | | | | | -114 | |
| | Bands FDD-M1_G | | | | | | -113 | |
| | Bands FDD-M1_H | | | | | | -112.5 | |
| \hat{E}_s / N_{oc} | | dB | 6 | 1 | 6 | 1 | 3 | -1 |
| \hat{E}_s / I_{ot} | | dB | 2.5 | -6 | 2.5 | -6 | 0.46 | -5.76 |
| RSRP ^{Note3} | Bands FDD-M1_A | dBm/15 kHz | -100 | -105 | -80 | -85 | -113 -117 | |
| | Bands FDD-M1_B | | | | | | -112.5 -116.5 | |
| | Bands FDD-M1_C | | | | | | -112 -116 | |
| | Bands FDD-M1_D | | | | | | -111.5 -115.5 | |
| | Bands FDD-M1_E, FDD-M1_F ^{Note 4} | | | | | | -111 -115 | |
| | Bands FDD-M1_G | | | | | | -110 -114 | |
| | Bands FDD-M1_H | | | | | | -109.5 -113.5 | |
| I_o ^{Note3} | Bands FDD-M1_A | dBm/9 MHz | -70.27 | | -50.27 | | -82.43 | |
| | Bands FDD-M1_B | | | | | | -81.93 | |
| | Bands FDD-M1_C | | | | | | -81.43 | |
| | Bands FDD-M1_D | | | | | | -80.93 | |
| | Bands FDD-M1_E, FDD-M1_F ^{Note 4} | | | | | | -80.43 | |
| | Bands FDD-M1_G | | | | | | -79.43 | |
| | Bands FDD-M1_H | | | | | | -78.93 | |
| Propagation condition | | - | AWGN | | AWGN | | AWGN | |
| Antenna Configuration | | | 1x1 | | 1x1 | | 1x1 | |
| Timing offset to Cell 1 | | ms | - | 3 | - | 3 | - | 3 |
| <p>Note 1: OCNG shall be used such that both cells are fully allocated and a constant total transmitted power spectral density is achieved for all OFDM symbols.</p> <p>Note 2: Interference from other cells and noise sources not specified in the test is assumed to be constant over subcarriers and time and shall be modelled as AWGN of appropriate power for N_{oc} to be fulfilled.</p> <p>Note 3: E_s/I_{ot}, RSRP and I_o levels have been derived from other parameters for information purposes. They are not settable parameters themselves.</p> <p>Note 4: For Band 26, the tests shall be performed with the carrier frequency of the assigned E-UTRA channel bandwidth within 865-894 MHz.</p> <p>Note 5: E-UTRA operating band groups are as defined in Section 3.5.</p> | | | | | | | | |

A.9.1.52.3 Test Requirements

The RSRP measurement accuracy shall fulfil the requirements in sections 9.1.21.1 and 9.1.21.2.

A.9.1.52A FD-FDD RSRP Intra frequency case for Cat-M1 UE for 5MHz Bandwidth in CEModeA

A.9.1.52A.1 Test Purpose and Environment

The purpose of this test is to verify that the RSRP measurement accuracy is within the specified limits. This test will verify the requirements in Sections 9.1.21.1 and 9.1.21.2 for FD-FDD intra frequency RSRP measurements for Cat-M1 UE in CEModeA.

A.9.1.52A.2 Test parameters

In this set of test cases all cells are on the same carrier frequency. Both absolute and relative accuracy of RSRP intra frequency measurements are tested by using the parameters in Table A.9.1.52A.2-1. In all test cases, Cell 1 is the PCell and Cell 2 the target cell.

Table A.9.1.52A.2-1: FD-FDD RSRP Intra frequency case for Cat-M1 UE for 5MHz Bandwidth in CEModeA

| Parameter | Unit | Test 1 | | Test 2 | | Test 3 | |
|---|----------------|------------------|-----------|------------------|-----------|------------------|-----------|
| | | Cell 1 | Cell 2 | Cell 1 | Cell 2 | Cell 1 | Cell 2 |
| E-UTRA RF Channel Number | | 1 | | 1 | | 1 | |
| BW _{channel} | MHz | 5 | | 5 | | 5 | |
| Measurement bandwidth | n_{PRB} | 10—15 | | 10—15 | | 10—15 | |
| PDSCH Reference measurement channel | | R.28 FDD | - | R.28 FDD | - | R.28 FDD | - |
| PDSCH allocation | n_{PRB} | Follows R.28 FDD | - | Follows R.28 FDD | - | Follows R.28 FDD | - |
| MPDCCH Reference measurement channel | | R.24 FDD | | R.24 FDD | | R.24 FDD | |
| OCNG Patterns | | OP.22 FDD | OP.19 FDD | OP.22 FDD | OP.19 FDD | OP.22 FDD | OP.19 FDD |
| PBCH_RA | dB | 0 | 0 | 0 | 0 | 0 | 0 |
| PBCH_RB | | | | | | | |
| PSS_RA | | | | | | | |
| SSS_RA | | | | | | | |
| PCFICH_RB | | | | | | | |
| PHICH_RA | | | | | | | |
| PHICH_RB | | | | | | | |
| MPDCCH_RA | | | | | | | |
| MPDCCH_RB | | | | | | | |
| PDSCH_RA | | | | | | | |
| PDSCH_RB | | | | | | | |
| OCNG_RA ^{Note1} | | | | | | | |
| OCNG_RB ^{Note1} | | | | | | | |
| N_{oc} ^{Note2} | | | | | | | |
| \hat{E}_s / N_{oc} | | 6 | 1 | 6 | 1 | 3 | -1 |
| \hat{E}_s / I_{ot} ^{Note3} | | 2.46 | -5.97 | 2.46 | -5.97 | 0.46 | -5.76 |
| RSRP ^{Note3} | Bands FDD-M1_N | -97 | -102 | -77 | -82 | -106.5 | -110.5 |
| I_o ^{Note3} | Bands FDD-M1_N | -70.28 | | -50.28 | | -78.94 | |
| Propagation condition | | AWGN | | AWGN | | AWGN | |
| Antenna Configuration | | 1x1 | | 1x1 | | 1x1 | |
| Timing offset to Cell 1 | ms | - | 3 | - | 3 | - | 3 |
| <p>Note 1: OCNG shall be used such that both cells are fully allocated and a constant total transmitted power spectral density is achieved for all OFDM symbols.</p> <p>Note 2: Interference from other cells and noise sources not specified in the test is assumed to be constant over subcarriers and time and shall be modelled as AWGN of appropriate power for N_{oc} to be fulfilled.</p> <p>Note 3: E_s/I_{ot}, RSRP and I_o levels have been derived from other parameters for information purposes. They are not settable parameters themselves.</p> | | | | | | | |

| | |
|---------|---|
| Note 4: | For Band 26, the tests shall be performed with the carrier frequency of the assigned E-UTRA channel bandwidth within 865-894 MHz. |
| Note 5: | E-UTRA operating band groups are as defined in Section 3.5. |

A.9.1.52A.3 Test Requirements

The RSRP measurement accuracy shall fulfil the requirements in sections 9.1.21.1 and 9.1.21.2.

A.9.1.53 HD-FDD RSRP Intra frequency case for Cat-M1 UE in CEModeA

A.9.1.53.1 Test Purpose and Environment

The purpose of this test is to verify that the RSRP measurement accuracy is within the specified limits. This test will verify the requirements in Sections 9.1.21.1 and 9.1.21.2 for HD-FDD intra frequency RSRP measurements for Cat-M1 UE in CEModeA.

A.9.1.53.2 Test parameters

In this set of test cases all cells are on the same carrier frequency. Both absolute and relative accuracy of RSRP intra frequency measurements are tested by using the parameters in Table A.9.1.53.2-1. In all test cases, Cell 1 is the PCell and Cell 2 the target cell.

Table A.9.1.53.2-1: HD-FDD RSRP Intra frequency test parameters for Cat-M1 UE in CEModeA

| Parameter | Unit | Test 1 | | Test 2 | | Test 3 | |
|--------------------------------------|--|---------------------|----------|---------------------|----------|---------------------|----------|
| | | Cell 1 | Cell 2 | Cell 1 | Cell 2 | Cell 1 | Cell 2 |
| E-UTRA RF Channel Number | | 1 | | 1 | | 1 | |
| BW _{channel} | MHz | 10 | | 10 | | 10 | |
| Measurement bandwidth | n_{PRB} | 22—27 | | 22—27 | | 22—27 | |
| PDSCH Reference measurement channel | | R.10 HD-FDD | - | R.10 HD-FDD | - | R.10 HD-FDD | - |
| PDSCH allocation | n_{PRB} | Follows R.10 HD-FDD | - | Follows R.10 HD-FDD | - | Follows R.10 HD-FDD | - |
| MPDCCH Reference measurement channel | | R.6 HD-FDD | | R.6 HD-FDD | | R.6 HD-FDD | |
| OCNG Patterns | | OP.21 FDD | OP.6 FDD | OP.21 FDD | OP.6 FDD | OP.21 FDD | OP.6 FDD |
| PBCH_RA | dB | 0 | 0 | 0 | 0 | 0 | 0 |
| PBCH_RB | | | | | | | |
| PSS_RA | | | | | | | |
| SSS_RA | | | | | | | |
| PCFICH_RB | | | | | | | |
| PHICH_RA | | | | | | | |
| PHICH_RB | | | | | | | |
| MPDCCH_RA | | | | | | | |
| MPDCCH_RB | | | | | | | |
| PDSCH_RA | | | | | | | |
| PDSCH_RB | | | | | | | |
| OCNG_RA ^{Note1} | | | | | | | |
| OCNG_RB ^{Note1} | | | | | | | |
| N_{oc} ^{Note2} | | | | | | | |
| | Bands FDD-M1_B | -115.5 | | | | | |
| | Bands FDD-M1_C | -115 | | | | | |
| | Bands FDD-M1_D | -114.5 | | | | | |
| | Bands FDD-M1_E, FDD-M1_F ^{Note 4} | -114 | | | | | |
| | Bands FDD-M1_G | -113 | | | | | |
| | Bands FDD-M1_H | -112.5 | | | | | |

| | | | | | | | | |
|---|---|------------|--------|------|------|--------|--------|--------|
| \hat{E}_s / N_{oc} | | dB | 6 | 1 | 6 | 1 | 3 | -1 |
| $\hat{E}_s / I_{ot}^{Note3}$ | | dB | 2.5 | -6 | 2.5 | -6 | 0.46 | -5.76 |
| RSRP ^{Note3} | Bands FDD-M1_A | dBm/15 kHz | -100 | -105 | -80 | -85 | -113 | -117 |
| | Bands FDD-M1_B | | | | | | -112.5 | -116.5 |
| | Bands FDD-M1_C | | | | | | -112 | -116 |
| | Bands FDD-M1_D | | | | | | -111.5 | -115.5 |
| | Bands FDD-M1_E, FDD-M1_F ^{Note 4} | | | | | | -111 | -115 |
| | Bands FDD-M1_G | | | | | | -110 | -114 |
| | Bands FDD-M1_H | | | | | | -109.5 | -113.5 |
| I _o ^{Note3} | Bands FDD-M1_A | dBm/9 MHz | -70.27 | | | -50.27 | -82.43 | |
| | Bands FDD-M1_B | | | | | | -81.93 | |
| | Bands FDD-M1_C | | | | | | -81.43 | |
| | Bands FDD-M1_D | | | | | | -80.93 | |
| | Bands FDD-M1_E, FDD-M1_F ^{Note 4} | | | | | | -80.43 | |
| | Bands FDD-M1_G | | | | | | -79.43 | |
| | Bands FDD-M1_H | | | | | | -78.93 | |
| Propagation condition | | - | AWGN | | AWGN | | AWGN | |
| Antenna Configuration | | | 1x1 | | 1x1 | | 1x1 | |
| Timing offset to Cell 1 | | ms | - | 3 | - | 3 | - | 3 |
| <p>Note 1: OCNG shall be used such that both cells are fully allocated and a constant total transmitted power spectral density is achieved for all OFDM symbols.</p> <p>Note 2: Interference from other cells and noise sources not specified in the test is assumed to be constant over subcarriers and time and shall be modelled as AWGN of appropriate power for N_{oc} to be fulfilled.</p> <p>Note 3: E_s/I_{ot}, RSRP and I_o levels have been derived from other parameters for information purposes. They are not settable parameters themselves.</p> <p>Note 4: For Band 26, the tests shall be performed with the carrier frequency of the assigned E-UTRA channel bandwidth within 865-894 MHz.</p> <p>Note 5: E-UTRA operating band groups are as defined in Section 3.5.</p> | | | | | | | | |

A.9.1.53.3 Test Requirements

The RSRP measurement accuracy shall fulfil the requirements in sections 9.1.21.1 and 9.1.21.2.

A.9.1.53A HD-FDD RSRP Intra frequency case for Cat-M1 UE for 5MHz Bandwidth in CEModeA

A.9.1.53A.1 Test Purpose and Environment

The purpose of this test is to verify that the RSRP measurement accuracy is within the specified limits. This test will verify the requirements in Sections 9.1.21.1 and 9.1.21.2 for HD-FDD intra frequency RSRP measurements for Cat-M1 UE in CEModeA.

A.9.1.53A.2 Test parameters

In this set of test cases all cells are on the same carrier frequency. Both absolute and relative accuracy of RSRP intra frequency measurements are tested by using the parameters in Table A.9.1.53A.2-1. In all test cases, Cell 1 is the PCell and Cell 2 the target cell.

Table A.9.1.53A.2-1: HD-FDD RSRP Intra frequency case for Cat-M1 UE for 5MHz Bandwidth in CEModeA

| Parameter | Unit | Test 1 | | Test 2 | | Test 3 | |
|--------------------------|-----------|--------|--------|--------|--------|--------|--------|
| | | Cell 1 | Cell 2 | Cell 1 | Cell 2 | Cell 1 | Cell 2 |
| E-UTRA RF Channel Number | | 1 | | 1 | | 1 | |
| BW _{channel} | MHz | 5 | | 5 | | 5 | |
| Measurement bandwidth | n_{PRB} | 10–15 | | 10–15 | | 10–15 | |

| | | | | | | | | | | | | | | | |
|---|----------------|---------------------|-----------|---------------------|-----------|---------------------|-----------|----------------|------------|-------|------|--------|-----|--------|--------|
| PDSCH Reference measurement channel | | R.18 HD-FDD | - | R.18 HD-FDD | - | R.18 HD-FDD | - | | | | | | | | |
| PDSCH allocation | n_{PRB} | Follows R.18 HD-FDD | - | Follows R.18 HD-FDD | - | Follows R.18 HD-FDD | - | | | | | | | | |
| MPDCCH Reference measurement channel | | R.14 HD-FDD | | R.14 HD-FDD | | R.14 HD-FDD | | | | | | | | | |
| OCNG Patterns | | OP.22 FDD | OP.19 FDD | OP.22 FDD | OP.19 FDD | OP.22 FDD | OP.19 FDD | | | | | | | | |
| PBCH_RA | dB | 0 | 0 | 0 | 0 | 0 | 0 | | | | | | | | |
| PBCH_RB | | | | | | | | | | | | | | | |
| PSS_RA | | | | | | | | | | | | | | | |
| SSS_RA | | | | | | | | | | | | | | | |
| PCFICH_RB | | | | | | | | | | | | | | | |
| PHICH_RA | | | | | | | | | | | | | | | |
| PHICH_RB | | | | | | | | | | | | | | | |
| MPDCCH_RA | | | | | | | | | | | | | | | |
| MPDCCH_RB | | | | | | | | | | | | | | | |
| PDSCH_RA | | | | | | | | | | | | | | | |
| PDSCH_RB | | | | | | | | | | | | | | | |
| OCNG_RA ^{Note1} | | | | | | | | | | | | | | | |
| OCNG_RB ^{Note1} | | | | | | | | | | | | | | | |
| N_{oc} ^{Note2} | | | | | | | | Bands FDD-M1_N | dBm/15 kHz | | -103 | | -83 | | -109.5 |
| \hat{E}_s / N_{oc} | | dB | | 6 | | 1 | | 6 | | 1 | | 3 | | -1 | |
| \hat{E}_s / I_{ot} ^{Note3} | | dB | | 2.46 | | -5.97 | | 2.46 | | -5.97 | | 0.46 | | -5.76 | |
| RSRP ^{Note3} | Bands FDD-M1_N | dBm/15 kHz | | -97 | | -102 | | -77 | | -82 | | -106.5 | | -110.5 | |
| I_o ^{Note3} | Bands FDD-M1_N | dBm/4.5 MHz | | -70.28 | | -50.27 | | -78.94 | | | | | | | |
| Propagation condition | | - | | AWGN | | AWGN | | AWGN | | | | | | | |
| Antenna configuration | | 1x1 | | 1x1 | | 1x1 | | | | | | | | | |
| Timing offset to Cell 1 | ms | - | 3 | - | 3 | - | 3 | | | | | | | | |
| <p>Note 1: OCNG shall be used such that both cells are fully allocated and a constant total transmitted power spectral density is achieved for all OFDM symbols.</p> <p>Note 2: Interference from other cells and noise sources not specified in the test is assumed to be constant over subcarriers and time and shall be modelled as AWGN of appropriate power for N_{oc} to be fulfilled.</p> <p>Note 3: E_s/I_{ot}, RSRP and I_o levels have been derived from other parameters for information purposes. They are not settable parameters themselves.</p> <p>Note 4: For Band 26, the tests shall be performed with the carrier frequency of the assigned E-UTRA channel bandwidth within 865-894 MHz.</p> <p>Note 5: E-UTRA operating band groups are as defined in Section 3.5.</p> | | | | | | | | | | | | | | | |

A.9.1.53A.3 Test Requirements

The RSRP measurement accuracy shall fulfil the requirements in sections 9.1.21.1 and 9.1.21.2.

A.9.1.54 TDD RSRP Intra frequency case for Cat-M1 UE in CEModeA

A.9.1.54.1 Test Purpose and Environment

The purpose of this test is to verify that the RSRP measurement accuracy is within the specified limits. This test will verify the requirements in Sections 9.1.21.1 and 9.1.21.2 for TDD intra frequency RSRP measurements for Cat-M1 UE in CEModeA.

A.9.1.54.2 Test parameters

In this set of test cases all cells are on the same carrier frequency. Both absolute and relative accuracy of RSRP intra frequency measurements are tested by using the parameters in Table A.9.1.54.2-1. In all test cases, Cell 1 is the PCell and Cell 2 the target cell.

Table A.9.1.54.2-1: TDD RSRP Intra frequency test parameters for Cat-M1 UE in CEModeA

| Parameter | | Unit | Test 1 | | Test 2 | | Test 3 | | | | | | | | |
|---|----------------|------------|------------------|----------|------------------|----------|------------------|----------|------------|------|--|-----|--|------|--|
| | | | Cell 1 | Cell 2 | Cell 1 | Cell 2 | Cell 1 | Cell 2 | | | | | | | |
| E-UTRA RF Channel Number | | | 1 | | 1 | | 1 | | | | | | | | |
| BW _{channel} | | MHz | 10 | | 10 | | 10 | | | | | | | | |
| Special subframe configuration ^{Note1} | | | 6 | | 6 | | 6 | | | | | | | | |
| Uplink/downlink configuration ^{Note1} | | | 1 | | 1 | | 1 | | | | | | | | |
| Measurement bandwidth | | n_{PRB} | 22—27 | | 22—27 | | 22—27 | | | | | | | | |
| PDSCH Reference measurement channel | | | R.16 TDD | - | R.16 TDD | - | R.16 TDD | - | | | | | | | |
| PDSCH allocation | | n_{PRB} | Follows R.16 TDD | - | Follows R.16 TDD | - | Follows R.16 TDD | - | | | | | | | |
| MPDCCH Reference measurement channel | | | R.14 TDD | | R.14 TDD | | R.14 TDD | | | | | | | | |
| OCNG Patterns | | | OP.11 TDD | OP.2 TDD | OP.11 TDD | OP.2 TDD | OP.11 TDD | OP.2 TDD | | | | | | | |
| PBCH_RA | | dB | 0 | 0 | 0 | 0 | 0 | 0 | | | | | | | |
| PBCH_RB | | | | | | | | | | | | | | | |
| PSS_RA | | | | | | | | | | | | | | | |
| SSS_RA | | | | | | | | | | | | | | | |
| PCFICH_RB | | | | | | | | | | | | | | | |
| PHICH_RA | | | | | | | | | | | | | | | |
| PHICH_RB | | | | | | | | | | | | | | | |
| MPDCCH_RA | | | | | | | | | | | | | | | |
| MPDCCH_RB | | | | | | | | | | | | | | | |
| PDSCH_RA | | | | | | | | | | | | | | | |
| PDSCH_RB | | | | | | | | | | | | | | | |
| OCNG_RA ^{Note2} | | | | | | | | | | | | | | | |
| OCNG_RB ^{Note2} | | | | | | | | | | | | | | | |
| N_{oc} ^{Note3} | Bands TDD-M1_A | | | | | | | | dBm/15 kHz | -106 | | -86 | | -116 | |
| | Bands TDD-M1_C | | | | | | | | | | | | | -115 | |
| | Bands TDD-M1_E | -114 | | | | | | | | | | | | | |
| \hat{E}_s / N_{oc} | | dB | 6 | 1 | 6 | 1 | 3 | -1 | | | | | | | |
| \hat{E}_s / I_{ot} | | dB | 2.5 | -6 | 2.5 | -6 | 0.5 | -5.76 | | | | | | | |
| RSRP ^{Note4} | Bands TDD-M1_A | dBm/15 kHz | -100 | -105 | -80 | -85 | -113 | -117 | | | | | | | |
| | Bands TDD-M1_C | | | | | | -112 | -116 | | | | | | | |
| | Bands TDD-M1_E | | | | | | -111 | -115 | | | | | | | |
| I_o ^{Note4} | Bands TDD-M1_A | dBm/9 MHz | -70.27 | | -50.27 | | -82.43 | | | | | | | | |
| | Bands TDD-M1_C | | | | | | -81.43 | | | | | | | | |
| | Bands TDD-M1_E | | | | | | -80.43 | | | | | | | | |
| Propagation condition | | - | AWGN | | AWGN | | AWGN | | | | | | | | |
| Correlation Matrix and Antenna Configuration | | | 1x1 | | 1x1 | | 1x1 | | | | | | | | |
| Timing offset to Cell 1 | | µs | - | 3 | - | 3 | - | 3 | | | | | | | |

| | |
|---------|--|
| Note 1: | For special subframe and uplink-downlink configurations see Tables 4.2-1 and 4.2-2 in TS 36.211. |
| Note 2: | OCNG shall be used such that both cells are fully allocated and a constant total transmitted power spectral density is achieved for all OFDM symbols. |
| Note 3: | Interference from other cells and noise sources not specified in the test is assumed to be constant over subcarriers and time and shall be modelled as AWGN of appropriate power for N_{oc} to be fulfilled. |
| Note 4: | Es/lot, RSRP and lo levels have been derived from other parameters for information purposes. They are not settable parameters themselves. |
| Note 5: | E-UTRA operating band groups are as defined in Section 3.5. |

A.9.1.54.3 Test Requirements

The RSRP measurement accuracy shall fulfil the requirements in sections 9.1.21.1 and 9.1.21.2.

A.9.1.55 FS3 Intra frequency absolute and relative RSRP accuracies with FDD PCell

A.9.1.55.1 Test Purpose and Environment

The purpose of this test is to verify that the FDD intra frequency RSRP absolute and relative measurement accuracies in carrier aggregation with frame structure 3 in the configured DMTC occasion are within the specified limits. This test will verify the absolute RSRP accuracy requirement of the secondary component carrier defined in clause 9.1.19.2, and the relative RSRP accuracy requirement of the secondary component carrier defined in clause 9.1.19.2. The test will also verify the primary and secondary component carrier relative RSRP accuracy requirement defined in Clause 9.1.19.4.

A.9.1.55.2 Test parameters

In this test case, Cell1 is PCell on the primary component carrier, Cell2 is SCell on the secondary component carrier with frame structure 3 and activated, and Cell3 is the neighboring cell on the same secondary component carrier of Cell2. The test parameters are given in Table A.9.1.55.2-1. The DMTC configuration for Cell2 and Cell3 is provided to the UE in the *measDS-Config* before the start of the test.

Table A.9.1.55.2-1: Test parameters for FDD RSRP accuracies of SCell with FS3

| Parameter | Unit | Test 1 | | |
|--|------|--|--|--------|
| | | Cell 1 | Cell 2 | Cell3 |
| E-UTRA RF Channel Number | | 1 | 2 | 2 |
| BW _{channel} | MHz | 5MHz: N _{RB,c} = 25 10MHz: N _{RB,c} = 50 20MHz: N _{RB,c} = 100 | 20 | 20 |
| DMTC period | ms | N/A | 40 | 40 |
| DMTC period offset | | N/A | 10 | 10 |
| Discovery signal occasion duration | ms | N/A | 1 | 1 |
| LBT model | | N/A | N/A | A.3.17 |
| Timing offset to cell1 | μs | - | 0 | 3 |
| Time alignment error between cell 2 and cell 1 | | - | ≤ Time alignment error as specified in 3GPP TS 36.104 [30] clause 6.5.3.1. | - |

| | | | | |
|---|--------------------------------------|---|-----------|-----------|
| Measurement bandwidth | n_{PRB} | 5MHz: 10-15 10MHz: 22-27 20MHz: 47-52 | 47-52 | 47-52 |
| PDSCH Reference measurement channel defined in A.3.1.1 and A.3.1.1.6(R.0 FS3) | | 5MHz: R.5 FDD 10MHz: R.0 FDD 20MHz: R.4 FDD | R.0 FS3 | - |
| PDSCH allocation | n_{PRB} | 5MHz: 7-17 10MHz: 13-36 20MHz: 38-61 | 38-61 | - |
| PDCCH/PCFICH/PHICH Reference measurement channel defined in A.3.1.2 | | 5MHz: R.11 FDD 10MHz: R.6 FDD 20MHz: R.10 FDD | R.0 FS3 | R.0 FS3 |
| OCNG Patterns defined in A.3.2 | | 5MHz: OP.15 FDD 10MHz: OP.1 FDD 20MHz: OP.11 FDD | OP.13 FDD | OP.14 FDD |
| PBCH_RA | dB | 0 | 0 | 0 |
| PBCH_RB | | | | |
| PSS_RA | | | | |
| SSS_RA | | | | |
| PCFICH_RB | | | | |
| PHICH_RA | | | | |
| PHICH_RB | | | | |
| PDCCH_RA | | | | |
| PDCCH_RB | | | | |
| PDSCH_RA | | | | |
| PDSCH_RB | | | | |
| OCNG_RA ^{Note1} | | | | |
| OCNG_RB ^{Note1} | | | | |
| N_{oc} ^{Note2} | | | | |
| | Bands FDD_B | -116.5 | | |
| | Bands FDD_C | -116 | | |
| | Bands FDD_D | -115.5 | | |
| | Bands FDD_E, FDD_F ^{Note 6} | -115 | | |
| | Bands FDD_G | -114 | | |
| | Bands FDD_H | -113.5 | | |

| | | | | | |
|--|--------------------------------------|---|--------------------------------|-------------------------------|-------|
| | Bands FS3_G | | - | $(N_{oc}$ for Channel 1 +1dB) | |
| \hat{E}_s / I_{ot} | | dB | -4 | 0.46 ^{Note9} | -5.76 |
| RSRP ^{Note3} | Bands FDD_A | dBm/15 kHz | -121 | - | |
| | Bands FDD_B | | -120.5 | | |
| | Bands FDD_C | | -120 | | |
| | Bands FDD_D | | -119.5 | | |
| | Bands FDD_E, FDD_F ^{Note 6} | | -119 | | |
| | Bands FDD_G | | -118 | | |
| | Bands FDD_H | | -117.5 | | |
| | Bands FS3_G | | - | | |
| I_o ^{Note3} | Bands FDD_A | 5MHz: dBm/4.5MHz 10MHz: dBm/9MHz 20MHz: dBm/18MHz | -87.76 +10log($N_{RB} / 50$) | - | |
| | Bands FDD_B | | -86.26 +10log($N_{RB} / 50$) | | |
| | Bands FDD_C | | -86.76 +10log($N_{RB} / 50$) | | |
| | Bands FDD_D | | -86.26 +10log($N_{RB} / 50$) | | |
| | Bands FDD_E, FDD_F ^{Note 6} | | -85.76 +10log($N_{RB} / 50$) | | |
| | Bands FDD_G | | -84.76 +10log($N_{RB} / 50$) | | |
| | Bands FDD_H | | -84.26 +10log($N_{RB} / 50$) | | |
| | Bands FS3_G | | - | | |
| \hat{E}_s / N_{oc} | | dB | -4 | 3 | -1 |
| Propagation condition | | - | AWGN | | |
| <p>Note 1: OCNG shall be used such that cells are fully allocated and a constant total transmitted power spectral density is achieved for all OFDM symbols. For cells with LBT model, OCNG is transmitted only in subframes with downlink transmission bursts, and is not transmitted during muted subframes or during DMTC windows.</p> <p>Note 2: Interference from other cells and noise sources not specified in the test is assumed to be constant over subcarriers and time and shall be modelled as AWGN of appropriate power for N_{oc} to be fulfilled.</p> <p>Note 3: RSRP and I_o levels have been derived from other parameters for information purposes. They are not settable parameters themselves.</p> <p>Note 4: RSRP minimum requirements are specified assuming independent interference and noise at each receiver antenna port.</p> <p>Note 5: The selection of the bands for testing depends on the configuration of the carrier aggregation supported by the UEs.</p> <p>Note 6: For Band 26, the tests shall be performed with the carrier frequency of the assigned E-UTRA channel bandwidth within 865-894 MHz.</p> <p>Note 7: This test verifies the RRM requirement which is independent of channel bandwidth and is performed according to the principle defined in section A.3.6.1.</p> <p>Note 8: E-UTRA operating band groups are as defined in Section 3.5.</p> <p>Note 9: The value is corresponding to DRS transmission through LBT operation in Cell3.</p> | | | | | |

A.9.1.55.3 Test Requirements

In the test, the performance of RSRP measurements is verified from following three perspectives:

- The absolute accuracy of intra-frequency RSRP measurements for Cell 3 on the secondary component carrier with frame structure 3 shall fulfil the requirements defined in clause 9.1.19.2.
- The relative accuracy of intra-frequency RSRP measurements for Cell 3 relative to Cell 2 on the secondary component carrier with frame structure 3 shall fulfil the requirements defined in clause 9.1.19.2
- The relative accuracy of inter-frequency RSRP measurements between the primary and secondary component carriers for Cell 3 relative to Cell 1 shall fulfil the requirements defined in clause 9.1.19.4.

A.9.1.56 FS3 Intra frequency absolute and relative RSRP accuracies with TDD PCell

A.9.1.56.1 Test Purpose and Environment

The purpose of this test is to verify that the TDD intra frequency RSRP absolute and relative measurement accuracies in carrier aggregation with frame structure 3 in the configured DMTC occasion are within the specified limits. This test will verify the absolute RSRP accuracy requirement of the secondary component carrier defined in clause 9.1.19.2, and the relative RSRP accuracy requirement of the secondary component carrier defined in clause 9.1.19.2. The test will also verify the primary and secondary component carrier relative RSRP accuracy requirement defined in Clause 9.1.19.4.

A.9.1.56.2 Test parameters

In this test case, Cell1 is PCell on the primary component carrier, Cell2 is SCell on the secondary component carrier with frame structure 3 and activated, and Cell3 is the neighboring cell on the same secondary component carrier of Cell2. The test parameters are given in Table A.9.1.56.2-1. The DMTC configuration for Cell2 and Cell3 is provided to the UE in the *measDS-Config* before the start of the test.

Table A.9.1.56.2-1: Test parameters for TDD RSRP accuracies of Scell with FS3

| Parameter | Unit | Test 1 | | |
|---|------|--|--|--------|
| | | Cell 1 | Cell 2 | Cell3 |
| E-UTRA RF Channel Number | | 1 | 2 | 2 |
| BW _{channel} | MHz | 5MHz: N _{RB,c} = 25 10MHz: N _{RB,c} = 50 20MHz: N _{RB,c} = 100 | 20 | 20 |
| DMTC period | ms | N/A | 40 | 40 |
| DMTC period offset | | N/A | 10 | 10 |
| Discovery signal occasion duration | ms | N/A | 1 | 1 |
| LBT model | | N/A | N/A | A.3.17 |
| Special subframe configuration ^{Note1} | | 6 | N/A | N/A |
| Uplink/downlink configuration ^{Note1} | | 1 | N/A | N/A |
| Timing offset to cell1 | μs | - | 0 | 3 |
| Time alignment error between cell 2 and cell 1 | | - | ≤ Time alignment error as specified in 3GPP TS 36.104 [30] clause 6.5.3.1. | - |

| | | | | |
|---|-------------|---|--------------------------------|------------------------|
| Measurement bandwidth | n_{PRB} | 5MHz: 10-15 10MHz: 22-27 20MHz: 47-52 | 47-52 | 47-52 |
| PDSCH Reference measurement channel defined in A.3.1.1 | | 5MHz: R.4 TDD 10MHz: R.0 TDD 20MHz: R.3 TDD | R.0 FS3 | - |
| PDSCH allocation | n_{PRB} | 5MHz: 7-17 10MHz: 13-36 20MHz: 38-61 | 38-61 | - |
| PDCCH/PCFICH/PHICH Reference measurement channel defined in A.3.1.2 | | 5MHz: R.11 TDD 10MHz: R.6 TDD 20MHz: R.10 TDD | R.0 FS3 | R.0 FS3 |
| OCNG Patterns defined in A.3.2 | | 5MHz: OP.9 TDD 10MHz: OP.1 TDD 20MHz: OP.7 TDD | OP.13 FDD | OP.14 FDD |
| PBCH_RA | dB | 0 | 0 | 0 |
| PBCH_RB | | | | |
| PSS_RA | | | | |
| SSS_RA | | | | |
| PCFICH_RB | | | | |
| PHICH_RA | | | | |
| PHICH_RB | | | | |
| PDCCH_RA | | | | |
| PDCCH_RB | | | | |
| PDSCH_RA | | | | |
| PDSCH_RB | | | | |
| OCNG_RA ^{Note2} | | | | |
| OCNG_RB ^{Note2} | | | | |
| N_{oc} ^{Note3} | | | | |
| | Bands TDD_C | -116 | | |
| | Bands TDD_E | -115 | | |
| | Bands FS3_G | - | (N_{oc} for Channel 1 +1dB) | |
| \hat{E}_s/I_{ot} | | -4 | 0.46 ^{Note9} | -5.76 |
| RSRP ^{Note4} | Bands TDD_A | -121 | - | |
| | Bands TDD_C | -120 | | |
| | Bands TDD_E | -119 | | |
| | Bands FS3_G | - | (RSRP for Cell 1 +8dB) | (RSRP for Cell 1 +4dB) |

| | | | | | |
|--|-------------|---|--|---|---|
| I _o ^{Note4} | Bands TDD_A | 5MHz: dBm/4.5MHz | -87.76 +10log(N _{RB} , /50) | - | |
| | Bands TDD_C | | -86.76 +10log(N _{RB} , /50) | | |
| | Bands TDD_E | | -85.76 +10log(N _{RB} , /50) | | |
| | Bands FS3_G | 10MHz: dBm/9MHz 20MHz: dBm/18MHz | - | (I _o for Channel 1 +5.33dB ^{Note9} +10log(N _{RB} channel2 / N _{RB} channel 1)) | (I _o for Channel 1 +5.33dB +10log(N _{RB} channel2 / N _{RB} channel 1)) |
| \hat{E}_s / N_{oc} | | dB | -4 | 3 | -1 |
| Propagation condition | | - | AWGN | | |
| <p>Note 1: For special subframe and uplink-downlink configurations see Tables 4.2-1 and 4.2-2 in TS 36.211.</p> <p>Note 2: OCNG shall be used such that cells are fully allocated and a constant total transmitted power spectral density is achieved for all OFDM symbols. For cells with LBT model, OCNG is transmitted only in subframes with downlink transmission bursts, and is not transmitted during muted subframes or during DMTC windows.</p> <p>Note 3: Interference from other cells and noise sources not specified in the test is assumed to be constant over subcarriers and time and shall be modelled as AWGN of appropriate power for N_{oc} to be fulfilled.</p> <p>Note 4: RSRP and I_o levels have been derived from other parameters for information purposes. They are not settable parameters themselves.</p> <p>Note 5: RSRP minimum requirements are specified assuming independent interference and noise at each receiver antenna port.</p> <p>Note 6: The selection of the bands for testing depends on the configuration of the carrier aggregation supported by the UEs.</p> <p>Note 7: This test verifies the RRM requirement which is independent of channel bandwidth and is performed according to the principle defined in section A.3.6.1.</p> <p>Note 8: E-UTRA operating band groups are as defined in Section 3.5.</p> <p>Note 9: The value is corresponding to DRS transmission through LBT operation in Cell3.</p> | | | | | |

A.9.1.56.3 Test Requirements

In the test, the performance of RSRP measurements is verified from following three perspectives:

- The absolute accuracy of intra-frequency RSRP measurements for Cell 3 on the secondary component carrier with frame structure 3 shall fulfil the requirements defined in clause 9.1.19.2.
- The relative accuracy of intra-frequency RSRP measurements for Cell 3 relative to Cell 2 on the secondary component carrier with frame structure 3 shall fulfil the requirements defined in clause 9.1.19.2
- The relative accuracy of inter-frequency RSRP measurements between the primary and secondary component carriers for Cell 3 relative to Cell 1 shall fulfil the requirements defined in clause 9.1.19.4.

A.9.1.57 FD-FDD RSRP Intra frequency case for Cat-M1 UE in CEModeB

A.9.1.57.1 Test Purpose and Environment

The purpose of this test is to verify that the RSRP measurement accuracy is within the specified limits. This test will verify the requirements in Sections 9.1.21.3 and 9.1.21.4 for FD-FDD intra frequency RSRP measurements for Cat-M1 UE in CEModeB.

A.9.1.57.2 Test parameters

In this set of test cases all cells are on the same carrier frequency. Both absolute and relative accuracy of RSRP intra frequency measurements are tested by using the parameters in Table A.9.1.57.2-1. In all test cases, Cell 1 is the PCell and Cell 2 the target cell. All the tests contain MPDCCH for UL grant for reporting RSRP.

Table A.9.1.57.2-1: FD-FDD RSRP Intra frequency test parameters for Cat-M1 UE in CEModeB

| Parameter | Unit | Test 1 | | Test 2 | | Test 3 | |
|---------------------------------------|--|------------------|----------|------------------|----------|------------------|----------|
| | | Cell 1 | Cell 2 | Cell 1 | Cell 2 | Cell 1 | Cell 2 |
| E-UTRA RF Channel Number | | 1 | | 1 | | 1 | |
| BW _{channel} | MHz | 10 | | 10 | | 10 | |
| Measurement bandwidth | n_{PRB} | 22—27 | | 22—27 | | 22—27 | |
| PDSCH Reference measurement channel | | R.22 FDD | - | R.22 FDD | - | R.22 FDD | - |
| PDSCH allocation | n_{PRB} | Follows R.22 FDD | - | Follows R.22 FDD | - | Follows R.22 FDD | - |
| MPDCCH Reference measurement channel | | R.18 FDD | | R.18 FDD | | R.18 FDD | |
| OCNG Patterns | | OP.21 FDD | OP.6 FDD | OP.21 FDD | OP.6 FDD | OP.21 FDD | OP.6 FDD |
| PBCH_RA | dB | 0 | 0 | 0 | 0 | 0 | 0 |
| PBCH_RB | | | | | | | |
| PSS_RA | | | | | | | |
| SSS_RA | | | | | | | |
| PCFICH_RB | | | | | | | |
| PHICH_RA | | | | | | | |
| PHICH_RB | | | | | | | |
| MPDCCH_RA | | | | | | | |
| MPDCCH_RB | | | | | | | |
| PDSCH_RA | | | | | | | |
| PDSCH_RB | | | | | | | |
| OCNG_RA ^{Note1} | | | | | | | |
| OCNG_RB ^{Note1} | | | | | | | |
| $b N_{oc}$ ^{Note2} | | | | | | | |
| | Bands FDD-M1_B | -106.5 | | | | | |
| | Bands FDD-M1_C | -106 | | | | | |
| | Bands FDD-M1_D | -105.5 | | | | | |
| | Bands FDD-M1_E, FDD-M1_F ^{Note 4} | -105 | | | | | |
| | Bands FDD-M1_G | -104 | | | | | |
| Bands FDD-M1_H | -103.5 | | | | | | |
| \hat{E}_s / N_{oc} | dB | -12 | -14 | -12 | -14 | -12 | -14 |
| \hat{E}_s / I_{ot} ^{Note3} | dB | -12.17 | -14.27 | -12.17 | -14.27 | -12.17 | -14.27 |
| RSRP ^{Note3} | Bands FDD-M1_A | -111 | -113 | -91 | -93 | -119 | |
| | Bands FDD-M1_B | | | | | -118.5 | |
| | Bands FDD-M1_C | | | | | -120.5 | |
| | Bands FDD-M1_D | | | | | -118 | |
| | Bands FDD-M1_E, FDD-M1_F ^{Note 4} | | | | | -120 | |
| | Bands FDD-M1_G | | | | | -117.5 | |
| Bands FDD-M1_H | -119.5 | | | | | | |
| I_o ^{Note3} | Bands FDD-M1_A | -70.79 | -70.79 | -50.79 | -50.79 | -78.79 | |
| | Bands FDD-M1_B | | | | | -78.29 | |
| | Bands FDD-M1_C | | | | | -77.79 | |
| | Bands FDD-M1_D | | | | | -77.29 | |
| | Bands FDD-M1_E, FDD-M1_F ^{Note 4} | | | | | -76.79 | |
| | Bands FDD-M1_G | | | | | -75.79 | |
| Bands FDD-M1_H | -75.29 | | | | | | |
| Propagation condition | - | AWGN | | AWGN | | AWGN | |
| Antenna Configuration | | 1x1 | | 1x1 | | 1x1 | |

| | |
|---------|--|
| Note 1: | OCNG shall be used such that both cells are fully allocated and a constant total transmitted power spectral density is achieved for all OFDM symbols. |
| Note 2: | Interference from other cells and noise sources not specified in the test is assumed to be constant over subcarriers and time and shall be modelled as AWGN of appropriate power for N_{oc} to be fulfilled. |
| Note 3: | Es/lot, RSRP and Io levels have been derived from other parameters for information purposes. They are not settable parameters themselves. |
| Note 4: | For Band 26, the tests shall be performed with the carrier frequency of the assigned E-UTRA channel bandwidth within 865-894 MHz. |
| Note 5: | E-UTRA operating band groups are as defined in Section 3.5. |

A.9.1.57.3 Test Requirements

The RSRP measurement accuracy shall fulfil the requirements in sections 9.1.21.3 and 9.1.21.4.

A.9.1.57A FD-FDD RSRP Intra frequency case for Cat-M1 UE for 5MHz Bandwidth in CEModeB

A.9.1.57A.1 Test Purpose and Environment

The purpose of this test is to verify that the RSRP measurement accuracy is within the specified limits. This test will verify the requirements in Sections 9.1.21.3 and 9.1.21.4 for FD-FDD intra frequency RSRP measurements for Cat-M1 UE in CEModeB.

A.9.1.57A.2 Test parameters

In this set of test cases all cells are on the same carrier frequency. Both absolute and relative accuracy of RSRP intra frequency measurements are tested by using the parameters in Table A.9.1.57A.2-1. In all test cases, Cell 1 is the PCell and Cell 2 the target cell. All the tests contain MPDCCH for UL grant for reporting RSRP.

Table A.9.1.57A.2-1: FD-FDD RSRP Intra frequency case for Cat-M1 UE for 5MHz Bandwidth in CEModeB

| Parameter | Unit | Test 1 | | Test 2 | | Test 3 | |
|--------------------------------------|-----------|------------------|-----------|------------------|-----------|------------------|-----------|
| | | Cell 1 | Cell 2 | Cell 1 | Cell 2 | Cell 1 | Cell 2 |
| E-UTRA RF Channel Number | | 1 | | 1 | | 1 | |
| BW _{channel} | MHz | 5 | | 5 | | 5 | |
| Measurement bandwidth | n_{PRB} | 10—15 | | 10—15 | | 10—15 | |
| PDSCH Reference measurement channel | | R.30 FDD | - | R.30 FDD | - | R.30 FDD | - |
| PDSCH allocation | n_{PRB} | Follows R.30 FDD | - | Follows R.30 FDD | - | Follows R.30 FDD | - |
| MPDCCH Reference measurement channel | | R.26 FDD | | R.26 FDD | | R.26 FDD | |
| OCNG Patterns | | OP.22 FDD | OP.19 FDD | OP.22 FDD | OP.19 FDD | OP.22 FDD | OP.19 FDD |
| PBCH_RA | dB | | | | | | |
| PBCH_RB | | | | | | | |
| PSS_RA | | | | | | | |
| SSS_RA | | | | | | | |
| PCFICH_RB | | | | | | | |
| PHICH_RA | | | | | | | |
| PHICH_RB | | 0 | 0 | 0 | 0 | 0 | 0 |
| MPDCCH_RA | | | | | | | |
| MPDCCH_RB | | | | | | | |
| PDSCH_RA | | | | | | | |
| PDSCH_RB | | | | | | | |
| OCNG_RA ^{Note1} | | | | | | | |
| OCNG_RB ^{Note1} | | | | | | | |

| | | | | | | | | |
|---|----------------|-------------|--------|--------|--------|--------|--------|--------|
| N_{oc} ^{Note2} | Bands FDD-M1_N | dBm/15 kHz | -96 | | -79 | | -97.5 | |
| \hat{E}_s / N_{oc} | | dB | -12 | -14 | -12 | -14 | -12 | -14 |
| \hat{E}_s / I_{ot} ^{Note3} | | dB | -12.17 | -14.27 | -12.17 | -14.27 | -12.17 | -14.27 |
| RSRP ^{Note3} | Bands FDD-M1_N | dBm/15 kHz | -108 | -110 | -88 | -90 | -112.5 | -114.5 |
| I_o ^{Note3} | Bands FDD-M1_N | dBm/4.5 MHz | -70.80 | | -50.80 | | -72.30 | |
| Propagation condition | | - | AWGN | | AWGN | | AWGN | |
| Antenna Configuration | | | 1x1 | | 1x1 | | 1x1 | |
| <p>Note 1: OCNG shall be used such that both cells are fully allocated and a constant total transmitted power spectral density is achieved for all OFDM symbols.</p> <p>Note 2: Interference from other cells and noise sources not specified in the test is assumed to be constant over subcarriers and time and shall be modelled as AWGN of appropriate power for N_{oc} to be fulfilled.</p> <p>Note 3: E_s/I_{ot}, RSRP and I_o levels have been derived from other parameters for information purposes. They are not settable parameters themselves.</p> <p>Note 4: For Band 26, the tests shall be performed with the carrier frequency of the assigned E-UTRA channel bandwidth within 865-894 MHz.</p> <p>Note 5: E-UTRA operating band groups are as defined in Section 3.5.</p> | | | | | | | | |

A.9.1.57A.3 Test Requirements

The RSRP measurement accuracy shall fulfil the requirements in sections 9.1.21.3 and 9.1.21.4.

A.9.1.58 HD-FDD RSRP Intra frequency case for Cat-M1 UE in CEModeB

A.9.1.58.1 Test Purpose and Environment

The purpose of this test is to verify that the RSRP measurement accuracy is within the specified limits. This test will verify the requirements in Sections 9.1.21.3 and 9.1.21.4 for HD-FDD intra frequency RSRP measurements for Cat-M1 UE in CEModeB.

A.9.1.58.2 Test parameters

In this set of test cases all cells are on the same carrier frequency. Both absolute and relative accuracy of RSRP intra frequency measurements are tested by using the parameters in Table A.9.1.58.2-1. In all test cases, Cell 1 is the PCell and Cell 2 the target cell. All the tests contain MPDCCH for UL grant for reporting RSRP.

Table A.9.1.58.2-1: HD-FDD RSRP Intra frequency test parameters for Cat-M1 UE in CEModeB

| Parameter | Unit | Test 1 | | Test 2 | | Test 3 | |
|--------------------------------------|-----------|---------------------|----------|---------------------|----------|---------------------|----------|
| | | Cell 1 | Cell 2 | Cell 1 | Cell 2 | Cell 1 | Cell 2 |
| E-UTRA RF Channel Number | | 1 | | 1 | | 1 | |
| BW _{channel} | MHz | 10 | | 10 | | 10 | |
| Measurement bandwidth | n_{PRB} | 22–27 | | 22–27 | | 22–27 | |
| PDSCH Reference measurement channel | | R.12 HD-FDD | - | R.12 HD-FDD | - | R.12 HD-FDD | - |
| PDSCH allocation | n_{PRB} | Follows R.12 HD-FDD | - | Follows R.12 HD-FDD | - | Follows R.12 HD-FDD | - |
| MPDCCH Reference measurement channel | | R.8 HD-FDD | | R.8 HD-FDD | | R.8 HD-FDD | |
| OCNG Patterns | | OP.21 FDD | OP.6 FDD | OP.21 FDD | OP.6 FDD | OP.21 FDD | OP.6 FDD |
| PBCH_RA | dB | 0 | 0 | 0 | 0 | 0 | 0 |
| PBCH_RB | | | | | | | |
| PSS_RA | | | | | | | |
| SSS_RA | | | | | | | |
| PCFICH_RB | | | | | | | |

| | | | | | | | | |
|---|--|------------|--------|--------|--------|--------|--------|--------|
| PHICH_RA | | | | | | | | |
| PHICH_RB | | | | | | | | |
| MPDCCH_RA | | | | | | | | |
| MPDCCH_RB | | | | | | | | |
| PDSCH_RA | | | | | | | | |
| PDSCH_RB | | | | | | | | |
| OCNG_RA ^{Note1} | | | | | | | | |
| OCNG_RB ^{Note1} | | | | | | | | |
| N_{oc} ^{Note2} | Bands FDD-M1_A | dBm/15 kHz | -99 | -79 | | | -107 | |
| | Bands FDD-M1_B | | | | | | -106.5 | |
| | Bands FDD-M1_C | | | | | | -106 | |
| | Bands FDD-M1_D | | | | | | -105.5 | |
| | Bands FDD-M1_E, FDD-M1_F ^{Note 4} | | | | | | -105 | |
| | Bands FDD-M1_G | | | | | | -104 | |
| | Bands FDD-M1_H | | | | | | -103.5 | |
| \hat{E}_s / N_{oc} | | dB | -12 | -14 | -12 | -14 | -12 | -14 |
| \hat{E}_s / I_{ot} ^{Note3} | | dB | -12.17 | -14.27 | -12.17 | -14.27 | -12.17 | -14.27 |
| RSRP ^{Note3} | Bands FDD-M1_A | dBm/15 kHz | -111 | -113 | -91 | -93 | -119 | -121 |
| | Bands FDD-M1_B | | | | | | -118.5 | -120.5 |
| | Bands FDD-M1_C | | | | | | -118 | -120 |
| | Bands FDD-M1_D | | | | | | -117.5 | -119.5 |
| | Bands FDD-M1_E, FDD-M1_F ^{Note 4} | | | | | | -117 | -119 |
| | Bands FDD-M1_G | | | | | | -116 | -118 |
| | Bands FDD-M1_H | | | | | | -115.5 | -117.5 |
| I_o ^{Note3} | Bands FDD-M1_A | dBm/9 MHz | -70.79 | -50.79 | | | -78.79 | |
| | Bands FDD-M1_B | | | | | | -78.29 | |
| | Bands FDD-M1_C | | | | | | -77.79 | |
| | Bands FDD-M1_D | | | | | | -77.29 | |
| | Bands FDD-M1_E, FDD-M1_F ^{Note 4} | | | | | | -76.79 | |
| | Bands FDD-M1_G | | | | | | -75.79 | |
| | Bands FDD-M1_H | | | | | | -75.29 | |
| Propagation condition | | - | AWGN | | AWGN | | AWGN | |
| Antenna Configuration | | | 1x1 | | 1x1 | | 1x1 | |
| <p>Note 1: OCNG shall be used such that both cells are fully allocated and a constant total transmitted power spectral density is achieved for all OFDM symbols.</p> <p>Note 2: Interference from other cells and noise sources not specified in the test is assumed to be constant over subcarriers and time and shall be modelled as AWGN of appropriate power for N_{oc} to be fulfilled.</p> <p>Note 3: E_s/I_{ot}, RSRP and I_o levels have been derived from other parameters for information purposes. They are not settable parameters themselves.</p> <p>Note 4: For Band 26, the tests shall be performed with the carrier frequency of the assigned E-UTRA channel bandwidth within 865-894 MHz.</p> <p>Note 5: E-UTRA operating band groups are as defined in Section 3.5.</p> | | | | | | | | |

A.9.1.58.3 Test Requirements

The RSRP measurement accuracy shall fulfil the requirements in sections 9.1.21.3 and 9.1.21.4.

A.9.1.58A HD-FDD RSRP Intra frequency case for Cat-M1 UE for 5MHz Bandwidth in CEModeB

A.9.1.58A.1 Test Purpose and Environment

The purpose of this test is to verify that the RSRP measurement accuracy is within the specified limits. This test will verify the requirements in Sections 9.1.21.3 and 9.1.21.4 for HD-FDD intra frequency RSRP measurements for Cat-M1 UE in CEModeB.

A.9.1.58A.2 Test parameters

In this set of test cases all cells are on the same carrier frequency. Both absolute and relative accuracy of RSRP intra frequency measurements are tested by using the parameters in Table A.9.1.58A.2-1. In all test cases, Cell 1 is the PCell and Cell 2 the target cell. All the tests contain MPDCCH for UL grant for reporting RSRP.

Table A.9.1.58.2-1: HD-FDD RSRP Intra frequency case for Cat-M1 UE for 5MHz Bandwidth in CEModeB

| Parameter | Unit | Test 1 | | Test 2 | | Test 3 | |
|--|----------------|---------------------|-----------|---------------------|-----------|---------------------|-----------|
| | | Cell 1 | Cell 2 | Cell 1 | Cell 2 | Cell 1 | Cell 2 |
| E-UTRA RF Channel Number | | 1 | | 1 | | 1 | |
| BW _{channel} | MHz | 5 | | 5 | | 5 | |
| Measurement bandwidth | n_{PRB} | 10–15 | | 10–15 | | 10–15 | |
| PDSCH Reference measurement channel | | R.20 HD-FDD | - | R.20 HD-FDD | - | R.20 HD-FDD | - |
| PDSCH allocation | n_{PRB} | Follows R.20 HD-FDD | - | Follows R.20 HD-FDD | - | Follows R.20 HD-FDD | - |
| MPDCCH Reference measurement channel | | R.16 HD-FDD | | R.16 HD-FDD | | R.16 HD-FDD | |
| OCNG Patterns | | OP.22 FDD | OP.19 FDD | OP.22 FDD | OP.19 FDD | OP.22 FDD | OP.19 FDD |
| PBCH_RA | dB | 0 | 0 | 0 | 0 | 0 | 0 |
| PBCH_RB | | | | | | | |
| PSS_RA | | | | | | | |
| SSS_RA | | | | | | | |
| PCFICH_RB | | | | | | | |
| PHICH_RA | | | | | | | |
| PHICH_RB | | | | | | | |
| MPDCCH_RA | | | | | | | |
| MPDCCH_RB | | | | | | | |
| PDSCH_RA | | | | | | | |
| PDSCH_RB | | | | | | | |
| OCNG_RA ^{Note1} | | | | | | | |
| OCNG_RB ^{Note1} | | | | | | | |
| N_{oc} ^{Note2} | | | | | | | |
| \hat{E}_s / N_{oc} | dB | -12 | -12 | -14 | -12 | -12 | -14 |
| \hat{E}_s / I_{ot} ^{Note3} | dB | -12.17 | -12.17 | -14.27 | -12.17 | -12.17 | -14.27 |
| RSRP ^{Note3} | Bands FDD-M1_N | -108 | | -88 | | -110 | |
| I_o ^{Note3} | Bands FDD-M1_N | -70.80 | | -50.80 | | -72.30 | |
| Propagation condition | - | AWGN | | AWGN | | AWGN | |
| Antenna Configuration | | 1x1 | | 1x1 | | 1x1 | |
| Note 1: OCNG shall be used such that both cells are fully allocated and a constant total transmitted power spectral density is achieved for all OFDM symbols. Note 2: Interference from other cells and noise sources not specified in the test is assumed to be constant over subcarriers and time and shall be modelled as AWGN of appropriate power for N_{oc} to be fulfilled. Note 3: E_s/I_{ot} , RSRP and I_o levels have been derived from other parameters for information purposes. They are not settable parameters themselves. Note 4: For Band 26, the tests shall be performed with the carrier frequency of the assigned E-UTRA channel bandwidth within 865-894 MHz. Note 5: E-UTRA operating band groups are as defined in Section 3.5. | | | | | | | |

A.9.1.58A.3 Test Requirements

The RSRP measurement accuracy shall fulfil the requirements in sections 9.1.21.3 and 9.1.21.4.

A.9.1.59 TDD RSRP Intra frequency case for Cat-M1 UE in CEModeB

A.9.1.59.1 Test Purpose and Environment

The purpose of this test is to verify that the RSRP measurement accuracy is within the specified limits. This test will verify the requirements in Sections 9.1.21.3 and 9.1.21.4 for TDD intra frequency RSRP measurements for Cat-M1 UE in CEModeB.

A.9.1.59.2 Test parameters

In this set of test cases all cells are on the same carrier frequency. Both absolute and relative accuracy of RSRP intra frequency measurements are tested by using the parameters in Table A.9.1.59.2-1. In all test cases, Cell 1 is the PCell and Cell 2 the target cell. All the tests contain MPDCCH for UL grant for reporting RSRP.

Table A.9.1.59.2-1: TDD RSRP Intra frequency test parameters for Cat-M1 UE in CEModeB

| Parameter | Unit | Test 1 | | Test 2 | | Test 3 | |
|---|----------------|------------------|----------|------------------|----------|------------------|----------|
| | | Cell 1 | Cell 2 | Cell 1 | Cell 2 | Cell 1 | Cell 2 |
| E-UTRA RF Channel Number | | 1 | | 1 | | 1 | |
| BW _{channel} | MHz | 10 | | 10 | | 10 | |
| Special subframe configuration ^{Note1} | | 6 | | 6 | | 6 | |
| Uplink/downlink configuration ^{Note1} | | 1 | | 1 | | 1 | |
| Measurement bandwidth | n_{PRB} | 22–27 | | 22–27 | | 22–27 | |
| PDSCH Reference measurement channel | | R.18 TDD | - | R.18 TDD | - | R.18 TDD | - |
| PDSCH allocation | n_{PRB} | Follows R.18 TDD | - | Follows R.18 TDD | - | Follows R.18 TDD | - |
| MPDCCH Reference measurement channel | | R.16 TDD | | R.16 TDD | | R.16 TDD | |
| OCNG Patterns | | OP.11 TDD | OP.2 TDD | OP.11 TDD | OP.2 TDD | OP.11 TDD | OP.2 TDD |
| PBCH_RA | | | | | | | |
| PBCH_RB | | | | | | | |
| PSS_RA | | | | | | | |
| SSS_RA | | | | | | | |
| PCFICH_RB | | | | | | | |
| PHICH_RA | | | | | | | |
| PHICH_RB | | | | | | | |
| MPDCCH_RA | | | | | | | |
| MPDCCH_RB | | | | | | | |
| PDSCH_RA | | | | | | | |
| PDSCH_RB | | | | | | | |
| OCNG_RA ^{Note2} | | | | | | | |
| OCNG_RB ^{Note2} | | | | | | | |
| N_{oc} ^{Note3} | Bands TDD-M1_A | | | | | -107 | |
| | Bands TDD-M1_C | | | | | -106 | |
| | Bands TDD-M1_E | | | | | -105 | |
| \hat{E}_s / N_{oc} | dB | -12 | -14 | -12 | -14 | -12 | -14 |
| \hat{E}_s / I_{ot} ^{Note4} | dB | -12.17 | -14.27 | -12.17 | -14.27 | -12.17 | -14.27 |
| RSRP ^{Note4} | Bands TDD-M1_A | | | | | -119 | -121 |
| | Bands TDD-M1_C | | | | | -118 | -120 |
| | Bands TDD-M1_E | | | | | -117 | -119 |
| I_o ^{Note4} | Bands TDD-M1_A | | | | | -78.79 | |
| | dBm/9 MHz | -70.79 | | -50.79 | | | |

| | | | | | |
|---|----------------|---|------|------|--------|
| | Bands TDD-M1_C | | | | -77.79 |
| | Bands TDD-M1_E | | | | -76.79 |
| Propagation condition | | - | AWGN | AWGN | AWGN |
| Correlation Matrix and Antenna Configuration | | | 1x1 | 1x1 | 1x1 |
| <p>Note 1: For special subframe and uplink-downlink configurations see Tables 4.2-1 and 4.2-2 in TS 36.211.</p> <p>Note 2: OCNB shall be used such that both cells are fully allocated and a constant total transmitted power spectral density is achieved for all OFDM symbols.</p> <p>Note 3: Interference from other cells and noise sources not specified in the test is assumed to be constant over subcarriers and time and shall be modelled as AWGN of appropriate power for N_{oc} to be fulfilled.</p> <p>Note 4: Es/lot, RSRP and Io levels have been derived from other parameters for information purposes. They are not settable parameters themselves.</p> <p>Note 5: E-UTRA operating band groups are as defined in Section 3.5.</p> | | | | | |

A.9.1.59.3 Test Requirements

The RSRP measurement accuracy shall fulfil the requirements in sections 9.1.21.3 and 9.1.21.4.

A.9.1.60 FS3 Absolute and relative CSI-RSRP accuracies in CSI-RS based discovery signal with FDD PCell

A.9.1.60.1 Test Purpose and Environment

The purpose of this test is to verify that CSI-RSRP measurement accuracy is within the specified limits. This test will verify the absolute intra-frequency CSI-RSRP accuracy requirements of the SCells defined in Section 9.1.18.4.4 for intra-frequency measurements under FS3, and the relative intra-frequency CSI-RSRP accuracy requirements between SCells defined in Section 9.1.18.4.5.

A.9.1.60.2 Test parameters

In this set of cases Cell 1 is PCell on the primary component carrier, Cell 2 using FS3 is SCell on the secondary component carrier and activated, and Cell 3 using FS3 is the neighbouring cell on the secondary component carrier. The test parameters are given in Table A.9.1.60.2-1. Intra-frequency measurements are supported by a DMTC configuration.

A.9.1.60.2-1: CSI-RSRP carrier aggregation test parameters with FDD PCell and FS3 SCells

| Parameter | Unit | Test 1 | | |
|--|---------|--|-----------------------------|-----------------------------|
| | | Cell 1 | Cell 2 | Cell3 |
| Frame structure | | FDD | FS3 | FS3 |
| E-UTRA RF Channel Number | | 1 | 2 | 2 |
| $BW_{channel}$ | MHz | 5 MHz: $N_{RB,c} = 25$ 10 MHz: $N_{RB,c} = 50$ 20 MHz: $N_{RB,c} = 100$ | 20 MHz: $N_{RB,c} = 100$ | 20 MHz: $N_{RB,c} = 100$ |
| Timing offset to Cell 1 | μs | - | 0 | 3 |
| Uplink/downlink configuration | | - | Note10 | Note10 |
| Time alignment error relative to cell 1 <small>Note 11</small> | | - | $\leq TAE$ | - |
| DMTC period | ms | - | 40 | 40 |
| DMTC period offset | ms | - | 10 | 10 |
| Discovery signal occasion duration | ms | - | 1 | 1 |
| CSI-RS resource configuration | | - | 1 | 6 |
| CSI-RS subframe offset | ms | - | 0 | 0 |
| CSI-RS individual offset[2] | dB | - | 0 | 0 |
| LBT model | | - | - | A.3.17 |

| | | | | | |
|---|---------------------------|---|----------------------------------|-------------------------|-------------------------|
| Measurement bandwidth | n_{PRB} | 5 MHz: 10—15 10 MHz: 22—27 20 MHz: 47—52 | 47—52 | 47—52 | |
| PDSCH Reference measurement channel defined in A.3.1.1 | | 5 MHz: R.5 FDD 10 MHz: R.0 FDD 20 MHz: R.4 FDD | R.0 FS3 | - | |
| PDSCH allocation | n_{PRB} | 5 MHz: 7-17 10 MHz: 13-36 20 MHz: 38-61 | 38—61 | - | |
| PDCCH/PCFICH/PHICH Reference measurement channel defined in A.3.1.2 | | 5 MHz: R.11 FDD 10 MHz: R.6 FDD 20 MHz: R.10 FDD | R.0 FS3 | R.0 FS3 | |
| OCNG Patterns defined in A.3.2 | | 5 MHz: OP.15 FDD 10 MHz: OP.1 FDD 20 MHz: OP.11 FDD | OP.13 FDD | OP.14 FDD | |
| PBCH_RA | dB | 0 | 0 | 0 | |
| PBCH_RB | | | | | |
| PSS_RA | | | | | |
| SSS_RA | | | | | |
| PCFICH_RB | | | | | |
| PHICH_RA | | | | | |
| PHICH_RB | | | | | |
| PDCCH_RA | | | | | |
| PDCCH_RB | | | | | |
| PDSCH_RA | | | | | |
| PDSCH_RB | | | | | |
| OCNG_RANote1 | | | | | |
| OCNG_RBNote | | | | | |
| N_{oc} Note2 | | | | | Bands FDD_A |
| | Bands FDD_B | -116.5 | | | |
| | Bands FDD_C | -116 | | | |
| | Bands FDD_D | -115.5 | | | |
| | Bands FDD_E, FDD_F Note 6 | -115 | | | |
| | Bands FDD_G | -114 | | | |
| | Bands FDD_H | -113.5 | | | |
| | Bands FS3_G | - | (N_{oc} for Channel 1 + 1 dB) | | |
| $CRS \hat{E}_s / I_{ot}$ | dB | -4 | 0.46 | -5.76 | |
| $CSI-RS \hat{E}_s / I_{ot}$ Note3 | dB | - | 6.46 | 0.24 | |
| RSRPNote3 | Bands FDD_A | -121 | - | - | |
| | Bands FDD_B | -120.5 | | | |
| | Bands FDD_C | -120 | | | |
| | Bands FDD_D | -119.5 | | | |
| | Bands FDD_E, FDD_F Note 6 | -119 | | | |
| | Bands FDD_G | -118 | | | |
| | Bands FDD_H | -117.5 | | | |
| | Bands FS3_G | - | | | RSRP for Cell 1 + 8 dB) |
| CSI-RSRPNote3 | Bands FS3_G | dBm/1 5 kHz | - | RSRP for Cell 2 + 6 dB) | RSRP for Cell 3 + 6 dB) |
| I_0 Note3 | Bands FDD_A | dBm/ BW _{chan} nel | -87.76+10log($N_{RB,c}/50$) | - | - |
| | Bands FDD_B | | -87.26+10log($N_{RB,c}/50$) | | |
| | Bands FDD_C | | -86.76+10log($N_{RB,c}/50$) | | |
| | Bands FDD_D | | -86.26+10log($N_{RB,c}/50$) | | |
| | Bands FDD_E, FDD_F Note 6 | | -85.76 +10log($N_{RB,c}/50$) | | |
| | Bands FDD_G | | -84.76 +10log($N_{RB,c}/50$) | | |
| | Bands FDD_H | | -84.26 +10log($N_{RB,c}/50$) | | |

| | | | | | |
|-----------------------------|---|----|------|---|------|
| | Bands FS3_G | | - | (lo for Channel 1 + 5.33 dB +10log ($N_{RB\ channel2} / N_{RB\ channel1}$)) | |
| CRS \hat{E}_s / N_{oc} | | dB | -4 | 3 | -1 |
| CSI-RS \hat{E}_s / N_{oc} | | dB | - | 9 | 5 |
| Propagation condition | - | | AWGN | AWGN | AWGN |
| Antenna Configuration | - | | 1x2 | 1x2 | 1x2 |
| Note 1: | OCNG shall be used such that cells are fully allocated and a constant total transmitted power spectral density is achieved for all OFDM symbols. For cells with LBT model, OCNG is transmitted only in subframes with downlink transmission bursts, and is not transmitted during muted subframes or during DMTC windows. | | | | |
| Note 2: | Interference from other cells and noise sources not specified in the test is assumed to be constant over subcarriers and time and shall be modelled as AWGN of appropriate power for N_{oc} to be fulfilled. | | | | |
| Note 3: | CSI-RS Es/lot, RSRP, CSI-RSRP and lo levels have been derived from other parameters for information purposes. They are not settable parameters themselves. lo levels are calculated in CRS symbols of measurement subframe. | | | | |
| Note 4: | RSRP minimum requirements are specified assuming independent interference and noise at each receiver antenna port. | | | | |
| Note 5: | The selection of the bands for testing depends on the configuration of the carrier aggregation supported by the UEs. | | | | |
| Note 6: | For Band 26, the tests shall be performed with the carrier frequency of the assigned E-UTRA channel bandwidth within 865-894 MHz. | | | | |
| Note 7: | Void | | | | |
| Note 8: | E-UTRA operating band groups are as defined in Section 3.5. | | | | |
| Note 9: | DMTC configurations are provided to the UE in the <i>measDS-Config</i> (in TS36.331) before the beginning of the test. | | | | |
| Note 10: | Downlink only configuration | | | | |
| Note 11: | Time alignment error (TAE) as specified in TS 36.104 [30] clause 6.5.3.1. The TAE value depends upon the type of carrier aggregation. | | | | |

A.9.1.60.3 Test Requirements

In the test, the performance of CSI-RSRP measurements is verified from following three perspectives:

- The absolute accuracy of intra-frequency CSI-RSRP measurements for Cell 2 on the secondary component carrier shall fulfil the requirements defined in clause 9.1.18.4.4.
- The absolute accuracy of intra-frequency CSI-RSRP measurements for Cell 3 on the secondary component carrier shall fulfil the requirements defined in clause 9.1.18.4.4.
- The relative accuracy of intra-frequency CSI-RSRP measurements for Cell 3 relative to Cell 2 on the secondary component carrier shall fulfil the requirements defined in clause 9.1.18.4.5.

A.9.1.61 FS3 Absolute and relative CSI-RSRP accuracies for in CSI-RS based discovery signal with TDD PCell

A.9.1.61.1 Test Purpose and Environment

The purpose of this test is to verify that CSI- RSRP measurement accuracy is within the specified limits. This test will verify the absolute intra-frequency CSI-RSRP accuracy requirements of the SCells defined in Section 9.1.18.4.4 for intra-frequency measurements under FS3, and the relative intra-frequency CSI-RSRP accuracy requirements between SCells defined in Section 9.1.18.4.5.

A.9.1.61.2 Test parameters

In this set of cases Cell 1 is PCell on the primary component carrier, Cell 2 using FS3 is SCell on the secondary component carrier and activated, and Cell 3 using FS3 is the neighboring cell on the secondary component carrier. The

test parameters are given in Table A.9.1.61.2-1. The intra-frequency measurements are supported by a DMTC configuration.

A.9.1.61.2-1: CSI-RSRP carrier aggregation test parameters with TDD PCell and FS3 SCells

| Parameter | Unit | Test 1 | | |
|---|-------------|---|---------------------------------|-----------------------------|
| | | Cell 1 | Cell 2 | Cell3 |
| Frame structure | | TDD | FS3 | FS3 |
| E-UTRA RF Channel Number | | 1 | 2 | 2 |
| $BW_{channel}$ | MHz | 5MHz: $N_{RB,c} = 25$ 10MHz: $N_{RB,c} = 50$ 20MHz: $N_{RB,c} = 100$ | 20 MHz: $N_{RB,c} = 100$ | 20 MHz: $N_{RB,c} = 100$ |
| Timing offset to cell1 | μs | - | 0 | 3 |
| Special subframe configuration ^{Note1} | | 6 | Note10 | Note10 |
| Uplink/downlink configuration ^{Note1} | | 1 | Note10 | Note10 |
| Time alignment error relative to cell 1 ^{Note 11} | | - | $\leq TAE$ | - |
| DMTC period | ms | - | 40 | 40 |
| DMTC period offset | ms | - | 10 | 10 |
| Discovery signal occasion duration | ms | - | 1 | 1 |
| CSI-RS resource configuration | | - | 1 | 6 |
| CSI-RS subframe offset | ms | - | 0 | 0 |
| CSI-RS individual offset[2] | dB | - | 0 | 0 |
| LBT model | | - | - | A.3.17 |
| Measurement bandwidth | n_{PRB} | 5 MHz: 10—15 10 MHz: 22—27 20 MHz: 47—52 | 47—52 | 47—52 |
| PDSCH Reference measurement channel defined in A.3.1.1 | | 5 MHz: R.4 TDD 10 MHz: R.0 TDD 20 MHz: R.3 TDD | R.0 FS3 | - |
| PDSCH allocation | n_{PRB} | 5 MHz: 7-17 10 MHz: 13-36 20 MHz: 38-61 | 38—61 | - |
| PDCCH/PCFICH/PHICH Reference measurement channel defined in A.3.1.2 | | 5 MHz: R.11 TDD 10 MHz: R.6 TDD 20 MHz: R.10 TDD | R.0 FS3 | R.0 FS3 |
| OCNG Patterns defined in A.3.2 | | 5 MHz: OP.9 TDD 10 MHz: OP.1 TDD 20 MHz: OP.7 TDD | OP.13 FDD | OP.14 FDD |
| PBCH_RA | dB | 0 | 0 | 0 |
| PBCH_RB | | | | |
| PSS_RA | | | | |
| SSS_RA | | | | |
| PCFICH_RB | | | | |
| PHICH_RA | | | | |
| PHICH_RB | | | | |
| PDCCH_RA | | | | |
| PDCCH_RB | | | | |
| PDSCH_RA | | | | |
| PDSCH_RB | | | | |
| OCNG_RANote1 | | | | |
| OCNG_RBNote | | | | |
| N_{oc} ^{Note2} | | | | |
| | Bands TDD_C | -116 | | |
| | Bands TDD_E | -115 | | |
| | Bands FS3_G | - | $(N_{oc}$ for Channel 1 + 1 dB) | |
| $CRS \hat{E}_s / I_{ot}$ | dB | -4 | 0.46 | -5.76 |
| CSI-RS \hat{E}_s / I_{ot} ^{Note3} | dB | - | 6.46 | 0.24 |
| RSRP ^{Note3} | Bands TDD_A | -121 | - | - |
| | Bands TDD_C | -120 | | |
| | Bands TDD_E | -119 | | |

| | | | | | |
|---|-------------|-------------------------------|-------------------------------------|--|-------------------------|
| | Bands FS3_G | | - | RSRP for Cell 1 + 8 dB) | RSRP for Cell 1 + 4 dB) |
| CSI-RSRP ^{Note3} | Bands FS3_G | dBm/15 kHz | - | RSRP for Cell 2 + 6 dB) | RSRP for Cell 3 + 6 dB) |
| I _o ^{Note3} | Bands TDD_A | dBm/ BW _{channel} | -87.76+10log(N _{RB,c} /50) | - | - |
| | Bands TDD_C | | -86.76+10log(N _{RB,c} /50) | | |
| | Bands TDD_E | | -85.76+10log(N _{RB,c} /50) | | |
| | Bands FS3_G | | - | (I _o for Channel 1 + 5.33 dB +10log (N _{RB channel2} / N _{RB channel1})) | |
| CRS \hat{E}_s / N_{oc} | | dB | -4 | 3 | -1 |
| CSI-RS \hat{E}_s / N_{oc} | | dB | - | 9 | 5 |
| Propagation condition | | - | AWGN | AWGN | AWGN |
| Antenna Configuration | | - | 1x2 | 1x2 | 1x2 |
| <p>Note 1: OCNG shall be used such that cells are fully allocated and a constant total transmitted power spectral density is achieved for all OFDM symbols. For cells with LBT model, OCNG is transmitted only in subframes with downlink transmission bursts, and is not transmitted during muted subframes or during DMTC windows.</p> <p>Note 2: Interference from other cells and noise sources not specified in the test is assumed to be constant over subcarriers and time and shall be modelled as AWGN of appropriate power for N_{oc} to be fulfilled.</p> <p>Note 3: CSI-RS E_s/I_{ot}, RSRP, CSI-RSRP and I_o levels have been derived from other parameters for information purposes. They are not settable parameters themselves. I_o levels are calculated in CRS symbols of measurement subframe.</p> <p>Note 4: RSRP minimum requirements are specified assuming independent interference and noise at each receiver antenna port.</p> <p>Note 5: The selection of the bands for testing depends on the configuration of the carrier aggregation supported by the UEs.</p> <p>Note 6: Void</p> <p>Note 7: Void</p> <p>Note 8: E-UTRA operating band groups are as defined in Section 3.5.</p> <p>Note 9: DMTC configurations are provided to the UE in the <i>measDS-Config</i> (in TS36.331) before the beginning of the test.</p> <p>Note 10: Downlink only configuration.</p> <p>Note 11: Time alignment error (TAE) as specified in TS 36.104 [30] clause 6.5.3.1. The TAE value depends upon the type of carrier aggregation.</p> | | | | | |

A.9.1.61.3 Test Requirements

In the test, the performance of CSI-RSRP measurements is verified from following three perspectives:

- The absolute accuracy of intra-frequency CSI-RSRP measurements for Cell 2 on the secondary component carrier shall fulfil the requirements defined in clause 9.1.18.4.4.
- The absolute accuracy of intra-frequency CSI-RSRP measurements for Cell 3 on the secondary component carrier shall fulfil the requirements defined in clause 9.1.18.4.4.
- The relative accuracy of intra-frequency CSI-RSRP measurements for Cell 3 relative to Cell 2 on the secondary component carrier shall fulfil the requirements defined in clause 9.1.18.4.5.

A.9.2 RSRQ

A.9.2.1 FDD Intra frequency case

A.9.2.1.1 Test Purpose and Environment

The purpose of this test is to verify that the RSRQ measurement accuracy is within the specified limits. This test will verify the requirements in Clause 9.1.5.1.

A.9.2.1.2 Test parameters

In this test case all cells are on the same carrier frequency. The absolute accuracy of RSRQ intra frequency measurement is tested by using the parameters in Table A.9.2.1.2-1. In all test cases, Cell 1 is the PCell and Cell 2 the target cell.

Table A.9.2.1.2-1: RSRQ FDD Intra frequency test parameters

| Parameter | Unit | Test 1 | | Test 2 | | Test 3 | | |
|--|--------------------------------------|------------|----------|----------|----------|----------|----------|--------|
| | | Cell 1 | Cell 2 | Cell 1 | Cell 2 | Cell 1 | Cell 2 | |
| E-UTRA RF Channel Number | | 1 | | 1 | | 1 | | |
| BW _{channel} | MHz | 10 | | 10 | | 10 | | |
| Measurement bandwidth | n_{PRB} | 22—27 | | 22—27 | | 22—27 | | |
| PDSCH Reference measurement channel defined in A.3.1.1.1 | | R.0 FDD | - | R.0 FDD | - | R.0 FDD | - | |
| PDSCH allocation | n_{PRB} | 13—36 | - | 13—36 | - | 13—36 | - | |
| PDCCH/PCFICH/PHICH Reference measurement channel defined in A.3.1.2.1 | | R.6 FDD | | R.6 FDD | | R.6 FDD | | |
| OCNG Patterns defined in A.3.2.1.1 (OP.1 FDD) and A.3.2.1.2 (OP.2 FDD) | | OP.1 FDD | OP.2 FDD | OP.1 FDD | OP.2 FDD | OP.1 FDD | OP.2 FDD | |
| PBCH_RA | | | | | | | | |
| PBCH_RB | | | | | | | | |
| PSS_RA | | | | | | | | |
| SSS_RA | | | | | | | | |
| PCFICH_RB | | | | | | | | |
| PHICH_RA | | | | | | | | |
| PHICH_RB | dB | 0 | 0 | 0 | 0 | 0 | 0 | |
| PDCCH_RA | | | | | | | | |
| PDCCH_RB | | | | | | | | |
| PDSCH_RA | | | | | | | | |
| PDSCH_RB | | | | | | | | |
| OCNG_RA ^{Note1} | | | | | | | | |
| OCNG_RB ^{Note1} | | | | | | | | |
| N_{oc} ^{Note2} | Bands FDD_A ^{Note 8} | | | | | -116 | | |
| | Bands FDD_B | | | | | -115.5 | | |
| | Bands FDD_C | | | | | -115 | | |
| | Bands FDD_D | | | | | -114.5 | | |
| | Bands FDD_E, FDD_F ^{Note 5} | dBm/15 kHz | -84.76 | -84.76 | -103.85 | -103.85 | -114 | |
| | Bands FDD_G ^{Note 7} | | | | | | -113 | |
| | Bands FDD_H | | | | | | -112.5 | |
| \hat{E}_s/I_{ot} | dB | -1.76 | -1.76 | -4.7 | -4.7 | -5.46 | -5.46 | |
| RSRP ^{Note3} | Bands FDD_A ^{Note 8} | | | | | -120 | -120 | |
| | Bands FDD_B | | | | | -119.5 | -119.5 | |
| | Bands FDD_C | | | | | -119 | -119 | |
| | Bands FDD_D | dBm/15 kHz | -81.76 | -81.76 | -106.75 | -106.75 | -118.5 | -118.5 |
| | Bands FDD_E, FDD_F ^{Note 5} | | | | | -118 | -118 | |
| | Bands FDD_G ^{Note 7} | | | | | -117 | -117 | |
| | Bands FDD_H | | | | | -116.5 | -116.5 | |
| RSRQ ^{Note3} | Bands FDD_A ^{Note 8} | | | | | | | |
| | Bands FDD_B | dB | -14.77 | -14.77 | -16.76 | -16.76 | -17.34 | -17.34 |
| | Bands FDD_C | | | | | | | |
| | Bands FDD_D | | | | | | | |
| | Bands FDD_E, FDD_F ^{Note 5} | | | | | | | |

| | | | | | | | | |
|--|------------------------------|-----------|------|-----|------|------|--------|----|
| | Bands FDD_G Note 7 | | | | | | | |
| | Bands FDD_H | | | | | | | |
| I _o Note3 | Bands FDD_A Note 8 | dBm/9 MHz | -50 | -50 | -73 | -73 | -85.67 | |
| | Bands FDD_B | | | | | | -85.17 | |
| | Bands FDD_C | | | | | | -84.67 | |
| | Bands FDD_D | | | | | | -84.17 | |
| | Bands FDD_E, FDD_F Note 5 | | | | | | -83.67 | |
| | Bands FDD_G Note 7 | | | | | | -82.67 | |
| | Bands FDD_H | | | | | | -82.17 | |
| \hat{E}_s / N_{oc} | | dB | 3 | 3 | -2.9 | -2.9 | -4 | -4 |
| Propagation condition | | - | AWGN | | AWGN | | AWGN | |
| <p>Note 1: OCNG shall be used such that both cells are fully allocated and a constant total transmitted power spectral density is achieved for all OFDM symbols.</p> <p>Note 2: Interference from other cells and noise sources not specified in the test is assumed to be constant over subcarriers and time and shall be modelled as AWGN of appropriate power for N_{oc} to be fulfilled.</p> <p>Note 3: RSRQ, RSRP and I_o levels have been derived from other parameters for information purposes. They are not settable parameters themselves.</p> <p>Note 4: RSRP and RSRQ minimum requirements are specified assuming independent interference and noise at each receiver antenna port.</p> <p>Note 5: For Band 26, the tests shall be performed with the carrier frequency of the assigned E-UTRA channel bandwidth within 865-894 MHz.</p> <p>Note 6: E-UTRA operating band groups are as defined in Section 3.5.</p> <p>Note 7: Except Band 29.</p> <p>Note 8: Except Band 32.</p> | | | | | | | | |

A.9.2.1.3 Test Requirements

The RSRQ measurement accuracy shall fulfil the requirements in Clause 9.1.5.1.

A.9.2.2 TDD Intra frequency case

A.9.2.2.1 Test Purpose and Environment

The purpose of this test is to verify that the RSRQ measurement accuracy is within the specified limits. This test will verify the requirements in Clause 9.1.5.1.

A.9.2.2.2 Test parameters

In this test case all cells are on the same carrier frequency. The absolute accuracy of RSRQ intra frequency measurement is tested by using the parameters in Table A.9.2.2.2-1. In all test cases, Cell 1 is the PCell and Cell 2 the target cell.

Table A.9.2.2-1: RSRQ TDD Intra frequency test parameters

| Parameter | Unit | Test 1 | | Test 2 | | Test 3 | | | | | | | | |
|--|---------------------------|------------|----------|----------|----------|----------|----------|-------------|--------|--------|---------|---------|------|--|
| | | Cell 1 | Cell 2 | Cell 1 | Cell 2 | Cell 1 | Cell 2 | | | | | | | |
| E-UTRA RF Channel Number | | 1 | | 1 | | 1 | | | | | | | | |
| $BW_{channel}$ | MHz | 10 | | 10 | | 10 | | | | | | | | |
| Special subframe configuration ^{Note1} | | 6 | | 6 | | 6 | | | | | | | | |
| Uplink-downlink configuration ^{Note1} | | 1 | | 1 | | 1 | | | | | | | | |
| Measurement bandwidth | n_{PRB} | 22—27 | | 22—27 | | 22—27 | | | | | | | | |
| PDSCH Reference measurement channel defined in A.3.1.1.2 | | R.0 TDD | - | R.0 TDD | - | R.0 TDD | - | | | | | | | |
| PDSCH allocation | n_{PRB} | 13—36 | - | 13—36 | - | 13—36 | - | | | | | | | |
| PDCCH/PCFICH/PHICH Reference measurement channel defined in A.3.1.2.2 | | R.6 TDD | | R.6 TDD | | R.6 TDD | | | | | | | | |
| OCNG Patterns defined in A.3.2.2.1 (OP.1 TDD) and A.3.2.2.2 (OP.2 TDD) | | OP.1 TDD | OP.2 TDD | OP.1 TDD | OP.2 TDD | OP.1 TDD | OP.2 TDD | | | | | | | |
| PBCH_RA | dB | 0 | 0 | 0 | 0 | 0 | 0 | | | | | | | |
| PBCH_RB | | | | | | | | | | | | | | |
| PSS_RA | | | | | | | | | | | | | | |
| SSS_RA | | | | | | | | | | | | | | |
| PCFICH_RB | | | | | | | | | | | | | | |
| PHICH_RA | | | | | | | | | | | | | | |
| PHICH_RB | | | | | | | | | | | | | | |
| PDCCH_RA | | | | | | | | | | | | | | |
| PDCCH_RB | | | | | | | | | | | | | | |
| PDSCH_RA | | | | | | | | | | | | | | |
| PDSCH_RB | | | | | | | | | | | | | | |
| OCNG_RA ^{Note2} | | | | | | | | | | | | | | |
| OCNG_RB ^{Note2} | | | | | | | | | | | | | | |
| N_{oc} ^{Note3} | | | | | | | | Bands TDD_A | | | | | -116 | |
| | | | | | | | | Bands TDD_C | -84.76 | -84.76 | -103.85 | -103.85 | -115 | |
| | Bands TDD_E | | | | | -114 | | | | | | | | |
| \hat{E}_s / I_{ot} | dB | -1.76 | -1.76 | -4.7 | -4.7 | -5.46 | -5.46 | | | | | | | |
| RSRP ^{Note4} | Bands TDD_A | dBm/15 kHz | -81.76 | -81.76 | -106.75 | -106.75 | -120 | -120 | | | | | | |
| | Bands TDD_C | | | | | | -119 | -119 | | | | | | |
| | Bands TDD_E | | | | | | -118 | -118 | | | | | | |
| RSRQ ^{Note4} | Bands TDD_A, TDD_C, TDD_E | dB | -14.77 | -14.77 | -16.76 | -16.76 | -17.34 | -17.34 | | | | | | |
| I_o ^{Note4} | Bands TDD_A | dBm/9 MHz | -50 | -50 | -73 | -73 | -85.67 | | | | | | | |
| | Bands TDD_C | | | | | | -84.67 | | | | | | | |
| | Bands TDD_E | | | | | | -83.67 | | | | | | | |
| \hat{E}_s / N_{oc} | dB | 3 | 3 | -2.9 | -2.9 | -4 | -4 | | | | | | | |
| Propagation condition | - | AWGN | | AWGN | | AWGN | | | | | | | | |
| <p>Note 1: For special subframe and uplink-downlink configurations see Tables 4.2-1 and 4.2-2 in TS 36.211.</p> <p>Note 2: OCNG shall be used such that both cells are fully allocated and a constant total transmitted power spectral density is achieved for all OFDM symbols.</p> <p>Note 3: Interference from other cells and noise sources not specified in the test is assumed to be constant over subcarriers and time and shall be modelled as AWGN of appropriate power for N_{oc} to be fulfilled.</p> <p>Note 4: RSRQ, RSRP and I_o levels have been derived from other parameters for information purposes. They are not settable parameters themselves.</p> <p>Note 5: RSRP and RSRQ minimum requirements are specified assuming independent interference and noise at each receiver antenna port.</p> <p>Note 6: E-UTRA operating band groups are as defined in Section 3.5.</p> | | | | | | | | | | | | | | |

A.9.2.2.3 Test Requirements

The RSRQ measurement accuracy shall fulfil the requirements in Sections 9.1.5.1.

A.9.2.3 FDD—FDD Inter frequency case

A.9.2.3.1 Test Purpose and Environment

The purpose of this test is to verify that the RSRQ measurement accuracy is within the specified limits. This test will verify the requirements in Sections 9.1.6.1 and 9.1.6.2.

A.9.2.3.2 Test parameters

In this test case the two cells are on different carrier frequencies and measurement gaps are provided. Both RSRQ inter frequency absolute and relative accuracy requirements are tested by using test parameters in Table A.9.2.3.2-1. In all tests, Cell 1 is the PCell and Cell 2 the target cell.

Table A.9.2.3.2-1: RSRQ FDD—FDD Inter frequency test parameters

| Parameter | Unit | Test 1 | | Test 2 | | Test 3 | | | | | | | | |
|--|--------------------------------------|----------|----------|----------|----------|----------|----------|-------------------------------|-----|-----|---------|---------|--------|--------|
| | | Cell 1 | Cell 2 | Cell 1 | Cell 2 | Cell 1 | Cell 2 | | | | | | | |
| E-UTRA RF Channel Number | | 1 | 2 | 1 | 2 | 1 | 2 | | | | | | | |
| BW _{channel} | MHz | 10 | 10 | 10 | 10 | 10 | 10 | | | | | | | |
| Gap Pattern Id | | 0 | - | 0 | - | 0 | - | | | | | | | |
| Measurement bandwidth | n_{PRB} | 22—27 | | 22—27 | | 22—27 | | | | | | | | |
| PDSCH Reference measurement channel defined in A.3.1.1.1 | | R.0 FDD | - | R.0 FDD | - | R.0 FDD | - | | | | | | | |
| PDSCH allocation | n_{PRB} | 13—36 | - | 13—36 | - | 13—36 | - | | | | | | | |
| PDCCH/PCFICH/PHICH Reference measurement channel defined in A.3.1.2.1 | | R.6 FDD | | R.6 FDD | | R.6 FDD | | | | | | | | |
| OCNG Patterns defined in A.3.2.1.1 (OP.1 FDD) and A.3.2.1.2 (OP.2 FDD) | | OP.1 FDD | OP.2 FDD | OP.1 FDD | OP.2 FDD | OP.1 FDD | OP.2 FDD | | | | | | | |
| PBCH_RA | dB | 0 | 0 | 0 | 0 | 0 | 0 | | | | | | | |
| PBCH_RB | | | | | | | | | | | | | | |
| PSS_RA | | | | | | | | | | | | | | |
| SSS_RA | | | | | | | | | | | | | | |
| PCFICH_RB | | | | | | | | | | | | | | |
| PHICH_RA | | | | | | | | | | | | | | |
| PHICH_RB | | | | | | | | | | | | | | |
| PDCCH_RA | | | | | | | | | | | | | | |
| PDCCH_RB | | | | | | | | | | | | | | |
| PDSCH_RA | | | | | | | | | | | | | | |
| PDSCH_RB | | | | | | | | | | | | | | |
| OCNG_RA ^{Note1} | | | | | | | | | | | | | | |
| OCNG_RB ^{Note1} | | | | | | | | | | | | | | |
| N_{oc} ^{Note2} | | | | | | | | Bands FDD_A ^{Note 8} | -80 | -80 | -104.70 | -104.70 | -119.5 | -119.5 |
| | | | | | | | | Bands FDD_B | | | | | -119 | -119 |
| | Bands FDD_C | -118.5 | -118.5 | | | | | | | | | | | |
| | Bands FDD_D | -118 | -118 | | | | | | | | | | | |
| | Bands FDD_E, FDD_F ^{Note 5} | -117.5 | -117.5 | | | | | | | | | | | |
| | Bands FDD_G ^{Note 7} | -116.5 | -116.5 | | | | | | | | | | | |
| Bands FDD_H | -116 | -116 | | | | | | | | | | | | |
| \hat{E}_s/I_{ot} | dB | -1.75 | -1.75 | -4.0 | -4.0 | -4.0 | -4.0 | | | | | | | |
| RSRP ^{Note3} | Bands FDD_A ^{Note 8} | -81.75 | -81.75 | -108.70 | -108.70 | -123.5 | -123.5 | | | | | | | |
| | Bands FDD_B | | | | | -123 | -123 | | | | | | | |

| | | | | | | | | |
|--|---|-----------|--------|--------|--------|--------|--------|--------|
| | Bands FDD_C | | | | | | -122.5 | -122.5 |
| | Bands FDD_D | | | | | | -122 | -122 |
| | Bands FDD_E, FDD_F ^{Note 5} | | | | | | -121.5 | -121.5 |
| | Bands FDD_G ^{Note 7} | | | | | | -120.5 | -120.5 |
| | Bands FDD_H | | | | | | -120 | -120 |
| RSRQ ^{Note3} | Bands FDD_A ^{Note 8} | | | | | | | |
| | Bands FDD_B | | | | | | | |
| | Bands FDD_C | dB | -14.76 | -14.76 | -16.25 | -16.25 | -16.25 | -16.25 |
| | Bands FDD_D | | | | | | | |
| | Bands FDD_E, FDD_F ^{Note 5} | | | | | | | |
| | Bands FDD_G ^{Note 7} | | | | | | | |
| Bands FDD_H | | | | | | | | |
| | | | | | | | | |
| I _o ^{Note3} | Bands FDD_A ^{Note 8} | dBm/9 MHz | -50 | -50 | -75.46 | -75.46 | -90.26 | -90.26 |
| | Bands FDD_B | | | | | | -89.76 | -89.76 |
| | Bands FDD_C | | | | | | -89.26 | -89.26 |
| | Bands FDD_D | | | | | | -88.76 | -88.76 |
| | Bands FDD_E, FDD_F ^{Note 5} | | | | | | -88.26 | -88.26 |
| | Bands FDD_G ^{Note 7} | | | | | | -87.26 | -87.26 |
| | Bands FDD_H | | | | | | -86.76 | -86.76 |
| \hat{E}_s / N_{oc} | dB | -1.75 | -1.75 | -4.0 | -4.0 | -4.0 | -4.0 | |
| Propagation condition | | - | AWGN | | AWGN | | AWGN | |
| <p>Note 1: OCNG shall be used such that both cells are fully allocated and a constant total transmitted power spectral density is achieved for all OFDM symbols.</p> <p>Note 2: Interference from other cells and noise sources not specified in the test is assumed to be constant over subcarriers and time and shall be modelled as AWGN of appropriate power for N_{oc} to be fulfilled.</p> <p>Note 3: RSRQ, RSRP and I_o levels have been derived from other parameters for information purposes. They are not settable parameters themselves.</p> <p>Note 4: RSRP and RSRQ minimum requirements are specified assuming independent interference and noise at each receiver antenna port.</p> <p>Note 5: For Band 26, the tests shall be performed with the carrier frequency of the assigned E-UTRA channel bandwidth within 865-894 MHz.</p> <p>Note 6: E-UTRA operating band groups are as defined in Section 3.5.</p> <p>Note 7: Except Band 29.</p> <p>Note 8: Except Band 32.</p> | | | | | | | | |

A.9.2.3.3 Test Requirements

The RSRQ measurement accuracy shall fulfil the requirements in Sections 9.1.6.1 and 9.1.6.2.

A.9.2.4 TDD—TDD Inter frequency case

A.9.2.4.1 Test Purpose and Environment

The purpose of this test is to verify that the RSRQ measurement accuracy is within the specified limits. This test will verify the requirements in Sections 9.1.6.1 and 9.1.6.2.

A.9.2.4.2 Test parameters

In this test case the two cells are on different carrier frequencies and measurement gaps are provided. Both RSRQ inter frequency absolute and relative accuracy requirements are tested by using test parameters in Table A.9.2.4.2-1 for TDD configuration 1 and in Table A.9.2.4.2-2 for TDD configuration 0. In all tests, Cell 1 is the PCell and Cell 2 the target cell.

Table A 9.2.4.2-1: RSRQ TDD—TDD Inter frequency test parameters for TDD configuration 1

| Parameter | Unit | Test 1 | | Test 2 | | Test 3 | | |
|--|---------------------------|------------|----------|----------|----------|----------|----------|-------------|
| | | Cell 1 | Cell 2 | Cell 1 | Cell 2 | Cell 1 | Cell 2 | |
| E-UTRA RF Channel Number | | 1 | 2 | 1 | 2 | 1 | 2 | |
| $BW_{channel}$ | MHz | 10 | 10 | 10 | 10 | 10 | 10 | |
| Gap Pattern Id | | 0 | - | 0 | - | 0 | - | |
| Special subframe configuration ^{Note1} | | 6 | | 6 | | 6 | | |
| Uplink-downlink configuration ^{Note1} | | 1 | | 1 | | 1 | | |
| Measurement bandwidth | n_{PRB} | 22—27 | | 22—27 | | 22—27 | | |
| PDSCH Reference measurement channel defined in A.3.1.1.2 | | R.0 TDD | - | R.0 TDD | - | R.0 TDD | - | |
| PDSCH allocation | n_{PRB} | 13—36 | - | 13—36 | - | 13—36 | - | |
| PDCCH/PCFICH/PHICH Reference measurement channel defined in A.3.1.2.2 | | R.6 TDD | | R.6 TDD | | R.6 TDD | | |
| OCNG Patterns defined in A.3.2.2.1 (OP.1 TDD) and A.3.2.2.2 (OP.2 TDD) | | OP.1 TDD | OP.2 TDD | OP.1 TDD | OP.2 TDD | OP.1 TDD | OP.2 TDD | |
| PBCH_RA | dB | 0 | 0 | 0 | 0 | 0 | 0 | |
| PBCH_RB | | | | | | | | |
| PSS_RA | | | | | | | | |
| SSS_RA | | | | | | | | |
| PCFICH_RB | | | | | | | | |
| PHICH_RA | | | | | | | | |
| PHICH_RB | | | | | | | | |
| PDCCH_RA | | | | | | | | |
| PDCCH_RB | | | | | | | | |
| PDSCH_RA | | | | | | | | |
| PDSCH_RB | | | | | | | | |
| OCNG_RA ^{Note2} | | | | | | | | |
| OCNG_RB ^{Note2} | | | | | | | | |
| N_{oc} ^{Note3} | | | | | | | | Bands TDD_A |
| | Bands TDD_C | -118.50 | -118.50 | | | | | |
| | Bands TDD_E | -117.50 | -117.50 | | | | | |
| \hat{E}_s / I_{ot} | | | -1.75 | -1.75 | -4.0 | -4.0 | -4.0 | -4.0 |
| RSRP ^{Note4} | Bands TDD_A | dBm/15 kHz | -81.75 | -81.75 | -108.70 | 108.70 | -123.50 | -123.50 |
| | Bands TDD_C | | | | | | -122.50 | -122.50 |
| | Bands TDD_E | | | | | | -121.50 | -121.50 |
| RSRQ ^{Note4} | Bands TDD_A, TDD_C, TDD_E | | -14.76 | -14.76 | -16.25 | -16.25 | -16.25 | -16.25 |
| I_o ^{Note4} | Bands TDD_A | dBm/9 MHz | -50 | -50 | -75.46 | -75.46 | -90.26 | -90.26 |
| | Bands TDD_C | | | | | | -89.26 | -89.26 |
| | Bands TDD_E | | | | | | -88.26 | -88.26 |
| \hat{E}_s / N_{oc} | | | -1.75 | -1.75 | -4.0 | -4.0 | -4.0 | -4.0 |
| Propagation condition | | | AWGN | | AWGN | | AWGN | |
| <p>Note 1: For special subframe and uplink-downlink configurations see Tables 4.2-1 and 4.2-2 in TS 36.211.</p> <p>Note 2: OCNG shall be used such that both cells are fully allocated and a constant total transmitted power spectral density is achieved for all OFDM symbols.</p> <p>Note 3: Interference from other cells and noise sources not specified in the test is assumed to be constant over subcarriers and time and shall be modelled as AWGN of appropriate power for N_{oc} to be fulfilled.</p> <p>Note 4: RSRQ, RSRP and I_o levels have been derived from other parameters for information purposes. They are not settable parameters themselves.</p> <p>Note 5: RSRP and RSRQ minimum requirements are specified assuming independent interference and noise at each receiver antenna port.</p> <p>Note 6: E-UTRA operating band groups are as defined in Section 3.5.</p> | | | | | | | | |

Table A 9.2.4.2-2: RSRQ TDD—TDD Inter frequency test parameters for TDD configuration 0

| Parameter | Unit | Test 1 | Test 2 | Test 3 |
|-----------|------|--------|--------|--------|
|-----------|------|--------|--------|--------|

| | | Cell 1 | Cell 2 | Cell 1 | Cell 2 | Cell 1 | Cell 2 | |
|--|---------------------------|------------|----------|----------|----------|----------|----------|------------|
| E-UTRA RF Channel Number | | 1 | 2 | 1 | 2 | 1 | 2 | |
| BW _{channel} | MHz | 10 | 10 | 10 | 10 | 10 | 10 | |
| Gap Pattern Id | | 0 | - | 0 | - | 0 | - | |
| Special subframe configuration ^{Note1} | | 6 | | 6 | | 6 | | |
| Uplink-downlink configuration ^{Note1} | | 0 | | 0 | | 0 | | |
| Measurement bandwidth | | n_{PRB} | | 22—27 | | 22—27 | | |
| PDSCH Reference measurement channel defined in A.3.1.1.2 | | R.5 TDD | - | R.5 TDD | - | R.5 TDD | - | |
| PDSCH allocation | | n_{PRB} | | 13—36 | | 13—36 | | |
| PDCCH/PCFICH/PHICH Reference measurement channel defined in A.3.1.2.2 | | R.6 TDD | | R.6 TDD | | R.6 TDD | | |
| OCNG Patterns defined in A.3.2.2.1 (OP.1 TDD) and A.3.2.2.2 (OP.2 TDD) | | OP.1 TDD | OP.2 TDD | OP.1 TDD | OP.2 TDD | OP.1 TDD | OP.2 TDD | |
| PBCH_RA | | dB | 0 | 0 | 0 | 0 | 0 | |
| PBCH_RB | | | | | | | | |
| PSS_RA | | | | | | | | |
| SSS_RA | | | | | | | | |
| PCFICH_RB | | | | | | | | |
| PHICH_RA | | | | | | | | |
| PHICH_RB | | | | | | | | |
| PDCCH_RA | | | | | | | | |
| PDCCH_RB | | | | | | | | |
| PDSCH_RA | | | | | | | | |
| PDSCH_RB | | | | | | | | |
| OCNG_RA ^{Note2} | | | | | | | | |
| OCNG_RB ^{Note2} | | | | | | | | |
| N_{oc} ^{Note3} | Bands TDD_A | | | | | | | dBm/15 kHz |
| | Bands TDD_C | -118.50 | -118.50 | | | | | |
| | Bands TDD_E | -117.50 | -117.50 | | | | | |
| \hat{E}_s/I_{ot} | | dB | -1.75 | -1.75 | -4.0 | -4.0 | -4.0 | -4.0 |
| RSRP ^{Note4} | Bands TDD_A | dBm/15 kHz | -81.75 | -81.75 | -108.70 | 108.70 | -123.50 | -123.50 |
| | Bands TDD_C | | | | | | -122.50 | -122.50 |
| | Bands TDD_E | | | | | | -121.50 | -121.50 |
| RSRQ ^{Note4} | Bands TDD_A, TDD_C, TDD_E | dB | -14.76 | -14.76 | -16.25 | -16.25 | -16.25 | -16.25 |
| I_o ^{Note4} | Bands TDD_A | dBm/9 MHz | -50 | -50 | -75.46 | -75.46 | -90.26 | -90.26 |
| | Bands TDD_C | | | | | | -89.26 | -89.26 |
| | Bands TDD_E | | | | | | -88.26 | -88.26 |
| \hat{E}_s/N_{oc} | | dB | -1.75 | -1.75 | -4.0 | -4.0 | -4.0 | -4.0 |
| Propagation condition | | - | AWGN | | AWGN | | AWGN | |
| <p>Note 1: For special subframe and uplink-downlink configurations see Tables 4.2-1 and 4.2-2 in TS 36.211.</p> <p>Note 2: OCNG shall be used such that both cells are fully allocated and a constant total transmitted power spectral density is achieved for all OFDM symbols.</p> <p>Note 3: Interference from other cells and noise sources not specified in the test is assumed to be constant over subcarriers and time and shall be modelled as AWGN of appropriate power for N_{oc} to be fulfilled.</p> <p>Note 4: RSRQ, RSRP and I_o levels have been derived from other parameters for information purposes. They are not settable parameters themselves.</p> <p>Note 5: RSRP and RSRQ minimum requirements are specified assuming independent interference and noise at each receiver antenna port.</p> <p>Note 6: E-UTRA operating band groups are as defined in Section 3.5.</p> | | | | | | | | |

A.9.2.4.3 Test Requirements

The RSRQ measurement accuracy shall fulfil the requirements in Sections 9.1.6.1 and 9.1.6.2.

A.9.2.4A FDD—TDD Inter frequency case

A.9.2.4A.1 Test Purpose and Environment

The purpose of this test is to verify that the RSRQ measurement accuracy is within the specified limits. This test will verify the requirements in Sections 9.1.6.1 and 9.1.6.2 for FDD—TDD inter frequency measurements.

A.9.2.4A.2 Test parameters

In this set of test cases the two cells are on different carrier frequencies. Both absolute and relative accuracy of RSRQ inter frequency measurements are tested by using the parameters in Table A.9.2.4A.2-1 and Table A.9.2.4A.2-2. In all test cases, Cell 1 is the PCell and Cell 2 the target cell. Cell 1 is FDD cell and Cell 2 is TDD cell. The inter frequency measurements are supported by a measurement gap.

Table A.9.2.4A.2-1: RSRQ FDD—TDD Inter frequency test parameters (FDD Cell1)

| Parameter | Unit | Test 1 | Test 2 | Test 3 |
|---|------------------|----------|----------|----------|
| | | Cell 1 | Cell 1 | Cell 1 |
| E-UTRA RF Channel Number | | 1 | 1 | 1 |
| BW_{channel} | MHz | 10 | 10 | 10 |
| Gap Pattern Id | | 0 | 0 | 0 |
| Measurement bandwidth | n_{PRB} | 22—27 | 22—27 | 22—27 |
| PDSCH Reference measurement channel defined in A.3.1.1.1 | | R.0 FDD | R.0 FDD | R.0 FDD |
| PDSCH allocation | n_{PRB} | 13—36 | 13—36 | 13—36 |
| PDCCH/PCFICH/PHICH Reference measurement channel defined in A.3.1.2.1 | | R.6 FDD | R.6 FDD | R.6 FDD |
| OCNG Patterns defined in A.3.2.1.1 (OP.1 FDD) | | OP.1 FDD | OP.1 FDD | OP.1 FDD |
| PBCH_RA | | | | |
| PBCH_RB | | | | |
| PSS_RA | | | | |
| SSS_RA | | | | |
| PCFICH_RB | | | | |
| PHICH_RA | | | | |
| PHICH_RB | dB | 0 | 0 | 0 |
| PDCCH_RA | | | | |
| PDCCH_RB | | | | |
| PDSCH_RA | | | | |
| PDSCH_RB | | | | |
| OCNG_RA ^{Note1} | | | | |
| OCNG_RB ^{Note1} | | | | |
| N_{oc} ^{Note2} | dBm/15 kHz | -80 | -104.70 | -114.5 |
| \hat{E}_s/I_{ot} | dB | -1.75 | -4.0 | -4.0 |
| RSRP ^{Note3} | dBm/15 kHz | -81.75 | -108.70 | -118.5 |
| RSRQ ^{Note3} | dB | -14.76 | -16.25 | -16.25 |
| I_o ^{Note3} | dBm/9 MHz | -50 | -75.46 | -85.26 |
| \hat{E}_s/N_{oc} | dB | -1.75 | -4.0 | -4.0 |
| Propagation condition | - | AWGN | AWGN | AWGN |

- Note 1: OCNG shall be used such that both cells are fully allocated and a constant total transmitted power spectral density is achieved for all OFDM symbols.
- Note 2: Interference from other cells and noise sources not specified in the test is assumed to be constant over subcarriers and time and shall be modelled as AWGN of appropriate power for N_{oc} to be fulfilled.
- Note 3: RSRQ, RSRP and I_o levels have been derived from other parameters for information purposes. They are not settable parameters themselves.
- Note 4: RSRP and RSRQ minimum requirements are specified assuming independent interference and noise at each receiver antenna port.

Table A.9.2.4A.2-2: RSRQ FDD—TDD Inter frequency test parameters (TDD cell2)

| Parameter | Unit | Test 1 | Test 2 | Test 3 | | | | |
|---|------------|----------|----------|----------|------------|-------|---------|---------|
| | | Cell 2 | Cell 2 | Cell 2 | | | | |
| E-UTRA RF Channel Number | | 2 | 2 | 2 | | | | |
| $BW_{channel}$ | MHz | 10 | 10 | 10 | | | | |
| Gap Pattern Id | | - | - | - | | | | |
| Special subframe configuration <small>Note1</small> | | 6 | 6 | 6 | | | | |
| Uplink-downlink configuration <small>Note1</small> | | 1 | 1 | 1 | | | | |
| Measurement bandwidth | n_{PRB} | 22—27 | 22—27 | 22—27 | | | | |
| PDSCH Reference measurement channel | | - | - | - | | | | |
| PDSCH allocation | n_{PRB} | - | - | - | | | | |
| PDCCH/PCFICH/PHICH Reference measurement channel defined in A.3.1.2.2 | | R.6 TDD | R.6 TDD | R.6 TDD | | | | |
| OCNG Patterns defined in A.3.2.2.2 (OP.2 TDD) | | OP.2 TDD | OP.2 TDD | OP.2 TDD | | | | |
| PBCH_RA | dB | 0 | 0 | 0 | | | | |
| PBCH_RB | | | | | | | | |
| PSS_RA | | | | | | | | |
| SSS_RA | | | | | | | | |
| PCFICH_RB | | | | | | | | |
| PHICH_RA | | | | | | | | |
| PHICH_RB | | | | | | | | |
| PDCCH_RA | | | | | | | | |
| PDCCH_RB | | | | | | | | |
| PDSCH_RA | | | | | | | | |
| PDSCH_RB | | | | | | | | |
| OCNG_RA <small>Note2</small> | | | | | | | | |
| OCNG_RB <small>Note2</small> | | | | | | | | |
| N_{oc} <small>Note3</small> | | | | | dBm/15 kHz | -80 | -104.70 | -114.50 |
| \hat{E}_s / I_{ot} | | | | | dB | -1.75 | -4.0 | -4.0 |
| RSRP <small>Note4</small> | dBm/15 kHz | -81.75 | -108.70 | -118.50 | | | | |
| RSRQ <small>Note4</small> | dB | -14.76 | -16.25 | -16.25 | | | | |
| I_o <small>Note4</small> | dBm/9 MHz | -50 | -75.46 | -85.26 | | | | |
| \hat{E}_s / N_{oc} | dB | -1.75 | -4.0 | -4.0 | | | | |
| Propagation condition | - | AWGN | AWGN | AWGN | | | | |
| <p>Note 1: For special subframe and uplink-downlink configurations see Tables 4.2-1 and 4.2-2 in TS 36.211.</p> <p>Note 2: OCNG shall be used such that both cells are fully allocated and a constant total transmitted power spectral density is achieved for all OFDM symbols.</p> <p>Note 3: Interference from other cells and noise sources not specified in the test is assumed to be constant over subcarriers and time and shall be modelled as AWGN of appropriate power for N_{oc} to be fulfilled.</p> <p>Note 4: RSRQ, RSRP and I_o levels have been derived from other parameters for information purposes. They are not settable parameters themselves.</p> <p>Note 5: RSRP and RSRQ minimum requirements are specified assuming independent interference and noise at each receiver antenna port.</p> | | | | | | | | |

A.9.2.4A.3 Test Requirements

The RSRQ measurement accuracy shall fulfil the requirements in sections 9.1.6.1 and 9.1.6.2.

A.9.2.5 FDD RSRQ for E-UTRA Carrier Aggregation

A.9.2.5.1 Test Purpose and Environment

The purpose of this test is to verify that the FDD RSRQ measurement accuracy in carrier aggregation is within the specified limits under AWGN propagation conditions. This test will verify the absolute accuracy of intra-frequency RSRQ measurements for the primary component carrier specified in clause 9.1.11.1, the absolute accuracy of intra-frequency RSRQ measurements for the secondary component carrier specified in clause 9.1.11.2 and also the relative inter-frequency RSRQ accuracy requirement between primary and secondary component carriers specified in clause 9.1.11.3.

A.9.2.5.2 Test parameters

In this test case the PCell and the SCell are on different carrier frequencies. There are three cells used in this test case. Both RSRQ absolute and relative accuracy requirements of the primary and secondary component carrier are tested by using test parameters specified in Table A.9.2.5.2-1. In the test, Cell 1 is the PCell, Cell 2 is the SCell on the Secondary Component Carrier (SCC) and Cell 3 is the neighbouring cell on the SCC. The SCC is configured and activated.

Table A.9.2.5.2-1: FDD RSRQ Carrier Aggregation test parameters

| Parameters | Test 1 | | | |
|--|------------------|----------|--|----------|
| | Units | Cell 1 | Cell 2 | Cell 3 |
| E-UTRA RF Channel Number | | 1 | 2 | 2 |
| $BW_{\text{channel_CA}}$ | MHz | 10 | 10 | 10 |
| Timing offset to Cell 1 | μs | - | 0 | 3 |
| Time alignment error between cell 2 and cell 1 | | - | \leq Time alignment error as specified in 3GPP TS 36.104 [30] clause 6.5.3.1 | - |
| Measurement bandwidth | n_{PRB} | 22—27 | 22—27 | 22—27 |
| PDSCH Reference measurement channel defined in A.3.1.1.1 | | R.0 FDD | R.0 FDD | - |
| PDSCH allocation | n_{PRB} | 13—36 | 13—36 | - |
| PDCCH/PCFICH/PHICH Reference measurement channel defined in A.3.1.2.1 | | R.6 FDD | R.6 FDD | R.6 FDD |
| OCNG Patterns defined in A.3.2.1.1 (OP.1 FDD) and A.3.2.1.2 (OP.2 FDD) | | OP.1 FDD | OP.1 FDD | OP.2 FDD |
| PBCH_RA | dB | 0 | 0 | 0 |
| PBCH_RB | | | | |
| PSS_RA | | | | |
| SSS_RA | | | | |
| PCFICH_RB | | | | |
| PHICH_RA | | | | |
| PHICH_RB | | | | |
| PDCCH_RA | | | | |
| PDCCH_RB | | | | |
| PDSCH_RA | | | | |
| PDSCH_RB | | | | |
| OCNG_RA ^{Note1} | | | | |
| OCNG_RB ^{Note1} | | | | |
| N_{oc} ^{Note2} | | | | |
| | Bands FDD_B | -119 | -115.5 | -115.5 |

| | | | | | |
|---|---|---------------|--------|--------|--------|
| | Bands FDD_C | | -118.5 | -115 | -115 |
| | Bands FDD_D | | -118 | -114.5 | -114.5 |
| | Bands FDD_E, FDD_F ^{Note 6} | | -117.5 | -114 | -114 |
| | Bands FDD_G | | -116.5 | -113 | -113 |
| | Bands FDD_H | | -116 | -112.5 | -112.5 |
| | \hat{E}_s / I_{ot} | dB | -4.0 | -5.46 | -5.46 |
| RSRP ^{Note3} | Bands FDD_A | dBm/15 kHz | -123.5 | -120 | -120 |
| | Bands FDD_B | | -123 | -119.5 | -119.5 |
| | Bands FDD_C | | -122.5 | -119 | -119 |
| | Bands FDD_D | | -122 | -118.5 | -118.5 |
| | Bands FDD_E, FDD_F ^{Note 6} | | -121.5 | -118 | -118 |
| | Bands FDD_G | | -120.5 | -117 | -117 |
| | Bands FDD_H | | -120 | -116.5 | -116.5 |
| RSRQ ^{Note3} | Bands FDD_A | dB | -16.25 | -17.34 | -17.34 |
| | Bands FDD_B | | | | |
| | Bands FDD_C | | | | |
| | Bands FDD_D | | | | |
| | Bands FDD_E, FDD_F ^{Note 6} | | | | |
| | Bands FDD_G | | | | |
| | Bands FDD_H | | | | |
| I _o ^{Note3} | Bands FDD_A | dBm/9 MHz | -90.26 | -85.67 | -85.67 |
| | Bands FDD_B | | -89.76 | -85.17 | -85.17 |
| | Bands FDD_C | | -89.26 | -84.67 | -84.67 |
| | Bands FDD_D | | -88.76 | -84.17 | -84.17 |
| | Bands FDD_E, FDD_F ^{Note 6} | | -88.26 | -83.67 | -83.67 |
| | Bands FDD_G | | -87.26 | -82.67 | -82.67 |
| | Bands FDD_H | | -86.76 | -82.17 | -82.17 |
| | \hat{E}_s / N_{oc} | dB | -4.0 | -4.0 | -4.0 |
| | Propagation condition | - | AWGN | | |
| <p>Note 1: OCNG shall be used such that both cells are fully allocated and a constant total transmitted power spectral density is achieved for all OFDM symbols.</p> <p>Note 2: Interference from other cells and noise sources not specified in the test is assumed to be constant over subcarriers and time and shall be modelled as AWGN of appropriate power for N_{oc} to be fulfilled.</p> <p>Note 3: RSRQ, RSRP and I_o levels have been derived from other parameters for information purposes. They are not settable parameters themselves.</p> <p>Note 4: RSRP and RSRQ minimum requirements are specified assuming independent interference and noise at each receiver antenna port.</p> <p>Note 5: The selection of the bands for testing depends on the configuration of the carrier aggregation supported by the UEs</p> <p>Note 6: For Band 26, the tests shall be performed with the carrier frequency of the assigned E-UTRA channel bandwidth within 865-894 MHz.</p> <p>Note 7: This test verifies the RRM requirement which is independent of channel bandwidth and is performed according to the principle defined in section A.3.6.1.</p> <p>Note 8: E-UTRA operating band groups are as defined in Section 3.5.</p> | | | | | |

A.9.2.5.3 Test Requirements

In the test, the RSRQ measurement accuracy in carrier aggregation shall fulfil the requirements in clause 9.1.11.1, 9.1.11.2, and 9.1.11.3.

- The absolute accuracy of intra-frequency RSRQ measurements of Cell 1 on the primary component carrier shall fulfil the requirements specified in clause 9.1.11.1.
- The absolute accuracy of intra-frequency RSRQ measurements of Cell 2 on the secondary component carrier shall fulfil the requirements specified in clause 9.1.11.2

- The relative accuracy of inter-frequency RSRQ measurements between the primary and secondary component carriers for Cell 2 relative to Cell 1 shall fulfil the requirements specified in clause 9.1.11.3.

A.9.2.6 TDD RSRQ for E-UTRA Carrier Aggregation

The test case in this clause are applicable to carrier aggregation capable UEs which have been configured with a downlink SCell.

A.9.2.6.1 Test Purpose and Environment

The purpose of this test is to verify that the TDD RSRQ measurement accuracy in carrier aggregation is within the specified limits in a synchronized network environment with AWGN propagation conditions. This test will verify the absolute accuracy of intra-frequency RSRQ measurements for the primary component carrier defined in Clause 9.1.11.1, the absolute accuracy of intra-frequency RSRQ measurements for the secondary component carrier defined in Clause 9.1.11.2, and also the relative inter-frequency RSRQ accuracy requirement between primary and secondary component carriers defined in Clause 9.1.11.3.

A.9.2.6.2 Test parameters

In the test there are three synchronous cells: Cell 1, Cell 2 and Cell 3. Cell 1 is PCell, Cell 2 is SCell, and Cell 3 is the target cell. PCell and SCell are in different RF channels. Cell 3 is in the same RF channel as Cell 2. The parameters for the test are listed in Table A.9.2.6.2-1.

Table A.9.2.6.2-1: TDD RSRQ test parameters

| Parameter | Unit | Test 1 | | |
|--|-----------|----------|---|----------|
| | | Cell 1 | Cell 2 | Cell 3 |
| E-UTRA RF Channel Number | | 1 | 2 | 2 |
| BW _{channel} | MHz | 10 | | |
| Timing offset to cell 1 | µs | - | 0 | 3 |
| Time alignment error between cell 2 and cell 1 | | - | ≤ Time alignment error as specified in 3GPP TS 36.104 [30] clause 6.5.3.1 | - |
| Special subframe configuration ^{Note1} | | 6 | | |
| Uplink-downlink configuration ^{Note1} | | 1 | | |
| Measurement bandwidth | n_{PRB} | 22—27 | | |
| PDSCH Reference measurement channel defined in A.3.1.1.2 | | R.0 TDD | R.0 TDD | - |
| PDSCH allocation | n_{PRB} | 13—36 | 13—36 | - |
| PDCCH/PCFICH/PHICH Reference measurement channel defined in A.3.1.2.2 | | R.6 TDD | R.6 TDD | R.6 TDD |
| OCNG Patterns defined in A.3.2.2.1 (OP.1 TDD) and A.3.2.2.2 (OP.2 TDD) | | OP.1 TDD | OP.1 TDD | OP.2 TDD |
| PBCH_RA | dB | 0 | 0 | |
| PBCH_RB | | | | |
| PSS_RA | | | | |
| SSS_RA | | | | |
| PCFICH_RB | | | | |
| PHICH_RA | | | | |
| PHICH_RB | | | | |
| PDCCH_RA | | | | |
| PDCCH_RB | | | | |
| PDSCH_RA | | | | |
| PDSCH_RB | | | | |

| | | | | | |
|--|---------------------------|------------|---------|--------|-------|
| OCNG_RA ^{Note2} | | | | | |
| OCNG_RB ^{Note2} | | | | | |
| N_{oc} ^{Note3} | Bands TDD_A | dBm/15 kHz | -119.5 | -116 | |
| | Bands TDD_C | | -118.5 | -115 | |
| | Bands TDD_E | | -117.5 | -114 | |
| \hat{E}_s / I_{ot} | | dB | -4.0 | -5.46 | -5.46 |
| RSRP ^{Note4} | Bands TDD_A | dBm/15 kHz | -123.50 | -120 | -120 |
| | Bands TDD_C | | -122.50 | -119 | -119 |
| | Bands TDD_E | | -121.50 | -118 | -118 |
| RSRQ ^{Note4} | Bands TDD_A, TDD_C, TDD_E | dB | -16.25 | -17.34 | |
| I_o ^{Note4} | Bands TDD_A | dBm/9 MHz | -90.26 | -85.67 | |
| | Bands TDD_C | | -89.26 | -84.67 | |
| | Bands TDD_E | | -88.26 | -83.67 | |
| \hat{E}_s / N_{oc} | | dB | -4.0 | -4.0 | -4.0 |
| Propagation condition | | - | AWGN | | |
| <p>Note 1: For special subframe and uplink-downlink configurations see Tables 4.2-1 and 4.2-2 in TS 36.211.</p> <p>Note 2: OCNG shall be used such that both cells are fully allocated and a constant total transmitted power spectral density is achieved for all OFDM symbols.</p> <p>Note 3: Interference from other cells and noise sources not specified in the test is assumed to be constant over subcarriers and time and shall be modelled as AWGN of appropriate power for N_{oc} to be fulfilled.</p> <p>Note 4: RSRQ, RSRP and I_o levels have been derived from other parameters for information purposes. They are not settable parameters themselves.</p> <p>Note 5: RSRP and RSRQ minimum requirements are specified assuming independent interference and noise at each receiver antenna port.</p> <p>Note 6: The selection of the bands for testing depends on the configuration of the carrier aggregation supported by the UEs.</p> <p>Note 7: This test verifies the RRM requirement which is independent of channel bandwidth and is performed according to the principle defined in section A.3.6.1.</p> <p>Note 8: E-UTRA operating band groups are as defined in Section 3.5.</p> | | | | | |

A.9.2.6.3 Test Requirements

In the test, the RSRQ measurement accuracy in carrier aggregation shall fulfil the requirements in section 9.1.11.1, 9.1.11.2, and 9.1.11.3.

- The absolute accuracy of intra-frequency RSRQ measurements of Cell 1 on the primary component carrier shall fulfil the requirements defined in clause 9.1.11.1.
- The absolute accuracy of intra-frequency RSRQ measurements of Cell 2 on the secondary component carrier shall fulfil the requirements defined in clause 9.1.11.2.
- The relative accuracy of inter-frequency RSRQ measurements between the primary and secondary component carriers for Cell 2 relative to Cell 1 shall fulfil the requirements defined in clause 9.1.11.3.

A.9.2.7 FDD RSRQ under Time Domain Measurement Resource Restriction with Non-MBSFN ABS

A.9.2.7.1 Test Purpose and Environment

The purpose of this test is to verify that the RSRQ measurement accuracy under time domain measurement resource restriction is within the specified limits. This test will verify the requirements in Clause 9.1.5.2 for FDD intra frequency measurements under time domain measurement resource restriction.

A.9.2.7.2 Test parameters

In this test case all cells are on the same carrier frequency. The absolute accuracy of RSRQ intra frequency measurements under time domain measurement resource restriction is tested by using the parameters in Table A.9.2.7.2-1 and Table A.9.2.7.2-2 for non-MBSFN ABS with non-colliding CRS. In all test cases, Cell 1 is the serving cell and also the aggressor cell to Cell 2. Cell 2 is the target cell to be measured for RSRQ.

The UE is configured by higher layers via Cell 1 with a time-domain measurement resource restriction pattern for performing E-UTRAN FDD intra-frequency measurements on neighbour cells and provided with a neighbour cell list associated with the pattern, where the cell list includes Cell 2. The UE is also configured with a time-domain measurement resource restriction pattern for the serving cell measurements. The information for both patterns shall be provided to the UE before the measurements start.

Table A.9.2.7.2-1: General test parameters for E-UTRAN FDD RSRQ intra frequency test parameters under time-domain measurement resource restriction with non-MBSFN ABS

| Parameter | Unit | Value | Comment |
|--|------|---|--|
| Serving cell (PCell) | | Cell 1 | The aggressor cell to Cell 2 |
| Neighbour cell | | Cell 2 | Cell to be measured |
| PCell ABS configuration | | Non-MBSFN ABS | As defined in Table A.3.4.1.1-1 |
| CP length | | Normal | For both cells in the test |
| DRX | | | OFF |
| Time offset between cells | | 3 μ s | Synchronous cells |
| Physical cell ID PCI | | $(PCI_{cell1} - PCI_{cell2}) \bmod 6 \neq 0$ | Cell PCIs for Cell 1 and Cell 2 are selected randomly so that the condition is met. |
| ABS pattern | | '100000001000000010000000100000001000000010000000' | Non-MBSFN ABS. FDD ABS Pattern Info IE, as defined in TS 36.423 [28], clause 9.2.54. Configured in Cell 1. The first/leftmost bit corresponds to the subframe #0 of a radio frame satisfying $SFN \bmod x = 0$, where x is the size of the bit string (40) divided by 10. No MBSFN subframes are configured in the ABS subframes in Cell 1. |
| Time-domain measurement resource restriction pattern for neighbour cell measurements on RF Channel 1 | | '100000001000000010000000100000001000000010000000' | Configured for Cell 2 measurements by measSubframePattern-Neigh IE in measSubframePatternConfig-Neigh, as defined in TS 36.331 [2], clause 6.3.5. measSubframeCellList contains Cell 2. |
| Time-domain measurement resource restriction pattern for serving cell measurements | | '0100000001000000010000000100000001000000010000000' | Configured for measurements on Cell 1. |

Table A.9.2.7.2-2: Cell-specific test parameters for E-UTRAN FDD RSRQ intra frequency test parameters under time domain measurement resource restriction with non-MBSFN ABS

| Parameter | Unit | Test 1 | | Test 2 | | Test 3 | |
|--|-----------|----------|----------|----------|----------|----------|----------|
| | | Cell 1 | Cell 2 | Cell 1 | Cell 2 | Cell 1 | Cell 2 |
| E-UTRA RF Channel Number | | 1 | | 1 | | 1 | |
| $BW_{channel}$ | MHz | 10 | | 10 | | 10 | |
| Measurement bandwidth | n_{PRB} | 22—27 | | 22—27 | | 22—27 | |
| PDSCH Reference measurement channel defined in A.3.1.1.1 | | R.0 FDD | - | R.0 FDD | - | R.0 FDD | - |
| PDSCH allocation | n_{PRB} | 13—36 | - | 13—36 | - | 13—36 | - |
| PDCCH/PCFICH/PHICH Reference measurement channel defined in A.3.1.2.1 | | R.6 FDD | | R.6 FDD | | R.6 FDD | |
| OCNG Patterns defined in A.3.2.1.5 (OP.5 FDD) and A.3.2.1.6 (OP.6 FDD) | | OP.5 FDD | OP.6 FDD | OP.5 FDD | OP.6 FDD | OP.5 FDD | OP.6 FDD |
| PBCH_RA | dB | Note 6 | 0 | Note 6 | 0 | Note 6 | 0 |
| PBCH_RB | | | | | | | |
| PCFICH_RB | | | | | | | |
| PHICH_RA | | | | | | | |

| | | | | | | | | |
|---|--|------------|--------|--------|---------|---------|--------|--------|
| PHICH_RB | | | | | | | | |
| PDCCH_RA | | | | | | | | |
| PDCCH_RB | | | | | | | | |
| PDSCH_RA | | | | | | | | |
| PDSCH_RB | | | | | | | | |
| OCNG_RA ^{Note1} | | | | | | | | |
| OCNG_RB ^{Note1} | | | | | | | | |
| PSS_RA | | dB | -4 | 0 | -4 | 0 | -4 | 0 |
| SSS_RA | | dB | -4 | 0 | -4 | 0 | -4 | 0 |
| N_{oc} ^{Note2} | Bands FDD_A <small>Note 10</small> | dBm/15 kHz | -84.76 | | -103.85 | -116 | | |
| | Bands FDD_B | | | | | -115.5 | | |
| | Bands FDD_C | | | | | -115 | | |
| | Bands FDD_D | | | | | -114.5 | | |
| | Bands FDD_E, FDD_F ^{Note 7} | | | | | -114 | | |
| | Bands FDD_G <small>Note 9</small> | | | | | -113 | | |
| | Bands FDD_H | | | | | -112.5 | | |
| CRS \hat{E}_s / N_{oc} | | dB | 5 | -2 | 5 | -2 | 5 | -4 |
| CRS $(\hat{E}_s / I_{ot})_{meas}$ ^{Note 5} | | dB | 2.88 | -2.00 | 2.88 | -2.00 | 3.54 | -4.00 |
| SCH \hat{E}_s / I_{ot} | | dB | -1.12 | -5.54 | -1.12 | -5.54 | -0.46 | -7.54 |
| RSRP ^{Note3,4,5} | Bands FDD_A <small>Note 10</small> | dBm/15 kHz | -79.76 | -86.76 | -98.85 | -105.85 | -111 | -120 |
| | Bands FDD_B | | | | | | -110.5 | -119.5 |
| | Bands FDD_C | | | | | | -110 | -119 |
| | Bands FDD_D | | | | | | -109.5 | -118.5 |
| | Bands FDD_E, FDD_F ^{Note 7} | | | | | | -109 | -118 |
| | Bands FDD_G <small>Note 9</small> | | | | | | -108 | -117 |
| | Bands FDD_H | | | | | | -107.5 | -116.5 |
| $(RSRQ)_{meas}$ <small>Note3,4,5</small> | Bands FDD_A <small>Note 10</small> , FDD_B, FDD_C, FDD_E, FDD_F ^{Note 7} , FDD_G ^{Note 9} , FDD_H | dB | -12.60 | -15.30 | -12.60 | -15.30 | -12.38 | -16.69 |
| $(I_o)_{meas}$ ^{Note3} | Bands FDD_A <small>Note 10</small> | dBm/9 MHz | -50.17 | -53.64 | -69.26 | -72.73 | -81.63 | -85.37 |
| | Bands FDD_B | | | | | | -81.13 | -84.87 |
| | Bands FDD_C | | | | | | -80.63 | -84.37 |
| | Bands FDD_D | | | | | | -80.13 | -83.87 |
| | Bands FDD_E, FDD_F ^{Note 7} | | | | | | -79.63 | -83.37 |
| | Bands FDD_G <small>Note 9</small> | | | | | | -78.63 | -82.37 |
| | Bands FDD_H | | | | | | -78.13 | -81.87 |
| Propagation condition | | - | AWGN | | AWGN | | AWGN | |

| | |
|----------|---|
| Note 1: | OCNG shall be used such that both cells are fully allocated and a constant total transmitted power spectral density is achieved for all OFDM symbols. |
| Note 2: | Interference from other cells and noise sources not specified in the test is assumed to be constant over subcarriers and time and shall be modelled as AWGN of appropriate power for N_{oc} to be fulfilled. Applies to all subframes. |
| Note 3: | RSRQ, RSRP and I_o levels have been derived from other parameters for information purposes. They are not settable parameters themselves. I_o levels are calculated in CRS symbols of measurement restricted subframes. |
| Note 4: | RSRP and RSRQ minimum requirements are specified assuming independent interference and noise at each receiver antenna port. |
| Note 5: | Applies to restricted measurement subframes of the respective cell. |
| Note 6: | Non-ABS and ABS subframe channel powers defined in Table A.3.4.1.1-1. |
| Note 7: | For Band 26, the tests shall be performed with the carrier frequency of the assigned E-UTRA channel bandwidth within 865-894 MHz. |
| Note 8: | E-UTRA operating band groups are as defined in Section 3.5. |
| Note 9: | Except Band 29. |
| Note 10: | Except Band 32. |

A.9.2.7.3 Test Requirements

The RSRQ measurement accuracy shall fulfil the requirements in Clause 9.1.5.2.

A.9.2.8 TDD RSRQ under Time Domain Measurement Resource Restriction with Non-MBSFN ABS

A.9.2.8.1 Test Purpose and Environment

The purpose of this test is to verify that the RSRQ measurement accuracy under time domain measurement resource restriction is within the specified limits. This test will verify the requirements in Clause 9.1.5.2 for TDD intra frequency measurements under time domain measurement resource restriction.

A.9.2.8.2 Test parameters

In this test case all cells are on the same carrier frequency. The absolute accuracy of RSRQ intra frequency measurements under time domain measurement resource restriction is tested by using the parameters in Table A.9.2.8.2-1 and Table A.9.2.8.2-2 for non-MBSFN ABS with non-colliding CRS. In all test cases, Cell 1 is the serving cell and also the aggressor cell to Cell 2. Cell 2 is the target cell to be measured for RSRQ.

The UE is configured by higher layers via Cell 1 with a time-domain measurement resource restriction pattern for performing E-UTRAN TDD intra-frequency measurements on neighbour cells and provided with a neighbour cell list associated with the pattern, where the cell list includes Cell 2. The UE is also configured with a time-domain measurement resource restriction pattern for the serving cell measurements. The information for both patterns shall be provided to the UE before the measurements start.

Table A.9.2.8.2-1: General test parameters for E-UTRAN TDD RSRQ intra frequency test parameters under time domain measurement resource restriction with non-MBSFN ABS

| Parameter | Unit | Value | Comment |
|--|------|--|---|
| Serving cell (PCell) | | Cell 1 | Also the aggressor cell. |
| Neighbour cell | | Cell 2 | Cell to be measured |
| PCell ABS configuration | | Non-MBSFN ABS | As defined in Table A.3.4.1.1-1 |
| Special subframe configuration | | 6 | For Cell 1 and Cell 2. For special subframe configurations see Table 4.2-1 in [16]. |
| Uplink/downlink subframe configuration | | 1 | For Cell 1 and Cell 2. For uplink-downlink subframe configurations see Table 4.2-2 in [16]. |
| CP length | | Normal | For both cells in the test |
| DRX | | | OFF |
| Time offset between cells | | 3 μ s | Synchronous cells |
| Physical cell ID PCI | | $(PCI_{cell1} - PCI_{cell2}) \bmod 6 \neq 0$ | Cell PCIs for Cell 1 and Cell 2 are randomly selected so that the condition is met |

| | | | |
|--|--|------------------------|--|
| ABS pattern | | '00000000010000000001' | Non-MBSFN ABS. TDD ABS Pattern Info IE, as defined in TS 36.423 [28], clause 9.2.54. Configured in Cell 1. The first/leftmost bit corresponds to the subframe #0 of a radio frame satisfying SFN mod x = 0, where x is the size of the bit string (20) divided by 10. No MBSFN subframes are configured in the ABS subframes in Cell 1. |
| Time-domain measurement resource restriction pattern for neighbour cell measurements on RF Channel 1 | | '00000000010000000001' | Configured for Cell 2 measurements by measSubframePattern-Neigh IE in measSubframePatternConfig-Neigh, as defined in TS 36.331 [2], clause 6.3.5. measSubframeCellList contains Cell 2. |
| Time-domain measurement resource restriction pattern for serving cell measurements | | '10000000001000000000' | Configured for Cell 1 measurements. |

Table A.9.2.8.2-2: Cell-specific test parameters for E-UTRAN TDD RSRQ intra frequency test parameters under time domain measurement resource restriction with non-MBSFN ABS

| Parameter | Unit | Test 1 | | Test 2 | | Test 3 | | |
|--|-------------|------------|----------|----------|----------|----------|----------|------|
| | | Cell 1 | Cell 2 | Cell 1 | Cell 2 | Cell 1 | Cell 2 | |
| E-UTRA RF Channel Number | | 1 | | 1 | | 1 | | |
| BW _{channel} | MHz | 10 | | 10 | | 10 | | |
| Measurement bandwidth | n_{PRB} | 22–27 | | 22–27 | | 22–27 | | |
| PDSCH Reference measurement channel defined in A.3.1.1.2 | | R.0 TDD | - | R.0 TDD | - | R.0 TDD | - | |
| PDSCH allocation | n_{PRB} | 13–36 | - | 13–36 | - | 13–36 | - | |
| PDCCH/PCFICH/PHICH Reference measurement channel defined in A.3.1.2.2 | | R.6 TDD | | R.6 TDD | | R.6 TDD | | |
| OCNG Patterns defined in A.3.2.2.1 (OP.1 TDD) and A.3.2.2.2 (OP.2 TDD) | | OP.1 TDD | OP.2 TDD | OP.1 TDD | OP.2 TDD | OP.1 TDD | OP.2 TDD | |
| PBCH_RA | dB | Note 6 | 0 | Note 6 | 0 | Note 6 | 0 | |
| PBCH_RB | | | | | | | | |
| PCFICH_RB | | | | | | | | |
| PHICH_RA | | | | | | | | |
| PHICH_RB | | | | | | | | |
| PDCCH_RA | | | | | | | | |
| PDCCH_RB | | | | | | | | |
| PDSCH_RA | | | | | | | | |
| PDSCH_RB | | | | | | | | |
| OCNG_RA ^{Note1} | | | | | | | | |
| OCNG_RB ^{Note1} | | | | | | | | |
| PSS_RA | | | | | | | | dB |
| SSS_RA | dB | -4 | 0 | -4 | 0 | -4 | 0 | |
| N_{oc} ^{Note2} | Bands TDD_A | dBm/15 kHz | -84.76 | -103.85 | -116 | | | |
| | Bands TDD_C | | | | -115 | | | |
| | Bands TDD_E | | | | -114 | | | |
| CRS \hat{E}_s/N_{oc} | dB | 5 | -2 | 5 | -2 | 5 | -4 | |
| CRS $(\hat{E}_s/I_{ot})_{meas}$ ^{Note 5} | dB | 2.88 | -2.00 | 2.88 | -2.00 | 3.54 | -4.00 | |
| SCH \hat{E}_s/I_{ot} | dB | -1.12 | -5.54 | -1.12 | -5.54 | -0.46 | -7.54 | |
| RSRP ^{Note3,4,5} | Bands TDD_A | dBm/15 kHz | -79.76 | -86.76 | -98.85 | -105.85 | -111 | -120 |
| | Bands TDD_C | | | | | | -110 | -119 |
| | Bands TDD_E | | | | | | -109 | -118 |
| $(RSRQ)_{meas}$ ^{Note3,4,5} | dB | -12.60 | -15.30 | -12.60 | -15.30 | -12.38 | -16.70 | |

| | | | | | | | | |
|---|-------------|-----------|--------|--------|--------|--------|--------|--------|
| $(I_o)_{meas}$ ^{Note3} | Bands TDD_A | dBm/9 MHz | -50.17 | -53.64 | -69.26 | -72.73 | -81.63 | -85.37 |
| | Bands TDD_C | | | | | | -80.63 | -84.37 |
| | Bands TDD_E | | | | | | -79.63 | -83.37 |
| Propagation condition | | - | AWGN | | AWGN | | AWGN | |
| <p>Note 1: OCNB shall be used such that both cells are fully allocated and a constant total transmitted power spectral density is achieved for all OFDM symbols.</p> <p>Note 2: Interference from other cells and noise sources not specified in the test is assumed to be constant over subcarriers and time and shall be modelled as AWGN of appropriate power for N_{oc} to be fulfilled. Applies to all subframes.</p> <p>Note 3: RSRQ, RSRP and I_o levels have been derived from other parameters for information purposes. They are not settable parameters themselves. I_o levels are calculated in CRS symbols of measurement restricted subframes.</p> <p>Note 4: RSRP and RSRQ minimum requirements are specified assuming independent interference and noise at each receiver antenna port.</p> <p>Note 5: Applies to restricted measurement subframes of the respective cell.</p> <p>Note 6: Non-ABS and ABS subframe channel powers defined in Table A.3.4.1.1-1.</p> <p>Note 7: E-UTRA operating band groups are as defined in Section 3.5.</p> | | | | | | | | |

A.9.2.8.3 Test Requirements

The RSRQ measurement accuracy shall fulfil the requirements in Clause 9.1.5.2.

A.9.2.9 FDD RSRQ under Time Domain Measurement Resource Restriction with MBSFN ABS

A.9.2.9.1 Test Purpose and Environment

The purpose of this test is to verify that the RSRQ measurement accuracy under time domain measurement resource restriction is within the specified limits under AWGN propagation conditions. This test will verify the absolute FDD RSRQ accuracy under time domain measurement resource restriction specified in Clause 9.1.5.2.

A.9.2.9.2 Test parameters

The test parameters are given in Tables A.9.2.9.2-1 and A.9.2.9.2-2 below. In this test case there are two cells on the same frequency used in this test case. In the test, Cell 1 is the serving cell and also the aggressor cell to Cell 2. Cell 2 is the target cell to be measured for RSRQ.

The UE is configured by higher layers via Cell 1 with a time-domain measurement resource restriction pattern for performing E-UTRAN FDD intra-frequency measurements on neighbour cells and provided with a neighbour cell list associated with the pattern, where the cell list includes Cell 2. The UE is also configured by higher layers with a time domain measurement restriction pattern for the serving cell measurements. The information for both patterns shall be provided to the UE before the measurements start.

Table A.9.2.9.2-1: General test parameters for FDD RSRQ under time domain measurement resource restriction with MBSFN ABS

| Parameter | Unit | Value | Comment |
|-------------------------------|------|---|---|
| PDSCH parameters | | DL Reference Measurement Channel R.0 FDD | As specified in clause A.3.1.1.1 |
| PCFICH/PDCCH/PHICH parameters | | DL Reference Measurement Channel R.6 FDD | As specified in clause A.3.1.2.1 |
| Serving cell (PCell) | | Cell 1 | Also the aggressor cell on E-UTRA RF channel number 1 |
| Neighbour cell | | Cell 2 | Cell to be identified on E-UTRA RF channel number 1 |
| PCell ABS configuration | | MBSFN ABS | As defined in Table A.3.4.2.1-1 |
| CP length | | Normal | |
| DRX | | OFF | |
| Time offset between cells | | 3 μ s | Synchronous cells |

| | | | |
|---|--|---|--|
| Physical cell ID PCI | | $(PCI_{cell1} - PCI_{cell2}) \bmod 6 = 0, PCI_{cell1}$ not equal to PCI_{cell2} | Cell PCIs are selected so that the condition is met (colliding CRS) |
| Cell 1 MBSFN ABS pattern | | '01000000100000001000000010000000' | ABS subframe is only MBSFN subframe. FDD ABS Pattern Info IE, as defined in TS 36.423 [28], clause 9.2.54. The first/leftmost bit corresponds to the subframe #0 of the radio frame satisfying $SFN \bmod x = 0$, where x is the size of the bit string (40) divided by 10. Configured in Cell 1. |
| Time domain measurement resource restriction pattern for PCell (Cell 1) measurements on RF Channel 1 | | '00010000000100000001000000010000' | Time domain measurement resource restriction pattern for PCell measurement signalled to the UE in measSubframePatternPCell. The IE MeasSubframePattern is used to specify the time domain measurement resource restriction as defined in TS 36.331 [2], clause 6.3.6. Configured for Cell 1 measurements. |
| Time domain measurement resource restriction pattern for neighbour cell (Cell 2) measurements on RF Channel 1 | | '01000000100000001000000010000000' | Time domain measurement resource restriction pattern for neighbour cell measurement signalled to the UE in measSubframePatternNeigh. The IE MeasSubframePattern is used to specify the time domain measurement resource restriction as defined in TS 36.331 [2], clause 6.3.6. Configured for Cell 2 measurements. |

Table A.9.2.9.2-2: Cell specific test parameters for FDD RSRQ under time domain measurement resource restriction with MBSFN ABS

| Parameter | Unit | Test 1 | | Test 2 | | Test 3 | |
|---|--------------------------------------|------------|----------|----------|----------|----------|----------|
| | | Cell 1 | Cell 2 | Cell 1 | Cell 2 | Cell 1 | Cell 2 |
| E-UTRA RF Channel Number | | 1 | | 1 | | 1 | |
| BW _{channel} | MHz | 10 | | 10 | | 10 | |
| OCNG Patterns defined in A.3.2.1.8 (OP.8 FDD) and A.3.2.1.6 (OP.6 FDD) ^{Note5} | | OP.8 FDD | OP.6 FDD | OP.8 FDD | OP.6 FDD | OP.8 FDD | OP.6 FDD |
| Measurement bandwidth | n_{PRB} | 22—27 | | 22—27 | | 22—27 | |
| PDSCH allocation | n_{PRB} | 13—36 | - | 13—36 | - | 13—36 | - |
| PBCH_RA | dB | Note 6 | 0 | Note 6 | 0 | Note 6 | 0 |
| PBCH_RB | | | | | | | |
| PCFICH_RB | | | | | | | |
| PHICH_RA | | | | | | | |
| PHICH_RB | | | | | | | |
| PDCCH_RA | | | | | | | |
| PDCCH_RB | | | | | | | |
| PDSCH_RA | | | | | | | |
| PDSCH_RB | | | | | | | |
| OCNG_RA ^{Note1} | | | | | | | |
| OCNG_RB ^{Note1} | | | | | | | |
| PSS_RA | | | | | | | |
| SSS_RA | dB | -4 | 0 | -4 | 0 | -4 | 0 |
| N_{oc} ^{Note2} | Bands FDD_A ^{Note 11} | dBm/15 kHz | -84.76 | -103.85 | -116 | | |
| | Bands FDD_B | | | | -115.5 | | |
| | Bands FDD_C | | | | -115 | | |
| | Bands FDD_D | | | | -114.5 | | |
| | Bands FDD_E, FDD_F ^{Note 8} | | | | -114 | | |
| | Bands FDD_G ^{Note 10} | | | | -113 | | |
| Bands FDD_H | -112.5 | | | | | | |
| CRS \hat{E}_s/N_{oc} | dB | 5 | -2 | 5 | -2 | 5 | -4 |

| | | | | | | | | |
|--|---------------------------|------------|--------|--------|--------|---------|--------|--------|
| CRS $(\hat{E}_s / I_{ot})_{meas}$ Note 5, 7 in the 1 st OFDM symbol | | dB | 2.88 | -8.19 | 2.88 | -8.19 | 3.54 | -10.19 |
| CRS $(\hat{E}_s / I_{ot})_{meas}$ note 5 in OFDM symbols 4,7,11 | | dB | 2.88 | -2 | 2.88 | -2 | 3.54 | -4 |
| SCH \hat{E}_s / I_{ot} | | dB | -1.12 | -5.54 | -1.12 | -5.54 | -0.46 | -7.54 |
| RSRP Note 3,4,5 | Bands FDD_A Note 11 | dBm/15 kHz | -79.76 | -86.76 | -98.85 | -105.85 | -111 | -120 |
| | Bands FDD_B | | | | | | -110.5 | -119.5 |
| | Bands FDD_C | | | | | | -110 | -119 |
| | Bands FDD_D | | | | | | -109.5 | -118.5 |
| | Bands FDD_E, FDD_F Note 8 | | | | | | -109 | -118 |
| | Bands FDD_G Note 10 | | | | | | -108 | -117 |
| | Bands FDD_H | | | | | | -107.5 | -116.5 |
| (RSRQ) $_{meas}$ Note 3,4,5 | Bands FDD_A Note 11 | dB | -12.60 | -15.02 | -12.60 | -15.02 | -12.38 | -16.36 |
| | Bands FDD_B | | | | | | | |
| | Bands FDD_C | | | | | | | |
| | Bands FDD_D | | | | | | | |
| | Bands FDD_E, FDD_F Note 8 | | | | | | | |
| | Bands FDD_G Note 10 | | | | | | | |
| | Bands FDD_H | | | | | | | |
| (I _o) $_{meas}$ Note 3 1 st OFDM symbol | Bands FDD_A Note 11 | dBm/9 MHz | -50.17 | -53.64 | -69.26 | -72.73 | -81.63 | -85.37 |
| | Bands FDD_B | | | | | | -81.13 | -84.87 |
| | Bands FDD_C | | | | | | -80.63 | -84.37 |
| | Bands FDD_D | | | | | | -80.13 | -83.87 |
| | Bands FDD_E, FDD_F Note 8 | | | | | | -79.63 | -83.37 |
| | Bands FDD_G Note 10 | | | | | | -78.63 | -82.37 |
| | Bands FDD_H | | | | | | -78.13 | -81.87 |
| (I _o) $_{meas}$ Note 3 OFDM symbols other than the 1 st one | Bands FDD_A Note 11 | dBm/9 MHz | -50.17 | -54.85 | -69.26 | -73.94 | -81.63 | -86.76 |
| | Bands FDD_B | | | | | | -81.13 | -86.26 |
| | Bands FDD_C | | | | | | -80.63 | -85.76 |
| | Bands FDD_D | | | | | | -80.13 | -85.26 |
| | Bands FDD_E, FDD_F Note 8 | | | | | | -79.63 | -84.76 |
| | Bands FDD_G Note 10 | | | | | | -78.63 | -83.76 |
| | Bands FDD_H | | | | | | -78.13 | -83.26 |
| Propagation condition | | - | AWGN | | AWGN | | AWGN | |
| <p>Note 1: OCNB shall be used such that both cells are fully allocated and a constant total transmitted power spectral density is achieved for all OFDM symbols.</p> <p>Note 2: Interference from other cells and noise sources not specified in the test is assumed to be constant over subcarriers and time and shall be modelled as AWGN of appropriate power for N_{oc} to be fulfilled.</p> <p>Applies to all subframes.</p> <p>Note 3: RSRQ, RSRP and I_o levels have been derived from other parameters for information purposes. They are not settable parameters themselves. I_o levels are calculated in CRS symbols of measurement restricted subframes</p> <p>Note 4: RSRP and RSRQ minimum requirements are specified assuming independent interference and noise at each receiver antenna port.</p> <p>Note 5: Applies to restricted measurement subframes of the respective cell.</p> <p>Note 6: Non-ABS and ABS subframe channel powers defined in Table A.3.4.2.1-1.</p> <p>Note 7: In the 1st OFDM symbol, Cell 2 is not expected to meet the Es/I_{ot} side condition in 9.1.5.2.</p> <p>Note 8: For Band 26, the tests shall be performed with the carrier frequency of the assigned E-UTRA channel bandwidth within 865-894 MHz.</p> <p>Note 9: E-UTRA operating band groups are as defined in Section 3.5.</p> <p>Note 10: Except Band 29.</p> <p>Note 11: Except Band 32.</p> | | | | | | | | |

A.9.2.9.3 Test Requirements

In the test, the RSRQ measurement accuracy under time domain measurement resource restriction shall fulfil the requirements in Clause 9.1.5.2

A.9.2.10 TDD Intra frequency case under time domain measurement resource restriction with MBSFN ABS

A.9.2.10.1 Test Purpose and Environment

The purpose of this test is to verify that the RSRQ measurement accuracy under time domain measurement resource restriction is within the specified limits. This test will verify the requirements in Clause 9.1.5.2 for TDD intra frequency measurements under time domain measurement resource restriction.

A.9.2.10.2 Test parameters

In this test case all cells are on the same carrier frequency. The absolute accuracy of RSRQ intra frequency measurements under time domain measurement resource restriction is tested by using the parameters in Table A.9.2.10.2-1 and Table A.9.2.10.2-2 for MBSFN ABS with colliding CRS. In all test cases, Cell 1 is the serving cell and also the aggressor cell to Cell 2. Cell 2 is the target cell to be measured for RSRQ.

The UE is configured by higher layers via Cell 1 with a time-domain measurement resource restriction pattern for performing E-UTRAN TDD intra-frequency measurements on neighbour cells and provided with a neighbour cell list associated with the pattern, where the cell list includes Cell 2. The UE is also configured with a time-domain measurement resource restriction pattern for the serving cell measurements. The information for both patterns shall be provided to the UE before the measurements start.

Table A.9.2.10.2-1: General test parameters for E-UTRAN TDD RSRQ intra frequency test parameters under time-domain measurement resource restriction with MBSFN ABS

| Parameter | Unit | Value | Comment |
|--|------|--|--|
| Serving cell (PCell) | | Cell 1 | The aggressor cell to Cell 2 |
| Neighbour cell | | Cell 2 | Cell to be measured |
| PCell ABS configuration | | MBSFN ABS | As defined in Table A.3.4.2.1-1 |
| Special subframe configuration | | 6 | For Cell 1 and Cell 2. For special subframe configurations see Table 4.2-1 in [16]. |
| Uplink/downlink subframe configuration | | 1 | For Cell 1 and Cell 2. For uplink-downlink subframe configurations see Table 4.2-2 in [16]. |
| CP length | | Normal | For both cells in the test |
| DRX | | | OFF |
| Time offset between cells | | 3 μ s | Synchronous cells |
| Physical cell ID PCI | | $(PCI_{cell1} - PCI_{cell2}) \bmod 6 \neq 0$ PCI _{cell1} not equal to PCI _{cell2} | Cell PCIs for Cell 1 and Cell 2 are selected randomly so that the condition is met |
| ABS pattern | | '00001000000000100000' | MBSFN ABS pattern. TDD ABS Pattern Info IE, as defined in TS 36.423 [28], clause 9.2.54. Configured in Cell 1. The first/leftmost bit corresponds to the subframe #0 of a radio frame satisfying SFN mod x = 0, where x is the size of the bit string (20) divided by 10. All ABS subframes are MBSFN subframes. |
| Time-domain measurement resource restriction pattern for neighbour cell measurements on RF Channel 1 | | '00001000000000100000' | Configured for Cell 2 measurements by measSubframePattern-Neigh IE in measSubframePatternConfig-Neigh, as defined in TS 36.331 [2], clause 6.3.5. measSubframeCellList contains Cell 2. |
| Time-domain measurement resource restriction pattern for serving cell measurements | | '10000000001000000000' | Configured for measurements on Cell 1. |

Table A.9.2.10.2-2: Cell-specific test parameters for E-UTRAN TDD RSRQ intra frequency test parameters under time domain measurement resource restriction with MBSFN ABS

| Parameter | Unit | Test 1 | | Test 2 | | Test 3 | | |
|--|---------------------------|------------|----------|----------|----------|----------|----------|--------|
| | | Cell 1 | Cell 2 | Cell 1 | Cell 2 | Cell 1 | Cell 2 | |
| E-UTRA RF Channel Number | | 1 | | 1 | | 1 | | |
| BW _{channel} | MHz | 10 | | 10 | | 10 | | |
| Measurement bandwidth | n_{PRB} | 22—27 | | 22—27 | | 22—27 | | |
| PDSCH Reference measurement channel defined in A.3.1.1.2 | | R.0 TDD | - | R.0 TDD | - | R.0 TDD | - | |
| PDSCH allocation | n_{PRB} | 13—36 | - | 13—36 | - | 13—36 | - | |
| PDCCH/PCFICH/PHICH Reference measurement channel defined in A.3.1.2.2 | | R.6 TDD | | R.6 TDD | | R.6 TDD | | |
| OCNG Patterns defined in A.3.2.2.5 (OP.5 TDD) and A.3.2.2.2 (OP.2 TDD) | | OP.5 TDD | OP.2 TDD | OP.5 TDD | OP.2 TDD | OP.5 TDD | OP.2 TDD | |
| PBCH_RA | dB | Note 6 | 0 | Note 6 | 0 | Note 6 | 0 | |
| PBCH_RB | | | | | | | | |
| PCFICH_RB | | | | | | | | |
| PHICH_RA | | | | | | | | |
| PHICH_RB | | | | | | | | |
| PDCCH_RA | | | | | | | | |
| PDCCH_RB | | | | | | | | |
| PDSCH_RA | | | | | | | | |
| PDSCH_RB | | | | | | | | |
| OCNG_RA ^{Note1} | | | | | | | | |
| OCNG_RB ^{Note1} | | | | | | | | |
| PSS_RA | | | | | | | | dB |
| SSS_RA | dB | -4 | 0 | -4 | 0 | -4 | 0 | |
| N_{oc} ^{Note2} | Bands TDD_A | dBm/15 kHz | -84.76 | -103.85 | -116 | | | |
| | Bands TDD_C | | | | -115 | | | |
| | Bands TDD_E | | | | -114 | | | |
| CRS \hat{E}_s/N_{oc} | dB | 5 | -2 | 5 | -2 | 5 | -4 | |
| CRS $(\hat{E}_s/I_{ot})_{meas}$ ^{Note 5, 7} In the 1 st OFDM symbol | dB | 2.88 | -8.19 | 2.88 | -8.19 | 3.54 | -10.19 | |
| CRS $(\hat{E}_s/I_{ot})_{meas}$ ^{Note 5} in OFDM symbols 4,7,11 | dB | 2.88 | -2 | 2.88 | -2 | 3.54 | -4 | |
| SCH \hat{E}_s/I_{ot} | dB | -1.12 | -5.54 | -1.12 | -5.54 | -0.46 | -7.54 | |
| RSRP ^{Note 3,4,5} | Bands TDD_A | dBm/15 kHz | -79.76 | -86.76 | -98.85 | -105.85 | -111 | -120 |
| | Bands TDD_C | | | | | | -110 | -119 |
| | Bands TDD_E | | | | | | -109 | -118 |
| $(RSRQ)_{meas}$ ^{Note 3,4,5} | Bands TDD_A, TDD_C, TDD_E | dB | -12.60 | -15.02 | -12.60 | -15.02 | -12.38 | -16.36 |
| $(I_o)_{meas}$ ^{Note 3} in the 1 st OFDM symbol | Bands TDD_A | dBm/9 MHz | -50.17 | -53.64 | -69.26 | -72.73 | -81.63 | -85.37 |
| | Bands TDD_C | | | | | | -80.63 | -84.37 |
| | Bands TDD_E | | | | | | -79.63 | -83.37 |
| $(I_o)_{meas}$ ^{Note 3} in OFDM symbols other than the 1 st one | Bands TDD_A | dBm/9 MHz | -50.17 | -54.85 | -69.26 | -73.94 | -81.63 | -86.76 |
| | Bands TDD_C | | | | | | -80.63 | -85.76 |
| | Bands TDD_E | | | | | | -79.63 | -84.76 |
| Propagation condition | - | AWGN | | AWGN | | AWGN | | |

| | |
|---------|---|
| Note 1: | OCNG shall be used such that both cells are fully allocated and a constant total transmitted power spectral density is achieved for all OFDM symbols. |
| Note 2: | Interference from other cells and noise sources not specified in the test is assumed to be constant over subcarriers and time and shall be modelled as AWGN of appropriate power for N_{oc} to be fulfilled. Applies to all subframes. |
| Note 3: | RSRQ, RSRP and I_0 levels have been derived from other parameters for information purposes. They are not settable parameters themselves. I_0 levels are calculated in CRS symbols of measurement restricted subframes. |
| Note 4: | RSRP and RSRQ minimum requirements are specified assuming independent interference and noise at each receiver antenna port. |
| Note 5: | Applies to restricted measurement subframes of the respective cell. |
| Note 6: | Non-ABS and ABS subframe channel powers defined in Table A.3.4.2.1-1. |
| Note 7: | In the 1 st OFDM symbol, Cell 2 is not expected to meet the E_s/I_{ot} side condition in 9.1.5.2. |
| Note 8: | E-UTRA operating band groups are as defined in Section 3.5. |

A.9.2.10.3 Test Requirements

The RSRQ measurement accuracy shall fulfil the requirements in clause 9.1.5.2.

A.9.2.11 FDD RSRQ for E-UTRA Carrier Aggregation (20MHz bandwidth)

The test case in this section are applicable to carrier aggregation capable UEs which have been configured with a downlink SCell.

A.9.2.11.1 Test Purpose and Environment

The purpose of this test is the same as defined in Subclause A.9.2.5.1.

A.9.2.11.2 Test parameters

The parameters of this test are the same as defined in Subclause A.9.2.5.2 except that the values of the parameters in the Table A.9.2.11.2-1 will replace the values of the corresponding parameters in A.9.2.5.2-1.

Table A.9.2.11.2-1: FDD RSRQ Carrier Aggregation test parameters

| Parameters | | Test 1 | | | |
|--|-----------------------------------|------------|-----------|-----------|-----------|
| | | Units | Cell 1 | Cell 2 | Cell 3 |
| $BW_{channel_CA}$ <small>Note 1</small> | | MHz | 20 | 20 | 20 |
| Measurement bandwidth | | n_{PRB} | 47-52 | 47-52 | 47-52 |
| PDSCH Reference measurement channel defined in A.3.1.1.1 | | | R.4 FDD | R.4 FDD | - |
| PDSCH allocation | | n_{PRB} | 38-61 | 38-61 | - |
| PDCCH/PCFICH/PHICH Reference measurement channel defined in A.3.1.2.1 | | | R.10 FDD | R.10 FDD | R.10 FDD |
| OCNG Patterns defined in A.3.2.1.11 (OP.11 FDD) and A.3.2.1.12 (OP.12 FDD) | | | OP.11 FDD | OP.11 FDD | OP.12 FDD |
| I_0 <small>Note 2</small> | Bands FDD_A <small>Note 5</small> | dBm/18 MHz | -87.26 | -82.67 | |
| | Bands FDD_B <small>Note 5</small> | | -86.76 | -82.17 | |
| | Bands FDD_C <small>Note 5</small> | | -86.26 | -81.67 | |
| | Bands FDD_D <small>Note 5</small> | | -85.76 | -81.17 | |

| | | | | |
|---------|--|--|--------|--------|
| | Bands FDD_E Note 5 | | -85.26 | -80.67 |
| | Bands FDD_G Note 5 | | -84.26 | -79.67 |
| | Bands FDD_H Note 5 | | -83.76 | -79.17 |
| Note 1: | This test verifies the RRM requirement which is independent of channel bandwidth and is performed according to the principle defined in section A.3.6.1. | | | |
| Note 2: | I _o levels have been derived from other parameters for information purposes. They are not settable parameters themselves | | | |
| Note 3: | See Table A.9.2.5.2-1 for the other parameters | | | |
| Note 4: | E-UTRA operating band groups are as defined in Section 3.5. | | | |
| Note 5: | The test applies for E-UTRA operating bands in this band group which are supporting 20 MHz channel bandwidth. | | | |

A.9.2.11.3 Test Requirements

The test requirements defined in section A.9.2.5.3 shall apply in this test case.

A.9.2.12 TDD RSRQ for E-UTRA Carrier Aggregation (20MHz bandwidth)

The test case in this section are applicable to carrier aggregation capable UEs which have been configured with a downlink SCell.

A.9.2.12.1 Test Purpose and Environment

The purpose of this test is the same as defined in Subclause A.9.2.6.1.

A.9.2.12.2 Test parameters

The parameters of this test are the same as defined in Subclause A.9.2.6.2 except that the values of the parameters in the Table A.9.2.12.2-1 will replace the values of the corresponding parameters in A.9.2.6.2-1.

Table A.9.2.12.2-1: TDD RSRQ Carrier Aggregation test parameters

| Parameters | | Test 1 | | | |
|--|--|------------|----------|----------|----------|
| | | Units | Cell 1 | Cell 2 | Cell 3 |
| BW _{channel_CA} Note1 | | MHZ | 20 | 20 | 20 |
| Measurement bandwidth | | n_{PRB} | 47-52 | 47-52 | 47-52 |
| PDSCH Reference measurement channel defined in A.3.1.1.2 | | | R.3 TDD | R.3 TDD | - |
| PDSCH allocation | | n_{PRB} | 38-61 | 38-61 | - |
| PDCCH/PCFICH/PHICH Reference measurement channel defined in A.3.1.2.2 | | | R.10 TDD | R.10 TDD | R.10 TDD |
| OCNG Patterns defined in A.3.2.2.7 (OP.7 TDD) and A.3.2.2.8 (OP.8 TDD) | | | OP.7 TDD | OP.7 TDD | OP.8 TDD |
| I _o Note2 | Bands TDD_A Note 5 | dBm/18 MHz | -87.26 | -82.67 | |
| | Bands TDD_C Note 5 | | -86.26 | -81.67 | |
| | Bands TDD_E Note 5 | | -85.26 | -80.67 | |
| Note 1: | This test verifies the RRM requirement which is independent of channel bandwidth and is performed according to the principle defined in section A.3.6.1. | | | | |

| | |
|---------|---|
| Note 2: | Io levels have been derived from other parameters for information purposes. They are not settable parameters themselves |
| Note 3: | See Table A.9.2.6.2-1 for the other parameters. |
| Note 4: | E-UTRA operating band groups are as defined in Section 3.5. |
| Note 5: | The test applies for E-UTRA operating bands in this band group which are supporting 20 MHz channel bandwidth. |

A.9.2.12.3 Test Requirements

The test requirements defined in section A.9.2.6.3 shall apply in this test case.

A.9.2.13 Void

A.9.2.14 Void

A.9.2.15 FDD RSRQ under Time Domain Measurement Resource Restriction with CRS Assistance Information and Non-MBSFN ABS

A.9.2.15.1 Test Purpose and Environment

The purpose of this test is to verify that the RSRQ measurement accuracy under time domain measurement resource restriction with CRS assistance information is within the specified limits. This test will verify the requirements in Clause 9.1.5.3 for FDD intra frequency measurements under time domain measurement resource restriction with CRS assistance information.

A.9.2.15.2 Test parameters

In this test case all cells are on the same carrier frequency. The absolute accuracy of RSRQ intra frequency measurements under time domain measurement resource restriction with CRS assistance information is tested by using the parameters in Table A.9.2.15.2-1 and Table A.9.2.15.2-2 for non-MBSFN ABS with colliding CRS between Cell1 and Cell3 and non-colliding CRS between Cell1 and Cell2. In all test cases, Cell 1 is the serving/aggressor cell, Cell2 is the neighbour/aggressor cell and Cell3 is the target cell to be measured for RSRQ.

The UE is configured by higher layers via Cell 1 with a time domain measurement resource restriction pattern for performing E-UTRAN FDD intra-frequency measurements on neighbour cells, namely Cell 3 measurements with a neighbour cell list, where the cell list includes Cell 3. The UE is also provided via higher layers with the CRS assistance information of Cell 2. The information for both measurement pattern and the CRS assistance information shall be provided to the UE before the measurements start.

Note: It's up to eNB's implementation whether the time domain measurement resource restriction pattern for PCell measurements is configured or not.

Table A.9.2.15.2-1: General test parameters for E-UTRAN FDD RSRQ intra frequency test parameters under time-domain measurement resource restriction with CRS assistance information and non-MBSFN ABS

| Parameter | Unit | Value | Comment |
|--------------------------------|------|---------------|---------------------------------|
| PCell | | Cell 1 | Serving/aggressor cell |
| Neighbour cells | | Cell 2 | Neighbour/aggressor cell |
| | | Cell3 | Cell to be measured |
| ABS transmission configuration | | Non-MBSFN ABS | As defined in Table A.3.4.1.1-1 |
| CP length | | Normal | For all cells in the test |
| DRX | | | OFF |

| | | | |
|--|--------------------------|---|---|
| Time offset between cells | μs | Cell 2 offset with respect to Cell 1: 0 Cell 3 offset with respect to Cell 1: -2.5 | Three synchronous cells |
| Physical cell IDs | | $(PCI_{cell1} - PCI_{cell3}) \bmod 6 = 0$ $(PCI_{cell2} - PCI_{cell3}) \bmod 6 \neq 0$ PCI_{cell1} not equal to PCI_{cell3} | Cell PCIs are selected so that all conditions are met |
| ABS pattern | | '1000000010000000100000 001000000010000000' | FDD ABS Pattern Info IE, as defined in TS 36.423[28], clause 9.2.54. The first/leftmost bit corresponds to the Pcell subframe #0 of the radio frame satisfying $SFN \bmod x = 0$, where x is the size of the bit string (40) divided by 10. No MBSFN subframes are configured in the ABS subframes. Configured in Cell 1 and Cell 2. |
| Time domain measurement resource restriction pattern for neighbour cell measurements on RF Channel 1 | | '1000000010000000100000 001000000010000000' | Time domain measurement resource restriction pattern for neighbor cell measurement signalled to the UE in measSubframePatternNeigh IE in measSubframePatternConfigNeigh, as defined in TS 36.331, clause 6.3.5. Configured for Cell 3 measurements. The cell list in measSubframeCellList IE shall contain Cell 3 but not Cell 2. |
| Time-domain measurement resource restriction pattern for serving cell measurements | | '0100000001000000010000 000100000001000000' | Configured for measurements on Cell 1. |
| CRS assistance information | physCellId | see PCI conditions above | Only the CRS information of cell 2 is provided in CRS-AssistanceInfo. It includes a single MBSFN-SubframeConfig element with subframe allocation <i>oneFrame</i> ='000000'. |
| | antennaPortsCount | 1 | |
| | mbsfn-SubframeConfigList | <i>oneFrame</i> = '000000' | |

Table A.9.2.15.2-2: Cell-specific test parameters for E-UTRAN FDD RSRQ intra frequency test parameters under time domain measurement resource restriction with CRS assistance information and non-MBSFN ABS

| Parameter | Unit | Test 1 | | | Test 2 | | | Test 3 | | |
|--|-----------|----------|----------|----------|----------|----------|----------|----------|----------|----------|
| | | Cell 1 | Cell 2 | Cell 3 | Cell 1 | Cell 2 | Cell 3 | Cell 1 | Cell 2 | Cell 3 |
| E-UTRA RF Channel Number | | 1 | | | 1 | | | 1 | | |
| BW _{channel} | MHz | 10 | | | 10 | | | 10 | | |
| Measurement bandwidth | n_{PRB} | 22–27 | | | 22–27 | | | 22–27 | | |
| PDSCH Reference measurement channel defined in A.3.1.1.1 | | R.0 FDD | - | | R.0 FDD | - | | R.0 FDD | - | |
| PDSCH allocation | n_{PRB} | 13–36 | - | | 13–36 | - | | 13–36 | - | |
| PDCCH/PCFICH/PHICH Reference measurement channel defined in A.3.1.2.1 | | R.6 FDD | | | R.6 FDD | | | R.6 FDD | | |
| OCNG Patterns defined in A.3.2.1.5 (OP.5 FDD) and A.3.2.1.6 (OP.6 FDD) | | OP.5 FDD | OP.6 FDD | OP.6 FDD | OP.5 FDD | OP.6 FDD | OP.6 FDD | OP.5 FDD | OP.6 FDD | OP.6 FDD |
| PBCH_RA | dB | Note 6 | 0 | | Note 6 | 0 | | Note 6 | 0 | |
| PBCH_RB | | | | | | | | | | |
| PSS_RA | | | | | | | | | | |
| SSS_RA | | | | | | | | | | |
| PCFICH_RB | | | | | | | | | | |
| PHICH_RA | | | | | | | | | | |
| PHICH_RB | | | | | | | | | | |

| | | | | | | | | | | | |
|--|---|-------------------|-----------|-----------|-----------|-----------|------------|------------|-----------|-----------|-------|
| PDCCH_RA | | | | | | | | | | | |
| PDCCH_RB | | | | | | | | | | | |
| PDSCH_RA | | | | | | | | | | | |
| PDSCH_RB | | | | | | | | | | | |
| OCNG_RA <small>Note 1</small> | | | | | | | | | | | |
| OCNG_RB <small>Note 1</small> | | | | | | | | | | | |
| N_{oc} <small>Note 2</small> | Bands FDD_A <small>Note 10</small> | dBm/ 15 kHz | -84.76 | | | -103.85 | | | -116 | | |
| | Bands FDD_B | | | | | | | | -115.5 | | |
| | Bands FDD_C | | | | | | | | -115 | | |
| | Bands FDD_D | | | | | | | | -114.5 | | |
| | Bands FDD_E, FDD_F <small>Note 7</small> | | | | | | | | -114 | | |
| | Bands FDD_G <small>Note 9</small> | | | | | | | | -113 | | |
| | Bands FDD_H | | | | | | | | -112.5 | | |
| CRS \hat{E}_s/N_{oc} | | dB | 4 | 2 | -1.5 | 4 | 2 | -1.5 | 4 | 2 | -4 |
| CRS $(\hat{E}_s/I_{ot})_{meas}$ <small>Note 5</small> | | dB | -1.18 | -0.32 | -6.96 | -1.18 | -0.32 | -6.96 | -0.75 | 0.54 | -9.46 |
| RSRP <small>Note 3,4,5</small> | Bands FDD_A <small>Note 10</small> | dBm/ 15 kHz | 80.7 6 | 82.7 6 | 86.26 | 99.8 5 | 101. 85 | 105.3 5 | -112 | -114 | -120 |
| | Bands FDD_B | | | | | | | | 111. 5 | 113. 5 | 119.5 |
| | Bands FDD_C | | | | | | | | -111 | -113 | -119 |
| | Bands FDD_D | | | | | | | | 110. 5 | 112. 5 | 118.5 |
| | Bands FDD_E, FDD_F <small>Note 7</small> | | | | | | | | -110 | -112 | -118 |
| | Bands FDD_G <small>Note 9</small> | | | | | | | | -109 | -111 | -117 |
| | Bands FDD_H | | | | | | | | 108. 5 | 110. 5 | 116.5 |
| $(RSRQ)_{meas}$ <small>Note 3,4,5</small> | Bands FDD_A <small>Note 10</small> , FDD_B, FDD_C, FDD_D, FDD_E, FDD_F <small>Note 7</small> , FDD_G <small>Note 9</small> , FDD_H | dB | 14.4 3 | 11.5 9 | 15.09 | 14.4 3 | 11.5 9 | 15.09 | - | - | - |
| | | | | | | | | | 14.1 9 | 10.8 1 | 16.81 |
| | | | | | | | | | | | |
| | | | | | | | | | | | |
| | | | | | | | | | | | |
| | | | | | | | | | | | |
| | | | | | | | | | | | |
| $(I_o)_{meas}$ <small>Note 3</small> | Bands FDD_A <small>Note 10</small> | dBm/ 9 MHz | 49.3 4 | -53.19 | 68.4 3 | -72.28 | | | 80.8 2 | -85.03 | |
| | Bands FDD_B | | | | | | | | 80.3 2 | -84.54 | |
| | Bands FDD_C | | | | | | | | 79.8 2 | -84.04 | |
| | Bands FDD_D | | | | | | | | 79.3 2 | -83.54 | |
| | Bands FDD_E, FDD_F <small>Note 7</small> | | | | | | | | 78.8 2 | -83.04 | |
| | Bands FDD_G <small>Note 9</small> | | | | | | | | 77.8 2 | -82.04 | |
| | Bands FDD_H | | | | | | | | 77.3 2 | -81.54 | |
| Propagation condition | | - | AWGN | | | AWGN | | | AWGN | | |
| <p>Note 1: OCNG shall be used such that all cells are fully allocated and a constant total transmitted power spectral density is achieved for all OFDM symbols.</p> <p>Note 2: Interference from other cells and noise sources not specified in the test is assumed to be constant over subcarriers and time and shall be modelled as AWGN of appropriate power for N_{oc} to be fulfilled. Applies to all subframes.</p> | | | | | | | | | | | |

| | |
|----------|---|
| Note 3: | RSRQ, RSRP and Io levels have been derived from other parameters for information purposes. They are not settable parameters themselves. Io levels are calculated in CRS symbols of measurement restricted subframes. |
| Note 4: | RSRP and RSRQ minimum requirements are specified assuming independent interference and noise at each receiver antenna port. |
| Note 5: | Applies to restricted measurement subframes for only Cell 2 and Cell 3. For Cell 1, the corresponding value is derived from the normal subframes other than the subframes indicated in the time domain measurement resource restriction pattern for intra-frequency measurements. |
| Note 6: | Non-ABS and ABS subframe channel powers defined in Table A.3.4.1.1-1. |
| Note 7: | For Band 26, the tests shall be performed with the carrier frequency of the assigned E-UTRA channel bandwidth within 865-894 MHz. |
| Note 8: | E-UTRA operating band groups are as defined in Section 3.5. |
| Note 9: | Except Band 29. |
| Note 10: | Except Band 32. |

A.9.2.15.3 Test Requirements

The RSRQ measurement accuracy shall fulfil the requirements in Clause 9.1.5.3.

A.9.2.16 TDD RSRQ under Time Domain Measurement Resource Restriction with CRS Assistance Information and Non-MBSFN ABS

A.9.2.16.1 Test Purpose and Environment

The purpose of this test is to verify that the RSRQ measurement accuracy under time domain measurement resource restriction with CRS assistance information is within the specified limits. This test will verify the requirements in Clause 9.1.5.3 for TDD intra frequency measurements under time domain measurement resource restriction with CRS assistance information.

A.9.2.16.2 Test parameters

In this test case all cells are on the same carrier frequency. The absolute accuracy of RSRQ intra frequency measurements under time domain measurement resource restriction with CRS assistance information is tested by using the parameters in Table A.9.2.16.2-1 and Table A.9.2.16.2-2 for non-MBSFN ABS with colliding CRS between Cell1 and Cell3 and non-colliding CRS between Cell1 and Cell2. In all test cases, Cell 1 is the serving/aggressor cell, Cell2 is the neighbour/aggressor cell and Cell3 is the target cell to be measured for RSRQ.

The UE is configured by higher layers via Cell1 with a time domain measurement resource restriction pattern for performing E-UTRAN TDD intra-frequency measurements on neighbour cells, namely Cell 3 measurements with a neighbour cell list, where the cell list includes Cell 3. The UE is also provided via higher layers with the CRS assistance information of Cell 2. The information for both measurement pattern and the CRS assistance information shall be provided to the UE before the measurements start.

Note: It's up to eNB's implementation whether the time domain measurement resource restriction pattern for PCell measurements is configured or not.

Table A.9.2.16.2-1: General test parameters for E-UTRAN TDD RSRQ intra frequency test parameters under time-domain measurement resource restriction with CRS assistance information and non-MBSFN ABS

| Parameter | Unit | Value | Comment |
|--|------|--------|---|
| PCell | | Cell 1 | Serving/aggressor cell |
| Neighbour cells | | Cell 2 | Neighbour/aggressor cell |
| | | Cell3 | Cell to be measured |
| Special subframe configuration | | 6 | For Cell 1, Cell 2 and Cell 3. For special subframe configurations see Table 4.2-1 in [16]. |
| Uplink/downlink subframe configuration | | 1 | For Cell 1, Cell 2 and Cell 2. For uplink-downlink subframe configurations see Table 4.2-2 in [16]. |

| | | | | |
|--|--------------------------|----|---|--|
| ABS transmission configuration | | | Non-MBSFN ABS | As defined in Table A.3.4.1.1-1 |
| CP length | | | Normal | For all cells in the test |
| DRX | | | | OFF |
| Time offset between cells | | μs | Cell 2 offset with respect to Cell 1: 0 Cell 3 offset with respect to Cell 1: -2.5 | Three synchronous cells |
| Physical cell IDs | | | $(PCI_{cell1} - PCI_{cell3}) \bmod 6 = 0$ $(PCI_{cell2} - PCI_{cell3}) \bmod 6 \neq 0$ PCI_{cell1} not equal to PCI_{cell3} | Cell PCIs are selected so that all conditions are met |
| ABS pattern | | | '00000000010000000001' | TDD ABS Pattern Info IE, as defined in TS 36.423 [28], clause 9.2.54. The first/leftmost bit corresponds to the Pcell subframe #0 of the radio frame satisfying $SFN \bmod x = 0$, where x is the size of the bit string (20) divided by 10. No MBSFN subframes are configured in the ABS subframes. Provided fto the UE for Cell 1 and Cell 2. |
| Time domain measurement resource restriction pattern for neighbour cell measurements on RF Channel 1 | | | '00000000010000000001' | Time domain measurement resource restriction pattern for neighbor cell measurement signalled to the UE in measSubframePatternNeigh IE in measSubframePatternConfigNeigh, as defined in TS 36.331, clause 6.3.5. Provided to the UE for Cell 3 measurements. The cell list in measSubframeCellList IE shall contain Cell 3 but not Cell 2. |
| Time-domain measurement resource restriction pattern for serving cell measurements | | | '10000000001000000000' | Configured for Cell 1 measurements. |
| CRS assistance information | physCellId | | see PCI conditions above | Only the CRS assistance information of cell 2 is provided for Cell 2 only in CRS-AssistanceInfo. It includes a single MBSFN-SubframeConfig element with subframe allocation <i>one Frame</i> ='000000'. |
| | antennaPortsCount | | 1 | |
| | mbsfn-SubframeConfigList | | <i>oneFrame</i> = '000000' | |

Table A.9.2.16.2-2: Cell-specific test parameters for E-UTRAN TDD RSRQ intra frequency test parameters under time domain measurement resource restriction with CRS assistance information and non-MBSFN ABS

| Parameter | Unit | Test 1 | | | Test 2 | | | Test 3 | | |
|--|-----------|----------|----------|----------|----------|----------|----------|----------|----------|----------|
| | | Cell 1 | Cell 2 | Cell 3 | Cell 1 | Cell 2 | Cell 3 | Cell 1 | Cell 2 | Cell 3 |
| E-UTRA RF Channel Number | | 1 | | | 1 | | | 1 | | |
| BW _{channel} | MHz | 10 | | | 10 | | | 10 | | |
| Measurement bandwidth | n_{PRB} | 22–27 | | | 22–27 | | | 22–27 | | |
| PDSCH Reference measurement channel defined in A.3.1.1.2 | | R.0 TDD | - | | R.0 TDD | - | | R.0 TDD | - | |
| PDSCH allocation | n_{PRB} | 13–36 | - | | 13–36 | - | | 13–36 | - | |
| PDCCH/PCFICH/PHICH Reference measurement channel defined in A.3.1.2.2 | | R.6 TDD | | | R.6 TDD | | | R.6 TDD | | |
| OCNG Patterns defined in A.3.2.2.1 (OP.1 TDD) and A.3.2.2.2 (OP.2 TDD) | | OP.1 TDD | OP.2 TDD | OP.2 TDD | OP.1 TDD | OP.2 TDD | OP.2 TDD | OP.1 TDD | OP.2 TDD | OP.2 TDD |
| PBCH_RA | dB | Note 6 | 0 | | Note 6 | 0 | | Note 6 | 0 | |
| PBCH_RB | | | | | | | | | | |
| PSS_RA | | | | | | | | | | |
| SSS_RA | | | | | | | | | | |

| | | | | | | | | | | | | | | |
|---|---------------------------|-------------------|-----------|-----------|-----------|-----------|-----------|-----------|-----------|-----------|-----------|--------|--|--|
| PCFICH_RB | | | | | | | | | | | | | | |
| PHICH_RA | | | | | | | | | | | | | | |
| PHICH_RB | | | | | | | | | | | | | | |
| PDCCH_RA | | | | | | | | | | | | | | |
| PDCCH_RB | | | | | | | | | | | | | | |
| PDSCH_RA | | | | | | | | | | | | | | |
| PDSCH_RB | | | | | | | | | | | | | | |
| OCNG_RA ^{Note1} | | | | | | | | | | | | | | |
| OCNG_RB ^{Note1} | | | | | | | | | | | | | | |
| N_{oc} ^{Note2} | Bands TDD_A | dBm/ 15 kHz | -84.76 | | | -103.85 | | | -116 | | | | | |
| | Bands TDD_C | | | | | | | | | | | -115 | | |
| | Bands TDD_E | | | | | | | | | | | | | |
| CRS \hat{E}_s/N_{oc} | dB | 4 | 2 | -1.5 | 4 | 2 | -1.5 | 4 | 2 | -4 | | | | |
| CRS $(\hat{E}_s/I_{ot})_{meas}$ ^{Note 5} | dB | - | - | -6.96 | - | - | -6.96 | - | 0.54 | -9.46 | | | | |
| RSRP ^{Note3,4,5} | Bands TDD_A | dBm/ 15 kHz | -84.76 | | | -103.85 | | | -116 | | | | | |
| | Bands TDD_C | | | | | | | | | | | -111 | | |
| | Bands TDD_E | | | | | | | | | | | | | |
| $(RSRQ)_{meas}$ ^{Note3,4,5} | Bands TDD_A, TDD_C, TDD_E | dB | 14.4 3 | 11.5 9 | 15.0 9 | 14.4 3 | 11.5 9 | 15.0 9 | 14.1 9 | 10.8 1 | 16.8 1 | | | |
| $(I_o)_{meas}$ ^{Note3} | Bands TDD_A | dBm/ 9 MHz | -53.19 | | | -72.28 | | | -85.03 | | | | | |
| | Bands TDD_C | | | | | | | | | | | -84.03 | | |
| | Bands TDD_E | | | | | | | | | | | | | |
| Propagation condition | | - | AWGN | | | AWGN | | | AWGN | | | | | |
| <p>Note 1: OCNG shall be used such that both cells are fully allocated and a constant total transmitted power spectral density is achieved for all OFDM symbols.</p> <p>Note 2: Interference from other cells and noise sources not specified in the test is assumed to be constant over subcarriers and time and shall be modelled as AWGN of appropriate power for N_{oc} to be fulfilled. Applies to all subframes.</p> <p>Note 3: RSRQ, RSRP and I_o levels have been derived from other parameters for information purposes. They are not settable parameters themselves. I_o levels are calculated in CRS symbols of measurement restricted subframes.</p> <p>Note 4: RSRP and RSRQ minimum requirements are specified assuming independent interference and noise at each receiver antenna port.</p> <p>Note 5: Applies to restricted measurement subframes for only Cell 2 and Cell 3. For Cell 1, the corresponding value is derived from the normal subframes other than the subframes indicated in the time domain measurement resource restriction pattern for intra-frequency measurements.</p> <p>Note 6: Non-ABS and ABS subframe channel powers defined in Table A.3.4.1.1-1.</p> <p>Note 7: E-UTRA operating band groups are as defined in Section 3.5.</p> | | | | | | | | | | | | | | |

A.9.2.16.3 Test Requirements

The RSRQ measurement accuracy shall fulfil the requirements in Clause 9.1.5.3.

A.9.2.17 FDD Intra frequency case for 5 MHz bandwidth

A.9.2.17.1 Test Purpose and Environment

The purpose of this test is to verify that the RSRQ measurement accuracy is within the specified limits. This test will verify the requirements in Clause 9.1.5.1.

A.9.2.17.2 Test parameters

In this test case all cells are on the same carrier frequency. The absolute accuracy of RSRQ intra frequency measurement is tested by using the parameters in Table A.9.2.17.2-1. In all test cases, Cell 1 is the PCell and Cell 2 the target cell.

Table A.9.2.17.2-1: RSRQ FDD Intra frequency test parameters, 5MHz

| Parameter | Unit | Test 1 | | Test 2 | | Test 3 | | |
|--|-------------|-------------|-----------|-----------|-----------|-----------|-----------|-------------|
| | | Cell 1 | Cell 2 | Cell 1 | Cell 2 | Cell 1 | Cell 2 | |
| E-UTRA RF Channel Number | | 1 | | 1 | | 1 | | |
| BW _{channel} | MHz | 5 | | 5 | | 5 | | |
| Measurement bandwidth | n_{PRB} | 10–15 | | 10–15 | | 10–15 | | |
| PDSCH Reference measurement channel defined in A.3.1.1.1 | | R.5 FDD | - | R.5 FDD | - | R.5 FDD | - | |
| PDSCH allocation | n_{PRB} | 7–17 | - | 7–17 | - | 7–17 | - | |
| PDCCH/PCFICH/PHICH Reference measurement channel defined in A.3.1.2.1 | | R.11 FDD | | R.11 FDD | | R.11 FDD | | |
| OCNG Patterns defined in A.3.2.1.15 (OP.15 FDD) and A.3.2.1.16 (OP.16 FDD) | | OP.15 FDD | OP.16 FDD | OP.15 FDD | OP.16 FDD | OP.15 FDD | OP.16 FDD | |
| PBCH_RA | dB | 0 | 0 | 0 | 0 | 0 | 0 | |
| PBCH_RB | | | | | | | | |
| PSS_RA | | | | | | | | |
| SSS_RA | | | | | | | | |
| PCFICH_RB | | | | | | | | |
| PHICH_RA | | | | | | | | |
| PHICH_RB | | | | | | | | |
| PDCCH_RA | | | | | | | | |
| PDCCH_RB | | | | | | | | |
| PDSCH_RA | | | | | | | | |
| PDSCH_RB | | | | | | | | |
| OCNG_RA ^{Note1} | | | | | | | | |
| OCNG_RB ^{Note1} | | | | | | | | |
| N_{oc} ^{Note2} | | | | | | | | Bands FDD_N |
| \hat{E}_s/I_{ot} | | dB | -1.76 | -1.76 | -4.70 | -4.70 | -5.46 | -5.46 |
| RSRP ^{Note3} | Bands FDD_N | dBm/15 kHz | -78.76 | -78.76 | -103.75 | -103.75 | -113.50 | -113.50 |
| RSRQ ^{Note3} | Bands FDD_N | dB | -14.77 | -14.77 | -16.76 | -16.76 | -17.34 | -17.34 |
| I_o ^{Note3} | Bands FDD_N | dBm/4.5 MHz | -50.01 | | -73.01 | | -82.19 | |

| | | | | | | | |
|-----------------------|--|------|---|------|------|------|----|
| \hat{E}_s / N_{oc} | dB | 3 | 3 | -2.9 | -2.9 | -4 | -4 |
| Propagation condition | - | AWGN | | AWGN | | AWGN | |
| Note 1: | OCNG shall be used such that both cells are fully allocated and a constant total transmitted power spectral density is achieved for all OFDM symbols. | | | | | | |
| Note 2: | Interference from other cells and noise sources not specified in the test is assumed to be constant over subcarriers and time and shall be modelled as AWGN of appropriate power for N_{oc} to be fulfilled. | | | | | | |
| Note 3: | RSRQ, RSRP and I_o levels have been derived from other parameters for information purposes. They are not settable parameters themselves. | | | | | | |
| Note 4: | RSRP and RSRQ minimum requirements are specified assuming independent interference and noise at each receiver antenna port. | | | | | | |

A.9.2.17.3 Test Requirements

The RSRQ measurement accuracy shall fulfil the requirements in Clause 9.1.5.1.

A.9.2.18 FDD—FDD Inter frequency case for 5MHz bandwidth

A.9.2.18.1 Test Purpose and Environment

The purpose of this test is to verify that the RSRQ measurement accuracy is within the specified limits. This test will verify the requirements in Sections 9.1.6.1 and 9.1.6.2.

A.9.2.18.2 Test parameters

In this test case the two cells are on different carrier frequencies and measurement gaps are provided. Both RSRQ inter frequency absolute and relative accuracy requirements are tested by using test parameters in Table A.9.2.18.2-1. In all tests, Cell 1 is the PCell and Cell 2 the target cell.

Table A.9.2.18.2-1: RSRQ FDD—FDD Inter frequency test parameters, 5MHz

| Parameter | Unit | Test 1 | | Test 2 | | Test 3 | |
|--|-----------|-----------|-----------|-----------|-----------|-----------|-----------|
| | | Cell 1 | Cell 2 | Cell 1 | Cell 2 | Cell 1 | Cell 2 |
| E-UTRA RF Channel Number | | 1 | 2 | 1 | 2 | 1 | 2 |
| BW _{channel} | MHz | 5 | 5 | 5 | 5 | 5 | 5 |
| Gap Pattern Id | | 0 | - | 0 | - | 0 | - |
| Measurement bandwidth | n_{PRB} | 10—15 | | 10—15 | | 10—15 | |
| PDSCH Reference measurement channel defined in A.3.1.1.1 | | R.5 FDD | - | R.5 FDD | - | R.6 FDD | - |
| PDSCH allocation | n_{PRB} | 7—17 | - | 7—17 | - | 7—17 | - |
| PDCCH/PCFICH/PHICH Reference measurement channel defined in A.3.1.2.1 | | R.11 FDD | | R.11 FDD | | R.11 FDD | |
| OCNG Patterns defined in A.3.2.1.15 (OP.15 FDD) and A.3.2.1.16 (OP.16 FDD) | | OP.15 FDD | OP.16 FDD | OP.15 FDD | OP.16 FDD | OP.15 FDD | OP.16 FDD |
| PBCH_RA | dB | 0 | 0 | 0 | 0 | 0 | 0 |
| PBCH_RB | | | | | | | |
| PSS_RA | | | | | | | |
| SSS_RA | | | | | | | |
| PCFICH_RB | | | | | | | |
| PHICH_RA | | | | | | | |
| PHICH_RB | | | | | | | |
| PDCCH_RA | | | | | | | |
| PDCCH_RB | | | | | | | |
| PDSCH_RA | | | | | | | |
| PDSCH_RB | | | | | | | |
| OCNG_RA ^{Note1} | | | | | | | |

| | | | | | | | | |
|---|--------------------------------------|-------------|--------|--------|---------|---------|--------|--------|
| OCNG_RB ^{Note1} | | | | | | | | |
| N_{oc} ^{Note2} | Bands FDD_A | dBm/15 kHz | -77 | -77 | -101.70 | -101.70 | -119.5 | N/A |
| | Bands FDD_B | | | | | | -119 | N/A |
| | Bands FDD_C | | | | | | -118.5 | N/A |
| | Bands FDD_D | | | | | | -118 | N/A |
| | Bands FDD_E, FDD_F ^{Note 5} | | | | | | -117.5 | N/A |
| | Bands FDD_G | | | | | | -116.5 | N/A |
| | Bands FDD_H | | | | | | -116 | N/A |
| | Bands FDD_N | | | | | | - N/A | -113 |
| \hat{E}_s / I_{ot} | | dB | -1.75 | -1.75 | -4.00 | -4.00 | -4.00 | -4.00 |
| RSRP ^{Note3} | Bands FDD_A | dBm/15 kHz | -78.75 | -78.75 | -105.70 | -105.70 | -123.5 | N/A |
| | Bands FDD_B | | | | | | -123 | N/A |
| | Bands FDD_C | | | | | | -122.5 | N/A |
| | Bands FDD_D | | | | | | -122 | N/A |
| | Bands FDD_E, FDD_F ^{Note 5} | | | | | | -121.5 | N/A |
| | Bands FDD_G | | | | | | -120.5 | N/A |
| | Bands FDD_H | | | | | | -120 | N/A |
| | Bands FDD_N | | | | | | N/A | -117 |
| RSRQ ^{Note3} | Bands FDD_A | dB | -14.76 | -14.76 | -16.25 | -16.25 | -16.25 | -16.25 |
| | Bands FDD_B | | | | | | | |
| | Bands FDD_C | | | | | | | |
| | Bands FDD_D | | | | | | | |
| | Bands FDD_E, FDD_F ^{Note 5} | | | | | | | |
| | Bands FDD_G | | | | | | | |
| | Bands FDD_H | | | | | | | |
| | Bands FDD_N | | | | | | | |
| I_o ^{Note3} | Bands FDD_A | dBm/4.5 MHz | -50.01 | -50.01 | -75.47 | -75.47 | -93.27 | N/A |
| | Bands FDD_B | | | | | | -92.77 | N/A |
| | Bands FDD_C | | | | | | -92.27 | N/A |
| | Bands FDD_D | | | | | | -91.77 | N/A |
| | Bands FDD_E, FDD_F ^{Note 5} | | | | | | -91.27 | N/A |
| | Bands FDD_G | | | | | | -90.27 | N/A |
| | Bands FDD_H | | | | | | -89.77 | N/A |
| | Bands FDD_N | | | | | | N/A | -86.77 |
| \hat{E}_s / N_{oc} | | dB | -1.75 | -1.75 | -4.0 | -4.0 | -4.0 | -4.0 |
| Propagation condition | | - | AWGN | | AWGN | | AWGN | |
| <p>Note 1: OCNG shall be used such that both cells are fully allocated and a constant total transmitted power spectral density is achieved for all OFDM symbols.</p> <p>Note 2: Interference from other cells and noise sources not specified in the test is assumed to be constant over subcarriers and time and shall be modelled as AWGN of appropriate power for N_{oc} to be fulfilled.</p> <p>Note 3: RSRQ, RSRP and I_o levels have been derived from other parameters for information purposes. They are not settable parameters themselves.</p> <p>Note 4: RSRP and RSRQ minimum requirements are specified assuming independent interference and noise at each receiver antenna port.</p> <p>Note 5: For Band 26, the tests shall be performed with the assigned E-UTRA channel bandwidth within 865-894 MHz.</p> <p>Note 6: This test is only applicable for testing inter-frequency requirements for Bands FDD_N. Cell 2 is on the Band under test, and Cell 1 is on another band supported by the UE.</p> <p>Note 7: E-UTRA operating band groups are as defined in Section 3.5.</p> | | | | | | | | |

A.9.2.18.3 Test Requirements

The RSRQ measurement accuracy shall fulfil the requirements in Sections 9.1.6.1 and 9.1.6.2.

A.9.2.19 FDD-FDD Inter Frequency WB-RSRQ

A.9.2.19.1 Test Purpose and Environment

The purpose of this test is to verify that the RSRQ measurement accuracy is within the specified limits when the measurement configuration message received by the UE contains *widebandRSRQ-Meas* parameter in TS 36.331 [2]. In the test the UE shall also be configured with the *AllowedMeasBandwidth* parameter defined in TS 36.331 [2]. The test shall verify the WB-RSRQ inter frequency absolute accuracy requirements defined in Section 9.1.6.3.

A.9.2.19.2 Test parameters

In this test case the two cells are on two different carrier frequencies and measurement gaps are provided. The WB-RSRQ inter frequency absolute accuracy requirement is tested by using test parameters in Table A.9.2.19.2-1. In the test, Cell 1 is the PCell and Cell 2 the target cell on which the UE shall be ordered to measure WB-RSRQ.

Table A.9.2.19.2-1: WB-RSRQ FDD-FDD Inter frequency test parameters

| Parameter | | Unit | Test 1 | | |
|---|-----------|------------|----------|---------------|-------|
| | | | Cell 1 | Cell 2 | |
| E-UTRA RF Channel Number | | | 1 | 2 | |
| BW_{channel} | | MHz | 10 | 10 | |
| Antenna Configuration | | | 1x2 | 1x2 | |
| Gap Pattern Id | | | 0 | - | |
| PBCH_RA | | dB | 0 | 0 | |
| PBCH_RB | | | | 0 | |
| PSS_RA | | | | 0 | |
| SSS_RA | | | | 0 | |
| PCFICH_RB | | | | -∞ | |
| PHICH_RA | | | | -∞ | |
| PHICH_RB | | | | -∞ | |
| PDCCH_RA | | | | -∞ | |
| PDCCH_RB | | | | -∞ | |
| PDSCH_RA | | | | -∞ | |
| PDSCH_RB | | | | -∞ | |
| OCNG_RA ^{Note1} | | | | -∞ | |
| OCNG_RB ^{Note1} | | | | -∞ | |
| <i>AllowedMeasBandwidth</i> in TS 36.331 [2] | | | | RB | 6 |
| PDSCH Reference measurement channel defined in A.3.1.1.1 | | | R.0 FDD | - | |
| PDSCH allocation | | n_{PRB} | 13-36 | - | |
| PDCCH/PCFICH/PHICH Reference measurement channel defined in A.3.1.2.1 | | | R.6 FDD | - | |
| OCNG Patterns defined in A.3.2.1.1 (OP.1 FDD) | | | OP.1 FDD | - | |
| I_{ot} ^{Note2} | bandwidth | n_{PRB} | 0-49 | 0-21 28-49 | 22-27 |
| | | dBm/15 kHz | -94 | -87 | -110 |
| \hat{E}_s / I_{ot} | bandwidth | n_{PRB} | 0-49 | 0-21 28-49 | 22-27 |
| | | dB | -4 | -3 | 20 |
| RSRP ^{Note3} | | dBm/15 kHz | -98 | -90 | |
| RSRQ ^{Note3} | | dB | -16.25 | - | |
| WB-RSRQ ₀ ^{Note3} in subframe 0 | | dB | - | -13.68 | |
| WB-RSRQ ₁ ^{Note3} in subframe ≠ 0 | | dB | - | -13.63 | |
| I_o ^{Note3} | | dBm/ 9 MHz | -64.76 | - | |
| I_o ^{Note3} in symbol 0, 4, 11 of subframe 0 | | dBm/ 9 MHz | - | -82.38 | |

| | | | |
|--|---|------|--------|
| I_{o}^{Note3} in symbol 7 of subframe 0 | dBm/ 9 MHz | - | -82.20 |
| I_{o}^{Note3} in symbol 0, 4, 7, 11 of subframes \neq 0 | dBm/ 9 MHz | - | -82.38 |
| Propagation condition | - | AWGN | AWGN |
| Note 1: | OCNG shall be used such that Cell 1 is fully allocated and a constant total transmitted power spectral density is achieved for all OFDM symbols. | | |
| Note 2: | Interference from other cells not specified in the test, assumed to be constant over time and modelled as noise. | | |
| Note 3: | RSRQ, RSRP, WB-RSRQ and I_o levels have been derived from other parameters for information purposes. They are not settable parameters themselves. The stated values represent the weighted average over the allowed measurement bandwidth, and the WB-RSRQ values assume averaging over symbols 0, 4, 7 and 11 of the subframe. | | |
| Note 4: | RSRP and RSRQ minimum requirements are specified assuming independent interference and noise at each receiver antenna port. | | |
| Note 5: | This test case is applicable to all FDD frequency bands except band 31. | | |

A.9.2.19.3 Test Requirements

The WB-RSRQ measurement accuracy for cell 2 shall fulfil the requirements in Section 9.1.6.3, compared with $WB\text{-RSRQ}_0$ or $WB\text{-RSRQ}_1$.

A.9.2.20 TDD—TDD Inter Frequency WB-RSRQ

A.9.2.20.1 Test Purpose and Environment

The purpose of this test is to verify that the RSRQ measurement accuracy is within the specified limits when the measurement configuration message received by the UE contains *widebandRSRQ-Meas* parameter in TS 36.331 [2]. In the test the UE shall also be configured with the *AllowedMeasBandwidth* parameter defined in TS 36.331 [2]. The test shall verify the WB-RSRQ inter frequency absolute accuracy requirements defined in Section 9.1.6.3.

A.9.2.20.2 Test parameters

In this test case the two cells are on two different carrier frequencies and measurement gaps are provided. The WB-RSRQ inter frequency absolute accuracy requirement is tested by using test parameters in Table A.9.2.20.2-1. In the test, Cell 1 is the PCell and Cell 2 the target cell on which the UE shall be ordered to measure WB-RSRQ.

Table A.9.2.20.2-1: WB-RSRQ TDD-TDD Inter frequency test parameters

| Parameter | Unit | Test 1 | |
|---|------|--------|-----------|
| | | Cell 1 | Cell 2 |
| E-UTRA RF Channel Number | | 1 | 2 |
| BW_{channel} | MHz | 10 | 10 |
| Special subframe configuration ^{Note1} | | 6 | 6 |
| Uplink-downlink configuration ^{Note1} | | 1 | 1 |
| Antenna Configuration | | 1x2 | 1x2 |
| Gap Pattern Id | | 0 | - |
| PBCH_RA | dB | 0 | 0 |
| PBCH_RB | | | 0 |
| PSS_RA | | | 0 |
| SSS_RA | | | 0 |
| PCFICH_RB | | | $-\infty$ |
| PHICH_RA | | | $-\infty$ |
| PHICH_RB | | | $-\infty$ |
| PDCCH_RA | | | $-\infty$ |
| PDCCH_RB | | | $-\infty$ |
| PDSCH_RA | | | $-\infty$ |
| PDSCH_RB | | | $-\infty$ |
| OCNG_RA ^{Note2} | | | $-\infty$ |
| OCNG_RB ^{Note2} | | | $-\infty$ |

| | | | | | |
|---|-----------|------------|----------|---------------|-------|
| <i>AllowedMeasBandwidth</i> in TS 36.331 [2] | | RB | 6 | 50 | |
| PDSCH Reference measurement channel defined in A.3.1.1.2 | | | R.0 TDD | - | |
| PDSCH allocation | | n_{PRB} | 13-36 | - | |
| PDCCH/PCFICH/PHICH Reference measurement channel defined in A.3.1.2.2 | | | R.6 TDD | - | |
| OCNG Patterns defined in A.3.2.2.1 (OP.1 TDD) | | | OP.1 TDD | - | |
| I_{ot} ^{Note3} | bandwidth | n_{PRB} | 0-49 | 0-21 28-49 | 22-27 |
| | | dBm/15 kHz | -94 | -87 | -110 |
| \hat{E}_s / I_{ot} | bandwidth | n_{PRB} | 0—49 | 0-21 28-49 | 22-27 |
| | | dB | -4 | -3 | 20 |
| RSRP ^{Note4} | | dBm/15 kHz | -98 | -90 | |
| RSRQ ^{Note4} | | dB | -16.25 | - | |
| WB-RSRQ ₀ ^{Note4} in subframe 0 | | dB | - | -13.68 | |
| WB-RSRQ ₁ ^{Note4} in subframe ≠ 0 | | dB | - | -13.63 | |
| I _o ^{Note4} | | dBm/ 9 MHz | -64.76 | - | |
| I _o ^{Note4} in symbol 0, 4, 11 of subframe 0 | | dBm/ 9 MHz | - | -82.38 | |
| I _o ^{Note4} in symbol 7 of subframe 0 | | dBm/ 9 MHz | - | -82.20 | |
| I _o ^{Note4} in symbol 0, 4, 7, 11 of subframes ≠ 0 | | dBm/ 9 MHz | - | -82.38 | |
| Propagation condition | | - | AWGN | AWGN | |
| <p>Note 1: For special subframe and uplink-downlink configurations see Tables 4.2-1 and 4.2-2 in TS 36.211.</p> <p>Note 2: OCNG shall be used such that Cell 1 is fully allocated and a constant total transmitted power spectral density is achieved for all OFDM symbols.</p> <p>Note 3: Interference from other cells not specified in the test, assumed to be constant over time and modelled as noise.</p> <p>Note 4: RSRQ, RSRP, WB-RSRQ and I_o levels have been derived from other parameters for information purposes. They are not settable parameters themselves. The stated values represent the weighted average over the allowed measurement bandwidth, and the WB-RSRQ values assume averaging over symbols 0, 4, 7 and 11 of the subframe.</p> <p>Note 5: RSRP and RSRQ minimum requirements are specified assuming independent interference and noise at each receiver antenna port.</p> | | | | | |

A.9.2.20.3 Test Requirements

The WB-RSRQ measurement accuracy for cell 2 shall fulfil the requirements in Section 9.1.6.3, compared with WB-RSRQ₀ or WB-RSRQ₁.

A.9.2.21 FDD RSRQ for E-UTRAN Carrier Aggregation for 10MHz+5MHz

The test case in this section are applicable to carrier aggregation capable UEs which have been configured with a downlink SCell.

A.9.2.21.1 Test Purpose and Environment

The purpose of this test is the same as defined in Subclause A.9.2.5.1.

A.9.2.21.2 Test parameters

The parameters of this test are the same as defined in Subclause A.9.2.5.2 except that the values of the parameters in the Table A.9.2.21.2-1 will replace the values of the corresponding parameters in A.9.2.5.2-1.

Table A.9.2.21.2-1: FDD RSRQ Carrier Aggregation test parameters

| Parameters | | Test 1 | | | |
|--|--------------------|------------|----------|-----------|-----------|
| | | Units | Cell 1 | Cell 2 | Cell 3 |
| BW _{channel_CA} ^{Note 1} | | MHz | 10 | 5 | |
| Measurement bandwidth | | n_{PRB} | 22-27 | 10-15 | |
| PDSCH Reference measurement channel defined in A.3.1.1.1 | | | R.0 FDD | R.5 FDD | - |
| PDSCH allocation | | n_{PRB} | 13-36 | 7-17 | - |
| PDCCH/PCFICH/PHICH Reference measurement channel defined in A.3.1.2.1 | | | R.6 FDD | R.11 FDD | |
| OCNG Patterns defined in A.3.2.1.1 (OP.1 FDD), A.3.2.1.15 (OP.15 FDD) and A.3.2.1.16 (OP.16 FDD) | | | OP.1 FDD | OP.15 FDD | OP.16 FDD |
| N_{oc} ^{Note2} | Bands FDD_A | dBm/15 kHz | -119.5 | -116 | -116 |
| | Bands FDD_B | | -119 | -115.5 | -115.5 |
| | Bands FDD_C | | -118.5 | -115 | -115 |
| | Bands FDD_D | | -118 | -114.5 | -114.5 |
| | Bands FDD_E, FDD_F | | -117.5 | -114 | -114 |
| | Bands FDD_G | | -116.5 | -113 | -113 |
| | Bands FDD_H | | -116 | -112.5 | -112.5 |
| | Bands FDD_N | | N/A | -109.5 | -109.5 |
| RSRP ^{Note2} | Bands FDD_A | dBm/15 kHz | -123.5 | -120 | -120 |
| | Bands FDD_B | | -123 | -119.5 | -119.5 |
| | Bands FDD_C | | -122.5 | -119 | -119 |
| | Bands FDD_D | | -122 | -118.5 | -118.5 |
| | Bands FDD_E, FDD_F | | -121.5 | -118 | -118 |
| | Bands FDD_G | | -120.5 | -117 | -117 |
| | Bands FDD_H | | -120 | -116.5 | -116.5 |
| | Bands FDD_N | | N/A | -113.5 | -113.5 |
| RSRQ ^{Note2} | Bands FDD_A | dB | -16.25 | -17.34 | -17.34 |
| | Bands FDD_B | | | | |
| | Bands FDD_C | | | | |

| | | | | | | |
|---------------------|--------------------|---|--------|--|--|--|
| | Bands FDD_D | | | | | |
| | Bands FDD_E, FDD_F | | | | | |
| | Bands FDD_G | | | | | |
| | Bands FDD_H | | | | | |
| | Bands FDD_N | | | | | |
| Io ^{Note2} | Bands FDD_A | dBm/9MHz | -90.26 | N/A | | |
| | Bands FDD_B | | -89.76 | | | |
| | Bands FDD_C | | -89.26 | | | |
| | Bands FDD_D | | -88.76 | | | |
| | Bands FDD_E, FDD_F | | -88.26 | | | |
| | Bands FDD_G | | -87.26 | | | |
| | Bands FDD_H | | -86.76 | | | |
| | Bands FDD_A | dBm/4.5MHz | N/A | -88.67 | | |
| | Bands FDD_B | | | -88.17 | | |
| | Bands FDD_C | | | -87.67 | | |
| | Bands FDD_D | | | -87.17 | | |
| | Bands FDD_E, FDD_F | | | -86.67 | | |
| | Bands FDD_G | | | -85.67 | | |
| | Bands FDD_H | | | -85.17 | | |
| | Bands FDD_N | | | -82.17 | | |
| | Note 1: | | | This test verifies the RRM requirement which is independent of channel bandwidth and is performed according to the principle defined in section A.3.6.1. | | |
| | Note 2: | RSRQ, RSRP and Io levels have been derived from other parameters for information purposes. They are not settable parameters themselves. | | | | |
| | Note 3: | See Table A.9.2.5.2-1 for the other parameters | | | | |

A.9.2.21.3 Test Requirements

The test requirements defined in section A.9.2.5.3 shall apply in this test case.

A.9.2.22 TDD RSRQ for E-UTRAN Carrier Aggregation for 10MHz+5MHz

The test case in this section are applicable to carrier aggregation capable UEs which have been configured with a downlink SCell.

A.9.2.22.1 Test Purpose and Environment

The purpose of this test is the same as defined in Subclause A.9.2.6.1.

A.9.2.22.2 Test parameters

The parameters of this test are the same as defined in Subclause A.9.2.6.2 except that the values of the parameters in the Table A.9.2.22.2-1 will replace the values of the corresponding parameters in A.9.2.6.2-1.

Table A.9.2.22.2-1: TDD RSRQ Carrier Aggregation test parameters

| Parameters | | Test 1 | | | |
|--|-------------|--|----------|----------|-----------|
| | | Units | Cell 1 | Cell 2 | Cell 3 |
| BW _{channel_CA} ^{Note1} | | MHz | 10 | 5 | |
| Measurement bandwidth | | n_{PRB} | 22-27 | 10-15 | |
| PDSCH Reference measurement channel defined in A.3.1.1.2 | | | R.0 TDD | R.4TDD | - |
| PDSCH allocation | | n_{PRB} | 13-36 | 7-17 | - |
| PDCCH/PCFICH/PHICH Reference measurement channel defined in A.3.1.2.2 | | | R.6 TDD | R.11 TDD | |
| OCNG Patterns defined in A.3.2.2.1 (OP.1 TDD), A.3.2.2.9 (OP.9 TDD) and A.3.2.2.10 (OP.10 TDD) | | | OP.1 TDD | OP.9 TDD | OP.10 TDD |
| I _o ^{Note2} | Bands TDD_A | dBm/9MHz | -90.26 | N/A | |
| | Bands TDD_C | | -89.26 | | |
| | Bands TDD_E | | -88.26 | | |
| | Bands TDD_A | dBm/4.5MHz | N/A | -88.67 | |
| | Bands TDD_C | | | -87.67 | |
| | Bands TDD_E | | | -86.67 | |
| Note 1: | | This test verifies the RRM requirement which is independent of channel bandwidth and is performed according to the principle defined in section A.3.6.1. | | | |
| Note 2: | | I _o levels have been derived from other parameters for information purposes. They are not settable parameters themselves | | | |
| Note 3: | | See Table A.9.2.6.2-1 for the other parameters | | | |

A.9.2.22.3 Test Requirements

The test requirements defined in section A.9.2.6.3 shall apply in this test case.

A.9.2.23 FDD RSRQ for E-UTRA Carrier Aggregation (5MHz + 5MHz bandwidth)

The test case in this section are applicable to carrier aggregation capable UEs which have been configured with a downlink SCell.

A.9.2.23.1 Test Purpose and Environment

The purpose of this test is the same as defined in Subclause A.9.2.5.1.

A.9.2.23.2 Test parameters

The parameters of this test are the same as defined in Subclause A.9.2.5.2 except that the values of the parameters in the Table A.9.2.23.2-1 will replace the values of the corresponding parameters in A.9.2.5.2-1.

Table A.9.2.23.2-1: FDD RSRQ Carrier Aggregation test parameters

| Parameters | | Test 1 | | | |
|---|--|------------|-----------|-----------|----------|
| | | Units | Cell 1 | Cell 2 | Cell 3 |
| $BW_{channel_CA}$ <small>Note 1</small> | | MHz | 5 | 5 | 5 |
| Measurement bandwidth | | n_{PRB} | 10-15 | 10-15 | 10-15 |
| PDSCH Reference measurement channel defined in A.3.1.1.1 | | | R.5 FDD | R.5 FDD | N/A |
| PDSCH allocation | | n_{PRB} | 7-17 | 7-17 | - |
| PDCCH/PCFICH/PHICH Reference measurement channel defined in A.3.1.2.1 | | | R.11 FDD | R.11 FDD | R.11 FDD |
| OCNG Patterns defined in A.3.2.1.15 (OP.15 FDD) and A.3.2.1.16 (OP.16 FDD) | | | OP.15 FDD | OP.15 FDD | OP.16FDD |
| N_{oc} <small>Note2</small> | Bands FDD_A | dBm/15 kHz | -119.5 | -116 | -116 |
| | Bands FDD_B | | -119 | -115.5 | -115.5 |
| | Bands FDD_C | | -118.5 | -115 | -115 |
| | Bands FDD_D | | -118 | -114.5 | -114.5 |
| | Bands FDD_E, FDD_F | | -117.5 | -114 | -114 |
| | Bands FDD_G | | -116.5 | -113 | -113 |
| | Bands FDD_H | | -116 | -112.5 | -112.5 |
| | Bands FDD_N | | -113 | -109.5 | -109.5 |
| RSRP <small>Note2</small> | Bands FDD_A | dBm/15 kHz | -123.5 | -120 | -120 |
| | Bands FDD_B | | -123 | -119.5 | -119.5 |
| | Bands FDD_C | | -122.5 | -119 | -119 |
| | Bands FDD_D | | -122 | -118.5 | -118.5 |
| | Bands FDD_E, FDD_F | | -121.5 | -118 | -118 |
| | Bands FDD_G | | -120.5 | -117 | -117 |
| | Bands FDD_H | | -120 | -116.5 | -116.5 |
| | Bands FDD_N | | -117 | -113.5 | -113.5 |
| RSRQ <small>Note2</small> | Bands FDD_A | dB | -16.25 | -17.34 | -17.34 |
| | Bands FDD_B | | | | |
| | Bands FDD_C | | | | |
| | Bands FDD_D | | | | |
| | Bands FDD_E, FDD_F | | | | |
| | Bands FDD_G | | | | |
| | Bands FDD_H | | | | |
| | Bands FDD_N | | | | |
| I_o <small>Note2</small> | Bands FDD_A <small>Note 5</small> | dBm/4.5MHz | -93.26 | -88.67 | |
| | Bands FDD_B <small>Note 5</small> | | -92.76 | -88.17 | |
| | Bands FDD_C <small>Note 5</small> | | -92.26 | -87.67 | |
| | Bands FDD_D | | -91.76 | -87.17 | |
| | Bands FDD_E, FDD_F <small>Note 5</small> | | -91.26 | -86.67 | |
| | Bands FDD_G <small>Note 5</small> | | -90.26 | -85.67 | |
| | Bands FDD_H <small>Note 5</small> | | -89.76 | -85.17 | |
| | Bands FDD_N <small>Note 5</small> | | -86.76 | -82.76 | |
| <p>Note 1: This test verifies the RRM requirement which is independent of channel bandwidth and is performed according to the principle defined in section A.3.6.1.</p> <p>Note 2: RSRQ, RSRP and I_o levels have been derived from other parameters for information purposes. They are not settable parameters themselves.</p> <p>Note 3: See Table A.9.2.5.2-1 for the other parameters</p> <p>Note 4: E-UTRA operating band groups are as defined in Section 3.5.</p> | | | | | |

Note 5: The test applies for E-UTRA operating bands in this band group which are supporting 5MHz + 5MHz channel bandwidth.

A.9.2.23.3 Test Requirements

The test requirements defined in section A.9.2.5.3 shall apply in this test case.

A.9.2.24 TDD RSRQ for E-UTRA Carrier Aggregation (5MHz + 5MHz bandwidth)

The test case in this section are applicable to carrier aggregation capable UEs which have been configured with a downlink SCell.

A.9.2.24.1 Test Purpose and Environment

The purpose of this test is the same as defined in Subclause A.9.2.6.1.

A.9.2.24.2 Test parameters

The parameters of this test are the same as defined in Subclause A.9.2.6.2 except that the values of the parameters in the Table A.9.2.24.2-1 will replace the values of the corresponding parameters in A.9.2.6.2-1.

Table A.9.2.24.2-1: TDD RSRQ Carrier Aggregation test parameters

| Parameters | | Test 1 | | | |
|--|-------------------------------|-----------|----------|----------|-----------|
| | | Units | Cell 1 | Cell 2 | Cell 3 |
| $BW_{\text{channel_CA}}$ ^{Note1} | | MHz | 10 | 5 | 5 |
| Measurement bandwidth | | n_{PRB} | 10-15 | 10-15 | 10-15 |
| PDSCH Reference measurement channel defined in A.3.1.1.1 | | | R.0 TDD | R.4 TDD | N/A |
| PDSCH allocation | | n_{PRB} | 13-36 | 7-17 | N/A |
| PDCCH/PCFICH/PHICH Reference measurement channel defined in A.3.1.2.2 | | | R.6 TDD | R.11 TDD | R.11 TDD |
| OCNG Patterns defined in A.3.2.2.9 (OP.9 TDD) and A.3.2.2.10 (OP.10 TDD) | | | OP.1 TDD | OP.9 TDD | OP.10 TDD |
| I_0 ^{Note2} | Bands TDD_A ^{Note 5} | dBm4.5MHz | -93.26 | -88.67 | |
| | Bands TDD_C ^{Note 5} | | -92.26 | -87.67 | |
| | Bands TDD_E ^{Note 5} | | -91.26 | -86.67 | |
| <p>Note 1: This test verifies the RRM requirement which is independent of channel bandwidth and is performed according to the principle defined in section A.3.6.1.</p> <p>Note 2: I_0 levels have been derived from other parameters for information purposes. They are not settable parameters themselves.</p> <p>Note 3: See Table A.9.2.6.2-1 for the other parameters</p> <p>Note 4: E-UTRA operating band groups are as defined in Section 3.5.</p> <p>Note 5: The test applies for E-UTRA operating bands in this band group which are supporting 5MHz + 5MHz channel bandwidth.</p> | | | | | |

A.9.2.24.3 Test Requirements

The test requirements defined in section A.9.2.6.3 shall apply in this test case.

A.9.2.25 RSRQ for E-UTRAN TDD-FDD Carrier Aggregation with PCell in FDD

The test case in this section are applicable to TDD-FDD carrier aggregation capable UEs which have been configured with a downlink SCell.

A.9.2.25.1 Test Purpose and Environment

The purpose of this test is to verify that the RSRQ for E-UTRAN TDD-FDD Carrier Aggregation with PCell in FDD measurement accuracy in carrier aggregation is within the specified limits under AWGN propagation conditions. This test will verify the absolute accuracy of RSRQ measurements for the primary component carrier defined in clause 9.1.11.1, the absolute accuracy of RSRQ measurements for the secondary component carrier defined in clause 9.1.11.2, and also the relative RSRQ accuracy requirement between primary and secondary component carriers defined in clause 9.1.11.3.

A.9.2.25.2 Test parameters

In this test case the PCell is FDD and SCell is TDD. Both RSRQ absolute and relative accuracy requirements of the primary and secondary component carrier are tested by using test parameters specified in Table A.9.2.25.2-1. In the test, Cell 1 is the PCell, Cell 2 is the SCell on the Secondary Component Carrier (SCC). The SCC is configured and activated.

The parameters of this test are given in Table A.9.2.25.2-1.

Table A.9.2.25.2-1: RSRQ for E-UTRAN TDD-FDD Carrier Aggregation with PCell in FDD test parameters

| Parameter | Unit | Cell 1 | Cell 2 |
|---|-----------|--|--|
| E-UTRA RF Channel Number | | 1 | 2 |
| BW_{channel} | | 5MHz: $N_{RB,c} = 25$ 10MHz: $N_{RB,c} = 50$ 20MHz: $N_{RB,c} = 100$ | 5MHz: $N_{RB,c} = 25$ 10MHz: $N_{RB,c} = 50$ 20MHz: $N_{RB,c} = 100$ |
| Special subframe configuration ^{Note1} | | - | 6 |
| Uplink-downlink configuration ^{Note1} | | - | 1 |
| Measurement bandwidth | n_{PRB} | 5MHz: 10-15 10MHz: 22-27 20MHz: 47-52 | 5MHz: 10-15 10MHz: 22-27 20MHz: 47-52 |
| PDSCH Reference measurement channel defined in A.3.1.1 | | 5MHz: R.5 FDD 10MHz: R.0 FDD 20MHz: R.4 FDD | 5MHz: R.4 TDD 10MHz: R.0 TDD 20MHz: R.3 TDD |
| PDSCH allocation | n_{PRB} | 5MHz: 7-17 10MHz: 13-36 20MHz: 38-61 | 5MHz: 7-17 10MHz: 13-36 20MHz: 38-61 |
| PDCCH/PCFICH/PHICH Reference measurement channel defined in A.3.1.2 | | 5MHz: R.11 FDD 10MHz: R.6 FDD 20MHz: R.10 FDD | 5MHz: R.11 TDD 10MHz: R.6 TDD 20MHz: R.10 TDD |
| OCNG Patterns defined in A.3.2 | | 5MHz: OP.15 FDD 10MHz: OP.1 FDD 20MHz: OP.11 FDD | 5MHz: OP.9 TDD 10MHz: OP.1 TDD 20MHz: OP.7 TDD |
| PBCH_RA | dB | 0 | 0 |
| PBCH_RB | | | |
| PSS_RA | | | |
| SSS_RA | | | |
| PCFICH_RB | | | |
| PHICH_RA | | | |
| PHICH_RB | | | |

| | | | | |
|---------------------------|---|---------------------------|--|--|
| PDCCH_RA | | | | |
| PDCCH_RB | | | | |
| PDSCH_RA | | | | |
| PDSCH_RB | | | | |
| OCNG_RA ^{Note2} | | | | |
| OCNG_RB ^{Note2} | | | | |
| N_{oc} ^{Note3} | Bands TDD_A | dBm/15 kHz | - | -116 |
| | Bands TDD_C | | - | -115 |
| | Bands TDD_E | | - | -114 |
| | Bands FDD_A | | -119.5 | - |
| | Bands FDD_B | | -119 | - |
| | Bands FDD_C | | -118.5 | - |
| | Bands FDD_D | | -118 | - |
| | Bands FDD_E, Bands FDD_F ^{Note 6} | | -117.5 | - |
| | Bands FDD_G | | -116.5 | - |
| Bands FDD_H | -116 | - | - | |
| \hat{E}_s / N_{oc} | | dB | -6.0 | -6.0 |
| \hat{E}_s / I_{ot} | | dB | -6.0 | -6.0 |
| RSRP ^{Note4} | Bands TDD_A | dBm/15 kHz | - | -122 |
| | Bands TDD_C | | - | -121 |
| | Bands TDD_E | | - | -120 |
| | Bands FDD_A | | -125.5 | - |
| | Bands FDD_B | | -123 | - |
| | Bands FDD_C | | -124.5 | - |
| | Bands FDD_D | | -124 | - |
| | Bands FDD_E, Bands FDD_F ^{Note 6} | | -123.5 | - |
| | Bands FDD_G | | -122.5 | - |
| Bands FDD_H | -122 | - | - | |
| RSRQ ^{Note4} | Bands TDD_A | dB | - | -17.77 |
| | Bands TDD_C | | | |
| | Bands TDD_E | | | |
| | Bands FDD_A | | | |
| | Bands FDD_B | | | |
| | Bands FDD_C | | | |
| | Bands FDD_D | | | |
| | Bands FDD_E, Bands FDD_F ^{Note 6} | | -17.77 | - |
| | Bands FDD_G | | | |
| Bands FDD_H | | | | |
| I_o ^{Note4} | Bands TDD_A | dBm/BW _{channel} | - | -87.25 + 10log(N _{RB,c} /50) |
| | Bands TDD_C | | - | -86.25 + 10log(N _{RB,c} /50) |
| | Bands TDD_E | | - | -85.25 + 10log(N _{RB,c} /50) |
| | Bands FDD_A | | -90.75 + 10log(N _{RB,c} /50) | - |
| | Bands FDD_B | | 89.76 | - |
| | Bands FDD_C | | -89.75 + 10log(N _{RB,c} /50) | - |
| | Bands FDD_D | | -89.25 + 10log(N _{RB,c} /50) | - |
| | Bands FDD_E, Bands FDD_F ^{Note 6} | | -88.75 + 10log(N _{RB,c} /50) | - |

| | | | | |
|---|-------------|---------------|--------------------------------|-------------------|
| | Bands FDD_G | | $-87.75 + 10\log(N_{RB,c}/50)$ | - |
| | Bands FDD_H | | $-87.25 + 10\log(N_{RB,c}/50)$ | - |
| Propagation Condition | | | AWGN | AWGN |
| Antenna Configuration | | | 1x2 | 1x2 |
| Timing offset to Cell 1 | | μs | - | 0 |
| Time alignment error relative to cell 1 <small>Note 10</small> | | | - | $\leq \text{TAE}$ |
| <p>Note 1: For special subframe and uplink-downlink configurations see Tables 4.2-1 and 4.2-2 in TS 36.211.</p> <p>Note 2: OCNG shall be used such that both cells are fully allocated and a constant total transmitted power spectral density is achieved for all OFDM symbols.</p> <p>Note 3: Interference from other cells and noise sources not specified in the test is assumed to be constant over subcarriers and time and shall be modelled as AWGN of appropriate power for N_{oc} to be fulfilled.</p> <p>Note 4: Es/lot, RSRP, RSRQ and Io levels have been derived from other parameters for information purposes. They are not settable parameters themselves.</p> <p>Note 5: RSRP and RSRQ minimum requirements are specified assuming independent interference and noise at each receiver antenna port.</p> <p>Note 6: For Band 26, the tests shall be performed with the carrier frequency of the assigned E-UTRA channel bandwidth within 865-894 MHz.</p> <p>Note 7: The selection of the bands for testing depends on the configuration of the carrier aggregation supported by the UEs.</p> <p>Note 8: This test verifies the RRM requirement which is independent of channel bandwidth and is performed according to the principle defined in section A.3.6.1.</p> <p>Note 9: E-UTRA operating band groups are as defined in Section 3.5.</p> <p>Note 10: Time alignment error (TAE) as specified in TS 36.104 [30] clause 6.5.3.1. The TAE value depends upon the type of carrier aggregation.</p> | | | | |

A.9.2.25.3 Test Requirements

In the test, the RSRQ measurement accuracy in carrier aggregation shall fulfil the requirements in clause 9.1.11.1, 9.1.11.2, and 9.1.11.3.

- The absolute accuracy of intra-frequency RSRQ measurements of Cell 1 on the primary component carrier shall fulfil the requirements specified in clause 9.1.11.1.
- The absolute accuracy of intra-frequency RSRQ measurements of Cell 2 on the secondary component carrier shall fulfil the requirements specified in clause 9.1.11.2.
- The relative accuracy of inter-frequency RSRQ measurements between the primary and secondary component carriers for Cell 2 relative to Cell 1 shall fulfil the requirements specified in clause 9.1.11.3.

A.9.2.26 RSRQ for E-UTRAN TDD-FDD Carrier Aggregation with PCell in TDD

The test case in this section are applicable to TDD-FDD carrier aggregation capable UEs which have been configured with a downlink SCell.

A.9.2.26.1 Test Purpose and Environment

The purpose of this test is to verify that the RSRQ for E-UTRAN TDD-FDD Carrier Aggregation with PCell in TDD measurement accuracy in carrier aggregation is within the specified limits. This test will verify the absolute accuracy of RSRQ measurements for the primary component carrier defined in Clause 9.1.11.1, the absolute accuracy of RSRQ measurements for the secondary component carrier defined in Clause 9.1.11.2, and also the relative RSRQ accuracy requirement between primary and secondary component carriers defined in Clause 9.1.11.3.

A.9.2.26.2 Test parameters

In this test case the PCell is TDD and SCell is FDD. Both RSRQ absolute and relative accuracy requirements of the primary and secondary component carrier are tested by using test parameters specified in Table A.9.2.26.2-1. In the test, Cell 1 is the PCell, Cell 2 is the SCell on the Secondary Component Carrier (SCC). The SCC is configured and activated.

The parameters of this test are given in Table A.9.2.26.2-1.

Table A.9.2.26.2-1: RSRQ for E-UTRAN TDD-FDD Carrier Aggregation with PCell in TDD test parameters

| Parameter | | Unit | Cell 1 | Cell 2 |
|---|--|------------------------|---|---|
| E-UTRA RF Channel Number | | | 1 | 2 |
| BW _{channel} | | | 5MHz: N _{RB,c} = 25 10MHz: N _{RB,c} = 50 20MHz: N _{RB,c} = 100 | 5MHz: N _{RB,c} = 25 10MHz: N _{RB,c} = 50 20MHz: N _{RB,c} = 100 |
| Special subframe configuration ^{Note1} | | | 6 | - |
| Uplink-downlink configuration ^{Note1} | | | 1 | - |
| Measurement bandwidth | | <i>n_{PRB}</i> | 5MHz: 10-15 10MHz: 22-27 20MHz: 47-52 | 5MHz: 10-15 10MHz: 22-27 20MHz: 47-52 |
| PDSCH Reference measurement channel defined in A.3.1.1 | | | 5MHz: R.4 TDD 10MHz: R.0 TDD 20MHz: R.3 TDD | 5MHz: R.5 FDD 10MHz: R.0 FDD 20MHz: R.4 FDD |
| PDSCH allocation | | <i>n_{PRB}</i> | 5MHz: 7-17 10MHz: 13-36 20MHz: 38-61 | 5MHz: 7-17 10MHz: 13-36 20MHz: 38-61 |
| PDCCH/PCFICH/PHICH Reference measurement channel defined in A.3.1.2 | | | 5MHz: R.11 TDD 10MHz: R.6 TDD 20MHz: R.10 TDD | 5MHz: R.11 FDD 10MHz: R.6 FDD 20MHz: R.10 FDD |
| OCNG Patterns defined in A.3.2 | | | 5MHz: OP.9 TDD 10MHz: OP.1 TDD 20MHz: OP.7 TDD | 5MHz: OP.15 FDD 10MHz: OP.1 FDD 20MHz: OP.11 FDD |
| PBCH_RA | | dB | 0 | 0 |
| PBCH_RB | | | | |
| PSS_RA | | | | |
| SSS_RA | | | | |
| PCFICH_RB | | | | |
| PHICH_RA | | | | |
| PHICH_RB | | | | |
| PDCCH_RA | | | | |
| PDCCH_RB | | | | |
| PDSCH_RA | | | | |
| PDSCH_RB | | | | |
| OCNG_RA ^{Note2} | | | | |
| OCNG_RB ^{Note2} | | | | |
| <i>N_{oc}</i> ^{Note3} | Bands TDD_A | | | |
| | Bands TDD_C | -118.5 | - | |
| | Bands TDD_E | -117.5 | - | |
| | Bands FDD_A | - | -116 | |
| | Bands FDD_B | - | -115.5 | |
| | Bands FDD_C | - | -115 | |
| | Bands FDD_D | - | -114.5 | |
| | Bands FDD_E, Bands FDD_F ^{Note 6} | - | -114 | |
| | Bands FDD_G | - | -113 | |
| Bands FDD_H | - | -112.5 | | |
| \hat{E}_s / N_{oc} | | dB | -6.0 | -6.0 |

| \hat{E}_s / I_{ot} | | dB | -6.0 | -6.0 |
|---|--|---------------------------|--|--|
| RSRP ^{Note4} | Bands TDD_A | dBm/15 kHz | -125.50 | - |
| | Bands TDD_C | | -124.50 | - |
| | Bands TDD_E | | -123.50 | - |
| | Bands FDD_A | | - | -122 |
| | Bands FDD_B | | - | -119.5 |
| | Bands FDD_C | | - | -121 |
| | Bands FDD_D | | - | -120.5 |
| | Bands FDD_E, Bands FDD_F <small>Note 6</small> | | - | -120 |
| | Bands FDD_G | | - | -119 |
| | Bands FDD_H | | - | -118.5 |
| RSRQ ^{Note4} | Bands TDD_A | dB | -17.77 | - |
| | Bands TDD_C | | | |
| | Bands TDD_E | | | |
| | Bands FDD_A | | - | -17.77 |
| | Bands FDD_B | | | |
| | Bands FDD_C | | | |
| | Bands FDD_D | | | |
| | Bands FDD_E, Bands FDD_F <small>Note 6</small> | | | |
| | Bands FDD_G | | | |
| | Bands FDD_H | | | |
| Io ^{Note4} | Bands TDD_A | dBm/BW _{channel} | -90.75 + 10log(N _{RB,c} /50) | - |
| | Bands TDD_C | | -89.75 + 10log(N _{RB,c} /50) | - |
| | Bands TDD_E | | -88.75 + 10log(N _{RB,c} /50) | - |
| | Bands FDD_A | | - | -87.25 + 10log(N _{RB,c} /50) |
| | Bands FDD_B | | - | -85.17 |
| | Bands FDD_C | | - | -86.25 + 10log(N _{RB,c} /50) |
| | Bands FDD_D | | - | -85.75 + 10log(N _{RB,c} /50) |
| | Bands FDD_E, Bands FDD_F <small>Note 6</small> | | - | -85.25 + 10log(N _{RB,c} /50) |
| | Bands FDD_G | | - | -84.25 + 10log(N _{RB,c} /50) |
| | Bands FDD_H | | - | -83.75 + 10log(N _{RB,c} /50) |
| Propagation Condition | | | AWGN | AWGN |
| Antenna Configuration | | | 1x2 | 1x2 |
| Timing offset to Cell 1 | | μs | - | 0 |
| Time alignment error relative to cell 1 <small>Note 10</small> | | | - | ≤ TAE |
| <p>Note 1: For special subframe and uplink-downlink configurations see Tables 4.2-1 and 4.2-2 in TS 36.211.</p> <p>Note 2: OCNG shall be used such that both cells are fully allocated and a constant total transmitted power spectral density is achieved for all OFDM symbols.</p> <p>Note 3: Interference from other cells and noise sources not specified in the test is assumed to be constant over subcarriers and time and shall be modelled as AWGN of appropriate power for N_{oc} to be fulfilled.</p> <p>Note 4: Es/Iot, RSRP, RSRQ and Io levels have been derived from other parameters for information purposes. They are not settable parameters themselves.</p> <p>Note 5: RSRP and RSRQ minimum requirements are specified assuming independent interference and noise at each receiver antenna port.</p> | | | | |

| | |
|----------|--|
| Note 6: | For Band 26, the tests shall be performed with the carrier frequency of the assigned E-UTRA channel bandwidth within 865-894 MHz. |
| Note 7: | The selection of the bands for testing depends on the configuration of the carrier aggregation supported by the UEs. |
| Note 8: | This test verifies the RRM requirement which is independent of channel bandwidth and is performed according to the principle defined in section A.3.6.1. |
| Note 9: | E-UTRA operating band groups are as defined in Section 3.5. |
| Note 10: | Time alignment error (TAE) as specified in TS 36.104 [30] clause 6.5.3.1. The TAE value depends upon the type of carrier aggregation. |

A.9.2.26.3 Test Requirements

In the test, the RSRQ measurement accuracy in carrier aggregation shall fulfil the requirements in section 9.1.11.1, 9.1.11.2, and 9.1.11.3.

- The absolute accuracy of intra-frequency RSRQ measurements of Cell 1 on the primary component carrier shall fulfil the requirements defined in clause 9.1.11.1.
- The absolute accuracy of intra-frequency RSRQ measurements of Cell 2 on the secondary component carrier shall fulfil the requirements defined in clause 9.1.11.2.
- The relative accuracy of inter-frequency RSRQ measurements between the primary and secondary component carriers for Cell 2 relative to Cell 1 shall fulfil the requirements defined in clause 9.1.11.3.

A.9.2.27 TDD RSRQ for E-UTRAN Carrier Aggregation for 20MHz+10MHz

The test case in this section are applicable to carrier aggregation capable UEs which have been configured with a downlink SCell.

A.9.2.27.1 Test Purpose and Environment

The purpose of this test is the same as defined in Subclause A.9.2.6.1.

A.9.2.27.2 Test parameters

The parameters of this test are the same as defined in Subclause A.9.2.6.2 except that the values of the parameters in the Table A.9.2.27.2-1 will replace the values of the corresponding parameters in A.9.2.6.2-1.

Table A.9.2.27.2-1: TDD RSRQ Carrier Aggregation test parameters

| Parameters | | Units | Combination | Test 1 | | |
|---|-------------|---------------------------|-------------|---------------------------------------|--------------------------------|----------|
| | | | | Cell 1 | Cell 2 | Cell 3 |
| BW _{channel_CA} Note1 | | MHz | 20MHz+10MHz | 20MHz: N _{RB,c} = 100 | 10MHz: N _{RB,c} = 50 | |
| | | | 10MHz+20MHz | 10MHz: N _{RB,c} = 50 | 20MHz: N _{RB,c} = 100 | |
| Measurement bandwidth | | n _{PRB} | 20MHz+10MHz | 47-52 | 22-27 | |
| | | | 10MHz+20MHz | 22-27 | 47-52 | |
| PDSCH Reference measurement channel defined in A.3.1.1.2 | | | 20MHz+10MHz | R.3 TDD | R.0 TDD | N/A |
| | | | 10MHz+20MHz | R.0 TDD | R.3 TDD | |
| PDSCH allocation | | n _{PRB} | 20MHz+10MHz | 38-61 | 13-36 | N/A |
| | | | 10MHz+20MHz | 13-36 | 38-61 | |
| PDCCH/PCFICH/PHICH Reference measurement channel defined in A.3.1.2.2 | | | 20MHz+10MHz | R.10 TDD | R.6 TDD | R.6 TDD |
| | | | 10MHz+20MHz | R.6 TDD | R.10 TDD | R.10 TDD |
| OCNG Patterns defined in A.3.2.2 (TDD) | | | 20MHz+10MHz | OP.7 TDD | OP.1 TDD | OP.2 TDD |
| | | | 10MHz+20MHz | OP.1 TDD | OP.7 TDD | OP.8 TDD |
| I _o Note2 | Bands TDD_A | dBm/BW _{channel} | All | -90.26 + 10log(N _{RB,c} /50) | N/A | |

| | | | | | | |
|--|-------------|---------------------------|-----|--|-----|--|
| | Bands TDD_C | dBm/BW _{channel} | All | -89.26 + 10log(N _{RB,c} /50) | N/A | -85.67 + 10log(N _{RB,c} /50) |
| | Bands TDD_E | | | -88.26 + 10log(N _{RB,c} /50) | | |
| | Bands TDD_A | | | | | |
| | Bands TDD_C | | | | | |
| | Bands TDD_E | | | | | |
| <p>Note 1: This test verifies the RRM requirement which is independent of channel bandwidth and is performed according to the principle defined in section A.3.6.1.</p> <p>Note 2: lo levels have been derived from other parameters for information purposes. They are not settable parameters themselves</p> <p>Note 3: See Table A.9.2.6.2-1 for the other parameters</p> | | | | | | |

A.9.2.27.3 Test Requirements

The test requirements defined in section A.9.2.6.3 shall apply in this test case.

A.9.2.28 FDD intra-frequency absolute RSRQ accuracy with CRS based discovery signal

A.9.2.28.1 Test Purpose and Environment

The purpose of this test is to verify that the RSRQ measurement accuracy is within the specified limits. This test will verify the requirements in Clause 9.1.14.4.

A.9.2.28.2 Test parameters

In this test case all cells are on the same carrier frequency. The absolute accuracy of RSRQ intra frequency measurement for Cell 2 is tested by using the parameters in Table A.9.2.28.2-1. In all test cases, Cell 1 is the PCell and Cell 2 the target cell. Cell 2 DMTC configuration is provided to the UE in the *measDS-Config* before the start of the test.

Table A.9.2.28.2-1: RSRQ FDD Intra frequency test parameters

| Parameter | Unit | Test 1 | |
|--|-----------|-------------|-------------|
| | | Cell 1 | Cell 2 |
| E-UTRA RF Channel Number | | 1 | |
| BW _{channel} | MHz | 10 | |
| Measurement bandwidth | n_{PRB} | 22—27 | |
| DMTC period | ms | N/A | 160 |
| DMTC period offset | ms | N/A | 10 |
| Discovery signal occasion duration | ms | N/A | 1 |
| Time offset between cell 1 and cell 2 | μs | 0 | 2.3 |
| PDSCH Reference measurement channel defined in A.3.1.1.1 | | R.0 FDD | - |
| PDSCH allocation | n_{PRB} | 13—36 | - |
| PDCCH/PCFICH/PHICH Reference measurement channel defined in A.3.1.2.1 | | R.6 FDD | |
| OCNG Patterns defined in A.3.2.1.1 (OP.1 FDD) and A.3.2.1.2 (OP.2 FDD) | | OP.1 FDD | OP.2 FDD |
| PBCH_RA | dB | 0 | 0 |
| PBCH_RB | | | |
| PSS_RA | | | |
| SSS_RA | | | |
| PCFICH_RB | | | |

| | | | | |
|---|--------------------------------------|------------|--------|--------|
| PHICH_RA | | | | |
| PHICH_RB | | | | |
| PDCCH_RA | | | | |
| PDCCH_RB | | | | |
| PDSCH_RA | | | | |
| PDSCH_RB | | | | |
| OCNG_RA ^{Note1} | | | | |
| OCNG_RB ^{Note1} | | | | |
| N_{oc} ^{Note2} | Bands FDD_A ^{Note 8} | dBm/15 kHz | -116 | |
| | Bands FDD_B | | -115.5 | |
| | Bands FDD_C | | -115 | |
| | Bands FDD_D | | -114.5 | |
| | Bands FDD_E, FDD_F ^{Note 5} | | -114 | |
| | Bands FDD_G ^{Note 7} | | -113 | |
| | Bands FDD_H | | -112.5 | |
| \hat{E}_s / I_{ot} | | dB | -5.46 | -5.46 |
| RSRP ^{Note3} | Bands FDD_A ^{Note 8} | dBm/15 kHz | -120 | -120 |
| | Bands FDD_B | | -119.5 | -119.5 |
| | Bands FDD_C | | -119 | -119 |
| | Bands FDD_D | | -118.5 | -118.5 |
| | Bands FDD_E, FDD_F ^{Note 5} | | -118 | -118 |
| | Bands FDD_G ^{Note 7} | | -117 | -117 |
| | Bands FDD_H | | -116.5 | -116.5 |
| RSRQ ^{Note3} | Bands FDD_A ^{Note 8} | dB | -17.34 | -17.34 |
| | Bands FDD_B | | | |
| | Bands FDD_C | | | |
| | Bands FDD_D | | | |
| | Bands FDD_E, FDD_F ^{Note 5} | | | |
| | Bands FDD_G ^{Note 7} | | | |
| | Bands FDD_H | | | |
| I_o ^{Note3} | Bands FDD_A ^{Note 8} | dBm/9 MHz | -85.67 | |
| | Bands FDD_B | | -85.17 | |
| | Bands FDD_C | | -84.67 | |
| | Bands FDD_D | | -84.17 | |
| | Bands FDD_E, FDD_F ^{Note 5} | | -83.67 | |
| | Bands FDD_G ^{Note 7} | | -82.67 | |
| | Bands FDD_H | | -82.17 | |
| \hat{E}_s / N_{oc} | | dB | -4 | -4 |
| Propagation condition | | - | AWGN | |
| <p>Note 1: OCNG shall be used such that both cells are fully allocated and a constant total transmitted power spectral density is achieved for all OFDM symbols.</p> <p>Note 2: Interference from other cells and noise sources not specified in the test is assumed to be constant over subcarriers and time and shall be modelled as AWGN of appropriate power for N_{oc} to be fulfilled.</p> <p>Note 3: RSRQ, RSRP and I_o levels have been derived from other parameters for information purposes. They are not settable parameters themselves.</p> <p>Note 4: RSRP and RSRQ minimum requirements are specified assuming independent interference and noise at each receiver antenna port.</p> <p>Note 5: For Band 26, the tests shall be performed with the carrier frequency of the assigned E-UTRA channel bandwidth within 865-894 MHz.</p> <p>Note 6: E-UTRA operating band groups are as defined in Section 3.5.</p> <p>Note 7: Except Band 29.</p> <p>Note 8: Except Band 32.</p> | | | | |

A.9.2.28.3 Test Requirements

The absolute accuracy of RSRQ intra frequency measurement for Cell 2 shall fulfil the requirements in Clause 9.1.14.4.

A.9.2.29 TDD intra-frequency absolute RSRQ accuracy with CRS based discovery signal

A.9.2.29.1 Test Purpose and Environment

The purpose of this test is to verify that the RSRQ measurement accuracy is within the specified limits. This test will verify the requirements in Clause 9.1.14.4.

A.9.2.29.2 Test parameters

In this test case all cells are on the same carrier frequency. The absolute accuracy of RSRQ intra frequency measurement for Cell 2 is tested by using the parameters in Table A.9.2.29.2-1. In all test cases, Cell 1 is the PCell and Cell 2 the target cell. Cell 2 DMTC configuration is provided to the UE in the *measDS-Config* before the start of the test.

Table A.9.2.29.2-1: RSRQ TDD Intra frequency test parameters

| Parameter | Unit | Test 1 | |
|--|-------------|-------------|-------------|
| | | Cell 1 | Cell 2 |
| E-UTRA RF Channel Number | | 1 | |
| BW _{channel} | MHz | 10 | |
| Special subframe configuration ^{Note1} | | 6 | |
| Uplink-downlink configuration ^{Note1} | | 1 | |
| Measurement bandwidth | n_{PRB} | 22–27 | |
| DMTC period | ms | N/A | 160 |
| DMTC period offset | ms | N/A | 10 |
| Discovery signal occasion duration | ms | N/A | 2 |
| Time offset between cell 1 and cell 2 | μs | 0 | 2.3 |
| PDSCH Reference measurement channel defined in A.3.1.1.2 | | R.0 TDD | - |
| <i>PDSCH allocation</i> | n_{PRB} | 13–36 | - |
| PDCCH/PCFICH/PHICH Reference measurement channel defined in A.3.1.2.2 | | R.6 TDD | |
| OCNG Patterns defined in A.3.2.2.1 (OP.1 TDD) and A.3.2.2.2 (OP.2 TDD) | | OP.1 TDD | OP.2 TDD |
| PBCH_RA | dB | 0 | 0 |
| PBCH_RB | | | |
| PSS_RA | | | |
| SSS_RA | | | |
| PCFICH_RB | | | |
| PHICH_RA | | | |
| PHICH_RB | | | |
| PDCCH_RA | | | |
| PDCCH_RB | | | |
| PDSCH_RA | | | |
| PDSCH_RB | | | |
| OCNG_RA ^{Note1} | | | |
| OCNG_RB ^{Note1} | | | |
| N_{oc} ^{Note2} | | | |
| | Bands TDD_C | -115 | |
| | Bands TDD_E | -114 | |
| \hat{E}_s/I_{ot} | dB | -5.46 | -5.46 |
| RSRP ^{Note3} | Bands TDD_A | -120 | -120 |
| | Bands TDD_C | -119 | -119 |
| | Bands TDD_E | -118 | -118 |
| RSRQ ^{Note3} | Bands TDD_A | dB | -17.34 |
| | Bands TDD_C | | |
| | Bands TDD_E | | |
| I_o ^{Note3} | Bands TDD_A | dBm/9 | -85.67 |

| | | | | |
|--|-------------|-----|--------|----|
| | Bands TDD_C | MHz | -84.67 | |
| | Bands TDD_E | | -83.67 | |
| \hat{E}_s / N_{oc} | | dB | -4 | -4 |
| Propagation condition | | - | AWGN | |
| Note 1: For special subframe and uplink-downlink configurations see Tables 4.2-1 and 4.2-2 in TS 36.211. | | | | |
| Note 2: OCNB shall be used such that both cells are fully allocated and a constant total transmitted power spectral density is achieved for all OFDM symbols. | | | | |
| Note 3: Interference from other cells and noise sources not specified in the test is assumed to be constant over subcarriers and time and shall be modelled as AWGN of appropriate power for N_{oc} to be fulfilled. | | | | |
| Note 4: RSRQ, RSRP and Io levels have been derived from other parameters for information purposes. They are not settable parameters themselves. | | | | |
| Note 5: RSRP and RSRQ minimum requirements are specified assuming independent interference and noise at each receiver antenna port. | | | | |
| Note 6: E-UTRA operating band groups are as defined in Section 3.5. | | | | |

A.9.2.29.3 Test Requirements

The absolute accuracy of RSRQ intra frequency measurement for Cell 2 shall fulfil the requirements in Clause 9.1.14.4.

A.9.2.30 FDD-FDD inter-frequency absolute and relative RSRQ accuracies with CRS based discovery signal

A.9.2.30.1 Test Purpose and Environment

The purpose of this test is to verify that the absolute and relative accuracy of RSRQ measurement in discovery signal occasions is within the specified limits. This test will verify the requirements in Sections 9.1.14.4.

A.9.2.30.2 Test parameters

In this test case the two cells are on different carrier frequencies and measurement gaps are provided. Both RSRQ inter frequency absolute and relative accuracy requirements are tested by using test parameters in Table A.9.2.30.2-1. In all tests, Cell 1 is the PCell and Cell 2 the target cell. For measurement of the carrier frequency of Cell 2, DMTC configuration is provided to the UE in the *measDS-Config* before the start of the test.

Table A.9.2.30.2-1: RSRQ in discovery signal occasions FDD—FDD Inter frequency test parameters

| Parameter | Unit | Test 1 | |
|---|-----------|----------|----------|
| | | Cell 1 | Cell 2 |
| E-UTRA RF Channel Number | | 1 | 2 |
| $BW_{channel}$ | MHz | 10 | 10 |
| Gap Pattern Id | | 0 | - |
| Gap Offset | ms | 9 | - |
| DMTC period | ms | - | 160 |
| DMTC period offset | ms | - | 10 |
| Discovery signal occasion duration | ms | - | 1 |
| Time offset between cell 2 and cell 1 | μ s | 3 | |
| Measurement bandwidth | n_{PRB} | 22-27 | |
| PDSCH Reference measurement channel defined in A.3.1.1.1 | | R.0 FDD | - |
| PDSCH allocation | n_{PRB} | 13-36 | - |
| PDCCH/PCFICH/PHICH Reference measurement channel defined in A.3.1.2.1 | | R.6 FDD | |
| OCNB Patterns defined in A.3.2.1.1 | | OP.1 FDD | OP.2 FDD |

| | | | | |
|---|--------------------------------------|------------|--------|--------|
| (OP.1 FDD) and A.3.2.1.2 (OP.2 FDD) | | | | |
| PBCH_RA | | dB | 0 | 0 |
| PBCH_RB | | | | |
| PSS_RA | | | | |
| SSS_RA | | | | |
| PCFICH_RB | | | | |
| PHICH_RA | | | | |
| PHICH_RB | | | | |
| PDCCH_RA | | | | |
| PDCCH_RB | | | | |
| PDSCH_RA | | | | |
| PDSCH_RB | | | | |
| OCNG_RA ^{Note1} | | | | |
| OCNG_RB ^{Note1} | | | | |
| N_{oc} ^{Note2} | Bands FDD_A ^{Note 8} | | | |
| | Bands FDD_B | -117 | -117 | |
| | Bands FDD_C | -116.5 | -116.5 | |
| | Bands FDD_D | -116 | -116 | |
| | Bands FDD_E, FDD_F ^{Note 5} | -115.5 | -115.5 | |
| | Bands FDD_G ^{Note 7} | -114.5 | -114.5 | |
| | Bands FDD_H | -114 | -114 | |
| \hat{E}_s/I_{ot} | | dB | -6 | -6 |
| RSRP ^{Note3} | Bands FDD_A ^{Note 8} | dBm/15 kHz | -123.5 | -123.5 |
| | Bands FDD_B | | -123 | -123 |
| | Bands FDD_C | | -122.5 | -122.5 |
| | Bands FDD_D | | -122 | -122 |
| | Bands FDD_E, FDD_F ^{Note 5} | | -121.5 | -121.5 |
| | Bands FDD_G ^{Note 7} | | -120.5 | -120.5 |
| | Bands FDD_H | | -120 | -120 |
| RSRQ ^{Note3} | Bands FDD_A ^{Note 8} | dB | -17.77 | -17.77 |
| | Bands FDD_B | | | |
| | Bands FDD_C | | | |
| | Bands FDD_D | | | |
| | Bands FDD_E, FDD_F ^{Note 5} | | | |
| | Bands FDD_G ^{Note 7} | | | |
| | Bands FDD_H | | | |
| I_o ^{Note3} | Bands FDD_A ^{Note 8} | dBm/ 9 MHz | -88.75 | -88.75 |
| | Bands FDD_B | | -88.25 | -88.25 |
| | Bands FDD_C | | -87.75 | -87.75 |
| | Bands FDD_D | | -87.25 | -87.25 |
| | Bands FDD_E, FDD_F ^{Note 5} | | -86.75 | -86.75 |
| | Bands FDD_G ^{Note 7} | | -85.75 | -85.75 |
| | Bands FDD_H | | -85.25 | -85.25 |
| \hat{E}_s/N_{oc} | | dB | -6 | -6 |
| Propagation condition | | - | AWGN | |
| <p>Note 1: OCNG shall be used such that both cells are fully allocated and a constant total transmitted power spectral density is achieved for all OFDM symbols.</p> <p>Note 2: Interference from other cells and noise sources not specified in the test is assumed to be constant over subcarriers and time and shall be modelled as AWGN of appropriate power for N_{oc} to be fulfilled.</p> <p>Note 3: RSRQ, RSRP and I_o levels have been derived from other parameters for information purposes. They are not settable parameters themselves.</p> <p>Note 4: RSRP and RSRQ minimum requirements are specified assuming independent interference and noise at each receiver antenna port.</p> <p>Note 5: For Band 26, the tests shall be performed with the carrier frequency of the assigned E-UTRA channel bandwidth within 865-894 MHz.</p> <p>Note 6: E-UTRA operating band groups are as defined in Section 3.5.</p> <p>Note 7: Except Band 29.</p> <p>Note 8: Except Band 32.</p> | | | | |

A.9.2.30.3 Test Requirements

The RSRQ measurement accuracy shall fulfil the requirements in Sections 9.1.14.4.

A.9.2.31 TDD-TDD inter-frequency absolute and relative RSRQ accuracies with CRS based discovery signal

A.9.2.31.1 Test Purpose and Environment

The purpose of this test is to verify that the RSRQ measurement accuracy in discovery signal occasions is within the specified limits. This test will verify the requirements in Sections 9.1.14.4.

A.9.2.31.2 Test parameters

In this test case the two cells are on different carrier frequencies and measurement gaps are provided. Both RSRQ inter frequency absolute and relative accuracy requirements are tested by using test parameters in Table A.9.2.31.2-1 for TDD configuration 1. In all tests, Cell 1 is the PCell and Cell 2 the target cell. DMTC configuration for Cell 2 is provided to UE in the *measDS-Config* before the start of the test.

Table A 9.2.31.2-1: RSRQ TDD—TDD Inter frequency test parameters for TDD configuration 1

| Parameter | | Unit | Test 1 | | | |
|--|-------------|------------|----------|----------|---------|---------|
| | | | Cell 1 | Cell 2 | | |
| E-UTRA RF Channel Number | | | 1 | 2 | | |
| BW _{channel} | | MHz | 10 | 10 | | |
| Gap Pattern Id | | | 0 | - | | |
| Gap Offset | | | 9 | - | | |
| DMTC period | | ms | - | 160 | | |
| DMTC period offset | | ms | - | 10 | | |
| Discovery signal occasion duration | | ms | - | 2 | | |
| Time offset between cells | | μs | 0 | 3 | | |
| Special subframe configuration ^{Note1} | | | 6 | | | |
| Uplink-downlink configuration ^{Note1} | | | 1 | | | |
| Measurement bandwidth | | n_{PRB} | 22-27 | | | |
| PDSCH Reference measurement channel defined in A.3.1.1.2 | | | R.0 TDD | - | | |
| PDSCH allocation | | n_{PRB} | 13—36 | - | | |
| PDCCH/PCFICH/PHICH Reference measurement channel defined in A.3.1.2.2 | | | R.6 TDD | | | |
| OCNG Patterns defined in A.3.2.2.1 (OP.1 TDD) and A.3.2.2.2 (OP.2 TDD) | | | OP.1 TDD | OP.2 TDD | | |
| PBCH_RA | | dB | 0 | 0 | | |
| PBCH_RB | | | | | | |
| PSS_RA | | | | | | |
| SSS_RA | | | | | | |
| PCFICH_RB | | | | | | |
| PHICH_RA | | | | | | |
| PHICH_RB | | | | | | |
| PDCCH_RA | | | | | | |
| PDCCH_RB | | | | | | |
| PDSCH_RA | | | | | | |
| PDSCH_RB | | | | | | |
| OCNG_RA ^{Note2} | | | | | | |
| OCNG_RB ^{Note2} | | | | | | |
| N_{oc} ^{Note3} | Bands TDD_A | | | | -117.50 | -117.50 |
| | Bands TDD_C | | | | -116.50 | -116.50 |
| | Bands TDD_E | -115.50 | -115.50 | | | |
| \hat{E}_s/I_{ot} | | dB | -6.0 | -6.0 | | |
| RSRP ^{Note4} | Bands TDD_A | dBm/15 kHz | -123.50 | -123.50 | | |

| | | | | |
|--|------------------------------|-----------|---------|---------|
| | Bands TDD_C | | -122.50 | -122.50 |
| | Bands TDD_E | | -121.50 | -121.50 |
| RSRQ ^{Note4} | Bands TDD_A, TDD_C, TDD_E | dB | -17.77 | -17.77 |
| I _o ^{Note4} | Bands TDD_A | dBm/9 MHz | -88.75 | -88.75 |
| | Bands TDD_C | | -87.75 | -87.75 |
| | Bands TDD_E | | -86.75 | -86.75 |
| \hat{E}_s / N_{oc} | | dB | -6.0 | -6.0 |
| Propagation condition | | - | AWGN | |
| <p>Note 1: For special subframe and uplink-downlink configurations see Tables 4.2-1 and 4.2-2 in TS 36.211.</p> <p>Note 2: OCNG shall be used such that both cells are fully allocated and a constant total transmitted power spectral density is achieved for all OFDM symbols.</p> <p>Note 3: Interference from other cells and noise sources not specified in the test is assumed to be constant over subcarriers and time and shall be modelled as AWGN of appropriate power for N_{oc} to be fulfilled.</p> <p>Note 4: RSRP and I_o levels have been derived from other parameters for information purposes. They are not settable parameters themselves.</p> <p>Note 5: RSRP minimum requirements are specified assuming independent interference and noise at each receiver antenna port.</p> <p>Note 6: E-UTRA operating band groups are as defined in Section 3.5.</p> | | | | |

A.9.2.31.3 Test Requirements

The RSRQ measurement accuracy shall fulfil the requirements in Sections 9.1.14.4.

A.9.2.32 FDD absolute and relative RSRQ accuracy for E-UTRAN Carrier Aggregation in CRS based discovery signal

A.9.2.32.1 Test Purpose and Environment

The purpose of this test is to verify that the FDD RSRQ measurement accuracy for carrier aggregation in CRS based discovery signal is within the specified limits under AWGN propagation conditions. This test will verify the absolute accuracy of intra-frequency RSRQ measurements for the secondary component carrier specified in clause 9.1.15.1.2, and also the relative inter-frequency RSRQ accuracy requirement between primary and secondary component carriers specified in clause 9.1.15.1.3.

A.9.2.32.2 Test parameters

In this test case the PCell and the SCell are on different carrier frequencies. There are three cells used in this test case. RSRQ absolute and relative accuracy requirements of the primary and secondary component carrier are tested by using test parameters specified in Table A.9.2.32.2-1. In the test, Cell 1 is the PCell, Cell 2 is the SCell on the Secondary Component Carrier (SCC) and Cell 3 is the neighbouring cell on the SCC. Cell 2 on SCC is configured and activated. Cell 3 DMTC configuration is provided to the UE in the *measDS-Config* before the start of the test.

Table A.9.2.32.2-1: FDD RSRQ Carrier Aggregation Test Parameters

| Parameters | Test 1 | | | |
|--|--------|--------|---------------------------|--------|
| | Units | Cell 1 | Cell 2 | Cell 3 |
| E-UTRA RF Channel Number | | 1 | 2 | 2 |
| BW _{channel_CA} | MHz | 10 | 10 | 10 |
| DMTC period | | N/A | N/A | 160 |
| DMTC period offset | | N/A | N/A | 10 |
| Discovery signal occasion duration | | N/A | N/A | 1 |
| Timing offset to Cell 1 | μs | - | 0 | 3 |
| Time alignment error between cell 2 and cell 1 | | - | ≤ Time alignment error as | - |

| | | | | | |
|--|--------------------------------------|------------|----------|---|--------|
| | | | | specified in 3GPP TS 36.104 [30] clause 6.5.3.1 | |
| Measurement bandwidth | n_{PRB} | 22—27 | 22—27 | 22—27 | |
| PDSCH Reference measurement channel defined in A.3.1.1.1 | | R.0 FDD | R.0 FDD | - | |
| PDSCH allocation | n_{PRB} | 13—36 | 13—36 | - | |
| PDCCH/PCFICH/PHICH Reference measurement channel defined in A.3.1.2.1 | | R.6 FDD | R.6 FDD | R.6 FDD | |
| OCNG Patterns defined in A.3.2.1.1 (OP.1 FDD) and A.3.2.1.2 (OP.2 FDD) | | OP.1 FDD | OP.1 FDD | OP.2 FDD | |
| PBCH_RA | dB | 0 | 0 | 0 | |
| PBCH_RB | | | | | |
| PSS_RA | | | | | |
| SSS_RA | | | | | |
| PCFICH_RB | | | | | |
| PHICH_RA | | | | | |
| PHICH_RB | | | | | |
| PDCCH_RA | | | | | |
| PDCCH_RB | | | | | |
| PDSCH_RA | | | | | |
| PDSCH_RB | | | | | |
| OCNG_RA ^{Note1} | | | | | |
| OCNG_RB ^{Note1} | | | | | |
| N_{oc} ^{Note2} | | | | | |
| | Bands FDD_B | -119 | -115.5 | -115.5 | |
| | Bands FDD_C | -118.5 | -115 | -115 | |
| | Bands FDD_D | -118 | -114.5 | -114.5 | |
| | Bands FDD_E, FDD_F ^{Note 6} | -117.5 | -114 | -114 | |
| | Bands FDD_G | -116.5 | -113 | -113 | |
| | Bands FDD_H | -116 | -112.5 | -112.5 | |
| \hat{E}_s / I_{ot} | | dB | -4.0 | -5.46 | -5.46 |
| RSRP ^{Note3} | Bands FDD_A | dBm/15 kHz | -123.5 | -120 | -120 |
| | Bands FDD_B | | -123 | -119.5 | -119.5 |
| | Bands FDD_C | | -122.5 | -119 | -119 |
| | Bands FDD_D | | -122 | -118.5 | -118.5 |
| | Bands FDD_E, FDD_F ^{Note 6} | | -121.5 | -118 | -118 |
| | Bands FDD_G | | -120.5 | -117 | -117 |
| | Bands FDD_H | | -120 | -116.5 | -116.5 |
| RSRQ ^{Note3} | Bands FDD_A | dB | -16.25 | -17.34 | -17.34 |
| | Bands FDD_B | | | | |
| | Bands FDD_C | | | | |
| | Bands FDD_D | | | | |
| | Bands FDD_E, FDD_F ^{Note 6} | | | | |
| | Bands FDD_G | | | | |
| | Bands FDD_H | | | | |
| I_0 ^{Note3} | Bands FDD_A | dBm/9 MHz | -90.26 | -85.67 | -85.67 |
| | Bands FDD_B | | -89.76 | -85.17 | -85.17 |
| | Bands FDD_C | | -89.26 | -84.67 | -84.67 |
| | Bands FDD_D | | -88.76 | -84.17 | -84.17 |
| | Bands FDD_E, FDD_F ^{Note 6} | | -88.26 | -83.67 | -83.67 |
| | Bands FDD_G | | -87.26 | -82.67 | -82.67 |
| | Bands FDD_H | | -86.76 | -82.17 | -82.17 |
| \hat{E}_s / N_{oc} | | dB | -4.0 | -4.0 | -4.0 |
| Propagation condition | - | AWGN | | | |

| | |
|---------|--|
| Note 1: | OCNG shall be used such that both cells are fully allocated and a constant total transmitted power spectral density is achieved for all OFDM symbols. |
| Note 2: | Interference from other cells and noise sources not specified in the test is assumed to be constant over subcarriers and time and shall be modelled as AWGN of appropriate power for N_{oc} to be fulfilled. |
| Note 3: | RSRQ, RSRP and I_0 levels have been derived from other parameters for information purposes. They are not settable parameters themselves. |
| Note 4: | RSRP and RSRQ minimum requirements are specified assuming independent interference and noise at each receiver antenna port. |
| Note 5: | The selection of the bands for testing depends on the configuration of the carrier aggregation supported by the UEs |
| Note 6: | For Band 26, the tests shall be performed with the carrier frequency of the assigned E-UTRA channel bandwidth within 865-894 MHz. |
| Note 7: | This test verifies the RRM requirement which is independent of channel bandwidth and is performed according to the principle defined in section A.3.6.1. |
| Note 8: | E-UTRA operating band groups are as defined in Section 3.5. |

A.9.2.32.3 Test Requirements

In the test, the RSRQ measurement accuracy in carrier aggregation shall fulfil the requirements in clause 9.1.15.1.1, 9.1.15.1.2, and 9.1.15.1.3.

- The absolute accuracy of intra-frequency RSRQ measurements of Cell 3 on the secondary component carrier shall fulfil the requirements specified in clause 9.1.15.1.2.
- The relative accuracy of inter-frequency RSRQ measurements between Cell 1 on primary component carriers and Cell 3 on the secondary component carrier shall fulfil the requirements specified in clause 9.1.15.1.3.

A.9.2.33 TDD absolute and relative RSRQ accuracy for E-UTRAN Carrier Aggregation in CRS based discovery signal

A.9.2.33.1 Test Purpose and Environment

The purpose of this test is to verify that the TDD RSRQ measurement accuracy for carrier aggregation in CRS based discovery signal is within the specified limits under AWGN propagation conditions. This test will verify the absolute accuracy of intra-frequency RSRQ measurements for the secondary component carrier specified in clause 9.1.15.1.2, and also the relative inter-frequency RSRQ accuracy requirement between primary and secondary component carriers specified in clause 9.1.15.1.3.

A.9.2.33.2 Test parameters

In this test case the PCell and the SCell are on different carrier frequencies. There are three cells used in this test case. RSRQ absolute and relative accuracy requirements of the primary and secondary component carrier are tested by using test parameters specified in Table A.9.2.33.2-1. In the test, Cell 1 is the PCell, Cell 2 is the SCell on the Secondary Component Carrier (SCC) and Cell 3 is the neighbouring cell on the SCC. Cell 2 on SCC is configured and activated. Cell 3 DMTC configuration is provided to the UE in the *measDS-Config* before the start of the test.

Table A.9.2.33.2-1: TDD RSRQ Carrier Aggregation Test Parameters

| Parameter | Unit | Test 1 | | |
|------------------------------------|---------|--------|--------|--------|
| | | Cell 1 | Cell 2 | Cell 3 |
| E-UTRA RF Channel Number | | 1 | 2 | 2 |
| $BW_{channel}$ | MHz | 10 | | |
| DMTC period | | N/A | N/A | 160 |
| DMTC period offset | | N/A | N/A | 10 |
| Discovery signal occasion duration | | N/A | N/A | 2 |
| Timing offset to cell 1 | μ s | - | 0 | 3 |

| | | | | | | |
|--|---------------------------|------------|---|----------|------------|--------|
| Time alignment error between cell 2 and cell 1 | | - | ≤ Time alignment error as specified in 3GPP TS 36.104 [30] clause 6.5.3.1 | - | | |
| Special subframe configuration ^{Note1} | | 6 | | | | |
| Uplink-downlink configuration ^{Note1} | | 1 | | | | |
| Measurement bandwidth | | n_{PRB} | 22—27 | | | |
| PDSCH Reference measurement channel defined in A.3.1.1.2 | | R.0 TDD | R.0 TDD | - | | |
| PDSCH allocation | | n_{PRB} | 13—36 | - | | |
| PDCCH/PCFICH/PHICH Reference measurement channel defined in A.3.1.2.2 | | R.6 TDD | R.6 TDD | R.6 TDD | | |
| OCNG Patterns defined in A.3.2.2.1 (OP.1 TDD) and A.3.2.2.2 (OP.2 TDD) | | OP.1 TDD | OP.1 TDD | OP.2 TDD | | |
| PBCH_RA | | dB | 0 | 0 | | |
| PBCH_RB | | | 0 | | | |
| PSS_RA | | | | | | |
| SSS_RA | | | | | | |
| PCFICH_RB | | | | | | |
| PHICH_RA | | | | | | |
| PHICH_RB | | | | | | |
| PDCCH_RA | | | | | | |
| PDCCH_RB | | | | | | |
| PDSCH_RA | | | | | | |
| PDSCH_RB | | | | | | |
| OCNG_RA ^{Note2} | | | | | | |
| OCNG_RB ^{Note2} | | | | | | |
| N_{oc} ^{Note3} | Bands TDD_A | | | | dBm/15 kHz | -119.5 |
| | Bands TDD_C | -118.5 | | | | -115 |
| | Bands TDD_E | -117.5 | -114 | | | |
| \hat{E}_s / I_{ot} | | dB | -4.0 | -5.46 | -5.46 | |
| RSRP ^{Note4} | Bands TDD_A | dBm/15 kHz | -123.50 | -120 | -120 | |
| | Bands TDD_C | | -122.50 | -119 | -119 | |
| | Bands TDD_E | | -121.50 | -118 | -118 | |
| RSRQ ^{Note4} | Bands TDD_A, TDD_C, TDD_E | dB | -16.25 | -17.34 | | |
| I _o ^{Note4} | Bands TDD_A | dBm/9 MHz | -90.26 | -85.67 | | |
| | Bands TDD_C | | -89.26 | -84.67 | | |
| | Bands TDD_E | | -88.26 | -83.67 | | |
| \hat{E}_s / N_{oc} | | dB | -4.0 | -4.0 | -4.0 | |
| Propagation condition | | - | AWGN | | | |
| <p>Note 1: For special subframe and uplink-downlink configurations see Tables 4.2-1 and 4.2-2 in TS 36.211.</p> <p>Note 2: OCNG shall be used such that both cells are fully allocated and a constant total transmitted power spectral density is achieved for all OFDM symbols.</p> <p>Note 3: Interference from other cells and noise sources not specified in the test is assumed to be constant over subcarriers and time and shall be modelled as AWGN of appropriate power for N_{oc} to be fulfilled.</p> <p>Note 4: RSRQ, RSRP and I_o levels have been derived from other parameters for information purposes. They are not settable parameters themselves.</p> <p>Note 5: RSRP and RSRQ minimum requirements are specified assuming independent interference and noise at each receiver antenna port.</p> <p>Note 6: The selection of the bands for testing depends on the configuration of the</p> | | | | | | |

| | |
|---------|--|
| Note 7: | carrier aggregation supported by the UEs. This test verifies the RRM requirement which is independent of channel bandwidth and is performed according to the principle defined in section A.3.6.1. |
| Note 8: | E-UTRA operating band groups are as defined in Section 3.5. |

A.9.2.33.3 Test Requirements

In the test, the RSRQ measurement accuracy in carrier aggregation shall fulfil the requirements in clause 9.1.15.1.1, 9.1.15.1.2, and 9.1.15.1.3.

- The absolute accuracy of intra-frequency RSRQ measurements of Cell 3 on the secondary component carrier shall fulfil the requirements specified in clause 9.1.15.1.2.
- The relative accuracy of inter-frequency RSRQ measurements between Cell 1 on primary component carriers and Cell 3 on the secondary component carrier shall fulfil the requirements specified in clause 9.1.15.1.3.

A.9.2.34 FDD—FDD Inter frequency new RSRQ

A.9.2.34.1 Test Purpose and Environment

The purpose of this test is to verify that the absolute accuracy of RSRQ measurement is within the specified limits when measurement configuration message received by the UE contains *measRSRQ-OnAllSymbols-r12* parameter in TS 36.331 [2]. This test will verify the requirements in Sections 9.1.16.

A.9.2.34.2 Test parameters

In this test case the two cells are on different carrier frequencies and measurement gaps are provided. The new RSRQ inter frequency absolute accuracy requirement is tested by using test parameters in Table A.9.2.34.2-1. In the test, Cell 1 is the PCell and Cell 2 the target cell.

Table A.9.2.34.2-1: New RSRQ FDD—FDD Inter frequency test parameters

| Parameter | Unit | Test 1 | |
|---|-----------|----------|--------|
| | | Cell 1 | Cell 2 |
| E-UTRA RF Channel Number | | 1 | 2 |
| BW _{channel} | MHz | 10 | 10 |
| Gap Pattern Id | | 0 | - |
| Antenna Configuration | | 1x2 | 1x2 |
| Time offset between cell 2 and cell 1 | μs | 3 | |
| Measurement bandwidth | n_{PRB} | 22-27 | |
| PDSCH Reference measurement channel defined in A.3.1.1.1 | | R.0 FDD | - |
| PDSCH allocation | n_{PRB} | - | - |
| PDCCH/PCFICH/PHICH Reference measurement channel defined in A.3.1.2.1 | | R.6 FDD | - |
| OCNG Patterns defined in A.3.2.1.1 (OP.1 FDD) | | OP.1 FDD | - |
| PBCH_RA | dB | 0 | 0 |
| PBCH_RB | | | 0 |
| PSS_RA | | | 0 |
| SSS_RA | | | 0 |
| PCFICH_RB | | | -∞ |
| PHICH_RA | | | -∞ |

| | | | | |
|--|------------------------------------|------------|---------|-----------|
| PHICH_RB | | | | $-\infty$ |
| PDCCH_RA | | | | $-\infty$ |
| PDCCH_RB | | | | $-\infty$ |
| PDSCH_RA | | | | $-\infty$ |
| PDSCH_RB | | | | $-\infty$ |
| OCNG_RA ^{Note1} | | | | $-\infty$ |
| OCNG_RB ^{Note1} | | | | $-\infty$ |
| I_{ot} ^{Note2} | Symbols with CRS, PSS, SSS or PBCH | dBm/15 kHz | -103.85 | -103.85 |
| | All the other symbols | | -94.75 | -94.75 |
| \hat{E}_s/I_{ot} | | dB | -3 | -3 |
| RSRP ^{Note3} | | dBm/15 kHz | -106.85 | -106.85 |
| RSRQ ^{Note3} | Subframe 0 | dB | -14.54 | -14.54 |
| | Subframes other than 0 | | -14.14 | -14.14 |
| New RSRQ ^{Note3} | Subframe 0 | dB | -19.57 | -19.57 |
| | Subframe 5 | | -20.93 | -20.93 |
| | Subframe other than 0 or 5 | | -21.66 | -21.66 |
| Io in subframe 0 ^{Note3} | Symbol 0/4/11 | dBm/ 9 MHz | -75.72 | -75.72 |
| | Symbol 1/2/3/12/13 | | -66.97 | -66.97 |
| | Symbol 5/6/8/9/10 | | -75.81 | -75.81 |
| | Symbol 7 | | -75.52 | -75.52 |
| Io in subframe 5 ^{Note3} | Symbol 0/4/7/11 | dBm/ 9 MHz | -75.72 | -75.72 |
| | Symbol 1/2/3/8/9/10/12/13 | | -66.97 | -66.97 |
| | Symbol 5/6 | | -75.81 | -75.81 |
| Io in subframes other than 0 or 5 ^{Note3} | Symbol 0/4/7/11 | dBm/ 9 MHz | -75.72 | -75.72 |
| | Symbol 1/2/3/5/6/8/9/10/12/13 | | -66.97 | -66.97 |
| Propagation condition | | - | AWGN | |
| Note 1: OCNG shall be used such that both cells are fully allocated and a constant total transmitted power spectral density is achieved for all OFDM symbols. | | | | |
| Note 2: Interference from other cells and noise sources not specified in the test is assumed to be constant over subcarriers and time and shall be modelled as AWGN of appropriate power for N_{oc} to be fulfilled. | | | | |
| Note 3: RSRQ, RSRP, new RSRQ and Io levels have been derived from other parameters for information purposes. They are not settable parameters themselves. The new RSRQ values assume RSSI averaging over all OFDM symbols of the subframe. | | | | |
| Note 4: RSRP and RSRQ minimum requirements are specified assuming independent interference and noise at each receiver antenna port. | | | | |

A.9.2.34.3 Test Requirements

The new RSRQ measurement accuracy for cell 2 shall fulfil the requirements in Section 9.1.16, compared with any nominal new RSRQ value in subframe 0, 5 or others.

A.9.2.35 TDD—TDD Inter frequency new RSRQ

A.9.2.35.1 Test Purpose and Environment

The purpose of this test is to verify that the absolute accuracy of RSRQ measurement is within the specified limits when measurement configuration message received by the UE contains *measRSRQ-OnAllSymbols-r12* parameter in TS 36.331 [2]. This test will verify the requirements in Sections 9.1.16.

A.9.2.35.2 Test parameters

In this test case the two cells are on different carrier frequencies and measurement gaps are provided. The new RSRQ inter frequency absolute accuracy requirement is tested by using test parameters in Table A.9.2.35.2-1. In the test, Cell 1 is the PCell and Cell 2 the target cell.

Table A.9.2.35.2-1: New RSRQ TDD—TDD Inter frequency test parameters

| Parameter | | Unit | Test 1 | | | |
|---|------------------------------------|------------------------|----------|------------|---------|---------|
| | | | Cell 1 | Cell 2 | | |
| E-UTRA RF Channel Number | | | 1 | 2 | | |
| BW _{channel} | | MHz | 10 | 10 | | |
| Special subframe configuration ^{Note1} | | | 6 | 6 | | |
| Uplink-downlink configuration ^{Note1} | | | 1 | 1 | | |
| Gap Pattern Id | | | 0 | - | | |
| Antenna Configuration | | | 1x2 | 1x2 | | |
| Time offset between cell 2 and cell 1 | | μs | 3 | | | |
| Measurement bandwidth | | <i>n_{PRB}</i> | 22-27 | | | |
| PDSCH Reference measurement channel defined in A.3.1.1.2 | | | R.0 TDD | - | | |
| PDSCH allocation | | <i>n_{PRB}</i> | - | - | | |
| PDCCH/PCFICH/PHICH Reference measurement channel defined in A.3.1.2.2 | | | R.6 TDD | - | | |
| OCNG Patterns defined in A.3.2.2.1 (OP.1 TDD) | | | OP.1 TDD | - | | |
| PBCH_RA | | dB | 0 | 0 | | |
| PBCH_RB | | | | 0 | | |
| PSS_RA | | | | 0 | | |
| SSS_RA | | | | 0 | | |
| PCFICH_RB | | | | -∞ | | |
| PHICH_RA | | | | -∞ | | |
| PHICH_RB | | | | -∞ | | |
| PDCCH_RA | | | | -∞ | | |
| PDCCH_RB | | | | -∞ | | |
| PDSCH_RA | | | | -∞ | | |
| PDSCH_RB | | | | -∞ | | |
| OCNG_RA ^{Note1} | | | | -∞ | | |
| OCNG_RB ^{Note1} | | | | -∞ | | |
| <i>I_{ot}</i> ^{Note2} | Symbols with CRS, PSS, SSS or PBCH | | | dBm/15 kHz | -103.85 | -103.85 |
| | All the other symbols | | | | -94.75 | -94.75 |
| \hat{E}_s/I_{ot} | | | | dB | -3 | -3 |
| RSRP ^{Note3} | | dBm/15 kHz | -106.85 | -106.85 | | |
| RSRQ ^{Note3} | Subframe 0 | dB | -14.54 | -14.54 | | |
| | Subframes other than 0 | | -14.14 | -14.14 | | |
| New RSRQ ^{Note3} | Subframe 0 | dB | -20.08 | -20.08 | | |
| | Subframe 5 | | -21.31 | -21.31 | | |
| | Subframe 1 or 6 | | -20.82 | -20.82 | | |
| | Subframe other than 0, 1, 5 or 6 | | -21.66 | -21.66 | | |
| I _o in subframe 0 ^{Note3} | Symbol 0/4/11 | dBm/ 9 MHz | -75.72 | -75.72 | | |
| | Symbol 1/2/3/5/6/12 | | -66.97 | -66.97 | | |
| | Symbol 8/9/10/13 | | -75.81 | -75.81 | | |
| | Symbol 7 | | -75.52 | -75.52 | | |
| I _o in subframe 5 ^{Note3} | Symbol 0/4/7/11 | dBm/ 9 MHz | -75.72 | -75.72 | | |
| | Symbol 1/2/3/5/6/8/9/10/12 | | -66.97 | -66.97 | | |
| | Symbol 13 | | -75.81 | -75.81 | | |
| I _o in subframe 1 or 6 ^{Note3} | Symbol 0/4/7 | dBm/ 9 MHz | -75.72 | -75.72 | | |
| | Symbol 1/3/5/6/8 | | -66.97 | -66.97 | | |

| | | | | |
|--|--|------------|--------|--------|
| | Symbol 2 | | -75.81 | -75.81 |
| Io in subframes other than 0, 1, 5 or 6 ^{Note3} | Symbol 0/4/7/11 | dBm/ 9 MHz | -75.72 | -75.72 |
| | Symbol 1/2/3/5/6/8/9/10/12/13 | | -66.97 | -66.97 |
| Propagation condition | | - | AWGN | |
| Note 1: | For special subframe and uplink-downlink configurations see Tables 4.2-1 and 4.2-2 in TS 36.211. | | | |
| Note 2: | OCNG shall be used such that both cells are fully allocated and a constant total transmitted power spectral density is achieved for all OFDM symbols. | | | |
| Note 3: | Interference from other cells and noise sources not specified in the test is assumed to be constant over subcarriers and time and shall be modelled as AWGN of appropriate power for N_{oc} to be fulfilled. | | | |
| Note 4: | RSRQ, RSRP, new RSRQ and Io levels have been derived from other parameters for information purposes. They are not settable parameters themselves. The new RSRQ values assume RSSI averaging over all OFDM symbols of the subframe. | | | |
| Note 5: | RSRP and RSRQ minimum requirements are specified assuming independent interference and noise at each receiver antenna port. | | | |

A.9.2.35.3 Test Requirements

The new RSRQ measurement accuracy for cell 2 shall fulfil the requirements in Section 9.1.16, compared with any nominal new RSRQ value in subframe 0, 5, 1, 6 or others.

A.9.2.36 FDD—FDD Inter frequency RSRQ measured on all OFDM symbols

A.9.2.36.1 Test Purpose and Environment

The purpose of this test is to verify that the absolute accuracy of RSRQ measurement is within the specified limits when measurement configuration message received by the UE contains *measRSRQ-OnAllSymbols-r12* parameter in TS 36.331 [2]. This test will verify the requirements in Section 9.1.16.

A.9.2.3 is also conducted even if UE is capable of measuring RSRQ on all OFDM symbols.

A.9.2.36.2 Test parameters

In this test case the two cells are on different carrier frequencies and measurement gaps are provided. Both RSRQ measured on all OFDM symbols inter frequency absolute and relative accuracy requirements are tested by using test parameters in Table A.9.2.36.2-1. In all tests, Cell 1 is the PCell and Cell 2 the target cell.

Table A.9.2.36.2-1: FDD—FDD Inter frequency test parameters

| Parameter | Unit | Test 1 | |
|--|-----------|----------|----------|
| | | Cell 1 | Cell 2 |
| E-UTRA RF Channel Number | | 1 | 2 |
| BW _{channel} | MHz | 10 | 10 |
| Gap Pattern Id | | 0 | - |
| Antenna Configuration | | 1x2 | 1x2 |
| Time offset between cell 2 and cell 1 | μs | 3 | |
| Measurement bandwidth | n_{PRB} | 22-27 | |
| PDSCH Reference measurement channel defined in A.3.1.1.1 | | R.0 FDD | - |
| PDSCH allocation | n_{PRB} | 13—36 | - |
| PDCCH/PCFICH/PHICH Reference measurement channel defined in A.3.1.2.1 | | R.6 FDD | |
| OCNG Patterns defined in A.3.2.1.1 (OP.1 FDD) and A.3.2.1.2 (OP.2 FDD) | | OP.1 FDD | OP.2 FDD |
| PBCH_RA | dB | 0 | 0 |
| PBCH_RB | | | |

| | | | |
|---------------------------|---|--------|--------|
| PSS_RA | | | |
| SSS_RA | | | |
| PCFICH_RB | | | |
| PHICH_RA | | | |
| PHICH_RB | | | |
| PDCCH_RA | | | |
| PDCCH_RB | | | |
| PDSCH_RA | | | |
| PDSCH_RB | | | |
| OCNG_RA ^{Note1} | | | |
| OCNG_RB ^{Note1} | | | |
| N_{oc} ^{Note2} | dBm/15 kHz | -80 | -80 |
| \hat{E}_s/I_{ot} | dB | -1.75 | -1.75 |
| RSRP ^{Note3} | dBm/15 kHz | -81.75 | -81.75 |
| RSRQ ^{Note3} | dB | -14.76 | -14.76 |
| I_o ^{Note3} | dBm/ 9 MHz | -50 | -50 |
| \hat{E}_s/N_{oc} | dBm/ 9 MHz | -1.75 | -1.75 |
| Propagation condition | - | AWGN | |
| Note 1: | OCNG shall be used such that both cells are fully allocated and a constant total transmitted power spectral density is achieved for all OFDM symbols. | | |
| Note 2: | Interference from other cells and noise sources not specified in the test is assumed to be constant over subcarriers and time and shall be modelled as AWGN of appropriate power for N_{oc} to be fulfilled. | | |
| Note 3: | RSRP, RSRQ and I_o levels have been derived from other parameters for information purposes. They are not settable parameters themselves. The RSRQ values assume RSSI averaging over all OFDM symbols of the subframe. | | |
| Note 4: | RSRP and RSRQ minimum requirements are specified assuming independent interference and noise at each receiver antenna port. | | |

A.9.2.36.3 Test Requirements

The RSRQ measurement accuracy shall fulfil the requirements in Section 9.1.16.

A.9.2.37 TDD—TDD Inter frequency RSRQ measurement on all OFDM symbols

A.9.2.37.1 Test Purpose and Environment

The purpose of this test is to verify that the absolute accuracy of RSRQ measurement is within the specified limits when measurement configuration message received by the UE contains *measRSRQ-OnAllSymbols-r12* parameter in TS 36.331 [2]. This test will verify the requirements in Section 9.1.16.

A.9.2.4 is also conducted even if UE is capable of measuring RSRQ on all OFDM symbols..

A.9.2.37.2 Test parameters

In this test case the two cells are on different carrier frequencies and measurement gaps are provided. Both RSRQ measured on all OFDM symbols inter frequency absolute and relative accuracy requirements are tested by using test parameters in Table A.9.2.37.2-1. In all tests, Cell 1 is the PCell and Cell 2 the target cell.

Table A.9.2.37.2-1: TDD-TDD Inter frequency test parameters

| Parameter | Unit | Test 1 | |
|---|---|----------|----------|
| | | Cell 1 | Cell 2 |
| E-UTRA RF Channel Number | | 1 | 2 |
| BW _{channel} | MHz | 10 | 10 |
| Special subframe configuration ^{Note1} | | 6 | 6 |
| Uplink-downlink configuration ^{Note1} | | 1 | 1 |
| Gap Pattern Id | | 0 | - |
| Antenna Configuration | | 1x2 | 1x2 |
| Time offset between cell 2 and cell 1 | μs | 3 | |
| Measurement bandwidth | n_{PRB} | 22-27 | |
| PDSCH Reference measurement channel defined in A.3.1.1.2 | | R.0 TDD | - |
| PDSCH allocation | n_{PRB} | 13–36 | - |
| PDCCH/PCFICH/PHICH Reference measurement channel defined in A.3.1.2.2 | | R.6 TDD | |
| OCNG Patterns defined in A.3.2.2.1 (OP.1 TDD) | | OP.1 TDD | OP.2 TDD |
| PBCH_RA | dB | 0 | 0 |
| PBCH_RB | | | |
| PSS_RA | | | |
| SSS_RA | | | |
| PCFICH_RB | | | |
| PHICH_RA | | | |
| PHICH_RB | | | |
| PDCCH_RA | | | |
| PDCCH_RB | | | |
| PDSCH_RA | | | |
| PDSCH_RB | | | |
| OCNG_RA ^{Note1} | | | |
| OCNG_RB ^{Note1} | | | |
| N_{oc} ^{Note2} | | | |
| \hat{E}_s / I_{ot} | dB | -1.75 | -1.75 |
| RSRP ^{Note3} | dBm/15 kHz | -81.75 | -81.75 |
| RSRQ ^{Note3} | dB | -14.76 | -14.76 |
| I_o ^{Note3} | dBm/ 9 MHz | -50 | -50 |
| \hat{E}_s / N_{oc} | dBm/ 9 MHz | -1.75 | -1.75 |
| Propagation condition | - | AWGN | |
| Note 1: | For special subframe and uplink-downlink configurations see Tables 4.2-1 and 4.2-2 in TS 36.211. | | |
| Note 2: | OCNG shall be used such that both cells are fully allocated and a constant total transmitted power spectral density is achieved for all OFDM symbols. | | |
| Note 3: | Interference from other cells and noise sources not specified in the test is assumed to be constant over subcarriers and time and shall be modelled as AWGN of appropriate power for N_{oc} to be fulfilled. | | |
| Note 4: | RSRP, RSRQ and I_o levels have been derived from other parameters for information purposes. They are not settable parameters themselves. The RSRQ values assume RSSI averaging over all OFDM symbols of the subframe. | | |
| Note 5: | RSRP and RSRQ minimum requirements are specified assuming independent interference and noise at each receiver antenna port. | | |

A.9.2.37.3 Test Requirements

The RSRQ measurement accuracy shall fulfil the requirements in Section 9.1.16.

A.9.2.38 3 DL PCell in FDD RSRQ for E-UTRAN in Carrier Aggregation

The test case in this clause is applicable to carrier aggregation capable UEs which have been configured with two downlink SCells.

A.9.2.38.1 Test Purpose and Environment

The purpose of this test is to verify that the RSRQ measurement accuracy in carrier aggregation is within the specified limits under AWGN propagation conditions. This test will verify the absolute accuracy of intra-frequency RSRQ measurements for the primary component carrier specified in clause 9.1.11.1, the absolute accuracy of intra-frequency RSRQ measurements for the secondary component carrier specified in clause 9.1.11.2 and also the relative inter-frequency RSRQ accuracy requirement between primary and secondary component carriers specified in clause 9.1.11.3.

A.9.2.38.2 Test parameters

In this set of test cases there are three cells on three carrier frequencies. Cell 1 is PCell on channel 1, Cell 2 is activated SCell on channel 2, and Cell 3 is activated SCell on channel 3. The parameters for the test are listed in Table A.9.2.38.2-1.

Table A.9.2.38.2-1: 3 DL PCell in FDD RSRQ for E-UTRAN in Carrier Aggregation test parameters (cell #1, cell #2 and cell #3)

| Parameter | Unit | Cell 1 | Cell 2 | Cell 3 |
|---|-------------|--|--|--|
| E-UTRA RF Channel Number | | 1 | 2 | 3 |
| BW_{channel} | | 5MHz: $N_{RB,c} = 25$ 10MHz: $N_{RB,c} = 50$ 20MHz: $N_{RB,c} = 100$ | 5MHz: $N_{RB,c} = 25$ 10MHz: $N_{RB,c} = 50$ 20MHz: $N_{RB,c} = 100$ | 5MHz: $N_{RB,c} = 25$ 10MHz: $N_{RB,c} = 50$ 20MHz: $N_{RB,c} = 100$ |
| Special subframe configuration ^{Note1} | | - | 6 | 6 |
| Uplink/downlink configuration ^{Note1} | | - | 1 | 1 |
| Measurement bandwidth | n_{PRB} | 5MHz: 10-15 10MHz: 22-27 20MHz: 47-52 | 5MHz: 10-15 10MHz: 22-27 20MHz: 47-52 | 5MHz: 10-15 10MHz: 22-27 20MHz: 47-52 |
| PDSCH Reference measurement channel defined in A.3.1.1 | | 5MHz: R.5 FDD 10MHz: R.0 FDD 20MHz: R.4 FDD | 5MHz: R.4 TDD 10MHz: R.0 TDD 20MHz: R.3 TDD | 5MHz: R.4 TDD 10MHz: R.0 TDD 20MHz: R.3 TDD |
| PDSCH allocation | n_{PRB} | 5MHz: 7-17 10MHz: 13-36 20MHz: 38-61 | 5MHz: 7-17 10MHz: 13-36 20MHz: 38-61 | 5MHz: 7-17 10MHz: 13-36 20MHz: 38-61 |
| PDCCH/PCFICH/PHICH Reference measurement channel defined in A.3.1.2 | | 5MHz: R.11 FDD 10MHz: R.6 FDD 20MHz: R.10 FDD | 5MHz: R.11 TDD 10MHz: R.6 TDD 20MHz: R.10 TDD | 5MHz: R.11 TDD 10MHz: R.6 TDD 20MHz: R.10 TDD |
| OCNG Patterns defined in A.3.2 | | 5MHz: OP.15 FDD 10MHz: OP.1 FDD 20MHz: OP.11 FDD | 5MHz: OP.9 TDD 10MHz: OP.1 TDD 20MHz: OP.7 TDD | 5MHz: OP.9 TDD 10MHz: OP.1 TDD 20MHz: OP.7 TDD |
| PBCH_RA | dB | 0 | 0 | 0 |
| PBCH_RB | | | | |
| PSS_RA | | | | |
| SSS_RA | | | | |
| PCFICH_RB | | | | |
| PHICH_RA | | | | |
| PHICH_RB | | | | |
| PDCCH_RA | | | | |
| PDCCH_RB | | | | |
| PDSCH_RA | | | | |
| PDSCH_RB | | | | |
| OCNG_RA ^{Note2} | | | | |
| OCNG_RB ^{Note2} | | | | |
| N_{oc} ^{Note3} | | | | |
| | Bands TDD_C | - | -115 | -115 |

| | | | | | |
|---------------------------------|---------------------------------------|-------------------------------|--|--|--|
| | Bands TDD_E | | - | -114 | -114 |
| | Bands FDD_A | | -119.5 | - | - |
| | Bands FDD_B | | -119 | - | - |
| | Bands FDD_C | | -118.5 | - | - |
| | Bands FDD_D | | -118 | - | - |
| | Bands FDD_E, Bands FDD_F Note 6 | | -117.5 | - | - |
| | Bands FDD_G | | -116.5 | - | - |
| | Bands FDD_H | | -116 | - | - |
| \hat{E}_s / N_{oc} | | dB | -6.0 | -6.0 | -6.0 |
| \hat{E}_s / I_{ot} | | dB | -6.0 | -6.0 | -6.0 |
| RSRP ^{Note4} | Bands TDD_A | dBm/ 15kHz | - | -122 | -122 |
| | Bands TDD_C | | - | -121 | -121 |
| | Bands TDD_E | | - | -120 | -120 |
| | Bands FDD_A | | -125.5 | - | - |
| | Bands FDD_B | | -125 | - | - |
| | Bands FDD_C | | -124.5 | - | - |
| | Bands FDD_D | | -124 | - | - |
| | Bands FDD_E, Bands FDD_F Note 6 | | -123.5 | - | - |
| | Bands FDD_G | | -122.5 | - | - |
| | Bands FDD_H | | -122 | - | - |
| RSRQ ^{Note4} | Bands TDD_A | dB | - | -17.77 | -17.77 |
| | Bands TDD_C | | - | - | - |
| | Bands TDD_E | | - | - | - |
| | Bands FDD_A | | -17.77 | - | - |
| | Bands FDD_B | | - | - | - |
| | Bands FDD_C | | - | - | - |
| | Bands FDD_D | | - | - | - |
| | Bands FDD_E, Bands FDD_F Note 6 | | - | - | - |
| | Bands FDD_G | | - | - | - |
| | Bands FDD_H | | - | - | - |
| I _o ^{Note4} | Bands TDD_A | dBm/ BW _{channel} | - | -87.25 + 10log(N _{RB,c} /50) | -87.25 + 10log(N _{RB,c} /50) |
| | Bands TDD_C | | - | -86.25 + 10log(N _{RB,c} /50) | -86.25 + 10log(N _{RB,c} /50) |
| | Bands TDD_E | | - | -85.25 + 10log(N _{RB,c} /50) | -85.25 + 10log(N _{RB,c} /50) |
| | Bands FDD_A | | -90.75 + 10log(N _{RB,c} /50) | - | - |
| | Bands FDD_B | | -90.25 + 10log(N _{RB,c} /50) | - | - |
| | Bands FDD_C | | -89.75 + 10log(N _{RB,c} /50) | - | - |
| | Bands FDD_D | | -89.25 + 10log(N _{RB,c} /50) | - | - |
| | Bands FDD_E, Bands FDD_F Note 6 | | -88.75 + 10log(N _{RB,c} /50) | - | - |
| | Bands FDD_G | | -87.75 + 10log(N _{RB,c} /50) | - | - |
| | Bands FDD_H | | -87.25 + 10log(N _{RB,c} /50) | - | - |
| Propagation Condition | | | AWGN | AWGN | AWGN |
| Antenna Configuration | | | 1x2 | 1x2 | 1x2 |
| Timing offset to Cell 1 | | μs | - | 0 | 0 |
| Time alignment error relative | | | - | ≤ TAE | ≤ TAE |

| | | | | |
|--|--|------------|---|------------|
| to cell 1 ^{Note 10} | | | | |
| Time alignment error relative to cell 2 ^{Note 10} | | \leq TAE | - | \leq TAE |
| Note 1: | For special subframe and uplink-downlink configurations see Tables 4.2-1 and 4.2-2 in TS 36.211. | | | |
| Note 2: | OCNG shall be used such that both cells are fully allocated and a constant total transmitted power spectral density is achieved for all OFDM symbols. | | | |
| Note 3: | Interference from other cells and noise sources not specified in the test is assumed to be constant over subcarriers and time and shall be modelled as AWGN of appropriate power for N_{oc} to be fulfilled. | | | |
| Note 4: | RSRP, RSRQ and Io levels have been derived from other parameters for information purposes. They are not settable parameters themselves. | | | |
| Note 5: | RSRP and RSRQ minimum requirements are specified assuming independent interference and noise at each receiver antenna port. | | | |
| Note 6: | For Band 26, the tests shall be performed with the carrier frequency of the assigned E-UTRA channel bandwidth within 865-894 MHz. | | | |
| Note 7: | The selection of the bands for testing depends on the configuration of the carrier aggregation supported by the UEs. | | | |
| Note 8: | This test verifies the RRM requirement which is independent of channel bandwidth and is performed according to the principle defined in section A.3.6.1. | | | |
| Note 9: | E-UTRA operating band groups are as defined in Section 3.5. | | | |
| Note 10: | Time alignment error (TAE) as specified in TS 36.104 [30] clause 6.5.3.1. The TAE value depends upon the type of carrier aggregation. | | | |

A.9.2.38.3 Test Requirements

In the test, the RSRQ measurement accuracy in carrier aggregation shall fulfil the requirements in clause 9.1.11.1, 9.1.11.2, and 9.1.11.3.

- The absolute accuracy of intra-frequency RSRQ measurements of Cell 1 on the primary component carrier shall fulfil the requirements specified in clause 9.1.11.1.
- The absolute accuracy of intra-frequency RSRQ measurements of Cell 2 on the secondary component carrier shall fulfil the requirements specified in clause 9.1.11.2
- The absolute accuracy of intra-frequency RSRQ measurements of Cell 3 on the secondary component carrier shall fulfil the requirements specified in clause 9.1.11.2
- The relative accuracy of inter-frequency RSRQ measurements between the primary and secondary component carriers for Cell 2 relative to Cell 1 shall fulfil the requirements specified in clause 9.1.11.3.
- The relative accuracy of inter-frequency RSRQ measurements between the primary and secondary component carriers for Cell 3 relative to Cell 1 shall fulfil the requirements specified in clause 9.1.11.3.

A.9.2.39 3 DL PCell in TDD RSRQ for E-UTRAN in Carrier Aggregation

The test case in this clause is applicable to carrier aggregation capable UEs which have been configured with two downlink SCells.

A.9.2.39.1 Test Purpose and Environment

The purpose of this test is to verify that the TDD-FDD RSRQ measurement accuracy in carrier aggregation is within the specified limits under AWGN propagation conditions. This test will verify the absolute accuracy of intra-frequency RSRQ measurements for the primary component carrier defined in Clause 9.1.11.1, the absolute accuracy of intra-frequency RSRQ measurements for the secondary component carrier defined in Clause 9.1.11.2, and also the relative inter-frequency RSRQ accuracy requirement between primary and secondary component carriers defined in Clause 9.1.11.3.

A.9.2.39.2 Test parameters

In this set of cases cell 1 is PCell on the primary component carrier, and cell 2 and cell 3 are activated SCells on secondary component carriers SCC1 and SCC2 respectively. The test parameters for the test are listed in Table A.9.2.39.2-1.

Table A.9.2.39.2-1: 3 Downlink TDD-FDD RSRQ carrier aggregation test parameters with PCell in TDD (cell #1, cell #2 and cell #3)

| Parameter | | Unit | Cell 1 | Cell 2 | Cell 3 |
|---|--|-------------------------|---|---|---|
| E-UTRA RF Channel Number | | | 1 | 2 | 3 |
| BW _{channel} | | | 5MHz: N _{RB,c} = 25 10MHz: N _{RB,c} = 50 20MHz: N _{RB,c} = 100 | 5MHz: N _{RB,c} = 25 10MHz: N _{RB,c} = 50 20MHz: N _{RB,c} = 100 | 5MHz: N _{RB,c} = 25 10MHz: N _{RB,c} = 50 20MHz: N _{RB,c} = 100 |
| Special subframe configuration ^{Note1} | | | 6 | - | - |
| Uplink/downlink configuration ^{Note1} | | | 1 | - | - |
| Measurement bandwidth | | <i>n</i> _{PRB} | 5MHz: 10-15 10MHz: 22-27 20MHz: 47-52 | 5MHz: 10-15 10MHz: 22-27 20MHz: 47-52 | 5MHz: 10-15 10MHz: 22-27 20MHz: 47-52 |
| PDSCH Reference measurement channel defined in A.3.1.1.1 and A.3.1.1.2 | | | 5MHz: R.4 TDD 10MHz: R.0 TDD 20MHz: R.3 TDD | 5MHz: R.5 FDD 10MHz: R.0 FDD 20MHz: R.4 FDD | 5MHz: R.5 FDD 10MHz: R.0 FDD 20MHz: R.4 FDD |
| PDSCH allocation | | <i>n</i> _{PRB} | 5MHz: 7-17 10MHz: 13-36 20MHz: 38-61 | 5MHz: 7-17 10MHz: 13-36 20MHz: 38-61 | 5MHz: 7-17 10MHz: 13-36 20MHz: 38-61 |
| PDCCH/PCFICH/PHICH Reference measurement channel defined in A.3.1.2.1 and A.3.1.2.2 | | | 5MHz: R.11 TDD 10MHz: R.6 TDD 20MHz: R.10 TDD | 5MHz: R.11 FDD 10MHz: R.6 FDD 20MHz: R.10 FDD | 5MHz: R.11 FDD 10MHz: R.6 FDD 20MHz: R.10 FDD |
| OCNG Patterns defined in A.3.2.1 and A.3.2.2 | | | 5MHz: OP.9 TDD 10MHz: OP.1 TDD 20MHz: OP.7 TDD | 5MHz: OP.15 FDD 10MHz: OP.1 FDD 20MHz: OP.11 FDD | 5MHz: OP.15 FDD 10MHz: OP.1 FDD 20MHz: OP.11 FDD |
| PBCH_RA | | dB | 0 | 0 | 0 |
| PBCH_RB | | | | | |
| PSS_RA | | | | | |
| SSS_RA | | | | | |
| PCFICH_RB | | | | | |
| PHICH_RA | | | | | |
| PHICH_RB | | | | | |
| PDCCH_RA | | | | | |
| PDCCH_RB | | | | | |
| PDSCH_RA | | | | | |
| PDSCH_RB | | | | | |
| OCNG_RA ^{Note2} | | | | | |
| OCNG_RB ^{Note2} | | | | | |
| <i>N</i> _{oc} ^{Note3} | Bands TDD_A | | | | |
| | Bands TDD_C | -118.5 | - | - | |
| | Bands TDD_E | -117.5 | - | - | |
| | Bands FDD_A | - | -116 | -116 | |
| | Bands FDD_B | - | -115.5 | -115.5 | |
| | Bands FDD_C | - | -115 | -115 | |
| | Bands FDD_D | - | -114.5 | -114.5 | |
| | Bands FDD_E, Bands FDD_F ^{Note 6} | - | -114 | -114 | |
| | Bands FDD_G | - | -113 | -113 | |
| Bands FDD_H | - | -112.5 | -112.5 | | |
| \hat{E}_s / N_{oc} | | dB | -6.0 | -6.0 | -6.0 |
| \hat{E}_s / I_{ot} | | dB | -6.0 | -6.00 | -6.00 |
| RSRP ^{Note4} | Bands TDD_A | dBm/ 15kHz | -125.50 | - | - |
| | Bands TDD_C | | -124.50 | - | - |
| | Bands TDD_E | | -123.50 | - | - |
| | Bands FDD_A | | - | -122 | -122 |
| | Bands FDD_B | | - | -121.5 | -121.5 |
| | Bands FDD_C | | - | -121 | -121 |
| | Bands FDD_D | | - | -120.5 | -120.5 |

| | | | | | |
|--|---------------------------------------|-------------------------------|--|--|--|
| | Bands FDD_E, Bands FDD_F Note 6 | | - | -120 | -120 |
| | Bands FDD_G | | - | -119 | -119 |
| | Bands FDD_H | | - | -118.5 | -118.5 |
| RSRQ ^{Note4} | Bands TDD_A | dB | -17.77 | - | - |
| | Bands TDD_C | | | | |
| | Bands TDD_E | | | | |
| | Bands FDD_A | | - | -17.77 | -17.77 |
| | Bands FDD_B | | | | |
| | Bands FDD_C | | | | |
| | Bands FDD_D | | | | |
| | Bands FDD_E, Bands FDD_F Note 6 | | | | |
| | Bands FDD_G | | | | |
| Bands FDD_H | | | | | |
| Io ^{Note4} | Bands TDD_A | dBm/ BW _{channel} | -90.75 + 10log(N _{RB,c} /50) | - | - |
| | Bands TDD_C | | -89.75 + 10log(N _{RB,c} /50) | - | - |
| | Bands TDD_E | | -88.75 + 10log(N _{RB,c} /50) | - | - |
| | Bands FDD_A | | - | -87.25 + 10log(N _{RB,c} /50) | -87.25 + 10log(N _{RB,c} /50) |
| | Bands FDD_B | | - | -86.75 + 10log(N _{RB,c} /50) | -86.75 + 10log(N _{RB,c} /50) |
| | Bands FDD_C | | - | -86.25 + 10log(N _{RB,c} /50) | -86.25 + 10log(N _{RB,c} /50) |
| | Bands FDD_D | | - | -85.75 + 10log(N _{RB,c} /50) | -85.75 + 10log(N _{RB,c} /50) |
| | Bands FDD_E, Bands FDD_F Note 6 | | - | -85.25 + 10log(N _{RB,c} /50) | -85.25 + 10log(N _{RB,c} /50) |
| | Bands FDD_G | | - | -84.25 + 10log(N _{RB,c} /50) | -84.25 + 10log(N _{RB,c} /50) |
| | Bands FDD_H | | - | -83.75 + 10log(N _{RB,c} /50) | -83.75 + 10log(N _{RB,c} /50) |
| Propagation Condition | | | AWGN | AWGN | AWGN |
| Antenna Configuration | | | 1x2 | 1x2 | 1x2 |
| Timing offset to Cell 1 | | µs | - | 0 | 0 |
| Time alignment error relative to cell 1 ^{Note 10} | | | - | ≤ TAE | ≤ TAE |
| Time alignment error relative to cell 2 ^{Note 10} | | | ≤ TAE | - | ≤ TAE |

Note 1: For special subframe and uplink-downlink configurations see Tables 4.2-1 and 4.2-2 in TS 36.211.

Note 2: OCNB shall be used such that both cells are fully allocated and a constant total transmitted power spectral density is achieved for all OFDM symbols.

Note 3: Interference from other cells and noise sources not specified in the test is assumed to be constant over subcarriers and time and shall be modelled as AWGN of appropriate power for N_{oc} to be fulfilled.

Note 4: RSRP, RSRQ and Io levels have been derived from other parameters for information purposes. They are not settable parameters themselves.

Note 5: RSRP and RSRQ minimum requirements are specified assuming independent interference and noise at each receiver antenna port.

Note 6: For Band 26, the tests shall be performed with the carrier frequency of the assigned E-UTRA channel bandwidth within 865-894 MHz.

Note 7: The selection of the bands for testing depends on the configuration of the carrier aggregation supported by the UEs.

Note 8: This test verifies the RRM requirement which is independent of channel bandwidth and is performed according to the principle defined in section A.3.6.1.

Note 9: E-UTRA operating band groups are as defined in Section 3.5.

Note 10: Time alignment error (TAE) as specified in TS 36.104 [30] clause 6.5.3.1. The TAE value depends upon the type of carrier aggregation.

A.9.2.39.3 Test Requirements

In the test, the RSRQ measurement accuracy in carrier aggregation shall fulfil the requirements in clause 9.1.11.1, 9.1.11.2, and 9.1.11.3.

- The absolute accuracy of intra-frequency RSRQ measurements of Cell 1 on the primary component carrier shall fulfil the requirements specified in clause 9.1.11.1.
- The absolute accuracy of intra-frequency RSRQ measurements of Cell 2 on the secondary component carrier shall fulfil the requirements specified in clause 9.1.11.2
- The absolute accuracy of intra-frequency RSRQ measurements of Cell 3 on the secondary component carrier shall fulfil the requirements specified in clause 9.1.11.2
- The relative accuracy of inter-frequency RSRQ measurements between the primary and secondary component carriers for Cell 2 relative to Cell 1 shall fulfil the requirements specified in clause 9.1.11.3.
- The relative accuracy of inter-frequency RSRQ measurements between the primary and secondary component carriers for Cell 3 relative to Cell 1 shall fulfil the requirements specified in clause 9.1.11.3.

A.9.2.40 3 DL FDD RSRQ for E-UTRAN in Carrier Aggregation

A.9.2.40.1 Test Purpose and Environment

The purpose of this test is to verify that the FDD RSRQ measurement accuracy in carrier aggregation is within the specified limits under AWGN propagation conditions. This test will verify the absolute accuracy of intra-frequency RSRQ measurements for the primary component carrier specified in clause 9.1.11.1, the absolute accuracy of intra-frequency RSRQ measurements for the secondary component carriers specified in clause 9.1.11.2 and also the relative inter-frequency RSRQ accuracy requirement between primary and secondary component carriers specified in clause 9.1.11.3.

A.9.2.40.2 Test parameters

In this test case the PCell and the SCells are on different carrier frequencies. There are three cells used in this test case. Both RSRQ absolute and relative accuracy requirements of the primary and secondary component carriers are tested by using test parameters specified in Table A.9.2.40.2-1. In the test, Cell 1 is the PCell, Cell 2 and Cell 3 are the SCells on secondary component carrier SCC1 and SCC2 respectively. The SCC1 and SCC2 are configured and activated.

Table A.9.2.40.2-1: 3 DL FDD RSRQ carrier aggregation test parameters

| Parameter | Unit | Cell 1 | Cell 2 | Cell 3 |
|---|-----------|--|--|--|
| E-UTRA RF Channel Number | | 1 | 2 | 3 |
| BW_{channel} | MHz | 5MHz: $N_{RB,c} = 25$ 10MHz: $N_{RB,c} = 50$ 20MHz: $N_{RB,c} = 100$ | 5MHz: $N_{RB,c} = 25$ 10MHz: $N_{RB,c} = 50$ 20MHz: $N_{RB,c} = 100$ | 5MHz: $N_{RB,c} = 25$ 10MHz: $N_{RB,c} = 50$ 20MHz: $N_{RB,c} = 100$ |
| Measurement bandwidth | n_{PRB} | 5MHz: 10-15 10MHz: 22-27 20MHz: 47-52 | 5MHz: 10-15 10MHz: 22-27 20MHz: 47-52 | 5MHz: 10-15 10MHz: 22-27 20MHz: 47-52 |
| PDSCH Reference measurement channel defined in A.3.1.1.1 | | 5MHz: R.5 FDD 10MHz: R.0 FDD 20MHz: R.4 FDD | 5MHz: R.5 FDD 10MHz: R.0 FDD 20MHz: R.4 FDD | 5MHz: R.5 FDD 10MHz: R.0 FDD 20MHz: R.4 FDD |
| PDSCH allocation | n_{PRB} | 5MHz: 7-17 10MHz: 13-36 20MHz: 38-61 | 5MHz: 7-17 10MHz: 13-36 20MHz: 38-61 | 5MHz: 7-17 10MHz: 13-36 20MHz: 38-61 |
| PDCCH/PCFICH/PHICH Reference measurement channel defined in A.3.1.2.1 | | 5MHz: R.11 FDD 10MHz: R.6 FDD 20MHz: R.10 FDD | 5MHz: R.11 FDD 10MHz: R.6 FDD 20MHz: R.10 FDD | 5MHz: R.11 FDD 10MHz: R.6 FDD 20MHz: R.10 FDD |
| OCNG Patterns defined in A.3.2.1 | | 5MHz: OP.15 FDD 10MHz: OP.1 FDD 20MHz: OP.11 FDD | 5MHz: OP.15 FDD 10MHz: OP.1 FDD 20MHz: OP.11 FDD | 5MHz: OP.15 FDD 10MHz: OP.1 FDD 20MHz: OP.11 FDD |
| PBCH_RA | dB | 0 | 0 | 0 |
| PBCH_RB | | | | |
| PSS_RA | | | | |

| | | | | | |
|--|--------------------------------------|-------------------------------|---|---|---|
| SSS_RA | | | | | |
| PCFICH_RB | | | | | |
| PHICH_RA | | | | | |
| PHICH_RB | | | | | |
| PDCCH_RA | | | | | |
| PDCCH_RB | | | | | |
| PDSCH_RA | | | | | |
| PDSCH_RB | | | | | |
| OCNG_RA ^{Note1} | | | | | |
| OCNG_RB ^{Note1} | | | | | |
| N_{oc} ^{Note2} | Bands FDD_A | dBm/15 kHz | -119.5 | -116 | -116 |
| | Bands FDD_B | | -119 | -115.5 | -115.5 |
| | Bands FDD_C | | -118.5 | -115 | -115 |
| | Bands FDD_D | | -118 | -114.5 | -114.5 |
| | Bands FDD_E, FDD_F ^{Note 6} | | -117.5 | -114 | -114 |
| | Bands FDD_G | | -116.5 | -113 | -113 |
| | Bands FDD_H | | -116 | -112.5 | -112.5 |
| \hat{E}_s / N_{oc} | | dB | -6.0 | -6.0 | -6.0 |
| \hat{E}_s / I_{ot} ^{Note3} | | dB | -6.0 | -6.0 | -6.0 |
| RSRP ^{Note3} | Bands FDD_A | dBm/15 kHz | -125.5 | -122 | -122 |
| | Bands FDD_B | | -125 | -121.5 | -121.5 |
| | Bands FDD_C | | -124.5 | -121 | -121 |
| | Bands FDD_D | | -124 | -120.5 | -120.5 |
| | Bands FDD_E, FDD_F ^{Note 6} | | -123.5 | -120 | -120 |
| | Bands FDD_G | | -122.5 | -119 | -119 |
| | Bands FDD_H | | -122 | -118.5 | -118.5 |
| RSRQ ^{Note3} | Bands FDD_A | dB | -17.77 | -17.77 | -17.77 |
| | Bands FDD_B | | | | |
| | Bands FDD_C | | | | |
| | Bands FDD_D | | | | |
| | Bands FDD_E, FDD_F ^{Note 6} | | | | |
| | Bands FDD_G | | | | |
| | Bands FDD_H | | | | |
| I_0 ^{Note3} | Bands FDD_A | dBm/ BW _{channel} | -90.75+ 10log(N _{RB,c} /50) | -87.25+ 10log(N _{RB,c} /50) | -87.25+ 10log(N _{RB,c} /50) |
| | Bands FDD_B | | -90.25+ 10log(N _{RB,c} /50) | -86.75+ 10log(N _{RB,c} /50) | -86.75+ 10log(N _{RB,c} /50) |
| | Bands FDD_C | | -89.75+ 10log(N _{RB,c} /50) | -86.25+ 10log(N _{RB,c} /50) | -86.25+ 10log(N _{RB,c} /50) |
| | Bands FDD_D | | -89.25+ 10log(N _{RB,c} /50) | -85.75+ 10log(N _{RB,c} /50) | -85.75+ 10log(N _{RB,c} /50) |
| | Bands FDD_E, FDD_F ^{Note 6} | | -88.75+ 10log(N _{RB,c} /50) | -85.25+ 10log(N _{RB,c} /50) | -85.25+ 10log(N _{RB,c} /50) |
| | Bands FDD_G | | -87.75+ 10log(N _{RB,c} /50) | -84.25+ 10log(N _{RB,c} /50) | -84.25+ 10log(N _{RB,c} /50) |
| | Bands FDD_H | | -87.25+ 10log(N _{RB,c} /50) | -83.75+ 10log(N _{RB,c} /50) | -83.75+ 10log(N _{RB,c} /50) |
| Propagation condition | | - | AWGN | AWGN | AWGN |
| Antenna Configuration | | - | 1x2 | 1x2 | 1x2 |
| Timing offset to Cell 1 | | μs | - | 0 | 0 |
| Time alignment error relative to cell 1 ^{Note 7} | | | - | ≤ TAE | ≤ TAE |
| Time alignment error relative to cell 2 ^{Note 7} | | | - | - | ≤ TAE |
| <p>Note 1: OCNG shall be used such that all cells are fully allocated and a constant total transmitted power spectral density is achieved for all OFDM symbols.</p> <p>Note 2: Interference from other cells and noise sources not specified in the test is assumed to be constant over subcarriers and time and shall be modelled as AWGN of appropriate power for N_{oc} to be fulfilled.</p> | | | | | |

| | |
|---------|---|
| Note 3: | Es/lot, RSRQ, RSRP and Io levels have been derived from other parameters for information purposes. They are not settable parameters themselves. |
| Note 4: | RSRP and RSRQ minimum requirements are specified assuming independent interference and noise at each receiver antenna port. |
| Note 5: | The selection of the bands for testing depends on the configuration of the carrier aggregation supported by the UEs. |
| Note 6: | For Band 26, the tests shall be performed with the carrier frequency of the assigned E-UTRA channel bandwidth within 865-894 MHz. |
| Note 7: | Time alignment error (TAE) as specified in TS 36.104 [30] clause 6.5.3.1. The TAE value depends upon the type of carrier aggregation. |
| Note 8: | E-UTRA operating band groups are as defined in Section 3.5. |

A.9.2.40.3 Test Requirements

In the test, the RSRQ measurement accuracy in carrier aggregation shall fulfil the requirements in clause 9.1.11.1, 9.1.11.2, and 9.1.11.3.

- The absolute accuracy of intra-frequency RSRQ measurements of Cell 1 on the primary component carrier shall fulfil the requirements defined in clause 9.1.11.1.
- The absolute accuracy of intra-frequency RSRQ measurements of Cell 2 on SCC1 shall fulfil the requirements defined in clause 9.1.11.2.
- The absolute accuracy of intra-frequency RSRQ measurements of Cell 3 on SCC2 shall fulfil the requirements defined in clause 9.1.11.2.
- The relative accuracy of inter-frequency RSRQ measurements between the primary component carrier and SCC1 for Cell 2 relative to Cell 1 shall fulfil the requirements defined in clause 9.1.11.3.
- The relative accuracy of inter-frequency RSRQ measurements between the primary component carrier and SCC2 for Cell 3 relative to Cell 1 shall fulfil the requirements defined in clause 9.1.11.3.

A.9.2.41 3 DL TDD RSRQ for E-UTRAN in Carrier Aggregation

A.9.2.41.1 Test Purpose and Environment

The purpose of this test is to verify that the TDD RSRQ measurement accuracy in carrier aggregation is within the specified limits in a synchronized network environment with AWGN propagation conditions. This test will verify the absolute accuracy of intra-frequency RSRQ measurements for the primary component carrier defined in Clause 9.1.11.1, the absolute accuracy of intra-frequency RSRQ measurements for the secondary component carriers defined in Clause 9.1.11.2, and also the relative inter-frequency RSRQ accuracy requirement between primary and secondary component carriers defined in Clause 9.1.11.3.

A.9.2.41.2 Test parameters

In the test there are three synchronous cells: Cell 1, Cell 2 and Cell 3. Cell 1 is PCell, Cell 2 and Cell 3 are the SCells on secondary component carrier SCC1 and SCC2 respectively. PCell and SCells are in different RF channels. The parameters for the test are listed in Table A.9.2.41.2-1.

Table A.9.2.41.2-1: 3 DL TDD RSRQ carrier aggregation test parameters

| Parameter | Unit | Cell 1 | Cell2 | Cell3 |
|---|------------------------|---|---|---|
| E-UTRA RF Channel Number | | 1 | 2 | 3 |
| BW _{channel} | MHz | 5MHz: N _{RB,c} = 25 10MHz: N _{RB,c} = 50 20MHz: N _{RB,c} = 100 | 5MHz: N _{RB,c} = 25 10MHz: N _{RB,c} = 50 20MHz: N _{RB,c} = 100 | 5MHz: N _{RB,c} = 25 10MHz: N _{RB,c} = 50 20MHz: N _{RB,c} = 100 |
| Special subframe configuration ^{Note1} | | 6 | | |
| Uplink-downlink configuration ^{Note1} | | 1 | | |
| Measurement bandwidth | <i>n_{PRB}</i> | 5MHz: 10-15 10MHz: 22-27 20MHz: 47-52 | 5MHz: 10-15 10MHz: 22-27 20MHz: 47-52 | 5MHz: 10-15 10MHz: 22-27 20MHz: 47-52 |

| | | | | | |
|--|---------------------------|-------------------------------|--|--|--|
| PDSCH Reference measurement channel defined in A.3.1.1.1 | | | 5MHz: R.4 TDD 10MHz: R.0 TDD 20MHz: R.3 TDD | 5MHz: R.4 TDD 10MHz: R.0 TDD 20MHz: R.3 TDD | 5MHz: R.4 TDD 10MHz: R.0 TDD 20MHz: R.3 TDD |
| PDSCH allocation | | n_{PRB} | 5MHz: 7-17 10MHz: 13-36 20MHz: 38-61 | 5MHz: 7-17 10MHz: 13-36 20MHz: 38-61 | 5MHz: 7-17 10MHz: 13-36 20MHz: 38-61 |
| PDCCH/PCFICH/PHICH Reference measurement channel defined in A.3.1.2.1 | | | 5MHz: R.11 TDD 10MHz: R.6 TDD 20MHz: R.10 TDD | 5MHz: R.11 TDD 10MHz: R.6 TDD 20MHz: R.10 TDD | 5MHz: R.11 TDD 10MHz: R.6 TDD 20MHz: R.10 TDD |
| OCNG Patterns defined in A.3.2.1 | | | 5MHz: OP.9 TDD 10MHz: OP.1 TDD 20MHz: OP.7 TDD | 5MHz: OP.9 TDD 10MHz: OP.1 TDD 20MHz: OP.7 TDD | 5MHz: OP.9 TDD 10MHz: OP.1 TDD 20MHz: OP.7 TDD |
| PBCH_RA | | dB | 0 | 0 | 0 |
| PBCH_RB | | | | | |
| PSS_RA | | | | | |
| SSS_RA | | | | | |
| PCFICH_RB | | | | | |
| PHICH_RA | | | | | |
| PHICH_RB | | | | | |
| PDCCH_RA | | | | | |
| PDCCH_RB | | | | | |
| PDSCH_RA | | | | | |
| PDSCH_RB | | | | | |
| OCNG_RA ^{Note2} | | | | | |
| OCNG_RB ^{Note2} | | | | | |
| N_{oc} ^{Note3} | Bands TDD_A | | | | |
| | Bands TDD_C | -118.5 | -115 | -115 | |
| | Bands TDD_E | -117.5 | -114 | -114 | |
| \hat{E}_s / N_{oc} | | dB | -6.0 | -6.0 | -6.0 |
| \hat{E}_s / I_{ot} ^{Note4} | | dB | -6.0 | -6.0 | -6.0 |
| RSRP ^{Note4} | Bands TDD_A | dBm/15 kHz | -125.5 | -122 | -122 |
| | Bands TDD_C | | -124.5 | -121 | -121 |
| | Bands TDD_E | | -123.5 | -120 | -120 |
| RSRQ ^{Note4} | Bands TDD_A, TDD_C, TDD_E | dB | -17.77 | -17.77 | -17.77 |
| I_o ^{Note4} | Bands TDD_A | dBm/ BW _{channel} | -90.75+ 10log(N _{RB,c} /50) | -87.25+ 10log(N _{RB,c} /50) | -87.25+ 10log(N _{RB,c} /50) |
| | Bands TDD_C | | -89.75+ 10log(N _{RB,c} /50) | -86.25+ 10log(N _{RB,c} /50) | -86.25+ 10log(N _{RB,c} /50) |
| | Bands TDD_E | | -88.75+ 10log(N _{RB,c} /50) | -85.25+ 10log(N _{RB,c} /50) | -85.25+ 10log(N _{RB,c} /50) |
| Propagation condition | | - | AWGN | AWGN | AWGN |
| Antenna Configuration | | - | 1x2 | 1x2 | 1x2 |
| Timing offset to Cell 1 | | μs | - | 0 | 0 |
| Time alignment error relative to cell 1 ^{Note 7} | | | - | ≤ TAE | ≤ TAE |
| Time alignment error relative to cell 2 ^{Note 7} | | | - | - | ≤ TAE |
| <p>Note 1: For special subframe and uplink-downlink configurations see Tables 4.2-1 and 4.2-2 in TS 36.211.</p> <p>Note 2: OCNG shall be used such that all cells are fully allocated and a constant total transmitted power spectral density is achieved for all OFDM symbols.</p> <p>Note 3: Interference from other cells and noise sources not specified in the test is assumed to be constant over subcarriers and time and shall be modelled as AWGN of appropriate power for N_{oc} to be fulfilled.</p> <p>Note 4: E_s/I_{ot}, RSRQ, RSRP and I_o levels have been derived from other parameters for information purposes. They are not settable parameters themselves.</p> | | | | | |

| | |
|---------|---|
| Note 5: | RSRP and RSRQ minimum requirements are specified assuming independent interference and noise at each receiver antenna port. |
| Note 6: | The selection of the bands for testing depends on the configuration of the carrier aggregation supported by the UEs. |
| Note 7: | Time alignment error (TAE) as specified in TS 36.104 [30] clause 6.5.3.1. The TAE value depends upon the type of carrier aggregation. |
| Note 8: | E-UTRA operating band groups are as defined in Section 3.5. |

A.9.2.41.3 Test Requirements

In the test, the RSRQ measurement accuracy in carrier aggregation shall fulfil the requirements in section 9.1.11.1, 9.1.11.2, and 9.1.11.3.

- The absolute accuracy of intra-frequency RSRQ measurements of Cell 1 on the primary component carrier shall fulfil the requirements defined in clause 9.1.11.1.
- The absolute accuracy of intra-frequency RSRQ measurements of Cell 2 on SCC1 shall fulfil the requirements defined in clause 9.1.11.2.
- The absolute accuracy of intra-frequency RSRQ measurements of Cell 3 on SCC2 shall fulfil the requirements defined in clause 9.1.11.2.
- The relative accuracy of inter-frequency RSRQ measurements between the primary component carrier and SCC1 for Cell 2 relative to Cell 1 shall fulfil the requirements defined in clause 9.1.11.3.
- The relative accuracy of inter-frequency RSRQ measurements between the primary component carrier and SCC2 for Cell 3 relative to Cell 1 shall fulfil the requirements defined in clause 9.1.11.3.

A.9.2.42 FD-FDD RSRQ Intra frequency case for UE category 0

A.9.2.42.1 Test Purpose and Environment

The purpose of this test is to verify that the RSRQ measurement accuracy is within the specified limits. This test will verify the requirements in Clause 9.1.13.3 for FD-FDD intra frequency RSRQ measurements for UE category 0.

A.9.2.42.2 Test parameters

In this test case all cells are on the same carrier frequency. The absolute accuracy of RSRQ intra frequency measurement is tested by using the parameters in Table A.9.2.42.2-1. In all test cases, Cell 1 is the PCell and Cell 2 the target cell.

Table A.9.2.42.2-1: FD-FDD RSRQ Intra frequency test parameters for UE category 0

| Parameter | Unit | Test 1 | | Test 2 | | Test 3 | |
|--|-----------|----------|----------|----------|----------|----------|----------|
| | | Cell 1 | Cell 2 | Cell 1 | Cell 2 | Cell 1 | Cell 2 |
| E-UTRA RF Channel Number | | 1 | | 1 | | 1 | |
| $BW_{channel}$ | MHz | 10 | | 10 | | 10 | |
| Measurement bandwidth | n_{PRB} | 22–27 | | 22–27 | | 22–27 | |
| PDSCH Reference measurement channel defined in A.3.1.1.3 | | R.13 FDD | - | R.13 FDD | - | R.13 FDD | - |
| PDSCH allocation | n_{PRB} | 13–36 | - | 13–36 | - | 13–36 | - |
| PDCCH/PCFICH/PHICH Reference measurement channel defined in A.3.1.2.1 | | R.6 FDD | | R.6 FDD | | R.6 FDD | |
| OCNG Patterns defined in A.3.2.1.1 (OP.1 FDD) and A.3.2.1.2 (OP.2 FDD) | | OP.1 FDD | OP.2 FDD | OP.1 FDD | OP.2 FDD | OP.1 FDD | OP.2 FDD |
| PBCH_RA | dB | 0 | 0 | 0 | 0 | 0 | 0 |
| PBCH_RB | | | | | | | |
| PSS_RA | | | | | | | |
| SSS_RA | | | | | | | |

| | | | | | | | | |
|--|--|------------|--------|---------|---------|---------|-------|--------|
| PCFICH_RB | | | | | | | | |
| PHICH_RA | | | | | | | | |
| PHICH_RB | | | | | | | | |
| PDCCH_RA | | | | | | | | |
| PDCCH_RB | | | | | | | | |
| PDSCH_RA | | | | | | | | |
| PDSCH_RB | | | | | | | | |
| OCNG_RA ^{Note1} | | | | | | | | |
| OCNG_RB ^{Note1} | | | | | | | | |
| N_{oc} ^{Note2} | Bands FDD-0_A <small>Note 7</small> | dBm/15 kHz | -84.76 | -103.85 | | | | -116 |
| | Bands FDD-0_B | | | | | | | -115.5 |
| | Bands FDD-0_C | | | | | | | -115 |
| | Bands FDD-0_D | | | | | | | -114.5 |
| | Bands FDD-0_E, FDD-0_F ^{Note 5} | | | | | | | -114 |
| | Bands FDD-0_G <small>Note 7</small> | | | | | | | -113 |
| Bands FDD-0_H | -112.5 | | | | | | | |
| \hat{E}_s / N_{oc} | | dB | 3 | 3 | -2.9 | -2.9 | -4 | -4 |
| \hat{E}_s / I_{ot} ^{Note3} | | dB | -1.76 | -1.76 | -4.7 | -4.7 | -5.46 | -5.46 |
| RSRP ^{Note3} | Bands FDD-0_A <small>Note 7</small> | dBm/15 kHz | -81.76 | -81.76 | -106.75 | -106.75 | | -120 |
| | Bands FDD-0_B | | | | | | | -119.5 |
| | Bands FDD-0_C | | | | | | | -119 |
| | Bands FDD-0_D | | | | | | | -118.5 |
| | Bands FDD-0_E, FDD-0_F ^{Note 4} | | | | | | | -118 |
| | Bands FDD-0_G <small>Note 6</small> | | | | | | | -117 |
| Bands FDD-0_H | -116.5 | | | | | | | |
| RSRQ ^{Note3} | Bands FDD-0_A <small>Note 7</small> | dB | -14.77 | -14.77 | -16.76 | -16.76 | | -17.34 |
| | Bands FDD-0_B | | | | | | | -17.34 |
| | Bands FDD-0_C | | | | | | | -17.34 |
| | Bands FDD-0_D | | | | | | | -17.34 |
| | Bands FDD-0_E, FDD-0_F ^{Note 45} | | | | | | | -17.34 |
| | Bands FDD-0_G <small>Note 6</small> | | | | | | | -17.34 |
| Bands FDD-0_H | -17.34 | | | | | | | |
| I_o ^{Note3} | Bands FDD-0_A <small>Note 7</small> | dBm/9 MHz | -50 | -73 | | | | -85.67 |
| | Bands FDD-0_B | | | | | | | -85.17 |
| | Bands FDD-0_C | | | | | | | -84.67 |
| | Bands FDD-0_D | | | | | | | -84.17 |
| | Bands FDD-0_E, FDD-0_F ^{Note 4} | | | | | | | -83.67 |
| | Bands FDD-0_G <small>Note 6</small> | | | | | | | -82.67 |
| Bands FDD-0_H | -82.17 | | | | | | | |
| Propagation condition | | - | AWGN | | AWGN | | AWGN | |
| Correlation Matrix and Antenna Configuration | | | 1x1 | | 1x1 | | 1x1 | |
| <p>Note 1: OCNG shall be used such that both cells are fully allocated and a constant total transmitted power spectral density is achieved for all OFDM symbols.</p> <p>Note 2: Interference from other cells and noise sources not specified in the test is assumed to be constant over subcarriers and time and shall be modelled as AWGN of appropriate power for N_{oc} to be fulfilled.</p> <p>Note 3: E_s/I_{ot}, RSRQ, RSRP and I_o levels have been derived from other parameters for information purposes. They are not settable parameters themselves.</p> <p>Note 4: For Band 26, the tests shall be performed with the carrier frequency of the assigned E-UTRA channel bandwidth within 865-894 MHz.</p> <p>Note 5: E-UTRA operating band groups are as defined in Section 3.5.</p> <p>Note 6: Except Band 29.</p> | | | | | | | | |

Note 7: Except Band 32.

A.9.2.42.3 Test Requirements

The RSRQ measurement accuracy shall fulfil the requirements in Clause 9.1.13.3.

A.9.2.43 HD-FDD RSRQ Intra frequency case for UE category 0

A.9.2.43.1 Test Purpose and Environment

The purpose of this test is to verify that the RSRQ measurement accuracy is within the specified limits. This test will verify the requirements in Clause 9.1.13.3 for HD-FDD intra frequency RSRQ measurements for UE category 0.

A.9.2.43.2 Test parameters

In this test case all cells are on the same carrier frequency. The absolute accuracy of RSRQ intra frequency measurement is tested by using the parameters in Table A.9.2.43.2-1. In all test cases, Cell 1 is the PCell and Cell 2 the target cell.

Table A.9.2.43.2-1: HD-FDD RSRQ Intra frequency test parameters for UE category 0

| Parameter | Unit | Test 1 | | Test 2 | | Test 3 | | | | | | | | |
|--|--|------------|----------|------------|----------|------------|----------|---------------------------------|--------|---------|--|--|--------|--|
| | | Cell 1 | Cell 2 | Cell 1 | Cell 2 | Cell 1 | Cell 2 | | | | | | | |
| E-UTRA RF Channel Number | | 1 | | 1 | | 1 | | | | | | | | |
| BW _{channel} | MHz | 10 | | 10 | | 10 | | | | | | | | |
| Measurement bandwidth | n_{PRB} | 22—27 | | 22—27 | | 22—27 | | | | | | | | |
| PDSCH Reference measurement channel defined in A.3.1.1.4 | | R.1 HD-FDD | - | R.1 HD-FDD | - | R.1 HD-FDD | - | | | | | | | |
| PDSCH allocation | n_{PRB} | 13—36 | - | 13—36 | - | 13—36 | - | | | | | | | |
| PDCCH/PCFICH/PHICH Reference measurement channel defined in A.3.1.2.3 | | R.3 HD-FDD | | R.3 HD-FDD | | R.3 HD-FDD | | | | | | | | |
| OCNG Patterns defined in A.3.2.1.1 (OP.1 FDD) and A.3.2.1.2 (OP.2 FDD) | | OP.1 FDD | OP.2 FDD | OP.1 FDD | OP.2 FDD | OP.1 FDD | OP.2 FDD | | | | | | | |
| PBCH_RA | dB | 0 | 0 | 0 | 0 | 0 | 0 | | | | | | | |
| PBCH_RB | | | | | | | | | | | | | | |
| PSS_RA | | | | | | | | | | | | | | |
| SSS_RA | | | | | | | | | | | | | | |
| PCFICH_RB | | | | | | | | | | | | | | |
| PHICH_RA | | | | | | | | | | | | | | |
| PHICH_RB | | | | | | | | | | | | | | |
| PDCCH_RA | | | | | | | | | | | | | | |
| PDCCH_RB | | | | | | | | | | | | | | |
| PDSCH_RA | | | | | | | | | | | | | | |
| PDSCH_RB | | | | | | | | | | | | | | |
| OCNG_RA ^{Note1} | | | | | | | | | | | | | | |
| OCNG_RB ^{Note1} | | | | | | | | | | | | | | |
| N_{oc} ^{Note2} | | | | | | | | Bands FDD-0_A ^{Note 7} | -84.76 | -103.85 | | | -116 | |
| | | | | | | | | Bands FDD-0_B | | | | | -115.5 | |
| | Bands FDD-0_C | | | -115 | | | | | | | | | | |
| | Bands FDD-0_D | | | -114.5 | | | | | | | | | | |
| | Bands FDD-0_E, FDD-0_F ^{Note 4} | | | -114 | | | | | | | | | | |
| | Bands FDD-0_G ^{Note 7} | | | -113 | | | | | | | | | | |
| | Bands FDD-0_H | | | -112.5 | | | | | | | | | | |
| \hat{E}_s/N_{oc} | dB | 3 | 3 | -2.9 | -2.9 | -4 | -4 | | | | | | | |

| | | | | | | | | |
|---|--|------------|--------|--------|---------|---------|--------|--------|
| \hat{E}_s/I_{ot} ^{Note3} | | dB | -1.76 | -1.76 | -4.7 | -4.7 | -5.46 | -5.46 |
| RSRP ^{Note3} | Bands FDD-0_A ^{Note 7} | dBm/15 kHz | -81.76 | -81.76 | -106.75 | -106.75 | -120 | -120 |
| | Bands FDD-0_B | | | | | | -119.5 | -119.5 |
| | Bands FDD-0_C | | | | | | -119 | -119 |
| | Bands FDD-0_D | | | | | | -118.5 | -118.5 |
| | Bands FDD-0_E, FDD-0_F ^{Note 4} | | | | | | -118 | -118 |
| | Bands FDD-0_G ^{Note 6} | | | | | | -117 | -117 |
| | Bands FDD-0_H | | | | | | -116.5 | -116.5 |
| RSRQ ^{Note3} | Bands FDD-0_A ^{Note 7} | dB | -14.77 | -14.77 | -16.76 | -16.76 | -17.34 | -17.34 |
| | Bands FDD-0_B | | | | | | | |
| | Bands FDD-0_C | | | | | | | |
| | Bands FDD-0_D | | | | | | | |
| | Bands FDD-0_E, FDD-0_F ^{Note 4} | | | | | | | |
| | Bands FDD-0_G ^{Note 6} | | | | | | | |
| | Bands FDD-0_H | | | | | | | |
| I _o ^{Note3} | Bands FDD-0_A ^{Note 7} | dBm/9 MHz | -50 | | | -73 | -85.67 | |
| | Bands FDD-0_B | | | | | | -85.17 | |
| | Bands FDD-0_C | | | | | | -84.67 | |
| | Bands FDD-0_D | | | | | | -84.17 | |
| | Bands FDD-0_E, FDD-0_F ^{Note 4} | | | | | | -83.67 | |
| | Bands FDD-0_G ^{Note 6} | | | | | | -82.67 | |
| | Bands FDD-0_H | | | | | | -82.17 | |
| Propagation condition | | - | AWGN | | AWGN | | AWGN | |
| Correlation Matrix and Antenna Configuration | | | 1x1 | | 1x1 | | 1x1 | |
| <p>Note 1: OCNG shall be used such that both cells are fully allocated and a constant total transmitted power spectral density is achieved for all OFDM symbols.</p> <p>Note 2: Interference from other cells and noise sources not specified in the test is assumed to be constant over subcarriers and time and shall be modelled as AWGN of appropriate power for N_{oc} to be fulfilled.</p> <p>Note 3: E_s/I_{ot}, RSRQ, RSRP and I_o levels have been derived from other parameters for information purposes. They are not settable parameters themselves.</p> <p>Note 4: For Band 26, the tests shall be performed with the carrier frequency of the assigned E-UTRA channel bandwidth within 865-894 MHz.</p> <p>Note 5: E-UTRA operating band groups are as defined in Section 3.5.</p> <p>Note 6: Except Band 29.</p> <p>Note 7: Except Band 32.</p> | | | | | | | | |

A.9.2.43.3 Test Requirements

The RSRQ measurement accuracy shall fulfil the requirements in Clause 9.1.13.3.

A.9.2.44 TDD RSRQ Intra frequency case for UE category 0

A.9.2.44.1 Test Purpose and Environment

The purpose of this test is to verify that the RSRQ measurement accuracy is within the specified limits. This test will verify the requirements in Clause 9.1.13.3 for TDD intra frequency RSRQ measurements for UE category 0.

A.9.2.44.2 Test parameters

In this test case all cells are on the same carrier frequency. The absolute accuracy of RSRQ intra frequency measurement is tested by using the parameters in Table A.9.2.44.2-1. In all test cases, Cell 1 is the PCell and Cell 2 the target cell.

Table A.9.2.44.2-1: TDD RSRQ Intra frequency test parameters for UE category 0

| Parameter | Unit | Test 1 | | Test 2 | | Test 3 | |
|---|---------------------------------|----------|----------|----------|----------|----------|----------|
| | | Cell 1 | Cell 2 | Cell 1 | Cell 2 | Cell 1 | Cell 2 |
| E-UTRA RF Channel Number | | 1 | | 1 | | 1 | |
| $BW_{channel}$ | MHz | 10 | | 10 | | 10 | |
| Special subframe configuration ^{Note1} | | 6 | | 6 | | 6 | |
| Uplink-downlink configuration ^{Note1} | | 1 | | 1 | | 1 | |
| Measurement bandwidth | n_{PRB} | 22—27 | | 22—27 | | 22—27 | |
| PDSCH Reference measurement channel defined in A.3.1.1.5 | | R.12 TDD | - | R.12 TDD | - | R.12 TDD | - |
| PDSCH allocation | n_{PRB} | 13—36 | - | 13—36 | - | 13—36 | - |
| PDCCH/PCFICH/PHICH Reference measurement channel defined in A.3.1.2.2 | | R.6 TDD | | R.6 TDD | | R.6 TDD | |
| OCNG Patterns defined in A.3.2.2.1 (OP.1 TDD) and A.3.2.2.2 (OP.2 TDD) | | OP.1 TDD | OP.2 TDD | OP.1 TDD | OP.2 TDD | OP.1 TDD | OP.2 TDD |
| PBCH_RA | dB | 0 | 0 | 0 | 0 | 0 | 0 |
| PBCH_RB | | | | | | | |
| PSS_RA | | | | | | | |
| SSS_RA | | | | | | | |
| PCFICH_RB | | | | | | | |
| PHICH_RA | | | | | | | |
| PHICH_RB | | | | | | | |
| PDCCH_RA | | | | | | | |
| PDCCH_RB | | | | | | | |
| PDSCH_RA | | | | | | | |
| PDSCH_RB | | | | | | | |
| OCNG_RA ^{Note2} | | | | | | | |
| OCNG_RB ^{Note2} | | | | | | | |
| N_{oc} ^{Note3} | | | | | | | |
| | Bands TDD-0_C | -115 | | | | | |
| | Bands TDD-0_E | -114 | | | | | |
| \hat{E}_s / N_{oc} | dB | 3 | 3 | -2.9 | -2.9 | -4 | -4 |
| \hat{E}_s / I_{ot} | dB | -1.76 | -1.76 | -4.7 | -4.7 | -5.46 | -5.46 |
| RSRP ^{Note4} | Bands TDD-0_A | -81.76 | | -106.75 | | -120 | |
| | Bands TDD-0_C | | | | | -119 | |
| | Bands TDD-0_E | | | | | -118 | |
| RSRQ ^{Note4} | Bands TDD-0_A, TDD-0_C, TDD-0_E | -14.77 | -14.77 | -16.76 | -16.76 | -17.34 | -17.34 |
| I_o ^{Note4} | Bands TDD-0_A | -50 | | -73 | | -85.67 | |
| | Bands TDD-0_C | | | | | -84.67 | |
| | Bands TDD-0_E | | | | | -83.67 | |
| Propagation condition | - | AWGN | | AWGN | | AWGN | |
| Correlation Matrix and Antenna Configuration | | 1x1 | | 1x1 | | 1x1 | |
| <p>Note 1: For special subframe and uplink-downlink configurations see Tables 4.2-1 and 4.2-2 in TS 36.211.</p> <p>Note 2: OCNG shall be used such that both cells are fully allocated and a constant total transmitted power spectral density is achieved for all OFDM symbols.</p> <p>Note 3: Interference from other cells and noise sources not specified in the test is assumed to be constant over subcarriers and time and shall be modelled as AWGN of appropriate power for N_{oc} to be fulfilled.</p> | | | | | | | |

| | |
|---------|--|
| Note 4: | RSRQ, RSRP and I_0 levels have been derived from other parameters for information purposes. They are not settable parameters themselves. |
| Note 5: | RSRP and RSRQ minimum requirements are specified assuming independent interference and noise at each receiver antenna port. |
| Note 6: | E-UTRA operating band groups are as defined in Section 3.5. |

A.9.2.44.3 Test Requirements

The RSRQ measurement accuracy shall fulfil the requirements in Clause 9.1.13.3.

A.9.2.45 4 DL CA PCell in FDD FDD-TDD RSRQ for E-UTRAN in Carrier Aggregation

The test case in this clause is applicable to carrier aggregation capable UEs which have been configured with three downlink SCells.

A.9.2.45.1 Test Purpose and Environment

The purpose of this test is to verify that the RSRQ measurement accuracy in carrier aggregation is within the specified limits under AWGN propagation conditions. This test will verify the absolute accuracy of intra-frequency RSRQ measurements for the primary component carrier specified in clause 9.1.11.1, the absolute accuracy of intra-frequency RSRQ measurements for the secondary component carriers specified in clause 9.1.11.2 and also the relative inter-frequency RSRQ accuracy requirement between primary and secondary component carriers specified in clause 9.1.11.3.

A.9.2.45.2 Test parameters

In this set of test cases there are four cells on four carrier frequencies. Cell 1 is PCell on channel 1, Cell 2 is activated SCell on channel 2, Cell 3 is activated SCell on channel 3, and Cell 4 is activated SCell on channel 4. The parameters for the test are listed in Table A.9.2.45.2-1.

Table A.9.2.45.2-1: 4 DL PCell in FDD RSRQ for E-UTRAN in Carrier Aggregation test parameters (cell #1, cell #2, cell #3 and cell #4)

| Parameter | Unit | Cell 1 | Cell 2 | Cell 3 | Cell 4 |
|---|-----------|--|--|--|--|
| E-UTRA RF Channel Number | | 1 | 2 | 3 | 4 |
| BW_{channel} | | 5MHz: $N_{RB,c} = 25$ 10MHz: $N_{RB,c} = 50$ 20MHz: $N_{RB,c} = 100$ | 5MHz: $N_{RB,c} = 25$ 10MHz: $N_{RB,c} = 50$ 20MHz: $N_{RB,c} = 100$ | 5MHz: $N_{RB,c} = 25$ 10MHz: $N_{RB,c} = 50$ 20MHz: $N_{RB,c} = 100$ | 5MHz: $N_{RB,c} = 25$ 10MHz: $N_{RB,c} = 50$ 20MHz: $N_{RB,c} = 100$ |
| Special subframe configuration ^{Note1} | | - | 6 | 6 | 6 |
| Uplink/downlink configuration ^{Note1} | | - | 1 | 1 | 1 |
| Measurement bandwidth | n_{PRB} | 5MHz: 10-15 10MHz: 22-27 20MHz: 47-52 | 5MHz: 10-15 10MHz: 22-27 20MHz: 47-52 | 5MHz: 10-15 10MHz: 22-27 20MHz: 47-52 | 5MHz: 10-15 10MHz: 22-27 20MHz: 47-52 |
| PDSCH Reference measurement channel defined in A.3.1.1 | | 5MHz: R.5 FDD 10MHz: R.0 FDD 20MHz: R.4 FDD | 5MHz: R.4 TDD 10MHz: R.0 TDD 20MHz: R.3 TDD | 5MHz: R.4 TDD 10MHz: R.0 TDD 20MHz: R.3 TDD | 5MHz: R.4 TDD 10MHz: R.0 TDD 20MHz: R.3 TDD |
| PDSCH allocation | n_{PRB} | 5MHz: 7-17 10MHz: 13-36 20MHz: 38-61 | 5MHz: 7-17 10MHz: 13-36 20MHz: 38-61 | 5MHz: 7-17 10MHz: 13-36 20MHz: 38-61 | 5MHz: 7-17 10MHz: 13-36 20MHz: 38-61 |
| PDCCH/PCFICH/PHICH Reference measurement channel defined in A.3.1.2 | | 5MHz: R.11 FDD 10MHz: R.6 FDD 20MHz: R.10 FDD | 5MHz: R.11 TDD 10MHz: R.6 TDD 20MHz: R.10 TDD | 5MHz: R.11 TDD 10MHz: R.6 TDD 20MHz: R.10 TDD | 5MHz: R.11 TDD 10MHz: R.6 TDD 20MHz: R.10 TDD |
| OCNG Patterns defined in A.3.2 | | 5MHz: OP.15 FDD 10MHz: OP.1 | 5MHz: OP.9 TDD 10MHz: OP.1 TDD | 5MHz: OP.9 TDD 10MHz: OP.1 TDD | 5MHz: OP.9 TDD 10MHz: OP.1 TDD |

| | | | FDD 20MHz: OP.11 FDD | 20MHz: OP.7 TDD | 20MHz: OP.7 TDD | 20MHz: OP.7 TDD |
|---------------------------|---|---------------|----------------------------|--------------------|--------------------|--------------------|
| PBCH_RA | | dB | 0 | 0 | 0 | 0 |
| PBCH_RB | | | | | | |
| PSS_RA | | | | | | |
| SSS_RA | | | | | | |
| PCFICH_RB | | | | | | |
| PHICH_RA | | | | | | |
| PHICH_RB | | | | | | |
| PDCCH_RA | | | | | | |
| PDCCH_RB | | | | | | |
| PDSCH_RA | | | | | | |
| PDSCH_RB | | | | | | |
| OCNG_RA ^{Note2} | | | | | | |
| OCNG_RB ^{Note2} | | | | | | |
| N_{oc} ^{Note3} | Bands TDD_A | | | | | |
| | Bands TDD_C | - | -115 | -115 | -115 | |
| | Bands TDD_E | - | -114 | -114 | -114 | |
| | Bands FDD_A | -119.5 | - | - | - | |
| | Bands FDD_B | -119 | - | - | - | |
| | Bands FDD_C | -118.5 | - | - | - | |
| | Bands FDD_D | -118 | - | - | - | |
| | Bands FDD_E, Bands FDD_F ^{Note 6} | -117.5 | - | - | - | |
| | Bands FDD_G | -116.5 | - | - | - | |
| | Bands FDD_H | -116 | - | - | - | |
| \hat{E}_s / N_{oc} | | dB | -6.0 | -6.0 | -6.0 | -6.0 |
| \hat{E}_s / I_{ot} | | dB | -6.0 | -6.0 | -6.0 | -6.0 |
| RSRP ^{Note4} | Bands TDD_A | dBm/ 15kHz | - | -122 | -122 | -122 |
| | Bands TDD_C | | - | -121 | -121 | -121 |
| | Bands TDD_E | | - | -120 | -120 | -120 |
| | Bands FDD_A | | -125.5 | - | - | - |
| | Bands FDD_B | | -125 | - | - | - |
| | Bands FDD_C | | -124.5 | - | - | - |
| | Bands FDD_D | | -124 | - | - | - |
| | Bands FDD_E, Bands FDD_F ^{Note 6} | | -123.5 | - | - | - |
| | Bands FDD_G | | -122.5 | - | - | - |
| | Bands FDD_H | | -122 | - | - | - |
| RSRQ ^{Note4} | Bands TDD_A | dB | - | -17.77 | -17.77 | -17.77 |
| | Bands | | | | | |

| | | | | | | |
|--|--|--|--|--|--|-------|
| | TDD_C | | -17.77 | - | - | - |
| | Bands TDD_E | | | | | |
| | Bands FDD_A | | | | | |
| | Bands FDD_B | | | | | |
| | Bands FDD_C | | | | | |
| | Bands FDD_D | | | | | |
| | Bands FDD_E, Bands FDD_F ^{Note 6} | | | | | |
| | Bands FDD_G | | | | | |
| | Bands FDD_H | | | | | |
| | I _o ^{Note 4} | | | | | |
| Bands TDD_C | | - | -86.25 + 10log(N _{RB,c} /50) | -86.25 + 10log(N _{RB,c} /50) | -86.25 + 10log(N _{RB,c} /50) | |
| Bands TDD_E | | - | -85.25 + 10log(N _{RB,c} /50) | -85.25 + 10log(N _{RB,c} /50) | -85.25 + 10log(N _{RB,c} /50) | |
| Bands FDD_A | | -90.75 + 10log(N _{RB,c} /50) | - | - | - | |
| Bands FDD_B | | -90.25 + 10log(N _{RB,c} /50) | - | - | - | |
| Bands FDD_C | | -89.75 + 10log(N _{RB,c} /50) | - | - | - | |
| Bands FDD_D | | -89.25 + 10log(N _{RB,c} /50) | - | - | - | |
| Bands FDD_E, Bands FDD_F ^{Note 6} | | -88.75 + 10log(N _{RB,c} /50) | - | - | - | |
| Bands FDD_G | | -87.75 + 10log(N _{RB,c} /50) | - | - | - | |
| Bands FDD_H | | -87.25 + 10log(N _{RB,c} /50) | - | - | - | |
| Propagation Condition | | | AWGN | AWGN | AWGN | AWGN |
| Antenna Configuration | | | 1x2 | 1x2 | 1x2 | 1x2 |
| Timing offset to Cell 1 | | μs | - | 0 | 0 | 0 |
| Time alignment error relative to cell 1 ^{Note 10} | | | - | ≤ TAE | ≤ TAE | ≤ TAE |
| Time alignment error relative to cell 2 ^{Note 10} | | | - | - | ≤ TAE | ≤ TAE |
| Time alignment error relative to cell 3 ^{Note 10} | | | - | - | - | ≤ TAE |
| <p>Note 1: For special subframe and uplink-downlink configurations see Tables 4.2-1 and 4.2-2 in TS 36.211.</p> <p>Note 2: OCNB shall be used such that both cells are fully allocated and a constant total transmitted power spectral density is achieved for all OFDM symbols.</p> <p>Note 3: Interference from other cells and noise sources not specified in the test is assumed to be constant over subcarriers and time and shall be modelled as AWGN of appropriate power for N_{oc} to be fulfilled.</p> <p>Note 4: RSRP, RSRQ and I_o levels have been derived from other parameters for information purposes. They are not settable parameters themselves.</p> <p>Note 5: RSRP and RSRQ minimum requirements are specified assuming independent interference and noise at each receiver antenna port.</p> <p>Note 6: For Band 26, the tests shall be performed with the carrier frequency of the assigned E-UTRA channel bandwidth within 865-894 MHz.</p> <p>Note 7: The selection of the bands for testing depends on the configuration of the carrier aggregation supported by the UEs.</p> <p>Note 8: Void</p> <p>Note 9: E-UTRA operating band groups are as defined in Section 3.5.</p> <p>Note 10: Time alignment error (TAE) as specified in TS 36.104 [30] clause 6.5.3.1. The TAE value depends upon the type of carrier aggregation.</p> | | | | | | |

A.9.2.45.3 Test Requirements

In the test, the RSRQ measurement accuracy in carrier aggregation shall fulfil the requirements in clause 9.1.11.1, 9.1.11.2, and 9.1.11.3.

- The absolute accuracy of intra-frequency RSRQ measurements of Cell 1 on the primary component carrier shall fulfil the requirements specified in clause 9.1.11.1.
- The absolute accuracy of intra-frequency RSRQ measurements of Cell 2 on the secondary component carrier shall fulfil the requirements specified in clause 9.1.11.2
- The absolute accuracy of intra-frequency RSRQ measurements of Cell 3 on the secondary component carrier shall fulfil the requirements specified in clause 9.1.11.2
- The absolute accuracy of intra-frequency RSRQ measurements of Cell 4 on the secondary component carrier shall fulfil the requirements specified in clause 9.1.11.2
- The relative accuracy of inter-frequency RSRQ measurements between the primary and secondary component carriers for Cell 2 relative to Cell 1 shall fulfil the requirements specified in clause 9.1.11.3.
- The relative accuracy of inter-frequency RSRQ measurements between the primary and secondary component carriers for Cell 3 relative to Cell 1 shall fulfil the requirements specified in clause 9.1.11.3.
- The relative accuracy of inter-frequency RSRQ measurements between the primary and secondary component carriers for Cell 4 relative to Cell 1 shall fulfil the requirements specified in clause 9.1.11.3.

A.9.2.46 4 DL CA PCell in TDD TDD-FDD RSRQ for E-UTRAN in Carrier Aggregation

The test case in this clause is applicable to carrier aggregation capable UEs which have been configured with three downlink SCells.

A.9.2.46.1 Test Purpose and Environment

The purpose of this test is to verify that the RSRQ measurement accuracy in carrier aggregation is within the specified limits under AWGN propagation conditions. This test will verify the absolute accuracy of intra-frequency RSRQ measurements for the primary component carrier specified in clause 9.1.11.1, the absolute accuracy of intra-frequency RSRQ measurements for the secondary component carriers specified in clause 9.1.11.2 and also the relative inter-frequency RSRQ accuracy requirement between primary and secondary component carriers specified in clause 9.1.11.3.

A.9.2.46.2 Test parameters

In this set of test cases there are four cells on four carrier frequencies. Cell 1 is PCell on channel 1, Cell 2 is activated SCell on channel 2, Cell 3 is activated SCell on channel 3, and Cell 4 is activated SCell on channel 4. The parameters for the test are listed in Table A.9.2.45.2-1.

Table A.9.2.46.2-1: 4 DL PCell in TDD RSRQ for E-UTRAN in Carrier Aggregation test parameters (cell #1, cell #2, cell #3 and cell #4)

| Parameter | Unit | Cell 1 | Cell 2 | Cell 3 | Cell 4 |
|---|------|--|--|--|--|
| E-UTRA RF Channel Number | | 1 | 2 | 3 | 4 |
| BW_{channel} | | 5MHz: $N_{RB,c} = 25$ 10MHz: $N_{RB,c} = 50$ 20MHz: $N_{RB,c} = 100$ | 5MHz: $N_{RB,c} = 25$ 10MHz: $N_{RB,c} = 50$ 20MHz: $N_{RB,c} = 100$ | 5MHz: $N_{RB,c} = 25$ 10MHz: $N_{RB,c} = 50$ 20MHz: $N_{RB,c} = 100$ | 5MHz: $N_{RB,c} = 25$ 10MHz: $N_{RB,c} = 50$ 20MHz: $N_{RB,c} = 100$ |
| Special subframe configuration ^{Note1} | | 6 | - | - | - |

| | | | | | | |
|---|---|---------------|--|--|--|--|
| Uplink/downlink configuration ^{Note1} | | | 1 | - | - | - |
| Measurement bandwidth | | n_{PRB} | 5MHz: 10-15 10MHz: 22-27 20MHz: 47-52 | 5MHz: 10-15 10MHz: 22-27 20MHz: 47-52 | 5MHz: 10-15 10MHz: 22-27 20MHz: 47-52 | 5MHz: 10-15 10MHz: 22-27 20MHz: 47-52 |
| PDSCH Reference measurement channel defined in A.3.1.1 | | | 5MHz: R.4 TDD 10MHz: R.0 TDD 20MHz: R.3 TDD | 5MHz: R.5 FDD 10MHz: R.0 FDD 20MHz: R.4 FDD | 5MHz: R.5 FDD 10MHz: R.0 FDD 20MHz: R.4 | 5MHz: R.5 FDD 10MHz: R.0 FDD 20MHz: R.4 |
| PDSCH allocation | | n_{PRB} | 5MHz: 7-17 10MHz: 13-36 20MHz: 38-61 | 5MHz: 7-17 10MHz: 13-36 20MHz: 38-61 | 5MHz: 7-17 10MHz: 13-36 20MHz: 38-61 | 5MHz: 7-17 10MHz: 13-36 20MHz: 38-61 |
| PDCCH/PCFICH/PHICH Reference measurement channel defined in A.3.1.2 | | | 5MHz: R.11 TDD 10MHz: R.6 TDD 20MHz: R.10 TDD | 5MHz: R.11 FDD 10MHz: R.6 FDD 20MHz: R.10 FDD | 5MHz: R.11 FDD 10MHz: R.6 FDD 20MHz: R.10 | 5MHz: R.11 FDD 10MHz: R.6 FDD 20MHz: R.10 |
| OCNG Patterns defined in A.3.2 | | | 5MHz: OP.9 TDD 10MHz: OP.1 TDD 20MHz: OP.7 TDD | 5MHz: OP.15 FDD 10MHz: OP.1 FDD 20MHz: OP.11 FDD | 5MHz: OP.15 FDD 10MHz: OP.1 FDD 20MHz: OP.11 | 5MHz: OP.15 FDD 10MHz: OP.1 FDD 20MHz: OP.11 |
| PBCH_RA | | dB | 0 | 0 | 0 | 0 |
| PBCH_RB | | | | | | |
| PSS_RA | | | | | | |
| SSS_RA | | | | | | |
| PCFICH_RB | | | | | | |
| PHICH_RA | | | | | | |
| PHICH_RB | | | | | | |
| PDCCH_RA | | | | | | |
| PDCCH_RB | | | | | | |
| PDSCH_RA | | | | | | |
| PDSCH_RB | | | | | | |
| OCNG_RA ^{Note2} | | | | | | |
| OCNG_RB ^{Note2} | | | | | | |
| N_{oc} ^{Note3} | Bands TDD_A | | | | | |
| | Bands TDD_C | -118.5 | - | - | - | |
| | Bands TDD_E | -117.5 | - | - | - | |
| | Bands FDD_A | - | -116 | -116 | -116 | |
| | Bands FDD_B | - | -115.5 | -115.5 | -115.5 | |
| | Bands FDD_C | - | -115 | -115 | -115 | |
| | Bands FDD_D | - | -114.5 | -114.5 | -114.5 | |
| | Bands FDD_E, Bands FDD_F ^{Note 6} | - | -114 | -114 | -114 | |
| | Bands FDD_G | - | -113 | -113 | -113 | |
| | Bands FDD_H | - | -112.5 | -112.5 | -112.5 | |
| \hat{E}_s/N_{oc} | | dB | -6.0 | -6.0 | -6.0 | -6.0 |
| \hat{E}_s/I_{ot} | | dB | -6.0 | -6.0 | -6.0 | -6.0 |
| RSRP ^{Note4} | Bands TDD_A | dBm/ 15kHz | -125.5 | - | - | - |
| | Bands TDD_C | | -124.5 | - | - | - |
| | Bands TDD_E | | -123.5 | - | - | - |
| | Bands | | - | -122 | -122 | -122 |

| | | | | | | | | |
|--|---|--|-------------------------------|--|--|--|---|---|
| | FDD_A | | | | | | | |
| | Bands FDD_B | | - | -121.5 | -121.5 | -121.5 | | |
| | Bands FDD_C | | - | -121 | -121 | -121 | | |
| | Bands FDD_D | | - | -120.5 | -120.5 | -120.5 | | |
| | Bands FDD_E, Bands FDD_F <small>Note 6</small> | | - | -120 | -120 | -120 | | |
| | Bands FDD_G | | - | -119 | -119 | -119 | | |
| | Bands FDD_H | | - | -118.5 | -118.5 | -118.5 | | |
| | RSRQ <small>Note4</small> | | Bands TDD_A | dB | | | | |
| Bands TDD_C | | -17.77 | - | | - | - | | |
| Bands TDD_E | | | | | | | | |
| Bands FDD_A | | | | | | | | |
| Bands FDD_B | | | | | | | | |
| Bands FDD_C | | | | | | | | |
| Bands FDD_D | | - | -17.77 | | -17.77 | -17.77 | | |
| Bands FDD_E, Bands FDD_F <small>Note 6</small> | | | | | | | | |
| Bands FDD_G | | | | | | | | |
| Bands FDD_H | | | | | | | | |
| Io <small>Note4</small> | | Bands TDD_A | dBm/ BW _{channel} | | -90.75 + 10log(N _{RB,c} /50) | - | - | - |
| | | Bands TDD_C | | | -89.75 + 10log(N _{RB,c} /50) | - | - | - |
| | Bands TDD_E | -88.75 + 10log(N _{RB,c} /50) | | - | - | - | | |
| | Bands FDD_A | - | | -87.25 + 10log(N _{RB,c} /50) | -87.25 + 10log(N _{RB,c} /50) | -87.25 + 10log(N _{RB,c} /50) | | |
| | Bands FDD_B | - | | -86.75 + 10log(N _{RB,c} /50) | -86.75 + 10log(N _{RB,c} /50) | -86.75 + 10log(N _{RB,c} /50) | | |
| | Bands FDD_C | - | | -86.25 + 10log(N _{RB,c} /50) | -86.25 + 10log(N _{RB,c} /50) | -86.25 + 10log(N _{RB,c} /50) | | |
| | Bands FDD_D | - | | -85.75 + 10log(N _{RB,c} /50) | -85.75 + 10log(N _{RB,c} /50) | -85.75 + 10log(N _{RB,c} /50) | | |
| | Bands FDD_E, Bands FDD_F <small>Note 6</small> | - | | -85.25 + 10log(N _{RB,c} /50) | -85.25 + 10log(N _{RB,c} /50) | -85.25 + 10log(N _{RB,c} /50) | | |
| | Bands FDD_G | - | | -84.25 + 10log(N _{RB,c} /50) | -84.25 + 10log(N _{RB,c} /50) | -84.25 + 10log(N _{RB,c} /50) | | |
| | Bands FDD_H | - | | -83.75 + 10log(N _{RB,c} /50) | -83.75 + 10log(N _{RB,c} /50) | -83.75 + 10log(N _{RB,c} /50) | | |
| Propagation Condition | | AWGN | AWGN | AWGN | AWGN | | | |
| Antenna Configuration | | 1x2 | 1x2 | 1x2 | 1x2 | | | |
| Timing offset to Cell 1 | μs | - | 0 | 0 | 0 | | | |
| Time alignment error relative to cell 1 <small>Note 10</small> | | - | ≤ TAE | ≤ TAE | ≤ TAE | | | |
| Time alignment error relative to cell 2 <small>Note 10</small> | | - | - | ≤ TAE | ≤ TAE | | | |
| Time alignment error | | - | - | - | ≤ TAE | | | |

| | | | | |
|---------------------------------------|--|--|--|--|
| relative to cell 3 ^{Note 10} | | | | |
| Note 1: | For special subframe and uplink-downlink configurations see Tables 4.2-1 and 4.2-2 in TS 36.211. | | | |
| Note 2: | OCNG shall be used such that both cells are fully allocated and a constant total transmitted power spectral density is achieved for all OFDM symbols. | | | |
| Note 3: | Interference from other cells and noise sources not specified in the test is assumed to be constant over subcarriers and time and shall be modelled as AWGN of appropriate power for N_{oc} to be fulfilled. | | | |
| Note 4: | RSRP, RSRQ and I_0 levels have been derived from other parameters for information purposes. They are not settable parameters themselves. | | | |
| Note 5: | RSRP and RSRQ minimum requirements are specified assuming independent interference and noise at each receiver antenna port. | | | |
| Note 6: | For Band 26, the tests shall be performed with the carrier frequency of the assigned E-UTRA channel bandwidth within 865-894 MHz. | | | |
| Note 7: | The selection of the bands for testing depends on the configuration of the carrier aggregation supported by the UEs. | | | |
| Note 9: | Void | | | |
| Note 10: | Time alignment error (TAE) as specified in TS 36.104 [30] clause 6.5.3.1. The TAE value depends upon the type of carrier aggregation. | | | |

A.9.2.46.3 Test Requirements

In the test, the RSRQ measurement accuracy in carrier aggregation shall fulfil the requirements in clause 9.1.11.1, 9.1.11.2, and 9.1.11.3.

- The absolute accuracy of intra-frequency RSRQ measurements of Cell 1 on the primary component carrier shall fulfil the requirements specified in clause 9.1.11.1.
- The absolute accuracy of intra-frequency RSRQ measurements of Cell 2 on the secondary component carrier shall fulfil the requirements specified in clause 9.1.11.2
- The absolute accuracy of intra-frequency RSRQ measurements of Cell 3 on the secondary component carrier shall fulfil the requirements specified in clause 9.1.11.2
- The absolute accuracy of intra-frequency RSRQ measurements of Cell 4 on the secondary component carrier shall fulfil the requirements specified in clause 9.1.11.2
- The relative accuracy of inter-frequency RSRQ measurements between the primary and secondary component carriers for Cell 2 relative to Cell 1 shall fulfil the requirements specified in clause 9.1.11.3.
- The relative accuracy of inter-frequency RSRQ measurements between the primary and secondary component carriers for Cell 3 relative to Cell 1 shall fulfil the requirements specified in clause 9.1.11.3.
- The relative accuracy of inter-frequency RSRQ measurements between the primary and secondary component carriers for Cell 4 relative to Cell 1 shall fulfil the requirements specified in clause 9.1.11.3.

A.9.2.47 5 DL FDD-TDD with PCell in FDD RSRQ for E-UTRAN in Carrier Aggregation

The test case in this clause is applicable to carrier aggregation capable UEs which have been configured with four downlink SCells.

A.9.2.47.1 Test Purpose and Environment

The purpose of this test is to verify that the RSRQ measurement accuracy in carrier aggregation is within the specified limits under AWGN propagation conditions. This test will verify the absolute accuracy of intra-frequency RSRQ measurements for the primary component carrier specified in clause 9.1.11.1, the absolute accuracy of intra-frequency RSRQ measurements for the secondary component carriers specified in clause 9.1.11.2 and also the relative inter-frequency RSRQ accuracy requirement between primary and secondary component carriers specified in clause 9.1.11.3.

A.9.2.47.2 Test parameters

In this set of test cases there are five cells on five carrier frequencies. Cell 1 is PCell on channel 1, Cell 2 is activated SCell on channel 2, Cell 3 is activated SCell on channel 3, Cell 4 is activated SCell on channel 4, and Cell 5 is activated SCell on channel 5. The parameters for the test are listed in Table A.9.2.45.2-1.

Table A.9.2.47.2-1: 5 DL PCell in FDD RSRQ for E-UTRAN in Carrier Aggregation test parameters (cell #1, cell #2, cell #3, cell #4 and cell#5)

| Parameter | Unit | Cell 1 | Cells | | | |
|---|--|--|--|---|---|---|
| | | | 2 | 3 | 4 | 5 |
| E-UTRA RF Channel Number | | 1 | 2 | 3 | 4 | 5 |
| $BW_{channel}$ | | 5MHz: $N_{RB,c} = 25$ 10MHz: $N_{RB,c} = 50$ 20MHz: $N_{RB,c} = 100$ | 5MHz: $N_{RB,c} = 25$ 10MHz: $N_{RB,c} = 50$ 20MHz: $N_{RB,c} = 100$ | | | |
| Special subframe configuration ^{Note1} | | - | 6 | | | |
| Uplink/downlink configuration ^{Note1} | | - | 1 | | | |
| Measurement bandwidth | n_{PRB} | 5MHz: 10-15 10MHz: 22-27 20MHz: 47-52 | 5MHz: 10-15 10MHz: 22-27 20MHz: 47-52 | | | |
| PDSCH Reference measurement channel defined in A.3.1.1 | | 5MHz: R.5 FDD 10MHz: R.0 FDD 20MHz: R.4 FDD | 5MHz: R.4 TDD 10MHz: R.0 TDD 20MHz: R.3 TDD | | | |
| PDSCH allocation | n_{PRB} | 5MHz: 7-17 10MHz: 13-36 20MHz: 38-61 | 5MHz: 7-17 10MHz: 13-36 20MHz: 38-61 | | | |
| PDCCH/PCFICH/PHICH Reference measurement channel defined in A.3.1.2 | | 5MHz: R.11 FDD 10MHz: R.6 FDD 20MHz: R.10 FDD | 5MHz: R.11 TDD 10MHz: R.6 TDD 20MHz: R.10 TDD | | | |
| OCNG Patterns defined in A.3.2 | | 5MHz: OP.15 FDD 10MHz: OP.1 FDD 20MHz: OP.11 FDD | 5MHz: OP.9 TDD 10MHz: OP.1 TDD 20MHz: OP.7 TDD | | | |
| PBCH_RA | dB | 0 | 0 | | | |
| PBCH_RB | | | | | | |
| PSS_RA | | | | | | |
| SSS_RA | | | | | | |
| PCFICH_RB | | | | | | |
| PHICH_RA | | | | | | |
| PHICH_RB | | | | | | |
| PDCCH_RA | | | | | | |
| PDCCH_RB | | | | | | |
| PDSCH_RA | | | | | | |
| PDSCH_RB | | | | | | |
| OCNG_RA ^{Note2} | | | | | | |
| OCNG_RB ^{Note2} | | | | | | |
| N_{oc} ^{Note3} | | | | | | |
| | Bands TDD_C | - | -115 | | | |
| | Bands TDD_E | - | -114 | | | |
| | Bands FDD_A | -119.5 | - | | | |
| | Bands FDD_B | -119 | - | | | |
| | Bands FDD_C | -118.5 | - | | | |
| | Bands FDD_D | -118 | - | | | |
| | Bands FDD_E, Bands FDD_F ^{Note 6} | -117.5 | - | | | |
| | Bands FDD_G | -116.5 | - | | | |
| Bands FDD_H | -116 | - | | | | |
| \hat{E}_s / N_{oc} | dB | -6.0 | -6.0 | | | |
| \hat{E}_s / I_{ot} | dB | -6.0 | -6.0 | | | |
| RSRP ^{Note4} | Bands TDD_A | - | -122 | | | |
| | Bands TDD_C | - | -121 | | | |

| | | | | | | | |
|--|---------------------------------------|-------------------------------|--------------------------------|--------------------------------|-------|-------|-------|
| | Bands TDD_E | | - | -120 | | | |
| | Bands FDD_A | | -125.5 | - | | | |
| | Bands FDD_B | | -125 | - | | | |
| | Bands FDD_C | | -124.5 | - | | | |
| | Bands FDD_D | | -124 | - | | | |
| | Bands FDD_E, Bands FDD_F Note 6 | | -123.5 | - | | | |
| | Bands FDD_G | | -122.5 | - | | | |
| | Bands FDD_H | | -122 | - | | | |
| RSRQ ^{Note4} | Bands TDD_A | dB | - | -17.77 | | | |
| | Bands TDD_C | | - | - | | | |
| | Bands TDD_E | | - | - | | | |
| | Bands FDD_A | | -17.77 | - | | | |
| | Bands FDD_B | | - | - | | | |
| | Bands FDD_C | | - | - | | | |
| | Bands FDD_D | | - | - | | | |
| | Bands FDD_E, Bands FDD_F Note 6 | | - | - | | | |
| Io ^{Note4} | Bands FDD_G | -17.77 | - | | | | |
| | Bands FDD_H | - | - | | | | |
| | Bands TDD_A | dBm/ BW _{channel} | - | $-87.25 + 10\log(N_{RB,c}/50)$ | | | |
| | Bands TDD_C | | - | $-86.25 + 10\log(N_{RB,c}/50)$ | | | |
| | Bands TDD_E | | - | $-85.25 + 10\log(N_{RB,c}/50)$ | | | |
| | Bands FDD_A | | $-90.75 + 10\log(N_{RB,c}/50)$ | - | | | |
| | Bands FDD_B | | $-90.25 + 10\log(N_{RB,c}/50)$ | - | | | |
| | Bands FDD_C | | $-89.75 + 10\log(N_{RB,c}/50)$ | - | | | |
| | Bands FDD_D | | $-89.25 + 10\log(N_{RB,c}/50)$ | - | | | |
| | Bands FDD_E, Bands FDD_F Note 6 | | $-88.75 + 10\log(N_{RB,c}/50)$ | - | | | |
| Bands FDD_G | $-87.75 + 10\log(N_{RB,c}/50)$ | | - | | | | |
| Bands FDD_H | $-87.25 + 10\log(N_{RB,c}/50)$ | | - | | | | |
| Propagation Condition | | | AWGN | | AWGN | | |
| Antenna Configuration | | | 1x2 | | 1x2 | | |
| Timing offset to Cell 1 | | μs | - | | 0 | | |
| Time alignment error relative to cell 1 ^{Note 10} | | | - | ≤ TAE | ≤ TAE | ≤ TAE | ≤ TAE |
| Time alignment error relative to cell 2 ^{Note 10} | | | - | - | ≤ TAE | ≤ TAE | ≤ TAE |
| Time alignment error relative to cell 3 ^{Note 10} | | | - | - | - | ≤ TAE | ≤ TAE |
| Time alignment error relative to cell 4 ^{Note 10} | | | - | - | - | - | ≤ TAE |
| <p>Note 1: For special subframe and uplink-downlink configurations see Tables 4.2-1 and 4.2-2 in TS 36.211.</p> <p>Note 2: OCNB shall be used such that both cells are fully allocated and a constant total transmitted power spectral density is achieved for all OFDM symbols.</p> <p>Note 3: Interference from other cells and noise sources not specified in the test is assumed to be constant over subcarriers and time and shall be modelled as AWGN of appropriate power for N_{oc} to be fulfilled.</p> <p>Note 4: RSRP, RSRQ and Io levels have been derived from other parameters for information purposes. They are not settable parameters themselves.</p> <p>Note 5: RSRP and RSRQ minimum requirements are specified assuming independent interference and noise at each receiver antenna port.</p> <p>Note 6: For Band 26, the tests shall be performed with the carrier frequency of the assigned E-UTRA</p> | | | | | | | |

| | |
|----------|---|
| | channel bandwidth within 865-894 MHz. |
| Note 7: | The selection of the bands for testing depends on the configuration of the carrier aggregation supported by the UEs. |
| Note 8: | Void |
| Note 9: | E-UTRA operating band groups are as defined in Section 3.5. |
| Note 10: | Time alignment error (TAE) as specified in TS 36.104 [30] clause 6.5.3.1. The TAE value depends upon the type of carrier aggregation. |

A.9.2.47.3 Test Requirements

In the test, the RSRQ measurement accuracy in carrier aggregation shall fulfil the requirements in clause 9.1.11.1, 9.1.11.2, and 9.1.11.3.

- The absolute accuracy of intra-frequency RSRQ measurements of Cell 1 on the primary component carrier shall fulfil the requirements specified in clause 9.1.11.1.
- The absolute accuracy of intra-frequency RSRQ measurements of Cell 2 on the secondary component carrier shall fulfil the requirements specified in clause 9.1.11.2
- The absolute accuracy of intra-frequency RSRQ measurements of Cell 3 on the secondary component carrier shall fulfil the requirements specified in clause 9.1.11.2
- The absolute accuracy of intra-frequency RSRQ measurements of Cell 4 on the secondary component carrier shall fulfil the requirements specified in clause 9.1.11.2
- The absolute accuracy of intra-frequency RSRQ measurements of Cell 5 on the secondary component carrier shall fulfil the requirements specified in clause 9.1.11.2
- The relative accuracy of inter-frequency RSRQ measurements between the primary and secondary component carriers for Cell 2 relative to Cell 1 shall fulfil the requirements specified in clause 9.1.11.3.
- The relative accuracy of inter-frequency RSRQ measurements between the primary and secondary component carriers for Cell 3 relative to Cell 1 shall fulfil the requirements specified in clause 9.1.11.3.
- The relative accuracy of inter-frequency RSRQ measurements between the primary and secondary component carriers for Cell 4 relative to Cell 1 shall fulfil the requirements specified in clause 9.1.11.3.
- The relative accuracy of inter-frequency RSRQ measurements between the primary and secondary component carriers for Cell 5 relative to Cell 1 shall fulfil the requirements specified in clause 9.1.11.3.

A.9.2.48 5 DL FDD-TDD with PCell in TDD RSRQ for E-UTRAN in Carrier Aggregation

The test case in this clause is applicable to carrier aggregation capable UEs which have been configured with four downlink SCells.

A.9.2.48.1 Test Purpose and Environment

The purpose of this test is to verify that the RSRQ measurement accuracy in carrier aggregation is within the specified limits under AWGN propagation conditions. This test will verify the absolute accuracy of intra-frequency RSRQ measurements for the primary component carrier specified in clause 9.1.11.1, the absolute accuracy of intra-frequency RSRQ measurements for the secondary component carriers specified in clause 9.1.11.2 and also the relative inter-frequency RSRQ accuracy requirement between primary and secondary component carriers specified in clause 9.1.11.3.

A.9.2.48.2 Test parameters

In this set of test cases there are five cells on five carrier frequencies. Cell 1 is PCell on channel 1, Cell 2 is activated SCell on channel 2, Cell 3 is activated SCell on channel 3, Cell 4 is activated SCell on channel 4, and Cell 5 is activated SCell on channel 5. The parameters for the test are listed in Table A.9.2.45.2-1.

Table A.9.2.48.2-1: 5 DL PCell in FDD RSRQ for E-UTRAN in Carrier Aggregation test parameters (cell #1, cell #2, cell #3, cell #4 and cell#5)

| Parameter | Unit | Cell 1 | Cells | | | | | | | | | |
|---|---|---|---|---|---|---|-------------|------|---|--|--|--|
| | | | 2 | 3 | 4 | 5 | | | | | | |
| E-UTRA RF Channel Number | | 1 | 2 | 3 | 4 | 5 | | | | | | |
| BW _{channel} | | 5MHz: N _{RB,c} = 25 10MHz: N _{RB,c} = 50 20MHz: N _{RB,c} = 100 | 5MHz: N _{RB,c} = 25 10MHz: N _{RB,c} = 50 20MHz: N _{RB,c} = 100 | | | | | | | | | |
| Special subframe configuration ^{Note1} | | 6 | - | | | | | | | | | |
| Uplink/downlink configuration ^{Note1} | | 1 | - | | | | | | | | | |
| Measurement bandwidth | <i>n_{PRB}</i> | 5MHz: 10-15 10MHz: 22-27 20MHz: 47-52 | 5MHz: 10-15 10MHz: 22-27 20MHz: 47-52 | | | | | | | | | |
| PDSCH Reference measurement channel defined in A.3.1.1 | | 5MHz: R.4 TDD 10MHz: R.0 TDD 20MHz: R.3 TDD | 5MHz: R.5 FDD 10MHz: R.0 FDD 20MHz: R.4 FDD | | | | | | | | | |
| PDSCH allocation | <i>n_{PRB}</i> | 5MHz: 7-17 10MHz: 13-36 20MHz: 38-61 | 5MHz: 7-17 10MHz: 13-36 20MHz: 38-61 | | | | | | | | | |
| PDCCH/PCFICH/PHICH Reference measurement channel defined in A.3.1.2 | | 5MHz: R.11 TDD 10MHz: R.6 TDD 20MHz: R.10 TDD | 5MHz: R.11 FDD 10MHz: R.6 FDD 20MHz: R.10 FDD | | | | | | | | | |
| OCNG Patterns defined in A.3.2 | | 5MHz: OP.9 TDD 10MHz: OP.1 TDD 20MHz: OP.7 TDD | 5MHz: OP.15 FDD 10MHz: OP.1 FDD 20MHz: OP.11 FDD | | | | | | | | | |
| PBCH_RA | dB | 0 | 0 | | | | | | | | | |
| PBCH_RB | | | | | | | | | | | | |
| PSS_RA | | | | | | | | | | | | |
| SSS_RA | | | | | | | | | | | | |
| PCFICH_RB | | | | | | | | | | | | |
| PHICH_RA | | | | | | | | | | | | |
| PHICH_RB | | | | | | | | | | | | |
| PDCCH_RA | | | | | | | | | | | | |
| PDCCH_RB | | | | | | | | | | | | |
| PDSCH_RA | | | | | | | | | | | | |
| PDSCH_RB | | | | | | | | | | | | |
| OCNG_RA ^{Note2} | | | | | | | | | | | | |
| OCNG_RB ^{Note2} | | | | | | | | | | | | |
| <i>N_{oc}</i> ^{Note3} | | | | | | | Bands TDD_A | -116 | - | | | |
| | | | | | | | Bands TDD_C | -115 | - | | | |
| | Bands TDD_E | -114 | - | | | | | | | | | |
| | Bands FDD_A | - | -119.5 | | | | | | | | | |
| | Bands FDD_B | - | -119 | | | | | | | | | |
| | Bands FDD_C | - | -118.5 | | | | | | | | | |
| | Bands FDD_D | - | -118 | | | | | | | | | |
| | Bands FDD_E, Bands FDD_F ^{Note 6} | - | -117.5 | | | | | | | | | |
| | Bands FDD_G | - | -116.5 | | | | | | | | | |
| Bands FDD_H | - | -116 | | | | | | | | | | |
| \hat{E}_s / N_{oc} | dB | -6.0 | -6.0 | | | | | | | | | |
| \hat{E}_s / I_{ot} | dB | -6.0 | -6.0 | | | | | | | | | |
| RSRP ^{Note4} | Bands TDD_A | -122 | - | | | | | | | | | |
| | Bands TDD_C | -121 | - | | | | | | | | | |
| | Bands TDD_E | -120 | - | | | | | | | | | |
| | Bands FDD_A | - | -125.5 | | | | | | | | | |
| | Bands FDD_B | - | -125 | | | | | | | | | |
| | Bands FDD_C | - | -124.5 | | | | | | | | | |
| | Bands FDD_D | - | -124 | | | | | | | | | |
| Bands FDD_E, | - | -123.5 | | | | | | | | | | |

| | | | | | | | |
|---|---------------------------------------|-------------------------------|--|-------|-------|--------|---------------------------------------|
| | Bands FDD_F Note 6 | | | | | | |
| | Bands FDD_G | | - | | | -122.5 | |
| | Bands FDD_H | | - | | | -122 | |
| RSRQ ^{Note4} | Bands TDD_A | dB | -17.77 | | | | - |
| | Bands TDD_C | | | | | | |
| | Bands TDD_E | | | | | | |
| | Bands FDD_A | | - | | | | -17.77 |
| | Bands FDD_B | | | | | | |
| | Bands FDD_C | | | | | | |
| | Bands FDD_D | | | | | | |
| | Bands FDD_E, Bands FDD_F Note 6 | | | | | | |
| | Bands FDD_G | | | | | | |
| | Bands FDD_H | | | | | | |
| I _o ^{Note4} | Bands TDD_A | dBm/ BW _{channel} | -87.25 + 10log(N _{RB,c} /50) | | | | - |
| | Bands TDD_C | | -86.25 + 10log(N _{RB,c} /50) | | | | - |
| | Bands TDD_E | | -85.25 + 10log(N _{RB,c} /50) | | | | - |
| | Bands FDD_A | | - | | | | -90.75 + 10log(N _{RB,c} /50) |
| | Bands FDD_B | | - | | | | -90.25 + 10log(N _{RB,c} /50) |
| | Bands FDD_C | | - | | | | -89.75 + 10log(N _{RB,c} /50) |
| | Bands FDD_D | | - | | | | -89.25 + 10log(N _{RB,c} /50) |
| | Bands FDD_E, Bands FDD_F Note 6 | | - | | | | -88.75 + 10log(N _{RB,c} /50) |
| | Bands FDD_G | | - | | | | -87.75 + 10log(N _{RB,c} /50) |
| | Bands FDD_H | | - | | | | -87.25 + 10log(N _{RB,c} /50) |
| Propagation Condition | | | AWGN | | AWGN | | |
| Antenna Configuration | | | 1x2 | | 1x2 | | |
| Timing offset to Cell 1 | | μs | 0 | | - | | |
| Time alignment error relative to cell 1 ^{Note 10} | | | - | ≤ TAE | ≤ TAE | ≤ TAE | ≤ TAE |
| Time alignment error relative to cell 2 ^{Note 10} | | | - | - | ≤ TAE | ≤ TAE | ≤ TAE |
| Time alignment error relative to cell 3 ^{Note 10} | | | - | - | - | ≤ TAE | ≤ TAE |
| Time alignment error relative to cell 4 ^{Note 10} | | | - | - | - | - | ≤ TAE |
| Time alignment error relative to cell 4 ^{Note 10} | | | - | - | - | - | - |
| <p>Note 1: For special subframe and uplink-downlink configurations see Tables 4.2-1 and 4.2-2 in TS 36.211.</p> <p>Note 2: OCNB shall be used such that both cells are fully allocated and a constant total transmitted power spectral density is achieved for all OFDM symbols.</p> <p>Note 3: Interference from other cells and noise sources not specified in the test is assumed to be constant over subcarriers and time and shall be modelled as AWGN of appropriate power for N_{oc} to be fulfilled.</p> <p>Note 4: RSRP, RSRQ and I_o levels have been derived from other parameters for information purposes. They are not settable parameters themselves.</p> <p>Note 5: RSRP and RSRQ minimum requirements are specified assuming independent interference and noise at each receiver antenna port.</p> <p>Note 6: For Band 26, the tests shall be performed with the carrier frequency of the assigned E-UTRA channel bandwidth within 865-894 MHz.</p> <p>Note 7: The selection of the bands for testing depends on the configuration of the carrier aggregation supported by the UEs.</p> <p>Note 8: Void.</p> <p>Note 9: E-UTRA operating band groups are as defined in Section 3.5.</p> <p>Note 10: Time alignment error (TAE) as specified in TS 36.104 [30] clause 6.5.3.1. The TAE value depends upon the type of carrier aggregation.</p> | | | | | | | |

A.9.2.48.3 Test Requirements

In the test, the RSRQ measurement accuracy in carrier aggregation shall fulfil the requirements in clause 9.1.11.1, 9.1.11.2, and 9.1.11.3.

- The absolute accuracy of intra-frequency RSRQ measurements of Cell 1 on the primary component carrier shall fulfil the requirements specified in clause 9.1.11.1.
- The absolute accuracy of intra-frequency RSRQ measurements of Cell 2 on the secondary component carrier shall fulfil the requirements specified in clause 9.1.11.2
- The absolute accuracy of intra-frequency RSRQ measurements of Cell 3 on the secondary component carrier shall fulfil the requirements specified in clause 9.1.11.2
- The absolute accuracy of intra-frequency RSRQ measurements of Cell 4 on the secondary component carrier shall fulfil the requirements specified in clause 9.1.11.2
- The absolute accuracy of intra-frequency RSRQ measurements of Cell 5 on the secondary component carrier shall fulfil the requirements specified in clause 9.1.11.2
- The relative accuracy of inter-frequency RSRQ measurements between the primary and secondary component carriers for Cell 2 relative to Cell 1 shall fulfil the requirements specified in clause 9.1.11.3.
- The relative accuracy of inter-frequency RSRQ measurements between the primary and secondary component carriers for Cell 3 relative to Cell 1 shall fulfil the requirements specified in clause 9.1.11.3.
- The relative accuracy of inter-frequency RSRQ measurements between the primary and secondary component carriers for Cell 4 relative to Cell 1 shall fulfil the requirements specified in clause 9.1.11.3.
- The relative accuracy of inter-frequency RSRQ measurements between the primary and secondary component carriers for Cell 5 relative to Cell 1 shall fulfil the requirements specified in clause 9.1.11.3.

A.9.2.49 5 DL FDD RSRQ for E-UTRAN in Carrier Aggregation

A.9.2.49.1 Test Purpose and Environment

The purpose of this test is to verify that the FDD RSRQ measurement accuracy in carrier aggregation is within the specified limits under AWGN propagation conditions. This test will verify the absolute accuracy of intra-frequency RSRQ measurements for the primary component carrier specified in clause 9.1.11.1, the absolute accuracy of intra-frequency RSRQ measurements for the secondary component carriers specified in clause 9.1.11.2 and also the relative inter-frequency RSRQ accuracy requirement between primary and secondary component carriers specified in clause 9.1.11.3.

A.9.2.49.2 Test parameters

In this set of test cases the PCell and the SCells are on different carrier frequencies. There are five cells used in this test case. Both RSRQ absolute and relative accuracy requirements of the primary and secondary component carriers are tested by using test parameters specified in Table A.9.2.49.2-1 and Table A.9.2.49.2-2. In the test, Cell 1 is the PCell, Cell 2, Cell 3, Cell 4 and Cell 5 are the SCells on secondary component carrier SCC1, SCC2, SCC3 and SCC4 respectively. The SCC1, SCC2, SCC3 and SCC4 are configured and activated.

Table A.9.2.49.2-1: 5 DL FDD RSRQ carrier aggregation test parameters for cell 1, cell 2 and cell 3

| Parameter | Unit | Cell 1 | Cell 2 | Cell 3 |
|--|-----------|--|--|--|
| E-UTRA RF Channel Number | | 1 | 2 | 3 |
| BW_{channel} | MHz | 5MHz: $N_{RB,c} = 25$ 10MHz: $N_{RB,c} = 50$ 20MHz: $N_{RB,c} = 100$ | 5MHz: $N_{RB,c} = 25$ 10MHz: $N_{RB,c} = 50$ 20MHz: $N_{RB,c} = 100$ | 5MHz: $N_{RB,c} = 25$ 10MHz: $N_{RB,c} = 50$ 20MHz: $N_{RB,c} = 100$ |
| Measurement bandwidth | n_{PRB} | 5MHz: 10-15 10MHz: 22-27 20MHz: 47-52 | 5MHz: 10-15 10MHz: 22-27 20MHz: 47-52 | 5MHz: 10-15 10MHz: 22-27 20MHz: 47-52 |
| PDSCH Reference measurement channel defined in A.3.1.1.1 | | 5MHz: R.5 FDD 10MHz: R.0 FDD | 5MHz: R.5 FDD 10MHz: R.0 FDD | 5MHz: R.5 FDD 10MHz: R.0 FDD |

| | | | | | |
|---|---|-------------------------------|---|---|---|
| | | | 20MHz:R.4 FDD | 20MHz:R.4 FDD | 20MHz:R.4 FDD |
| PDSCH allocation | n_{PRB} | | 5MHz:7-17 10MHz:13-36 20MHz:38-61 | 5MHz:7-17 10MHz:13-36 20MHz:38-61 | 5MHz:7-17 10MHz:13-36 20MHz:38-61 |
| PDCCH/PCFICH/PHICH Reference measurement channel defined in A.3.1.2.1 | | | 5MHz:R.11 FDD 10MHz:R.6 FDD 20MHz:R.10 FDD | 5MHz:R.11 FDD 10MHz:R.6 FDD 20MHz:R.10 FDD | 5MHz:R.11 FDD 10MHz:R.6 FDD 20MHz:R.10 FDD |
| OCNG Patterns defined in A.3.2.1 | | | 5MHz:OP.15 FDD 10MHz:OP.1 FDD 20MHz:OP.11 FDD | 5MHz:OP.15 FDD 10MHz:OP.1 FDD 20MHz:OP.11 FDD | 5MHz:OP.15 FDD 10MHz:OP.1 FDD 20MHz:OP.11 FDD |
| PBCH_RA | dB | 0 | | 0 | 0 |
| PBCH_RB | | | | | |
| PSS_RA | | | | | |
| SSS_RA | | | | | |
| PCFICH_RB | | | | | |
| PHICH_RA | | | | | |
| PHICH_RB | | | | | |
| PDCCH_RA | | | | | |
| PDCCH_RB | | | | | |
| PDSCH_RA | | | | | |
| PDSCH_RB | | | | | |
| OCNG_RA ^{Note1} | | | | | |
| OCNG_RB ^{Note1} | | | | | |
| N_{oc} ^{Note2} | | | | | |
| | Bands FDD_B | -119 | | | |
| | Bands FDD_C | -118.5 | | | |
| | Bands FDD_D | -118 | | | |
| | Bands FDD_E, FDD_F ^{Note 6} | -117.5 | | | |
| | Bands FDD_G | -116.5 | | | |
| | Bands FDD_H | -116 | | | |
| \hat{E}_s/N_{oc} | dB | -6.0 | -6.0 | -6.0 | |
| \hat{E}_s/I_{ot} ^{Note3} | dB | -6.0 | -6.0 | -6.0 | |
| RSRP ^{Note3} | Bands FDD_A | dBm/15 kHz | | | -125.5 |
| | Bands FDD_B | | | | -125 |
| | Bands FDD_C | | | | -124.5 |
| | Bands FDD_D | | | | -124 |
| | Bands FDD_E, FDD_F ^{Note 6} | | | | -123.5 |
| | Bands FDD_G | | | | -122.5 |
| | Bands FDD_H | | | | -122 |
| RSRQ ^{Note3} | Bands FDD_A | dB | | | -17.77 |
| | Bands FDD_B | | | | |
| | Bands FDD_C | | | | |
| | Bands FDD_D | | | | |
| | Bands FDD_E, FDD_F ^{Note 6} | | | | |
| | Bands FDD_G | | | | |
| | Bands FDD_H | | | | |
| I_0 ^{Note3} | Bands FDD_A | dBm/ BW _{channel} | | | -90.75+ 10log(N _{RB,c} /50) |
| | Bands FDD_B | | | | -87.25+ 10log(N _{RB,c} /50) |
| | Bands FDD_C | | | | -86.75+ 10log(N _{RB,c} /50) |
| | Bands FDD_D | | | | -86.25+ 10log(N _{RB,c} /50) |
| | Bands FDD_E, FDD_F ^{Note 6} | | | | -86.25+ 10log(N _{RB,c} /50) |
| | Bands FDD_G | | | | -85.75+ 10log(N _{RB,c} /50) |
| | Bands FDD_H | | | | -85.75+ 10log(N _{RB,c} /50) |

| | | | 10log(N _{RB,c} /50) | 10log(N _{RB,c} /50) | 10log(N _{RB,c} /50) |
|---|----|--|------------------------------|------------------------------|------------------------------|
| Propagation condition | - | | AWGN | AWGN | AWGN |
| Antenna Configuration | - | | 1x2 | 1x2 | 1x2 |
| Timing offset to Cell 1 | μs | | - | 0 | 0 |
| Time alignment error relative to cell 1 ^{Note 7} | | | - | ≤ TAE | ≤ TAE |
| Time alignment error relative to cell 2 ^{Note 7} | | | - | - | ≤ TAE |
| <p>Note 1: OCNG shall be used such that all cells are fully allocated and a constant total transmitted power spectral density is achieved for all OFDM symbols.</p> <p>Note 2: Interference from other cells and noise sources not specified in the test is assumed to be constant over subcarriers and time and shall be modelled as AWGN of appropriate power for N_{oc} to be fulfilled.</p> <p>Note 3: Es/lot, RSRQ, RSRP and Io levels have been derived from other parameters for information purposes. They are not settable parameters themselves.</p> <p>Note 4: RSRP and RSRQ minimum requirements are specified assuming independent interference and noise at each receiver antenna port.</p> <p>Note 5: The selection of the bands for testing depends on the configuration of the carrier aggregation supported by the UEs.</p> <p>Note 6: For Band 26, the tests shall be performed with the carrier frequency of the assigned E-UTRA channel bandwidth within 865-894 MHz.</p> <p>Note 7: Time alignment error (TAE) as specified in TS 36.104 [30] clause 6.5.3.1. The TAE value depends upon the type of carrier aggregation.</p> <p>Note 8: E-UTRA operating band groups are as defined in Section 3.5.</p> | | | | | |

Table A.9.2.49.2-2: 5 DL FDD RSRQ carrier aggregation test parameters for cell 4 and cell 5

| Parameter | | Unit | Cell 4 | Cell 5 |
|---|-------------|-----------|---|---|
| E-UTRA RF Channel Number | | | 2 | 3 |
| BW _{channel} | | MHz | 5MHz: N _{RB,c} = 25 10MHz: N _{RB,c} = 50 20MHz: N _{RB,c} = 100 | 5MHz: N _{RB,c} = 25 10MHz: N _{RB,c} = 50 20MHz: N _{RB,c} = 100 |
| Measurement bandwidth | | n_{PRB} | 5MHz: 10-15 10MHz: 22-27 20MHz: 47-52 | 5MHz: 10-15 10MHz: 22-27 20MHz: 47-52 |
| PDSCH Reference measurement channel defined in A.3.1.1.1 | | | 5MHz:R.5 FDD 10MHz:R.0 FDD 20MHz:R.4 FDD | 5MHz:R.5 FDD 10MHz:R.0 FDD 20MHz:R.4 FDD |
| PDSCH allocation | | n_{PRB} | 5MHz:7-17 10MHz:13-36 20MHz:38-61 | 5MHz:7-17 10MHz:13-36 20MHz:38-61 |
| PDCCH/PCFICH/PHICH Reference measurement channel defined in A.3.1.2.1 | | | 5MHz:R.11 FDD 10MHz:R.6 FDD 20MHz:R.10 FDD | 5MHz:R.11 FDD 10MHz:R.6 FDD 20MHz:R.10 FDD |
| OCNG Patterns defined in A.3.2.1 | | | 5MHz:OP.15 FDD 10MHz:OP.1 FDD 20MHz:OP.11 FDD | 5MHz:OP.15 FDD 10MHz:OP.1 FDD 20MHz:OP.11 FDD |
| PBCH_RA | | dB | 0 | 0 |
| PBCH_RB | | | | |
| PSS_RA | | | | |
| SSS_RA | | | | |
| PCFICH_RB | | | | |
| PHICH_RA | | | | |
| PHICH_RB | | | | |
| PDCCH_RA | | | | |
| PDCCH_RB | | | | |
| PDSCH_RA | | | | |
| PDSCH_RB | | | | |
| OCNG_RA ^{Note1} | | | | |
| OCNG_RB ^{Note1} | | | | |
| N_{oc} ^{Note2} | Bands FDD_A | | | |
| | Bands FDD_B | -115.5 | -115.5 | |
| | Bands FDD_C | -115 | -115 | |
| | Bands FDD_D | -114.5 | -114.5 | |

| | | | | |
|---|---|-------------------------------|---|---|
| | Bands FDD_E, FDD_F ^{Note 6} | | -114 | -114 |
| | Bands FDD_G | | -113 | -113 |
| | Bands FDD_H | | -112.5 | -112.5 |
| \hat{E}_s / N_{oc} | | dB | -6.0 | -6.0 |
| \hat{E}_s / I_{ot} ^{Note3} | | dB | -6.0 | -6.0 |
| RSRP ^{Note3} | Bands FDD_A | dBm/15 kHz | -122 | -122 |
| | Bands FDD_B | | -121.5 | -121.5 |
| | Bands FDD_C | | -121 | -121 |
| | Bands FDD_D | | -120.5 | -120.5 |
| | Bands FDD_E, FDD_F ^{Note 6} | | -120 | -120 |
| | Bands FDD_G | | -119 | -119 |
| | Bands FDD_H | | -118.5 | -118.5 |
| RSRQ ^{Note3} | Bands FDD_A | dB | -17.77 | -17.77 |
| | Bands FDD_B | | | |
| | Bands FDD_C | | | |
| | Bands FDD_D | | | |
| | Bands FDD_E, FDD_F ^{Note 6} | | | |
| | Bands FDD_G | | | |
| I _o ^{Note3} | Bands FDD_A | dBm/ BW _{channel} | -87.25+ 10log(N _{RB,c} /50) | -87.25+ 10log(N _{RB,c} /50) |
| | Bands FDD_B | | -86.75+ 10log(N _{RB,c} /50) | -86.75+ 10log(N _{RB,c} /50) |
| | Bands FDD_C | | -86.25+ 10log(N _{RB,c} /50) | -86.25+ 10log(N _{RB,c} /50) |
| | Bands FDD_D | | -85.75+ 10log(N _{RB,c} /50) | -85.75+ 10log(N _{RB,c} /50) |
| | Bands FDD_E, FDD_F ^{Note 6} | | -85.25+ 10log(N _{RB,c} /50) | -85.25+ 10log(N _{RB,c} /50) |
| | Bands FDD_G | | -84.25+ 10log(N _{RB,c} /50) | -84.25+ 10log(N _{RB,c} /50) |
| | Bands FDD_H | | -83.75+ 10log(N _{RB,c} /50) | -83.75+ 10log(N _{RB,c} /50) |
| Propagation condition | | - | AWGN | AWGN |
| Antenna Configuration | | - | 1x2 | 1x2 |
| Timing offset to Cell 1 | | μs | 0 | 0 |
| Time alignment error relative to cell 1 ^{Note 7} | | | ≤ TAE | ≤ TAE |
| Time alignment error relative to cell 2 ^{Note 7} | | | ≤ TAE | ≤ TAE |
| Time alignment error relative to cell 3 ^{Note 7} | | | ≤ TAE | ≤ TAE |
| Time alignment error relative to cell 4 ^{Note 7} | | | - | ≤ TAE |
| <p>Note 1: OCNG shall be used such that all cells are fully allocated and a constant total transmitted power spectral density is achieved for all OFDM symbols.</p> <p>Note 2: Interference from other cells and noise sources not specified in the test is assumed to be constant over subcarriers and time and shall be modelled as AWGN of appropriate power for N_{oc} to be fulfilled.</p> <p>Note 3: Es/Iot, RSRQ, RSRP and Io levels have been derived from other parameters for information purposes. They are not settable parameters themselves.</p> <p>Note 4: RSRP and RSRQ minimum requirements are specified assuming independent interference and noise at each receiver antenna port.</p> <p>Note 5: The selection of the bands for testing depends on the configuration of the carrier aggregation supported by the UEs.</p> <p>Note 6: For Band 26, the tests shall be performed with the carrier frequency of the assigned E-UTRA channel bandwidth within 865-894 MHz.</p> <p>Note 7: Time alignment error (TAE) as specified in TS 36.104 [30] clause 6.5.3.1. The TAE value depends upon the type of carrier aggregation.</p> <p>Note 8: E-UTRA operating band groups are as defined in Section 3.5.</p> | | | | |

A.9.2.49.3 Test Requirements

In the test, the RSRQ measurement accuracy in carrier aggregation shall fulfil the requirements in clause 9.1.11.1, 9.1.11.2, and 9.1.11.3.

- The absolute accuracy of intra-frequency RSRQ measurements of Cell 1 on the primary component carrier shall fulfil the requirements defined in clause 9.1.11.1.
- The absolute accuracy of intra-frequency RSRQ measurements of Cell 2 on SCC1 shall fulfil the requirements defined in clause 9.1.11.2.
- The absolute accuracy of intra-frequency RSRQ measurements of Cell 3 on SCC2 shall fulfil the requirements defined in clause 9.1.11.2.
- The absolute accuracy of intra-frequency RSRQ measurements of Cell 4 on SCC3 shall fulfil the requirements defined in clause 9.1.11.2.
- The absolute accuracy of intra-frequency RSRQ measurements of Cell 5 on SCC4 shall fulfil the requirements defined in clause 9.1.11.2.
- The relative accuracy of inter-frequency RSRQ measurements between the primary component carrier and SCC1 for Cell 2 relative to Cell 1 shall fulfil the requirements defined in clause 9.1.11.3.
- The relative accuracy of inter-frequency RSRQ measurements between the primary component carrier and SCC2 for Cell 3 relative to Cell 1 shall fulfil the requirements defined in clause 9.1.11.3.
- The relative accuracy of inter-frequency RSRQ measurements between the primary component carrier and SCC3 for Cell 4 relative to Cell 1 shall fulfil the requirements defined in clause 9.1.11.3.
- The relative accuracy of inter-frequency RSRQ measurements between the primary component carrier and SCC4 for Cell 5 relative to Cell 1 shall fulfil the requirements defined in clause 9.1.11.3.

A.9.2.50 5 DL TDD RSRQ for E-UTRAN in Carrier Aggregation

A.9.2.50.1 Test Purpose and Environment

The purpose of this test is to verify that the TDD RSRQ measurement accuracy in carrier aggregation is within the specified limits under AWGN propagation conditions. This test will verify the absolute accuracy of intra-frequency RSRQ measurements for the primary component carrier specified in clause 9.1.11.1, the absolute accuracy of intra-frequency RSRQ measurements for the secondary component carriers specified in clause 9.1.11.2 and also the relative inter-frequency RSRQ accuracy requirement between primary and secondary component carriers specified in clause 9.1.11.3.

A.9.2.50.2 Test parameters

In this set of test cases the PCell and the SCells are on different carrier frequencies. There are five cells used in this test case. Both RSRQ absolute and relative accuracy requirements of the primary and secondary component carriers are tested by using test parameters specified in Table A.9.2.50.2-1 and Table A.9.2.50.2-2. In the test, Cell 1 is the PCell, Cell 2, Cell 3, Cell 4 and Cell 5 are the SCells on secondary component carrier SCC1, SCC2, SCC3 and SCC4 respectively. The SCC1, SCC2, SCC3 and SCC4 are configured and activated.

Table A.9.2.50.2-1: 5 DL TDD RSRQ carrier aggregation test parameters for cell 1, cell 2 and cell 3

| Parameter | Unit | Cell 1 | Cell 2 | Cell 3 |
|---|-----------|--|--|--|
| E-UTRA RF Channel Number | | 1 | 2 | 3 |
| BW_{channel} | MHz | 5MHz: $N_{RB,c} = 25$ 10MHz: $N_{RB,c} = 50$ 20MHz: $N_{RB,c} = 100$ | 5MHz: $N_{RB,c} = 25$ 10MHz: $N_{RB,c} = 50$ 20MHz: $N_{RB,c} = 100$ | 5MHz: $N_{RB,c} = 25$ 10MHz: $N_{RB,c} = 50$ 20MHz: $N_{RB,c} = 100$ |
| Special subframe configuration ^{Note1} | | 6 | | |
| Uplink-downlink configuration ^{Note1} | | 1 | | |
| Measurement bandwidth | n_{PRB} | 5MHz: 10-15 10MHz: 22-27 | 5MHz: 10-15 10MHz: 22-27 | 5MHz: 10-15 10MHz: 22-27 |

| | | | | | |
|--|---------------------------|-------------------------------|--|--|--|
| | | | 20MHz: 47-52 | 20MHz: 47-52 | 20MHz: 47-52 |
| PDSCH Reference measurement channel defined in A.3.1.1.1 | | | 5MHz: R.4 TDD 10MHz: R.0 TDD 20MHz: R.3 TDD | 5MHz: R.4 TDD 10MHz: R.0 TDD 20MHz: R.3 TDD | 5MHz: R.4 TDD 10MHz: R.0 TDD 20MHz: R.3 TDD |
| PDSCH allocation | n_{PRB} | | 5MHz: 7-17 10MHz: 13-36 20MHz: 38-61 | 5MHz: 7-17 10MHz: 13-36 20MHz: 38-61 | 5MHz: 7-17 10MHz: 13-36 20MHz: 38-61 |
| PDCCH/PCFICH/PHICH Reference measurement channel defined in A.3.1.2.1 | | | 5MHz: R.11 TDD 10MHz: R.6 TDD 20MHz: R.10 TDD | 5MHz: R.11 TDD 10MHz: R.6 TDD 20MHz: R.10 TDD | 5MHz: R.11 TDD 10MHz: R.6 TDD 20MHz: R.10 TDD |
| OCNG Patterns defined in A.3.2.1 | | | 5MHz: OP.9 TDD 10MHz: OP.1 TDD 20MHz: OP.7 TDD | 5MHz: OP.9 TDD 10MHz: OP.1 TDD 20MHz: OP.7 TDD | 5MHz: OP.9 TDD 10MHz: OP.1 TDD 20MHz: OP.7 TDD |
| PBCH_RA | dB | 0 | 0 | 0 | 0 |
| PBCH_RB | | | | | |
| PSS_RA | | | | | |
| SSS_RA | | | | | |
| PCFICH_RB | | | | | |
| PHICH_RA | | | | | |
| PHICH_RB | | | | | |
| PDCCH_RA | | | | | |
| PDCCH_RB | | | | | |
| PDSCH_RA | | | | | |
| PDSCH_RB | | | | | |
| OCNG_RA ^{Note2} | | | | | |
| OCNG_RB ^{Note2} | | | | | |
| N_{oc} ^{Note3} | | | | | |
| | Bands TDD_C | -118.5 | -115 | -115 | |
| | Bands TDD_E | -117.5 | -114 | -114 | |
| \hat{E}_s / N_{oc} | dB | -6.0 | -6.0 | -6.0 | |
| \hat{E}_s / I_{ot} ^{Note4} | dB | -6.0 | -6.0 | -6.0 | |
| RSRP ^{Note4} | Bands TDD_A | dBm/15 kHz | -125.5 | -122 | -122 |
| | Bands TDD_C | | -124.5 | -121 | -121 |
| | Bands TDD_E | | -123.5 | -120 | -120 |
| RSRQ ^{Note4} | Bands TDD_A, TDD_C, TDD_E | dB | -17.77 | -17.77 | -17.77 |
| I_o ^{Note4} | Bands TDD_A | dBm/ BW _{channel} | -90.75+ 10log(N _{RB,c} /50) | -87.25+ 10log(N _{RB,c} /50) | -87.25+ 10log(N _{RB,c} /50) |
| | Bands TDD_C | | -89.75+ 10log(N _{RB,c} /50) | -86.25+ 10log(N _{RB,c} /50) | -86.25+ 10log(N _{RB,c} /50) |
| | Bands TDD_E | | -88.75+ 10log(N _{RB,c} /50) | -85.25+ 10log(N _{RB,c} /50) | -85.25+ 10log(N _{RB,c} /50) |
| Propagation condition | - | AWGN | AWGN | AWGN | |
| Antenna Configuration | - | 1x2 | 1x2 | 1x2 | |
| Timing offset to Cell 1 | μs | - | 0 | 0 | |
| Time alignment error relative to cell 1 ^{Note 7} | | - | ≤ TAE | ≤ TAE | |
| Time alignment error relative to cell 2 ^{Note 7} | | - | - | ≤ TAE | |
| <p>Note 1: For special subframe and uplink-downlink configurations see Tables 4.2-1 and 4.2-2 in TS 36.211.</p> <p>Note 2: OCNG shall be used such that all cells are fully allocated and a constant total transmitted power spectral density is achieved for all OFDM symbols.</p> <p>Note 3: Interference from other cells and noise sources not specified in the test is assumed to be constant over subcarriers and time and shall be modelled as AWGN of appropriate power for N_{oc} to be fulfilled.</p> <p>Note 4: E_s/I_{ot}, RSRQ, RSRP and I_o levels have been derived from other parameters for information purposes. They</p> | | | | | |

are not settable parameters themselves.

Note 5: RSRP and RSRQ minimum requirements are specified assuming independent interference and noise at each receiver antenna port.

Note 6: The selection of the bands for testing depends on the configuration of the carrier aggregation supported by the UEs.

Note 7: Time alignment error (TAE) as specified in TS 36.104 [30] clause 6.5.3.1. The TAE value depends upon the type of carrier aggregation.

Note 8: E-UTRA operating band groups are as defined in Section 3.5.

Table A.9.2.50.2-2: 5 DL TDD RSRQ carrier aggregation test parameters for cell 4 and cell 5

| Parameter | | Unit | Cell 4 | Cell 5 |
|---|---------------------------|-------------------------|---|---|
| E-UTRA RF Channel Number | | | 4 | 5 |
| BW _{channel} | | MHz | 5MHz: N _{RB,c} = 25 10MHz: N _{RB,c} = 50 20MHz: N _{RB,c} = 100 | 5MHz: N _{RB,c} = 25 10MHz: N _{RB,c} = 50 20MHz: N _{RB,c} = 100 |
| Special subframe configuration ^{Note1} | | | 6 | 6 |
| Uplink-downlink configuration ^{Note1} | | | 1 | 1 |
| Measurement bandwidth | | <i>n</i> _{PRB} | 5MHz: 10-15 10MHz: 22-27 20MHz: 47-52 | 5MHz: 10-15 10MHz: 22-27 20MHz: 47-52 |
| PDSCH Reference measurement channel defined in A.3.1.1.1 | | | 5MHz: R.4 TDD 10MHz: R.0 TDD 20MHz: R.3 TDD | 5MHz: R.4 TDD 10MHz: R.0 TDD 20MHz: R.3 TDD |
| PDSCH allocation | | <i>n</i> _{PRB} | 5MHz: 7-17 10MHz: 13-36 20MHz: 38-61 | 5MHz: 7-17 10MHz: 13-36 20MHz: 38-61 |
| PDCCH/PCFICH/PHICH Reference measurement channel defined in A.3.1.2.1 | | | 5MHz:R.11 TDD 10MHz:R.6 TDD 20MHz:R.10 TDD | 5MHz:R.11 TDD 10MHz:R.6 TDD 20MHz:R.10 TDD |
| OCNG Patterns defined in A.3.2.1 | | | 5MHz: OP.9 TDD 10MHz: OP.1 TDD 20MHz: OP.7 TDD | 5MHz: OP.9 TDD 10MHz: OP.1 TDD 20MHz: OP.7 TDD |
| PBCH_RA | | dB | 0 | 0 |
| PBCH_RB | | | | |
| PSS_RA | | | | |
| SSS_RA | | | | |
| PCFICH_RB | | | | |
| PHICH_RA | | | | |
| PHICH_RB | | | | |
| PDCCH_RA | | | | |
| PDCCH_RB | | | | |
| PDSCH_RA | | | | |
| PDSCH_RB | | | | |
| OCNG_RA ^{Note2} | | | | |
| OCNG_RB ^{Note2} | | | | |
| <i>N</i> _{oc} ^{Note3} | Bands TDD_A | | | |
| | Bands TDD_C | -115 | -115 | |
| | Bands TDD_E | -114 | -114 | |
| \hat{E}_s / N_{oc} | | dB | -6.0 | -6.0 |
| \hat{E}_s / I_{ot} ^{Note4} | | dB | -6.0 | -6.0 |
| RSRP ^{Note4} | Bands TDD_A | dBm/15 kHz | -122 | -122 |
| | Bands TDD_C | | -121 | -121 |
| | Bands TDD_E | | -120 | -120 |
| RSRQ ^{Note4} | Bands TDD_A, TDD_C, TDD_E | dB | -17.77 | -17.77 |
| I _o ^{Note4} | Bands TDD_A | dBm/ | -87.25+ | -87.25+ |

| | Bands TDD_C | BW_{channel} | $10\log(N_{RB,c}/50)$ | $10\log(N_{RB,c}/50)$ |
|---|-------------|-----------------------|----------------------------------|----------------------------------|
| | | | -86.25+ $10\log(N_{RB,c}/50)$ | -86.25+ $10\log(N_{RB,c}/50)$ |
| | Bands TDD_E | | -85.25+ $10\log(N_{RB,c}/50)$ | -85.25+ $10\log(N_{RB,c}/50)$ |
| Propagation condition | | - | AWGN | AWGN |
| Antenna Configuration | | - | 1x2 | 1x2 |
| Timing offset to Cell 1 | | μs | 0 | 0 |
| Time alignment error relative to cell 1 ^{Note 7} | | | $\leq \text{TAE}$ | $\leq \text{TAE}$ |
| Time alignment error relative to cell 2 ^{Note 7} | | | $\leq \text{TAE}$ | $\leq \text{TAE}$ |
| Time alignment error relative to cell 3 ^{Note 7} | | | $\leq \text{TAE}$ | $\leq \text{TAE}$ |
| Time alignment error relative to cell 4 ^{Note 7} | | | - | $\leq \text{TAE}$ |
| <p>Note 1: For special subframe and uplink-downlink configurations see Tables 4.2-1 and 4.2-2 in TS 36.211.</p> <p>Note 2: OCNB shall be used such that all cells are fully allocated and a constant total transmitted power spectral density is achieved for all OFDM symbols.</p> <p>Note 3: Interference from other cells and noise sources not specified in the test is assumed to be constant over subcarriers and time and shall be modelled as AWGN of appropriate power for N_{oc} to be fulfilled.</p> <p>Note 4: E_s/lot, RSRQ, RSRP and I_0 levels have been derived from other parameters for information purposes. They are not settable parameters themselves.</p> <p>Note 5: RSRP and RSRQ minimum requirements are specified assuming independent interference and noise at each receiver antenna port.</p> <p>Note 6: The selection of the bands for testing depends on the configuration of the carrier aggregation supported by the UEs.</p> <p>Note 7: Time alignment error (TAE) as specified in TS 36.104 [30] clause 6.5.3.1. The TAE value depends upon the type of carrier aggregation.</p> <p>Note 8: E-UTRA operating band groups are as defined in Section 3.5.</p> | | | | |

A.9.2.50.3 Test Requirements

In the test, the RSRQ measurement accuracy in carrier aggregation shall fulfil the requirements in clause 9.1.11.1, 9.1.11.2, and 9.1.11.3.

- The absolute accuracy of intra-frequency RSRQ measurements of Cell 1 on the primary component carrier shall fulfil the requirements defined in clause 9.1.11.1.
- The absolute accuracy of intra-frequency RSRQ measurements of Cell 2 on SCC1 shall fulfil the requirements defined in clause 9.1.11.2.
- The absolute accuracy of intra-frequency RSRQ measurements of Cell 3 on SCC2 shall fulfil the requirements defined in clause 9.1.11.2.
- The absolute accuracy of intra-frequency RSRQ measurements of Cell 4 on SCC3 shall fulfil the requirements defined in clause 9.1.11.2.
- The absolute accuracy of intra-frequency RSRQ measurements of Cell 5 on SCC4 shall fulfil the requirements defined in clause 9.1.11.2.
- The relative accuracy of inter-frequency RSRQ measurements between the primary component carrier and SCC1 for Cell 2 relative to Cell 1 shall fulfil the requirements defined in clause 9.1.11.3.
- The relative accuracy of inter-frequency RSRQ measurements between the primary component carrier and SCC2 for Cell 3 relative to Cell 1 shall fulfil the requirements defined in clause 9.1.11.3.
- The relative accuracy of inter-frequency RSRQ measurements between the primary component carrier and SCC3 for Cell 4 relative to Cell 1 shall fulfil the requirements defined in clause 9.1.11.3.
- The relative accuracy of inter-frequency RSRQ measurements between the primary component carrier and SCC4 for Cell 5 relative to Cell 1 shall fulfil the requirements defined in clause 9.1.11.3.

A.9.2.51 FS3 Intra frequency absolute and relative RSRQ accuracies with FDD PCell

A.9.2.51.1 Test Purpose and Environment

The purpose of this test is to verify that the FDD intra frequency RSRQ absolute and relative measurement accuracies in carrier aggregation with frame structure 3 in the configured DMTC occasion are within the specified limits. This test will verify the absolute RSRQ accuracy requirement of the secondary component carrier defined in clause 9.1.19.2. The test will also verify the primary and secondary component carrier relative RSRQ accuracy requirement defined in Clause 9.1.19.4.

A.9.2.51.2 Test parameters

In this test case, Cell1 is PCell on the primary component carrier, Cell2 is SCell on the secondary component carrier with frame structure 3 and activated, and Cell3 is the neighboring cell on the same secondary component carrier of Cell2. The test parameters are given in Table A.9.2.51.2-1. The DMTC configuration for Cell2 and Cell3 is provided to the UE in the *measDS-Config* before the start of the test.

Table A.9.2.51.2-1: Test parameters for FDD RSRQ accuracies of SCell with FS3

| Parameter | Unit | Test 1 | | |
|--|---------------|---|---|--------|
| | | Cell 1 | Cell 2 | Cell3 |
| E-UTRA RF Channel Number | | 1 | 2 | 2 |
| BW_{channel} | MHz | 5MHz: $N_{RB,c} = 25$ 10MHz: $N_{RB,c} = 50$ 20MHz: $N_{RB,c} = 100$ | 20 | 20 |
| DMTC period | ms | N/A | 40 | 40 |
| DMTC period offset | | N/A | 10 | 10 |
| Discovery signal occasion duration | ms | N/A | 1 | 1 |
| LBT model | | N/A | N/A | A.3.17 |
| Timing offset to cell1 | μs | - | 0 | 3 |
| Time alignment error between cell 2 and cell 1 | | - | \leq Time alignment error as specified in 3GPP TS 36.104 [30] clause 6.5.3.1. | - |
| Measurement bandwidth | n_{PRB} | 5MHz: 10-15 10MHz: 22-27 20MHz: 47-52 | 47-52 | 47-52 |
| PDSCH Reference measurement channel defined in A.3.1.1 | | 5MHz: R.5 FDD 10MHz: R.0 FDD 20MHz: R.4 FDD | R.0 FS3 | - |

| | | | | | |
|---|---|------------|---|------------------------|--------------|
| PDSCH allocation | | n_{PRB} | 5MHz: 7-17 10MHz: 13-36 20MHz: 38-61 | 38-61 | - |
| PDCCH/PCFICH/PHICH Reference measurement channel defined in A.3.1.2 | | | 5MHz: R.11 FDD 10MHz: R.6 FDD 20MHz: R.10 FDD | R.0 FS3 | R.0 FS3 |
| OCNG Patterns defined in A.3.2 | | | 5MHz: OP.15 FDD 10MHz: OP.1 FDD 20MHz: OP.11 FDD | OP.13 FDD | OP.14 FDD |
| PBCH_RA | | dB | 0 | 0 | 0 |
| PBCH_RB | | | | | |
| PSS_RA | | | | | |
| SSS_RA | | | | | |
| PCFICH_RB | | | | | |
| PHICH_RA | | | | | |
| PHICH_RB | | | | | |
| PDCCH_RA | | | | | |
| PDCCH_RB | | | | | |
| PDSCH_RA | | | | | |
| PDSCH_RB | | | | | |
| OCNG_RA ^{Note1} | | | | | |
| OCNG_RB ^{Note1} | | | | | |
| N_{oc} ^{Note2} | Bands FDD_A | dBm/15 kHz | -119.5 | - | |
| | Bands FDD_B | | -119 | | |
| | Bands FDD_C | | -118.5 | | |
| | Bands FDD_D | | -118 | | |
| | Bands FDD_E, FDD_F ^{Note 6} | | -117.5 | | |
| | Bands FDD_G | | -116.5 | | |
| | Bands FDD_H | | -116 | | |
| | Bands FS3_G | | - | | |
| \hat{E}_s/I_{ot} | | dB | -4 | -5.46 ^{Note9} | -5.46 |
| RSRP ^{Note3} | Bands FDD_A | dBm/15 kHz | -123.5 | - | |
| | Bands FDD_B | | -123 | | |
| | Bands FDD_C | | -122.5 | | |
| | Bands FDD_D | | -122 | | |
| | Bands FDD_E, FDD_F ^{Note 6} | | -121.5 | | |
| | Bands FDD_G | | -120.5 | | |
| | Bands FDD_H | | -120 | | |
| | Bands FS3_G | | - | | |
| RSRQ ^{Note3} | Bands FDD_A | dBm/15 kHz | -16.25 | - | |
| | Bands FDD_B | | | | |
| | Bands FDD_C | | | | |

| | | | | | |
|--|---|--|--------------------------------------|-------------------------|--------|
| | Bands FDD_D | | | | |
| | Bands FDD_E, FDD_F ^{Note 6} | | | | |
| | Bands FDD_G | | | | |
| | Bands FDD_H | | | | |
| | Bands FS3_G | | - | -17.34 ^{Note9} | -17.34 |
| I_o ^{Note3} | Bands FDD_A | 5MHz: dBm/4.5MHz 10MHz: dBm/9MHz 20MHz: dBm/18MHz | -90.26 +10log(N_{RB} , /50) | - | |
| | Bands FDD_B | | -89.76 +10log(N_{RB} , /50) | | |
| | Bands FDD_C | | -89.26 +10log(N_{RB} , /50) | | |
| | Bands FDD_D | | -88.76 +10log(N_{RB} , /50) | | |
| | Bands FDD_E, FDD_F ^{Note 6} | | -88.26 +10log(N_{RB} , /50) | | |
| | Bands FDD_G | | -87.26 +10log(N_{RB} , /50) | | |
| | Bands FDD_H | | -86.76 +10log(N_{RB} , /50) | | |
| | Bands FS3_G | | - | | |
| \hat{E}_s / N_{oc} | | dB | -4 | -4 | -4 |
| Propagation condition | | - | AWGN | | |
| <p>Note 1: OCNG shall be used such that cells are fully allocated and a constant total transmitted power spectral density is achieved for all OFDM symbols. For cells with LBT model, OCNG is transmitted only in subframes with downlink transmission bursts, and is not transmitted during muted subframes or during DMTC windows.</p> <p>Note 2: Interference from other cells and noise sources not specified in the test is assumed to be constant over subcarriers and time and shall be modelled as AWGN of appropriate power for N_{oc} to be fulfilled.</p> <p>Note 3: RSRP, RSRQ and I_o levels have been derived from other parameters for information purposes. They are not settable parameters themselves.</p> <p>Note 4: RSRP and RSRQ minimum requirements are specified assuming independent interference and noise at each receiver antenna port.</p> <p>Note 5: The selection of the bands for testing depends on the configuration of the carrier aggregation supported by the UEs.</p> <p>Note 6: For Band 26, the tests shall be performed with the carrier frequency of the assigned E-UTRA channel bandwidth within 865-894 MHz</p> <p>Note 7: This test verifies the RRM requirement which is independent of channel bandwidth and is performed according to the principle defined in section A.3.6.1.</p> <p>Note 8: E-UTRA operating band groups are as defined in Section 3.5.</p> <p>Note 9: The value is corresponding to DRS transmission through LBT operation in Cell3.</p> | | | | | |

A.9.2.51.3 Test Requirements

In the test, the performance of RSRQ measurements is verified from following three perspectives:

- The absolute accuracy of intra-frequency RSRQ measurements for Cell 3 on the secondary component carrier with frame structure 3 shall fulfil the requirements defined in clause 9.1.19.2.
- The relative accuracy of inter-frequency RSRQ measurements between the primary and secondary component carriers for Cell 3 relative to Cell 1 shall fulfil the requirements defined in clause 9.1.19.4.

A.9.2.52 FS3 Intra frequency absolute and relative RSRQ accuracies with TDD PCell

A.9.2.52.1 Test Purpose and Environment

The purpose of this test is to verify that the TDD intra frequency RSRQ absolute and relative measurement accuracies in carrier aggregation with frame structure 3 in the configured DMTC occasion are within the specified limits. This test will verify the absolute RSRQ accuracy requirement of the secondary component carrier defined in clause 9.1.19.2. The test will also verify the primary and secondary component carrier relative RSRQ accuracy requirement defined in Clause 9.1.19.4.

A.9.2.52.2 Test parameters

In this test case, Cell1 is PCell on the primary component carrier, Cell2 is SCell on the secondary component carrier with frame structure 3 and activated, and Cell3 is the neighboring cell on the same secondary component carrier of Cell2. The test parameters are given in Table A.9.2.52.2-1. The DMTC configuration for Cell2 and Cell3 is provided to the UE in the *measDS-Config* before the start of the test.

Table A.9.2.52.2-1: Test parameters for FDD RSRQ accuracies of SCell with FS3

| Parameter | Unit | Test 1 | | |
|--|---------------|---|---|--------|
| | | Cell 1 | Cell 2 | Cell3 |
| E-UTRA RF Channel Number | | 1 | 2 | 2 |
| BW_{channel} | MHz | 5MHz: $N_{RB,c} = 25$ 10MHz: $N_{RB,c} = 50$ 20MHz: $N_{RB,c} = 100$ | 20 | 20 |
| DMTC period | ms | N/A | 40 | 40 |
| DMTC period offset | | N/A | 10 | 10 |
| Discovery signal occasion duration | ms | N/A | 1 | 1 |
| LBT model | | N/A | N/A | A.3.17 |
| Special subframe configuration ^{Note1} | | 6 | N/A | N/A |
| Uplink/downlink configuration ^{Note1} | | 1 | N/A | N/A |
| Timing offset to cell1 | μs | - | 0 | 3 |
| Time alignment error between cell 2 and cell 1 | | - | \leq Time alignment error as specified in 3GPP TS 36.104 [30] clause 6.5.3.1. | - |
| Measurement bandwidth | n_{PRB} | 5MHz: 10-15 10MHz: 22-27 20MHz: 47-52 | 47-52 | 47-52 |
| PDSCH Reference measurement channel defined in A.3.1.1 | | 5MHz: R.4 TDD 10MHz: R.0 TDD 20MHz: R.3 TDD | R.0 FS3 | - |

| | | | | | |
|---|-------------|--|---|--|--------------------------------------|
| PDSCH allocation | | n_{PRB} | 5MHz: 7-17 10MHz: 13-36 20MHz: 38-61 | 38-61 | - |
| PDCCH/PCFICH/PHICH Reference measurement channel defined in A.3.1.2 | | | 5MHz: R.11 TDD 10MHz: R.6 TDD 20MHz: R.10 TDD | R.0 FS3 | R.0 FS3 |
| OCNG Patterns defined in A.3.2 | | | 5MHz: OP.9 TDD 10MHz: OP.1 TDD 20MHz: OP.7 TDD | OP.13 FDD | 14 FDDOP. |
| PBCH_RA | | dB | 0 | 0 | 0 |
| PBCH_RB | | | | | |
| PSS_RA | | | | | |
| SSS_RA | | | | | |
| PCFICH_RB | | | | | |
| PHICH_RA | | | | | |
| PHICH_RB | | | | | |
| PDCCH_RA | | | | | |
| PDCCH_RB | | | | | |
| PDSCH_RA | | | | | |
| PDSCH_RB | | | | | |
| OCNG_RA ^{Note2} | | | | | |
| OCNG_RB ^{Note2} | | | | | |
| N_{oc} ^{Note3} | Bands TDD_A | dBm/15 kHz | -119.5 | - | |
| | Bands TDD_C | | -118.5 | | |
| | Bands TDD_E | | -117.5 | | |
| | Bands FS3_G | | - | (N_{oc} for Channel 1 +3.5dB) | |
| \hat{E}_s/I_{ot} | | dB | -4 | -5.52 ^{Note9} | -5.52 |
| RSRP ^{Note4} | Bands TDD_A | dBm/15 kHz | -123.5 | - | |
| | Bands TDD_C | | -122.5 | | |
| | Bands TDD_E | | -121.5 | | |
| | Bands FS3_G | | - | (RSRP for Cell 1 +3.5dB) | (RSRP for Cell 1 +3.5dB) |
| RSRQ ^{Note4} | Bands TDD_A | dBm/15 kHz | -16.25 | - | |
| | Bands TDD_C | | | | |
| | Bands TDD_E | | | | |
| | Bands FS3_G | | - | -17.34 ^{Note9} | -17.34 |
| I_o ^{Note4} | Bands TDD_A | 5MHz: dBm/4.5MHz 10MHz: dBm/9MHz 20MHz: dBm/18MHz | -90.26 +10log(N_{RB} , /50) | - | |
| | Bands TDD_C | | -89.26 +10log(N_{RB} , /50) | | |
| | Bands TDD_E | | -88.26 +10log(N_{RB} , /50) | | |
| | Bands FS3_G | | - | (I_o for Channel 1 +4.59dB ^{Note9}) | (I_o for Channel 1 +4.59dB) |

| | | | | | |
|-----------------------|---|----|------|----|----|
| \hat{E}_s / N_{oc} | | dB | -4 | -4 | -4 |
| Propagation condition | | - | AWGN | | |
| Note 1: | For special subframe and uplink-downlink configurations see Tables 4.2-1 and 4.2-2 in TS 36.211. | | | | |
| Note 2: | OCNG shall be used such that cells are fully allocated and a constant total transmitted power spectral density is achieved for all OFDM symbols. For cells with LBT model, OCNG is transmitted only in subframes with downlink transmission bursts, and is not transmitted during muted subframes or during DMTC windows. | | | | |
| Note 3: | Interference from other cells and noise sources not specified in the test is assumed to be constant over subcarriers and time and shall be modelled as AWGN of appropriate power for N_{oc} to be fulfilled. | | | | |
| Note 4: | RSRQ, RSRP and I_0 levels have been derived from other parameters for information purposes. They are not settable parameters themselves. | | | | |
| Note 5: | RSRP and RSRQ minimum requirements are specified assuming independent interference and noise at each receiver antenna port. | | | | |
| Note 6: | The selection of the bands for testing depends on the configuration of the carrier aggregation supported by the UEs. | | | | |
| Note 7: | This test verifies the RRM requirement which is independent of channel bandwidth and is performed according to the principle defined in section A.3.6.1. | | | | |
| Note 8: | E-UTRA operating band groups are as defined in Section 3.5. | | | | |
| Note 9: | The value is corresponding to DRS transmission through LBT operation in Cell3. | | | | |

A.9.2.52.3 Test Requirements

In the test, the performance of RSRQ measurements is verified from following three perspectives:

- The absolute accuracy of intra-frequency RSRQ measurements for Cell 3 on the secondary component carrier with frame structure 3 shall fulfil the requirements defined in clause 9.1.19.2.
- The relative accuracy of inter-frequency RSRQ measurements between the primary and secondary component carriers for Cell 3 relative to Cell 1 shall fulfil the requirements defined in clause 9.1.19.4.

A.9.2.53 4DL FDD RSRQ for E-UTRAN in Carrier Aggregation

A.9.2.53.1 Test Purpose and Environment

The purpose of this test is to verify that the FDD RSRQ measurement accuracy in carrier aggregation is within the specified limits under AWGN propagation conditions. This test will verify the absolute accuracy of intra-frequency RSRQ measurements for the primary component carrier specified in clause 9.1.11.1, the absolute accuracy of intra-frequency RSRQ measurements for the secondary component carriers specified in clause 9.1.11.2 and also the relative inter-frequency RSRQ accuracy requirement between primary and secondary component carriers specified in clause 9.1.11.3.

A.9.2.53.2 Test parameters

In this set of test cases the PCell and the SCells are on different carrier frequencies. There are five cells used in this test case. Both RSRQ absolute and relative accuracy requirements of the primary and secondary component carriers are tested by using test parameters specified in Table A.9.2.53.2-1 and Table A.9.2.53.2-2. In the test, Cell 1 is the PCell, Cell 2, Cell 3 and Cell 4 are the SCells on secondary component carrier SCC1, SCC2 and SCC3 respectively. The SCC1, SCC2 and SCC3 are configured and activated.

Table A.9.2.53.2-1: 4 DL FDD RSRQ carrier aggregation test parameters for cell 1, cell 2 and cell 3

| Parameter | Unit | Cell 1 | Cell 2 | Cell 3 |
|--------------------------|-----------|--|--|--|
| E-UTRA RF Channel Number | | 1 | 2 | 3 |
| $BW_{channel}$ | MHz | 5MHz: $N_{RB,c} = 25$ 10MHz: $N_{RB,c} = 50$ 20MHz: $N_{RB,c} = 100$ | 5MHz: $N_{RB,c} = 25$ 10MHz: $N_{RB,c} = 50$ 20MHz: $N_{RB,c} = 100$ | 5MHz: $N_{RB,c} = 25$ 10MHz: $N_{RB,c} = 50$ 20MHz: $N_{RB,c} = 100$ |
| Measurement bandwidth | n_{PRB} | 5MHz: 10-15 10MHz: 22-27 | 5MHz: 10-15 10MHz: 22-27 | 5MHz: 10-15 10MHz: 22-27 |

| | | | | | | |
|---|--------------------------------------|--------|---|---|---|--------------------------------------|
| | | | 20MHz:47-52 | 20MHz: 47-52 | 20MHz: 47-52 | |
| PDSCH Reference measurement channel defined in A.3.1.1.1 | | | 5MHz:R.5 FDD 10MHz:R.0 FDD 20MHz:R.4 FDD | 5MHz:R.5 FDD 10MHz:R.0 FDD 20MHz:R.4 FDD | 5MHz:R.5 FDD 10MHz:R.0 FDD 20MHz:R.4 FDD | |
| PDSCH allocation | n_{PRB} | | 5MHz:7-17 10MHz:13-36 20MHz:38-61 | 5MHz:7-17 10MHz:13-36 20MHz:38-61 | 5MHz:7-17 10MHz:13-36 20MHz:38-61 | |
| PDCCH/PCFICH/PHICH Reference measurement channel defined in A.3.1.2.1 | | | 5MHz:R.11 FDD 10MHz:R.6 FDD 20MHz:R.10 FDD | 5MHz:R.11 FDD 10MHz:R.6 FDD 20MHz:R.10 FDD | 5MHz:R.11 FDD 10MHz:R.6 FDD 20MHz:R.10 FDD | |
| OCNG Patterns defined in A.3.2.1 | | | 5MHz:OP.15 FDD 10MHz:OP.1 FDD 20MHz:OP.11 FDD | 5MHz:OP.15 FDD 10MHz:OP.1 FDD 20MHz:OP.11 FDD | 5MHz:OP.15 FDD 10MHz:OP.1 FDD 20MHz:OP.11 FDD | |
| PBCH_RA | dB | | 0 | 0 | 0 | |
| PBCH_RB | | | | | | |
| PSS_RA | | | | | | |
| SSS_RA | | | | | | |
| PCFICH_RB | | | | | | |
| PHICH_RA | | | | | | |
| PHICH_RB | | | | | | |
| PDCCH_RA | | | | | | |
| PDCCH_RB | | | | | | |
| PDSCH_RA | | | | | | |
| PDSCH_RB | | | | | | |
| OCNG_RA ^{Note1} | | | | | | |
| OCNG_RB ^{Note1} | | | | | | |
| N_{oc} ^{Note2} | | | | | | dBm/15 kHz |
| | Bands FDD_B | -119 | -115.5 | | | |
| | Bands FDD_C | -118.5 | -115 | | | |
| | Bands FDD_D | -118 | -114.5 | | | |
| | Bands FDD_E, FDD_F ^{Note 6} | -117.5 | -114 | | | |
| | Bands FDD_G | -116.5 | -113 | | | |
| | Bands FDD_H | -116 | -112.5 | | | |
| \hat{E}_s / N_{oc} | dB | | -6.0 | -6.0 | -6.0 | |
| \hat{E}_s / I_{ot} ^{Note3} | dB | | -6.0 | -6.0 | -6.0 | |
| RSRP ^{Note3} | dBm/15 kHz | | Bands FDD_A | -125.5 | -122 | |
| | | | Bands FDD_B | -125 | -121.5 | |
| | | | Bands FDD_C | -124.5 | -121 | |
| | | | Bands FDD_D | -124 | -120.5 | |
| | | | Bands FDD_E, FDD_F ^{Note 6} | -123.5 | -120 | |
| | | | Bands FDD_G | -122.5 | -119 | |
| | | | Bands FDD_H | -122 | -118.5 | |
| RSRQ ^{Note3} | dB | | -17.77 | -17.77 | -17.77 | |
| | | | | | | Bands FDD_A |
| | | | | | | Bands FDD_B |
| | | | | | | Bands FDD_C |
| | | | | | | Bands FDD_D |
| | | | | | | Bands FDD_E, FDD_F ^{Note 6} |
| | | | | | | Bands FDD_G |
| Bands FDD_H | | | | | | |
| I_o ^{Note3} | dBm/ BW _{channel} | | Bands FDD_A | -90.75+ 10log(N _{RB,c} /50) | -87.25+ 10log(N _{RB,c} /50) | |
| | | | Bands FDD_B | -90.25+ 10log(N _{RB,c} /50) | -86.75+ 10log(N _{RB,c} /50) | |
| | | | Bands FDD_C | -89.75+ 10log(N _{RB,c} /50) | -86.25+ 10log(N _{RB,c} /50) | |
| | | | Bands FDD_D | -89.25+ 10log(N _{RB,c} /50) | -85.75+ 10log(N _{RB,c} /50) | |
| | | | Bands FDD_E, FDD_F ^{Note 6} | -88.75+ 10log(N _{RB,c} /50) | -85.25+ 10log(N _{RB,c} /50) | |

| | | | | | |
|---|-------------|--|---|---|---|
| | Bands FDD_G | | -87.75+ 10log(N _{RB,c} /50) | -84.25+ 10log(N _{RB,c} /50) | -84.25+ 10log(N _{RB,c} /50) |
| | Bands FDD_H | | -87.25+ 10log(N _{RB,c} /50) | -83.75+ 10log(N _{RB,c} /50) | -83.75+ 10log(N _{RB,c} /50) |
| Propagation condition | - | | AWGN | AWGN | AWGN |
| Antenna Configuration | - | | 1x2 | 1x2 | 1x2 |
| Timing offset to Cell 1 | μs | | - | 0 | 0 |
| Time alignment error relative to cell 1 ^{Note 7} | | | - | ≤ TAE | ≤ TAE |
| Time alignment error relative to cell 2 ^{Note 7} | | | - | - | ≤ TAE |
| <p>Note 1: OCNG shall be used such that all cells are fully allocated and a constant total transmitted power spectral density is achieved for all OFDM symbols.</p> <p>Note 2: Interference from other cells and noise sources not specified in the test is assumed to be constant over subcarriers and time and shall be modelled as AWGN of appropriate power for N_{oc} to be fulfilled.</p> <p>Note 3: Es/lot, RSRQ, RSRP and Io levels have been derived from other parameters for information purposes. They are not settable parameters themselves.</p> <p>Note 4: RSRP and RSRQ minimum requirements are specified assuming independent interference and noise at each receiver antenna port.</p> <p>Note 5: The selection of the bands for testing depends on the configuration of the carrier aggregation supported by the UEs.</p> <p>Note 6: For Band 26, the tests shall be performed with the carrier frequency of the assigned E-UTRA channel bandwidth within 865-894 MHz.</p> <p>Note 7: Time alignment error (TAE) as specified in TS 36.104 [30] clause 6.5.3.1. The TAE value depends upon the type of carrier aggregation.</p> <p>Note 8: E-UTRA operating band groups are as defined in Section 3.5.</p> | | | | | |

Table A.9.2.53.2-2: 4 DL FDD RSRQ carrier aggregation test parameters for cell 4

| Parameter | Unit | Cell 4 | | |
|---|-----------|---|-------------|--------|
| E-UTRA RF Channel Number | | 2 | | |
| BW _{channel} | MHz | 5MHz: N _{RB,c} = 25 10MHz: N _{RB,c} = 50 20MHz: N _{RB,c} = 100 | | |
| Measurement bandwidth | n_{PRB} | 5MHz: 10-15 10MHz: 22-27 20MHz: 47-52 | | |
| PDSCH Reference measurement channel defined in A.3.1.1.1 | | 5MHz:R.5 FDD 10MHz:R.0 FDD 20MHz:R.4 FDD | | |
| PDSCH allocation | n_{PRB} | 5MHz:7-17 10MHz:13-36 20MHz:38-61 | | |
| PDCCH/PCFICH/PHICH Reference measurement channel defined in A.3.1.2.1 | | 5MHz:R.11 FDD 10MHz:R.6 FDD 20MHz:R.10 FDD | | |
| OCNG Patterns defined in A.3.2.1 | | 5MHz:OP.15 FDD 10MHz:OP.1 FDD 20MHz:OP.11 FDD | | |
| PBCH_RA | dB | 0 | | |
| PBCH_RB | | | | |
| PSS_RA | | | | |
| SSS_RA | | | | |
| PCFICH_RB | | | | |
| PHICH_RA | | | | |
| PHICH_RB | | | | |
| PDCCH_RA | | | | |
| PDCCH_RB | | | | |
| PDSCH_RA | | | | |
| PDSCH_RB | | | | |
| OCNG_RA ^{Note1} | | | | |
| OCNG_RB ^{Note1} | | | | |
| N ^{Note2} | | | Bands FDD_A | dBm/15 |
| | | | | -116 |

| | | | |
|--|---|-------------------------------|---|
| | Bands FDD_B | kHz | -115.5 |
| | Bands FDD_C | | -115 |
| | Bands FDD_D | | -114.5 |
| | Bands FDD_E, FDD_F ^{Note 6} | | -114 |
| | Bands FDD_G | | -113 |
| | Bands FDD_H | | -112.5 |
| \hat{E}_s / N_{oc} | | dB | -6.0 |
| \hat{E}_s / I_{ot} ^{Note3} | | dB | -6.0 |
| RSRP ^{Note3} | Bands FDD_A | dBm/15 kHz | -122 |
| | Bands FDD_B | | -121.5 |
| | Bands FDD_C | | -121 |
| | Bands FDD_D | | -120.5 |
| | Bands FDD_E, FDD_F ^{Note 6} | | -120 |
| | Bands FDD_G | | -119 |
| | Bands FDD_H | | -118.5 |
| RSRQ ^{Note3} | Bands FDD_A | dB | -17.77 |
| | Bands FDD_B | | |
| | Bands FDD_C | | |
| | Bands FDD_D | | |
| | Bands FDD_E, FDD_F ^{Note 6} | | |
| | Bands FDD_G | | |
| | Bands FDD_H | | |
| Io ^{Note3} | Bands FDD_A | dBm/ BW _{channel} | -87.25+ 10log(N _{RB,c} /50) |
| | Bands FDD_B | | -86.75+ 10log(N _{RB,c} /50) |
| | Bands FDD_C | | -86.25+ 10log(N _{RB,c} /50) |
| | Bands FDD_D | | -85.75+ 10log(N _{RB,c} /50) |
| | Bands FDD_E, FDD_F ^{Note 6} | | -85.25+ 10log(N _{RB,c} /50) |
| | Bands FDD_G | | -84.25+ 10log(N _{RB,c} /50) |
| | Bands FDD_H | | -83.75+ 10log(N _{RB,c} /50) |
| | Propagation condition | | - |
| Antenna Configuration | - | 1x2 | |
| Timing offset to Cell 1 | µs | 0 | |
| Time alignment error relative to cell 1 ^{Note 7} | | ≤ TAE | |
| Time alignment error relative to cell 2 ^{Note 7} | | ≤ TAE | |
| Time alignment error relative to cell 3 ^{Note 7} | | ≤ TAE | |
| Time alignment error relative to cell 4 ^{Note 7} | | - | |
| <p>Note 1: OCNG shall be used such that all cells are fully allocated and a constant total transmitted power spectral density is achieved for all OFDM symbols.</p> <p>Note 2: Interference from other cells and noise sources not specified in the test is assumed to be constant over subcarriers and time and shall be modelled as AWGN of appropriate power for N_{oc} to be fulfilled.</p> <p>Note 3: E_s/I_{ot}, RSRQ, RSRP and I_o levels have been derived from other parameters for information purposes. They are not settable parameters themselves.</p> <p>Note 4: RSRP and RSRQ minimum requirements are specified assuming independent interference and noise at each receiver antenna port.</p> <p>Note 5: The selection of the bands for testing depends on the configuration of the carrier aggregation supported by the UEs.</p> <p>Note 6: For Band 26, the tests shall be performed with the carrier frequency of the assigned E-UTRA channel bandwidth within 865-894 MHz.</p> <p>Note 7: Time alignment error (TAE) as specified in TS 36.104 [30] clause 6.5.3.1. The TAE value depends upon the type of carrier aggregation.</p> <p>Note 8: E-UTRA operating band groups are as defined in Section 3.5.</p> | | | |

A.9.2.53.3 Test Requirements

In the test, the RSRQ measurement accuracy in carrier aggregation shall fulfil the requirements in clause 9.1.11.1, 9.1.11.2, and 9.1.11.3.

- The absolute accuracy of intra-frequency RSRQ measurements of Cell 1 on the primary component carrier shall fulfil the requirements defined in clause 9.1.11.1.
- The absolute accuracy of intra-frequency RSRQ measurements of Cell 2 on SCC1 shall fulfil the requirements defined in clause 9.1.11.2.
- The absolute accuracy of intra-frequency RSRQ measurements of Cell 3 on SCC2 shall fulfil the requirements defined in clause 9.1.11.2.
- The absolute accuracy of intra-frequency RSRQ measurements of Cell 4 on SCC3 shall fulfil the requirements defined in clause 9.1.11.2.
- The relative accuracy of inter-frequency RSRQ measurements between the primary component carrier and SCC1 for Cell 2 relative to Cell 1 shall fulfil the requirements defined in clause 9.1.11.3.
- The relative accuracy of inter-frequency RSRQ measurements between the primary component carrier and SCC2 for Cell 3 relative to Cell 1 shall fulfil the requirements defined in clause 9.1.11.3.
- The relative accuracy of inter-frequency RSRQ measurements between the primary component carrier and SCC3 for Cell 4 relative to Cell 1 shall fulfil the requirements defined in clause 9.1.11.3.

A.9.2.54 4DL TDD RSRQ for E-UTRAN in Carrier Aggregation

A.9.2.54.1 Test Purpose and Environment

The purpose of this test is to verify that the TDD RSRQ measurement accuracy in carrier aggregation is within the specified limits under AWGN propagation conditions. This test will verify the absolute accuracy of intra-frequency RSRQ measurements for the primary component carrier specified in clause 9.1.11.1, the absolute accuracy of intra-frequency RSRQ measurements for the secondary component carriers specified in clause 9.1.11.2 and also the relative inter-frequency RSRQ accuracy requirement between primary and secondary component carriers specified in clause 9.1.11.3.

A.9.2.54.2 Test parameters

In this set of test cases the PCell and the SCells are on different carrier frequencies. There are five cells used in this test case. Both RSRQ absolute and relative accuracy requirements of the primary and secondary component carriers are tested by using test parameters specified in Table A.9.2.54.2-1 and Table A.9.2.54.2-2. In the test, Cell 1 is the PCell, Cell 2, Cell 3 and Cell 4 are the SCells on secondary component carrier SCC1, SCC2 and SCC3 respectively. The SCC1, SCC2 and SCC3 are configured and activated.

Table A.9.2.54.2-1: 4 DL TDD RSRQ carrier aggregation test parameters for cell 1, cell 2 and cell 3

| Parameter | Unit | Cell 1 | Cell 2 | Cell 3 |
|--|-----------|---|---|---|
| E-UTRA RF Channel Number | | 1 | 2 | 3 |
| BW _{channel} | MHz | 5MHz: N _{RB,c} = 25 10MHz: N _{RB,c} = 54 20MHz: N _{RB,c} = 100 | 5MHz: N _{RB,c} = 25 10MHz: N _{RB,c} = 54 20MHz: N _{RB,c} = 100 | 5MHz: N _{RB,c} = 25 10MHz: N _{RB,c} = 54 20MHz: N _{RB,c} = 100 |
| Special subframe configuration ^{Note1} | | 6 | | |
| Uplink-downlink configuration ^{Note1} | | 1 | | |
| Measurement bandwidth | n_{PRB} | 5MHz: 10-15 10MHz: 22-27 20MHz: 47-52 | 5MHz: 10-15 10MHz: 22-27 20MHz: 47-52 | 5MHz: 10-15 10MHz: 22-27 20MHz: 47-52 |
| PDSCH Reference measurement channel defined in A.3.1.1.1 | | 5MHz: R.4 TDD 10MHz: R.0 TDD 20MHz: R.3 TDD | 5MHz: R.4 TDD 10MHz: R.0 TDD 20MHz: R.3 TDD | 5MHz: R.4 TDD 10MHz: R.0 TDD 20MHz: R.3 TDD |
| PDSCH allocation | n_{PRB} | 5MHz: 7-17 10MHz: 13-36 | 5MHz: 7-17 10MHz: 13-36 | 5MHz: 7-17 10MHz: 13-36 |

| | | | | | |
|---|------------------------------|-------------------------------|--|--|--|
| | | | 20MHz: 38-61 | 20MHz: 38-61 | 20MHz: 38-61 |
| PDCCH/PCFICH/PHICH Reference measurement channel defined in A.3.1.2.1 | | | 5MHz: R.11 TDD 10MHz: R.6 TDD 20MHz: R.10 TDD | 5MHz:R.11 TDD 10MHz:R.6 TDD 20MHz:R.10 TDD | 5MHz:R.11 TDD 10MHz:R.6 TDD 20MHz:R.10 TDD |
| OCNG Patterns defined in A.3.2.1 | | | 5MHz: OP.9 TDD 10MHz: OP.1 TDD 20MHz: OP.7 TDD | 5MHz: OP.9 TDD 10MHz: OP.1 TDD 20MHz: OP.7 TDD | 5MHz: OP.9 TDD 10MHz: OP.1 TDD 20MHz: OP.7 TDD |
| PBCH_RA | | | | | |
| PBCH_RB | | | | | |
| PSS_RA | | | | | |
| SSS_RA | | | | | |
| PCFICH_RB | | | | | |
| PHICH_RA | | | | | |
| PHICH_RB | | | | | |
| PDCCH_RA | | | | | |
| PDCCH_RB | | | | | |
| PDSCH_RA | | | | | |
| PDSCH_RB | | | | | |
| OCNG_RA ^{Note2} | | | | | |
| OCNG_RB ^{Note2} | | | | | |
| N_{oc} ^{Note3} | Bands TDD_A | dBm/15 kHz | -119.5 | -116 | -116 |
| | Bands TDD_C | | -118.5 | -115 | -115 |
| | Bands TDD_E | | -117.5 | -114 | -114 |
| \hat{E}_s/N_{oc} | | dB | -6.0 | -6.0 | -6.0 |
| \hat{E}_s/I_{ot} ^{Note4} | | dB | -6.0 | -6.0 | -6.0 |
| RSRP ^{Note4} | Bands TDD_A | dBm/15 kHz | -125.5 | -122 | -122 |
| | Bands TDD_C | | -124.5 | -121 | -121 |
| | Bands TDD_E | | -123.5 | -120 | -120 |
| RSRQ ^{Note4} | Bands TDD_A, TDD_C, TDD_E | dB | -17.77 | -17.77 | -17.77 |
| I_o ^{Note4} | Bands TDD_A | dBm/ BW _{channel} | -90.75+ 10log(N _{RB,c} /54) | -87.25+ 10log(N _{RB,c} /54) | -87.25+ 10log(N _{RB,c} /54) |
| | Bands TDD_C | | -89.75+ 10log(N _{RB,c} /54) | -86.25+ 10log(N _{RB,c} /54) | -86.25+ 10log(N _{RB,c} /54) |
| | Bands TDD_E | | -88.75+ 10log(N _{RB,c} /54) | -85.25+ 10log(N _{RB,c} /54) | -85.25+ 10log(N _{RB,c} /54) |
| Propagation condition | | - | AWGN | AWGN | AWGN |
| Antenna Configuration | | - | 1x2 | 1x2 | 1x2 |
| Timing offset to Cell 1 | | μs | - | 0 | 0 |
| Time alignment error relative to cell 1 ^{Note 7} | | | - | ≤ TAE | ≤ TAE |
| Time alignment error relative to cell 2 ^{Note 7} | | | - | - | ≤ TAE |
| <p>Note 1: For special subframe and uplink-downlink configurations see Tables 4.2-1 and 4.2-2 in TS 36.211.</p> <p>Note 2: OCNG shall be used such that all cells are fully allocated and a constant total transmitted power spectral density is achieved for all OFDM symbols.</p> <p>Note 3: Interference from other cells and noise sources not specified in the test is assumed to be constant over subcarriers and time and shall be modelled as AWGN of appropriate power for N_{oc} to be fulfilled.</p> <p>Note 4: E_s/I_{ot}, RSRQ, RSRP and I_o levels have been derived from other parameters for information purposes. They are not settable parameters themselves.</p> <p>Note 5: RSRP and RSRQ minimum requirements are specified assuming independent interference and noise at each receiver antenna port.</p> <p>Note 6: The selection of the bands for testing depends on the configuration of the carrier aggregation supported by the UEs.</p> <p>Note 7: Time alignment error (TAE) as specified in TS 36.104 [30] clause 6.5.3.1. The TAE value depends upon the</p> | | | | | |

type of carrier aggregation.
 Note 8: E-UTRA operating band groups are as defined in Section 3.5.

Table A.9.2.54.2-2: 4 DL TDD RSRQ carrier aggregation test parameters for cell 4

| Parameter | | Unit | Cell 4 |
|---|---------------------------|-------------------------------|---|
| E-UTRA RF Channel Number | | | 4 |
| BW _{channel} | | MHz | 5MHz: N _{RB,c} = 25 10MHz: N _{RB,c} = 54 20MHz: N _{RB,c} = 100 |
| Special subframe configuration ^{Note1} | | | 6 |
| Uplink-downlink configuration ^{Note1} | | | 1 |
| Measurement bandwidth | | <i>n</i> _{PRB} | 5MHz: 10-15 10MHz: 22-27 20MHz: 47-52 |
| PDSCH Reference measurement channel defined in A.3.1.1.1 | | | 5MHz: R.4 TDD 10MHz: R.0 TDD 20MHz: R.3 TDD |
| PDSCH allocation | | <i>n</i> _{PRB} | 5MHz: 7-17 10MHz: 13-36 20MHz: 38-61 |
| PDCCH/PCFICH/PHICH Reference measurement channel defined in A.3.1.2.1 | | | 5MHz:R.11 TDD 10MHz:R.6 TDD 20MHz:R.10 TDD |
| OCNG Patterns defined in A.3.2.1 | | | 5MHz: OP.9 TDD 10MHz: OP.1 TDD 20MHz: OP.7 TDD |
| PBCH_RA | | dB | 0 |
| PBCH_RB | | | |
| PSS_RA | | | |
| SSS_RA | | | |
| PCFICH_RB | | | |
| PHICH_RA | | | |
| PHICH_RB | | | |
| PDCCH_RA | | | |
| PDCCH_RB | | | |
| PDSCH_RA | | | |
| PDSCH_RB | | | |
| OCNG_RA ^{Note2} | | | |
| OCNG_RB ^{Note2} | | | |
| <i>N</i> _{oc} ^{Note3} | Bands TDD_A | | |
| | Bands TDD_C | -115 | |
| | Bands TDD_E | -114 | |
| \hat{E}_s / N_{oc} | | dB | -6.0 |
| \hat{E}_s / I_{ot} ^{Note4} | | dB | -6.0 |
| RSRP ^{Note4} | Bands TDD_A | dBm/15 kHz | -122 |
| | Bands TDD_C | | -121 |
| | Bands TDD_E | | -120 |
| RSRQ ^{Note4} | Bands TDD_A, TDD_C, TDD_E | dB | -17.77 |
| I _o ^{Note4} | Bands TDD_A | dBm/ BW _{channel} | -87.25+ 10log(N _{RB,c} /54) |
| | Bands TDD_C | | -86.25+ 10log(N _{RB,c} /54) |

| | Bands TDD_E | | -85.25+ 10log(N _{RB,c} /54) |
|--|-------------|----|---|
| Propagation condition | | - | AWGN |
| Antenna Configuration | | - | 1x2 |
| Timing offset to Cell 1 | | μs | 0 |
| Time alignment error relative to cell 1 ^{Note 7} | | | ≤ TAE |
| Time alignment error relative to cell 2 ^{Note 7} | | | ≤ TAE |
| Time alignment error relative to cell 3 ^{Note 7} | | | ≤ TAE |
| Time alignment error relative to cell 4 ^{Note 7} | | | - |
| <p>Note 1: For special subframe and uplink-downlink configurations see Tables 4.2-1 and 4.2-2 in TS 36.211.</p> <p>Note 2: OCNG shall be used such that all cells are fully allocated and a constant total transmitted power spectral density is achieved for all OFDM symbols.</p> <p>Note 3: Interference from other cells and noise sources not specified in the test is assumed to be constant over subcarriers and time and shall be modelled as AWGN of appropriate power for N_{oc} to be fulfilled.</p> <p>Note 4: Es/lot, RSRQ, RSRP and Io levels have been derived from other parameters for information purposes. They are not settable parameters themselves.</p> <p>Note 5: RSRP and RSRQ minimum requirements are specified assuming independent interference and noise at each receiver antenna port.</p> <p>Note 6: The selection of the bands for testing depends on the configuration of the carrier aggregation supported by the UEs.</p> <p>Note 7: Time alignment error (TAE) as specified in TS 36.104 [30] clause 6.5.3.1. The TAE value depends upon the type of carrier aggregation.</p> <p>Note 8: E-UTRA operating band groups are as defined in Section 3.5.</p> | | | |

A.9.2.54.3 Test Requirements

In the test, the RSRQ measurement accuracy in carrier aggregation shall fulfil the requirements in clause 9.1.11.1, 9.1.11.2, and 9.1.11.3.

- The absolute accuracy of intra-frequency RSRQ measurements of Cell 1 on the primary component carrier shall fulfil the requirements defined in clause 9.1.11.1.
- The absolute accuracy of intra-frequency RSRQ measurements of Cell 2 on SCC1 shall fulfil the requirements defined in clause 9.1.11.2.
- The absolute accuracy of intra-frequency RSRQ measurements of Cell 3 on SCC2 shall fulfil the requirements defined in clause 9.1.11.2.
- The absolute accuracy of intra-frequency RSRQ measurements of Cell 4 on SCC3 shall fulfil the requirements defined in clause 9.1.11.2.
- The relative accuracy of inter-frequency RSRQ measurements between the primary component carrier and SCC1 for Cell 2 relative to Cell 1 shall fulfil the requirements defined in clause 9.1.11.3.
- The relative accuracy of inter-frequency RSRQ measurements between the primary component carrier and SCC2 for Cell 3 relative to Cell 1 shall fulfil the requirements defined in clause 9.1.11.3.
- The relative accuracy of inter-frequency RSRQ measurements between the primary component carrier and SCC3 for Cell 4 relative to Cell 1 shall fulfil the requirements defined in clause 9.1.11.3.

A.9.3 UTRAN FDD CPICH RSCP

A.9.3.1 E-UTRAN FDD

A.9.3.1.1 Test Purpose and Environment

The purpose of this test is to verify that the CPICH RSCP absolute measurement accuracy is within the specified limits. This test will verify the requirements in Clause 9.2.1. There are two different test setups with different UTRAN parameters.

A.9.3.1.2 Parameters

The test parameters are given in Tables A.9.3.1.2-1, A.9.3.1.2-2 and A.9.3.1.2-3 below.

Table A.9.3.1.2-1: General test parameters for UTRAN FDD CPICH RSCP absolute measurement accuracy test in E-UTRAN FDD

| Parameter | Unit | Value | Comment |
|--|------|--|--|
| PDSCH parameters | | DL Reference Measurement Channel R.0 FDD | As specified in clause A.3.1.1.1 |
| PCFICH/PDCCH/PHICH parameters | | DL Reference Measurement Channel R.6 FDD | As specified in clause A.3.1.2.1 |
| E-UTRAN RF Channel Number | | 1 | One E-UTRAN FDD carrier frequency is used. |
| UTRAN RF Channel Number | | 1 | One UTRAN FDD carrier frequency is used. |
| E-UTRAN Channel Bandwidth ($BW_{channel}$) | MHz | 10 | |
| Active cell | | Cell 1 | E-UTRAN cell 1 on RF channel number 1 |
| Neighbor cells | | Cell 2 | UTRAN cell 2 on RF channel number 1 |
| Gap Pattern Id | | 0 | As specified in TS 36.133 clause 8.1.2.1. |
| Inter-RAT (UTRAN FDD) measurement quantity | | CPICH RSCP | |
| Monitored UTRA FDD cell list size | | 12 | UTRA cells on UTRA RF channel 1 provided in the cell list. |
| CP length | | Normal | |
| Filter coefficient | | 0 | L3 filtering is not used |
| DRX | | OFF | OFF |

Table A.9.3.1.2-2: E-UTRAN FDD cell specific test parameters for UTRAN FDD CPICH RSCP absolute measurement accuracy test in E-UTRAN FDD

| Parameter | Unit | Test 1 | Test 2 |
|---|------|----------|--------|
| E-UTRAN RF Channel Number | | 1 | |
| $BW_{channel}$ | MHz | 10 | |
| OCNG Patterns defined in A.3.2.1.1 (OP.1 FDD) | | OP.1 FDD | |
| PBCH_RA | dB | 0 | |
| PBCH_RB | dB | | |
| PSS_RA | dB | | |
| SSS_RA | dB | | |
| PCFICH_RB | dB | | |
| PHICH_RA | dB | | |
| PHICH_RB | dB | | |
| PDCCH_RA | dB | | |
| PDCCH_RB | dB | | |
| PDSCH_RA | dB | | |
| PDSCH_RB | dB | | |
| OCNG_RA ^{Note 1} | dB | | |
| OCNG_RB ^{Note 1} | dB | | |

| | | |
|--|------------|------|
| N_{oc} ^{Note 2} | dBm/15 kHz | -98 |
| RSRP ^{Note 3} | dBm/15 kHz | -94 |
| \hat{E}_s/I_{ot} | dB | 4 |
| SCH_RP ^{Note 3} | dBm/15 kHz | -94 |
| \hat{E}_s/N_{oc} | dB | 4 |
| Propagation Condition | | AWGN |
| <p>Note 1: OCNG shall be used such that all cells are fully allocated and a constant total transmitted power spectral density is achieved for all OFDM symbols.</p> <p>Note 2: Interference from other cells and noise sources not specified in the test is assumed to be constant over subcarriers and time and shall be modeled as AWGN of appropriate power for N_{oc} to be fulfilled.</p> <p>Note 3: RSRP and SCH_RP levels have been derived from other parameters for information purposes. They are not settable parameters themselves.</p> | | |

Table A.9.3.1.2-3: UTRAN FDD cell specific test parameters for UTRAN FDD CPICH RSCP absolute measurement accuracy test in E-UTRAN FDD

| Parameter | | Unit | Test 1 Cell 2 | Test 2 Cell 2 |
|---|--|--------------|------------------|------------------|
| CPICH_Ec/lor | | dB | -10 | -10 |
| PCCPCH_Ec/lor | | dB | -12 | -12 |
| SCH_Ec/lor | | dB | -12 | -12 |
| PICH_Ec/lor | | dB | -15 | -15 |
| DPCH_Ec/lor | | dB | - | - |
| OCNS_Ec/lor | | dB | -0.94 | -0.94 |
| lor | Band I, IV, VI, X, XI, XIX, XXI | dBm/3.84 MHz | -60.00 | -94.46 |
| | Band II, V, VII | | | -92.46 |
| | Band XXV, XXVI | | | -90.96 (Note 3) |
| | Band III, VIII, XII, XIII, XIV, XX, XXII | | | -91.46 |
| | Band IX (Note 2) | | | -93.46 |
| lor/lor | | dB | 9.54 | -9.54 |
| CPICH RSCP, Note 1 | Band I, IV, VI, X, XI, XIX, XXI | dBm | -60.46 | -114.0 |
| | Band II, V, VII | | | -112.0 |
| | Band XXV, XXVI | | | -110.5 (Note 3) |
| | Band III, VIII, XII, XIII, XIV, XX, XXII | | | -111.0 |
| | Band IX (Note 2) | | | -113.0 |
| lo, Note 1 | Band I, IV, VI, X, XI, XIX, XXI | dBm/3.84 MHz | -50.00 | -94.0 |
| | Band II, V, VII | | | -92.0 |
| | Band XXV, XXVI | | | -90.5 (Note 3) |
| | Band III, VIII, XII, XIII, XIV, XX, XXII | | | -91.0 |
| | Band IX (Note 2) | | | -93.0 |
| Propagation condition | | - | AWGN | AWGN |
| <p>NOTE 1: CPICH RSCP and lo levels have been calculated from other parameters for information purposes. They are not settable parameters themselves.</p> <p>NOTE 2: For the UE which supports both Band III and Band IX operating frequencies, the measurement performance requirements for Band III shall apply to the multi-band UE.</p> <p>NOTE 3: The test parameter is modified by -1.5 dB when the carrier frequency of the assigned UTRA channel is within 869-894 MHz for the UE which supports both Band V and Band XXVI operating frequencies.</p> | | | | |
| Tests shall be done sequentially. Test 1 shall be done first. After test 1 has been executed test parameters for test 2 shall be set within 5 seconds so that UE does not loose the Cell 2 in between the tests. | | | | |

A.9.3.1.3 Test Requirements

The CPICH RSCP measurement absolute accuracy shall meet the requirements in Clause 9.2.1.

A.9.3.2 E-UTRAN TDD

A.9.3.2.1 Test Purpose and Environment

The purpose of this test is to verify that the CPICH RSCP absolute measurement accuracy is within the specified limits. This test will verify the requirements in Clause 9.2.1. There are three different test setups with different UTRAN parameters.

A.9.3.2.2 Parameters

The test parameters are given in Tables A.9.3.2.2-1, A.9.3.2.2-2 and A.9.3.2.2-3 below.

Table A.9.3.2.2-1: General test parameters for UTRAN FDD CPICH RSCP absolute measurement accuracy test in E-UTRAN TDD

| Parameter | Unit | Value | Comment |
|---|------|--|--|
| PDSCH parameters | | DL Reference Measurement Channel R.0 TDD | As specified in clause A.3.1.1.2 |
| PCFICH/PDCCH/PHICH parameters | | DL Reference Measurement Channel R.6 TDD | As specified in clause A.3.1.2.2 |
| E-UTRAN RF Channel Number | | 1 | One E-UTRAN TDD carrier frequency is used. |
| UTRAN RF Channel Number | | 1 | One UTRAN FDD carrier frequency is used. |
| E-UTRAN Channel Bandwidth (BW_{channel}) | MHz | 10 | |
| Active cell | | Cell 1 | E-UTRAN cell 1 on RF channel number 1 |
| Neighbor cells | | Cell 2 | UTRAN cell 2 on RF channel number 1 |
| Gap Pattern Id | | 1 | As specified in TS 36.133 clause 8.1.2.1. |
| Inter-RAT (UTRAN FDD) measurement quantity | | CPICH RSCP | |
| Monitored UTRA FDD cell list size | | 12 | UTRA cells on UTRA RF channel 1 provided in the cell list. |
| CP length | | Normal | |
| Filter coefficient | | 0 | L3 filtering is not used |
| DRX | | OFF | OFF |

Table A.9.3.2.2-2: E-UTRAN TDD cell specific test parameters for UTRAN FDD CPICH RSCP absolute measurement accuracy test in E-UTRAN TDD

| Parameter | Unit | Test 1 | Test 2 |
|--|------------|--------|----------|
| E-UTRAN RF Channel Number | | | 1 |
| BW_{channel} | MHz | | 10 |
| Special subframe configuration ^{Note 1} | | | 6 |
| Uplink-downlink configuration ^{Note 1} | | | 1 |
| OCNG Patterns defined in A.3.2.2.1 (OP.1 TDD) | | | OP.1 TDD |
| PBCH_RA | dB | | |
| PBCH_RB | dB | | |
| PSS_RA | dB | | |
| SSS_RA | dB | | |
| PCFICH_RB | dB | | |
| PHICH_RA | dB | | |
| PHICH_RB | dB | | 0 |
| PDCCH_RA | dB | | |
| PDCCH_RB | dB | | |
| PDSCH_RA | dB | | |
| PDSCH_RB | dB | | |
| OCNG_RA ^{Note 2} | dB | | |
| OCNG_RB ^{Note 2} | dB | | |
| N_{oc} ^{Note 3} | dBm/15 kHz | | -98 |

| | | |
|--------------------------|---|------|
| RSRP ^{Note 4} | dBm/15 kHz | -94 |
| \hat{E}_s/I_{ot} | dB | 4 |
| SCH_RP ^{Note 4} | dBm/15 kHz | -94 |
| \hat{E}_s/N_{oc} | dB | 4 |
| Propagation Condition | | AWGN |
| Note 1: | For special subframe and uplink-downlink configurations see Tables 4.2-1 and 4.2-2 in TS 36.211. | |
| Note 2: | OCNG shall be used such that all cells are fully allocated and a constant total transmitted power spectral density is achieved for all OFDM symbols. | |
| Note 3: | Interference from other cells and noise sources not specified in the test is assumed to be constant over subcarriers and time and shall be modeled as AWGN of appropriate power for N_{oc} to be fulfilled. | |
| Note 4: | RSRP and SCH_RP levels have been derived from other parameters for information purposes. They are not settable parameters themselves. | |

Table A.9.3.2.2-3: UTRAN FDD cell specific test parameters for UTRAN FDD CPICH RSCP absolute measurement accuracy test in E-UTRAN TDD

| Parameter | | Unit | Test 1 | Test 2 |
|--|--|--------------|--------|-----------------|
| | | | Cell 2 | Cell 2 |
| CPICH_Ec/lor | | dB | -10 | -10 |
| PCCPCH_Ec/lor | | dB | -12 | -12 |
| SCH_Ec/lor | | dB | -12 | -12 |
| PICH_Ec/lor | | dB | -15 | -15 |
| DPCH_Ec/lor | | dB | - | - |
| OCNS_Ec/lor | | dB | -0.94 | -0.94 |
| Ioc | Band I, IV, VI, X, XI, XIX, XXI | dBm/3.84 MHz | -60.00 | -94.46 |
| | Band II, V, VII | | | -92.46 |
| | Band XXV, XXVI | | | -90.96 (Note 3) |
| | Band III, VIII, XII, XIII, XIV, XX, XXII | | | -91.46 |
| | Band IX (Note 2) | | | -93.46 |
| lor/Ioc | | dB | 9.54 | -9.54 |
| CPICH RSCP, Note 1 | Band I, IV, VI, X, XI, XIX, XXI | dBm | -60.46 | -114.0 |
| | Band II, V, VII | | | -112.0 |
| | Band XXV, XXVI | | | -110.5 (Note 3) |
| | Band III, VIII, XII, XIII, XIV, XX, XXII | | | -111.0 |
| | Band IX (Note 2) | | | -113.0 |
| Io, Note 1 | Band I, IV, VI, X, XI, XIX, XXI | dBm/3.84 MHz | -50.00 | -94.0 |
| | Band II, V, VII | | | -92.0 |
| | Band XXV, XXVI | | | -90.5 (Note 3) |
| | Band III, VIII, XII, XIII, XIV, XX, XXII | | | -91.0 |
| | Band IX (Note 2) | | | -93.0 |
| Propagation condition | | - | AWGN | AWGN |
| NOTE 1: CPICH RSCP and Io levels have been calculated from other parameters for information purposes. They are not settable parameters themselves. | | | | |
| NOTE 2: For the UE which supports both Band III and Band IX operating frequencies, the measurement performance requirements for Band III shall apply to the multi-band UE. | | | | |
| NOTE 3: The test parameter is modified by -1.5 dB when the carrier frequency of the assigned UTRA channel is within 869-894 MHz for the UE which supports both Band V and Band XXVI operating frequencies. | | | | |
| Tests shall be done sequentially. Test 1 shall be done first. After test 1 has been executed test parameters for test 2 shall be set within 5 seconds so that UE does not loose the Cell 2 in between the tests. | | | | |

A.9.3.2.3 Test Requirements

The CPICH RSCP measurement absolute accuracy shall meet the requirements in Clause 9.2.1.

A.9.3.3 E-UTRAN FDD for 5MHz Bandwidth

A.9.3.3.1 Test Purpose and Environment

The purpose of this test case is the same as for the test defined in subclause A.9.3.1.1.

A.9.3.3.2 Parameters

The parameters of this test are the same as defined in Subclause A.9.3.1.2 except that the values of the parameters in the Table A.9.3.3.2-1 will replace the values of the corresponding parameters in A.9.3.1.2-1, and the values of E-UTRAN FDD cell specific parameters in the Table A.9.3.3.2-2 shall be adopted, and the values of UTRA FDD cell specific parameters shall be reused as defined in Table A.9.3.1.2-3 of Subclause A.9.3.1.2.

Table A.9.3.3.2-1: General test parameters for UTRAN FDD CPICH RSCP absolute measurement accuracy test in E-UTRAN FDD for 5MHz bandwidth

| Parameter | Unit | Value | Comment |
|--|------|---|----------------------------------|
| PDSCH parameters | | DL Reference Measurement Channel R.5 FDD | As specified in clause A.3.1.1.1 |
| PCFICH/PDCCH/PHICH parameters | | DL Reference Measurement Channel R.11 FDD | As specified in clause A.3.1.2.1 |
| E-UTRAN Channel Bandwidth (BW_{channel}) | MHz | 5 | |
| Note 1: See Table A.9.3.1.2-1 for other general test parameters. | | | |

Table A.9.3.3.2-2: E-UTRAN FDD cell specific test parameters for UTRAN FDD CPICH RSCP absolute measurement accuracy test in E-UTRAN FDD for 5MHz bandwidth

| Parameter | Unit | Test 1 | Test 2 |
|---|---------|-------------|--------|
| E-UTRAN RF Channel Number | | 1 | |
| BW_{channel} | MHz | 5 | |
| OCNG Patterns defined in A.3.2.1.15 (OP.15 FDD) | | OP.15 FDD | |
| PBCH_RA | dB | 0 | |
| PBCH_RB | dB | | |
| PSS_RA | dB | | |
| SSS_RA | dB | | |
| PCFICH_RB | dB | | |
| PHICH_RA | dB | | |
| PHICH_RB | dB | | |
| PDCCH_RA | dB | | |
| PDCCH_RB | dB | | |
| PDSCH_RA | dB | | |
| PDSCH_RB | dB | | |
| OCNG_RA ^{Note 1} | dB | | |
| OCNG_RB ^{Note 1} | dB | | |
| N_{oc} ^{Note 2} | Band 31 | | |
| RSRP ^{Note 3} | Band 31 | dBm/15 kHz | -94 |
| \hat{E}_s / I_{ot} | | dB | 4 |
| SCH_RP ^{Note 3} | Band 31 | dBm/15 kHz | -94 |
| \hat{E}_s / N_{oc} | | dB | 4 |
| I_o ^{Note 3} | Band 31 | dBm/4.5 MHz | -67.8 |
| Propagation Condition | | AWGN | |
| Note 1: OCNG shall be used such that all cells are fully allocated and a constant total transmitted power spectral density is achieved for all OFDM symbols. | | | |
| Note 2: Interference from other cells and noise sources not specified in the test is assumed to be constant over subcarriers and time and shall be modeled as AWGN of appropriate power for N_{oc} to be fulfilled. | | | |

Note 3: RSRP, SCH_RP and Io levels have been derived from other parameters for information purposes. They are not settable parameters themselves.

A.9.3.3.3 Test Requirements

The test requirements defined in section A.9.3.1.3 shall apply to this test case.

A.9.4 UTRAN FDD CPICH E_c/N_0

A.9.4.1 E-UTRAN FDD

A.9.4.1.1 Test Purpose and Environment

The purpose of this test is to verify that the CPICH E_c/N_0 absolute measurement accuracy is within the specified limits. This test will verify the requirements in Clause 9.2.3. There are three different test setups with different UTRAN parameters.

A.9.4.1.2 Parameters

The test parameters are given in Tables A.9.4.1.2-1, A.9.4.1.2-2 and A.9.4.1.2-3 below.

Table A.9.4.1.2-1: General test parameters for UTRAN FDD CPICH E_c/N_0 absolute measurement accuracy test in E-UTRAN FDD

| Parameter | Unit | Value | Comment |
|--|------|--|--|
| PDSCH parameters | | DL Reference Measurement Channel R.0 FDD | As specified in clause A.3.1.1.1 |
| PCFICH/PDCCH/PHICH parameters | | DL Reference Measurement Channel R.6 FDD | As specified in clause A.3.1.2.1 |
| E-UTRAN RF Channel Number | | 1 | One E-UTRAN FDD carrier frequency is used. |
| UTRAN RF Channel Number | | 1 | One UTRAN FDD carrier frequency is used. |
| E-UTRAN Channel Bandwidth ($BW_{channel}$) | MHz | 10 | |
| Active cell | | Cell 1 | E-UTRAN cell 1 on RF channel number 1 |
| Neighbor cells | | Cell 2 | UTRAN cell 2 on RF channel number 1 |
| Gap Pattern Id | | 0 | As specified in TS 36.133 clause 8.1.2.1. |
| Inter-RAT (UTRAN FDD) measurement quantity | | CPICH E_c/N_0 | |
| Monitored UTRA FDD cell list size | | 12 | UTRA cells on UTRA RF channel 1 provided in the cell list. |
| CP length | | Normal | |
| Filter coefficient | | 0 | L3 filtering is not used |
| DRX | | OFF | OFF |

Table A.9.4.1.2-2: E-UTRAN FDD cell specific test parameters for UTRAN FDD CPICH E_c/N_0 absolute measurement accuracy test in E-UTRAN FDD

| Parameter | Unit | Test 1 | Test 2 | Test 3 |
|---|------|--------|----------|--------|
| E-UTRAN RF Channel Number | | | 1 | |
| $BW_{channel}$ | MHz | | 10 | |
| OCNG Patterns defined in A.3.2.1.1 (OP.1 FDD) | | | OP.1 FDD | |
| PBCH_RA | dB | | 0 | |
| PBCH_RB | dB | | | |
| PSS_RA | dB | | | |
| SSS_RA | dB | | | |

| | | |
|---|------------|------|
| PCFICH_RB | dB | |
| PHICH_RA | dB | |
| PHICH_RB | dB | |
| PDCCH_RA | dB | |
| PDCCH_RB | dB | |
| PDSCH_RA | dB | |
| PDSCH_RB | dB | |
| OCNG_RA ^{Note 1} | dB | |
| OCNG_RB ^{Note 1} | dB | |
| N_{oc} ^{Note 2} | dBm/15 kHz | -98 |
| RSRP ^{Note 3} | dBm/15 kHz | -94 |
| \hat{E}_s/I_{ot} | dB | 4 |
| SCH_RP ^{Note 3} | dBm/15 kHz | -94 |
| \hat{E}_s/N_{oc} | dB | 4 |
| Propagation Condition | | AWGN |
| Note 1: OCNG shall be used such that all cells are fully allocated and a constant total transmitted power spectral density is achieved for all OFDM symbols. | | |
| Note 2: Interference from other cells and noise sources not specified in the test is assumed to be constant over subcarriers and time and shall be modeled as AWGN of appropriate power for N_{oc} to be fulfilled. | | |
| Note 3: RSRP and SCH_RP levels have been derived from other parameters for information purposes. They are not settable parameters themselves. | | |

Table A.9.4.1.2-3: UTRAN FDD cell specific test parameters for UTRAN FDD CPICH Ec/No absolute measurement accuracy test in E-UTRAN FDD

| Parameter | | Unit | Test 1 | Test 2 | Test 3 |
|---|--|---------------------|--------|--------|-----------------|
| | | | Cell 2 | Cell 2 | Cell 2 |
| CPICH_Ec/lor | | dB | -10 | -10 | -10 |
| PCCPCH_Ec/lor | | dB | -12 | -12 | -12 |
| SCH_Ec/lor | | dB | -12 | -12 | -12 |
| PICH_Ec/lor | | dB | -15 | -15 | -15 |
| DPCH_Ec/lor | | dB | - | - | - |
| OCNS_Ec/lor | | dB | -0.94 | -0.94 | -0.94 |
| loc | Band I, IV, VI, X, XI, XIX, XXI | dBm/ 3.84 MHz | -52.22 | -87.27 | -94.46 |
| | Band II, V, VII | | | | -92.46 |
| | Band XXV, XXVI | | | | -90.96 (Note 3) |
| | Band III, VIII, XII, XIII, XIV, XX, XXII | | | | -91.46 |
| | Band IX (Note 2) | | | | -93.46 |
| \bar{I}_{or}/loc | | dB | -1.75 | -4.7 | -9.54 |
| CPICH Ec/lo, Note 1 | | dBm | -14.0 | -16.0 | -20.0 |
| lo, Note 1 | Band I, IV, VI, X, XI, XIX, XXI | dBm/ 3.84 MHz | -50 | -86 | -94 |
| | Band II, V, VII | | | | -92.0 |
| | Band XXV, XXVI | | | | -90.5 (Note 3) |
| | Band III, VIII, XII, XIII, XIV, XX, XXII | | | | -91.0 |
| | Band IX (Note 2) | | | | -93 |
| Propagation condition | | - | AWGN | AWGN | AWGN |
| NOTE 1: CPICH Ec/lo and lo levels have been calculated from other parameters for information purposes. They are not settable parameters themselves. | | | | | |
| NOTE 2: For the UE which supports both Band III and Band IX operating frequencies, the measurement performance requirements for Band III shall apply to the multi-band UE. | | | | | |
| NOTE 3: The test parameter is modified by -1.5 dB when the carrier frequency of the assigned UTRA channel is within 869-894 MHz for the UE which supports both Band V and Band XXVI operating frequencies. | | | | | |
| Tests shall be done sequentially. Test 1 shall be done first. After test 1 has been executed test parameters for tests 2 and 3 shall be set within 5 seconds so that UE does not loose the Cell 2 in between the tests. | | | | | |

A.9.4.1.3 Test Requirements

The CPICH Ec/No measurement absolute accuracy shall meet the requirements in Clause 9.2.3.

The effect of assumed thermal noise and noise generated in the receiver (-99 dBm for frequency bands I, IV, VI, X, XI, XIX and XXI; -98 dBm for frequency band IX, -97dBm for frequency bands II, V and VII; -95.5dBm for frequency band XXV and XXVI; and -96dBm for frequency band III) shall be added into the required accuracy. The test requirements for the absolute CPICH_Ec/lo measurement are shown in Table A.9.4.1.3-1.

Table A.9.4.1.3-1: CPICH_Ec/lo absolute accuracy

| Parameter | Unit | Accuracy [dB] | | Conditions |
|--|------|--|-------------------|---|
| | | Normal condition | Extreme condition | Io [dBm/3,84 MHz] |
| CPICH_Ec/lo | dB | -2.7...1.5 for $-14 \leq \text{CPICH Ec/lo}$ -3.2...2 for $-16 \leq \text{CPICH Ec/lo} < -14$ -4.2...3 for $-20 \leq \text{CPICH Ec/lo} < -16$ | -4.2...3 | -94...-87(Band I, IV, VI, X, XI, XIX, XXI) -92...-85 (Band II, V, VII) -90.5...-83.5 (Band XXV, XXVI (Note 2)) -91...-84 (Band III, VIII, XII, XIII, XIV, XX, XXII) 93...-86 (Band IX (Note 1)) |
| | | ± 1.5 for $-14 \leq \text{CPICH Ec/lo}$ ± 2 for $-16 \leq \text{CPICH Ec/lo} < -14$ ± 3 for $-20 \leq \text{CPICH Ec/lo} < -16$ | ± 3 | -87...-50(Band I, IV, VI, X, XI, XIX, XXI) -85...-50 (Band II, V, VII) -83.5...-50 (Band XXV, XXVI (Note 2)) -84...-50 (Band III, VIII, XII, XIII, XIV, XX, XXII) -86...-50 (Band IX (Note 1)) |
| NOTE1: For the UE which supports both Band III and Band IX operating frequencies, the measurement performance requirements for Band III shall apply to the multi-band UE. | | | | |
| NOTE 2: The test parameter is modified by -1.5 dB when the carrier frequency of the assigned UTRA channel is within 869-894 MHz for the UE which supports both Band V and Band XXVI operating frequencies. | | | | |

A.9.4.2 E-UTRAN TDD

A.9.4.2.1 Test Purpose and Environment

The purpose of this test is to verify that the CPICH Ec/No absolute measurement accuracy is within the specified limits. This test will verify the requirements in Clause 9.2.3. There are three different test setups with different UTRAN parameters.

A.9.4.2.2 Parameters

The test parameters are given in Tables A.9.4.2.2-1, A.9.4.2.2-2 and A.9.4.2.2-3 below.

Table A.9.4.2.2-1: General test parameters for UTRAN FDD CPICH Ec/No absolute measurement accuracy test in E-UTRAN TDD

| Parameter | Unit | Value | Comment |
|---|------|--|--|
| PDSCH parameters | | DL Reference Measurement Channel R.0 TDD | As specified in clause A.3.1.1.2 |
| PCFICH/PDCCH/PHICH parameters | | DL Reference Measurement Channel R.6 TDD | As specified in clause A.3.1.2.2 |
| E-UTRAN RF Channel Number | | 1 | One E-UTRAN TDD carrier frequency is used. |
| UTRAN RF Channel Number | | 1 | One UTRAN FDD carrier frequency is used. |
| E-UTRAN Channel Bandwidth (BW_{channel}) | MHz | 10 | |

| | | | |
|--|--|-------------|--|
| Active cell | | Cell 1 | E-UTRAN cell 1 on RF channel number 1 |
| Neighbor cells | | Cell 2 | UTRAN cell 2 on RF channel number 1 |
| Gap Pattern Id | | 0 | As specified in TS 36.133 clause 8.1.2.1. |
| Inter-RAT (UTRAN FDD) measurement quantity | | CPICH Ec/No | |
| Monitored UTRA FDD cell list size | | 12 | UTRA cells on UTRA RF channel 1 provided in the cell list. |
| CP length | | Normal | |
| Filter coefficient | | 0 | L3 filtering is not used |
| DRX | | OFF | OFF |

Table A.9.4.2.2-2: E-UTRAN TDD cell specific test parameters for UTRAN FDD CPICH Ec/No absolute measurement accuracy test in E-UTRAN TDD

| Parameter | Unit | Test 1 | Test 2 | Test 3 |
|--|------------|--------|----------|--------|
| E-UTRAN RF Channel Number | | | 1 | |
| BW _{channel} | MHz | | 10 | |
| Special subframe configuration ^{Note1} | | | 6 | |
| Uplink-downlink configuration ^{Note1} | | | 1 | |
| OCNG Patterns defined in A.3.2.2.1 (OP.1 TDD) | | | OP.1 TDD | |
| PBCH_RA | dB | | | |
| PBCH_RB | dB | | | |
| PSS_RA | dB | | | |
| SSS_RA | dB | | | |
| PCFICH_RB | dB | | | |
| PHICH_RA | dB | | | |
| PHICH_RB | dB | | 0 | |
| PDCCH_RA | dB | | | |
| PDCCH_RB | dB | | | |
| PDSCH_RA | dB | | | |
| PDSCH_RB | dB | | | |
| OCNG_RA ^{Note 2} | dB | | | |
| OCNG_RB ^{Note 2} | dB | | | |
| N_{oc} ^{Note 3} | dBm/15 kHz | | -98 | |
| RSRP ^{Note 4} | dBm/15 kHz | | -94 | |
| \hat{E}_s/I_{ot} | dB | | 4 | |
| SCH_RP ^{Note 4} | dBm/15 kHz | | -94 | |
| \hat{E}_s/N_{oc} | dB | | 4 | |
| Propagation Condition | | | AWGN | |
| <p>Note 1: For special subframe and uplink-downlink configurations see Tables 4.2-1 and 4.2-2 in TS 36.211.</p> <p>Note 2: OCNG shall be used such that all cells are fully allocated and a constant total transmitted power spectral density is achieved for all OFDM symbols.</p> <p>Note 3: Interference from other cells and noise sources not specified in the test is assumed to be constant over subcarriers and time and shall be modeled as AWGN of appropriate power for N_{oc} to be fulfilled.</p> <p>Note 4: RSRP and SCH_RP levels have been derived from other parameters for information purposes. They are not settable parameters themselves.</p> | | | | |

Table A.9.4.2.2-3: UTRAN FDD cell specific test parameters for UTRAN FDD CPICH Ec/No absolute measurement accuracy test in E-UTRAN TDD

| Parameter | Unit | Test 1 | Test 2 | Test 3 |
|---------------|------|--------|--------|--------|
| | | Cell 2 | Cell 2 | Cell 2 |
| CPICH_Ec/Ior | dB | -10 | -10 | -10 |
| PCCPCH_Ec/Ior | dB | -12 | -12 | -12 |

| | | | | | |
|---|--|---------------------|--------|--------|-----------------|
| SCH_Ec/lor | | dB | -12 | -12 | -12 |
| PICH_Ec/lor | | dB | -15 | -15 | -15 |
| DPCH_Ec/lor | | dB | - | - | - |
| OCNS_Ec/lor | | dB | -0.94 | -0.94 | -0.94 |
| loc | Band I, IV, VI, X, XI, XIX, XXI | dBm/ 3.84 MHz | -52.22 | -87.27 | -94.46 |
| | Band II, V, VII | | | | -92.46 |
| | Band XXV, XXVI | | | | -90.96 (Note 3) |
| | Band III, VIII, XII, XIII, XIV, XX, XXII | | | | -91.46 |
| | Band IX (Note 2) | | | | -93.46 |
| lor/loc | | dB | -1.75 | -4.7 | -9.54 |
| CPICH Ec/lo, Note 1 | | dBm | -14.0 | -16.0 | -20.0 |
| lo, Note 1 | Band I, IV, VI, X, XI, XIX, XXI | dBm/ 3.84 MHz | -50 | -86 | -94 |
| | Band II, V, VII | | | | -92.0 |
| | Band XXV, XXVI | | | | -90.5 (Note 3) |
| | Band III, VIII, XII, XIII, XIV, XX, XXII | | | | -91.0 |
| | Band IX (Note 2) | | | | -93 |
| Propagation condition | | - | AWGN | AWGN | AWGN |
| NOTE 1: CPICH Ec/lo and lo levels have been calculated from other parameters for information purposes. They are not settable parameters themselves. | | | | | |
| NOTE 2: For the UE which supports both Band III and Band IX operating frequencies, the measurement performance requirements for Band III shall apply to the multi-band UE. | | | | | |
| NOTE 3: The test parameter is modified by -1.5 dB when the carrier frequency of the assigned UTRA channel is within 869-894 MHz for the UE which supports both Band V and Band XXVI operating frequencies. | | | | | |
| Tests shall be done sequentially. Test 1 shall be done first. After test 1 has been executed test parameters for tests 2 and 3 shall be set within 5 seconds so that UE does not loose the Cell 2 in between the tests. | | | | | |

A.9.4.2.3 Test Requirements

The CPICH Ec/No measurement absolute accuracy shall meet the requirements in Clause 9.2.3.

The effect of assumed thermal noise and noise generated in the receiver (-99 dBm for frequency bands I, IV, VI, X, XI, XIX and XXI; -98 dBm for frequency band IX, -97dBm for frequency bands II, V and VII; -95.5dBm for frequency band XXV and XXVI; and -96dBm for frequency band III) shall be added into the required accuracy. The test requirements for the absolute CPICH_Ec/lo measurement are shown in Table A.9.4.2.3-1.

Table A.9.4.2.3-1: CPICH_Ec/lo absolute accuracy

| Parameter | Unit | Accuracy [dB] | | Conditions |
|--|------|--|-------------------|---|
| | | Normal condition | Extreme condition | lo [dBm/3,84 MHz] |
| CPICH_Ec/lo | dB | -2.7...1.5 for $-14 \leq \text{CPICH Ec/lo}$ -3.2...2 for $-16 \leq \text{CPICH Ec/lo} < -14$ -4.2...3 for $-20 \leq \text{CPICH Ec/lo} < -16$ | -4.2...3 | -94...-87(Band I, IV, VI, X, XI, XIX, XXI) -92...-85 (Band II, V, VII) -90.5...-83.5 (Band XXV, XXVI (Note 2)) -91...-84 (Band III, VIII, XII, XIII, XIV, XX, XXII) 93...-86 (Band IX (Note 1)) |
| | | ± 1.5 for $-14 \leq \text{CPICH Ec/lo}$ ± 2 for $-16 \leq \text{CPICH Ec/lo} < -14$ ± 3 for $-20 \leq \text{CPICH Ec/lo} < -16$ | ± 3 | -87...-50(Band I, IV, VI, X, XI, XIX, XXI) -85...-50 (Band II, V, VII) -83.5...-50 (Band XXV, XXVI (Note 2)) -84...-50 (Band III, VIII, XII, XIII, XIV, XX, XXII) -86...-50 (Band IX (Note 1)) |
| NOTE1: For the UE which supports both Band III and Band IX operating frequencies, the measurement performance requirements for Band III shall apply to the multi-band UE. | | | | |
| NOTE 2: The test parameter is modified by -1.5 dB when the carrier frequency of the assigned UTRA channel is within 869-894 MHz for the UE which supports both Band V and Band XXVI operating frequencies. | | | | |

A.9.4.3 E-UTRAN FDD for 5MHz Bandwidth

A.9.4.3.1 Test Purpose and Environment

The purpose of this test case is the same as for the test defined in subclause A.9.4.1.1.

A.9.4.3.2 Parameters

The parameters of this test are the same as defined in Subclause A.9.4.1.2 except that the values of the parameters in the Table A.9.4.3.2-1 will replace the values of the corresponding parameters in A.9.4.1.2-1, and the values of E-UTRAN FDD cell specific parameters in the Table A.9.4.3.2-2 shall be adopted, and the values of UTRA FDD cell specific parameters shall be reused as defined in Table A.9.4.1.2-3 of Subclause A.9.4.1.2.

Table A.9.4.3.2-1: General test parameters for UTRAN FDD CPICH Ec/No absolute measurement accuracy test in E-UTRAN FDD for 5MHz bandwidth

| Parameter | Unit | Value | Comment |
|--|------|---|----------------------------------|
| PDSCH parameters | | DL Reference Measurement Channel R.5 FDD | As specified in clause A.3.1.1.1 |
| PCFICH/PDCCH/PHICH parameters | | DL Reference Measurement Channel R.11 FDD | As specified in clause A.3.1.2.1 |
| E-UTRAN Channel Bandwidth ($BW_{channel}$) | MHz | 5 | |

Note 1: See Table A.9.4.1.2-1 for other general test parameters.

Table A.9.4.3.2-2: E-UTRAN FDD cell specific test parameters for UTRAN FDD CPICH Ec/No absolute measurement accuracy test in E-UTRAN FDD for 5MHz bandwidth

| Parameter | Unit | Test 1 | Test 2 | Test 3 |
|--|---------|-------------|--------|--------|
| E-UTRAN RF Channel Number | | 1 | | |
| $BW_{channel}$ | MHz | 5 | | |
| OCNG Patterns defined in A.3.2.1.15 (OP.15 FDD) | | OP.15 FDD | | |
| PBCH_RA | dB | 0 | | |
| PBCH_RB | dB | | | |
| PSS_RA | dB | | | |
| SSS_RA | dB | | | |
| PCFICH_RB | dB | | | |
| PHICH_RA | dB | | | |
| PHICH_RB | dB | | | |
| PDCCH_RA | dB | | | |
| PDCCH_RB | dB | | | |
| PDSCH_RA | dB | | | |
| PDSCH_RB | dB | | | |
| OCNG_RA ^{Note 1} | dB | | | |
| OCNG_RB ^{Note 1} | dB | | | |
| N_{oc} ^{Note 2} | Band 31 | | | |
| RSRP ^{Note 3} | Band 31 | dBm/15 kHz | | |
| \hat{E}_s / I_{ot} | dB | 4 | | |
| SCH_RP ^{Note 3} | Band 31 | dBm/15 kHz | | |
| \hat{E}_s / N_{oc} | dB | 4 | | |
| I_o ^{Note3} | Band 31 | dBm/4.5 MHz | | |
| Propagation Condition | | AWGN | | |
| Note 1: OCNG shall be used such that all cells are fully allocated and a constant total transmitted power spectral density is achieved for all OFDM symbols. | | | | |
| Note 2: Interference from other cells and noise sources not specified in the test is assumed | | | | |

to be constant over subcarriers and time and shall be modeled as AWGN of appropriate power for N_{oc} to be fulfilled.

Note 3: RSRP and SCH_RP levels have been derived from other parameters for information purposes. They are not settable parameters themselves.

A.9.4.3.3 Test Requirements

The test requirements defined in section A.9.4.1.3 shall apply to this test case.

A.9.5 UTRAN TDD measurement

A.9.5.1 P-CCPCH RSCP absolute accuracy for E-UTRAN FDD

A.9.5.1.1 Test Purpose and Environment

The purpose of this test is to verify that the UTRAN TDD P-CCPCH RSCP measurement absolute accuracy is within the specified limits. This test will verify the requirements in clause 9.3.1 and applies to UE supporting this capability.

Gap pattern configuration with id #1 as specified in Table 8.1.2.1-1 is provided. In the measurement control information it is indicated to the UE that periodic reporting of the UTRA TDD P-CCPCH RSCP measurement is used.

A.9.5.1.2 Test parameters

In this set of test cases there are two cells. Cell 1 is a E-UTRA FDD cell and cell 2 is a UTRA TDD cell. The absolute accuracy of P-CCPCH RSCP measurements are tested by using test parameters in Table A.9.5.1-1, Table A.9.5.1-2, and Table A.9.5.1-3. In all test cases, Cell 1 is the PCell and Cell 2 is the target cell.

Table A.9.5.1-1: General test parameters for UTRA TDD P-CCPCH RSCP measurement absolute accuracy in E-UTRAN FDD

| Parameter | Unit | Value | Comment |
|--|------|--|---|
| PDSCH parameters | | DL Reference Measurement Channel R.0 FDD | As specified in clause A.3.1.1.1 |
| PCFICH/PDCCH/PHICH parameters | | DL Reference Measurement Channel R.6 FDD | As specified in clause A.3.1.2.1 |
| E-UTRAN RF Channel Number | | 1 | One E-UTRAN FDD carrier frequency is used. |
| UTRAN RF Channel Number | | 2 | One UTRAN TDD carrier frequency is used. |
| E-UTRAN Channel Bandwidth (BWchannel) | MHz | 10 | |
| Active cell | | Cell 1 | E-UTRAN FDD cell 1 on RF channel number 1 |
| Neighbor cells | | Cell 2 | 1.28Mcps UTRA TDD cell 2 on RF channel number 2 |
| Gap Pattern Id | | 1 | As specified in TS 36.133 clause 8.1.2.1. |
| CP length of cell 1 | | Normal | |
| Filter coefficient | | 0 | L3 filtering is not used |
| DRX | | OFF | OFF |
| Inter-RAT (UTRAN TDD) measurement quantity | | P-CCPCH RSCP | |

Table A.9.5.1-2: UTRA TDD P-CCPCH RSCP measurement tests parameters (cell 1)

| Parameter | Unit | Test 1 | Test 2 | Test 3 |
|---|------|--------|----------|--------|
| E-UTRA RF Channel Number | | | 1 | |
| BWchannel | MHz | | 10 | |
| OCNG Patterns defined in A.3.2.1.1 (OP.1) | | | OP.1 FDD | |

| | | |
|--|------------|--------|
| FDD) | | |
| PBCH_RA | dB | 0 |
| PBCH_RB | | |
| PSS_RA | | |
| SSS_RA | | |
| PCFICH_RB | | |
| PHICH_RA | | |
| PHICH_RB | | |
| PDCCH_RA | | |
| PDCCH_RB | | |
| PDSCH_RA | | |
| PDSCH_RB | | |
| OCNG_RA ^{Note1} | | |
| OCNG_RB ^{Note1} | | |
| N_{oc} ^{Note2} | | |
| \hat{E}_s / I_{ot} | dB | 4 |
| RSRP ^{Note3} | dBm/15 kHz | -94 |
| I_o ^{Note3} | dBm/9 MHz | -64.76 |
| \hat{E}_s / N_{oc} | dB | 4 |
| Propagation condition | - | AWGN |
| <p>Note 1: OCNG shall be used such that both cells are fully allocated and a constant total transmitted power spectral density is achieved for all OFDM symbols.</p> <p>Note 2: Interference from other cells and noise sources not specified in the test is assumed to be constant over subcarriers and time and shall be modelled as AWGN of appropriate power for N_{oc} to be fulfilled.</p> <p>Note 3: RSRP and I_o levels have been derived from other parameters for information purposes. They are not settable parameters themselves.</p> <p>Note 4: RSRP minimum requirements are specified assuming independent interference and noise at each receiver antenna port.</p> | | |

Table A.9.5.1-3: UTRA TDD P-CCPCH RSCP measurement tests parameters (cell 2)

| Parameter | Unit | Test 1 | | Test 2 | | Test 3 | |
|--|-------------|-----------|---|-----------|---|-----------|-------|
| | | | | | | | |
| DL timeslot number | | 0 | | DwPTS | | 0 | DwPTS |
| UTRA RF Channel number ^{Note2} | | Channel 2 | | Channel 2 | | Channel 2 | |
| PCCPCH_Ec/Ior | dB | -3 | | -3 | | -3 | |
| DwPCH_Ec/Ior | dB | | 0 | | 0 | | 0 |
| OCNS_Ec/Ior | dB | -3 | | -3 | | -3 | |
| Ioc | dBm/1.28MHz | -54.1 | | -75.2 | | -97 | |
| Ior/Ioc | dB | 2 | | 5 | | 0 | |
| PCCPCH RSCP ^{Note1} | dBm | -55.1 | | -73.2 | | -100 | |
| Io ^{Note1} | dBm/1.28MHz | -50 | | -69 | | -94 | |
| Propagation condition | | AWGN | | | | | |
| <p>Note 1: PCCPCH RSCP and I_o levels have been calculated from other parameters for information purposes. They are not settable parameters themselves.</p> <p>Note 2: In the case of multi-frequency network of 1.28 Mcps TDD, the UTRA RF Channel Number can be set for the primary frequency in this test.</p> | | | | | | | |

A.9.5.1.3 Test Requirements

The UTRA TDD P-CCPCH RSCP measurement accuracy shall meet the requirements in clause 9.3.1.

A.9.5.2 P-CCPCH RSCP absolute accuracy for E-UTRAN TDD

A.9.5.2.1 Test Purpose and Environment

The purpose of this test is to verify that the UTRAN TDD P-CCPCH RSCP measurement accuracy is within the specified limits. This test will verify the requirements in clause 9.3.1 and applies to UE supporting this capability.

Gap pattern configuration with id #1 as specified in Table 8.1.2.1-1 is provided. In the measurement control information it is indicated to the UE that periodic reporting of the UTRA TDD P-CCPCH RSRP measurement is used.

A.9.5.2.2 Test parameters

In this set of test cases there are two cells. Cell 1 is a E-UTRA TDD cell and cell 2 is a UTRA TDD cell. The absolute accuracy of P-CCPCH RSCP measurements are tested by using test parameters in Table A.9.5.2-1, Table A.9.5.2-2, and Table A.9.5.2-3. In all test cases, Cell 1 is the PCell and Cell 2 is the target cell.

Table A.9.5.2-1: General test parameters for UTRA TDD P-CCPCH RSCP measurement

| Parameter | Unit | Value | Comment |
|--|------|--|--|
| PDSCH parameters | | DL Reference Measurement Channel R.0 TDD | As specified in clause A.3.1.1.2 |
| PCFICH/PDCCH/PHICH parameters | | DL Reference Measurement Channel R.6 TDD | As specified in clause A.3.1.2.2 |
| E-UTRAN RF Channel Number | | 1 | One E-UTRAN TDD carrier frequency is used. |
| UTRAN RF Channel Number | | 2 | One UTRAN TDD carrier frequency is used. |
| E-UTRAN Channel Bandwidth (BWchannel) | MHz | 10 | |
| Active cell | | Cell 1 | E-UTRA TDD cell1 on RF channel number 1 |
| Neighbour cell | | Cell 2 | 1.28Mcps UTRA TDD Cell2 on RF channel number 2 |
| Gap Pattern Id | | 1 | As specified in TS 36.133 clause 8.1.2.1. |
| Uplink-downlink configuration of cell 1 | | 1 | As specified in table 4.2.2 in TS 36.211 |
| Special subframe configuration of cell 1 | | 6 | As specified in table 4.2.1 in TS 36.211 |
| CP length of cell 1 | | Normal | |
| Filter coefficient | | 0 | L3 filtering is not used |
| DRX | | OFF | |
| Time offset between cells | ms | 3 | Asynchronous cells |
| Inter-RAT (UTRAN TDD) measurement quantity | | P-CCPCH RSCP | |

Table A.9.5.2-2: UTRA TDD P-CCPCH RSCP measurement tests parameters (cell 1)

| Parameter | Unit | Test 1 | Test 2 | Test 3 |
|---|------------|--------|----------|--------|
| E-UTRA RF Channel Number | | | 1 | |
| BWchannel | MHz | | 10 | |
| OCNG Patterns defined in A.3.2.2.1 (OP.1 TDD) | | | OP.1 TDD | |
| PBCH_RA | dB | | 0 | |
| PBCH_RB | | | | |
| PSS_RA | | | | |
| SSS_RA | | | | |
| PCFICH_RB | | | | |
| PHICH_RA | | | | |
| PHICH_RB | | | | |
| PDCCH_RA | | | | |
| PDCCH_RB | | | | |
| PDSCH_RA | | | | |
| PDSCH_RB | | | | |
| OCNG_RA ^{Note1} | | | | |
| OCNG_RB ^{Note1} | | | | |
| N_{oc} ^{Note2} | | | | |
| \hat{E}_s / I_{ot} | dB | | 4 | |
| RSRP ^{Note3} | dBm/15 kHz | | -94 | |

| | | |
|--|-----------|--------|
| I_o ^{Note3} | dBm/9 MHz | -64.76 |
| \hat{E}_s / N_{oc} | dB | 4 |
| Propagation condition | - | AWGN |
| <p>Note 1: OCNG shall be used such that both cells are fully allocated and a constant total transmitted power spectral density is achieved for all OFDM symbols.</p> <p>Note 2: Interference from other cells and noise sources not specified in the test is assumed to be constant over subcarriers and time and shall be modelled as AWGN of appropriate power for N_{oc} to be fulfilled.</p> <p>Note 3: RSRP and I_o levels have been derived from other parameters for information purposes. They are not settable parameters themselves.</p> <p>Note 4: RSRP minimum requirements are specified assuming independent interference and noise at each receiver antenna port.</p> | | |

Table A.9.5.2-3: UTRA TDD P-CCPCH RSCP measurement tests parameters (cell 2)

| Parameter | Unit | Test 1 | | Test 2 | | Test 3 | |
|--|-------------|-----------|---|-----------|---|-----------|-------|
| | | 0 | | DwPTS | | 0 | DwPTS |
| DL timeslot number | | 0 | | DwPTS | | 0 | DwPTS |
| UTRA RF Channel number ^{Note2} | | Channel 2 | | Channel 2 | | Channel 2 | |
| PCCPCH_Ec/lor | dB | -3 | | -3 | | -3 | |
| DwPCH_Ec/lor | dB | | 0 | | 0 | | 0 |
| OCNS_Ec/lor | dB | -3 | | -3 | | -3 | |
| loc | dBm/1.28MHz | -54.1 | | -75.2 | | -97 | |
| lor/loc | dB | 2 | | 5 | | 0 | |
| PCCPCH RSCP ^{Note1} | dBm | -55.1 | | -73.2 | | -100 | |
| I_o ^{Note1} | dBm/1.28MHz | -50 | | -69 | | -94 | |
| Propagation condition | | AWGN | | | | | |
| <p>Note 1: PCCPCH RSCP and I_o levels have been calculated from other parameters for information purposes. They are not settable parameters themselves.</p> <p>Note 2: In the case of multi-frequency network of 1.28 Mcps TDD, the UTRA RF Channel Number can be set for the primary frequency in this test.</p> | | | | | | | |

A.9.5.2.3 Test Requirements

The UTRA TDD P-CCPCH RSCP measurement accuracy shall meet the requirements in clause 9.3.1.

A.9.6 GSM Carrier RSSI

A.9.6.1 E-UTRAN FDD

A.9.6.1.1 Test Purpose and Environment

The purpose of this test is to verify that the GSM Carrier RSSI measurement accuracy is within the specified limits when the active cell is E-UTRAN FDD. This test will verify the requirements in clause 9.4.1. There are 12 different test setups with different signal levels for the GSM cells.

Measurement gaps are configured to measure on the GSM cells. Table A.9.6.1.1-2 defines the cell specific test parameters for the E-UTRAN FDD cell. In the measurement control information it is indicated to the UE that periodic reporting of the GSM RSSI measurement is used. The limits of the GSM test parameters in terms of GSM BCCH received level at the receiver inputs are defined in Table A.9.6.1.1-3.

Table A.9.6.1.1-1: General GSM Carrier RSSI test parameters

| Parameter | Unit | Value | Comment |
|---|------|--|-----------------------------------|
| PDSCH parameters (E-UTRAN FDD) | | DL Reference Measurement Channel R.0 FDD | As specified in clause A.3.1.1.1. |
| PCFICH/PDCCH/PHICH parameters (E-UTRAN FDD) | | DL Reference Measurement Channel R.6 FDD | As specified in clause A.3.1.2.1. |
| Active cell | - | Cell 1 | |

| | | | |
|--------------------------------|---|------------------------------------|---|
| DRX | - | OFF | |
| Gap pattern Id | | 1 | As specified in TS 36.133 clause 8.1.2.1. |
| Filtering coefficient | - | 0 | L3 filtering is not used. |
| Inter-RAT measurement quantity | | GSM Carrier RSSI | |
| Monitored cell list size | | 6 GSM neighbours including ARFCN 1 | Included in the Measurement control information |

Table A.9.6.1.1.-2: E-UTRAN FDD Cell specific test parameters for GSM Carrier RSSI accuracy test in E-UTRAN FDD

| Parameter | Unit | Tests 1-12 |
|---|------------|------------|
| E-UTRAN RF Channel Number | | 1 |
| BW_{channel} | MHz | 10 |
| OCNG Patterns defined in A.3.2.1.1 (OP.1 FDD) | | OP.1 FDD |
| PBCH_RA | dB | |
| PBCH_RB | dB | |
| PSS_RA | dB | |
| SSS_RA | dB | |
| PCFICH_RB | dB | |
| PHICH_RA | dB | |
| PHICH_RB | dB | 0 |
| PDCCH_RA | dB | |
| PDCCH_RB | dB | |
| PDSCH_RA | dB | |
| PDSCH_RB | dB | |
| OCNG_RA ^{Note 1} | dB | |
| OCNG_RB ^{Note 1} | dB | |
| N_{oc} ^{Note 2} | dBm/15 kHz | -98 |
| RSRP ^{Note 3} | dBm/15 kHz | -94 |
| \hat{E}_s / I_{ot} | dB | 4 |
| SCH_RP ^{Note 3} | dBm/15 kHz | -94 |
| \hat{E}_s / N_{oc} | dB | 4 |
| Propagation Condition | | AWGN |

Note 1: OCNG shall be used such that all cells are fully allocated and a constant total transmitted power spectral density is achieved for all OFDM symbols.

Note 2: Interference from other cells and noise sources not specified in the test is assumed to be constant over subcarriers and time and shall be modeled as AWGN of appropriate power for N_{oc} to be fulfilled.

Note 3: RSRP and SCH_RP levels have been derived from other parameters for information purposes. They are not settable parameters themselves.

Table A.9.6.1.1-3: BCCH signal levels at receiver input in dBm

| Step | BCCH1 | BCCH2 | BCCH3 | BCCH4 | BCCH5 | BCCH6 |
|------|--------|--------|-------|-------|-------|-------|
| 1 | -38.5 | -38.5 | NA | NA | NA | NA |
| 2 | -48.5 | -48.5 | NA | NA | NA | NA |
| 3 | -70.5 | -70.5 | NA | NA | NA | NA |
| 4 | -109.5 | -109.5 | NA | NA | NA | NA |
| 5 | -57.5 | NA | -54.5 | NA | NA | NA |
| 6 | -64.5 | NA | -59.5 | NA | NA | NA |
| 7 | -71.5 | NA | NA | -64.5 | NA | NA |
| 8 | -78.5 | NA | NA | -69.5 | NA | NA |
| 9 | -85.5 | NA | NA | NA | -74.5 | NA |
| 10 | -92.5 | NA | NA | NA | -79.5 | NA |
| 11 | -99.5 | NA | NA | NA | NA | -84.5 |
| 12 | -106.5 | NA | NA | NA | NA | -89.5 |

A.9.6.1.2 Test Requirements

The GSM Carrier RSSI measurement accuracy shall meet the requirements in clause 9.4.1.

A.9.6.2 E-UTRAN TDD

A.9.6.2.1 Test Purpose and Environment

The purpose of this test is to verify that the GSM Carrier RSSI measurement accuracy is within the specified limits when the active cell is E-UTRAN TDD. This test will verify the requirements in clause 9.4.1. There are 12 different test setups with different signal levels for the GSM cells.

Measurement gaps are configured to measure on the GSM cells. Table A.9.6.2.1-2 defines the cell specific test parameters for the E-UTRAN TDD cell. In the measurement control information it is indicated to the UE that periodic reporting of the GSM RSSI measurement is used. The limits of the GSM test parameters in terms of GSM BCCH received level at the receiver inputs are defined in Table A.9.6.2.1-3.

Table A.9.6.2.1-1: General GSM Carrier RSSI test parameters

| Parameter | Unit | Value | Comment |
|---|------|--|---|
| PDSCH parameters (E-UTRAN TDD) | | DL Reference Measurement Channel R.0 TDD | As specified in clause A.3.1.1.2. |
| PCFICH/PDCCH/PHICH parameters (E-UTRAN TDD) | | DL Reference Measurement Channel R.6 TDD | As specified in clause A.3.1.2.2. |
| Active cell | - | Cell 1 | |
| DRX | - | OFF | |
| Uplink-downlink configuration of cell 1 | | 1 | As specified in table 4.2.2 in TS 36.211 |
| Special subframe configuration of cell 1 | | 6 | As specified in table 4.2.1 in TS 36.211 |
| Gap pattern Id | | 1 | As specified in TS 36.133 clause 8.1.2.1. |
| Filtering coefficient | - | 0 | L3 filtering is not used. |
| Inter-RAT measurement quantity | | GSM Carrier RSSI | |
| Monitored cell list size | | 6 GSM neighbours including ARFCN 1 | Included in the Measurement control information |

Table A.9.6.2.1-2: E-UTRAN TDD Cell specific test parameters for GSM Carrier RSSI accuracy test in E-UTRAN TDD

| Parameter | Unit | Tests 1 - 12 |
|---------------------------|------|--------------|
| E-UTRAN RF Channel Number | | 1 |

| | | |
|--|------------|----------|
| BW _{channel} | MHz | 10 |
| OCNG Patterns defined in A.3.2.2.1 (OP.1 TDD) | | OP.1 TDD |
| PBCH_RA | dB | 0 |
| PBCH_RB | dB | |
| PSS_RA | dB | |
| SSS_RA | dB | |
| PCFICH_RB | dB | |
| PHICH_RA | dB | |
| PHICH_RB | dB | |
| PDCCH_RA | dB | |
| PDCCH_RB | dB | |
| PDSCH_RA | dB | |
| PDSCH_RB | dB | |
| OCNG_RA ^{Note 1} | dB | |
| OCNG_RB ^{Note 1} | dB | |
| N_{oc} ^{Note 2} | dBm/15 kHz | -98 |
| RSRP ^{Note 3} | dBm/15 kHz | -94 |
| \hat{E}_s/I_{ot} | dB | 4 |
| SCH_RP ^{Note 3} | dBm/15 kHz | -94 |
| \hat{E}_s/N_{oc} | dB | 4 |
| Propagation Condition | | AWGN |
| <p>Note 1: OCNG shall be used such that all cells are fully allocated and a constant total transmitted power spectral density is achieved for all OFDM symbols.</p> <p>Note 2: Interference from other cells and noise sources not specified in the test is assumed to be constant over subcarriers and time and shall be modeled as AWGN of appropriate power for N_{oc} to be fulfilled.</p> <p>Note 3: RSRP and SCH_RP levels have been derived from other parameters for information purposes. They are not settable parameters themselves.</p> | | |

Table A.9.6.2.1-3: BCCH signal levels at receiver input in dBm

| Step | BCCH1 | BCCH2 | BCCH3 | BCCH4 | BCCH5 | BCCH6 |
|------|--------|--------|-------|-------|-------|-------|
| 1 | -38.5 | -38.5 | NA | NA | NA | NA |
| 2 | -48.5 | -48.5 | NA | NA | NA | NA |
| 3 | -70.5 | -70.5 | NA | NA | NA | NA |
| 4 | -109.5 | -109.5 | NA | NA | NA | NA |
| 5 | -57.5 | NA | -54.5 | NA | NA | NA |
| 6 | -64.5 | NA | -59.5 | NA | NA | NA |
| 7 | -71.5 | NA | NA | -64.5 | NA | NA |
| 8 | -78.5 | NA | NA | -69.5 | NA | NA |
| 9 | -85.5 | NA | NA | NA | -74.5 | NA |
| 10 | -92.5 | NA | NA | NA | -79.5 | NA |
| 11 | -99.5 | NA | NA | NA | NA | -84.5 |
| 12 | -106.5 | NA | NA | NA | NA | -89.5 |

A.9.6.2.2 Test Requirements

The GSM Carrier RSSI measurement accuracy shall meet the requirements in clause 9.4.1.

A.9.7 UE Rx – Tx Time Difference

A.9.7.1 E-UTRAN FDD UE Rx – Tx time difference case

A.9.7.1.1 Test Purpose and Environment

The purpose of this test is to verify that the E-UTRAN FDD UE Rx – Tx time difference measurement accuracy is within the specified limits in Clause 9.1.9.

There is only one active cell in the test. The tested UE is connected with the PCell, configured to transmit SRS signals periodically, and signaled to report UE Rx – Tx time difference measurement. The test equipment measures the transmit timing of the UE using the transmitted SRS, and measures the receive timing using the downlink CRS. The test equipment then compares the difference of these two timings to the UE Rx-Tx measurement reported by the UE.

A.9.7.1.2 Test parameters

The parameters for this test case are defined in Table A.9.7.1.2-1, and the SRS configuration used is defined in Table A.9.7.1.2-2.

Table A.9.7.1.2-1: FDD UE Rx – Tx time difference test parameters

| Parameter | Unit | Test 1 | Test 2 |
|---|--------------|----------|----------|
| E-UTRAN RF Channel Number | | 1 | 1 |
| BW_{channel} | MHz | 1.4 | 10 |
| DRX | | OFF | |
| PDSCH Reference measurement channel defined in A.3.1.1.1 | | R.2 FDD | R.0 FDD |
| PDSCH allocation | n_{PRB} | 2–3 | 13–36 |
| PDCCH/PCFICH/PHICH Reference measurement channel defined in A.3.1.2.1 | | R.8 FDD | R.6 FDD |
| OCNG Patterns defined in A.3.2.1.3 (OP.3 FDD) and A.3.2.1.1 (OP.1 FDD) | | OP.3 FDD | OP.1 FDD |
| PBCH_RA | dB | 0 | 0 |
| PBCH_RB | dB | | |
| PSS_RA | dB | | |
| SSS_RA | dB | | |
| PCFICH_RB | dB | | |
| PHICH_RA | dB | | |
| PHICH_RB | dB | | |
| PDCCH_RA | dB | | |
| PDCCH_RB | dB | | |
| PDSCH_RA | dB | | |
| PDSCH_RB | dB | | |
| OCNG_RA ^{Note1} | dB | | |
| OCNG_RB ^{Note1} | dB | | |
| N_{oc} ^{Note2} | dBm/15 kHz | | |
| RSRP ^{Note3} | dBm/15 kHz | -101 | -101 |
| \hat{E}_s / N_{oc} | dB | -3 | -3 |
| I_o ^{Note3} | dBm/1.08 MHz | -77.66 | N/A |
| | dBm/9 MHz | N/A | -68.45 |
| \hat{E}_s / I_{ot} | dB | -3 | -3 |
| Propagation Condition | | AWGN | |
| Note 1: OCNG shall be used such that the resources in the active cell are fully allocated and a constant total transmitted power spectral density is achieved for all OFDM symbols. | | | |
| Note 2: Interference from other cells and noise sources not specified in the test is assumed to be constant over subcarriers and time and shall be modeled as AWGN of appropriate power for N_{oc} to be fulfilled. | | | |
| Note 3: RSRP and I_o levels have been derived from other parameters for information purposes. They are not settable | | | |

| |
|------------------------|
| parameters themselves. |
|------------------------|

Table A.9.7.1.2-2: Sounding Reference Symbol Configuration to be used in FDD UE Rx – Tx time difference test

| Field | Test 1 | Test 2 | Comment |
|--|--------|--------|---|
| | Value | | |
| srsBandwidthConfiguration | bw7 | bw5 | |
| srsSubframeConfiguration | sc1 | | |
| ackNackSrsSimultaneousTransmission | FALSE | | |
| srsMaxUpPTS | N/A | | Not applicable for FDD |
| srsBandwidth | 0 | | No hopping |
| srsHoppingBandwidth | hbw0 | | |
| frequencyDomainPosition | 0 | | |
| Duration | TRUE | | Indefinite duration |
| Srs-ConfigurationIndex | 0 | | SRS periodicity of 2ms for all Tests. |
| transmissionComb | 0 | | |
| cyclicShift | cs0 | | No cyclic shift |
| SRS-AntennaPort | an1 | | Number of antenna ports used for SRS transmission |
| Note: For further information see clause 6.3.2 in TS 36.331. | | | |

A.9.7.1.3 Test Requirements

The UE Rx – Tx time difference measurement accuracy shall fulfill the requirements in Clause 9.1.9.1.

A.9.7.2 E-UTRA TDD

A.9.7.2.1 Test Purpose and Environment

The purpose of this test is to verify that the E-UTRAN TDD UE Rx-Tx time difference measurement accuracy is within the specified limits in clause 9.1.9.

There is only one cell in the test. The tested UE is connected with the PCell, configured to transmit SRS signals periodically, and signaled to report UE Rx – Tx time difference measurement. The test equipment measures the transmit timing of the UE using the transmitted SRS, and measures the receive timing using the downlink CRS. The test equipment then compares the difference of these two timings to the UE Rx – Tx measurement reported by the UE.

A.9.7.2.2 Test parameters

The parameters for this test case are defined in Table A.9.7.2.2-1, and the SRS configuration used is defined in Table A.9.7.2.2-2.

Table A.9.7.2.2-1: Cell specific test parameters for UE Rx-Tx time difference measurement

| Parameter | Unit | Tests 1 | Tests 2 |
|--|-----------|----------|----------|
| E-UTRAN RF Channel Number | - | 1 | 1 |
| BW_{channel} | MHz | 1.4 | 10 |
| Uplink-downlink configuration of cell ^{Note1} | | 1 | 1 |
| Special subframe configuration of cell ^{Note1} | | 6 | 6 |
| PDSCH Reference measurement channel defined in A.3.1.1.2 | - | R.2 TDD | R.0 TDD |
| PDSCH allocation | n_{PRB} | 2-3 | 13-36 |
| PDCCH/PCFICH/PHICH Reference measurement channel defined in A.3.1.2.2 | - | R.8 TDD | R.6 TDD |
| OCNG Patterns defined in A.3.2.2.3 (OP.3 TDD) and A.3.2.2.1 (OP.1 TDD) | - | OP.3 TDD | OP.1 TDD |
| PBCH_RA | dB | 0 | 0 |
| PBCH_RB | dB | | |

| | | | |
|----------------------------|---|--------|--------|
| PSS_RA | dB | | |
| SSS_RA | dB | | |
| PCFICH_RB | dB | | |
| PHICH_RA | dB | | |
| PHICH_RB | dB | | |
| PDCCH_RA | dB | | |
| PDCCH_RB | dB | | |
| PDSCH_RA | dB | | |
| PDSCH_RB | dB | | |
| OCNG_RA ^{Note2} | dB | | |
| OCNG_RB ^{Note2} | dB | | |
| N_{oc} ^{Note 3} | dBm/15 kHz | -98 | -98 |
| RSRP ^{Note 4} | dBm/15 kHz | -101 | -101 |
| \hat{E}_s/N_{oc} | dB | -3 | -3 |
| I_o ^{Note 4} | dBm/1.08 MHz | -77.66 | N/A |
| | dBm/9 MHz | N/A | -68.45 |
| \hat{E}_s/I_{ot} | dB | -3 | -3 |
| Propagation Condition | | AWGN | |
| Note 1: | For special subframe and uplink-downlink configurations see Tables 4.2-1 and 4.2-2 in TS 36.211. | | |
| Note 2: | OCNG shall be used such that the cell is fully allocated and a constant total transmitted power spectral density is achieved for all OFDM symbols. | | |
| Note 3: | Interference from other cells and noise sources not specified in the test is assumed to be constant over subcarriers and time and shall be modeled as AWGN of appropriate power for N_{oc} to be fulfilled. | | |
| Note 4: | RSRP and I_o levels have been derived from other parameters for information purposes. They are not settable parameters themselves. | | |

Table A.9.7.2.2-2: Sounding Reference Symbol Configuration to be used in TDD UE Rx – Tx time difference test

| Field | Test 1 | Test 2 | Comment |
|------------------------------------|--|--------|---|
| | Value | | |
| srsBandwidthConfiguration | bw7 | bw5 | |
| srsSubframeConfiguration | sc1 | | |
| ackNackSrsSimultaneousTransmission | FALSE | | |
| srsMaxUpPTS | TRUE | | |
| srsBandwidth | 0 | | No hopping |
| srsHoppingBandwidth | hbw0 | | |
| frequencyDomainPosition | 0 | | |
| Duration | TRUE | | Indefinite duration |
| Srs-ConfigurationIndex | 10 | | SRS periodicity of 10ms for all Tests. |
| transmissionComb | 0 | | |
| cyclicShift | cs0 | | No cyclic shift |
| SRS-AntennaPort | an1 | | Number of antenna ports used for SRS transmission |
| Note: | For further information see clause 6.3.2 in TS 36.331. | | |

A.9.7.2.3 Test Requirements

The UE Rx – Tx time difference measurement accuracy shall fulfill the requirements in clause 9.1.9.1.

A.9.7.3 E-UTRAN FDD UE Rx–Tx Time Difference under Time-Domain Measurement Resource Restriction with Non-MBSFN ABS

A.9.7.3.1 Test Purpose and Environment

The purpose of this test is to verify that the E-UTRAN FDD UE Rx–Tx time difference measurement accuracy is within the specified limits. This test will verify the requirements in Section 9.1.9.3 when time-domain measurement resource restriction is configured for PCell measurements via higher-layer signalling [2] and non-MBSFN ABS are configured in the interfering cell.

A.9.7.3.2 Test parameters

In this test case, there are two synchronous cells, Cell 1 and Cell 2, on the same RF channel. Cell 1 is the PCell on which UE Rx–Tx is measured, and Cell 2 is the interfering cell. Non-MBSFN ABS pattern is configured in Cell 2 during the entire test.

The tested UE is connected to the PCell and configured to transmit SRS signals periodically. The SRS configuration is provided to the UE before the measurement starts. The UE is configured to report UE Rx–Tx time difference measurement. The test equipment measures the transmit timing of the UE using the transmitted SRS, and measures the receive timing using the downlink CRS. The test equipment then compares the difference of these two timings to the UE Rx–Tx measurement reported by the UE. The UE is configured by higher layers via Cell 1 with a time-domain measurement resource restriction pattern for performing E-UTRAN FDD intra-frequency measurements on PCell. The information for both patterns shall be provided to the UE before the measurement starts.

The general and cell-specific parameters for this test case are defined in Table A.9.7.3.2-1 and Table A.9.7.3.2-2, respectively, and the SRS configuration used is specified in Table A.9.7.3.2-3.

Table A.9.7.3.2-1: General test parameters for FDD UE Rx–Tx time difference measurement under time-domain measurement resource restriction with non-MBSFN ABS

| Parameter | Unit | Value | Comment |
|--|---------------|--|--|
| Serving cell (PCell) | | Cell 1 | The measured cell |
| Neighbour cell | | Cell 2 | The cell interfering to Cell 1 |
| PCell ABS configuration | | Non-MBSFN ABS | As defined in Table A.3.4.1.1-1 |
| E-UTRA RF Channel Number | | 1 | One FDD carrier frequency is used |
| Downlink Channel Bandwidth (BW_{channel}) | MHz | 10 | For both cells in the test |
| CP length | | Normal | For both cells in the test |
| DRX | | | OFF |
| Time offset between cells | μs | 3 | Synchronous cells |
| Physical cell ID PCI | | $(\text{PCI}_{\text{cell1}} - \text{PCI}_{\text{cell2}}) \bmod 6 \neq 0$ | Cell PCIs for Cell 1 and Cell 2 are selected randomly so that the condition is met |
| ABS pattern | | '10000000100000001000000010000000000010000000100000000' | Non-MBSFN ABS. FDD ABS Pattern Info IE, as defined in TS 36.423 [28], clause 9.2.54. Configured in Cell 2. The first/leftmost bit corresponds to the subframe #0 of a radio frame satisfying $\text{SFN} \bmod 40 = 0$. No MBSFN subframes are configured in Cell 1 or Cell 2 during the ABS subframes of Cell 2. |
| Time-domain measurement resource restriction pattern for serving cell measurements | | '10000000100000001000000010000000000010000000100000000' | Configured for measurements on Cell 1. |

Table A.9.7.3.2-2: Cell-specific test parameters for FDD UE Rx–Tx time difference measurement under time-domain measurement resource restriction with non-MBSFN ABS

| Parameter | Unit | Cell 1 | Cell 2 |
|--|------|---------|--------|
| E-UTRAN RF Channel Number | | 1 | 1 |
| Channel bandwidth (BW_{channel}) | MHz | 10 | 10 |
| PDSCH Reference measurement channel defined in | | R.0 FDD | N/A |

| | | | |
|---|------------|----------|---|
| A.3.1.1.1 | | | |
| PDSCH allocation | n_{PRB} | 13—36 | N/A |
| PDCCH/PCFICH/PHICH Reference measurement channel defined in A.3.1.2.1 | | R.6 FDD | N/A |
| OCNG Patterns defined in A.3.2.1.1 (OP.1 FDD) and in A.3.2.1.6 (OP.6 FDD) | | OP.5 FDD | OP.6 FDD |
| PBCH_RA | dB | 0 | Non-ABS and ABS subframe channel powers defined in Table A.3.4.1.1-1. |
| PBCH_RB | dB | | |
| PSS_RA | dB | | |
| SSS_RA | dB | | |
| PCFICH_RB | dB | | |
| PHICH_RA | dB | | |
| PHICH_RB | dB | | |
| PDCCH_RA | dB | | |
| PDCCH_RB | dB | | |
| PDSCH_RA | dB | | |
| PDSCH_RB | dB | | |
| OCNG_RA ^{Note1} | dB | | |
| OCNG_RB ^{Note1} | dB | | |
| N_{oc} ^{Note 2} | dBm/15 kHz | | |
| CRS \hat{E}_s/N_{oc} | dB | -3 | 1 |
| CRS $(\hat{E}_s/I_{ot})_{meas}$ ^{Note 3} | dB | -3 | -0.76 |
| CRS $(\hat{E}_s/I_{ot})_{nonABS}$ ^{Note 3} | dB | -6.54 | -0.76 |
| RSRP ^{Note 4} | dBm/15 kHz | -101 | -97 |
| $(I_o)_{meas}$ ^{Note 4} | dBm/9 MHz | -67.89 | -67.89 |
| $(I_o)_{nonABS}$ ^{Note 4} | dBm/9 MHz | -65.81 | -65.81 |
| Propagation condition | | AWGN | |
| <p>NOTE 1: OCNG shall be used such that the resources in the active cell are fully allocated and a constant total transmitted power spectral density is achieved for all OFDM symbols.</p> <p>NOTE 2: Interference from other cells and noise sources not specified in the test is assumed to be constant over subcarriers and time and shall be modelled as AWGN of appropriate power for N_{oc} to be fulfilled. Applies to all subframes.</p> <p>Note 3: $(\hat{E}_s/I_{ot})_{meas}$ is calculated in CRS REs in the subframes indicated for PCell measurements by measurement resource restriction pattern, whilst $(\hat{E}_s/I_{ot})_{nonABS}$ is calculated in CRS REs in the subframes not indicated for PCell measurements by measurement resource restriction pattern.</p> <p>Note 4: RSRP and I_o levels have been derived from other parameters for information purposes. They are not settable parameters themselves. $(I_o)_{meas}$ is calculated in CRS symbols in the subframes indicated for PCell measurements by measurement resource restriction pattern, whilst $(I_o)_{nonABS}$ is calculated in CRS symbols in the subframes not indicated for PCell measurements by measurement resource restriction pattern.</p> | | | |

Table A.9.7.3.2-3: Sounding Reference Symbol Configuration to be used in FDD UE Rx–Tx time difference test

| Field | Value | Comment |
|------------------------------------|--------|--------------------------|
| UL bandwidth | 50 RBs | Same as the DL bandwidth |
| srsBandwidthConfiguration | bw5 | |
| srsSubframeConfiguration | sc1 | |
| ackNackSrsSimultaneousTransmission | FALSE | |
| srsMaxUpPTS | N/A | Not applicable for FDD |
| srsBandwidth | 0 | No hopping |
| srsHoppingBandwidth | hbw0 | |
| frequencyDomainPosition | 0 | |
| Duration | TRUE | Indefinite duration |

| | | |
|------------------|--|-----------------------------|
| srs-ConfigIndex | 0 | SRS periodicity of 2ms |
| transmissionComb | 0 | |
| cyclicShift | cs0 | No cyclic shift |
| srsAntennaPort | an1 | Number of SRS antenna ports |
| Note: | For further information see clause 6.3.2 in TS 36.331. | |

A.9.7.3.3 Test Requirements

The UE Rx–Tx time difference measurement accuracy shall fulfill the requirements in Section 9.1.9.3.

A.9.7.4 E-UTRAN TDD UE Rx-Tx Time Difference under Time-Domain Measurement Resource Restriction with Non-MBSFN ABS

A.9.7.4.1 Test Purpose and Environment

The purpose of this test is to verify that the TDD UE Rx-Tx time difference measurement accuracy is within the specified limits. This test will verify the requirements in Section 9.1.9.3 when time-domain measurement resource restriction is configured for PCell measurements via higher-layer signalling [2] and non-MBSFN ABS are configured in the interfering cell.

A.9.7.4.2 Test Parameters

In the test, there are two synchronous cells, Cell 1 and Cell 2, on the same RF channel. Cell 1 is the PCell on which UE Rx-Tx is measured, and Cell 2 is the interfering cell. Non-MBSFN ABS pattern is configured in Cell 2 during the entire test.

The tested UE is connected to the PCell and configured to transmit SRS signals periodically. The SRS configuration is provided to the UE before the measurement starts. The UE is configured to report UE Rx–Tx time difference measurement. The test equipment measures the transmit timing of the UE using the transmitted SRS, and measures the receive timing using the downlink CRS. The test equipment then compares the difference of these two timings to the UE Rx-Tx measurement reported by the UE. The UE is configured by higher layers via Cell 1 with a time-domain measurement resource restriction pattern for performing E-UTRAN TDD UE Rx-Tx time difference measurements on PCell. The information for both patterns shall be provided to the UE before the measurement starts.

The general and cell-specific parameters for this test case are defined in Table A.9.7.4.2-1 and Table A.9.7.4.2-2, respectively, and the SRS configuration used is defined in Table A.9.7.4.2-3.

Table A.9.7.4.2-1: General test parameters for E-UTRAN TDD UE Rx-Tx time difference measurement under time-domain measurement resource restriction with non-MBSFN ABS

| Parameter | Unit | Value | Comment |
|---|------|--|---|
| Serving cell (PCell) | | Cell 1 | Cell to be measured |
| Neighbour cell | | Cell 2 | The cell interfering to Cell 1 |
| PCell ABS configuration | | Non-MBSFN ABS | As defined in Table A.3.4.1.1-1 |
| E-UTRA RF Channel Number | | 1 | One TDD carrier frequency is used |
| Downlink Channel Bandwidth (BW _{channel}) | MHz | 10 | For both cells in the test |
| CP length | | Normal | For both cells in the test |
| Special subframe configuration | | 6 | For Cell 1 and Cell 2. For special subframe configurations see Table 4.2-1 in [16]. |
| Uplink/downlink subframe configuration | | 1 | For Cell 1 and Cell 2. For uplink-downlink subframe configurations see Table 4.2-2 in [16]. |
| DRX | | | OFF |
| Time offset between cells | μs | 3 | Synchronous cells |
| Physical cell ID PCI | | $(PCI_{cell1} - PCI_{cell2}) \bmod 6 \neq 0$ | Cell PCIs for Cell 1 and Cell 2 are selected randomly so that the condition is met. |

| | | | |
|--|--|------------------------|---|
| ABS pattern | | '00000000010000000001' | Non-MBSFN ABS. TDD ABS Pattern Info IE, as defined in TS 36.423 [28], clause 9.2.54. Configured in Cell 2. The first/leftmost bit corresponds to the subframe #0 of a radio frame satisfying SFN mod 20 = 0. No MBSFN subframes are configured in the ABS subframes in Cell 2. |
| Time-domain measurement resource restriction pattern for serving cell measurements | | '00000000010000000001' | Configured for measurements on Cell 1. |

Table A.9.7.4.2-2: Cell-specific test parameters for E-UTRAN TDD UE Rx-Tx time difference measurement under time-domain measurement resource restriction with non-MBSFN ABS

| Parameter | Unit | Cell 1 | Cell 2 |
|---|------------|----------|---|
| PDSCH Reference measurement channel defined in A.3.1.1.2 | | R.0 TDD | N/A |
| PDSCH allocation | n_{PRB} | 13—36 | N/A |
| PDCCH/PCFICH/PHICH Reference measurement channel defined in A.3.1.2.2 | | R.6 TDD | R.6 TDD |
| OCNG Patterns defined in A.3.2.2.1 (OP.1 TDD) and A.3.2.2.2 (OP.2 TDD) | | OP.1 TDD | OP.2 TDD |
| PBCH_RA | dB | 0 | Non-ABS and ABS subframe channel powers defined in Table A.3.4.1.1-1. |
| PBCH_RB | dB | | |
| PSS_RA | dB | | |
| SSS_RA | dB | | |
| PCFICH_RB | dB | | |
| PHICH_RA | dB | | |
| PHICH_RB | dB | | |
| PDCCH_RA | dB | | |
| PDCCH_RB | dB | | |
| PDSCH_RA | dB | | |
| PDSCH_RB | dB | | |
| OCNG_RA ^{Note1} | dB | | |
| OCNG_RB ^{Note1} | dB | | |
| N_{oc} ^{Note2} | dBm/15 kHz | | |
| $CRS \hat{E}_s / N_{oc}$ | dB | -3 | 1 |
| $CRS \left(\hat{E}_s / I_{ot} \right)_{meas}$ ^{Note 3} | dB | -3 | -0.76 |
| $CRS \left(\hat{E}_s / I_{ot} \right)_{nonABS}$ ^{Note 3} | dB | -6.54 | -0.76 |
| RSRP ^{Note 4} | dBm/15 kHz | -101 | -97 |
| $(I_o)_{meas}$ ^{Note 4} | dBm/9 MHz | -67.89 | -67.89 |
| $(I_o)_{nonABS}$ ^{Note 4} | dBm/9 MHz | -65.81 | -65.81 |
| Propagation Condition | | AWGN | |
| <p>Note 1: OCNG shall be used such that the resources in the active cell are fully allocated and a constant total transmitted power spectral density is achieved for all OFDM symbols.</p> <p>Note 2: Interference from other cells and noise sources not specified in the test is assumed to be constant over subcarriers and time and shall be modeled as AWGN of appropriate power for N_{oc} to be fulfilled.</p> <p>Note 3: $\left(\hat{E}_s / I_{ot} \right)_{meas}$ is calculated in CRS REs in the subframes indicated for PCell measurements by measurement resource restriction pattern, whilst $\left(\hat{E}_s / I_{ot} \right)_{nonABS}$ is calculated in CRS REs in the subframes not indicated for PCell measurements by measurement resource restriction pattern.</p> <p>Note 4: RSRP and I_o levels have been derived from other parameters for information purposes. They are not settable parameters themselves. $(I_o)_{meas}$ is calculated in CRS symbols in the subframes indicated for PCell</p> | | | |

measurements by measurement resource restriction pattern, whilst $(I_o)_{nonABS}$ is calculated in CRS symbols

Table A.9.7.4.2-3: Sounding Reference Symbol Configuration to be used in TDD UE Rx–Tx time difference test

| Field | Value | Comment |
|------------------------------------|--|---|
| UL bandwidth | 50 RBs | Same as the DL bandwidth |
| srsBandwidthConfiguration | bw5 | |
| srsSubframeConfiguration | sc1 | |
| ackNackSrsSimultaneousTransmission | FALSE | |
| srsMaxUpPTS | TRUE | |
| srsBandwidth | 0 | No hopping |
| srsHoppingBandwidth | hbw0 | |
| frequencyDomainPosition | 0 | |
| Duration | TRUE | Indefinite duration |
| Srs-ConfigurationIndex | 10 | SRS periodicity of 10ms for all Tests. |
| transmissionComb | 0 | |
| cyclicShift | cs0 | No cyclic shift |
| SRS-AntennaPort | an1 | Number of antenna ports used for SRS transmission |
| Note: | For further information see clause 6.3.2 in TS 36.331. | |

A.9.7.4.3 Test Requirements

The UE Rx–Tx time difference measurement accuracy shall fulfill the requirements in Section 9.1.9.3.

A.9.7.5 E-UTRAN FDD UE Rx–Tx time difference under Time Domain Measurement Resource Restriction with CRS Assistance Information and Non-MBSFN ABS

A.9.7.5.1 Test Purpose and Environment

The purpose of this test is to verify that the E-UTRAN FDD UE Rx–Tx time difference measurement accuracy is within the specified limits. This test will verify the requirements in Section 9.1.9.4 when the UE is provided with a time-domain measurement resource restriction pattern and CRS assistance information, and when non-MBSFN ABS configured in the interfering cells.

A.9.7.5.2 Test parameters

In this test case, there are three synchronous cells, Cell 1, Cell 2 and Cell 3, on the same RF channel. Cell 1 is the PCell on which UE Rx-Tx is measured. Cell 2 and Cell 3 are the interfering cells. A non-MBSFN ABS pattern is configured in each of the Cell 2 and Cell 3 during the entire test.

The tested UE is connected to the PCell and configured to transmit SRS signals periodically. The SRS configuration is provided to the UE before the measurement starts. The UE is configured to report UE Rx–Tx time difference measurement. The test equipment measures the transmit timing of the UE using the transmitted SRS, and measures the receive timing using the downlink CRS. The test equipment then compares the difference of these two timings to the UE Rx-Tx measurement reported by the UE. The UE is configured by higher layers via Cell 1 with a time-domain measurement resource restriction pattern for performing E-UTRAN FDD intra-frequency measurements on PCell. The UE is also provided via higher layers with the CRS assistance information for Cell 2. The information for both measurement patterns and the CRS assistance information shall be provided via RRC to the UE before the measurement starts.

The general and cell-specific parameters for this test case are defined in Table A.9.7.5.2-1 and Table A.9.7.5.2-2, respectively, and the SRS configuration used is specified in Table A.9.7.5.2-3.

Table A.9.7.5.2-1: General test parameters for FDD UE Rx–Tx time difference measurement under time-domain measurement resource restriction with CRS assistance information and non-MBSFN ABS

| Parameter | Unit | Value | Comment |
|---|--------------------------|---|---|
| Serving cell (PCell) | | Cell 1 | The measured cell |
| Neighbour cell | | Cell 2 and Cell 3 | Cell 2 is the first interfering cell to Cell 1, whilst Cell 3 is the second interfering cell to Cell 1. |
| ABS transmission configuration | | Non-MBSFN ABS | As defined in Table A.3.4.1.1-1 |
| E-UTRA RF Channel Number | | 1 | One FDD carrier frequency is used |
| Downlink Channel Bandwidth (BW _{channel}) | MHz | 10 | For all cells in the test |
| CP length | | Normal | For all cells in the test |
| DRX | | | OFF |
| Time offset between cells | µs | Cell 2 offset with respect to Cell 1: 3 Cell 3 offset with respect to Cell 1: 2 | Three synchronous cells |
| Physical cell ID PCI | | $(PCI_{cell1} - PCI_{cell2}) \bmod 6 = 0$ $(PCI_{cell1} - PCI_{cell3}) \bmod 6 \neq 0$ | Cell PCIs are selected so that both conditions are met |
| ABS pattern | | '100000001000000010000000000010000000010000000' | Non-MBSFN ABS. FDD ABS Pattern Info IE, as defined in TS 36.423 [28], clause 9.2.54. The first/leftmost bit corresponds to the Pcell subframe #0 of a radio frame satisfying SFN mod x = 0, where x is the size of the bit string (40) divided by 10. No MBSFN subframes are configured in the ABS subframes. Configured in Cell 2 and Cell 3 during the testing. |
| Time-domain measurement resource restriction pattern for PCell measurements | | '100000001000000010000000000010000000010000000' | Configured for measurements on Cell 1. |
| CRS assistance information | physCellId | see PCI conditions above | The CRS assistance information is provided for Cell 2 and Cell 3 in CRS-AssistanceInfo. It includes a single MBSFN-SubframeConfigList element with subframe allocation one Frame='000000'. |
| | antennaPortsCount | 1 | |
| | mbsfn-SubframeConfigList | oneFrame = '000000' | |

Table A.9.7.5.2-2: Cell-specific test parameters for FDD UE Rx–Tx time difference measurement under time-domain measurement resource restriction with CRS assistance information and non-MBSFN ABS

| Parameter | Unit | Cell 1 | Cell 2 | Cell 3 |
|---|-----------|----------|---|----------|
| E-UTRAN RF Channel Number | | 1 | 1 | 1 |
| PDSCH Reference measurement channel defined in A.3.1.1.1 | | R.0 FDD | N/A | N/A |
| PDSCH allocation | n_{PRB} | 13–36 | N/A | N/A |
| PDCCH/PCFICH/PHICH Reference measurement channel defined in A.3.1.2.1 | | R.6 FDD | N/A | N/A |
| OCNG Patterns defined in A.3.2.1.5 (OP.5 FDD) and in A.3.2.1.6 (OP.6 FDD) | | OP.5 FDD | OP.6 FDD | OP.6 FDD |
| PBCH_RA | dB | 0 | Non-ABS and ABS subframe channel powers defined in Table A.3.4.1.1-1. | |
| PBCH_RB | dB | | | |
| PSS_RA | dB | | | |
| SSS_RA | dB | | | |
| PCFICH_RB | dB | | | |
| PHICH_RA | dB | | | |
| PHICH_RB | dB | | | |
| PDCCH_RA | dB | | | |
| PDCCH_RB | dB | | | |

| | | | | |
|--|------------|--------|--------|--------|
| PDSCH_RA | dB | | | |
| PDSCH_RB | dB | | | |
| OCNG_RA ^{Note 1} | dB | | | |
| OCNG_RB ^{Note 1} | dB | | | |
| N_{oc} ^{Note 2} | dBm/15 kHz | -98 | -98 | -98 |
| CRS \hat{E}_s/N_{oc} | dB | -3 | 3 | 1 |
| CRS $\left(\hat{E}_s/I_{ot}\right)_{meas}$ ^{Note 3} | dB | -7.76 | 1.24 | -0.76 |
| CRS $\left(\hat{E}_s/I_{ot}\right)_{nonABS}$ ^{Note 3} | dB | -9.29 | -1.41 | -4.44 |
| RSRP ^{Note 4} | dBm/15 kHz | -101 | -95 | -97 |
| $(Io)_{meas}$ ^{Note 4} | dBm/9 MHz | -67.11 | -67.11 | -67.11 |
| $(Io)_{nonABS}$ ^{Note 4} | dBm/9 MHz | -63.45 | -63.45 | -63.45 |
| Propagation condition | | AWGN | | |
| NOTE 1: OCNG shall be used such that the resources in the active cell are fully allocated and a constant total transmitted power spectral density is achieved for all OFDM symbols. | | | | |
| NOTE 2: Interference from other cells and noise sources not specified in the test is assumed to be constant over subcarriers and time and shall be modelled as AWGN of appropriate power for N_{oc} to be fulfilled. Applies to all subframes. | | | | |
| Note 3: $\left(\hat{E}_s/I_{ot}\right)_{meas}$ is calculated in CRS REs in the subframes indicated for PCell measurements by measurement resource restriction pattern, whilst $\left(\hat{E}_s/I_{ot}\right)_{nonABS}$ is calculated in CRS REs in the subframes not indicated for PCell measurements by measurement resource restriction pattern. | | | | |
| Note 4: RSRP and Io levels have been derived from other parameters for information purposes. They are not settable parameters themselves. $(Io)_{meas}$ is calculated in CRS symbols in the subframes indicated for PCell measurements by measurement resource restriction pattern, whilst $(Io)_{nonABS}$ is calculated in CRS symbols in the subframes not indicated for PCell measurements by measurement resource restriction pattern. | | | | |

Table A.9.7.5.2-3: Sounding Reference Symbol Configuration to be used in FDD UE Rx–Tx time difference test

| Field | Value | Comment |
|------------------------------------|--|-----------------------------|
| UL bandwidth | 50 RBs | Same as the DL bandwidth |
| srsBandwidthConfiguration | bw5 | |
| srsSubframeConfiguration | sc1 | |
| ackNackSrsSimultaneousTransmission | FALSE | |
| srsMaxUpPTS | N/A | Not applicable for FDD |
| srsBandwidth | 0 | No hopping |
| srsHoppingBandwidth | hbw0 | |
| frequencyDomainPosition | 0 | |
| Duration | TRUE | Indefinite duration |
| srs-ConfigIndex | 0 | SRS periodicity of 2ms |
| transmissionComb | 0 | |
| cyclicShift | cs0 | No cyclic shift |
| srsAntennaPort | an1 | Number of SRS antenna ports |
| Note: | For further information see clause 6.3.2 in TS 36.331. | |

A.9.7.5.3 Test Requirements

The UE Rx–Tx time difference measurement accuracy shall fulfill the requirements in Section 9.1.9.4.

A.9.7.6 E-UTRAN TDD UE Rx-Tx Time Difference under Time-Domain Measurement Resource Restriction with CRS Assistance Information and Non-MBSFN ABS

A.9.7.6.1 Test Purpose and Environment

The purpose of this test is to verify that the E-UTRAN TDD UE Rx–Tx time difference measurement accuracy is within the specified limits. This test will verify the requirements in Section 9.1.9.4 when the UE is provided with a time-domain measurement resource restriction pattern and CRS assistance information, and when non-MBSFN ABS configured in the interfering cells.

A.9.7.6.2 Test Parameters

In this test case, there are three synchronous cells, Cell 1, Cell 2 and Cell 3, on the same RF channel. Cell 1 is the PCell on which UE Rx-Tx is measured. Cell 2 and Cell 3 are the interfering cells. A non-MBSFN ABS pattern is configured in each of the Cell 2 and Cell 3 during the entire test.

The tested UE is connected to the PCell and configured to transmit SRS signals periodically. The SRS configuration is provided to the UE before the measurement starts. The UE is configured to report UE Rx–Tx time difference measurement. The test equipment measures the transmit timing of the UE using the transmitted SRS, and measures the receive timing using the downlink CRS. The test equipment then compares the difference of these two timings to the UE Rx-Tx measurement reported by the UE. The UE is configured by higher layers via Cell 1 with a time-domain measurement resource restriction pattern for performing E-UTRAN TDD intra-frequency measurements on PCell. The UE is also provided via higher layers with the CRS assistance information for Cell 2. The information for both measurement patterns and the CRS assistance information shall be provided via RRC to the UE before the measurement starts.

The general and cell-specific parameters for this test case are defined in Table A.9.7.6.2-1 and Table A.9.7.6.2-2, respectively, and the SRS configuration used is specified in Table A.9.7.6.2-3.

Table A.9.7.6.2-1: General test parameters for E-UTRAN TDD UE Rx-Tx time difference measurement under time-domain measurement resource restriction with CRS assistance information and non-MBSFN ABS

| Parameter | Unit | Value | Comment |
|---|------|---|---|
| Serving cell (PCell) | | Cell 1 | Cell to be measured |
| Neighbour cell | | Cell 2 and Cell 3 | Cell 2 is the first interfering cell to Cell 1, whilst Cell 3 is the second interfering cell to Cell 1. |
| ABS transmission configuration | | Non-MBSFN ABS | As defined in Table A.3.4.1.1-1 |
| E-UTRA RF Channel Number | | 1 | One TDD carrier frequency is used |
| Downlink Channel Bandwidth (BW _{channel}) | MHz | 10 | For all cells in the test |
| CP length | | Normal | For all cells in the test |
| Special subframe configuration | | 6 | For all cells in the test. For special subframe configurations see Table 4.2-1 in [16]. |
| Uplink/downlink subframe configuration | | 1 | For all cells in the test. For uplink-downlink subframe configurations see Table 4.2-2 in [16]. |
| DRX | | | OFF |
| Time offset between cells | μs | Cell 2 offset with respect to Cell 1: 3 Cell 3 offset with respect to Cell 1: 2 | Three synchronous cells |
| Physical cell ID PCI | | $(PCI_{cell1} - PCI_{cell2}) \bmod 6 = 0$ $(PCI_{cell1} - PCI_{cell3}) \bmod 6 \neq 0$ | Cell PCIs are selected so that both conditions are met |

| | | | | |
|--|--------------------------|--|--------------------------|---|
| ABS pattern | | | '00000000010000000001' | Non-MBSFN ABS. TDD ABS Pattern Info IE, as defined in TS 36.423 [28], clause 9.2.54. The first/leftmost bit corresponds to the Pcell subframe #0 of a radio frame satisfying SFN mod x = 0, where x is the size of the bit string (20) divided by 10. No MBSFN subframes are configured in the ABS subframes. Configured in Cell 2 and Cell 3 during the testing. |
| Time-domain measurement resource restriction pattern for serving cell measurements | | | '00000000010000000001' | Configured for measurements on Cell 1. |
| CRS assistance information | physCellId | | see PCI conditions above | The CRS assistance information is provided for Cell 2 and Cell 3 in CRS-AssistanceInfo. It includes a single MBSFN-SubframeConfig element with subframe allocation one Frame='000000'. |
| | antennaPortsCount | | 1 | |
| | mbsfn-SubframeConfigList | | oneFrame = '000000' | |

Table A.9.7.6.2-2: Cell-specific test parameters for E-UTRAN TDD UE Rx-Tx time difference measurement under time-domain measurement resource restriction with CRS assistance information and non-MBSFN ABS

| Parameter | Unit | Cell 1 | Cell 2 | Cell 3 |
|--|------------|----------|---|----------|
| E-UTRAN RF Channel Number | | 1 | 1 | 1 |
| PDSCH Reference measurement channel defined in A.3.1.1.2 | | R.0 TDD | N/A | N/A |
| PDSCH allocation | n_{PRB} | 13–36 | N/A | N/A |
| PDCCH/PCFICH/PHICH Reference measurement channel defined in A.3.1.2.2 | | R.6 TDD | N/A | N/A |
| OCNG Patterns defined in A.3.2.2.1 (OP.1 TDD) and A.3.2.2.2 (OP.2 TDD) | | OP.1 TDD | OP.2 TDD | OP.2 TDD |
| PBCH_RA | dB | 0 | Non-ABS and ABS subframe channel powers defined in Table A.3.4.1.1-1. | |
| PBCH_RB | dB | | | |
| PSS_RA | dB | | | |
| SSS_RA | dB | | | |
| PCFICH_RB | dB | | | |
| PHICH_RA | dB | | | |
| PHICH_RB | dB | | | |
| PDCCH_RA | dB | | | |
| PDCCH_RB | dB | | | |
| PDSCH_RA | dB | | | |
| PDSCH_RB | dB | | | |
| OCNG_RA ^{Note1} | dB | | | |
| OCNG_RB ^{Note1} | dB | | | |
| N_{oc} ^{Note2} | dBm/15 kHz | -98 | -98 | -98 |
| CRS \hat{E}_s / N_{oc} | dB | -3 | 3 | 1 |
| CRS $(\hat{E}_s / I_{ot})_{meas}$ ^{Note 3} | dB | -7.76 | 1.24 | -0.76 |
| CRS $(\hat{E}_s / I_{ot})_{nonABS}$ ^{Note 3} | dB | -9.29 | -1.41 | -4.44 |
| RSRP ^{Note 4} | dBm/15 kHz | -101 | -95 | -97 |
| $(I_o)_{meas}$ ^{Note 4} | dBm/9 MHz | -67.11 | -67.11 | -67.11 |
| $(I_o)_{nonABS}$ ^{Note 4} | dBm/9 MHz | -63.45 | -63.45 | -63.45 |
| Propagation Condition | | AWGN | | |
| Note 1: OCNG shall be used such that the resources in the active cell are fully allocated and a constant total transmitted power spectral density is achieved for all OFDM symbols. Note 2: Interference from other cells and noise sources not specified in the test is assumed to be constant over subcarriers and time and shall be modeled as AWGN of appropriate power for N_{oc} to be fulfilled. | | | | |

Note 3: $(\hat{E}_s/I_{ot})_{meas}$ is calculated in CRS REs in the subframes indicated for PCell measurements by measurement resource restriction pattern, whilst $(\hat{E}_s/I_{ot})_{nonABS}$ is calculated in CRS REs in the subframes not indicated for PCell measurements by measurement resource restriction pattern.

Note 4: RSRP and I_o levels have been derived from other parameters for information purposes. They are not settable parameters themselves. $(I_o)_{meas}$ is calculated in CRS symbols in the subframes indicated for PCell measurements by measurement resource restriction pattern, whilst $(I_o)_{nonABS}$ is calculated in CRS symbols

Table A.9.7.6.2-3: Sounding Reference Symbol Configuration to be used in TDD UE Rx–Tx time difference test

| Field | Value | Comment |
|------------------------------------|--|---|
| UL bandwidth | 50 RBs | Same as the DL bandwidth |
| srsBandwidthConfiguration | bw5 | |
| srsSubframeConfiguration | sc1 | |
| ackNackSrsSimultaneousTransmission | FALSE | |
| srsMaxUpPTS | TRUE | |
| srsBandwidth | 0 | No hopping |
| srsHoppingBandwidth | hbw0 | |
| frequencyDomainPosition | 0 | |
| Duration | TRUE | Indefinite duration |
| Srs-ConfigurationIndex | 10 | SRS periodicity of 10ms for all Tests. |
| transmissionComb | 0 | |
| cyclicShift | cs0 | No cyclic shift |
| SRS-AntennaPort | an1 | Number of antenna ports used for SRS transmission |
| Note: | For further information see clause 6.3.2 in TS 36.331. | |

A.9.7.6.3 Test Requirements

The UE Rx–Tx time difference measurement accuracy shall fulfill the requirements in Section 9.1.9.4.

A.9.8 RSTD

A.9.8.1 E-UTRAN FDD RSTD intra frequency case

A.9.8.1.1 Test Purpose and Environment

The purpose of this test is to verify that the RSTD intra-frequency measurement accuracy is within the specified limits in clause 9.1.10.1 in AWGN channels.

In the test, there are two synchronous cells, Cell 1 as the reference cell and Cell 2 as the neighbour cell on the same frequency.

The OTDOA assistance data as defined in TS 36.355, Clause 6.5.1, shall be provided to the UE before the measurement period. The last TTI containing the OTDOA assistance data shall be provided to the UE ΔT ms before the start of measurement period, where $\Delta T = 150$ ms is the maximum processing time of the OTDOA assistance data.

A time span of $T_{RSTD \text{ IntraFreqFDD, E-UTRAN}}$ is provided for the measurement period, and PRS are configured according to I_{PRS} in Tables A.9.8.1.1-1 and A.9.8.1.1-2 during this time.

The test parameters are given in Table A.9.8.1.1-1 and Table A.9.8.1.1-2.

Table A.9.8.1.1-1: General Test Parameters for intra frequency RSTD Tests for E-UTRAN FDD

| Parameter | Unit | Value | | | | Comment |
|---|------|---|--|--|---|---|
| | | Test1 | Test2 | Test3 | Test4 | |
| PCFICH/PDCCH/PHICH parameters | | R.14 FDD | | R.6 FDD | | As specified in clause A.3.1.2.1 |
| OCNG Patterns defined in A.3.2.1 | | OP.7 FDD | | OP.6 FDD | | OCNG shall be used such that both cells are fully allocated and a constant total transmitted power spectral density is achieved for all OFDM symbols (other than those in the PRS subframes). |
| Reference cell | | Cell 1 | | | | |
| Neighbour cell | | Cell 2 | | | | |
| E-UTRA RF Channel Number | | 1 | | | | One FDD carrier frequency is used. |
| Channel Bandwidth (BW_{channel}) | MHz | 1.4 | | 10 | | |
| PRS Bandwidth | RB | 6 | | 50 | | PRS bandwidth is as indicated in <i>prs-Bandwidth</i> in the OTDOA assistance data defined in [24]. |
| PRS configuration Index I_{PRS} | | 12 | | 2 | | As defined in TS 36.211 |
| Number of consecutive positioning downlink subframes N_{PRS} | | 6 | | 1 | | As defined in TS 36.211 |
| prs-MutingInfo | | Cell 1: '11110000' Cell 2: '11110000' | | | | See clause 6.5.1.2 in TS 36.355 for more information |
| Cell ID | | (Cell ID of cell 1 – Cell ID of cell 2) mod 6 = 0 | (Cell ID of cell 1 – Cell ID of cell 2) mod 6 = 1 | (Cell ID of cell 1 – Cell ID of cell 2) mod 6 = 0 | (Cell ID of cell 1 – Cell ID of cell 2) mod 6 = 3 | |
| expectedRSTD | us | Cell 2: 1 Other neighbour cells: randomly between -3 and 3 | Cell 2: -1 Other neighbour cells: randomly between -3 and 3 | Cell 2: -1 Other neighbour cells: randomly between -3 and 3 | Cell 2: 1 Other neighbour cells: randomly between -3 and 3 | |
| expectedRSTDUncertainty for all neighbour cells | us | 5 | 5 | 5 | 5 | |
| CP length | | Normal | | | | |
| DRX | | OFF | | | | |
| Radio frame receive time offset between the cells at the UE antenna connector | us | Cell 2 to Cell 1: -3 | Cell 2 to Cell 1: 3 | Cell 2 to Cell 1: 3 | Cell 2 to Cell 1: -3 | PRS are transmitted from synchronous cells |
| Number of cells provided in OTDOA assistance data | | 16 | | | | The number of cells includes the reference cell |
| $T_{\text{RSTD IntraFreqFDD, E-UTRAN}}$ | ms | 2560 | | | | Derived according to the RSTD measurement requirements specified in Clause 8.1.2.5.1 |

Table A.9.8.1.1-2: Cell Specific Test Parameters for intra frequency RSTD Tests for E-UTRAN FDD

| Parameter | Unit | Test1 | Test2 | Test3 | Test4 |
|-----------|------|-------|-------|-------|-------|
|-----------|------|-------|-------|-------|-------|

| | | Cell1 | Cell2 | Cell1 | Cell2 | Cell1 | Cell2 | Cell1 | Cell2 |
|--|--------------|---------|---------|--------|--------|---------|---------|-------|-------|
| E-UTRA RF Channel Number | | 1 | | | | | | | |
| PBCH_RA | dB | 0 | 0 | 0 | 0 | 0 | 0 | 0 | 0 |
| PBCH_RB | | | | | | | | | |
| PSS_RA | | | | | | | | | |
| SSS_RA | | | | | | | | | |
| PCFICH_RB | | | | | | | | | |
| PHICH_RA | | | | | | | | | |
| PHICH_RB | | | | | | | | | |
| PDCCH_RA | | | | | | | | | |
| PDCCH_RB | | | | | | | | | |
| OCNG_RA ^{Note1} | | | | | | | | | |
| OCNG_RB ^{Note1} | | | | | | | | | |
| PRS_RA | dB | 0 | 0 | -3 | 0 | 0 | 0 | -3 | 0 |
| N_{oc} ^{Note2} | dBm/15 kHz | -98 | -98 | -98 | -98 | -98 | -98 | -98 | -98 |
| $\text{PRS } \hat{E}_s/N_{oc}$ | dB | -2.37 | -8.02 | -6 | -13 | -2.37 | -8.02 | -6 | -13 |
| $\text{PRS } \hat{E}_s/I_{ot}$ ^{Note3} | dB | -3 | -10 | -6 | -13 | -3 | -10 | -6 | -13 |
| I_o ^{Note3} | dBm/1.08 MHz | -78.92 | -78.92 | -79.21 | -79.21 | N/A | N/A | N/A | N/A |
| | dBm/9 MHz | N/A | N/A | N/A | N/A | -69.72 | -69.72 | -70 | -70 |
| PRP ^{Note3} | dBm/15kHz | -100.37 | -106.02 | -104 | -111 | -100.37 | -106.02 | -104 | -111 |
| \hat{E}_s/N_{oc} ^{Note 3} | dB | -2.37 | -8.02 | -3 | -13 | -2.37 | -8.02 | -3 | -13 |
| RSRP ^{Note 3} | dBm/15kHz | -100.37 | -106.02 | -101 | -111 | -100.37 | -106.02 | -101 | -111 |
| Propagation condition | | AWGN | | | | | | | |
| <p>Note 1: OCNG shall be used such that both cells are fully allocated and a constant total transmitted power spectral density is achieved for all OFDM symbols (other than those in the PRS subframes).</p> <p>Note 2: Interference from other cells and noise sources not specified in the test is assumed to be constant over subcarriers and time and shall be modelled as AWGN of appropriate power for N_{oc} to be fulfilled.</p> <p>Note 3: \hat{E}_s/N_{oc}, $\text{PRS } \hat{E}_s/I_{ot}$, I_o, RSRP and PRP levels have been derived from other parameters for information purposes. They are not settable parameters themselves. I_o values are derived in the case that there is no PBCH, PSS or SSS in the OFDM symbols carrying PRS</p> | | | | | | | | | |

A.9.8.1.2 Test Requirements

The RSTD measurement accuracy shall fulfill the requirements in clause 9.1.10.1.

A.9.8.2 E-UTRAN TDD RSTD intra frequency case

A.9.8.2.1 Test Purpose and Environment

The purpose of this test is to verify that the RSTD intra-frequency measurement accuracy is within the specified limits in clause 9.1.10.1 in AWGN channels.

In the test, there are two synchronous cells, Cell 1 as the reference cell and Cell 2 as the neighbour cell on the same frequency.

The OTDOA assistance data as defined in TS 36.355, Clause 6.5.1, shall be provided to the UE before the measurement period. The last TTI containing the OTDOA assistance data shall be provided to the UE ΔT ms before the start of measurement period, where $\Delta T = 150$ ms is the maximum processing time of the OTDOA assistance data.

A time span of $T_{\text{RSTD IntraFreqTDD, E-UTRAN}}$ is provided for the measurement period, and PRS are configured according to I_{PRS} in Tables A.9.8.2.1-1 and A.9.8.2.1-2 during this time.

The test parameters are given in Table A.9.8.2.1-1 and Table A.9.8.2.1-2.

Table A.9.8.2.1-1: General Test Parameters for intra frequency RSTD Tests for E-UTRAN TDD

| Parameter | Unit | Value | | | | Comment |
|---|------|---|--|--|---|---|
| | | Test1 | Test2 | Test3 | Test4 | |
| PCFICH/PDCCH/PHICH parameters | | R.14 TDD | | R.6 TDD | | As specified in clause A.3.1.2.2 |
| OCNG Patterns defined in A.3.2.2 | | OP.4 TDD | | OP.2 TDD | | OCNG shall be used such that both cells are fully allocated and a constant total transmitted power spectral density is achieved for all OFDM symbols (other than those in the PRS subframes). |
| Reference cell | | Cell 1 | | | | |
| Neighbour cell | | Cell 2 | | | | |
| E-UTRA RF Channel Number | | 1 | | | | One TDD carrier frequency is used. |
| Channel Bandwidth (BW_{channel}) | MHz | 1.4 | | 10 | | |
| PRS Bandwidth | RB | 6 | | 50 | | PRS bandwidth is as indicated in <i>prs-Bandwidth</i> in the OTDOA assistance data defined in [24]. |
| Special subframe configuration | | 6 | | 6 | | As specified in table 4.2-1 in TS 36.211. The same configuration in both cells. |
| Uplink-downlink configuration | | 3 | | 1 | | As specified in table 4.2-2 in TS 36.211 and table 8.1.2.5.2-2. The same configuration in both cells. |
| PRS configuration Index I_{PRS} | | 9 | | 14 | | As defined in TS 36.211 |
| Number of consecutive positioning downlink subframes N_{PRS} | | 6 | | 1 | | As defined in TS 36.211 |
| prs-MutingInfo | | Cell 1: '11110000' Cell 2: '11110000' | | | | See clause 6.5.1.2 in TS 36.355 for more information |
| Cell ID | | (Cell ID of cell 1 – Cell ID of cell 2) mod 6 = 0 | (Cell ID of cell 1 – Cell ID of cell 2) mod 6 = 1 | (Cell ID of cell 1 – Cell ID of cell 2) mod 6 = 0 | (Cell ID of cell 1 – Cell ID of cell 2) mod 6 = 3 | |
| expectedRSTD | us | Cell 2: 1 Other neighbour cells: randomly between -3 and 3 | Cell 2: -1 Other neighbour cells: randomly between -3 and 3 | Cell 2: -1 Other neighbour cells: randomly between -3 and 3 | Cell 2: 1 Other neighbour cells: randomly between -3 and 3 | |
| expectedRSTDUncertainty for all neighbour cells | us | 5 | 5 | 5 | 5 | |
| CP length | | Normal | | | | |
| DRX | | OFF | | | | |
| Radio frame receive time offset between the cells at the UE antenna connector | us | Cell 2 to Cell 1: -3 | Cell 2 to Cell 1: 3 | Cell 2 to Cell 1: 3 | Cell 2 to Cell 1: -3 | PRS are transmitted from synchronous cells |
| Number of cells provided in OTDOA assistance data | | 16 | | | | The number of cells includes the reference cell |

| | | | |
|---|----|------|--|
| $T_{\text{RSTD IntraFreqTDD, E-UTRAN}}$ | ms | 2560 | Derived according to the RSTD measurement requirements specified in Clause 8.1.2.5.2 |
|---|----|------|--|

Table A.9.8.2.1-2: Cell Specific Test Parameters for intra frequency RSTD Tests for E-UTRAN TDD

| Parameter | Unit | Test1 | | Test2 | | Test3 | | Test4 | |
|---|--------------|---------|---------|--------|--------|---------|---------|-------|-------|
| | | Cell1 | Cell2 | Cell1 | Cell2 | Cell1 | Cell2 | Cell1 | Cell2 |
| E-UTRA RF Channel Number | | 1 | | | | | | | |
| PBCH_RA | dB | 0 | 0 | 0 | 0 | 0 | 0 | 0 | 0 |
| PBCH_RB | | | | | | | | | |
| PSS_RA | | | | | | | | | |
| SSS_RA | | | | | | | | | |
| PCFICH_RB | | | | | | | | | |
| PHICH_RA | | | | | | | | | |
| PHICH_RB | | | | | | | | | |
| PDCCH_RA | | | | | | | | | |
| PDCCH_RB | | | | | | | | | |
| OCNG_RA ^{Note1} | | | | | | | | | |
| OCNG_RB ^{Note1} | | | | | | | | | |
| PRS_RA | | | | | | | | | |
| N_{oc} ^{Note2} | dBm/15 kHz | -98 | -98 | -98 | -98 | -98 | -98 | -98 | -98 |
| $\text{PRS } \hat{E}_s / N_{oc}$ | dB | -2.37 | -8.02 | -6 | -13 | -2.37 | -8.02 | -6 | -13 |
| $\text{PRS } \hat{E}_s / I_{ot}$ ^{Note3} | dB | -3 | -10 | -6 | -13 | -3 | -10 | -6 | -13 |
| I_o ^{Note3} | dBm/1.08 MHz | -78.92 | -78.92 | -79.21 | -79.21 | N/A | N/A | N/A | N/A |
| | dBm/9 MHz | N/A | N/A | N/A | N/A | -69.72 | -69.72 | -70 | -70 |
| PRP ^{Note3} | dBm/15kHz | -100.37 | -106.02 | -104 | -111 | -100.37 | -106.02 | -104 | -111 |
| \hat{E}_s / N_{oc} ^{Note 3} | dB | -2.37 | -8.02 | -3 | -13 | -2.37 | -8.02 | -3 | -13 |
| RSRP ^{Note 3} | dBm/15kHz | -100.37 | -106.02 | -101 | -111 | -100.37 | -106.02 | -101 | -111 |
| Propagation condition | | AWGN | | | | | | | |
| <p>Note 1: OCNG shall be used such that both cells are fully allocated and a constant total transmitted power spectral density is achieved for all OFDM symbols (other than those in the PRS subframes).</p> <p>Note 2: Interference from other cells and noise sources not specified in the test is assumed to be constant over subcarriers and time and shall be modelled as AWGN of appropriate power for N_{oc} to be fulfilled.</p> <p>Note 3: \hat{E}_s / N_{oc}, $\text{PRS } \hat{E}_s / I_{ot}$, I_o, RSRP and PRP levels have been derived from other parameters for information purposes. They are not settable parameters themselves. I_o values are derived in the case that there is no PBCH, PSS or SSS in the OFDM symbols carrying PRS.</p> | | | | | | | | | |

A.9.8.2.2 Test Requirements

The RSTD measurement accuracy shall fulfill the requirements in clause 9.1.10.1.

A.9.8.3 E-UTRAN FDD-FDD RSTD inter frequency case

A.9.8.3.1 Test Purpose and Environment

The purpose of these tests is to verify that the RSTD inter-frequency measurement accuracy is within the specified limits in clause 9.1.10.2 in AWGN channels.

There are two synchronous cells on different carrier frequencies in the test. In all test cases, Cell 1 is the reference cell as well as the PCell and Cell 2 the neighbor cell. The inter frequency measurements on Cell 2 are supported by measurement gaps. PCIs of the two cells are selected randomly.

The OTDOA assistance data as defined in TS 36.355, Clause 6.5.1, shall be provided to the UE before the measurement period. The last TTI containing the OTDOA assistance data shall be provided to the UE ΔT ms before the start of measurement period, where $\Delta T = 150$ ms is the maximum processing time of the OTDOA assistance data. The measurement gap configuration is known and configured in the UE before the measurements start.

There is no PDSCH allocated in the subframe transmitting PRS. A time span of $T_{\text{RSTD InterFreqFDD, E-UTRAN}}$ is provided for the measurement period, and PRS are configured according to I_{PRS} in Table A.9.8.3.1-1 and Table A.9.8.3.1-2 for each of the two cells during this time.

The test parameters are given in Table A.9.8.3.1-1 and Table A.9.8.3.1-2.

Table A.9.8.3.1-1: General Test Parameters for inter frequency RSTD Tests for E-UTRAN FDD

| Parameter | Unit | Value | | Comment |
|--|---------------|--|-------------------------|---|
| | | Test1 | Test2 | |
| PCFICH/PDCCH/PHICH parameters | | R.14 FDD | R.6 FDD | As specified in clause A.3.1.2.1 |
| OCNG Patterns defined in A.3.2.1 | | OP.7 FDD | OP.6 FDD | OCNG shall be used such that both cells are fully allocated and a constant total transmitted power spectral density is achieved for all OFDM symbols (other than those in the PRS subframes). |
| Reference cell | | Cell 1 | | Cell 1 on RF channel number 1 |
| Neighbour cell | | Cell 2 | | Cell 2 on RF channel number 2 |
| E-UTRA RF Channel Number | | 1,2 | | Two FDD carrier frequencies are used. |
| Channel Bandwidth (BW_{channel}) | MHz | 1.4 | 10 | |
| PRS Bandwidth | RB | 6 | 50 | PRS bandwidth is as indicated in <i>prs-Bandwidth</i> in the OTDOA assistance data defined in [24]. |
| Number of consecutive positioning downlink subframes N_{PRS} | | 6 | 1 | As defined in TS 36.211 |
| prs-MutingInfo | | Cell1:'11110000' Cell2:'11110000' | | See clause 6.5.1.2 in TS 36.355 for more information |
| expectedRSTD | μs | Cell 2:1 Other neighbour cells: randomly between -3 and 3 | | The expected RSTD is what is expected at the receiver. The corresponding parameter in the OTDOA assistance data specified in TS 36.355 [24] is the expectedRSTD indicator |
| expectedRSTDUncertainty for all neighbour cells | μs | 5 | | The corresponding parameter in the OTDOA assistance data specified in TS 36.355 [24] is the expectedRSTD-Uncertainty index |
| CP length | | Normal | | |
| DRX | | OFF | | |
| Radio frame transmit time offset between the cells at the UE antenna connector | μs | Cell 2 to Cell 1: 3 | Cell 2 to Cell 1: -3 | Synchronous cells |
| Number of cells provided in OTDOA assistance data | | 16 | | The list includes the reference cell (received in <i>OTDOA-ReferenceCellInfo</i> [24]) on RF channel 1 and 15 other cells on RF channel 2, all received in <i>OTDOA-ProvideAssistanceData</i> [24]. |
| $T_{\text{RSTD InterFreqFDD, E-UTRAN}}$ | ms | 5120 | | Derived according to the RSTD measurement requirements specified in Clause 8.1.2.6.1 |

Table A.9.8.3.1-2: Cell Specific Test Parameters for inter frequency RSTD Tests for E-UTRAN FDD

| Parameter | Unit | Test1 | | Test2 | |
|--|------|-------|-------|-------|-------|
| | | Cell1 | Cell2 | Cell1 | Cell2 |
| E-UTRA RF Channel Number | | 1 | 2 | 1 | 2 |
| GapOffset | | 18 | N/A | 11 | N/A |
| Gap Pattern ID | | 0 | N/A | 0 | N/A |
| PRS configuration Index I_{PRS} | | 12 | 19 | 2 | 12 |
| PRS subframe offset | | N/A | 7 | N/A | 10 |
| PBCH_RA | dB | 0 | 0 | 0 | 0 |
| PBCH_RB | | | | | |
| PSS_RA | | | | | |
| SSS_RA | | | | | |

| | | | | | |
|---|--------------|--------|--------|--------|--------|
| PCFICH_RB | | | | | |
| PHICH_RA | | | | | |
| PHICH_RB | | | | | |
| PDCCH_RA | | | | | |
| PDCCH_RB | | | | | |
| OCNG_RA ^{Note1} | | | | | |
| OCNG_RB ^{Note1} | | | | | |
| PRS_RA | dB | -3 | 0 | -3 | 0 |
| N_{oc} ^{Note2} | dBm/15 kHz | -98 | | | |
| $PRS \hat{E}_s / N_{oc}$ | dB | -6 | -13 | -6 | -13 |
| $PRS \hat{E}_s / I_{ot}$ ^{Note3} | dB | -6 | -13 | -6 | -13 |
| I_o ^{Note3} | dBm/1.08 MHz | -79.25 | -79.39 | N/A | N/A |
| | dBm/9 MHz | N/A | N/A | -70.04 | -70.18 |
| PRP ^{Note3} | dBm/15kHz | -104 | -111 | -104 | -111 |
| \hat{E}_s / N_{oc} ^{Note 3} | dB | -3 | -13 | -3 | -13 |
| RSRP ^{Note 3} | dBm/15kHz | -101 | -111 | -101 | -111 |
| Propagation condition | | AWGN | | | |
| <p>Note 1: OCNG shall be used such that both cells are fully allocated and a constant total transmitted power spectral density is achieved for all OFDM symbols (other than those in the PRS subframes).</p> <p>Note 2: Interference from other cells and noise sources not specified in the test is assumed to be constant over subcarriers and time and shall be modelled as AWGN of appropriate power for N_{oc} to be fulfilled.</p> <p>Note 3: \hat{E}_s / N_{oc}, $PRS \hat{E}_s / I_{ot}$, I_o, RSRP and PRP levels have been derived from other parameters for information purposes. They are not settable parameters themselves. I_o values are derived in the case that there is no PBCH, PSS or SSS in the OFDM symbols carrying PRS.</p> | | | | | |

A.9.8.3.2 Test Requirements

The RSTD measurement accuracy shall fulfill the requirements in clause 9.1.10.2.

A.9.8.4 E-UTRAN TDD-TDD RSTD inter frequency case

A.9.8.4.1 Test Purpose and Environment

The purpose of this test is to verify that the RSTD inter-frequency measurement accuracy is within the specified limits in clause 9.1.10.2 in AWGN channels.

There are two synchronous cells on different carrier frequencies in the test. In all test cases, Cell 1 is the reference cell as well as the PCell and Cell 2 is the neighbour cell. The inter frequency measurements on Cell 2 are supported by a measurement gap. PCIs of the two cells are selected randomly.

The OTDOA assistance data as defined in TS 36.355, Clause 6.5.1, shall be provided to the UE before the measurement period. The last TTI containing the OTDOA assistance data shall be provided to the UE ΔT ms before the start of measurement period, where $\Delta T = 150$ ms is the maximum processing time of the OTDOA assistance data. The measurement gap configuration is known and configured in the UE before the measurements start.

There is no PDSCH allocated in the subframe transmitting PRS. A time span of $T_{RSTD \text{ InterFreqTDD, E-UTRAN}}$ is provided for the measurement period, and PRS are configured according to I_{PRS} in Table A.9.8.4.1-1 and Table A.9.8.4.1-2 for each of the two cells during this time.

The test parameters are given in Table A.9.8.4.1-1 and Table A.9.8.4.1-2.

Table A.9.8.4.1-1: General Test Parameters for inter frequency RSTD Tests for E-UTRAN TDD

| Parameter | Unit | Value | | Comment |
|-----------|------|-------|-------|---------|
| | | Test1 | Test2 | |

| | | | | |
|---|---------|---|----------------------|---|
| PCFICH/PDCCH/PHICH parameters | | R.14 TDD | R.6 TDD | As specified in clause A.3.1.2.2 |
| OCNG Patterns defined in A.3.2.2 | | OP.4 TDD | OP.2 TDD | OCNG shall be used such that both cells are fully allocated and a constant total transmitted power spectral density is achieved for all OFDM symbols (other than those in the PRS subframes). |
| Reference cell | | Cell 1 | | Cell 1 on RF channel number 1 |
| Neighbour cell | | Cell 2 | | Cell 2 on RF channel number 2 |
| E-UTRA RF Channel Number | | 1,2 | | Two TDD carrier frequencies are used. |
| Channel Bandwidth ($BW_{channel}$) | MHz | 1.4 | 10 | |
| PRS Bandwidth | RB | 6 | 50 | PRS bandwidth is as indicated in <i>prs-Bandwidth</i> in the OTDOA assistance data defined in [24]. |
| Special subframe configuration | | 6 | | As specified in table 4.2-1 in TS 36.211. The same configuration in both cells. |
| Uplink-downlink configuration | | 3 | 1 | As specified in table 4.2-2 in TS 36.211 and table 8.1.2.5.2-2. |
| Number of consecutive positioning downlink subframes N_{PRS} | | 6 | 1 | As defined in TS 36.211 |
| prs-MutingInfo | | Cell1:'11110000' Cell2:'11110000' | | PRS muting is not used. See clause 6.5.1.2 in TS 36.355 for more information |
| expectedRSTD | μ s | Cell 2: 1 Other neighbour cells: randomly between -3 and 3 | | The expected RSTD is what is expected at the receiver. The corresponding parameter in the OTDOA assistance data specified in TS 36.355 [24] is the expectedRSTD indicator |
| expectedRSTDUncertainty for all neighbour cells | μ s | 5 | 5 | The corresponding parameter in the OTDOA assistance data specified in TS 36.355 [24] is the expectedRSTD-Uncertainty index |
| CP length | | Normal | | |
| DRX | | OFF | | |
| Radio frame receive time offset between the cells at the UE antenna connector | μ s | Cell 2 to Cell 1: 3 | Cell 2 to Cell 1: -3 | PRS are transmitted from synchronous cells |
| Number of cells provided in OTDOA assistance data | | 16 | | The list includes the reference cell (received in <i>OTDOA-ReferenceCellInfo</i> [24]) on RF channel 1 and 15 other cells on RF channel 2, all received in <i>OTDOA-ProvideAssistanceData</i> [24]. |
| T_{RSTD} InterFreqTDD, E-UTRAN | ms | 5120 | | Derived according to the RSTD measurement requirements specified in Clause 8.1.2.6.3 |

Table A.9.8.4.1-2: Cell Specific Test Parameters for inter frequency RSTD Tests for E-UTRAN TDD

| Parameter | Unit | Test1 | | Test2 | |
|-----------------------------------|------------|-------|-------|-------|-------|
| | | Cell1 | Cell2 | Cell1 | Cell2 |
| E-UTRA RF Channel Number | | 1 | 2 | 1 | 2 |
| Gap pattern ID | | 0 | N/A | 0 | N/A |
| Gapoffset | | 34 | N/A | 13 | N/A |
| PRS configuration Index I_{PRS} | | 15 | 35 | 4 | 14 |
| PRS subframe offset | | N/A | 20 | N/A | 10 |
| PBCH_RA | dB | 0 | | | |
| PBCH_RB | | | | | |
| PSS_RA | | | | | |
| SSS_RA | | | | | |
| PCFICH_RB | | | | | |
| PHICH_RA | | | | | |
| PHICH_RB | | | | | |
| PDCCH_RA | | | | | |
| PDCCH_RB | | | | | |
| OCNG_RA ^{Note1} | | | | | |
| OCNG_RB ^{Note1} | | | | | |
| PRS_RA | | | | | |
| N_{oc} ^{Note2} | dBm/15 kHz | -98 | | | |
| PRS \hat{E}_s/N_{oc} | dB | -6 | -13 | -6 | -13 |

| | | | | | |
|---|--------------|--------|--------|--------|--------|
| PRS \hat{E}_s/I_{ot} Note3 | dB | -6 | -13 | -6 | -13 |
| I_o Note3 | dBm/1.08 MHz | -79.25 | -79.39 | N/A | N/A |
| | dBm/9 MHz | N/A | N/A | -70.04 | -70.18 |
| PRP Note3 | dBm/15kHz | -104 | -111 | -104 | -111 |
| \hat{E}_s/N_{oc} Note 3 | dB | -3 | -13 | -3 | -13 |
| RSRP Note 3 | dBm/15kHz | -101 | -111 | -101 | -111 |
| Propagation condition | | AWGN | | | |
| Note 1: OCNG shall be used such that both cells are fully allocated and a constant total transmitted power spectral density is achieved for all OFDM symbols (other than those in the PRS subframes). | | | | | |
| Note 2: Interference from other cells and noise sources not specified in the test is assumed to be constant over subcarriers and time and shall be modelled as AWGN of appropriate power for N_{oc} to be fulfilled. | | | | | |
| Note 3: \hat{E}_s/N_{oc} , PRS \hat{E}_s/I_{ot} , I_o , RSRP and PRP levels have been derived from other parameters for information purposes. They are not settable parameters themselves. I_o values are derived in the case that there is no PBCH, PSS or SSS in the OFDM symbols carrying PRS. | | | | | |

A.9.8.4.2 Test Requirements

The RSTD measurement accuracy shall fulfill the requirements in clause 9.1.10.2.

A.9.8.5 E-UTRAN FDD RSTD Measurement Accuracy in Carrier Aggregation

A.9.8.5.1 Test Purpose and Environment

The purpose of these tests is to verify that the E-UTRAN FDD RSTD measurement accuracy in carrier aggregation is within the specified limits in clause 9.1.12.

There are three synchronous cells on two different carrier frequencies in the test. Cell 1 is the PCell on primary component carrier F1 (RF channel number 1), Cell 2 is the SCell and reference cell on secondary component carrier F2 (RF channel number 2), and Cell 3 is the neighbor cell on F2.

Cell2 and Cell3 are included in the OTDOA assistance data, whilst Cell1 is not included in the OTDOA assistance data. The RSTD measurements are performed between Cell 2 and Cell 3 to verify that when both the reference cell and neighbouring cell belong to the secondary component carrier the RSTD measurement accuracy can meet the intra-frequency RSTD accuracy requirements defined in clause 9.1.10.1.

The OTDOA assistance data as defined in TS 36.355, Clause 6.5.1.1, shall be provided to the UE before the measurement period. The last TTI containing the OTDOA assistance data shall be provided to the UE ΔT ms before the start of measurement period, where $\Delta T = 150$ ms is the maximum processing time of the OTDOA assistance data. The measurement gap is not configured in the test because of UE carrier aggregation capability.

There is no PDSCH allocated in the subframe transmitting PRS. A time span of $T_{RSTD \text{ IntraFreqFDD, E-UTRAN}}$ is provided for the measurement period, and PRS are configured according to I_{PRS} in Table A.9.8.5.1-1 and Table A.9.8.5.1-2 for each of the three cells during this time.

The test parameters are given in Table A.9.8.5.1-1 and Table A.9.8.5.1-2.

Table A.9.8.5.1-1: General Test Parameters for RSTD Tests for E-UTRAN FDD for Carrier Aggregation

| Parameter | Unit | Value | Comment |
|-------------------------------|------|---------|----------------------------------|
| PCFICH/PDCCH/PHICH parameters | | R.6 FDD | As specified in clause A.3.1.2.1 |

| | | | |
|---|---------|---|---|
| OCNG Patterns defined in A.3.2.1 | | OP.6 FDD | OCNG shall be used such that both cells are fully allocated and a constant total transmitted power spectral density is achieved for all OFDM symbols (other than those in the PRS subframes). There is no PDSCH allocated in the subframe transmitting PRS. |
| Assistance data reference cell | | Cell 2 | Cell 2 is the SCell on RF channel number 2 |
| PCell | | Cell 1 | Cell 1 on RF channel number 1 |
| Neighbour cell | | Cell 3 | Cell 3 on RF channel number 2 |
| E-UTRA RF Channel Number | | 1,2 | Two FDD carrier frequencies are used. |
| Channel Bandwidth ($BW_{channel}$) | MHz | 10 | |
| PRS Bandwidth | RB | 50 | PRS Bandwidth bandwidth is as indicated in <i>prs-Bandwidth</i> in the OTDOA assistance data defined in [24]. |
| Number of consecutive positioning downlink subframes N_{PRS} | | 1 | As defined in TS 36.211 |
| prs-MutingInfo | | Cell1:'11110000' Cell2:'11110000' Cell3:'11110000' | See clause 6.5.1.2 in TS 36.355 for more information |
| Cell ID | | (Cell ID of cell 2 – Cell ID of cell 3) mod 6 = 3 | PCI of cell 1 is selected randomly. |
| expectedRSTD | μs | Cell 3:-2 Other neighbour cells: randomly between -3 and 3 | The expected RSTD is what is expected at the receiver. The corresponding parameter in the OTDOA assistance data specified in TS 36.355 [24] is the expectedRSTD indicator |
| expectedRSTDUncertainty for all neighbour cells | μs | 5 | The corresponding parameter in the OTDOA assistance data specified in TS 36.355 [24] is the expectedRSTD-Uncertainty index |
| CP length | | Normal | |
| DRX | | OFF | |
| Radio frame receive time offset between the cells at the UE antenna connector | μs | Cell 1 to Cell 2: -1 Cell 3 to Cell 2:1 | PRS are transmitted from synchronous cells |
| Time alignment error between cell2 and cell1 | μs | \leq Time alignment error as specified in 3GPP TS 36.104 [30] clause 6.5.3.1. | The value of time alignment error depends upon the type of carrier aggregation. |
| Number of cells provided in OTDOA assistance data | | 16 | The list includes the assistance-data-reference cell (received in <i>OTDOA-ReferenceCellInfo</i> [24]) and 15 other cells, all received in <i>OTDOA-ProvideAssistanceData</i> [24]. All cells provided in OTDOA assistance data are on RF channel 2. |
| T_{RSTD} IntraFreqFDD, E-UTRAN | ms | 2560 | Derived according to the RSTD measurement requirements specified in Clause 8.1.2.5.1 |

Table A.9.8.5.1-2: Cell Specific Test Parameters for RSTD Tests for E-UTRAN FDD for Carrier Aggregation

| Parameter | Unit | Cell1 | Cell2 | Cell3 |
|-----------------------------------|------|-------|-------|-------|
| E-UTRA RF Channel Number | | 1 | 2 | 2 |
| PRS configuration Index I_{PRS} | | 2 | 2 | 2 |
| PBCH_RA | dB | 0 | 0 | 0 |
| PBCH_RB | | | | |
| PSS_RA | | | | |
| SSS_RA | | | | |
| PCFICH_RB | | | | |
| PHICH_RA | | | | |

| | | | | |
|-------------------------------------|--|--------|--------|--------|
| PHICH_RB | | | | |
| PDCCH_RA | | | | |
| PDCCH_RB | | | | |
| OCNG_RA ^{Note1} | | | | |
| OCNG_RB ^{Note1} | | | | |
| PRS_RA | dB | -3 | 0 | 0 |
| N_{oc} ^{Note2} | dBm/15 kHz | -98 | | |
| PRS \hat{E}_s/N_{oc} | dB | -6 | -6 | -13 |
| PRS \hat{E}_s/I_{ot} | dB | -6 | -6 | -13 |
| I_o ^{Note3} | dBm/9 MHz | -70.04 | -70.01 | -70.01 |
| PRP ^{Note3} | dBm/15kHz | -104 | -104 | -111 |
| RSRP ^{Note3} | dBm/15kHz | -101 | -104 | -111 |
| \hat{E}_s/N_{oc} ^{Note3} | dB | -3 | -6 | -13 |
| Propagation condition | | AWGN | | |
| Note 1: | OCNG shall be used such that both cells are fully allocated and a constant total transmitted power spectral density is achieved for all OFDM symbols (other than those in the PRS subframes). | | | |
| Note 2: | Interference from other cells and noise sources not specified in the test is assumed to be constant over subcarriers and time and shall be modelled as AWGN of appropriate power for N_{oc} to be fulfilled. | | | |
| Note 3: | \hat{E}_s/N_{oc} , PRS \hat{E}_s/I_{ot} , RSRP, I_o and PRP levels have been derived from other parameters for information purposes. They are not settable parameters themselves. I_o values are derived in the case that there is no PBCH, PSS or SSS in the OFDM symbols carrying PRS. | | | |

A.9.8.5.2 Test Requirements

The measurement accuracy of RSTD between Cell2 and Cell3 shall fulfill the requirements in clause 9.1.12.

A.9.8.6 E-UTRAN TDD RSTD Measurement Accuracy in Carrier Aggregation

A.9.8.6.1 Test Purpose and Environment

The purpose of these tests is to verify that the E-UTRAN TDD RSTD measurement accuracy in carrier aggregation is within the specified limits in clause 9.1.12.

There are three synchronous cells on two different carrier frequencies in the test. Cell 1 is the PCell on primary component carrier F1 (RF channel number 1), Cell 2 is the SCell and reference cell on secondary component carrier F2 (RF channel number 2), and Cell 3 is the neighbor cell on F2.

Cell2 and Cell3 are included in the OTDOA assistance data, whilst Cell1 is not included in the OTDOA assistance data. The RSTD measurements are performed between Cell 2 and Cell 3 to verify that when both the reference cell and neighbouring cell belong to the secondary component carrier the RSTD measurement accuracy can meet the intra-frequency RSTD accuracy requirements defined in clause 9.1.10.1.

The OTDOA assistance data as defined in TS 36.355, Clause 6.5.1.1, shall be provided to the UE before the measurement period. The last TTI containing the OTDOA assistance data shall be provided to the UE ΔT ms before the start of measurement period, where $\Delta T = 150$ ms is the maximum processing time of the OTDOA assistance data. The measurement gap is not configured in the test because of UE carrier aggregation capability.

There is no PDSCH allocated in the subframe transmitting PRS. A time span of $T_{\text{RSTD IntraFreqTDD, E-UTRAN}}$ is provided for the measurement period, and PRS are configured according to I_{PRS} in Table A.9.8.6.1-1 and Table A.9.8.6.1-2 for each of the three cells during this time.

The test parameters are given in Table A.9.8.6.1-1 and Table A.9.8.6.1-2.

Table A.9.8.6.1-1: General Test Parameters for RSTD Tests for E-UTRAN TDD for Carrier Aggregation

| Parameter | Unit | Value | Comment |
|---|---------|---|---|
| PCFICH/PDCCH/PHICH parameters | | R.6 TDD | As specified in clause A.3.1.2.2 |
| OCNG Patterns defined in A.3.2.2 | | OP.2 TDD | OCNG shall be used such that both cells are fully allocated and a constant total transmitted power spectral density is achieved for all OFDM symbols (other than those in the PRS subframes). There is no PDSCH allocated in the subframe transmitting PRS. |
| Assistance data reference cell | | Cell 2 | Cell 2 is the SCell on RF channel number 2 |
| PCell | | Cell 1 | Cell 1 on RF channel number 1 |
| Neighbour cell | | Cell 3 | Cell 3 on RF channel number 2 |
| E-UTRA RF Channel Number | | 1,2 | Two TDD carrier frequencies are used. |
| Channel Bandwidth ($BW_{channel}$) | MHz | 10 | |
| PRS Bandwidth | RB | 50 | PRS Bandwidth bandwidth is as indicated in <i>prs-Bandwidth</i> in the OTDOA assistance data defined in [24]. |
| Number of consecutive positioning downlink subframes N_{PRS} | | 1 | As defined in TS 36.211 |
| Special subframe configuration | | 6 | As specified in table 4.2-1 in TS 36.211. The same configuration in both cells. |
| Uplink-downlink configuration | | 1 | As specified in table 4.2-2 in TS 36.211 and table 8.1.2.5.2-2. The same configuration in both cells. |
| prs-MutingInfo | | Cell1:'11110000' Cell2:'11110000' Cell3:'11110000' | See clause 6.5.1.2 in TS 36.355 for more information |
| Cell ID | | (Cell ID of cell 2 – Cell ID of cell 3) mod 6 = 3 | PCI of cell 1 is selected randomly. |
| expectedRSTD | μ s | Cell 3:-2 Other neighbour cells: randomly between -3 and 3 | The expected RSTD is what is expected at the receiver. The corresponding parameter in the OTDOA assistance data specified in TS 36.355 [24] is the expectedRSTD indicator |
| expectedRSTDUncertainty for all neighbour cells | μ s | 5 | The corresponding parameter in the OTDOA assistance data specified in TS 36.355 [24] is the expectedRSTD-Uncertainty index |
| CP length | | Normal | |
| DRX | | OFF | |
| Radio frame receive time offset between the cells at the UE antenna connector | μ s | Cell 1 to Cell 2: -1 Cell 3 to Cell 2:1 | PRS are transmitted from synchronous cells |
| Time alignment error between cell2 and cell1 | μ s | \leq Time alignment error as specified in 3GPP TS 36.104 [30] clause 6.5.3.1. | The value of time alignment error depends upon the type of carrier aggregation. |
| Number of cells provided in OTDOA assistance data | | 16 | The list includes the assistance-data-reference cell (received in <i>OTDOA-ReferenceCellInfo</i> [24]) and 15 other cells, all received in <i>OTDOA-ProvideAssistanceData</i> [24]. All cells provided in OTDOA assistance data are on RF channel 2. |
| T_{RSTD} IntraFreqTDD, E-UTRAN | ms | 2560 | Derived according to the RSTD measurement requirements specified in Clause 8.1.2.5.2 |

Table A.9.8.6.1-2: Cell Specific Test Parameters for RSTD Tests for E-UTRAN TDD for Carrier Aggregation

| Parameter | Unit | Cell1 | Cell2 | Cell3 |
|--|------------|--------|--------|--------|
| E-UTRA RF Channel Number | | 1 | 2 | 2 |
| PRS configuration Index I_{PRS} | | 14 | 14 | 14 |
| PBCH_RA | dB | 0 | 0 | 0 |
| PBCH_RB | | | | |
| PSS_RA | | | | |
| SSS_RA | | | | |
| PCFICH_RB | | | | |
| PHICH_RA | | | | |
| PHICH_RB | | | | |
| PDCCH_RA | | | | |
| PDCCH_RB | | | | |
| OCNG_RA ^{Note1} | | | | |
| OCNG_RB ^{Note1} | | | | |
| PRS_RA | dB | -3 | 0 | 0 |
| N_{oc} ^{Note2} | dBm/15 kHz | -98 | | |
| PRS \hat{E}_s/N_{oc} | dB | -6 | -6 | -13 |
| PRS \hat{E}_s/I_{ot} | dB | -6 | -6 | -13 |
| I_o ^{Note3} | dBm/9 MHz | -70.04 | -70.01 | -70.01 |
| PRP ^{Note3} | dBm/15kHz | -104 | -104 | -111 |
| RSRP ^{Note3} | dBm/15kHz | -101 | -104 | -111 |
| \hat{E}_s/N_{oc} ^{Note3} | dB | -3 | -6 | -13 |
| Propagation condition | | AWGN | | |
| Note 1: OCNG shall be used such that both cells are fully allocated and a constant total transmitted power spectral density is achieved for all OFDM symbols (other than those in the PRS subframes). | | | | |
| Note 2: Interference from other cells and noise sources not specified in the test is assumed to be constant over subcarriers and time and shall be modelled as AWGN of appropriate power for N_{oc} to be fulfilled. | | | | |
| Note 3: \hat{E}_s/N_{oc} , PRS \hat{E}_s/I_{ot} , RSRP, I_o and PRP levels have been derived from other parameters for information purposes. They are not settable parameters themselves. I_o values are derived in the case that there is no PBCH, PSS or SSS in the OFDM symbols carrying PRS. | | | | |

A.9.8.6.2 Test Requirements

The measurement accuracy of RSTD between Cell2 and Cell3 shall fulfill the requirements in clause 9.1.12.

A.9.8.7 E-UTRAN FDD RSTD Measurement Accuracy in Carrier Aggregation for 20MHz bandwidth

A.9.8.7.1 Test Purpose and Environment

The purpose of this test case is the same as for the test defined in subclause A.9.8.5.1. The test parameters are the same except those described in the following section. The listed parameter values in Tables A.9.8.7.1-1 and A.9.8.7.1-2 will replace the values of corresponding parameters in Tables A.9.8.5.1-1 and A.9.8.5.1-2.

Table A.9.8.7.1-1: General Test Parameters for RSTD Tests for E-UTRAN FDD for Carrier Aggregation for 20MHz bandwidth

| Parameter | Unit | Value | Comment |
|-------------------------------|------|----------|----------------------------------|
| PCFICH/PDCCH/PHICH parameters | | R.10 FDD | As specified in clause A.3.1.2.1 |

| | | | |
|--|-----|-----------|---|
| OCNG Patterns defined in A.3.2.1.14 | | OP.14 FDD | OCNG shall be used such that both cells are fully allocated and a constant total transmitted power spectral density is achieved for all OFDM symbols (other than those in the PRS subframes). There is no PDSCH allocated in the subframe transmitting PRS. |
| Channel Bandwidth ($BW_{channel}$) | MHz | 20 | |
| PRS Bandwidth | RB | 100 | PRS Bandwidth bandwidth is as indicated in <i>prs-Bandwidth</i> in the OTDOA assistance data defined in [24]. |
| Note 1: See Table A.9.8.5.1-1 for other general test parameters. | | | |
| Note 2: N/A | | | |

Table A.9.8.7.1-2: Cell Specific Test Parameters for RSTD Tests for E-UTRAN FDD for Carrier Aggregation for 20MHz bandwidth

| Parameter | Unit | Cell1 | Cell2 | Cell3 |
|---|------------|--------|--------|--------|
| I_0 ^{Note1} | dBm/18 MHz | -67.03 | -67.00 | -67.00 |
| Note 1: I_0 level has been derived from other parameters for information purposes. It is not settable parameter itself. I_0 values are derived in the case that there is no PBCH, PSS or SSS in the OFDM symbols carrying PRS | | | | |
| Note 2: See Table A.9.8.5.1-2 for other cell specific test parameters. | | | | |

A.9.8.7.2 Test Requirements

The test requirements defined in section A.9.8.5.2 shall apply to this test case.

A.9.8.8 E-UTRAN TDD RSTD Measurement Accuracy in Carrier Aggregation for 20MHz bandwidth

A.9.8.8.1 Test Purpose and Environment

The purpose of this test case is the same as for the test defined in subclause A.9.8.6.1. The test parameters are the same except those described in the following section. The listed parameter values in Tables A.9.8.8.1-1 and A.9.8.8.1-2 will replace the values of corresponding parameters in Tables A.9.8.6.1-1 and A.9.8.6.1-2.

Table A.9.8.8.1-1: General Test Parameters for RSTD Tests for E-UTRAN TDD for Carrier Aggregation for 20MHz bandwidth

| Parameter | Unit | Value | Comment |
|--|------|----------|---|
| PCFICH/PDCCH/PHICH parameters | | R.10 TDD | As specified in clause A.3.1.2.2 |
| OCNG Patterns defined in A.3.2.2.8 | | OP.8 TDD | OCNG shall be used such that both cells are fully allocated and a constant total transmitted power spectral density is achieved for all OFDM symbols (other than those in the PRS subframes). There is no PDSCH allocated in the subframe transmitting PRS. |
| Channel Bandwidth ($BW_{channel}$) | MHz | 20 | |
| PRS Bandwidth | RB | 100 | PRS Bandwidth bandwidth is as indicated in <i>prs-Bandwidth</i> in the OTDOA assistance data defined in [24]. |
| Note 1: See Table A.9.8.6.1-1 for other general test parameters. | | | |
| Note 2: N/A | | | |

Table A.9.8.8.1-2: Cell Specific Test Parameters for RSTD Tests for E-UTRAN TDD for Carrier Aggregation for 20MHz bandwidth

| Parameter | Unit | Cell1 | Cell2 | Cell3 |
|------------------------|---|--------|--------|--------|
| I_0 ^{Note1} | dBm/18 MHz | -67.03 | -67.00 | -67.00 |
| Note 1: | Io level has been derived from other parameters for information purposes. It is not settable parameter itself. Io values are derived in the case that there is no PBCH, PSS or SSS in the OFDM symbols carrying PRS | | | |
| Note 2: | See Table A.9.8.6.1-2 for other cell specific test parameters. | | | |

A.9.8.8.2 Test Requirements

The test requirements defined in section A.9.8.6.2 shall apply to this test case.

A.9.8.9 E-UTRAN FDD RSTD Measurement Accuracy in Carrier Aggregation for 10MHz+5MHz

A.9.8.9.1 Test Purpose and Environment

The purpose of this test case is the same as for the test defined in subclause A.9.8.5.1. The test parameters are the same except those described in the following section. The listed parameter values in Tables A.9.8.9.1-1 and A.9.8.9.1-2 will replace the values of corresponding parameters in Tables A.9.8.5.1-1 and A.9.8.5.1-2.

Table A.9.8.9.1-1: General Test Parameters for RSTD Tests for E-UTRAN FDD for Carrier Aggregation for 10MHz+5MHz

| Parameter | Unit | Value | Comment |
|---|--|---|---|
| PCFICH/PDCCH/PHICH parameters | | Cell1: R.6 FDD Cell2: R.11 FDD Cell3: R.11 FDD | As specified in clause A.3.1.2.1 |
| OCNG Patterns defined in A.3.2.1 | | Cell1: OP.6 FDD Cell2: OP.19 FDD Cell3: OP.19 FDD | OCNG shall be used such that both cells are fully allocated and a constant total transmitted power spectral density is achieved for all OFDM symbols (other than those in the PRS subframes). There is no PDSCH allocated in the subframe transmitting PRS. |
| Channel Bandwidth (BW_{channel}) | MHz | Cell1: 10 Cell2: 5 Cell3: 5 | |
| PRS Bandwidth | RB | Cell1: 50 Cell2: 25 Cell3: 25 | PRS Bandwidth bandwidth is as indicated in <i>prs-Bandwidth</i> in the OTDOA assistance data defined in [24]. |
| Number of consecutive positioning downlink subframes N_{PRS} | | 2 | As defined in TS 36.211 |
| Note 1: | See Table A.9.8.5.1-1 for other general test parameters. | | |
| Note 2: | N/A | | |

Table A.9.8.9.1-2: Cell Specific Test Parameters for RSTD Tests for E-UTRAN FDD for Carrier Aggregation for 10MHz+5MHz

| Parameter | Unit | Cell1 | Cell2 | Cell3 |
|------------------------|---|--------|--------|--------|
| I_0 ^{Note1} | dBm/9 MHz | -70.04 | N/A | N/A |
| | dBm/4.5 MHz | N/A | -73.02 | -73.02 |
| Note 1: | Io level has been derived from other parameters for information purposes. It is not settable parameter itself. Io values are derived in the case that there is no PBCH, PSS or SSS in the OFDM symbols carrying PRS | | | |
| Note 2: | See Table A.9.8.5.1-2 for other cell specific test parameters. | | | |

A.9.8.9.2 Test Requirements

The test requirements defined in section A.9.8.5.2 shall apply to this test case.

A.9.8.10 E-UTRAN TDD RSTD Measurement Accuracy in Carrier Aggregation for 10MHz+5MHz

A.9.8.10.1 Test Purpose and Environment

The purpose of this test case is the same as for the test defined in subclause A.9.8.6.1. The test parameters are the same except those described in the following section. The listed parameter values in Tables A.9.8.10.1-1 and A.9.8.10.1-2 will replace the values of corresponding parameters in Tables A.9.8.6.1-1 and A.9.8.6.1-2.

Table A.9.8.10.1-1: General Test Parameters for RSTD Tests for E-UTRAN TDD for Carrier Aggregation for 10MHz+5MHz

| Parameter | Unit | Value | Comment |
|---|------|---|---|
| PCFICH/PDCCH/PHICH parameters | | Cell1: R.6 TDD Cell2: R.11 TDD Cell3: R.11 TDD | As specified in clause A.3.1.2.2 |
| OCNG Patterns defined in A.3.2.2 | | Cell1: OP.2 TDD Cell2: OP.10 TDD Cell3: OP.10 TDD | OCNG shall be used such that both cells are fully allocated and a constant total transmitted power spectral density is achieved for all OFDM symbols (other than those in the PRS subframes). There is no PDSCH allocated in the subframe transmitting PRS. |
| Channel Bandwidth (BW_{channel}) | MHz | Cell1: 10 Cell2: 5 Cell3: 5 | |
| PRS Bandwidth | RB | Cell1: 50 Cell2: 25 Cell3: 25 | PRS Bandwidth bandwidth is as indicated in <i>prs-Bandwidth</i> in the OTDOA assistance data defined in [24]. |
| Number of consecutive positioning downlink subframes N_{PRS} | | 2 | As defined in TS 36.211 |
| Note 1: See Table A.9.8.6.1-1 for other general test parameters. | | | |
| Note 2: N/A | | | |

Table A.9.8.10.1-2: Cell Specific Test Parameters for RSTD Tests for E-UTRAN TDD for Carrier Aggregation for 10MHz+5MHz

| Parameter | Unit | Cell1 | Cell2 | Cell3 |
|---|-------------|--------|--------|--------|
| I_0 ^{Note1} | dBm/9 MHz | -70.04 | N/A | N/A |
| | dBm/4.5 MHz | N/A | -73.02 | -73.02 |
| Note 1: I_0 level has been derived from other parameters for information purposes. It is not settable parameter itself. I_0 values are derived in the case that there is no PBCH, PSS or SSS in the OFDM symbols carrying PRS | | | | |
| Note 2: See Table A.9.8.6.1-2 for other cell specific test parameters. | | | | |

A.9.8.10.2 Test Requirements

The test requirements defined in section A.9.8.6.2 shall apply to this test case.

A.9.8.11 E-UTRAN FDD RSTD Measurement Accuracy in Carrier Aggregation for 5 + 5MHz bandwidth

A.9.8.11.1 Test Purpose and Environment

The purpose of this test case is the same as for the test defined in subclause A.9.8.5.1. The test parameters are the same except those described in the following section. The listed parameter values in Tables A.9.8.11.1-1 and A.9.8.11.1-2 will replace the values of corresponding parameters in Tables A.9.8.5.1-1 and A.9.8.5.1-2.

Table A.9.8.11.1-1: General Test Parameters for RSTD Tests for E-UTRAN FDD for Carrier Aggregation for 5+5MHz bandwidth

| Parameter | Unit | Value | Comment |
|---|------|-----------|---|
| PCFICH/PDCCH/PHICH parameters | | R.11 FDD | As specified in clause A.3.1.2.1 |
| OCNG Patterns defined in A.3.2.1.19 | | OP.19 FDD | OCNG shall be used such that both cells are fully allocated and a constant total transmitted power spectral density is achieved for all OFDM symbols (other than those in the PRS subframes). There is no PDSCH allocated in the subframe transmitting PRS. |
| Channel Bandwidth (BW_{channel}) | MHz | 5 | |
| PRS Bandwidth | RB | 25 | PRS Bandwidth bandwidth is as indicated in <i>prs-Bandwidth</i> in the OTDOA assistance data defined in [24]. |
| Number of consecutive positioning downlink subframes N_{PRS} | | 2 | As defined in TS 36.211 |
| Note 1: See Table A.9.8.5.1-1 for other general test parameters. | | | |
| Note 2: N/A | | | |

Table A.9.8.11.1-2: Cell Specific Test Parameters for RSTD Tests for E-UTRAN FDD for Carrier Aggregation for 5+5MHz bandwidth

| Parameter | Unit | Cell1 | Cell2 | Cell3 |
|---|-------------|--------|--------|--------|
| I_0 ^{Note1} | dBm/4.5 MHz | -73.05 | -73.02 | -73.02 |
| Note 1: I_0 level has been derived from other parameters for information purposes. It is not settable parameter itself. I_0 values are derived in the case that there is no PBCH, PSS or SSS in the OFDM symbols carrying PRS | | | | |
| Note 2: See Table A.9.8.5.1-2 for other cell specific test parameters. | | | | |

A.9.8.11.2 Test Requirements

The test requirements defined in section A.9.8.5.2 shall apply to this test case.

A.9.8.12 E-UTRAN TDD RSTD Measurement Accuracy in Carrier Aggregation for 5+5MHz bandwidth

A.9.8.12.1 Test Purpose and Environment

The purpose of this test case is the same as for the test defined in subclause A.9.8.6.1. The test parameters are the same except those described in the following section. The listed parameter values in Tables A.9.8.12.1-1 and A.9.8.12.1-2 will replace the values of corresponding parameters in Tables A.9.8.6.1-1 and A.9.8.6.1-2.

Table A.9.8.12.1-1: General Test Parameters for RSTD Tests for E-UTRAN TDD for Carrier Aggregation for 5+5MHz bandwidth

| Parameter | Unit | Value | Comment |
|-------------------------------|------|----------|----------------------------------|
| PCFICH/PDCCH/PHICH parameters | | R.11 TDD | As specified in clause A.3.1.2.2 |

| | | | |
|--|-----|-----------|---|
| OCNG Patterns defined in A.3.2.2.10 | | OP.10 TDD | OCNG shall be used such that both cells are fully allocated and a constant total transmitted power spectral density is achieved for all OFDM symbols (other than those in the PRS subframes). There is no PDSCH allocated in the subframe transmitting PRS. |
| Channel Bandwidth ($BW_{channel}$) | MHz | 5 | |
| PRS Bandwidth | RB | 25 | PRS Bandwidth bandwidth is as indicated in <i>prs-Bandwidth</i> in the OTDOA assistance data defined in [24]. |
| Number of consecutive positioning downlink subframes N_{PRS} | | 2 | As defined in TS 36.211 |
| Note 1: See Table A.9.8.6.1-1 for other general test parameters. | | | |
| Note 2: N/A | | | |

Table A.9.8.12.1-2: Cell Specific Test Parameters for RSTD Tests for E-UTRAN TDD for Carrier Aggregation for 5+5MHz bandwidth

| Parameter | Unit | Cell1 | Cell2 | Cell3 |
|---|-------------|--------|--------|--------|
| I_0 ^{Note1} | dBm/4.5 MHz | -73.05 | -73.02 | -73.02 |
| Note 1: I_0 level has been derived from other parameters for information purposes. It is not settable parameter itself. I_0 values are derived in the case that there is no PBCH, PSS or SSS in the OFDM symbols carrying PRS | | | | |
| Note 2: See Table A.9.8.6.1-2 for other cell specific test parameters. | | | | |

A.9.8.12.2 Test Requirements

The test requirements defined in section A.9.8.6.2 shall apply to this test case.

A.9.8.13 E-UTRAN TDD RSTD Measurement Accuracy in Carrier Aggregation for 20MHz+10MHz

A.9.8.13.1 Test Purpose and Environment

The purpose of this test case is the same as for the test defined in subclause A.9.8.6.1. The test parameters are the same except those described in the following section. The listed parameter values in Tables A.9.8.13.1-1 and A.9.8.13.1-2 will replace the values of corresponding parameters in Tables A.9.8.6.1-1 and A.9.8.6.1-2.

Table A.9.8.13.1-1: General Test Parameters for RSTD Tests for E-UTRAN TDD for Carrier Aggregation for 20MHz+10MHz

| Parameter | Unit | Value | Comment |
|--------------------------------------|------|---|---|
| PCFICH/PDCCH/PHICH parameters | | Cell1: R.10 TDD Cell2: R.6 TDD Cell3: R.6 TDD | As specified in clause A.3.1.2.2 |
| OCNG Patterns defined in A.3.2.2 | | Cell1: OP.8 TDD Cell2: OP.2 TDD Cell3: OP.2 TDD | OCNG shall be used such that both cells are fully allocated and a constant total transmitted power spectral density is achieved for all OFDM symbols (other than those in the PRS subframes). There is no PDSCH allocated in the subframe transmitting PRS. |
| Channel Bandwidth ($BW_{channel}$) | MHz | Cell1: 20 Cell2: 10 Cell3: 10 | |
| PRS Bandwidth | RB | Cell1: 100 Cell2: 50 Cell3: 50 | PRS Bandwidth bandwidth is as indicated in <i>prs-Bandwidth</i> in the OTDOA assistance data defined in [24]. |

| |
|--|
| Note 1: See Table A.9.8.6.1-1 for other general test parameters. |
| Note 2: N/A |

Table A.9.8.13.1-2: Cell Specific Test Parameters for RSTD Tests for E-UTRAN TDD for Carrier Aggregation for 20MHz+10MHz

| Parameter | Unit | Cell1 | Cell2 | Cell3 |
|---|---------------|--------|--------|--------|
| I_{o} ^{Note1} | dBm/ 18MHz | -67.03 | N/A | N/A |
| | dBm/ 9MHz | N/A | -70.01 | -70.01 |
| Note 1: I_{o} level has been derived from other parameters for information purposes. It is not settable parameter itself. I_{o} values are derived in the case that there is no PBCH, PSS or SSS in the OFDM symbols carrying PRS | | | | |
| Note 2: See Table A.9.8.6.1-2 for other cell specific test parameters. | | | | |

A.9.8.13.2 Test Requirements

The test requirements defined in section A.9.8.6.2 shall apply to this test case.

A.9.8.14 E-UTRAN FDD RSTD Measurement Accuracy in 3DL Carrier Aggregation

A.9.8.14.1 Test Purpose and Environment

The purpose of these tests is to verify that the E-UTRAN FDD RSTD measurement accuracy in carrier aggregation is within the specified limits in clause 9.1.12.

There are four synchronous cells on three different carrier frequencies in the test. Cell 1 is the PCell on primary component carrier F1 (RF channel number 1), Cell 2 is an SCell on secondary component carrier F2 (RF channel number 2), Cell 3 is an SCell and reference cell on secondary component carrier F3 (RF channel number 3), and Cell 4 is the neighbor cell on F3.

Cell 1, Cell2, Cell3, and Cell 4 are included in the OTDOA assistance data. The RSTD measurements are performed

- between Cell 4 and Cell 3 to verify the accuracy of RSTD measurement when the reference cell and neighbouring cell belong to the same secondary component carrier can meet the intra-frequency RSTD accuracy requirements defined in clause 9.1.10.1.
- between Cell 1 and Cell 3 to verify the accuracy of RSTD measurement between the PCell and an SCell can meet the inter-frequency RSTD accuracy requirements defined in clause 9.1.10.2.
- between Cell 2 and Cell 3 to verify the accuracy of RSTD measurement between two SCells can meet the inter-frequency RSTD accuracy requirements defined in clause 9.1.10.2.

The OTDOA assistance data as defined in TS 36.355, Clause 6.5.1.1, shall be provided to the UE before the measurement period. The last TTI containing the OTDOA assistance data shall be provided to the UE ΔT ms before the start of measurement period, where $\Delta T = 150$ ms is the maximum processing time of the OTDOA assistance data. The measurement gap is not configured in the test because of UE carrier aggregation capability.

There is no PDSCH allocated in the subframe transmitting PRS. A time span of $T_{\text{RSTD InterFreqFDD, E-UTRAN}}$ is provided for the measurement period, and PRS are configured according to I_{PRS} in Table A.9.8.14.1-1 and Table A.9.8.14.1-2 for each of the three cells during this time.

The test parameters are given in Table A.9.8.14.1-1 and Table A.9.8.14.1-2.

Table A.9.8.14.1-1: General Test Parameters for RSTD Tests for E-UTRAN FDD for 3DL Carrier Aggregation

| Parameter | Unit | Value | Comment |
|-----------|------|-------|---------|
|-----------|------|-------|---------|

| | | | |
|---|---------------|--|--|
| PCell | | Cell 1 | Cell 1 on RF channel number 1 |
| SCell 1 | | Cell 2 | Cell 2 is an SCell on RF channel number 2 |
| SCell 2 (Assistance data reference cell) | | Cell 3 | Cell 3 is an SCell on RF channel number 3 |
| Neighbour cell | | Cell 4 | Cell 4 on RF channel number 3 |
| PRS configuration index I_{PRS} | | 171 for all cells on PCC 181 for all cells on SCC1 191 for all cells on SCC2 | This corresponds to periodicity of 320 ms and PRS subframe offset of $I_{PRS} - 160$ DL subframes, as defined in TS 36.211 [16], Table 6.10.4.3-1 |
| prs-MutingInfo | | Cell1:'11110000' Cell2:'11110000' Cell3:'11110000' Cell4:'11110000' | See clause 6.5.1.2 in TS 36.355 for more information |
| prs-SubframeOffset | | Cells on PCC: 300 Cells on SCC1: 310 Cells on SCC2, except reference cell: 0 | Subframe offset, counted in full subframes. The corresponding parameter in the OTDOA assistance data is prs-SubframeOffset specified in TS 36.355 [24] |
| slotNumberOffset | | Cells on PCC: 0 Cells on SCC1: 0 Cells on SCC2, except reference cell: 0 | The slot number offset at the transmitter between a neighbour cell and the assistance data reference cell. The corresponding parameter in the OTDOA assistance data is slotNumberOffset specified in TS 36.355 [24]. |
| Cell ID | | (Cell ID of cell 4 – Cell ID of cell 3) mod 6 = 3 | PCIs of cell 1 and cell 2 are selected randomly. |
| expectedRSTD | μs | Cell 1: -2 Cell 2: 0 Cell 4: 2 Other neighbour cells: randomly between -3 and 3 | The expected RSTD is what is expected at the receiver. The corresponding parameter in the OTDOA assistance data specified in TS 36.355 [24] is the expectedRSTD indicator |
| expectedRSTDUncertainty for all neighbour cells | μs | 5 | The corresponding parameter in the OTDOA assistance data specified in TS 36.355 [24] is the expectedRSTD-Uncertainty index |
| CP length | | Normal | |
| DRX | | OFF | |
| Radio frame receive time offset between the cells at the UE antenna connector | μs | Cell 1 to Cell 3: 1 Cell 2 to Cell 3: -1 Cell 4 to Cell 3: 3 | PRS are transmitted from synchronous cells |
| Time alignment errors between Cell 1, Cell 2, and Cell 3 | μs | \leq Time alignment error as specified in 3GPP TS 36.104 [30] clause 6.5.3.1. | The value of time alignment error depends upon the type of carrier aggregation. |

| | | | |
|---|----|------|--|
| Number of cells provided in OTDOA assistance data | | 16 | The list includes the assistance-data-reference cell (received in <i>OTDOA-ReferenceCellInfo</i> [24]) and 15 other cells, all received in <i>OTDOA-ProvideAssistanceData</i> [24]. Cell 1 and Cell 2 appears at random places in the first half of the neighbour cell list in the OTDOA assistance data. Cell 4 always appears at random places in the second half of the list. |
| T_{RSTD} InterFreqFDD, E-UTRAN | ms | 4960 | Derived according to the RSTD measurement requirements specified in Clause 8.1.2.6.1 |

Table A.9.8.14.1-2: Cell Specific Test Parameters for RSTD Tests for E-UTRAN FDD for Carrier Aggregation

| Parameter | Unit | Cell1 | Cell2 | Cell3 | Cell 4 |
|--|------------|--|--|--|--|
| E-UTRA RF Channel Number | | 1 | 2 | 3 | 3 |
| Channel Bandwidth ($BW_{channel}$) | MHz | 5,10,20 | 5,10,20 | 5,10,20 | 5,10,20 |
| PCFICH/PDCCH/PHICH parameters as specified in clause A.3.1.2.1 | | 5MHz: R.11 FDD 10MHz: R.6 FDD 20MHz: R.10 FDD | 5MHz: R.11 FDD 10MHz: R.6 FDD 20MHz: R.10 FDD | 5MHz: R.11 FDD 10MHz: R.6 FDD 20MHz: R.10 FDD | 5MHz: R.11 FDD 10MHz: R.6 FDD 20MHz: R.10 FDD |
| OCNG Patterns defined in A.3.2.1 | | 5MHz: OP.18 FDD 10MHz: OP.5 FDD 20MHz: OP.13 FDD | 5MHz: OP.18 FDD 10MHz: OP.5 FDD 20MHz: OP.13 FDD | 5MHz: OP.18 FDD 10MHz: OP.5 FDD 20MHz: OP.13 FDD | 5MHz: OP.18 FDD 10MHz: OP.5 FDD 20MHz: OP.13 FDD |
| PRS Transmission Bandwidth (PRS transmission bandwidth depends on selected channel bandwidth. PRS are transmitted over the system bandwidth) | RB | 5MHz: 25 10MHz: 50 20MHz:100 | 5MHz: 25 10MHz: 50 20MHz:100 | 5MHz: 25 10MHz: 50 20MHz:100 | 5MHz: 25 10MHz: 50 20MHz:100 |
| Number of consecutive downlink positioning subframes N_{PRS} . N_{PRS} also depends on selected channel bandwidth. As defined in TS 36.211 [16]. The number of subframes in a positioning occasion | | 5MHz: 2 10MHz: 1 20MHz:1 | 5MHz: 2 10MHz: 1 20MHz:1 | 5MHz: 2 10MHz: 1 20MHz:1 | 5MHz: 2 10MHz: 1 20MHz:1 |
| PBCH_RA | dB | 0 | 0 | 0 | 0 |
| PBCH_RB | | | | | |
| PSS_RA | | | | | |
| SSS_RA | | | | | |
| PCFICH_RB | | | | | |
| PHICH_RA | | | | | |
| PHICH_RB | | | | | |
| PDCCH_RA | | | | | |
| PDCCH_RB | | | | | |
| OCNG_RA ^{Note1} | | | | | |
| OCNG_RB ^{Note1} | | | | | |
| PRS_RA | dB | -3 | 0 | 0 | 0 |
| N_{oc} ^{Note2} | dBm/15 kHz | -98 | | | |
| PRS \hat{E}_s/N_{oc} | dB | -6 | -6 | -6 | -13 |
| PRS \hat{E}_s/I_{ot} | dB | -6 | -6 | -6 | -13 |

| | | | | | |
|--|-----------|---------------------------------|---------------------------------|---------------------------------|---------------------------------|
| I_o ^{Note3} | dBm/9 MHz | -70.04 +10log ($N_{RB,c}/50$) | -70.04 +10log ($N_{RB,c}/50$) | -70.01 +10log ($N_{RB,c}/50$) | -70.01 +10log ($N_{RB,c}/50$) |
| PRP ^{Note3} | dBm/15kHz | -104 | -104 | -104 | -111 |
| RSRP ^{Note3} | dBm/15kHz | -101 | -104 | -104 | -111 |
| \hat{E}_s/N_{oc} ^{Note3} | dB | -3 | -6 | -6 | -13 |
| Propagation condition | | AWGN | | | |
| Note 1: OCNG shall be used such that both cells are fully allocated and a constant total transmitted power spectral density is achieved for all OFDM symbols (other than those in the PRS subframes). | | | | | |
| Note 2: Interference from other cells and noise sources not specified in the test is assumed to be constant over subcarriers and time and shall be modelled as AWGN of appropriate power for N_{oc} to be fulfilled. | | | | | |
| Note 3: \hat{E}_s/N_{oc} , PRS \hat{E}_s/I_{ot} , RSRP, I_o and PRP levels have been derived from other parameters for information purposes. They are not settable parameters themselves. I_o values are derived in the case that there is no PBCH, PSS or SSS in the OFDM symbols carrying PRS. | | | | | |

A.9.8.14.2 Test Requirements

The measurement accuracy of RSTD between Cell1 and Cell3 shall fulfill the requirements in clause 9.1.12.2

The measurement accuracy of RSTD between Cell2 and Cell3 shall fulfill the requirements in clause 9.1.12.2

The measurement accuracy of RSTD between Cell4 and Cell3 shall fulfill the requirements in clause 9.1.12.1.

A.9.8.15 E-UTRAN TDD RSTD Measurement Accuracy in 3DL Carrier Aggregation

A.9.8.15.1 Test Purpose and Environment

The purpose of these tests is to verify that the E-UTRAN TDD RSTD measurement accuracy in carrier aggregation is within the specified limits in clause 9.1.12.

There are four synchronous cells on three different carrier frequencies in the test. Cell 1 is the PCell on primary component carrier F1 (RF channel number 1), Cell 2 is an SCell on secondary component carrier F2 (RF channel number 2), Cell 3 is an SCell and reference cell on secondary component carrier F3 (RF channel number 3), and Cell 4 is the neighbor cell on F3.

Cell 1, Cell2, Cell3, and Cell 4 are included in the OTDOA assistance data. The RSTD measurements are performed

- between Cell 4 and Cell 3 to verify the accuracy of RSTD measurement when the reference cell and neighbouring cell belong to the same secondary component carrier can meet the intra-frequency RSTD accuracy requirements defined in clause 9.1.10.1.
- between Cell 1 and Cell 3 to verify the accuracy of RSTD measurement between the PCell and an SCell can meet the inter-frequency RSTD accuracy requirements defined in clause 9.1.10.2.
- between Cell 2 and Cell 3 to verify the accuracy of RSTD measurement between two SCells can meet the inter-frequency RSTD accuracy requirements defined in clause 9.1.10.2.

The OTDOA assistance data as defined in TS 36.355, Clause 6.5.1.1, shall be provided to the UE before the measurement period. The last TTI containing the OTDOA assistance data shall be provided to the UE ΔT ms before the start of measurement period, where $\Delta T = 150$ ms is the maximum processing time of the OTDOA assistance data. The measurement gap is not configured in the test because of UE carrier aggregation capability.

There is no PDSCH allocated in the subframe transmitting PRS. A time span of $T_{RSTD\ InterFreqTDD, E-UTRAN}$ is provided for the measurement period, and PRS are configured according to I_{PRS} in Table A.9.8.15.1-1 and Table A.9.8.15.1-2 for each of the three cells during this time.

The test parameters are given in Table A.9.8.15.1-1 and Table A.9.8.15.1-2.

Table A.9.8.15.1-1: General Test Parameters for RSTD Tests for E-UTRAN TDD for 3DL Carrier Aggregation

| Parameter | Unit | Value | Comment |
|---|---------------|--|--|
| PCell | | Cell 1 | Cell 1 on RF channel number 1 |
| SCell 1 | | Cell 2 | Cell 2 is an SCell on RF channel number 2 |
| SCell 2 (Assistance data reference cell) | | Cell 3 | Cell 3 is an SCell on RF channel number 3 |
| Neighbour cell | | Cell 4 | Cell 4 on RF channel number 3 |
| E-UTRA RF Channel Number | | 1,2,3 | Three TDD carrier frequencies are used. |
| PRS configuration index I_{PRS} | | 171 for all cells on PCC 181 for all cells on SCC1 191 for all cells on SCC2 | This corresponds to periodicity of 320 ms and PRS subframe offset of $I_{PRS} - 160$ DL subframes, as defined in TS 36.211 [16], Table 6.10.4.3-1 |
| prs-MutingInfo | | Cell1:'11110000' Cell2:'11110000' Cell3:'11110000' Cell4:'11110000' | See clause 6.5.1.2 in TS 36.355 for more information |
| prs-SubframeOffset | | Cells on PCC: 300 Cells on SCC1: 310 Cells on SCC2, except reference cell: 0 | Subframe offset, counted in full subframes. The corresponding parameter in the OTDOA assistance data is prs-SubframeOffset specified in TS 36.355 [24] |
| slotNumberOffset | | Cells on PCC: 0 Cells on SCC1: 0 Cells on SCC2, except reference cell: 0 | The slot number offset at the transmitter between a neighbour cell and the assistance data reference cell. The corresponding parameter in the OTDOA assistance data is slotNumberOffset specified in TS 36.355 [24]. |
| Special subframe configuration | | 6 | As specified in table 4.2-1 in TS 36.211. The same configuration in both cells. |
| Uplink-downlink configuration | | 1 | As specified in table 4.2-2 in TS 36.211 and table 8.1.2.5.2-2. The same configuration in both cells. |
| Cell ID | | (Cell ID of cell 4 – Cell ID of cell 3) mod 6 = 3 | PCIs of cell 1 and cell 2 are selected randomly. |
| expectedRSTD | μs | Cell 1: -2 Cell 2: 0 Cell 4: 2 Other neighbour cells: randomly between -3 and 3 | The expected RSTD is what is expected at the receiver. The corresponding parameter in the OTDOA assistance data specified in TS 36.355 [24] is the expectedRSTD indicator |
| expectedRSTDUncertainty for all neighbour cells | μs | 5 | The corresponding parameter in the OTDOA assistance data specified in TS 36.355 [24] is the expectedRSTD-Uncertainty index |
| CP length | | Normal | |
| DRX | | OFF | |
| Radio frame receive time offset between the cells at the UE antenna connector | μs | Cell 1 to Cell 3: 1 Cell 2 to Cell 3: -1 Cell 4 to Cell 3: 3 | PRS are transmitted from synchronous cells |
| Time alignment errors between Cell 1, Cell 2, and Cell 3 | μs | \leq Time alignment error as specified in 3GPP TS 36.104 [30] clause 6.5.3.1. | The value of time alignment error depends upon the type of carrier aggregation. |

| | | | |
|---|----|------|--|
| Number of cells provided in OTDOA assistance data | | 16 | The list includes the assistance-data-reference cell (received in <i>OTDOA-ReferenceCellInfo</i> [24]) and 15 other cells, all received in <i>OTDOA-ProvideAssistanceData</i> [24]. Cell 1 and Cell 2 appears at random places in the first half of the neighbour cell list in the OTDOA assistance data. Cell 4 always appears at random places in the second half of the list. |
| T_{RSTD} InterFreqTDD, E-UTRAN | ms | 4960 | Derived according to the RSTD measurement requirements specified in Clause 8.1.2.6.3 |

Table A.9.8.15.1-2: Cell Specific Test Parameters for RSTD Tests for E-UTRAN TDD for Carrier Aggregation

| Parameter | Unit | Cell1 | Cell2 | Cell3 | Cell 4 |
|--|------------|---|---|---|---|
| E-UTRA RF Channel Number | | 1 | 2 | 3 | 3 |
| Channel Bandwidth ($BW_{channel}$) | MHz | 5,10,20 | 5,10,20 | 5,10,20 | 5,10,20 |
| PCFICH/PDCCH/PHICH parameters as specified in clause A.3.1.2.2 | | 5MHz: R11 TDD 10MHz: R6 TDD 20MHz: R10 TDD | 5MHz: R11 TDD 10MHz: R6 TDD 20MHz: R10 TDD | 5MHz: R11 TDD 10MHz: R6 TDD 20MHz: R10 TDD | 5MHz: R11 TDD 10MHz: R6 TDD 20MHz: R10 TDD |
| OCNG Patterns defined in A.3.2.2 (There is no PDSCH allocated in the subframe transmitting PRS) | | 5MHz: OP.10 TDD 10MHz: OP.2 TDD 20MHz: OP.8 TDD | 5MHz: OP.10 TDD 10MHz: OP.2 TDD 20MHz: OP.8 TDD | 5MHz: OP.10 TDD 10MHz: OP.2 TDD 20MHz: OP.8 TDD | 5MHz: OP.10 TDD 10MHz: OP.2 TDD 20MHz: OP.8 TDD |
| PRS Transmission Bandwidth (PRS transmission bandwidth depends on selected channel bandwidth. PRS are transmitted over the system bandwidth) | RB | 5MHz: 25 10MHz: 50 20MHz:100 | 5MHz: 25 10MHz: 50 20MHz:100 | 5MHz: 25 10MHz: 50 20MHz:100 | 5MHz: 25 10MHz: 50 20MHz:100 |
| Number of consecutive downlink positioning subframes N_{PRS} . N_{PRS} also depends on selected channel bandwidth. As defined in TS 36.211 [16]. The number of subframes in a positioning occasion | | 5MHz: 2 10MHz: 1 20MHz:1 | 5MHz: 2 10MHz: 1 20MHz:1 | 5MHz: 2 10MHz: 1 20MHz:1 | 5MHz: 2 10MHz: 1 20MHz:1 |
| PBCH_RA | dB | 0 | 0 | 0 | 0 |
| PBCH_RB | | | | | |
| PSS_RA | | | | | |
| SSS_RA | | | | | |
| PCFICH_RB | | | | | |
| PHICH_RA | | | | | |
| PHICH_RB | | | | | |
| PDCCH_RA | | | | | |
| PDCCH_RB | | | | | |
| OCNG_RA ^{Note1} | | | | | |
| OCNG_RB ^{Note1} | | | | | |
| PRS_RA | dB | -3 | 0 | 0 | 0 |
| N_{oc} ^{Note2} | dBm/15 kHz | -98 | | | |
| PRS \hat{E}_s/N_{oc} | dB | -6 | -6 | -6 | -13 |
| PRS \hat{E}_s/I_{ot} | dB | -6 | -6 | -6 | -13 |

| | | | | | |
|--|-----------|---------------------------------|---------------------------------|---------------------------------|---------------------------------|
| I_o ^{Note3} | dBm/9 MHz | -70.04 +10log ($N_{RB,c}/50$) | -70.04 +10log ($N_{RB,c}/50$) | -70.01 +10log ($N_{RB,c}/50$) | -70.01 +10log ($N_{RB,c}/50$) |
| PRP ^{Note3} | dBm/15kHz | -104 | -104 | -104 | -111 |
| RSRP ^{Note3} | dBm/15kHz | -101 | -104 | -104 | -111 |
| \hat{E}_s/N_{oc} ^{Note3} | dB | -3 | -6 | -6 | -13 |
| Propagation condition | | AWGN | | | |
| Note 1: OCNG shall be used such that both cells are fully allocated and a constant total transmitted power spectral density is achieved for all OFDM symbols (other than those in the PRS subframes). | | | | | |
| Note 2: Interference from other cells and noise sources not specified in the test is assumed to be constant over subcarriers and time and shall be modelled as AWGN of appropriate power for N_{oc} to be fulfilled. | | | | | |
| Note 3: \hat{E}_s/N_{oc} , PRS \hat{E}_s/I_{ot} , RSRP, I_o and PRP levels have been derived from other parameters for information purposes. They are not settable parameters themselves. I_o values are derived in the case that there is no PBCH, PSS or SSS in the OFDM symbols carrying PRS. | | | | | |

A.9.8.15.2 Test Requirements

The measurement accuracy of RSTD between Cell1 and Cell3 shall fulfill the requirements in clause 9.1.12.2

The measurement accuracy of RSTD between Cell2 and Cell3 shall fulfill the requirements in clause 9.1.12.2

The measurement accuracy of RSTD between Cell4 and Cell3 shall fulfill the requirements in clause 9.1.12.1.

A.9.9 RSRP and RSRQ on the serving cell

A.9.9.1 FDD Intra frequency serving cell case

A.9.9.1.1 Test Purpose and Environment

The purpose of this test is to verify that the RSRP/RSRQ absolute measurement accuracy is within the specified limits. This test will verify the requirements in Clause 9.1.2.1 and 9.1.5.1 for FDD intra frequency measurements.

A.9.9.1.2 Test parameters

In this set of test case there is only the serving cell. Absolute accuracy of RSRP/RSRQ intra frequency measurements for the serving cell is tested by using the parameters in Table A.9.9.1.2-1. In the test case, Cell 1 is the serving cell.

Table A.9.9.1.2-1: RSRP FDD Intra frequency test parameters

| Parameter | Unit | Test |
|---|-----------|----------|
| | | Cell 1 |
| E-UTRA RF Channel Number | | 1 |
| $BW_{channel}$ | MHz | 10 |
| Measurement bandwidth | n_{PRB} | 22—27 |
| PDSCH Reference measurement channel defined in A.3.1.1.1 | | R.0 FDD |
| PDSCH allocation | n_{PRB} | 13—36 |
| PDCCH/PCFICH/PHICH Reference measurement channel defined in A.3.1.2.1 | | R.6 FDD |
| OCNG Patterns defined in A.3.2.1.1 (OP.1 FDD) | | OP.1 FDD |
| PBCH_RA | dB | 0 |
| PBCH_RB | | |
| PSS_RA | | |
| SSS_RA | | |
| PCFICH_RB | | |

| | | | |
|---------------------------|---|------------|--------|
| PHICH_RA | | | |
| PHICH_RB | | | |
| PDCCH_RA | | | |
| PDCCH_RB | | | |
| PDSCH_RA | | | |
| PDSCH_RB | | | |
| OCNG_RA ^{Note1} | | | |
| OCNG_RB ^{Note1} | | | |
| N_{oc} ^{Note2} | Bands FDD_A ^{Note 8} | dBm/15 kHz | -122 |
| | Bands FDD_B | | -121.5 |
| | Bands FDD_C | | -121 |
| | Bands FDD_D | | -120.5 |
| | Bands FDD_E, FDD_F ^{Note 5} | | -120 |
| | Bands FDD_G ^{Note 7} | | -119 |
| | Bands FDD_H | | -118.5 |
| \hat{E}_s/I_{ot} | | dB | -4 |
| RSRP ^{Note3} | Bands FDD_A ^{Note 8} | dBm/15 kHz | -126 |
| | Bands FDD_B | | -125.5 |
| | Bands FDD_C | | -125 |
| | Bands FDD_D | | -124.5 |
| | Bands FDD_E, FDD_F ^{Note 5} | | -124 |
| | Bands FDD_G ^{Note 7} | | -123 |
| | Bands FDD_H | | -122.5 |
| RSRQ ^{Note3} | Bands FDD_A ^{Note 8} | dB | -16.25 |
| | Bands FDD_B | | -16.25 |
| | Bands FDD_C | | -16.25 |
| | Bands FDD_D | | -16.25 |
| | Bands FDD_E, FDD_F ^{Note 5} | | -16.25 |
| | Bands FDD_G ^{Note 7} | | -16.25 |
| | Bands FDD_H | | -16.25 |
| I_o ^{Note3} | Bands FDD_A ^{Note 8} | dBm/9 MHz | -92.76 |
| | Bands FDD_B | | -92.26 |
| | Bands FDD_C | | -91.76 |
| | Bands FDD_D | | -91.26 |
| | Bands FDD_E, FDD_F ^{Note 5} | | -90.76 |
| | Bands FDD_G ^{Note 7} | | -89.76 |
| | Bands FDD_H | | -89.26 |
| \hat{E}_s/N_{oc} | | dB | -4 |
| Propagation condition | | - | AWGN |

| | |
|---------|--|
| Note 1: | OCNG shall be used such that both cells are fully allocated and a constant total transmitted power spectral density is achieved for all OFDM symbols. |
| Note 2: | Interference from other cells and noise sources not specified in the test is assumed to be constant over subcarriers and time and shall be modelled as AWGN of appropriate power for N_{oc} to be fulfilled. |
| Note 3: | RSRP, RSRQ and Io levels have been derived from other parameters for information purposes. They are not settable parameters themselves. |
| Note 4: | RSRP minimum requirements are specified assuming independent interference and noise at each receiver antenna port. |
| Note 5: | For Band 26, the tests shall be performed with the carrier frequency of the assigned E-UTRA channel bandwidth within 865-894 MHz. |
| Note 6: | E-UTRA operating band groups are as defined in Section 3.5. |
| Note 7: | Except Band 29. |
| Note 8: | Except Band 32. |

A.9.9.1.3 Test Requirements

The absolute RSRP and RSRQ measurement accuracy shall fulfil the requirements in clause 9.1.2.1 and 9.1.5.1 respectively.

A.9.9.2 TDD Intra frequency serving cell case

A.9.9.2.1 Test Purpose and Environment

The purpose of this test is to verify that the RSRP/ RSRQ absolute measurement accuracy is within the specified limits. This test will verify the requirements in Section 9.1.2.1 and 9.1.5.1 for TDD intra frequency measurements.

A.9.9.2.2 Test parameters

In this set of test case there is only the serving cell. Absolute accuracy of RSRP/ RSRQ intra frequency measurements for the serving cell is tested by using the parameters in Table A.9.9.2.2-1. In the test case, Cell 1 is the serving cell.

Table A.9.9.2.2-1: RSRP TDD Intra frequency test parameters

| Parameter | Unit | Test |
|---|-----------|----------|
| | | Cell 1 |
| E-UTRA RF Channel Number | | 1 |
| BW _{channel} | MHz | 10 |
| Special subframe configuration ^{Note1} | | 6 |
| Uplink/downlink configuration ^{Note1} | | 1 |
| Measurement bandwidth | n_{PRB} | 22—27 |
| PDSCH Reference measurement channel defined in A.3.1.1.2 | | R.0 TDD |
| PDSCH allocation | n_{PRB} | 13—36 |
| PDCCH/PCFICH/PHICH Reference measurement channel defined in A.3.1.2.2 | | R.6 TDD |
| OCNG Patterns defined in A.3.2.2.1 (OP.1 TDD) | | OP.1 TDD |
| PBCH_RA | dB | 0 |
| PBCH_RB | | |
| PSS_RA | | |
| SSS_RA | | |
| PCFICH_RB | | |
| PHICH_RA | | |
| PHICH_RB | | |

| | | | |
|--|-------------|------------|--------|
| PDCCH_RA | | | |
| PDCCH_RB | | | |
| PDSCH_RA | | | |
| PDSCH_RB | | | |
| OCNG_RA ^{Note2} | | | |
| OCNG_RB ^{Note2} | | | |
| N_{oc} ^{Note3} | Bands TDD_A | dBm/15 kHz | -122 |
| | Bands TDD_C | | -121 |
| | Bands TDD_E | | -120 |
| \hat{E}_s / I_{ot} | | dB | -4 |
| RSRP ^{Note4} | Bands TDD_A | dBm/15 kHz | -126 |
| | Bands TDD_C | | -125 |
| | Bands TDD_E | | -124 |
| RSRQ ^{Note4} | Bands TDD_A | dB | -16.25 |
| | Bands TDD_C | | |
| | Bands TDD_E | | |
| I _o ^{Note4} | Bands TDD_A | dBm/9 MHz | -92.76 |
| | Bands TDD_C | | -91.76 |
| | Bands TDD_E | | -90.76 |
| \hat{E}_s / N_{oc} | | dB | -4 |
| Propagation condition | | - | AWGN |
| <p>Note 1: For special subframe and uplink-downlink configurations see Tables 4.2-1 and 4.2-2 in TS 36.211.</p> <p>Note 2: OCNG shall be used such that both cells are fully allocated and a constant total transmitted power spectral density is achieved for all OFDM symbols.</p> <p>Note 3: Interference from other cells and noise sources not specified in the test is assumed to be constant over subcarriers and time and shall be modelled as AWGN of appropriate power for N_{oc} to be fulfilled.</p> <p>Note 4: RSRP, RSRQ and I_o levels have been derived from other parameters for information purposes. They are not settable parameters themselves.</p> <p>Note 5: RSRP minimum requirements are specified assuming independent interference and noise at each receiver antenna port.</p> <p>Note 6: E-UTRA operating band groups are as defined in Section 3.5.</p> | | | |

A.9.9.2.3 Test Requirements

The absolute RSRP and RSRQ measurement accuracy shall fulfil the requirements in section 9.1.2.1 and 9.1.5.1 respectively.

A.9.10 SSTD

A.9.10.1 EUTRAN FDD-FDD SSTD accuracy in asynchronous DC

A.9.10.1.1 Test Purpose and Environment

The purpose of this test is to verify that the SSTD measurement accuracy is within the specified limits. This test will verify the requirements in Section 9.1.20 for FDD SSTD measurements.

A.9.10.1.2 Test parameters

The test parameters are given in Tables A.9.10.1.2-1 and A.9.10.1.2-2. In this test there are 2 cells. Cell 1 is the PCell and cell 2 is the PScell. Cell 1 and cell 2 are on different frequencies. The SSTD time difference between PCell and

PSCell reported by the UE is compared to the actual SSTD. The SSTD time difference between PCell and PSCell shall be set by the test equipment to one of the time differences in table A.9.10.1.2-3.

Table A.9.10.1.2-1: EUTRAN FDD-FDD SSTD accuracy in asynchronous DC

| Parameter | Unit | Value | Comment |
|--|------|--------|--|
| E-UTRA RF Channel Number | | 1, 2 | Two radio channels are used for this test. |
| Active PCell | | Cell1 | PCell on RF channel number 1. |
| Configured PSCell | | Cell2 | PSCell on RF channel number 2. |
| CP length | | Normal | |
| DRX | | OFF | |
| Note 1: This test verifies the RRM requirement which is independent of channel bandwidth and is performed according to the principle defined in section A.3.6.1. | | | |

Table A.9.10.1.2-2: EUTRAN FDD-FDD SSTD accuracy in asynchronous DC

| Parameter | Unit | Cell 1 | Cell 2 |
|--|---------------|---|---|
| E-UTRA RF Channel Number | | 1 | 2 |
| BW _{channel} | MHz | 5MHz: N _{RB,c} = 25 10MHz: N _{RB,c} = 50 20MHz: N _{RB,c} = 100 | 5MHz: N _{RB,c} = 25 10MHz: N _{RB,c} = 50 20MHz: N _{RB,c} = 100 |
| PDSCH parameters: DL Reference Measurement Channel | | 5MHz: R.5 FDD 10MHz: R.0 FDD 20MHz: R.4 FDD | 5MHz: R.5 FDD 10MHz: R.0 FDD 20MHz: R.4 FDD |
| PCFICH/PDCCH/PHICH parameters: DL Reference Measurement Channel | | 5MHz: R.11 FDD 10MHz: R.6 FDD 20MHz: R.10 FDD | 5MHz: R.11 FDD 10MHz: R.6 FDD 20MHz: R.10 FDD |
| OCNG Patterns | | 5MHz: OP.15 FDD 10MHz: OP.1 FDD 20MHz: OP.11 FDD | 5MHz: OP.15 FDD 10MHz: OP.1 FDD 20MHz: OP.11 FDD |
| PBCH_RA | dB | 0 | 0 |
| PBCH_RB | dB | | |
| PSS_RA | dB | | |
| SSS_RA | dB | | |
| PCFICH_RB | dB | | |
| PHICH_RA | dB | | |
| PHICH_PB | dB | | |
| PDCCH_RA | dB | | |
| PDCCH_PB | dB | | |
| PDSCH_RA | dB | | |
| PDSCH_RB | dB | | |
| OCNG_RA ^{Note 1} | dB | | |
| OCNG_RB ^{Note 1} | dB | | |
| N _{oc} ^{Note 2} | dBm/15 KHz | | |
| \hat{E}_s / N_{oc} | dB | -3 | -3 |
| \hat{E}_s / I_{ot} | dB | -3 | -3 |
| RSRP ^{Note 3} | dBm/15 KHz | -107 | -107 |
| SCH_RP ^{Note 3} | dBm/15 KHz | -107 | -107 |
| I _o ^{Note 3} | dBm/Ch BW | -74.45 +10log (N _{RB,c} /50) | -74.45 +10log (N _{RB,c} /50) |
| Propagation Condition | | AWGN | AWGN |
| Correlation Matrix and Antenna Configuration | | 1x2 Low | 1x2 Low |
| Receive Time offset to cell1 ^{Note 4} | μs | - | Between 22.8 and 42.9 |

| | |
|---------|---|
| Note 1: | OCNG shall be used such that both cells are fully allocated and a constant total transmitted power spectral density is achieved for all OFDM symbols. |
| Note 2: | Interference from other cells and noise sources not specified in the test is assumed to be constant over subcarriers and time and shall be modelled as AWGN of appropriate power for Noc to be fulfilled. |
| Note 3: | RSRP, SCH_RP and Io levels have been derived from other parameters for information purposes. They are not settable parameters themselves. |
| Note 4: | Offset shall be chosen by the test equipment. Test equipment may also select any SFN and frame offset between cell 1 and cell 2 |

Table A.9.10.1.2-3: EUTRAN FDD-FDD SSTD accuracy in asynchronous DC timing offsets

| Configuration | SFN offset between MeNB and SeNB (ΔX) | Frame boundary offset between MeNB and SeNB (ΔY) | Subframe boundary offset between MeNB and SeNB (ΔZ). |
|---------------|---|--|--|
| 1 | 100 | -4 | 800 |
| 2 | 300 | -2 | 900 |
| 3 | 500 | 0 | 1000 |
| 4 | 700 | 3 | 1100 |
| 5 | 900 | 5 | 1200 |

A.9.10.1.3 Test Requirements

The SSTD reported by the UE consists of 3 elements, SFN offset between MeNB and SeNB (ΔX), frame boundary offset between MeNB and SeNB (ΔY) and subframe boundary offset between MeNB and SeNB (ΔZ).

The reported ΔX , ΔY and ΔZ shall meet the accuracy requirements in section 9.1.20.

A.9.10.2 Void

A.9.10.3 Void

A.9.10.4 Void

A.9.11 RSSI

A.9.11.1 FS3 average RSSI accuracy case (PCell using FDD)

A.9.11.1.1 Test Purpose and Environment

The purpose of this test is to verify that the average RSSI measurement accuracy is within the specified limits. This test will partially verify the requirements in Section 9.1.18.5.2.

A.9.11.1.2 Test parameters

In all test cases, Cell 1 is the PCell and Cell 2 the FS3 Scell. RSSI is measured on channel number 2.

Table A.9.11.1.2-1: Average RSSI test parameters

| Parameter | Unit | Test 1 | |
|--------------------------|------|----------------|----------|
| | | Cell 1 | Cell 2 |
| E-UTRA RF Channel Number | | 1 | 2 |
| BW_{channel} | MHz | 5 10 20 | 20 |
| Listen before talk model | | Not applicable | Not used |

| | | | |
|--|--------------|--|-----------|
| Measurement bandwidth | n_{PRB} | 6 | |
| PDSCH Reference measurement channel defined in A.3.1.1.1 | | 5MHz: R.5 FDD 10MHz: R.0 FDD 20MHz: R.4 FDD | R0.FS3 |
| PDCCH/PCFICH/PHICH Reference measurement channel defined in A.3.1.2.1 | | 5MHz: R.11 FDD 10MHz: R.6 FDD 20MHz: R.10 FDD | R0.FS3 |
| OCNG Patterns defined in A.3.2.1.1 (OP.1 FDD) and A.3.2.1.2 (OP.2 FDD) | | 5MHz: OP.15 FDD 10MHz: OP.1 FDD 20MHz: OP.11 FDD | OP.14 FDD |
| PBCH_RA | dB | 0 | 0 |
| PBCH_RB | | | |
| PSS_RA | | | |
| SSS_RA | | | |
| PCFICH_RB | | | |
| PHICH_RA | | | |
| PHICH_RB | | | |
| PDCCH_RA | | | |
| PDCCH_RB | | | |
| PDSCH_RA | | | |
| PDSCH_RB | | | |
| OCNG_RA ^{Note1} | | | |
| OCNG_RB ^{Note1} | | | |
| N_{oc} in subframes not corresponding to RSSI measurement time configuration (RMTC) | dBm/15 kHz | -106 | -106 |
| N_{oc} in subframes corresponding to RSSI measurement time configuration (RMTC) | dBm/15 kHz | -106 | -83 |
| \hat{E}_s/I_{ot} in subframes not corresponding to RSSI measurement time configuration (RMTC) | dB | 2.5 | 2.5 |
| \hat{E}_s/I_{ot} in subframes corresponding to RSSI measurement time configuration (RMTC) | dB | 2.5 | -Infinity |
| RSRP in subframes not corresponding to RSSI measurement time configuration (RMTC) | dBm/15 kHz | -103.5 | -103.5 |
| RSRP in subframes corresponding to RSSI measurement time configuration (RMTC) | | -103.5 | -Infinity |
| Io within measurement bandwidth in subframes corresponding to RSSI measurement time configuration (RMTC) | dBm/1.08 MHz | -83 | -64.43 |
| Io within measurement bandwidth in subframes not corresponding to RSSI measurement time configuration (RMTC) | dBm/1.08 MHz | -83 | -83 |
| Propagation condition | - | AWGN | |

Table A.9.11.1.2-2: Average RSSI RMTC and DMTC parameters

| | |
|-------------------------|-------|
| measDuration-r13 | sym14 |
| rmtc-Period-r13 | ms40 |
| rmtc-SubframeOffset-r13 | 20 |
| ReportInterval | ms120 |

| | |
|-----------------------|------------------|
| dmtc-PeriodOffset-r12 | ms40-r12 value 0 |
|-----------------------|------------------|

A.9.11.1.3 Test Requirements

The average RSSI measurement accuracy shall fulfil the requirements in sections 9.1.18.5.2. The nominal RSSI used to evaluate the requirement shall be based on I_0 in subframes corresponding to RSSI measurement time configuration (RMTC).

A.9.11.2 FS3 average RSSI accuracy case (PCell using TDD)

A.9.11.2.1 Test Purpose and Environment

The purpose of this test is to verify that the average RSSI measurement accuracy is within the specified limits. This test will partially verify the requirements in Section 9.1.18.5.2.

A.9.11.2.2 Test parameters

In all test cases, Cell 1 is the PCell and Cell 2 the FS3 Scell. RSSI is measured on channel number 2.

Table A.9.11.2.2-1: Average RSSI test parameters

| Parameter | Unit | Test 1 | |
|---|------------------|--|-----------|
| | | Cell 1 | Cell 2 |
| E-UTRA RF Channel Number | | 1 | 2 |
| BW_{channel} | MHz | 5 10 20 | 20 |
| Listen before talk model | | Not applicable | Not used |
| Measurement bandwidth | n_{PRB} | 6 | |
| PDSCH Reference measurement channel defined in A.3.1.1.1 | | 5MHz: R.4 TDD 10MHz: R.0 TDD 20MHz: R.3 TDD | R0.FS3 |
| PDCCH/PCFICH/PHICH Reference measurement channel defined in A.3.1.2.1 | | 5MHz: R.11 TDD 10MHz: R.6 TDD 20MHz: R.10 TDD | R0.FS3 |
| OCNG Patterns defined in A.3.2.1.1 (OP.1 FDD) and A.3.2.1.2 (OP.2 FDD) | | 5MHz: OP.9 TDD 10MHz: OP.1 TDD 20MHz: OP.7 TDD | OP.14 FDD |
| PBCH_RA | dB | 0 | 0 |
| PBCH_RB | | | |
| PSS_RA | | | |
| SSS_RA | | | |
| PCFICH_RB | | | |
| PHICH_RA | | | |
| PHICH_RB | | | |
| PDCCH_RA | | | |
| PDCCH_RB | | | |
| PDSCH_RA | | | |
| PDSCH_RB | | | |
| OCNG_RA ^{Note1} | | | |
| OCNG_RB ^{Note1} | | | |
| N_{oc} in subframes not corresponding to RSSI measurement time configuration (RMTC) | dBm/15 kHz | -106 | -106 |
| N_{oc} in subframes corresponding to RSSI measurement time configuration (RMTC) | dBm/15 kHz | -106 | -83 |

| | | | |
|--|--------------|--------|-----------|
| \hat{E}_s/I_{ot} in subframes not corresponding to RSSI measurement time configuration (RMTC) | dB | 2.5 | 2.5 |
| \hat{E}_s/I_{ot} in subframes corresponding to RSSI measurement time configuration (RMTC) | dB | 2.5 | -Infinity |
| RSRP in subframes not corresponding to RSSI measurement time configuration (RMTC) | dBm/15 kHz | -103.5 | -103.5 |
| RSRP in subframes corresponding to RSSI measurement time configuration (RMTC) | | -103.5 | -Infinity |
| Io within measurement bandwidth in subframes corresponding to RSSI measurement time configuration (RMTC) | dBm/1.08 MHz | -83 | -64.43 |
| Io within measurement bandwidth in subframes not corresponding to RSSI measurement time configuration (RMTC) | dBm/1.08 MHz | -83 | -83 |
| Propagation condition | - | AWGN | |

Table A.9.11.2.2-2: Average RSSI RMTC and DMTC parameters

| | |
|-------------------------|------------------|
| measDuration-r13 | sym14 |
| rmtc-Period-r13 | ms40 |
| rmtc-SubframeOffset-r13 | 20 |
| ReportInterval | ms120 |
| dmtd-PeriodOffset-r12 | ms40-r12 value 0 |

A.9.11.2.3 Test Requirements

The average RSSI measurement accuracy shall fulfil the requirements in sections 9.1.18.5.2. The nominal RSSI used to evaluate the requirement shall be based on Io in subframes corresponding to RSSI measurement time configuration (RMTC).

A.9.12 Channel occupancy

A.9.12.1 FS3 channel occupancy test (PCell using FDD)

A.9.12.1.1 Test Purpose and Environment

The purpose of this test is to verify that the channel occupancy is within the specified limits. This test will partially verify the requirements in Section 9.1.18.6.1.

A.9.12.1.2 Test parameters

In all test cases, Cell 1 is the PCell and Cell 2 the FS3 Scell. Channel occupancy is measured on channel number 2.

Table A.9.12.1.2-1: Channel occupancy test parameters

| Parameter | Unit | Test 1 | |
|--------------------------|------|--------|--------|
| | | Cell 1 | Cell 2 |
| E-UTRA RF Channel Number | | 1 | 2 |

| | | | |
|--|--------------|--|-----------|
| BW _{channel} | MHz | 5 10 20 | 20 |
| Listen before talk model | | Not applicable | Not used |
| Measurement bandwidth | n_{PRB} | 6 | |
| PDSCH Reference measurement channel defined in A.3.1.1.1 | | 5MHz: R.5 FDD 10MHz: R.0 FDD 20MHz: R.4 FDD | R0.FS3 |
| PDCCH/PCFICH/PHICH Reference measurement channel defined in A.3.1.2.1 | | 5MHz: R.11 FDD 10MHz: R.6 FDD 20MHz: R.10 FDD | R0.FS3 |
| OCNG Patterns defined in A.3.2.1.1 (OP.1 FDD) and A.3.2.1.2 (OP.2 FDD) | | 5MHz: OP.15 FDD 10MHz: OP.1 FDD 20MHz: OP.11 FDD | OP.14 FDD |
| PBCH_RA | dB | 0 | 0 |
| PBCH_RB | | | |
| PSS_RA | | | |
| SSS_RA | | | |
| PCFICH_RB | | | |
| PHICH_RA | | | |
| PHICH_RB | | | |
| PDCCH_RA | | | |
| PDCCH_RB | | | |
| PDSCH_RA | | | |
| PDSCH_RB | | | |
| OCNG_RA ^{Note1} | | | |
| OCNG_RB ^{Note1} | | | |
| N_{oc} in subframes not corresponding to RSSI measurement time configuration (RMTC) | dBm/15 kHz | -106 | -106 |
| N_{oc} in subframes corresponding to RSSI measurement time configuration (RMTC) where system frame number mod 12 = 2 (NOTE 1) | dBm/15 kHz | -106 | -90.28 |
| N_{oc} in subframes corresponding to RSSI measurement time configuration (RMTC) where system frame number mod 12 is not equal to 2 (NOTE 1) | dBm/15 kHz | -106 | -97.28 |
| \hat{E}_s/I_{ot} in subframes not corresponding to RSSI measurement time configuration (RMTC) | dB | 2.5 | 2.5 |
| \hat{E}_s/I_{ot} in subframes corresponding to RSSI measurement time configuration (RMTC) | dB | 2.5 | -Infinity |
| RSRP in subframes not corresponding to RSSI measurement time configuration (RMTC) | dBm/15 kHz | -103.5 | -103.5 |
| RSRP in subframes corresponding to RSSI measurement time configuration (RMTC) | | -103.5 | -Infinity |
| Io within measurement bandwidth in subframes corresponding to RSSI measurement time configuration (RMTC) where system frame number mod 12 = 2 (NOTE 1) | dBm/1.08 MHz | -83 | -71.73 |
| Io within measurement bandwidth in subframes corresponding to RSSI | dBm/1.08 MHz | -83 | -78.73 |

| | | | |
|--|--------------|-------|-----|
| measurement time configuration (RMTC) where system frame number mod 12 is not equal to 2 (NOTE 1) | | | |
| lo within measurement bandwidth in subframes not corresponding to RSSI measurement time configuration (RMTC) | dBm/1.08 MHz | -83 | -83 |
| Propagation condition | - | AWGN | |
| channelOccupancyThreshold | dBm | -75.2 | |
| NOTE 1: Accumulated system frame number is used to avoid a configuration not matching the test purpose at the boundary of hyper frame numbers. | | | |

Table A.9.12.1.2-2: Channel occupancy RMTC and DMTC parameters

| | |
|-------------------------|---------------------|
| measDuration-r13 | sym14 |
| rmtc-Period-r13 | ms40 |
| rmtc-SubframeOffset-r13 | 20 |
| ReportInterval | ms120 |
| dmtc-PeriodOffset-r12 | ms40-r12 value 0 |

A.9.12.1.3 Test Requirements

The nominal reported *channelOccupancy* shall be 33. At least 90% of channel occupancy reports made by the UE shall indicate this value.

A.9.12.2 FS3 channel occupancy test (PCell using TDD)

A.9.12.2.1 Test Purpose and Environment

The purpose of this test is to verify that the channel occupancy is within the specified limits. This test will partially verify the requirements in Section 9.1.18.6.1.

A.9.12.2.2 Test parameters

In all test cases, Cell 1 is the PCell and Cell 2 the FS3 Scell. Channel occupancy is measured on channel number 2.

Table A.9.12.2.2-1: Channel occupancy test parameters

| Parameter | Unit | Test 1 | |
|--|-----------|--|-----------|
| | | Cell 1 | Cell 2 |
| E-UTRA RF Channel Number | | 1 | 2 |
| $BW_{channel}$ | MHz | 5 10 20 | 20 |
| Listen before talk model | | Not applicable | Not used |
| Measurement bandwidth | n_{PRB} | 6 | |
| PDSCH Reference measurement channel defined in A.3.1.1.1 | | 5MHz: R.4 TDD 10MHz: R.0 TDD 20MHz: R.3 TDD | R0.FS3 |
| PDCCH/PCFICH/PHICH Reference measurement channel defined in A.3.1.2.1 | | 5MHz: R.11 TDD 10MHz: R.6 TDD 20MHz: R.10 TDD | R0.FS3 |
| OCNG Patterns defined in A.3.2.1.1 (OP.1 FDD) and A.3.2.1.2 (OP.2 FDD) | | 5MHz: OP.9 TDD 10MHz: OP.1 TDD 20MHz: OP.7 TDD | OP.14 FDD |
| PBCH_RA | dB | 0 | 0 |

| | | | |
|--|--------------|--------|-----------|
| PBCH_RB | | | |
| PSS_RA | | | |
| SSS_RA | | | |
| PCFICH_RB | | | |
| PHICH_RA | | | |
| PHICH_RB | | | |
| PDCCH_RA | | | |
| PDCCH_RB | | | |
| PDSCH_RA | | | |
| PDSCH_RB | | | |
| OCNG_RA ^{Note1} | | | |
| OCNG_RB ^{Note1} | | | |
| N_{oc} in subframes not corresponding to RSSI measurement time configuration (RMTC) | dBm/15 kHz | -106 | -106 |
| N_{oc} in subframes corresponding to RSSI measurement time configuration (RMTC) where system frame number mod 12 = 2 (NOTE 1) | dBm/15 kHz | -106 | -90.28 |
| N_{oc} in subframes corresponding to RSSI measurement time configuration (RMTC) where system frame number mod 12 is not equal to 2 (NOTE 1) | dBm/15 kHz | -106 | -97.28 |
| \hat{E}_s/I_{ot} in subframes not corresponding to RSSI measurement time configuration (RMTC) | dB | 2.5 | 2.5 |
| \hat{E}_s/I_{ot} in subframes corresponding to RSSI measurement time configuration (RMTC) | dB | 2.5 | -Infinity |
| RSRP in subframes not corresponding to RSSI measurement time configuration (RMTC) | dBm/15 kHz | -103.5 | -103.5 |
| RSRP in subframes corresponding to RSSI measurement time configuration (RMTC) | | -103.5 | -Infinity |
| Io within measurement bandwidth in subframes corresponding to RSSI measurement time configuration (RMTC) where system frame number mod 12 = 2 (NOTE 1) | dBm/1.08 MHz | -83 | -71.73 |
| Io within measurement bandwidth in subframes corresponding to RSSI measurement time configuration (RMTC) where system frame number mod 12 is not equal to 2 (NOTE 1) | dBm/1.08 MHz | -83 | -78.73 |
| Io within measurement bandwidth in subframes not corresponding to RSSI measurement time configuration (RMTC) | dBm/1.08 MHz | -83 | -83 |
| Propagation condition | - | AWGN | |
| channelOccupancyThreshold | dBm | -75.2 | |
| NOTE 1: Accumulated system frame number is used to avoid a configuration not matching the test purpose at the boundary of hyper frame numbers. | | | |

Table A.9.12.2.2-2: Channel occupancy RMTC and DMTC parameters

| | |
|------------------|-------|
| measDuration-r13 | sym14 |
| rmtc-Period-r13 | ms40 |

| | |
|-------------------------|-------------------------|
| rmtc-SubframeOffset-r13 | 20 |
| ReportInterval | ms120 |
| dmtc-PeriodOffset-r12 | ms40- r12 value 0 |

A.9.12.2.3 Test Requirements

The nominal reported *channelOccupancy* in this test is 33. At least 90% of channel occupancy reports made by the UE shall indicate this value.

A.9.13 RS-SINR

A.9.13.1 FDD Intra-Frequency Case

A.9.13.1.1 Test Purpose and Environment

The purpose of this test is to verify that the RS-SINR measurement accuracy is within the specified limits. This test will verify the requirements in Section 9.1.17.2.1.

A.9.13.1.2 Test parameters

In this test case all cells are on the same carrier frequency. The absolute accuracy of RS-SINR intra-frequency measurement is tested by using the parameters in Table A.9.13.1.2-1. In all test cases, Cell 1 is the PCell and Cell 2 the target cell.

Table A.9.13.1.2-1: RS-SINR FDD intra-frequency test parameters

| Parameter | Unit | Test 1 | | Test 2 | |
|--|-----------|---|--------|---|--------|
| | | Cell 1 | Cell 2 | Cell 1 | Cell 2 |
| E-UTRA RF Channel Number | | 1 | | 1 | |
| Cell Ids | | (Cell ID of cell 1 – Cell ID of cell 2) mod 3 ≠ 0 | | (Cell ID of cell 1 – Cell ID of cell 2) mod 6 = 0 | |
| BW _{channel} | MHz | 10 | | 10 | |
| Measurement bandwidth | n_{PRB} | 22–27 | | 22–27 | |
| PDSCH Reference measurement channel defined in A.3.1.1.1 | | R.0 FDD | - | R.0 FDD | - |
| PDSCH allocation | n_{PRB} | 13–36 | - | 13–36 | - |
| PDCCH/PCFICH/PHICH Reference measurement channel defined in A.3.1.2.1 | | R.6 FDD | - | R.6 FDD | - |
| OCNG Patterns defined in A.3.2.1.1 (OP.1 FDD) and A.3.2.1.2 (OP.2 FDD) | | OP.1 FDD | - | OP.1 FDD | - |
| PBCH_RA | dB | 0 | 0 | 0 | 0 |
| PBCH_RB | | | 0 | | |
| PSS_RA | | | 0 | | |
| SSS_RA | | | 0 | | |
| PCFICH_RB | | | -∞ | | |
| PHICH_RA | | | -∞ | | |
| PHICH_RB | | | -∞ | | |
| PDCCH_RA | | | -∞ | | |
| PDCCH_RB | | | -∞ | | |
| PDSCH_RA | | | -∞ | | |
| PDSCH_RB | | | -∞ | | |
| OCNG_RA ^{Note1} | | | -∞ | | |
| OCNG_RB ^{Note1} | | | -∞ | | |

| | | | | | | |
|---|---|------------|--------|--------|--------|--------|
| N_{oc} ^{Note2} | Bands FDD_A <small>Note 8</small> | dBm/15 kHz | -90 | -90 | -116 | |
| | Bands FDD_B | | | | -115.5 | |
| | Bands FDD_C | | | | -115 | |
| | Bands FDD_D | | | | -114.5 | |
| | Bands FDD_E, FDD_F ^{Note 5} | | | | -114 | |
| | Bands FDD_G <small>Note 7</small> | | | | -113 | |
| | Bands FDD_H | | | | -112.5 | |
| CRS \hat{E}_s / I_{ot} | | dB | 5 | -3.19 | -5.46 | -5.46 |
| RSRP ^{Note3} | Bands FDD_A <small>Note 8</small> | dBm/15 kHz | -85.00 | -87.00 | -120 | -120 |
| | Bands FDD_B | | | | -119.5 | -119.5 |
| | Bands FDD_C | | | | -119 | -119 |
| | Bands FDD_D | | | | -118.5 | -118.5 |
| | Bands FDD_E, FDD_F ^{Note 5} | | | | -118 | -118 |
| | Bands FDD_G <small>Note 7</small> | | | | -117 | -117 |
| | Bands FDD_H | | | | -116.5 | -116.5 |
| RS-SINR ^{Note3} | Bands FDD_A <small>Note 8</small> | dB | 5 | -3.19 | -5.46 | -5.46 |
| | Bands FDD_B | | | | | |
| | Bands FDD_C | | | | | |
| | Bands FDD_D | | | | | |
| | Bands FDD_E, FDD_F ^{Note 5} | | | | | |
| | Bands FDD_G <small>Note 7</small> | | | | | |
| | Bands FDD_H | | | | | |
| I_o ^{Note3} | Bands FDD_A <small>Note 8</small> | dBm/9 MHz | -55.69 | -55.69 | -86.56 | |
| | Bands FDD_B | | | | -86.06 | |
| | Bands FDD_C | | | | -85.56 | |
| | Bands FDD_D | | | | -85.06 | |
| | Bands FDD_E, FDD_F ^{Note 5} | | | | -84.56 | |
| | Bands FDD_G <small>Note 7</small> | | | | -83.56 | |
| | Bands FDD_H | | | | -83.06 | |
| CRS \hat{E}_s / N_{oc} | | dB | 5 | 3 | -4 | -4 |
| Propagation condition | | - | AWGN | | AWGN | |
| <p>Note 1: OCNG shall be used such that both cells are fully allocated and a constant total transmitted power spectral density is achieved for all OFDM symbols.</p> <p>Note 2: Interference from other cells and noise sources not specified in the test is assumed to be constant over subcarriers and time and shall be modelled as AWGN of appropriate power for N_{oc} to be fulfilled.</p> <p>Note 3: RS-SINR, RSRP and I_o levels have been derived from other parameters for information purposes. They are not settable parameters themselves.</p> <p>Note 4: RSRP and RS-SINR minimum requirements are specified assuming independent interference and noise at each receiver antenna port.</p> <p>Note 5: For Band 26, the tests shall be performed with the carrier frequency of the assigned E-UTRA channel bandwidth within 865-894 MHz.</p> <p>Note 6: E-UTRA operating band groups are as defined in Section 3.5.</p> <p>Note 7: Except Band 29.</p> <p>Note 8: Except Band 32.</p> | | | | | | |

A.9.13.1.3 Test Requirements

The RS-SINR measurement accuracy for Cell 2 shall fulfil the requirements in Section 9.1.17.2.1.

A.9.13.2 TDD Intra-Frequency Case

A.9.13.2.1 Test Purpose and Environment

The purpose of this test is to verify that the RS-SINR measurement accuracy is within the specified limits. This test will verify the requirements in Section 9.1.17.2.1.

A.9.13.2.2 Test parameters

In this test case all cells are on the same carrier frequency. The absolute accuracy of RS-SINR intra-frequency measurement is tested by using the parameters in Table A.9.13.2.2-1. In all test cases, Cell 1 is the PCell and Cell 2 the target cell.

Table A.9.13.2.2-1: RS-SINR TDD intra-frequency test parameters

| Parameter | Unit | Test 1 | | Test 2 | | | | | | |
|--|---------------------------|---|--------|---|--------|-------------|--------|--------|------|--|
| | | Cell 1 | Cell 2 | Cell 1 | Cell 2 | | | | | |
| E-UTRA RF Channel Number | | 1 | | 1 | | | | | | |
| Cell Ids | | (Cell ID of cell 1 – Cell ID of cell 2) mod 3 ≠ 0 | | (Cell ID of cell 1 – Cell ID of cell 2) mod 6 = 0 | | | | | | |
| BW _{channel} | MHz | 10 | | 10 | | | | | | |
| Special subframe configuration ^{Note1} | | 6 | | 6 | | | | | | |
| Uplink-downlink configuration ^{Note1} | | 1 | | 1 | | | | | | |
| Measurement bandwidth | n_{PRB} | 22–27 | | 22–27 | | | | | | |
| PDSCH Reference measurement channel defined in A.3.1.1.2 | | R.0 TDD | - | R.0 TDD | - | | | | | |
| PDSCH allocation | n_{PRB} | 13–36 | - | 13–36 | - | | | | | |
| PDCCH/PCFICH/PHICH Reference measurement channel defined in A.3.1.2.2 | | R.6 TDD | - | R.6 TDD | - | | | | | |
| OCNG Patterns defined in A.3.2.2.1 (OP.1 TDD) and A.3.2.2.2 (OP.2 TDD) | | OP.1 TDD | - | OP.1 TDD | - | | | | | |
| PBCH_RA | dB | 0 | 0 | 0 | 0 | | | | | |
| PBCH_RB | | | | | | | | | | |
| PSS_RA | | | | | | | | | | |
| SSS_RA | | | | | | | | | | |
| PCFICH_RB | | | | | | | | | | |
| PHICH_RA | | | | | | | | | | |
| PHICH_RB | | | | | | | | | | |
| PDCCH_RA | | | | | | | | | | |
| PDCCH_RB | | | | | | | | | | |
| PDSCH_RA | | | | | | | | | | |
| PDSCH_RB | | | | | | | | | | |
| OCNG_RA ^{Note2} | | | | | | | | | | |
| OCNG_RB ^{Note2} | | | | | | | | | | |
| N_{oc} ^{Note3} | | | | | | Bands TDD_A | -90.00 | -90.00 | -116 | |
| | | | | | | Bands TDD_C | | | -115 | |
| | | | | | | Bands TDD_E | | | -114 | |
| \hat{E}_s/I_{ot} | | 5 | -3.19 | -5.46 | -5.46 | | | | | |
| RSRP ^{Note4} | Bands TDD_A | -85 | -87 | -120 | -120 | | | | | |
| | Bands TDD_C | | | -119 | -119 | | | | | |
| | Bands TDD_E | | | -118 | -118 | | | | | |
| RS-SINR ^{Note4} | Bands TDD_A, TDD_C, TDD_E | | 5 | -3.19 | -5.46 | -5.46 | | | | |

| | | | | | | |
|---|-------------|-----------|--------|--------|--------|----|
| I _o ^{Note4} | Bands TDD_A | dBm/9 MHz | -55.69 | -55.69 | -86.56 | |
| | Bands TDD_C | | | | -85.56 | |
| | Bands TDD_E | | | | -84.56 | |
| \hat{E}_s / N_{oc} | | dB | 5 | 3 | -4 | -4 |
| Propagation condition | | - | AWGN | | AWGN | |
| <p>Note 1: For special subframe and uplink-downlink configurations see Tables 4.2-1 and 4.2-2 in TS 36.211.</p> <p>Note 2: OCNG shall be used such that both cells are fully allocated and a constant total transmitted power spectral density is achieved for all OFDM symbols.</p> <p>Note 3: Interference from other cells and noise sources not specified in the test is assumed to be constant over subcarriers and time and shall be modelled as AWGN of appropriate power for N_{oc} to be fulfilled.</p> <p>Note 4: RS-SINR, RSRP and I_o levels have been derived from other parameters for information purposes. They are not settable parameters themselves.</p> <p>Note 5: RSRP and RS-SINR minimum requirements are specified assuming independent interference and noise at each receiver antenna port.</p> <p>Note 6: E-UTRA operating band groups are as defined in Section 3.5.</p> | | | | | | |

A.9.13.2.3 Test Requirements

The RS-SINR measurement accuracy for Cell 2 shall fulfil the requirements in Section 9.1.17.2.1.

A.9.13.3 FDD—FDD Inter frequency case

A.9.13.3.1 Test Purpose and Environment

The purpose of this test is to verify that the RS-SINR measurement accuracy is within the specified limits. This test will verify the requirements in Sections 9.1.17.3.

A.9.13.3.2 Test parameters

In this test case the two cells are on different carrier frequencies and measurement gaps are provided. Both RS-SINR inter-frequency absolute and relative accuracy requirements are tested by using test parameters in Table A.9.13.3.2-1 and Table A.9.13.3.2-2. In all tests, Cell 1 is the PCell and Cell 2 the target cell.

Table A.9.13.3.2-1: RS-SINR FDD—FDD Inter frequency test parameters (Cell 1)

| Parameter | Unit | Test 1 | Test 2 | Test 3 |
|---|-----------|----------|----------|----------|
| | | Cell 1 | Cell 1 | Cell 1 |
| E-UTRA RF Channel Number | | 2 | 2 | 2 |
| BW _{channel} | MHz | 10 | 10 | 10 |
| Gap Pattern Id | | 0 | 0 | 0 |
| Measurement bandwidth | n_{PRB} | 22—27 | 22—27 | 22—27 |
| PDSCH Reference measurement channel defined in A.3.1.1.1 | | R.0 FDD | R.0 FDD | R.0 FDD |
| PDSCH allocation | n_{PRB} | 13—36 | 13—36 | 13—36 |
| PDCCH/PCFICH/PHICH Reference measurement channel defined in A.3.1.2.1 | | R.6 FDD | R.6 FDD | R.6 FDD |
| OCNG Patterns defined in A.3.2.1.1 | | OP.1 FDD | OP.1 FDD | OP.1 FDD |
| PBCH_RA | dB | 0 | 0 | 0 |
| PBCH_RB | | | | |
| PSS_RA | | | | |
| SSS_RA | | | | |
| PCFICH_RB | | | | |
| PHICH_RA | | | | |
| PHICH_RB | | | | |

| | | | | | |
|---|---|------------|--------|---------|--------|
| PDCCH_RA | | | | | |
| PDCCH_RB | | | | | |
| PDSCH_RA | | | | | |
| PDSCH_RB | | | | | |
| OCNG_RA ^{Note1} | | | | | |
| OCNG_RB ^{Note1} | | | | | |
| N_{oc} ^{Note2} | Bands FDD_A <small>Note 8</small> | dBm/15 kHz | -80 | -108.50 | -119.5 |
| | Bands FDD_B | | | | -119 |
| | Bands FDD_C | | | | -118.5 |
| | Bands FDD_D | | | | -118 |
| | Bands FDD_E, FDD_F ^{Note 5} | | | | -117.5 |
| | Bands FDD_G <small>Note 7</small> | | | | -116.5 |
| | Bands FDD_H | | | | -116 |
| $CRS \hat{E}_s / N_{oc}$ | | dB | -1.75 | 20 | -4.0 |
| RSRP ^{Note3} | Bands FDD_A <small>Note 8</small> | dBm/15 kHz | -81.75 | -88.50 | -123.5 |
| | Bands FDD_B | | | | -123 |
| | Bands FDD_C | | | | -122.5 |
| | Bands FDD_D | | | | -122 |
| | Bands FDD_E, FDD_F ^{Note 5} | | | | -121.5 |
| | Bands FDD_G <small>Note 7</small> | | | | -120.5 |
| | Bands FDD_H | | | | -120 |
| RS-SINR ^{Note3} | Bands FDD_A <small>Note 8</small> | dB | -1.75 | 20 | -4.0 |
| | Bands FDD_B | | | | |
| | Bands FDD_C | | | | |
| | Bands FDD_D | | | | |
| | Bands FDD_E, FDD_F ^{Note 5} | | | | |
| | Bands FDD_G <small>Note 7</small> | | | | |
| | Bands FDD_H | | | | |
| I_o ^{Note3} | Bands FDD_A <small>Note 8</small> | dBm/9 MHz | -50 | -60.68 | -90.26 |
| | Bands FDD_B | | | | -89.76 |
| | Bands FDD_C | | | | -89.26 |
| | Bands FDD_D | | | | -88.76 |
| | Bands FDD_E, FDD_F ^{Note 5} | | | | -88.26 |
| | Bands FDD_G <small>Note 7</small> | | | | -87.26 |
| | Bands FDD_H | | | | -86.76 |
| Propagation condition | | - | AWGN | AWGN | AWGN |
| Antenna Configuration | | - | 1x2 | 1x2 | 1x2 |
| <p>Note 1: OCNG shall be used such that both cells are fully allocated and a constant total transmitted power spectral density is achieved for all OFDM symbols.</p> <p>Note 2: Interference from other cells and noise sources not specified in the test is assumed to be constant over subcarriers and time and shall be modelled as AWGN of appropriate power for N_{oc} to be fulfilled.</p> <p>Note 3: RSRP, RS-SINR and I_o levels have been derived from other parameters for information purposes. They are not settable parameters themselves.</p> <p>Note 4: RSRP and RS-SINR minimum requirements are specified assuming independent interference and noise at each receiver antenna port.</p> <p>Note 5: For Band 26, the tests shall be performed with the carrier frequency of the assigned E-UTRA channel bandwidth within 865-894 MHz.</p> <p>Note 6: E-UTRA operating band groups are as defined in Section 3.5.</p> <p>Note 7: Except Band 29.</p> <p>Note 8: Except Band 32.</p> | | | | | |

Table A.9.13.3.2-2: RS-SINR FDD—FDD Inter frequency test parameters (Cell 2)

| Parameter | | Unit | Test 1 | Test 2 | Test 3 | | | | |
|---|--------------------------------------|------------|----------|----------|----------|------------|-----|--------|--------|
| | | | Cell 1 | Cell 1 | Cell 1 | | | | |
| E-UTRA RF Channel Number | | | 2 | 2 | 2 | | | | |
| BW _{channel} | | MHz | 10 | 10 | 10 | | | | |
| Gap Pattern Id | | | - | - | - | | | | |
| Measurement bandwidth | | n_{PRB} | 22—27 | 22—27 | 22—27 | | | | |
| PDSCH Reference measurement channel defined in A.3.1.1.1 | | | - | - | - | | | | |
| PDSCH allocation | | n_{PRB} | - | - | - | | | | |
| PDCCH/PCFICH/PHICH Reference measurement channel defined in A.3.1.2.1 | | | R.6 FDD | R.6 FDD | R.6 FDD | | | | |
| OCNG Patterns defined in A.3.2.1.1 (OP.1 FDD) | | | OP.1 FDD | OP.1 FDD | OP.1 FDD | | | | |
| PBCH_RA | | dB | 0 | 0 | 0 | | | | |
| PBCH_RB | | | | | | | | | |
| PSS_RA | | | | | | | | | |
| SSS_RA | | | | | | | | | |
| PCFICH_RB | | | | | | | | | |
| PHICH_RA | | | | | | | | | |
| PHICH_RB | | | | | | | | | |
| PDCCH_RA | | | | | | | | | |
| PDCCH_RB | | | | | | | | | |
| PDSCH_RA | | | | | | | | | |
| PDSCH_RB | | | | | | | | | |
| OCNG_RA ^{Note1} | | | | | | | | | |
| OCNG_RB ^{Note1} | | | | | | | | | |
| N_{oc1} ^{Note2} | Bands FDD_A ^{Note 8} | | | | | dBm/15 kHz | -85 | -108.5 | -119.5 |
| | Bands FDD_B | | | | | | | | -119 |
| | Bands FDD_C | -118.5 | | | | | | | |
| | Bands FDD_D | -118 | | | | | | | |
| | Bands FDD_E, FDD_F ^{Note 5} | -117.5 | | | | | | | |
| | Bands FDD_G ^{Note 7} | -116.5 | | | | | | | |
| | Bands FDD_H | -116 | | | | | | | |
| N_{oc2} ^{Note2a} | Bands FDD_A ^{Note 8} | dBm/15 kHz | -79 | -114.5 | -113.5 | | | | |
| | Bands FDD_B | | | | -113 | | | | |
| | Bands FDD_C | | | | -112.5 | | | | |
| | Bands FDD_D | | | | -112 | | | | |
| | Bands FDD_E, FDD_F ^{Note 5} | | | | -111.5 | | | | |
| | Bands FDD_G ^{Note 7} | | | | -110.5 | | | | |
| | Bands FDD_H | | | | -110 | | | | |
| CRS \hat{E}_s / N_{oc} | | dB | -1.75 | 20 | -4.0 | | | | |
| RSRP ^{Note3} | Bands FDD_A ^{Note 8} | dBm/15 kHz | -86.75 | -88.50 | -123.5 | | | | |
| | Bands FDD_B | | | | -123 | | | | |
| | Bands FDD_C | | | | -122.5 | | | | |
| | Bands FDD_D | | | | -122 | | | | |
| | Bands FDD_E, FDD_F ^{Note 5} | | | | -121.5 | | | | |
| | Bands FDD_G ^{Note 7} | | | | -120.5 | | | | |
| | Bands FDD_H | | | | -120 | | | | |
| RS-SINR ^{Note3} | | dB | -1.75 | 20 | -4.0 | | | | |
| I_0 ^{Note3} | Bands FDD_A ^{Note 8} | dBm/9 MHz | -50.68 | -60.71 | -85.45 | | | | |

| | | | | | |
|---|---|---|------|------|--------|
| | Bands FDD_B | | | | -84.95 |
| | Bands FDD_C | | | | -84.45 |
| | Bands FDD_D | | | | -83.95 |
| | Bands FDD_E, FDD_F ^{Note 5} | | | | -83.45 |
| | Bands FDD_G ^{Note 7} | | | | -82.45 |
| | Bands FDD_H | | | | -81.95 |
| Propagation condition | | - | AWGN | AWGN | AWGN |
| Antenna Configuration | | - | 1x2 | 1x2 | 1x2 |
| <p>Note 1: OCNG shall be used such that both cells are fully allocated and a constant total transmitted power spectral density is achieved for all OFDM symbols.</p> <p>Note 2: Interference from other cells and noise sources not specified in the test is assumed to be constant over CRS subcarriers and time and shall be modelled as AWGN of appropriate power for N_{oc1} to be fulfilled.</p> <p>Note 2a: Interference from other cells and noise sources not specified in the test is assumed to be constant over subcarriers other than CRS subcarriers and time and shall be modelled as AWGN of appropriate power for N_{oc2} to be fulfilled.</p> <p>Note 3: RSRP, RS-SINR and I_o levels have been derived from other parameters for information purposes. They are not settable parameters themselves.</p> <p>Note 4: RSRP and RS-SINR minimum requirements are specified assuming independent interference and noise at each receiver antenna port.</p> <p>Note 5: For Band 26, the tests shall be performed with the carrier frequency of the assigned E-UTRA channel bandwidth within 865-894 MHz.</p> <p>Note 6: E-UTRA operating band groups are as defined in Section 3.5.</p> <p>Note 7: Except Band 29.</p> <p>Note 8: Except Band 32.</p> | | | | | |

A.9.13.3.3 Test Requirements

The RS-SINR measurement accuracy shall fulfil the requirements in Sections 9.1.17.3.

A.9.13.4 TDD—TDD Inter frequency case

A.9.13.4.1 Test Purpose and Environment

The purpose of this test is to verify that the RS-SINR measurement accuracy is within the specified limits. This test will verify the requirements in Sections 9.1.17.3.

A.9.13.4.2 Test parameters

In this test case the two cells are on different carrier frequencies and measurement gaps are provided. Both RS-SINR inter-frequency absolute and relative accuracy requirements are tested by using test parameters in Table A.9.13.4.2-1 and Table A.9.13.4.2-2 for TDD configuration 1 and in Table A.9.13.4.2-3 and Table A.9.13.4.2-4 for TDD configuration 0. In all tests, Cell 1 is the PCell and Cell 2 the target cell.

Table A.9.13.4.2-1: RS-SINR TDD—TDD Inter frequency test parameters for TDD configuration 1 (Cell 1)

| Parameter | Unit | Test 1 | Test 2 | Test 3 | |
|---|-------------|------------|----------|----------|-------------|
| | | Cell 2 | Cell 2 | Cell 2 | |
| E-UTRA RF Channel Number | | 2 | 2 | 2 | |
| BW _{channel} | MHz | 10 | 10 | 10 | |
| Gap Pattern Id | | 0 | 0 | 0 | |
| Special subframe configuration <small>Note1</small> | | 6 | 6 | 6 | |
| Uplink-downlink configuration <small>Note1</small> | | 1 | 1 | 1 | |
| Measurement bandwidth | n_{PRB} | 22—27 | 22—27 | 22—27 | |
| PDSCH Reference measurement channel defined in A.3.1.1.2 | | R.0 TDD | R.0 TDD | R.0 TDD | |
| PDSCH allocation | n_{PRB} | 13—36 | 13—36 | 13—36 | |
| PDCCH/PCFICH/PHICH Reference measurement channel defined in A.3.1.2.2 | | R.6 TDD | R.6 TDD | R.6 TDD | |
| OCNG Patterns defined in A.3.2.2.1 | | OP.1 TDD | OP.1 TDD | OP.1 TDD | |
| PBCH_RA | dB | 0 | 0 | 0 | |
| PBCH_RB | | | | | |
| PSS_RA | | | | | |
| SSS_RA | | | | | |
| PCFICH_RB | | | | | |
| PHICH_RA | | | | | |
| PHICH_RB | | | | | |
| PDCCH_RA | | | | | |
| PDCCH_RB | | | | | |
| PDSCH_RA | | | | | |
| PDSCH_RB | | | | | |
| OCNG_RA <small>Note2</small> | | | | | |
| OCNG_RB <small>Note2</small> | | | | | |
| N_{oc} <small>Note3</small> | | | | | Bands TDD_A |
| | Bands TDD_C | -118.50 | | | |
| | Bands TDD_E | -117.50 | | | |
| CRS \hat{E}_s/N_{oc} | dB | -1.75 | 20 | -4.0 | |
| RSRP <small>Note4</small> | Bands TDD_A | dBm/15 kHz | -81.75 | -88.50 | -123.50 |
| | Bands TDD_C | | | | -122.50 |
| | Bands TDD_E | | | | -121.50 |
| RS-SINR <small>Note4</small> | dB | -1.75 | 20 | -4.0 | |
| I _o <small>Note4</small> | Bands TDD_A | dBm/9 MHz | -50 | -60.68 | -90.26 |
| | Bands TDD_C | | | | -89.26 |
| | Bands TDD_E | | | | -88.26 |
| Propagation condition | - | AWGN | AWGN | AWGN | |
| Antenna Configuration | - | 1x2 | 1x2 | 1x2 | |
| <p>Note 1: For special subframe and uplink-downlink configurations see Tables 4.2-1 and 4.2-2 in TS 36.211.</p> <p>Note 2: OCNG shall be used such that both cells are fully allocated and a constant total transmitted power spectral density is achieved for all OFDM symbols.</p> <p>Note 3: Interference from other cells and noise sources not specified in the test is assumed to be constant over subcarriers and time and shall be modelled as AWGN of appropriate power for N_{oc} to be fulfilled.</p> <p>Note 4: RSRP, RS-SINR and I_o levels have been derived from other parameters for information purposes. They are not settable parameters themselves.</p> <p>Note 5: RSRP and RS-SINR minimum requirements are specified assuming independent interference and noise at each receiver antenna port.</p> <p>Note 6: E-UTRA operating band groups are as defined in Section 3.5.</p> | | | | | |

Table A.9.13.4.2-2: RS-SINR TDD—TDD Inter frequency test parameters for TDD configuration 1 (Cell 2)

| Parameter | Unit | Test 1 | Test 2 | Test 3 |
|-----------|------|--------|--------|--------|
|-----------|------|--------|--------|--------|

| | | | Cell 2 | Cell 2 | Cell 2 | | | | |
|---|-------------|------------|----------|----------|----------|------------|-----|---------|---------|
| E-UTRA RF Channel Number | | | 2 | 2 | 2 | | | | |
| BW _{channel} | | MHz | 10 | 10 | 10 | | | | |
| Gap Pattern Id | | | - | - | - | | | | |
| Special subframe configuration <small>Note1</small> | | | 6 | 6 | 6 | | | | |
| Uplink-downlink configuration <small>Note1</small> | | | 1 | 1 | 1 | | | | |
| Measurement bandwidth | | n_{PRB} | 22—27 | 22—27 | 22—27 | | | | |
| PDSCH Reference measurement channel | | | - | - | - | | | | |
| PDSCH allocation | | n_{PRB} | - | - | - | | | | |
| PDCCH/PCFICH/PHICH Reference measurement channel defined in A.3.1.2.2 | | | R.6 TDD | R.6 TDD | R.6 TDD | | | | |
| OCNG Patterns defined in A.3.2.2.2 | | | OP.2 TDD | OP.2 TDD | OP.2 TDD | | | | |
| PBCH_RA | | dB | 0 | 0 | 0 | | | | |
| PBCH_RB | | | | | | | | | |
| PSS_RA | | | | | | | | | |
| SSS_RA | | | | | | | | | |
| PCFICH_RB | | | | | | | | | |
| PHICH_RA | | | | | | | | | |
| PHICH_RB | | | | | | | | | |
| PDCCH_RA | | | | | | | | | |
| PDCCH_RB | | | | | | | | | |
| PDSCH_RA | | | | | | | | | |
| PDSCH_RB | | | | | | | | | |
| OCNG_RA <small>Note2</small> | | | | | | | | | |
| OCNG_RB <small>Note2</small> | | | | | | | | | |
| N_{oc1} <small>Note3</small> | Bands TDD_A | | | | | dBm/15 kHz | -85 | -108.50 | -119.50 |
| | Bands TDD_C | | | | | | | | -118.50 |
| | Bands TDD_E | -117.50 | | | | | | | |
| N_{oc2} <small>Note3a</small> | Bands TDD_A | dBm/15 kHz | -79 | -114.50 | -113.50 | | | | |
| | Bands TDD_C | | | | -112.50 | | | | |
| | Bands TDD_E | | | | -111.50 | | | | |
| CRS \hat{E}_s/N_{oc} | | dB | -1.75 | 20 | -4.0 | | | | |
| RSRP <small>Note4</small> | Bands TDD_A | dBm/15 kHz | -81.75 | -88.50 | -123.50 | | | | |
| | Bands TDD_C | | | | -122.50 | | | | |
| | Bands TDD_E | | | | -121.50 | | | | |
| RS-SINR <small>Note4</small> | | dB | -1.75 | 20 | -4.0 | | | | |
| I _o <small>Note4</small> | Bands TDD_A | dBm/9 MHz | -50.68 | -60.71 | -85.45 | | | | |
| | Bands TDD_C | | | | -84.45 | | | | |
| | Bands TDD_E | | | | -83.45 | | | | |
| Propagation condition | | - | AWGN | AWGN | AWGN | | | | |
| Antenna Configuration | | - | 1x2 | 1x2 | 1x2 | | | | |
| <p>Note 1: For special subframe and uplink-downlink configurations see Tables 4.2-1 and 4.2-2 in TS 36.211.</p> <p>Note 2: OCNG shall be used such that both cells are fully allocated and a constant total transmitted power spectral density is achieved for all OFDM symbols.</p> <p>Note 3: Interference from other cells and noise sources not specified in the test is assumed to be constant over CRS subcarriers and time and shall be modelled as AWGN of appropriate power for CRS N_{oc} to be fulfilled.</p> <p>Note 3a: Interference from other cells and noise sources not specified in the test is assumed to be constant over Non-CRS subcarriers and time and shall be modelled as AWGN of appropriate power for Non-CRS N_{oc} to be fulfilled.</p> <p>Note 4: RSRP, RS-SINR and I_o levels have been derived from other parameters for information purposes. They are not settable parameters themselves.</p> <p>Note 5: RSRP and RS-SINR minimum requirements are specified assuming independent interference and noise at each receiver antenna port.</p> <p>Note 6: E-UTRA operating band groups are as defined in Section 3.5.</p> | | | | | | | | | |

Table A.9.13.4.2-3: RS-SINR TDD—TDD Inter frequency test parameters for TDD configuration 0 (Cell 1)

| Parameter | Unit | Test 1 | Test 2 | Test 3 | | | | | |
|---|-------------|------------|----------|----------|-------------|------------|-----|---------|---------|
| | | Cell 2 | Cell 2 | Cell 2 | | | | | |
| E-UTRA RF Channel Number | | 2 | 2 | 2 | | | | | |
| BW _{channel} | MHz | 10 | 10 | 10 | | | | | |
| Gap Pattern Id | | 0 | 0 | 0 | | | | | |
| Special subframe configuration <small>Note1</small> | | 6 | 6 | 6 | | | | | |
| Uplink-downlink configuration ^{Note1} | | 0 | 0 | 0 | | | | | |
| Measurement bandwidth | n_{PRB} | 22—27 | 22—27 | 22—27 | | | | | |
| PDSCH Reference measurement channel defined in A.3.1.1.2 | | R.0 TDD | R.0 TDD | R.0 TDD | | | | | |
| PDSCH allocation | n_{PRB} | 13—36 | 13—36 | 13—36 | | | | | |
| PDCCH/PCFICH/PHICH Reference measurement channel defined in A.3.1.2.2 | | R.6 TDD | R.6 TDD | R.6 TDD | | | | | |
| OCNG Patterns defined in A.3.2.2.1 | | OP.1 TDD | OP.1 TDD | OP.1 TDD | | | | | |
| PBCH_RA | dB | 0 | 0 | 0 | | | | | |
| PBCH_RB | | | | | | | | | |
| PSS_RA | | | | | | | | | |
| SSS_RA | | | | | | | | | |
| PCFICH_RB | | | | | | | | | |
| PHICH_RA | | | | | | | | | |
| PHICH_RB | | | | | | | | | |
| PDCCH_RA | | | | | | | | | |
| PDCCH_RB | | | | | | | | | |
| PDSCH_RA | | | | | | | | | |
| PDSCH_RB | | | | | | | | | |
| OCNG_RA ^{Note2} | | | | | | | | | |
| OCNG_RB ^{Note2} | | | | | | | | | |
| N_{oc} ^{Note3} | | | | | Bands TDD_A | dBm/15 kHz | -80 | -108.50 | -119.50 |
| | | | | | Bands TDD_C | | | | -118.50 |
| | Bands TDD_E | -117.50 | | | | | | | |
| CRS \hat{E}_s / N_{oc} | dB | -1.75 | 20 | -4.0 | | | | | |
| RSRP ^{Note4} | Bands TDD_A | dBm/15 kHz | -81.75 | -88.50 | -123.50 | | | | |
| | Bands TDD_C | | | | -122.50 | | | | |
| | Bands TDD_E | | | | -121.50 | | | | |
| RS-SINR ^{Note4} | dB | -1.75 | 20 | -4.0 | | | | | |
| I _o ^{Note4} | Bands TDD_A | dBm/9 MHz | -50 | -60.68 | -90.26 | | | | |
| | Bands TDD_C | | | | -89.26 | | | | |
| | Bands TDD_E | | | | -88.26 | | | | |
| Propagation condition | - | AWGN | AWGN | AWGN | | | | | |
| Antenna Configuration | - | 1x2 | 1x2 | 1x2 | | | | | |
| <p>Note 1: For special subframe and uplink-downlink configurations see Tables 4.2-1 and 4.2-2 in TS 36.211.</p> <p>Note 2: OCNG shall be used such that both cells are fully allocated and a constant total transmitted power spectral density is achieved for all OFDM symbols.</p> <p>Note 3: Interference from other cells and noise sources not specified in the test is assumed to be constant over subcarriers and time and shall be modelled as AWGN of appropriate power for N_{oc} to be fulfilled.</p> <p>Note 4: RSRP, RS-SINR and I_o levels have been derived from other parameters for information purposes. They are not settable parameters themselves.</p> <p>Note 5: RSRP and RS-SINR minimum requirements are specified assuming independent interference and noise at each receiver antenna port.</p> <p>Note 6: E-UTRA operating band groups are as defined in Section 3.5.</p> | | | | | | | | | |

Table A.9.13.4.2-4: RS-SINR TDD—TDD Inter frequency test parameters for TDD configuration 0 (Cell 2)

| Parameter | Unit | Test 1 | Test 2 | Test 3 |
|-----------|------|--------|--------|--------|
| | | Cell 2 | Cell 2 | Cell 2 |

| | | | | | | | | | |
|--|-------------|------------|----------|----------|----------|------------|-----|---------|---------|
| E-UTRA RF Channel Number | | | 2 | 2 | 2 | | | | |
| BW _{channel} | | MHz | 10 | 10 | 10 | | | | |
| Gap Pattern Id | | | - | - | - | | | | |
| Special subframe configuration Note1 | | | 6 | 6 | 6 | | | | |
| Uplink-downlink configuration Note1 | | | 0 | 0 | 0 | | | | |
| Measurement bandwidth | | n_{PRB} | 22—27 | 22—27 | 22—27 | | | | |
| PDSCH Reference measurement channel | | | - | - | - | | | | |
| PDSCH allocation | | n_{PRB} | - | - | - | | | | |
| PDCCH/PCFICH/PHICH Reference measurement channel defined in A.3.1.2.2 | | | R.6 TDD | R.6 TDD | R.6 TDD | | | | |
| OCNG Patterns defined in A.3.2.2.2 | | | OP.2 TDD | OP.2 TDD | OP.2 TDD | | | | |
| PBCH_RA | | dB | 0 | 0 | 0 | | | | |
| PBCH_RB | | | | | | | | | |
| PSS_RA | | | | | | | | | |
| SSS_RA | | | | | | | | | |
| PCFICH_RB | | | | | | | | | |
| PHICH_RA | | | | | | | | | |
| PHICH_RB | | | | | | | | | |
| PDCCH_RA | | | | | | | | | |
| PDCCH_RB | | | | | | | | | |
| PDSCH_RA | | | | | | | | | |
| PDSCH_RB | | | | | | | | | |
| OCNG_RA ^{Note2} | | | | | | | | | |
| OCNG_RB ^{Note2} | | | | | | | | | |
| CRS N_{oc} ^{Note3} | Bands TDD_A | | | | | dBm/15 kHz | -85 | -108.50 | -119.50 |
| | Bands TDD_C | | | | | | | | -118.50 |
| | Bands TDD_E | -117.50 | | | | | | | |
| Non-CRS N_{oc} ^{Note3a} | Bands TDD_A | dBm/15 kHz | -79 | -114.50 | -113.50 | | | | |
| | Bands TDD_C | | | | -112.50 | | | | |
| | Bands TDD_E | | | | -111.50 | | | | |
| CRS \hat{E}_s/N_{oc} | | dB | -1.75 | 20 | -4.0 | | | | |
| RSRP ^{Note4} | Bands TDD_A | dBm/15 kHz | -81.75 | -88.50 | -123.50 | | | | |
| | Bands TDD_C | | | | -122.50 | | | | |
| | Bands TDD_E | | | | -121.50 | | | | |
| RS-SINR ^{Note4} | | dB | -1.75 | 20 | -4.0 | | | | |
| I _o ^{Note4} | Bands TDD_A | dBm/9 MHz | -50.68 | -60.71 | -85.45 | | | | |
| | Bands TDD_C | | | | -84.45 | | | | |
| | Bands TDD_E | | | | -83.45 | | | | |
| Propagation condition | | - | AWGN | AWGN | AWGN | | | | |
| Antenna Configuration | | - | 1x2 | 1x2 | 1x2 | | | | |
| <p>Note 1: For special subframe and uplink-downlink configurations see Tables 4.2-1 and 4.2-2 in TS 36.211.</p> <p>Note 2: OCNG shall be used such that both cells are fully allocated and a constant total transmitted power spectral density is achieved for all OFDM symbols.</p> <p>Note 3: Interference from other cells and noise sources not specified in the test is assumed to be constant over CRS subcarriers and time and shall be modelled as AWGN of appropriate power for to be fulfilled.</p> <p>Note 3a: Interference from other cells and noise sources not specified in the test is assumed to be constant over subcarriers other than CRS subcarriers and time and shall be modelled as AWGN of appropriate power for to be fulfilled.</p> <p>Note 4: RSRP, RS-SINR and I_o levels have been derived from other parameters for information purposes. They are not settable parameters themselves.</p> <p>Note 5: RSRP and RS-SINR minimum requirements are specified assuming independent interference and noise at each receiver antenna port.</p> <p>Note 6: E-UTRA operating band groups are as defined in Section 3.5.</p> | | | | | | | | | |

A.9.13.4.3 Test Requirements

The RS-SINR measurement accuracy shall fulfil the requirements in Sections 9.1.17.3.

A.9.13.5 FDD—TDD Inter frequency case

A.9.13.5.1 Test Purpose and Environment

The purpose of this test is to verify that the RS-SINR measurement accuracy is within the specified limits. This test will verify the requirements in Sections 9.1.17.3.

A.9.13.5.2 Test parameters

In this set of test cases the two cells are on different carrier frequencies. Both absolute and relative accuracy of RS-SINR inter frequency measurements are tested by using the parameters in Table A.9.13.5.2-1. In all test cases, Cell 1 is the PCell and Cell 2 is the target cell. Cell 1 is FDD cell and Cell 2 is TDD cell. The inter frequency measurements are supported by a measurement gap.

Table A.9.13.5.2-1: RS-SINR FDD—TDD Inter frequency test parameters (FDD Cell1)

| Parameter | | Unit | Test 1 | Test 2 | Test 2 |
|---|--------------------------------------|------------|----------|----------|----------|
| | | | Cell 1 | Cell 1 | Cell 1 |
| E-UTRA RF Channel Number | | | 2 | 2 | 2 |
| BW _{channel} | | MHz | 10 | 10 | 10 |
| Gap Pattern Id | | | 0 | 0 | 0 |
| Measurement bandwidth | | n_{PRB} | 22—27 | 22—27 | 22—27 |
| PDSCH Reference measurement channel defined in A.3.1.1.1 | | | R.0 FDD | R.0 FDD | R.0 FDD |
| PDSCH allocation | | n_{PRB} | 13—36 | 13—36 | 13—36 |
| PDCCH/PCFICH/PHICH Reference measurement channel defined in A.3.1.2.1 | | | R.6 FDD | R.6 FDD | R.6 FDD |
| OCNG Patterns defined in A.3.2.1.1 (OP.1 FDD) | | | OP.1 FDD | OP.1 FDD | OP.1 FDD |
| PBCH_RA | | dB | 0 | 0 | 0 |
| PBCH_RB | | | | | |
| PSS_RA | | | | | |
| SSS_RA | | | | | |
| PCFICH_RB | | | | | |
| PHICH_RA | | | | | |
| PHICH_RB | | | | | |
| PDCCH_RA | | | | | |
| PDCCH_RB | | | | | |
| PDSCH_RA | | | | | |
| PDSCH_RB | | | | | |
| OCNG_RA ^{Note1} | | | | | |
| OCNG_RB ^{Note1} | | | | | |
| N_{oc} ^{Note2} | Bands FDD_A ^{Note 8} | | | | |
| | Bands FDD_B | -119 | | | |
| | Bands FDD_C | -118.5 | | | |
| | Bands FDD_D | -118 | | | |
| | Bands FDD_E, FDD_F ^{Note 5} | -117.5 | | | |
| | Bands FDD_G ^{Note 7} | -116.5 | | | |
| | Bands FDD_H | -116 | | | |
| CRS \hat{E}_s / I_{ot} | | dB | -1.75 | 20 | -4.0 |
| RSRP ^{Note3} | Bands FDD_A ^{Note 8} | dBm/15 kHz | -81.75 | -88.50 | -123.5 |
| | Bands FDD_B | | | | -123 |
| | Bands FDD_C | | | | -122.5 |
| | Bands FDD_D | | | | -122 |
| | Bands FDD_E, FDD_F ^{Note 5} | | | | -121.5 |

| | | | | | |
|--|---|-----------|-------|--------|--------|
| | Bands FDD_G Note 7 | | | | -120.5 |
| | Bands FDD_H | | | | -120 |
| RS-SINR ^{Note3} | Bands FDD_A Note 8 | dB | -1.75 | 20 | -4.0 |
| | Bands FDD_B | | | | |
| | Bands FDD_C | | | | |
| | Bands FDD_D | | | | |
| | Bands FDD_E, FDD_F ^{Note 5} | | | | |
| | Bands FDD_G Note 7 | | | | |
| | Bands FDD_H | | | | |
| I _o ^{Note3} | Bands FDD_A Note 8 | dBm/9 MHz | -50 | -60.68 | -90.26 |
| | Bands FDD_B | | | | -89.76 |
| | Bands FDD_C | | | | -89.26 |
| | Bands FDD_D | | | | -88.76 |
| | Bands FDD_E, FDD_F ^{Note 5} | | | | -88.26 |
| | Bands FDD_G Note 7 | | | | -87.26 |
| | Bands FDD_H | | | | -86.76 |
| CRS \hat{E}_s/N_{oc} | | dB | -1.75 | 20 | -4.0 |
| Propagation condition | | - | | AWGN | AWGN |
| <p>Note 1: OCNG shall be used such that both cells are fully allocated and a constant total transmitted power spectral density is achieved for all OFDM symbols.</p> <p>Note 2: Interference from other cells and noise sources not specified in the test is assumed to be constant over subcarriers and time and shall be modelled as AWGN of appropriate power for N_{oc} to be fulfilled.</p> <p>Note 3: RS-SINR, RSRP and I_o levels have been derived from other parameters for information purposes. They are not settable parameters themselves.</p> <p>Note 4: RSRP and RS-SINR minimum requirements are specified assuming independent interference and noise at each receiver antenna port.</p> <p>Note 5: For Band 26, the tests shall be performed with the carrier frequency of the assigned E-UTRA channel bandwidth within 865-894 MHz.</p> <p>Note 6: E-UTRA operating band groups are as defined in Section 3.5.</p> <p>Note 7: Except Band 29.</p> <p>Note 8: Except Band 32.</p> | | | | | |

Table A.9.13.5.2-2: RS-SINR FDD—TDD Inter frequency test parameters (TDD cell2)

| Parameter | Unit | Test 1 | Test 2 | Test 3 |
|---|-----------|----------|----------|----------|
| | | Cell 2 | Cell 2 | Cell 2 |
| E-UTRA RF Channel Number | | 2 | 2 | 2 |
| BW _{channel} | MHz | 10 | 10 | 10 |
| Gap Pattern Id | | - | - | - |
| Special subframe configuration Note1 | | 6 | 6 | 6 |
| Uplink-downlink configuration ^{Note1} | | 1 | 1 | 1 |
| Measurement bandwidth | n_{PRB} | 22—27 | 22—27 | 22—27 |
| PDSCH Reference measurement channel | | - | - | - |
| PDSCH allocation | n_{PRB} | - | - | - |
| PDCCH/PCFICH/PHICH Reference measurement channel defined in A.3.1.2.2 | | R.6 TDD | R.6 TDD | R.6 TDD |
| OCNG Patterns defined in A.3.2.2.2 (OP.2 TDD) | | OP.2 TDD | OP.2 TDD | OP.2 TDD |
| PBCH_RA | dB | 0 | 0 | 0 |
| PBCH_RB | | | | |
| PSS_RA | | | | |

| | | | | | |
|---|-------------|------------|--------|---------|---------|
| SSS_RA | | | | | |
| PCFICH_RB | | | | | |
| PHICH_RA | | | | | |
| PHICH_RB | | | | | |
| PDCCH_RA | | | | | |
| PDCCH_RB | | | | | |
| PDSCH_RA | | | | | |
| PDSCH_RB | | | | | |
| OCNG_RA ^{Note2} | | | | | |
| OCNG_RB ^{Note2} | | | | | |
| N_{oc1} ^{Note3} | Bands TDD_A | dBm/15 kHz | -85 | -108.50 | -119.50 |
| | Bands TDD_C | | | | -118.50 |
| | Bands TDD_E | | | | -117.50 |
| N_{oc2} ^{Note3a} | Bands TDD_A | dBm/15 kHz | -79 | -114.50 | -113.50 |
| | Bands TDD_C | | | | -112.50 |
| | Bands TDD_E | | | | -111.50 |
| CRS \hat{E}_s/I_{ot} | dB | -1.75 | 20 | -4.0 | |
| RSRP ^{Note4} | Bands TDD_A | dBm/15 kHz | -81.75 | -88.50 | -123.50 |
| | Bands TDD_C | | | | -122.50 |
| | Bands TDD_E | | | | -121.50 |
| RS-SINR ^{Note4} | Bands TDD_A | dB | -1.75 | 20 | -4.0 |
| | Bands TDD_C | | | | |
| | Bands TDD_E | | | | |
| I_o ^{Note4} | Bands TDD_A | dBm/9 MHz | -50.79 | -60.56 | -93.48 |
| | Bands TDD_C | | | | -92.48 |
| | Bands TDD_E | | | | -91.48 |
| CRS \hat{E}_s/N_{oc} | dB | -1.75 | 20 | -4.0 | |
| Propagation condition | - | AWGN | AWGN | AWGN | |
| <p>Note 1: For special subframe and uplink-downlink configurations see Tables 4.2-1 and 4.2-2 in TS 36.211.</p> <p>Note 2: OCNG shall be used such that both cells are fully allocated and a constant total transmitted power spectral density is achieved for all OFDM symbols.</p> <p>Note 3: Interference from other cells and noise sources not specified in the test is assumed to be constant over CRS subcarriers and time and shall be modelled as AWGN of appropriate power for N_{oc1} to be fulfilled.</p> <p>Note 3a: Interference from other cells and noise sources not specified in the test is assumed to be constant over subcarriers other than CRS subcarriers and time and shall be modelled as AWGN of appropriate power for N_{oc2} to be fulfilled.</p> <p>Note 4: RS-SINR, RSRP and I_o levels have been derived from other parameters for information purposes. They are not settable parameters themselves.</p> <p>Note 5: RSRP and RS-SINR minimum requirements are specified assuming independent interference and noise at each receiver antenna port.</p> <p>Note 6: E-UTRA operating band groups are as defined in Section 3.5.</p> | | | | | |

A.9.13.5.3 Test Requirements

The RS-SINR measurement accuracy shall fulfil the requirements in Sections 9.1.17.3.

A.9.13.6 TDD—FDD Inter frequency case

A.9.13.6.1 Test Purpose and Environment

The purpose of this test is to verify that the RS-SINR measurement accuracy is within the specified limits. This test will verify the requirements in Sections 9.1.17.3.

A.9.13.6.2 Test parameters

In this set of test cases the two cells are on different carrier frequencies. Both absolute and relative accuracy of RS-SINR inter frequency measurements are tested by using the parameters in Table A.9.13.6.2-1. In all test cases, Cell 1 is

the PCell and Cell 2 is the target cell. Cell 1 is TDD cell and Cell 2 is FDD cell. The inter frequency measurements are supported by a measurement gap.

Table A.9.13.6.2-1: RS-SINR TDD—FDD Inter frequency test parameters (TDD cell1)

| Parameter | Unit | Test 1 | Test 2 | Test 3 | | | | | |
|---|-------------|------------|----------|----------|-------------|------------|-----|---------|---------|
| | | Cell 2 | Cell 2 | Cell 2 | | | | | |
| E-UTRA RF Channel Number | | 2 | 2 | 2 | | | | | |
| BW _{channel} | MHz | 10 | 10 | 10 | | | | | |
| Gap Pattern Id | | - | - | - | | | | | |
| Special subframe configuration <small>Note1</small> | | 6 | 6 | 6 | | | | | |
| Uplink-downlink configuration ^{Note1} | | 1 | 1 | 1 | | | | | |
| Measurement bandwidth | n_{PRB} | 22—27 | 22—27 | 22—27 | | | | | |
| PDSCH Reference measurement channel | | - | - | - | | | | | |
| PDSCH allocation | n_{PRB} | - | - | - | | | | | |
| PDCCH/PCFICH/PHICH Reference measurement channel defined in A.3.1.2.2 | | R.6 TDD | R.6 TDD | R.6 TDD | | | | | |
| OCNG Patterns defined in A.3.2.2.2 (OP.2 TDD) | | OP.2 TDD | OP.2 TDD | OP.2 TDD | | | | | |
| PBCH_RA | dB | 0 | 0 | 0 | | | | | |
| PBCH_RB | | | | | | | | | |
| PSS_RA | | | | | | | | | |
| SSS_RA | | | | | | | | | |
| PCFICH_RB | | | | | | | | | |
| PHICH_RA | | | | | | | | | |
| PHICH_RB | | | | | | | | | |
| PDCCH_RA | | | | | | | | | |
| PDCCH_RB | | | | | | | | | |
| PDSCH_RA | | | | | | | | | |
| PDSCH_RB | | | | | | | | | |
| OCNG_RA ^{Note2} | | | | | | | | | |
| OCNG_RB ^{Note2} | | | | | | | | | |
| N_{oc} ^{Note3} | | | | | Bands TDD_A | dBm/15 kHz | -80 | -108.50 | -119.50 |
| | | | | | Bands TDD_C | | | | -118.50 |
| | Bands TDD_E | -117.50 | | | | | | | |
| CRS \hat{E}_s/I_{ot} | dB | -1.75 | 20 | -4.0 | | | | | |
| RSRP ^{Note4} | Bands TDD_A | dBm/15 kHz | -81.75 | -88.50 | -123.50 | | | | |
| | Bands TDD_C | | | | -122.50 | | | | |
| | Bands TDD_E | | | | -121.50 | | | | |
| RS-SINR ^{Note4} | Bands TDD_A | dB | -1.75 | 20 | -4.0 | | | | |
| | Bands TDD_C | | | | | | | | |
| | Bands TDD_E | | | | | | | | |
| I _o ^{Note4} | Bands TDD_A | dBm/9 MHz | -50 | -60.68 | -90.26 | | | | |
| | Bands TDD_C | | | | -89.26 | | | | |
| | Bands TDD_E | | | | -88.26 | | | | |
| CRS \hat{E}_s/N_{oc} | dB | -1.75 | 20 | -4.0 | | | | | |
| Propagation condition | - | AWGN | AWGN | AWGN | | | | | |
| <p>Note 1: For special subframe and uplink-downlink configurations see Tables 4.2-1 and 4.2-2 in TS 36.211.</p> <p>Note 2: OCNG shall be used such that both cells are fully allocated and a constant total transmitted power spectral density is achieved for all OFDM symbols.</p> <p>Note 3: Interference from other cells and noise sources not specified in the test is assumed to be constant over subcarriers and time and shall be modelled as AWGN of appropriate power for N_{oc} to be fulfilled.</p> <p>Note 4: RS-SINR, RSRP and I_o levels have been derived from other parameters for information purposes. They are not settable parameters themselves.</p> <p>Note 5: RSRP and RS-SINR minimum requirements are specified assuming independent interference and noise at each receiver antenna port.</p> <p>Note 6: E-UTRA operating band groups are as defined in Section 3.5.</p> | | | | | | | | | |

Table A.9.13.6.2-2: RS-SINR TDD—FDD Inter frequency test parameters (FDD Cell2)

| Parameter | | Unit | Test 1 | Test 2 | Test 2 |
|---|--------------------------------------|------------|----------|----------|----------|
| | | | Cell 1 | Cell 1 | Cell 1 |
| E-UTRA RF Channel Number | | | 2 | 2 | 2 |
| BW _{channel} | | MHz | 10 | 10 | 10 |
| Gap Pattern Id | | | 0 | 0 | 0 |
| Measurement bandwidth | | n_{PRB} | 22—27 | 22—27 | 22—27 |
| PDSCH Reference measurement channel defined in A.3.1.1.1 | | | R.0 FDD | R.0 FDD | R.0 FDD |
| PDSCH allocation | | n_{PRB} | 13—36 | 13—36 | 13—36 |
| PDCCH/PCFICH/PHICH Reference measurement channel defined in A.3.1.2.1 | | | R.6 FDD | R.6 FDD | R.6 FDD |
| OCNG Patterns defined in A.3.2.1.1 (OP.1 FDD) | | | OP.1 FDD | OP.1 FDD | OP.1 FDD |
| PBCH_RA | | dB | 0 | 0 | 0 |
| PBCH_RB | | | | | |
| PSS_RA | | | | | |
| SSS_RA | | | | | |
| PCFICH_RB | | | | | |
| PHICH_RA | | | | | |
| PHICH_RB | | | | | |
| PDCCH_RA | | | | | |
| PDCCH_RB | | | | | |
| PDSCH_RA | | | | | |
| PDSCH_RB | | | | | |
| OCNG_RA ^{Note1} | | | | | |
| OCNG_RB ^{Note1} | | | | | |
| N_{oc1} ^{Note2} | Bands FDD_A ^{Note 8} | | | | |
| | Bands FDD_B | -119 | | | |
| | Bands FDD_C | -118.5 | | | |
| | Bands FDD_D | -118 | | | |
| | Bands FDD_E, FDD_F ^{Note 5} | -117.5 | | | |
| | Bands FDD_G ^{Note 7} | -116.5 | | | |
| | Bands FDD_H | -116 | | | |
| N_{oc2} ^{Note2a} | Bands FDD_A ^{Note 8} | dBm/15 kHz | -79 | -114.5 | -113.5 |
| | Bands FDD_B | | | | -113 |
| | Bands FDD_C | | | | -112.5 |
| | Bands FDD_D | | | | -112 |
| | Bands FDD_E, FDD_F ^{Note 5} | | | | -111.5 |
| | Bands FDD_G ^{Note 7} | | | | -110.5 |
| | Bands FDD_H | | | | -110 |
| CRS \hat{E}_s/I_{ot} | | dB | -1.75 | 20 | -4.0 |
| RSRP ^{Note3} | Bands FDD_A ^{Note 8} | dBm/15 kHz | -86.75 | -88.50 | -123.5 |
| | Bands FDD_B | | | | -123 |
| | Bands FDD_C | | | | -122.5 |
| | Bands FDD_D | | | | -122 |
| | Bands FDD_E, FDD_F ^{Note 5} | | | | -121.5 |
| | Bands FDD_G ^{Note 7} | | | | -120.5 |
| | Bands FDD_H | | | | -120 |
| RS-SINR ^{Note3} | Bands FDD_A ^{Note 8} | dB | -1.75 | 20 | -4.0 |
| | Bands FDD_B | | | | |

| | | | | | |
|---|---|-----------|--------|--------|--------|
| | Bands FDD_C | | | | |
| | Bands FDD_D | | | | |
| | Bands FDD_E, FDD_F ^{Note 5} | | | | |
| | Bands FDD_G ^{Note 7} | | | | |
| | Bands FDD_H | | | | |
| I _o ^{Note3} | Bands FDD_A ^{Note 8} | dBm/9 MHz | -50.79 | -60.56 | -93.48 |
| | Bands FDD_B | | | | -92.98 |
| | Bands FDD_C | | | | -92.48 |
| | Bands FDD_D | | | | -91.98 |
| | Bands FDD_E, FDD_F ^{Note 5} | | | | -91.48 |
| | Bands FDD_G ^{Note 7} | | | | -90.48 |
| | Bands FDD_H | | | | -89.98 |
| CRS \hat{E}_s/N_{oc1} | dB | -1.75 | 20 | -4.0 | |
| Propagation condition | - | AWGN | AWGN | AWGN | |
| <p>Note 1: OCNG shall be used such that both cells are fully allocated and a constant total transmitted power spectral density is achieved for all OFDM symbols.</p> <p>Note 2: Interference from other cells and noise sources not specified in the test is assumed to be constant over CRS subcarriers and time and shall be modelled as AWGN of appropriate power for N_{oc1} to be fulfilled.</p> <p>Note 2a: Interference from other cells and noise sources not specified in the test is assumed to be constant over subcarriers other than CRS subcarriers and time and shall be modelled as AWGN of appropriate power for N_{oc2} to be fulfilled.</p> <p>Note 3: RS-SINR, RSRP and I_o levels have been derived from other parameters for information purposes. They are not settable parameters themselves.</p> <p>Note 4: RSRP and RS-SINR minimum requirements are specified assuming independent interference and noise at each receiver antenna port.</p> <p>Note 5: For Band 26, the tests shall be performed with the carrier frequency of the assigned E-UTRA channel bandwidth within 865-894 MHz.</p> <p>Note 6: E-UTRA operating band groups are as defined in Section 3.5.</p> <p>Note 7: Except Band 29.</p> <p>Note 8: Except Band 32.</p> | | | | | |

A.9.13.6.3 Test Requirements

The RS-SINR measurement accuracy shall fulfil the requirements in Sections 9.1.17.3.

A.10 Proximity-based Services in Any Cell Selection State

A.10.1 E-UTRAN FDD – UE ProSe Direct Communication Transmission Timing Accuracy Test

A.10.1.1 Test Purpose and Environment

The purpose of this test is to verify the timing requirements for ProSe Direct Communication transmissions in Any Cell Selection state defined in clause 11.2.

For this test, the UE is triggered by the test loop function or the upper layers to transmit for ProSe Direct Communication.

The test parameters are given in Table A.10.1.1-1 below. There is no serving cell and one active SyncRef UE in this test. The test system shall emulate the SyncRef UE to transmit SLSS and MIB-SL every synchronization period.

The test system will configure the ProSe UE to transmit SLSS in each period (40ms) by configuring *syncTxThreshOoC* as +infinity in the pre-configured parameters. The ProSe UE is expected to synchronize to the SyncRef UE and transmit its own SLSS and SL-MIB in accordance to the procedure specified in clause 5.10.7.3 of TS 36.331.

The transmit timing is verified using the transmission timing of SLSS transmissions.

Table A.10.1.1-1: Test parameters for ProSe Transmission Timig Accuracy test for E-UTRAN FDD

| Parameter | | Unit | Value | Comment |
|--|--|------------|--|---|
| E-UTRA RF Channel Number | | | 1 | |
| Channel Bandwidth (BW_{channel}) | | MHz | 5 or 10 | According to principle defined in clause A.3.12.3 |
| Active cell | | | None | |
| Active SyncRef UE | | | SyncRef UE 1 | Transmitting SLSS+MIB-SL on uplink of RF channel number 1 |
| ProSe Direct Communication preconfiguration | | | As specified in Table A.3.12.5-2 (Configuration #2) | IE values unless specified otherwise in this test. |
| syncTxThreshOoC | | | 11 (+infinity) | |
| N_{oc} | | dBm/15 kHz | -98 | |
| SyncRef UE 1 | syncCP-Len | | Normal | |
| | syncOffsetIndicator | | Set same as <i>syncOffsetIndicator1</i> in ProSe Direct Communication preconfiguration | |
| | sllsid | | 30 | |
| | inCoverage | | TRUE | In MIB-SL |
| | networkControlledSyncTx | | ON | |
| | ProSe Direct Communication resource pool configuration | | As specified in Table A.3.12.5-1 (Configuration #1) | IE values unless specified otherwise in this test; Note resource pool is same as Configuration #2 used by ProSe UE. |
| | \hat{E}_s/N_{oc} | | 3 | |
| | S-RSRP <small>Note1, Note 2</small> | | -95 | |
| Propagation condition | | | AWGN | |
| Note 1: RSRP levels have been derived from other parameters for information purposes. They are not settable parameters themselves. | | | | |
| Note 2: SSSS Es/lot is set the same as PSSS/PSBCH Es/lot. | | | | |

A.10.1.2 Test Requirements

For parameters specified in Tables A.10.1.1-1, the timing accuracy for ProSe Direct Communication transmissions shall be within the limits defined in clause 11.2.2. The timing accuracy is verified using SLSS transmissions.

Prior to start of test, test system is required to ensure that the ProSe UE is synchronozed to the SyncRef UE 1 and is transmitting SLSS + MIB-SL as derived from the SLSS + MIB-SL of SyncRef UE 1 as per clause 5.10.7.3 of TS 36.331. For the test configuration, the SLSSID used by the ProSe UE shall be 30 with *inCoverage* IE in MIB-SL set as FALSE.

The following sequence of events shall be used to verify that the requirements are met.

For 5MHz or 10MHz channel bandwith, the test sequence shall be carried out in Any Cell Selection state.

- After the ProSe UE is synchronized to SyncRef UE 1, the test system shall verify that the ProSe UE SLSS transmission timing offset is within $\pm 24 \times T_S$ with respect to the first detected path (in time) of the corresponding frame of SyncRef UE 1.
- The test system adjusts the transmit timing of SyncRef UE 1 by $+24 \times T_S$ compared to that in (a). The test system shall wait for at least one SLSS period (40ms) before verifying the requirement again in (c).

- c) The test system shall verify that the UE SLSS transmission timing offset stays within $\pm 24 \times T_s$ with respect to the first detected path (in time) of the corresponding frame of SyncRef UE 1.

A.10.2 E-UTRAN FDD – Initiation/Cease of SLSS Transmission with ProSe Direct Communication

A.10.2.1 Test Purpose and Environment

The purpose of this test is to verify the requirements related to the evaluation time allowed to initiate and cease SLSS transmissions in Any Cell Selection state defined in clause 11.3.

For this test, the UE is triggered by the test loop function or the upper layers to transmit for ProSe Direct Communication.

The test parameters are given in Table A. X.2.1-1 and Table A.10.2.1-2 below. There are no active cells in this test. There is one active SyncRef UE (SyncRef UE 1) in this test. The test system shall emulate SyncRef UE 1 to transmit SLSS and MIB-SL every synchronization period.

Prior to start of test, test system is required to ensure that the ProSe UE is synchronized to the SyncRef UE 1 and is transmitting SLSS + MIB-SL as derived from the SLSS + MIB-SL of SyncRef UE 1 as per clause 5.10.7.3 of TS 36.331. For the test configuration, the SLSSID used by the ProSe UE shall be 30 with *inCoverage* IE in MIB-SL set as FALSE.

The test consists of three successive time periods, with time duration of T1, T2 and T3 respectively. During T1, the S-RSRP of SyncRef UE 1 is above *syncTxThreshOoC* and the UE is not expected to be transmitting SLSS. During T2, the S-RSRP of SyncRef UE 1 is lowered below *syncTxThreshOoC* and the UE is expected to initiate SLSS transmissions. During T3, the S-RSRP of SyncRef UE 1 is increased back to be above *syncTxThreshOoC* and the UE is expected to cease SLSS transmissions.

Table A.10.2.1-1: Test parameters for initiation/cease of SLSS transmissions test for E-UTRAN FDD

| Parameter | Unit | Value | Comment |
|---|------------|---|---|
| E-UTRA RF Channel Number | | 1 | |
| Channel Bandwidth ($BW_{channel}$) | MHz | 5 or 10 | According to principle defined in clause A.3.12.3 |
| Active cell | | None | |
| Active SyncRef UE | | SyncRef UE 1 | Transmitting SLSS+MIB-SL on uplink of RF channel number 1 |
| ProSe Direct Communication preconfiguration | | As specified in Table A.3.12.5-2 (Configuration #2) | IE values unless specified otherwise in this test. |
| <i>syncTxThreshOoC</i> | dBm/15 kHz | -95 | |
| T1 | s | 3 | |
| T2 | s | 5.24 | |
| T3 | s | 5.24 | |

Table A.10.2.1-2: SyncRef UE specific test parameters for initiation/cease of SLSS transmissions test for E-UTRAN FDD

| Parameter | Unit | SyncRef UE 1 | | |
|--|------|---|----|----|
| | | T1 | T2 | T3 |
| E-UTRA RF Channel Number | | 1 | | |
| $BW_{channel}$ ^{Note 4} | MHz | 5 or 10 | | |
| ProSe Direct Communication resource pool configuration | | As specified in Table A.3.12.5-1 (Configuration #1) Note resource pool is same as Configuration #2 used by ProSe UE. | | |
| <i>syncOffsetIndicator</i> | | Set same as <i>syncOffsetIndicator1</i> in ProSe Direct Communication preconfiguration | | |
| <i>slssid</i> | | 30 | | |

| | | | | |
|------------------------------------|--|-------|-------|-------|
| inCoverage | | TRUE | | |
| networkControlledSyncTx | | ON | | |
| N_{oc} <small>Note1</small> | dBm/15 kHz | -96 | | |
| \hat{E}_s / N_{oc} | dB | 5.5 | -3.5 | 5.5 |
| S-RSRP <small>Note2, Note3</small> | dBm/15 kHz | -90.5 | -99.5 | -90.5 |
| Propagation Condition | | AWGN | | |
| Note 1: | Interference from other cells and noise sources not specified in the test is assumed to be constant over subcarriers and time and shall be modelled as AWGN of appropriate power for N_{oc} to be fulfilled. | | | |
| Note 2: | RSRP levels have been derived from other parameters for information purposes. They are not settable parameters themselves. | | | |
| Note 3: | SSSS Es/lot is set the same as PSSS/PSBCH Es/lot. | | | |
| Note 4: | This test is according to the principle defined in section A.3.12.3. | | | |

A.10.2.2 Test Requirements

The SLSS transmission initiation delay is defined as the time from the beginning of time period T2 up to the moment when the UE initiates the SLSS transmission.

The SLSS transmission initiation delay shall be less than 0.84 s.

The SLSS transmission cease delay is defined as the time from the beginning of time period T3 up to the moment when the UE ceases the SLSS transmission.

The SLSS transmission cease delay shall be less than 0.84 s.

The rate of correct initiation/cease delay of SLSS transmissions observed during repeated tests shall be at least 90%.

NOTE: The initiation/cease delay of SLSS transmissions can be expressed as: $T_{\text{evaluate,SLSS}} + \text{SLSS period}$,

Where:

$T_{\text{evaluate,SLSS}}$ is the evaluation time for initiate/cease of SLSS, and is 0.8 sec (clause 11.3.2) for the parameters in this test;

SLSS period is set as 40ms in this test.

A.10.3 E-UTRAN FDD – SyncRef UE Selection / Reselection Test

A.10.3.1 Test Purpose and Environment

The purpose of this test is to verify the requirements related to SyncRef UE selection / reselection in Any Cell Selection state defined in clause 11.5.

For this test, the UE is triggered by the test loop function or the upper layers to transmit for ProSe Direct Communication.

The test parameters are given in Table A. X.3.1-1 and Table A.10.3.1-2 below. There are no active cells in this test. There are two active SyncRef UEs (SyncRef UE 1 and SyncRef UE 2) in this test. The test system shall emulate SyncRef UE 1 and SyncRef UE 2 to transmit SLSS and MIB-SL every SLSS period (40ms).

The test system can verify the selection / reselection of SyncRef UE by monitoring the SLSS ID used by the ProSe UE for its SLSS+MIB-SL transmissions. When the ProSe UE is not synchronized to any SyncRef UE, then the ProSe UE shall use the SLSS ID pre-configured in the ProSe UE. When the ProSe UE is synchronized to a SyncRef UE, the ProSe UE shall derive its SLSS ID from the SLSS ID of the SyncRef UE as per clause 5.10.7.3 of TS 36.331.

The test consists of three successive time periods, with time duration of T1, T2 and T3 respectively. During T1, both SyncRef UE 1 and SyncRef UE 2 are powered off and the ProSe UE is expected to transmit SLSS as an independent synchronization source. During T1, SyncRef UE 1 is powered ON and the ProSe UE will select SyncRef UE 1 as the

synchronization source. During T2, a higher priority SyncRef UE 2 is additionally powered ON and the ProSe UE will reselect to the higher priority SyncRef UE 2 as the synchronization source.

Table A.10.3.1-1: Test parameters for SyncRef UE selection/reselection test for E-UTRAN FDD

| Parameter | | Unit | Value | Comment |
|---|-------------------------------|------|---|--|
| Initial condition | Active synchronization source | | Independent synchronization source | UE transmits for ProSe Direct Communication and SLSS+MIB-SL with some random SLSS ID and in-coverage set as FALSE in MIB-SL. |
| T2 end condition | Active synchronization source | | Sync Ref UE 1 | UE transmits for ProSe Direct Communication and SLSS+MIB-SL with SLSS ID = 168+59 and in-coverage set as FALSE in MIB-SL. |
| Final condition | Active synchronization source | | Sync Ref UE 2 | UE transmits for ProSe Direct Communication and SLSS+MIB-SL with SLSS ID = 30 and in-coverage set as FALSE in MIB-SL. |
| E-UTRA RF Channel Number | | | 1 | |
| Channel Bandwidth (BW_{channel}) | | MHz | 5 or 10 | According to principle defined in clause A.3.12.3 |
| Active cell | | | None | |
| Active SyncRef UEs | | | SyncRef UE 1 SyncRef UE 2 | Transmitting SLSS+MIB-SL on uplink of RF channel number 1 |
| Timing offset between SyncRef UE 1 and SyncRef UE 2 | | ms | 3 | Asynchronous |
| Frequency offset of SyncRef UE 1 | | ppm | 0 | |
| Frequency offset of SyncRef UE 2 | | ppm | 5 | |
| ProSe Direct Communication preconfiguration | | | As specified in Table A.3.12.5-2 (Configuration #2) | IE values unless specified otherwise in this test. |
| syncTxThreshOoC | | | 11 (+infinity) | |
| T1 | | s | 24 | |
| T2 | | s | 24 | |
| T3 | | s | 24 | |

Table A.10.3.1-2: SyncRef UE specific test parameters for SyncRef UE selection/reselection test for E-UTRAN FDD

| Parameter | Unit | SyncRef UE 1 | | | SyncRef UE 2 | | |
|--|------------|---|-----|------|---|-----------|-------|
| | | T1 | T2 | T3 | T1 | T2 | T3 |
| E-UTRA RF Channel Number | | 1 | | | | | |
| BW_{channel} ^{Note 4} | MHz | 5 or 10 | | | | | |
| ProSe Direct Communication resource pool configuration | | As specified in Table A.3.12.5-2 (Configuration #2) | | | As specified in Table A.3.12.5-1 (Configuration #1) | | |
| networkControlledSyncTx | | N/A | | | ON | | |
| syncTxThreshOoC | dBm/15 kHz | +infinity | | | N/A | | |
| slssid | | 59 | | | 30 | | |
| inCoverage (in MIB-SL) | | FALSE | | | TRUE | | |
| syncOffsetIndicator | | syncOffsetIndicator2 | | | syncOffsetIndicator1 | | |
| N_{oc} ^{Note 1} | dBm/15 kHz | -98 | | | | | |
| \hat{E}_s/N_{oc} | dB | -infinity | 16 | 16 | -infinity | -infinity | 13 |
| \hat{E}_s/I_{ot} | dB | -infinity | 16 | 2.79 | -infinity | -infinity | -3.11 |
| S-RSRP ^{Note 2, Note 3} | dBm/15 kHz | -infinity | -82 | -82 | -infinity | -infinity | -85 |
| Propagation Condition | | AWGN | | | | | |

| | |
|---------|--|
| Note 1: | Interference from other cells and noise sources not specified in the test is assumed to be constant over subcarriers and time and shall be modelled as AWGN of appropriate power for N_{oc} to be fulfilled. |
| Note 2: | RSRP levels have been derived from other parameters for information purposes. They are not settable parameters themselves. |
| Note 3: | SSSS Es/lot is set the same as PSSS/PSBCH Es/lot. |
| Note 4: | This test is according to the principle defined in section A.3.12.3. |

A.10.3.2 Test Requirements

SyncRef UE selection delay is defined as the time from the beginning of T2 to the time UE is synchronized to SyncRef UE 1 and changes its SLSS transmissions timing and SLSS ID to follow SyncRef UE 1 as the synchronization source. For the test configuration, the SLSS ID will be changed to 168+59 (with in-coverage IE in MIB-SL set to FALSE) after SyncRef UE selection delay from start of T2.

The SyncRef UE selection delay shall be less than 20.84sec.

SyncRef UE reselection delay is defined as the time from the beginning of T3 to the time UE changes its synchronization source from SyncRef UE 1 to SyncRef UE 2, and changes its SLSS transmissions timing and SLSS ID to follow SyncRef UE 2 as the synchronization source. For the test configuration, the SLSS ID will be changed to 30 (with in-coverage IE in MIB-SL set to FALSE) after SyncRef UE selection delay from start of T3.

The SyncRef UE reselection delay shall be less than 20.84sec.

The rate of correct SyncRef UE selection / reselection observed during repeated tests shall be at least 90%.

The test system will verify that the ProSe UE does not drop or delay more than 2% of its SLSS transmissions during the duration of T1, T2, and T3.

The SyncRef UE selection/reselection delay can be expressed as:

$$\text{SyncRef UE selection/reselection delay} = T_{\text{detect,SyncRef UE}} + T_{\text{evaluate,SLSS}} + \text{SLSS period}$$

Where

- $T_{\text{detect,SyncRef UE}} = 20\text{sec}$ (as specified in sub-clause 11.5.2.2)
- $T_{\text{evaluate,SLSS}} = 0.8$ (as specified in sub-clause 11.3.2)
- SLSS period = 40ms

This gives a total of 20.84 seconds.

A.10.4 E-UTRAN FDD – Cell Identification on downlink frequency associated with ProSe frequency (when UE is transmitting for ProSe)

A.10.4.1 Test Purpose and Environment

The purpose of this test is to verify cell identification delay requirement for a newly detectable cell on the downlink frequency associated with the pre-configured ProSe carrier frequency in Any Cell Selection state. This test will verify the requirements in clause 11.4 when the UE is transmitting for ProSe.

For this test, the UE is triggered by the test loop function or the upper layers to transmit for ProSe Direct Communication.

The test parameters are given in Table A. 10.4.1-1, Table A. 10.4.1-2, and Table A.10.4.1-3 below. There is one active cell (Cell 1) and active SyncRef UE (SyncRef UE 1) in this test. The test system shall emulate SyncRef UE 1 to transmit SLSS and MIB-SL every SLSS period (40ms).

The test consists of two successive time periods, with time duration of T1 and T2 respectively. During T1, the cell is powered OFF and the ProSe UE is synchronized to SyncRef UE 1. During T2, the cell is powered ON and the ProSe UE will detect the cell and attempt to camp on the cell.

Prior to start of test, test system is required to ensure that the ProSe UE is synchronizd to the SyncRef UE 1 and is transmitting SLSS + MIB-SL as derived from the SLSS + MIB-SL of SyncRef UE 1 as per clause 5.10.7.3 of TS 36.331. For the test configuration, the SLSSID used by the ProSe UE shall be 30 with *inCoverage* IE in MIB-SL set as FALSE.

Table A.10.4.1-1: Test parameters for cell identification test on on downlink frequency associated with ProSe frequency for E-UTRAN FDD (when UE is transmitting for ProSe)

| Parameter | | Unit | Value | Comment |
|---|-------------------------------|------|---|---|
| Initial condition | Active synchronization source | | Sync Ref UE 1 | |
| Final condition | Active synchronization source | | Cell1 | |
| E-UTRA RF Channel Number | | | 1 | |
| Channel Bandwidth ($BW_{channel}$) | | MHz | 5 or 10 | According to principle defined in clause A.3.12.3 |
| Active cell | | | Cell1 | |
| Active SyncRef UEs | | | SyncRef UE 1 | Transmitting SLSS+MIB-SL on uplink of RF channel number 1 |
| ProSe Direct Communication preconfiguration | | | As specified in Table A.3.12.5-2 (Configuration #2) | IE values unless specified otherwise in this test. |
| syncTxThreshOoC | | | 11 (+infinity) | |
| T1 | | s | 2 | |
| T2 | | s | 30 | |

Table A.10.4.1-2: Cell specific test parameters for cell identification test on on downlink frequency associated with ProSe frequency for E-UTRAN FDD (when UE is transmitting for ProSe)

| Parameter | Unit | Cell 1 | |
|--|------------|--------------------------------------|------|
| | | T1 | T2 |
| E-UTRA RF Channel Number | | 1 | |
| $BW_{channel}$ ^{Note 4} | MHz | 5 or 10 | |
| OCNG Patterns defined in A.3.2.1.2 ^{Note 4} | | 5 MHz: OP.16 FDD 10 MHz: OP.2 FDD | |
| PBCH_RA | dB | 0 | |
| PBCH_RB | | | |
| PSS_RA | | | |
| SSS_RA | | | |
| PCFICH_RB | | | |
| PHICH_RA | | | |
| PHICH_RB | | | |
| PDCCH_RA | | | |
| PDCCH_RB | | | |
| PDSCH_RA | | | |
| PDSCH_RB | | | |
| OCNG_RA ^{Note 1} | | | |
| OCNG_RB ^{Note 1} | | | |
| N_{oc} ^{Note 2} | dBm/15 kHz | -98 | |
| \hat{E}_s / N_{oc} | dB | -infinity | -3 |
| RSRP ^{Note 3} | dBm/15 kHz | -infinity | -101 |
| SCH_RP ^{Note 3} | dBm/15 kHz | -infinity | -101 |
| Propagation Condition | | AWGN | |

| | |
|---------|--|
| Note 1: | OCNG shall be used such that cell is fully allocated and a constant total transmitted power spectral density is achieved for all OFDM symbols. |
| Note 2: | Interference from other cells and noise sources not specified in the test is assumed to be constant over subcarriers and time and shall be modelled as AWGN of appropriate power for N_{oc} to be fulfilled. |
| Note 3: | RSRP levels have been derived from other parameters for information purposes. They are not settable parameters themselves. |
| Note 4: | This test is according to the principle defined in section A.3.12.3. |

Table A.10.4.1-3: SyncRef UE specific test parameters for cell identification test on on downlink frequency associated with ProSe frequency for E-UTRAN FDD

| Parameter | Unit | SyncRef UE 1 | |
|--|--|---|----|
| | | T1 | T2 |
| E-UTRA RF Channel Number | | 1 (Uplink) | |
| $BW_{channel}$ ^{Note 4} | MHz | 5 or 10 | |
| ProSe Direct Communication resource pool configuration | | As specified in Table A.3.12.5-1 (Configuration #1) | |
| networkControlledSyncTx | | ON | |
| slssid | | 30 | |
| inCoverage (in MIB-SL) | | TRUE | |
| syncOffsetIndicator | | syncOffsetIndicator1 | |
| N_{oc} ^{Note1} | dBm/15 kHz | -98 | |
| \hat{E}_s / N_{oc} | dB | 13 | |
| S-RSRP ^{Note2, Note3} | dBm/15 kHz | -85 | |
| Propagation Condition | | AWGN | |
| Note 1: | Interference from other cells and noise sources not specified in the test is assumed to be constant over subcarriers and time and shall be modelled as AWGN of appropriate power for N_{oc} to be fulfilled. | | |
| Note 2: | RSRP levels have been derived from other parameters for information purposes. They are not settable parameters themselves. | | |
| Note 3: | SSSS Es/lot is set the same as PSSS/PSBCH Es/lot. | | |
| Note 4: | This test is according to the principle defined in section A.3.12.3. | | |

A.10.4.2 Test Requirements

The cell selection delay to a newly detectable cell on the downlink associated with the preconfigured ProSe carrier is defined as the time from the beginning of T2 to the time UE camps on the cell and starts to send preambles on the PRACH for sending the RRC CONNECTION REQUEST.

The cell selection delay to a newly detectable cell on the downlink associated with the preconfigured ProSe carrier shall be less than 7.68 s.

The cell selection delay can be expressed as $T_{\text{basic_identify_OoC_ProSe Tx_ON}} + T_{\text{SI}}$, where

- $T_{\text{basic_identify_OoC_ProSe Tx_ON}} = 6.4\text{sec}$ as specified in sub-clause 11.4.2.2
- T_{SI} = Maximum repetition period of relevant system info blocks that needs to be received by the UE to camp on a cell; 1280 ms is assumed in this test case

This gives a total of 7.68 sec.

Annex B (normative):

Conditions for RRM requirements applicability for operating bands

B.1 Conditions for E-UTRAN RRC_IDLE state mobility

B.1.1 Conditions for measurements of intra-frequency E-UTRAN cells for cell re-selection

This clause defines the E-UTRAN intra-frequency RSRP, RSRP $\hat{E}s/Iot$, SCH_RP and SCH $\hat{E}s/Iot$ applicable for a corresponding operating band.

The conditions for measurements of intra-frequency E-UTRAN cells for cell re-selection are defined in Table B.1.1-1.

Table B.1.1-1: Conditions for measurements of intra-frequency E-UTRAN cells for cell re-selection

| Parameter | E-UTRA operating band groups ^{Note 3} | Minimum RSRP ^{Note 1} | Minimum SCH_RP ^{Note 1} | RSRP $\hat{E}s/Iot$ | SCH $\hat{E}s/Iot$ |
|------------|--|--------------------------------|----------------------------------|---------------------|--------------------|
| | | dBm/15kHz | dBm/15kHz | dB | dB |
| Conditions | FDD_A, TDD_A | -124 | -124 | ≥ -4 | ≥ -4 |
| | FDD_B | -123.5 | -123.5 | | |
| | FDD_C, TDD_C | -123 | -123 | | |
| | FDD_D | -122.5 | -122.5 | | |
| | FDD_E, TDD_E | -122 | -122 | | |
| | FDD_F | -121.5 ^{Note 2} | -121.5 ^{Note 2} | | |
| | FDD_G | -121 | -121 | | |
| | FDD_H | -120.5 | -120.5 | | |
| | FDD_N | -117.5 | -117.5 | | |

NOTE 1: This condition level is increased by $\Delta > 0$, when applicable, as described in Section B.4.2.
NOTE 2: The condition is -122 dBm/15kHz when the carrier frequency of the assigned E-UTRA channel bandwidth is within 865-894 MHz.
NOTE 3: E-UTRA operating band groups are as defined in Section 3.5.

B.1.2 Conditions for measurements of inter-frequency E-UTRAN cells for cell re-selection

This clause defines the E-UTRAN inter-frequency RSRP, RSRP $\hat{E}s/Iot$, SCH_RP and SCH $\hat{E}s/Iot$ applicable for a corresponding operating band.

The conditions for measurements of intra-frequency E-UTRAN cells for cell re-selection defined in Table B.1.1-1 also apply for inter-frequency E-UTRAN cells in this section.

B.1.3 Conditions for measurements of intra-frequency E-UTRAN cells for cell re-selection for UE Category M1

This clause defines the E-UTRAN intra-frequency RSRP, RSRP $\hat{E}s/Iot$, SCH_RP and SCH $\hat{E}s/Iot$ applicable for a corresponding operating band. The UE category M1 applicability of the conditions in Appendix B.1.3 is defined in Section 3.1.

The conditions for normal coverage measurements of FDD and TDD intra-frequency E-UTRAN cells for cell re-selection are defined in Table B.1.3-1 and for E-UTRAN HD-FDD are defined in Table B.1.3-2.

The conditions for enhanced coverage measurements of FDD and TDD intra-frequency E-UTRAN cells for cell re-selection are defined in Table B.1.3-3 and for E-UTRAN HD-FDD are defined in Table B.1.3-4.

Table B.1.3-1: E-UTRAN intra-frequency measurements for FDD and TDD for normal coverage

| Parameter | E-UTRA operating band groups ^{Note 3} | Minimum RSRP ^{Note 1} | Minimum SCH_RP ^{Note 1} | RSRP \hat{E}_s/lot | SCH \hat{E}_s/lot |
|------------|--|--------------------------------|----------------------------------|-----------------------------|----------------------------|
| | | dBm/15kHz | dBm/15kHz | dB | dB |
| Conditions | FDD-M1_A, TDD-M1_A | -125 | -125 | ≥ -6 | ≥ -6 |
| | FDD-M1_D | -123.5 | -123.5 | | |
| | FDD-M1_E, TDD-M1_E | -123 | -123 | | |
| | FDD-M1_F | -122.5 ^{Note 2} | -122.5 ^{Note 2} | | |
| | FDD-M1_G | -122 | -122 | | |
| | FDD-M1_N | -118.5 | -118.5 | | |

NOTE 1: This condition level is increased by $\Delta > 0$, when applicable, as described in Sections B.4.2.
NOTE 2: The condition is -125 dBm/15kHz when the carrier frequency of the assigned E-UTRA channel bandwidth is within 865-894 MHz.
NOTE 3: E-UTRA operating band groups are as defined in Section 3.5.

Table B.1.3-2: E-UTRAN intra-frequency measurements for HD-FDD for normal coverage

| Parameter | E-UTRA operating band groups ^{Note 3} | Minimum RSRP ^{Note 1} | Minimum SCH_RP ^{Note 1} | RSRP \hat{E}_s/lot | SCH \hat{E}_s/lot |
|------------|--|--------------------------------|----------------------------------|-----------------------------|----------------------------|
| | | dBm/15kHz | dBm/15kHz | dB | dB |
| Conditions | FDD-M1_A | -125 | -125 | ≥ -6 | ≥ -6 |
| | FDD-M1_D | -123.5 | -123.5 | | |
| | FDD-M1_E | -123 | -123 | | |
| | FDD-M1_F | -122.5 ^{Note 2} | -122.5 ^{Note 2} | | |
| | FDD-M1_G | -122 | -122 | | |
| | FDD-M1_N | -118.5 | -118.5 | | |

NOTE 1: This condition level is increased by $\Delta > 0$, when applicable, as described in Sections B.4.2.
NOTE 2: The condition is -125 dBm/15kHz when the carrier frequency of the assigned E-UTRA channel bandwidth is within 865-894 MHz.
NOTE 3: E-UTRA operating band groups are as defined in Section 3.5.

Table B.1.3-3: E-UTRAN intra-frequency measurements for FDD and TDD for enhanced coverage

| Parameter | E-UTRA operating band groups ^{Note 3} | Minimum RSRP ^{Note 1} | Minimum SCH_RP ^{Note 1} | RSRP \hat{E}_s/lot | SCH \hat{E}_s/lot |
|------------|--|--------------------------------|----------------------------------|-----------------------------|----------------------------|
| | | dBm/15kHz | dBm/15kHz | dB | dB |
| Conditions | FDD-M1_A, TDD-M1_A | -135 | -135 | ≥ -15 | ≥ -15 |
| | FDD-M1_D | -133.5 | -133.5 | | |
| | FDD-M1_E, TDD-M1_E | -133 | -133 | | |
| | FDD-M1_F | -132.5 ^{Note 2} | -132.5 ^{Note 2} | | |
| | FDD-M1_G | -132 | -132 | | |
| | FDD-M1_N | -128.5 | -128.5 | | |

NOTE 1: This condition level is increased by $\Delta > 0$, when applicable, as described in Sections B.4.2.
NOTE 2: The condition is -125 dBm/15kHz when the carrier frequency of the assigned E-UTRA channel bandwidth is within 865-894 MHz.
NOTE 3: E-UTRA operating band groups are as defined in Section 3.5.

Table B.1.3-4: E-UTRAN intra-frequency measurements for HD-FDD for enhanced coverage

| Parameter | E-UTRA operating band groups ^{Note 3} | Minimum RSRP ^{Note 1} | Minimum SCH_RP ^{Note 1} | RSRP \hat{E}_s/lot | SCH \hat{E}_s/lot |
|------------|--|--------------------------------|----------------------------------|-----------------------------|----------------------------|
| | | dBm/15kHz | dBm/15kHz | dB | dB |
| Conditions | FDD-M1_A | -135 | -135 | ≥ -15 | ≥ -15 |
| | FDD-M1_D | -133.5 | -133.5 | | |
| | FDD-M1_E | -133 | -133 | | |

| | | | | |
|--|----------|--------------------------|--------------------------|--|
| | FDD-M1_F | -132.5 ^{Note 2} | -132.5 ^{Note 2} | |
| | FDD-M1_G | -132 | -132 | |
| | FDD-M1_N | -128.5 | -128.5 | |
| NOTE 1: This condition level is increased by $\Delta > 0$, when applicable, as described in Sections B.4.2. | | | | |
| NOTE 2: The condition is -125 dBm/15kHz when the carrier frequency of the assigned E-UTRA channel bandwidth is within 865-894 MHz. | | | | |
| NOTE 3: E-UTRA operating band groups are as defined in Section 3.5. | | | | |

B.1.4 Conditions for measurements of intra-frequency NB-IoT cells for cell re-selection for UE Category NB1

This clause defines the NB-IoT intra-frequency NRSRP, NRSRP \hat{E}_s/I_{ot} , NSCH_RP and NSCH \hat{E}_s/I_{ot} applicable for a corresponding operating band. The UE category NB1 applicability of the conditions in Appendix B.1.4 is defined in Section 3.6.

The conditions for measurements of intra-frequency NB-IoT cells in normal coverage for cell re-selection are defined in Table B.1.4-1.

The conditions for measurements of intra-frequency NB-IoT cells in enhanced coverage for cell re-selection are defined in Table B.1.4-2.

Table B.1.4-1: NB-IoT intra-frequency measurements for HD-FDD in normal coverage

| Parameter | E-UTRA operating band groups ^{Note 1} | Minimum NRSRP | Minimum NSCH_RP | NRS \hat{E}_s/I_{ot} | NSCH \hat{E}_s/I_{ot} |
|------------|--|---------------|-----------------|------------------------|-------------------------|
| | | dBm/15kHz | dBm/15kHz | dB | dB |
| Conditions | NFDD_G | -129 | -129 | ≥ -6 | ≥ -6 |

NOTE 1: E-UTRA operating band groups are as defined in Section 3.5.

Table B.1.4-2: NB-IoT intra-frequency measurements for HD-FDD in enhanced coverage

| Parameter | E-UTRA operating band groups ^{Note 1} | Minimum NRSRP | Minimum NSCH_RP | NRS \hat{E}_s/I_{ot} | NSCH \hat{E}_s/I_{ot} |
|------------|--|---------------|-----------------|------------------------|-------------------------|
| | | dBm/15kHz | dBm/15kHz | dB | dB |
| Conditions | NFDD_G | -138 | -138 | ≥ -15 | ≥ -15 |

NOTE 1: E-UTRA operating band groups are as defined in Section 3.5.

B.1.5 Conditions for measurements of inter-frequency NB-IoT cells for cell re-selection for UE Category NB1

This clause defines the NB-IoT inter-frequency NRSRP, NRSRP \hat{E}_s/I_{ot} , NSCH_RP and NSCH \hat{E}_s/I_{ot} applicable for a corresponding operating band. The UE category NB1 applicability of the conditions in Appendix B.1.5 is defined in Section 3.6.

The conditions for measurements of intra-frequency NB-IoT cells in normal coverage for cell re-selection defined in Table B.1.4-1 also apply for inter-frequency NB-IoT cells in normal coverage in this section.

The conditions for measurements of intra-frequency NB-IoT cells in enhanced coverage for cell re-selection defined in Table B.1.4-2 also apply for inter-frequency NB-IoT cells in enhanced coverage in this section.

B.2 Conditions for UE Measurements Procedures in RRC_CONNECTED State

B.2.1 Conditions for E-UTRAN intra-frequency measurements

This clause defines the E-UTRAN intra-frequency SCH_{RP} and SCH Ês/Iot applicable for a corresponding operating band.

The conditions for intra-frequency E-UTRAN measurements are defined in Table B.2.1-1.

Table B.2.1-1: E-UTRAN intra-frequency measurements

| Parameter | E-UTRA operating band groups ^{Note 3} | Minimum SCH _{RP} ^{Note 1} | SCH Ês/Iot |
|------------|--|---|------------|
| | | dBm/15kHz | dB |
| Conditions | FDD_A, TDD_A | -127 | ≥ -6 |
| | FDD_B | -126.5 | |
| | FDD_C, TDD_C | -126 | |
| | FDD_D | -125.5 | |
| | FDD_E, TDD_E | -125 | |
| | FDD_F | -124.5 ^{Note 2} | |
| | FDD_G | -124 | |
| | FDD_H | -123.5 | |
| | FDD_N | -120.5 | |

NOTE 1: This condition level is increased by $\Delta > 0$, when applicable, as described in Sections B.4.2.
NOTE 2: The condition is -125 dBm/15kHz when the carrier frequency of the assigned E-UTRA channel bandwidth is within 865-894 MHz.
NOTE 3: E-UTRA operating band groups are as defined in Section 3.5.

B.2.2 Conditions for E-UTRAN intra-frequency measurements with autonomous gaps

This clause defines the E-UTRAN intra-frequency SCH_{RP} and SCH Ês/Iot applicable for a corresponding operating band.

The conditions for intra-frequency E-UTRAN measurements with autonomous gap are as in Table B.2.1-1.

Table B.2.2-1: Void

B.2.3 Conditions for E-UTRAN inter-frequency measurements

This clause defines the E-UTRAN inter-frequency SCH_{RP}, SCH Ês/Iot, RSRP and RSRP Ês/Iot applicable for a corresponding operating band.

The conditions for inter-frequency E-UTRAN measurements with autonomous gap are defined in Table B.2.3-1.

Table B.2.3-1: E-UTRAN inter-frequency measurements

| Parameter | E-UTRA operating band groups ^{Note 3} | Minimum RSRP ^{Note 1} | Minimum SCH _{RP} ^{Note 1} | RSRP Ês/Iot | SCH Ês/Iot |
|------------|--|--------------------------------|---|-------------|------------|
| | | dBm/15kHz | dBm/15kHz | dB | dB |
| Conditions | FDD_A, TDD_A | -125 | -125 | ≥ -4 | ≥ -4 |
| | FDD_B | -124.5 | -124.5 | | |
| | FDD_C, TDD_C | -124 | -124 | | |
| | FDD_D | -123.5 | -123.5 | | |

| | | |
|--------------|--------------------------|--------------------------|
| FDD_E, TDD_E | -123 | -123 |
| FDD_F | -122.5 ^{Note 2} | -122.5 ^{Note 2} |
| FDD_G | -122 | -122 |
| FDD_H | -121.5 | -121.5 |
| FDD_N | -118.5 | -118.5 |

NOTE 1: This condition level is increased by $\Delta > 0$, when applicable, as described in Sections B.4.2 and B.4.3.
NOTE 2: The condition is -123 dBm/15kHz when the carrier frequency of the assigned E-UTRA channel bandwidth is within 865-894 MHz.
NOTE 3: E-UTRA operating band groups are as defined in Section 3.5.

B.2.4 Conditions for E-UTRAN inter-frequency measurements with autonomous gaps

This clause defines the E-UTRAN inter-frequency SCH_RP and SCH Ês/Iot applicable for a corresponding operating band.

The conditions for inter-frequency E-UTRAN measurements with autonomous gap are defined in Table B.2.4-1.

Table B.2.4-1: E-UTRAN inter-frequency measurements with autonomous gaps

| Parameter | E-UTRA operating band groups ^{Note 3} | Minimum SCH_RP ^{Note 1} | SCH Ês/Iot |
|------------|--|----------------------------------|------------|
| | | dBm/15kHz | dB |
| Conditions | FDD_A, TDD_A | -125 | ≥ -4 |
| | FDD_B | -124.5 | |
| | FDD_C, TDD_C | -124 | |
| | FDD_D | -123.5 | |
| | FDD_E, TDD_E | -123 | |
| | FDD_F | -122.5 ^{Note 2} | |
| | FDD_G | -122 | |
| | FDD_H | -121.5 | |
| | FDD_N | -118.5 | |

NOTE 1: This condition level is increased by $\Delta > 0$, when applicable, as described in Sections B.4.2 and B.4.3.
NOTE 2: The condition is -123 dBm/15kHz when the carrier frequency of the assigned E-UTRA channel bandwidth is within 865-894 MHz.
NOTE 3: E-UTRA operating band groups are as defined in Section 3.5.

B.2.5 Conditions for E-UTRAN OTDOA intra-frequency RSTD Measurements

This clause defines the E-UTRAN intra-frequency PRP1,2 applicable for a corresponding operating band

The conditions for E-UTRAN OTDOA intra-frequency RSTD measurements are defined in Table B.2.5-1

Table B.2.5-1: E-UTRAN OTDOA intra-frequency RSTD measurements

| Parameter | E-UTRA operating band groups ^{Note 3} | Minimum PRP1,2 ^{Note 1} |
|------------|--|----------------------------------|
| | | dBm/15kHz |
| Conditions | FDD_A, TDD_A | -127 |
| | FDD_B | -126.5 |
| | FDD_C, TDD_C | -126 |
| | FDD_D | -125.5 |
| | FDD_E, TDD_E | -125 |
| | FDD_F | -124.5 ^{Note 2} |
| | FDD_G | -124 |
| | FDD_H | -123.5 |
| | FDD_N | -120.5 |

NOTE 1: This condition level is increased by $\Delta > 0$, when applicable, as described in Sections B.4.2 and B.4.3.

NOTE 2: The condition is -125 dBm/15kHz when the carrier frequency of the assigned E-UTRA channel bandwidth is within 865-894 MHz.

NOTE 3: E-UTRA operating band groups are as defined in Section 3.5.

B.2.6 Conditions for E-UTRAN OTDOA inter-frequency RSTD Measurements

This clause defines the E-UTRAN inter-frequency PRP_{1,2} applicable for a corresponding operating band.

The conditions for E-UTRAN OTDOA inter-frequency RSTD measurements are defined in Table B.2.5-1.

B.2.7 Conditions for Measurements of the secondary component carrier with deactivated SCell

This clause defines the SCH_{RP} and SCH Ês/Iot for measurements in the secondary component carrier applicable for a corresponding operating band.

The conditions for measurements of the secondary component carrier with deactivated SCell are defined in Table B.2.7-1.

Table B.2.7-1: Measurements of the secondary component carrier with deactivated SCell

| Parameter | E-UTRA operating band groups ^{Note 3} | Minimum SCH _{RP} ^{Note 1} | SCH Ês/Iot |
|--|--|---|------------|
| | | dBm/15kHz | dB |
| Conditions | FDD_A, TDD_A | -127 | ≥ -6 |
| | FDD_B | -126.5 | |
| | FDD_C, TDD_C | -126 | |
| | FDD_D | -125.5 | |
| | FDD_E, TDD_E | -125 | |
| | FDD_F | -124.5 ^{Note 2} | |
| | FDD_G | -124 | |
| | FDD_H | -123.5 | |
| | FDD_N | -120.5 | |
| NOTE 1: This condition level is increased by Δ>0, when applicable, as described in Sections B.4.2 and B.4.3. | | | |
| NOTE 2: The condition is -125 dBm/15kHz when the carrier frequency of the assigned E-UTRA channel bandwidth is within 865-894 MHz. | | | |
| NOTE 3: E-UTRA operating band groups are as defined in Section 3.5. | | | |

B.2.8 Conditions for E-UTRAN Intra-Frequency Measurements under Time Domain Measurement Resource Restriction

This clause defines the E-UTRAN intra-frequency SCH_{RP} and SCH Ês/Iot applicable for a corresponding operating band.

The conditions for intra-frequency E-UTRAN measurements under time domain measurement resource restriction are defined in Table B.2.8-1.

Table B.2.8-1: E-UTRAN intra-frequency measurements under time domain measurement resource restriction

| Parameter | E-UTRA operating band groups ^{Note 3} | Minimum SCH _{RP} ^{Note 1} | SCH Ês/Iot |
|------------|--|---|------------|
| | | dBm/15kHz | dB |
| Conditions | FDD_A, TDD_A | -127 | ≥ -7.5 |
| | FDD_B | -126.5 | |
| | FDD_C, TDD_C | -126 | |

| | |
|--------------|--------------------------|
| FDD_D | -125.5 |
| FDD_E, TDD_E | -125 |
| FDD_F | -124.5 ^{Note 2} |
| FDD_G | -124 |
| FDD_H | -123.5 |
| FDD_N | -120.5 |

NOTE 1: This condition level is increased by $\Delta > 0$, when applicable, as described in Sections B.4.2 and B.4.3.
NOTE 2: The condition is -125 dBm/15kHz when the carrier frequency of the assigned E-UTRA channel bandwidth is within 865-894 MHz.
NOTE 3: E-UTRA operating band groups are as defined in Section 3.5.

B.2.9 Conditions for E-UTRAN Intra-Frequency Measurements under Time Domain Measurement Resource Restriction with CRS Assistance Information

This clause defines the E-UTRAN intra-frequency SCH_{RP} and SCH Ês/Iot applicable for a corresponding operating band.

The conditions for intra-frequency E-UTRAN measurements under time domain measurement resource restriction with CRS assistance information are defined in Table B.2.9-1.

Table B.2.9-1: E-UTRAN intra-frequency measurements under time domain measurement resource restriction with CRS assistance information

| Parameter | E-UTRA operating band groups ^{Note 3} | Minimum SCH _{RP} ^{Note 1} | SCH Ês/Iot |
|------------|--|---|------------|
| | | dBm/15kHz | dB |
| Conditions | FDD_A, TDD_A | -127 | ≥ -11.07 |
| | FDD_B | -126.5 | |
| | FDD_C, TDD_C | -126 | |
| | FDD_D | -125.5 | |
| | FDD_E, TDD_E | -125 | |
| | FDD_F | -124.5 ^{Note 2} | |
| | FDD_G | -124 | |
| | FDD_H | -123.5 | |
| | FDD_N | -120.5 | |

NOTE 1: This condition level is increased by $\Delta > 0$, when applicable, as described in Sections B.4.2 and B.4.3.
NOTE 2: The condition is -125 dBm/15kHz when the carrier frequency of the assigned E-UTRA channel bandwidth is within 865-894 MHz.
NOTE 3: E-UTRA operating band groups are as defined in Section 3.5.

B.2.10 Conditions for E-UTRAN intra-frequency discovery signal measurements

B.2.10.1 Conditions for E-UTRAN intra-frequency CRS-based measurements

This clause defines the E-UTRAN intra-frequency SCH_{RP}, SCH Ês/Iot in discovery signal occasions [16], applicable for a corresponding operating band for CRS based discovery signal measurements

The conditions for E-UTRAN intra-frequency CRS based discovery signal measurements are as in Table B.2.1-1.

B.2.10.2 Conditions for E-UTRAN intra-frequency CSI-RS based measurements

This clause defines the E-UTRAN intra-frequency SCH_{RP}, SCH Ês/Iot, CSI-RSRP, and CSI-RS Ês/Iot in discovery signal occasions [16], applicable for a corresponding operating band for CSI-RS based discovery signal measurements.

The conditions for E-UTRAN intra-frequency CRI-RS based discovery signal measurements in discovery signal occasions are specified in Table B.2.10.2-1.

Table B.2.10.2-1: E-UTRAN intra-frequency discovery signal measurements

| Parameter | E-UTRA operating band groups ^{Note 3} | Minimum CSI-RSRP ^{Note 1} | Minimum SCH_RP ^{Note 1} | CSI-RS \hat{E}_s/lot | SCH \hat{E}_s/lot |
|--|--|------------------------------------|----------------------------------|-------------------------------|----------------------------|
| | | dBm/15kHz | dBm/15kHz | dB | dB |
| Conditions | FDD_A, TDD_A | -121 | -127 | ≥ 0 | ≥ -6 |
| | FDD_B | -120.5 | -126.5 | | |
| | FDD_C, TDD_C | -120 | -126 | | |
| | FDD_D | -119.5 | -125.5 | | |
| | FDD_E, TDD_E | -119 | -125 | | |
| | FDD_F | -118.5 ^{Note 2} | -124.5 ^{Note 2} | | |
| | FDD_G | -118 | -124 | | |
| | FDD_H | -117.5 | -123.5 | | |
| | FDD_N | -114.5 | -120.5 | | |
| NOTE 1: This condition level is increased by $\Delta > 0$, when applicable, as described in Sections B.4.2 and B.4.3. | | | | | |
| NOTE 2: The condition is -123 dBm/15kHz when the carrier frequency of the assigned E-UTRA channel bandwidth is within 865-894 MHz. | | | | | |
| NOTE 3: E-UTRA operating band groups are as defined in Section 3.5. | | | | | |

B.2.11 Conditions for E-UTRAN inter-frequency discovery signal measurements

B.2.11.1 Conditions for E-UTRAN inter-frequency CRS-based measurements

This clause defines the E-UTRAN inter-frequency SCH_RP, SCH \hat{E}_s/lot , RSRP, and \hat{E}_s/lot in discovery signal occasions [16], applicable for a corresponding operating band for CRS based discovery signal measurements.

The conditions for E-UTRAN inter-frequency CRS-based discovery signal measurements in discovery signal occasions are specified in Table B.2.11.1-1.

Table B.2.11.1-1: E-UTRAN inter-frequency discovery signal measurements

| Parameter | E-UTRA operating band groups ^{Note 3} | Minimum RSRP ^{Note 1} | Minimum SCH_RP ^{Note 1} | RSRP \hat{E}_s/lot | SCH \hat{E}_s/lot |
|--|--|--------------------------------|----------------------------------|-----------------------------|----------------------------|
| | | dBm/15kHz | dBm/15kHz | dB | dB |
| Conditions | FDD_A, TDD_A | -125 | -125 | ≥ -6 | ≥ -6 |
| | FDD_B | -124.5 | -124.5 | | |
| | FDD_C, TDD_C | -124 | -124 | | |
| | FDD_D | -123.5 | -123.5 | | |
| | FDD_E, TDD_E | -123 | -123 | | |
| | FDD_F | -122.5 ^{Note 2} | -122.5 ^{Note 2} | | |
| | FDD_G | -122 | -122 | | |
| | FDD_H | -121.5 | -121.5 | | |
| | FDD_N | -118.5 | -118.5 | | |
| NOTE 1: This condition level is increased by $\Delta > 0$, when applicable, as described in Sections B.4.2 and B.4.3. | | | | | |
| NOTE 2: The condition is -123 dBm/15kHz when the carrier frequency of the assigned E-UTRA channel bandwidth is within 865-894 MHz. | | | | | |
| NOTE 3: E-UTRA operating band groups are as defined in Section 3.5. | | | | | |

B.2.11.2 Conditions for E-UTRAN inter-frequency CSI-RS based measurements

This clause defines the E-UTRAN inter-frequency SCH_RP, SCH \hat{E}_s/lot , CSI-RSRP, and CSI-RS \hat{E}_s/lot in discovery signal occasions [16], applicable for a corresponding operating band for CSI-RS based discovery signal measurements.

The conditions for E-UTRAN inter-frequency CRS-based discovery signal measurements in discovery signal occasions are specified in Table B.2.11.2-1.

Table B.2.11.2-1: E-UTRAN inter-frequency discovery signal measurements

| Parameter | E-UTRA operating band groups ^{Note 3} | Minimum CSI-RSRP ^{Note 1} | Minimum SCH_RP ^{Note 1} | CSI-RS \bar{E}_s/lot | SCH \bar{E}_s/lot |
|------------|--|------------------------------------|----------------------------------|-------------------------------|----------------------------|
| | | dBm/15kHz | dBm/15kHz | dB | dB |
| Conditions | FDD_A, TDD_A | -119 | -125 | ≥ 0 | ≥ -6 |
| | FDD_B | -118.5 | -124.5 | | |
| | FDD_C, TDD_C | -118 | -124 | | |
| | FDD_D | -117.5 | -123.5 | | |
| | FDD_E, TDD_E | -117 | -123 | | |
| | FDD_F | -116.5 ^{Note 2} | -122.5 ^{Note 2} | | |
| | FDD_G | -116 | -122 | | |
| | FDD_H | -115.5 | -121.5 | | |
| | FDD_N | -112.5 | -118.5 | | |

NOTE 1: This condition level is increased by $\Delta > 0$, when applicable, as described in Sections B.4.2 and B.4.3.
NOTE 2: The condition is -123 dBm/15kHz when the carrier frequency of the assigned E-UTRA channel bandwidth is within 865-894 MHz.
NOTE 3: E-UTRA operating band groups are as defined in Section 3.5.

B.2.12 Conditions for E-UTRAN intra-frequency discovery signal measurements under operation with frame structure 3

This section defines the E-UTRAN intra-frequency SCH_RP in discovery signal occasions [16], applicable for a corresponding operating band for discovery signal measurements under frame structure type 3.

The conditions for E-UTRAN intra-frequency discovery signal measurements are defined in Table B.2.12-1.

Table B.2.12-1: E-UTRAN intra-frequency measurements under operation with frame structure 3

| Parameter | E-UTRA operating band groups ^{Note 2} | Minimum SCH_RP ^{Note 1} |
|------------|--|----------------------------------|
| | | dBm/15kHz |
| Conditions | FS3_G | -124 |

NOTE 1: This condition level is increased by $\Delta > 0$, when applicable, as described in Sections B.4.2.
NOTE 2: E-UTRA operating band groups are as defined in Section 3.5.

B.2.13 Conditions for E-UTRAN inter-frequency discovery signal measurements under operation with frame structure 3

B.2.13.1 Conditions for E-UTRAN inter-frequency CRS-based measurements

This section defines the E-UTRAN inter-frequency SCH_RP in discovery signal occasions [16], applicable for a corresponding operating band for CRS based discovery signal measurements under frame structure 3.

The conditions for E-UTRAN inter-frequency CRS-based discovery signal measurements in discovery signal occasions are specified in Table B.2.13.1-1.

Table B.2.13.1-1: E-UTRAN inter-frequency discovery signal measurements

| Parameter | E-UTRA operating band groups ^{Note 2} | Minimum SCH_RP ^{Note 1} |
|------------|--|----------------------------------|
| | | dBm/15kHz |
| Conditions | FS3_G | -124 |

NOTE 1: This condition level is increased by $\Delta > 0$, when applicable, as described in Sections B.4.2.
NOTE 2: E-UTRA operating band groups are as defined in Section 3.5.

B.2.13.2 Conditions for E-UTRAN inter-frequency CSI-RS based measurements

This section defines the E-UTRAN inter-frequency SCH_{RP} in discovery signal occasions [16], applicable for a corresponding operating band for CSI-RS based discovery signal measurements.

The conditions for E-UTRAN inter-frequency CSI-RS based discovery signal measurements in discovery signal occasions under frame structure 3 are specified in Table B.2.13.2-1.

Table B.2.13.2-1: E-UTRAN inter-frequency discovery signal measurements

| Parameter | E-UTRA operating band groups ^{Note 2} | Minimum SCH _{RP} ^{Note 1} |
|--|--|---|
| | | dBm/15kHz |
| Conditions | FS3_G | -124 |
| NOTE 1: This condition level is increased by $\Delta > 0$, when applicable, as described in Sections B.4.2. | | |
| NOTE 2: E-UTRA operating band groups are as defined in Section 3.5. | | |

B.2.14 Conditions for E-UTRAN intra-frequency measurements by UE Category M1

This clause defines the E-UTRAN intra-frequency SCH_{RP} and SCH \hat{E}_s/I_{ot} applicable for a corresponding operating band. The UE category M1 applicability of the conditions in Appendix B.2.14 is defined in Section 3.1.

The conditions for CE mode A intra-frequency E-UTRAN FDD and TDD measurements are defined in Table B.2.14-1 and for E-UTRAN HD-FDD measurements are defined in Table B.2.14-2.

The conditions for CE mode B for intra-frequency E-UTRAN FDD and TDD measurements are defined in Table B.2.14-3 and for E-UTRAN HD-FDD measurements are defined in Table B.2.14-4.

Table B.2.14-1: E-UTRAN intra-frequency measurements for FDD and TDD for CE mode A

| Parameter | E-UTRA operating band groups ^{Note 3} | Minimum SCH _{RP} ^{Note 1} | SCH \hat{E}_s/I_{ot} |
|--|--|---|------------------------|
| | | dBm/15kHz | dB |
| Conditions | FDD-M1_A, TDD-M1_A | -127 | ≥ -6 |
| | FDD-M1_D | -125.5 | |
| | FDD-M1_E, TDD-M1_E | -125 | |
| | FDD-M1_F | -124.5 ^{Note 2} | |
| | FDD-M1_G | -124 | |
| | FDD-M1_N | -120.5 | |
| NOTE 1: This condition level is increased by $\Delta > 0$, when applicable, as described in Sections B.4.2. | | | |
| NOTE 2: The condition is -125 dBm/15kHz when the carrier frequency of the assigned E-UTRA channel bandwidth is within 865-894 MHz. | | | |
| NOTE 3: E-UTRA operating band groups are as defined in Section 3.5. | | | |

Table B.2.14-2: E-UTRAN intra-frequency measurements for HD-FDD for CE mode A

| Parameter | E-UTRA operating band groups ^{Note 3} | Minimum SCH _{RP} ^{Note 1} | SCH \hat{E}_s/I_{ot} |
|------------|--|---|------------------------|
| | | dBm/15kHz | dB |
| Conditions | FDD-M1_A, | -127 | ≥ -6 |
| | FDD-M1_D | -125.5 | |
| | FDD-M1_E | -125 | |
| | FDD-M1_F | -124.5 ^{Note 2} | |
| | FDD-M1_G | -124 | |

| | | | |
|--|----------|--------|--|
| | FDD-M1_N | -120.5 | |
| NOTE 1: This condition level is increased by $\Delta > 0$, when applicable, as described in Sections B.4.2. | | | |
| NOTE 2: The condition is -125 dBm/15kHz when the carrier frequency of the assigned E-UTRA channel bandwidth is within 865-894 MHz. | | | |
| NOTE 3: E-UTRA operating band groups are as defined in Section 3.5. | | | |

Table B.2.14-3: E-UTRAN intra-frequency measurements for FDD and TDD for CE mode B

| Parameter | E-UTRA operating band groups ^{Note 3} | Minimum SCH_RP ^{Note 1} | SCH Ês/lot |
|--|--|----------------------------------|------------|
| | | dBm/15kHz | dB |
| Conditions | FDD-M1_A, TDD-M1_A | -136 | ≥ -15 |
| | FDD-M1_D | -134.5 | |
| | FDD-M1_E, TDD-M1_E | -134 | |
| | FDD-M1_F | -133.5 ^{Note 2} | |
| | FDD-M1_G | -133 | |
| | FDD-M1_N | -129.5 | |
| NOTE 1: This condition level is increased by $\Delta > 0$, when applicable, as described in Sections B.4.2. | | | |
| NOTE 2: The condition is -125 dBm/15kHz when the carrier frequency of the assigned E-UTRA channel bandwidth is within 865-894 MHz. | | | |
| NOTE 3: E-UTRA operating band groups are as defined in Section 3.5. | | | |

Table B.2.14-4: E-UTRAN intra-frequency measurements for HD-FDD for CE mode B

| Parameter | E-UTRA operating band groups ^{Note 3} | Minimum SCH_RP ^{Note 1} | SCH Ês/lot |
|--|--|----------------------------------|------------|
| | | dBm/15kHz | dB |
| Conditions | FDD-M1_A, | -136 | ≥ -15 |
| | FDD-M1_D | -134.5 | |
| | FDD-M1_E | -134 | |
| | FDD-M1_F | -133.5 ^{Note 2} | |
| | FDD-M1_G | -133 | |
| | FDD-M1_N | -129.5 | |
| NOTE 1: This condition level is increased by $\Delta > 0$, when applicable, as described in Sections B.4.2. | | | |
| NOTE 2: The condition is -125 dBm/15kHz when the carrier frequency of the assigned E-UTRA channel bandwidth is within 865-894 MHz. | | | |
| NOTE 3: E-UTRA operating band groups are as defined in Section 3.5. | | | |

B.2.15 Conditions for NB-IoT intra-frequency measurements by UE Category NB1

This clause defines the NB-IoT intra-frequency NSCH_RP and NSCH Ês/lot applicable for a corresponding operating band. The UE category NB1 applicability of the conditions in Appendix B.2.15 is defined in Section 3.6.

The conditions for intra-frequency measurements in normal coverage are defined in Table B.2.15-1.

The conditions for intra-frequency measurements in denhanced coverage are defined in Table B.2.15-2.

Table B.2.15-1: NB-IoT intra-frequency measurements for HD-FDD in normal coverage

| Parameter | E-UTRA operating band groups ^{Note 1} | Minimum NSCH_RP | NSCH Ês/lot |
|---|--|-----------------|-------------|
| | | dBm/15kHz | dB |
| Conditions | NFDD_G | -129 | ≥ -6 |
| NOTE 1: E-UTRA operating band groups are as defined in Section 3.5. | | | |

Table B.2.15-2: NB-IoT intra-frequency measurements for HD-FDD in enhanced coverage

| Parameter | E-UTRA operating band groups ^{Note 1} | Minimum NSCH_RP | SCH Ês/lot |
|------------|--|-----------------|------------|
| | | dBm/15kHz | dB |
| Conditions | NFDD_G | -138 | ≥ -15 |

NOTE 1: E-UTRA operating band groups are as defined in Section 3.5.

B.3 Conditions for measurements performance requirements for UE

B.3.1 Conditions for intra-frequency RSRP and RSRQ Accuracy Requirements

This clause defines the E-UTRAN intra-frequency RSRP applicable for a corresponding operating band.

The conditions for intra-frequency absolute RSRP and RSRQ accuracy requirements are defined in Table B.3.1-1.

Table B.3.1-1: Intra-frequency absolute RSRP and RSRQ Accuracy Requirements

| Parameter | E-UTRA operating band groups ^{Note 3} | Minimum RSRP ^{Note 1} |
|------------|--|--------------------------------|
| | | dBm/15kHz |
| Conditions | FDD_A, TDD_A | -127 |
| | FDD_B | -126.5 |
| | FDD_C, TDD_C | -126 |
| | FDD_D | -125.5 |
| | FDD_E, TDD_E | -125 |
| | FDD_F | -124.5 ^{Note 2} |
| | FDD_G | -124 |
| | FDD_H | -123.5 |
| | FDD_N | -120.5 |

NOTE 1: This condition level is increased by $\Delta > 0$, when applicable, as described in Sections B.4.2 and B.4.3.
NOTE 2: The condition is -125 dBm/15kHz when the carrier frequency of the assigned E-UTRA channel bandwidth is within 865-894 MHz.
NOTE 3: E-UTRA operating band groups are as defined in Section 3.5.

B.3.2 Void

B.3.3 Conditions for inter-frequency RSRP and RSRQ Accuracy Requirements

This clause defines the E-UTRAN inter-frequency RSRP applicable for a corresponding operating band.

The conditions for inter-frequency absolute RSRP and RSRQ accuracy requirements are defined in Table B.3.1-1.

B.3.4 Conditions for inter-frequency relative RSRP and RSRQ Accuracy Requirements

This clause defines the E-UTRAN inter-frequency RSRP_{1,2} applicable for a corresponding operating band.

The conditions for inter-frequency relative RSRP and RSRQ accuracy requirements are defined in Table B.3.8-1.

B.3.5 Conditions for UE Rx – Tx time difference

This clause defines the E-UTRAN RSRP applicable for a corresponding operating band.

The conditions for UE Rx-Tx time difference are defined in Table B.3.1-1.

B.3.6 Conditions for intra-frequency Reference Signal Time Difference (RSTD) measurements

This sections defines the E-UTRAN intra-frequency PRP applicable for a corresponding operating band.

The conditions for intra-frequency RSTD measurements are defined in Table B.2.5-1.

B.3.7 Conditions for inter-frequency RSTD measurements

This sections defines the E-UTRAN inter-frequency PRP applicable for a corresponding operating band.

The conditions for inter-frequency RSTD measurements are defined in Table B.2.5-1.

B.3.8 Conditions for Intra-Frequency Relative RSRP Accuracy Requirements

This clause defines the E-UTRAN intra-frequency RSRP_{1,2} applicable for a corresponding operating band.

The conditions for intra-frequency relative RSRP accuracy requirements are specified in Table B.3.8-1.

Table B.3.8-1: Intra-frequency relative RSRP accuracy requirements

| Parameter | E-UTRA operating band groups ^{Note 3} | Minimum RSRP _{1,2} ^{Note 1} |
|--|--|---|
| | | dBm/15kHz |
| Conditions | FDD_A, TDD_A | -127 |
| | FDD_B | -126.5 |
| | FDD_C, TDD_C | -126 |
| | FDD_D | -125.5 |
| | FDD_E, TDD_E | -125 |
| | FDD_F | -124.5 ^{Note 2} |
| | FDD_G | -124 |
| | FDD_H | -123.5 |
| | FDD_N | -120.5 |
| NOTE 1: This condition level is increased by $\Delta > 0$, when applicable, as described in Sections B.4.2 and B.4.3. | | |
| NOTE 2: The condition is -125 dBm/15kHz when the carrier frequency of the assigned E-UTRA channel bandwidth is within 865-894 MHz. | | |
| NOTE 3: E-UTRA operating band groups are as defined in Section 3.5. | | |

B.3.9 Conditions for Intra-Frequency Absolute RSRP and RSRQ Accuracy Requirements under Time Domain Measurement Resource Restriction

This clause defines the E-UTRAN intra-frequency RSRP applicable for a corresponding operating band.

The conditions for intra-frequency absolute RSRP and RSRQ accuracy requirements under time domain measurement resource restriction are as specified in Table B.3.1-1.

B.3.10 Conditions for Intra-Frequency Relative RSRP Accuracy Requirements under Time Domain Measurement Resource Restriction

This clause defines the E-UTRAN intra-frequency RSRP_{1,2} applicable for a corresponding operating band.

The conditions for intra-frequency relative RSRP accuracy requirements under time domain measurement resource restriction are defined in Table B.3.8-1.

B.3.11 Conditions for Intra-Frequency Absolute RSRP and RSRQ Accuracy Requirements under Time Domain Measurement Resource Restriction with CRS Assistance Information

This clause defines the E-UTRAN intra-frequency RSRP applicable for a corresponding operating band.

The conditions for intra-frequency absolute RSRP and RSRQ accuracy requirements under time domain measurement resource restriction with CRS assistance information are as specified in Table B.3.1-1.

B.3.12 Conditions for Intra-Frequency Relative RSRP Accuracy Requirements under Time Domain Measurement Resource Restriction with CRS Assistance Information

This clause defines the E-UTRAN intra-frequency RSRP_{1,2} applicable for a corresponding operating band.

The conditions for intra-frequency relative RSRP accuracy requirements under time domain measurement resource restriction with CRS assistance information are as specified in Table B.3.8-1.

B.3.13 Conditions for UE Rx–Tx Time Difference Measurement under Time Domain Measurement Resource Restriction with CRS Assistance Information

This clause defines the E-UTRAN RSRP applicable for a corresponding operating band.

The conditions for UE Rx-Tx time difference measurements, when time domain measurement resource restriction pattern and CRS assistance information are provided, are as defined in Table B.3.1-1.

B.3.14 Conditions for Intra-Frequency Absolute Discovery Signal Measurement Accuracy Requirements

B.3.14.1 Conditions for Intra-frequency CRS-based measurements

This clause defines the intra-frequency RSRP in discovery signal occasions [16], applicable for a corresponding operating band for CRS based discovery signal measurements.

The conditions for intra-frequency absolute RSRP and RSRQ accuracy requirements for CRS-based discovery signal measurements in discovery signal occasions are as in Table B.3.1-1

B.3.14.2 Conditions for Intra-frequency CSI-RS-based measurements

This clause defines the intra-frequency CSI-RSRP in discovery signal occasions [16], applicable for a corresponding operating band for CSI-RS based discovery signal measurements.

The conditions for intra-frequency absolute CSI-RSRP accuracy requirements for CSI-RS-based discovery signal measurements in discovery signal occasions are specified in Table B.3.14.2-1

Table B.3.14.2-1: Intra-frequency Absolute CSI-RSRP Accuracy Requirements

| Parameter | E-UTRA operating band groups ^{Note 3} | Minimum CSI-RSRP ^{Note 1} |
|--|--|------------------------------------|
| | | dBm/15kHz |
| Conditions | FDD_A, TDD_A | -127 |
| | FDD_B | -126.5 |
| | FDD_C, TDD_C | -126 |
| | FDD_D | -125.5 |
| | FDD_E, TDD_E | -125 |
| | FDD_F | -124.5 ^{Note 2} |
| | FDD_G | -124 |
| | FDD_H | -123.5 |
| | FDD_N | -120.5 |
| NOTE 1: This condition level is increased by $\Delta > 0$, when applicable, as described in Sections B.4.2 and B.4.3. | | |
| NOTE 2: The condition is -125 dBm/15kHz when the carrier frequency of the assigned E-UTRA channel bandwidth is within 865-894 MHz. | | |
| NOTE 3: E-UTRA operating band groups are as defined in Section 3.5. | | |

B.3.15 Conditions for Intra-Frequency Relative Discovery Signal Measurement Accuracy Requirements

B.3.15.1 Conditions for Intra-frequency CRS-based measurements

This clause defines the intra-frequency RSRP in discovery signal occasions [16], applicable for a corresponding operating band for CRS based discovery signal measurements.

The conditions for intra-frequency relative RSRP accuracy requirements for CRS-based discovery signal measurements in discovery signal occasions are as in Table B.3.8-1

B.3.15.2 Conditions for Intra-frequency CSI-RS-based measurements

This clause defines the intra-frequency CSI-RSRP in discovery signal occasions [16], applicable for a corresponding operating band for CSI-RS based discovery signal measurements.

The conditions for intra-frequency relative CSI-RSRP accuracy requirements for CSI-RS-based discovery signal measurements in discovery signal occasions are specified in Table B.3.15.2-1

Table B.3.15.2-1: Intra-frequency Relative CSI-RSRP Accuracy Requirements

| Parameter | E-UTRA operating band groups ^{Note 3} | Minimum CSI-RSRP _{1,2} ^{Note 1} |
|--|--|---|
| | | dBm/15kHz |
| Conditions | FDD_A, TDD_A | -127 |
| | FDD_B | -126.5 |
| | FDD_C, TDD_C | -126 |
| | FDD_D | -125.5 |
| | FDD_E, TDD_E | -125 |
| | FDD_F | -124.5 ^{Note 2} |
| | FDD_G | -124 |
| | FDD_H | -123.5 |
| | FDD_N | -120.5 |
| NOTE 1: This condition level is increased by $\Delta > 0$, when applicable, as described in Sections B.4.2 and B.4.3. | | |
| NOTE 2: The condition is -125 dBm/15kHz when the carrier frequency of the assigned E-UTRA channel bandwidth is within 865-894 MHz. | | |
| NOTE 3: E-UTRA operating band groups are as defined in Section 3.5. | | |

B.3.16 Conditions for Inter-Frequency Absolute Discovery Signal Measurement Accuracy Requirements

B.3.16.1 Conditions for Inter-frequency CRS-based measurements

This clause defines the inter-frequency RSRP in discovery signal occasions [16], applicable for a corresponding operating band for CRS based discovery signal measurements.

The conditions for inter-frequency absolute RSRP and RSRQ accuracy requirements for CRS-based discovery signal measurements in discovery signal occasions are as in Table B.3.1-1

B.3.16.2 Conditions for Inter-frequency CSI-RS-based measurements

This clause defines the inter-frequency CSI-RSRP in discovery signal occasions [16], applicable for a corresponding operating band for CSI-RS based discovery signal measurements.

The conditions for inter-frequency absolute CSI-RSRP accuracy requirements for CSI-RS-based discovery signal measurements in discovery signal occasions are as in Table B.3.14.2-1.

B.3.17 Conditions for Inter-Frequency Relative Discovery Signal Measurement Accuracy Requirements

B.3.17.1 Conditions for Inter-frequency CRS-based measurements

This clause defines the inter-frequency RSRP in discovery signal occasions [16], applicable for a corresponding operating band for CRS based discovery signal measurements.

The conditions for inter-frequency relative RSRP and RSRQ accuracy requirements for CRS-based discovery signal measurements in discovery signal occasions are as in Table B.3.8-1

B.3.17.2 Conditions for Inter-frequency CSI-RS-based measurements

This clause defines the inter-frequency CSI-RSRP in discovery signal occasions [16], applicable for a corresponding operating band for CSI-RS based discovery signal measurements.

The conditions for inter-frequency relative CSI-RSRP accuracy requirements for CSI-RS-based discovery signal measurements in discovery signal occasions are as in Table B.3.15.2-1.

B.3.18 Conditions for Intra-frequency Absolute RS-SINR Accuracy Requirements

This clause defines the E-UTRAN intra-frequency RSRP applicable for a corresponding operating band.

The conditions for intra-frequency absolute RS-SINR accuracy requirements are the same as defined in Table B.3.1-1.

B.3.19 Conditions for Inter-frequency Absolute RS-SINR Accuracy Requirements

This clause defines the E-UTRAN inter-frequency RSRP applicable for a corresponding operating band.

The conditions for inter-frequency absolute RS-SINR accuracy requirements are the same as defined in Table B.3.1-1.

B.3.20 Conditions for Inter-frequency Relative RS-SINR Accuracy Requirements

This clause defines the E-UTRAN inter-frequency RSRP_{1,2} applicable for a corresponding operating band.

The conditions for inter-frequency relative RS-SINR accuracy requirements are the same as defined in Table B.3.8-1.

B.3.21 Conditions for Intra-Frequency Absolute Accuracy Requirements for Measurements under Operation with Frame Structure 3

B.3.21.1 Conditions for RSRP measurements

This clause defines the intra-frequency absolute RSRP during the configured DMTC occasion [2] under operation with frame structure 3 [16], applicable for a corresponding operating band.

The conditions for intra-frequency absolute RSRP accuracy requirements are defined in Table B.3.21.1-1.

Table B.3.21.1-1: Intra-frequency absolute RSRP requirements

| Parameter | E-UTRA operating band groups ^{Note 2} | Minimum RSRP ^{Note 1} |
|--|--|--------------------------------|
| | | dBm/15kHz |
| Conditions | FS3_G | -124 |
| NOTE 1: This condition level is increased by $\Delta > 0$, when applicable, as described in Sections B.4.2 and B.4.3. | | |
| NOTE 2: E-UTRA operating band groups are as defined in Section 3.5. | | |

B.3.21.2 Conditions for RSRQ measurements

This clause defines the intra-frequency absolute RSRQ during the configured DMTC occasion [2] under operation with frame structure 3 [16], applicable for a corresponding operating band.

The conditions for intra-frequency absolute RSRQ accuracy requirements are the same as defined in Table B.3.21.1-1.

B.3.21.3 Conditions for CSI-RSRP measurements

This clause defines the intra-frequency absolute CSI-RSRP during the configured DMTC occasion [2] under operation with frame structure 3 [16], applicable for a corresponding operating band.

The conditions for intra-frequency absolute RSRP accuracy requirements are defined in Table B.3.21.3-1.

Table B.3.21.3-1: Intra-frequency absolute CSI-RSRP requirements

| Parameter | E-UTRA operating band groups ^{Note 2} | Minimum CSI-RSRP ^{Note 1} |
|--|--|------------------------------------|
| | | dBm/15kHz |
| Conditions | FS3_G | -124 |
| NOTE 1: This condition level is increased by $\Delta > 0$, when applicable, as described in Sections B.4.2 and B.4.3. | | |
| NOTE 2: E-UTRA operating band groups are as defined in Section 3.5. | | |

B.3.22 Conditions for Intra-Frequency Relative Accuracy Requirements for Measurements under Operation with Frame Structure 3

B.3.22.1 Conditions for RSRP measurements

This clause defines the intra-frequency relative RSRP during the configured DMTC occasion [2] under operation with frame structure 3 [16], applicable for a corresponding operating band.

The conditions for intra-frequency relative RSRP accuracy requirements are as defined in Table B.3.22.1-1.

Table B.3.22.1-1: Intra-frequency relative RSRP requirements

| Parameter | E-UTRA operating band groups ^{Note 2} | Minimum RSRP _{1,2} ^{Note 1} |
|--|--|---|
| | | dBm/15kHz |
| Conditions | FS3_G | -124 |
| NOTE 1: This condition level is increased by $\Delta > 0$, when applicable, as described in Sections B.4.2 and B.4.3. | | |
| NOTE 2: E-UTRA operating band groups are as defined in Section 3.5. | | |

B.3.22.2 Void

B.3.22.3 Conditions for CSI-RSRP measurements

This clause defines the intra-frequency relative CSI-RSRP during the configured DMTC occasion [2] under operation with frame structure 3 [16], applicable for a corresponding operating band.

The conditions for intra-frequency relative CSI-RSRP accuracy requirements are as defined in Table B.3.22.3-1.

Table B.3.22.3-1: Intra-frequency relative CSI-RSRP requirements

| Parameter | E-UTRA operating band groups ^{Note 2} | Minimum CSI-RSRP _{1,2} ^{Note 1} |
|--|--|---|
| | | dBm/15kHz |
| Conditions | FS3_G | -124 |
| NOTE 1: This condition level is increased by $\Delta > 0$, when applicable, as described in Sections B.4.2 and B.4.3. | | |
| NOTE 2: E-UTRA operating band groups are as defined in Section 3.5. | | |

B.3.23 Conditions for Inter-Frequency Absolute Accuracy Requirements for Measurements under Operation with Frame Structure 3

B.3.23.1 Conditions for RSRP measurements

This clause defines the inter-frequency absolute RSRP during the configured DMTC occasion [2] under operation with frame structure 3 [16], applicable for a corresponding operating band.

The conditions for inter-frequency absolute RSRP accuracy requirements are the same as defined in Table B.3.21.1-1.

B.3.23.2 Conditions for RSRQ measurements

This clause defines the inter-frequency absolute RSRQ during the configured DMTC occasion [2] under operation with frame structure 3 [16], applicable for a corresponding operating band.

The conditions for inter-frequency absolute RSRQ accuracy requirements are the same as defined in Table B.3.21.1-1.

B.3.23.3 Conditions for CSI-RSRP measurements

This clause defines the inter-frequency absolute CSI-RSRP during the configured DMTC occasion [2] under operation with frame structure 3 [16], applicable for a corresponding operating band.

The conditions for inter-frequency absolute CSI-RSRP accuracy requirements are the same as defined in Table B.3.21.3-1.

B.3.24 Conditions for Inter-Frequency Relative Accuracy Requirements for Measurements under Operation with Frame Structure 3

B.3.24.1 Conditions for RSRP measurements

This clause defines the inter-frequency relative RSRP during the configured DMTC occasion [2] under operation with frame structure 3 [16], applicable for a corresponding operating band.

The conditions for inter-frequency relative RSRP accuracy requirements are the same as defined in Table B.3.22.1-1.

B.3.24.2 Conditions for RSRQ measurements

This clause defines the inter-frequency relative RSRQ during the configured DMTC occasion [2] under operation with frame structure 3 [16], applicable for a corresponding operating band.

The conditions for inter-frequency relative RSRP accuracy requirements are the same as defined in Table B.3.22.1-1.

B.3.24.3 Conditions for CSI-RSRP measurements

This clause defines the inter-frequency relative CSI-RSRP during the configured DMTC occasion [2] under operation with frame structure 3 [16], applicable for a corresponding operating band.

The conditions for inter-frequency relative CSI-RSRP accuracy requirements are the same as defined in Table B.3.22.3-1.

B.3.25 Conditions for NB-IoT intra-frequency Absolute NRSRP and NRSRQ Accuracy Requirements for UE Category NB1

This clause defines the NB-IoT intra-frequency NRSRP applicable for a corresponding operating band. The UE category NB1 applicability of the conditions in Appendix B.3.25 is defined in Section 3.6.

The conditions for intra-frequency absolute NRSRP and NRSRQ accuracy requirements are defined in Table B.3.25-1.

Table B.3.25-1: NB-IoT intra-frequency absolute NRSRP and NRSRQ Accuracy Requirements

| Parameter | E-UTRA operating band groups ^{Note 1} | Minimum NRSRP |
|---|--|---------------|
| | | dBm/15kHz |
| Conditions | NFDD_G | - 139.8 |
| NOTE 1: E-UTRA operating band groups are as defined in Section 3.5. | | |

B.3.26 Conditions for NB-IoT inter-frequency Absolute NRSRP and NRSRQ Accuracy Requirements for UE Category NB1

This clause defines the NB-IoT inter-frequency NRSRP applicable for a corresponding operating band. The UE category NB1 applicability of the conditions in Appendix B.3.26 is defined in Section 3.6.

The conditions for inter-frequency absolute NRSRP and NRSRQ accuracy requirements are defined in Table B.3.25-1.

B.3.27 Conditions for intra-frequency RSRP and RSRQ Accuracy Requirements for Category 0

This clause defines the E-UTRAN intra-frequency RSRP applicable for a corresponding operating band. The UE category 0 applicability of the conditions in Appendix B.3.27 is defined in Section 3.1.

The conditions for intra-frequency absolute RSRP and RSRQ accuracy requirements are defined in Table B.3.27-1.

Table B.3.27-1: Intra-frequency absolute RSRP and RSRQ Accuracy Requirements

| Parameter | E-UTRA operating band groups ^{Note 3} | Minimum RSRP ^{Note 1} |
|------------|--|--------------------------------|
| | | dBm/15kHz |
| Conditions | FDD-0_A, TDD-0_A | -127 |
| | FDD-0_E, TDD-0_E | -125 |
| | FDD-0_G | -124 |

B.3.28 Conditions for Intra-Frequency Relative RSRP Accuracy Requirements for Category 0

This clause defines the E-UTRAN intra-frequency RSRP_{1,2} applicable for a corresponding operating band. The UE category 0 applicability of the conditions in Appendix B.3.28 is defined in Section 3.1.

The conditions for intra-frequency relative RSRP accuracy requirements are specified in Table B.3.28-1.

Table B.3.28-1: Intra-frequency relative RSRP accuracy requirements

| Parameter | E-UTRA operating band groups ^{Note 3} | Minimum RSRP _{1,2} ^{Note 1} |
|------------|--|---|
| | | dBm/15kHz |
| Conditions | FDD-0_A, TDD-0_A | -127 |
| | FDD-0_E, TDD-0_E | -125 |
| | FDD-0_G | -124 |

B.4 RRM Requirements Exceptions

B.4.1 General

B.4.2 Receiver sensitivity relaxation for UE supporting CA

For a UE supporting inter-band carrier aggregation configuration with uplink in one E-UTRA band, if there is a relaxation of receiver sensitivity $\Delta R_{IB,c} > 0$ dB as defined in TS 36.101 [5], Table 7.3.1-1A, the relevant side conditions specifying received power levels (E-UTRA RSRP, SCH_{RP}, PRP, CSI-RSRP, and I_o) shall be increased by the amount $\Delta = \Delta R_{IB,c}$ defined for each of the downlink E-UTRA bands.

NOTE: This side condition adjustment applies only for a UE supporting a single inter-band LTE CA band combination. For a UE supporting additional inter-band LTE CA band combinations, the $\Delta R_{IB,c}$ for all bands supported by the UE, need to be studied [5].

B.4.3 Receiver sensitivity relaxation for UE configured with CA

B.4.3.1 Inter-band carrier aggregation

In this section, requirements exceptions are described for the UE configured with inter-band carrier aggregation with one uplink active in low operating band.

A relevant side condition (e.g., E-UTRA RSRP, SCH_RP, PRP, CSI-RSRP, and Io) in a requirement shall be increased by the amount $\Delta=L2-L1$, where L1 is the reference sensitivity level specified in 36.101, Table 7.3.1-1, and L2 is the reference sensitivity level specified in 36.101, Table 7.3.1A-0a, when the following conditions are fulfilled,

- both downlink component carriers on different bands are configured with CA and active,
- the single uplink is active in the low operating band,
- the exception requirements specified in TS36.101, Table 7.3.1A-0a, apply.

If the relaxation Δ specified in this section applies, then the relaxation specified in Section B.4.2 should not be applied.

B.4.3.2 Intra-band non-contiguous carrier aggregation

For a UE configured with intra-band non-contiguous carrier aggregation configuration with uplink in one E-UTRA band, if there is a relaxation of receiver sensitivity $\Delta R_{IBNC}>0$ as defined in TS 36.101 [5], Table 7.3.1A-3, the relevant side conditions specifying received power levels (E-UTRA RSRP, SCH_RP, PRP, CSI-RSRP, and Io) shall be increased by the amount $\Delta=\Delta R_{IBNC}$ defined for the downlink SCC, when the following conditions are fulfilled,

- both downlink component carriers are configured with CA and active,
- one uplink carrier is active,
- the exception requirements specified in TS36.101, Table 7.3.1A-3, apply.

If the relaxation Δ specified in this section applies, then the relaxation specified in Section B.4.2 should not be applied.

B.4.3.3 Inter-band carrier aggregation with operating bands without uplink band

In this section, requirements are described for the UE configured with inter-band carrier aggregation involving one operating band without uplink band.

There is no relaxation in relevant side condition (e.g., E-UTRA RSRP, SCH_RP, PRP, CSI-RSRP, and Io) in a requirement, i.e., $\Delta=0$, when the following conditions are fulfilled,

- both downlink component carriers on different bands are configured with CA and active,
- the single uplink is active in the high operating band,
- conditions specified in TS36.101, Table 7.3.1A-0d, apply.

If Δ specified in this section applies, then no other additional relaxation to REFSSENS shall be applied.

B.5 Conditions for Measurement Performance Requirements for ProSe UE

B.5.1 Conditions for S-RSRP Accuracy Requirements

This clause defines the S-RSRP applicable for a corresponding operating band.

The conditions for absolute S-RSRP accuracy requirements are defined in Table B.5.1-1.

Table B.5.1-1: Absolute S-RSRP Requirements

| Parameter | E-UTRA ProSe operating band groups ^{Note 3} | Minimum S-RSRP ^{Note 1} |
|-----------|--|----------------------------------|
| | | dBm/15kHz |
| | FDD_D | -125.5 |
| | FDD_E | -125 |
| | FDD_F | -124.5 ^{Note 2} |
| | FDD_G | -124 |
| | FDD_N | -120.5 |

NOTE 1: This condition level is increased by $\Delta > 0$, when applicable, as described in Sections B.4.2 and B.4.3.
NOTE 2: The condition is -125 dBm/15kHz when the carrier frequency of the assigned E-UTRA channel bandwidth is within 865-894 MHz.
NOTE 3: E-UTRA ProSe operating band groups are as defined in Section 3.5 for the corresponding E-UTRA operating bands.

B.5.2 Conditions for Relative S-RSRP Accuracy Requirements

This clause defines the S-RSRP_{1,2} applicable for a corresponding operating band.

The conditions for relative S-RSRP accuracy requirements are specified in Table B.5.2-1.

Table B.5.2-1: Relative S-RSRP accuracy requirements

| Parameter | E-UTRA ProSe operating band groups ^{Note 3} | Minimum S-RSRP _{1,2} ^{Note 1} |
|-----------|--|---|
| | | dBm/15kHz |
| | FDD_D | -125.5 |
| | FDD_E | -125 |
| | FDD_F | -124.5 ^{Note 2} |
| | FDD_G | -124 |
| | FDD_N | -120.5 |

NOTE 1: This condition level is increased by $\Delta > 0$, when applicable, as described in Sections B.4.2 and B.4.3.
NOTE 2: The condition is -125 dBm/15kHz when the carrier frequency of the assigned E-UTRA channel bandwidth is within 865-894 MHz.
NOTE 3: E-UTRA ProSe operating band groups are as defined in Section 3.5 for the corresponding E-UTRA operating bands.

B.5.3 Conditions for Selection/Reselection to Intra-frequency SyncRef UE

This clause defines the ProSe SCH_{RP} and SCH_{Es/lot} applicable for a corresponding operating band.

The conditions for selection/reselection to intra-frequency SyncRef UE are defined in Table B.5.3-1.

Table B.5.3-1: ProSe synchronization measurements

| Parameter | E-UTRA ProSe operating band groups ^{Note 3} | Minimum ProSe SCH _{RP} ^{Note 1} | ProSe SCH _{Es/lot} ^{Note 4} |
|-----------|--|---|---|
| | | dBm/15kHz | dB |
| | FDD_D | -125.5 | ≥ -4 |
| | FDD_E | -125 | |
| | FDD_F | -124.5 | |
| | FDD_G | -124 | |
| | FDD_N | -120.5 | |

NOTE 1: This condition level is increased by $\Delta > 0$, when applicable, as described in Sections B.4.2 and B.4.3.
NOTE 2: Void
NOTE 3: E-UTRA ProSe operating band groups are as defined in Section 3.5 for the corresponding E-UTRA operating bands.
NOTE 4: ProSe SCH_{Es/lot} for a SyncRef UE is the minimum of the \hat{E}_s/lot of PSSS/PSBCH and the \hat{E}_s/lot of SSSS

B.5.4 Conditions for SD-RSRP Accuracy Requirements

This clause defines the intra-frequency SD-RSRP applicable for a corresponding operating band.

The conditions for intra-frequency absolute SD-RSRP accuracy requirements are defined in Table B.5.4-1.

Table B.5.4-1: Absolute SD-RSRP Requirements

| Parameter | E-UTRA ProSe operating band groups ^{Note 3} | Minimum SD-RSRP ^{Note 1} dBm/15kHz |
|-----------|--|--|
| | | FDD_D |
| | FDD_E | -125 |
| | FDD_F | -124.5 |
| | FDD_G | -124 |
| | FDD_N | -120.5 |

NOTE 1: This condition level is increased by $\Delta > 0$, when applicable, as described in Sections B.4.2 and B.4.3.
NOTE 2: Void
NOTE 3: E-UTRA ProSe operating band groups are as defined in Section 3.5 for the corresponding E-UTRA operating bands.

B.5.5 Conditions for Relative SD-RSRP Accuracy Requirements

This clause defines the intra-frequency SD-RSRP applicable for a corresponding operating band.

The conditions for intra-frequency relative S-RSRP accuracy requirements are specified in Table B.5.5-1.

Table B.5.5-1: Relative S-RSRP accuracy requirements

| Parameter | E-UTRA ProSe operating band groups ^{Note 3} | Minimum SD-RSRP _{1,2} ^{Note 1} dBm/15kHz |
|-----------|--|---|
| | | FDD_D |
| | FDD_E | -125 |
| | FDD_F | -124.5 |
| | FDD_G | -124 |
| | FDD_N | -120.5 |

NOTE 1: This condition level is increased by $\Delta > 0$, when applicable, as described in Sections B.4.2 and B.4.3.
NOTE 2: Void
NOTE 3: E-UTRA ProSe operating band groups are as defined in Section 3.5 for the corresponding E-UTRA operating bands.

Annex C (informative): Change history:

| Date | Meeting | TDoc | CR | Rev | Cat | Subject/Comment | New version |
|---------|---------|-----------|-----|-----|-----|--|-------------|
| 2007-12 | RP#38 | RP-071037 | | | | Approved version in TSG RAN#38 | 8.0.0 |
| 2008-03 | RP#39 | RP-080123 | 2 | | | Updates of TS36.133 | 8.1.0 |
| 2008-05 | RP#40 | RP-080325 | 3 | | | Updates of TS36.133 | 8.2.0 |
| 2008-09 | RP#41 | RP-080644 | 006 | 1 | | E-UTRAN TDD intra frequency measurements when DRX is used | 8.3.0 |
| 2008-09 | RP#41 | RP-080644 | 008 | 1 | | E-UTRAN TDD - UTRAN TDD measurements | 8.3.0 |
| 2008-09 | RP#41 | RP-080644 | 012 | | | RSRQ reporting Range | 8.3.0 |
| 2008-09 | RP#41 | RP-080644 | 018 | 1 | | Interfrequency and UTRA interRAT DRX performance requirements | 8.3.0 |
| 2008-09 | RP#41 | RP-080644 | 020 | 1 | | Additions to UE transmit timing requirements | 8.3.0 |
| 2008-09 | RP#41 | RP-080644 | 043 | | | Received interference power measurement performance requirement | 8.3.0 |
| 2008-09 | RP#41 | RP-080644 | 044 | | | Cell Synchronization requirement for E-UTRA TDD | 8.3.0 |
| 2008-09 | RP#41 | RP-080644 | 047 | | | Power Headroom Requirements | 8.3.0 |
| 2008-09 | RP#41 | RP-080644 | 048 | | | Event Triggering and Reporting Criteria Capability Requirements | 8.3.0 |
| 2008-09 | RP#41 | RP-080642 | 004 | | | Correction of E-UTRAN to UTRAN TDD handover | 8.3.0 |
| 2008-09 | RP#41 | RP-080642 | 016 | 1 | | Definition of Symbols | 8.3.0 |
| 2008-09 | RP#41 | RP-080642 | 019 | 1 | | Idle mode requirements updates | 8.3.0 |
| 2008-09 | RP#41 | RP-080642 | 021 | 1 | | General updates to 36.133 | 8.3.0 |
| 2008-09 | RP#41 | RP-080642 | 023 | 1 | | Handover requirements for E-UTRAN to cdma200 HRPD/1x | 8.3.0 |
| 2008-09 | RP#41 | RP-080642 | 024 | | | Inter-frequency and inter-RAT measurement requirements for multiple layer monitoring | 8.3.0 |
| 2008-09 | RP#41 | RP-080642 | 025 | | | Side conditions for UE measurement procedures and measurement performance requirements | 8.3.0 |
| 2008-09 | RP#41 | RP-080642 | 026 | | | Correction to cell reselection Requirement from E-UTRAN to HRPD/cdma200 1x | 8.3.0 |
| 2008-09 | RP#41 | RP-080642 | 027 | | | IRAT Measurement requirements in TS 36.133 | 8.3.0 |
| 2008-09 | RP#41 | RP-080713 | 022 | 1 | | Corrections to Handover requirements | 8.3.0 |
| 2008-09 | RP#41 | RP-080713 | 028 | | | Measurement reporting requirements | 8.3.0 |
| 2008-09 | RP#41 | RP-080713 | 029 | 2 | | RRC re-establishment requirements | 8.3.0 |
| 2008-09 | RP#41 | RP-080713 | 032 | | | Correction to UE measurement requirements | 8.3.0 |
| 2008-09 | RP#41 | RP-080713 | 033 | | | Correction for the definition of interruption time | 8.3.0 |
| 2008-09 | RP#41 | RP-080713 | 040 | 1 | | Correction to idle mode higher priority search requirements | 8.3.0 |
| 2008-09 | RP#41 | RP-080713 | 045 | | | E-UTRAN TDD inter frequency measurement requirements | 8.3.0 |
| 2008-09 | RP#41 | RP-080713 | 046 | | | Updates of the Measurement procedures in RRC_Connected state from RAN 4#47bis and RAN 4#48 | 8.3.0 |
| 2008-12 | RP#42 | RP-080919 | 53 | | | Introduction of 700MHz Bands 12, 14 and 17 | 8.4.0 |
| 2008-12 | RP#42 | RP-080928 | 88 | 1 | | CR to 36.133 on Radio Link Failure Monitoring | 8.4.0 |
| 2008-12 | RP#42 | RP-080929 | 51 | | | Correction to idle mode requirements | 8.4.0 |
| 2008-12 | RP#42 | RP-080929 | 52 | | | Definition of out of service area | 8.4.0 |
| 2008-12 | RP#42 | RP-080929 | 54 | | | Measurement requirements for UTRAN TDD cells in idle state | 8.4.0 |
| 2008-12 | RP#42 | RP-080929 | 69 | 2 | | Correction of Inter-RAT UTRA cell reselection requirement | 8.4.0 |
| 2008-12 | RP#42 | RP-080929 | 55 | | | Correction of E-UTRAN cell measurement requirements in idle state | 8.4.0 |
| 2008-12 | RP#42 | RP-080930 | 76 | | | Correction to HO Requirements | 8.4.0 |
| 2008-12 | RP#42 | RP-080931 | 71 | | | Random access requirements | 8.4.0 |
| 2008-12 | RP#42 | RP-080932 | 85 | | | Cell phase synchronization error for large cell | 8.4.0 |
| 2008-12 | RP#42 | RP-080932 | 63 | 4 | | Synchronization Requirements for E-UTRAN to 1xRTT and HRPD Handovers | 8.4.0 |
| 2008-12 | RP#42 | RP-080933 | 49 | | | E-UTRAN TDD-TDD intra/inter frequency measurement reporting requirements | 8.4.0 |
| 2008-12 | RP#42 | RP-080933 | 50 | | | E-UTRAN FDD – UTRAN FDD Measurement reporting requirements | 8.4.0 |
| 2008-12 | RP#42 | RP-080933 | 58 | | | Measurement requirement for E-UTRAN TDD to UTRAN TDD/FDD when DRX is used | 8.4.0 |
| 2008-12 | RP#42 | RP-080933 | 60 | | | Interfrequency and GSM measurement | 8.4.0 |

| | | | | | | | |
|---------|-------|-----------|-----|---|--|--|-------|
| | | | | | | performance requirements in large DRX | |
| 2008-12 | RP#42 | RP-080933 | 62 | | | Correction of implementation margin for transmission gap. | 8.4.0 |
| 2008-12 | RP#42 | RP-080933 | 72 | | | Alignment of DRX cycle dependent requirements | 8.4.0 |
| 2008-12 | RP#42 | RP-080933 | 73 | 1 | | Alignment of side conditions for mobility measurements | 8.4.0 |
| 2008-12 | RP#42 | RP-080933 | 66 | 1 | | Measurement models in RRC_CONNECTED | 8.4.0 |
| 2008-12 | RP#42 | RP-080933 | 78 | 1 | | Limitation of maximum number of layers for multiple monitoring | 8.4.0 |
| 2008-12 | RP#42 | RP-080933 | 83 | 1 | | GSM Cell identification requirements for parallel monitoring | 8.4.0 |
| 2008-12 | RP#42 | RP-080933 | 87 | | | UE transmit timing requirement | 8.4.0 |
| 2008-12 | RP#42 | RP-080933 | 56 | | | Correction of TS 36.133 clause 8.1.2.1.1. | 8.4.0 |
| 2008-12 | RP#42 | RP-080934 | 77 | | | Correction to RSRQ Report Mapping | 8.4.0 |
| 2008-12 | RP#42 | | 86 | | | Missing side conditions for RSRP and RSRQ | 8.4.0 |
| 2008-12 | RP#42 | RP-080935 | 81 | 1 | | Phase I RRM Test Cases | 8.4.0 |
| 2008-12 | RP#42 | | 80 | 1 | | Test Configuration for RRM Tests: Measurement Reference Channels and OCNG | 8.4.0 |
| 2008-12 | RP#42 | RP-080936 | 75 | | | Cdma200 1xRTT Measurement Requirements | 8.4.0 |
| 2008-12 | RP#42 | RP-080937 | 74 | 1 | | E-UTRA to UTRA cell search requirements for SON | 8.4.0 |
| 2009-03 | RP#43 | RP-090182 | 101 | 1 | | Correction of A3-offset parameter in RRM test case | 8.5.0 |
| 2009-03 | RP#43 | RP-090182 | 105 | | | Some Editorial Corrections | 8.5.0 |
| 2009-03 | RP#43 | RP-090182 | 145 | | | Clarifications for the DRX state | 8.5.0 |
| 2009-03 | RP#43 | RP-090183 | 89 | | | Modification on measurements of UTRAN TDD cells | 8.5.0 |
| 2009-03 | RP#43 | RP-090183 | 91 | | | Clarification of the correct behavior when Treselection is not a multiple of idle mode reselection evaluation period | 8.5.0 |
| 2009-03 | RP#43 | RP-090183 | 98 | | | Clarification of 'Out of Service Area' Concept and Definition | 8.5.0 |
| 2009-03 | RP#43 | RP-090183 | 118 | | | Radio link monitoring | 8.5.0 |
| 2009-03 | RP#43 | RP-090183 | 142 | 1 | | Update of RRC_IDLE state mobility side conditions | 8.5.0 |
| 2009-03 | RP#43 | RP-090183 | 150 | | | UE measurement capability in Idle mode | 8.5.0 |
| 2009-03 | RP#43 | RP-090184 | 133 | | | Removal of RRC re-establishment procedure delay | 8.5.0 |
| 2009-03 | RP#43 | RP-090184 | 138 | 1 | | Correction for the UE Re-establishment delay requirement | 8.5.0 |
| 2009-03 | RP#43 | RP-090185 | 92 | 2 | | Cell phase synchronization accuracy | 8.5.0 |
| 2009-03 | RP#43 | RP-090185 | 97 | | | Radio link monitoring in DRX | 8.5.0 |
| 2009-03 | RP#43 | RP-090185 | 120 | | | UE Transmit Timing | 8.5.0 |
| 2009-03 | RP#43 | RP-090185 | 137 | 1 | | Clarification of the reference point for the UE initial transmission timing control requirement | 8.5.0 |
| 2009-03 | RP#43 | RP-090186 | 90 | | | Correction of clause 8.1.2.2.2.2 in TS36.133 | 8.5.0 |
| 2009-03 | RP#43 | RP-090186 | 93 | 1 | | cdma2000 1xRTT and HRPD Measurement Requirements | 8.5.0 |
| 2009-03 | RP#43 | RP-090186 | 94 | | | Event Triggered Periodic Reporting Requirements for IRAT Measurements | 8.5.0 |
| 2009-03 | RP#43 | RP-090186 | 95 | | | Measurement Reporting Requirements for E-UTRAN TDD – UTRAN TDD Measurements | 8.5.0 |
| 2009-03 | RP#43 | RP-090186 | 99 | 1 | | Clarification of UE behavior when measurement gap is used | 8.5.0 |
| 2009-03 | RP#43 | RP-090186 | 100 | | | E-UTRA to UTRA cell search requirements in DRX for SON | 8.5.0 |
| 2009-03 | RP#43 | RP-090186 | 110 | 1 | | Correction to GSM BSIC Requirements for Parallel Monitoring | 8.5.0 |
| 2009-03 | RP#43 | RP-090186 | 117 | | | Alignment of terminology for GAP | 8.5.0 |
| 2009-03 | RP#43 | RP-090186 | 134 | | | Inter frequency and Inter RAT cell search requirement when DRX is used | 8.5.0 |
| 2009-03 | RP#43 | RP-090186 | 139 | | | Correction of E-UTRAN FDD – UTRAN FDD measurements when no DRX | 8.5.0 |
| 2009-03 | RP#43 | RP-090186 | 146 | | | Addition of the definition of "when DRX is used" | 8.5.0 |

| | | | | | | | |
|---------|-------|-----------|-----|---|--|---|-------|
| 2009-03 | RP#43 | RP-090186 | 147 | 1 | | Corrections to E-UTRAN inter-frequency side conditions | 8.5.0 |
| 2009-03 | RP#43 | RP-090187 | 96 | | | Correction to Intra-frequency RSRP Accuracy Requirements | 8.5.0 |
| 2009-03 | RP#43 | RP-090187 | 136 | 1 | | Power Headroom reporting delay | 8.5.0 |
| 2009-03 | RP#43 | RP-090370 | 103 | 1 | | E-UTRAN -GSM Handover Test Case | 8.5.0 |
| 2009-03 | RP#43 | RP-090370 | 104 | 1 | | E-UTRAN FDD - UTRAN TDD Cell Search Test Cases in Fading | 8.5.0 |
| 2009-03 | RP#43 | RP-090370 | 106 | 1 | | E-UTRA FDD to UTRA FDD Handover Test Case | 8.5.0 |
| 2009-03 | RP#43 | RP-090370 | 107 | 1 | | Correction of E-UTRA FDD-FDD Intra-frequency cell reselection test case | 8.5.0 |
| 2009-03 | RP#43 | RP-090370 | 108 | 1 | | Correction of E-UTRA FDD-FDD priority based Inter-frequency cell reselection test case | 8.5.0 |
| 2009-03 | RP#43 | RP-090370 | 111 | | | E-UTRAN FDD - UTRAN FDD Handover Test Case | 8.5.0 |
| 2009-03 | RP#43 | RP-090370 | 112 | 1 | | E-UTRAN FDD - GSM Cell Search Test Case in AWGN | 8.5.0 |
| 2009-03 | RP#43 | RP-090370 | 113 | | | E-UTRAN - UTRAN FDD Cell Search Test Cases in Fading | 8.5.0 |
| 2009-03 | RP#43 | RP-090370 | 114 | 1 | | E-UTRAN UE Timing Accuracy Related Test Cases | 8.5.0 |
| 2009-03 | RP#43 | RP-090370 | 115 | 1 | | Inclusion of MBSFN Configurations for RRM Test Cases | 8.5.0 |
| 2009-03 | RP#43 | RP-090370 | 116 | | | E-UTRAN FDD HRPD Cell Reselection Test Case; HRPD of Low Priority | 8.5.0 |
| 2009-03 | RP#43 | RP-090370 | 122 | 1 | | Clarification on Annex A.9: Measurement performance requirements | 8.5.0 |
| 2009-03 | RP#43 | RP-090370 | 125 | | | E-UTRA TDD – UTRA TDD cell reselection: UTRA is of higher priority | 8.5.0 |
| 2009-03 | RP#43 | RP-090370 | 126 | | | E-UTRA TDD – UTRA TDD cell reselection: UTRA is of lower priority | 8.5.0 |
| 2009-03 | RP#43 | RP-090370 | 127 | | | E-UTRA FDD – UTRA TDD cell reselection | 8.5.0 |
| 2009-03 | RP#43 | RP-090370 | 128 | 1 | | E-UTRA TDD-UTRA TDD cell search (fading) | 8.5.0 |
| 2009-03 | RP#43 | RP-090370 | 129 | 1 | | E-UTRA TDD-UTRA TDD handover | 8.5.0 |
| 2009-03 | RP#43 | RP-090370 | 132 | 1 | | Addition of E-UTRA FDD to UTRA FDD reselection test cases | 8.5.0 |
| 2009-03 | RP#43 | RP-090370 | 141 | 1 | | Correction and introduction of some test related parameters | 8.5.0 |
| 2009-03 | RP#43 | RP-090370 | 143 | | | Description of Annex A in TS 36.133 | 8.5.0 |
| 2009-03 | RP#43 | RP-090370 | 148 | | | Reselection from E-UTRA to GSM cell test case | 8.5.0 |
| 2009-03 | RP#43 | RP-090370 | 149 | | | Radio Link Monitoring Test Cases | 8.5.0 |
| 2009-05 | RP#44 | RP-090546 | 151 | | | E-UTRA FDD UTRA TDD HO delay test case | 8.6.0 |
| 2009-05 | RP#44 | RP-090546 | 153 | | | Correction of CQI reporting periodicity for TDD RLM test cases | 8.6.0 |
| 2009-05 | RP#44 | RP-090546 | 157 | | | Correction to inter RAT reselection requirements to exclude equal priority. (Technically Endorsed CR in R4-50bis - R4-091092) | 8.6.0 |
| 2009-05 | RP#44 | RP-090546 | 167 | | | Clarification of the number of monitoring carriers in idle mode. (Technically Endorsed CR in R4-50bis - R4-091394) | 8.6.0 |
| 2009-05 | RP#44 | RP-090546 | 180 | | | Correction of Core spec references in A.9 Measurements performance test cases | 8.6.0 |
| 2009-05 | RP#44 | RP-090546 | 984 | | | UTRA FDD-E-UTRA FDD/ TDD handover test cases | 8.6.0 |
| 2009-05 | RP#44 | RP-090546 | 184 | | | SON ANR UTRAN FDD Cell Search Test Case | 8.6.0 |
| 2009-05 | RP#44 | RP-090546 | 187 | | | E-UTRAN FDD cdma2000 1x RTT Cell Reselection Test Case; Cdma2000 1X of Low Priority | 8.6.0 |
| 2009-05 | RP#44 | RP-090546 | 188 | | | E-UTRAN FDD cdma2000 HO Test cases | 8.6.0 |
| 2009-05 | RP#44 | RP-090546 | 190 | | | E-UTRAN Random Access Test Cases | 8.6.0 |
| 2009-05 | RP#44 | RP-090546 | 191 | | | E-UTRAN RRC Re-establishment Test Cases | 8.6.0 |
| 2009-05 | RP#44 | RP-090546 | 192 | | | E-UTRAN TDD - GSM Cell Search Test Case in AWGN | 8.6.0 |
| 2009-05 | RP#44 | RP-090546 | 197 | | | Correction to E-UTRAN FDD - GSM Handover Test case | 8.6.0 |
| 2009-05 | RP#44 | RP-090546 | 173 | 1 | | Correction of cell reselection test cases | 8.6.0 |
| 2009-05 | RP#44 | RP-090546 | 179 | 1 | | Test cases of E-UTRA TDD intra-frequency cell search in fading environment when DRX is used | 8.6.0 |
| 2009-05 | RP#44 | RP-090546 | 152 | 1 | | E-UTRA TDD GSM handover test case | 8.6.0 |
| 2009-05 | RP#44 | RP-090546 | 178 | 1 | | Test cases of E-UTRA FDD intra-frequency cell search in fading environment when DRX is used | 8.6.0 |
| 2009-05 | RP#44 | RP-090546 | 201 | 1 | | Test case for E-UTRA FDD E-UTRA FDD inter frequency cell search when DRX is used in fading | 8.6.0 |

| | | | | | | | |
|---------|-------|-----------|-----|---|--|--|-------|
| | | | | | | conditions | |
| 2009-05 | RP#44 | RP-090546 | 185 | 1 | | Correction to Radio Link Monitoring Tests | 8.6.0 |
| 2009-05 | RP#44 | RP-090546 | 203 | | | Correction to E-UTRAN FDD to HRPD Cell Reselection Test Case | 8.6.0 |
| 2009-05 | RP#44 | RP-090546 | 177 | 1 | | Introduction of New Reference Channels and OCNG Patterns for 1.4MHz Bandwidth | 8.6.0 |
| 2009-05 | RP#44 | RP-090546 | 200 | 2 | | Test case for E-UTRA TDD E-UTRA TDD inter frequency cell search when DRX is used in fading conditions | 8.6.0 |
| 2009-05 | RP#44 | RP-090547 | 158 | | | Alignment of inter frequency and inter RAT RRM reselection testcases with core requirements. (Technically Endorsed CR in R4-50bis - R4-091094) | 8.6.0 |
| 2009-05 | RP#44 | RP-090547 | 160 | | | Correction relating E-UTRAN TDD - UE Transmit Timing Accuracy Tests. (Technically Endorsed CR in R4-50bis - R4-091198) | 8.6.0 |
| 2009-05 | RP#44 | RP-090547 | 165 | | | Modifications of T3 and the verification point for in-sync test cases. (Technically Endorsed CR in R4-50bis - R4-091386) | 8.6.0 |
| 2009-05 | RP#44 | RP-090547 | 172 | | | E-UTRAN UE Timing Accuracy Related Test Cases. (Technically Endorsed CR in R4-50bis - R4-091517) | 8.6.0 |
| 2009-05 | RP#44 | RP-090547 | 171 | 1 | | Reference measurement Channels for Radio Link Monitoring Tests with 2 Antennas. (Technically Endorsed CR in R4-50bis - R4-091508) | 8.6.0 |
| 2009-05 | RP#44 | RP-090548 | 170 | | | Misalignment between TS36.133 and TS36.321. (Technically Endorsed CR in R4-50bis - R4-091457) | 8.6.0 |
| 2009-05 | RP#44 | RP-090548 | 193 | | | Correction to Inter-RAT HO Interruption Time Definition | 8.6.0 |
| 2009-05 | RP#44 | RP-090548 | 195 | | | CR c2k RRC delay | 8.6.0 |
| 2009-05 | RP#44 | RP-090548 | 196 | | | CR c2k interruption time | 8.6.0 |
| 2009-05 | RP#44 | RP-090548 | 162 | | | Clarifications to UE UL timing requirements. (Technically Endorsed CR in R4-50bis - R4-091357) | 8.6.0 |
| 2009-05 | RP#44 | RP-090548 | 176 | | | Corrections of Random Access Requirements | 8.6.0 |
| 2009-05 | RP#44 | RP-090548 | 154 | | | Correction of TGRP in clause 8.1.2.1.1 | 8.6.0 |
| 2009-05 | RP#44 | RP-090548 | 168 | | | Clarifications for the Relative RSRP and RSRQ measurement requirements. (Technically Endorsed CR in R4-50bis - R4-091407) | 8.6.0 |
| 2009-05 | RP#44 | RP-090549 | 161 | | | E-UTRAN UTRAN HO Command Processing Delay. (Technically Endorsed CR in R4-50bis - R4-091291) | 8.6.0 |
| 2009-05 | RP#44 | RP-090549 | 175 | | | Corrections of Cell Reselection Requirements in Idle Mode | 8.6.0 |
| 2009-05 | RP#44 | RP-090549 | 181 | 2 | | Removal of [] from ranking criteria in Idle mode cell reselection | 8.6.0 |
| 2009-05 | RP#44 | RP-090550 | 156 | | | Correction on the TDD-TDD inter frequency measurements. (Technically Endorsed CR in R4-50bis - R4-091071) | 8.6.0 |
| 2009-05 | RP#44 | RP-090550 | 159 | | | Correction to the Referenced Clause Number for Tinter1. (Technically Endorsed CR in R4-50bis - R4-091153) | 8.6.0 |
| 2009-05 | RP#44 | RP-090551 | 166 | | | Further clarification of DRX/Non-DRX state. (Technically Endorsed CR in R4-50bis - R4-091389) | 8.6.0 |
| 2009-05 | RP#44 | RP-090551 | 202 | | | Correction on reference to 3GPP2 specification | 8.6.0 |
| 2009-05 | RP#44 | RP-090551 | 169 | | | OCNG simplification. (Technically Endorsed CR in R4-50bis - R4-091410) | 8.6.0 |
| 2009-05 | RP#44 | RP-090559 | 155 | | | Introduction of Extended LTE800 requirements. (Technically Endorsed CR in R4-50bis - R4-091063) | 9.0.0 |
| 2009-05 | RP#45 | RP-090817 | 211 | | | Correction to TDD RMC references in RLM test cases | 9.1.0 |
| 2009-05 | RP#45 | RP-090880 | 205 | | | Introduction of Reference DRX configurations | 9.1.0 |
| 2009-05 | RP#45 | RP-090880 | 207 | | | Addition of DRX configurations into non DRX test cases | 9.1.0 |
| 2009-05 | RP#45 | RP-090880 | 225 | | | Correction to HO Test Cases | 9.1.0 |
| 2009-05 | RP#45 | RP-090880 | 227 | | | Correction to E-UTRAN GSM BSIC Identification Requirements with DRX | 9.1.0 |
| 2009-05 | RP#45 | RP-090880 | 259 | | | Corrections of Test Cases | 9.1.0 |
| 2009-05 | RP#45 | RP-090880 | 314 | | | E-UTRA FDD - E-UTRA FDD and UTRA FDD cell search test cases | 9.1.0 |

| | | | | | | | |
|---------|-------|-----------|-----|---|--|---|-------|
| 2009-05 | RP#45 | RP-090880 | 315 | | | E-UTRAN Radio Link Monitoring Test Cases in DRX | 9.1.0 |
| 2009-05 | RP#45 | RP-090880 | 316 | | | Inter-frequency E-UTRA - E-UTRA HO test cases: unknown target cell | 9.1.0 |
| 2009-05 | RP#45 | RP-090880 | 263 | 2 | | E-UTRA FDD UTRA FDD Blind Handover test case: unknown target cell | 9.1.0 |
| 2009-05 | RP#45 | RP-090836 | 321 | 1 | | Small corrections to Measurements performance tests parameters | 9.1.0 |
| 2009-05 | RP#45 | RP-090836 | 285 | 1 | | E-UTRAN GSM Cell Search in DRX Test Cases | 9.1.0 |
| 2009-05 | RP#45 | RP-090836 | 267 | | | Set 3.2. E-UTRA TDD to UTRA TDD cell search in DRX under fading | 9.1.0 |
| 2009-05 | RP#45 | RP-090836 | 269 | | | Set 3.6. Test case of E-UTRA TDD to E-UTRA TDD and UTRA TDD combined cell search under fading | 9.1.0 |
| 2009-05 | RP#45 | RP-090836 | 271 | | | Set 3.12. E-UTRA TDD to UTRA TDD blind handover test | 9.1.0 |
| 2009-05 | RP#45 | RP-090836 | 279 | | | E-UTRAN FDD - UTRAN FDD Cell Search in DRX Test Cases | 9.1.0 |
| 2009-05 | RP#45 | RP-090836 | 281 | | | E-UTRAN TDD- E-UTRAN TDD and E-UTRAN TDD Inter-frequency Cell Search Test Case | 9.1.0 |
| 2009-05 | RP#45 | RP-090836 | 283 | | | E-UTRAN GSM Blind Handover Test Cases | 9.1.0 |
| 2009-05 | RP#45 | RP-090836 | 287 | | | E-UTRAN FDD cdma2000 Blind HO Test cases | 9.1.0 |
| 2009-05 | RP#45 | RP-090836 | 302 | | | RRM Test case for multiple E-UTRAN FDD-FDD Inter-frequency event triggered reporting under fading propagation conditions | 9.1.0 |
| 2009-05 | RP#45 | RP-090836 | 304 | | | Fading reselection test case between E-UTRA and UTRA (UTRA of lower priority) | 9.1.0 |
| 2009-05 | RP#45 | RP-090828 | 233 | | | CR SI HRPD correction | 9.1.0 |
| 2009-05 | RP#45 | RP-090879 | 215 | 1 | | Corrections to Measurements of HRPD cells and cdma2000 1X | 9.1.0 |
| 2009-05 | RP#45 | RP-090879 | 231 | | | CR reference correction | 9.1.0 |
| 2009-05 | RP#45 | RP-090879 | 235 | 1 | | Corrections to Measurements of GSM cells in RRC_IDLE | 9.1.0 |
| 2009-05 | RP#45 | RP-090879 | 247 | | | Range of Idle Mode Es/lot side conditions | 9.1.0 |
| 2009-05 | RP#45 | RP-090879 | 249 | | | Removal of [] from Tdetect, Tmeasure and Tevaluate | 9.1.0 |
| 2009-05 | RP#45 | RP-090879 | 245 | 1 | | Clarification to applicability of RSRP side conditions in Idle mode | 9.1.0 |
| 2009-05 | RP#45 | RP-090879 | 317 | | | CR Idle mode IF measurement condition | 9.1.0 |
| 2009-05 | RP#45 | RP-090879 | 318 | | | CR Idle mode IF measurement period | 9.1.0 |
| 2009-05 | RP#45 | RP-090879 | 217 | 2 | | Corrections to E-UTRAN RRC_IDLE state mobility requirements | 9.1.0 |
| 2009-05 | RP#45 | RP-090814 | 265 | 1 | | Correction to Random Access | 9.1.0 |
| 2009-05 | RP#45 | RP-090816 | 221 | | | E-UTRAN TDD-TDD inter frequency cell search/measurement requirements when DRX is used | 9.1.0 |
| 2009-05 | RP#45 | RP-090816 | 223 | | | E-UTRAN inter RAT measurement requirements | 9.1.0 |
| 2009-05 | RP#45 | RP-090816 | 229 | | | Correction to Monitoring of Multiple Layers Using Gaps | 9.1.0 |
| 2009-05 | RP#45 | RP-090816 | 219 | 1 | | E-UTRAN FDD-FDD inter frequency measurements when DRX is used | 9.1.0 |
| 2009-05 | RP#45 | RP-090816 | 322 | | | CR GSM measurement period | 9.1.0 |
| 2009-05 | RP#45 | RP-090816 | 323 | | | CR cdma2000 1x and HRPD number of carriers | 9.1.0 |
| 2009-05 | RP#45 | RP-090816 | 213 | 1 | | Editorial correction on E-UTRAN inter frequency measurements | 9.1.0 |
| 2009-05 | RP#45 | RP-090816 | 261 | 1 | | E-UTRAN TDD intra frequency measurements | 9.1.0 |
| 2009-05 | RP#45 | RP-090816 | 319 | 1 | | Clarification of the number of monitoring cells for intra frequency measurements | 9.1.0 |
| 2009-05 | RP#45 | RP-090815 | 237 | | | Correction of timing advance adjustment accuracy test case | 9.1.0 |
| 2009-05 | RP#45 | RP-090815 | 291 | | | Correction to UE Transmit Timing Requirements | 9.1.0 |
| 2009-12 | RP-46 | RP-091275 | 329 | | | Defining requirements for UTRA TDD measurements for SON (Technically endorsed at RAN 4 52bis in R4-093512) | 9.2.0 |
| 2009-12 | RP-46 | RP-091272 | 332 | | | Modification of test case of E-UTRA TDD intra frequency cell reselection (Technically endorsed at RAN 4 52bis in R4-093552) | 9.2.0 |
| 2009-12 | RP-46 | RP-091272 | 333 | | | Modification of test case of E-UTRA TDD inter frequency cell reselection (Technically endorsed at RAN 4 52bis in R4-093553) | 9.2.0 |
| 2009-12 | RP-46 | RP-091286 | 334 | | | Introduction of Extended LTE1500 requirements for TS36.133 (Technically endorsed at RAN 4 52bis in R4-093636) | 9.2.0 |

| | | | | | | | |
|---------|-------|-----------|-----|---|--|---|-------|
| 2009-12 | RP-46 | RP-091272 | 336 | | | Addition of E-UTRA TDD to UTRA FDD reselection test cases (Technically endorsed at RAN 4 52bis in R4-093686) | 9.2.0 |
| 2009-12 | RP-46 | RP-091271 | 338 | | | Correction of missing accuracy requirements for UTRAN FDD (Technically endorsed at RAN 4 52bis in R4-093689) | 9.2.0 |
| 2009-12 | RP-46 | RP-091275 | 340 | | | CR cdma2000 HRPD measurement period (Technically endorsed at RAN 4 52bis in R4-093720) | 9.2.0 |
| 2009-12 | RP-46 | RP-091275 | 342 | | | CR cdma2000 1x measurement period (Technically endorsed at RAN 4 52bis in R4-093721) | 9.2.0 |
| 2009-12 | RP-46 | RP-091272 | 344 | | | Correction for E-UTRAN FDD - UTRAN FDD Cell Search in DRX Test Cases (Technically endorsed at RAN 4 52bis in R4-093890) | 9.2.0 |
| 2009-12 | RP-46 | RP-091272 | 346 | | | Revise geometry factors for Intra freq Reselection Test Cases | 9.2.0 |
| 2009-12 | RP-46 | RP-091271 | 348 | | | Corrections on RRM parameters for Bands 12, 14, 17 | 9.2.0 |
| 2009-12 | RP-46 | RP-091271 | 351 | 1 | | Corrections to PDSCH RMC-s | 9.2.0 |
| 2009-12 | RP-46 | RP-091271 | 353 | | | Corrections of TS36.133 | 9.2.0 |
| 2009-12 | RP-46 | RP-091275 | 356 | 1 | | UTRA TDD P-CCPCH RSCP absolute accuracy measurement in E-UTRAN | 9.2.0 |
| 2009-12 | RP-46 | RP-091275 | 358 | 1 | | E-UTRAN TDD - UTRAN TDD cell search for SON | 9.2.0 |
| 2009-12 | RP-46 | RP-091275 | 361 | | | Cell Search Requirements for Intra-LTE Handover to Unknown Target Cell | 9.2.0 |
| 2009-12 | RP-46 | RP-091273 | 365 | | | Combined E-UTRAN interfrequency and GSM cell search test cases (Scenario set 3.2) | 9.2.0 |
| 2009-12 | RP-46 | RP-091271 | 367 | 1 | | Correction in UE UTRA TDD P-CCPCH RSCP measurement capability for R9 | 9.2.0 |
| 2009-12 | RP-46 | RP-091273 | 374 | | | E-UTRAN GSM RSSI Measurement Accuracy Tests | 9.2.0 |
| 2009-12 | RP-46 | RP-091273 | 375 | | | E-UTRAN UTRAN FDD CPICH RSCP Measurement Accuracy Tests | 9.2.0 |
| 2009-12 | RP-46 | RP-091273 | 376 | | | E-UTRAN UTRAN FDD CPICH Ec/No Measurement Accuracy Tests | 9.2.0 |
| 2009-12 | RP-46 | RP-091275 | 378 | | | Cell Timing Change Requirements for Event Triggered Reporting | 9.2.0 |
| 2009-12 | RP-46 | RP-091271 | 380 | | | Correction to Power Headroom Requirements | 9.2.0 |
| 2009-12 | RP-46 | RP-091271 | 382 | | | Editorial corrections to 36.133 | 9.2.0 |
| 2009-12 | RP-46 | RP-091271 | 387 | | | Editorial corrections to the time units for RRC Re-establishment test cases | 9.2.0 |
| 2009-12 | RP-46 | RP-091272 | 389 | 1 | | Introduction of cell search test case in DRX to verify L3 filtering | 9.2.0 |
| 2009-12 | RP-46 | RP-091271 | 391 | | | Correction to ONCG Patterns | 9.2.0 |
| 2009-12 | RP-46 | RP-091275 | 329 | | | Defining requirements for UTRA TDD measurements for SON (Technically endorsed at RAN 4 52bis in R4-093512) | 9.2.0 |
| 2009-12 | RP-46 | RP-091272 | 332 | | | Modification of test case of E-UTRA TDD intra frequency cell reselection (Technically endorsed at RAN 4 52bis in R4-093552) | 9.2.0 |
| 2009-12 | RP-46 | RP-091272 | 333 | | | Modification of test case of E-UTRA TDD inter frequency cell reselection (Technically endorsed at RAN 4 52bis in R4-093553) | 9.2.0 |
| 2010-03 | RP-47 | RP-100254 | 410 | | | Idle mode corrections | 9.3.0 |
| 2010-03 | RP-47 | RP-100254 | 405 | 1 | | UE measurement capability requirements in Idle and Connected | 9.3.0 |
| 2010-03 | RP-47 | RP-100254 | 423 | | | Correction to UE Measurement Capability Requirements in Idle Mode | 9.3.0 |
| 2010-03 | RP-47 | RP-100254 | 412 | | | Removal of activation time from interRAT handover requirements | 9.3.0 |
| 2010-03 | RP-47 | RP-100254 | 417 | 1 | | Correction to UE Transmit Timing Requirements | 9.3.0 |
| 2010-03 | RP-47 | RP-100254 | 402 | | | Correction of E-UTRAN TDD inter frequency measurements_R9 | 9.3.0 |
| 2010-03 | RP-47 | RP-100254 | 414 | 1 | | Enhanced GSM Requirements for CSFB | 9.3.0 |
| 2010-03 | RP-47 | RP-100254 | 415 | 1 | | Enhanced UTRA FDD Requirements for CSFB | 9.3.0 |
| 2010-03 | RP-47 | RP-100255 | 399 | | | Correction of RSRP value in E-UTRAN FDDFDD Inter frequency reselection test | 9.3.0 |
| 2010-03 | RP-47 | RP-100255 | 397 | | | Addition of missing Es/Noc parameters in RRM test cases | 9.3.0 |
| 2010-03 | RP-47 | RP-100255 | 421 | | | Correction to RRC Re-establishment Test Case | 9.3.0 |
| 2010-03 | RP-47 | RP-100255 | 427 | 1 | | Correction of UE transmit timing test case | 9.3.0 |
| 2010-03 | RP-47 | RP-100255 | 419 | 1 | | Correction to RLM Test Cases | 9.3.0 |
| 2010-03 | RP-47 | RP-100262 | 407 | | | Editorial Corrections in TS36.133(Rel-9) | 9.3.0 |

| | | | | | | | |
|---------|-------|-----------|-----|---|--|---|-------|
| 2010-03 | RP-47 | RP-100263 | 413 | | | Introduction of LTE in 800 MHz for Europe requirements in TS 36.133 | 9.3.0 |
| 2010-03 | RP-47 | RP-100264 | 395 | | | Corrections for Extended UMTS1500 in TS36.133(Rel-9) | 9.3.0 |
| 2010-03 | RP-47 | RP-100269 | 393 | | | AOA and TA measurement report mappings | 9.3.0 |
| 2010-03 | RP-47 | RP-100269 | 403 | 2 | | Mapping of UE RxTx time difference measurement | 9.3.0 |
| 2010-03 | RP-47 | RP-100266 | 425 | 2 | | Home eNode B synchronization requirement | 9.3.0 |
| 2010-03 | RP-47 | RP-100266 | 424 | 2 | | Minimum requirements on SI reading for HeNB inbound mobility | 9.3.0 |
| 2010-06 | RP-48 | RP-100622 | 473 | | | Clarification on radio link monitoring | 9.4.0 |
| 2010-06 | | | | | | Corrections of clause numbering on the test case of E-UTRAN FDD-FDD inter-frequency cell search requirements for L3 filtering | 9.4.0 |
| 2010-06 | RP-48 | RP-100622 | 472 | | | | |
| 2010-06 | RP-48 | RP-100622 | 466 | 1 | | Correction to RRM Test Cases | 9.4.0 |
| 2010-06 | RP-48 | RP-100622 | 464 | | | Correction to RRM Requirements | 9.4.0 |
| 2010-06 | RP-48 | RP-100622 | 462 | 1 | | Correction to Absolute RSRP/RSRQ Definitions | 9.4.0 |
| 2010-06 | | | | | | UE Measurement Capability Requirements for CDMA2000 | 9.4.0 |
| 2010-06 | RP-48 | RP-100622 | 457 | | | | |
| 2010-06 | RP-48 | RP-100622 | 455 | 1 | | Correction of E-UTRAN Inter-frequency Cell Re-selection Requirements | 9.4.0 |
| 2010-06 | RP-48 | RP-100622 | 451 | 1 | | Correction to idle mode requirements(Rel-9) | 9.4.0 |
| 2010-06 | RP-48 | RP-100622 | 449 | 1 | | Editorial corrections to 36.133(Rel-9) | 9.4.0 |
| 2010-06 | | | | | | Correction to TDD intrafrequency accuracy test case | 9.4.0 |
| 2010-06 | RP-48 | RP-100622 | 447 | | | | |
| 2010-06 | RP-48 | RP-100622 | 441 | 1 | | Correction of Io value in E-UTRAN FDD and TDD Inter frequency RSRP tests | 9.4.0 |
| 2010-06 | RP-48 | RP-100627 | 444 | 2 | | Corrections to CSG SI reading core requirement | 9.4.0 |
| 2010-06 | RP-48 | RP-100627 | 445 | 1 | | RSRQ idle mode requirements | 9.4.0 |
| 2010-06 | RP-48 | RP-100630 | 470 | 1 | | Test cases for R9 cell reselection enhancements | 9.4.0 |
| 2010-06 | RP-48 | RP-100630 | 460 | | | Missing E-UTRA - UTRA FDD DRX Requirements | 9.4.0 |
| 2010-06 | | | | | | Corrections to enhanced cell identification core requirement | 9.4.0 |
| 2010-06 | RP-48 | RP-100631 | 442 | 2 | | | |
| 2010-06 | | | | | | Applicability of mobility requirements with inter-frequency RSTD measurements | 9.4.0 |
| 2010-06 | RP-48 | RP-100632 | 469 | | | | |
| 2010-06 | RP-48 | RP-100632 | 439 | | | UE Rx-Tx Time Difference Measurement Requirements for E-CID | 9.4.0 |
| 2010-06 | | | | | | CR UE RX-TX time-difference measurement requirement | 9.4.0 |
| 2010-06 | RP-48 | RP-100632 | 438 | 2 | | | |
| 2010-06 | RP-48 | RP-100632 | 433 | 5 | | RSTD Measurement Requirements for OTDOA | 9.4.0 |
| 2010-06 | RP-48 | RP-100632 | 432 | 5 | | RSTD Accuracy Requirements for OTDOA | 9.4.0 |
| 2010-09 | RP-49 | RP-100914 | 477 | 1 | | Cell identity change time in RRM Test cases | 9.5.0 |
| 2010-09 | RP-49 | RP-100919 | 537 | | | A clarification text in the RSTD intra-frequency accuracy requirements | 9.5.0 |
| 2010-09 | RP-49 | RP-100920 | 506 | | | Correction of drx-RetransmissionTimer parameters | 9.5.0 |
| 2010-09 | RP-49 | RP-100915 | 508 | | | Correction of Io value in RSRP FDD and TDD Intra frequency test | 9.5.0 |
| 2010-09 | RP-49 | RP-100920 | 521 | 1 | | Editorial corrections to 36.133 (R9) | 9.5.0 |
| 2010-09 | RP-49 | RP-100914 | 523 | | | Alignment of REFSENS between 36.101 and 36.133(R9) | 9.5.0 |
| 2010-09 | RP-49 | RP-100920 | 525 | 1 | | Correction of Time to Trigger unit for 36.133(R9) | 9.5.0 |
| 2010-09 | RP-49 | RP-100915 | 505 | 1 | | Corrections to 36.133(R9) | 9.5.0 |
| 2010-09 | RP-49 | RP-100920 | 528 | 1 | | E-UTRAN FDD Intra Frequency RSTD Measurement Accuracy test case | 9.5.0 |
| 2010-09 | RP-49 | RP-100919 | 538 | 1 | | Correction to Enhanced BSIC Verification Requirements | 9.5.0 |
| 2010-09 | RP-49 | RP-100919 | 539 | | | Enhanced CSFB Requirements with DRX | 9.5.0 |
| 2010-09 | RP-49 | RP-100919 | 540 | | | Correction to E-CID Requirements | 9.5.0 |
| 2010-09 | RP-49 | RP-100920 | 544 | 1 | | Addition of UTRA and GSM enhanced cell identification test cases | 9.5.0 |
| 2010-09 | RP-49 | RP-100920 | 547 | 1 | | E-UTRAN FDD UE Rx – Tx Time Difference Measurement Accuracy test case | 9.5.0 |
| 2010-09 | RP-49 | RP-100914 | 479 | 1 | | Scrambling code change time in RRM Test cases | 9.5.0 |
| 2010-09 | RP-49 | RP-100914 | 549 | | | Introduction of CSG cell reselection requirements | 9.5.0 |
| 2010-09 | RP-49 | RP-100920 | 527 | | | correction of redundant Hysteresis(Hys) for 36.133(R9) | 9.5.0 |
| 2010-09 | RP-49 | RP-100920 | 488 | 2 | | Test case for TDD UE Rx-Tx time difference measurement | 9.5.0 |
| 2010-09 | RP-49 | RP-100914 | 483 | | | Clarification of Radio link monitoring test cases | 9.5.0 |
| 2010-09 | RP-49 | RP-100915 | 485 | | | Test case for E-UTRA TDD event triggered reporting when L3 filtering is used in R9 | 9.5.0 |
| 2010-09 | RP-49 | RP-100915 | 487 | | | E-UTRA TDD - UTRA TDD cell reselection in fading propagation conditions: UTRA TDD is of lower | 9.5.0 |

| | | | | | | | |
|---------|-------|-----------|-----|---|--|--|--------|
| | | | | | | priority in R9 | |
| 2010-09 | RP-49 | RP-100924 | 492 | | | Test case for E-UTRAN TDD in the existence of non-allowed CSG cell | 9.5.0 |
| 2010-09 | RP-49 | RP-100915 | 494 | | | PDCCH Aggregation level for RRM tests | 9.5.0 |
| 2010-09 | RP-49 | RP-100915 | 503 | | | Correction of ES/lot value in E-UTRAN RSRQ FDD intra frequency test | 9.5.0 |
| 2010-09 | RP-49 | RP-100915 | 496 | | | Corrections to RRM OCNG Patterns | 9.5.0 |
| 2010-09 | RP-49 | RP-100919 | 498 | | | RRC timer accuracy requirement | 9.5.0 |
| 2010-09 | RP-49 | RP-100915 | 501 | | | Correction of OCNG | 9.5.0 |
| 2010-09 | RP-49 | RP-100914 | 477 | 1 | | Cell identity change time in RRM Test cases | 9.5.0 |
| 2010-09 | RP-49 | RP-100919 | 537 | | | A clarification text in the RSTD intra-frequency accuracy requirements | 9.5.0 |
| 2010-09 | RP-49 | RP-100920 | 506 | | | Correction of drx-RetransmissionTimer parameters | 9.5.0 |
| 2010-09 | RP-49 | RP-100915 | 508 | | | Correction of Io value in RSRP FDD and TDD Intra frequency test | 9.5.0 |
| 2010-09 | RP-49 | RP-100920 | 521 | 1 | | Editorial corrections to 36.133 (R9) | 9.5.0 |
| 2010-09 | RP-49 | RP-100914 | 523 | | | Alignment of REFSENS between 36.101 and 36.133(R9) | 9.5.0 |
| 2010-09 | RP-49 | RP-100920 | 525 | 1 | | Correction of Time to Trigger unit for 36.133(R9) | 9.5.0 |
| 2010-09 | RP-49 | RP-100915 | 505 | 1 | | Corrections to 36.133(R9) | 9.5.0 |
| 2010-09 | RP-49 | RP-100920 | 528 | 1 | | E-UTRAN FDD Intra Frequency RSTD Measurement Accuracy test case | 9.5.0 |
| 2010-09 | RP-49 | RP-100919 | 538 | 1 | | Correction to Enhanced BSIC Verification Requirements | 9.5.0 |
| 2010-09 | RP-49 | RP-100919 | 539 | | | Enhanced CSFB Requirements with DRX | 9.5.0 |
| 2010-09 | RP-49 | RP-100919 | 540 | | | Correction to E-CID Requirements | 9.5.0 |
| 2010-09 | RP-49 | RP-100920 | 544 | 1 | | Addition of UTRA and GSM enhanced cell identification test cases | 9.5.0 |
| 2010-09 | RP-49 | RP-100920 | 547 | 1 | | E-UTRAN FDD UE Rx – Tx Time Difference Measurement Accuracy test case | 9.5.0 |
| 2010-09 | RP-49 | RP-100914 | 479 | 1 | | Scrambling code change time in RRM Test cases | 9.5.0 |
| 2010-09 | RP-49 | RP-100914 | 549 | | | Introduction of CSG cell reselection requirements | 9.5.0 |
| 2010-09 | RP-49 | RP-100920 | 527 | | | correction of redundant Hysteresis(Hys) for 36.133(R9) | 9.5.0 |
| 2010-09 | RP-49 | RP-100920 | 488 | 2 | | Test case for TDD UE Rx-Tx time difference measurement | 9.5.0 |
| 2010-09 | RP-49 | RP-100914 | 483 | | | Clarification of Radio link monitoring test cases | 9.5.0 |
| 2010-09 | RP-49 | RP-100915 | 485 | | | Test case for E-UTRA TDD event triggered reporting when L3 filtering is used in R9 | 9.5.0 |
| 2010-09 | RP-49 | RP-100915 | 487 | | | E-UTRA TDD - UTRA TDD cell reselection in fading propagation conditions: UTRA TDD is of lower priority in R9 | 9.5.0 |
| 2010-09 | RP-49 | RP-100924 | 492 | | | Test case for E-UTRAN TDD in the existence of non-allowed CSG cell | 9.5.0 |
| 2010-09 | RP-49 | RP-100915 | 494 | | | PDCCH Aggregation level for RRM tests | 9.5.0 |
| 2010-09 | RP-49 | RP-100915 | 503 | | | Correction of ES/lot value in E-UTRAN RSRQ FDD intra frequency test | 9.5.0 |
| 2010-09 | RP-49 | RP-100915 | 496 | | | Corrections to RRM OCNG Patterns | 9.5.0 |
| 2010-09 | RP-49 | RP-100919 | 498 | | | RRC timer accuracy requirement | 9.5.0 |
| 2010-09 | RP-49 | RP-100915 | 501 | | | Correction of OCNG | 9.5.0 |
| 2010-09 | RP-49 | RP-100927 | 497 | | | CR LTE_TDD_2600_US spectrum band definition additions to TS 36.133 | 10.0.0 |
| 2010-12 | RP-50 | RP-101331 | 635 | | | Corrections to 36.133 performance requirements | 10.1.0 |
| 2010-12 | RP-50 | RP-101331 | 638 | | | Correction to intra frequency cell identification time for FDD and TDD | 10.1.0 |
| 2010-12 | RP-50 | RP-101331 | 566 | 1 | | Corrections and Clarifications to TS36.133 | 10.1.0 |
| 2010-12 | RP-50 | RP-101331 | 592 | 2 | | Correction to Radio link monitoring test cases | 10.1.0 |
| 2010-12 | RP-50 | RP-101332 | 563 | | | PDCCH Aggregation Level for RRM Tests | 10.1.0 |
| 2010-12 | RP-50 | RP-101332 | 571 | | | MIMO correlation scenario for RLM test cases | 10.1.0 |
| 2010-12 | RP-50 | RP-101332 | 580 | | | Removal of [] from PDSCH and PCFICH/PDCCH/PHICH Measurement Channel references in Annex A. | 10.1.0 |
| 2010-12 | RP-50 | RP-101332 | 585 | | | Enabling HARQ for RRM Tests | 10.1.0 |
| 2010-12 | RP-50 | RP-101335 | 643 | 1 | | Completion of CSG cell reselection requirements | 10.1.0 |
| 2010-12 | RP-50 | RP-101343 | 568 | | | Clarification of measurements requirements for HRPD and cdma2000 1x | 10.1.0 |
| 2010-12 | RP-50 | RP-101343 | 589 | | | Addition of Band 18, 19 and 21 into UE Rx - Tx time difference requirements | 10.1.0 |
| 2010-12 | RP-50 | RP-101343 | 604 | | | Correction to Enhanced GSM Cell Identification Requirement | 10.1.0 |
| 2010-12 | RP-50 | RP-101343 | 632 | | | Correction of reselection requirement for UTRAN FDD cells | 10.1.0 |

| | | | | | | | |
|---------|-------|-----------|------|---|--|--|--------|
| 2010-12 | RP-50 | RP-101343 | 640 | | | Correction to Enhanced UTRA FDD Cell Identification Requirements | 10.1.0 |
| 2010-12 | RP-50 | RP-101343 | 645 | | | E-UTRAN TDD Intra Frequency RSTD Measurement Accuracy test case | 10.1.0 |
| 2010-12 | RP-50 | RP-101343 | 621 | 1 | | Correction for Measurements of inter-RAT cells | 10.1.0 |
| 2010-12 | RP-50 | RP-101343 | 598 | 2 | | E-UTRAN FDD intra-frequency RSTD measurement reporting delay test case | 10.1.0 |
| 2010-12 | RP-50 | RP-101343 | 600 | 2 | | E-UTRAN TDD intra-frequency RSTD measurement reporting delay test case | 10.1.0 |
| 2010-12 | RP-50 | RP-101356 | 644 | | | Band 42 and 43 parameters for UMTS/LTE 3500 (TDD) for TS 36.133 | 10.1.0 |
| 2010-12 | RP-50 | RP-101361 | 552 | | | Introduction of L-band in TS36.133 | 10.1.0 |
| 2010-12 | RP-50 | RP-101388 | 648 | | | Removal of square brackets from scope of TS36.133 | 10.1.0 |
| 2011-04 | RP-51 | RP-110359 | 0658 | - | | Addition of UE RRM capabilities for CA | 10.2.0 |
| 2011-04 | RP-51 | RP-110340 | 0663 | - | | Correction to E-UTRAN TDD in-sync test requirements | 10.2.0 |
| 2011-04 | RP-51 | RP-110348 | 0665 | 1 | | RSTD requirements, RMC and OCNG patterns | 10.2.0 |
| 2011-04 | RP-51 | RP-110350 | 0669 | - | | CR to 36.133: Aligning relevant RRM requirements for Band 41 with the reference sensitivity values in 36.101 | 10.2.0 |
| 2011-04 | RP-51 | RP-110339 | 0676 | - | | Modification on test case of E-UTRA TDD to UTRA TDD cell reselection(R10) | 10.2.0 |
| 2011-04 | RP-51 | RP-110339 | 0681 | 1 | | Value of MS_TXPWR_MAX_CCH for EUTRA-GSM reselection test cases A.4.4.x | 10.2.0 |
| 2011-04 | RP-51 | RP-110339 | 0687 | 1 | | Rearrangement of Time periods for EUTRA-UTRA reselection test case A.4.3.1.1 | 10.2.0 |
| 2011-04 | RP-51 | RP-110339 | 0690 | 1 | | Removal of "Force to Cell 2" during initialisation for EUTRA-UTRA reselection test case A.4.3.1.2 | 10.2.0 |
| 2011-04 | RP-51 | RP-110340 | 0693 | 1 | | SNR for RRM A.8.x test cases using ETU70 | 10.2.0 |
| 2011-04 | RP-51 | RP-110408 | 0697 | 1 | | Requirements for Minimization of Drive Tests (MDT) in LTE | |
| 2011-04 | RP-51 | RP-110339 | 0703 | - | | Correction to test cases of E-UTRA to UTRA cell reselection when UE is in idle state | 10.2.0 |
| 2011-04 | RP-51 | RP-110359 | 0706 | 2 | | Introduction of measurement requirements for carrier aggregation | 10.2.0 |
| 2011-04 | RP-51 | RP-110347 | 0709 | 1 | | Addition of test cases for FDD intra-frequency SI reading using autonomous gaps with both non DRX and DRX for Rel-10 | 10.2.0 |
| 2011-04 | RP-51 | RP-110347 | 0711 | 1 | | Addition of test cases for FDD inter-frequency SI reading using autonomous gaps with both non DRX and DRX for Rel-10 | 10.2.0 |
| 2011-04 | RP-51 | RP-110359 | 0713 | 1 | | Introduction of core requirements of radio link monitoring in CA | 10.2.0 |
| 2011-04 | RP-51 | RP-110339 | 0719 | 1 | | Modification on Test Requirements in E-UTRA - UTRA TDD SON Test Case (A.8.7.3) (R10) | 10.2.0 |
| 2011-04 | RP-51 | RP-110348 | 0727 | 2 | | Requirements for reporting criteria with positioning measurements | 10.2.0 |
| 2011-04 | RP-51 | RP-110340 | 0736 | - | | Correction of RLM evaluation period in DRX | 10.2.0 |
| 2011-04 | RP-51 | RP-110340 | 0739 | - | | Correction of inter-frequency measurement accuracy test cases | 10.2.0 |
| 2011-04 | RP-51 | RP-110339 | 0744 | - | | Modification on Test Requirements in E-UTRA GSM cell reselection Test Case (A.4.4) (R10) | 10.2.0 |
| 2011-04 | RP-51 | RP-110348 | 0747 | 1 | | Corrections to RSTD measurement for Rel-9 | 10.2.0 |
| 2011-04 | RP-51 | RP-110348 | 0748 | - | | Correction on FDD Intra Frequency RSTD Measurement Accuracy test case | 10.2.0 |
| 2011-04 | RP-51 | RP-110348 | 0751 | 1 | | RSTD test case corrections | 10.2.0 |
| 2011-04 | RP-51 | RP-110344 | 0753 | - | | Correction of serving cell performance requirements for autonomous SI acquisition | 10.2.0 |
| 2011-06 | RP-52 | RP-110753 | 0785 | 1 | | Simplification of frequency dependent requirements in 36.133 (Table B.2.2-1 contains erroneous values. These wrong values will be corrected in the RAN#53 meeting.) | 10.3.0 |
| 2011-06 | RP-52 | RP-110793 | 754 | | | E-UTRAN FDD-FDD inter-frequency RSTD measurement reporting delay test case with the reference cell on the serving carrier frequency | 10.3.0 |
| 2011-06 | RP-52 | RP-110793 | 755 | | | E-UTRAN TDD-TDD inter-frequency RSTD measurement reporting delay test case with the reference cell on the serving carrier frequency | 10.3.0 |
| 2011-06 | RP-52 | RP-110807 | 757 | | | Core requirements on RRC connection mobility control in CA | 10.3.0 |
| 2011-06 | RP-52 | RP-110807 | 758 | | | Timing core requirements in CA | 10.3.0 |
| 2011-06 | RP-52 | RP-110807 | 759 | | | Introduction of Handover Requirements for Carrier | 10.3.0 |

| | | | | | | | |
|---------|-------|-----------|-----|---|--|--|--------|
| | | | | | | Aggregation | |
| 2011-06 | RP-52 | RP-110793 | 760 | | | E-UTRAN FDD Inter Frequency RSTD Measurement Accuracy test case | 10.3.0 |
| 2011-06 | RP-52 | RP-110793 | 761 | | | E-UTRAN TDD Inter Frequency RSTD Measurement Accuracy test case | 10.3.0 |
| 2011-06 | RP-52 | RP-110786 | 765 | | | Rearrangement of Time periods for EUTRA-UTRA reselection test case A.4.3.4.1 | 10.3.0 |
| 2011-06 | RP-52 | RP-110786 | 768 | | | Removal of "Force to Cell 2" during initialisation for EUTRA -UTRA reselection test cases | 10.3.0 |
| 2011-06 | RP-52 | RP-110807 | 776 | | | Introduction of UE interruption requirements in SCC measurements with de-activated SCell | 10.3.0 |
| 2011-06 | RP-52 | RP-110794 | 797 | | | Editorial Correction to Cell Re-selection Requirements | 10.3.0 |
| 2011-06 | RP-52 | RP-110789 | 808 | | | Correction to side conditions for TDD inter-frequency CGI identification for Rel-10 | 10.3.0 |
| 2011-06 | RP-52 | RP-110786 | 814 | | | Correction to inter-RAT cell identification time in DRX for Rel-10 | 10.3.0 |
| 2011-06 | RP-52 | RP-110787 | 817 | | | Correction to identification time of UTRA FDD cell for SON in DRX for Rel-10 | 10.3.0 |
| 2011-06 | RP-52 | RP-110787 | 822 | | | Correction to requirements of E-UTRAN TDDUTRAN TDD measurements for SON when DRX is used for Rel-10 | 10.3.0 |
| 2011-06 | RP-52 | RP-110807 | 829 | | | Correction to the side condition for measurements for E-UTRA carrier aggregation | 10.3.0 |
| 2011-06 | RP-52 | RP-110803 | 850 | | | CR Timestamp accuracy requirements for MDT | 10.3.0 |
| 2011-06 | RP-52 | RP-110812 | 778 | 1 | | Add 2GHz S-Band (Band 23) in 36.133 | 10.3.0 |
| 2011-06 | RP-52 | RP-110796 | 787 | 1 | | Clarification on inter-frequency layers for RSTD | 10.3.0 |
| 2011-06 | RP-52 | RP-110794 | 780 | 1 | | Correction to RSTD measurement for Rel-10 | 10.3.0 |
| 2011-06 | RP-52 | RP-110807 | 852 | 1 | | Pcm _{max,c} mapping | 10.3.0 |
| 2011-06 | RP-52 | RP-110787 | 771 | 1 | | Clarification of Radio link monitoring test requirements (The CR was not implemented as it is not based on the latest version of the specification) | 10.3.0 |
| 2011-06 | RP-52 | RP-110807 | 793 | 1 | | E-CID Measurement Requirements under Pcell Switching | 10.3.0 |
| 2011-06 | RP-52 | RP-110807 | 775 | 1 | | Removal of undefined intra-freq RSRQ relative accuracy requirements in CA | 10.3.0 |
| 2011-06 | RP-52 | RP-110789 | 856 | | | Correction on E-UTRAN FDD RSTD intra frequency case | 10.3.0 |
| 2011-06 | RP-52 | RP-110796 | 800 | 1 | | Addition of E-UTRAN FDD/TDD cdma2000 1xRTT measurements requirement for SON for Rel-10 | 10.3.0 |
| 2011-06 | RP-52 | RP-110790 | 804 | 1 | | Addition of test cases for TDD intra-frequency SI reading using autonomous gaps with both non DRX and DRX for Rel-10 | 10.3.0 |
| 2011-06 | RP-52 | RP-110790 | 806 | 1 | | Addition of test cases for TDD inter-frequency SI reading using autonomous gaps with both non DRX and DRX for Rel-10 | 10.3.0 |
| 2011-06 | RP-52 | RP-110787 | 828 | 1 | | Addition of missing EsNoc parameters in E-UTRAN TDD UTRAN TDD Measurements test cases for Rel-10 | 10.3.0 |
| 2011-06 | RP-52 | RP-110807 | 835 | 1 | | Clarification of UE Rx-Tx time difference measurement requirement for carrier aggregation | 10.3.0 |
| 2011-06 | RP-52 | RP-110804 | 859 | | | Expanded 1900 MHz addition to 36.133 | 10.3.0 |
| 2011-06 | RP-52 | RP-110811 | 860 | | | Introduction of RLM requirement for eICIC | 10.3.0 |
| 2011-06 | RP-52 | RP-110796 | 794 | 1 | | E-CID Measurement Requirements under Handover | 10.3.0 |
| 2011-06 | RP-52 | RP-110811 | 762 | 1 | | CR on RLM requirements for eICIC | 10.3.0 |
| 2011-06 | RP-52 | RP-110811 | 788 | 2 | | RSRP and RSRQ measurement requirements for eICIC | 10.3.0 |
| 2011-06 | RP-52 | RP-110811 | 851 | 1 | | CR on RSRP and RSRQ measurement accuracy requirements for eICIC | 10.3.0 |
| 2011-06 | RP-52 | RP-110807 | 802 | 2 | | Addition of OTDOA measurement requirement for E-UTRAN carrier aggregation | 10.3.0 |
| 2011-09 | RP-53 | RP-111246 | 863 | | | Thresholds and margins for reporting of neighbour cells in RRM test A.8.9.1 | 10.4.0 |
| 2011-09 | RP-53 | RP-111246 | 902 | | | Thresholds and margins for RRM tests A.5.2.1 and A.5.2.2 | 10.4.0 |
| 2011-09 | RP-53 | RP-111246 | 905 | | | Thresholds and margins for RRM tests A.5.2.4 and A.5.2.5 | 10.4.0 |
| 2011-09 | RP-53 | RP-111247 | 889 | | | Removing [] in clause 8.1.2.2.2.2 for Rel-10 | 10.4.0 |
| 2011-09 | RP-53 | RP-111247 | 915 | | | Adding condition of UTRA TDD measurement report delay requirements applied | 10.4.0 |
| 2011-09 | RP-53 | RP-111247 | 930 | | | Clarify time points and time duration for RLM tests | 10.4.0 |

| | | | | | | | |
|---------|-------|-----------|------|---|--|--|--------|
| | | | | | | A.7.3.x | |
| 2011-09 | RP-53 | RP-111251 | 926 | 1 | | Adding enhanced UTRA TDD cell identification requirements for Rel-10 | 10.4.0 |
| 2011-09 | RP-53 | RP-111251 | 969 | | | CR for E-UTRAN FDD GSM event triggered reporting in AWGN with enhanced BSIC identification in R10 | 10.4.0 |
| 2011-09 | RP-53 | RP-111252 | 894 | | | Requirements for RRC Connection Release with Redirection | 10.4.0 |
| 2011-09 | RP-53 | RP-111252 | 960 | | | Missing RSRQ in Intra-frequency measurement requirements | 10.4.0 |
| 2011-09 | RP-53 | RP-111252 | 965 | 1 | | Requirements for RRC Connection Release with Redirection for TDD in R10 | 10.4.0 |
| 2011-09 | RP-53 | RP-111255 | 946 | | | Introduction of Band 22 | 10.4.0 |
| 2011-09 | RP-53 | RP-111255 | 979 | 1 | | Modifications of Band 42 and 43 | 10.4.0 |
| 2011-09 | RP-53 | RP-111263 | 879 | 1 | | Correction to RRC connection mobility control in CA | 10.4.0 |
| 2011-09 | RP-53 | RP-111263 | 895 | 2 | | RSTD Measurement Requirements under Handover | 10.4.0 |
| 2011-09 | RP-53 | RP-111263 | 896 | 2 | | RSTD Measurement Requirements under Pcell Switching | 10.4.0 |
| 2011-09 | RP-53 | RP-111263 | 920 | 1 | | Editorial corrections for 36.133 (Rel-10) | 10.4.0 |
| 2011-09 | RP-53 | RP-111263 | 924 | 1 | | Correction to RRC connection mobility control in CA | 10.4.0 |
| 2011-09 | RP-53 | RP-111263 | 927 | | | Modifications on TDD inter frequency measurements with autonomous gaps | 10.4.0 |
| 2011-09 | RP-53 | RP-111263 | 945 | 1 | | Frequency band related requirements to 36.133 | 10.4.0 |
| 2011-09 | RP-53 | RP-111263 | 949 | 1 | | Correction of references | 10.4.0 |
| 2011-09 | RP-53 | RP-111263 | 950 | | | Alignment of the carrier aggregation terminology | 10.4.0 |
| 2011-09 | RP-53 | RP-111263 | 951 | | | Band simplification for core requirements | 10.4.0 |
| 2011-09 | RP-53 | RP-111263 | 952 | | | Clarification in inter-frequency RSTD accuracy tests | 10.4.0 |
| 2011-09 | RP-53 | RP-111263 | 953 | 1 | | Editorial corrections for RRM requirements | 10.4.0 |
| 2011-09 | RP-53 | RP-111263 | 961 | | | Missing RSRQ in E-UTRA carrier aggregation measurement requirements | 10.4.0 |
| 2011-09 | RP-53 | RP-111265 | 874 | 1 | | Clarification of TDD uplink-downlink subframe configurations applicability for RSTD measurement in CA | 10.4.0 |
| 2011-09 | RP-53 | RP-111265 | 875 | 3 | | CR on UE interruption requirements in SCC measurements with de-activated SCell when common DRX is used | 10.4.0 |
| 2011-09 | RP-53 | RP-111265 | 883 | 1 | | Alignment of terminology for SCell measurement cycle | 10.4.0 |
| 2011-09 | RP-53 | RP-111265 | 921 | 1 | | Introduction of P _{max,c} reporting requirements for carrier aggregation | 10.4.0 |
| 2011-09 | RP-53 | RP-111266 | 849 | 3 | | RSTD Accuracy Requirements for Carrier Aggregation | 10.4.0 |
| 2011-09 | RP-53 | RP-111266 | 898 | 1 | | Introduction of power headroom reporting requirement for carrier aggregation | 10.4.0 |
| 2011-09 | RP-53 | RP-111308 | 891 | 1 | | RSRP and RSRQ measurement requirements for eICIC | 10.4.0 |
| 2011-12 | RP-54 | RP-111681 | 982 | | | Corrections of inter-frequency measurement accuracy RSRP and RSRQ test cases | 10.5.0 |
| 2011-12 | RP-54 | RP-111682 | 984 | | | Removing [] in CSFB requirement for Rel-10 | 10.5.0 |
| 2011-12 | RP-54 | RP-111693 | 985 | | | Reference channel for RLM testing with eICIC | 10.5.0 |
| 2011-12 | RP-54 | RP-111683 | 987 | | | Clarification on RSTD test cases | 10.5.0 |
| 2011-12 | RP-54 | RP-111690 | 988 | | | RSRP Measurement performance Io corrections | 10.5.0 |
| 2011-12 | RP-54 | RP-111686 | 989 | | | RLM measurement requirements for eICIC | 10.5.0 |
| 2011-12 | RP-54 | RP-111693 | 990 | | | PDCCH/PCFICH transmission parameters for RLM | 10.5.0 |
| 2011-12 | RP-54 | RP-111683 | 992 | | | Clarification on PRS bandwidth | 10.5.0 |
| 2011-12 | RP-54 | RP-111735 | 993 | | | Missing RSRQ in intra-frequency measurement requirements for eICIC | 10.5.0 |
| 2011-12 | RP-54 | RP-111686 | 994 | 1 | | Test case for TDD RSRQ Accuracy for Carrier Aggregation | 10.5.0 |
| 2011-12 | RP-54 | RP-111686 | 995 | | | Cell identification requirements without DRX | 10.5.0 |
| 2011-12 | RP-54 | RP-111693 | 997 | 1 | | Test case for cell identification with eICIC in E-UTRAN FDD | 10.5.0 |
| 2011-12 | RP-54 | RP-111693 | 998 | 1 | | Test case for cell identification with eICIC in E-UTRAN TDD | 10.5.0 |
| 2011-12 | RP-54 | RP-111691 | 999 | 1 | | Carrier aggregation RSRP measurement test case for TDD | 10.5.0 |
| 2011-12 | RP-54 | RP-111690 | 1001 | | | Test case for enhanced UTRA TDD cell identification for R10 | 10.5.0 |
| 2011-12 | RP-54 | RP-111690 | 1003 | | | Test case for RRC connection release redirection to UTRA TDD for R10 | 10.5.0 |
| 2011-12 | RP-54 | RP-111735 | 1005 | | | Clarification of the Successful Percentage for Measurement Performance Requirements | 10.5.0 |

| | | | | | | | |
|---------|-------|-----------|------|---|--|---|--------|
| 2011-12 | RP-54 | RP-111691 | 1007 | 2 | | FDD Absolute and Relative RSRQ Accuracy test in CA | 10.5.0 |
| 2011-12 | RP-54 | RP-111691 | 1011 | 1 | | FDD absolute and relative RSRP accuracies test in CA | 10.5.0 |
| 2011-12 | RP-54 | RP-111693 | 1014 | 1 | | E-UTRAN TDD Radio Link Monitoring Test for Out-of-sync under time domain measurement resource restriction | 10.5.0 |
| 2011-12 | RP-54 | RP-111735 | 1016 | | | E-UTRAN FDD - UTRAN TDD enhanced cell identification test under AWGN propagation conditions in R10 | 10.5.0 |
| 2011-12 | RP-54 | RP-111735 | 1018 | 1 | | E-UTRAN FDD RRC connection release with redirection to UTRAN TDD in R10 | 10.5.0 |
| 2011-12 | RP-54 | RP-111735 | 1021 | 1 | | CR for Inter-RAT SI reading | 10.5.0 |
| 2011-12 | RP-54 | RP-111687 | 1022 | | | Addition of E-UTRAN FDD - TDD Inter frequency cell reselection test case | 10.5.0 |
| 2011-12 | RP-54 | RP-111687 | 1023 | | | Addition of E-UTRAN TDD - FDD Inter frequency cell reselection test case | 10.5.0 |
| 2011-12 | RP-54 | RP-111687 | 1024 | | | Addition of E-UTRAN FDD - TDD Inter frequency handover test case | 10.5.0 |
| 2011-12 | RP-54 | RP-111687 | 1025 | | | Addition of E-UTRAN TDD - FDD Inter frequency handover test case | 10.5.0 |
| 2011-12 | RP-54 | RP-111687 | 1026 | | | Addition of E-UTRAN TDD-FDD Inter-frequency event triggered reporting under fading propagation conditions in asynchronous cells test case | 10.5.0 |
| 2011-12 | RP-54 | RP-111687 | 1027 | 1 | | Addition of E-UTRAN FDD-TDD Inter-frequency event triggered reporting under fading propagation conditions in asynchronous cells test case | 10.5.0 |
| 2011-12 | RP-54 | RP-111687 | 1028 | | | Addition of E-UTRAN FDD - TDD inter frequency measurement accuracy test case | 10.5.0 |
| 2011-12 | RP-54 | RP-111681 | 1031 | | | Correction for the identification time in DRX for UTRA TDD in R10 | 10.5.0 |
| 2011-12 | RP-54 | RP-111735 | 1032 | | | Correction the side condition for SCH in R10 | 10.5.0 |
| 2011-12 | RP-54 | RP-111735 | 1033 | 1 | | Correction to event triggered reporting for TS 36.133 in R10 | 10.5.0 |
| 2011-12 | RP-54 | RP-111681 | 1039 | 1 | | Correction of E-UTRAN TDD-TDD inter frequency handover test case in R10 | 10.5.0 |
| 2011-12 | RP-54 | RP-111735 | 1041 | | | Clarification of Expected RSTD and Expected RSTD uncertainty in RSTD test cases in R10 | 10.5.0 |
| 2011-12 | RP-54 | RP-111680 | 1043 | | | Thresholds and margins for RRM tests A.8.11.3 and A.8.11.4 | 10.5.0 |
| 2011-12 | RP-54 | RP-111683 | 1046 | | | Thresholds and margins for RRM tests A.8.11.5 and A.8.11.6 | 10.5.0 |
| 2011-12 | RP-54 | RP-111693 | 1047 | 2 | | RLM Out of Sync Detection Test for eICIC | 10.5.0 |
| 2011-12 | RP-54 | RP-111683 | 1049 | | | RRC Connection Release with Redirection from E-UTRAN FDD to GERAN | 10.5.0 |
| 2011-12 | RP-54 | RP-111693 | 1051 | | | Colliding CRS in non-MBSFN ABS | 10.5.0 |
| 2011-12 | RP-54 | RP-111683 | 1052 | | | RRC Connection Release with Redirection from E-UTRAN TDD to GERAN | 10.5.0 |
| 2011-12 | RP-54 | RP-111693 | 1053 | 1 | | RLM In Sync Detection Test for FDD eICIC | 10.5.0 |
| 2011-12 | RP-54 | RP-111693 | 1054 | 1 | | RLM In Sync Detection Test for FDD eICIC | 10.5.0 |
| 2011-12 | RP-54 | RP-111691 | 1055 | 1 | | FDD Event triggered reporting on deactivated Scell in non-DRX | 10.5.0 |
| 2011-12 | RP-54 | RP-111691 | 1056 | 1 | | TDD Event triggered reporting on deactivated Scell in non-DRX | 10.5.0 |
| 2011-12 | RP-54 | RP-111683 | 1058 | | | Adding Band XX | 10.5.0 |
| 2011-12 | RP-54 | RP-111690 | 1061 | 1 | | Optional faster higher priority reselection | 10.5.0 |
| 2011-12 | RP-54 | RP-111735 | 1064 | 1 | | Addition of a test case at lower RSRP level for the serving cell measurement accuracy | 10.5.0 |
| 2011-12 | RP-54 | RP-111683 | 1066 | | | Test cases for RRC connection release with redirection to UTRAN FDD | 10.5.0 |
| 2011-12 | RP-54 | RP-111735 | 1072 | | | CA definition alignment in test cases | 10.5.0 |
| 2011-12 | RP-54 | RP-111683 | 1074 | | | Applicable PRS BW for RSTD accuracy requirements | 10.5.0 |
| 2012-03 | RP-55 | RP-120304 | 1077 | 1 | | RSTD signalling modifications | 10.6.0 |
| 2012-03 | RP-55 | RP-120294 | 1079 | 1 | | Test case for E-UTRA TDD RRC connection release redirection to UTRA TDD without SI provided for R10 | 10.6.0 |
| 2012-03 | RP-55 | RP-120294 | 1081 | 1 | | Test case for E-UTRA FDD RRC connection release redirection to UTRA TDD without SI provided for R10 | 10.6.0 |
| 2012-03 | RP-55 | RP-120291 | 1084 | | | Thresholds and margins for E-UTRAN to C2K RRM reselection test cases (Rel-10) | 10.6.0 |
| 2012-03 | RP-55 | RP-120294 | 1087 | | | Addition of E-UTRAN TDD-HRPD Cell Reselection: HRPD is of Lower Priority test case R10 | 10.6.0 |

| | | | | | | | |
|---------|-------|-----------|------|---|--|--|--------------|
| 2012-03 | RP-55 | RP-120293 | 1089 | | | Addition of E-UTRAN TDD-cdma2000 1X Cell Reselection: cdma2000 1X is of Lower Priority test case R10 | 10.6.0 |
| 2012-03 | RP-55 | RP-120293 | 1091 | | | Addition of E-UTRAN TDD-HRPD Handover test case R10 | 10.6.0 |
| 2012-03 | RP-55 | RP-120294 | 1093 | | | Addition of E-UTRAN TDD-cdma2000 1X Handover test case R10 | 10.6.010.6.0 |
| 2012-03 | RP-55 | RP-120294 | 1099 | | | Addition of E-UTRAN FDD-TDD inter frequency RSRQ measurement accuracy test case R10 | 10.6.0 |
| 2012-03 | RP-55 | RP-120300 | 1112 | 1 | | RLM test cases with SNRs for OOS and INS for E-UTRAN TDD in eICIC | 10.6.0 |
| 2012-03 | RP-55 | RP-120304 | 1115 | | | Io difference band-independent in Inter-frequency RSRP TDD TC A.9.1.4 | 10.6.0 |
| 2012-03 | RP-55 | RP-120292 | 1118 | 1 | | Thresholds and margins in RRM test case A.8.11.4 | 10.6.0 |
| 2012-03 | RP-55 | RP-120292 | 1121 | | | TDD PRACH Test cases value of PRACH Configuration Index and first preamble power | 10.6.0 |
| 2012-03 | RP-55 | RP-120292 | 1124 | 1 | | PDSCH and OCNG pattern in PRACH Test cases A.6.2.1 and A.6.2.3 | 10.6.0 |
| 2012-03 | RP-55 | RP-120300 | 1134 | 1 | | Clarification of colliding CRS in MBSFN ABS | 10.6.0 |
| 2012-03 | RP-55 | RP-120304 | 1135 | | | Editorial corrections on the test cases of RRC connection release with redirection to UTRAN FDD | 10.6.0 |
| 2012-03 | RP-55 | RP-120304 | 1139 | 1 | | Corrections on test case of Event triggered reporting on deactivated Scell in non-DRX CR not implemented as it is based on the wrong version of the spec | 10.6.0 |
| 2012-03 | RP-55 | RP-120304 | 1140 | | | Core requirements for E-UTRAN TDD inter-RAT UTRAN FDD SI acquisition using autonomous gaps | 10.6.0 |
| 2012-03 | RP-55 | RP-120304 | 1143 | 1 | | Editorial corrections | 10.6.0 |
| 2012-03 | RP-55 | RP-120300 | 1145 | 1 | | Side condition clarification for eICIC with MBSFN | 10.6.0 |
| 2012-03 | RP-55 | RP-120300 | 1146 | | | Clarification on reported cells with eICIC | 10.6.0 |
| 2012-03 | RP-55 | RP-120294 | 1148 | | | Correction of RSTD accuracy test cases for TDD | 10.6.0 |
| 2012-03 | RP-55 | RP-120300 | 1151 | 2 | | RLM requirements with autonomous gaps | 10.6.0 |
| 2012-03 | RP-55 | RP-120300 | 1152 | 1 | | SNR levels in out-of-sync RLM test cases for eICIC | 10.6.0 |
| 2012-03 | RP-55 | RP-120303 | 1156 | 1 | | CR for 36.133: B41 REFSENS and MOP changes to accommodate single filter architecture | 10.6.0 |
| 2012-03 | RP-55 | RP-120300 | 1157 | | | eICIC measurement accuracy | 10.6.0 |
| 2012-03 | RP-55 | RP-120307 | 1154 | 1 | | Introduction of Band 26/XXVI to TS 36.133 | 11.0.0 |
| 2012-06 | RP-56 | RP-120782 | 1162 | | | Resolve Band 41 omission between R4-120125 and R4-121106 | 11.1.0 |
| 2012-06 | RP-56 | RP-120770 | 1165 | 1 | | Corrections to FDD-TDD Inter-freq RSRP measurement accuracy test case parameters | 11.1.0 |
| 2012-06 | RP-56 | RP-120771 | 1168 | | | OCNG and PDSCH for FDD-TDD event triggered reporting test cases | 11.1.0 |
| 2012-06 | RP-56 | RP-120771 | 1171 | | | RRC Connection Release with Redirection from E-UTRAN FDD to GERAN without System Information | 11.1.0 |
| 2012-06 | RP-56 | RP-120771 | 1174 | | | RRC Connection Release with Redirection from E-UTRAN TDD to GERAN without System Information | 11.1.0 |
| 2012-06 | RP-56 | RP-120784 | 1176 | | | OCNG Patterns for MBSFN ABS | 11.1.0 |
| 2012-06 | RP-56 | RP-120769 | 1183 | | | Addition of E-UTRAN TDD-FDD Inter-frequency event triggered reporting when DRX is used under fading propagation conditions in asynchronous cells test case R11 | 11.1.0 |
| 2012-06 | RP-56 | RP-120769 | 1186 | | | Addition of E-UTRAN TDD - FDD Inter-frequency identification of a new CGI of E-UTRA cell using autonomous gaps test case R11 | 11.1.0 |
| 2012-06 | RP-56 | RP-120769 | 1189 | | | Addition of E-UTRAN FDD-TDD Inter-frequency event triggered reporting when DRX is used under fading propagation conditions in asynchronous cells R11 | 11.1.0 |
| 2012-06 | RP-56 | RP-120769 | 1192 | | | Addition of E-UTRAN FDD - TDD Inter-frequency identification of a new CGI of E-UTRA cell using autonomous gaps test case R11 | 11.1.0 |
| 2012-06 | RP-56 | RP-120777 | 1195 | 1 | | Addition of E-UTRAN TDD-HRPD event triggered reporting under fading propagation conditions test case R11 | 11.1.0 |
| 2012-06 | RP-56 | RP-120769 | 1198 | | | Addition of E-UTRAN TDD-CDMA2000 1X event triggered reporting under fading propagation conditions test case R11 | 11.1.0 |
| 2012-06 | RP-56 | RP-120770 | 1201 | | | E-UTRA TDD RRC connection release redirection to UTRA FDD test without SI provided R11 | 11.1.0 |
| 2012-06 | RP-56 | RP-120784 | 1205 | 1 | | FDD RSRQ under Time Domain Measurement Resource Restriction with Non-MBSFN ABS R11 | 11.1.0 |

| | | | | | | | |
|---------|-------|-----------|------|---|--|---|--------|
| 2012-06 | RP-56 | RP-120784 | 1207 | 1 | | TDD RSRQ under Time Domain Measurement Resource Restriction with Non-MBSFN ABS R11 | 11.1.0 |
| 2012-06 | RP-56 | RP-120780 | 1213 | | | CR to TS36.133 Corrections on RRC signalling in RLM test cases for eICIC | 11.1.0 |
| 2012-06 | RP-56 | RP-120773 | 1223 | | | Test case for event-triggered reporting on deactivated SCell with PCell interruption | 11.1.0 |
| 2012-06 | RP-56 | RP-120770 | 1227 | 1 | | Finalization of Rel.9 cell reselection enhancement related test cases | 11.1.0 |
| 2012-06 | RP-56 | RP-120770 | 1231 | | | E-UTRAN FDD to UTRAN FDD RRC connection release with redirection test case when SI is not provided | 11.1.0 |
| 2012-06 | RP-56 | RP-120781 | 1233 | | | No interruptions on PCell at SCell activation/deactivation when measCycleSCell is smaller than 640 ms | 11.1.0 |
| 2012-06 | RP-56 | RP-120780 | 1235 | | | Editorial corrections | 11.1.0 |
| 2012-06 | RP-56 | RP-120782 | 1237 | 1 | | Reporting criteria requirements for carrier aggregation | 11.1.0 |
| 2012-06 | RP-56 | RP-120784 | 1239 | | | Cell identification requirements with DRX | 11.1.0 |
| 2012-06 | RP-56 | RP-120784 | 1241 | 1 | | Phase II eICIC FDD: absolute and relative RSRP accuracies in non-MBSFN ABS | 11.1.0 |
| 2012-06 | RP-56 | RP-120784 | 1243 | 1 | | Phase II eICIC TDD: absolute and relative RSRP accuracies in non-MBSFN ABS | 11.1.0 |
| 2012-06 | RP-56 | RP-120784 | 1249 | | | RLM requirements with autonomous gaps for DRX | 11.1.0 |
| 2012-06 | RP-56 | RP-120779 | 1251 | | | CR for 36.133: Aligning RSRQ measurement requirements in TS 36.133 with TS 36.101 regarding the modification of B41 REFSENS | 11.1.0 |
| 2012-06 | RP-56 | RP-120777 | 1260 | | | Bands 22, 23, 42 and 43 side conditions for inter-frequency measurements with autonomous gaps | 11.1.0 |
| 2012-06 | RP-56 | RP-120772 | 1261 | | | Clarification on UE Rx-Tx with eICIC | 11.1.0 |
| 2012-06 | RP-56 | RP-120767 | 1271 | | | sr-ConfigIndex in TDD DRX test cases | 11.1.0 |
| 2012-06 | RP-56 | RP-120782 | 1273 | | | Remove [] from eICIC RSRP, RSRQ Es/lot side conditions | 11.1.0 |
| 2012-06 | RP-56 | RP-120764 | 1277 | 1 | | RRM: Clarifications to the OCNG patterns | 11.1.0 |
| 2012-06 | RP-56 | RP-120784 | 1279 | 2 | | Intra-Frequency FDD RSRQ Accuracy under Time Domain Measurement Resource Restriction with MBSFN ABS | 11.1.0 |
| 2012-06 | RP-56 | RP-120784 | 1286 | 1 | | eICIC FDD out-of-sync RLM test case in MBSFN ABS | 11.1.0 |
| 2012-06 | RP-56 | RP-120784 | 1288 | 1 | | eICIC TDD out-of-sync RLM test case in MBSFN ABS | 11.1.0 |
| 2012-06 | RP-56 | RP-120781 | 1289 | 1 | | On UE behavior in the uplink subframe after measurement GAP | 11.1.0 |
| 2012-06 | RP-56 | RP-120773 | 1293 | 1 | | Clarification on the number of monitoring layers for CA UEs | 11.1.0 |
| 2012-06 | RP-56 | RP-120784 | 1299 | 2 | | CR on TDD RSRQ test case under Time Domain Measurement Resource Restriction with MBSFN ABS Rel11 | 11.1.0 |
| 2012-06 | RP-56 | RP-120784 | 1303 | 1 | | In-Sync RLM test case in MBSFN ABS for E-UTRAN FDD R11 | 11.1.0 |
| 2012-06 | RP-56 | RP-120784 | 1306 | 1 | | In-Sync RLM test case in MBSFN ABS for E-UTRAN TDD R11 | 11.1.0 |
| 2012-06 | RP-56 | RP-120781 | 1310 | | | Inter-frequency and Inter-RAT Requirements for Measurements without Measurement Gaps | 11.1.0 |
| 2012-06 | RP-56 | RP-120788 | 1318 | 1 | | The introduction of Multi-TA timing requirements R11 | 11.1.0 |
| 2012-06 | RP-56 | RP-120777 | 1320 | 1 | | Addition of E-UTRAN FDD RSTD measurement accuracy test case in carrier aggregation R11 | 11.1.0 |
| 2012-06 | RP-56 | RP-120777 | 1322 | | | Addition of E-UTRAN TDD RSTD measurement accuracy test case in carrier aggregation R11 | 11.1.0 |
| 2012-06 | RP-56 | RP-120779 | 1328 | | | Correction to RLM requirements in eICIC with Autonomous gaps R11 | 11.1.0 |
| 2012-06 | RP-56 | RP-120769 | 1331 | 1 | | Correction to E-UTRAN FDD/TDD - UTRAN FDD /TDD enhanced cell identification test case R11 | 11.1.0 |
| 2012-06 | RP-56 | RP-120770 | 1336 | | | Correction to E-UTRAN TDD redirection to UTRAN FDD test configuration R11 | 11.1.0 |
| 2012-06 | RP-56 | RP-120780 | 1337 | 1 | | FDD CA RSTD Measurement Reporting Delay Test Case (Rel-11) | 11.1.0 |
| 2012-06 | RP-56 | RP-120782 | 1338 | 1 | | TDD CA RSTD Measurement Reporting Delay Test Case (Rel-11) | 11.1.0 |
| 2012-06 | RP-56 | RP-120779 | 1342 | | | Correction to RSTD measurement reporting delay requirement in CA R11 | 11.1.0 |
| 2012-06 | RP-56 | RP-120795 | 1345 | 1 | | Add Band 25 Io values R11 | 11.1.0 |
| 2012-06 | RP-56 | RP-120777 | 1347 | 1 | | Clarification for cell identification condition in inter-RAT SI reading requirement R11 | 11.1.0 |

| | | | | | | | |
|---------|-------|-----------|------|---|--|--|--------|
| 2012-06 | RP-56 | RP-120793 | 1349 | | | Introduction of Band 28 | 11.1.0 |
| 2012-06 | RP-56 | RP-120794 | 1350 | 1 | | Introduction of Band 44 | 11.1.0 |
| 2012-06 | RP-56 | RP-120780 | 1355 | | | Editorial corrections | 11.1.0 |
| 2012-06 | RP-56 | RP-120766 | 1361 | 2 | | Correction of a timer period in inter-frequency measurement tests | 11.1.0 |
| 2012-06 | RP-56 | RP-120764 | 1363 | 1 | | UL Transmit Timing Requirements | 11.1.0 |
| 2012-06 | RP-56 | RP-120784 | 1364 | 2 | | Phase IIbis eICIC FDD absolute and relative RSRP accuracy with MBSFN ABS | 11.1.0 |
| 2012-06 | RP-56 | RP-120784 | 1366 | 2 | | Phase IIbis eICIC TDD absolute and relative RSRP accuracy with MBSFN ABS | 11.1.0 |
| 2012-06 | RP-56 | RP-120784 | 1368 | | | OCNG correction in Phase I eICIC test cases | 11.1.0 |
| 2012-06 | RP-56 | RP-120792 | 1379 | | | Introduction of e850_LB (Band 27) to TS 36.133 | 11.1.0 |
| 2012-09 | RP-57 | RP-121301 | 1385 | | | Identification of Cell 3 in RRM Test cases A.4.2.7 and A.4.2.8 | 11.2.0 |
| 2012-09 | RP-57 | RP-121301 | 1390 | | | Making FDD-TDD Inter-freq RSRQ measurement accuracy test case band-agnostic | 11.2.0 |
| 2012-09 | RP-57 | RP-121304 | 1392 | | | Thresholds and margins in RRM test cases A.8.16.1 and A.8.16.2 | 11.2.0 |
| 2012-09 | RP-57 | RP-121295 | 1398 | 1 | | Modification of Handover Delay Requirement and Test Cases from E-UTRAN to cdma2000 1x (Rel-11) | 11.2.0 |
| 2012-09 | RP-57 | RP-121302 | 1400 | | | Correction to RSRP/RSRQ measurement accuracy tests in MBSFN R11 | 11.2.0 |
| 2012-09 | RP-57 | RP-121304 | 1403 | | | Activation/ deactivation core requirement for carrier aggregation R11 | 11.2.0 |
| 2012-09 | RP-57 | RP-121313 | 1405 | | | Minor corrections for E-UTRAN â€ˆ GSM measurements without Measurement Gaps and Rx-Tx measurements when PCell is changed | 11.2.0 |
| 2012-09 | RP-57 | RP-121304 | 1407 | 3 | | RRM requirements for CA REFSENSE (Rel-11) | 11.2.0 |
| 2012-09 | RP-57 | RP-121304 | 1409 | | | Square Bracket Removal for RSTD measurement requirement in Pcell changing and Handover R11 | 11.2.0 |
| 2012-09 | RP-57 | RP-121304 | 1411 | | | Correction to the E-UTRAN secondary component carrier measurements when common DRX is used R11 | 11.2.0 |
| 2012-09 | RP-57 | RP-121304 | 1413 | | | Requirements for Inter-frequency Measurements without Gaps when DRX is used R11 | 11.2.0 |
| 2012-09 | RP-57 | RP-121304 | 1415 | | | Clarification on TDD UL-DL subframe configurations in inter-frequency RSTD measurement without gaps R11 | 11.2.0 |
| 2012-09 | RP-57 | RP-121301 | 1418 | | | Correction for E-UTRA TDD RRC connection release redirection to UTRA TDD test case R11 | 11.2.0 |
| 2012-09 | RP-57 | RP-121340 | 1419 | | | Addition of E-UTRAN FDD - UTRAN FDD identification of a new CGI of UTRAN cell using autonomous gaps | 11.2.0 |
| 2012-09 | RP-57 | RP-121340 | 1420 | | | Addition of E-UTRAN TDD - UTRAN FDD identification of a new CGI of UTRAN cell using autonomous gaps | 11.2.0 |
| 2012-09 | RP-57 | RP-121301 | 1423 | | | Correction to E-UTRAN TDD-FDD Inter-frequency event triggered reporting test case R11 | 11.2.0 |
| 2012-09 | RP-57 | RP-121302 | 1432 | | | Alignment for ABS configurations in RRM Tests R11 | 11.2.0 |
| 2012-09 | RP-57 | RP-121294 | 1433 | 1 | | Correction to RSRQ accuracy test cases R11 | 11.2.0 |
| 2012-09 | RP-57 | RP-121297 | 1438 | | | Radio conditions for PBCH reading in E-UTRA | 11.2.0 |
| 2012-09 | RP-57 | RP-121305 | 1444 | | | Introduction of inter-frequency/ RAT measurements in CA | 11.2.0 |
| 2012-09 | RP-57 | RP-121302 | 1449 | | | ABS signal transmission configuration for RRM tests | 11.2.0 |
| 2012-09 | RP-57 | RP-121340 | 1450 | 1 | | Table format update for adding new bands | 11.2.0 |
| 2012-09 | RP-57 | RP-121301 | 1454 | | | Editorial correction RRM | 11.2.0 |
| 2012-12 | RP-58 | RP-121899 | 1458 | - | | Random Access requirements for SCell | 11.3.0 |
| 2012-12 | RP-58 | RP-121861 | 1459 | - | | Correction on CA TDD RSTD measurement accuracy test cases R11 | 11.3.0 |
| 2012-12 | RP-58 | RP-121849 | 1461 | - | | Correction to high priority cell measurement of UTRA TDD R11 | 11.3.0 |
| 2012-12 | RP-58 | RP-121861 | 1467 | - | | Clarification of Test Requirements for CA RSRP, RSRQ Test Cases | 11.3.0 |
| 2012-12 | RP-58 | RP-121850 | 1470 | - | | Remove [] from 10% requirement in RRM Test cases A.4.2.7 and A.4.2.8 | 11.3.0 |
| 2012-12 | RP-58 | RP-121861 | 1486 | 1 | | Clean up for CA | 11.3.0 |
| 2012-12 | RP-58 | RP-121911 | 1487 | - | | Clarification of CPICH RSCP side conditions | 11.3.0 |
| 2012-12 | RP-58 | RP-121867 | 1489 | - | | Editorial corrections | 11.3.0 |
| 2012-12 | RP-58 | RP-121867 | 1497 | - | | Band correction in RRM requirements | 11.3.0 |
| 2012-12 | RP-58 | RP-121861 | 1499 | - | | Correction to RSTD Measurement Reporting Delay for Carrier Aggregation Test Cases | 11.3.0 |

| | | | | | | | |
|---------|-------|-----------|------|---|--|---|--------|
| 2012-12 | RP-58 | RP-121861 | 1506 | - | | Band-dependent RRM requirements for CA | 11.3.0 |
| 2012-12 | RP-58 | RP-121872 | 1507 | 1 | | CR on RLM Requirements for FeICIC | 11.3.0 |
| 2012-12 | RP-58 | RP-121854 | 1516 | - | | Correction of OCNG Patterns for UE Rx - Tx Time Difference Test Cases | 11.3.0 |
| 2012-12 | RP-58 | RP-121872 | 1517 | 1 | | Cell identification requirements in FeICIC | 11.3.0 |
| 2012-12 | RP-58 | RP-121851 | 1522 | - | | Time offset correction in CA test cases R11 | 11.3.0 |
| 2012-12 | RP-58 | RP-121854 | 1529 | 1 | | Clarification on RSTD measurement requirement under HO and Pcell changing | 11.3.0 |
| 2012-12 | RP-58 | RP-121910 | 1530 | 2 | | Introduction the IDC requirements in 36.133 Rel-11 | 11.3.0 |
| 2012-12 | RP-58 | RP-121849 | 1537 | - | | Correction on test cases for handover to UTRAN TDD for Rel-11 | 11.3.0 |
| 2012-12 | RP-58 | RP-121910 | 1542 | - | | Updating RRM requirements in 36.133 | 11.3.0 |
| 2012-12 | RP-58 | RP-121867 | 1545 | - | | Editorial corrections RRM | 11.3.0 |
| 2012-12 | RP-58 | RP-121852 | 1549 | - | | Conditions in CSG reselection requirements | 11.3.0 |
| 2012-12 | RP-58 | RP-121852 | 1553 | - | | Correcting inconsistency between inter-RAT UTRA measurements and requirements | 11.3.0 |
| 2012-12 | RP-58 | RP-121861 | 1555 | - | | Refsens requirements for CA capable UE | 11.3.0 |
| 2012-12 | RP-58 | RP-121854 | 1558 | 1 | | Intra-frequency RSTD accuracy requirements account for serving cell bandwidth | 11.3.0 |
| 2012-12 | RP-58 | RP-121854 | 1559 | 1 | | Clarification on the total number of cells for RSTD inter-frequency measurement | 11.3.0 |
| 2012-12 | RP-58 | RP-121860 | 1561 | 1 | | Clarification of the TDM pattern conditions | 11.3.0 |
| 2012-12 | RP-58 | RP-121873 | 1562 | 1 | | MDT requirements in Rel-11 | 11.3.0 |
| 2012-12 | RP-58 | RP-121901 | 1563 | - | | Introduction of Band 29 | 11.3.0 |
| 2012-12 | | | | | | Editorial Correction | 11.3.1 |
| 2013-03 | RP-59 | RP-130268 | 1477 | 1 | | Correction to Inter-frequency Measurements in CA mode test case R11 | 11.4.0 |
| 2013-03 | RP-59 | RP-130287 | 1480 | 1 | | Requirements for RSRP and RSRQ for E-CID Positioning | 11.4.0 |
| 2013-03 | RP-59 | RP-130263 | 1566 | | | Secondary Component carrier levels for CA RSRP Test cases A.9.1.6 and A.9.1.7 | 11.4.0 |
| 2013-03 | RP-59 | RP-130263 | 1568 | | | Remove intra-frequency relative Requirement for CA RSRQ Test Cases | 11.4.0 |
| 2013-03 | RP-59 | RP-130263 | 1572 | | | Cell timing for CA RSRP and RSRQ Test cases | 11.4.0 |
| 2013-03 | RP-59 | RP-130277 | 1573 | 1 | | Editorial correction for introduction of Band 29 | 11.4.0 |
| 2013-03 | RP-59 | RP-130263 | 1576 | | | Clarification of retuning interruption in single carrier operation | 11.4.0 |
| 2013-03 | RP-59 | RP-130260 | 1579 | | | RRM: RMC and OCNG pattern for FDD CGI test with autonomous gaps (Rel-11) | 11.4.0 |
| 2013-03 | RP-59 | RP-130268 | 1582 | | | Correction to CSG proximity requirement | 11.4.0 |
| 2013-03 | RP-59 | RP-130268 | 1584 | | | E-UTRAN FDD Proximity Indication RRM Requirements (Rel-11) | 11.4.0 |
| 2013-03 | RP-59 | RP-130275 | 1589 | 1 | | Clarification of Cell Identification core requirement in FeICIC | 11.4.0 |
| 2013-03 | RP-59 | RP-130283 | 1591 | 1 | | RSRP/RSRQ measurement accuracy requirements in FeICIC | 11.4.0 |
| 2013-03 | RP-59 | RP-130263 | 1598 | | | UE interruption requirements in SCC RSTD measurements with de-activated Scell R11 | 11.4.0 |
| 2013-03 | RP-59 | RP-130287 | 1602 | | | Timing offset correction in CA RSTD test cases | 11.4.0 |
| 2013-03 | RP-59 | RP-130280 | 1616 | | | Editorial corrections for IDC | 11.4.0 |
| 2013-03 | RP-59 | RP-130262 | 1618 | | | Editorial corrections for eICIC | 11.4.0 |
| 2013-03 | RP-59 | RP-130258 | 1622 | | | Editorial corrections RRM | 11.4.0 |
| 2013-03 | RP-59 | RP-130259 | 1627 | | | A clarification on measurement gap pattern in RSTD requirements | 11.4.0 |
| 2013-03 | RP-59 | RP-130268 | 1642 | 1 | | Modification of PRS configuration for RSTD measurement reporting delay test cases(Rel-11) | 11.4.0 |
| 2013-03 | RP-59 | RP-130261 | 1644 | | | E-UTRAN FDD Proximity Indication Test Case (Rel-11) | 11.4.0 |
| 2013-06 | RP-60 | RP-130763 | 1648 | | | Correction to test parameters for combined E-UTRA - E-UTRA and GSM cell search - Rel 11 | 11.5.0 |
| 2013-06 | RP-60 | RP-130770 | 1649 | | | Remove the Brackets in cell identification of FeICIC | 11.5.0 |
| 2013-06 | RP-60 | RP-130763 | 1657 | | | Clarification on inter-frequency RSTD measurement accuracy requirement R11 | 11.5.0 |
| 2013-06 | RP-60 | RP-130765 | 1659 | 1 | | RRM test configurations for 20MHz R11 | 11.5.0 |
| 2013-06 | RP-60 | RP-130763 | 1668 | 1 | | Corrections on RSTD measurement test cases (Rel-11) | 11.5.0 |
| 2013-06 | RP-60 | RP-130763 | 1673 | | | Remove [] from GCI identification Test cases A.8.4.4 and A.8.4.5 | 11.5.0 |
| 2013-06 | RP-60 | RP-130761 | 1677 | | | Cell 1 levels for RSRP Test cases A.9.1.3 and A.9.1.4 | 11.5.0 |
| 2013-06 | RP-60 | RP-130765 | 1679 | 1 | | RSRP, RSRQ RRM eICIC Test case cleanup | 11.5.0 |
| 2013-06 | RP-60 | RP-130761 | 1683 | | | Update on the GSM carrier RSSI measurement period when DRX is used | 11.5.0 |

| | | | | | | | |
|---------|-------|-----------|------|---|--|--|--------|
| 2013-06 | RP-60 | RP-130763 | 1692 | | | sr-ConfigIndex in TDD-FDD Inter-frequency event triggered DRX Test case A.8.14.2 | 11.5.0 |
| 2013-06 | RP-60 | RP-130767 | 1694 | | | Testing of CA tests with multiple BW combinations | 11.5.0 |
| 2013-06 | RP-60 | RP-130767 | 1696 | | | Reference measurement channels for 20 MHz Tests | 11.5.0 |
| 2013-06 | RP-60 | RP-130765 | 1702 | | | Editorial corrections RRM | 11.5.0 |
| 2013-06 | RP-60 | RP-130761 | 1706 | | | Section numbering correction | 11.5.0 |
| 2013-06 | RP-60 | RP-130770 | 1708 | 1 | | Editorial corrections for FeICIC | 11.5.0 |
| 2013-06 | RP-60 | RP-130770 | 1709 | 1 | | Removing an eICIC note on measurements | 11.5.0 |
| 2013-06 | RP-60 | RP-130770 | 1713 | | | Clean up for CA | 11.5.0 |
| 2013-06 | RP-60 | RP-130763 | 1716 | | | Editorial corrections in RSTD requirements | 11.5.0 |
| 2013-06 | RP-60 | RP-130766 | 1719 | | | SCell Activation Delay Requirements in CA | 11.5.0 |
| 2013-06 | RP-60 | RP-130765 | 1721 | | | Clarification on supported bandwidth combinations in RSTD requirements with CA | 11.5.0 |
| 2013-06 | RP-60 | RP-130770 | 1723 | 1 | | Impact of REFSENS requirements on the core specification | 11.5.0 |
| 2013-06 | RP-60 | RP-130770 | 1724 | | | Correction of the total number of reporting criteria | 11.5.0 |
| 2013-06 | RP-60 | RP-130769 | 1728 | 1 | | Condition clarification in MDT requirements | 11.5.0 |
| 2013-06 | RP-60 | RP-130769 | 1732 | | | Band 26 test cases corrections | 11.5.0 |
| 2013-06 | RP-60 | RP-130770 | 1739 | | | CR on Interruptions for Intra-band Non-contiguous Carrier Aggregation | 11.5.0 |
| 2013-06 | RP-60 | RP-130763 | 1744 | | | Time Alignment Timer in Test Case A.8.2.4 | 11.5.0 |
| 2013-06 | RP-60 | RP-130763 | 1745 | | | RRM: Adding required measurement gap | 11.5.0 |
| 2013-06 | RP-60 | RP-130761 | 1749 | | | TDD PRACH configuration index for Test Cases A.8.7.2, A.8.15.2 | 11.5.0 |
| 2013-06 | RP-60 | RP-130763 | 1752 | | | GSM cell list size for Test Cases A.6.3.10, A.6.3.11 | 11.5.0 |
| 2013-06 | RP-60 | RP-130763 | 1755 | | | Neighbour list for Test cases A.8.5.4, A.8.7.4, A.8.9.2 | 11.5.0 |
| 2013-06 | RP-60 | RP-130763 | 1758 | | | Additional corrections on intra-frequency RSTD test parameters (Rel-11) | 11.5.0 |
| 2013-06 | RP-60 | RP-130763 | 1760 | | | Additional corrections on inter-frequency RSTD test parameters (Rel-11) | 11.5.0 |
| 2013-06 | RP-60 | RP-130767 | 1762 | | | Phase I CA 20 MHz Tests: Event triggered reporting on deactivating Scells in non-DRX | 11.5.0 |
| 2013-06 | RP-60 | RP-130763 | 1767 | | | Corrections of E-UTRAN FDD CSG Proximity Indication Test Case (Rel-11) | 11.5.0 |
| 2013-06 | RP-60 | RP-130770 | 1770 | 1 | | In sync detection with CRS assistance information with non-MBSFN ABS in FDD | 11.5.0 |
| 2013-06 | RP-60 | RP-130770 | 1771 | 1 | | In sync detection with CRS assistance information with non-MBSFN ABS in TDD | 11.5.0 |
| 2013-06 | RP-60 | RP-130770 | 1772 | 1 | | E-UTRAN FDD RLM Out-of-sync Test of FeICIC | 11.5.0 |
| 2013-06 | RP-60 | RP-130770 | 1773 | 1 | | E-UTRAN TDD RLM Out-of-sync Test of FeICIC | 11.5.0 |
| 2013-06 | RP-60 | RP-130767 | 1776 | | | E-UTRAN FDD absolute and relative RSRP accuracies for 20MHz in CA R11 | 11.5.0 |
| 2013-06 | RP-60 | RP-130767 | 1778 | | | E-UTRAN TDD absolute and relative RSRP accuracies for 20MHz in CA R11 | 11.5.0 |
| 2013-06 | RP-60 | RP-130765 | 1780 | | | Modification of OCNG patterns of RRM test configuration for 20MHz R11 | 11.5.0 |
| 2013-06 | RP-60 | RP-130761 | 1782 | | | Clarification of Pcell in 36.133 R11 | 11.5.0 |
| 2013-06 | RP-60 | RP-130767 | 1784 | | | FDD Absolute and relative RSRQ accuracies for CA with 20MHz BW (Rel-11) | 11.5.0 |
| 2013-06 | RP-60 | RP-130767 | 1786 | | | TDD Absolute and relative RSRQ accuracies for CA with 20MHz BW (Rel-11) | 11.5.0 |
| 2013-06 | RP-60 | RP-130761 | 1790 | | | Correction on fading propagation condition for CA inter-RAT test cases R11 | 11.5.0 |
| 2013-06 | RP-60 | RP-130770 | 1791 | | | Clean up for band 44 | 11.5.0 |
| 2013-06 | RP-60 | RP-130765 | 1793 | 1 | | E-UTRAN TDD UE Rx-Tx time difference test case in eICIC | 11.5.0 |
| 2013-06 | RP-60 | RP-130770 | 1799 | 1 | | Test case for UE Transmit Timing Accuracy for SCell | 11.5.0 |
| 2013-06 | RP-60 | RP-130767 | 1801 | | | CR on measurements without gaps | 11.5.0 |
| 2013-06 | RP-60 | RP-130770 | 1804 | 1 | | Editorial corrections RRM | 11.5.0 |
| 2013-06 | RP-60 | RP-130765 | 1806 | 1 | | Clarification for UE Rx-Tx with eICIC | 11.5.0 |
| 2013-06 | RP-60 | RP-130770 | 1807 | 2 | | Capturing RF requirements in the core specification | 11.5.0 |
| 2013-06 | RP-60 | RP-130765 | 1808 | 1 | | Test case for UE Rx-Tx accuracy with eICIC in FDD | 11.5.0 |
| 2013-06 | RP-60 | RP-130770 | 1812 | 1 | | RSRP and RSRQ relative accuracy requirements for FeICIC | 11.5.0 |
| 2013-06 | RP-60 | RP-130765 | 1814 | 1 | | Adding clarification for begin and end of measurement GAP for Rel-11 | 11.5.0 |
| 2013-06 | RP-60 | RP-130770 | 1821 | | | Measurement requirements with interruptions due to CA | 11.5.0 |
| 2013-06 | RP-60 | RP-130770 | 1822 | | | Clarification on antenna ports in the measured and aggressor cells with FeICIC | 11.5.0 |

| | | | | | | | |
|---------|-------|-----------|------|---|--|--|--------|
| 2013-06 | RP-60 | RP-130770 | 1825 | 1 | | UE Rx-Tx accuracy requirements with FeICIC | 11.5.0 |
| 2013-06 | RP-60 | RP-130770 | 1826 | | | UE Rx-Tx measurement requirements with FeICIC | 11.5.0 |
| 2013-06 | RP-60 | RP-130770 | 1827 | 2 | | Test case for cell identification with FeICIC in FDD | 11.5.0 |
| 2013-06 | RP-60 | RP-130770 | 1828 | 2 | | Test case for cell identification with FeICIC in TDD | 11.5.0 |
| 2013-06 | RP-60 | RP-130770 | 1829 | 1 | | Corrections on Wideband RSRQ inter-frequency accuracy requirements | 11.5.0 |
| 2013-06 | RP-60 | RP-130791 | 1769 | 1 | | Introduction of Band 30 | 12.0.0 |
| 09-2013 | RP-61 | RP-131303 | 1830 | 1 | | UTRAN FDD CPICH Ec/No measurement accuracy test for 5MHz bandwidth | 12.1.0 |
| 09-2013 | RP-61 | RP-131291 | 1832 | | | Correction on the test cases for UE Transmit Timing Accuracy for SCell (Rel-12) | 12.1.0 |
| 09-2013 | RP-61 | RP-131282 | 1836 | | | Corrections on RSTD CA test parameters (Rel-12) | 12.1.0 |
| 09-2013 | RP-61 | RP-131282 | 1839 | | | FDD: RSTD measurement reporting test cases for CA with 20MHz BW (Rel-12) | 12.1.0 |
| 09-2013 | RP-61 | RP-131282 | 1842 | | | TDD: RSTD measurement reporting test cases for CA with 20MHz BW (Rel-12) | 12.1.0 |
| 09-2013 | RP-61 | RP-131285 | 1844 | | | Timing and RSRP value corrections in Test cases A.9.2.6 and A.9.2.9 | 12.1.0 |
| 09-2013 | RP-61 | RP-131285 | 1846 | | | Corrections to Bands for 20MHz CA Test cases | 12.1.0 |
| 09-2013 | RP-61 | RP-131279 | 1854 | | | Cell time offset in TDD Inter-RAT test cases | 12.1.0 |
| 09-2013 | RP-61 | RP-131303 | 1855 | | | EUTRA FDD-UTRA FDD cell reselection: UTRA FDD is of lower priority | 12.1.0 |
| 09-2013 | RP-61 | RP-131282 | 1860 | | | Rel-12 CRs on synchronization requirements for E-UTRA to CDMA 2000 handover | 12.1.0 |
| 09-2013 | RP-61 | RP-131290 | 1866 | 1 | | Correct the SNR values for RLM tests with non-MBSFN ABS in FeICIC R12 | 12.1.0 |
| 09-2013 | RP-61 | RP-131290 | 1869 | 1 | | E-UTRAN FDD RSRP Measurement Accuracy Test in FeICIC R12 | 12.1.0 |
| 09-2013 | RP-61 | RP-131290 | 1871 | 1 | | E-UTRAN TDD RSRP Measurement Accuracy Test in FeICIC R12 | 12.1.0 |
| 09-2013 | RP-61 | RP-131284 | 1873 | | | E-UTRAN FDD UE Rx-Tx Time difference test in FeICIC R12 | 12.1.0 |
| 09-2013 | RP-61 | RP-131284 | 1875 | | | E-UTRAN TDD UE Rx-Tx Time difference test in FeICIC R12 | 12.1.0 |
| 09-2013 | RP-61 | RP-131284 | 1881 | | | Clarification on UE Rx-Tx accuracy requirements in FeICIC R12 | 12.1.0 |
| 09-2013 | RP-61 | RP-131284 | 1883 | | | Clarification on UE Rx-Tx measurement requirements in FeICIC R12 | 12.1.0 |
| 09-2013 | RP-61 | RP-131282 | 1886 | | | Clarification on antenna port for timing and eCID test cases R12 | 12.1.0 |
| 09-2013 | RP-61 | RP-131282 | 1889 | 1 | | Addition of TDD serving cell measurement accuracy tests R12 | 12.1.0 |
| 09-2013 | RP-61 | RP-131303 | 1890 | | | Introduction of Band 31 in 36.133 | 12.1.0 |
| 09-2013 | RP-61 | RP-131303 | 1891 | | | Addition of New OCNG Pattern for 5MHz | 12.1.0 |
| 09-2013 | RP-61 | RP-131303 | 1892 | | | E-UTRAN FDD intra-frequency RSRP measurement accuracy for 5MHz bandwidth | 12.1.0 |
| 09-2013 | RP-61 | RP-131303 | 1893 | | | E-UTRAN FDD-FDD inter-frequency RSRP measurement accuracy for 5MHz bandwidth | 12.1.0 |
| 09-2013 | RP-61 | RP-131303 | 1894 | | | E-UTRAN FDD Radio Link Monitoring Test for Out-of-sync for 5MHz Bandwidth | 12.1.0 |
| 09-2013 | RP-61 | RP-131303 | 1895 | | | E-UTRAN FDD-FDD intra-frequency event triggered reporting under fading propagation conditions in asynchronous cells for 5MHz bandwidth | 12.1.0 |
| 09-2013 | RP-61 | RP-131303 | 1896 | | | E-UTRAN FDD-FDD intra-frequency Cell Re-selection case for 5MHz bandwidth | 12.1.0 |
| 09-2013 | RP-61 | RP-131303 | 1897 | | | E-UTRAN FDD intra-frequency RRC re-establishment for 5MHz bandwidth | 12.1.0 |
| 09-2013 | RP-61 | RP-131303 | 1898 | | | E-UTRAN FDD - Contention Based Random Access Test for 5MHz bandwidth | 12.1.0 |
| 09-2013 | RP-61 | RP-131303 | 1899 | 1 | | E-UTRAN FDD - UE Transmit Timing Accuracy Tests for 5MHz bandwidth | 12.1.0 |
| 09-2013 | RP-61 | RP-131303 | 1900 | | | E-UTRA FDD- UTRA FDD inter-RAT handover case for 5MHz bandwidth | 12.1.0 |
| 09-2013 | RP-61 | RP-131303 | 1901 | 1 | | E-UTRA FDD- UTRA FDD CPICH RSCP measurement accuracy issues | 12.1.0 |
| 09-2013 | RP-61 | RP-131285 | 1903 | | | Clarification of Refesens in WB-RSRQ sections of 36.133 R12 | 12.1.0 |
| 09-2013 | RP-61 | RP-131290 | 1905 | | | Remove the brackets of FeICIC side conditions R12 | 12.1.0 |
| 09-2013 | RP-61 | RP-131282 | 1908 | 1 | | Test cases of E-UTRAN FDD RSTD Measurement Accuracy for Carrier Aggregation for 20MHz R12 | 12.1.0 |
| 09-2013 | RP-61 | RP-131282 | 1913 | 1 | | Test cases of E-UTRAN TDD RSTD Measurement Accuracy for Carrier Aggregation for 20MHz R12 | 12.1.0 |
| 09-2013 | RP-61 | RP-131284 | 1916 | | | Correction to SCH Es/lot side condition for intra- | 12.1.0 |

| | | | | | | | |
|---------|-------|-----------|------|---|--|--|--------|
| | | | | | | frequency measurements under time domain measurement resource restriction with CRS assistance information | |
| 09-2013 | RP-61 | RP-131303 | 1919 | | | E-UTRAN FDD " Non-contention Based Random Access Test for 5MHz bandwidth | 12.1.0 |
| 09-2013 | RP-61 | RP-131282 | 1921 | | | Modification on the requirement for PCell interruption for Rel-12 | 12.1.0 |
| 09-2013 | RP-61 | RP-131303 | 1922 | | | E-UTRAN FDD " Timing Advance Accuracy Test for 5MHz bandwidth | 12.1.0 |
| 09-2013 | RP-61 | RP-131282 | 1928 | | | Phase II CA 20 MHz Tests: Event triggered reporting on deactivating SCell and and interruption probability without DRX | 12.1.0 |
| 09-2013 | RP-61 | RP-131303 | 1945 | 1 | | CR on Applicability of 5MHz Test Cases | 12.1.0 |
| 09-2013 | RP-61 | RP-131303 | 1946 | 1 | | E-UTRAN FDD Radio Link Monitoring Test for In-Sync for 5MHz | 12.1.0 |
| 09-2013 | RP-61 | RP-131303 | 1947 | | | E-UTRAN FDD Intra-frequency handover test for 5MHz Channel Bandwidth | 12.1.0 |
| 09-2013 | RP-61 | RP-131303 | 1948 | | | E-UTRAN FDD Intra-frequency RSRQ Accuracy Test for 5MHz Channel Bandwidth | 12.1.0 |
| 09-2013 | RP-61 | RP-131293 | 1952 | | | Editorial corrections RRM | 12.1.0 |
| 09-2013 | RP-61 | RP-131303 | 1954 | | | E-UTRAN FDD Inter-frequency RSRQ Accuracy Test for 5MHz Channel Bandwidth | 12.1.0 |
| 09-2013 | RP-61 | RP-131293 | 1955 | | | Clarification of CGI reading requirements | 12.1.0 |
| 09-2013 | RP-61 | RP-131303 | 1958 | 2 | | E-UTRAN FDD Radio Link Monitoring Test for In-Sync for 5MHz with DRX | 12.1.0 |
| 09-2013 | RP-61 | RP-131285 | 1961 | | | Editorial corrections in capturing RF requirements | 12.1.0 |
| 09-2013 | RP-61 | RP-131282 | 1964 | | | Clarification on tests for multiple bandwidths | 12.1.0 |
| 09-2013 | RP-61 | RP-131282 | 1969 | | | CR on PCell interruptions | 12.1.0 |
| 09-2013 | RP-61 | RP-131283 | 1970 | | | Time stamp accuracy for RLF and handover failure reporting with eMDT | 12.1.0 |
| 09-2013 | RP-61 | RP-131303 | 1971 | | | FDD reference measurement channels for 5 MHz tests | 12.1.0 |
| 09-2013 | RP-61 | RP-131303 | 1972 | | | Part II RRM tests: UE intra-frequency measurements with synchronous cells in DRX FDD | 12.1.0 |
| 09-2013 | RP-61 | RP-131303 | 1973 | | | Part II RRM tests: E-UTRAN FDD - UTRAN FDD event triggered reporting under fading propagation conditions | 12.1.0 |
| 09-2013 | RP-61 | RP-131284 | 1978 | | | Correction of cell identification test case with FeICIC | 12.1.0 |
| 09-2013 | RP-61 | RP-131284 | 1984 | | | RLM requirements correction | 12.1.0 |
| 09-2013 | RP-61 | RP-131284 | 1988 | | | Clarification on antenna ports in the measured and aggressor cells for UE Rx-Tx with FeICIC | 12.1.0 |
| 09-2013 | RP-61 | RP-131290 | 1990 | | | FeICIC FDD Test for In-sync With MBSFN ABS for Rel. 12 | 12.1.0 |
| 09-2013 | RP-61 | RP-131290 | 1992 | | | FeICIC TDD Test for In-sync With MBSFN ABS for Rel. 12 | 12.1.0 |
| 09-2013 | RP-61 | RP-131303 | 1993 | | | Correction of the SNR value of Out of sync RLM test for 5MHz | 12.1.0 |
| 12-2013 | RP-62 | RP-131927 | 1996 | | | Corrections to CA event triggered tests on deactivated SCell with PCell interruption in non-DRX (Rel-12) | 12.2.0 |
| 12-2013 | RP-62 | RP-131928 | 2003 | | | Corrections to CA Interruption Requirements | 12.2.0 |
| 12-2013 | RP-62 | RP-131926 | 2009 | | | CRS Es/lot for eICIC RSRP, RSRQ with MBSFN ABS Test Cases | 12.2.0 |
| 12-2013 | RP-62 | RP-131941 | 2010 | | | Correction to RSTD measurement accuracy side condition for Band 31 | 12.2.0 |
| 12-2013 | RP-62 | RP-131928 | 2013 | | | Amendment on SCell Activation Delay Requirements for other activation actions | 12.2.0 |
| 12-2013 | RP-62 | RP-131928 | 2016 | | | Amendment on SCell Activation Delay Requirements in case no RS for measurement | 12.2.0 |
| 12-2013 | RP-62 | RP-131936 | 2019 | | | Correction to the SNR values for RLM tests with MBSFN ABS in FeICIC R12 | 12.2.0 |
| 12-2013 | RP-62 | RP-131936 | 2023 | | | Correction for the RSRP/RSRQ test cases in FeICIC R12 | 12.2.0 |
| 12-2013 | RP-62 | RP-131928 | 2031 | 1 | | CR on PCell Interruptions For Inter-band CA During Measurements | 12.2.0 |
| 12-2013 | RP-62 | RP-131939 | 2039 | | | Introduction of E-UTRAN TDD WB-RSRQ test case R12 | 12.2.0 |
| 12-2013 | RP-62 | RP-131925 | 2044 | | | Correction of Proximity Indication Test Case Not implemented as it is not based on the latest version of the spec | 12.2.0 |
| 12-2013 | RP-62 | RP-131939 | 2053 | | | Clarifications for intra-band non-contiguous CA R12 | 12.2.0 |
| 12-2013 | RP-62 | RP-131939 | 2058 | | | Inter-frequency WB-RSRQ FDD test case | 12.2.0 |
| 12-2013 | RP-62 | RP-131928 | 2071 | | | Clarification on Pcell Interruption shall not occur before SF n+5 | 12.2.0 |

| | | | | | | | |
|---------|-------|-----------|------|---|--|--|--------|
| 12-2013 | RP-62 | RP-131925 | 2078 | | | Correction in RSTD requirements | 12.2.0 |
| 12-2013 | RP-62 | RP-131939 | 2080 | | | Editorial corrections RRM | 12.2.0 |
| 12-2013 | RP-62 | RP-131939 | 2084 | 1 | | Band simplification | 12.2.0 |
| 12-2013 | RP-62 | RP-131931 | 2091 | | | Requirements clarification under different BWs in FeICIC | 12.2.0 |
| 12-2013 | RP-62 | RP-131931 | 2095 | | | Correction in cell search FeICIC test cases | 12.2.0 |
| 12-2013 | RP-62 | RP-131936 | 2097 | 1 | | Correct ABS pattern for FeICIC for In-sync with MBSFN ABS for Rel. 12 | 12.2.0 |
| 12-2013 | RP-62 | RP-131926 | 2104 | | | Correction to Test cases A.9.2.9 and A.9.2.10 | 12.2.0 |
| 12-2013 | RP-62 | RP-131942 | 2106 | 1 | | Bands applicability in RSRP, RSRQ FDD-FDD Inter frequency tests for 5MHz Bandwidth | 12.2.0 |
| 12-2013 | RP-62 | RP-131925 | 2111 | | | Corrections to CGI Reading in Autonomous Gap | 12.2.0 |
| 12-2013 | RP-62 | RP-131936 | 2123 | | | Remove the brackets of SNR values in RLM test cases in FeICIC R12 | 12.2.0 |
| 12-2013 | RP-62 | RP-131967 | 2129 | | | Correction on RMC pattern for 5MHz UE Transmit Timing Accuracy Tests | 12.2.0 |
| 12-2013 | RP-62 | RP-131928 | 2135 | | | CSI Reporting in SCell Activation Requirements | 12.2.0 |
| 12-2013 | RP-62 | RP-131927 | 2143 | | | Editorial corrections RRM | 12.2.0 |
| 12-2013 | RP-62 | RP-131939 | 2145 | | | Applying band simplification | 12.2.0 |
| 12-2013 | RP-62 | RP-131939 | 2151 | | | Correction to MTA requirements | 12.2.0 |
| 12-2013 | RP-62 | RP-131925 | 2155 | | | Correction in RSTD test cases | 12.2.0 |
| 12-2013 | RP-62 | RP-131931 | 2157 | | | Correction to interference clarification in FeICIC requirements | 12.2.0 |
| 03-2014 | RP-63 | RP-140389 | 2236 | | | Band simplification clean up | 12.3.0 |
| 03-2014 | RP-63 | RP-140368 | 2234 | | | Missing condition in CGI identification requirements | 12.3.0 |
| 03-2014 | RP-63 | RP-140368 | 2224 | | | CSI Reporting in SCell Activation Requirements | 12.3.0 |
| 03-2014 | RP-63 | RP-140368 | 2258 | | | Alignment between interruption requirements for RSTD and mobility measurements for SCell | 12.3.0 |
| 03-2014 | RP-63 | RP-140367 | 2263 | | | Correction of Proximity Indication Test Case | 12.3.0 |
| 03-2014 | RP-63 | RP-140380 | 2259 | | | Addition of new OCNG pattern for E-UTRA TDD with 5MHz bandwidth | 12.3.0 |
| 03-2014 | RP-63 | RP-140380 | 2260 | | | Addition of new RMC for E-UTRA TDD with 5MHz bandwidth | 12.3.0 |
| 03-2014 | RP-63 | RP-140380 | 2261 | | | Addition of OCNG pattern for E-UTRA FDD with 5MHz bandwidth without MBSFN | 12.3.0 |
| 03-2014 | RP-63 | RP-140381 | 2169 | | | Updates on test case A.9.1.17 FDD—FDD Inter frequency case for 5MHz Bandwidth for R12 | 12.3.0 |
| 03-2014 | RP-63 | RP-140389 | 2170 | | | Correction on the SNR values of in-sync RLM test for 5MHz | 12.3.0 |
| 03-2014 | RP-63 | RP-140371 | 2200 | 1 | | Clarification of BW applicability in Rx-Tx Time Difference measurement R12 | 12.3.0 |
| 03-2014 | RP-63 | RP-140389 | 2182 | | | Clarification on FDD reference measurement channels for 5 MHz tests | 12.3.0 |
| 03-2014 | RP-63 | RP-140368 | 2181 | | | Correction on PDSCH allocation in PRS subframe r12 | 12.3.0 |
| 03-2014 | RP-63 | RP-140367 | 2192 | | | PRS_RA corrections | 12.3.0 |
| 06-2014 | RP-64 | RP-140650 | 2331 | 3 | | Introduction of test cases for 5MHz +5MHz : absolute and relative RSRQ accuracies in CA for FDD and TDD The CR was not implemented as it contained the wrong content. | 12.4.0 |
| 06-2014 | RP-64 | RP-140743 | 2366 | 1 | | SCell activation and deactivation delay test case for known SCell | 12.4.0 |
| 06-2014 | RP-64 | RP-140910 | 2312 | | | Clarification on UE Transmit Timing Accuracy test cases in DRX mode R12 | 12.4.0 |
| 06-2014 | RP-64 | RP-140910 | 2267 | | | RRM: Clean-up of time offset between cells in RSTD tests (Rel-12) | 12.4.0 |
| 06-2014 | RP-64 | RP-140910 | 2354 | | | RSTD inter-frequency requirements applicability | 12.4.0 |
| 06-2014 | RP-64 | RP-140911 | 2382 | | | RRM: Remove square brackets from eICIC RLM test requirement (Rel-12) | 12.4.0 |
| 06-2014 | RP-64 | RP-140911 | 2379 | | | Correction to periodicity of ABS pattern in eICIC RRM test cases | 12.4.0 |
| 06-2014 | RP-64 | RP-140911 | 2315 | | | Correction for OCNG pattern number in RRM tests R12 | 12.4.0 |
| 06-2014 | RP-64 | RP-140911 | 2302 | | | Introduce the CGI reading requirements in CA R12 | 12.4.0 |
| 06-2014 | RP-64 | RP-140911 | 2360 | 1 | | Test case corrections for eICIC | 12.4.0 |
| 06-2014 | RP-64 | RP-140911 | 2278 | | | Removing DPCH for handover from E-UTRAN to UTRA TDD for Rel-12 | 12.4.0 |
| 06-2014 | RP-64 | RP-140911 | 2422 | | | Clean up the correction on PDSCH allocation in PRS subframe R12 | 12.4.0 |
| 06-2014 | RP-64 | RP-140911 | 2319 | | | Clarification on E-UTRAN TDD - UE Timing Advance Adjustment Accuracy Test R12 | 12.4.0 |

| | | | | | | | |
|---------|-------|-----------|------|---|--|--|--------|
| 06-2014 | RP-64 | RP-140914 | 2416 | | | Correction to PCI configuration conditions in FeICIC tests R12 | 12.4.0 |
| 06-2014 | RP-64 | RP-140914 | 2338 | | | CQI feedback periodicity correction for RLM in eICIC/FeICIC test setup | 12.4.0 |
| 06-2014 | RP-64 | RP-140916 | 2307 | | | E-UTRAN TDD - UE Timing Advance Adjustment Accuracy Test for SCell in sTAG | 12.4.0 |
| 06-2014 | RP-64 | RP-140916 | 2340 | 1 | | Test case for RACH on SCell | 12.4.0 |
| 06-2014 | RP-64 | RP-140916 | 2306 | | | E-UTRAN FDD - UE Timing Advance Adjustment Accuracy Test for SCell in sTAG | 12.4.0 |
| 06-2014 | RP-64 | RP-140918 | 2357 | | | Editorial corrections RRM | 12.4.0 |
| 06-2014 | RP-64 | RP-140918 | 2364 | | | Clean up for Band 29 | 12.4.0 |
| 06-2014 | RP-64 | RP-140918 | 2445 | | | Removing square brackets in FeICIC test cases | 12.4.0 |
| 06-2014 | RP-64 | RP-140923 | 2387 | | | E-UTRAN FDD RSTD measurement reporting in carrier aggregation for 10MHz+5MHz | 12.4.0 |
| 06-2014 | RP-64 | RP-140923 | 2388 | | | E-UTRAN TDD RSTD measurement reporting in carrier aggregation for 10MHz+5MHz | 12.4.0 |
| 06-2014 | RP-64 | RP-140923 | 2389 | | | E-UTRAN FDD RSTD measurement accuracy in CA for 10MHz+5MHz | 12.4.0 |
| 06-2014 | RP-64 | RP-140923 | 2390 | | | E-UTRAN TDD RSTD measurement accuracy in CA for 10MHz+5MHz | 12.4.0 |
| 06-2014 | RP-64 | RP-140923 | 2290 | | | E-UTRAN FDD absolute and relative RSRP accuracies in CA for 10MHz+5MHz | 12.4.0 |
| 06-2014 | RP-64 | RP-140923 | 2291 | | | E-UTRAN TDD absolute and relative RSRP accuracies in CA for 10MHz+5MHz | 12.4.0 |
| 06-2014 | RP-64 | RP-140926 | 2339 | | | Introduction of Band 32/XXXII | 12.4.0 |
| 06-2014 | RP-64 | RP-140928 | 2394 | 1 | | Introduce RRM measurement requirements for eIMTA | 12.4.0 |
| 06-2014 | RP-64 | RP-140928 | 2396 | 1 | | Inter frequency measurements using autonomous gaps | 12.4.0 |
| 06-2014 | RP-64 | RP-140930 | 2374 | 1 | | RRM requirements for TDD-FDD CA | 12.4.0 |
| 06-2014 | RP-64 | RP-140937 | 2412 | 1 | | Introduction of test cases for 5MHz +5MHz : RSTD Measurement Accuracy in Carrier Aggregation for 5 + 5MHz bandwidth | 12.4.0 |
| 06-2014 | RP-64 | RP-140937 | 2330 | 1 | | Introduction of test cases for 5MHz +5MHz : absolute and relative RSRP accuracies in CA for FDD and TDD | 12.4.0 |
| 06-2014 | RP-64 | RP-140937 | 2410 | 1 | | Introduction of test cases for 5MHz +5MHz : RSTD Measurement Reporting Test Case | 12.4.0 |
| 06-2014 | RP-64 | RP-140937 | 2332 | 2 | | Introduction of test cases for 5MHz +5MHz : Event triggered reporting on deactivating Scells in non-DRX FDD and TDD | 12.4.0 |
| 06-2014 | RP-64 | RP-140937 | 2415 | 1 | | Introduction of test cases for 5MHz +5MHz : E-UTRA event triggered reporting on deactivated SCell with PCell interruption in non-DRX | 12.4.0 |
| 06-2014 | RP-64 | RP-140939 | 2294 | | | E-UTRAN TDD absolute and relative RSRQ accuracies in CA for 10MHz+5MHz | 12.4.0 |
| 06-2014 | RP-64 | RP-140939 | 2385 | | | E-UTRAN FDD Event triggered reporting on deactivating Scells and interruption probability (0.5%) without DRX for 10MHz+5MHz | 12.4.0 |
| 06-2014 | RP-64 | RP-140939 | 2386 | | | E-UTRAN TDD Event triggered reporting on deactivating Scells and interruption probability (0.5%) without DRX for 10MHz+5MHz | 12.4.0 |
| 06-2014 | RP-64 | RP-140939 | 2292 | | | E-UTRAN FDD absolute and relative RSRQ accuracies in CA for 5MHz+10MHz | 12.4.0 |
| 06-2014 | RP-64 | RP-140939 | 2289 | | | E-UTRAN TDD Event triggered reporting under deactivated Scell in non-DRX for 10MHz+5MHz | 12.4.0 |
| 06-2014 | RP-64 | RP-140939 | 2288 | | | E-UTRAN FDD Event triggered reporting under deactivated Scell in non-DRX for 10MHz+5MHz | 12.4.0 |
| 06-2014 | RP-64 | RP-140945 | 2384 | | | Correct Correlation Matrix and Antenna Configuration for RRM test cases A.8 | 12.4.0 |
| 06-2014 | RP-64 | RP-140945 | 2346 | 1 | | E-UTRAN TDD - UE Transmit Timing Accuracy Tests for SCell in sTAG | 12.4.0 |
| 06-2014 | RP-64 | RP-140945 | 2383 | | | Correct Correlation Matrix and Antenna Configuration for RRM test cases A.4, A.7 | 12.4.0 |
| 06-2014 | RP-64 | RP-140945 | 2336 | 2 | | New Test Case for UE Transmit Timing Accuracy requirements in DRX | 12.4.0 |
| 06-2014 | RP-64 | RP-140945 | 2268 | 1 | | UE Behaviour after Measurement Gap | 12.4.0 |
| 06-2014 | RP-64 | RP-140945 | 2345 | 1 | | E-UTRAN FDD - UE Transmit Timing Accuracy Tests for SCell in sTAG | 12.4.0 |
| 06-2014 | RP-64 | RP-140945 | 2419 | | | Editorial correction for band 31 in 36.133 | 12.4.0 |
| 06-2014 | RP-64 | RP-140959 | 2395 | 2 | | Introduce RSRP/RSRQ measurement accuracy requirements for 3DL CA | 12.4.0 |
| 06-2014 | RP-64 | RP-140959 | 2376 | 3 | | Introduce the support of 3DL CA to TS 36.133 Section 7.8 "Interruptions with Carrier Aggregation" | 12.4.0 |

| | | | | | | | |
|---------|-------|-----------|------|---|--|--|--------|
| 06-2014 | RP-64 | RP-140959 | 2375 | 2 | | Introduce the support of 3DL CA to TS 36.133 Section 7.1 "UE transmit timing" | 12.4.0 |
| 06-2014 | RP-64 | RP-140959 | 2373 | 2 | | SCell activation and deactivation delay requirements for 3 DL CA | 12.4.0 |
| 09-2014 | RP-65 | RP-141526 | 2527 | | | Tolerance levels for measurements on UTRAN | 12.5.0 |
| 09-2014 | RP-65 | RP-141530 | 2474 | | | Correction to periodicity of ABS pattern in feICIC RRM test cases | 12.5.0 |
| 09-2014 | RP-65 | RP-141531 | 2515 | 1 | | Maximum transmission timing difference | 12.5.0 |
| 09-2014 | RP-65 | RP-141536 | 2502 | | | Introduction of test cases for 5MHz +5MHz : absolute and relative RSRQ accuracies in CA for FDD and TDD | 12.5.0 |
| 09-2014 | RP-65 | RP-141539 | 2481 | | | Modification on E-UTRAN event triggered reporting under deactivated SCell for 20 MHz bandwidth | 12.5.0 |
| 09-2014 | RP-65 | RP-141545 | 2523 | 2 | | Introduction of BeaconRSSI measurements for WLAN/3GPP Radio Interworking | 12.5.0 |
| 09-2014 | RP-65 | RP-141554 | 2492 | | | Interruptions on Activated Serving Cells for 3DL CA | 12.5.0 |
| 09-2014 | RP-65 | RP-141554 | 2495 | | | Requirements for UE Measurements Procedures in RRC_CONNECTED State for 3DL CA | 12.5.0 |
| 09-2014 | RP-65 | RP-141562 | 2454 | 1 | | Correction of values in RSTD tests | 12.5.0 |
| 09-2014 | RP-65 | RP-141562 | 2457 | | | Clarification to RSTD CA Reporting Delay tests | 12.5.0 |
| 09-2014 | RP-65 | RP-141562 | 2480 | 1 | | Clarification on UE behavior considering max transmit timing difference between TAGs R12 | 12.5.0 |
| 09-2014 | RP-65 | RP-141562 | 2496 | 1 | | Applicability of requirements | 12.5.0 |
| 09-2014 | RP-65 | RP-141562 | 2510 | | | Note to clarify that certain requirements do not apply to band 32 | 12.5.0 |
| 09-2014 | RP-65 | RP-141700 | 2471 | 3 | | Clarification for ACK/NACK feedback of CGI measurement | 12.5.0 |
| 12-2014 | RP-66 | RP-142176 | 2484 | 2 | | Introducing measurement accuracy requirements for UE category 0 in TS36.133 Clause 9 | 12.6.0 |
| 12-2014 | RP-66 | RP-142176 | 2506 | 3 | | Measurements requirements for UE category 0 with 1 Rx | 12.6.0 |
| 12-2014 | RP-66 | RP-142143 | 2534 | - | | Correction of PRS Signal Levels in RSTD Reporting Tests | 12.6.0 |
| 12-2014 | RP-66 | RP-142144 | 2538 | - | | Correction of Es/Noc values in inter-frequency RSTD tests | 12.6.0 |
| 12-2014 | RP-66 | RP-142174 | 2547 | 1 | | Introduction of PDSCH FRC for TDD UL-DL configuration 0 | 12.6.0 |
| 12-2014 | RP-66 | RP-142144 | 2553 | 1 | | Clarification on time to identify the target UTRA TDD cell for blind redirection from E-UTRA to UTRA TDD | 12.6.0 |
| 12-2014 | RP-66 | RP-142174 | 2555 | 1 | | CR on inter frequency RSRP test case for eIMTA | 12.6.0 |
| 12-2014 | RP-66 | RP-142174 | 2556 | 1 | | CR on inter frequency RSRQ test case for eIMTA | 12.6.0 |
| 12-2014 | RP-66 | RP-142147 | 2566 | - | | Correction to ABS pattern and CRS Es/lot in feICIC RRM test cases | 12.6.0 |
| 12-2014 | RP-66 | RP-142144 | 2569 | - | | SCell activation and deactivation delay test case for unknown SCell R12 | 12.6.0 |
| 12-2014 | RP-66 | RP-142157 | 2573 | 2 | | Clarification on cell identification for TDD config 0 | 12.6.0 |
| 12-2014 | RP-66 | RP-142177 | 2585 | 1 | | RSRQ accuracy test case in TDD-FDD CA when Pcell is FDD R12 | 12.6.0 |
| 12-2014 | RP-66 | RP-142177 | 2586 | 1 | | RSRQ accuracy test case in TDD-FDD CA when Pcell is TDD R12 | 12.6.0 |
| 12-2014 | RP-66 | RP-142147 | 2597 | - | | Correction on Io value in CA 20MHz RSRQ test case R12 | 12.6.0 |
| 12-2014 | RP-66 | RP-142163 | 2598 | - | | Correction on Io value in CA 10MHz+5MHz RSRQ test case R12 | 12.6.0 |
| 12-2014 | RP-66 | RP-142188 | 2599 | - | | Range increase for RSRQ | 12.6.0 |
| 12-2014 | RP-66 | RP-142188 | 2606 | 1 | | Clarification of parallel reporting criteria (E-UTRA) | 12.6.0 |
| 12-2014 | RP-66 | RP-142164 | 2611 | 1 | | Interruptions with RSTD Measurements for 3DL CA | 12.6.0 |
| 12-2014 | RP-66 | RP-142164 | 2614 | - | | RRM requirements for RSTD in 3 DL CA | 12.6.0 |
| 12-2014 | RP-66 | RP-142177 | 2619 | 1 | | RSRP accuracy test cases for TDD-FDD CA | 12.6.0 |
| 12-2014 | RP-66 | RP-142176 | 2630 | - | | SI reading requirements for UE category 0 with 1 Rx in FDD, TDD and HD-FDD | 12.6.0 |
| 12-2014 | RP-66 | RP-142144 | 2639 | - | | Changes to RSTD CA Reporting Delay tests | 12.6.0 |
| 12-2014 | RP-66 | RP-142188 | 2640 | - | | Revision of RSRP absolute accuracy requirements in Rel-12 | 12.6.0 |
| 12-2014 | RP-66 | RP-142144 | 2644 | - | | Clarifications to RSTD values | 12.6.0 |
| 12-2014 | RP-66 | RP-142144 | 2656 | - | | Correction to RSTD Intra Frequency Delay Test Case | 12.6.0 |
| 12-2014 | RP-66 | RP-142144 | 2665 | - | | Correction on autonomous time adjustment in MTAG case | 12.6.0 |
| 12-2014 | RP-66 | RP-142176 | 2666 | - | | Introduce RLM requirements for LC-MTC in TS36.133 | 12.6.0 |
| 12-2014 | RP-66 | RP-142174 | 2669 | 1 | | Introducing test case for TDD-TDD Inter-frequency event triggered reporting for TDD UL/DL | 12.6.0 |

| | | | | | | | |
|---------|-------|-----------|------|---|--|--|--------|
| | | | | | | configuration 0 | |
| 12-2014 | RP-66 | RP-142179 | 2670 | 1 | | Introducing requirements for small cell enhancement in TS36.133 | 12.6.0 |
| 12-2014 | RP-66 | RP-142180 | 2671 | 2 | | Introducing interruption requirements for dual connectivity into TS36.133 | 12.6.0 |
| 12-2014 | RP-66 | RP-142162 | 2674 | - | | E-UTRAN TDD event triggered reporting under deactivated SCell in non-DRX for 20MHz+10MHz | 12.6.0 |
| 12-2014 | RP-66 | RP-142162 | 2675 | - | | E-UTRAN TDD event triggered reporting on deactivating SCell with PCell interruption in non-DRX for 20MHz+10MHz | 12.6.0 |
| 12-2014 | RP-66 | RP-142162 | 2676 | - | | E-UTRAN TDD RSTD Measurement Reporting Test Case for 20MHz+10MHz | 12.6.0 |
| 12-2014 | RP-66 | RP-142162 | 2677 | - | | TDD RSRP for E-UTRAN Carrier Aggregation for 20MHz+10MHz | 12.6.0 |
| 12-2014 | RP-66 | RP-142162 | 2678 | 1 | | TDD RSRP for E-UTRAN Carrier Aggregation for 20MHz+10MHz | 12.6.0 |
| 12-2014 | RP-66 | RP-142162 | 2679 | - | | E-UTRAN TDD RSTD Measurement Accuracy in Carrier Aggregation for 20MHz+10MHz | 12.6.0 |
| 12-2014 | RP-66 | RP-142143 | 2682 | 1 | | Introducing positioning enhancement requirement for UE Rx-Tx accuracy | 12.6.0 |
| 12-2014 | RP-66 | RP-142144 | 2686 | - | | Correction on CA test cases in R12 | 12.6.0 |
| 12-2014 | RP-66 | RP-142188 | 2687 | - | | Correction on E-UTRAN TDD – Non-Contention Based Random Access Test For Scell | 12.6.0 |
| 12-2014 | RP-66 | RP-142179 | 2688 | 1 | | Introduction of RSRP measurement accuracy requirement for DRS based measurement | 12.6.0 |
| 12-2014 | RP-66 | RP-142188 | 2690 | 1 | | Ecat clarification for iRAT | 12.6.0 |
| 12-2014 | RP-66 | RP-142180 | 2694 | - | | CR for TS36.133 on Cell phase accuracy for Dual Connectivity | 12.6.0 |
| 12-2014 | RP-66 | RP-142180 | 2695 | 1 | | Introduction of RRM requirements for Dual Connectivity | 12.6.0 |
| 12-2014 | RP-66 | RP-142180 | 2696 | 1 | | Introduction of measurement requirements for Dual Connectivity | 12.6.0 |
| 12-2014 | RP-66 | RP-142178 | 2697 | 1 | | Measurement and reporting of BLER in section 9 | 12.6.0 |
| 12-2014 | RP-66 | RP-142177 | 2698 | 1 | | Introduction of TDD-FDD CA test cases | 12.6.0 |
| 12-2014 | RP-66 | RP-142178 | 2699 | 1 | | CR on measurement for MBSFN MDT | 12.6.0 |
| 12-2014 | RP-66 | RP-142188 | 2707 | 1 | | PCell Interruption in Rel-12 CA | 12.6.0 |
| 12-2014 | RP-66 | RP-142158 | 2708 | 1 | | UE Behaviour after Measurement Gap in CA | 12.6.0 |
| 12-2014 | RP-66 | RP-142177 | 2709 | 1 | | CA RRM Testing for Multiple Duplex Modes | 12.6.0 |
| 12-2014 | RP-66 | RP-142177 | 2710 | 1 | | CA RRM Testing for Fall back CA Configuration | 12.6.0 |
| 12-2014 | RP-66 | RP-142188 | 2712 | 1 | | Introduction of High Doppler measurement accuracy requirements | 12.6.0 |
| 12-2014 | RP-66 | RP-142172 | 2714 | 1 | | Requirements for increased carrier monitoring for idle mode 36.133 | 12.6.0 |
| 12-2014 | RP-66 | RP-142172 | 2715 | 1 | | Requirements for increased carrier monitoring in RRC connected state 36.133 | 12.6.0 |
| 12-2014 | RP-66 | RP-142161 | 2716 | 1 | | Different TDD configurations in CA | 12.6.0 |
| 12-2014 | RP-66 | RP-142178 | 2722 | 1 | | MBMS requirements in section 9 | 12.6.0 |
| 12-2014 | RP-66 | RP-142179 | 2725 | 1 | | Intra-frequency and inter-frequency measurement accuracy requirements with DMTC | 12.6.0 |
| 12-2014 | RP-66 | RP-142188 | 2727 | - | | RSTD accuracy requirements for smaller and larger bandwidths | 12.6.0 |
| 12-2014 | RP-66 | RP-142149 | 2736 | - | | Corrections to E-UTRAN TDD RLM In-sync under Time Domain Measurement Resource Restriction with CRS assistance information | 12.6.0 |
| 12-2014 | RP-66 | RP-142149 | 2738 | - | | Corrections to E-UTRAN TDD RLM Out-of-sync under Time Domain Measurement Resource Restriction with CRS Assistance Information | 12.6.0 |
| 12-2014 | RP-66 | RP-142149 | 2740 | - | | Test case for inter-RAT HO to multicarrier UTRA | 12.6.0 |
| 12-2014 | RP-66 | RP-142178 | 2741 | - | | CR on parallel reporting criteria for eMBMS | 12.6.0 |
| 12-2014 | RP-66 | RP-142186 | 2742 | - | | Introduction of 2UL non-contiguous intra-band CA | 12.6.0 |
| 12-2014 | RP-66 | RP-142021 | 2743 | - | | Introduction of 2UL inter-band CA | 12.6.0 |
| 12-2014 | RP-66 | RP-142150 | 2745 | - | | Requirements for multicarrier handover from EUTRA to UTRA | 12.6.0 |
| 03-2015 | RP-77 | RP-150387 | 2747 | - | | CR to Correct Implementation Error in FDD RSTD Measurement Reporting Delay Test Case and to Update Io Levels for Certain RSTD Test Cases | 12.7.0 |
| 03-2015 | RP-77 | RP-150382 | 2750 | - | | Remove incorrect note from CA RSTD Accuracy tests | 12.7.0 |
| 03-2015 | RP-77 | RP-150387 | 2751 | - | | Change Nprs value for 5MHz CA RSTD Accuracy tests | 12.7.0 |
| 03-2015 | RP-77 | RP-150066 | 2754 | 1 | | Maximum allowed layers for multiple monitoring for CA | 12.7.0 |
| 03-2015 | RP-77 | RP-150387 | 2756 | - | | DRX correction for interruption with dual connectivity | 12.7.0 |

| | | | | | | | |
|---------|-------|-----------|--------|---|--|--|--------|
| 03-2015 | RP-77 | RP-150388 | 2757 | - | | Correction of Interruptions with RSTD Measurements for 3DL CA | 12.7.0 |
| 03-2015 | RP-77 | RP-150387 | 2761 | 1 | | RRM requirements for ProSe | 12.7.0 |
| 03-2015 | RP-77 | RP-150396 | 2763 | 1 | | Updating the requirements applicability for TDD config 0 | 12.7.0 |
| 03-2015 | RP-77 | RP-150394 | 2764 | 1 | | Cleanup for RSRQ measurement requirement for SCE | 12.7.0 |
| 03-2015 | RP-77 | RP-150394 | 2774 | 1 | | Clean up the correction on discovery signal measurements | 12.7.0 |
| 03-2015 | RP-77 | RP-150387 | 2775 | 1 | | Correction on MBSFN measurements | 12.7.0 |
| 03-2015 | RP-77 | RP-150394 | 2776 | - | | Introduce CA measurement accuracy requirements for SCE | 12.7.0 |
| 03-2015 | RP-77 | RP-150382 | 2777 | - | | Correction on lo in carrier aggregation test cases | 12.7.0 |
| 03-2015 | RP-77 | RP-150387 | 2783 | - | | Introducing accuracy requirement for new RSRQ | 12.7.0 |
| 03-2015 | RP-77 | RP-150384 | 2785 | - | | Time-domain measurement resource restriction pattern for serving cell in feICIC RSRP and RSRQ test cases | 12.7.0 |
| 03-2015 | RP-77 | RP-150384 | 2791 | - | | CR on typo of referencing section name in CA measurements | 12.7.0 |
| 03-2015 | RP-77 | RP-150393 | 2797 | 1 | | Clarification including PSCell in Note 1 for Ecat | 12.7.0 |
| 03-2015 | RP-77 | RP-150386 | 2798 | 1 | | Clarification of IncMon requirements for E-UTRA idle state | 12.7.0 |
| 03-2015 | RP-77 | RP-150386 | 2799 | 1 | | Clarification of IncMon requirements for E-UTRA connected state | 12.7.0 |
| 03-2015 | RP-77 | RP-150386 | 2800 | 1 | | Clarification concerning IncMon scaling for non-gap-assisted measurements | 12.7.0 |
| 03-2015 | RP-77 | RP-150382 | 2803 | - | | Correction of RMC and OCNG pattern in event triggered tests without measurement gap | 12.7.0 |
| 03-2015 | RP-77 | RP-150394 | 2804 | - | | CR on RSRQ requirements for CRS based discovery signal | 12.7.0 |
| 03-2015 | RP-77 | RP-150387 | 2808 | - | | Correction to RRM test cases | 12.7.0 |
| 03-2015 | RP-77 | RP-150388 | 2809 | - | | Correction to CA Testing with Different CA Configurations | 12.7.0 |
| 03-2015 | RP-77 | RP-150393 | 2811 | - | | Principle to test synchronous and asynchronous DC requirements | 12.7.0 |
| 03-2015 | RP-77 | RP-150387 | 2814 | - | | Further revision of RSRP requirement for 36.133 release 12 | 12.7.0 |
| 03-2015 | RP-77 | RP-150387 | 2815 | - | | Additional bandwidths for EUTRAN activation and deactivation of known and unknown SCell in non-DRX | 12.7.0 |
| 03-2015 | RP-77 | RP-150387 | 2816 | 1 | | High Doppler measurement accuracy requirements | 12.7.0 |
| 03-2015 | RP-77 | RP-150384 | 2817 | 1 | | 36.133 CR to change CPICH Ec/No to CPICH Ec/lo in EUTRA FDD to UTRA FDD HO test cases | 12.7.0 |
| 03-2015 | RP-77 | RP-150388 | 2822 | - | | Maximum Transmission Timing Difference in 3DL CA | 12.7.0 |
| 03-2015 | RP-77 | RP-150053 | 2824 | - | | Correction to the implementation of CR 2471r3 (Clarification for ACK/NACK feedback of CGI measurement) | 12.7.0 |
| 06-2015 | RP-68 | RP-150972 | 2825 | | | 3 DL CA Phase I tests # 1-2: Event triggered reporting tests with deactivated SCells in non-DRX for TDD-FDD CA | 12.8.0 |
| 06-2015 | RP-68 | RP-150961 | 2828 | | | RMC for 10 MHz for UE category 0 RRM tests | 12.8.0 |
| 06-2015 | RP-68 | RP-150957 | 2829 | | | Correction to measurement scaling factor for incmon | 12.8.0 |
| 06-2015 | RP-68 | RP-150957 | 2832 | | | RSRP requirement for SCE | 12.8.0 |
| 06-2015 | RP-68 | RP-150962 | 2833r1 | 1 | | CR on FDD-FDD inter-frequency absolute and relative CRS RSRP accuracy test case | 12.8.0 |
| 06-2015 | RP-68 | RP-150962 | 2834r1 | 1 | | CR on TDD-TDD inter-frequency absolute and relative CRS RSRP accuracy test case | 12.8.0 |
| 06-2015 | RP-68 | RP-150962 | 2835r1 | 1 | | CR on FDD absolute and relative CSI-RSRP accuracy test case for E-UTRAN Carrier Aggregation | 12.8.0 |
| 06-2015 | RP-68 | RP-150962 | 2836r1 | 1 | | CR on TDD absolute and relative CSI-RSRP accuracy test case for E-UTRAN Carrier Aggregation | 12.8.0 |
| 06-2015 | RP-68 | RP-150962 | 2837r1 | 1 | | CR on FDD-FDD inter-frequency absolute and relative CSI-RSRP accuracy test case | 12.8.0 |
| 06-2015 | RP-68 | RP-150962 | 2838r1 | 1 | | CR on TDD-TDD inter-frequency absolute and relative CSI-RSRP accuracy test case | 12.8.0 |
| 06-2015 | RP-68 | RP-150962 | 2839r1 | 1 | | CR on FDD intra frequency absolute and relative CSI-RSRP accuracy test case | 12.8.0 |
| 06-2015 | RP-68 | RP-150962 | 2840r1 | 1 | | CR on TDD intra frequency absolute and relative CSI-RSRP accuracy test case | 12.8.0 |
| 06-2015 | RP-68 | RP-150962 | 2842r1 | 1 | | Intra-frequency absolute and relative RSRP | 12.8.0 |

| | | | | | | | |
|---------|-------|-----------|------------|---|--|---|--------|
| | | | 1 | | | accuracies in CRS based discovery signal | |
| 06-2015 | RP-68 | RP-150962 | 2843r 1 | 1 | | Absolute and relative RSRP accuracies for E-UTRAN Carrier Aggregation in CRS based discovery signal | 12.8.0 |
| 06-2015 | RP-68 | RP-150962 | 2845r 1 | 1 | | SCE FDD intra-frequency absolute RSRQ accuracy | 12.8.0 |
| 06-2015 | RP-68 | RP-150962 | 2846r 1 | 1 | | SCE TDD intra-frequency absolute RSRQ accuracy | 12.8.0 |
| 06-2015 | RP-68 | RP-150962 | 2847 | | | SCE FDD absolute RSRQ accuracy for CA | 12.8.0 |
| 06-2015 | RP-68 | RP-150962 | 2848 | | | SCE TDD absolute RSRQ accuracy for CA | 12.8.0 |
| 06-2015 | RP-68 | RP-150961 | 2849r 1 | 1 | | Test for CGI acquisition requirements for UE category 0 | 12.8.0 |
| 06-2015 | RP-68 | RP-150961 | 2850r 1 | 1 | | Test for cell identification for UE category 0 | 12.8.0 |
| 06-2015 | RP-68 | RP-150961 | 2851 | | | Test for handover requirements for UE category 0 | 12.8.0 |
| 06-2015 | RP-68 | RP-150961 | 2852 | | | Test for RRC re-establishment requirements for UE category 0 | 12.8.0 |
| 06-2015 | RP-68 | RP-150961 | 2853r 1 | 1 | | HD-FDD handover requirements for UE category 0 | 12.8.0 |
| 06-2015 | RP-68 | RP-150957 | 2855r 1 | 1 | | Correction of requirements for ProSe in DRX | 12.8.0 |
| 06-2015 | RP-68 | RP-150962 | 2857r 1 | 1 | | E-UTRAN FDD intra frequency CRS based discovery signal measurements when DRX is used | 12.8.0 |
| 06-2015 | RP-68 | RP-150962 | 2858r 1 | 1 | | E-UTRAN TDD intra frequency CRS based discovery signal measurements when DRX is used | 12.8.0 |
| 06-2015 | RP-68 | RP-150962 | 2859r 1 | 1 | | E-UTRAN FDD-FDD inter-frequency event triggered reporting under fading propagation conditions in DRX based on CRS based discovery signal | 12.8.0 |
| 06-2015 | RP-68 | RP-150962 | 2860r 1 | 1 | | E-UTRAN TDD-TDD inter-frequency event triggered reporting under fading propagation conditions in DRX based on CRS based discovery signal | 12.8.0 |
| 06-2015 | RP-68 | RP-150962 | 2861r 1 | 1 | | E-UTRAN FDD event triggered reporting under deactivated SCell in non-DRX based on CRS based discovery signal | 12.8.0 |
| 06-2015 | RP-68 | RP-150962 | 2862r 1 | 1 | | E-UTRAN TDD event triggered reporting under deactivated SCell in non-DRX based on CRS based discovery signal | 12.8.0 |
| 06-2015 | RP-68 | RP-150961 | 2866r 1 | 1 | | RSRP accuracy FD-FDD Intra frequency case for UE category 0 | 12.8.0 |
| 06-2015 | RP-68 | RP-150961 | 2867r 1 | 1 | | RSRP accuracy HD-FDD Intra frequency case for UE category 0 | 12.8.0 |
| 06-2015 | RP-68 | RP-150961 | 2868r 1 | 1 | | RSRP accuracy TDD Intra frequency case for UE category 0 | 12.8.0 |
| 06-2015 | RP-68 | RP-150961 | 2869r 1 | 1 | | RSRQ accuracy FD-FDD Intra frequency case for UE category 0 | 12.8.0 |
| 06-2015 | RP-68 | RP-150961 | 2870r 1 | 1 | | RSRQ accuracy HD-FDD Intra frequency case for UE category 0 | 12.8.0 |
| 06-2015 | RP-68 | RP-150961 | 2871r 1 | 1 | | RSRQ accuracy TDD Intra frequency case for UE category 0 | 12.8.0 |
| 06-2015 | RP-68 | RP-150972 | 2872r 1 | 1 | | Test case for 3DL CA: PCell in FDD: Event triggered reporting on deactivated SCells and interruption probability (0.5%) without DRX (TDD-FDD CA) | 12.8.0 |
| 06-2015 | RP-68 | RP-150972 | 2873r 1 | 1 | | Test case for 3DL CA: PCell in TDD: Event triggered reporting on deactivated SCells and interruption probability (0.5%) without DRX (TDD-FDD CA) | 12.8.0 |
| 06-2015 | RP-68 | RP-150958 | 2874r 1 | 1 | | Test case for 3DL CA: Event triggered reporting on deactivated SCells and interruption probability (0.5%) without DRX (FDD CA) | 12.8.0 |
| 06-2015 | RP-68 | RP-150968 | 2875r 1 | 1 | | Test case for 3DL CA: Event triggered reporting on deactivated SCells and interruption probability (0.5%) without DRX (TDD 3 DL CA) | 12.8.0 |
| 06-2015 | RP-68 | RP-150965 | 2880 | | | OTDOA RSTD Measurements on different secondary component carriers | 12.8.0 |
| 06-2015 | RP-68 | RP-150955 | 2884 | | | E-UTRAN TDD-TDD Inter-frequency event triggered reporting under fading propagation conditions in synchronous cells for 20 MHz +20 MHz bandwidth R12 | 12.8.0 |
| 06-2015 | RP-68 | RP-150958 | 2885 | | | E-UTRAN TDD-TDD Inter-frequency event triggered reporting under fading propagation conditions in synchronous cells for 20 MHz +10 MHz bandwidth R12 | 12.8.0 |

| | | | | | | | |
|---------|-------|-----------|-------------|---|--|--|--------|
| 06-2015 | RP-68 | RP-150955 | 2886 | | | E-UTRAN TDD with 20 MHz +20 MHz bandwidth to UTRAN TDD cell search under fading propagation conditions R12 | 12.8.0 |
| 06-2015 | RP-68 | RP-150958 | 2887 | | | E-UTRAN TDD with 20 MHz +10 MHz bandwidth to UTRAN TDD cell search under fading propagation conditions R12 | 12.8.0 |
| 06-2015 | RP-68 | RP-150957 | 2897 | | | Further clarification of MBMSBLER reporting in section 9 | 12.8.0 |
| 06-2015 | RP-68 | RP-150962 | 2903r 1 | 1 | | Test case of FDD-FDD inter-frequency RSRQ measurement accuracy in discovery signal occasions | 12.8.0 |
| 06-2015 | RP-68 | RP-150962 | 2904 | | | CR on side conditions for inter-frequency measurement for SCE | 12.8.0 |
| 06-2015 | RP-68 | RP-150962 | 2905 | | | CR on test case for RSRQ TDD-TDD inter frequency measurement accuracy requirement for SCE | 12.8.0 |
| 06-2015 | RP-68 | RP-150955 | 2906r 1 | 1 | | Maximum Rx difference between Pcell and Scell in section 7.9 | 12.8.0 |
| 06-2015 | RP-68 | RP-150962 | 2908r 1 | 1 | | FDD-FDD intra frequency event triggered reporting in DRX based on CSI-RS based discovery signal | 12.8.0 |
| 06-2015 | RP-68 | RP-150962 | 2909r 1 | 1 | | TDD-TDD intra frequency event triggered reporting in DRX based on CSI-RS based discovery signal | 12.8.0 |
| 06-2015 | RP-68 | RP-150962 | 2910r 1 | 1 | | FDD-FDD inter frequency event triggered reporting in DRX based on CSI-RS based discovery signal | 12.8.0 |
| 06-2015 | RP-68 | RP-150962 | 2911r 1 | 1 | | TDD-TDD inter frequency event triggered reporting in DRX based on CSI-RS based discovery signal | 12.8.0 |
| 06-2015 | RP-68 | RP-150962 | 2912r 1 | 1 | | FDD event triggered reporting under deactivated SCell in non-DRX based on CSI-RS based discovery signal | 12.8.0 |
| 06-2015 | RP-68 | RP-150962 | 2913r 1 | 1 | | TDD event triggered reporting under deactivated SCell in non-DRX based on CSI-RS based discovery signal | 12.8.0 |
| 06-2015 | RP-68 | RP-150957 | 2915r 2 | 2 | | CR of DC interruption requirements | 12.8.0 |
| 06-2015 | RP-68 | RP-150965 | 2916r 1 | 1 | | Event triggered reporting on deactivated SCells in non-DRX (FDD CA) | 12.8.0 |
| 06-2015 | RP-68 | RP-150965 | 2917r 1 | 1 | | Event triggered reporting on deactivated SCells in non-DRX (TDD CA) | 12.8.0 |
| 06-2015 | RP-68 | RP-150972 | 2919r 1 | 1 | | Introduction of RRM test case for E-UTRAN TDD-FDD 3 DL CA activation and deactivation of known SCell in non-DRX with PCell in FDD | 12.8.0 |
| 06-2015 | RP-68 | RP-150972 | 2920r 1 | 1 | | Introduction of RRM test case for E-UTRAN TDD-FDD 3 DL CA activation and deactivation of known SCell in non-DRX with PCell in TDD | 12.8.0 |
| 06-2015 | RP-68 | RP-150972 | 2921 | | | 3DL CA Phase I tests #11_3DL FDD CA SCell activation and deactivation for known SCells without DRX | 12.8.0 |
| 06-2015 | RP-68 | RP-150965 | 2921a | | | Correction of implementation of CR 2644 in Table A.9.8.1.1-1 | 12.8.0 |
| 06-2015 | RP-68 | RP-150972 | 2922 | | | 3DL CA Phase I tests #12_3DL TDD CA SCell activation and deactivation for known SCells without DRX | 12.8.0 |
| 06-2015 | RP-68 | RP-150959 | 2922a r2 | 2 | | Incmon CR for FDD-FDD Interfrequency correct reporting of measurement events without reduced performance group configured, non DRX | 12.8.0 |
| 06-2015 | RP-68 | RP-150959 | 2923r 2 | 2 | | Incmon CR for TDD-TDD Interfrequency correct reporting of measurement events without reduced performance group configured, non DRX | 12.8.0 |
| 06-2015 | RP-68 | RP-150963 | 2928r 1 | 1 | | FDD RLM Test Case for Out-of-sync in DRX for PSCell in asynchronous DC | 12.8.0 |
| 06-2015 | RP-68 | RP-150963 | 2929r 1 | 1 | | FDD RLM Test Case for In-sync in DRX for PSCell in asynchronous DC | 12.8.0 |
| 06-2015 | RP-68 | RP-150954 | 2932 | | | Correction of Cell Time offset in RSTD CA Test cases (Rel-12) | 12.8.0 |
| 06-2015 | RP-68 | RP-150963 | 2933r 1 | 1 | | Introduction of DC intra-frequency event triggered reporting with DRX in synchronous FDD DC | 12.8.0 |
| 06-2015 | RP-68 | RP-150963 | 2934r 1 | 1 | | Introduction of DC intra-frequency event triggered reporting with DRX in synchronous TDD DC | 12.8.0 |
| 06-2015 | RP-68 | RP-150963 | 2935r 1 | 1 | | Introduction of DC intra-frequency event triggered reporting with DRX in asynchronous FDD DC | 12.8.0 |
| 06-2015 | RP-68 | RP-150963 | 2936r 1 | 1 | | Introduction of DC inter-frequency event triggered reporting with DRX in synchronous FDD DC | 12.8.0 |
| 06-2015 | RP-68 | RP-150963 | 2937r 1 | 1 | | Introduction of DC inter-frequency event triggered reporting with DRX in synchronous TDD DC | 12.8.0 |
| 06-2015 | RP-68 | RP-150959 | 2938r | 1 | | Testcases for E-UTRA Incmon idle interfrequency | 12.8.0 |

| | | | | | | | |
|---------|-------|-----------|------------|---|--|--|--------|
| | | | 1 | | | reselection | |
| 06-2015 | RP-68 | RP-150962 | 2940r 2 | 2 | | CR on minimum number of subframes for discovery-based measurements | 12.8.0 |
| 06-2015 | RP-68 | RP-150961 | 2941r 1 | 1 | | E-UTRAN FD-FDD Radio Link Monitoring Tests for UE category 0 | 12.8.0 |
| 06-2015 | RP-68 | RP-150961 | 2942r 1 | 1 | | E-UTRAN HD-FDD Radio Link Monitoring Tests for UE category 0 | 12.8.0 |
| 06-2015 | RP-68 | RP-150961 | 2943r 1 | 1 | | E-UTRAN TDD Radio Link Monitoring Tests for UE category 0 | 12.8.0 |
| 06-2015 | RP-68 | RP-150958 | 2944r 1 | 1 | | Absolute and relative RSRP accuracies in FDD 3 DL CA | 12.8.0 |
| 06-2015 | RP-68 | RP-150968 | 2945r 1 | 1 | | Absolute and relative RSRP accuracies in TDD 3 DL CA | 12.8.0 |
| 06-2015 | RP-68 | RP-150972 | 2946r 1 | 1 | | PCell in FDD: absolute and relative RSRQ accuracies in TDD-FDD 3 DL CA | 12.8.0 |
| 06-2015 | RP-68 | RP-150972 | 2947r 1 | 1 | | PCell in TDD: absolute and relative RSRQ accuracies in TDD-FDD 3 DL CA | 12.8.0 |
| 06-2015 | RP-68 | RP-150959 | 2950 | | | FDD-FDD Interfrequency correct reporting of measurement events with reduced performance group configured for non DRX IncMon | 12.8.0 |
| 06-2015 | RP-68 | RP-150959 | 2951 | | | TDD-TDD Interfrequency correct reporting of measurement events with reduced performance group configured for non DRX IncMon | 12.8.0 |
| 06-2015 | RP-68 | RP-150963 | 2952r 1 | 1 | | E-UTRAN FDD Radio Link Monitoring Test for In-sync in DRX for PSCell in synchronous dual connectivity | 12.8.0 |
| 06-2015 | RP-68 | RP-150963 | 2953r 1 | 1 | | E-UTRAN TDD Radio Link Monitoring Test for In-sync in DRX for PSCell in synchronous dual connectivity | 12.8.0 |
| 06-2015 | RP-68 | RP-150961 | 2954r 1 | 1 | | E-UTRAN FDD PCell interruption at transitions between active and non-active when DRX is used in PSCell in asynchronous dual connectivity | 12.8.0 |
| 06-2015 | RP-68 | RP-150958 | 2955 | | | E-UTRAN TDD - UE Transmit Timing Accuracy Tests for SCell for 20 MHz +10 MHz bandwidth R12 | 12.8.0 |
| 06-2015 | RP-68 | RP-150955 | 2956 | | | E-UTRAN TDD - UE Transmit Timing Accuracy Tests for SCell in sTAG for 20 MHz +20 MHz bandwidth R12 | 12.8.0 |
| 06-2015 | RP-68 | RP-150958 | 2957 | | | E-UTRAN TDD - UE Transmit Timing Accuracy Tests for SCell in sTAG for 20 MHz +10 MHz bandwidth R12 | 12.8.0 |
| 06-2015 | RP-68 | RP-150955 | 2958 | | | E-UTRAN TDD – UE Timing Advance Adjustment Accuracy Test for Scell in sTAG for 20 MHz +20 MHz bandwidth R12 | 12.8.0 |
| 06-2015 | RP-68 | RP-150958 | 2959 | | | E-UTRAN TDD – UE Timing Advance Adjustment Accuracy Test for Scell in sTAG for 20 MHz +10 MHz bandwidth R12 | 12.8.0 |
| 06-2015 | RP-68 | RP-150965 | 2962 | | | Addition PDSCH RMC for 5MHz with user data | 12.8.0 |
| 06-2015 | RP-68 | RP-150972 | 2967r 1 | 1 | | 3 DL CA Phase II tests # 1-2: RSRP measurement accuracies for TDD-FDD CA | 12.8.0 |
| 06-2015 | RP-68 | RP-150963 | 2971r 1 | 1 | | PSCell Add and Release Delay Tests for Synchronous DC | 12.8.0 |
| 06-2015 | RP-68 | RP-150963 | 2972r 1 | 1 | | PSCell Add and Release Delay Tests for Asynchronous DC | 12.8.0 |
| 06-2015 | RP-68 | RP-150959 | 2975r 1 | 1 | | Idle mode FDD to UTRA FDD interRAT reselection | 12.8.0 |
| 06-2015 | RP-68 | RP-150959 | 2976r 1 | 1 | | Idle mode TDD to UTRA FDD interRAT reselection | 12.8.0 |
| 06-2015 | RP-68 | RP-150959 | 2977 | | | E-UTRA FDD InterRAT UTRA FDD correct reporting of measurement events with reduced performance group configured, non DRX | 12.8.0 |
| 06-2015 | RP-68 | RP-150959 | 2978 | | | E-UTRA TDD InterRAT UTRA FDD correct reporting of measurement events with reduced performance group configured, non DRX | 12.8.0 |
| 06-2015 | RP-68 | RP-150963 | 2979r 1 | 1 | | E-UTRAN FDD PCell interruption at transitions between active and non-active when DRX is used in PSCell in synchronous dual connectivity | 12.8.0 |
| 06-2015 | RP-68 | RP-150963 | 2980r 1 | 1 | | E-UTRAN TDD PCell interruption at transitions between active and non-active when DRX is used in PSCell in synchronous dual connectivity | 12.8.0 |
| 06-2015 | RP-68 | RP-150963 | 2981r 1 | 1 | | E-UTRAN FDD inter-frequency event triggered reporting in asynchronous dual connectivity | 12.8.0 |
| 06-2015 | RP-68 | RP-150958 | 2984r 1 | 1 | | Modification for interruption period for SCell (de-)activation with 3DL | 12.8.0 |
| 06-2015 | RP-68 | RP-150959 | 2987r 1 | 1 | | Test cases of Idle mode E-UTRA to UTRA TDD interRAT cell reselection for IncMon | 12.8.0 |

| | | | | | | | |
|---------|-------|-----------|------------|---|--|---|--------|
| 06-2015 | RP-68 | RP-150959 | 2988r 1 | 1 | | Test cases of Interfrequency correct reporting of measurement events with reduced performance group configured, DRX | 12.8.0 |
| 06-2015 | RP-68 | RP-150963 | 2989r 2 | 2 | | E-UTRAN FDD Radio Link Monitoring Test for Out-of-sync in DRX for PSCell in synchronous dual connectivity | 12.8.0 |
| 06-2015 | RP-68 | RP-150963 | 2990r 2 | 2 | | E-UTRAN TDD Radio Link Monitoring Test for Out-of-sync in DRX for PSCell in synchronous dual connectivity | 12.8.0 |
| 06-2015 | RP-68 | RP-150957 | 2992 | | | CR on interruption during D2D discovery for D2D single RF chain | 12.8.0 |
| 06-2015 | RP-68 | RP-150965 | 2993 | | | CR on E-UTRAN TDD-TDD inter frequency measurements when DRX is used | 12.8.0 |
| 06-2015 | RP-68 | RP-150965 | 2998 | | | Test case of FDD-FDD inter-frequency new RSRQ measurement accuracy | 12.8.0 |
| 06-2015 | RP-68 | RP-150965 | 2999 | | | Test case of TDD-TDD inter-frequency new RSRQ measurement accuracy | 12.8.0 |
| 06-2015 | RP-68 | RP-150955 | 3001 | | | Correction to felCIC cell configurations in RLM | 12.8.0 |
| 06-2015 | RP-68 | RP-150955 | 3003 | | | Correction to A.8.1.8 | 12.8.0 |
| 06-2015 | RP-68 | RP-150972 | 3004r 1 | 1 | | CR on absolute and relative RSRQ accuracies in TDD 3DL CA | 12.8.0 |
| 06-2015 | RP-68 | RP-150972 | 3005r 1 | 1 | | CR on absolute and relative RSRQ accuracies in FDD 3DL CA | 12.8.0 |
| 06-2015 | RP-68 | RP-150965 | 3006 | | | CR for test case of new RSRQ measurement accuracy in FDD | 12.8.0 |
| 06-2015 | RP-68 | RP-150965 | 3007 | | | CR for test case of new RSRQ measurement accuracy in TDD | 12.8.0 |
| 06-2015 | RP-68 | RP-150972 | 3008r 1 | 1 | | RSTD measurement reporting in FDD 3 DL CA | 12.8.0 |
| 06-2015 | RP-68 | RP-150972 | 3009r 1 | 1 | | RSTD measurement reporting in TDD 3 DL CA | 12.8.0 |
| 06-2015 | RP-68 | RP-150972 | 3010r 1 | 1 | | RSTD measurement accuracy in FDD 3 DL CA | 12.8.0 |
| 06-2015 | RP-68 | RP-150972 | 3011r 1 | 1 | | RSTD measurement accuracy in TDD 3 DL CA | 12.8.0 |
| 06-2015 | RP-68 | RP-150964 | 3012r 2 | 2 | | Clarification of ProSe requirements in ONC | 12.8.0 |
| 06-2015 | RP-68 | RP-150957 | 3013 | | | Correction to Asynchronous Requirements for DC for only FDD-FDD | 12.8.0 |
| 06-2015 | RP-68 | RP-150959 | 3014 | | | E-UTRA TDD InterRAT UTRA TDD correct reporting of measurement events with reduced performance group configured non DRX IncMon | 12.8.0 |
| 06-2015 | RP-68 | RP-150959 | 3015 | | | E-UTRA FDD InterRAT UTRA TDD correct reporting of measurement events with reduced performance group configured non DRX for IncMon | 12.8.0 |
| 06-2015 | RP-68 | RP-150958 | 3016 | | | Correction to E-UTRA TDD event triggered reporting under deactivated SCell in non-DRX for 20 MHz + 10 MHz | 12.8.0 |
| 06-2015 | RP-68 | RP-150969 | 2893 | | | Carrier aggregation test cases for band 31 | 13.0.0 |
| 06-2015 | RP-68 | RP-150974 | 2966 | | | 4DL CA RRM requirements for "UE Measurements Procedures in RRC_CONNECTED State" | 13.0.0 |
| 06-2015 | RP-68 | RP-150974 | 2970 | 1 | | RRM Requirements in Section 7 for 4 DL CA | 13.0.0 |
| 09-2015 | RP-69 | RP-151475 | 3020 | - | | Correction of lor/loc value in RRM Test case A.4.3.1.1 | 13.1.0 |
| 09-2015 | RP-69 | RP-151479 | 3022 | - | | Cleanup of 3DL CA RRM Test cases | 13.1.0 |
| 09-2015 | RP-69 | RP-151483 | 3031 | - | | Time offset between cells | 13.1.0 |
| 09-2015 | RP-69 | RP-151497 | 3032 | - | | Requirements for DC on ACK/NACK reporting for measurements using autonomous gaps | 13.1.0 |
| 09-2015 | RP-69 | RP-151475 | 3034 | - | | Interruptions at overlapping addition/release/activation/deactivation of SCells | 13.1.0 |
| 09-2015 | RP-69 | RP-151504 | 3035 | - | | RRM Requirements for 3 DL/2UL Inter-band CA | 13.1.0 |
| 09-2015 | RP-69 | RP-151483 | 3037 | - | | CR on editorial corrections in TS36133 in Rel-13 | 13.1.0 |
| 09-2015 | RP-69 | RP-151478 | 3039 | - | | CR on item title of table in clause 8.1.2.4.5.1 in TS36133 in Rel-13 | 13.1.0 |
| 09-2015 | RP-69 | RP-151500 | 3041 | - | | 3DL CA Phase II tests #15_ SCell activation and deactivation for unknown SCells without DRX (FDD 3 DL CA) in Rel-13 | 13.1.0 |
| 09-2015 | RP-69 | RP-151500 | 3043 | - | | 3DL CA Phase II tests #16_ SCell activation and deactivation for unknown SCells without DRX (TDD 3 DL CA) in Rel-13 | 13.1.0 |
| 09-2015 | RP-69 | RP-151475 | 3045 | - | | Modifying test case of E-UTRAN 2DL TDD CA activation of unknown SCell in non-DRX in Rel-13 | 13.1.0 |
| 09-2015 | RP-69 | RP-151480 | 3047 | - | | CR on delete note in table 8.5.2.1.6.1-1 in TS36133 in Rel-13 | 13.1.0 |

| | | | | | | | |
|---------|-------|-----------|------|---|--|--|--------|
| 09-2015 | RP-69 | RP-151479 | 3052 | - | | Correction of inconsistency in 3 DL CA Event Triggered Reporting under Deactivated SCells in Non-DRX | 13.1.0 |
| 09-2015 | RP-69 | RP-151479 | 3054 | - | | CR on Interruptions at PSCell Addition/release | 13.1.0 |
| 09-2015 | RP-69 | RP-151483 | 3062 | - | | Corrections to the RMC configurations in 36.133 R13 | 13.1.0 |
| 09-2015 | RP-69 | RP-151479 | 3064 | - | | Remove the Brackets in RLM Tests for UE category 0 R13 | 13.1.0 |
| 09-2015 | RP-69 | RP-151474 | 3066 | 1 | | Adding SNR values to DC RLM test cases R13 | 13.1.0 |
| 09-2015 | RP-69 | RP-151486 | 3068 | - | | Correction on Band 31 test cases R13 | 13.1.0 |
| 09-2015 | RP-69 | RP-151483 | 3070 | - | | Correction to UE transmit timing accuracy tests R13 | 13.1.0 |
| 09-2015 | RP-69 | RP-151500 | 3078 | - | | Introduction of RRM test case for E-UTRAN TDD-FDD 3DL CA activation and deactivation of unknown SCell in non-DRX with PCell in TDD | 13.1.0 |
| 09-2015 | RP-69 | RP-151483 | 3079 | - | | Modifying test case of E-UTRAN 2DL FDD CA activation of unknown SCell in non-DRX | 13.1.0 |
| 09-2015 | RP-69 | RP-151500 | 3080 | - | | Introduction of RRM test case for E-UTRAN TDD-FDD 3DL CA activation and deactivation of unknown SCell in non-DRX with PCell in FDD | 13.1.0 |
| 12-2015 | RP-70 | RP-152131 | 3086 | - | | Correction of RSRQ value in RRM Serving Cell Test cases A.9.9.1, A.9.9.2 | 13.2.0 |
| 12-2015 | RP-70 | RP-152136 | 3088 | - | | Remove brackets in RSTD measurement accuracy R13 | 13.2.0 |
| 12-2015 | RP-70 | RP-152133 | 3090 | - | | Remove bracket for CSI-RSRP measurement R13 | 13.2.0 |
| 12-2015 | RP-70 | RP-152133 | 3094 | - | | Correction to E-UTRAN TDD-FDD CA Event Triggered Reporting Under Deactivated SCell in Non-DRX with PCell in FDD R13 | 13.2.0 |
| 12-2015 | RP-70 | RP-152133 | 3096 | - | | Correction to E-UTRAN TDD-FDD CA Event Triggered Reporting Under Deactivated SCell in Non-DRX with PCell in TDD R13 | 13.2.0 |
| 12-2015 | RP-70 | RP-152133 | 3098 | - | | Correction to E-UTRAN TDD-FDD CA Event triggered reporting on deactivated SCell with PCell interruption in non-DRX with PCell in FDD R13 | 13.2.0 |
| 12-2015 | RP-70 | RP-152133 | 3100 | - | | Correction to E-UTRAN TDD-FDD CA Event triggered reporting on deactivated SCell with PCell interruption in non-DRX with PCell in TDD R13 | 13.2.0 |
| 12-2015 | RP-70 | RP-152133 | 3102 | - | | Correction to RSRP for E-UTRAN TDD-FDD Carrier Aggregation with PCell in FDD R13 | 13.2.0 |
| 12-2015 | RP-70 | RP-152133 | 3104 | - | | Correction to RSRP for E-UTRAN TDD-FDD Carrier Aggregation with PCell in TDD R13 | 13.2.0 |
| 12-2015 | RP-70 | RP-152133 | 3106 | - | | Correction to RSRQ for E-UTRAN TDD-FDD Carrier Aggregation with PCell in FDD R13 | 13.2.0 |
| 12-2015 | RP-70 | RP-152133 | 3108 | - | | Correction to RSRQ for E-UTRAN TDD-FDD Carrier Aggregation with PCell in TDD R13 | 13.2.0 |
| 12-2015 | RP-70 | RP-152136 | 3114 | - | | Alignment of UE reporting criteria requirements | 13.2.0 |
| 12-2015 | RP-70 | RP-152131 | 3116 | - | | Removal of square brackets for some CA requirements | 13.2.0 |
| 12-2015 | RP-70 | RP-152133 | 3118 | - | | Cleanup of 3DL CA RRM Test cases | 13.2.0 |
| 12-2015 | RP-70 | RP-152134 | 3121 | - | | Correction of definition of antenna connection in some RSTD tests | 13.2.0 |
| 12-2015 | RP-70 | RP-152133 | 3129 | - | | Different TDD configurations for OTDOA in CA in release 12 | 13.2.0 |
| 12-2015 | RP-70 | RP-152157 | 3131 | - | | Introduction of Band 67 | 13.2.0 |
| 12-2015 | RP-70 | RP-152133 | 3136 | - | | Correction of definition of pTAG and psTAG | 13.2.0 |
| 12-2015 | RP-70 | RP-152133 | 3145 | - | | Title of new section A.7.4 in TS36.133 for Rel-13 | 13.2.0 |
| 12-2015 | RP-70 | RP-152133 | 3146 | - | | SNR levels and Reference channels for DC RLM test cases for Rel-13 | 13.2.0 |
| 12-2015 | RP-70 | RP-152131 | 3150 | - | | Correction on measurement category for reporting criteria | 13.2.0 |
| 12-2015 | RP-70 | RP-152133 | 3167 | - | | Alignment of dB values for 2DL CA activation and deactivation Test cases | 13.2.0 |
| 12-2015 | RP-70 | RP-152135 | 3173 | - | | CR on editorial cleanup for D2D RRM requirements | 13.2.0 |
| 12-2015 | RP-70 | RP-152136 | 3178 | - | | Correction to Trstd values in 3DL RSTD Measurement Accuracy test cases | 13.2.0 |
| 12-2015 | RP-70 | RP-152133 | 3183 | - | | Update of 2DL CA activation and deactivation of unknown SCell Test cases A.8.16.19+A.8.16.20 | 13.2.0 |
| 12-2015 | RP-70 | RP-152133 | 3185 | - | | Update of 3DL CA activation and deactivation of unknown SCell Test cases A.8.16.41+A.8.16.42 | 13.2.0 |
| 12-2015 | RP-70 | RP-152133 | 3187 | - | | Update to RRM test case for E-UTRAN TDD-FDD 3DL CA activation and deactivation of unknown SCell in non-DRX with PCell in FDD | 13.2.0 |
| 12-2015 | RP-70 | RP-152133 | 3189 | - | | Update to RRM test case for E-UTRAN TDD-FDD 3DL CA activation and deactivation of unknown SCell in non-DRX with PCell in TDD | 13.2.0 |

| | | | | | | | |
|---------|-------|-----------|------|---|---|---|--------|
| 12-2015 | RP-70 | RP-152136 | 3191 | - | | Correction to Cells in OTDOA assistance data in 3DL RSTD Measurement Reporting Delay test cases | 13.2.0 |
| 12-2015 | RP-70 | RP-152153 | 3192 | 2 | | CR on RS-SINR accuracy in 36.133 | 13.2.0 |
| 12-2015 | RP-70 | RP-152136 | 3195 | 1 | | Correction on RSRQ measurement report mapping R13 | 13.2.0 |
| 12-2015 | RP-70 | RP-152173 | 3196 | - | | Introduction of Band 45 into TS36.133 | 13.2.0 |
| 12-2015 | RP-70 | RP-152131 | 3211 | - | | Further Correction of Cell Time offset in RSTD CA test cases (Rel-13) | 13.2.0 |
| 12-2015 | RP-70 | RP-152155 | 3213 | 1 | | CR for clarification of band combination in 36133 | 13.2.0 |
| 12-2015 | RP-70 | RP-152166 | 3214 | 1 | | CR for RRM requirement up to 3UL CA in 36133 | 13.2.0 |
| 12-2015 | RP-70 | RP-152152 | 3216 | 1 | | CR on measurement performance requirements for UE reporting SSTD between MeNB and SeNB for dual connectivity enhancements | 13.2.0 |
| 12-2015 | RP-70 | RP-152133 | 3223 | - | | Adding the title of A.8.22 in TS 36.133 R13 | 13.2.0 |
| 12-2015 | RP-70 | RP-152133 | 3227 | - | | Correction on A.8.16.17 E-UTRAN FDD activation and deactivation of known SCell in non-DRX | 13.2.0 |
| 12-2015 | RP-70 | RP-152133 | 3229 | - | | Correction on A.8.16.18 E-UTRAN TDD activation and deactivation of known SCell in non-DRX | 13.2.0 |
| 12-2015 | RP-70 | RP-152133 | 3231 | - | | Correction on A.8.16.35 3 DL PCell in FDD CA Activation and Deactivation of Known SCell in Non-DRX | 13.2.0 |
| 12-2015 | RP-70 | RP-152133 | 3233 | - | | Correction on A.8.16.36 3 DL PCell in TDD CA Activation and Deactivation of Known SCell in Non-DRX | 13.2.0 |
| 12-2015 | RP-70 | RP-152133 | 3235 | - | | Correction on A.8.16.37 3DL FDD CA activation and deactivation of known SCell in non-DRX | 13.2.0 |
| 12-2015 | RP-70 | RP-152133 | 3237 | - | | Correction on A.8.16.38 3DL TDD CA activation and deactivation of known SCell in non-DRX | 13.2.0 |
| 12-2015 | RP-70 | RP-152152 | 3238 | 1 | | CR on RRM requirements for SSTD reporting for Dual Connectivity | 13.2.0 |
| 12-2015 | RP-70 | RP-152152 | 3239 | 1 | | CR on maximum uplink timing difference for Dual Connectivity | 13.2.0 |
| 12-2015 | RP-70 | RP-152152 | 3240 | 1 | | CR on RRM requirements for 3 DL CC Dual connectivity | 13.2.0 |
| 12-2015 | RP-70 | RP-152152 | 3241 | 1 | | CR on requirements of interruption for 3 DL CC Dual connectivity | 13.2.0 |
| 12-2015 | RP-70 | RP-152163 | 3243 | 1 | | CR on RRM requirements for 5DL CC CA | 13.2.0 |
| 12-2015 | RP-70 | RP-152171 | 3250 | - | | Introduction of Band 65 | 13.2.0 |
| 12-2015 | RP-70 | RP-152172 | 3251 | - | | Introduction of Band 66 | 13.2.0 |
| 12-2015 | RP-70 | RP-152149 | 3253 | 2 | | SCell activation/deactivation delay for PUCCH SCell | 13.2.0 |
| 12-2015 | RP-70 | RP-152146 | 3256 | 1 | | Beacon RSSI Reporting Requirements | 13.2.0 |
| 12-2015 | RP-70 | RP-152148 | 3260 | 1 | | Core RRM requirements for LAA | 13.2.0 |
| 12-2015 | RP-70 | RP-152148 | 3262 | 1 | | LAA measurement requirements | 13.2.0 |
| 12-2015 | RP-70 | RP-152148 | 3263 | 1 | | LAA measurement accuracy requirements and measurement report mapping | 13.2.0 |
| 12-2015 | RP-70 | RP-152153 | 3265 | - | | RS-SINR measurement requirements | 13.2.0 |
| 12-2015 | RP-70 | RP-152153 | 3268 | 1 | | RS-SINR measurement report mapping | 13.2.0 |
| 12-2015 | RP-70 | RP-152154 | 3269 | 1 | | Extended DRX requirements in RRC_CONNECTED state | 13.2.0 |
| 12-2015 | RP-70 | RP-152135 | 3275 | - | | CR on ProSe UE transmission timing in Any Cell Selection State | 13.2.0 |
| 12-2015 | RP-70 | RP-152133 | 3279 | - | | Alignment of time when UE starts CSI reporting for activated SCell | 13.2.0 |
| 03/2016 | RP-71 | RP-160472 | 3317 | | B | RRM requirements for eMTC in IDLE mode in section 4 | 13.3.0 |
| 03/2016 | RP-71 | RP-160472 | 3355 | | B | Reference configuration for Rel-13 MTC | 13.3.0 |
| 03/2016 | RP-71 | RP-160472 | 3346 | 1 | B | CR on eMTC positioning | 13.3.0 |
| 03/2016 | RP-71 | RP-160472 | 3369 | 1 | B | Random access requirements for eMTC UEs | 13.3.0 |
| 03/2016 | RP-71 | RP-160472 | 3331 | 1 | F | CR on CGI reading of eMTC | 13.3.0 |
| 03/2016 | RP-71 | RP-160472 | 3354 | 1 | B | Radio link monitoring for Rel-13 MTC UE | 13.3.0 |
| 03/2016 | RP-71 | RP-160472 | 3353 | 1 | B | Measurement accuracy requirements for Rel-13 MTC UE | 13.3.0 |
| 03/2016 | RP-71 | RP-160472 | 3352 | 1 | B | Measurement requirements for Rel-13 MTC UE under normal coverage | 13.3.0 |
| 03/2016 | RP-71 | RP-160472 | 3356 | 1 | B | Measurement requirements for Rel-13 MTC UE under enhanced coverage | 13.3.0 |
| 03/2016 | RP-71 | RP-160473 | 3285 | 1 | B | CR on eD2D RRM requirements: Inter-freq discovery and multicarrier D2D | 13.3.0 |
| 03/2016 | RP-71 | RP-160473 | 3286 | 1 | B | CR on eD2D RRM requirements: UE-NW relays | 13.3.0 |
| 03/2016 | RP-71 | RP-160473 | 3284 | 1 | B | CR on eD2D RRM requirements: OOC Discovery | 13.3.0 |
| 03/2016 | RP-71 | RP-160473 | 3310 | 2 | F | CR of measurement performance on eD2D | 13.3.0 |

| | | | | | | | |
|---------|-------|-----------|------|---|---|--|--------|
| 03/2016 | RP-71 | RP-160475 | 3347 | 1 | B | Correction to SSTD measurement accuracy and reporting range | 13.3.0 |
| 03/2016 | RP-71 | RP-160476 | 3366 | 1 | B | Measurement requirements in RRC CONNECTED state | 13.3.0 |
| 03/2016 | RP-71 | RP-160476 | 3367 | 2 | B | Measurement requirements in RRC IDLE state | 13.3.0 |
| 03/2016 | RP-71 | RP-160477 | 3341 | 1 | F | CR on RSSI measurement | 13.3.0 |
| 03/2016 | RP-71 | RP-160477 | 3351 | 1 | B | RSSI Report Mapping Requirements | 13.3.0 |
| 03/2016 | RP-71 | RP-160478 | 3362 | 1 | F | Corrections in measurement accuracy requirements for LAA | 13.3.0 |
| 03/2016 | RP-71 | RP-160488 | 3321 | | A | Correction to felCIC TDD RSRP accuracy OCNG in TS 36.133 | 13.3.0 |
| 03/2016 | RP-71 | RP-160489 | 3283 | | A | CR for correction to syncOffsetIndicator parameter in D2D resource pool configuration | 13.3.0 |
| 03/2016 | RP-71 | RP-160489 | 3288 | | A | Change OGNNG for 3DL CA Event Triggered Reporting on Deactivated SCell with PCell and SCell Interruptions, A.8.16.32+A.8.16.33 | 13.3.0 |
| 03/2016 | RP-71 | RP-160489 | 3293 | | F | Correction of errors in Annex A Activation/Deactivation Test cases | 13.3.0 |
| 03/2016 | RP-71 | RP-160489 | 3323 | | A | CR on E-UTRAN TDD-FDD CA activation and deactivation of known SCell in non-DRX with PCell in FDD for Rel-13 | 13.3.0 |
| 03/2016 | RP-71 | RP-160489 | 3326 | | A | CR on E-UTRAN TDD-FDD CA activation and deactivation of unknown SCell in non-DRX with PCell in FDD for Rel-13 | 13.3.0 |
| 03/2016 | RP-71 | RP-160489 | 3344 | | A | Correction on SCE requirements and test cases R13 | 13.3.0 |
| 03/2016 | RP-71 | RP-160489 | 3349 | | A | Correction to antenna configuration principle | 13.3.0 |
| 03/2016 | RP-71 | RP-160489 | 3372 | | A | CR for IncMon requirements alignment 36.133 Rel-13 | 13.3.0 |
| 03/2016 | RP-71 | RP-160489 | 3373 | | A | Editorial corrections | 13.3.0 |
| 03/2016 | RP-71 | RP-160489 | 3295 | 1 | F | Modification for MBSFN measurements for R13 | 13.3.0 |
| 03/2016 | RP-71 | RP-160490 | 3290 | | F | Correction to RS-SINR measurement accuracy requirements | 13.3.0 |
| 03/2016 | RP-71 | RP-160490 | 3297 | | F | Modification for interruptions with Carrier Aggregation | 13.3.0 |
| 03/2016 | RP-71 | RP-160490 | 3305 | | F | Clarification on timing of interruption for PUCCH SCell activation/deactivation | 13.3.0 |
| 03/2016 | RP-71 | RP-160490 | 3316 | | F | Activation and deactivation delay requirements for PUCCH SCell with four downlink SCeLLs | 13.3.0 |
| 03/2016 | RP-71 | RP-160490 | 3339 | | F | CR on maximum UL transmission time difference for R13 DC | 13.3.0 |
| 03/2016 | RP-71 | RP-160490 | 3357 | | F | Interruptions on RSTD in CA | 13.3.0 |
| 03/2016 | RP-71 | RP-160490 | 3303 | 1 | F | Clarification of SSTD measurement requirements | 13.3.0 |
| 03/2016 | RP-71 | RP-160490 | 3361 | 1 | F | Corrections for intra-frequency measurement requirements for LAA | 13.3.0 |
| 03/2016 | RP-71 | RP-160490 | 3312 | 1 | F | CR on measurement and measurement accuracy for LAA | 13.3.0 |
| 03/2016 | RP-71 | RP-160490 | 3330 | 2 | F | Correction on LAA measurement conditions | 13.3.0 |
| 03/2016 | RP-71 | RP-160490 | 3363 | 2 | F | Reporting criteria for RS-SINR | 13.3.0 |
| 03/2016 | RP-71 | RP-160490 | 3327 | 2 | F | Modification on the SCell activation delay requirement for deactivated SCell under Frame Structure 3 | 13.3.0 |
| 2016/06 | RP-72 | RP-161128 | 3374 | 1 | B | CR: MPDCCH RMCs for Cat-M1 RRM Tests | 13.4.0 |
| 2016/06 | RP-72 | RP-161128 | 3375 | 1 | B | CR: PDSCH RMCs for Cat-M1 RRM Tests | 13.4.0 |
| 2016/06 | RP-72 | RP-161142 | 3377 | 3 | F | CR: Intra-frequency handover requirements for Cat-M1 UEs in CEModeA | 13.4.0 |
| 2016/06 | RP-72 | RP-161142 | 3379 | 1 | F | CR: UE transmit timing Requirements for Cat-M1 UEs | 13.4.0 |
| 2016/06 | RP-72 | RP-161142 | 3384 | | F | Removal of conditions for intra-frequency relative RSRQ measurement accuracy requirements under operation with frame structure 3 | 13.4.0 |
| 2016/06 | RP-72 | RP-161141 | 3385 | | F | Radio Link Monitoring Test for In-sync in DRX for PSCell | 13.4.0 |
| 2016/06 | RP-72 | RP-161141 | 3393 | | F | Introduction of test cases for E-UTRAN FDD-TDD and TDD-FDD DC interruption at transitions between active and non-active during DRX in synchronous DC | 13.4.0 |
| 2016/06 | RP-72 | RP-161142 | 3394 | | F | CR: Correction to Band 66 notes in E-UTRA band groups | 13.4.0 |
| 2016/06 | RP-72 | RP-161141 | 3395 | | F | New test cases: E-UTRAN TDD-FDD DC intra-frequency event triggered reporting with DRX in synchronous DC with PCell in FDD/PCell in TDD | 13.4.0 |
| 2016/06 | RP-72 | RP-161142 | 3396 | 1 | F | New test cases: Event triggered reporting on deactivated SCeLLs and interruption probability | 13.4.0 |

| | | | | | | | |
|---------|-------|-----------|------|---|---|---|--------|
| | | | | | | (0.5%) without DRX (FDD 4 DL CA and TDD 4 DL CA) | |
| 2016/06 | RP-72 | RP-161142 | 3397 | 1 | F | New test cases: Event triggered reporting on deactivated SCells and interruption probability (0.5%) without DRX (FDD 5 DL CA and TDD 5 DL CA) | 13.4.0 |
| 2016/06 | RP-72 | RP-161134 | 3402 | 1 | F | CR on measurement reference channel and OCNB with FS3 | 13.4.0 |
| 2016/06 | RP-72 | RP-161141 | 3404 | | A | CR on minimum ProSe SCH_RP condition on FDD_F | 13.4.0 |
| 2016/06 | RP-72 | RP-161130 | 3405 | | F | CR on minimum ProSe SCH_RP condition on FDD_F | 13.4.0 |
| 2016/06 | RP-72 | RP-161142 | 3406 | | F | CR of typo in interruption requirements | 13.4.0 |
| 2016/06 | RP-72 | RP-161141 | 3408 | | A | Editorial CR in RSRQ test case for CA in CRS based discovery signal | 13.4.0 |
| 2016/06 | RP-72 | RP-161141 | 3411 | | F | CR on TDD-FDD DC Radio Link Monitoring Test for Out-of-sync | 13.4.0 |
| 2016/06 | RP-72 | RP-161142 | 3418 | | F | Editorial correction in RRM requirements | 13.4.0 |
| 2016/06 | RP-72 | RP-161142 | 3421 | 1 | F | Reporting criteria for LAA | 13.4.0 |
| 2016/06 | RP-72 | RP-161142 | 3423 | | F | Channel occupancy measurement requirements | 13.4.0 |
| 2016/06 | RP-72 | RP-161142 | 3428 | | F | Inter-frequency RSSI measurement requirements | 13.4.0 |
| 2016/06 | RP-72 | RP-161134 | 3429 | 1 | B | RSRP and RSRQ accuracy requirements | 13.4.0 |
| 2016/06 | RP-72 | RP-161142 | 3430 | | F | Editorial correction in LAA requirements | 13.4.0 |
| 2016/06 | RP-72 | RP-161142 | 3432 | | F | RS-SINR accuracy requirements with CA | 13.4.0 |
| 2016/06 | RP-72 | RP-161142 | 3433 | 1 | F | RS-SINR measurement requirements with CA | 13.4.0 |
| 2016/06 | RP-72 | RP-161142 | 3434 | | F | 4 DL PCell in FDD Event triggered reporting on deactivated SCells in non-DRX # 3 | 13.4.0 |
| 2016/06 | RP-72 | RP-161142 | 3435 | | F | 4 DL PCell in TDD Event triggered reporting on deactivated SCells in non-DRX # 4 | 13.4.0 |
| 2016/06 | RP-72 | RP-161142 | 3436 | | F | 5 DL PCell in FDD Event triggered reporting on deactivated SCells in non-DRX # 1 | 13.4.0 |
| 2016/06 | RP-72 | RP-161142 | 3437 | | F | 5 DL PCell in TDD Event triggered reporting on deactivated SCells in non-DRX # 2 | 13.4.0 |
| 2016/06 | RP-72 | RP-161141 | 3439 | | A | Correction on E-UTRAN TDD-FDD CA activation and deactivation of known/unknown SCell in non-DRX with PCell in FDD for Rel-13 | 13.4.0 |
| 2016/06 | RP-72 | RP-161141 | 3442 | | A | CR on E-UTRAN TDD-FDD CA activation and deactivation of known SCell in non-DRX with PCell in TDD for Rel-13 | 13.4.0 |
| 2016/06 | RP-72 | RP-161141 | 3444 | | A | CR on E-UTRAN TDD-FDD CA activation and deactivation of unknown SCell in non-DRX with PCell in TDD for Rel-13 | 13.4.0 |
| 2016/06 | RP-72 | RP-161141 | 3446 | | A | Corrections on PDSCH RMC for UE category 0 R13 | 13.4.0 |
| 2016/06 | RP-72 | RP-161142 | 3450 | 1 | F | 5 DL FDD CA Event Triggered Reporting with Deactivated SCells in Non-DRX | 13.4.0 |
| 2016/06 | RP-72 | RP-161142 | 3451 | 1 | F | 5 DL TDD CA Event Triggered Reporting with Deactivated SCells in Non-DRX | 13.4.0 |
| 2016/06 | RP-72 | RP-161142 | 3452 | 1 | F | 4 DL FDD CA Event Triggered Reporting with 3 deactivated SCells in Non-DRX | 13.4.0 |
| 2016/06 | RP-72 | RP-161142 | 3453 | 1 | F | 4 DL TDD CA Event Triggered Reporting with 3 deactivated SCells in Non-DRX | 13.4.0 |
| 2016/06 | RP-72 | RP-161142 | 3455 | | F | RSTD CA interruption on SCC in release 13 | 13.4.0 |
| 2016/06 | RP-72 | RP-161134 | 3460 | 1 | B | CR on testing principle of Carrier Aggregation under operation with Frame 3 with Different Duplex Modes | 13.4.0 |
| 2016/06 | RP-72 | RP-161132 | 3466 | 1 | F | E-UTRAN TDD-FDD Addition and Release Delay of known PCell in Synchronous DC with PCell in FDD | 13.4.0 |
| 2016/06 | RP-72 | RP-161132 | 3467 | 1 | F | E-UTRAN TDD-FDD Addition and Release Delay of known PCell in Synchronous DC with PCell in TDD | 13.4.0 |
| 2016/06 | RP-72 | RP-161142 | 3474 | 2 | F | maintenance on radio link monitoring for Rel-13 MTC UE | 13.4.0 |
| 2016/06 | RP-72 | RP-161142 | 3475 | 2 | F | Maintenance on measurement requirements for Rel-13 MTC UE under normal coverage | 13.4.0 |
| 2016/06 | RP-72 | RP-161142 | 3476 | 2 | F | Maintenance on measurement requirements for Rel-13 MTC UE under CEModeB | 13.4.0 |
| 2016/06 | RP-72 | RP-161142 | 3478 | 1 | F | CR for eMTC RLM | 13.4.0 |
| 2016/06 | RP-72 | RP-161141 | 3479 | | F | New Test cases: E-UTRAN TDD-FDD DC inter-frequency event triggered reporting with DRX in synchronous DC with PCell in FDD/PCell in TDD | 13.4.0 |
| 2016/06 | RP-72 | RP-161142 | 3483 | | B | Measurement accuracy requirements for Rel-13 | 13.4.0 |

| | | | | | | MTC UE | |
|---------|-------|-----------|------|---|---|--|--------|
| 2016/06 | RP-72 | RP-161142 | 3484 | 1 | F | Timing requirements for eMTC | 13.4.0 |
| 2016/06 | RP-72 | RP-161141 | 3487 | | A | Physical channels undefined in RRM Test cases A.9.1.22, A.9.1.23 | 13.4.0 |
| 2016/06 | RP-72 | RP-161141 | 3489 | | A | Cleanup of Dual Connectivity RRM Test cases | 13.4.0 |
| 2016/06 | RP-72 | RP-161141 | 3494 | - | A | Corrections to values for 3DL RSTD test cases | 13.4.0 |
| 2016/06 | RP-72 | RP-161141 | 3497 | - | A | Removal of duplicated parameter from 3DL RSTD reporting delay test cases | 13.4.0 |
| 2016/06 | RP-72 | RP-161129 | 3498 | 2 | B | 2DL/2UL FDD CA activation and deactivation of known PUCCH SCell without valid TA in non-DRX | 13.4.0 |
| 2016/06 | RP-72 | RP-161142 | 3502 | 1 | F | Rx-Tx time difference reporting CR not implemented: Not based on the latest version of the spec. | 13.4.0 |
| 2016/06 | RP-72 | RP-161141 | 3506 | - | A | Corrections in A.8.16.12, A.8.16.21, A.8.16.22, A.8.16.30, A.9.1.15 and A.9.1.37 | 13.4.0 |
| 2016/06 | RP-72 | RP-161141 | 3510 | - | A | Editorial corrections | 13.4.0 |
| 2016/06 | RP-72 | RP-161134 | 3512 | - | B | CSI-RSRP measurement accuracy requirements | 13.4.0 |
| 2016/06 | RP-72 | RP-161142 | 3515 | - | F | A clarification on LAA band | 13.4.0 |
| 2016/06 | RP-72 | RP-161142 | 3516 | - | F | Editorial corrections for LAA | 13.4.0 |
| 2016/06 | RP-72 | RP-161142 | 3519 | 1 | F | Inter-frequency measurement requirements | 13.4.0 |
| 2016/06 | RP-72 | RP-161128 | 3521 | 2 | F | eMTC requirements with eDRX in RRC_CONNECTED | 13.4.0 |
| 2016/06 | RP-72 | RP-161141 | 3526 | - | F | CR on correction for section number of A.7.3.29 | 13.4.0 |
| 2016/06 | RP-72 | RP-161139 | 3528 | - | A | CR on correction for test cases in A.8.16.17x Rel-13 | 13.4.0 |
| 2016/06 | RP-72 | RP-161142 | 3530 | - | F | Editorial correction for title in section A.8 and A.9 Rel-13 | 13.4.0 |
| 2016/06 | RP-72 | RP-161141 | 3533 | - | F | 3DL/3UL TDD CA - UE Transmit Timing Accuracy Tests for 2SCells | 13.4.0 |
| 2016/06 | RP-72 | RP-161142 | 3534 | 1 | F | Test cases for E-UTRAN DC Inter-frequency identification of a new CGI of E-UTRA cell using autonomous gaps | 13.4.0 |
| 2016/06 | RP-72 | RP-161128 | 3535 | 1 | B | UE Timing Advance Adjustment Accuracy Test for Cat-M1 UE in CEModeA | 13.4.0 |
| 2016/06 | RP-72 | RP-161168 | 3536 | - | F | E-UTRAN 4DL CA activation and deactivation of know SCell in non-DRX | 13.4.0 |
| 2016/06 | RP-72 | RP-161168 | 3537 | - | F | E-UTRAN 5DL CA activation and deactivation of know SCell in non-DRX | 13.4.0 |
| 2016/06 | RP-72 | RP-161141 | 3539 | - | A | PCC and SCC assignment in 20MHz+10MHz test case A.9.1.24 | 13.4.0 |
| 2016/06 | RP-72 | RP-161142 | 3541 | 1 | F | Modifications on LAA SCell activation delay requirements | 13.4.0 |
| 2016/06 | RP-72 | RP-161133 | 3544 | 1 | B | Antenna connection method for RLM and RRM tests with 4RX | 13.4.0 |
| 2016/06 | RP-72 | RP-161132 | 3548 | 1 | B | Dual connectivity enhancements test case : SSTD accuracy | 13.4.0 |
| 2016/06 | RP-72 | RP-161132 | 3549 | - | B | Dual connectivity enhancements test case : SSTD delay with DRX | 13.4.0 |
| 2016/06 | RP-72 | RP-161132 | 3550 | - | B | Dual connectivity enhancements test case : SSTD delay in non DRX | 13.4.0 |
| 2016/06 | RP-72 | RP-161142 | 3553 | - | F | Absolute and relative RSRP accuracies in FDD 4DL CA# 3 | 13.4.0 |
| 2016/06 | RP-72 | RP-161142 | 3554 | - | F | Absolute and relative RSRP accuracies in TDD 4DL CA# 4 | 13.4.0 |
| 2016/06 | RP-72 | RP-161142 | 3555 | 1 | F | PCell in FDD: absolute and relative RSRP accuracies in TDD-FDD 5 DL CA # 1 | 13.4.0 |
| 2016/06 | RP-72 | RP-161142 | 3556 | 1 | F | PCell in TDD: absolute and relative RSRP accuracies in TDD-FDD 5 DL CA # 2 | 13.4.0 |
| 2016/06 | RP-72 | RP-161142 | 3557 | - | F | Absolute and relative RSRQ accuracies in 5 DL FDD CA # 7 | 13.4.0 |
| 2016/06 | RP-72 | RP-161142 | 3558 | - | F | Absolute and relative RSRQ accuracies in 5 DL TDD CA # 8 | 13.4.0 |
| 2016/06 | RP-72 | RP-161141 | 3559 | - | F | Test Case on Random Acces for 3 DL/3UL TDD CA | 13.4.0 |
| 2016/06 | RP-72 | RP-161129 | 3560 | 1 | B | SCell activation and deactivation of known PUCCH SCell in TDD CA without valid TA | 13.4.0 |
| 2016/06 | RP-72 | RP-161142 | 3562 | - | F | E-UTRAN-WLAN RSSI event triggered reporting in non-DRX | 13.4.0 |
| 2016/06 | RP-72 | RP-161128 | 3563 | 1 | B | CR for Cat-M1 CEMode A RLM test cases: DRX FDD | 13.4.0 |
| 2016/06 | RP-72 | RP-161128 | 3564 | 1 | B | CR for Cat-M1 CEMode A RLM test cases: DRX HD-FDD | 13.4.0 |
| 2016/06 | RP-72 | RP-161128 | 3565 | 1 | B | CR for Cat-M1 CEMode A RLM test cases: DRX TDD | 13.4.0 |

| | | | | | | | |
|---------|-------|-----------|------|---|---|---|--------|
| 2016/06 | RP-72 | RP-161132 | 3567 | - | B | CR on activation and deactivation of known SCell for 3DL CC DC | 13.4.0 |
| 2016/06 | RP-72 | RP-161132 | 3568 | - | B | CR on additional test requirements for Maximum transmission timing difference for DC | 13.4.0 |
| 2016/06 | RP-72 | RP-161142 | 3569 | - | F | CR on TDD-FDD 4DL CA activation and deactivation of known SCell in non-DRX | 13.4.0 |
| 2016/06 | RP-72 | RP-161142 | 3570 | 1 | F | CR on TDD-FDD 5DL CA activation and deactivation of known SCell in non-DRX | 13.4.0 |
| 2016/06 | RP-72 | RP-161142 | 3571 | - | F | CR on TDD-FDD 4DL CA activation and deactivation of unknown SCell in non-DRX | 13.4.0 |
| 2016/06 | RP-72 | RP-161142 | 3572 | 1 | F | CR on TDD-FDD 5DL CA activation and deactivation of unknown SCell in non-DRX | 13.4.0 |
| 2016/06 | RP-72 | RP-161126 | 3573 | 1 | B | CR on RRM requirements in Section 3 for NB-IoT | 13.4.0 |
| 2016/06 | RP-72 | RP-161126 | 3574 | 1 | B | Draft CR on RRM requirements in Annex B for NB-IoT | 13.4.0 |
| 2016/06 | RP-72 | RP-161142 | 3578 | 1 | F | Editorial corrections of an incorrect note for Band 32 | 13.4.0 |
| 2016/06 | RP-72 | RP-161142 | 3587 | 1 | F | Modification on intra-frequency discovery signal measurement requirements in LAA | 13.4.0 |
| 2016/06 | RP-72 | RP-161142 | 3591 | 2 | F | Modification on CA requirements in LAA | 13.4.0 |
| 2016/06 | RP-72 | RP-161141 | 3596 | - | A | Correction of SCE event triggered reporting test cases for CSI-RS based discovery signal R13 | 13.4.0 |
| 2016/06 | RP-72 | RP-161129 | 3602 | 1 | B | 2DL/2UL TDD-FDD CA (TDD PCell) activation and deactivation of known PUCCH SCell without valid TA in non-DRX | 13.4.0 |
| 2016/06 | RP-72 | RP-161132 | 3603 | - | B | CR: Introduction of testing principle for different combination of duplex modes DC | 13.4.0 |
| 2016/06 | RP-72 | RP-161141 | 3605 | - | A | CR of RLM requirement for PSCell in dual connectivity R12 | 13.4.0 |
| 2016/06 | RP-72 | RP-161132 | 3606 | - | B | E-UTRAN FDD - FDD DC intra-frequency identification of a new CGI of E-UTRA cell using autonomous gaps in synchronous DC | 13.4.0 |
| 2016/06 | RP-72 | RP-161132 | 3607 | - | B | E-UTRAN FDD - FDD DC intra-frequency identification of a new CGI of E-UTRA cell using autonomous gaps in asynchronous DC | 13.4.0 |
| 2016/06 | RP-72 | RP-161132 | 3608 | - | B | E-UTRAN TDD - TDD DC intra-frequency identification of a new CGI of E-UTRA cell using autonomous gaps in synchronous DC | 13.4.0 |
| 2016/06 | RP-72 | RP-161142 | 3609 | 1 | F | CR on UE transmit timing requirement | 13.4.0 |
| 2016/06 | RP-72 | RP-161142 | 3612 | - | F | PCell in FDD: absolute and relative RSRP accuracies in FDD-TDD 4DL CA | 13.4.0 |
| 2016/06 | RP-72 | RP-161142 | 3613 | - | F | PCell in TDD: absolute and relative RSRP accuracies in TDD-FDD 4DL CA. | 13.4.0 |
| 2016/06 | RP-72 | RP-161142 | 3614 | - | F | absolute and relative RSRP accuracies in FDD 5 DL CA | 13.4.0 |
| 2016/06 | RP-72 | RP-161142 | 3615 | - | F | absolute and relative RSRP accuracies in TDD 5 DL CA | 13.4.0 |
| 2016/06 | RP-72 | RP-161128 | 3616 | 1 | B | E-UTRAN Intra frequency case for Cat-M1 UE in normal coverage | 13.4.0 |
| 2016/06 | RP-72 | RP-161128 | 3617 | 1 | B | E-UTRAN FDD-FDD intra-frequency event triggered reporting under fading propagation conditions for Cat-M1 UE in CEModeA | 13.4.0 |
| 2016/06 | RP-72 | RP-161128 | 3618 | 1 | B | E-UTRAN HD-FDD intra-frequency event triggered reporting under fading propagation conditions for Cat-M1 UE in CEModeA | 13.4.0 |
| 2016/06 | RP-72 | RP-161128 | 3619 | 1 | B | E-UTRAN TDD-TDD intra-frequency event triggered reporting under fading propagation conditions for Cat-M1 UE in CEModeA | 13.4.0 |
| 2016/06 | RP-72 | RP-161128 | 3620 | 1 | B | CR on RSRP Intra frequency test cases for Cat-M1 UE in CEModeA | 13.4.0 |
| 2016/06 | RP-72 | RP-161128 | 3621 | - | B | PRACH configuration for eMTC | 13.4.0 |
| 2016/06 | RP-72 | RP-161142 | 3622 | 2 | F | CR on eMTC eDRX | 13.4.0 |
| 2016/06 | RP-72 | RP-161128 | 3629 | 3 | B | FD-FDD Radio Link Monitoring Test for Out-of-sync for Cat-M1 UE in CEModeA | 13.4.0 |
| 2016/06 | RP-72 | RP-161128 | 3630 | 3 | B | FD-FDD Radio Link Monitoring Test for In-sync for Cat-M1 UE in CEModeA | 13.4.0 |
| 2016/06 | RP-72 | RP-161128 | 3631 | 3 | B | HD-FDD Radio Link Monitoring Test for Out-of-sync for Cat-M1 UE in CEModeA: CR Not implemented as there are no track changes | 13.4.0 |
| 2016/06 | RP-72 | RP-161128 | 3632 | 3 | B | HD-FDD Radio Link Monitoring Test for In-sync for Cat-M1 UE in CEModeA | 13.4.0 |
| 2016/06 | RP-72 | RP-161128 | 3633 | 3 | B | TDD Radio Link Monitoring Test for Out-of-sync for Cat-M1 UE in CEModeA | 13.4.0 |
| 2016/06 | RP-72 | RP-161128 | 3634 | 3 | B | TDD Radio Link Monitoring Test for In-sync for Cat- | 13.4.0 |

| | | | | | | | |
|---------|-------|-----------|------|---|---|---|--------|
| | | | | | | M1 UE in CEModeA | |
| 2016/06 | RP-72 | RP-161132 | 3636 | 1 | B | E-UTRAN FDD-FDD DC event triggered reporting under deactivated SCell with PCell and PSCell interruption in non-DRX in synchronous DC | 13.4.0 |
| 2016/06 | RP-72 | RP-161132 | 3637 | 1 | B | E-UTRAN FDD-FDD DC event triggered reporting under deactivated SCell with PCell and PSCell interruption in non-DRX in asynchronous DC | 13.4.0 |
| 2016/06 | RP-72 | RP-161126 | 3638 | 1 | B | Uplink transmit timing adjustments in HD-FDD operation | 13.4.0 |
| 2016/06 | RP-72 | RP-161132 | 3639 | 1 | B | E-UTRAN TDD-TDD DC event triggered reporting under deactivated SCell with PCell and PSCell interruption in non-DRX in synchronous DC | 13.4.0 |
| 2016/06 | RP-72 | RP-161142 | 3640 | 1 | F | 4 DL CA PCell in FDD FDD-TDD RSRQ for E-UTRAN in Carrier Aggregation | 13.4.0 |
| 2016/06 | RP-72 | RP-161142 | 3641 | 2 | F | 4 DL CA PCell in TDD TDD-FDD RSRQ for E-UTRAN in Carrier Aggregation | 13.4.0 |
| 2016/06 | RP-72 | RP-161142 | 3642 | 2 | F | 5 DL PCell in FDD RSRQ for E-UTRAN in Carrier Aggregation | 13.4.0 |
| 2016/06 | RP-72 | RP-161142 | 3643 | 2 | F | 5 DL PCell in TDD RSRQ for E-UTRAN in Carrier Aggregation | 13.4.0 |
| 2016/06 | RP-72 | RP-161129 | 3644 | 1 | B | 2DL/2UL TDD-FDD CA (FDD PCell) activation and deactivation of known PUCCH SCell without valid TA in non-DRX | 13.4.0 |
| 2016/06 | RP-72 | RP-161142 | 3647 | 2 | F | CR: RRC re-establishment requirements for Cat-M1 UEs | 13.4.0 |
| 2016/06 | RP-72 | RP-161128 | 3648 | 1 | B | CR: Cat-M1 PRACH test cases for FDD in CEModeA | 13.4.0 |
| 2016/06 | RP-72 | RP-161128 | 3649 | 1 | B | CR: Cat-M1 PRACH test cases for HD-FDD in CEModeA | 13.4.0 |
| 2016/06 | RP-72 | RP-161128 | 3650 | 1 | B | CR: Cat-M1 PRACH test cases for TDD in CEModeA | 13.4.0 |
| 2016/06 | RP-72 | RP-161128 | 3651 | 1 | B | CR: Cat-M1 Intra-frequency handover test cases for CEModeA | 13.4.0 |
| 2016/06 | RP-72 | RP-161142 | 3653 | 1 | B | UE transmit timing test for eMTC UEs in CEModeA | 13.4.0 |
| 2016/06 | RP-72 | RP-161128 | 3654 | 1 | B | RRC Re-establishment test for eMTC UEs in CEModeA | 13.4.0 |
| 2016/06 | RP-72 | RP-161142 | 3655 | 1 | F | Defining of ProSe periodicity for ProSe inter-frequency and CA operation | 13.4.0 |
| 2016/06 | RP-72 | RP-161141 | 3657 | - | F | Editorial corrections in Rel-12 Cat-0 requirements | 13.4.0 |
| 2016/06 | RP-72 | RP-161126 | 3659 | 2 | B | Draft CR on RRC_IDLE state requirements for NB-IOT | 13.4.0 |
| 2016/06 | RP-72 | RP-161168 | 3664 | - | F | E-UTRAN 4DL CA activation and deactivation for unknown SCells without DRX | 13.4.0 |
| 2016/06 | RP-72 | RP-161168 | 3665 | - | F | E-UTRAN 5DL CA activation and deactivation of unknown SCell in non-DRX | 13.4.0 |
| 2016/06 | RP-72 | RP-161142 | 3666 | 1 | F | CR: Intra-frequency handover requirements for Cat-M1 UEs in CEModeB | 13.4.0 |
| 2016/06 | RP-72 | RP-161126 | 3667 | - | B | Modification on RRC re-establishment requirement for NB-IoT | 13.4.0 |
| 2016/06 | RP-72 | RP-161126 | 3668 | - | B | Modification for random access requirement for NB-IoT | 13.4.0 |
| 2016/06 | RP-72 | RP-161126 | 3669 | - | B | Intra-frequency Absolute NRSRP Accuracy for UE Category NB1 in Normal Mode | 13.4.0 |
| 2016/06 | RP-72 | RP-161126 | 3670 | - | B | Intra-frequency Absolute NRSRP Accuracy for UE Category NB1 in Enhanced Mode | 13.4.0 |
| 2016/06 | RP-72 | RP-161126 | 3671 | - | B | Intra-frequency Absolute NRSRQ Accuracy for UE Category NB1 in Normal Mode | 13.4.0 |
| 2016/06 | RP-72 | RP-161126 | 3672 | - | B | Intra-frequency Absolute NRSRQ Accuracy for UE Category NB1 in Enhanced Mode | 13.4.0 |
| 2016/06 | RP-72 | RP-161126 | 3673 | - | B | Inter-frequency Absolute NRSRP Accuracy for UE Category NB1 in Normal Mode | 13.4.0 |
| 2016/06 | RP-72 | RP-161126 | 3674 | - | B | Inter-frequency Absolute NRSRP Accuracy for UE Category NB1 in Enhanced Mode | 13.4.0 |
| 2016/06 | RP-72 | RP-161126 | 3675 | 1 | B | CR on measurement requirement in RRC_CONNECTED state for NB-IoT | 13.4.0 |
| 2016/06 | RP-72 | RP-161126 | 3676 | - | B | CR on Radio Link Monitoring for NB-IoT | 13.4.0 |
| 2016/09 | RP-73 | RP-161610 | 3376 | 2 | B | CR: OCNG patterns for Cat-M1 RRM Tests | 13.5.0 |
| 2016-09 | RP-73 | RP-161634 | 3678 | - | A | Duration of T3 in RRM 3DL Test cases A.8.16.31, A.8.16.32, A.8.16.33, A.8.16.34. | 13.5.0 |
| 2016-09 | RP-73 | RP-161631 | 3680 | - | F | Duration of T3 in RRM 4DL/5DL Test cases A.8.16.55, A.8.16.56, A.8.16.73, A.8.16.74. | 13.5.0 |
| 2016-09 | RP-73 | RP-161613 | 3682 | - | F | Square bracket removal for RLM antenna connection for 4 Rx capable UEs | 13.5.0 |
| 2016-09 | RP-73 | RP-161614 | 3684 | - | B | LAA channel occupancy test | 13.5.0 |

| | | | | | | | |
|---------|-------|-----------|------|---|---|---|--------|
| 2016-09 | RP-73 | RP-161783 | 3686 | 1 | B | LBT model for LAA RRM tests | 13.5.0 |
| 2016-09 | RP-73 | RP-161614 | 3688 | - | B | LAA Average RSSI accuracy test | 13.5.0 |
| 2016-09 | RP-73 | RP-161612 | 3694 | 1 | B | Intra-frequency FDD test cases for RS-SINR | 13.5.0 |
| 2016-09 | RP-73 | RP-161612 | 3696 | 1 | B | Intra-frequency TDD test cases for RS-SINR | 13.5.0 |
| 2016-09 | RP-73 | RP-161638 | 3698 | 1 | F | Applicability of intra-frequency maximum measurement time requirements | 13.5.0 |
| 2016-09 | RP-73 | RP-161638 | 3702 | 2 | F | Known cell requirements | 13.5.0 |
| 2016-09 | RP-73 | RP-161783 | 3704 | - | B | Channel occupancy accuracy requirements | 13.5.0 |
| 2016-09 | RP-73 | RP-161780 | 3706 | - | B | CR: Reference NPRACH Configuration for NB-IoT RRM test cases | 13.5.0 |
| 2016-09 | RP-73 | RP-161639 | 3708 | - | F | CR: Corrections on Section 4.6 "Cell Selection and Re-selection Requirements for UE category NB1 | 13.5.0 |
| 2016-09 | RP-73 | RP-161639 | 3714 | - | F | CR: Correction of E-CID RSRP measurement requirements for Cat-M1 UEs | 13.5.0 |
| 2016-09 | RP-73 | RP-161610 | 3718 | - | F | CR: Correction of Cat-M1 Intra-frequency handover test cases for CEModeA | 13.5.0 |
| 2016-09 | RP-73 | RP-161610 | 3720 | - | F | CR: Correction of Transmit Timing Accuracy Tests for Cat-M1 UE in CEModeA | 13.5.0 |
| 2016-09 | RP-73 | RP-161782 | 3724 | 1 | B | CR: Cat-M1 PRACH test cases for FDD in Enhanced Coverage | 13.5.0 |
| 2016-09 | RP-73 | RP-161782 | 3726 | 1 | B | CR: Cat-M1 PRACH test cases for HD-FDD in Enhanced Coverage | 13.5.0 |
| 2016-09 | RP-73 | RP-161782 | 3728 | 1 | B | CR: Cat-M1 PRACH test cases for TDD in Enhanced Coverage | 13.5.0 |
| 2016-09 | RP-73 | RP-161612 | 3738 | 3 | B | CR on RS-SINR TDD-FDD inter-frequency accuracy test case | 13.5.0 |
| 2016-09 | RP-73 | RP-161612 | 3739 | 2 | B | CR on RS-SINR FDD-TDD inter-frequency accuracy test case | 13.5.0 |
| 2016-09 | RP-73 | RP-161612 | 3742 | 1 | F | CR on RS-SINR measurement accuracy requirements | 13.5.0 |
| 2016-09 | RP-73 | RP-161783 | 3747 | - | B | CR of FDD intrafrequency absolute and relative RSRP accuracy test for SCell with FS3 | 13.5.0 |
| 2016-09 | RP-73 | RP-161783 | 3748 | - | B | CR of TDD intrafrequency absolute and relative RSRP accuracy test for SCell with FS3 | 13.5.0 |
| 2016-09 | RP-73 | RP-161783 | 3749 | - | B | CR of FDD intrafrequency RSRQ measurement accuracy test for SCell with FS3 | 13.5.0 |
| 2016-09 | RP-73 | RP-161783 | 3750 | - | B | CR of TDD intrafrequency RSRQ measurement accuracy test for SCell with FS3 | 13.5.0 |
| 2016-09 | RP-73 | RP-161781 | 3756 | 1 | B | CR for Cat-M1 CEMode A RLM test cases: DRX FDD | 13.5.0 |
| 2016-09 | RP-73 | RP-161781 | 3758 | 1 | B | CR for Cat-M1 CEMode A RLM test cases: DRX HD-FDD | 13.5.0 |
| 2016-09 | RP-73 | RP-161781 | 3760 | 1 | B | CR for Cat-M1 CEMode A RLM test cases: DRX TDD | 13.5.0 |
| 2016-09 | RP-73 | RP-161640 | 3766 | - | F | CR on modification on report mapping of TADV measurement in TS36.133 for Rel-13 | 13.5.0 |
| 2016-09 | RP-73 | RP-161636 | 3768 | 1 | F | Editing change in TS36.133 for Rel-13 | 13.5.0 |
| 2016-09 | RP-73 | RP-161614 | 3770 | - | B | LAA SCell activation and deactivation for known SCells without DRX | 13.5.0 |
| 2016-09 | RP-73 | RP-161783 | 3772 | - | B | Event triggered reporting on LAA deactivated SCells and interruption probability (0.5%) without DRX | 13.5.0 |
| 2016-09 | RP-73 | RP-161631 | 3784 | - | A | Correction to RSTD Test Cases for 1.4 MHz | 13.5.0 |
| 2016-09 | RP-73 | RP-161635 | 3786 | - | F | Correction to Band 66 notes in E-UTRA band groups in Rel-13 | 13.5.0 |
| 2016-09 | RP-73 | RP-161609 | 3790 | - | B | RMCS for NPDSCH and NPDCCH for in-band for NB-IoT test cases | 13.5.0 |
| 2016-09 | RP-73 | RP-161634 | 3794 | 1 | F | Resolving TBDs in HD-FDD RLM test-cases for Rel-12 category 0 UEs | 13.5.0 |
| 2016-09 | RP-73 | RP-161610 | 3795 | 1 | B | E-UTRAN UE Transmit Timing Accuracy Tests for Cat-M1 UE in CEModeB | 13.5.0 |
| 2016-09 | RP-73 | RP-161610 | 3800 | - | B | RRC Re-establishment test for eMTC UEs in CEModeB | 13.5.0 |
| 2016-09 | RP-73 | RP-161609 | 3821 | 2 | B | Power headroom reporting requirements | 13.5.0 |
| 2016-09 | RP-73 | RP-161635 | 3827 | - | A | Correction to DL RMCS for Cell1 in A 8.16.25 | 13.5.0 |
| 2016-09 | RP-73 | RP-161612 | 3831 | 2 | B | CR on FDD-FDD inter-frequency RS-SINR accuracy test case R13 | 13.5.0 |
| 2016-09 | RP-73 | RP-161612 | 3833 | 2 | B | CR on TDD-TDD inter-frequency RS-SINR accuracy test case R13 | 13.5.0 |
| 2016-09 | RP-73 | RP-161638 | 3837 | - | B | Definition and abbreviation of frame structure 3 | 13.5.0 |
| 2016-09 | RP-73 | RP-161638 | 3839 | - | F | Editorial correction on LAA measurement requirements | 13.5.0 |
| 2016-09 | RP-73 | RP-161614 | 3841 | - | B | Intra-frequency event triggered reporting under fading propagation conditions in synchronous cells | 13.5.0 |

| | | | | | | | |
|---------|-------|-----------|------|---|---|---|--------|
| | | | | | | in non-DRX based on CRS under Operation with Frame Structure 3 | |
| 2016-09 | RP-73 | RP-161614 | 3843 | - | B | Intra-frequency event triggered reporting under fading propagation conditions in synchronous cells in DRX based on CRS under Operation with Frame Structure 3 | 13.5.0 |
| 2016-09 | RP-73 | RP-161638 | 3845 | 1 | F | CR on inter-frequency infinite measurement in LAA R13 | 13.5.0 |
| 2016-09 | RP-73 | RP-161638 | 3847 | 2 | F | Correction on discovery signal conditions in LAA R13 | 13.5.0 |
| 2016-09 | RP-73 | RP-161785 | 3853 | - | A | Modification on inter-frequency CSI-RS related test cases R13 | 13.5.0 |
| 2016-09 | RP-73 | RP-161785 | 3856 | - | A | Modification on CSI-RS related CA test cases R13 | 13.5.0 |
| 2016-09 | RP-73 | RP-161785 | 3859 | - | A | Correction on discovery signal conditions for SCE R13 | 13.5.0 |
| 2016-09 | RP-73 | RP-161785 | 3862 | - | F | Correction of Band group for TDD SCE test R13 | 13.5.0 |
| 2016-09 | RP-73 | RP-161785 | 3865 | - | A | Correction on accuracy test cases for CRS based measurement R13 | 13.5.0 |
| 2016-09 | RP-73 | RP-161610 | 3867 | 1 | B | E-UTRAN Intra frequency case for Cat-M1 UE in enhanced coverage R13 | 13.5.0 |
| 2016-09 | RP-73 | RP-161610 | 3869 | 1 | B | E-UTRAN FDD-FDD intra-frequency event triggered reporting under fading propagation conditions for Cat-M1 UE in CEModeB R13 | 13.5.0 |
| 2016-09 | RP-73 | RP-161610 | 3871 | 1 | B | E-UTRAN HD-FDD intra-frequency event triggered reporting under fading propagation conditions for Cat-M1 UE in CEModeB R13 | 13.5.0 |
| 2016-09 | RP-73 | RP-161610 | 3873 | 1 | B | E-UTRAN TDD-TDD intra-frequency event triggered reporting under fading propagation conditions for Cat-M1 UE in CEModeB R13 | 13.5.0 |
| 2016-09 | RP-73 | RP-161610 | 3875 | 1 | B | RSRP Intra frequency case for Cat-M1 UE in CEModeB R13 | 13.5.0 |
| 2016-09 | RP-73 | RP-161782 | 3877 | 1 | F | CR on PRACH configuration reference R13 | 13.5.0 |
| 2016-09 | RP-73 | RP-161639 | 3883 | 1 | F | CR on eMTC maintenance R13 | 13.5.0 |
| 2015-09 | RP-73 | RP-161639 | 3885 | - | F | CGI requirement for eMTC R13 | 13.5.0 |
| 2016-09 | RP-73 | RP-161639 | 3889 | - | F | Correction on UE Category M1 measurement requirement R13 | 13.5.0 |
| 2016-09 | RP-73 | RP-161637 | 3891 | 2 | F | CR for NB-IoT RRC re-establishment R13 | 13.5.0 |
| 2016-09 | RP-73 | RP-161637 | 3899 | 1 | F | Modification on requirement of measurement in RRC_CONNECTED for NB-IoT R13 | 13.5.0 |
| 2016-09 | RP-73 | RP161637 | 3903 | 1 | F | CR for Conditions on NSCH Es/lot of identified and of the neighbour cell R13 | 13.5.0 |
| 2016-09 | RP-73 | RP-161780 | 3905 | 1 | B | CR for OCNG pattern for NB-IoT standalone operation R13 | 13.5.0 |
| 2016-09 | RP-73 | RP-161609 | 3907 | 3 | B | HD-FDD Intra-frequency RRC Re-establishment for UE category NB1 under normal coverage R13 | 13.5.0 |
| 2016-09 | RP-73 | RP-161609 | 3909 | 3 | B | HD-FDD Inter-frequency RRC Re-establishment for UE category NB1 under enhanced coverage R13 | 13.5.0 |
| 2016-09 | RP-73 | RP-161609 | 3911 | - | B | Draft CR: RMCs for NPDCCH RMCs for standalone and guard band NB-IoT test cases | 13.5.0 |
| 2016-09 | RP-73 | RP-161609 | 3912 | - | B | Draft CR: RMCs for NPDCCH RMCs for standalone and guard band NB-IoT test cases | 13.5.0 |
| 2016-09 | RP-73 | RP-161780 | 3913 | 1 | B | CR of OCNG pattern for guard band for NB-IoT test cases | 13.5.0 |
| 2016-09 | RP-73 | RP-161609 | 3917 | - | B | Introduce inter-frequency NRSRQ measurement accuracy requirement R13 | 13.5.0 |
| 2016-09 | RP-73 | RP-161609 | 3919 | 1 | F | Modification on Conditions for NB-IoT inter-frequency Accuracy Requirements for UE Category NB1 R13 | 13.5.0 |
| 2016-09 | RP-73 | RP-161784 | 3922 | - | A | CR of test principle for DC test cases with different bandwidth combinations R13 | 13.5.0 |
| 2016-09 | RP-73 | RP-161780 | 3924 | 1 | B | CR OCNG pattern for in-band RRM tests | 13.5.0 |
| 2016-09 | RP-73 | RP-161634 | 3929 | - | A | CR for correction to some parameters in D2D RRM tests | 13.5.0 |
| 2016-09 | RP-73 | RP-161611 | 3931 | 1 | B | CR on eD2D RRM tests | 13.5.0 |
| 2016-09 | RP-73 | RP-161614 | 3932 | - | B | Inter-frequency event triggered reporting | 13.5.0 |
| 2016-09 | RP-73 | RP-161614 | 3933 | 1 | B | Intra-frequency absolute and relative CSI-RSRP accuracies for SCell with FS3 | 13.5.0 |
| 2016-09 | RP-73 | RP-161609 | 3944 | 1 | B | E-UTRAN UE Timing Advance Adjustment Accuracy Test for NB-IoT UE in Enhanced Coverage | 13.5.0 |
| 2016-09 | RP-73 | RP-161781 | 3946 | 1 | B | HD-FDD Radio Link Monitoring Test for Out-of-sync for Cat-M1 UE in CEModeA | 13.5.0 |
| 2016-09 | RP-73 | RP-161637 | 3950 | - | F | Correction CR on UE Measurement Capability for NB-IOT | 13.5.0 |

| | | | | | | | |
|---------|-------|-----------|------|---|---|---|--------|
| 2016-09 | RP-73 | RP-161637 | 3953 | - | F | Correction to Radio Link Monitoring Requirements for NB-IoT | 13.5.0 |
| 2016-09 | RP-73 | RP-161781 | 3957 | 1 | F | Corrections on FD-FDD Radio Link Monitoring Test for Out-of-sync for Cat-M1 UE in CEModeA | 13.5.0 |
| 2016-09 | RP-73 | RP-161781 | 3959 | 1 | F | Corrections on FD-FDD Radio Link Monitoring Test for In-sync for Cat-M1 UE in CEModeA | 13.5.0 |
| 2016-09 | RP-73 | RP-161781 | 3961 | 1 | F | Corrections on HD-FDD Radio Link Monitoring Test for In-sync for Cat-M1 UE in CEModeA | 13.5.0 |
| 2016-09 | RP-73 | RP-161781 | 3963 | 1 | F | Corrections on TDD Radio Link Monitoring Test for Out-of-sync for Cat-M1 UE in CEModeA | 13.5.0 |
| 2016-09 | RP-73 | RP-161781 | 3965 | 1 | F | Corrections on TDD Radio Link Monitoring Test for In-sync for Cat-M1 UE in CEModeA | 13.5.0 |
| 2016-09 | RP-73 | RP-161640 | 3967 | - | F | Rx-Tx time difference reporting | 13.5.0 |
| 2016-09 | RP-73 | RP-161830 | 3975 | 1 | B | Correction of transmit timing for category M1 | 13.5.0 |
| 2016-12 | RP-74 | RP-162431 | 3978 | 2 | F | Correction of RRC re-establishment delay for eMTC | 13.6.0 |
| 2016-12 | RP-74 | RP-162424 | 3988 | - | F | Modifications on SSTD measurement reporting | 13.6.0 |
| 2016-12 | RP-74 | RP-162385 | 3989 | 2 | F | UE Timing Advance Adjustment Accuracy Test for Cat-M1 UE in CEModeB for Rel-13 | 13.6.0 |
| 2016-12 | RP-74 | RP-162423 | 3996 | - | F | Corrections to Antenna connection for 4 Rx capable UEs | 13.6.0 |
| 2016-12 | RP-74 | RP-162458 | 4000 | - | A | Corrections on inter-frequency measurement test cases for IncMon in R13 | 13.6.0 |
| 2016-12 | RP-74 | RP-162424 | 4005 | 1 | F | Corrections on DC measurements test cases R13 | 13.6.0 |
| 2016-12 | RP-74 | RP-162424 | 4007 | 1 | F | Corrections on DC test cases for measurements with autonomous gaps R13 | 13.6.0 |
| 2016-12 | RP-74 | RP-162385 | 4009 | 3 | F | Corrections on RLM test cases for Cat-M1 UE in R13 | 13.6.0 |
| 2016-12 | RP-74 | RP-162434 | 4016 | 1 | F | CR on RRC re-establishment RRM requirement | 13.6.0 |
| 2016-12 | RP-74 | RP-162435 | 4024 | - | F | Introduce test requirements for E-UTRAN TDD - TDD Intra frequency handover for UE category 0 R13 | 13.6.0 |
| 2016-12 | RP-74 | RP-162426 | 4026 | - | F | CR on eDRX maintenance R13 | 13.6.0 |
| 2016-12 | RP-74 | RP-162431 | 4028 | - | F | CR on TDD CEModeB measurement requirement R13 | 13.6.0 |
| 2016-12 | RP-74 | RP-162431 | 4030 | - | F | CR on eMTC maintenance R13 | 13.6.0 |
| 2016-12 | RP-74 | RP-162459 | 4042 | - | A | Correction on the test cases of autonomous gaps in R13 | 13.6.0 |
| 2016-12 | RP-74 | RP-162428 | 4067 | 1 | F | Requirements applicability for LAA | 13.6.0 |
| 2016-12 | RP-74 | RP-162384 | 4082 | - | F | CR: Cat-M1 Editorial Corrections | 13.6.0 |
| 2016-12 | RP-74 | RP-162385 | 4097 | 2 | F | Correction to RRC reestablishment test case in CE mode A | 13.6.0 |
| 2016-12 | RP-74 | RP-162385 | 4101 | 2 | F | Correction to transmit timing accuracy test case in CE mode A | 13.6.0 |
| 2016-12 | RP-74 | RP-162430 | 4103 | 2 | F | Modification to Handover Delay in CE ModeA | 13.6.0 |
| 2016-12 | RP-74 | RP-162431 | 4107 | 1 | F | Modification to Handover Delay in CE ModeB | 13.6.0 |
| 2016-12 | RP-74 | RP-162434 | 4111 | 1 | F | Corrections on NPDCCH transmission parameters | 13.6.0 |
| 2016-12 | RP-74 | RP-162429 | 4115 | - | F | CR on finalization of RS-SINR measurement accuracy requirements | 13.6.0 |
| 2016-12 | RP-74 | RP-162428 | 4122 | 1 | F | Correction on the discovery signal measurements under FS3 R13 | 13.6.0 |
| 2016-12 | RP-74 | RP-162428 | 4124 | - | F | Editorial correction on the measurement applicability in LAA R13 | 13.6.0 |
| 2016-12 | RP-74 | RP-162416 | 4127 | - | A | Corrections to 3DL CA Event triggered reporting Test cases A.8.16.29, A.8.16.30 | 13.6.0 |
| 2016-12 | RP-74 | RP-162456 | 4129 | 2 | F | CR on NB-IoT measurement conditions | 13.6.0 |
| 2016-12 | RP-74 | RP-162385 | 4130 | 1 | F | CR on eMTC measurement conditions R13 (Note: this CR is not implemented since it clashes with CR#4093). | 13.6.0 |
| 2016-12 | RP-74 | RP-162459 | 4133 | - | A | CR on CSI-RS based measurement conditions R13 | 13.6.0 |
| 2016-12 | RP-74 | RP-162432 | 4143 | - | F | Correction to levels in LTE-WLAN RRM test | 13.6.0 |
| 2016-12 | RP-74 | RP-162431 | 4147 | 1 | F | Correction to RRC re-establishment requirements in eMTC | 13.6.0 |
| 2016-12 | RP-74 | RP-162431 | 4149 | 1 | F | Requirements for RRC Connection Release with Redirection in eMTC | 13.6.0 |
| 2016-12 | RP-74 | RP-162434 | 4151 | 1 | F | Requirements for redirection to non-anchor carrier | 13.6.0 |
| 2016-12 | RP-74 | RP-162430 | 4156 | 4 | F | UE Transmit timing accuracy in CE mode B | 13.6.0 |
| 2016-12 | RP-74 | RP-162434 | 4157 | 2 | F | CR on PTW length in cell reselection requirement for NB-IoT | 13.6.0 |
| 2016-12 | RP-74 | RP-162385 | 4159 | - | F | CR for Cat-M1 CEMode A RLM DRX test cases | 13.6.0 |
| 2016-12 | RP-74 | RP-162384 | 4162 | 1 | F | CR on cell re-selection test case for Cat-M1 in normal coverage | 13.6.0 |
| 2016-12 | RP-74 | RP-162382 | 4166 | 1 | F | CR on RRC re-establishment test case for Cat-M1 in CE Mode A | 13.6.0 |

| | | | | | | | |
|---------|-------|-----------|------|---|---|--|--------|
| 2016-12 | RP-74 | RP-162384 | 4168 | 1 | F | CR on RRC re-establishment test case for Cat-M1 in CE Mode B | 13.6.0 |
| 2016-12 | RP-74 | RP-162415 | 4174 | - | A | PCC and SCC assignment in 20MHz+10MHz test case A.8.20.2B and A.9.2.27 | 13.6.0 |
| 2016-12 | RP-74 | RP-162418 | 4177 | - | A | Remove redundant requirement for Intra-frequency relative CSI-RSRP | 13.6.0 |
| 2016-12 | RP-74 | RP-162420 | 4180 | - | A | Correct InformationBitPayload for Sub-Frame 1, 6 and Max T-put of TDD PDSCH RMC | 13.6.0 |
| 2016-12 | RP-74 | RP-162382 | 4184 | - | F | Correction to Es/Noc, Es/Iot and RSRP values in Idle mode re-selection test in normal coverage | 13.6.0 |
| 2016-16 | RP-74 | RP-162382 | 4186 | - | F | Corrections to rsrp-ThresholdsPrach and test requirement in Random Access Test in enhanced coverage | 13.6.0 |
| 2016-12 | RP-74 | RP-162435 | 4197 | - | F | 4 DL CA PCell in FDD FDD-TDD RSRQ for E-UTRAN in Carrier Aggregation | 13.6.0 |
| 2016-12 | RP-74 | RP-162435 | 4199 | - | F | 4 DL CA PCell in TDD TDD-FDD RSRQ for E-UTRAN in Carrier Aggregation | 13.6.0 |
| 2016-12 | RP-74 | RP-162435 | 4203 | - | F | 5 DL PCell in TDD RSRQ for E-UTRAN in Carrier Aggregation | 13.6.0 |
| 2016-12 | RP-74 | RP-162456 | 4205 | - | F | Clarification to applicability of NRSRQ for UE category NB1 | 13.6.0 |
| 2016-12 | RP-74 | RP-162433 | 4207 | - | F | Introducing agreed measurement period for NB IoT connected mode | 13.6.0 |
| 2016-12 | RP-74 | RP-162456 | 4209 | 1 | F | Introducing agreed measurement accuracy for NB IoT | 13.6.0 |
| 2016-12 | RP-74 | RP-162383 | 4220 | 1 | B | CR: E-UTRAN FDD-FDD Intra frequency handover for Cat-M1 UEs in CEModeB | 13.6.0 |
| 2016-12 | RP-74 | RP-162383 | 4222 | 1 | B | CR: E-UTRAN HD-FDD Intra frequency handover for Cat-M1 UEs in CEModeB | 13.6.0 |
| 2016-12 | RP-74 | RP-162383 | 4224 | 1 | B | CR: E-UTRAN TDD-TDD Intra frequency handover for Cat-M1 UEs in CEModeB | 13.6.0 |
| 2016-12 | RP-74 | RP-162386 | 4231 | - | F | CR for Inter-frequency event triggered reporting | 13.6.0 |
| 2016-12 | RP-74 | RP-162379 | 4236 | - | B | CR on UE Transmit Timing Accuracy Tests for NB-IoT UE | 13.6.0 |
| 2016-12 | RP-74 | RP-162380 | 4238 | 1 | F | CR for PHR requirement for NB-IoT | 13.6.0 |
| 2016-12 | RP-74 | RP-162379 | 4240 | - | F | CR for NPDCCH RMC | 13.6.0 |
| 2016-12 | RP-74 | RP-162380 | 4242 | 1 | F | CR for NPDSCH RMC | 13.6.0 |
| 2016-12 | RP-74 | RP-162380 | 4244 | 2 | F | CR on test parameter for RRC re-establishment | 13.6.0 |
| 2016-12 | RP-74 | RP-162380 | 4247 | - | B | HD-FDD radio Link Monitoring Test for Out-of-sync in DRX for UE category NB1 under normal coverage R13 | 13.6.0 |
| 2016-12 | RP-74 | RP-162380 | 4249 | - | B | HD-FDD radio Link Monitoring Test for Out-of-sync in DRX for UE category NB1 under enhanced coverage R13 | 13.6.0 |
| 2016-12 | RP-74 | RP-162383 | 4251 | 1 | F | Correction on test parameter in RSRP Intra frequency case for Cat-M1 UE in CE mode A | 13.6.0 |
| 2016-12 | RP-74 | RP-162383 | 4253 | 1 | F | Correction on test parameter in RSRP Intra frequency case for Cat-M1 UE in CE mode B | 13.6.0 |
| 2016-12 | RP-74 | RP-162384 | 4255 | 2 | B | Introduce RSRP accuracy test case for Band 31 for Cat-M1 UE | 13.6.0 |
| 2016-12 | RP-74 | RP-162384 | 4257 | 1 | B | Introduce 5MHz Bandwidth MPDCCH Reference Channel for Cat-M1 UE | 13.6.0 |
| 2016-12 | RP-74 | RP-162384 | 4259 | 1 | B | Introduce 5MHz Bandwidth MPDSCH Reference Channel for Cat-M1 UE | 13.6.0 |
| 2016-12 | RP-74 | RP-162384 | 4261 | 1 | B | Introduce 5MHz Bandwidth OCNG for Cat-M1 UE | 13.6.0 |
| 2016-12 | RP-74 | RP-162433 | 4263 | 1 | F | CR on RRC re-establishment RRM requirement | 13.6.0 |
| 2016-12 | RP-74 | RP-162433 | 4265 | 1 | F | CR on paging interruption for NB-IoT | 13.6.0 |
| 2016-12 | RP-74 | RP-162430 | 4269 | 1 | F | CR on CGI reading of eMTC R13 | 13.6.0 |
| 2016-12 | RP-74 | RP-162430 | 4271 | 1 | F | CR on handover of eMTC R13 | 13.6.0 |
| 2016-12 | RP-74 | RP-162384 | 4279 | 2 | F | CR on modification of cell reselection test case R13 | 13.6.0 |
| 2016-12 | RP-74 | RP-162459 | 4287 | 1 | A | Corrections on DC interruption test cases R13 | 13.6.0 |
| 2016-12 | RP-74 | RP-162418 | 4298 | - | A | Correction on SCE test cases R13 | 13.6.0 |
| 2016-12 | RP-74 | RP-162420 | 4301 | - | A | Correction on the test cases of RSTD Measurement in R13 | 13.6.0 |
| 2016-12 | RP-74 | RP-162420 | 4304 | - | A | Corrections on the test cases of UE measurement procedures and measurement performance requirements in R13 | 13.6.0 |
| 2016-12 | RP-74 | RP-162383 | 4308 | 1 | B | SI reading tests for eMTC UEs in CEModeB | 13.6.0 |
| 2016-12 | RP-74 | RP-162456 | 4310 | 2 | B | RLM in-sync test DRX under enhanced coverage | 13.6.0 |
| 2016-12 | RP-74 | RP-162456 | 4311 | 2 | B | RLM in-sync test with DRX under normal coverage | 13.6.0 |
| 2016-12 | RP-74 | RP-162380 | 4314 | 1 | B | Intra-frequency cell reselection under normal coverage for NB-IOT | 13.6.0 |
| 2016-12 | RP-74 | RP-162383 | 4320 | 1 | B | Applicability rule for eMTC test cases in CEModeA and CEModeB | 13.6.0 |

| | | | | | | | |
|---------|-------|-----------|------|---|---|---|--------|
| 2016-12 | RP-74 | RP-162456 | 4339 | 2 | B | CR on RLM in-sync test without DRX under normal coverage | 13.6.0 |
| 2016-12 | RP-74 | RP-162432 | 4340 | 3 | F | Correction to WLAN measurement configuration | 13.6.0 |
| 2016-12 | RP-74 | RP-162420 | 4347 | - | A | RRM: Correction to TCs A.7.1.7A and A.7.1.7B (Rel-13) | 13.6.0 |
| 2016-12 | RP-74 | RP-162383 | 4351 | 1 | F | Correction to the handover test case in CE mode A | 13.6.0 |
| 2016-12 | RP-74 | RP-162414 | 4353 | - | A | PCFICH/PDCCH/PHICH Reference channel in UE Cat 0 new CGI RRM test cases | 13.6.0 |
| 2016-12 | RP-74 | RP-162417 | 4357 | - | A | Correction to RRM tests on dual connectivity | 13.6.0 |
| 2016-12 | RP-74 | RP-162456 | 4363 | 2 | B | CR on RLM in-sync test without DRX under enhanced coverage | 13.6.0 |
| 2017-03 | RP-75 | RP-170595 | 4367 | | F | Correction to transmit timing accuracy test case in Cat-m1 CE mode B | 13.7.0 |
| 2017-03 | RP-75 | RP-170596 | 4371 | | F | Correction to the intra-frequency reselection requirements in Cat-m1 enhanced coverage | 13.7.0 |
| 2017-03 | RP-75 | RP-170595 | 4373 | | F | Correction to intra-frequency handover test case in CE mode B | 13.7.0 |
| 2017-03 | RP-75 | RP-170595 | 4375 | | F | Correction to intra-frequency handover test case in CE mode A | 13.7.0 |
| 2017-03 | RP-75 | RP-170597 | 4377 | | F | Modification the intra-frequency event triggered reporting test cases in Cat-m1 CE mode B | 13.7.0 |
| 2017-03 | RP-75 | RP-170596 | 4379 | 1 | F | Correction to the CGI requirement test case in Cat-M1 | 13.7.0 |
| 2017-03 | RP-75 | RP-170597 | 4381 | | D | Editorial correction to the CGI requirements | 13.7.0 |
| 2017-03 | RP-75 | RP-170596 | 4383 | | F | Correction to payload sizes in reference channels for Cat-m1 | 13.7.0 |
| 2017-03 | RP-75 | RP-170598 | 4387 | 1 | F | CR Update to Radio Link Monitoring Requirements for NB-IoT | 13.7.0 |
| 2017-03 | RP-75 | RP-170598 | 4389 | 2 | F | Correction CR on RRC_IDLE state requirements for NB-IOT | 13.7.0 |
| 2017-03 | RP-75 | RP-170596 | 4394 | 1 | F | Correction to prach-ConfigIndex for TDD Random Access Test for Cat-M1 | 13.7.0 |
| 2017-03 | RP-75 | RP-170596 | 4398 | 1 | F | Corrections to UE Cat M1 Intra-frequency Event triggered Reporting CE Mode A Test Cases | 13.7.0 |
| 2017-03 | RP-75 | RP-170588 | 4400 | | F | Correct 4DL Act-deact Unknown SCell Test Cases A.8.16.63 and A.8.16.64 | 13.7.0 |
| 2017-03 | RP-75 | RP-170600 | 4402 | 1 | F | Correct parameters for UE Category NB1 Reselection Test Case A.4.2.18 | 13.7.0 |
| 2017-03 | RP-75 | RP-170595 | 4404 | 1 | F | Correct Frequency hopping parameters for UE Cat M1 PDSCH Reference channel | 13.7.0 |
| 2017-03 | RP-75 | RP-170596 | 4406 | 1 | F | Correction to OCNG pattern for CatM1 FD-FDD and HD-FDD re-establishment TCs | 13.7.0 |
| 2017-03 | RP-75 | RP-170596 | 4419 | 1 | F | Corrections to UE Cat M1 Intra-frequency Event triggered Reporting CE Mode B Test Cases | 13.7.0 |
| 2017-03 | RP-75 | RP-170597 | 4423 | 1 | F | RRM: Corrections to eMTC PRACH TC A.6.2.10 and A.6.2.11 (Rel-13) | 13.7.0 |
| 2017-03 | RP-75 | RP-170596 | 4436 | 1 | F | CR on initial PRACH transmit power in RA test for Cat-M1 CEMode B R13 | 13.7.0 |
| 2017-03 | RP-75 | RP-170594 | 4447 | | F | Correction to core requirement of RRC re-establishment in Cat-m1 | 13.7.0 |
| 2017-03 | RP-75 | RP-170594 | 4449 | 1 | F | Correction to core requirement of Handover in Cat-m1 | 13.7.0 |
| 2017-03 | RP-75 | RP-170597 | 4451 | | D | Removing square brackets from RLM test case in Cat-m1 | 13.7.0 |
| 2017-03 | RP-75 | RP-170600 | 4465 | | F | CR on RRC re-establishment test case R13 | 13.7.0 |
| 2017-03 | RP-75 | RP-170601 | 4471 | 1 | F | Remove square brackets in NB-IoT performance requirement R13 | 13.7.0 |
| 2017-03 | RP-75 | RP-170581 | 4476 | | F | Correction on test parameter in RSRP Intra frequency case for UE category 0 R13 | 13.7.0 |
| 2017-03 | RP-75 | RP-170595 | 4479 | | F | Correction on RSRP level in RSRP Intra frequency case for Cat-M1 UE in CEModeB R13 | 13.7.0 |
| 2017-03 | RP-75 | RP-170595 | 4481 | | F | Correction of 8.13 Measurements for UE Category M1 R13 | 13.7.0 |
| 2017-03 | RP-75 | RP-170564 | 4483 | 1 | F | CR on WLAN RSSI R13 | 13.7.0 |
| 2017-03 | RP-75 | RP-170594 | 4488 | 2 | F | Not implement CRs for eMTC R13 | 13.7.0 |
| 2017-03 | RP-75 | RP-170600 | 4507 | 2 | F | CR for the correction on the testcases of HD-FDD Radio Link Monitoring for UE category NB1 in R13 | 13.7.0 |
| 2017-03 | RP-75 | RP-170603 | 4509 | 1 | F | Correction on measurement performance requirements for UE category M1 in R13 | 13.7.0 |
| 2017-03 | RP-75 | RP-170585 | 4512 | | F | CR for the correction on the testcases of Proximity-based Services and measurement performance requirement in R13 | 13.7.0 |
| 2017-03 | RP-75 | RP-170591 | 4517 | 1 | F | Remove the brackets in LAA requirements R13 | 13.7.0 |
| 2017-03 | RP-75 | RP-170592 | 4519 | | F | Correction on LAA test cases R13 | 13.7.0 |

| | | | | | | | |
|---------|-------|-----------|------|---|---|--|--------|
| 2017-03 | RP-75 | RP-170592 | 4521 | | F | Correction on p-C-r10 value for LAA test cases R13 | 13.7.0 |
| 2017-03 | RP-75 | RP-170584 | 4524 | | A | Correction on SCE event triggered reporting for CSI-RS based test cases R13 | 13.7.0 |
| 2017-03 | RP-75 | RP-170601 | 4542 | 1 | F | Intra-frequency cell reselection under enhanced coverage for NB-IOT | 13.7.0 |
| 2017-03 | RP-75 | RP-170595 | 4544 | 2 | F | Correction to Cat-M1 UE RRC re-establishment tests | 13.7.0 |
| 2017-03 | RP-75 | RP-170581 | 4549 | | A | Correction of RMC reference in the cat-0 HD-FDD intra-frequency test case | 13.7.0 |
| 2017-03 | RP-75 | RP-170594 | 4551 | 1 | F | Clarification on measurement reporting delay for eMTC | 13.7.0 |
| 2017-03 | RP-75 | RP-170598 | 4564 | 1 | F | Correction to redirection to NB-IoT non-anchor carrier | 13.7.0 |
| 2017-03 | RP-75 | RP-170594 | 4566 | | F | Correction to RRC release with redirection in eMTC | 13.7.0 |
| 2017-03 | RP-75 | RP-170597 | 4571 | | F | Renumbering of wrongly numbered sections A.7.2.9 - A.7.2.11 | 13.7.0 |
| 2017-03 | RP-75 | RP-170582 | 4573 | 1 | A | PCC and SCC assignment in 20MHz+10MHz test case A.8.16.21 and A.8.20.4B | 13.7.0 |
| 2017-03 | RP-75 | RP-170603 | 4577 | | F | 5 DL PCell in FDD RSRQ for E-UTRAN in Carrier Aggregation | 13.7.0 |
| 2017-03 | RP-75 | RP-170598 | 4581 | 2 | F | Capturing agreements for NB-IoT | 13.7.0 |
| 2017-03 | RP-75 | RP-170591 | 4597 | 1 | F | LAA SCC requirements with inter-frequency measurements | 13.7.0 |
| 2017-03 | RP-75 | RP-170592 | 4600 | | F | Correction of LAA RRM test cases | 13.7.0 |
| 2017-06 | RP-76 | RP-171309 | 4602 | | F | PDSCH allocation parameters for UE Cat M1 RSRP Test Cases | 13.8.0 |
| 2017-06 | RP-76 | RP-171301 | 4611 | 1 | F | CR: NB-IoT Radio Link Monitoring Performance Test for Out-of-Sync in Normal Coverage | 13.8.0 |
| 2017-06 | RP-76 | RP-171302 | 4613 | 1 | F | CR: NB-IoT Radio Link Monitoring Performance Test for Out-of-Sync in Enhanced Coverage | 13.8.0 |
| 2017-06 | RP-76 | RP-171307 | 4618 | | F | LAA RRM: Correction to test case titles (Rel-13) | 13.8.0 |
| 2017-06 | RP-76 | RP-171309 | 4620 | | F | eMTC RRM: Correction to prach test cases (Rel-13) | 13.8.0 |
| 2017-06 | RP-76 | RP-171309 | 4622 | | F | eMTC RRM: Alignment of used OCNG patterns (Rel-13) | 13.8.0 |
| 2017-06 | RP-76 | RP-171301 | 4624 | | F | NB-IoT RRM: Correction to used RMC and NOCNG (Rel-13) | 13.8.0 |
| 2017-06 | RP-76 | RP-171311 | 4626 | 1 | F | CA RRM: 5DL CA test case titles for inter-mode (FDD-TDD) scenarios (Rel-13) | 13.8.0 |
| 2017-06 | RP-76 | RP-171311 | 4641 | 1 | F | CR on requirement applicability for Cat-M1 and non-BL/CE UE R13 | 13.8.0 |
| 2017-06 | RP-76 | RP-171308 | 4645 | 1 | F | CR on measurement condition in B.1.3 R13 | 13.8.0 |
| 2017-06 | RP-76 | RP-171296 | 4685 | 1 | A | Band groups for category 0 operation | 13.8.0 |
| 2017-06 | RP-76 | RP-171308 | 4687 | | B | Band groups for category M1 operation | 13.8.0 |
| 2017-06 | RP-76 | RP-171298 | 4691 | 1 | F | Prose Operation during CA | 13.8.0 |
| 2017-06 | RP-76 | RP-171309 | 4697 | | F | Correction to Cat-M1 UE RRC re-establishment tests | 13.8.0 |
| 2017-06 | RP-76 | RP-171308 | 4699 | 1 | F | Correction to CONNECTED mode Cat-M1 requirements | 13.8.0 |
| 2017-06 | RP-76 | RP-171309 | 4713 | 1 | F | Correction to event triggered reporting test cases in eMTC | 13.8.0 |
| 2017-06 | RP-76 | RP-171299 | 4715 | 1 | F | Correction to inter-frequency requirements in NB-IOT | 13.8.0 |
| 2017-06 | RP-76 | RP-171307 | 4723 | 1 | F | Requirements applicability for LAA | 13.8.0 |
| 2017-06 | RP-76 | RP-171299 | 4759 | | F | Maintenance of core requirements for UE Cat.NB1 R13 | 13.8.0 |
| 2017-06 | RP-76 | RP-171301 | 4763 | | F | CR on test parameters for UE transmit timing for UE Cat.NB1 R13 | 13.8.0 |
| 2017-06 | RP-76 | RP-171267 | 4765 | 3 | F | CR for PHR requirement for NB-IoT R13 | 13.8.0 |
| 2017-06 | RP-76 | RP-171301 | 4765 | 1 | F | CR for PHR requirement for NB-IoT R13 | 13.8.0 |
| 2017-06 | RP-76 | RP-171301 | 4767 | | F | CR on T311 timer in RRC re-establishment test case R13 | 13.8.0 |
| 2017-06 | RP-76 | RP-171301 | 4769 | | F | CR on conditions for NRSRP and NRSRQ accuracy R13 | 13.8.0 |
| 2017-06 | RP-76 | RP-171301 | 4771 | 1 | F | CR on lo range for NB-IoT measurement accuracy R13 | 13.8.0 |
| 2017-06 | RP-76 | RP-171301 | 4775 | 2 | F | CR for cell reselection test parameter for NB-IoT R13 | 13.8.0 |
| 2017-06 | RP-76 | RP-171302 | 4777 | 1 | F | Correction on T2 time duration for RLM in-sync test R13 | 13.8.0 |
| 2017-06 | RP-76 | RP-171309 | 4818 | | F | CR on RA test for Cat-M1 normal coverage R13 | 13.8.0 |
| 2017-06 | RP-76 | RP-171308 | 4831 | 2 | F | CR on idle mode requirements for eMTC in R13 | 13.8.0 |
| 2017-06 | RP-76 | RP-171307 | 4833 | | F | LAA RRM: Correction to test case A.9.11.x and A.9.12.x (Rel-13) | 13.8.0 |

| | | | | | | | |
|---------|-------|-----------|------|---|---|---|--------|
| 2017-06 | RP-76 | RP-171309 | 4835 | | F | eMTC RRM: Correction to MPDCCH and PDSCH Reference Measurement Channels (Rel-13) | 13.8.0 |
| 2017-06 | RP-76 | RP-171298 | 4838 | | F | Correction to RRM 4DL FDD CA test cases | 13.8.0 |
| 2017-06 | RP-76 | RP-171307 | 4840 | | F | Corrections to LAA Event-triggered reporting Test Cases A.8.26 | 13.8.0 |
| 2017-06 | RP-76 | RP-171299 | 4842 | | F | Rel-13 CR on the applicability of RRC procedures | 13.8.0 |
| 2017-06 | RP-76 | RP-171298 | 4859 | | F | CA RRM: 4DL CA test parameter correction for A.8.16.51 and A.8.16.52 (Rel-13) | 13.8.0 |
| 2017-06 | RP-76 | RP-171296 | 4862 | | A | PCC and SCC assignment in 20MHz+10MHz test case A.8.16.22 | 13.8.0 |
| 2017-06 | RP-76 | RP-171300 | 4874 | | F | Introduce NPDCCH RMC with DCI format N0 R13 | 13.8.0 |
| 2017-06 | RP-76 | RP-171302 | 4876 | 2 | F | Correction on UE transmit timing test for NB-IoT R13 | 13.8.0 |
| 2017-06 | RP-76 | RP-171303 | 4878 | 1 | F | Correction on timing advance test for NB-IoT R13 | 13.8.0 |
| 2017-06 | RP-76 | RP-171299 | 4880 | | F | Maintenance CR on NB-IoT core requirements R13 | 13.8.0 |
| 2017-06 | RP-76 | RP-171302 | 4882 | | F | Correction on side condition for RRC re-establishment test cases R13 | 13.8.0 |
| 2017-06 | RP-76 | RP-171310 | 4887 | 1 | F | Correction on transmit timing requirement R13 | 13.8.0 |
| 2017-06 | RP-76 | RP-171311 | 4910 | 2 | F | 4DL FDD RSRQ for E-UTRAN in Carrier Aggregation in R13 | 13.8.0 |
| 2017-06 | RP-76 | RP-171311 | 4912 | 2 | F | 4DL TDD RSRQ for E-UTRAN in Carrier Aggregation in R13 | 13.8.0 |
| 2017-06 | RP-76 | RP-171311 | 4914 | 2 | F | Correction on the test cases of RLM for Cat-M1 UE in R13 | 13.8.0 |
| 2017-06 | RP-76 | RP-171307 | 4925 | | F | Modification on LAA measurement considering Inter-frequency RSSI measurement R13 | 13.8.0 |
| 2017-06 | RP-76 | RP-171307 | 4927 | 1 | F | Corrections on the LAA test cases R13 | 13.8.0 |
| 2017-06 | RP-76 | RP-171297 | 4930 | | A | Update of some SCE test case | 13.8.0 |
| 2017-06 | RP-76 | RP-171311 | 4932 | | F | Event triggered reporting on deactivated SCells and interruption probability (0.5%) without DRX (FDD-TDD 4DL CA) R13 | 13.8.0 |
| 2017-06 | RP-76 | RP-171311 | 4934 | | F | Event triggered reporting on deactivated SCells and interruption probability (0.5%) without DRX (TDD-FDD 4 DL CA) R13 | 13.8.0 |
| 2017-06 | RP-76 | RP-171303 | 4936 | 2 | B | Inter-frequency cell reselection under enhanced coverage for NB-IOT | 13.8.0 |
| 2017-06 | RP-76 | RP-171308 | 4940 | 1 | F | Timing advance requirements for Cat M1 UEs | 13.8.0 |
| 2017-06 | RP-76 | RP-171303 | 4952 | 1 | F | Contention Based Random Access Test for UE category NB1 UEs in Normal Coverage | 13.8.0 |
| 2017-06 | RP-76 | RP-171303 | 4954 | 1 | F | Contention Based Random Access Test for UE category NB1 UEs in Enhanced Coverage | 13.8.0 |
| 2017-06 | RP-76 | RP-171297 | 4958 | 1 | A | Correction to RSTD test cases for carrier aggregation (R13) | 13.8.0 |
| 2017-06 | RP-76 | RP-171302 | 4962 | 1 | F | Correction to inter-frequency RRC re-establishment test case in NB-IOT | 13.8.0 |
| 2017-06 | RP-76 | RP-171307 | 4983 | | F | Corrections in LAA requirements | 13.8.0 |
| 2017-06 | RP-76 | RP-171308 | 4989 | 1 | F | Introducing gapless measurement requirement for eMTC R13 | 13.8.0 |
| 2017-06 | RP-76 | RP-171266 | 4999 | | F | CR on UE timer accuracy for FeMTC in R13 | 13.8.0 |
| 2017-09 | RP-77 | RP-171967 | 5006 | | A | Updates to Intra-freq Event-triggered reporting Test cases for UE Cat 0 | 13.9.0 |
| 2017-09 | RP-77 | RP-171971 | 5008 | | F | Reference Channels in UE Cat M1 RRC Re-establishment test cases | 13.9.0 |
| 2017-09 | RP-77 | RP-171971 | 5010 | 1 | F | OCNG and RMCs in UE Cat M1 Handover TCs | 13.9.0 |
| 2017-09 | RP-77 | RP-171971 | 5014 | | F | Es/lot and RSRP values in UE Cat M1 Re-selection test cases | 13.9.0 |
| 2017-09 | RP-77 | RP-171971 | 5016 | | F | Reference PRACH Configurations for Cat M1 test cases | 13.9.0 |
| 2017-09 | RP-77 | RP-171971 | 5018 | | F | PRACH Configurations and parameters for Cat M1 test cases A.6.2.10/11/12 | 13.9.0 |
| 2017-09 | RP-77 | RP-171971 | 5020 | | F | PRACH Configuration for Cat M1 test case A.6.2.15 | 13.9.0 |
| 2017-09 | RP-77 | RP-171972 | 5024 | 1 | F | Correction to RLM test cases Category NB1 | 13.9.0 |
| 2017-09 | RP-77 | RP-171973 | 5027 | | F | CA RRM: Correction of Cell 3 Es/lot for T2 and T4 for TC A.8.16.55 and 56 (Rel-13) | 13.9.0 |
| 2017-09 | RP-77 | RP-171967 | 5030 | | A | CA RRM: Correction of PRS Subframe Offset for TC A.8.17.10 and A.8.17.11 (Rel-13) | 13.9.0 |
| 2017-09 | RP-77 | RP-171971 | 5032 | | F | eMTC RRM: Corrections to Timing Advance Adjustment Accuracy test for Cat-M1 UE (Rel-13) | 13.9.0 |
| 2017-09 | RP-77 | RP-171972 | 5034 | 1 | F | NB-IoT RRM: Correction of antenna configuration of LTE and NB-IoT cells in Inband RRM scenarios (Rel-13) | 13.9.0 |
| 2017-09 | RP-77 | RP-171972 | 5036 | 1 | F | NB-IoT RRM: Corrections to the NOCNG definition (Rel-13) | 13.9.0 |
| 2017-09 | RP-77 | RP-171969 | 5057 | 1 | F | Correction CR on adding band group to RS-SINR | 13.9.0 |

| | | | | | | | |
|---------|--------|-----------|------|---|---|--|---------|
| | | | | | | measurement conditions | |
| 2017-09 | RP-77 | RP-171969 | 5067 | | F | Applicability rule for Rel-13 non-BL CE UE requirements | 13.9.0 |
| 2017-09 | RP-77 | RP-171972 | 5077 | 1 | F | NB-IoT RRM: Corrections to invalid configuration for In-band Intra-frequency scenarios (Rel-13) | 13.9.0 |
| 2017-09 | RP-77 | RP-171968 | 5079 | | F | LAA RRM: Remove Square brackets from TCs A.9.1.60 and A.9.1.61 (Rel-13) | 13.9.0 |
| 2017-09 | RP-77 | RP-171971 | 5081 | | F | eMTC RRM: MPDSCH Repetitions in CEModeA test cases with DRX (Rel-13) | 13.9.0 |
| 2017-09 | RP-77 | RP-171972 | 5094 | 1 | F | Correction on RLM core requirements for NB-IoT | 13.9.0 |
| 2017-09 | RP-77 | RP-171972 | 5096 | 1 | F | Correction on cell reselection test case for NB-IoT | 13.9.0 |
| 2017-09 | RP-77 | RP-171973 | 5102 | | F | Event triggered reporting on deactivated SCells and interruption probability (0.5%) without DRX (FDD-TDD 5DL CA) | 13.9.0 |
| 2017-09 | RP-77 | RP-171973 | 5104 | 1 | F | Event triggered reporting on deactivated SCells and interruption probability (0.5%) without DRX (TDD-FDD 5DL CA) | 13.9.0 |
| 2017-09 | RP-77 | RP-171969 | 5118 | | F | CR on RSRP range of eMTC Rel-13 | 13.9.0 |
| 2017-09 | RP-77 | RP-171972 | 5128 | 1 | F | CR for NB-IoT Transmit Timing Test | 13.9.0 |
| 2017-09 | RP-77 | RP-171969 | 5130 | 1 | F | Restructuring of Handover Requirements in eMTC | 13.9.0 |
| 2017-09 | RP-77 | RP-171973 | 5137 | | F | Correction to LAA RRM measurement requirement R13 | 13.9.0 |
| 2017-09 | RP-77 | RP-171973 | 5138 | 2 | F | Correction to LAA RRM test cases | 13.9.0 |
| 2017-12 | RP-78 | RP-172607 | 5160 | | F | Correction of test requirement for LAA Test cases A.8.26.x | 13.10.0 |
| 2017-12 | RP-78 | RP-172609 | 5171 | 1 | F | Clarification on the SNR transition in NB-IoT RLM test for in-sync | 13.10.0 |
| 2017-12 | RP-78 | RP-172608 | 5215 | 2 | B | CR for RLM tests for non-BL/CE UE (R13) | 13.10.0 |
| 2017-12 | RP-78 | RP-172583 | 5241 | 1 | F | Correction on coverage enhancement level for cat-M1 in IDLE state for Rel-13 MTC | 13.10.0 |
| 2017-12 | RP-78 | RP-172574 | 5244 | 1 | F | Correction to Rel-13 cat-M1 cell re-selection and RRC re-establishment test cases | 13.10.0 |
| 2017-12 | RP-78 | RP-172610 | 5298 | | F | correctoin on cell reselectoin test case | 13.10.0 |
| 2017-12 | RP-78 | RP-172607 | 5311 | | F | Correction of OCNG for LAA Test cases A.8.26.x, A.9.1.x, A.9.2.x | 13.10.0 |
| 2017-12 | RP-78 | RP-172609 | 5323 | 1 | F | Clarification on the SNR transition in NB-IoT RLM test for out-of-sync | 13.10.0 |
| 2017-12 | RP-78 | RP-172607 | 5326 | | F | Correction to Test Parameters for FS3 Channel Occupancy tests | 13.10.0 |
| 2017-12 | RP-78 | RP-172611 | 5356 | 1 | F | RRM NB-IoT: Correction to transmit timing accuracy test under enhanced coverage (Rel-13) | 13.10.0 |
| 2017-12 | RP-78 | RP-172613 | 5359 | | F | RRM 4DL: Correction of cell powers for TC A.9.2.46 (Rel-13) | 13.10.0 |
| 2017-12 | RP-78 | RP-172608 | 5368 | 1 | F | Introducing PBCH repetition for eMTC RRM test case | 13.10.0 |
| 2017-12 | RP-78 | RP-172610 | 5391 | 1 | F | Correctoin on cell reselectoin test case | 13.10.0 |
| 2017-12 | RP-78 | RP-172610 | 5394 | 1 | F | Correctoin on random access test case | 13.10.0 |
| 2017-12 | RP-78 | RP-172610 | 5397 | 1 | F | Correction on NPRACH configuration in RRC re-establishment test cases | 13.10.0 |
| 2017-12 | RP-78 | RP-172606 | 5405 | | A | Correct the core requirements refered in multiple TDD-TDD inter-frequency measurements test cases. | 13.10.0 |
| 2018-03 | RAN#79 | RP-180293 | 5534 | 1 | F | Correction to Reference NPRACH Configurations | 13.11.0 |
| 2018-03 | RAN#79 | RP-180293 | 5537 | | F | Finalising NB-IoT NPRACH Test cases A.6.2.16 and A.6.2.17 | 13.11.0 |
| 2018-03 | RAN#79 | RP-180293 | 5540 | 1 | F | Correction to NB-IoT UE Transmit Timing Accuracy Test cases | 13.11.0 |
| 2018-03 | RAN#79 | RP-180291 | 5543 | | F | Correction to successful report rate threshold for FS3 channel occupancy tests | 13.11.0 |
| 2018-03 | RAN#79 | RP-180291 | 5546 | | F | Correction to incorrect reference for A8.26.9 and A8.26.10 | 13.11.0 |
| 2018-03 | RAN#79 | RP-180291 | 5549 | | F | Correction to OCNG pattern for FS3 RSSI and channel occupancy tests | 13.11.0 |
| 2018-03 | RAN#79 | RP-180294 | 5564 | 1 | F | Correction for LAA channel occupancy test (R13) | 13.11.0 |
| 2018-03 | RAN#79 | RP-180294 | 5567 | | F | Correction for LAA RSSI measurement accuracy requirement (R13) | 13.11.0 |
| 2018-03 | RAN#79 | RP-180293 | 5611 | | D | Editorial change on RLM requirement | 13.11.0 |
| 2018-03 | RAN#79 | RP-180294 | 5640 | | F | CR for 36.133 introducing band 68 | 13.11.0 |
| 2018-03 | RAN#79 | RP-180293 | 5643 | 2 | F | Clarification on coverage enhancement level for category NB1 UEs in IDLE state | 13.11.0 |
| 2018-06 | RAN#80 | RP-181113 | 5662 | | F | Editorial changes to single carrier RLM test case for 4 Rx capable Ues R13 | 13.12.0 |
| 2018-06 | RAN#80 | RP-181112 | 5668 | | F | Remove [] from Physical channels for NB-IoT Test case A.6.1.16 | 13.12.0 |

| | | | | | | | |
|---------|--------|-----------|------|---|---|--|---------|
| 2018-06 | RAN#80 | RP-181110 | 5671 | | F | Correction of test parameters for LAA Test cases A.9.1.60 and A.9.1.61 | 13.12.0 |
| 2018-06 | RAN#80 | RP-181112 | 5674 | 1 | F | Update parameters for NB-IoT Tx Timing Test case A.7.1.18 | 13.12.0 |
| 2018-06 | RAN#80 | RP-181110 | 5677 | | F | Specify Measurement BW for LAA Test cases A.8.26.3/4 and A.8.26.9/10 | 13.12.0 |
| 2018-06 | RAN#80 | RP-181111 | 5737 | | F | Clarification on measurement reporting delay for eMTC | 13.12.0 |
| 2018-06 | RAN#80 | RP-181113 | 5745 | | F | Corrections to CA activation and deactivation test cases (Rel-13) | 13.12.0 |
| 2018-06 | RAN#80 | RP-181110 | 5748 | | F | Correction to Test Parameters for FS3 Channel Occupancy tests | 13.12.0 |
| 2018-06 | RAN#80 | RP-181111 | 5773 | | F | Correction to eMTC CGI reading delay requirement R13 | 13.12.0 |
| 2018-06 | RAN#80 | RP-181112 | 5776 | 1 | F | Correction to the delay requirement for RRC connection redirection to non-anchor carrier for NB-IoT R13 | 13.12.0 |
| 2018-09 | RAN#81 | RP-181911 | 5859 | | F | Correction of test parameters for LAA Test cases A.9.1.60 and A.9.1.61 | 13.13.0 |
| 2018-09 | RAN#81 | RP-181911 | 5870 | 1 | F | Clarification of the measurement gap offset in LAA inter-frequency measurement test R13 | 13.13.0 |
| 2018-09 | RAN#81 | RP-181912 | 5912 | 1 | F | Correction of terminology for non-BL CE UE for Rel-13 | 13.13.0 |
| 2018-09 | RAN#81 | RP-181912 | 5919 | | F | Correcton to category M1 PDSCH RMCs | 13.13.0 |
| 2018-12 | RAN#82 | RP-182379 | 6022 | | A | CR 36.133 Correction of references in OCNG patterns Rel-13 | 13.14.0 |
| 2018-12 | RAN#82 | RP-182381 | 6041 | 1 | F | Correction to FDD-FS3 Intra-frequency event triggered reporting in DRX | 13.14.0 |
| 2018-12 | RAN#82 | RP-182382 | 6056 | | F | Corrections to feMTC RRM test case A.8.1.28 (Rel-13) | 13.14.0 |
| 2018-12 | RAN#82 | RP-182382 | 6077 | 1 | F | CR on NRSRP accuracy applicability for UE Category NB1 R13 | 13.14.0 |
| 2018-12 | RAN#82 | RP-182382 | 6085 | 1 | F | CR on NB random access test cases R13 | 13.14.0 |
| 2018-12 | RAN#82 | RP-182382 | 6147 | | F | Clarification on the applicability of side condition for CE UE R13 | 13.14.0 |
| 2018-12 | RAN#82 | RP-182379 | 6184 | | A | Corrections to incmon testcases | 13.14.0 |
| 2019-03 | RAN#83 | RP-190414 | 6189 | 1 | F | Correction to FDD-FS3 Intra-frequency event triggered reporting in DRX | 13.15.0 |
| 2019-03 | RAN#83 | RP-190413 | 6194 | 1 | F | Clarifications on HD-FDD NB-IoT Out-of-sync RLM test cases | 13.15.0 |
| 2019-03 | RAN#83 | RP-190413 | 6198 | 1 | F | Corrections to HD-FDD NB-IoT In-Sync RLM tests | 13.15.0 |
| 2019-03 | RAN#83 | RP-190413 | 6202 | 1 | F | Clarification on test requirements for transmit timing accuracy for HD-FDD Category NB1 UE | 13.15.0 |
| 2019-03 | RAN#83 | RP-190411 | 6227 | | A | Correction to Incmon test cases for reselection from E-UTRA FDD/TDD to UTRA | 13.15.0 |
| 2019-03 | RAN#83 | RP-190414 | 6237 | 1 | F | CR to 36.133 for corrections on section A.9.10 and section A.9.13 | 13.15.0 |
| 2019-03 | RAN#83 | RP-190413 | 6243 | | F | CR on NB random access test cases R13 | 13.15.0 |
| 2019-06 | RAN#84 | RP-191260 | 6446 | | F | Correction to event triggered reporting on Deactivated SCeLL | 13.16.0 |
| 2019-06 | RAN#84 | RP-191258 | 6450 | | F | Correction to timing advance adjustment accuracy test for Cat-M1 UE | 13.16.0 |
| 2019-06 | RAN#84 | RP-191260 | 6462 | 1 | F | Maintenance on HD-FDD inter-frequency re-establishment test cases R13 | 13.16.0 |
| 2019-06 | RAN#84 | RP-191260 | 6488 | 1 | F | CR on threshold for FS3 RSSI and channel occupancy tests R13 | 13.16.0 |
| 2019-06 | RAN#84 | RP-191260 | 6509 | | F | Corrections on inter-frequency RS-SINR measurement accuracy test in TS36.133 R13 | 13.16.0 |
| 2019-06 | RAN#84 | RP-191260 | 6533 | | F | Corrections to NB-IoT PRACH test cases (Rel-13) | 13.16.0 |
| 2019-09 | RAN#85 | RP-192051 | 6559 | 2 | F | Corrections to test case for HD – FDD Inter frequency reselection case for UE Category NB1 In-Band mode in enhanced coverage | 13.17.0 |
| 2019-09 | RAN#85 | RP-192051 | 6597 | | F | Correction of references to RSRP performance requirements for CE Mode B | 13.17.0 |
| 2019-09 | RAN#85 | RP-192051 | 6607 | | F | Clarification of enhanced coverage UE requirements in IDLE mode for Rel-13 | 13.17.0 |
| 2019-12 | RAN#86 | RP-193043 | 6770 | | F | Clarifications on RSSI and Channel Occupancy measurement requirements in LTE LAA | 13.18.0 |
| 2019-12 | RAN#86 | RP-193043 | 6774 | | F | Correction to misused variables in intra-frequency cell identification requirements | 13.18.0 |
| 2019-12 | RAN#86 | RP-193043 | 6682 | | F | CR on clarification on RSSI measurement requirement R13 | 13.18.0 |
| 2020-06 | RAN#88 | RP-200990 | 6834 | | A | CR to RRM MPDSCH Repetitions in CE ModeA test case | 13.19.0 |

| | | | | | | | |
|---------|---------|-----------|------|---|---|---|---------|
| 2020-06 | RAN#88 | RP-200990 | 6859 | | A | CR to TS 36.133: Change of SR-ConfigIndex in eMTC RLM DRX test cases (Rel-14) | 13.19.0 |
| 2020-06 | RAN#88 | RP-200990 | 6872 | | A | CR on NB-IoT cell reselection margin in enhanced coverage in Rel-14 (Cat A) | 13.19.0 |
| 2020-06 | RAN#88 | RP-200989 | 6891 | | F | Correction to eMTC inter-frequency reselection margin R14 | 13.19.0 |
| 2020-09 | RAN#89 | RP-201512 | 6913 | | F | Correction to intra-frequency event triggered reporting test case in CEModeA | 13.20.0 |
| 2020-12 | RAN#90 | RP-202513 | 7002 | 1 | F | Correction to test parameters for FDD and TDD intra-frequency RSRP for Cat-M1 UE in CEModeA | 13.21.0 |
| 2021-09 | RAN#93 | RP-211923 | 7130 | | F | Big CR to TS 36.133: LTE RRM maintenance (Rel-13) | 13.22.0 |
| 2022-09 | RAN#97 | RP-222054 | 7165 | 1 | F | Correction of Configuration Parameters for Test 1 in Test Case A.7.1.11 | 13.23.0 |
| 2024-09 | RAN#105 | RP-242154 | 7337 | 2 | F | (NB_IOT-Perf) CR on RSRP-ThresholdsNPRACH-InfoList for NB-IoT (Cat-F Rel-13) | 13.24.0 |

History

| Document history | | |
|-------------------------|---------------|-------------|
| V13.2.0 | April 2016 | Publication |
| V13.3.0 | May 2016 | Publication |
| V13.4.0 | November 2016 | Publication |
| V13.5.0 | December 2016 | Publication |
| V13.6.0 | March 2017 | Publication |
| V13.7.0 | April 2017 | Publication |
| V13.8.0 | August 2017 | Publication |
| V13.9.0 | November 2017 | Publication |
| V13.10.0 | January 2018 | Publication |
| V13.11.0 | April 2018 | Publication |
| V13.12.0 | October 2018 | Publication |
| V13.13.0 | January 2019 | Publication |
| V13.14.0 | May 2019 | Publication |
| V13.15.0 | July 2019 | Publication |
| V13.16.0 | July 2019 | Publication |
| V13.17.0 | October 2019 | Publication |
| V13.18.0 | February 2020 | Publication |
| V13.19.0 | August 2020 | Publication |
| V13.20.0 | December 2020 | Publication |
| V13.21.0 | February 2021 | Publication |
| V13.22.0 | November 2021 | Publication |
| V13.23.0 | January 2023 | Publication |
| V13.24.0 | October 2024 | Publication |