

ETSI TS 138 101-5 V18.7.0 (2024-10)



**5G;
NR;
User Equipment (UE) radio transmission and reception;
Part 5: Satellite access Radio Frequency (RF)
and performance requirements
(3GPP TS 38.101-5 version 18.7.0 Release 18)**



Reference

RTS/TSGR-0438101-5vi70

Keywords

5G

ETSI

650 Route des Lucioles
F-06921 Sophia Antipolis Cedex - FRANCE

Tel.: +33 4 92 94 42 00 Fax: +33 4 93 65 47 16

Siret N° 348 623 562 00017 - APE 7112B
Association à but non lucratif enregistrée à la
Sous-Préfecture de Grasse (06) N° w061004871

Important notice

The present document can be downloaded from the
ETSI [Search & Browse Standards application](#).

The present document may be made available in electronic versions and/or in print. The content of any electronic and/or print versions of the present document shall not be modified without the prior written authorization of ETSI. In case of any existing or perceived difference in contents between such versions and/or in print, the prevailing version of an ETSI deliverable is the one made publicly available in PDF format on [ETSI deliver](#).

Users should be aware that the present document may be revised or have its status changed,
this information is available in the [Milestones listing](#).

If you find errors in the present document, please send your comments to
the relevant service listed under [Committee Support Staff](#).

If you find a security vulnerability in the present document, please report it through our
[Coordinated Vulnerability Disclosure \(CVD\)](#) program.

Notice of disclaimer & limitation of liability

The information provided in the present deliverable is directed solely to professionals who have the appropriate degree of experience to understand and interpret its content in accordance with generally accepted engineering or other professional standard and applicable regulations.

No recommendation as to products and services or vendors is made or should be implied.

No representation or warranty is made that this deliverable is technically accurate or sufficient or conforms to any law and/or governmental rule and/or regulation and further, no representation or warranty is made of merchantability or fitness for any particular purpose or against infringement of intellectual property rights.

In no event shall ETSI be held liable for loss of profits or any other incidental or consequential damages.

Any software contained in this deliverable is provided "AS IS" with no warranties, express or implied, including but not limited to, the warranties of merchantability, fitness for a particular purpose and non-infringement of intellectual property rights and ETSI shall not be held liable in any event for any damages whatsoever (including, without limitation, damages for loss of profits, business interruption, loss of information, or any other pecuniary loss) arising out of or related to the use of or inability to use the software.

Copyright Notification

No part may be reproduced or utilized in any form or by any means, electronic or mechanical, including photocopying and microfilm except as authorized by written permission of ETSI.

The content of the PDF version shall not be modified without the written authorization of ETSI.

The copyright and the foregoing restriction extend to reproduction in all media.

© ETSI 2024.
All rights reserved.

Intellectual Property Rights

Essential patents

IPRs essential or potentially essential to normative deliverables may have been declared to ETSI. The declarations pertaining to these essential IPRs, if any, are publicly available for **ETSI members and non-members**, and can be found in ETSI SR 000 314: "*Intellectual Property Rights (IPRs); Essential, or potentially Essential, IPRs notified to ETSI in respect of ETSI standards*", which is available from the ETSI Secretariat. Latest updates are available on the ETSI Web server (<https://ipr.etsi.org/>).

Pursuant to the ETSI Directives including the ETSI IPR Policy, no investigation regarding the essentiality of IPRs, including IPR searches, has been carried out by ETSI. No guarantee can be given as to the existence of other IPRs not referenced in ETSI SR 000 314 (or the updates on the ETSI Web server) which are, or may be, or may become, essential to the present document.

Trademarks

The present document may include trademarks and/or tradenames which are asserted and/or registered by their owners. ETSI claims no ownership of these except for any which are indicated as being the property of ETSI, and conveys no right to use or reproduce any trademark and/or tradename. Mention of those trademarks in the present document does not constitute an endorsement by ETSI of products, services or organizations associated with those trademarks.

DECT™, **PLUGTESTS™**, **UMTS™** and the ETSI logo are trademarks of ETSI registered for the benefit of its Members. **3GPP™** and **LTE™** are trademarks of ETSI registered for the benefit of its Members and of the 3GPP Organizational Partners. **oneM2M™** logo is a trademark of ETSI registered for the benefit of its Members and of the oneM2M Partners. **GSM®** and the GSM logo are trademarks registered and owned by the GSM Association.

Legal Notice

This Technical Specification (TS) has been produced by ETSI 3rd Generation Partnership Project (3GPP).

The present document may refer to technical specifications or reports using their 3GPP identities. These shall be interpreted as being references to the corresponding ETSI deliverables.

The cross reference between 3GPP and ETSI identities can be found under <https://webapp.etsi.org/key/queryform.asp>.

Modal verbs terminology

In the present document "**shall**", "**shall not**", "**should**", "**should not**", "**may**", "**need not**", "**will**", "**will not**", "**can**" and "**cannot**" are to be interpreted as described in clause 3.2 of the [ETSI Drafting Rules](#) (Verbal forms for the expression of provisions).

"**must**" and "**must not**" are **NOT** allowed in ETSI deliverables except when used in direct citation.

Contents

Intellectual Property Rights	2
Legal Notice	2
Modal verbs terminology.....	2
Foreword.....	9
1 Scope	11
2 References	11
3 Definitions of terms, symbols and abbreviations	12
3.1 Terms.....	12
3.2 Symbols.....	13
3.3 Abbreviations	14
4 General	15
4.1 Relationship between minimum requirements and test requirements	15
4.2 Applicability of minimum requirements	15
4.3 Specification suffix information.....	16
4.4 Relationship with other core specifications.....	16
5 Operating bands and channel arrangement.....	16
5.1 General	16
5.2 Operating bands.....	16
5.2.1 General.....	16
5.2.2 Operating bands with conducted requirements	16
5.2.3 Operating bands with radiated requirements	17
5.3 UE channel bandwidth	17
5.3.1 General.....	17
5.3.2 Maximum transmission bandwidth configuration	18
5.3.3 Minimum guardband and transmission bandwidth configuration.....	18
5.3.4 RB alignment	19
5.3.5 UE channel bandwidth per operating band	19
5.3.6 Asymmetric channel bandwidths	20
5.4 Channel arrangement.....	21
5.4.1 Channel spacing.....	21
5.4.1.1 Channel spacing for adjacent NTN satellite carriers	21
5.4.2 Channel raster	21
5.4.2.1 NR-ARFCN and channel raster.....	21
5.4.2.2 Channel raster to resource element mapping.....	21
5.4.2.3 Channel raster entries for each operating band	22
5.4.3 Synchronization raster	23
5.4.3.1 Synchronization raster and numbering.....	23
5.4.3.2 Synchronization raster to synchronization block resource element mapping.....	23
5.4.3.3 Synchronization raster entries for each operating band.....	23
5.4.4 TX–RX frequency separation	24
6 Conducted transmitter characteristics	24
6.1 General	24
6.2 Transmitter power	24
6.2.1 UE maximum output power.....	24
6.2.2 UE maximum output power reduction.....	25
6.2.3 UE additional maximum output power reduction	25
6.2.3.1 General	25
6.2.3.2 A-MPR for NS_03N	26
6.2.3.3 A-MPR for NS_04N	27
6.2.3.4 A-MPR for NS_05N	27
6.2.4 Configured transmitted power	28
6.3 Output power dynamics.....	28

6.3.1	Minimum output power	28
6.3.2	Transmit OFF power.....	28
6.3.3	Transmit ON/OFF time mask	29
6.3.4	Power control.....	29
6.4	Transmit signal quality	29
6.4.1	Frequency error.....	29
6.4.2	Transmit modulation quality.....	29
6.4.2.1	General	29
6.4.2.2	Phase continuity requirements for DMRS bundling	29
6.5	Output RF spectrum emissions.....	30
6.5.1	Occupied bandwidth	30
6.5.2	Out of band emission	30
6.5.2.1	General	30
6.5.2.2	Spectrum emission mask.....	30
6.5.2.3	Additional spectrum emission mask	31
6.5.2.3.1	Requirements for network signalling value "NS_04N"	31
6.5.2.3.2	Requirements for network signalling value "NS_05N"	31
6.5.2.4	Adjacent channel leakage ratio	31
6.5.2.4.1	NR ACLR.....	31
6.5.2.4.2	UTRA ACLR	32
6.5.3	Spurious emission.....	32
6.5.3.1	General spurious emissions.....	32
6.5.3.2	Spurious emissions for UE co-existence	33
6.5.3.3	Additional spurious emissions	34
6.5.3.3.1	General	34
6.5.3.3.2	Requirement for network signalling value "NS_02N"	34
6.5.3.3.3	Requirement for network signalling value "NS_03N"	34
6.5.3.3.4	Requirement for network signalling value "NS_04N" and "NS_05N".....	35
6.5.4	Transmit intermodulation	35
7	Conducted receiver characteristics	36
7.1	General	36
7.2	Diversity characteristics	36
7.3	Reference sensitivity	36
7.3.1	General.....	36
7.3.2	Reference sensitivity power level	37
7.4	Maximum input level	38
7.5	Adjacent channel selectivity.....	38
7.6	Blocking characteristics	39
7.6.1	General.....	39
7.6.2	In-band blocking.....	39
7.6.3	Out-of-band blocking.....	40
7.6.4	Narrow band blocking	41
7.7	Spurious response.....	42
7.8	Intermodulation characteristics	42
7.9	Spurious emissions	43
8	Conducted performance requirements.....	43
8.1	General	43
8.1.1	Relationship between minimum requirements and test requirements.....	43
8.1.2	Applicability of minimum requirements.....	43
8.1.3	Conducted requirements	43
8.1.3.1	Introduction.....	43
8.1.3.2	Reference point	44
8.1.3.3	SNR definition	44
8.1.3.4	Noc.....	44
8.1.3.4.1	Introduction	44
8.1.3.4.2	Noc for NR operating bands in FR1	44
8.2	Demodulation performance requirements	45
8.2.1	General.....	45
8.2.1.1	Applicability of requirements.....	45
8.2.1.1.1	General	45

8.2.1.1.2	Applicability of requirements for optional UE features	45
8.2.1.2	PDSCH demodulation requirements	45
8.2.1.2.1	1RX requirements	48
8.2.1.2.2	2RX requirements	48
8.2.1.2.2.1.1	Minimum requirements for PDSCH Mapping Type A	48
8.3	CSI reporting requirements	50
9	Radiated transmitter characteristics	50
9.1	General	50
9.2	Transmitter power	50
9.2.1	NTN VSAT maximum output power	50
9.2.1.0	General	50
9.2.1.1	Minimum requirements for Fixed VSAT	50
9.2.1.2	Minimum requirements for Mobile VSAT	51
9.2.2	Off-axis EIRP emission density limit within the operating band	52
9.2.2.1	General	52
9.2.2.2	Minimum requirement for bands n510 and n511	52
9.2.2.3	Additional regional minimum requirement for band n512 (NS_201N)	53
9.2.2.3.1	Fixed VSAT	53
9.2.2.3.2	Mobile VSAT	54
9.2.2.3.3	Additional Off-axis EIRP density requirements for protection of fixed services	55
9.2.3	Configured transmitted power	55
9.3	Output power dynamics	55
9.3.1	Minimum output power	55
9.3.2	Transmit OFF power	55
9.3.2.1	General	55
9.3.3	Transmit ON/OFF time mask	56
9.3.3.1	General	56
9.3.3.2	General ON/OFF time mask	56
9.3.3.3	Transmit power time mask for slot and short or long subslot boundaries	56
9.3.3.4	PRACH time mask	57
9.3.3.5	Void	57
9.3.3.6	SRS time mask	57
9.3.3.7	PUSCH-PUCCH and PUSCH-SRS time masks	59
9.3.3.8	Transmit power time mask for consecutive slot or long subslot transmission and short subslot transmission boundaries	59
9.3.3.9	Transmit power time mask for consecutive short subslot transmissions boundaries	59
9.3.4	Power control	60
9.3.4.1	General	60
9.4	Transmitter signal quality	60
9.4.1	Frequency Error	60
9.4.2	Transmit modulation quality	61
9.4.2.1	General	61
9.4.2.2	Error vector magnitude	61
9.5	Output RF spectrum emissions	62
9.5.1	Occupied bandwidth	62
9.5.2	Out of Band Emissions	62
9.5.2.1	General	62
9.5.2.2	Spectrum emission mask	62
9.5.2.2.1	General NR spectrum emission mask	62
9.5.2.2.2	Additional spectrum emission mask	63
9.5.2.3	Adjacent channel leakage ratio	63
9.5.3	Spurious Emissions	64
9.5.3.1	General	64
9.5.3.2	On-axis spurious requirement	65
9.5.3.2.1	Applicability	65
9.5.3.2.2	“Emissions disabled” and “Carrier-off” states	65
9.5.3.2.3	“Carrier-on” state	65
9.5.3.3	Off-axis spurious requirement	66
9.5.3.3.1	Applicability	66
9.5.3.3.2	General	66
9.5.3.3.3	“Emissions disabled” state	66

9.5.3.3.4	“Carrier-on” and “Carrier-off” states.....	66
9.6	Antenna pointing accuracy and performance	67
9.6.1	Antenna pointing accuracy	67
9.6.1.1	Minimum requirements for NTN VSAT.....	67
9.6.1.1.1	Applicability.....	67
9.6.1.1.2	Pointing Accuracy	67
9.6.1.1.3	On-axis cross polarization isolation.....	67
9.6.1.2	Minimum requirement for Fixed VSAT types 1 or 2.....	67
9.6.1.2.1	Applicability.....	67
9.6.1.2.2	Pointing Stability	67
9.6.1.2.3	Pointing Accuracy	68
9.6.1.2.4	Polarization angle alignment capability for linear polarization	68
9.6.2	Antenna performance.....	68
9.7	Additional regional requirements indicated by NS	69
9.7.1	General.....	69
10	Radiated receiver characteristics	70
10.1	General	70
10.2	Polarization characteristics.....	70
10.3	OTA reference sensitivity level.....	70
10.3.1	General.....	70
10.3.2	Minimum requirement	70
10.4	Maximum input level	71
10.4.1	General.....	71
10.4.2	Minimum requirement for Mobile VSAT.....	71
10.4.3	Minimum requirement for Fixed VSAT	71
10.5	Adjacent channel selectivity.....	72
10.5.1	Minimum requirement for Mobile VSAT.....	72
10.5.2	Minimum requirement for Fixed VSAT	73
10.6	Blocking characteristics	74
10.6.1	General.....	74
10.6.2	Minimum requirement for Mobile VSAT.....	74
10.6.3	Minimum requirement for Fixed VSAT	75
10.7	Spurious emissions	76
10.8	Receiver antenna off-axis performance.....	76
11	Demodulation performance requirements (Radiated requirements)	77
11.1	General	77
11.1.2	Applicability of minimum requirements.....	77
11.1.3	Radiated requirements	77
11.1.3.1	Introduction.....	77
11.1.3.2	Reference point	77
11.1.3.3	SNR definition	77
11.1.3.4	Noc.....	78
11.1.3.4.1	Introduction	78
11.1.3.4.2	Noc for operating bands in FR2-NTN	78
11.2	Demodulation performance requirements	78
11.2.1	General.....	78
11.2.1.1	Applicability of requirements.....	78
11.2.1.1.1	General	78
11.2.1.1.2	Applicability of requirements for optional UE features	78
11.2.2	PDSCH demodulation requirements	79
11.2.2.1	1Rx requirements	82
11.2.2.1.1	FDD	82
11.2.3	PDCCH demodulation requirements	84
11.2.3.1	1RX requirements	87
11.2.3.1.1	Minimum requirements with 1Tx Antenna	87
Annex A (normative):	Measurement channels.....	89
A.1	General	89
A.1.1	Throughput definition.....	89

A.2	UL reference measurement channels	89
A.2.1	General	89
A.2.2	Reference measurement channels for FR1-NTN FDD.....	90
A.2.2.1	DFT-s-OFDM Pi/2-BPSK	90
A.2.2.2	DFT-s-OFDM QPSK.....	91
A.2.2.3	DFT-s-OFDM 16QAM.....	92
A.2.2.4	DFT-s-OFDM 64QAM.....	93
A.2.2.5	DFT-s-OFDM 256QAM.....	94
A.2.2.6	CP-OFDM QPSK	95
A.2.2.7	CP-OFDM 16QAM	96
A.2.2.8	CP-OFDM 64QAM	97
A.2.2.9	CP-OFDM 256QAM	98
A.2.3	Reference measurement channels for FR2-NTN FDD.....	98
A.2.3.1	DFT-s-OFDM Pi/2-BPSK	98
A.2.3.2	DFT-s-OFDM QPSK.....	99
A.2.3.3	DFT-s-OFDM 16QAM.....	99
A.2.3.4	DFT-s-OFDM 64QAM.....	100
A.2.3.5	CP-OFDM QPSK	100
A.2.3.6	CP-OFDM 16QAM	101
A.2.3.7	CP-OFDM 64QAM	101
A.3	DL reference measurement channels	102
A.3.1	General	102
A.3.2	Reference measurement channels for PDSCH performance requirements	102
A.3.2.1	FDD	103
A.3.2.1.1	Reference measurement channels for SCS 15 kHz FR1	103
A.3.2.1.2	Reference measurement channels for SCS 60 kHz FR2-NTN.....	105
A.3.2.1.3	Reference measurement channels for SCS 120 kHz FR2-NTN.....	107
A.3.3	Reference measurement channels for PDCCH performance requirements.....	113
A.3.3.1	FDD	113
A.3.3.1.1	Reference measurement channels for SCS 120 kHz FR2-NTN.....	113
A.4	Testing related to Satellite Access.....	113
A.4.1	General	113
A.4.2	Test condition for transmitter characteristics	113
A.4.3	Test condition for receiver characteristics.....	114
A.4.4	Test condition for performance requirements.....	114
A.5	OFDMA Channel Noise Generator (OCNG).....	114
A.5.1	OCNG Patterns for FDD	114
A.5.1.1	OCNG FDD pattern 1: Generic OCNG FDD Pattern for all unused REs.....	114
Annex B (normative): Propagation conditions.....		115
B.1	Static propagation condition.....	115
B.1.1	UE Receiver with 1Rx.....	115
B.1.2	UE Receiver with 2Rx.....	115
B.2.1	Delay profiles	115
B.2.2	Combinations of channel model parameters	116
B.2.3	MIMO Channel Correlation Matrices	116
B.2.3.1	MIMO Correlation Matrices using Uniform Linear Array (ULA)	116
B.2.3.1.1	Definition of MIMO Correlation Matrices.....	116
B.2.3.1.2	MIMO Correlation Matrices at High, Medium and Low Level	117
Annex C (normative): Downlink physical channels.....		119
C.1	General	119
C.2	Setup (Conducted).....	119
C.3	Connection (Conducted).....	119
C.3.1	Measurement of Performance requirements.....	119
C.4	Setup (Radiated).....	120

C.5	Connection (Radiated).....	120
C.5.1	Measurement of Receiver Characteristics	120
Annex D (informative):	Void	122
Annex E (normative):	Environmental conditions	123
E.1	General	123
E.2	Environmental (Conducted)	123
E.2.1	Temperature	123
E.2.2	Voltage	123
E.2.3	Vibration.....	124
Annex F (informative):	Antenna modelling for NTN VSAT.....	125
Annex G (informative):	Change history	126
History		128

Foreword

This Technical Specification has been produced by the 3rd Generation Partnership Project (3GPP).

The contents of the present document are subject to continuing work within the TSG and may change following formal TSG approval. Should the TSG modify the contents of the present document, it will be re-released by the TSG with an identifying change of release date and an increase in version number as follows:

Version x.y.z

where:

- x the first digit:
 - 1 presented to TSG for information;
 - 2 presented to TSG for approval;
 - 3 or greater indicates TSG approved document under change control.
- y the second digit is incremented for all changes of substance, i.e. technical enhancements, corrections, updates, etc.
- z the third digit is incremented when editorial only changes have been incorporated in the document.

In the present document, modal verbs have the following meanings:

- shall** indicates a mandatory requirement to do something
- shall not** indicates an interdiction (prohibition) to do something

The constructions "shall" and "shall not" are confined to the context of normative provisions, and do not appear in Technical Reports.

The constructions "must" and "must not" are not used as substitutes for "shall" and "shall not". Their use is avoided insofar as possible, and they are not used in a normative context except in a direct citation from an external, referenced, non-3GPP document, or so as to maintain continuity of style when extending or modifying the provisions of such a referenced document.

- should** indicates a recommendation to do something
- should not** indicates a recommendation not to do something
- may** indicates permission to do something
- need not** indicates permission not to do something

The construction "may not" is ambiguous and is not used in normative elements. The unambiguous constructions "might not" or "shall not" are used instead, depending upon the meaning intended.

- can** indicates that something is possible
- cannot** indicates that something is impossible

The constructions "can" and "cannot" are not substitutes for "may" and "need not".

- will** indicates that something is certain or expected to happen as a result of action taken by an agency the behaviour of which is outside the scope of the present document
- will not** indicates that something is certain or expected not to happen as a result of action taken by an agency the behaviour of which is outside the scope of the present document
- might** indicates a likelihood that something will happen as a result of action taken by some agency the behaviour of which is outside the scope of the present document

might not indicates a likelihood that something will not happen as a result of action taken by some agency the behaviour of which is outside the scope of the present document

In addition:

is (or any other verb in the indicative mood) indicates a statement of fact

is not (or any other negative verb in the indicative mood) indicates a statement of fact

The constructions "is" and "is not" do not indicate requirements.

1 Scope

The present document establishes the minimum RF and performance requirements for NR User Equipment (UE) supporting satellite access operation.

The Mobile VSAT communicating with non-GSO is not considered in this release.

2 References

The following documents contain provisions which, through reference in this text, constitute provisions of the present document.

- References are either specific (identified by date of publication, edition number, version number, etc.) or non-specific.
- For a specific reference, subsequent revisions do not apply.
- For a non-specific reference, the latest version applies. In the case of a reference to a 3GPP document (including a GSM document), a non-specific reference implicitly refers to the latest version of that document *in the same Release as the present document*.

- [1] 3GPP TR 21.905: "Vocabulary for 3GPP Specifications".
- [2] 3GPP TS 38.521-5: "NR; User Equipment (UE) conformance specification; Radio transmission and reception; Part 5: Satellite access Radio Frequency (RF) and performance requirements".
- [3] Recommendation ITU-R M.1545: "Measurement uncertainty as it applies to test limits for the terrestrial component of International Mobile Telecommunications-2000".
- [4] 3GPP TS 38.108: "NR; Satellite Node radio transmission and reception"
- [5] 3GPP TS 38.101-1: "NR; User Equipment (UE) radio transmission and reception; Part 1: Range 1 Standalone".
- [6] 3GPP TS 38.101-4: "NR; User Equipment (UE) radio transmission and reception; Part 4: Performance requirements".
- [7] 3GPP TS 38.213: "NR; Physical layer procedures for control"
- [8] 3GPP TS 38.331: "Radio Resource Control (RRC) protocol specification".
- [9] 3GPP TS 38.300: "NR; NR and NG-RAN Overall description; Stage-2".
- [10] 3GPP TS 36.101: "Evolved Universal Terrestrial Radio Access (E-UTRA); User Equipment (UE) radio transmission and reception".
- [11] 3GPP TS 38.306: "User Equipment (UE) radio access capabilities".
- [12] 3GPP TR 38.811: "Study on New Radio (NR) to support non-terrestrial networks".
- [13] 3GPP TS 38.508-1: "5GS; User Equipment (UE) conformance specification; Part 1: Common test environment".
- [14] 3GPP TS 38.214: "NR; Physical layer procedures for data".
- [15] 3GPP TS 38.101-2: "NR; User Equipment (UE) radio transmission and reception; Part 2: Range 2 Standalone".
- [16] Recommendation ITU-R SM.329-12, "Unwanted emissions in the spurious domain".

- [17] EN 303 978, Satellite Earth Stations and Systems (SES); Harmonised Standard for Earth Stations on Mobile Platforms (ESOMP) transmitting towards satellites in geostationary orbit, operating in the 27,5 GHz to 30,0 GHz frequency bands covering the essential requirements of article 3.2 of the Directive 2014/53/EU, v2.1.2, 2016-10.
- [18] EN 301 459, Satellite Earth Stations and Systems (SES); Harmonised Standard for Satellite Interactive Terminals (SIT) and Satellite User Terminals (SUT) transmitting towards satellites in geostationary orbit, operating in the 29,5 GHz to 30,0 GHz frequency bands covering the essential requirements of article 3.2 of the Directive 2014/53/EU, v2.1.1, 2016-05.
- [19] IEEE Std 149: "IEEE Standard Test Procedures for Antennas", IEEE.

3 Definitions of terms, symbols and abbreviations

3.1 Terms

For the purposes of the present document, the terms given in 3GPP TR 21.905 [1] and the following apply. A term defined in the present document takes precedence over the definition of the same term, if any, in 3GPP TR 21.905 [1].

"Carrier-off" state: radio state in which the NTN VSAT may transmit but does not transmit any carrier.

NOTE: "NTN VSAT may transmit" means that all the conditions for transmission are satisfied (e.g. in a state where transmissions are permitted, no failure detected, and the NTN VSAT is correctly pointed towards the satellite).

NOTE: The existence of a "Carrier-off" radio state depends on the system of transmission used. For NTN VSATs designed for continuous transmission mode there may be no "Carrier-off" state.

"Carrier-on" state: Radio state in which the NTN VSAT may transmit and transmits a carrier.

Co-polarized transmission: when the DUT transmission antenna polarization is aligned with test antenna polarization.

Cross-polarized transmission: when the DUT transmission antenna polarization is such with respect to the test antenna polarization that an incident wave from the DUT transmission antenna results in lowest available power at the test antenna.

"Emissions disabled" state: Radio state in which the Mobile VSAT is not emitting (e.g. before system monitoring pass, before the control channel is received, when a failure is detected, when a Mobile VSAT is commanded to disable, and when the Mobile VSAT is in a location requiring cessation of emissions).

Enhanced channel raster: channel raster with a 10 kHz granularity in bands with a 100 kHz channel raster.

Feeder link: A radio link from an earth station at a given location to a space station, or vice versa, conveying information for a space radiocommunication service other than for the fixed-satellite service. The given location may be at a specified fixed point, or at any fixed point within specified areas.

Fixed Satellite Service: A radiocommunication service between earth stations at given positions, when one or more satellites are used; the given position may be a specified fixed point or any fixed point within specified areas; in some cases this service includes satellite-to-satellite links, which may also be operated in the inter-satellite service; the fixed-satellite service may also include feeder links for other space radiocommunication services.

Fixed VSAT: VSAT used in FSS system at given position; the given position may be a specified fixed point or any fixed point within specified areas.

NOTE: Mobile VSAT is excluded from this definition.

Geostationary satellite: A geosynchronous satellite whose circular and direct orbit lies in the plane of the Earth's equator and which thus remains fixed relative to the Earth; by extension, a geosynchronous satellite which remains approximately fixed relative to the Earth.

Geostationary-Satellite Orbit: The orbit of a geosynchronous satellite whose circular and direct orbit lies in the plane of the Earth's equator.

Geosynchronous Earth Orbit: Earth-centered orbit at approximately 35786 kilometres above Earth's surface and synchronised with Earth's rotation. A geostationary orbit is a non-inclined geosynchronous orbit, i.e. in the Earth's equator plane.

Geosynchronous satellite: An earth satellite whose period of revolution is equal to the period of rotation of the Earth about its axis.

Low Earth Orbit: Orbit around the Earth with an altitude between 300 km, and 1500 km.

Mobile VSAT: VSAT on moving platform, and which can be further declined in three types: airborne, maritime or land based.

NOTE: Mobile VSAT can be also referred to as ESIM or ESOMP.

Non-terrestrial networks: Networks, or segments of networks, using an airborne or space-borne vehicle to embark a transmission equipment relay node or SAN.

NTN VSAT: a UE operating in FR2-NTN which could be a Fixed VSAT or a Mobile VSAT.

Plane perpendicular to the GSO arc: The plane that is perpendicular to the “plane tangent to the GSO arc,” as defined below, and includes a line between the [earth station](#) in question and the GSO [space station](#) that it is communicating with (FCC 47 CFR 25.103).

Plane tangent to the GSO arc: The plane defined by the location of an [earth station](#)'s transmitting antenna and a line in the equatorial plane that is tangent to the GSO arc at the location of the GSO [space station](#) that the [earth station](#) is communicating with (FCC 47 CFR 25.103).

Satellite: A space-borne vehicle embarking a transparent payload, or a regenerative payload telecommunication transmitter, placed into Low-Earth Orbit (LEO), Medium-Earth Orbit (MEO), or Geostationary Earth Orbit (GEO).

Satellite Access Node: node providing NR user plane and control plane protocol terminations towards NTN satellite capable UE, and connected via the NG interface to the 5GC. It encompasses a transparent payload on board a NTN platform, with satellite-gateway and gNB functions.

UE transmission bandwidth configuration: Set of resource blocks located within the UE channel bandwidth which may be used for transmitting or receiving by the UE.

3.2 Symbols

For the purposes of the present document, the following symbols apply:

ΔF_{Global}	Granularity of the global frequency raster
ΔF_{Raster}	Band dependent channel raster granularity
BW_{Channel}	Channel bandwidth
$BW_{\text{interferer}}$	Bandwidth of the interferer
$F_{\text{DL_low}}$	The lowest frequency of the downlink <i>operating band</i>
$F_{\text{DL_high}}$	The highest frequency of the downlink <i>operating band</i>
$F_{\text{UL_low}}$	The lowest frequency of the uplink <i>operating band</i>
$F_{\text{UL_high}}$	The highest frequency of the uplink <i>operating band</i>
$F_{\text{Interferer}}$	Frequency of the interferer
$F_{\text{Interferer}}(\text{offset})$	Frequency offset of the interferer (between the center frequency of the interferer and the carrier frequency of the carrier measured)
F_{offset}	Frequency offset of the interferer (between the center frequency of the interferer and the closest edge of the carrier measured)
F_{OOB}	The boundary between the NR out of band emission and spurious emission domains
F_{REF}	RF reference frequency
$F_{\text{REF-Offs}}$	Offset used for calculating F_{REF}
$F_{\text{uw}}(\text{offset})$	The frequency separation of the center frequency of the carrier closest to the interferer and the center frequency of the interferer
N_{RB}	Transmission bandwidth configuration, expressed in units of resource blocks
N_{REF}	NR Absolute Radio Frequency Channel Number (NR-ARFCN)

$N_{\text{REF-Offs}}$	Offset used for calculating N_{REF}
$P_{\text{Interferer}}$	Modulated mean power of the interferer
P_{UEType}	Minimum UE type peak EIPR (i.e. no tolerance) as specified in sub-clause 9.2.1
P_{uw}	Power of an unwanted DL signal
θ	Angle in degrees from a line from the earth station antenna to the assigned orbital location of the target satellite
TRP_{max}	The maximum TRP for the NTN VSAT as specified in sub-clause 9.2.1

3.3 Abbreviations

For the purposes of the present document, the abbreviations given in 3GPP TR 21.905 [1] and the following apply. An abbreviation defined in the present document takes precedence over the definition of the same abbreviation, if any, in 3GPP TR 21.905 [1].

ACLR	Adjacent Channel Leakage Ratio
ACS	Adjacent Channel Selectivity
A-MPR	Additional Maximum Power Reduction
BW	Bandwidth
BWP	Bandwidth Part
CP-OFDM	Cyclic Prefix-OFDM
CW	Continuous Wave
DFT-s-OFDM	Discrete Fourier Transform-spread-OFDM
DM-RS	Demodulation Reference Signal
DTX	Discontinuous Transmission
EIRP	Equivalent Isotropically Radiated Power
ESIM	Earth Station in Motion
ESOMP	Earth Stations on Mobile Platforms
EVM	Error Vector Magnitude
FR	Frequency Range
FRC	Fixed Reference Channel
FSS	Fixed Satellite Service
GEO	Geosynchronous Earth Orbit
GSCN	Global Synchronization Channel Number
GSO	Geostationary-Satellite Orbit
IBB	In-band Blocking
ITU-R	Radiocommunication Sector of the International Telecommunication Union
LEO	Low Earth Orbiting
MBW	Measurement bandwidth defined for the protected band
MOP	Maximum Output Power
MPR	Allowed maximum power reduction
MSD	Maximum Sensitivity Degradation
NGEO	Non-Geostationary Earth Orbiting
NGSO	Non-Geostationary-Satellite Orbit
NR	New Radio
NR-ARFCN	NR Absolute Radio Frequency Channel Number
NS	Network Signalling
NTN	Non-Terrestrial Network
OCNG	OFDMA Channel Noise Generator
OOB	Out-of-band
PRB	Physical Resource Block
QAM	Quadrature Amplitude Modulation
RAN	Radio Access Network
RE	Resource Element
REFSENS	REFerence SENSitivity
RF	Radio Frequency
RMS	Root Mean Square (value)
RSRP	Reference Signal Receive Power
RSRQ	Reference Signal Receive Quality
RX	Receiver
SAN	Satellite Access Node
SC	Single Carrier

SCS	Subcarrier spacing
SEM	Spectrum Emission Mask
SNR	Signal-to-Noise Ratio
SRS	Sounding Reference Symbol
SS	Synchronization Symbol
TN	Terrestrial Network
TX	Transmitter
TxD	Tx Diversity
UE	User Equipment
VSAT	Very Small Aperture Terminal

4 General

4.1 Relationship between minimum requirements and test requirements

The present document is a Single-RAT specification for satellite NR UE, covering RF characteristics and minimum performance requirements. Conformance to the present specification is demonstrated by fulfilling the test requirements specified in the conformance specification 3GPP TS 38.521-5 [2].

The Minimum Requirements given in this specification make no allowance for measurement uncertainty. The test specification 3GPP TS 38.521-5 [2] defines test tolerances. These test tolerances are individually calculated for each test. The test tolerances are used to relax the minimum requirements in this specification to create test requirements. For some requirements, including regulatory requirements, the test tolerance is set to zero.

The measurement results returned by the test system are compared - without any modification - against the test requirements as defined by the shared risk principle.

The shared risk principle is defined in Recommendation ITU-R M.1545 [3].

4.2 Applicability of minimum requirements

- In this specification the Minimum Requirements are specified as general requirements and additional requirements. Where the Requirement is specified as a general requirement, the requirement is mandated to be met in all scenarios
- For specific scenarios for which an additional requirement is specified, in addition to meeting the general requirement, the UE is mandated to meet the additional requirements.
- The spurious emissions power requirements are for the long-term average of the power. For the purpose of reducing measurement uncertainty, it is acceptable to average the measured power over a period of time sufficient to reduce the uncertainty due to the statistical nature of the signal.
- In table 4.2-1, the requirement applicability for the NR NTN bands in each NTN frequency range (as specified in Table 5.1-1) is defined. For each requirement, the applicable requirement clause in the specification is identified. Requirements not included in a requirement set is marked not applicable (NA).

Table 4.2-1: Requirement set applicability

Requirement	Requirement set	
	FR1-NTN bands	FR2-NTN bands
Conducted transmitter characteristics	Clause 6	NA
Conducted receiver characteristics	Clause 7	NA
Conducted performance requirements	Clause 8	NA
Radiated transmitter characteristics	NA	Clause 9
Radiated receiver characteristics	NA	Clause 10
Demodulation performance requirements (Radiated requirements)	NA	Clause 11

4.3 Specification suffix information

Specification suffix information is not defined for the time being in this release of specification.

4.4 Relationship with other core specifications

The present document establishes the minimum RF and performance requirements for NR User Equipment (UE) operating in a Non-Terrestrial Network. The present document for the single-RAT specification of a satellite NR UE side is used together with the technical specification 3GPP TS 38.108 [4] specifying the Satellite Access Node (SAN).

5 Operating bands and channel arrangement

5.1 General

The channel arrangements presented in this clause are based on the operating bands and channel bandwidths defined in the present Release of specifications.

NOTE: Other operating bands and channel bandwidths may be considered in future Releases.

Requirements throughout the RF specifications are in many cases defined separately for different frequency ranges (FR). The frequency ranges in which NTN satellite can operate according to this version of the specification are identified as described in Table 5.1-1.

Table 5.1-1: Definition of NTN frequency ranges

Frequency range designation	Corresponding frequency range
FR1-NTN (Note 1)	410 MHz – 7125 MHz
FR2-NTN (Note 2)	17300 MHz – 30000 MHz
NOTE 1: NTN bands within this frequency range are regarded as a FR1 band when references from other specifications.	
NOTE 2: NTN bands within this frequency range are regarded as a FR2 band when references from other specifications.	

5.2 Operating bands

5.2.1 General

NTN satellite covers FR1-NTN and FR2-NTN operating bands in the present specification.

5.2.2 Operating bands with conducted requirements

NTN satellite is designed to operate in the operating bands defined in Table 5.2.2-1.

Table 5.2.2-1: NTN satellite bands in FR1-NTN

NTN satellite operating band	Uplink (UL) operating band Satellite Access Node receive / UE transmit $F_{UL,low} - F_{UL,high}$	Downlink (DL) operating band Satellite Access Node transmit / UE receive $F_{DL,low} - F_{DL,high}$	Duplex mode
n256	1980 MHz – 2010 MHz	2170 MHz – 2200 MHz	FDD
n255	1626.5 MHz – 1660.5 MHz	1525 MHz – 1559 MHz	FDD
n254	1610 – 1626.5 MHz	2483.5 – 2500 MHz	FDD
NOTE: NTN satellite bands are numbered in descending order from n256.			

5.2.3 Operating bands with radiated requirements

NTN satellite is designed to operate in the operating bands defined in Table 5.2.3-1.

Table 5.2.3-1: Satellite operating bands in FR2-NTN

Satellite operating band	Uplink (UL) operating band SAN receive / UE transmit $F_{UL,low} - F_{UL,high}$	Downlink (DL) operating band SAN transmit / UE receive $F_{DL,low} - F_{DL,high}$	Duplex mode
n512(Note 1)	27500 MHz - 30000 MHz	17300 MHz - 20200 MHz	FDD
n511(Note 2)	28350 MHz - 30000 MHz	17300 MHz - 20200 MHz	FDD
n510(Note 3)	27500 MHz - 28350 MHz	17300 MHz - 20200 MHz	FDD

NOTE 1: This band is applicable in the countries subject to CEPT ECC Decision(05)01 and ECC Decision (13)01.
 NOTE 2: This band is applicable in the USA subject to FCC 47 CFR part 25.
 NOTE 3: This band is applicable for Earth Station operations in the USA subject to FCC 47 CFR part 25. FCC rules currently do not include ESIM operations in this band (47 CFR 25.202).

5.3 UE channel bandwidth

5.3.1 General

The UE channel bandwidth supports a single RF carrier in the uplink or downlink at the UE. From a SAN perspective, different UE channel bandwidths may be supported within the same spectrum for transmitting to and receiving from UEs connected to the SAN.

From a UE perspective, the UE is configured with one or more BWP / carriers, each with its own UE channel bandwidth. The UE does not need to be aware of the SAN channel bandwidth or how the SAN allocates bandwidth to different UEs.

The placement of the UE channel bandwidth for each UE carrier is flexible but can only be completely within the SAN channel bandwidth.

The relationship between the channel bandwidth, the guardband and the maximum transmission bandwidth configuration is shown in Figure 5.3.1-1.

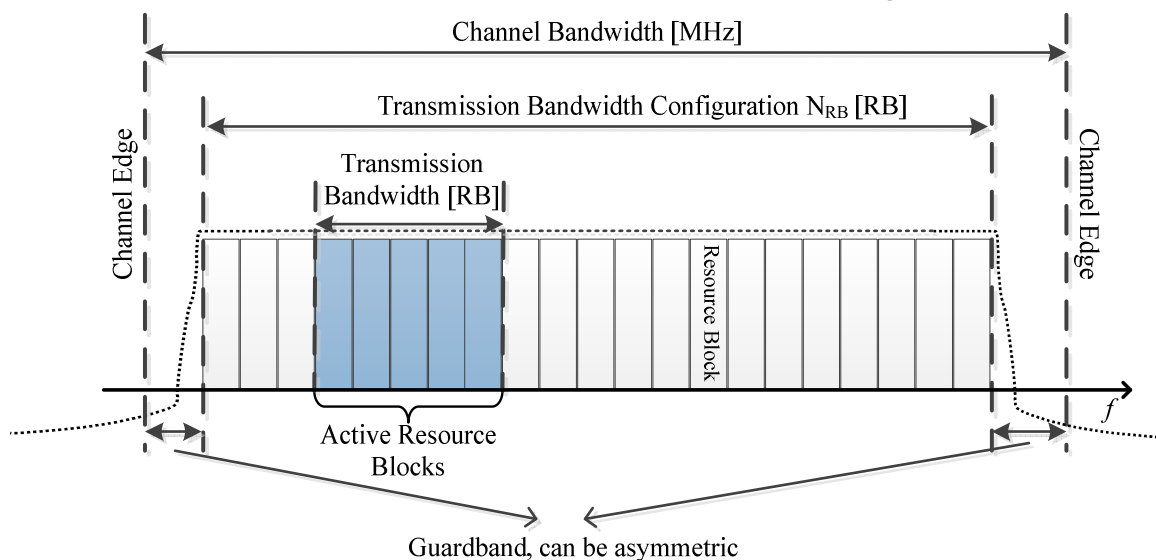

Figure 5.3.1-1: Definition of the channel bandwidth and the maximum transmission bandwidth configuration for one channel

5.3.2 Maximum transmission bandwidth configuration

The maximum transmission bandwidth configuration N_{RB} for each UE channel bandwidth and subcarrier spacing is specified in Table 5.3.2-1 for FR1-NTN and table 5.3.2-2 for FR2-NTN.

Table 5.3.2-1: Maximum transmission bandwidth configuration N_{RB} for FR1-NTN

SCS (kHz)	5 MHz	10 MHz	15 MHz	20 MHz	30 MHz
	N_{RB}	N_{RB}	N_{RB}	N_{RB}	N_{RB}
15	25	52	79	106	160
30	11	24	38	51	78
60	N/A	11	18	24	38

Table 5.3.2-2: Maximum transmission bandwidth configuration N_{RB} for FR2-NTN

SCS (kHz)	50 MHz	100 MHz	200 MHz	400 MHz
	N_{RB}	N_{RB}	N_{RB}	N_{RB}
60	66	132	264	N/A
120	32	66	132	264

5.3.3 Minimum guardband and transmission bandwidth configuration

The minimum guardband for each UE channel bandwidth and SCS is specified in Table 5.3.3-1 for FR1-NTN and in table 5.3.3-2 for FR2-NTN.

Table 5.3.3-1: Minimum guardband for each UE channel bandwidth and SCS (kHz) for FR1-NTN

SCS (kHz)	5 MHz	10 MHz	15 MHz	20 MHz	30 MHz
15	242.5	312.5	382.5	452.5	592.5
30	505	665	645	805	945
60	N/A	1010	990	1330	1290

Table 5.3.3-2: Minimum guardband for each UE channel bandwidth and SCS (kHz) for FR2-NTN

SCS (kHz)	50 MHz	100 MHz	200 MHz	400 MHz
60	1210	2450	4930	N/A
120	1900	2420	4900	9860

NOTE: The minimum guardbands have been calculated using the following equation: $(BW_{\text{Channel}} \times 1000 \text{ (kHz)} - N_{RB} \times SCS \times 12) / 2 - SCS/2$, where N_{RB} are from Table 5.3.2-1 and Table 5.3.2-2.

Figure 5.3.3-1: Void

The number of RBs configured in any channel bandwidth shall ensure that the minimum guardband specified in this clause is met.

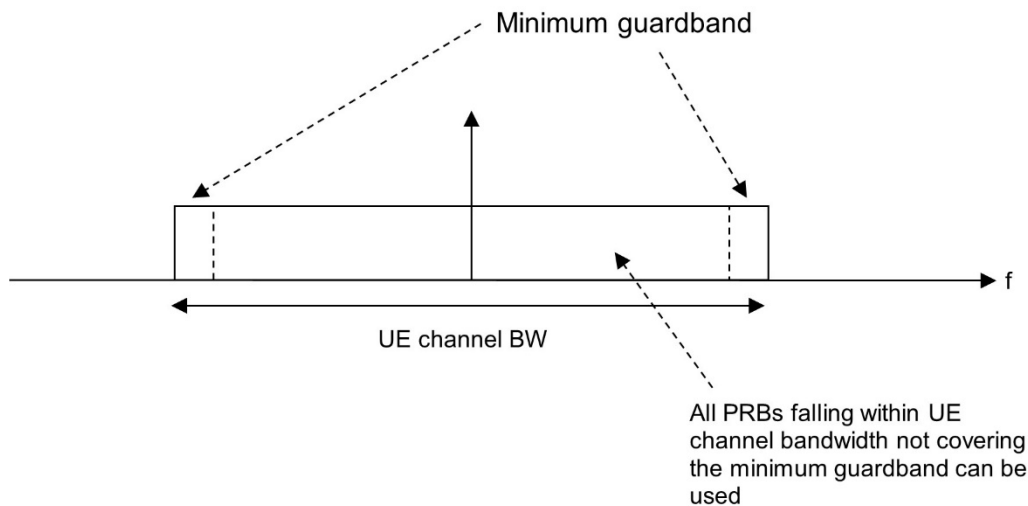

Figure 5.3.3-2: UE PRB utilization

In the case that multiple numerologies are multiplexed in the same symbol, the minimum guard band on each side of the carrier is the guard band applied at the configured UE channel bandwidth for the numerology that is transmitted/received immediately adjacent to the guard band.

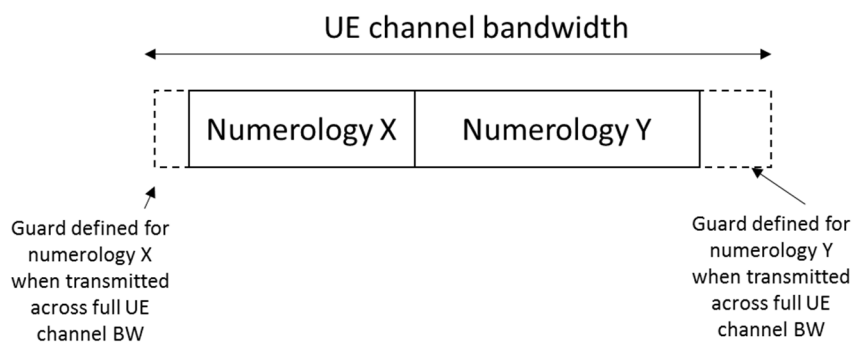

Figure 5.3.3-3: Guard band definition when transmitting multiple numerologies

NOTE: Figure 5.3.3-2 is not intended to imply the size of any guard between the two numerologies. Inter-numerology guard band within the carrier is implementation dependent.

5.3.4 RB alignment

The RB alignment for FR1-NTN refers to NR RB alignments as specified in 3GPP TS 38.101-1 [5] clause 5.3.4.

The RB alignment for FR2-NTN refers to NR RB alignments as specified in 3GPP TS 38.101-2 [15] clause 5.3.4.

5.3.5 UE channel bandwidth per operating band

The requirements in this specification apply to the combination of channel bandwidths, SCS and operating bands shown in Table 5.3.5-1 for FR1-NTN and table 5.3.5-2 for FR2-NTN. The transmission bandwidth configuration in Table 5.3.2-1 and Table 5.3.2-2 shall be supported for each of the specified channel bandwidths. The channel bandwidths are specified for both the Tx and Rx path.

Table 5.3.5-1: Channel bandwidths for each NTN satellite band in FR1-NTN

NTN satellite band	SCS kHz	UE Channel bandwidth (MHz)				
		5	10	15	20	30 (NOTE)
n256	15	5	10	15	20	
	30		10	15	20	
	60		10	15	20	
n255	15	5	10	15	20	
	30		10	15	20	
	60		10	15	20	
n254	15	5	10	15		
	30		10	15		
	60		10	15		

NOTE: Deployment of 30 MHz channel bandwidth for NTN SAN needs to be preceded by introduction of all applicable Tx RF, Rx RF, and demodulation requirements.

Table 5.3.5-2: Channel bandwidths for each NTN satellite band in FR2-NTN

SAN Operating Band	SCS (kHz)	SAN channel bandwidth (MHz)			
		50	100	200	400
n512	60	50	100	200	
	120	50	100	200	400
n511	60	50	100	200	
	120	50	100	200	400
n510	60	50	100	200	
	120	50	100	200	400

5.3.6 Asymmetric channel bandwidths

The UE channel bandwidth can be asymmetric in downlink and uplink. In asymmetric channel bandwidth operation, the narrower carrier shall be confined within the frequency range of the wider channel bandwidth.

In FDD, the confinement is defined as a maximum deviation to the Tx-Rx carrier center frequency separation (defined in table 5.4.4-1) as following:

$$\Delta F_{\text{TX-RX}} = |(BW_{\text{DL}} - BW_{\text{UL}})/2|$$

The operating bands and supported asymmetric channel bandwidth combinations are defined in table 5.3.6-1.

Table 5.3.6-1: FDD asymmetric UL and DL channel bandwidth combinations

NR Band	Channel bandwidths for UL (MHz)	Channel bandwidths for DL (MHz)	Asymmetric channel bandwidth combination set
n254	5	10,15	0
	10	15	0

NOTE 1: The assignment of the paired UL and DL channels are subject to a TX-RX separation as specified in clause 5.4.4.
NOTE 2: As indicated in TS38.306 [11], it is mandatory for UEs to support asymmetric channel BCS0 if there is an asymmetric BCS0 defined for the band.

5.4 Channel arrangement

5.4.1 Channel spacing

5.4.1.1 Channel spacing for adjacent NTN satellite carriers

The channel spacing for adjacent NTN satellite carriers in FR1-NTN refers to the NR channel spacing as specified in 3GPP TS 38.101-1 [5] clause 5.4.1.1.

The channel spacing for adjacent NTN satellite carriers in FR2-NTN refers to the NR channel spacing as specified in 3GPP TS 38.101-2 [15] clause 5.4.1.1.

5.4.2 Channel raster

5.4.2.1 NR-ARFCN and channel raster

The global frequency channel raster defines a set of RF reference frequencies F_{REF} . The RF reference frequency is used in signalling to identify the position of RF channels, SS blocks and other elements.

The global frequency raster is defined for all frequencies from 0 to 100 GHz. The granularity of the global frequency raster is ΔF_{Global} .

RF reference frequencies are designated by an NR Absolute Radio Frequency Channel Number (NR-ARFCN) in the range (0...2016666) on the global frequency raster. The relation between the NR-ARFCN and the RF reference frequency F_{REF} in MHz is given by the following equation, where $F_{\text{REF-Offs}}$ and $N_{\text{REF-Offs}}$ are given in Table 5.4.2.1-1 and N_{REF} is the NR-ARFCN.

$$F_{\text{REF}} = F_{\text{REF-Offs}} + \Delta F_{\text{Global}} (N_{\text{REF}} - N_{\text{REF-Offs}})$$

Table 5.4.2.1-1: NR-ARFCN parameters for the global frequency raster

Frequency range (MHz)	ΔF_{Global} (kHz)	$F_{\text{REF-Offs}}$ (MHz)	$N_{\text{REF-Offs}}$	Range of N_{REF}
0 – 3000	5	0	0	0 – 599999
3000 – 24250	15	3000	600000	600000 – 2016666
24250 – 30000	60	24250.08	2016667	2016667 – 2112499

The channel raster defines a subset of RF reference frequencies that can be used to identify the RF channel position in the uplink and downlink. The RF reference frequency for an RF channel maps to a resource element on the carrier. For each operating band, a subset of frequencies from the global frequency raster are applicable for that band and forms a channel raster with a granularity ΔF_{Raster} , which may be equal to or larger than ΔF_{Global} .

For the uplink of FDD FR1 NTN bands defined in Table 5.2.2-1.

$$F_{\text{REF, shift}} = F_{\text{REF}} + \Delta_{\text{shift}}, \Delta_{\text{shift}} = 0 \text{ kHz or } 7.5 \text{ kHz.}$$

where Δ_{shift} is signalled by the network in higher layer parameter *frequencyShift7p5khz* [7].

The mapping between the channel raster and corresponding resource element is given in clause 5.4.2.2. The applicable entries for each operating band are defined in clause 5.4.2.3.

5.4.2.2 Channel raster to resource element mapping

The mapping between the RF reference frequency on the channel raster and the corresponding resource element for FR1-NTN refers to the NR requirements specified in 3GPP TS 38.101-1 [5] clause 5.4.2.2.

The mapping between the RF reference frequency on the channel raster and the corresponding resource element for FR2-NTN refers to the NR requirements specified in 3GPP TS 38.101-2 [15] clause 5.4.2.2.

5.4.2.3 Channel raster entries for each operating band

The RF channel positions on the channel raster in each NTN satellite operating band are given through the applicable NR-ARFCN in Table 5.4.2.3-1 and Table 5.4.2.3-2 for FR1-NTN, and in Table 5.4.2.3-3 for FR2-NTN, using the channel raster to resource element mapping in clause 5.4.2.2.

For NTN satellite operating bands with 100 kHz channel raster, $\Delta F_{\text{Raster}} = 20 \times \Delta F_{\text{Global}}$. In this case every 20th NR-ARFCN within the operating band are applicable for the channel raster within the operating band and the step size for the channel raster in Table 5.4.2.3-1 is given as <20> for FR1-NTN.

Table 5.4.2.3-1: Applicable NR-ARFCN per operating band in FR1-NTN

NTN satellite operating band	ΔF_{Raster} (kHz)	Uplink Range of N_{REF} (First – <Step size> – Last)	Downlink Range of N_{REF} (First – <Step size> – Last)
n256	100	396000 – <20> – 402000	434000 – <20> – 440000
n255	100	325300 – <20> – 332100	305000 – <20> – 311800
n254	100	322000 – <20> – 325300	496700 – <20> – 500000
NOTE : The channel numbers that designate carrier frequencies so close to the operating band edges that the carrier extends beyond the operating band edge shall not be used.			

For NTN operating bands with 100 kHz channel raster, Enhanced channel raster is defined with $\Delta F_{\text{Raster}} = 2 \times \Delta F_{\text{Global}}$. In this case every 2th NR-ARFCN within the operating band are applicable for the channel raster within the operating band and the step size for the channel raster in Table 5.4.2.3-2 is given as <2>.

Table 5.4.2.3-2: Applicable NR-ARFCN per operating band in FR1-NTN

NTN satellite operating band	ΔF_{Raster} (kHz)	Uplink Range of N_{REF} (First – <Step size> – Last)	Downlink Range of N_{REF} (First – <Step size> – Last)	Mandatory support
n256	10	396000 – <2> – 402000	434000 – <2> – 440000	Yes
n255	10	325300 – <2> – 332100	305000 – <2> – 311800	Yes
n254	10	322000 – <2> – 325300	496700 – <2> – 500000	Yes
NOTE: The channel numbers that designate carrier frequencies so close to the operating band edges that the carrier extends beyond the operating band edge shall not be used. These channel numbers shall also be such that the minimum guard band for each channel bandwidth and SCS specified in Table 5.3.3-1 are met for carriers located at the upper or lower edge of an operating band.				

For FR2-NTN satellite operating bands, $\Delta F_{\text{Raster}} = I_1 \times \Delta F_{\text{Global}}$ for UL channel and $\Delta F_{\text{Raster}} = I_2 \times \Delta F_{\text{Global}}$ for DL channel, where $(I_1, I_2) \in \{(1,4) \text{ or } (2, 8)\}$. But $(I_1, I_2) = (2, 8)$ only applies under the condition that 120kHz SCS is configured in the channel and SSB SCS is equal to or larger than 120kHz. In this case, every I_1^{th} NR-ARFCN for UL channel and I_2^{th} NR-ARFCN for DL channel are applicable for the UL and DL channel raster correspondingly within the operating band and the <(UL_step size, DL_step size)> for the UL and DL channel raster in Table 5.4.2.3-3 is given as <(I₁, I₂)> for FR2-NTN.

Table 5.4.2.3-3: Applicable NR-ARFCN per operating band in FR2-NTN

SAN operating band	ΔF_{Raster} (kHz)	Uplink range of N_{REF} (First – <Step size> – Last)	Downlink range of N_{REF} (First – <Step size> – Last)
n512	60	2070833 – <1> – 2112499	1553336 – <4> – 1746664
	120	2070833 – <2> – 2112499	1553336 – <8> – 1746664
n511	60	2084999 – <1> – 2112499	1553336 – <4> – 1746664
	120	2084999 – <2> – 2112499	1553336 – <8> – 1746664
n510	60	2070833 – <1> – 2084999	1553336 – <4> – 1746664
	120	2070833 – <2> – 2084999	1553336 – <8> – 1746664

5.4.3 Synchronization raster

5.4.3.1 Synchronization raster and numbering

The synchronization raster indicates the frequency positions of the synchronization block that can be used by the UE for system acquisition when explicit signalling of the synchronization block position is not present.

A global synchronization raster is defined for all frequencies. The frequency position of the SS block is defined as SS_{REF} with corresponding number GSCN. The parameters defining the SS_{REF} and GSCN for all the frequency ranges are in Table 5.4.3.1-1.

The resource element corresponding to the SS block reference frequency SS_{REF} is given in clause 5.4.3.2. The synchronization raster and the subcarrier spacing of the synchronization block is defined separately for each band.

The synchronization raster and the corresponding SS block do not cover all possible RF channel bandwidth and locations on Enhanced channel raster.

Table 5.4.3.1-1: GSCN parameters for the global frequency raster

Frequency range	SS Block frequency position SS_{REF}	GSCN	Range of GSCN
0 – 3000 MHz	$N * 1200\text{kHz} + M * 50\text{ kHz}$, $N=1:2499, M \in \{1,3,5\}^1$	$3N + (M-3)/2$	2 – 7498
3000 – 24250	$3000\text{ MHz} + N * 1.44\text{ MHz}$, $N = 0:14756$	$7499 + N$	7499 – 22255

NOTE: The default value for operating bands with which only support SCS spaced channel raster(s) is $M=3$.

5.4.3.2 Synchronization raster to synchronization block resource element mapping

The mapping between the synchronization raster and the corresponding resource element of the SS block in FR1-NTN refers to 3GPP TS 38.101-1 [5] clause 5.4.3.2.

The mapping between the synchronization raster and the corresponding resource element of the SS block in FR2-NTN refers to 3GPP TS 38.101-2 [15] clause 5.4.3.2.

5.4.3.3 Synchronization raster entries for each operating band

The synchronization raster for each band is give in Table 5.4.3.3-1 and Table 5.4.3.3-2. The distance between applicable GSCN entries is given by the <Step size> indicated in Table 5.4.3.3-1 for FR1-NTN and Table 5.4.3.3-2 for FR2-NTN.

Table 5.4.3.3-1: Applicable SS raster entries per operating band (FR1-NTN)

NTN satellite operating band	SS Block SCS	SS Block pattern ¹	Range of GSCN (First – <Step size> – Last)
n256	15 kHz	Case A	5429 – <1> – 5494
n255	15 kHz	Case A	3818 – <1> – 3892
	30 kHz	Case B	3824 – <1> – 3886
n254	15 kHz	Case A	6215 – <1> – 6244
	30 kHz	Case C	6218 – <1> – 6241

NOTE : SS Block pattern is defined in clause 4.1 in 3GPP TS 38.213 [7].

Table 5.4.3.3-2: Applicable SS raster entries per operating band (FR2-NTN)

SAN operating band	SS Block SCS	SS Block pattern (NOTE)	Range of GSCN (First – <Step size> – Last)
n512	120 kHz	Case D	17448 – <12> – 19428
	240 kHz	Case E	17472 – <24> – 19416
n511	120 kHz	Case D	17448 – <12> – 19428
	240 kHz	Case E	17472 – <24> – 19416
n510	120 kHz	Case D	17448 – <12> – 19428
	240 kHz	Case E	17472 – <24> – 19416

NOTE: SS Block pattern is defined in section 4.1 in TS 38.213 [7].

5.4.4 TX–RX frequency separation

The default TX channel (carrier centre frequency) to RX channel (carrier centre frequency) separation for operating bands is specified in Table 5.4.4-1 for FR1-NTN.

Table 5.4.4-1: UE TX-RX frequency separation (FR1-NTN)

NTN Satellite Operating Band	TX – RX carrier centre frequency separation
n256	190 MHz ¹ 165 to 215 MHz ²
n255	-101.5 MHz ¹ -72.5 to -130.5 MHz ²
n254	862 – 885 MHz

NOTE 1: Default Tx-Rx separation
NOTE 2: The verification of flexible Tx-Rx frequency separation within this range is limited to reference sensitivity. Further details are specified in clause 7.3.2

6 Conducted transmitter characteristics

6.1 General

Unless otherwise stated, the transmitter characteristics for satellite access UEs are specified at the antenna connector of the UE with a single or multiple transmit antenna(s). For UE with integral antenna only, a reference antenna with a gain of 0 dBi is assumed. Handheld power class 3 UE is assumed in Release 17 for satellite access.

All requirements in this section are applicable to devices supporting GSO and/or NGSO satellites.

6.2 Transmitter power

6.2.1 UE maximum output power

The following UE Power Classes define the maximum output power for any transmission bandwidth within the channel bandwidth of NR carrier unless otherwise stated. The period of measurement shall be at least one sub frame (1ms).

Table 6.2.1-1: UE Power Class

NR satellite band	Class 3 (dBm)	Tolerance (dB)
n256	23	±2
n255	23	±2
n254	23	±2
NOTE 1: $P_{\text{PowerClass}}$ is the maximum UE power specified without taking into account the tolerance		
NOTE 2: Power class 3 is default power class unless otherwise stated		

The UE shall meet the following additional requirements for maximum mean transmission power density specified in Table 6.2.1-2 when NS is signaled and when the configured channel overlaps with any portion of the specified frequency range.

Table 6.2.1-2: Additional requirements for transmit power density

NR Band	NS value	Channel bandwidth (MHz)	Frequency range (MHz)	Maximum power density
n254	NS_04N	5	1610 - 1618.25	27dBm/4kHz (mean) 15dBm/4kHz (peak limit)
	NS_05N	5	1618.25 - 1626.5	
		10, 15	1610 – 1626.5	

6.2.2 UE maximum output power reduction

UE is allowed to reduce the maximum output power due to higher order modulations and transmit bandwidth configurations. For UE power class 3, the allowed maximum power reduction (MPR) is defined as Table 6.2.2-1 in 3GPP TS 38.101-1[5] clause 6.2.2.

6.2.3 UE additional maximum output power reduction

6.2.3.1 General

Additional emission requirements can be signalled by the network. Each additional emission requirement is associated with a unique network signalling (NS) value indicated in RRC signalling by an NR frequency band number of the applicable operating band and an associated value in the field *additionalSpectrumEmission*. Throughout this specification, the notion of indication or signalling of an NS value refers to the corresponding indication of an NR satellite band number of the applicable operating band, the IE field *freqBandIndicatorNR* and an associated value of *additionalSpectrumEmission* in the relevant RRC information elements [8].

To meet the additional requirements, additional maximum power reduction (A-MPR) is allowed for the maximum output power as specified in Table 6.2.1-1. Unless stated otherwise, the total reduction to UE maximum output power is $\max(\text{MPR}, \text{A-MPR})$ where MPR is defined in clause 6.2.2. Outer and inner allocation notation used in clause 6.2.3 is defined in 3GPP TS 38.101-1 [5] clause 6.2.2. In absence of modulation and waveform types the A-MPR applies to all modulation and waveform types.

Table 6.2.3.1-1 specifies the additional requirements with their associated network signalling values and the allowed A-MPR and applicable operating band(s) for each NS value. The mapping of NR satellite band numbers and values of the *additionalSpectrumEmission* to network signalling labels is specified in Table 6.2.3.1-1A.

Table 6.2.3.1-1: Additional maximum power reduction (A-MPR)

Network signalling label	Requirements (clause)	NR satellite Band	Channel bandwidth (MHz)	Resources blocks (N_{RB})	A-MPR (dB)
NS_01		Table 5.2.2-1 (NOTE 3)	5, 10, 15, 20	Table 5.3.2-1	N/A
NS_24	6.5.3.3.13 in 3GPP TS 38.101-1 [5]	n256	5, 10, 15, 20	Table 6.2.3.15-1 in 3GPP TS 38.101-1 [5]	Clause 6.2.3.15 in 3GPP TS 38.101-1 [5] ²
NS_02N	6.5.3.3.2	n255	5, 10, 15, 20		N/A
NS_100	6.5.2.4.2 in 3GPP TS 38.101-1 [5]	n256 ¹			Table 6.2.3.1-2 in 3GPP TS 38.101-1 [5]
NS_03N	6.5.3.3.3	n254	5, 10, 15		Clause 6.2.3.2
NS_04N	6.5.3.3.4	n254	5		Clause 6.2.3.3
NS_05N	6.5.3.3.4	n254	5, 10, 15		Clause 6.2.3.4

NOTE 1: This NS can be signalled for NR satellite bands that have UTRA services deployed.
 NOTE 2: A-MPR for the upper 5 MHz of the band is not specified, and therefore shall be used as a guard band.
 NOTE 3: The NS_01 label with the field *additionalPmax* [8] absent is default for all NR satellite bands.

Table 6.2.3.1-1A: Mapping of network signalling label

NR satellite band	Value of <i>additionalSpectrumEmission</i>							
	0	1	2	3	4	5	6	7
n256	NS_01	NS_24	NS_100					
n255	NS_01	NS_02N						
n254	NS_01	NS_03N	NS_04N	NS_05N				

NOTE: *additionalSpectrumEmission* corresponds to an information element of the same name defined in clause 6.3.2 of 3GPP TS 38.331 [8].

6.2.3.2 A-MPR for NS_03N

Table 6.2.3.2-1: A-MPR regions for NS_03N

Channel BW	Carrier Center Frequency	RB_start*12*SCS (MHz)	LCRB*12*SCS (MHz)	A-MPR	
5MHz	1612.5 <= fc < 1613.9	<= 0.36	<= 0.36	A1	
			>= 2.88	A2	
10MHz	1613.9 <= fc < 1615.7		>= 3.24	A3	
		1615 <= fc < 1620.1	<= 1.8	<= 5.04	A4
			<= 1.8	> 5.04	A5
			> 7.2	> 0	A6
			> 1.8	>= 2.88	A2
		1620.1 <= fc < 1621.5		<= 6.48	A6
15MHz	all		<= 0.36	A1	
			>= 7.2	A1	
			<= 5.04	A4	
			> 5.04	A5	
		> 10.44		A6	
		> 3.6	>= 4.32	A2	

Table 6.2.3.2-2: A-MPR for NS_03N

	Modulation	A1	A2	A3	A4	A5	A6
DFT-s-OFDM	Pi/2 BPSK	2.5	3.0	1.0	4.0	6.5	1.5
	QPSK	2.5	4.0	2.5	6.0	7.0	2.0
	16QAM	3.0	4.5	3.0	6.5	7.5	2.5
	64QAM	3.5	5	3.5	7	8	3
	256QAM	4.5	6	4.5	8	9	4
CP-OFDM	QPSK	3.5	6.0	4.0	8.0	10.0	4.0
	16QAM	3.5	6.0	4.0	8.0	10.0	4.0
	64QAM	3.5	6.0	4.0	8.0	10.0	4.0
	256QAM	3.5	6.0	4.0	8.0	10.0	4.0

6.2.3.3 A-MPR for NS_04N

Table 6.2.3.3-1: A-MPR regions for NS_04N

Channel BW	Carrier Center Frequency	RB_start*12*SCS (MHz)	LCRB*12*SCS (MHz)	A-MPR
5MHz	1612.5 <= fc < 1613.9	<= 0.36	<= 0.36	A1
			>= 2.88	A2
	1613.9 <= fc < 1615.7		>= 3.24	A3

Table 6.2.3.3-2: A-MPR for NS_04N

	Modulation	A1	A2	A3
DFT-s-OFDM	Pi/2 BPSK	2.5	3.0	1.0
	QPSK	2.5	4.0	2.5
	16QAM	3.0	4.5	3.0
	64QAM	3.5	5	3.5
	256QAM	4.5	6	4.5
CP-OFDM	QPSK	3.5	6.0	4.0
	16QAM	3.5	6.0	4.0
	64QAM	3.5	6.0	4.0
	256QAM	3.5	6.0	4.0

6.2.3.4 A-MPR for NS_05N

Table 6.2.3.4-1: A-MPR regions for NS_05N

Channel BW	Carrier Center Frequency	RB_start*12*SCS (MHz)	LCRB*12*SCS (MHz)	A-MPR
5MHz	1622.4 < fc <= 1624	>= 3.6	> 0	A3
			>= 2.88	A1
			> 5.04	A4
10MHz	1615 <= fc < 1620.1	<= 1.8	<= 5.04	A4
		<= 1.8	> 5.04	A5
		> 7.2	> 0	A6
		> 1.8	>= 2.88	A2
	1620.1 <= fc <= 1621.5		<= 7.2	A6
		<= 0.36	<= 0.36	A1
15MHz	all	> 7.2	> 0	A6
		<= 3.6	<= 5.04	A4
		<= 3.6	> 5.04	A5
		> 10.44		A6
		> 3.6	>= 4.32	A2

Table 6.2.3.4-2: A-MPR for NS_05N

	Modulation	A1	A2	A3	A4	A5	A6
DFT-s-OFDM	Pi/2 BPSK	1.5	5.0	1.5	6.5	6.5	2.0
	QPSK	1.5	5.0	1.5	6.5	7.0	2.5
	16QAM	2.0	5.5	2.0	7.0	7.5	3.0
	64QAM	2.5	6	2.5	7.5	8	3.5
	256QAM	3.5	7	3.5	8.5	9	4.5
CP-OFDM	QPSK	3.0	6.5		8.0	10.0	4.5
	16QAM	3.0	6.5		8.0	10.0	4.5
	64QAM	3.0	6.5		8.0	10.0	4.5
	256QAM	3.0	6.5		8.0	10.0	4.5

6.2.4 Configured transmitted power

The requirements for configured transmitted power defined in subclause 6.2.4 of 3GPP TS 38.101-1 [5] clause 6.2.4 shall apply to NTN satellite UE.

6.3 Output power dynamics.

6.3.1 Minimum output power

The minimum controlled output power of the UE is defined as the power in the channel bandwidth for all transmit bandwidth configurations (resource blocks), when the power is set to a minimum value.

The minimum output power is defined as the mean power in at least one sub-frame (1 ms). The minimum output power shall not exceed the values specified in Table 6.3.1-1.

Table 6.3.1-1: Minimum output power

Channel bandwidth (MHz)	Minimum output power (dBm)	Measurement bandwidth (MHz)
5	-40	4.515
10	-40	9.375
15	-40	14.235
20	-40	19.095

6.3.2 Transmit OFF power

Transmit OFF power is defined as the mean power in the channel bandwidth when the transmitter is OFF. The transmitter is considered OFF when the UE is not allowed to transmit on any of its ports.

The transmit OFF power is defined as the mean power in a duration of at least one sub-frame (1 ms) excluding any transient periods. The transmit OFF power shall not exceed the values specified in Table 6.3.2-1.

Table 6.3.2-1: Transmit OFF power

Channel bandwidth	(MHz)	5, 10, 15, 20
REF_SCS	(kHz)	15
Transmit OFF power	(dBm)	-50
Measurement bandwidth	(MHz)	$MBW=REF_SCS*(12*N_{RB}+1)/1000$

6.3.3 Transmit ON/OFF time mask

The requirements for transmit ON/OFF time mask defined in 3GPP TS 38.101-1 [5] clause 6.3.3 shall apply for NTN satellite UE.

6.3.4 Power control

The requirements for Power control defined in 3GPP TS 38.101-1 [5] clause 6.3.4 shall apply for NTN satellite UE.

6.4 Transmit signal quality

6.4.1 Frequency error

The NTN satellite UE basic measurement interval of modulated carrier frequency is 1 UL slot. The NTN satellite UE pre-compensates the uplink modulated carrier frequency by the estimated Doppler shift according to 3GPP TS 38.300 [9] clause 16.14.2. The mean value of basic measurements of NTN UE modulated carrier frequency shall be accurate to within ± 0.1 PPM observed over a period of 1 ms of cumulated measurement intervals compared to ideally pre-compensated reference uplink carrier frequency.

[NOTE: The ideally pre-compensated reference uplink carrier frequency consists of the UL carrier frequency signalled to the UE by SAN and UL pre-compensated Doppler frequency shift.]

6.4.2 Transmit modulation quality

6.4.2.1 General

The requirements for transmit modulation quality defined in 3GPP TS 38.101-1 [5] clause 6.4.2 shall apply for NTN satellite UE except for clause 6.4.2.5.

6.4.2.2 Phase continuity requirements for DMRS bundling

For bands that NTN UE indicates the support of DMRS bundling, when the NTN UE is configured with DMRS bundling, the maximum allowable difference between the measured phase value in any slot $p-1$ and slot p , or slot 0 and any slot p for each antenna connector shall satisfy the requirements as listed in Table 6.4.2.5-1 of TS 38.101-1 [5] for the measurement conditions defined in Table 6.4.2.5-2 of TS 38.101-1 [5], within a measurement time window limited by the UE capability of maximum duration for DMRS bundling [*maxDurationDMRS-Bundling-r17*] for GSO scenario and [*maxDurationDMRS-Bundling-NTN-NGSO-r18*] for NGSO scenario, and defined for each frequency band separately. The phase value for each slot is measured as shown in Annex F.9 of TS 38.101-1 [5]. These requirements apply to PUCCH and PUSCH transmissions with DFT-s-OFDM and CP-OFDM waveforms.

The above requirements are applicable when all the following conditions are met within the measurement time window:

- RB allocation in terms of length and frequency position does not change, and intra-slot and inter-slot frequency hopping is not activated.
- Modulation order does not change.
- No network commanded TA takes effect.
- The TPMI precoder does not change.
- There is no change in UE transmission power level, and no change in the level of P-MPR applied by the UE.
- UE is not scheduled with uplink transmission of other physical channel/signal in-between the PUSCH or PUCCH transmissions.
- Doppler conditions are set to zero and delay conditions are set to constant.

6.5 Output RF spectrum emissions

6.5.1 Occupied bandwidth

Occupied bandwidth is defined as the bandwidth containing 99 % of the total integrated mean power of the transmitted spectrum on the assigned channel. The occupied bandwidth for all transmission bandwidth configurations (Resources Blocks) shall be less than the channel bandwidth specified in Table 6.5.1-1.

Table 6.5.1-1: Occupied channel bandwidth

	NR NTN satellite channel bandwidth (MHz)
	5, 10, 15, 20
Occupied channel bandwidth (MHz)	Same as NR NTN satellite channel bandwidth

6.5.2 Out of band emission

6.5.2.1 General

The Out of band emissions are unwanted emissions immediately outside the assigned channel bandwidth resulting from the modulation process and non-linearity in the transmitter but excluding spurious emissions. This out of band emission limit is specified in terms of a spectrum emission mask and an adjacent channel leakage power ratio.

To improve measurement accuracy, sensitivity and efficiency, the resolution bandwidth may be smaller than the measurement bandwidth. When the resolution bandwidth is smaller than the measurement bandwidth, the result should be integrated over the measurement bandwidth in order to obtain the equivalent noise bandwidth of the measurement bandwidth.

6.5.2.2 Spectrum emission mask

The spectrum emission mask of the UE applies to frequencies (Δf_{OOB}) starting from the \pm edge of the assigned NR channel bandwidth. For frequencies offset greater than Δf_{OOB} , the spurious requirements in clause 6.5.3 are applicable.

NOTE: For measurement conditions at the edge of each frequency range, the lowest frequency of the measurement position in each frequency range should be set at the lowest boundary of the frequency range plus MBW/2. The highest frequency of the measurement position in each frequency range should be set at the highest boundary of the frequency range minus MBW/2. MBW denotes the measurement bandwidth defined for the protected band.

The power of any UE emission shall not exceed the levels specified in Table 6.5.2.2-1 for the specified channel bandwidth.

Table 6.5.2.2-1: General NR spectrum emission mask

Δf_{OOB} (MHz)	Channel bandwidth (MHz) / Spectrum emission limit (dBm)		Measurement bandwidth
	5	10, 15, 20	
$\pm 0-1$	-13	-13	1 % of channel BW
$\pm 1-5$	-10	-10	1 MHz
$\pm 5-6$	-13		
$\pm 6-10$	-25		
$\pm 5-BW_{\text{Channel}}$		-13	
$\pm BW_{\text{Channel}}-(BW_{\text{Channel}}+5)$		-25	

6.5.2.3 Additional spectrum emission mask

6.5.2.3.1 Requirements for network signalling value "NS_04N"

When "NS_04N" is indicated in the cell, the power of any UE emission shall not exceed the levels specified in Table 6.5.2.3.1-1 for any channel bandwidth configured within 1610-1618.25MHz.

Table 6.5.2.3.1-1: Additional requirements for "NS_04N"

Δf_{OoB} (kHz)	Spectrum emission limit (dBm)	Measurement bandwidth
$\pm 0-160$	-2	30kHz
$\pm 160-2300$	-2 to -26	
$\pm 2300-18500$	-26	
NOTE 1: Spectrum emissions are linearly interpolated in dBm versus frequency offset.		
NOTE 2: The EIRP requirement in regulation is converted to conducted requirement using a 0dBi antenna.		

6.5.2.3.2 Requirements for network signalling value "NS_05N"

When "NS_05N" is indicated in the cell, the power of any UE emission shall not exceed the levels specified in Table 6.5.2.3.2-1 for any channel bandwidth configured within 1618.25-1626.5MHz.

Table 6.5.2.3.2-1: Additional requirements for "NS_05N"

Δf_{OoB} (kHz)	Spectrum emission limit (dBm)	Measurement bandwidth
$\pm 0-160$	-5	30kHz
$\pm 160-225$	-5 to -8.5	
$\pm 225-650$	-8.5 to -15	
$\pm 650-1365$	-15	
$\pm 1365-1800$	-23 to -26	
$\pm 1800-16500$	-26	
NOTE 1: Spectrum emissions are linearly interpolated in dBm versus frequency offset.		
NOTE 2: The EIRP requirement in regulation is converted to conducted requirement using a 0dBi antenna.		

6.5.2.4 Adjacent channel leakage ratio

Adjacent Channel Leakage power Ratio (ACLR) is the ratio of the filtered mean power centred on the assigned channel frequency to the filtered mean power centred on an adjacent channel frequency.

To improve measurement accuracy, sensitivity and efficiency, the resolution bandwidth may be smaller than the measurement bandwidth. When the resolution bandwidth is smaller than the measurement bandwidth, the result should be integrated over the measurement bandwidth in order to obtain the equivalent noise bandwidth of the measurement bandwidth.

6.5.2.4.1 NR ACLR

NR Adjacent Channel Leakage power Ratio (NR_{ACLR}) is the ratio of the filtered mean power centred on the assigned NR channel frequency to the filtered mean power centred on an adjacent NR channel frequency at nominal channel spacing.

The assigned NR channel power and adjacent NR channel power are measured with rectangular filters with measurement bandwidths specified in Table 6.5.2.4.1-1.

If the measured adjacent channel power is greater than -50 dBm then the NR_{ACLR} shall be higher than the value specified in Table 6.5.2.4.1-2.

Table 6.5.2.4.1-1: NR ACLR measurement bandwidth

Channel bandwidth	(MHz)	5,10,15,20
REF_SCS	(kHz)	15
NR ACLR measurement bandwidth	(MHz)	$MBW=REF_SCS*(12*N_{RB}+1)/1000$

Table 6.5.2.4.1-2: NR ACLR requirement

	Power class 3
NR ACLR	30 dB

6.5.2.4.2 UTRA ACLR

UTRA adjacent channel leakage power ratio ($UTRA_{ACLR}$) is the ratio of the filtered mean power centred on the assigned NR channel frequency to the filtered mean power centred on an adjacent(s) UTRA channel frequency.

$UTRA_{ACLR}$ is specified for the first adjacent UTRA channel ($UTRA_{ACLR1}$) which center frequency is ± 2.5 MHz from NR channel edge and for the 2nd adjacent UTRA channel ($UTRA_{ACLR2}$) which center frequency is ± 7.5 MHz from NR channel edge.

The UTRA channel power is measured with a RRC filter with roll-off factor $\alpha = 0.22$ and bandwidth of 3.84 MHz. The assigned NR channel power is measured with a rectangular filter with measurement bandwidth specified in Table 6.5.2.4.1-1.

If the measured adjacent channel power is greater than -50 dBm then the $UTRA_{ACLR1}$ and $UTRA_{ACLR2}$ shall be higher than the value specified in Table 6.5.2.4.2-1.

Table 6.5.2.4.2-1: UTRA ACLR requirement

	Power class 3
$UTRA_{ACLR1}$	33 dB
$UTRA_{ACLR2}$	36 dB

UTRA ACLR requirement is applicable when signalled by the network with network signalling value indicated by the field *additionalSpectrumEmission*.

6.5.3 Spurious emission

6.5.3.1 General spurious emissions

Unless otherwise stated, the spurious emission limits apply for the frequency ranges that are more than F_{OOB} (MHz) in Table 6.5.3.1-1 from the edge of the channel bandwidth. The spurious emission limits in Table 6.5.3.1-2 apply for all transmitter band configurations (N_{RB}) and channel bandwidths.

Table 6.5.3.1-1: Boundary between NR out of band and general spurious emission domain

Channel bandwidth	OOB boundary F_{OOB} (MHz)
$BW_{Channel}$	$BW_{Channel} + 5$

Table 6.5.3.1-2: Requirement for general spurious emissions limits

Frequency Range	Maximum Level	Measurement bandwidth	NOTE
9 kHz ≤ f < 150 kHz	-36 dBm	1 kHz	
150 kHz ≤ f < 30 MHz	-36 dBm	10 kHz	
30 MHz ≤ f < 1000 MHz	-36 dBm	100 kHz	
1 GHz ≤ f < 5 th harmonic of the upper frequency edge of the UL operating band in GHz	-30 dBm	1 MHz	

6.5.3.2 Spurious emissions for UE co-existence

This clause specifies the requirements for NR NTN satellite bands for UE coexistence with protected bands.

Table 6.5.3.2-1: Requirements for spurious emissions for UE co-existence

NR NTN satellite Band	Spurious emission for UE co-existence						
	Protected band	Frequency range (MHz)			Maximum Level (dBm)	MBW (MHz)	NOTE
n254	NR Band n1, n2, n3, n5, n7, n8, n12, n13, n14, n18, n20, n24, n25, n26, n28, n29, n30, n31, n34, n38, n39, n40, n41, n48, n50, n51, n53, n54, n65, n66, n67, n70, n71, n72, n74, n75, n76, n77, n78, n85, n90, n91, n92, n93, n94, n100, n101, n105, n106, n109	F _{DL_low}	-	F _{DL_high}	-50	1	
	E-UTRA Band 73, 87, 88, 103	F _{DL_low}	-	F _{DL_high}	-50	1	
	NR Band n79, n104	F _{DL_low}	-	F _{DL_high}	-50	1	2
n255	NR Band n1, n2, n3, n5, n7, n8, n12, n13, n14, n18, n20, n24, n25, n26, n28, n29, n30, n31, n34, n38, n39, n40, n41, n48, n50, n51, n53, n65, n66, n67, n70, n71, n72, n74, n75, n76, n85, n90, n91, n92, n93, n94, n100, n101, n105, n106, n109	F _{DL_low}	-	F _{DL_high}	-50	1	
	NR Band n77, n78, n79	F _{DL_low}	-	F _{DL_high}	-50	1	2
n256	NR Band n1, n3, n5, n7, n8, n12, n13, n14, n18, n20, n24, n26, n28, n29, n30, n31, n38, n39, n40, n41, n48, n50, n51, n53, n54, n65, n66, n67, n71, n72, n74, n75, n76, n78, n79, n85, n90, n91, n92, n93, n94, n100, n101, n105, n106, n109	F _{DL_low}	-	F _{DL_high}	-50	1	
	E-UTRA Band 33, 35	F _{DL_low}	-	F _{DL_high}	-50	1	
	NR Band n77	F _{DL_low}	-	F _{DL_high}	-50	1	2
	NR Band n2, n25, n70	F _{DL_low}	-	F _{DL_high}	NA	NA	3
<p>NOTE 1: The protected NR or E-UTRA bands are specified in clause 5.2 from 3GPP TS 38.101-1 [5] or 3GPP TS 36.101 [10]. F_{DL_low} and F_{DL_high} refer to each frequency band specified in Table 5.2-1 in 3GPP TS 38.101-1 [5] or 3GPP TS 36.101 [10].</p> <p>NOTE 2: As exceptions, measurements with a level up to the applicable requirements defined in Table 6.5.3.1-2 are permitted for each assigned NR carrier used in the measurement due to 2nd, 3rd, 4th or 5th harmonic spurious emissions. Due to spreading of the harmonic emission the exception is also allowed for the first 1 MHz frequency range immediately outside the harmonic emission on both sides of the harmonic emission. This results in an overall exception interval centred at the harmonic emission of (2 MHz + N x L_{CRB} x R_{Bsize} kHz), where N is 2, 3, 4, 5 for the 2nd, 3rd, 4th or 5th harmonic respectively. The exception is allowed if the measurement bandwidth (MBW) totally or partially overlaps the overall exception interval.</p>							

NR NTN satellite Band	Spurious emission for UE co-existence			
	Protected band	Frequency range (MHz)	Maximum Level (dBm)	MBW (MHz)
NOTE 3: The co-existence between n256 and band n2, n25 and n70 is subject to regional/national regulation.				

NOTE: To simplify Table 6.5.3.2-1, NR band numbers are listed for bands which are specified only for NR operation or both E-UTRA and NR operation. E-UTRA band numbers are listed for bands which are specified only for E-UTRA operation.

6.5.3.3 Additional spurious emissions

6.5.3.3.1 General

These requirements are specified in terms of an additional spectrum emission requirement. Additional spurious emission requirements are signalled by the network to indicate that the UE shall meet an additional requirement for a specific deployment scenario as part of the cell handover/broadcast message.

6.5.3.3.2 Requirement for network signalling value "NS_02N"

When "NS_02N" is indicated in the cell, the power of any UE emission shall not exceed the levels specified in Table 6.5.3.3.2-1. This requirement also applies for the frequency ranges that are less than F_{OOB} (MHz) in Table 6.5.3.1-1 from the edge of the channel bandwidth.

Table 6.5.3.3.2-1: Additional requirements for "NS_02N"

Frequency range (MHz)	Channel bandwidth / Spectrum emission limit ¹ (dBm)	Measurement bandwidth	NOTE
	5 MHz, 10 MHz, 15 MHz, 20 MHz		
$1559 \leq f < 1605$	-50	700 Hz	Averaged over any 2 millisecond active transmission interval
$1605 \leq f \leq 1610$	$-50 + 24/5 (f-1605)$	700Hz	
$1559 \leq f < 1605$	-40	1MHz	Averaged over any 2 millisecond active transmission interval
$1605 \leq f \leq 1610$	$-40 + 24/5 (f-1605)$	1MHz	
NOTE: The EIRP requirement in regulation is converted to conducted requirement using a 0 dBi antenna.			

6.5.3.3.3 Requirement for network signalling value "NS_03N"

When "NS_03N" is indicated in the cell, the power of any UE emission shall not exceed the levels specified in Table 6.5.3.3.3-1. This requirement also applies for the frequency ranges that are less than F_{OOB} (MHz) in Table 6.5.3.1-1 from the edge of the channel bandwidth.

Table 6.5.3.3-1: Additional out-of-band requirements for "NS_03N"

Frequency range (MHz)	Channel bandwidth / Spectrum emission limit ¹ (dBm)	Measurement bandwidth	NOTE
	5 MHz, 10 MHz, 15 MHz		
$1559 \leq f < 1605$	-50	700 Hz	Discreet emissions averaged over any 2 millisecond active transmission interval
$1605 \leq f \leq 1610$	$-50 + 60/5 (f-1605)$	700 Hz	
$1559 \leq f < 1605$	-40	1MHz	Averaged over any 2 millisecond active transmission interval
$1605 \leq f \leq 1610$	$-40 + 60/5 (f-1605)$	1MHz	
NOTE: The EIRP requirement in regulation is converted to conducted requirement using a 0dBi antenna.			

6.5.3.3.4 Requirement for network signalling value "NS_04N" and "NS_05N"

When "NS_04N" or "NS_05N" is indicated in the cell, the power of any UE emission shall not exceed the levels specified in Table 6.5.3.3.4-1. This requirement also applies for the frequency ranges that are less than F_{OOB} (MHz) in Table 6.5.3.1-1 from the edge of the channel bandwidth.

Table 6.5.3.3.4-1: Additional out-of-band requirements for "NS_04N" and "NS_05N"

Frequency range (MHz)	Channel bandwidth / Spectrum emission limit ¹ (dBm)	Measurement bandwidth	NOTE
	5 MHz, 10 MHz, 15 MHz		
$1559 \leq f < 1605$	-40	1MHz	Averaged over any 2 millisecond active transmission interval
$1605 \leq f \leq 1610$	$-40 + 60/5 (f-1605)$	1MHz	
$1628.5 \leq f < 1631.5$	-30	30kHz	
$1631.5 \leq f < 1636.5$	-30	100kHz	
$1636.5 \leq f < 1646.5$	-30	300kHz	
$1646.5 \leq f < 1666.5$	-30	1MHz	
$1666.5 \leq f \leq 2200$	-30	3MHz	
NOTE: The EIRP requirement in regulation is converted to conducted requirement using a 0dBi antenna.			

6.5.4 Transmit intermodulation

The transmit intermodulation performance is a measure of the capability of the transmitter to inhibit the generation of signals in its non-linear elements caused by presence of the wanted signal and an interfering signal reaching the transmitter via the antenna.

UE transmit intermodulation is defined by the ratio of the mean power of the wanted signal to the mean power of the intermodulation product when an interfering CW signal is added at a level below the wanted signal at each transmitter antenna port with the other antenna port(s) if any terminated. Both the wanted signal power and the intermodulation product power are measured through NR rectangular filter with measurement bandwidth shown in Table 6.5.4-1.

The requirement of transmit intermodulation is specified in Table 6.5.4-1.

Table 6.5.4-1: Transmit Intermodulation

Wanted signal channel bandwidth	BW_{Channel}	
Interference signal frequency offset from channel center	BW_{Channel}	$2 \cdot BW_{\text{Channel}}$
Interference CW signal level	-40 dBc	
Intermodulation product	< -29 dBc	< -35 dBc
Measurement bandwidth	The maximum transmission bandwidth configuration among the different SCS's for the channel BW as defined in Table 6.5.2.4.1-1	
Measurement offset from channel center	BW_{Channel} and $2 \cdot BW_{\text{Channel}}$	$2 \cdot BW_{\text{Channel}}$ and $4 \cdot BW_{\text{Channel}}$

7 Conducted receiver characteristics

7.1 General

Unless otherwise stated the receiver characteristics are specified at the antenna connector(s) of the UE. For UE(s) with an integral antenna only, a reference antenna(s) with a gain of 0 dBi is assumed for each antenna port(s). UE with an integral antenna(s) may be taken into account by converting these power levels into field strength requirements, assuming a 0 dBi gain antenna. For UEs with more than one receiver antenna connector, identical interfering signals shall be applied to each receiver antenna port if more than one of these is used (diversity).

The levels of the test signal applied to each of the antenna connectors shall be as defined in the respective clauses below.

With the exception of clause 7.3, the requirements shall be verified with the network signalling value NS_01 configured in Table 6.2.3.1-1.

All requirements in this section are applicable to devices supporting GSO and/or NGSO satellites.

All the parameters in clause 7 are defined using the UL reference measurement channels specified in 3GPP TS 38.101-1 [5] Annex A.2.2, the DL reference measurement channels specified in 3GPP TS 38.101-1 [5] Annex A.3.2 and using the set-up specified in 3GPP TS 38.101-1 [5] Annex C.3.1.

All Rx requirements are verified with default Tx-Rx separation specified in Table 5.4.4-1. Additional Tx-Rx frequency separations specified in clause 7.3.2 do not apply to other requirements.

7.2 Diversity characteristics

The UE is required to be equipped with a minimum of two RX antenna ports in all operating bands.

The UE shall be verified with two RX antenna ports in all supported frequency bands.

The above rules apply for all clauses with the exception of clause 7.9.

7.3 Reference sensitivity

7.3.1 General

The reference sensitivity power level REFSSENS is the minimum mean power applied to each one of the UE antenna ports for all UE categories, at which the throughput shall meet or exceed the requirements for the specified reference measurement channel.

In later clauses of Clause 7 where the value of REFSSENS is used as a reference to set the corresponding requirement:

- In all bands, the UE shall be verified against those requirements by applying the REFSSENS value in Table 7.3.2-1.

7.3.2 Reference sensitivity power level

The throughput shall be $\geq 95\%$ of the maximum throughput of the reference measurement channels as specified in Annex A3.2.2 of 3GPP TS 38.101-1 [5], with parameters specified in Table 7.3.2-1.

Table 7.3.2-1: Two antenna port reference sensitivity QPSK PREFSENS for FDD bands

Operating band / SCS / Channel bandwidth											
Operating Band	SCS kHz	5 MHz (dBm)	10 MHz (dBm)	15 MHz (dBm)	20 MHz (dBm)	25 MHz (dBm)	30 MHz (dBm)	35 MHz (dBm)	40 MHz (dBm)	45 MHz (dBm)	50 MHz (dBm)
n256	15	-99.5	-96.3	-94.5	-93.3						
	30		-96.6	-94.6	-93.5						
	60		-97.0	-94.9	-93.7						
n255	15	-100.0	-96.8	-95.0	-93.8						
	30		-97.1	-95.1	-94.0						
	60		-97.5	-95.4	-94.2						
n254	15	-99.5	-96.3	-94.5							
	30		-96.6	-94.6							
	60		-97.0	-94.9							

NOTE: The transmitter shall be set to P_{UMAX} as defined in clause 6.2.4 of 3GPP TS 38.101-1 [5].

The reference receiver sensitivity (REFSENS) requirement specified in Table 7.3.2-1 shall be met with uplink transmission bandwidth less than or equal to that specified in Table 7.3.2-2 and with default Tx-Rx carrier center frequency separation except for cases specified in Table 7.3.2-3.

Table 7.3.2-2: Uplink configuration for reference sensitivity

Operating band / SCS (kHz) / Channel bandwidth (MHz) / Duplex mode						
Operating Band	SCS	5	10	15	20	Duplex Mode
n256	15	25	50	75	100	FDD
	30		24	36	50	
	60		10	18	24	
n255	15	25	50	75	75^2 50^3	FDD
	30		24	36	36^2 24^3	
	60		10	18	18^2 10^3	
n254	15	25	50	75		FDD
	30		24	36		
	60		10	18		

NOTE: UL resource blocks shall be located as close as possible to the downlink operating band but confined within the transmission bandwidth configuration for the channel bandwidth in Table 5.3.2-1.

Table 7.3.2-3: TX – RX carrier centre frequency separation for REFSSENS verification

Operating Band	Channel bandwidth	TX – RX carrier centre frequency separation for REFSSENS verification
n256	5 MHz	165 MHz, 215 MHz
	20 MHz	180 MHz, 200 MHz
n255	5 MHz	-72.5 MHz, -130.5 MHz
	20 MHz	-87.5 MHz, -115.5 MHz

The minimum requirements specified in Table 7.3.2-1 shall be verified with the network signalling value NS_01 configured in Table 6.2.3.1-1.

7.4 Maximum input level

Maximum input level is defined as the maximum mean power received at the UE antenna port, at which the specified relative throughput shall meet or exceed the minimum requirements for the specified reference measurement channel. The throughput shall be $\geq 95\%$ of the maximum throughput of the reference measurement channels as specified in 3GPP TS 38.101-1 [5] Annex A.3.2 (with one sided dynamic OCNG Pattern OP.1 FDD as described in 3GPP TS 38.101-1 [5] Annex A.5.1.1) with parameters specified in Table 7.4-1.

Table 7.4-1: Maximum input level

Rx Parameter	Units	Channel bandwidth (MHz)		
		5	10	15, 20
Power in Transmission Bandwidth Configuration ³	dBm	-40 ²		
NOTE 1: The transmitter shall be set to 4 dB below $P_{\text{CMAX_L,f,c}}$ at the minimum uplink configuration specified in Table 7.3.2-2 with $P_{\text{CMAX_L,f,c}}$ as defined in clause 6.2.4.				
NOTE 2: Reference measurement channel is specified in 3GPP TS 38.101-1 [5] Annex A.3.2.3 for 64 QAM.				
NOTE 3: Power in transmission bandwidth configuration value is rounded to the nearest 0.5dB value.				

7.5 Adjacent channel selectivity

Adjacent channel selectivity (ACS) is a measure of a receiver's ability to receive an NR signal at its assigned channel frequency in the presence of an adjacent channel signal at a given frequency offset from the centre frequency of the assigned channel. ACS is the ratio of the receive filter attenuation on the assigned channel frequency to the receive filter attenuation on the adjacent channel(s).

In Release 17, only frequency bands below 2.7GHz are considered. The NR satellite UE shall fulfil the minimum requirements specified in Table 7.5-1 for NR satellite bands with $F_{\text{DL_high}} < 2700$ MHz and $F_{\text{UL_high}} < 2700$ MHz. These requirements apply for all values of an adjacent channel interferer in case 1 and for any SCS specified for the channel bandwidth of the wanted signal. The lower and upper range of test parameters are chosen as in Table 7.5-2 and Table 7.5-3 for verification of the requirements specified in Table 7.5-1. For these test parameters, the throughput shall be $\geq 95\%$ of the maximum throughput of the reference measurement channels as specified in 3GPP TS 38.101-1 [5] Annexes A.2.2 and A.3.2 (with one sided dynamic OCNG Pattern OP.1 FDD for the DL-signal as described in 3GPP TS 38.101-1 [5] Annex A.5.1.1).

Table 7.5-1: ACS for NR satellite bands with $F_{\text{DL_high}} < 2700$ MHz and $F_{\text{UL_high}} < 2700$ MHz

RX parameter	Units	Channel bandwidth (MHz)		
		5, 10	15	20
ACS	dB	33	30	27

Table 7.5-2: Test parameters for NR bands with $F_{DL_high} < 2700$ MHz and $F_{UL_high} < 2700$ MHz, case 1

RX parameter	Units	Channel bandwidth (MHz)		
		5, 10	15	20
Power in transmission bandwidth configuration	dBm	REFSENS + 14 dB		
$P_{interferer}^1$	dBm	REFSENS + 45.5 dB	REFSENS + 42.5 dB	REFSENS + 39.5
$BW_{interferer}$	MHz	5		
$F_{interferer}$ (offset) ²	MHz	$BW_{Channel}/2 + 2.5$ $/$ $-(BW_{Channel}/2 + 2.5)$		
NOTE 1: The transmitter shall be set to 4 dB below $P_{CMAX_L,f,c}$ at the minimum UL configuration specified in clause 7.3.2 with $P_{CMAX_L,f,c}$ defined in clause 6.2.4.				
NOTE 2: The absolute value of the interferer offset $F_{interferer}$ (offset) shall be further adjusted to $(\lceil F_{interferer} / SCS \rceil + 0.5) SCS$ MHz with SCS the sub-carrier spacing of the wanted signal in MHz. The interferer is an NR signal with 15 kHz SCS.				
NOTE 3: The interferer consists of the NR interferer RMC specified in 3GPP TS 38.101-1 [5] Annex A.3.2.2 with one sided dynamic OCNG Pattern OP.1 FDD for the DL-signal as described in 3GPP TS 38.101-1 [5] Annex A.5.1.1.				
NOTE 4: $P_{interferer}$ shall be rounded to the next higher 0.5dB value.				

Table 7.5-3: Test parameters for NR bands with $F_{DL_high} < 2700$ MHz and $F_{UL_high} < 2700$ MHz, case 2

RX parameter	Units	Channel bandwidth (MHz)		
		5, 10	15	20
Power in transmission bandwidth configuration	dBm	-71.5	-68.5	-65.5
$P_{interferer}$	dBm	-40		
$BW_{interferer}$	MHz	5		
$F_{interferer}$ (offset)	MHz	$BW_{Channel}/2 + 2.5$ $/$ $-(BW_{Channel}/2 + 2.5)$		
NOTE 1: The transmitter shall be set to 24 dB below $P_{CMAX_L,f,c}$ at the minimum UL configuration specified in clause 7.3.2 with $P_{CMAX_L,f,c}$ defined in clause 6.2.4.				
NOTE 2: The absolute value of the interferer offset $F_{interferer}$ (offset) shall be further adjusted to $(\lceil F_{interferer} / SCS \rceil + 0.5) SCS$ MHz with SCS the sub-carrier spacing of the wanted signal in MHz. The interferer is an NR signal with 15 kHz SCS.				
NOTE 3: The interferer consists of the NR interferer RMC specified in 3GPP TS 38.101-1 [5] Annex A.3.2.2 with one sided dynamic OCNG Pattern OP.1 FDD for the DL-signal as described in 3GPP TS 38.101-1 [5] Annex A.5.1.1.				
NOTE 4: $P_{interferer}$ shall be rounded to the next higher 0.5dB value.				

7.6 Blocking characteristics

7.6.1 General

The blocking characteristic is a measure of the receiver's ability to receive a wanted signal at its assigned channel frequency in the presence of an unwanted interferer on frequencies other than those of the spurious response or the adjacent channels, without this unwanted input signal causing a degradation of the performance of the receiver beyond a specified limit. The blocking performance shall apply at all frequencies except those at which a spurious response occurs.

7.6.2 In-band blocking

For NR satellite bands with $F_{DL_high} < 2700$ MHz and $F_{UL_high} < 2700$ MHz in-band blocking (IBB) is defined for an unwanted interfering signal falling into the UE receive band or into the first 15 MHz below or above the UE receive band.

The throughput of the wanted signal shall be $\geq 95\%$ of the maximum throughput of the reference measurement channels as specified in 3GPP TS 38.101-1 [5] Annexes A.2.2 and A.3.2 (with one sided dynamic OCNG Pattern OP.1 FDD for the DL-signal as described in Annex A.5.1.1) with parameters specified in Table 7.6.2-1 and Table 7.6.2-2. The relative throughput requirement shall be met for any SCS specified for the channel bandwidth of the wanted signal.

Table 7.6.2-1: In-band blocking parameters for NR satellite bands with $F_{DL_high} < 2700$ MHz and $F_{UL_high} < 2700$ MHz

RX parameter	Units	Channel bandwidth (MHz)		
		5, 10	15	20
Power in transmission bandwidth configuration ³	dBm	REFSENS + 6 dB	REFSENS + 7 dB	REFSENS + 9 dB
$BW_{interferer}$	MHz	5		
$F_{offset, case 1}$	MHz	7.5		
$F_{offset, case 2}$	MHz	12.5		
NOTE 1: The transmitter shall be set to 4 dB below $P_{CMAX_L,f,c}$ at the minimum UL configuration specified in clause 7.3.2 with $P_{CMAX_L,f,c}$ defined in clause 6.2.4.				
NOTE 2: The interferer consists of the RMC specified in 3GPP TS 38.101-1 [5] Annex A.3.2.2 with one sided dynamic OCNG Pattern OP.1 FDD for the DL-signal as described in Annex A.5.1.1 and 15 kHz SCS.				
NOTE 3: Power in transmission bandwidth configuration shall be rounded to the next higher 0.5dB value.				

Table 7.6.2-2: In-band blocking for NR satellite bands with $F_{DL_high} < 2700$ MHz and $F_{UL_high} < 2700$ MHz

Operating Band	Parameter	Unit	Case 1	Case 2
	$P_{interferer}$	dBm	-56	-44
n254, n255, n256	$F_{interferer}$ (offset)	MHz	$-BW_{Channel}/2 - F_{offset, case 1}$ and $BW_{Channel}/2 + F_{offset, case 1}$	$\leq -BW_{Channel}/2 - F_{offset, case 2}$ and $\geq BW_{Channel}/2 + F_{offset, case 2}$
	$F_{interferer}$	MHz	NOTE 2	$F_{DL_low} - 15$ to $F_{DL_high} + 15$
NOTE 1: The absolute value of the interferer offset $F_{interferer}$ (offset) shall be further adjusted to $(F_{interferer} / SCS + 0.5) SCS$ MHz with SCS the sub-carrier spacing of the wanted signal in MHz. The interferer is an NR signal with 15 kHz SCS.				
NOTE 2: For each carrier frequency, the requirement applies for two interferer carrier frequencies: a: $-BW_{Channel}/2 - F_{offset, case 1}$; b: $BW_{Channel}/2 + F_{offset, case 1}$				

7.6.3 Out-of-band blocking

For NR satellite bands with $F_{DL_high} < 2700$ MHz and $F_{UL_high} < 2700$ MHz out-of-band band blocking is defined for an unwanted CW interfering signal falling outside a frequency range 15 MHz below or above the UE receive band.

The throughput of the wanted signal shall be $\geq 95\%$ of the maximum throughput of the reference measurement channels as specified in 3GPP TS 38.101-1 [5] Annexes A.2.2 and A.3.2 (with one sided dynamic OCNG Pattern OP.1 FDD for the DL-signal as described in Annex A.5.1.1) with parameters specified in Table 7.6.3-1 and Table 7.6.3-2. The relative throughput requirement shall be met for any SCS specified for the channel bandwidth of the wanted signal.

Table 7.6.3-1: Out-of-band blocking parameters for NR satellite bands with $F_{DL_high} < 2700$ MHz and $F_{UL_high} < 2700$ MHz

RX parameter	Units	Channel bandwidth (MHz)		
		5, 10	15	20
Power in transmission bandwidth configuration ²	dBm	REFSENS + 6 dB	REFSENS + 7 dB	REFSENS + 9 dB
NOTE 1: The transmitter shall be set to 4 dB below $P_{CMAX_L,f,c}$ at the minimum UL configuration specified in clause 7.3.2 with $P_{CMAX_L,f,c}$ defined in clause 6.2.4.				
NOTE 2: Power in transmission bandwidth configuration shall be rounded to the next higher 0.5dB value.				

Table 7.6.3-2: Out of-band blocking for NR satellite bands with $F_{DL_high} < 2700$ MHz and $F_{UL_high} < 2700$ MHz

Operating Band	Parameter	Unit	Range 1	Range 2	Range 3
	$P_{interferer}$	dBm	-44	-30	-15
n254 ²	$F_{interferer}$ (CW)	MHz	$-60 < f - F_{DL_low} < -15$ or $15 < f - F_{DL_high} < 60$	$-85 < f - F_{DL_low} \leq -60$ or $60 \leq f - F_{DL_high} < 85$	$1 \leq f \leq F_{DL_low} - 85$ or $F_{DL_high} + 85 \leq f \leq 12750$
n255	$F_{interferer}$ (CW)	MHz	$-60 < f - F_{DL_low} < -15$ or $15 < f - F_{DL_high} < 60$	$-85 < f - F_{DL_low} \leq -60$ or $60 \leq f - F_{DL_high} < 85$	$1 \leq f \leq F_{DL_low} - 85$ or $F_{DL_high} + 85 \leq f \leq 12750$
n256 ¹	$F_{interferer}$ (CW)	MHz	$-100 < f - F_{DL_low} < -15$ or $15 < f - F_{DL_high} < 60$	$-145 < f - F_{DL_low} \leq -100$ or $60 \leq f - F_{DL_high} < 85$	$1 \leq f \leq F_{DL_low} - 145$ or $F_{DL_high} + 85 \leq f \leq 12750$
NOTE 1: Band n256 lower frequency ranges are modified to enable specific implementations					
NOTE 2: Band n254 power level of the interferer ($P_{interferer}$) for Range 3 shall be modified to -20 dBm for $F_{interferer} > 2585$ MHz and $F_{interferer} < 2775$ MHz.					
NOTE 3: void					
NOTE 4: void					

For interferer frequencies across ranges 1, 2 and 3 in Table 7.6.3-1, a maximum of

$$\lfloor \max \{ 24,6 \cdot \lceil n \cdot N_{RB} / 6 \rceil / \min \{ \lfloor n \cdot N_{RB} / 10 \rfloor, 5 \} \} \rfloor$$

exceptions are allowed for spurious response frequencies in each assigned frequency channel when measured using a step size of $\min(\lfloor BW_{channel} / 2 \rfloor, 5)$ MHz with N_{RB} the number of resource blocks in the downlink transmission bandwidth configuration, $BW_{channel}$ the bandwidth of the frequency channel in MHz and $n = 1, 2, 3$ for SCS = 15, 30, 60 kHz, respectively. For these exceptions, the requirements in clause 7.7 apply.

7.6.4 Narrow band blocking

This requirement is measure of a receiver's ability to receive a NR signal at its assigned channel frequency in the presence of an unwanted narrow band CW interferer at a frequency, which is less than the nominal channel spacing. The relative throughput shall be ≥ 95 % of the maximum throughput of the reference measurement channels as specified in 3GPP TS 38.101-1 [5] Annexes A.2.2 and A.3.2 (with one sided dynamic OCNG Pattern OP.1 FDD for the DL-signal as described in Annex A.5.1.1) with parameters specified in Table 7.6.4-1.

Table 7.6.4-1: Narrow Band Blocking

Operating Band	Parameter	Unit	Channel Bandwidth (MHz)			
			5	10	15	20
n254, n255, n256	P _w	dBm	P _{REFSENS} + channel-bandwidth specific value below			
			16	13	14	16
	P _{uw} (CW)	dBm	-55			
	F _{uw} (offset SCS= 15 kHz) 3	MHz	$\left(\left(\frac{BW_{channel}}{2} + 0.2 \right) \frac{1}{SCS} + 0.5 \right) + 0.5 \text{ SCS}$			
F _{uw} (offset SCS= 30 kHz) ³	MHz	NA				
NOTE 1: The transmitter shall be set a 4 dB below P _{C_{MAX}L,f,c} at the minimum UL configuration specified in clause 7.3.2 with P _{C_{MAX}L,f,c} defined in clause 6.2.4						
NOTE 2: The P _{REFSENS} power level is specified in clause 7.3.2.						
NOTE 3: F _{uw} shall be rounded to half of SCS.						

7.7 Spurious response

Spurious response is a measure of the ability of the receiver to receive a wanted signal on its assigned channel frequency without exceeding a given degradation due to the presence of an unwanted CW interfering signal at any other frequency for which a response is obtained, i.e. for which the out-of-band blocking limit as specified in clause 7.6.3 is not met.

The throughput shall be ≥ 95 % of the maximum throughput of the reference measurement channels as specified in 3GPP TS 38.101-1 [5] Annexes A.2.2 and A.3.2 (with one sided dynamic OCNG Pattern OP.1 FDD for the DL-signal as described in Annex A.5.1.1) with parameters for the wanted signal as specified in Table 7.7-1 for NR bands with F_{DL_high} < 2700 MHz and F_{UL_high} < 2700 MHz for the interferer as specified in Table 7.7-2. The relative throughput requirement shall be met for any SCS specified for the channel bandwidth of the wanted signal.

Table 7.7-1: Spurious response parameters for NR bands with F_{DL_high} < 2700 MHz and F_{UL_high} < 2700 MHz

RX parameter	Units	Channel bandwidth (MHz)		
		5, 10	15	20
Power in transmission bandwidth configuration ²	dBm	REFSENS + 6 dB	REFSENS + 7 dB	REFSENS + 9 dB
NOTE 1: The transmitter shall be set to 4 dB below P _{C_{MAX}L,f,c} at the minimum UL configuration specified in Table 7.3.2-3 with P _{C_{MAX}L,f,c} defined in clause 6.2.4.				
NOTE 2: Power in transmission bandwidth configuration value is rounded to the next higher 0.5dB value.				

Table 7.7-2: Spurious response

Parameter	Unit	Level
P _{Interferer} (CW)	dBm	-44
F _{Interferer}	MHz	Spurious response frequencies

7.8 Intermodulation characteristics

The definition and requirements for intermodulation characteristics specified in 3GPP TS 38.101-1 [5] clause 7.8 shall apply for NTN satellite UE.

7.9 Spurious emissions

The spurious emissions power is the power of emissions generated or amplified in a receiver that appear at the UE antenna connector.

The power of any narrow band CW spurious emission shall not exceed the maximum level specified in Table 7.9-1

Table 7.9-1: General receiver spurious emission requirements

Frequency range	Measurement bandwidth	Maximum level	NOTE
$30 \text{ MHz} \leq f < 1 \text{ GHz}$	100 kHz	-57 dBm	
$1 \text{ GHz} \leq f \leq 12.75 \text{ GHz}$	1 MHz	-47 dBm	
NOTE: Unused PDCCH resources are padded with resource element groups with power level given by PDCCH as defined in 3GPP TS 38.101-1 [5] Annex C.3.1.			

8 Conducted performance requirements

8.1 General

8.1.1 Relationship between minimum requirements and test requirements

The present document is a Single-RAT and interwork specification for NR UE, covering minimum performance requirements of both conducted and radiated requirements. Conformance to the present specification is demonstrated by fulfilling the test requirements specified in the conformance specification TS TBD [TBD].

The Minimum Requirements given in this specification make no allowance for measurement uncertainty. The test specification TS TBD [TBD] defines test tolerances. These test tolerances are individually calculated for each test. The test tolerances are used to relax the minimum requirements in this specification to create test requirements.

The measurement results returned by the test system are compared – without any modification – against the test requirements as defined by the shared risk principle.

The shared risk principle is defined in Recommendation ITU-R M.1545 [TBD].

The applicability of each requirement is described under each sub-clause in [8.2.1] and [8.3.1].

8.1.2 Applicability of minimum requirements

The conducted minimum requirements specified in this specification shall be met in all applicable scenarios for FR1.

Unless otherwise stated, all minimum performance requirements defined in Clauses 8 are applicable to UE power class 3 only.

8.1.3 Conducted requirements

8.1.3.1 Introduction

The requirements are defined for the following modes:

- Mode 1: Conditions with external noise source
 - Wanted signal with power level E_s is transmitted.
 - External white noise source with power spectral density N_{oc} is used.
 - E_s and N_{oc} levels are selected to achieve target SNR as described in Clause 8.1.3.3.

8.1.3.2 Reference point

The reference point for SNR, Es and Noc of DL signal is the UE antenna connector or connectors.

8.1.3.3 SNR definition

For Mode 1 conditions conducted UE demodulation and CSI requirements the SNR is defined as:

$$SNR = \frac{\sum_{j=1}^{N_{RX}} E_s^{(j)}}{\sum_{j=1}^{N_{RX}} N_{oc}^{(j)}}$$

Where

- N_{RX} denotes the number of receiver antenna connectors and the superscript receiver antenna connector j .
- The above SNR definition assumes that the REs are not precoded, and does not account for any gain which can be associated to the precoding operation.
- Unless otherwise stated, the SNR refers to the SSS wanted signal.
- The downlink SSS transmit power is defined as the linear average over the power contributions in [W] of all resource elements that carry the SSS within the operating system bandwidth.
- The power ratio of other wanted signals to the SSS is defined in clause [C.3.1].

8.1.3.4 Noc

8.1.3.4.1 Introduction

This clause describes the Noc power level for Mode 1 conditions conducted testing of demodulation and CSI requirements.

8.1.3.4.2 Noc for NR operating bands in FR1

The Noc power spectrum density shall be larger or equal to the minimum Noc power level for each operating band supported by the UE as defined in clause 8.1.3.4.2.1.

Unless otherwise stated, a fixed Noc power level of -145 dBm/Hz shall be used for all operating bands.

8.1.3.4.2.1 Derivation of Noc values for NR operating bands in FR1

The minimum Noc power level for an operating band, subcarrier spacing and channel bandwidth is derived based on the following equation:

$$NOC_{Band_X, SCS_Y, CBW_Z} = REFSENS_{Band_X, SCS_Y, CBW_Z} - 10 \cdot \log_{10}(12 \cdot SCS_Y \cdot nPRB) + D - SNR_{REFSENS} + \Delta_{thermal}$$

where

- $REFSENS_{Band_X, SCS_Y, CBW_Z}$ is the REFSENS value in dBm for Band X, SCS Y and CBW Z specified in Table 7.3.2-1 of TS 38.101-5 [TBD]
- 12 is the number of subcarriers in a PRB
- SCS Y is the subcarrier spacing associated with the REFSENS value
- nPRB is the maximum number of PRB for SCS Y and CBW Z associated with the REFSENS value, and is specified in Table 5.3.2-1 of TS 38.101-5 [TBD]
- D is diversity gain equal to 3 dB
- $SNR_{REFSENS} = -1$ dB is the SNR used for simulation of REFSENS

- Δ_{thermal} is the amount of dB that the wanted noise is set above UE thermal noise, giving a defined rise in total noise. $\Delta_{\text{thermal}} = 16\text{dB}$, giving a rise in total noise of 0.1dB, regarded as insignificant.

The calculated Noc value for the baseline of Band n256, 15 kHz SCS, 10 MHz CBW is -146.5 dBm/Hz.

An allowance of 1.5dB is made for future bands, giving an Noc power level of -145 dBm/Hz.

8.2 Demodulation performance requirements

8.2.1 General

8.2.1.1 Applicability of requirements

8.2.1.1.1 General

The minimum performance requirements are applicable to all FR1 operating bands defined in clause 5.2.

If same test is listed for different UE features/capabilities in Clauses 8.2.1.1.2, then this test shall apply for UEs which support all corresponding UE features/capabilities.

8.2.1.1.2 Applicability of requirements for optional UE features

The performance requirements in Table 8.2.1.1.2-1 shall apply for UEs which support optional UE features only.

Table 8.2.1.1.2-1: Requirements applicability for optional UE features

UE feature/capability [TBD]	Test type		Test list	Applicability notes
NR NTN access (nonTerrestrialNetwork-r17)	FR1 FDD	PDSCH	Clause 8.2.1.2.2.1 (Test 1-1, Test 1-2, Test 1-3, Test 1-4)	
NR NTN scenario support (ntn-ScenarioSupport-r17)	FR1 FDD	PDSCH	Clause 8.2.1.2.2.1 (Test 1-1, Test 1-2, Test 1-3, Test 1-4)	The requirements apply only when <i>ntn-ScenarioSupport-r17</i> is "ngso" or is not configured.
Increasing the number of HARQ processes (max-HARQ-ProcessNumber-r17)	FR1 FDD	PDSCH	Clause 8.2.1.2.2.1 (Test 1-3)	
Disabled HARQ feedback for downlink transmission (harq-FeedbackDisabled-r17)	FR1 FDD	PDSCH	Clause 8.2.1.2.2.1 (Test 1-4)	
Note:	For UE supporting NR NTN access (nonTerrestrialNetwork-r17), the requirements in TS38.101-4 also applies to UE according to applicability rules in TS38.101-4 Clause 5.1, 6.1, 7.1 and 8.1			

8.2.1.2 PDSCH demodulation requirements

The parameters specified in Table 8.2.1.2-1 are valid for all PDSCH tests unless otherwise stated.

Table 8.2.1.2-1: Common test parameters

Parameter		Unit	Value
PDSCH transmission scheme			Transmission scheme 1
Carrier configuration	Offset between Point A and the lowest usable subcarrier on this carrier (Note 2)	RBs	0
	Subcarrier spacing	kHz	15
DL BWP configuration #1	Cyclic prefix		Normal
	RB offset	RBs	0
	Number of contiguous PRB	PRBs	Maximum transmission bandwidth configuration as specified in clause 5.3.2 of TS 38.101-1 [6] for tested channel bandwidth and subcarrier spacing
Common serving cell parameters	Physical Cell ID		0
	SSB position in burst		First SSB in Slot #0
	SSB periodicity	ms	20
PDCCH configuration	Slots for PDCCH monitoring		Each slot
	Symbols with PDCCH	Symbols	0, 1
	Number of PRBs in CORESET		Table 5.2-2 of 38.101-4 for tested channel bandwidth and subcarrier spacing
	Number of PDCCH candidates and aggregation levels		1/AL8
	CCE-to-REG mapping type		Non-interleaved
	DCI format		1_1
	TCI state		TCI state #1
	PDCCH & PDCCH DMRS Precoding configuration		Single Panel Type I, Random per slot with equal probability of each applicable i_1, i_2 combination, and with REG bundling granularity for number of Tx larger than 1
Cross carrier scheduling			Not configured
CSI-RS for tracking	First subcarrier index in the PRB used for CSI-RS		$k_0=0$ for CSI-RS resource 1,2,3,4
	First OFDM symbol in the PRB used for CSI-RS		$l_0 = 6$ for CSI-RS resource 1 and 3 $l_0 = 10$ for CSI-RS resource 2 and 4
	Number of CSI-RS ports (X)		1 for CSI-RS resource 1,2,3,4
	CDM Type		'No CDM' for CSI-RS resource 1,2,3,4
	Density (ρ)		3 for CSI-RS resource 1,2,3,4
	CSI-RS periodicity	Slots	15 kHz SCS: 20 for CSI-RS resource 1,2,3,4
	CSI-RS offset	Slots	15 kHz SCS: 10 for CSI-RS resource 1 and 2 11 for CSI-RS resource 3 and 4
	Frequency Occupation		Start PRB 0 Number of PRB = $\text{ceil}(\text{BWP size}/4)*4$
	QCL info		TCI state #0
NZP CSI-RS for CSI acquisition	Row index (Note 3)		3 for 2 CSI-RS ports and 5 for 4 CSI-RS ports
	First subcarrier index in the PRB used for CSI-RS		$k_0 = 0$
	First OFDM symbol in the PRB used for CSI-RS		$l_0 = 12$
	Number of CSI-RS ports (X)		Same as number of transmit antenna
	CDM Type		'No CDM' for 1 transmit antenna 'FD-CDM2' for 2 and 4 transmit antenna
	Density (ρ)		1
	CSI-RS periodicity	Slots	15 kHz SCS: 20
	CSI-RS offset	Slots	0
	Frequency Occupation		Start PRB 0 Number of PRB = $\text{ceil}(\text{BWP size}/4)*4$
QCL info		TCI state #1	
ZP CSI-RS for CSI acquisition	Row index (Note 3)		5
	First subcarrier index in the PRB used for CSI-RS		$k_0 = 4$
	First OFDM symbol in the PRB used for CSI-RS		$l_0 = 12$

	Number of CSI-RS ports (X)		4
	CDM Type		'FD-CDM2'
	Density (ρ)		1
	CSI-RS periodicity	Slots	15 kHz SCS: 20
	CSI-RS offset	Slots	0
	Frequency Occupation		Start PRB 0 Number of PRB = $\text{ceil}(\text{BWP size}/4)*4$
PDSCH DMRS configuration	Antenna ports indexes		{1000} for Rank 1 tests
	Position of the first DMRS for PDSCH mapping type A		2
	Number of PDSCH DMRS CDM group(s) without data		1 for Rank 1
TCI state #0	Type 1 QCL information	SSB index	SSB #0
		QCL Type	Type C
	Type 2 QCL information	SSB index	N/A
		QCL Type	N/A
TCI state #1	Type 1 QCL information	CSI-RS resource	CSI-RS resource 1 from 'CSI-RS for tracking' configuration
		QCL Type	Type A
	Type 2 QCL information	CSI-RS resource	N/A
		QCL Type	N/A
PT-RS configuration			PT-RS is not configured
Maximum number of code block groups for ACK/NACK feedback			1
Maximum number of HARQ transmission			4
HARQ ACK/NACK bundling			Multiplexed
Redundancy version coding sequence			{0,2,3,1}
PDSCH & PDSCH DMRS Precoding configuration			Single Panel Type I, Random precoder selection updated per slot, with equal probability of each applicable i_1, i_2 combination, and with PRB bundling granularity
Symbols for all unused REs			OP.1 FDD as defined in Annex A.5.1.1 of 38.101-4
Physical signals, channels mapping and precoding			As specified in Annex B.4.1 of 38.101-4
Note 1: UE assumes that the TCI state for the PDSCH is identical to the TCI state applied for the PDCCH transmission.			
Note 2: Point A coincides with minimum guard band as specified in Table 5.3.3-1 from TS 38.101-1 [6] for tested channel bandwidth and subcarrier spacing.			
Note 3: Refer to Table 7.4.1.5.3-1 in [9]			

8.2.1.2.1 1RX requirements

8.2.1.2.2 2RX requirements

8.2.1.2.2.1 FDD

8.2.1.2.2.1.1 Minimum requirements for PDSCH Mapping Type A

The performance requirements are specified in Table 8.2.1.2.2.1.1-3 with the addition of test parameters in Table 8.2.1.2.2.1.1-2 and the downlink physical channel setup according to Annex C.3.1.

The test purposes are specified in Table 8.2.1.2.2.1.1-1.

Table 8.2.1.2.2.1.1-1: Tests purpose

Purpose	Test index
Verify the PDSCH mapping Type A normal performance under 2 receive antenna conditions and with different channel models and MCS	1-1, 1-2, 1-3, 1-4

Table 8.2.1.2.2.1.1-2: Test parameters

Parameter		Unit	Value
Duplex mode			FDD
Active DL BWP index			1
PDSCH configuration	Mapping type		Type A
	k0		0
	Starting symbol (S)		2
	Length (L)		12
	PDSCH aggregation factor		1
	PRB bundling type		Static
	PRB bundling size		2
	Resource allocation type		Type 0
	RBG size		Config2
	VRB-to-PRB mapping type		Non-interleaved
	VRB-to-PRB mapping interleaver bundle size		N/A
PDSCH DMRS configuration	DMRS Type		Type 1
	Number of additional DMRS		1
	Maximum number of OFDM symbols for DL front loaded DMRS		1
CSI-RS for tracking	CSI-RS periodicity	Slots	20 for CSI-RS resource 1,2,3,4.
	CSI-RS offset	Slots	10 for CSI-RS resource 1 and 2 11 for CSI-RS resource 3 and 4.
Number of HARQ Processes			16 for Test 1-1, Test 1-2 32 for Test 1-3 4 with feedback disabled, 12 with feedback enabled in 16 HARQ processes with re-Tx disable for all HARQ for Test 1-4 in which 4 disabled processes are randomly select at test configuration
The number of slots between PDSCH and corresponding HARQ-ACK information			10 for Test 1-1, Test 1-2, Test 1-3 N/A for Test 1-4
Maximum number of HARQ transmission			4 for Test 1-1, Test 1-2, Test 1-3 Disabled for all HARQ processes for Test 1-4

Table 8.2.1.2.2.1.1-3: Minimum performance for Rank 1

Test num.	Reference channel	Bandwidth (MHz) / Subcarrier spacing (kHz)	Modulation format and code rate	Propagation condition	Correlation matrix and antenna configuration	Reference value	
						Fraction of maximum throughput (%)	SNR (dB)
1-1	R.PDSCH.1-1.1 FDD	10 / 15	QPSK, 0.30	NTN-TDLA100-200	1x2, ULA Low	70	0.3
1-2	R.PDSCH.1-2.1 FDD	10 / 15	16QAM, 0.48	NTN-TDLC5-200	1x2, ULA Low	70	7.6
1-3	R.PDSCH.1-1.1 FDD	10 / 15	QPSK, 0.30	NTN-TDLC5-200	1x2, ULA Low	70	-0.4
1-4	R.PDSCH.1-1.1 FDD ⁽¹⁾	10 / 15	QPSK, 0.30	NTN-TDLA100-200	1x2, ULA Low	70	1.1

Note1: The Maximum throughput is based on the HARQ processes with HARQ feedback enabled.

8.3 CSI reporting requirements

[To be updated]

9 Radiated transmitter characteristics

9.1 General

Unless otherwise stated, the transmitter characteristics are specified over the air (OTA) with a single or multiple transmit chains under either LHCP (Left Hand Circular Polarization) or RHCP (Right Hand Circular Polarization) or Linear Polarization.

9.2 Transmitter power

9.2.1 NTN VSAT maximum output power

9.2.1.0 General

The NTN VSAT classes are specified based on the assumptions of certain NTN VSAT types with specific device architectures including antenna beam steering types. The requirements are specified for different NTN VSAT types. For the hybrid beam steering capable NTN VSAT, which can adjust its antenna(s) or beam(s) in both electronic steering and mechanical steering ways, the applicable requirements shall follow either electronic or mechanical beam steering requirements depending on the NTN VSAT type it declared. The NTN VSAT types are specified in Table 9.2.1.0-1 below.

Table 9.2.1.0-1: The definitions of NTN VSAT Types

NTN VSAT class	NTN VSAT type	Type description
Fixed VSAT	1	Fixed VSAT communicating with GSO and LEO with mechanical steering antenna.
	2 ²	Fixed VSAT communicating with GSO and LEO with electronic steering antenna.
	3	Fixed VSAT communicating with LEO only with electronic steering antenna.
Mobile VSAT	4	Mobile VSAT communicating with GSO with mechanical steering antenna.
	5 ²	Mobile VSAT communicating with GSO with electronic steering antenna.
NOTE 1: The NTN VSAT types are assuming NTN VSAT has only one antenna beam towards one satellite at a given time in this release.		
NOTE 2: NTN VSAT may need power reduction to comply with OFF-axis EIRP requirement defined in clause 9.2.2. There is no requirement for the potential power reduction.		

9.2.1.1 Minimum requirements for Fixed VSAT

The following requirements define the maximum output power radiated by the Fixed VSAT for any transmission bandwidth within the channel bandwidth for non-CA configuration, unless otherwise stated. The period of measurement shall be at least one sub frame (1ms). The minimum output power values for EIRP are specified in Table 9.2.1.1-1. The requirement should be verified with test metrics of EIRP (Link=Tx beam peak direction, Meas=Link angle). The peak EIRP of Tx beam peak direction should be verified within the declared minimum elevation angle supported for transmitting. The steered beam peak directions can be achieved by mechanical steering and/or electronic steering according to VSAT Type. Where the supported minimum elevation angle shall be declared by manufacturer and within the range of $3^\circ \leq \text{minimum elevation angle} \leq 75^\circ$, and it can be expressed as $(90-\theta)$ if the coordinate systems in Figure 9.2.1.1-1 below is taken as an example.

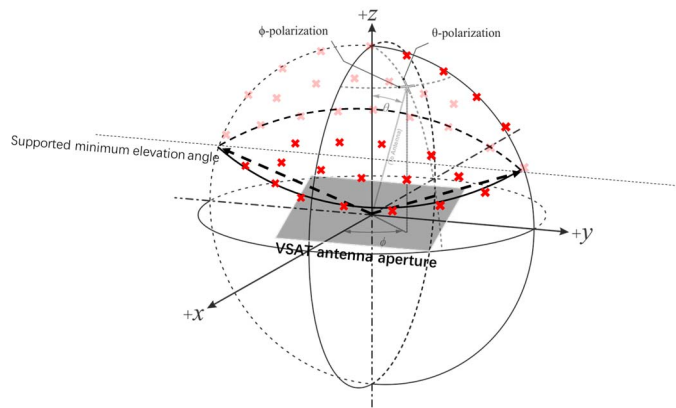

Figure 9.2.1.1-1 Example measurement grid for min peak EIRP with the declared supported minimum elevation angle

Table 9.2.1.1-1: Minimum peak EIRP for Fixed VSAT

Operating band	UE Type	Min peak EIRP (dBm)
n512, n511, n510	1	70
	2	70
	3	61
NOTE: Minimum peak EIRP is defined as the lower limit without tolerance.		

The maximum output power values for TRP and EIRP for fixed VSAT are specified in Table 9.2.1.1-2 below.

Table 9.2.1.1-2: Maximum output power limits for Fixed VSAT

Operating band	UE Type	TRP _{MAX} (dBm)	EIRP _{max} (dBm)
n512, n511, n510	1	35	76.2
	2, 3	43	76.2
NOTE: Maximum EIRP is defined using 13RBs allocation with 120kHz SCS.			

9.2.1.2 Minimum requirements for Mobile VSAT

The following requirements define the maximum output power radiated by the Mobile VSAT for any transmission bandwidth within the channel bandwidth for non-CA configuration, unless otherwise stated. The period of measurement shall be at least one sub frame (1ms). The minimum output power values for EIRP are specified in Table 9.2.1.2-1. The requirement should be verified with test metrics of EIRP (Link=Tx beam peak direction, Meas=Link angle).

The peak EIRP of Tx beam peak direction should be verified within the declared minimum elevation angle supported for transmitting. The steered beam peak directions can be achieved by mechanical steering and/or electronic steering according to VSAT Type. Where the supported minimum elevation angle shall be declared by manufacturer and within the range of $3^\circ \leq \text{minimum elevation angle} \leq 75^\circ$, and it can be expressed as $(90-\theta)$ if the coordinate systems in Figure 9.2.1.2-1 below is taken as an example.

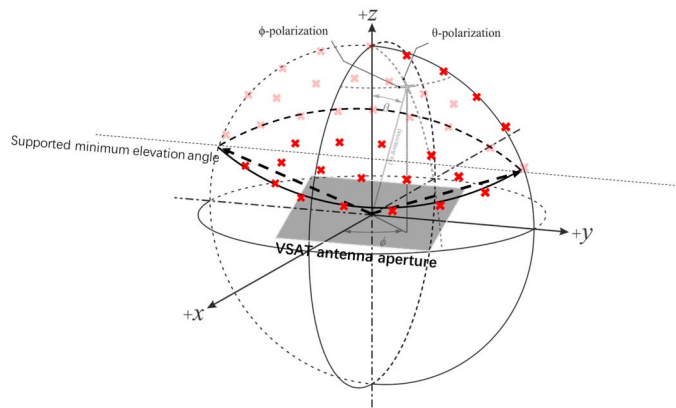

Figure 9.2.1.2-1 Example measurement grid for min peak EIRP with the declared supported minimum elevation angle

Table 9.2.1.2-1: Minimum peak EIRP for Mobile VSAT

Operating band	UE Type	Min peak EIRP (dBm)
n512, n511	4	70
	5	70
NOTE: Minimum peak EIRP is defined as the lower limit without tolerance.		

The maximum output power values for TRP and EIRP for mobile VSAT are specified in Table 9.2.1.2-2 below.

Table 9.2.1.2-2: Maximum output power limits for Mobile VSAT

Operating band	UE Type	TRP _{MAX} (dBm)	EIRP _{max} (dBm)
n512, n511, n510	4	35	76.2
	5	43	76.2
NOTE: Maximum EIRP is defined using 13RBs allocation with 120kHz SCS.			

9.2.2 Off-axis EIRP emission density limit within the operating band

9.2.2.1 General

The Off-axis EIRP density envelope is applicable within the band to NTN VSAT transmitting towards geostationary satellite orbit.

9.2.2.2 Minimum requirement for bands n510 and n511

For co-polarized transmissions in the plane tangent to the GSO arc, the requirements specified in Table 9.2.2.2-1 apply to NTN VSAT.

Table 9.2.2.2-1: Off-axis EIRP density limits for co-polarized transmissions in the plane tangent to the GSO arc

θ value	Maximum Off-axis EIRP (dBm)	Measurement bandwidth (MHz)
$2.0^\circ \leq \theta \leq 7^\circ$	$62.5 - 25\log_{10}(\theta)$	1
$7^\circ \leq \theta \leq 9.2^\circ$	41.5	1
$9.2^\circ \leq \theta \leq 19.1^\circ$	$65.5 - 25\log_{10}(\theta)$	1
$19.1^\circ < \theta \leq 180^\circ$	33.5	1

For co-polarized transmissions in the plane perpendicular to the GSO arc, the requirements specified in Table 9.2.2.2-2 apply to NTN VSAT.

Table 9.2.2.2-2: Off-axis EIRP density limits for co-polarized transmissions in the plane perpendicular to the GSO arc

θ value	Maximum Off-axis EIRP (dBm)	Measurement bandwidth (MHz)
$3.5^\circ \leq \theta \leq 7^\circ$	$65.5 - 25\log_{10}(\theta)$	1
$7^\circ \leq \theta \leq 9.2^\circ$	44.5	1
$9.2^\circ \leq \theta \leq 19.1^\circ$	$68.5 - 25\log_{10}(\theta)$	1
$19.1^\circ < \theta \leq 180^\circ$	36.5	1

The EIRP density levels specified in Table 9.2.2.2-1 and Table 9.2.2.2-2 may be exceeded by up to 3 dB, for values of $\theta > 7^\circ$, over 10% of the range of theta (θ) angles from 7–180° on each side of the line from the NTN VSAT to the target SAN.

For cross-polarized transmissions in the plane tangent to the GSO arc and in the plane perpendicular to the GSO arc, the requirements specified in Table 9.2.2.2-3 apply to NTN VSAT.

Table 9.2.2.2-2: Off-axis EIRP density limits for cross-polarized transmissions in the plane tangent to the GSO arc and in the plane perpendicular to the GSO arc

θ value	Maximum Off-axis EIRP (dBm)	Measurement bandwidth (MHz)
$2.0^\circ \leq \theta \leq 7^\circ$	$52.5 - 25\log_{10}(\theta)$	1

9.2.2.3 Additional regional minimum requirement for band n512 (NS_201N)

9.2.2.3.1 Fixed VSAT

For co-polarized transmissions, the requirements specified in Table 9.2.2.3.1-1 apply to Fixed VSAT type 1 or 2 when transmitting towards satellites in geostationary orbit.

Table 9.2.2.3.1-1: Off-axis EIRP density limits for co-polarized transmissions

θ value	Maximum Off-axis EIRP (dBm)	Measurement bandwidth (kHz)
$1.8^\circ \leq \theta \leq 7^\circ$	$49 - 25\log_{10}(\theta) - K$	40
$7^\circ \leq \theta \leq 9.2^\circ$	$28 - K$	40
$9.2^\circ \leq \theta \leq 48^\circ$	$52 - 25\log_{10}(\theta) - K$	40
$48^\circ < \theta$	$20 - K$	40
NOTE: $K=10\log(N)$ with N the number of terminals simultaneously transmitting at the same EIRP on a given carrier frequency in the same measurement bandwidth. $K = 0$ if only one Fixed VSAT transmits at any one time on a given carrier frequency. See sub-clause 4.2.4.2 in [18]. The manufacturer shall declare the value of N.		

For cross-polarized transmissions, the requirements specified in Table 9.2.2.3.1-2 apply to Fixed VSAT type 1 or 2 when transmitting towards satellites in geostationary orbit.

Table 9.2.2.3.1-2: Off-axis EIRP density limits for cross-polarized transmissions

θ value	Maximum Off-axis EIRP (dBm)	Measurement bandwidth (kHz)
$1.8^\circ \leq \theta \leq 7^\circ$	$39 - 25\log_{10}(\theta) - K$	40
$7^\circ \leq \theta \leq 9.2^\circ$	$18 - K$	40
NOTE: $K=10\log_{10}(N)$ with N the number of terminals simultaneously transmitting at the same EIRP on a given carrier frequency in the same measurement bandwidth. $K = 0$ if only one Fixed VSAT transmits at any one time on a given carrier frequency. See sub-clause 4.2.4.2 in [18]. The manufacturer shall declare the value of N.		

9.2.2.3.2 Mobile VSAT

For co-polarized transmissions, the requirements specified in Table 9.2.2.3.2-1 apply to Mobile VSAT.

Table 9.2.2.3.2-1: Off-axis EIRP density limits for co-polarized transmissions

θ value	Maximum Off-axis EIRP (dBm)	Measurement bandwidth (kHz)
$2.0^\circ \leq \theta \leq 7^\circ$	$49 - 25\log_{10}(\theta) - K$	40
$7^\circ \leq \theta \leq 9.2^\circ$	$28 - K$	40
$9.2^\circ \leq \theta \leq 48^\circ$	$52 - 25\log_{10}(\theta) - K$	40
$48^\circ < \theta \leq 180^\circ$	$20 - K$	40
NOTE1: $K=10\log_{10}(N)$ with N the number of terminals simultaneously transmitting at the same EIRP on a given carrier frequency in the same measurement bandwidth. $K = 0$ if only one Mobile VSAT transmits at any one time on a given carrier frequency. See sub-clause 4.2.2.2.1 in [17]. The manufacturer shall declare the value of N.		
NOTE2: The manufacturer shall declare the operational conditions of the system e.g. motion of the platform with 6 degrees of freedom and the duration for which the limits will not be exceeded for more than 0,01% of the time.		

Mobile VSAT with low elevation angles may exceed the limits specified in Table 9.2.2.3.2-1 by the amount specified in Table 9.2.2.3.2-2.

Table 9.2.2.3.2-2: Off-axis EIRP density limits for co-polarized transmissions

Elevation angle to Satellite (ϵ)	Increase in EIRP density (dB)
$\epsilon < 5^\circ$	2.5
$5^\circ < \epsilon < 30^\circ$	$3 - 0.1 * \epsilon$

For cross-polarized transmissions, the requirements specified in Table 9.2.2.3.2-3 apply to Mobile VSAT.

Table 9.2.2.3.2-3: Off-axis EIRP density limits for cross-polarized transmissions

θ value	Maximum Off-axis EIRP (dBm)	Measurement bandwidth (kHz)
$2.0^\circ \leq \theta \leq 7^\circ$	$39 - 25\log_{10}(\theta) - K$	40
$7^\circ \leq \theta \leq 9.2^\circ$	$18 - K$	40
NOTE 1: $K=10\log_{10}(N)$ with N the number of terminals simultaneously transmitting at the same EIRP on a given carrier frequency in the same measurement bandwidth. $K = 0$ if only one Mobile VSAT transmits at any one time on a given carrier frequency. See sub-clause 4.2.2.2.1 in [17]. The manufacturer shall declare the value of N.		
NOTE 2: The manufacturer shall declare the operational conditions of the system e.g. motion of the platform with 6 degrees of freedom and the duration for which the requirement will not be exceeded for more than 0,01% of the time.		

9.2.2.3.3 Additional Off-axis EIRP density requirements for protection of fixed services

For NTN VSAT, the requirements specified in Table 9.2.2.3.3-1 apply.

Table 9.2.2.3.3-1: Off-axis EIRP density limits for protection of fixed services

Frequency Range (GHz)	Maximum Off-axis EIRP (dBm)	Measurement bandwidth (MHz)
27.8285—28.4445	-5	1
28.8365 – 28.9485 (Note 1)		
28.9485 – 29.4525		
NOTE1: When applicable, if this frequency range is allocated to fixed service.		

9.2.3 Configured transmitted power

The NTN VSAT can configure its maximum output power. The configured NTN VSAT maximum output power $P_{\text{CMAX},f,c}$ for carrier f of a serving cell c is defined as that available to the reference point of a given transmitter branch that corresponds to the reference point of the higher-layer filtered RSRP measurement as specified in TS 38.215 [11].

The configured NTN VSAT maximum output power $P_{\text{CMAX},f,c}$ for carrier f of a serving cell c shall be set such that the corresponding measured peak EIRP $P_{\text{UMAX},f,c}$ is within the following bounds

$$P_{\text{UEType}} - T_{\text{EIRP}} \leq P_{\text{UMAX},f,c} \leq \text{EIRP}_{\text{max}} + T_{\text{EIRP}}$$

with P_{UEType} is the NTN VSAT minimum peak EIRP as specified in sub-clause 9.2.1, EIRP_{max} is the applicable maximum EIRP as specified in sub-clause 9.2.1 and T_{EIRP} is equal to 3.4 dB. The requirement is verified with the test metric of EIRP (Link=TX beam peak direction, Meas=Link angle).

while the corresponding measured total radiated power $P_{\text{TMAX},f,c}$ is bounded by the maximum TRP limit TRP_{MAX} for NTN VSAT defined in sub-clause 9.2.1:

$$P_{\text{TMAX},f,c} \leq \text{TRP}_{\text{MAX}} + T_{\text{TRP}}$$

where, T_{TRP} is specified as 3 dB. The $P_{\text{TMAX},f,c}$ requirement is verified with the test metrics of TRP (Link=TX beam peak direction, Meas=TRP grid) in beam locked mode.

9.3 Output power dynamics

9.3.1 Minimum output power

The requirement is not applicable in this version of the specification.

9.3.2 Transmit OFF power

9.3.2.1 General

The transmit OFF power is defined as the TRP in the channel bandwidth when the transmitter is OFF. The transmitter is considered OFF when the NTN VSAT is not allowed to transmit on any of its ports.

The transmit OFF power shall be less than -36 dBm/MHz. The requirement is verified with the test metric of TRP (Link=TX beam peak direction, Meas=TRP grid).

9.3.3 Transmit ON/OFF time mask

9.3.3.1 General

The transmit ON/OFF time mask defines the transient period(s) allowed

- between transmit OFF power and transmit ON power symbols (transmit ON/OFF)
- between continuous ON-power transmissions when power change or RB hopping is applied.

In case of RB hopping, transition period is shared symmetrically.

Unless otherwise stated the minimum requirements in clause 9.5 apply also in transient periods.

The transmit ON/OFF time mask is defined as a directional requirement. The requirement is verified in beam locked mode at beam peak direction. The maximum allowed EIRP OFF power level is -36dBm/MHz at beam peak direction. The requirement is verified with the test metric of EIRP (Link=TX beam peak direction, Meas=Link angle).

In the following sub-clauses, following definitions apply:

- A slot transmission is a Type A transmission.
- A long subslot transmission is a Type B transmission with more than 2 symbols.
- A short subslot transmission is a Type B transmission with 1 or 2 symbols.

9.3.3.2 General ON/OFF time mask

The general ON/OFF time mask defines the observation period allowed between transmit OFF and ON power. ON/OFF scenarios include: contiguous, and non-contiguous transmission, etc

The OFF power measurement period is defined in a duration of at least one slot excluding any transient periods. The ON power is defined as the mean power over one slot excluding any transient period.



Figure 9.3.3.2-1: General ON/OFF time mask for NR UL transmission in FR2-NTN

9.3.3.3 Transmit power time mask for slot and short or long subslot boundaries

The transmit power time mask for slot and a long subslot transmission boundaries defines the transient periods allowed between slot and long subslot PUSCH transmissions. For PUSCH-PUCCH and PUSCH-SRS transitions and multiplexing the time masks in sub-clause 9.3.3.7 apply.

The transmit power time mask for slot or long subslot and short subslot transmission boundaries defines the transient periods allowed between slot or long subslot and short subslot transmissions. The time masks in sub-clause 9.3.3.8 apply.

The transmit power time mask for short subslot transmission boundaries defines the transient periods allowed between short subslot transmissions. The time masks in sub-clause 9.3.3.9 apply.

9.3.3.4 PRACH time mask

The PRACH ON power is specified as the mean power over the PRACH measurement period excluding any transient periods as shown in Figure 9.3.3.4-1. The measurement period for different PRACH preamble format is specified in Table 9.3.3.4-1.

Table 9.3.3.4-1: PRACH ON power measurement period

Format	SCS	Measurement period
A ₁	60 kHz	0.035677 ms
	120 kHz	0.017839 ms
A ₂	60 kHz	0.071354 ms
	120 kHz	0.035677 ms
A ₃	60 kHz	0.107031 ms
	120 kHz	0.053516 ms
B ₁	60 kHz	0.035091 ms
	120 kHz	0.0175455 ms
B ₄	60 kHz	0.207617 ms
	120 kHz	0.103809 ms
A ₁ /B ₁	60 kHz	0.035677 ms for front X1 occasion 0.035091 ms for last occasion X1 = [2,5]
	120 kHz	0.017839 ms for front X1 occasion 0.017546 ms for last occasion X1 = [2,5]
A ₂ /B ₂	60 kHz	0.071354 ms for front X2 occasion 0.069596 ms for last occasion X2 = [1,2]
	120 kHz	0.035677 ms for front X2 occasion 0.034798 ms for last occasion X2 = [1,2]
A ₃ /B ₃	60 kHz	0.107031 ms for first occasion 0.104101 ms for second occasion
	120 kHz	0.053515 ms for first occasion 0.052050 ms for second occasion
C ₀	60 kHz	0.026758 ms
	120 kHz	0.013379 ms
C ₂	60 kHz	0.083333 ms
	120 kHz	0.0416667 ms

NOTE: For PRACH on PRACH occasion start from begin of 0ms or 0.5 ms boundary, the measurement period will plus 0.032552 μs

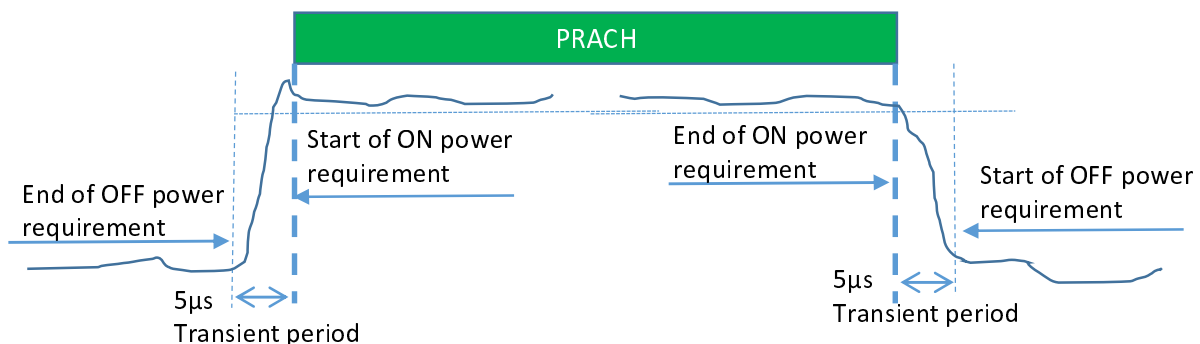

Figure 9.3.3.4-1: PRACH ON/OFF time mask

9.3.3.5 Void

9.3.3.6 SRS time mask

In the case a single SRS transmission, the ON power is defined as the mean power over the symbol duration excluding any transient period; Figure 9.3.3.6-1.

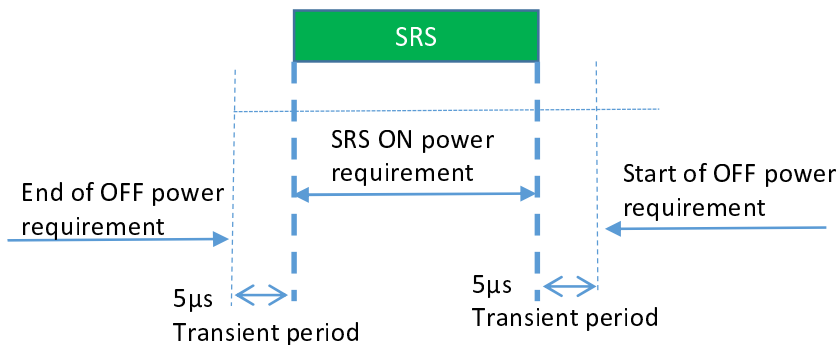

Figure 9.3.3.6-1: Single SRS time mask for NR UL transmission

In the case multiple consecutive SRS transmission, the ON power is defined as the mean power for each symbol duration excluding any transient period. See Figure 9.3.3.6-2

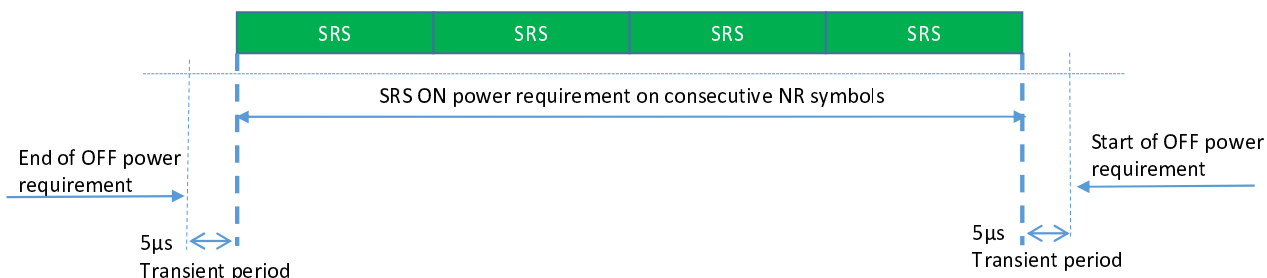

Figure 9.3.3.6-2: Consecutive SRS time mask for the case when no power change is required

When power change between consecutive SRS transmissions is required, then Figure 9.3.3.6-3 and Figure 9.3.3.6-4 apply.

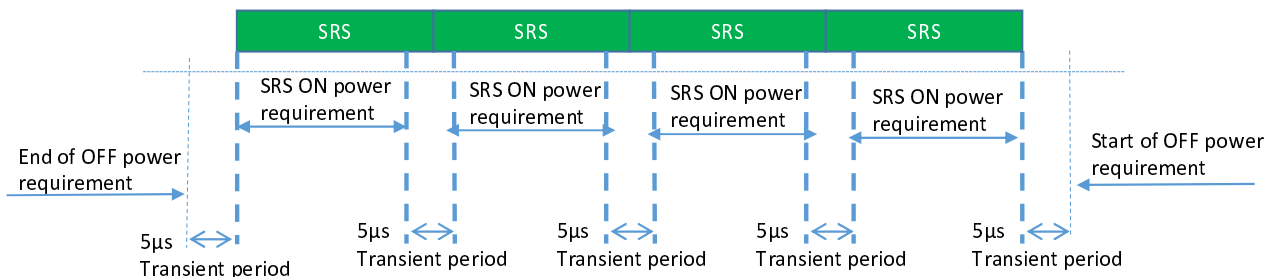

Figure 9.3.3.6-3: Consecutive SRS time mask for the case when power change is required and when 60kHz SCS is used in FR2-NTN

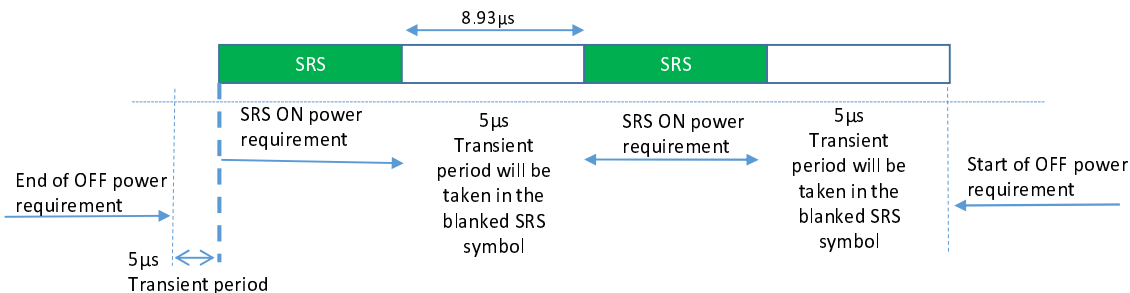

Figure 9.3.3.6-4: Consecutive SRS time mask for the case when power change is required and when 120kHz SCS is used in FR2-NTN

9.3.3.7 PUSCH-PUCCH and PUSCH-SRS time masks

The PUCCH/PUSCH/SRS time mask defines the observation period between sounding reference symbol (SRS) and an adjacent PUSCH/PUCCH symbol and subsequent UL transmissions. The time masks apply for all types of frame structures and their allowed PUCCH/PUSCH/SRS transmissions unless otherwise stated.

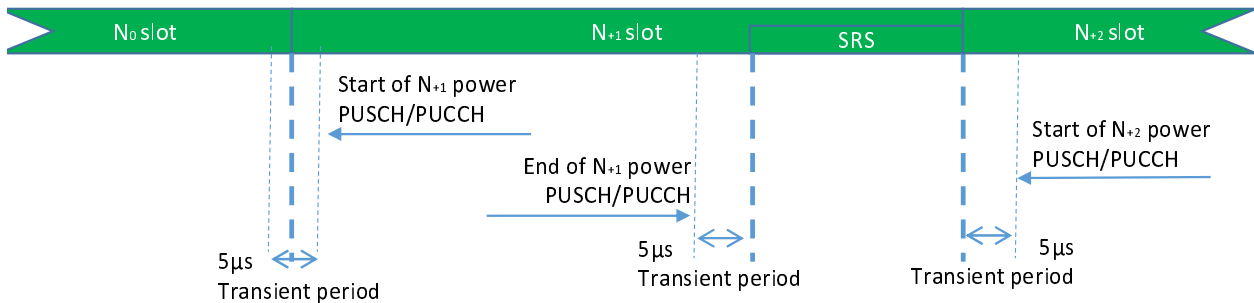

Figure 9.3.3.7-1: PUCCH/PUSCH/SRS time mask when there is a transmission before or after or both before and after SRS

When there is no transmission preceding SRS transmission or succeeding SRS transmission, then the same time mask applies as shown in Figure 9.3.3.7-1.

9.3.3.8 Transmit power time mask for consecutive slot or long subslot transmission and short subslot transmission boundaries

The transmit power time mask for consecutive slot or long subslot transmission and short subslot transmission boundaries defines the transient periods allowed between such transmissions.

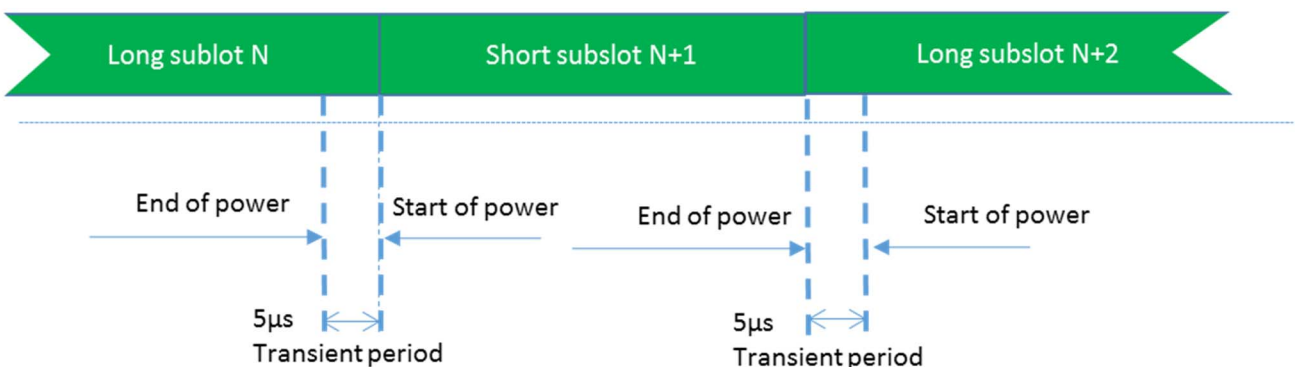

Figure 9.3.3.8-1: Consecutive slot or long subslot transmission and short subslot transmission time mask

9.3.3.9 Transmit power time mask for consecutive short subslot transmissions boundaries

The transmit power time mask for consecutive short subslot transmission boundaries defines the transient periods allowed between short subslot transmissions.

The transient period shall be equally shared as shown on Figure 9.3.3.9-1.

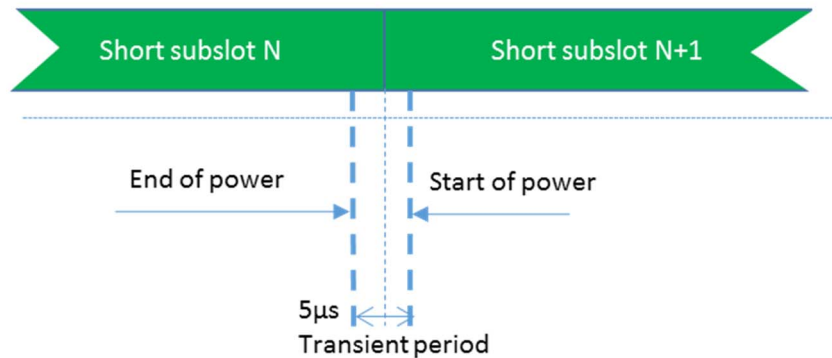

Figure 9.3.3.9-1: Consecutive short subslot transmissions time mask where DMRS is not the first symbol in the adjacent short subslot transmission

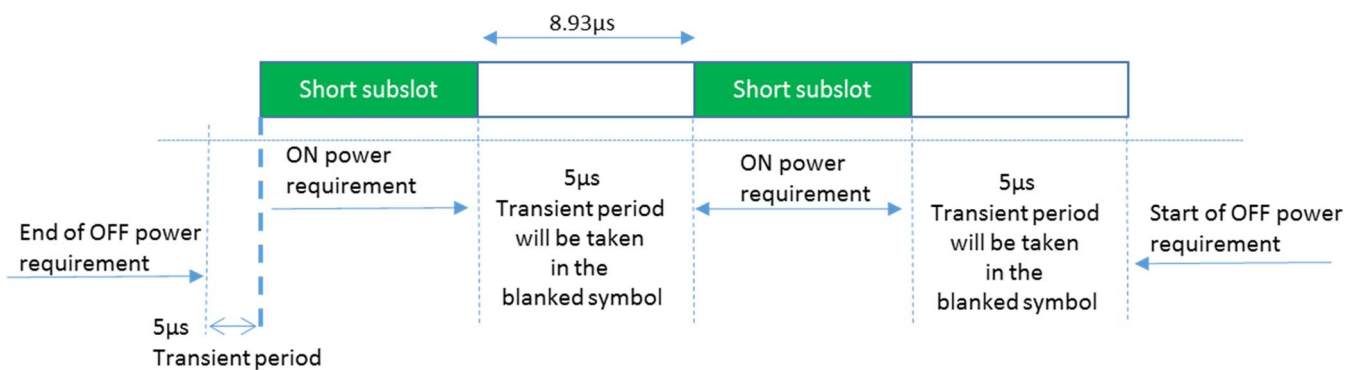

Figure 9.3.3.9-2: Consecutive short subslot (1 symbol gap) time mask for the case when transient period is required on both sides of the symbol and when 120 kHz SCS is used in FR2

9.3.4 Power control

9.3.4.1 General

The requirements on power control accuracy apply under normal conditions and are defined as a directional requirement. The requirements are verified in beam locked mode on beam peak direction.

The applicant shall declare the method and accuracy of uplink power control.

9.4 Transmitter signal quality

9.4.1 Frequency Error

The NTN VSAT basic measurement interval of modulated carrier frequency is 1 UL slot. The NTN VSAT pre-compensates the uplink modulated carrier frequency by the estimated Doppler shift according to 3GPP TS 38.300 [9] sub-clause 16.14.2. The mean value of basic measurements of NTN VSAT modulated carrier frequency shall be accurate to within ± 0.1 PPM observed over a period of 1 ms of cumulated measurement intervals compared to ideally pre-compensated reference uplink carrier frequency.

[NOTE: The ideally pre-compensated reference uplink carrier frequency consists of the UL carrier frequency signalled to the NTN VSAT by SAN and UL pre-compensated Doppler frequency shift. For the test case, the location of the NTN VSAT is explicitly provided to the NTN VSAT from the test equipment.]

Requirement will be verified for at least two cases of which one has zero Doppler conditions.

The frequency error is defined as a directional requirement. The requirement is verified in beam locked mode with the test metric of Frequency (Link=TX beam peak direction, Meas=Link angle).

9.4.2 Transmit modulation quality

9.4.2.1 General

Transmit modulation quality defines the modulation quality for expected in-channel RF transmissions from the NTN VSAT. The transmit modulation quality is specified in terms of:

- Error Vector Magnitude (EVM) for the allocated resource blocks (RBs)

All the parameters defined in sub-clause 9.4.2 are defined using the measurement methodology specified in Annex F.

All the requirements in sub-clause 9.4.2 are defined as directional requirement. The requirements are verified in beam locked mode on beam peak direction, with parameter *maxRank* (as defined in TS 38.331 [11]) set to 1. The requirements are applicable to UL transmission from each configurable antenna port (as defined in TS 38.331 [11]) of UE, enabled one at a time.

9.4.2.2 Error vector magnitude

The Error Vector Magnitude is a measure of the difference between the reference waveform and the measured waveform. This difference is called the error vector. Before calculating the EVM, the measured waveform is corrected by the sample timing offset and RF frequency offset. Then the carrier leakage shall be removed from the measured waveform before calculating the EVM.

For DFT-s-OFDM waveforms, the EVM result is defined after the front-end FFT and IDFT as the square root of the ratio of the mean error vector power to the mean reference power expressed as a percentage value (%). For CP-OFDM waveforms, the EVM result is defined after the front-end FFT as the square root of the ratio of the mean error vector power to the mean reference power expressed as a percentage value (%).

The basic EVM measurement interval in the time domain is one preamble sequence for the PRACH and one slot for PUCCH and PUSCH in the time domain. The EVM measurement interval is reduced by any symbols that contains an allowable power transient in the measurement interval as defined in sub-clause 9.3.3.

The RMS average of the basic EVM measurements over 10 subframes for the average EVM case, and over 60 subframes for the reference signal EVM case, for the different modulation schemes shall not exceed the values specified in Table 9.4.2.2-1 for the parameters defined in Table 9.4.2.2-2. For EVM evaluation purposes, all 13 PRACH preamble formats and all 5 PUCCH formats are considered to have the same EVM requirement as QPSK modulated.

The requirement is verified with the test metric of EVM (Link=TX beam peak direction, Meas=Link angle).

Table 9.4.2.2-1: Minimum requirements for error vector magnitude

Parameter	Unit	Average EVM level	Reference signal EVM level
Pi/2 BPSK	%	30.0	30.0
QPSK	%	17.5	17.5
16QAM	%	12.5	12.5
64QAM	%	8.0	8.0

Table 9.4.2.2-2: Parameters for Error Vector Magnitude

Parameter	Unit	Level
NTN VSAT EIRP	dBm	≥ [Min peak EIRP]
NTN VSAT EIRP for UL 16QAM	dBm	≥ [Min peak EIRP]
NTN VSAT EIRP for UL 64QAM	dBm	≥ [Min peak EIRP]
Operating conditions		Normal conditions

9.5 Output RF spectrum emissions

9.5.1 Occupied bandwidth

Occupied bandwidth is defined as the bandwidth containing 99 % of the total integrated mean power of the transmitted spectrum on the assigned channel. The occupied bandwidth for all transmission bandwidth configurations (Resources Blocks) shall be less than the channel bandwidth specified in Table 9.5.1-1.

The occupied bandwidth is defined as a directional requirement. The requirement is verified in beam locked mode with the test metric of OBW (Link=TX beam peak direction, Meas=Link angle).

Table 9.5.1-1: Occupied channel bandwidth

	Occupied channel bandwidth / Channel bandwidth			
	50 MHz	100 MHz	200 MHz	400 MHz
Channel bandwidth (MHz)	50	100	200	400

9.5.2 Out of Band Emissions

9.5.2.1 General

The Out of band emissions are unwanted emissions immediately outside the assigned channel bandwidth resulting from the modulation process and non-linearity in the transmitter but excluding spurious emissions. This out of band emission limit is specified in terms of a spectrum emission mask and an adjacent channel leakage power ratio. Additional requirements to protect specific bands are also considered.

The requirements in sub-clause 9.5.2.2 only apply when both UL and DL of an NTN VSAT are configured for single CC operation, and they are of the same bandwidth.

All out of band emissions for FR2-NTN are specified as TRP.

The spectrum emission mask of the NTN VSAT applies to frequencies starting from the \pm edge of the assigned NR channel bandwidth.

9.5.2.2 Spectrum emission mask

9.5.2.2.1 General NR spectrum emission mask

The power of any NTN VSAT emission shall not exceed the Basic limits specified in Table 9.5.2.2-1 for the specified channel bandwidth. The requirement is verified in beam locked mode with the test metric of TRP (Link=TX beam peak direction, Meas=TRP grid). Where:

- Δf is the separation between the Transmission BW *channel edge* frequency and the nominal -3dB point of the measuring filter closest to the carrier frequency.

- f_{offset} is the separation between the *channel edge* frequency and the centre of the measuring filter. **Table 9.5.2.2.1-1: General NR spectrum emission mask for FR2-NTN**

Frequency offset of measurement filter -3dB point, Δf	Frequency offset of measurement filter centre frequency, f_{offset}	Basic limits (dBm)	Measurement bandwidth
$0 \text{ MHz} \leq \Delta f < 2 \times \text{BW}$	$0.5 \text{ MHz} \leq f_{\text{offset}} < 2 \times \text{BW} + 0.5 \text{ MHz}$	$\max \left(11, \text{TRP}_{\text{rated}} - 10 \log_{10}(\text{BW}) - 40 \times \log_{10} \left(\frac{f_{\text{offset}} - 0.5}{\text{BW}} \times 2 + 1 \right) \right) \text{ dBm}$	1 MHz
NOTE 1: $\text{TRP}_{\text{rated}}$ is the declared rated output power lower than or equal to TRP_{max} specified in sub-clause 9.2.1; NOTE 2: Transmission BW is in the unit of MHz; NOTE 3: The 11dBm/1MHz value corresponds to the spurious emission limit specified in spurious emission sub-clause 9.5.3, and is converted from the SE limit requirement defined on 4 kHz to a value defined over 1 MHz; NOTE 4: PSD attenuation as in ITU-R SM.1541-6 [6], Annex 5 OoB domain emission limits for earth stations.			

9.5.2.2.2 Additional spectrum emission mask

For bands n511 and n510 the mean power of emissions shall be attenuated below the mean output power of the transmitter (measured in dBm) in accordance with [FCC 25.202].

The power of any NTN VSAT emission shall not exceed the Basic limits specified in Table 9.5.2.2.2-1 for the specified channel bandwidth. The requirement is verified in beam locked mode with the test metric of TRP (Link=TX beam peak direction, Meas=TRP grid). Where: f_{offset} is the separation between the *channel edge* frequency and the centre of the measuring filter.

Table 9.5.2.2.2-1: Additional spectrum emission mask

Frequency offset of measurement filter centre frequency, f_{offset}	Basic limits (dBm)	Measurement bandwidth
$0.002\text{MHz} + 0.5 \times \text{BW} \leq f_{\text{offset}} < 1 \times \text{BW} - 0.002\text{MHz}$	$\text{TRP}_{\text{rated}}(\text{dBm}) - 25 \text{ dB}$	4 kHz
$0.002\text{MHz} + 1 \times \text{BW} \leq f_{\text{offset}} < 2.5 \times \text{BW} - 0.002\text{MHz}$	$\text{TRP}_{\text{rated}}(\text{dBm}) - 35 \text{ dB}$	4 kHz
$0.002\text{MHz} + 2.5 \times \text{BW} \leq f_{\text{offset}} < 2^{\text{nd}}$ harmonic of the upper frequency edge of the UL operating band in GHz	-13 dBm	4 kHz
NOTE 1: $\text{TRP}_{\text{rated}}$ is the declared rated output power lower than or equal to TRP_{max} specified in sub-clause 9.2.1; NOTE 2: Transmission BW is in the unit of MHz; NOTE 3: <i>Measurement bandwidths</i> as in ITU-R SM.329 [16], s4.1. NOTE 4: Upper frequency as in ITU-R SM.329 [16], s2.5 table 1.		

9.5.2.3 Adjacent channel leakage ratio

Adjacent Channel Leakage power Ratio (ACLR) is the ratio of the filtered mean power centred on the assigned channel frequency to the filtered mean power centred on an adjacent channel frequency. ACLR requirement is specified for a scenario in which adjacent carrier is another NR channel.

NR Adjacent Channel Leakage power Ratio (NR_{ACLR}) is the ratio of the filtered mean power centred on the assigned channel frequency to the filtered mean power centred on an adjacent channel frequency at nominal channel spacing. The

assigned NR channel power and adjacent NR channel power are measured with rectangular filters with measurement bandwidths specified in Table 9.5.2.3-1 for FR2-NTN.

If the measured adjacent channel power is greater than $[-35]$ dBm then the NR_{ACLR} shall be higher than the value specified in Table 9.5.2.3-1. The requirement is verified in beam locked mode with the test metric of TRP (Link=TX beam peak direction, Meas=TRP grid).

Table 9.5.2.3-1: General requirements for NR_{ACLR} for FR2-NTN

	Channel bandwidth / NR_{ACLR} / Measurement bandwidth			
	50 MHz	100 MHz	200 MHz	400 MHz
NR_{ACLR} for band n512, n511, n510	14 dB	14 dB	14 dB	14 dB
NR channel measurement bandwidth (MHz)	47.58	95.16	190.20	380.28
Adjacent channel centre frequency offset (MHz)	+50 / -50	+100 / -100	+200 / -200	+400 / -400

9.5.3 Spurious Emissions

9.5.3.1 General

Spurious emissions are emissions which are caused by unwanted transmitter effects such as harmonics emission, parasitic emissions, intermodulation products and frequency conversion products, but exclude out of band emissions unless otherwise stated. The spurious emission limits are specified in terms of general requirements in line with SM.329 [16] and NR operating band requirement to address UE co-existence. Spurious emissions are measured as TRP.

To improve measurement accuracy, sensitivity and efficiency, the resolution bandwidth may be smaller than the measurement bandwidth. When the resolution bandwidth is smaller than the measurement bandwidth, the result should be integrated over the measurement bandwidth in order to obtain the equivalent noise bandwidth of the measurement bandwidth.

Unless otherwise stated, the spurious emission limits apply for the frequency ranges that are more than F_{OOB} (MHz) in Table 9.5.3.1-1 starting from the edge of the assigned NR channel bandwidth. The spurious emission limits in Table 9.5.3.1-2 apply for all transmitter band configurations (NRB) and channel bandwidths. The requirement is verified in beam locked mode with the test metric of TRP (Link=TX beam peak direction, Meas=TRP grid).

NOTE: For measurement conditions at the edge of each frequency range, the lowest frequency of the measurement position in each frequency range should be set at the lowest boundary of the frequency range plus $MBW/2$. The highest frequency of the measurement position in each frequency range should be set at the highest boundary of the frequency range minus $MBW/2$. MBW denotes the measurement bandwidth defined for the protected band.

Table 9.5.3.1-1: Boundary between NR out of band and spurious emission domain

Channel bandwidth	50 MHz	100 MHz	200 MHz	400 MHz
OOB boundary F_{OOB} (MHz)	100	200	400	800

Table 9.5.3.1-2: Spurious emissions limits

Frequency Range	Maximum Level	Measurement bandwidth
$30 \text{ MHz} \leq f \leq 2^{\text{nd}}$ harmonic of the upper frequency edge of the UL operating band in GHz	-13 dBm	4 kHz

9.5.3.2 On-axis spurious requirement

9.5.3.2.1 Applicability

The additional regional On-axis spurious requirement is applicable to NTN VSAT operating in band n512 (NS_201N and NS_202N). The On-axis spurious emissions are measured as EIRP.

These limits are applicable to the complete NTN VSAT equipment, including cabling between the units.

9.5.3.2.2 “Emissions disabled” and “Carrier-off” states

The requirements specified in table 9.5.3.2.2-1 apply to NTN VSAT in “Emissions disabled” and “Carrier-off” states. They apply outside the transmission bandwidth.

Table 9.5.3.2.2-1: On-axis spurious limits in “Emissions disabled” and “Carrier-off” states

Frequency range (GHz)	EIRP Limit (dBm)	Measurement bandwidth (MHz)
27.5 – 30.0	19	1

9.5.3.2.3 “Carrier-on” state

The requirements specified in Tables 9.5.3.2.3-1 and 9.5.3.2.3-2 apply to NTN VSAT in “Carrier-on”.

The requirement specified in Table 9.5.3.2.3-1 apply outside a bandwidth of 5 times the occupied bandwidth centred on the carrier centre frequency.

The requirement specified in Table 9.5.3.2.3-2 apply inside a bandwidth of 5 times the occupied bandwidth centred on the carrier centre frequency, and outside the transmission bandwidth.

NOTE: The on-axis spurious radiations, outside the frequency range 27.5 GHz to 30.0 GHz, are indirectly limited by sub-clause 9.5.3.3.

Table 9.5.5.2.2.3-1: On-axis spurious limits in “Carrier-on” state - outside

Frequency range (GHz)	NTN VSAT type	EIRP Limit (dBm)	Measurement bandwidth (MHz)
27.5 – 30.0	4, 5	44 - K (NOTE)	1
	1, 2, 3	4 - K (NOTE)	1
NOTE: $K=10\log_{10}(N)$ with N the number of terminals simultaneously transmitting at the same EIRP on a given carrier frequency in the same measurement bandwidth. $K = 0$ if only one NTN VSAT transmits at any one time on a given carrier frequency. See sub-clause 4.2.2.2.1 in [17] for Mobile VSAT or sub-clause 4.2.4.2 in [18] for Fixed VSAT. The manufacturer shall declare the value of N.			

Table 9.5.5.2.2.3-2: On-axis spurious limits in “Carrier-on” state - inside

Frequency range (GHz)	NTN VSAT type	EIRP Limit (dBm)	Measurement bandwidth (MHz)
27.5 – 30.0	4, 5	58 - K (NOTE)	1
	1, 2, 3	48 - K (NOTE)	1
NOTE: $K=10\log_{10}(N)$ with N the number of terminals simultaneously transmitting at the same EIRP on a given carrier frequency in the same measurement bandwidth. $K = 0$ if only one NTN VSAT transmits at any one time on a given carrier frequency. See sub-clause 4.2.2.2.1 in [17] for Mobile VSAT or sub-clause 4.2.4.2 in [18] for Fixed VSAT. The manufacturer shall declare the value of N.			

9.5.3.3 Off-axis spurious requirement

9.5.3.3.1 Applicability

The additional regional Off-axis spurious requirement is applicable to NTN VSAT operating in band n512 (NS_201N and NS_202N). The Off-axis spurious emissions are measured as EIRP.

These limits are applicable to the complete NTN VSAT equipment, including cabling between the units.

9.5.3.3.2 General

The requirements specified in table 9.5.3.3.2-1 apply to NTN VSAT at 10 meters distance from the NTN VSAT.

Table 9.5.3.3.2-1: Radiated field strength limits at 10m from the NTN VSAT

Frequency range (MHz)	EIRP Limit (dB μ V/m)	Measurement bandwidth (kHz)
30 – 230	30	120
230 – 1000	37	120

9.5.3.3.3 “Emissions disabled” state

The requirements specified in table 9.5.3.3.3-1 apply to NTN VSAT in “Emissions disabled” state for all off-axis angles greater than 7° or greater than the minimum elevation angle supported, whichever is lower.

Table 9.5.3.3.3-1: Off-axis spurious limits in “Emissions disabled” state

Frequency range (GHz)	EIRP Limit (dBm)	Measurement bandwidth (kHz)
1.0 – 2.0	-48	100
2.0 – 10.7	-42	100
10.7 – 21.2	-36	100
21.2 – 60.0	-30	100

9.5.3.3.4 “Carrier-on” and “Carrier-off” states

The requirements specified in table 9.5.3.3.4-1 apply to NTN VSAT in “Carrier-on” and “Carrier-off” states for all off-axis angles greater than 7° or greater than the minimum elevation angle supported, whichever is lower.

Table 9.5.3.3.4-1: Off-axis spurious limits in “Carrier-on” and “Carrier-off” states

Frequency range (GHz)	EIRP Limit (dBm)	Measurement bandwidth (MHz)
1.00 – 3.40	-41	0.1
3.40 – 10.70	-35	0.1
10.70 – 21.20	-29	0.1
21.20 – 27.35	-23	0.1
27.35 – 27.50	-5 (Note 1)	1
	-23 (Note 2)	0.1
27.50 – 29.35	-5 (Note 1)	1
	-23 (Note 2)	0.1
29.35 – 29.50	-5	1
30.00 – 30.15	-5	1
30.15 – 60.00	-23	0.1

NOTE 1: For mobile VSAT transmitting in the frequency range 29.5 – 30.0 GHz
NOTE 2: For mobile VSAT transmitting in the frequency range 27.5 – 29.5 GHz

9.6 Antenna pointing accuracy and performance

9.6.1 Antenna pointing accuracy

9.6.1.1 Minimum requirements for NTN VSAT

9.6.1.1.1 Applicability

Except if otherwise stated, the following additional regional requirements are applicable to NTN VSAT types 1, 2, 3, 4 or 5 operating in band n512 (NS_201N and NS_202N).

9.6.1.1.2 Pointing Accuracy

The manufacturer shall declare the peak pointing accuracy ($\delta\phi$) and the associated statistical basis.

The antenna shall maintain the declared peak pointing accuracy ($\delta\phi$), such that the off-axis EIRP emission density pattern projected onto the geostationary arc remains within the mask specified in sub-clauses 9.2.2.2 and 9.2.2.3 when shifted by an angle of $\pm(\delta\phi^\circ)$, taking into account the following factors [17]:

- the worst case operational environmental conditions;
- maximum dynamics for Mobile VSAT (e.g. maximum movement of the platform e.g. airplane, boat, vehicle during the connectivity time); and
- the range of latitude, longitude and altitude relative to the satellite orbital position.

9.6.1.1.3 On-axis cross polarization isolation

9.6.1.1.3.1 Linearly polarized NTN VSAT

This requirement is applicable to NTN VSAT type 1, 2, 4 and 5.

For linearly polarized NTN VSAT, the manufacturer shall declare the on-axis cross polarization isolation of the NTN VSAT [17, 18].

The polarization angle shall be continuously adjustable within the operational range as declared by the manufacturer.

It shall be possible to fix the transmit antenna polarization angle with an accuracy of at least 1° .

When linear polarization is used for both transmission and reception, the angle between the receive and corresponding transmit polarization planes shall not deviate by more than 1° from the nominal value declared by the manufacturer.

9.6.1.1.3.2 Circularly polarized NTN VSAT

For circularly polarized NTN VSAT, the manufacturer shall declare the voltage axial ratio.

9.6.1.2 Minimum requirement for Fixed VSAT types 1 or 2

9.6.1.2.1 Applicability

The following additional regional requirements are applicable to Fixed VSAT types 1 or 2 operating in band n512 when connected to Geostationary Satellite Orbit (GSO) SAN (NS_201N).

9.6.1.2.2 Pointing Stability

Pointing stability: Under the condition of 100 km/h maximum wind speed, with gusts of 130 km/h lasting 3 seconds, the installation shall not show any sign of permanent distortion and shall not need repointing after the application of the wind load.

9.6.1.2.3 Pointing Accuracy

9.6.1.2.3.1 General

The manufacturer shall declare the usage area in terms of the range of latitude and longitude relative to the satellite orbital position where the alignments specified below are possible.

9.6.1.2.3.2 Main beam pointing accuracy

The antenna sub-system alignment facilities shall enable the main beam axis to be adjusted and fixed with a pointing accuracy ($\delta\phi$) of either:

- 1) $0,1^\circ$; or
- 2) a greater value declared by the applicant, subject to the following restrictions:
 - the pointing accuracy ($\delta\phi$) shall not exceed 30 % of the antenna transmit main beam half power beamwidth;
 - the off-axis e.i.r.p. emission density pattern remains within the mask specified in sub-clause 9.2.2.3 when shifted by an angle of $\pm(\delta\phi - 0,1^\circ)$.

9.6.1.2.3.3 Alignment with the geostationary satellite orbit

Alignment with the geostationary satellite orbit. For antennas with asymmetric main beam, the antenna shall be capable of having the plane defined by the antenna main beam axis and its major axis aligned with the tangent to the geostationary orbit in accordance with the method declared by the manufacturer.

9.6.1.2.4 Polarization angle alignment capability for linear polarization

Following conditions will apply:

- The polarization angle shall be continuously adjustable within the operational range as declared by the manufacturer.
- It shall be possible to fix the transmit antenna polarization angle with an accuracy of at least 1° .
- When linear polarization is used for both transmission and reception, the angle between the receive and corresponding transmit polarization planes shall not deviate by more than 1° from the nominal value declared by the manufacturer.

9.6.2 Antenna performance

The following requirements are applicable to NTN VSAT type 1, type 2, type 4 or type 5 operating in band n511 or in band n510 and communicating with Geostationary Satellite Orbit (GSO) SAN.

The co-polarization gain in the plane tangent to the GSO arc shall not exceed the levels specified in Table 9.6.2-1. This envelope may be exceeded by up to 3 dB in 10% of the range of θ angles from $\pm 7-180^\circ$, and by up to 6 dB in the region of main reflector spillover energy.

Table 9.6.2-1: Co-polarization gain limit in the plane tangent to the GSO arc

θ value	Co-polarization gain (dBi)
$2^\circ \leq \theta \leq 7^\circ$	$29 - 25\log_{10}(\theta)$
$7^\circ \leq \theta \leq 9.2^\circ$	8
$9.2^\circ \leq \theta \leq 19.1^\circ$	$32 - 25\log_{10}(\theta)$
$19.1^\circ < \theta \leq 180^\circ$	0

The co-polarization gain in the plane perpendicular to the GSO arc shall not exceed the levels specified in Table 9.6.2-2. This envelope may be exceeded by up to 3 dB in 10% of the range of θ angles from $\pm 7-180^\circ$, and by up to 6 dB in the region of main reflector spillover energy.

Table 9.6.2-2: Co-polarization gain limit in the plane perpendicular to the GSO arc

θ value	Co-polarization gain (dBi)
$3.5^\circ \leq \theta \leq 7^\circ$	$32 - 25\log_{10}(\theta)$
$7^\circ \leq \theta \leq 9.2^\circ$	10.9
$9.2^\circ \leq \theta \leq 19.1^\circ$	$35 - 25\log_{10}(\theta)$
$19.1^\circ < \theta \leq 180^\circ$	3

The off-axis cross-polarization gain in the plane tangent and in the plane perpendicular to the GSO arc shall not exceed the levels specified in Table 9.6.2-3.

Table 9.6.2-3: Cross-polarization gain limit

θ value	Co-polarization gain (dBi)
$2^\circ \leq \theta \leq 7^\circ$	$19 - 25\log_{10}(\theta)$

9.7 Additional regional requirements indicated by NS

9.7.1 General

Additional regional requirements can be signalled by the network. Each group of additional regional requirements is associated with a unique network signalling (NS) value indicated in RRC signalling by an NR NTN frequency band number of the applicable FR2-NTN operating band and an associated value in the field *additionalSpectrumEmission*. Throughout this specification, the notion of indication or signalling of an NS value refers to the corresponding indication of an NR frequency band number of the applicable operating band, the IE field *freqBandIndicatorNR* and an associated value of *additionalSpectrumEmission* in the relevant RRC information elements [8].

Table 9.7.1-1 specifies the additional regional requirements with their associated network signalling values, the applicable satellite orbit scenario(s) and applicable FR2-NTN operating band(s) for each NS value. The mapping of NR frequency band numbers and values of the *additionalSpectrumEmission* to network signalling labels is specified in Table 9.7.1-2.

Table 9.7.1-1: Additional regional requirements indicated by Network Signalling label

Network Signalling label	Requirements (clause)	Applicable Satellite orbit scenario	NR satellite Band	Channel bandwidth (MHz)
NS_200N		GSO and LEO	Table 5.2.3-1	50, 100, 200, 400
NS_201N	Clause 9.2.2.3 Clause 9.5.3.2 Clause 9.5.3.3 Clause 9.6.1.1 Clause 9.6.1.2 Clause 10.8	GSO	n512	50, 100, 200, 400
NS_202N	Clause 9.5.3.2 Clause 9.5.3.3 Clause 9.6.1.1	LEO	n512	50, 100, 200, 400

Table 9.7.1-2: Mapping of network signalling label

NR satellite band	Value of <i>additionalSpectrumEmission</i>							
	0	1	2	3	4	5	6	7
n512	NS_200N	NS_201N	NS_202N					Reserved
n511	NS_200N							Reserved
n510	NS_200N							Reserved
NOTE 1: <i>additionalSpectrumEmission</i> corresponds to an information element of the same name defined in clause 6.3.2 of 3GPP TS 38.331 [8].								
NOTE 2: For band n511 and n510, only NS_200N can be used to map.								

10 Radiated receiver characteristics

10.1 General

Unless otherwise stated, the receiver characteristics are specified over the air (OTA) at the RIB for Ka bands fixed and mobile VSAT. The power level for all DL wanted signals and interference is defined assuming a 0 dBi reference antenna located at the center of the quiet zone.

10.2 Polarization characteristics

The minimum requirements on the receiver characteristics apply under either LHCP (Left Hand Circular Polarization) or RHCP (Right Hand Circular Polarization) or Linear Polarization.

10.3 OTA reference sensitivity level

10.3.1 General

The OTA REFSSENS requirement is a *directional requirement* and is intended to ensure the minimum OTA reference sensitivity level at the centre of the quiet zone in the RX beam peak direction. The OTA reference sensitivity power level $EIS_{REFSENS}$ is the minimum mean power received over the air at the RIB, at which the throughput shall meet or exceed the requirements for a specified reference measurement channel.

10.3.2 Minimum requirement

The throughput shall be $\geq 95\%$ of the maximum throughput of the reference measurement channels as specified in Annexes A.3.2.1.2 and A.3.2.1.3 (with one sided dynamic OCNG Pattern OP.1 FDD for the DL-signal as described in Annex A.5.1.1) with peak reference sensitivity specified in Table 10.3.2-1. $EIS_{REFSENS_50M}$ declared by the vendor is an integer value in the range specified in Table 10.3.2-2 for different types of NTN VSAT. The requirement is verified with the test metric of EIS (Link=RX beam peak direction, Meas=Link Angle).

The EIS of Rx beam peak direction should be verified within the declared minimum elevation angle supported for receiving. The steered beam peak directions can be achieved by mechanical steering and/or electronic steering according to VSAT Type. Where the supported minimum elevation angle shall be declared by manufacturer and within the range of $3^\circ \leq \text{minimum elevation angle} \leq 75^\circ$, and it can be expressed as $(90-\theta)$ if the coordinate systems in Figure 10.3.2-1 below is taken as an example.

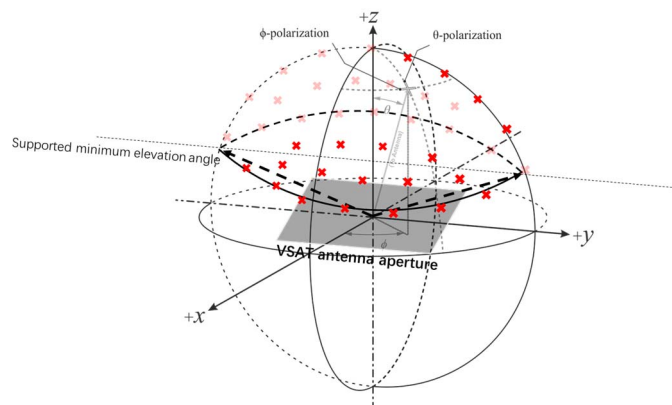

Figure 10.3.2-1 Example measurement grid for EIS with the declared supported minimum elevation angle

Table 10.3.2-1: OTA reference sensitivity requirement for NTN VSAT

NTN VSAT channel bandwidth (MHz)	UL/DL RB allocation	OTA reference sensitivity level, $EIS_{REFSENS}$ (dBm)
50, 100, 200, 400	Full RB allocation N_{RB} as specified in sub-clause 5.3.2	$EIS_{REFSENS_50MHz} + 10\log_{10}(N_{RB} \times SCS \times 12 / \text{factor})$ (NOTE 1)
NOTE 1: The "factor" represents the normalized factor to scale EIS for different (Channel bandwidth, SCS) configurations. The value of factor is 66 RBs x 60 kHz SCS x 12, i.e. 47520 kHz.		

Table 10.3.2-2: The range of $EIS_{REFSENS_50MHz}$ declared by vendor per NTN VSAT

Operating band	NTN VSAT class	NTN VSAT type	The range of $EIS_{REFSENS_50MHz}$ (dBm)
n512, n511	Fixed VSAT	1, 2	≤ -122
		3	≤ -115.6
n512, n511, n510	Mobile VSAT	4, 5	≤ -122

10.4 Maximum input level

10.4.1 General

The maximum input level is defined as the maximum mean power, for which the throughput shall meet or exceed the minimum requirements for the specified reference measurement channel.

The maximum input level is defined as a directional requirement. The requirement is verified in beam locked mode in the direction where peak gain is achieved.

10.4.2 Minimum requirement for Mobile VSAT

For mobile VSAT, the throughput shall be $\geq 95\%$ of the maximum throughput of the reference measurement channels as specified in Annex A (with one sided dynamic OCNG Pattern for the DL-signal as described in Annex A.5.1.1) with parameters specified in Table 10.4.2-1. The requirement is verified with the test metric of EIS (Link=RX beam peak direction, Meas=Link angle).

Table 10.4.2-1: Maximum input level

Rx Parameter	Units	Channel bandwidth			
		50 MHz	100 MHz	200 MHz	400 MHz
Power in transmission bandwidth configuration	dBm	-109.6 for type 4 and type 5 (NOTE 2, 3, 4)			
NOTE 1: The transmitter shall be set to [4 dB] below the $P_{UMAX,f,c}$ as defined in sub-clause 9.2.3, with uplink configuration specified in Table 10.3.2-1.					
NOTE 2: Reference measurement channel is specified in Annex A.3.2.1.2 and A.3.2.1.3: QPSK, R=1/3 variant with one sided dynamic OCNG Pattern as described in Annex A.5.1.1.					
NOTE 3: Reference measurement channel is specified in Annex A.3.2.1.2 and A.3.2.1.3: 16QAM, R=1/2 variant with one sided dynamic OCNG Pattern as described in Annex A.5.1.1.					
NOTE 4: Reference measurement channel is specified in Annex A.3.2.1.2 and A.3.2.1.3: 64QAM, R=1/2 variant with one sided dynamic OCNG Pattern as described in Annex A.5.1.1.					

10.4.3 Minimum requirement for Fixed VSAT

For fixed VSAT, the throughput shall be $\geq 95\%$ of the maximum throughput of the reference measurement channels as specified in Annex A (with one sided dynamic OCNG Pattern for the DL-signal as described in Annex A.5.1.1) with

parameters specified in Table 10.4.3.-1. The requirement is verified with the test metric of EIS (Link=RX beam peak direction, Meas=Link angle).

Table 10.4.3-1: Maximum input level

Rx Parameter	Units	Channel bandwidth			
		50 MHz	100 MHz	200 MHz	400 MHz
Power in transmission bandwidth configuration	dBm	-101 for type 1, type 2 and type 3 (NOTE 2, 3, 4)			
NOTE 1: The transmitter shall be set to [4 dB] below the $P_{UMAX,f,c}$ as defined in sub-clause 9.2.3, with uplink configuration specified in Table 10.3.2-1.					
NOTE 2: Reference measurement channel is specified in Annex A.3.2.1.2 and A.3.2.1.3: QPSK, R=1/3 variant with one sided dynamic OCNG Pattern as described in Annex A.5.1.1.					
NOTE 3: Reference measurement channel is specified in Annex A.3.2.1.2 and A.3.2.1.3: 16QAM, R=1/2 variant with one sided dynamic OCNG Pattern as described in Annex A.5.1.1.					
NOTE 4: Reference measurement channel is specified in Annex A.3.2.1.2 and A.3.2.1.3: 64QAM, R=1/2 variant with one sided dynamic OCNG Pattern as described in Annex A.5.1.1.					

10.5 Adjacent channel selectivity

10.5.1 Minimum requirement for Mobile VSAT

Adjacent Channel Selectivity (ACS) is a measure of a receiver's ability to receive a NR signal at its assigned channel frequency in the presence of an adjacent channel signal at a given frequency offset from the centre frequency of the assigned channel. ACS is the ratio of the receive filter attenuation on the assigned channel frequency to the receive filter attenuation on the adjacent channel(s).

The requirement applies at the RIB when the AoA of the incident wave of the wanted signal and the interfering signal are both from the same direction.

For mobile VSAT, the throughput shall be ≥ 95 % of the maximum throughput of the reference measurement channels as specified in Annexes A.3.2.1.2 and A.3.2.1.3 (with one sided dynamic OCNG Pattern OP.1 FDD for the DL-signal as described in Annex A.5.1.1) with parameters specified in Table 10.5.1-1 and Table 10.5.1-2. The requirement is verified with the test metric of EIS (Link=RX beam peak direction, Meas=Link angle).

Table 10.5.1-1: Adjacent channel selectivity

Operating band	Units	Adjacent channel selectivity / Channel bandwidth			
		50 MHz	100 MHz	200 MHz	400 MHz
n512, n511, n510	dB	25	25	25	25

Table 10.5.1-2: Adjacent channel selectivity test parameters

Rx Parameter	Units	Channel bandwidth			
		50 MHz	100 MHz	200 MHz	400 MHz
Power in Transmission Bandwidth Configuration	dBm	$EIS_{REFSENS_50M} + 6 \text{ dB} + 10\log_{10}(N_{RB} \times SCS \times 12 / \text{factor})$ NOTE 5			
$P_{Interferer}$ for band n512, n511, n510	dBm	$EIS_{REFSENS_50M} + 28.7 + 10\log_{10}(N_{RB} \times SCS \times 12 / \text{factor})$ NOTE 5			
$BW_{Interferer}$	MHz	50	100	200	400
$F_{Interferer}$ (offset)	MHz	50 / -50 NOTE 3	100 / -100 NOTE 3	200 / -200 NOTE 3	400 / -400 NOTE 3
NOTE 1: The interferer consists of the Reference measurement channel specified in Annex A.3.3 [15] with one sided dynamic OCNG Pattern as described in Annex A.5.2.1 [15] and set-up according to Annex C.					
NOTE 2: $EIS_{REFSENS_50M}$ declared by the vendor is an integer value in the range specified in Table 10.3.2-2 for different types of NTN VSAT.					
NOTE 3: The absolute value of the interferer offset $F_{Interferer}$ (offset) shall be further adjusted to $(CEIL(F_{Interferer}(\text{offset}) /SCS) + 0.5) * SCS$ MHz with SCS the sub-carrier spacing of the wanted signal in MHz. Wanted and interferer signal have same SCS.					
NOTE 4: The transmitter shall be set to same as the $P_{UMAX,f,c}$ as defined in clause 9.2.3, with uplink configuration specified in Table 10.3.2-1.					
NOTE 5: SCS is in kHz, the "factor" represents the normalized factor to scale wanted signal and interference level for different (Channel bandwidth, SCS) configurations. The value of factor is $66 \text{ RBs} \times 60 \text{ kHz SCS} \times 12$, i.e. 47520 kHz.					

10.5.2 Minimum requirement for Fixed VSAT

Adjacent Channel Selectivity (ACS) is a measure of a receiver's ability to receive a NR signal at its assigned channel frequency in the presence of an adjacent channel signal at a given frequency offset from the centre frequency of the assigned channel. ACS is the ratio of the receive filter attenuation on the assigned channel frequency to the receive filter attenuation on the adjacent channel(s).

The requirement applies at the RIB when the AoA of the incident wave of the wanted signal and the interfering signal are both from the same direction.

For fixed VSAT, the throughput shall be ≥ 95 % of the maximum throughput of the reference measurement channels as specified in Annexes A.3.2.1.2 and A.3.2.1.3 (with one sided dynamic OCNG Pattern OP.1 FDD for the DL-signal as described in Annex A.5.1.1) with parameters specified in Table 10.5.2-1 and Table 10.5.2-2. The requirement is verified with the test metric of EIS (Link=RX beam peak direction, Meas=Link angle).

Table 10.5.2-1: Adjacent channel selectivity

Operating band	Units	Adjacent channel selectivity / Channel bandwidth			
		50 MHz	100 MHz	200 MHz	400 MHz
n512, n511, n510	dB	25	25	25	25

Table 10.5.2-2: Adjacent channel selectivity test parameters

Rx Parameter	Units	Channel bandwidth			
		50 MHz	100 MHz	200 MHz	400 MHz
Power in Transmission Bandwidth Configuration	dBm	$EIS_{REFSENS_50M} + 6 \text{ dB} + 10\log_{10}(N_{RB} \times SCS \times 12 / \text{factor})$ NOTE 5			
$P_{Interferer}$ for band n512, n511, n510	dBm	$EIS_{REFSENS_50M} + 28.7 + 10\log_{10}(N_{RB} \times SCS \times 12 / \text{factor})$ NOTE 5			
$BW_{Interferer}$	MHz	50	100	200	400
$F_{Interferer}$ (offset)	MHz	50 / -50 NOTE 3	100 / -100 NOTE 3	200 / -200 NOTE 3	400 / -400 NOTE 3
NOTE 1: The interferer consists of the Reference measurement channel specified in Annex A.3.3 [15] with one sided dynamic OCNG Pattern as described in Annex A.5.2.1 [15] and set-up according to Annex C.					
NOTE 2: $EIS_{REFSENS_50M}$ declared by the vendor is an integer value in the range specified in Table 10.3.2-2 for different types of NTN VSAT.					
NOTE 3: The absolute value of the interferer offset $F_{Interferer}$ (offset) shall be further adjusted to $(\text{CEIL}(F_{Interferer}(\text{offset}) /SCS) + 0.5) \times SCS$ MHz with SCS the sub-carrier spacing of the wanted signal in MHz. Wanted and interferer signal have same SCS.					
NOTE 4: The transmitter shall be set to same as the $P_{UMAX,f,c}$ as defined in clause 9.2.3, with uplink configuration specified in Table 10.3.2-1.					
NOTE 5: SCS is in kHz, the "factor" represents the normalized factor to scale wanted signal and interference level for different (Channel bandwidth, SCS) configurations. The value of factor is $66 \text{ RBs} \times 60 \text{ kHz SCS} \times 12$, i.e. 47520 kHz.					

10.6 Blocking characteristics

10.6.1 General

The blocking characteristic is a measure of the receiver's ability to receive a wanted signal at its assigned channel frequency in the presence of an unwanted interferer on frequencies other than those of the spurious response or the adjacent channels, without this unwanted input signal causing a degradation of the performance of the receiver beyond a specified limit. The blocking performance shall apply at all frequencies except those at which a spurious response occurs.

The requirement applies at the RIB when the AoA of the incident wave of the wanted signal and the interfering signal are both from the direction where peak gain is achieved.

The wanted and interfering signals apply to all supported polarizations, under the assumption of polarization match.

10.6.2 Minimum requirement for Mobile VSAT

In-band blocking is a measure of a receiver's ability to receive a NR signal at its assigned channel frequency in the presence of an interferer at a given frequency offset from the centre frequency of the assigned channel.

For mobile VSAT, the throughput shall be $\geq 95\%$ of the maximum throughput of the reference measurement channels as specified in Annexes A.3.2.1.2 and A.3.2.1.3 (with one sided dynamic OCNG Pattern OP.1 FDD for the DL-signal as described in Annex A.5.1.1) with parameters specified in Table 10.6.2-1. The requirement is verified with the test metric of EIS (Link=RX beam peak direction, Meas=Link angle).

Table 10.6.2-1: In band blocking requirements

Rx parameter	Units	Channel bandwidth			
		50 MHz	100 MHz	200 MHz	400 MHz
Power in Transmission Bandwidth Configuration	dBm	$EIS_{REFSENS_50M} + 6 \text{ dB} + 10\log_{10}(N_{RB} \times SCS \times 12 / \text{factor})$			
$BW_{Interferer}$	MHz	50	100	200	400
$P_{Interferer}$ for bands n512, n511	dBm	$EIS_{REFSENS_50M} + 28.7 + 10\log_{10}(N_{RB} \times SCS \times 12 / \text{factor})$			
$F_{Interferer}$ (offset)	MHz	≤ -100 & ≥ 100 NOTE 5	≤ -200 & ≥ 200 NOTE 5	≤ -400 & ≥ 400 NOTE 5	≤ -800 & ≥ 800 NOTE 5
$F_{Interferer}$	MHz	$F_{DL_low} + 25$ to $F_{DL_high} - 25$	$F_{DL_low} + 50$ to $F_{DL_high} - 50$	$F_{DL_low} + 100$ to $F_{DL_high} - 100$	$F_{DL_low} + 200$ to $F_{DL_high} - 200$
NOTE 1: The interferer consists of the Reference measurement channel specified in Annex A.3.3 [15] with one sided dynamic OCNG Pattern as described in Annex A.5.2.1 [15] and set-up according to Annex C.					
NOTE 2: $EIS_{REFSENS_50M}$ declared by the vendor is an integer value in the range specified in Table 10.3.2-2 for different types of NTN VSAT.					
NOTE 3: The wanted signal consists of the reference measurement channel specified in Annex A.3.2 with one sided dynamic OCNG pattern as described in Annex A.5.1.1 and set-up according to Annex C.					
NOTE 4: Void					
NOTE 5: The absolute value of the interferer offset $F_{Interferer}$ (offset) shall be further adjusted $(\text{CEIL}(F_{Interferer}(\text{offset}) /SCS) + 0.5) * SCS$ MHz with SCS the sub-carrier spacing of the wanted signal in MHz. Wanted and interferer signal have same SCS.					
NOTE 6: $F_{Interferer}$ range values for unwanted modulated interfering signals are interferer center frequencies.					
NOTE 7: The transmitter shall be set to [4 dB] below the $P_{UMAX,t,c}$ as defined in clause 9.2.3, with uplink configuration specified in Table 10.3.2-1.					
NOTE 8: The "factor" represents the normalized factor to scale EIS for different (Channel bandwidth, SCS) configurations. The value of factor is $66 \text{ RBs} \times 60 \text{ kHz SCS} \times 12$, i.e. 47520 kHz.					

10.6.3 Minimum requirement for Fixed VSAT

In-band blocking is a measure of a receiver's ability to receive a NR signal at its assigned channel frequency in the presence of an interferer at a given frequency offset from the centre frequency of the assigned channel.

For fixed VSAT, the throughput shall be ≥ 95 % of the maximum throughput of the reference measurement channels as specified in Annexes A.2.3.2 and A.3.3.2 (with one sided dynamic OCNG Pattern OP.1 FDD for the DL-signal as described in Annex A.5.1.1) with parameters specified in Table 10.6.3-1. The requirement is verified with the test metric of EIS (Link=RX beam peak direction, Meas=Link angle).

Table 10.6.3-1: In band blocking requirements

Rx parameter	Units	Channel bandwidth			
		50 MHz	100 MHz	200 MHz	400 MHz
Power in Transmission Bandwidth Configuration	dBm	$EIS_{REFSENS_50M} + 6 \text{ dB} + 10\log_{10}(N_{RB} \times SCS \times 12 / \text{factor})$			
$BW_{Interferer}$	MHz	50	100	200	400
$P_{Interferer}$ for bands n512, n511, n510	dBm	$EIS_{REFSENS_50M} + 28.7 + 10\log_{10}(N_{RB} \times SCS \times 12 / \text{factor})$			
$F_{Interferer}$ (offset)	MHz	≤ -100 & ≥ 100 NOTE 5	≤ -200 & ≥ 200 NOTE 5	≤ -400 & ≥ 400 NOTE 5	≤ -800 & ≥ 800 NOTE 5
$F_{Interferer}$	MHz	$F_{DL_low} + 25$ to $F_{DL_high} - 25$	$F_{DL_low} + 50$ to $F_{DL_high} - 50$	$F_{DL_low} + 100$ to $F_{DL_high} - 100$	$F_{DL_low} + 200$ to $F_{DL_high} - 200$
NOTE 1: The interferer consists of the Reference measurement channel specified in Annex A.3.3 [15] with one sided dynamic OCNG Pattern as described in Annex A.5.2.1 [15] and set-up according to Annex C.					
NOTE 2: $EIS_{REFSENS_50M}$ declared by the vendor is an integer value in the range specified in Table 10.3.2-2 for different types of NTN VSAT.					
NOTE 3: The wanted signal consists of the reference measurement channel specified in Annex A.3.2 with one sided dynamic OCNG pattern as described in Annex A.5.1.1 and set-up according to Annex C.					
NOTE 4: Void					
NOTE 5: The absolute value of the interferer offset $F_{Interferer}$ (offset) shall be further adjusted $(CEIL(F_{Interferer}(\text{offset}) /SCS) + 0.5) * SCS$ MHz with SCS the sub-carrier spacing of the wanted signal in MHz. Wanted and interferer signal have same SCS.					
NOTE 6: $F_{Interferer}$ range values for unwanted modulated interfering signals are interferer center frequencies.					
NOTE 7: The transmitter shall be set to [4 dB] below the $P_{UMAX,t,c}$ as defined in clause 9.2.3, with uplink configuration specified in Table 10.3.2-1.					
NOTE 8: The "factor" represents the normalized factor to scale EIS for different (Channel bandwidth, SCS) configurations. The value of factor is 66 RBs x 60 kHz SCS x 12, i.e. 47520 kHz.					

10.7 Spurious emissions

The requirement is not applicable in this version of the specification.

10.8 Receiver antenna off-axis performance

The following additional regional requirements are applicable to NTN VSAT operating in band n512 (NS_201N) towards geostationary satellite orbit.

The receiver antenna off-axis gain of each co-polarized components in any direction ϕ degrees from the antenna main beam shall not exceed the levels specified in Table 10.8-1.

Table 10.8-1: Off-axis Co-polarized gain limit

ϕ value (degree)	gain (dBi)
$\phi_{min} \leq \phi \leq 48^\circ$	$32 - 25\log\phi$
$48^\circ \leq \phi \leq 85^\circ$	-10
$85^\circ \leq \phi \leq 180^\circ$	0
NOTE: $\phi_{min} = 1^\circ$ or $100\lambda/D$ (degrees) whichever is the greater, for $D/\lambda \geq 50$. $\phi_{min} = 2^\circ$ or $114(D/\lambda)^{-1.09}$ (degrees) whichever is the greater, for $D/\lambda < 50$. where D is the nominal diameter of the antenna	

The receiver antenna off-axis gain of each cross-polarized components in any direction ϕ degrees from the antenna main beam shall not exceed the levels specified in Table 10.8-2.

Table 10.8-2: Off-axis Cross-polarized gain limit

ϕ value (degree)	gain (dBi)
$\phi_r \leq \phi \leq 7^\circ$	$23 - 20\log\phi$
NOTE: $\phi_r = 1^\circ$ or $100\lambda/D$ (degrees) whichever is the greater where D is the nominal diameter of the antenna	

11 Demodulation performance requirements (Radiated requirements)

11.1 General

11.1.2 Applicability of minimum requirements

The conducted minimum requirements specified in this specification shall be met in all applicable scenarios for FR2-NTN.

11.1.3 Radiated requirements

11.1.3.1 Introduction

The requirements are defined for the following modes:

- Mode 1: Conditions with external noise source
 - Wanted signal with power level E_s is transmitted.
 - External white noise source with power spectral density N_{oc} is used.
 - E_s and N_{oc} levels are selected to achieve target SNR as described in Clause 11.1.3.3.

11.1.3.2 Reference point

The reference point for SNR, E_s and N_{oc} of DL signal is the UE antenna connector or connectors.

11.1.3.3 SNR definition

For Mode 1 conditions UE demodulation and CSI requirements, the Minimum performance requirement in clause 11 are defined relative to the baseband SNR level SNR_{BB} . The SNR at the reference point is defined as

$$SNR = SNR_{BB} + \Delta_{BB}$$

where Δ_{BB} is specified in clause 4.5.3.

The reference point SNR is defined as:

$$SNR = \frac{\sum_{j=1}^{N_{RX}} E_s^{(j)}}{\sum_{j=1}^{N_{RX}} N_{oc}^{(j)}}$$

- N_{RX} denotes the number of receiver reference points, and the super script receiver reference point j .
- The above SNR definition assumes that the REs are not precoded, and does not account for any gain which can be associated to the precoding operation.
- Unless otherwise stated, the SNR refers to the SSS wanted signal.

- The downlink SSS transmit power is defined as the linear average over the power contributions in [W] of all resource elements that carry the SSS within the operating system bandwidth.
- The power ratio of other wanted signals to the SSS is defined in Clause C.3.1.

11.1.3.4 Noc

11.1.3.4.1 Introduction

This clause describes the Noc power level for Mode 1 conditions conducted testing of demodulation and CSI requirements.

11.1.3.4.2 Noc for operating bands in FR2-NTN

Unless otherwise stated, a fixed Noc power level of -145 dBm/Hz shall be used for all operating bands.

11.2 Demodulation performance requirements

11.2.1 General

11.2.1.1 Applicability of requirements

11.2.1.1.1 General

The minimum performance requirements are applicable to all FR2-NTN operating bands defined in clause 5.2.

If same test is listed for different UE features/capabilities in Clauses 11.2.1.1.2, then this test shall apply for UEs which support all corresponding UE features/capabilities.

11.2.1.1.2 Applicability of requirements for optional UE features

The performance requirements in Table 11.2.1.1.2-1 shall apply for UEs which support optional UE features only.

Table 11.2.1.1.2-1: Requirements applicability for optional UE features

UE feature/capability [11]	Test type		Test list	Applicability notes
NR NTN access (nonTerrestrialNetwork-r17)	FR2-NTN	PDCCH	Clause 11.2.3.1.1.1 (Test 1-1, Test 1-2)	
NR NTN scenario support (ntn-ScenarioSupport-r17)	FR2-NTN	PDSCH	Clause 11.2.2.1.1.1 (Test 2-1, Test 2-2, Test 2-3, Test 2-4)	The requirements apply only when <i>ntn-ScenarioSupport-r17</i> is "gso"
	FR2-NTN	PDSCH	Clause 11.2.2.1.1.1 (Test 1-1, Test 1-2, Test 1-3, Test 1-4)	The requirements apply only when <i>ntn-ScenarioSupport-r17</i> is "ngso" or is not configured.
Increasing the number of HARQ processes (max-HARQ-ProcessNumber-r17)	FR2-NTN	PDSCH	Clause 11.2.1.2.2.1 (Test 1-3, 2-3)	
Disabled HARQ feedback for downlink transmission (harq-FeedbackDisabled-r17)	FR2-NTN	PDSCH	Clause 11.2.1.2.2.1 (Test 1-4, 2-4)	

11.2.2 PDSCH demodulation requirements

The parameters specified in Table 11.2.2-1 are valid for all PDSCH tests unless otherwise stated.

Table 11.2.2-1: Common test parameters

Parameter		Unit	Value
PDSCH transmission scheme			Transmission scheme 1
Carrier configuration	Offset between Point A and the lowest usable subcarrier on this carrier (Note 2)	RBs	0
	Subcarrier spacing	kHz	120
DL BWP configuration #1	Cyclic prefix		Normal
	RB offset	RBs	0
	Number of contiguous PRB	PRBs	Maximum transmission bandwidth configuration as specified in clause 5.3.2 of TS 38.101-2 [15] for tested channel bandwidth and subcarrier spacing
Common serving cell parameters	Physical Cell ID		0
	SSB position in burst		First SSB in Slot #0
	SSB periodicity	ms	20
PDCCH configuration	Slots for PDCCH monitoring		Each slot
	Symbols with PDCCH	Symbols	0
	Number of PRBs in CORESET		Table 7.2-2 of 38.101-4 for tested channel bandwidth and subcarrier spacing
	Number of PDCCH candidates and aggregation levels		1/AL8
	CCE-to-REG mapping type		Non-interleaved
	DCI format		1_1
	TCI state		TCI state #1
	PDCCH & PDCCH DMRS Precoding configuration		No precoding
Cross carrier scheduling			Not configured
CSI-RS for tracking	First subcarrier index in the PRB used for CSI-RS		$k_0=0$ for CSI-RS resource 1,2,3,4
	First OFDM symbol in the PRB used for CSI-RS		$l_0 = 6$ for CSI-RS resource 1 and 3 $l_0 = 10$ for CSI-RS resource 2 and 4
	Number of CSI-RS ports (X)		1 for CSI-RS resource 1,2,3,4
	CDM Type		'No CDM' for CSI-RS resource 1,2,3,4
	Density (ρ)		3 for CSI-RS resource 1,2,3,4
	CSI-RS periodicity	Slots	160 for CSI-RS resource 1,2,3,4
	CSI-RS offset	Slots	80 for CSI-RS resource 1 and 2 81 for CSI-RS resource 3 and 4
	Frequency Occupation		Start PRB 0 Number of PRB = $\text{ceil}(\text{BWP size}/4)*4$
	QCL info		TCI state #0
NZP CSI-RS for CSI acquisition	Row index (Note 3)		3 for 2 CSI-RS ports and 5 for 4 CSI-RS ports
	First subcarrier index in the PRB used for CSI-RS		$k_0 = 0$
	First OFDM symbol in the PRB used for CSI-RS		$l_0 = 12$
	Number of CSI-RS ports (X)		1
	CDM Type		No CDM
	Density (ρ)		1
	CSI-RS periodicity	Slots	160
	CSI-RS offset	Slots	0
	Frequency Occupation		Start PRB 0 Number of PRB = $\text{ceil}(\text{BWP size}/4)*4$
QCL info		TCI state #1	
ZP CSI-RS for CSI acquisition	Row index (Note 3)		5
	First subcarrier index in the PRB used for CSI-RS		$k_0 = 4$
	First OFDM symbol in the PRB used for CSI-RS		$l_0 = 12$
	Number of CSI-RS ports (X)		4
	CDM Type		'FD-CDM2'
	Density (ρ)		1
	CSI-RS periodicity	Slots	160
	CSI-RS offset	Slots	0

	Frequency Occupation		Start PRB 0 Number of PRB = $\text{ceil}(\text{BWP size}/4)*4$
ZP CSI-RS for CSI acquisition	First subcarrier index in the PRB used for CSI-RS		$k_0 = 0$ for CSI-RS resource 1,2
	First OFDM symbol in the PRB used for CSI-RS		$l_0 = 8$ for CSI-RS resource 1 $l_0 = 9$ for CSI-RS resource 2
	Number of CSI-RS ports (X)		1 for CSI-RS resource 1,2
	CDM Type		'No CDM' for CSI-RS resource 1,2
	Density (ρ)		3 for CSI-RS resource 1,2
	CSI-RS periodicity	Slots	160 for CSI-RS resource 1,2
	CSI-RS offset	Slots	0 for CSI-RS resource 1,2
	Frequency Occupation		Start PRB 0 Number of PRB = $\text{ceil}(\text{BWP size}/4)*4$
	Repetition		ON
QCL info		TCI state #1	
PDSCH DMRS configuration	Antenna ports indexes		{1000} for Rank 1 tests
	Position of the first DMRS for PDSCH mapping type A		2
	Number of PDSCH DMRS CDM group(s) without data		1 for Rank 1
TCI state #0	Type 1 QCL information	SSB index	SSB #0
		QCL Type	Type C
	Type 2 QCL information	SSB index	SSB #0
		QCL Type	Type D
TCI state #1	Type 1 QCL information	CSI-RS resource	CSI-RS resource 1 from 'CSI-RS for tracking' configuration
		QCL Type	Type A
	Type 2 QCL information	CSI-RS resource	CSI-RS resource 1 from 'CSI-RS for tracking' configuration
		QCL Type	Type D
PT-RS configuration			Not configured
Maximum number of code block groups for ACK/NACK feedback			1
Maximum number of HARQ transmission			4
HARQ ACK/NACK bundling			Not configured
Redundancy version coding sequence			{0,2,3,1}
PDSCH & PDSCH DMRS Precoding configuration			No precoding
Symbols for all unused REs			OP.1 FDD as defined in Annex A.5.1.1 of 38.101-4
Physical signals, channels mapping and precoding			As specified in Annex B.4.1 of 38.101-4
Note 1:	UE assumes that the TCI state for the PDSCH is identical to the TCI state applied for the PDCCH transmission.		
Note 2:	Point A coincides with minimum guard band as specified in Table 5.3.3-1 from TS 38.101-2 [15] for tested channel bandwidth and subcarrier spacing.		
Note 3:	Refer to Table 7.4.1.5.3-1 in [9]		

11.2.2.1 1Rx requirements

11.2.2.1.1 FDD

11.2.2.1.1.1 Minimum requirements for PDSCH Mapping Type A

The performance requirements are specified in Table 11.2.2.1.1.1-3 with the addition of test parameters in Table 11.2.2.1.1.1-2 and the downlink physical channel setup according to Annex A.3.

The test purposes are specified in Table 11.2.2.1.1.1-1.

Table 11.2.2.1.1.1-1: Tests purpose

Purpose	Test index
Verify the PDSCH mapping Type A normal performance under 2 receive antenna conditions and with different channel models and MCS	1-1, 1-2, 1-3, 1-4, 2-1, 2-2, 2-3, 2-4

Table 11.2.2.1.1.1-2: Test parameters

Parameter	Unit	Value	
Duplex mode		FDD	
Active DL BWP index		1	
PDSCH configuration	Mapping type	Type A	
	k0	0	
	Starting symbol (S)	1	
	Length (L)	13	
	PDSCH aggregation factor	1	
	PRB bundling type	Static	
	PRB bundling size	2	
	Resource allocation type	Type 0	
	RBG size	Config2	
	VRB-to-PRB mapping type	Non-interleaved	
PDSCH DMRS configuration	VRB-to-PRB mapping interleave bundle size	N/A	
	DMRS Type	Type 1	
	Number of additional DMRS	1	
CSI-RS for tracking	Maximum number of OFDM symbols for DL front loaded DMRS	1	
	CSI-RS periodicity	Slots	160 for CSI-RS resource 1,2,3,4.
	CSI-RS offset	Slots	80 for CSI-RS resource 1 and 2 81 for CSI-RS resource 3 and 4.
Number of HARQ Processes		16 for Test 1-1, Test 1-2 32 for Test 1-3 4 with feedback disabled, 12 with feedback enabled in 16 HARQ processes for Test 1-4 in which 4 disabled processes are randomly selected at test configuration	
The number of slots between PDSCH and corresponding HARQ-ACK information		80 for Test 1-1, Test 1-2, Test 1-3 and Test 1-4 2080 for Test 2-1, Test 2-2, Test 2-3 and Test 2-4	
Maximum number of HARQ transmission		4 for Test 1-1, Test 1-2, Test 1-3 1 for Test 1-4 (re-Tx disabled for all HARQ processes)	

Table 11.2.2.1.1.1-3: Minimum performance for Rank 1

Test num.	Reference channel	Bandwidth (MHz) / Subcarrier spacing (kHz)	Modulation format and code rate	Propagation condition	Correlation matrix and antenna configuration	Reference value	
						Fraction of maximum throughput (%)	SNR (dB)
1-1	R.PDSCH.3-3.1 FDD	200 / 120	QPSK, 0.30	NTN-TDLC5-1200	1x1	70	3.5
1-2	R.PDSCH.3-4.1 FDD	200 / 120	16QAM, 0.48	NTN-TDLC5-1200	1x1	70	11.2
1-3	R.PDSCH.3-3.1 FDD	200 / 120	QPSK, 0.30	NTN-TDLC5-1200	1x1	70	3.5
1-4	R.PDSCH.3-3.1 FDD (Note 1)	200 / 120	QPSK, 0.30	NTN-TDLC5-1200	1x1	70	4.2

Note1: The Maximum throughput is based on the HARQ processes with HARQ feedback enabled.

Table 11.2.2.1.1.1-4: Minimum performance for Rank 1

Test num.	Reference channel	Bandwidth (MHz) / Subcarrier spacing (kHz)	Modulation format and code rate	Propagation condition	Correlation matrix and antenna configuration	Reference value	
						Fraction of maximum throughput (%)	SNR (dB)
2-1	R.PDSCH.3-3.1 FDD	200 / 120	QPSK, 0.30	NTN-TDLC5-1200	1x1	70	3.5
2-2	R.PDSCH.3-4.1 FDD	200 / 120	16QAM, 0.48	NTN-TDLC5-1200	1x1	70	11.2
2-3	R.PDSCH.3-3.1 FDD	200 / 120	QPSK, 0.30	NTN-TDLC5-1200	1x1	70	3.5
2-4	R.PDSCH.3-3.1 FDD (Note 1)	200 / 120	QPSK, 0.30	NTN-TDLC5-1200	1x1	70	4.2

Note1: The Maximum throughput is based on the HARQ processes with HARQ feedback enabled.

11.2.3 PDCCH demodulation requirements

The receiver characteristics of the PDCCH are determined by the probability of miss-detection of the Downlink Scheduling Grant (P_{m-dsg}).

The parameters specified in Table 11.2.3-1 are valid for all PDCCH tests unless otherwise stated.

Table 11.2.3-1: Common test Parameters

Parameter		Unit	Value
Carrier configuration	Offset between Point A and the lowest usable subcarrier on this carrier (Note 1)		0
DL BWP configuration #1	Cyclic prefix		Normal
Common serving cell parameters	Physical Cell ID		0
	SSB position in burst		First SSB in Slot #0
	SSB periodicity	ms	20
PDCCH configuration	Slots for PDCCH monitoring		Each slot
	Number of PDCCH candidates		1
	Frequency domain resource allocation for CORESET		Start from RB = 0 with contiguous RB allocation
	TCI state		TCI state #1
CSI-RS for tracking	First subcarrier index in the PRB used for CSI-RS (k ₀)		0
	First OFDM symbol in the PRB used for CSI-RS (l ₀)		CSI-RS resource 1: 4 CSI-RS resource 2: 8 CSI-RS resource 3: 4 CSI-RS resource 4: 8
	Number of CSI-RS ports (X)		1
	CDM Type		No CDM
	Density (ρ)		3
	CSI-RS periodicity	Slots	160
	CSI-RS offset	Slots	80 for CSI-RS resource 1 and 2 81 for CSI-RS resource 3 and 4
	Frequency Occupation		Start PRB 0 Number of PRB = $\text{ceil}(\text{BWP size}/4) \cdot 4$
	QCL info		TCI state #0
NZP CSI-RS for beam refinement	First subcarrier index in the PRB used for CSI-RS (k ₀)		0
	First OFDM symbol in the PRB used for CSI-RS (l ₀)		CSI-RS resource 1: 8 CSI-RS resource 2: 9
	Number of CSI-RS ports (X)		1
	CDM Type		No CDM
	Density (ρ)		3
	CSI-RS periodicity	Slots	120 kHz SCS: 160 for CSI-RS resource 1,2
	CSI-RS offset	Slots	0 for CSI-RS resource 1,2
	Frequency Occupation		Start PRB 0 Number of PRB = $\text{ceil}(\text{BWP size}/4) \cdot 4$
	Repetition		ON
QCL info		TCI state #1	

PDCCH & PDCCH DMRS Precoding configuration			For number of TX = 1: No precoding; For number of TX > 1: Single Panel Type I, Randomized precoder selection for every REG bundle and updated per slot with equal probability of each applicable i_1/i_2 combination or codebook index, chosen from section 5.2.2.2.1 of TS 38.214 [12].
TCI state #0	Type 1 QCL information	SSB index	SSB #0
		QCL Type	Type C
TCI state #0	Type 2 QCL information	SSB index	SSB #0
		QCL Type	Type D
TCI state #1	Type 1 QCL information	CSI-RS resource	CSI-RS resource 1 from 'CSI-RS for tracking' configuration
		QCL Type	Type A
	Type 2 QCL information	CSI-RS resource	CSI-RS resource 1 from 'CSI-RS for tracking' configuration
		QCL Type	Type D
Symbols for all unused REs			OP.1 FDD as defined in Annex A.5.1.1
The number of slots between PDSCH and corresponding HARQ-ACK information			2
Note 1: Point A coincides with minimum guard band as specified in Table 5.3.3-1 from TS 38.101-1 [6] for tested channel bandwidth and subcarrier spacing. Note 2: The high layer parameter <i>precoderGranularity</i> equals to <i>sameAsREG-bundle</i> as defined in clause 7.4.1.3 of TS 38.211 [9]			

11.2.3.1 1RX requirements

The parameters specified in Table 11.2.3.1-1 are valid for all PDCCH requirements unless otherwise stated.

Table 11.2.3.1-1: Test Parameters

Parameter	Unit	Value
CCE to REG mapping type		Interleaved
REG bundle size		2
Interleaver size		3
Shift index		0

11.2.3.1.1 Minimum requirements with 1Tx Antenna

For the parameters specified in Table 11.2.3.1-1, the average probability of a missed downlink scheduling grant (P_{m-dsg}) shall be below the specified value in Table 11.2.3.1.1-1. The downlink physical setup is in accordance with Annex C.5.1.

Table 11.2.3.1.1-1: Minimum performance requirements with 1 Tx Antenna

Test number	Bandwidth (MHz)	CORESET RB	CORESET duration	Aggregation level	Reference Channel	Propagation Condition	Antenna configuration and correlation Matrix	Reference value	
								Pm-dsg (%)	SNR _B (dB)
1-1	200	132	1	8	R.PDCCH. 1-1.1 FDD	NTN-TDLC5-1200	1x1 Low	1	4.6
1-2	200	132	2	16	R.PDCCH. 1-1.2 FDD	NTN-TDLC5-1200	1x1 Low	1	3.2

Annex A (normative): Measurement channels

A.1 General

A.1.1 Throughput definition

The throughput values defined in the measurement channels specified in Annex A, are calculated and are valid per codeword. For multi-codeword transmissions, the throughput referenced in the minimum requirements is the sum of throughputs of all codewords.

A.2 UL reference measurement channels

A.2.1 General

The measurement channels in the subclause A2.2 are defined to derive the requirements in clause 6 (Transmitter Characteristics) and clause 7 (Receiver Characteristics). And the measurement channels in the subclause A2.3 are defined to derive the requirements in clause 9 (Radiated Transmitter Characteristics) and clause 10 (Radiated Receiver Characteristics). The measurement channels represent example configurations of physical channels for different data rates.

The measurement channels in the following clauses are applicable only to FDD.

A.2.2 Reference measurement channels for FR1-NTN FDD

A.2.2.1 DFT-s-OFDM Pi/2-BPSK

Table A.2.2.1-1: Reference Channels for DFT-s-OFDM Pi/2-BPSK

Parameter	Allocated resource blocks (L _{CRB})	DFT-s-OFDM Symbols per slot (Note 1)	Modulation	MCS Index (Note 2)	Payload size	Transport block CRC	LDPC Base Graph	Number of code blocks per slot (Note 3)	Total number of bits per slot	Total modulated symbols per slot
Unit					Bits	Bits			Bits	
	1	11	pi/2 BPSK	0	24	16	2	1	132	132
	5	11	pi/2 BPSK	0	160	16	2	1	660	660
	9	11	pi/2 BPSK	0	288	16	2	1	1188	1188
	10	11	pi/2 BPSK	0	320	16	2	1	1320	1320
	12	11	pi/2 BPSK	0	384	16	2	1	1584	1584
	15	11	pi/2 BPSK	0	480	16	2	1	1980	1980
	18	11	pi/2 BPSK	0	576	16	2	1	2376	2376
	24	11	pi/2 BPSK	0	768	16	2	1	3168	3168
	25	11	pi/2 BPSK	0	808	16	2	1	3300	3300
	30	11	pi/2 BPSK	0	984	16	2	1	3960	3960
	32	11	pi/2 BPSK	0	1032	16	2	1	4224	4224
	36	11	pi/2 BPSK	0	1128	16	2	1	4752	4752
	45	11	pi/2 BPSK	0	1416	16	2	1	5940	5940
	50	11	pi/2 BPSK	0	1544	16	2	1	6600	6600
	60	11	pi/2 BPSK	0	1864	16	2	1	7920	7920
	64	11	pi/2 BPSK	0	2024	16	2	1	8448	8448
	75	11	pi/2 BPSK	0	2408	16	2	1	9900	9900
	80	11	pi/2 BPSK	0	2472	16	2	1	10560	10560
	81	11	pi/2 BPSK	0	2536	16	2	1	10692	10692
	90	11	pi/2 BPSK	0	2792	16	2	1	11880	11880
	100	11	pi/2 BPSK	0	3104	16	2	1	13200	13200

NOTE 1: PUSCH mapping Type-A and single-symbol DM-RS configuration Type-1 with 2 additional DM-RS symbols, such that the DM-RS positions are set to symbols 2, 7, 11. DMRS is [TDM'ed] with PUSCH data. DM-RS symbols are not counted.

NOTE 2: MCS Index is based on MCS table 6.1.4.1-1 defined in TS 38.214 [14].

NOTE 3: If more than one Code Block is present, an additional CRC sequence of L = 24 Bits is attached to each Code Block (otherwise L = 0 Bit)

NOTE 4: The RMCs apply to all channel bandwidth where L_{CRB} ≤ N_{RB}.

A.2.2.2 DFT-s-OFDM QPSK

Table A.2.2.2-1: Reference Channels for DFT-s-OFDM QPSK

Parameter	Allocated resource blocks (L_{CRB})	DFT-s-OFDM Symbols per slot (Note 1)	Modulation	MCS Index (Note 2)	Payload size	Transport block CRC	LDPC Base Graph	Number of code blocks per slot (Note 3)	Total number of bits per slot	Total modulated symbols per slot
Unit					Bits	Bits			Bits	
	1	11	QPSK	2	48	16	2	1	264	132
	5	11	QPSK	2	256	16	2	1	1320	660
	9	11	QPSK	2	456	16	2	1	2376	1188
	10	11	QPSK	2	504	16	2	1	2640	1320
	12	11	QPSK	2	608	16	2	1	3168	1584
	15	11	QPSK	2	768	16	2	1	3960	1980
	18	11	QPSK	2	928	16	2	1	4752	2376
	20	11	QPSK	2	1032	16	2	1	5280	2640
	24	11	QPSK	2	1192	16	2	1	6336	3168
	25	11	QPSK	2	1256	16	2	1	6600	3300
	30	11	QPSK	2	1544	16	2	1	7920	3960
	32	11	QPSK	2	1608	16	2	1	8448	4224
	36	11	QPSK	2	1800	16	2	1	9504	4752
	45	11	QPKS	2	2208	16	2	1	11880	5940
	50	11	QPSK	2	2472	16	2	1	13200	6600
	60	11	QPSK	2	3104	16	2	1	15840	7920
	64	11	QPSK	2	3240	16	2	1	16896	8448
	75	11	QPSK	2	3752	16	2	1	19800	9900
	80	11	QPSK	2	3976	24	2	2	21120	10560
	81	11	QPSK	2	4040	24	2	2	21384	10692
	90	11	QPSK	2	4488	24	2	2	23760	11880
	100	11	QPSK	2	5000	24	2	2	26400	13200

NOTE 1: PUSCH mapping Type-A and single-symbol DM-RS configuration Type-1 with 2 additional DM-RS symbols, such that the DM-RS positions are set to symbols 2, 7, 11. DMRS is [TDM'ed] with PUSCH data. DM-RS symbols are not counted.

NOTE 2: MCS Index is based on MCS table 6.1.4.1-1 defined in TS 38.214 [14].

NOTE 3: If more than one Code Block is present, an additional CRC sequence of $L = 24$ Bits is attached to each Code Block (otherwise $L = 0$ Bit)

NOTE 4: The RMCs apply to all channel bandwidth where $L_{CRB} \leq N_{RB}$.

A.2.2.3 DFT-s-OFDM 16QAM

Table A.2.2.3-1: Reference Channels for DFT-s-OFDM 16QAM

Parameter	Allocated resource blocks (L_{CRB})	DFT-s-OFDM Symbols per slot (Note 1)	Modulation	MCS Index (Note 2)	Payload size	Transport block CRC	LDPC Base Graph	Number of code blocks per slot (Note 3)	Total number of bits per slot	Total modulated symbols per slot
Unit					Bits	Bits			Bits	
	1	11	16QAM	10	176	16	2	1	528	132
	5	11	16QAM	10	888	16	2	1	2640	660
	9	11	16QAM	10	1608	16	2	1	4752	1188
	10	11	16QAM	10	1800	16	2	1	5280	1320
	12	11	16QAM	10	2088	16	2	1	6336	1584
	15	11	16QAM	10	2664	16	2	1	7920	1980
	18	11	16QAM	10	3240	16	2	1	9504	2376
	24	11	16QAM	10	4224	24	1	1	12672	3168
	25	11	16QAM	10	4352	24	1	1	13200	3300
	30	11	16QAM	10	5248	24	1	1	15840	3960
	32	11	16QAM	10	5632	24	1	1	16896	4224
	36	11	16QAM	10	6272	24	1	1	19008	4752
	45	11	16QAM	10	7808	24	1	1	23760	5940
	50	11	16QAM	10	8712	24	1	2	26400	6600
	60	11	16QAM	10	10504	24	1	2	31680	7920
	64	11	16QAM	10	11272	24	1	2	33792	8448
	75	11	16QAM	10	13064	24	1	2	39600	9900
	80	11	16QAM	10	14088	24	1	2	42240	10560
	81	11	16QAM	10	14088	24	1	2	42768	10692
	90	11	16QAM	10	15880	24	1	2	47520	11880
	100	11	16QAM	10	17424	24	1	3	52800	13200

NOTE 1: PUSCH mapping Type-A and single-symbol DM-RS configuration Type-1 with 2 additional DM-RS symbols, such that the DM-RS positions are set to symbols 2, 7, 11. DMRS is [TDM'ed] with PUSCH data. DM-RS symbols are not counted.

NOTE 2: MCS Index is based on MCS table 6.1.4.1-1 defined in TS 38.214 [14].

NOTE 3: If more than one Code Block is present, an additional CRC sequence of $L = 24$ Bits is attached to each Code Block (otherwise $L = 0$ Bit)

NOTE 4: The RMCs apply to all channel bandwidth where $L_{CRB} \leq N_{RB}$.

A.2.2.4 DFT-s-OFDM 64QAM

Table A.2.2.4-1: Reference Channels for DFT-s-OFDM 64QAM

Parameter	Allocated resource blocks (L_{CRB})	DFT-s-OFDM Symbols per slot (Note 1)	Modulation	MCS Index (Note 2)	Payload size	Transport block CRC	LDPC Base Graph	Number of code blocks per slot (Note 3)	Total number of bits per slot	Total modulated symbols per slot
Unit					Bits	Bits			Bits	
	1	11	64QAM	18	408	16	2	1	792	132
	5	11	64QAM	18	2024	16	2	1	3960	660
	9	11	64QAM	18	3624	16	2	1	7128	1188
	10	11	64QAM	18	3968	24	1	1	7920	1320
	12	11	64QAM	18	4736	24	1	1	9504	1584
	15	11	64QAM	18	6016	24	1	1	11880	1980
	18	11	64QAM	18	7168	24	1	1	14256	2376
	24	11	64QAM	18	9480	24	1	2	19008	3168
	25	11	64QAM	18	9992	24	1	2	19800	3300
	30	11	64QAM	18	12040	24	1	2	23760	3960
	32	11	64QAM	18	12808	24	1	2	25344	4224
	36	11	64QAM	18	14344	24	1	2	28512	4752
	45	11	64QAM	18	17928	24	1	3	35640	5940
	50	11	64QAM	18	19968	24	1	3	39600	6600
	60	11	64QAM	18	24072	24	1	3	47520	7920
	64	11	64QAM	18	25608	24	1	4	50688	8448
	75	11	64QAM	18	30216	24	1	4	59400	9900
	80	11	64QAM	18	31752	24	1	4	63360	10560
	81	11	64QAM	18	32264	24	1	4	64152	10692
	90	11	64QAM	18	35856	24	1	5	71280	11880
	100	11	16QAM	10	17424	24	1	3	52800	13200

NOTE 1: PUSCH mapping Type-A and single-symbol DM-RS configuration Type-1 with 2 additional DM-RS symbols, such that the DM-RS positions are set to symbols 2, 7, 11. DMRS is [TDM'ed] with PUSCH data. DM-RS symbols are not counted.

NOTE 2: MCS Index is based on MCS table 6.1.4.1-1 defined in TS 38.214 [14].

NOTE 3: If more than one Code Block is present, an additional CRC sequence of $L = 24$ Bits is attached to each Code Block (otherwise $L = 0$ Bit)

NOTE 4: The RMCs apply to all channel bandwidth where $L_{CRB} \leq N_{RB}$.

A.2.2.5 DFT-s-OFDM 256QAM

Table A.2.2.5-1: Reference Channels for DFT-s-OFDM 256QAM

Parameter	Allocated resource blocks (L_{CRB})	DFT-s-OFDM Symbols per slot (Note 1)	Modulation	MCS Index (Note 2)	Payload size	Transport block CRC	LDPC Base Graph	Number of code blocks per slot (Note 3)	Total number of bits per slot	Total modulated symbols per slot
Unit					Bits	Bits			Bits	
	1	11	256QAM	20	704	16	2	1	1056	132
	5	11	256QAM	20	3496	16	2	1	5280	660
	9	11	256QAM	20	6272	24	1	1	9504	1188
	10	11	256QAM	20	7040	24	1	1	10560	1320
	12	11	256QAM	20	8456	24	1	2	12672	1584
	15	11	256QAM	20	10504	24	1	2	15840	1980
	18	11	256QAM	20	12552	24	1	2	19008	2376
	24	11	256QAM	20	16896	24	1	3	25344	3168
	25	11	256QAM	20	17424	24	1	3	26400	3300
	30	11	256QAM	20	21000	24	1	3	31680	3960
	32	11	256QAM	20	22536	24	1	3	33792	4224
	36	11	256QAM	20	25104	24	1	3	38016	4752
	45	11	256QAM	20	31752	24	1	4	47520	5940
	50	11	256QAM	20	34816	24	1	5	52800	6600
	60	11	256QAM	20	42016	24	1	5	63360	7920
	64	11	256QAM	20	45096	24	1	6	67584	8448
	75	11	256QAM	20	53288	24	1	7	79200	9900
	80	11	256QAM	20	56368	24	1	7	84480	10560
	81	11	256QAM	20	57376	24	1	7	85536	10692
	90	11	256QAM	20	63528	24	1	8	95040	11880
	100	11	256QAM	20	69672	24	1	9	105600	13200

NOTE 1: PUSCH mapping Type-A and single-symbol DM-RS configuration Type-1 with 2 additional DM-RS symbols, such that the DM-RS positions are set to symbols 2, 7, 11. DMRS is [TDM'ed] with PUSCH data. DM-RS symbols are not counted.

NOTE 2: MCS Index is based on MCS table 5.1.3.1-2 defined in TS 38.214 [14].

NOTE 3: If more than one Code Block is present, an additional CRC sequence of L = 24 Bits is attached to each Code Block (otherwise L = 0 Bit)

NOTE 4: The RMCs apply to all channel bandwidth where $L_{CRB} \leq N_{RB}$.

A.2.2.6 CP-OFDM QPSK

Table A.2.2.6-1: Reference Channels for CP-OFDM QPSK

Parameter	Allocated resource blocks (L _{CRB})	CP-OFDM Symbols per slot (Note 1)	Modulation	MCS Index (Note 2)	Payload size	Transport block CRC	LDPC Base Graph	Number of code blocks per slot (Note 3)	Total number of bits per slot	Total modulated symbols per slot
Unit					Bits	Bits			Bits	
	1	11	QPSK	2	48	16	2	1	264	132
	5	11	QPSK	2	256	16	2	1	1320	660
	6	11	QPSK	2	304	16	2	1	1584	792
	9	11	QPSK	2	456	16	2	1	2376	1188
	10	11	QPSK	2	504	16	2	1	2640	1320
	11	11	QPSK	2	552	16	2	1	2904	1452
	12	11	QPSK	2	608	16	2	1	3168	1584
	13	11	QPSK	2	672	16	2	1	3432	1716
	15	11	QPSK	2	768	16	2	1	3960	1980
	16	11	QPSK	2	808	16	2	1	4224	2112
	18	11	QPSK	2	928	16	2	1	4752	2376
	19	11	QPSK	2	984	16	2	1	5016	2508
	24	11	QPSK	2	1192	16	2	1	6336	3168
	25	11	QPSK	2	1256	16	2	1	6600	3300
	26	11	QPSK	2	1288	16	2	1	6864	3432
	31	11	QPSK	2	1544	16	2	1	8184	4092
	33	11	QPSK	2	1672	16	2	1	8712	4356
	38	11	QPSK	2	1928	16	2	1	10032	5016
	39	11	QPSK	2	2024	16	2	1	10296	5148
	40	11	QPSK	2	2024	16	2	1	10560	5280
	47	11	QPSK	2	2408	16	2	1	12408	6204
	51	11	QPSK	2	2536	16	2	1	13464	6732
	52	11	QPSK	2	2600	16	2	1	13728	6864
	53	11	QPSK	2	2664	16	2	1	13992	6996
	54	11	QPSK	2	2664	16	2	1	14256	7128
	61	11	QPSK	2	3104	16	2	1	16104	8052
	65	11	QPSK	2	3240	16	2	1	17160	8580
	67	11	QPSK	2	3368	16	2	1	17688	8844
	68	11	QPSK	2	3368	16	2	1	17952	8976
	78	11	QPSK	2	3848	24	2	2	20592	10296
	79	11	QPSK	2	3912	24	2	2	20856	10428
	80	11	QPSK	2	3976	24	2	2	21120	10560
	81	11	QPSK	2	4040	24	2	2	21384	10692
	93	11	QPSK	2	4616	24	2	2	24552	12276
	95	11	QPSK	2	4744	24	2	2	25080	12540
	106	11	QPSK	2	5256	24	2	2	27984	13992

NOTE 1: PUSCH mapping Type-A and single-symbol DM-RS configuration Type-1 with 2 additional DM-RS symbols, such that the DM-RS positions are set to symbols 2, 7, 11. DMRS is [TDM'ed] with PUSCH data. DM-RS symbols are not counted.

NOTE 2: MCS Index is based on MCS table 5.1.3.1-1 defined in TS 38.214 [14].

NOTE 3: If more than one Code Block is present, an additional CRC sequence of L = 24 Bits is attached to each Code Block (otherwise L = 0 Bit)

NOTE 4: The RMCs apply to all channel bandwidth where $L_{CRB} \leq N_{RB}$.

A.2.2.7 CP-OFDM 16QAM

Table A.2.2.7-1: Reference Channels for CP-OFDM 16QAM

Parameter	Allocated resource blocks (L _{CRB})	CP-OFDM Symbols per slot (Note 1)	Modulation	MCS Index (Note 2)	Payload size	Transport block CRC	LDPC Base Graph	Number of code blocks per slot (Note 3)	Total number of bits per slot	Total modulated symbols per slot
Unit					Bits	Bits			Bits	
	1	11	16QAM	10	176	16	2	1	528	132
	5	11	16QAM	10	888	16	2	1	2640	660
	6	11	16QAM	10	1064	16	2	1	3168	792
	9	11	16QAM	10	1608	16	2	1	4752	1188
	10	11	16QAM	10	1800	16	2	1	5280	1320
	11	11	16QAM	10	1928	16	2	1	5808	1452
	12	11	16QAM	10	2088	16	2	1	6336	1584
	13	11	16QAM	10	2280	16	2	1	6864	1716
	15	11	16QAM	10	2664	16	2	1	7920	1980
	16	11	16QAM	10	2792	16	2	1	8448	2112
	18	11	16QAM	10	3240	16	2	1	9504	2376
	19	11	16QAM	10	3368	16	2	1	10032	2508
	24	11	16QAM	10	4224	24	1	1	12672	3168
	25	11	16QAM	10	4352	24	1	1	13200	3300
	26	11	16QAM	10	4480	24	1	1	13728	3432
	31	11	16QAM	10	5376	24	1	1	16368	4092
	33	11	16QAM	10	5760	24	1	1	17424	4356
	38	11	16QAM	10	6656	24	1	1	20064	5016
	39	11	16QAM	10	6784	24	1	1	20592	5148
	40	11	16QAM	10	7040	24	1	1	21120	5280
	47	11	16QAM	10	8192	24	1	1	24816	6204
	51	11	16QAM	10	8968	24	1	2	26928	6732
	52	11	16QAM	10	9224	24	1	2	27456	6864
	53	11	16QAM	10	9224	24	1	2	27984	6996
	54	11	16QAM	10	9480	24	1	2	28512	7128
	61	11	16QAM	10	10760	24	1	2	32208	8052
	65	11	16QAM	10	11272	24	1	2	34320	8580
	67	11	16QAM	10	11784	24	1	2	35376	8844
	68	11	16QAM	10	11784	24	1	2	35904	8976
	78	11	16QAM	10	13576	24	1	2	41184	10296
	79	11	16QAM	10	13832	24	1	2	41712	10428
	80	11	16QAM	10	14088	24	1	2	42240	10560
	81	11	16QAM	10	14088	24	1	2	42768	10692
	93	11	16QAM	10	16392	24	1	2	49404	12276
	95	11	16QMA	10	16392	24	1	2	50160	12540
	106	11	16QAM	10	18432	24	1	3	55968	13992

NOTE 1: PUSCH mapping Type-A and single-symbol DM-RS configuration Type-1 with 2 additional DM-RS symbols, such that the DM-RS positions are set to symbols 2, 7, 11. DMRS is [TDM'ed] with PUSCH data. DM-RS symbols are not counted.

NOTE 2: MCS Index is based on MCS table 5.1.3.1-1 defined in TS 38.214 [14].

NOTE 3: If more than one Code Block is present, an additional CRC sequence of L = 24 Bits is attached to each Code Block (otherwise L = 0 Bit)

NOTE 4: The RMCs apply to all channel bandwidth where $L_{CRB} \leq N_{RB}$.

A.2.2.8 CP-OFDM 64QAM

Table A.2.2.8-1: Reference Channels for CP-OFDM 64QAM

Parameter	Allocated resource blocks (L _{CRB})	CP-OFDM Symbols per slot (Note 1)	Modulation	MCS Index (Note 2)	Payload size	Transport block CRC	LDPC Base Graph	Number of code blocks per slot (Note 3)	Total number of bits per slot	Total modulated symbols per slot
Unit					Bits	Bits			Bits	
	1	11	64QAM	19	408	16	2	1	792	132
	5	11	64QAM	19	2024	16	2	1	3960	660
	9	11	64QAM	19	3624	16	2	1	7128	1188
	10	11	64QAM	19	3968	24	1	1	7920	1320
	11	11	64QAM	19	4352	24	1	1	8712	1452
	12	11	64QAM	19	4736	24	1	1	9504	1584
	13	11	64QAM	19	5120	24	1	1	10296	1716
	15	11	64QAM	19	6016	24	1	1	11880	1980
	18	11	64QAM	19	7168	24	1	1	14256	2376
	19	11	64QAM	19	7552	24	1		15048	2508
	24	11	64QAM	19	9480	24	1	2	19008	3168
	25	11	64QAM	19	9992	24	1	2	19800	3300
	26	11	64QAM	19	10504	24	1	2	20592	3432
	31	11	64QAM	19	12296	24	1	2	24552	4092
	33	11	64QAM	19	13064	24	1	2	26136	4356
	38	11	64QAM	19	15112	24	1	2	30096	5016
	39	11	64QAM	19	15624	24	1	2	30888	5148
	47	11	64QAM	19	18960	24	1	3	37224	6204
	51	11	64QAM	19	20496	24	1	3	40392	6732
	52	11	64QAM	19	21000	24	1	3	41184	6864
	53	11	64QAM	19	21000	24	1	3	41976	6996
	61	11	64QAM	19	24567	24	1	3	48312	8052
	65	11	64QAM	19	26120	24	1	4	51480	8580
	67	11	64QAM	19	26632	24	1	4	53064	8844
	78	11	64QAM	19	31240	24	1	4	61776	10296
	79	11	64QAM	19	31752	24	1	4	62568	10428
	80	11	64QAM	19	31752	24	1	4	63360	10560
	81	11	64QAM	19	32264	24	1	4	64152	10692
	93	11	64QAM	19	36896	24	1	5	73656	12276
	95	11	64QAM	19	37896	24	1	5	75240	12540
	106	11	64QAM	19	42016	24	1	5	83952	13992

NOTE 1: PUSCH mapping Type-A and single-symbol DM-RS configuration Type-1 with 2 additional DM-RS symbols, such that the DM-RS positions are set to symbols 2, 7, 11. DMRS is [TDM'ed] with PUSCH data. DM-RS symbols are not counted.

NOTE 2: MCS Index is based on MCS table 5.1.3.1-1 defined in TS 38.214 [14].

NOTE 3: If more than one Code Block is present, an additional CRC sequence of L = 24 Bits is attached to each Code Block (otherwise L = 0 Bit)

NOTE 4: The RMCs apply to all channel bandwidth where $L_{CRB} \leq N_{RB}$.

A.2.2.9 CP-OFDM 256QAM

Table A.2.2.9-1: Reference Channels for CP-OFDM 256QAM

Parameter	Allocated resource blocks (L _{CRB})	DFT-s-OFDM Symbols per slot (Note 1)	Modulation	MCS Index (Note 2)	Payload size	Transport block CRC	LDPC Base Graph	Number of code blocks per slot (Note 3)	Total number of bits per slot	Total modulated symbols per slot
Unit					Bits	Bits			Bits	
	1	11	256QAM	20	704	16	2	1	1056	132
	5	11	256QAM	20	3496	16	2	1	5280	660
	9	11	256QAM	20	6272	24	1	1	9504	1188
	10	11	256QAM	20	7040	24	1	1	10560	1320
	11	11	256QAM	20	7680	24	1	1	11616	1452
	12	11	256QAM	20	8456	24	1	2	12672	1584
	13	11	256QAM	20	9224	24	1	2	13728	1716
	15	11	256QAM	20	10504	24	1	2	15840	1980
	18	11	256QAM	20	12552	24	1	2	19008	2376
	19	11	256QAM	20	13320	24	1	2	20064	2508
	24	11	256QAM	20	16896	24	1	3	25344	3168
	25	11	256QAM	20	17424	24	1	3	26400	3300
	26	11	256QAM	20	18432	24	1	3	27456	3432
	31	11	256QAM	20	22032	24	1	3	32736	4092
	33	11	256QAM	20	23040	24	1	3	34848	4356
	38	11	256QAM	20	26632	24	1	4	40128	5016
	39	11	256QAM	20	27656	24	1	4	41184	5148
	47	11	256QAM	20	32776	24	1	4	49632	6204
	51	11	256QAM	20	35856	24	1	5	53856	6732
	52	11	256QAM	20	36896	24	1	5	54912	6864
	53	11	256QAM	20	36896	24	1	5	55968	6996
	61	11	256QAM	20	43032	24	1	6	64416	8052
	65	11	256QAM	20	46104	24	1	6	68640	8580
	67	11	256QAM	20	47112	24	1	6	70752	8844
	78	11	256QAM	20	55304	24	1	7	82368	10296
	79	11	256QAM	20	55304	24	1	7	83424	10428
	80	11	256QAM	20	56368	24	1	7	84480	10560
	81	11	256QAM	20	57376	24	1	7	85536	10692
	93	11	256QAM	20	65576	24	1	8	98208	12276
	95	11	256QAM	20	67584	24	1	8	100320	12540
	106	11	256QAM	20	73776	24	1	9	111936	13992

NOTE 1: PUSCH mapping Type-A and single-symbol DM-RS configuration Type-1 with 2 additional DM-RS symbols, such that the DM-RS positions are set to symbols 2, 7, 11. DMRS is [TDM'ed] with PUSCH data. DM-RS symbols are not counted.

NOTE 2: MCS Index is based on MCS table 5.1.3.1-2 defined in TS 38.214 [14].

NOTE 3: If more than one Code Block is present, an additional CRC sequence of L = 24 Bits is attached to each Code Block (otherwise L = 0 Bit)

NOTE 4: The RMCs apply to all channel bandwidth where L_{CRB} ≤ N_{RB}.

A.2.3 Reference measurement channels for FR2-NTN FDD

A.2.3.1 DFT-s-OFDM Pi/2-BPSK

Table A.2.3.1-1: Reference Channels for DFT-s-OFDM pi/2-BPSK

Parameter	Allocated resource blocks (L _{CRB})	DFT-s-OFDM Symbols per slot (Note 1)	Modulation	MCS Index (Note 2)	Payload size	Transport block CRC	LDPC Base Graph	Number of code blocks per slot (Note 3)	Total number of bits per slot	Total modulated symbols per slot
Unit					Bits	Bits			Bits ⁹	
	1	11	pi/2 BPSK	0	24	16	2	1	132	132
	16	11	pi/2 BPSK	0	504	16	2	1	2112	2112

	32	11	pi/2 BPSK	0	1032	16	2	1	4224	4224
	60	11	pi/2 BPSK	0	1864	16	2	1	7920	7920
	64	11	pi/2 BPSK	0	2024	16	2	1	8448	8448
	120	11	pi/2 BPSK	0	3752	16	2	1	15840	15840
	128	11	pi/2 BPSK	0	3976	24	2	2	16896	16896
	144	11	pi/2 BPSK	0	4488	24	2	2	19008	19008
	243	11	pi/2 BPSK	0	7560	24	2	2	32076	32076
	256	11	pi/2 BPSK	0	7944	24	2	3	33792	33792

NOTE 1: PUSCH mapping Type-A and single-symbol DM-RS configuration Type-1 with 2 additional DM-RS symbols, such that the DM-RS positions are set to symbols 2, 7, 11. DMRS is [TDM'ed] with PUSCH data. DM-RS symbols are not counted.

NOTE 2: MCS Index is based on MCS table 6.1.4.1-1 defined in 38.214.

NOTE 3: If more than one Code Block is present, an additional CRC sequence of L = 24 Bits is attached to each Code Block (otherwise L = 0 Bit)

NOTE 4: The RMCs apply to all channel bandwidth where $L_{CRB} \leq N_{RB}$.

A.2.3.2 DFT-s-OFDM QPSK

Table A.2.3.2-1: Reference Channels for DFT-s-OFDM QPSK

Parameter	Allocated resource blocks (L_{CRB})	DFT-s-OFDM Symbols per slot (Note 1)	Modulation	MCS Index (Note 2)	Payload size	Transport block CRC	LDPC Base Graph	Number of code blocks per slot (Note 3)	Total number of bits per slot	Total modulated symbols per slot
Unit					Bits	Bits			Bits	
	1	11	QPSK	2	48	16	2	1	264	132
	16	11	QPSK	2	808	16	2	1	4224	2112
	20	11	QPSK	2	1032	16	2	1	5280	2640
	32	11	QPSK	2	1608	16	2	1	8448	4224
	60	11	QPSK	2	2976	16	2	1	15840	7920
	64	11	QPSK	2	3240	16	2	1	16896	8448
	120	11	QPSK	2	5896	24	2	2	31680	15840
	128	11	QPSK	2	6408	24	2	2	33792	16896
	144	11	QPSK	2	7176	24	2	2	38016	19008
	243	11	QPSK	2	12040	24	2	4	64152	32076
	256	11	QPSK	2	12808	24	2	4	67584	33792

NOTE 1: PUSCH mapping Type-A and single-symbol DM-RS configuration Type-1 with 2 additional DM-RS symbols, such that the DM-RS positions are set to symbols 2, 7, 11. DMRS is [TDM'ed] with PUSCH data. DM-RS symbols are not counted.

NOTE 2: MCS Index is based on MCS table 6.1.4.1-1 defined in 38.214.

NOTE 3: If more than one Code Block is present, an additional CRC sequence of L = 24 Bits is attached to each Code Block (otherwise L = 0 Bit)

NOTE 4: The RMCs apply to all channel bandwidth where $L_{CRB} \leq N_{RB}$.

A.2.3.3 DFT-s-OFDM 16QAM

Table A.2.3.3-1: Reference Channels for DFT-s-OFDM 16QAM

Parameter	Allocated resource blocks (L_{CRB})	DFT-s-OFDM Symbols per slot (Note 1)	Modulation	MCS Index (Note 2)	Payload size	Transport block CRC	LDPC Base Graph	Number of code blocks per slot (Note 3)	Total number of bits per slot	Total modulated symbols per slot
Unit					Bits	Bits			Bits	
	1	11	16QAM	10	176	16	2	1	528	132
	16	11	16QAM	10	2792	16	2	1	8448	2112
	32	11	16QAM	10	5632	24	1	1	16896	4224
	60	11	16QAM	10	10504	24	1	2	31680	7920
	64	11	16QAM	10	11272	24	1	2	33792	8448
	120	11	16QAM	10	21000	24	1	3	63360	15840
	128	11	16QAM	10	22536	24	1	3	67584	16896
	144	11	16QAM	10	25104	24	1	3	76032	19008

	243	11	16QAM	10	43032	24	1	6	128304	32076
	256	11	16QAM	10	45096	24	1	6	135168	33792

NOTE 1: PUSCH mapping Type-A and single-symbol DM-RS configuration Type-1 with 2 additional DM-RS symbols, such that the DM-RS positions are set to symbols 2, 7, 11. DMRS is [TDM'ed] with PUSCH data. DM-RS symbols are not counted.

NOTE 2: MCS Index is based on MCS table 6.1.4.1-1 defined in 38.214.

NOTE 3: If more than one Code Block is present, an additional CRC sequence of L = 24 Bits is attached to each Code Block (otherwise L = 0 Bit)

NOTE 4: The RMCs apply to all channel bandwidth where $L_{CRB} \leq N_{RB}$.

A.2.3.4 DFT-s-OFDM 64QAM

Table A.2.3.4-1: Reference Channels for DFT-s-OFDM 64QAM

Parameter	Allocated resource blocks (L_{CRB})	DFT-s-OFDM Symbols per slot (Note 1)	Modulation	MCS Index (Note 2)	Payload size	Transport block CRC	LDPC Base Graph	Number of code blocks per slot (Note 3)	Total number of bits per slot	Total modulated symbols per slot
Unit					Bits	Bits			Bits	
	1	11	64QAM	18	408	16	2	1	792	132
	16	11	64QAM	18	6400	24	1	1	12672	2112
	32	11	64QAM	18	12808	24	1	2	25344	4224
	60	11	64QAM	18	24072	24	1	3	47520	7920
	64	11	64QAM	18	25608	24	1	4	50688	8448
	120	11	64QAM	18	48168	24	1	6	95040	15840
	128	11	64QAM	18	51216	24	1	7	101376	16896
	144	11	64QAM	18	57376	24	1	7	114048	19008
	243	11	64QAM	18	96264	24	1	12	192456	32076
	256	11	64QAM	18	102416	24	1	13	202752	33792

NOTE 1: PUSCH mapping Type-A and single-symbol DM-RS configuration Type-1 with 2 additional DM-RS symbols, such that the DM-RS positions are set to symbols 2, 7, 11. DMRS is [TDM'ed] with PUSCH data. DM-RS symbols are not counted.

NOTE 2: MCS Index is based on MCS table 6.1.4.1-1 defined in 38.214.

NOTE 3: If more than one Code Block is present, an additional CRC sequence of L = 24 Bits is attached to each Code Block (otherwise L = 0 Bit)

NOTE 4: The RMCs apply to all channel bandwidth where $L_{CRB} \leq N_{RB}$.

A.2.3.5 CP-OFDM QPSK

Table A.2.3.5-1: Reference Channels for CP-OFDM QPSK

Parameter	Allocated resource blocks (L_{CRB})	DFT-s-OFDM Symbols per slot (Note 1)	Modulation	MCS Index (Note 2)	Payload size	Transport block CRC	LDPC Base Graph	Number of code blocks per slot (Note 3)	Total number of bits per slot	Total modulated symbols per slot
Unit					Bits	Bits			Bits	
	1	11	QPSK	2	48	16	2	1	264	132
	16	11	QPSK	2	808	16	2	1	4224	2112
	32	11	QPSK	2	1608	16	2	1	8448	4224
	33	11	QPSK	2	1672	16	2	1	8712	4356
	62	11	QPSK	2	3104	16	2	1	16368	8184
	66	11	QPSK	2	3368	16	2	1	17424	8712
	124	11	QPSK	2	6152	24	2	2	32736	16368
	132	11	QPSK	2	6536	24	2	2	34848	17424
	148	11	QPSK	2	7304	24	2	2	39072	19536
	248	11	QPSK	2	12296	24	2	4	65472	32736
	264	11	QPSK	2	13064	24	2	4	69696	34848

NOTE 1: PUSCH mapping Type-A and single-symbol DM-RS configuration Type-1 with 2 additional DM-RS symbols, such that the DM-RS positions are set to symbols 2, 7, 11. DMRS is [TDM'ed] with PUSCH data. DM-RS symbols are not counted.

NOTE 2: MCS Index is based on MCS table 5.1.3.1-1 defined in 38.214.

NOTE 3: If more than one Code Block is present, an additional CRC sequence of L = 24 Bits is attached to each Code Block (otherwise L = 0 Bit)

NOTE 4: The RMCs apply to all channel bandwidth where $L_{CRB} \leq N_{RB}$.

A.2.3.6 CP-OFDM 16QAM

Table A.2.3.6-1: Reference Channels for CP-OFDM 16QAM

Parameter	Allocated resource blocks (L_{CRB})	DFT-s-OFDM Symbols per slot (Note 1)	Modulation	MCS Index (Note 2)	Payload size	Transport block CRC	LDPC Base Graph	Number of code blocks per slot (Note 3)	Total number of bits per slot	Total modulated symbols per slot
Unit					Bits	Bits			Bits	
	1	11	16QAM	10	176	16	2	1	528	132
	16	11	16QAM	10	2792	16	2	1	8448	2112
	32	11	16QAM	10	5632	24	1	1	16896	4224
	33	11	16QAM	10	5760	24	1	1	17424	4356
	62	11	16QAM	10	10760	24	1	2	32736	8184
	66	11	16QAM	10	11528	24	1	2	34848	8712
	124	11	16QAM	10	21504	24	1	3	65472	16368
	132	11	16QAM	10	23040	24	1	3	69696	17424
	148	11	16QAM	10	26120	24	1	4	78144	19536
	248	11	16QAM	10	43032	24	1	6	130944	32736
	264	11	16QAM	10	46104	24	1	6	139392	34848

NOTE 1: PUSCH mapping Type-A and single-symbol DM-RS configuration Type-1 with 2 additional DM-RS symbols, such that the DM-RS positions are set to symbols 2, 7, 11. DMRS is [TDM'ed] with PUSCH data. DM-RS symbols are not counted.

NOTE 2: MCS Index is based on MCS table 5.1.3.1-1 defined in 38.214.

NOTE 3: If more than one Code Block is present, an additional CRC sequence of $L = 24$ Bits is attached to each Code Block (otherwise $L = 0$ Bit)

NOTE 4: The RMCs apply to all channel bandwidth where $L_{CRB} \leq N_{RB}$.

A.2.3.7 CP-OFDM 64QAM

Table A.2.3.7-1: Reference Channels for CP-OFDM 64QAM

Parameter	Allocated resource blocks (L_{CRB})	DFT-s-OFDM Symbols per slot (Note 1)	Modulation	MCS Index (Note 2)	Payload size	Transport block CRC	LDPC Base Graph	Number of code blocks per slot (Note 3)	Total number of bits per slot	Total modulated symbols per slot
Unit					Bits	Bits			Bits	
	1	11	64QAM	19	408	16	2	1	792	132
	16	11	64QAM	19	6400	24	1	1	12672	2112
	32	11	64QAM	19	12808	24	1	2	25344	4224
	33	11	64QAM	19	13064	24	1	2	26136	4356
	62	11	64QAM	19	24576	24	1	3	49104	8184
	66	11	64QAM	19	26120	24	1	4	52272	8712
	124	11	64QAM	19	49176	24	1	6	98208	16368
	132	11	64QAM	19	53288	24	1	7	104544	17424
	148	11	64QAM	19	59432	24	1	8	117216	19536
	248	11	64QAM	19	98376	24	1	12	196416	32736
	264	11	64QAM	19	106576	24	1	13	209088	34848

NOTE 1: PUSCH mapping Type-A and single-symbol DM-RS configuration Type-1 with 2 additional DM-RS symbols, such that the DM-RS positions are set to symbols 2, 7, 11. DMRS is [TDM'ed] with PUSCH data. DM-RS symbols are not counted.

NOTE 2: MCS Index is based on MCS table 5.1.3.1-1 defined in 38.214.

NOTE 3: If more than one Code Block is present, an additional CRC sequence of $L = 24$ Bits is attached to each Code Block (otherwise $L = 0$ Bit)

NOTE 4: The RMCs apply to all channel bandwidth where $L_{CRB} \leq N_{RB}$.

A.3 DL reference measurement channels

A.3.1 General

The transport block size (TBS) determination procedure is described in sub-clause 5.1.3.2 of TS 38.214 [12].

Unless otherwise stated, no user data is scheduled on slot #0 within 20 ms in order to avoid SSB and PDSCH transmissions in one slot and simplify test configuration.

A.3.2 Reference measurement channels for PDSCH performance requirements

For PDSCH reference channels if more than one Code Block is present, an additional CRC sequence of $L = 24$ Bits is attached to each Code Block (otherwise $L = 0$ Bit).

A.3.2.1 FDD

A.3.2.1.1 Reference measurement channels for SCS 15 kHz FR1

Table A.3.2.1.1-1: PDSCH Reference Channel for FDD (QPSK)

Parameter	Unit	Value			
Reference channel		R.PDSCH.1-1.1 FDD			
Channel bandwidth	MHz	10			
Subcarrier spacing	kHz	15			
Number of allocated resource blocks	PRBs	52			
Number of consecutive PDSCH symbols		12			
Allocated slots per 2 frames	Slots	19			
MCS table		64QAM			
MCS index		4			
Modulation		QPSK			
Target Coding Rate		0.30			
Number of MIMO layers		1			
Number of DMRS REs		12			
Overhead for TBS determination		0			
Information Bit Payload per Slot					
For Slot $i = 0$	Bits	N/A			
For Slots $i = 1, \dots, 19$	Bits	4096			
Transport block CRC per Slot					
For Slot $i = 0$	Bits	N/A			
For Slots $i = 1, \dots, 19$	Bits	24			
Number of Code Blocks per Slot					
For Slot $i = 0$	CBs	N/A			
For Slots $i = 1, \dots, 19$	CBs	1			
Binary Channel Bits Per Slot					
For Slot $i = 0$	Bits	N/A			
For Slots $i = 10, 11$	Bits	13104			
For Slots $i = 1, \dots, 9, 12, \dots, 19$	Bits	13728			
Max. Throughput averaged over 2 frames	Mbps	3.891			
Note 1: SS/PBCH block is transmitted in slot #0 with periodicity 20 ms					
Note 2: Slot i is slot index per 2 frames					

Table A.3.2.1.1-2: PDSCH Reference Channel for FDD (16QAM)

Parameter	Unit	Value					
Reference channel		R.PDSCH.1-2.1 FDD					
Channel bandwidth	MHz	10					
Subcarrier spacing	kHz	15					
Number of allocated resource blocks	PRBs	52					
Number of consecutive PDSCH symbols		12					
Allocated slots per 2 frames	Slots	19					
MCS table		64QAM					
MCS index		13					
Modulation		16QAM					
Target Coding Rate		0.48					
Number of MIMO layers		1					
Number of DMRS REs		12					
Overhead for TBS determination		0					
Information Bit Payload per Slot							
For Slot $i = 0$	Bits	N/A					
For Slots $i = 1, \dots, 19$	Bits	13064					
Transport block CRC per Slot							
For Slot $i = 0$	Bits	N/A					
For Slots $i = 1, \dots, 19$	Bits	24					
Number of Code Blocks per Slot							
For Slot $i = 0$	CBs	N/A					
For Slots $i = 1, \dots, 19$	CBs	2					
Binary Channel Bits Per Slot							
For Slot $i = 0$	Bits	N/A					
For Slots $i = 10, 11$	Bits	26208					
For Slots $i = 1, \dots, 9, 12, \dots, 19$	Bits	27456					
Max. Throughput averaged over 2 frames	Mbps	12.411					
NOTE 1: SS/PBCH block is transmitted in slot #0 with periodicity 20 ms							
NOTE 2: Slot i is slot index per 2 frames							

A.3.2.1.2 Reference measurement channels for SCS 60 kHz FR2-NTN

Table A.3.2.1.2-1: PDSCH Reference Channel for FDD (QPSK)

Parameter	Unit	Value		
Channel bandwidth	MHz	50	100	200
Subcarrier spacing configuration μ		2	2	2
Allocated resource blocks		66	132	264
Subcarriers per resource block		12	12	12
Allocated slots per Frame (NOTE 7)		23/24	23/24	23/24
MCS index		4	4	4
Modulation		QPSK	QPSK	QPSK
Target Coding Rate		1/3	1/3	1/3
Maximum number of HARQ transmissions		1	1	1
Information Bit Payload per Slot				
For Slots 0 and Slot i, if $\text{mod}(i, 5) = \{3,4\}$ for i from $\{0, \dots, 79\}$ (NOTE 5)	Bits	N/A	N/A	N/A
For Slot i, if $\text{mod}(i, 5) = \{0,1,2\}$ for i from $\{1, \dots, 79\}$ (NOTE 6)	Bits	4224	8456	16896
Transport block CRC	Bits	24	24	24
LDPC base graph		1	1	1
Number of Code Blocks per Slot				
For Slots 0 and Slot i, if $\text{mod}(i, 5) = \{3,4\}$ for i from $\{0, \dots, 79\}$ (NOTE 5)	CBs	N/A	N/A	N/A
For Slot i, if $\text{mod}(i, 5) = \{0,1,2\}$ for i from $\{1, \dots, 79\}$ (NOTE 6)	CBs	1	2	3
Binary Channel Bits Per Slot				
For Slots 0 and Slot i, if $\text{mod}(i, 5) = \{3,4\}$ for i from $\{0, \dots, 79\}$ (NOTE 5)	Bits	N/A	N/A	N/A
For Slot i, if $\text{mod}(i, 5) = \{0,1,2\}$ for i from $\{1, \dots, 79\}$ (NOTE 6)	Bits	14256	28512	57024
Max. Throughput averaged over 1 frame (NOTE 8)	Mbps	10.138	20.294	40.550
NOTE 1: Additional parameters are specified in Table A.3.1-1 and Table A.3.3.1-1.				
NOTE 2: If more than one Code Block is present, an additional CRC sequence of L = 24 Bits is attached to each Code Block (otherwise L = 0 Bit).				
NOTE 3: SS/PBCH block is transmitted in slot 0 with periodicity 20 ms.				
NOTE 4: Slot i is slot index per 2 frames.				
NOTE 5: When this DL RMC used together with the UL RMC for the transmitter requirements requiring at least one sub frame (1ms) for the measurement period, Slot i, if $\text{mod}(i, 8) = \{3,4,5,6,7\}$ for i from $\{0, \dots, 79\}$.				
NOTE 6: When this DL RMC used together with the UL RMC for the transmitter requirements requiring at least one sub frame (1ms) for the measurement period, Slot i, if $\text{mod}(i, 8) = \{0,1,2\}$ for i from $\{0, \dots, 79\}$.				
NOTE 7: First number corresponds to the number slots allocated in the first frame of the RMC; second number corresponds to the number slots allocated in the second frame of the RMC.				
NOTE 8: Throughput is averaged over 2nd frame of RMC.				

Table A.3.2.1.2-2: PDSCH Reference Channel for FDD (16QAM)

Parameter	Unit	Value		
Channel bandwidth	MHz	50	100	200
Subcarrier spacing configuration μ		2	2	2
Allocated resource blocks		66	132	264
Subcarriers per resource block		12	12	12
Allocated slots per Frame (NOTE 6)		23/24	23/24	23/24
MCS index		13	13	13
Modulation		16QAM	16QAM	16QAM
Target Coding Rate		0.48	0.48	0.48
Maximum number of HARQ transmissions		1	1	1
Information Bit Payload per Slot				
For Slots 0 and Slot i, if $\text{mod}(i, 5) = \{3,4\}$ for i from $\{0, \dots, 79\}$	Bits	N/A	N/A	N/A
For Slot i, if $\text{mod}(i, 5) = \{0,1,2\}$ for i from $\{1, \dots, 79\}$	Bits	12808	25608	51216
Transport block CRC	Bits	24	24	24
LDPC base graph		1	1	1
Number of Code Blocks per Slot				
For Slot i, if $\text{mod}(i, 10) = \{0,1,2\}$ for i from $\{1, \dots, 79\}$	CBs	N/A	N/A	N/A
For Slot i, if $\text{mod}(i, 5) = \{0,1,2\}$ for i from $\{1, \dots, 79\}$	CBs	2	4	7
Binary Channel Bits Per Slot				
For Slots 0 and Slot i, if $\text{mod}(i, 5) = \{3,4\}$ for i from $\{0, \dots, 79\}$	Bits	N/A	N/A	N/A
For Slot i, if $\text{mod}(i, 5) = \{0,1,2\}$ for i from $\{1, \dots, 79\}$	Bits	27324	54648	109296
Max. Throughput averaged over 1 frame (NOTE 7)	Mbps	30.739	61.459	122.918
<p>NOTE 1: Additional parameters are specified in Table A.3.1-1 and Table A.3.3.1-1.</p> <p>NOTE 2: If more than one Code Block is present, an additional CRC sequence of L = 24 Bits is attached to each Code Block (otherwise L = 0 Bit).</p> <p>NOTE 3: SS/PBCH block is transmitted in slot 0 with periodicity 20 ms.</p> <p>NOTE 4: Slot i is slot index per 2 frames.</p> <p>NOTE 5: PTRS is configured on symbols containing PDSCH with 1 port, per 2PRB in frequency domain, per symbol in time domain. Overhead for TBS calculation is assumed to be 6.</p> <p>NOTE 6: First number corresponds to the number slots allocated in the first frame of the RMC; second number corresponds to the number slots allocated in the second frame of the RMC.</p> <p>NOTE 7: Throughput is averaged over 2nd frame of RMC.</p>				

Table A.3.2.1.2-3: PDSCH Reference Channel for FDD (64QAM)

Parameter	Unit	Value		
Channel bandwidth	MHz	50	100	200
Subcarrier spacing configuration μ		2	2	2
Allocated resource blocks		66	132	264
Subcarriers per resource block		12	12	12
Allocated slots per Frame (NOTE 6)		23/24	23/24	23/24
MCS index		19	19	19
Modulation		64QAM	64QAM	64QAM
Target Coding Rate		1/2	1/2	1/2
Maximum number of HARQ transmissions		1	1	1
Information Bit Payload per Slot				
For Slots 0 and Slot i, if $\text{mod}(i, 5) = \{3,4\}$ for i from $\{0, \dots, 79\}$	Bits	N/A	N/A	N/A
For Slot i, if $\text{mod}(i, 5) = \{0,1,2\}$ for i from $\{1, \dots, 79\}$	Bits	20496	40976	81976
Transport block CRC	Bits	24	24	24
LDPC base graph		1	1	1
Number of Code Blocks per Slot				
For Slot i, if $\text{mod}(i, 10) = \{0,1,2\}$ for i from $\{1, \dots, 79\}$	CBs	N/A	N/A	N/A
For Slot i, if $\text{mod}(i, 5) = \{0,1,2\}$ for i from $\{1, \dots, 79\}$	CBs	3	5	10
Binary Channel Bits Per Slot				
For Slots 0 and Slot i, if $\text{mod}(i, 5) = \{3,4\}$ for i from $\{0, \dots, 79\}$	Bits	N/A	N/A	N/A
For Slot i, if $\text{mod}(i, 5) = \{0,1,2\}$ for i from $\{1, \dots, 79\}$	Bits	40986	81972	163944
Max. Throughput averaged over 1 frame (NOTE 7)	Mbps	49.190	98.342	196.742
NOTE 1: Additional parameters are specified in Table A.3.1-1 and Table A.3.3.1-1.				
NOTE 2: If more than one Code Block is present, an additional CRC sequence of L = 24 Bits is attached to each Code Block (otherwise L = 0 Bit).				
NOTE 3: SS/PBCH block is transmitted in slot 0 with periodicity 20 ms.				
NOTE 4: Slot i is slot index per 2 frames.				
NOTE 5: PTRS is configured on symbols containing PDSCH with 1 port, per 2PRB in frequency domain, per symbol in time domain. Overhead for TBS calculation is assumed to be 6.				
NOTE 6: First number corresponds to the number slots allocated in the first frame of the RMC; second number corresponds to the number slots allocated in the second frame of the RMC.				
NOTE 7: Throughput is averaged over 2nd frame of RMC.				

A.3.2.1.3 Reference measurement channels for SCS 120 kHz FR2-NTN

Table A.3.2.1.3-1: PDSCH Reference Channel for FDD (QPSK)

Parameter	Unit	Value			
		50	100	200	400
Channel bandwidth	MHz	50	100	200	400
Subcarrier spacing configuration μ		3	3	3	3
Allocated resource blocks		32	66	132	264
Subcarriers per resource block		12	12	12	12
Allocated slots per Frame (NOTE 7)		47/48	47/48	47/48	47/48
MCS index		4	4	4	4
Modulation		QPSK	QPSK	QPSK	QPSK
Target Coding Rate		1/3	1/3	1/3	1/3
Maximum number of HARQ transmissions		1	1	1	1
Information Bit Payload per Slot					
For Slots 0 and Slot i, if $\text{mod}(i, 5) = \{3,4\}$ for i from $\{0, \dots, 159\}$ (NOTE 5)	Bits	N/A	N/A	N/A	N/A
For Slot i, if $\text{mod}(i, 5) = \{0,1,2\}$ for i from $\{1, \dots, 159\}$ (NOTE 6)	Bits	2088	4224	8456	16896
Transport block CRC	Bits	16	24	24	24
LDPC base graph		2	1	1	1
Number of Code Blocks per Slot					
For Slots 0 and Slot i, if $\text{mod}(i, 5) = \{3,4\}$ for i from $\{0, \dots, 159\}$ (NOTE 5)	CBs	N/A	N/A	N/A	N/A
For Slot i, if $\text{mod}(i, 5) = \{0,1,2\}$ for i from $\{1, \dots, 159\}$ (NOTE 6)	CBs	1	1	2	3
Binary Channel Bits Per Slot					
For Slots 0 and Slot i, if $\text{mod}(i, 5) = \{3,4\}$ for i from $\{0, \dots, 159\}$ (NOTE 5)	Bits	N/A	N/A	N/A	N/A
For Slot i, if $\text{mod}(i, 5) = \{0,1,2\}$ for i from $\{1, \dots, 159\}$ (NOTE 6)	Bits	6912	14256	28512	57024
Max. Throughput averaged over 1 frame (NOTE 8)	Mbps	10.022	20.275	40.589	81.101
NOTE 1: Additional parameters are specified in Table A.3.1-1 and Table A.3.3.1-1.					
NOTE 2: If more than one Code Block is present, an additional CRC sequence of L = 24 Bits is attached to each Code Block (otherwise L = 0 Bit).					
NOTE 3: SS/PBCH block is transmitted in slot 0 with periodicity 20 ms.					
NOTE 4: Slot i is slot index per 2 frames.					
NOTE 5: When this DL RMC used together with the UL RMC for the transmitter requirements requiring at least one sub frame (1ms) for the measurement period, Slot i, if $\text{mod}(i, 16) = \{7, \dots, 15\}$ for i from $\{0, \dots, 159\}$.					
NOTE 6: When this DL RMC used together with the UL RMC for the transmitter requirements requiring at least one sub frame (1ms) for the measurement period, Slot i, if $\text{mod}(i, 16) = \{0, \dots, 6\}$ for i from $\{0, \dots, 159\}$.					
NOTE 7: First number corresponds to the number slots allocated in the first frame of the RMC; second number corresponds to the number slots allocated in the second frame of the RMC.					
NOTE 8: Throughput is averaged over 2nd frame of RMC.					

Table A.3.2.1.3-2: PDSCH Reference Channel for FDD (16QAM)

Parameter	Unit	Value			
		50	100	200	400
Channel bandwidth	MHz	50	100	200	400
Subcarrier spacing configuration μ		3	3	3	3
Allocated resource blocks		32	66	132	264
Subcarriers per resource block		12	12	12	12
Allocated slots per Frame (NOTE 6)		47/48	47/48	47/48	47/48
MCS index		13	13	13	13
Modulation		16QAM	16QAM	16QAM	16QAM
Target Coding Rate		0.48	0.48	0.48	0.48
Maximum number of HARQ transmissions		1	1	1	1
Information Bit Payload per Slot					
For Slots 0 and Slot i, if $\text{mod}(i, 5) = \{3,4\}$ for i from $\{0, \dots, 159\}$	Bits	N/A	N/A	N/A	N/A
For Slot i, if $\text{mod}(i, 5) = \{0,1,2\}$ for i from $\{1, \dots, 159\}$	Bits	6272	12808	25608	51216
Transport block CRC	Bits	24	24	24	24
LDPC base graph		1	1	1	1
Number of Code Blocks per Slot					
For Slots 0 and Slot i, if $\text{mod}(i, 5) = \{3,4\}$ for i from $\{0, \dots, 159\}$	CBs	N/A	N/A	N/A	N/A
For Slot i, if $\text{mod}(i, 5) = \{0,1,2\}$ for i from $\{1, \dots, 159\}$	CBs	1	2	4	7
Binary Channel Bits Per Slot					
For Slots 0 and Slot i, if $\text{mod}(i, 5) = \{3,4\}$ for i from $\{0, \dots, 159\}$	Bits	N/A	N/A	N/A	N/A
For Slot i, if $\text{mod}(i, 5) = \{0,1,2\}$ for i from $\{1, \dots, 159\}$	Bits	13248	27324	54648	109296
Max. Throughput averaged over 1 frame (NOTE 7)	Mbps	30.106	61.478	122.918	245.837
NOTE 1: Additional parameters are specified in Table A.3.1-1 and Table A.3.3.1-1.					
NOTE 2: If more than one Code Block is present, an additional CRC sequence of L = 24 Bits is attached to each Code Block (otherwise L = 0 Bit).					
NOTE 3: SS/PBCH block is transmitted in slot 0 of each frame.					
NOTE 4: Slot i is slot index per frame.					
NOTE 5: PTRS is configured on symbols containing PDSCH with 1 port, per 2PRB in frequency domain, per symbol in time domain. Overhead for TBS calculation is assumed to be 6.					
NOTE 6: First number corresponds to the number slots allocated in the first frame of the RMC; second number corresponds to the number slots allocated in the second frame of the RMC.					
NOTE 7: Throughput is averaged over 2nd frame of RMC.					

Table A.3.2.1.3-3: PDSCH Reference Channel for FDD (QPSK)

Parameter	Unit	Value			
Reference channel		R.PDSCH.3-3.1 FDD			
Channel bandwidth	MHz	200			
Subcarrier spacing	kHz	120			
Number of allocated resource blocks	PRBs	132			
Number of consecutive PDSCH symbols		13			
Allocated slots per 2 frames	Slots	159			
MCS table		64QAM			
MCS index		4			
Modulation		QPSK			
Target Coding Rate		0.30			
Number of MIMO layers		1			
Number of DMRS REs		12			
Overhead for TBS determination		0			
Information Bit Payload per Slot					
For Slot $i = 0$	Bits	N/A			
For Slots $i = 1, \dots, 159$	Bits	11528			
Transport block CRC per Slot					
For Slot $i = 0$	Bits	N/A			
For Slots $i = 1, \dots, 159$	Bits	24			
Number of Code Blocks per Slot					
For Slot $i = 0$	CBs	N/A			
For Slots $i = 1, \dots, 159$	CBs	2			
Binary Channel Bits Per Slot					
For Slot $i = 0$	Bits	N/A			
For Slots $i = 80, 81$	Bits	36432			
For Slots $i = 1, \dots, 79, 82, \dots, 159$	Bits	38016			
Max. Throughput averaged over 2 frames	Mbps	91.648			
Note 1: SS/PBCH block is transmitted in slot #0 with periodicity 20 ms					
Note 2: Slot i is slot index per 2 frames					

Table A.3.2.1.3-4: PDSCH Reference Channel for FDD (16QAM)

Parameter	Unit	Value			
Reference channel		R.PDSCH.3-4.1 FDD			
Channel bandwidth	MHz	200			
Subcarrier spacing	kHz	120			
Number of allocated resource blocks	PRBs	132			
Number of consecutive PDSCH symbols		13			
Allocated slots per 2 frames	Slots	159			
MCS table		64QAM			
MCS index		13			
Modulation		16QAM			
Target Coding Rate		0.48			
Number of MIMO layers		1			
Number of DMRS REs		12			
Overhead for TBS determination		0			
Information Bit Payload per Slot					
For Slot $i = 0$	Bits	N/A			
For Slots $i = 1, \dots, 159$	Bits	36896			
Transport block CRC per Slot					
For Slot $i = 0$	Bits	N/A			
For Slots $i = 1, \dots, 159$	Bits	24			
Number of Code Blocks per Slot					
For Slot $i = 0$	CBs	N/A			
For Slots $i = 1, \dots, 159$	CBs	5			
Binary Channel Bits Per Slot					
For Slot $i = 0$	Bits	N/A			
For Slots $i = 80, 81$	Bits	72864			
For Slots $i = 1, \dots, 79, 82, \dots, 159$	Bits	76032			
Max. Throughput averaged over 2 frames	Mbps	293.323			
Note 1: SS/PBCH block is transmitted in slot #0 with periodicity 20 ms					
Note 2: Slot i is slot index per 2 frames					

Table A.3.2.1.3-5: PDSCH Reference Channel for FDD (64QAM)

Parameter	Unit	Value			
		50	100	200	400
Channel bandwidth	MHz	50	100	200	400
Subcarrier spacing configuration μ		3	3	3	3
Allocated resource blocks		32	66	132	264
Subcarriers per resource block		12	12	12	12
Allocated slots per Frame (NOTE 6)		47/48	47/48	47/48	47/48
MCS index		19	19	19	19
Modulation		64QAM	64QAM	64QAM	64QAM
Target Coding Rate		1/2	1/2	1/2	1/2
Maximum number of HARQ transmissions		1	1	1	1
Information Bit Payload per Slot					
For Slots 0 and Slot i, if $\text{mod}(i, 5) = \{3,4\}$ for i from $\{0, \dots, 159\}$	Bits	N/A	N/A	N/A	N/A
For Slot i, if $\text{mod}(i, 5) = \{0,1,2\}$ for i from $\{1, \dots, 159\}$	Bits	9992	20496	40976	81976
Transport block CRC	Bits	24	24	24	24
LDPC base graph		1	1	1	1
Number of Code Blocks per Slot					
For Slots 0 and Slot i, if $\text{mod}(i, 5) = \{3,4\}$ for i from $\{0, \dots, 159\}$	CBs	N/A	N/A	N/A	N/A
For Slot i, if $\text{mod}(i, 5) = \{0,1,2\}$ for i from $\{1, \dots, 159\}$	CBs	2	3	5	10
Binary Channel Bits Per Slot					
For Slots 0 and Slot i, if $\text{mod}(i, 5) = \{3,4\}$ for i from $\{0, \dots, 159\}$	Bits	N/A	N/A	N/A	N/A
For Slot i, if $\text{mod}(i, 5) = \{0,1,2\}$ for i from $\{1, \dots, 159\}$	Bits	19872	40986	81972	163944
Max. Throughput averaged over 1 frame (NOTE 7)	Mbps	47.962	98.381	196.685	393.485
NOTE 1: Additional parameters are specified in Table A.3.1-1 and Table A.3.3.1-1.					
NOTE 2: If more than one Code Block is present, an additional CRC sequence of L = 24 Bits is attached to each Code Block (otherwise L = 0 Bit).					
NOTE 3: SS/PBCH block is transmitted in slot 0 of each frame.					
NOTE 4: Slot i is slot index per frame.					
NOTE 5: PTRS is configured on symbols containing PDSCH with 1 port, per 2PRB in frequency domain, per symbol in time domain. Overhead for TBS calculation is assumed to be 6.					
NOTE 6: First number corresponds to the number slots allocated in the first frame of the RMC; second number corresponds to the number slots allocated in the second frame of the RMC.					
NOTE 7: Throughput is averaged over 2nd frame of RMC.					

A.3.3 Reference measurement channels for PDCCH performance requirements

A.3.3.1 FDD

A.3.3.1.1 Reference measurement channels for SCS 120 kHz FR2-NTN

Table A.3.3.1.1-1: PDCCH Reference Channels

Parameter	Unit	Value	
		R.PDCCH.1-1.1 FDD	R.PDCCH.1-1.2 FDD
Reference channel			
Subcarrier spacing	kHz	120	120
CORESET frequency domain allocation		132	132
CORESET time domain allocation		1	2
Aggregation level		8	16
DCI Format		1_0	1_1
Payload (without CRC)	Bits	42	56

A.4 Testing related to Satellite Access

A.4.1 General

The following test conditions should be maintained for Satellite Access when test equipment emulates the snapshot of the satellite link channel.

- The same ephemeris info will be maintained during each test.
- A set of ephemeris information are pre-defined for each satellite corresponding to respective epoch times in TS 38.508-1 [13].
- The range of the selected constant delay shift is as follows:
 - For NGSO an altitude of 600km and 1200km on a circular orbit are considered. The range of the one-way delay between UE and satellite is from 2ms (lowest value for LEO orbit 600km) to 6.67ms (highest value for LEO orbit 1200km).
 - For GSO the range of the one-way delay from UE to satellite is within 119.375ms to 128.79ms.
- Constant delay value is derived from ephemeris info (SIB19) and UE location associated to zero Doppler or non-zero Doppler value under test.

A.4.2 Test condition for transmitter characteristics

All requirements in section 6 for transmitter characteristics, other than frequency error in clause 6.4.1, shall be verified when Doppler conditions are set to zero and delay conditions are set to constant for all types of satellites.

Frequency error requirement in clause 6.4.1 shall be verified for at least two cases: one with zero Doppler condition and the other with a constant Doppler shift where the range of the absolute value of Doppler is greater than zero and up to [0.93] ppm if the IE field *ntn-ScenarioSupport-r17* is present and indicated as GSO and up to 24 ppm if the IE field *ntn-ScenarioSupport-r17* is present and indicated as NGSO or only the IE field *nonTerrestrialNetwork-r17* is present. The delay condition is a constant.

A.4.3 Test condition for receiver characteristics

All requirements in section 7 for receiver characteristics shall be verified when Doppler conditions are set to zero and delay conditions are set to constant for all types of satellites.

A.4.4 Test condition for performance requirements

All requirements in section 8 for performance requirements shall be verified when Doppler conditions related to satellite motion for DL in service link are set to zero and delay conditions are set to constant for all types of NGSO satellites.

The one-way delay between UE and satellite for NGSO at an altitude of 600km is 2ms.

A.5 OFDMA Channel Noise Generator (OCNG)

A.5.1 OCNG Patterns for FDD

A.5.1.1 OCNG FDD pattern 1: Generic OCNG FDD Pattern for all unused REs

Table A.5.1.1-1: OP.1 FDD: Generic OCNG FDD Pattern for all unused REs

OCNG Parameters	OCNG Appliance	Control Region (Core Set)	Data Region
Resources allocated		All unused REs (Note 1)	All unused REs (Note 2)
Structure		PDCCH	PDSCH
Content		Uncorrelated pseudo random QPSK modulated data	Uncorrelated pseudo random QPSK modulated data
Transmission scheme for multiple antennas ports transmission		Single Tx port transmission	Spatial multiplexing using any precoding matrix with dimensions same as the precoding matrix for PDSCH
Subcarrier Spacing		Same as for RMC PDCCH in the active BWP	Same as for RMC PDSCH in the active BWP
Power Level		Same as for RMC PDCCH	Same as for RMC PDSCH
NOTE 1: All unused REs in the active CORESETS appointed by the search spaces in use.			
NOTE 2: Unused available REs refer to REs in PRBs not allocated for any physical channels, CORESETs, synchronization signals or reference signals in channel bandwidth.			

Annex B (normative): Propagation conditions

B.1 Static propagation condition

B.1.1 UE Receiver with 1Rx

For 2 port transmission the channel matrix is defined in the frequency domain by

$$\mathbf{H} = [1 \ 1].$$

B.1.2 UE Receiver with 2Rx

For 1 port transmission the channel matrix is defined in the frequency domain by

$$\mathbf{H} = \begin{pmatrix} 1 \\ 1 \end{pmatrix}.$$

For 2 port transmission the channel matrix is defined in the frequency domain by

$$\mathbf{H} = \begin{pmatrix} 1 & j \\ 1 & -j \end{pmatrix}.$$

B.2 Multi-path fading propagation conditions

The multipath propagation conditions consist of several parts:

- A delay profile in the form of a "tapped delay-line", characterized by a number of taps at fixed positions on a sampling grid. The profile can be further characterized by the r.m.s. delay spread and the maximum delay spanned by the taps.
- A combination of channel model parameters that include the Delay profile and the Doppler spectrum that is characterized by a classical spectrum shape and a maximum Doppler frequency.

Initial channel matrix for LOS component of NTN-TDL-C channel model is equal to channel matrix of Static propagation conditions in Clause B.1.

B.2.1 Delay profiles

The delay profiles are derived from the TR 38.811 [12] NTN-TDL models for the desired delay spread and tap resolution. After scaling the normalized delay spread values for each tap by the desired RMS delay spread, the tap delays are quantized to a delay resolution of 5ns by rounding to the nearest multiple of the delay resolution.

Table B.2.1-1: Delay profiles for NR NTN channel models

Type	Model	Delay spread (r.m.s.)	Delay resolution
NLOS	NTN-TDLA100	100 ns	5 ns
LOS	NTN-TDLC5	5 ns	5 ns

Table B.2.1-2: NTN-TDLA100 (DS = 100 ns)

Tap #	Delay [ns]	Power [dB]	Fading distribution
1	0	0	Rayleigh
2	110	-4.7	Rayleigh
3	285	-6.5	Rayleigh

Table B.2.1-3 NTN-TDLC5 (DS = 5 ns)

Tap #	Delay [ns]	Power [dB]	Fading distribution
1	0	-0.6	LOS path
	0	-8.9	Rayleigh
2	60	-21.5	Rayleigh

Note 1: Tap #1 follows a Rician distribution.

B.2.2 Combinations of channel model parameters

The propagation conditions used for the performance measurements in multi-path fading environment are indicated as a combination of a channel model name and a maximum Doppler frequency, i.e., NTN-TDLA<DS>-<Doppler>, or NTN-TDLC<DS>-<Doppler> where '<DS>' indicates the desired delay spread and '<Doppler>' indicates the maximum Doppler frequency (Hz).

Table B.2.2-1 show the propagation conditions that are used for the performance measurements in multi-path fading environment for NLOS and LOS propagation conditions.

Table B.2.2-1: Channel model parameters for NTN

Combination name	Model	Maximum Doppler frequency
NTN-TDLA100-200	NTN-TDLA100	200 Hz
NTN-TDLC5-200	NTN-TDLC5	200 Hz
NTN-TDLC5-1200	NTN-TDLC5	1200Hz

B.2.3 MIMO Channel Correlation Matrices

The MIMO channel correlation matrices defined in B.2.3 apply for the antenna configuration using uniform linear arrays at both gNB and UE.

B.2.3.1 MIMO Correlation Matrices using Uniform Linear Array (ULA)

The MIMO channel correlation matrices defined in B.2.3.1 apply for the antenna configuration using uniform linear array (ULA) at both gNB and UE.

B.2.3.1.1 Definition of MIMO Correlation Matrices

Table B.2.3.1.1-1 defines the correlation matrix for the gNB.

Table B.2.3.1.1-1: gNB correlation matrix

	One antenna	Two antennas
gNB Correlation	$R_{gNB}=1$	$R_{gNB} = \begin{pmatrix} 1 & \alpha \\ \alpha^* & 1 \end{pmatrix}$

Table B.2.3.1.1-2 defines the correlation matrix for the UE:

Table B.2.3.1.1-2: UE correlation matrix

	One antenna	Two antennas
UE Correlation	$R_{UE}=1$	$R_{UE} = \begin{pmatrix} 1 & \beta \\ \beta^* & 1 \end{pmatrix}$

Table B.2.3.1.1-3 defines the channel spatial correlation matrix R_{spat} . The parameters, α and β in Table B.2.3.1-3 defines the spatial correlation between the antennas at the gNB and UE.

Table B.2.3.1.1-3: R_{spat} correlation matrices

1x2 case	$R_{spat} = R_{UE} = \begin{bmatrix} 1 & \beta \\ \beta^* & 1 \end{bmatrix}$
2x1 case	$R_{spat} = R_{gNB} = \begin{bmatrix} 1 & \alpha \\ \alpha^* & 1 \end{bmatrix}$
2x2 case	$R_{spat} = R_{gNB} \otimes R_{UE} = \begin{bmatrix} 1 & \alpha \\ \alpha^* & 1 \end{bmatrix} \otimes \begin{bmatrix} 1 & \beta \\ \beta^* & 1 \end{bmatrix} = \begin{bmatrix} 1 & \beta & \alpha & \alpha\beta \\ \beta^* & 1 & \alpha\beta^* & \alpha \\ \alpha^* & \alpha^*\beta & 1 & \beta \\ \alpha^*\beta^* & \alpha^* & \beta^* & 1 \end{bmatrix}$

B.2.3.1.2 MIMO Correlation Matrices at High, Medium and Low Level

The α and β for different correlation types are given in Table B.2.3.1.2-1.

Table B.2.3.1.2-1: The α and β parameters for ULA MIMO correlation matrices

Correlation Model	α	β
Low correlation	0	0

The correlation matrices low correlation are defined in Table B.2.3.1.2-2 below.

Table B.2.3.1.2-2: MIMO correlation matrices for low correlation

1x2 case	$R_{low} = \mathbf{I}_2$
2x1 case	$R_{low} = \mathbf{I}_2$
2x2 case	$R_{low} = \mathbf{I}_4$
Note: \mathbf{I}_d is the $d \times d$ identity matrix.	

Annex C (normative): Downlink physical channels

C.1 General

This annex specifies the downlink physical channels that are needed for setting a connection and channels that are needed during a connection.

C.2 Setup (Conducted)

Table C.2-1 describes the downlink Physical Channels that are required for connection set up.

Table C.2-1: Downlink Physical Channels required for connection set-up

Physical Channel
PBCH
SSS
PSS
PDCCH
PDSCH
PBCH DMRS
PDCCH DMRS
PDSCH DMRS
CSI-RS

C.3 Connection (Conducted)

The following clauses, describes the downlink Physical Channels that are transmitted during a connection i.e., when measurements are done.

C.3.1 Measurement of Performance requirements

Table C.3.1-1 is applicable for measurements in which uniform RS-to-EPRE boosting for all downlink physical channels, unless otherwise stated.

Table C.3.1-1: Downlink Physical Channels transmitted during a connection (FDD and TDD)

Parameter	Unit	Value (Note 2)
SSS transmit power	W	Test specific
EPRE ratio of PSS to SSS	dB	0
EPRE ratio of PBCH to SSS	dB	0
EPRE ratio of PBCH to PBCH DMRS	dB	0
EPRE ratio of PDCCH to SSS	dB	0
EPRE ratio of PDCCH to PDCCH DMRS	dB	0
EPRE ratio of PDSCH to SSS	dB	0
EPRE ratio of PDSCH to PDSCH DMRS	dB	Test specific (Note 1)
EPRE ratio of CSI-RS to SSS	dB	$-10 \cdot \log_{10}(L)$ (Note 3)
EPRE ratio of OCNG to SSS	dB	0
EPRE ratio of PDCCH OCNG to SSS	dB	0
EPRE ratio of LTE CRS to NR SSS	dB	0 (Note 4)

Note 1: Value is derived from Table 4.1-1 in TS 38.214 [12] based on "Number of DM-RS CDM groups without data" and "DMRS Type" parameters specified for each test.

Note 2: The value is the energy of per RE for a single antenna port before pre-coding.

Note 3: $L \in \{1,2,4,8\}$ is the CDM group size of NZP CSI-RS specified for each test.

Note 4: It is only applicable to LTE-NR coexistence tests.

C.4 Setup (Radiated)

Table C.4-1 describes the downlink Physical Channels that are required for connection set up.

Table C.4-1: Downlink Physical Channels required for connection set-up

Physical Channel
PBCH
SSS
PSS
PDCCH
PDSCH
PBCH DMRS
PDCCH DMRS
PDSCH DMRS
CSI-RS
PTRS

C.5 Connection (Radiated)

The following clauses, describes the downlink Physical Channels that are transmitted during a connection i.e., when measurements are done.

C.5.1 Measurement of Receiver Characteristics

Table C.5.1-1 is applicable for measurements in which uniform RS-to-EPRE boosting for all downlink physical channels, unless otherwise stated.

Table C.5.1-1: Downlink Physical Channels transmitted during a connection (TDD)

Parameter	Unit	Value (Note 2)
SSS transmit power	W	Test specific
EPRE ratio of PSS to SSS	dB	0
EPRE ratio of PBCH to SSS	dB	0
EPRE ratio of PBCH to PBCH DMRS	dB	0
EPRE ratio of PDCCH to SSS	dB	0
EPRE ratio of PDCCH to PDCCH DMRS	dB	0
EPRE ratio of PDSCH to SSS	dB	0
EPRE ratio of PDSCH to PDSCH DMRS	dB	Test specific (Note 1)
EPRE ratio of CSI-RS to SSS	dB	$-10 \cdot \log_{10}(L)$ (Note 3)
EPRE ratio of PTRS to PDSCH	dB	Test specific
EPRE ratio of OCNG to SSS	dB	0
EPRE ratio of PDCCH OCNG to SSS	dB	0
Note 1: Value is derived from Table 4.1-1 in TS 38.214 [12] based on "Number of DM-RS CDM groups without data" and "DMRS Type" parameters specified for each test. Note 2: The value is the energy of per RE for a single antenna port before pre-coding. Note 3: $L \in \{1,2,4,8\}$ is the CDM group size of NZP CSI-RS specified for each test. Note 4: Value is derived from Table 4.1-2 in TS 38.214 [12] based on "The number of PDSCH layers" and "epre-Ratio" parameters specified for each test.		

Annex D (informative): Void

Annex E (normative): Environmental conditions

E.1 General

This annex specifies the environmental requirements of the UE. Within these limits the requirements of the present documents shall be fulfilled.

E.2 Environmental (Conducted)

The requirements in this clause apply to all types of UE(s).

E.2.1 Temperature

The UE shall fulfil all the requirements in the temperature range defined in Table E.2.1-1.

Table E.2.1-1: Temperature conditions

Temperature	Temperature conditions
+15°C to +35°C	For normal conditions (with relative humidity of 25 % to 75 %)

Outside this temperature range the UE, if powered on, shall not make ineffective use of the radio frequency spectrum. In no case shall the UE exceed the transmitted levels as defined in clause 6.2 of TS 38.101-1 [6] for extreme operation.

E.2.2 Voltage

The UE shall fulfil all the requirements in the voltage range defined in Table E.2.2-1.

Table E.2.2-1: Voltage conditions

Power source	Normal conditions voltage
AC mains	nominal
Regulated lead acid battery	1,1 * nominal
Non regulated batteries:	
Leclanché	Nominal
Lithium	1,1 * Nominal
Mercury/nickel & cadmium	Nominal

Outside this voltage range the UE if powered on, shall not make ineffective use of the radio frequency spectrum. In no case shall the UE exceed the transmitted levels as defined in TS 38.101-1[6, Clause 6.2] for extreme operation. In particular, the UE shall inhibit all RF transmissions when the power supply voltage is below the manufacturer declared shutdown voltage.

E.2.3 Vibration

The UE shall fulfil all the requirements when vibrated at the following frequency/amplitudes.

Table E.2.3-1: Vibration conditions

Frequency	ASD (Acceleration Spectral Density) random vibration
5 Hz to 20 Hz	0,96 m ² /s ³
20 Hz to 500 Hz	0,96 m ² /s ³ at 20 Hz, thereafter –3 dB/Octave

Outside the specified frequency range the UE, if powered on, shall not make ineffective use of the radio frequency spectrum. In no case shall the UE exceed the transmitted levels as defined in TS 38.101-1[6] for extreme operation.

Annex F (informative): Antenna modelling for NTN VSAT

[To be updated]

Annex G (informative): Change history

Change history							
Date	Meeting	TDoc	CR	Rev	Cat	Subject/Comment	New version
2022-01	RAN4#10 1-bis-e	R4-2203086				Draft skeleton approved	0.0.1
2022-03	RAN4#10 2-e	R4-2207514				Added approved TPs in RAN4#102-e including: R4-2207332, R4-2207334, R4-2207343, R4-2207344, R4-2207391, R4-2207393, R4-2207394, R4-2207396, R4-2207400, R4-2207404, R4-2207405, R4-2207410, R4-2207411, R4-2207413, R4-2207415	0.1.0
2022-05	RAN4#10 3-e	R4-2208641				Added approved TPs in RAN4#103-e including: R4-2208662, TP to TS 38.101-5 on Conducted transmitter characteristics R4-2209366, TP for 38.101-5 on Output RF spectrum emissions for satellite UE except for UE coexistence R4-2210851, Draft text proposal for Clause 3 - TS 38.101-5 R4-2210874, TP to TS 38.101-5 on 7.3 Reference Sensitivity R4-2210876, Updates to TS 38.101-5 related to n255 A-MPR clause R4-2210877, TP for 38.101-5 on Spurious emissions for UE coexistence R4-2210878, TP to update TS 38.101-5 clause 7.6.3 on OOB R4-2211220, TP for 38.101-5 on frequency error	0.2.0

Change history							
Date	Meeting	TDoc	CR	Rev	Cat	Subject/Comment	New version
2022-06	RAN#96					Approved by plenary – Rel-17 spec under change control	17.0.0
2022-09	RAN#97	RP-222035	0001	1	F	CR to 38.101-5: Corrections on Rx requirements for NTN UE	17.1.0
2022-09	RAN#97	RP-222035	0002		F	CR to TS 38.101-5 - Tx requirements issues fixes	17.1.0
2022-09	RAN#97	RP-222035	0003	1	F	CR to TS 38.101-5 - Rx requirements issues fixes	17.1.0
2022-12	RAN#98-e	RP-223306	0005	1	F	CR: 0005 Doppler test conditions for RF requirements 38.101-5	17.2.0
2022-12	RAN#98-e	RP-223306	0006		F	CR to 38.101-5: Corrections on section 5.3.3 for NTN UE	17.2.0
2022-12	RAN#98-e	RP-223311	0010	2	F	CR to 38.101-5 for NTN UE RF requirements corrections	17.2.0
2022-12	RAN#98-e	RP-223309	0012		F	CR addition of protection for n100 and n101 into 38.101-5	17.2.0
2022-12	RAN#98-e	RP-223311	0013		F	CR to 38.101-5: Corrections on reference for NTN UE	17.2.0
2022-12	RAN#98-e	RP-223303	0015		B	Big CR for UE NTN performance requirements (TS38.101-5, Rel-17, CAT B)	17.2.0

Date	Meeting	TDoc	CR	Rev	Cat	Subject/Comment	New version
2022-12	RAN#98-e	RP-223315	0009	1	B	CR related to Introduction of LTE TDD Band in 1670 – 1675 MHz	18.0.0
2023-03	RAN#99	RP-230535	0016		B	CR related to Introduction of NR TDD Band n54	18.1.0
2023-03	RAN#99	RP-230516	0018	1	A	Correction of the out-of-band blocking requirements	18.1.0
2023-06	RAN#100	RP-231344	0026		A	Correction to reference measurement channels for NTN	18.2.0
2023-09	RAN#101	RP-232494	0028		A	CR to TS38.101-5: Corrections to NR-NTN requirements (Rel-18)	18.3.0
2023-09	RAN#101	RP-232494	0031		A	[NR_NTN_solutions-Core] CR to 38.101-5 corrections A-MPR requirement reference-r18	18.3.0
2023-09	RAN#101	RP-232522	0033	1	B	CR for TS 38.101-5 – Adding 30 MHz CBW for NTN UE	18.3.0
2023-09	RAN#101	RP-232494	0035	1	A	Clarifications to 38.101-5 (Rel-18)	18.3.0
2023-12	RAN#102	RP-233365	0039		B	Introduction of the enhanced channel raster to TS 38.101-5	18.4.0
2023-12	RAN#102	RP-233349	0042		A	CR to 38.101-5 on clarification for NR NTN UE RF and Demod requirements test conditions	18.4.0
2023-12	RAN#102	RP-233349	0044		A	CR to 38.101-5: Correction on the reference measurement channel for NTN PDSCH requirement	18.4.0
2023-12	RAN#102	RP-233349	0046		A	[NR_NTN_solutions-Core] CR for 38.101-5 to align the understanding of GEO (R18)	18.4.0
2023-12	RAN#102	RP-233349	0052		A	Clarification for the Pi/2 BPSK modulation	18.4.0
2023-12	RAN#102	RP-233366	0054	1	B	Introduction of the NTN L/S-band	18.4.0
2024-03	RAN#103	RP-240609	0055	1	F	Correction of the A-MPR values for the satellite band n254	18.5.0
2024-03	RAN#103	RP-240609	0057		F	Adding satellite band n254 to the list of bands with enhanced channel raster	18.5.0
2024-03	RAN#103	RP-240569	0059		A	(NR_NTN_solutions-Core) CR for TS 38.101-5 on NTN spurious emission and reference sensitivity power level (R18_CAT_A)	18.5.0
2024-03	RAN#103	RP-240589	0060		B	Big CR on TS38.101-5 for UE RF Requirements	18.5.0
2024-03	RAN#103	RP-240570	0064		A	(NR_NTN_solutions-Core) CR for TS 38.101-5 to update NTN frequency range (R18)	18.5.0
2024-03	RAN#103	RP-240589	0068	1	B	CR for 38.101-5 to introduce Phase continuity requirements for NTN UE DMRS bundling	18.5.0
2024-03	RAN#103	RP-240610	0070		F	CR to TS38.101-5: Addition of some missing bands in UE spurious emissions coexistence clause	18.5.0
2024-03	RAN#103	RP-240570	0074	4	F	Correction on DSS support for the NTN bands from Rel-18	18.5.0
2024-03	RAN#103	RP-240552	0076		A	UL RMCs updates for NR NTN (Rel-18)	18.5.0
2024-06	RAN#104	RP-241386	0078	1	F	Clarification for applicability of DSS for NTN FR1 bands	18.6.0
2024-06	RAN#104	RP-241489	0079		F	Clarification for the mandatory support of enhanced channel raster for the NTN bands	18.6.0
2024-06	RAN#104	RP-241387	0081		A	(NR_NTN_solutions-Perf) CR to 38.101-5 to update section with PDSCH demod requirements	18.6.0
2024-06	RAN#104	RP-241386	0087		A	(NR_NTN_solutions-Core) CR for TS 38.101-5: Corrections on REFSENS for band n256	18.6.0
2024-06	RAN#104	RP-241429	0088		B	Big CR on NTN demodulation requirements (TS38.101-5, Rel-18)	18.6.0
2024-06	RAN#104	RP-241386	0092		A	(NR_NTN_solutions-Core) CR for TS 38.101-5 on UE additional maximum output power reduction (R18_CAT_A)	18.6.0
2024-06	RAN#104	RP-241386	0094		A	CR to TS 38.101-5: Terminology alignment with SAN RF specification	18.6.0
2024-06	RAN#104	RP-241429	0098		B	Big CR to TS 38.101-5	18.6.0
2024-06	RAN#104	RP-241585	0099		B	CR to TS 38.101-5 - Adding clause 10.5 ACS requirements for NTN VSAT UE	18.6.0
2024-09	RAN#105	RP-242179	0100	1	F	(NR_NTN_enh-Perf) CR on performance requirements for 38.101-5	18.7.0
2024-09	RAN#105	RP-242177	0101		F	(NR_NTN_enh-Core)CR for TS 38.101-5, Correction on ACS requirement for mobile VSAT and fixed VSAT	18.7.0
2024-09	RAN#105	RP-242180	0102		F	(NR_NTN_LSband-Core) Correction of NS_05N in band n254	18.7.0
2024-09	RAN#105	RP-242177	0103		F	(NR_NTN_enh-Core) CR to TS 38.101-5: clarification of the additional requirements for n512 + additional fixes	18.7.0
2024-09	RAN#105	RP-242179	0106		F	CR to 38.101-5 on eNTN demod requirements for PDCCH	18.7.0
2024-09	RAN#105	RP-242177	0107		F	CR on log formula for FR2-NTN UE RF requirement	18.7.0
2024-09	RAN#105	RP-242179	0108	1	F	CR to 38.101-5: Correction on UE demodulation requirement for NTN FR2	18.7.0
2024-09	RAN#105	RP-242177	0111		F	(NR_NTN_enh-Core) CR to correct the definition of cross-polarized transmission - TS38.101-5	18.7.0
2024-09	RAN#105	RP-242177	0112	1	F	Maintenance CR for NTN VSAT in Ka-band	18.7.0
2024-09	RAN#105	RP-242178	0116	1	F	(NR_NTN_enh-Core) CR for TS 38.101-5 to modify the mistakes for Tx requirements (R18)	18.7.0
2024-09	RAN#105	RP-242178	0117	1	F	(NR_NTN_enh-Core) CR for TS 38.101-5 to modify the mistakes for Rx requirements (R18)	18.7.0
2024-09	RAN#105	RP-242177	0119		F	(NR_NTN_enh-Core) CR for TS 38.101-5 to clarify the applicability for different requirements (R18)	18.7.0
2024-09	RAN#105	RP-242181	0121		A	(NR_NTN_solutions-Core) CR to TS 38.101-5: variable duplex distance	18.7.0

History

Document history		
V18.5.0	May 2024	Publication
V18.6.0	August 2024	Publication
V18.7.0	October 2024	Publication