

ETSI TS 138 108 V17.8.0 (2024-08)



**5G;
NR;
Satellite Access Node radio transmission and reception
(3GPP TS 38.108 version 17.8.0 Release 17)**



Reference

RTS/TSGR-0438108vh80

Keywords

5G

ETSI

650 Route des Lucioles
F-06921 Sophia Antipolis Cedex - FRANCE

Tel.: +33 4 92 94 42 00 Fax: +33 4 93 65 47 16

Siret N° 348 623 562 00017 - APE 7112B
Association à but non lucratif enregistrée à la
Sous-Préfecture de Grasse (06) N° w061004871

Important notice

The present document can be downloaded from the
ETSI [Search & Browse Standards application](#).

The present document may be made available in electronic versions and/or in print. The content of any electronic and/or print versions of the present document shall not be modified without the prior written authorization of ETSI. In case of any existing or perceived difference in contents between such versions and/or in print, the prevailing version of an ETSI deliverable is the one made publicly available in PDF format on [ETSI deliver](#).

Users should be aware that the present document may be revised or have its status changed,
this information is available in the [Milestones listing](#).

If you find errors in the present document, please send your comments to
the relevant service listed under [Committee Support Staff](#).

If you find a security vulnerability in the present document, please report it through our
[Coordinated Vulnerability Disclosure \(CVD\)](#) program.

Notice of disclaimer & limitation of liability

The information provided in the present deliverable is directed solely to professionals who have the appropriate degree of experience to understand and interpret its content in accordance with generally accepted engineering or other professional standard and applicable regulations.

No recommendation as to products and services or vendors is made or should be implied.

No representation or warranty is made that this deliverable is technically accurate or sufficient or conforms to any law and/or governmental rule and/or regulation and further, no representation or warranty is made of merchantability or fitness for any particular purpose or against infringement of intellectual property rights.

In no event shall ETSI be held liable for loss of profits or any other incidental or consequential damages.

Any software contained in this deliverable is provided "AS IS" with no warranties, express or implied, including but not limited to, the warranties of merchantability, fitness for a particular purpose and non-infringement of intellectual property rights and ETSI shall not be held liable in any event for any damages whatsoever (including, without limitation, damages for loss of profits, business interruption, loss of information, or any other pecuniary loss) arising out of or related to the use of or inability to use the software.

Copyright Notification

No part may be reproduced or utilized in any form or by any means, electronic or mechanical, including photocopying and microfilm except as authorized by written permission of ETSI.

The content of the PDF version shall not be modified without the written authorization of ETSI.

The copyright and the foregoing restriction extend to reproduction in all media.

© ETSI 2024.
All rights reserved.

Intellectual Property Rights

Essential patents

IPRs essential or potentially essential to normative deliverables may have been declared to ETSI. The declarations pertaining to these essential IPRs, if any, are publicly available for **ETSI members and non-members**, and can be found in ETSI SR 000 314: "*Intellectual Property Rights (IPRs); Essential, or potentially Essential, IPRs notified to ETSI in respect of ETSI standards*", which is available from the ETSI Secretariat. Latest updates are available on the ETSI Web server (<https://ipr.etsi.org/>).

Pursuant to the ETSI Directives including the ETSI IPR Policy, no investigation regarding the essentiality of IPRs, including IPR searches, has been carried out by ETSI. No guarantee can be given as to the existence of other IPRs not referenced in ETSI SR 000 314 (or the updates on the ETSI Web server) which are, or may be, or may become, essential to the present document.

Trademarks

The present document may include trademarks and/or tradenames which are asserted and/or registered by their owners. ETSI claims no ownership of these except for any which are indicated as being the property of ETSI, and conveys no right to use or reproduce any trademark and/or tradename. Mention of those trademarks in the present document does not constitute an endorsement by ETSI of products, services or organizations associated with those trademarks.

DECT™, **PLUGTESTS™**, **UMTS™** and the ETSI logo are trademarks of ETSI registered for the benefit of its Members. **3GPP™** and **LTE™** are trademarks of ETSI registered for the benefit of its Members and of the 3GPP Organizational Partners. **oneM2M™** logo is a trademark of ETSI registered for the benefit of its Members and of the oneM2M Partners. **GSM®** and the GSM logo are trademarks registered and owned by the GSM Association.

Legal Notice

This Technical Specification (TS) has been produced by ETSI 3rd Generation Partnership Project (3GPP).

The present document may refer to technical specifications or reports using their 3GPP identities. These shall be interpreted as being references to the corresponding ETSI deliverables.

The cross reference between 3GPP and ETSI identities can be found under <https://webapp.etsi.org/key/queryform.asp>.

Modal verbs terminology

In the present document "**shall**", "**shall not**", "**should**", "**should not**", "**may**", "**need not**", "**will**", "**will not**", "**can**" and "**cannot**" are to be interpreted as described in clause 3.2 of the [ETSI Drafting Rules](#) (Verbal forms for the expression of provisions).

"**must**" and "**must not**" are **NOT** allowed in ETSI deliverables except when used in direct citation.

Contents

| | |
|---|----|
| Intellectual Property Rights | 2 |
| Legal Notice | 2 |
| Modal verbs terminology..... | 2 |
| Foreword..... | 9 |
| 1 Scope | 11 |
| 2 References | 11 |
| 3 Definitions, symbols and abbreviations | 11 |
| 3.1 Definitions | 11 |
| 3.2 Symbols..... | 15 |
| 3.3 Abbreviations | 16 |
| 4 General | 17 |
| 4.1 Relationship with other core specifications..... | 17 |
| 4.2 Relationship between minimum requirements and test requirements | 17 |
| 4.3 Requirement reference points..... | 17 |
| 4.3.1 SAN type 1-H | 17 |
| 4.3.2 SAN type 1-O | 18 |
| 4.4 Satellite Access Node classes..... | 18 |
| 4.5 Regional requirements..... | 19 |
| 4.6 Applicability of minimum requirements | 19 |
| 5 Operating bands and channel arrangement..... | 20 |
| 5.1 General | 20 |
| 5.2 Operating bands..... | 21 |
| 5.3 Satellite Access Node channel bandwidth..... | 21 |
| 5.3.1 General..... | 21 |
| 5.3.2 Transmission bandwidth configuration..... | 22 |
| 5.3.3 Minimum guardband and transmission bandwidth configuration..... | 22 |
| 5.3.4 RB alignment | 23 |
| 5.3.5 SAN channel bandwidth per operating band | 23 |
| 5.4 Channel arrangement..... | 24 |
| 5.4.1 Channel spacing..... | 24 |
| 5.4.1.1 Channel spacing for adjacent carriers | 24 |
| 5.4.2 Channel raster | 24 |
| 5.4.2.1 NR-ARFCN and channel raster..... | 24 |
| 5.4.2.2 Channel raster to resource element mapping..... | 25 |
| 5.4.2.3 Channel raster entries for each <i>operating band</i> | 25 |
| 5.4.3 Synchronization raster | 25 |
| 5.4.3.1 Synchronization raster and numbering..... | 25 |
| 5.4.3.2 Synchronization raster to synchronization block resource element mapping..... | 26 |
| 5.4.3.3 Synchronization raster entries for each operating band..... | 26 |
| 6 Conducted transmitter characteristics | 26 |
| 6.1 General | 26 |
| 6.2 Satellite Access Node output power..... | 26 |
| 6.2.1 General..... | 26 |
| 6.2.2 Minimum requirement for <i>SAN type 1-H</i> | 27 |
| 6.3 Output power dynamics..... | 27 |
| 6.3.1 General..... | 27 |
| 6.3.2 RE power control dynamic range | 27 |
| 6.3.2.1 General | 27 |
| 6.3.2.2 Minimum requirement for <i>SAN type 1-H</i> | 27 |
| 6.3.3 Total power dynamic range | 27 |
| 6.3.3.1 General | 27 |
| 6.3.3.2 Minimum requirement for <i>SAN type 1-H</i> | 28 |

| | | |
|-----------|--|----|
| 6.4 | Transmit ON/OFF power | 28 |
| 6.5 | Transmitted signal quality | 28 |
| 6.5.1 | Frequency error..... | 28 |
| 6.5.1.1 | General | 28 |
| 6.5.1.2 | Minimum requirement for <i>SAN type 1-H</i> | 28 |
| 6.5.2 | Modulation quality..... | 28 |
| 6.5.2.1 | General | 28 |
| 6.5.2.2 | Minimum Requirement for <i>SAN type 1-H</i> | 28 |
| 6.5.2.3 | EVM frame structure for measurement..... | 29 |
| 6.5.3 | Time alignment error | 29 |
| 6.6 | Unwanted emissions..... | 29 |
| 6.6.1 | General..... | 29 |
| 6.6.2 | Occupied bandwidth | 29 |
| 6.6.2.1 | General | 29 |
| 6.6.2.2 | Minimum requirement for <i>SAN type 1-H</i> | 30 |
| 6.6.3 | Adjacent Channel Leakage Power Ratio | 30 |
| 6.6.3.1 | General | 30 |
| 6.6.3.2 | Minimum requirement for <i>SAN type 1-H</i> | 30 |
| 6.6.4 | Out-of-band emissions..... | 31 |
| 6.6.4.1 | General | 31 |
| 6.6.4.2 | Basic limits..... | 31 |
| 6.6.4.3 | Minimum requirements for <i>SAN type 1-H</i> | 31 |
| 6.6.5 | Transmitter spurious emissions..... | 31 |
| 6.6.5.1 | General | 31 |
| 6.6.5.2 | <i>Basic limits</i> | 32 |
| 6.6.5.2.1 | General transmitter spurious emissions requirements | 32 |
| 6.6.5.2.2 | Protection of the own Satellite Access Node receiver..... | 32 |
| 6.6.5.2.3 | Additional spurious emissions requirements | 32 |
| 6.6.5.2.4 | Co-location with other Satellite Access Nodes..... | 32 |
| 6.6.5.3 | Minimum requirements for <i>SAN type 1-H</i> | 32 |
| 6.7 | Transmitter intermodulation..... | 33 |
| 7 | Conducted receiver characteristics..... | 33 |
| 7.1 | General | 33 |
| 7.2 | Reference sensitivity level..... | 33 |
| 7.2.1 | General..... | 33 |
| 7.2.2 | Minimum requirements for <i>SAN type 1-H</i> | 33 |
| 7.3 | Dynamic range | 34 |
| 7.3.1 | General..... | 34 |
| 7.3.2 | Minimum requirements for <i>SAN type 1-H</i> | 34 |
| 7.4 | In-band selectivity and blocking | 35 |
| 7.4.1 | Adjacent Channel Selectivity (ACS) | 35 |
| 7.4.1.1 | General | 35 |
| 7.4.1.2 | Minimum requirements for <i>SAN type 1-H</i> | 35 |
| 7.4.2 | In-band blocking..... | 36 |
| 7.5 | Out-of-band blocking | 36 |
| 7.5.1 | General..... | 36 |
| 7.5.2 | Minimum requirements for <i>SAN type 1-H</i> | 36 |
| 7.6 | Receiver spurious emissions..... | 36 |
| 7.6.1 | Void | 37 |
| 7.6.2 | Void | 37 |
| 7.7 | Receiver intermodulation | 37 |
| 7.8 | In-channel selectivity | 37 |
| 7.8.1 | General..... | 37 |
| 7.8.2 | Minimum requirements for <i>SAN type 1-H</i> | 37 |
| 8 | Conducted performance requirements..... | 38 |
| 8.1 | General | 38 |
| 8.2 | Performance requirements for PUSCH | 39 |
| 8.2.1 | Requirements for PUSCH with transform precoding disabled | 39 |
| 8.2.1.1 | General | 39 |
| 8.2.1.2 | Minimum requirements | 39 |

| | | |
|-------------|---|----|
| 8.2.2 | Requirements for PUSCH with transform precoding enabled | 40 |
| 8.2.2.1 | General | 40 |
| 8.2.2.2 | Minimum requirements | 41 |
| 8.2.3 | Requirements for UL timing adjustment | 42 |
| 8.2.3.2 | Minimum requirements | 43 |
| 8.2.4 | Requirements for PUSCH repetition Type A | 44 |
| 8.2.4.1 | General | 44 |
| 8.2.4.2 | Minimum requirements | 45 |
| 8.3 | Performance requirements for PUCCH | 46 |
| 8.3.1 | DTX to ACK probability | 46 |
| 8.3.1.1 | General | 46 |
| 8.3.1.2 | Minimum requirement | 46 |
| 8.3.2 | Performance requirements for PUCCH format 0 | 46 |
| 8.3.2.1 | General | 46 |
| 8.3.2.2 | Minimum requirements | 46 |
| 8.3.3 | Performance requirements for PUCCH format 1 | 47 |
| 8.3.3.1 | NACK to ACK requirements | 47 |
| 8.3.3.1.1 | General | 47 |
| 8.3.3.1.2 | Minimum requirements | 47 |
| 8.3.3.2 | ACK missed detection requirements | 48 |
| 8.3.3.2.1 | General | 48 |
| 8.3.3.2.2 | Minimum requirements | 48 |
| 8.3.4 | Performance requirements for PUCCH format 2 | 48 |
| 8.3.4.1 | ACK missed detection requirements | 48 |
| 8.3.4.1.1 | General | 48 |
| 8.3.4.1.2 | Minimum requirements | 49 |
| 8.3.4.2 | UCI BLER performance requirements | 49 |
| 8.3.4.2.1 | General | 49 |
| 8.3.4.2.2 | Minimum requirements | 50 |
| 8.3.5 | Performance requirements for PUCCH format 3 | 50 |
| 8.3.5.1 | General | 50 |
| 8.3.5.2 | Minimum requirements | 51 |
| 8.3.6 | Performance requirements for PUCCH format 4 | 51 |
| 8.3.6.1 | General | 51 |
| 8.3.6.2 | Minimum requirement | 52 |
| 8.3.7 | Performance requirements for multi-slot PUCCH | 52 |
| 8.3.7.1 | General | 52 |
| 8.3.7.2 | Performance requirements for multi-slot PUCCH format 1 | 52 |
| 8.3.7.2.1 | NACK to ACK requirements | 52 |
| 8.3.7.2.1.1 | General | 52 |
| 8.3.7.2.1.2 | Minimum requirements | 53 |
| 8.3.7.2.2 | ACK missed detection requirements | 53 |
| 8.3.7.2.2.1 | General | 53 |
| 8.3.7.2.2.2 | Minimum requirements | 54 |
| 8.4 | Performance requirements for PRACH | 54 |
| 8.4.1 | PRACH False alarm probability | 54 |
| 8.4.1.1 | General | 54 |
| 8.4.1.2 | Minimum requirement | 54 |
| 8.4.2 | PRACH detection requirements | 54 |
| 8.4.2.1 | General | 54 |
| 8.4.2.2 | Minimum requirements | 55 |
| 9 | Radiated transmitter characteristics | 55 |
| 9.1 | General | 55 |
| 9.2 | Radiated transmit power | 55 |
| 9.2.1 | General | 55 |
| 9.2.2 | Minimum requirement for <i>SAN type 1-H</i> and <i>SAN type 1-O</i> | 56 |
| 9.3 | OTA Satellite Access Node output power | 56 |
| 9.3.1 | General | 56 |
| 9.3.2 | Minimum requirement for <i>SAN type 1-O</i> | 56 |
| 9.4 | OTA output power dynamics | 56 |
| 9.4.1 | General | 56 |

| | | |
|-----------|---|----|
| 9.4.2 | OTA RE power control dynamic range | 57 |
| 9.4.2.1 | General | 57 |
| 9.4.2.2 | Minimum requirement for <i>SAN type 1-O</i> | 57 |
| 9.4.3 | OTA total power dynamic range | 57 |
| 9.4.3.1 | General | 57 |
| 9.4.3.2 | Minimum requirement for <i>SAN type 1-O</i> | 57 |
| 9.5 | OTA transmit ON/OFF power | 57 |
| 9.6 | OTA transmitted signal quality | 57 |
| 9.6.1 | OTA frequency error | 57 |
| 9.6.1.1 | General | 57 |
| 9.6.1.2 | Minimum requirement for <i>SAN type 1-O</i> | 58 |
| 9.6.2 | OTA modulation quality | 58 |
| 9.6.2.1 | General | 58 |
| 9.6.2.2 | Minimum requirement for <i>SAN type 1-O</i> | 58 |
| 9.6.3 | OTA time alignment error | 58 |
| 9.7 | OTA unwanted emissions | 58 |
| 9.7.1 | General | 58 |
| 9.7.2 | OTA occupied bandwidth | 58 |
| 9.7.2.1 | General | 58 |
| 9.7.2.2 | Minimum requirement for <i>SAN type 1-O</i> | 59 |
| 9.7.3 | OTA Adjacent Channel Leakage Power Ratio (ACLR) | 59 |
| 9.7.3.1 | General | 59 |
| 9.7.3.2 | Minimum requirement for <i>SAN type 1-O</i> | 59 |
| 9.7.4 | OTA out-of-band emissions | 59 |
| 9.7.4.1 | General | 59 |
| 9.7.4.2 | Minimum requirement for <i>SAN type 1-O</i> | 59 |
| 9.7.5 | OTA transmitter spurious emissions | 59 |
| 9.7.5.1 | General | 59 |
| 9.7.5.2 | Minimum requirement for <i>SAN type 1-O</i> | 60 |
| 9.7.5.2.1 | General | 60 |
| 9.7.5.2.2 | General OTA transmitter spurious emissions requirements | 60 |
| 9.7.5.2.3 | Protection of the SAN receiver | 60 |
| 9.7.5.2.4 | Additional spurious emissions requirements | 60 |
| 9.8 | OTA transmitter intermodulation | 60 |
| 10 | Radiated receiver characteristics | 61 |
| 10.1 | General | 61 |
| 10.2 | OTA sensitivity | 61 |
| 10.2.1 | General | 61 |
| 10.2.2 | Minimum requirement for <i>SAN type 1-O</i> | 62 |
| 10.3 | OTA reference sensitivity level | 62 |
| 10.3.1 | General | 62 |
| 10.3.2 | Minimum requirement for <i>SAN type 1-O</i> | 62 |
| 10.4 | OTA dynamic range | 63 |
| 10.4.1 | General | 63 |
| 10.4.2 | Minimum requirement for <i>SAN type 1-O</i> | 63 |
| 10.5 | OTA in-band selectivity and blocking | 64 |
| 10.5.1 | OTA adjacent channel selectivity | 64 |
| 10.5.1.1 | General | 64 |
| 10.5.1.2 | Minimum requirement for <i>SAN type 1-O</i> | 64 |
| 10.5.2 | OTA in-band blocking | 65 |
| 10.6 | OTA out-of-band blocking | 65 |
| 10.6.1 | General | 65 |
| 10.6.2 | Minimum requirement for <i>SAN type 1-O</i> | 65 |
| 10.6.2.1 | General minimum requirement | 65 |
| 10.7 | OTA receiver spurious emissions | 66 |
| 10.7.1 | Void | 66 |
| 10.7.2 | Void | 66 |
| 10.8 | OTA receiver intermodulation | 66 |
| 10.9 | OTA in-channel selectivity | 66 |
| 10.9.1 | General | 66 |
| 10.9.2 | Minimum requirement for <i>SAN type 1-O</i> | 66 |

| | | |
|---|---|-----------|
| 11 | Radiated performance requirements..... | 67 |
| 11.1 | General..... | 67 |
| 11.1.1 | Scope and definitions..... | 67 |
| 11.1.2 | OTA demodulation branches..... | 68 |
| 11.2 | Performance requirements for PUSCH..... | 68 |
| 11.2.1 | Requirements for PUSCH with transform precoding disabled..... | 68 |
| 11.2.2 | Requirements for PUSCH with transform precoding enabled..... | 68 |
| 11.2.3 | Requirements for UL timing adjustment..... | 69 |
| 11.2.4 | Requirements for PUSCH repetition Type A..... | 69 |
| 11.3 | Performance requirements for PUCCH..... | 69 |
| 11.3.1 | Requirements for <i>SAN type I-O</i> | 69 |
| 11.3.1.1 | DTX to ACK probability..... | 69 |
| 11.3.1.2 | Performance requirements for PUCCH format 0..... | 69 |
| 11.3.1.3 | Performance requirements for PUCCH format 1..... | 69 |
| 11.3.1.4 | Performance requirements for PUCCH format 2..... | 69 |
| 11.3.1.5 | Performance requirements for PUCCH format 3..... | 69 |
| 11.3.1.6 | Performance requirements for PUCCH format 4..... | 69 |
| 11.3.1.7 | Performance requirements for multi-slot PUCCH..... | 69 |
| 11.4 | Performance requirements for PRACH..... | 69 |
| 11.4.1 | PRACH False alarm probability..... | 69 |
| 11.4.2 | PRACH detection requirements..... | 69 |
| Annex A (normative): Reference measurement channels..... | | 70 |
| A.1 | Fixed Reference Channels for RF Rx requirements in FR1 (QPSK, R=1/3)..... | 70 |
| A.2 | Fixed Reference Channels for dynamic range (16QAM, R=2/3)..... | 70 |
| A.3 | Fixed Reference Channels for performance requirements (QPSK, R=308/1024)..... | 71 |
| A.3A | Fixed Reference Channels for performance requirements (QPSK, R=99/1024)..... | 72 |
| A.4 | PRACH test preambles..... | 73 |
| Annex B (normative): Error Vector Magnitude (FR1)..... | | 74 |
| B.1 | Reference point for measurement..... | 74 |
| B.2 | Basic unit of measurement..... | 74 |
| B.3 | Modified signal under test..... | 75 |
| B.4 | Estimation of frequency offset..... | 75 |
| B.5 | Estimation of time offset..... | 75 |
| B.5.1 | General..... | 75 |
| B.5.2 | Window length..... | 76 |
| B.6 | Estimation of TX chain amplitude and frequency response parameters..... | 76 |
| B.7 | Averaged EVM..... | 78 |
| Annex C (normative): Characteristics of the interfering signals..... | | 79 |
| Annex D (Normative): Propagation conditions..... | | 80 |
| D.1 | Static propagation condition..... | 80 |
| D.2 | Multi-path fading propagation conditions..... | 80 |
| D.2.1 | Delay profiles..... | 80 |
| D.2.1.1 | Delay profiles for FR1..... | 80 |
| D.2.2 | Combinations of channel model parameters..... | 81 |
| D.2.3 | MIMO channel correlation matrices..... | 81 |
| D.2.3.1 | MIMO correlation matrices using Uniform Linear Array..... | 81 |
| D.2.3.1.1 | Definition of MIMO correlation matrices..... | 81 |
| D.2.3.1.2 | MIMO correlation matrices at high, medium and low level..... | 82 |

Annex E (informative): **Change history**84
History86

Foreword

This Technical Specification has been produced by the 3rd Generation Partnership Project (3GPP).

The contents of the present document are subject to continuing work within the TSG and may change following formal TSG approval. Should the TSG modify the contents of the present document, it will be re-released by the TSG with an identifying change of release date and an increase in version number as follows:

Version x.y.z

where:

- x the first digit:
 - 1 presented to TSG for information;
 - 2 presented to TSG for approval;
 - 3 or greater indicates TSG approved document under change control.
- y the second digit is incremented for all changes of substance, i.e. technical enhancements, corrections, updates, etc.
- z the third digit is incremented when editorial only changes have been incorporated in the document.

In the present document, modal verbs have the following meanings:

- shall** indicates a mandatory requirement to do something
- shall not** indicates an interdiction (prohibition) to do something

The constructions "shall" and "shall not" are confined to the context of normative provisions, and do not appear in Technical Reports.

The constructions "must" and "must not" are not used as substitutes for "shall" and "shall not". Their use is avoided insofar as possible, and they are not used in a normative context except in a direct citation from an external, referenced, non-3GPP document, or so as to maintain continuity of style when extending or modifying the provisions of such a referenced document.

- should** indicates a recommendation to do something
- should not** indicates a recommendation not to do something
- may** indicates permission to do something
- need not** indicates permission not to do something

The construction "may not" is ambiguous and is not used in normative elements. The unambiguous constructions "might not" or "shall not" are used instead, depending upon the meaning intended.

- can** indicates that something is possible
- cannot** indicates that something is impossible

The constructions "can" and "cannot" are not substitutes for "may" and "need not".

- will** indicates that something is certain or expected to happen as a result of action taken by an agency the behaviour of which is outside the scope of the present document
- will not** indicates that something is certain or expected not to happen as a result of action taken by an agency the behaviour of which is outside the scope of the present document
- might** indicates a likelihood that something will happen as a result of action taken by some agency the behaviour of which is outside the scope of the present document

might not indicates a likelihood that something will not happen as a result of action taken by some agency the behaviour of which is outside the scope of the present document

In addition:

is (or any other verb in the indicative mood) indicates a statement of fact

is not (or any other negative verb in the indicative mood) indicates a statement of fact

The constructions "is" and "is not" do not indicate requirements.

1 Scope

The present document establishes the minimum RF characteristics and minimum performance requirements of NR Satellite Access Node (SAN).

2 References

The following documents contain provisions which, through reference in this text, constitute provisions of the present document.

- References are either specific (identified by date of publication, edition number, version number, etc.) or non-specific.
- For a specific reference, subsequent revisions do not apply.
- For a non-specific reference, the latest version applies. In the case of a reference to a 3GPP document (including a GSM document), a non-specific reference implicitly refers to the latest version of that document *in the same Release as the present document*.

- [1] 3GPP TR 21.905: "Vocabulary for 3GPP Specifications".
- [2] ITU-R Recommendation SM.329: "Unwanted emissions in the spurious domain".
- [3] 3GPP TS 38.181: "NR; Satellite Node conformance testing".
- [4] ITU-R Recommendation M.1545: "Measurement uncertainty as it applies to test limits for the terrestrial component of International Mobile Telecommunications-2000".
- [5] 3GPP TS 38.211: "NR; Physical channels and modulation".
- [6] 3GPP TS 38.331: "NR; Radio Resource Control (RRC); Protocol specification".
- [7] 3GPP TS 38.213: "NR; Physical layer procedures for control".
- [8] ITU-R Recommendation SM.328: "Spectra and bandwidth of emissions".
- [9] ITU-R Recommendation SM.1541-6: "Unwanted emissions in the out-of-band domain".
- [10] 3GPP TS 38.212: "NR; Multiplexing and channel coding".
- [11] 3GPP TS 38.101-5: "NR; User Equipment (UE) radio transmission and reception; Part 5: Satellite access Radio Frequency (RF) and performance requirements"
- [12] 3GPP TR 38.901: "Study on channel model for frequencies from 0.5 to 100 GHz"
- [13] 3GPP TR 38.811: "Study on New Radio (NR) to support non-terrestrial networks"

3 Definitions, symbols and abbreviations

3.1 Definitions

For the purposes of the present document, the terms given in 3GPP TR 21.905 [1] and the following apply. A term defined in the present document takes precedence over the definition of the same term, if any, in 3GPP TR 21.905 [1].

basic limit: emissions limit relating to the power supplied by a single transmitter to a single antenna transmission line in ITU-R SM.329 [2] used for the formulation of unwanted emission requirements for FR1-NTN.

beam: beam (of the antenna) is the main lobe of the radiation pattern of an *antenna array*.

NOTE: For certain *antenna array*, there may be more than one beam.

beam centre direction: direction equal to the geometric centre of the half-power contour of the beam.

beam direction pair: data set consisting of the *beam centre direction* and the related *beam peak direction*.

beam peak direction: direction where the maximum EIRP is found.

beamwidth: beam which has a half-power contour that is essentially elliptical, the half-power beamwidths in the two pattern cuts that respectively contain the major and minor axis of the ellipse.

Channel edge: lowest or highest frequency of the NR carrier, separated by the *SAN channel bandwidth*.

directional requirement: requirement which is applied in a specific direction within the *OTA coverage range* for the Tx and when the AoA of the incident wave of a received signal is within the *OTA REFSENS RoAoA* or the *minSENS RoAoA* as appropriate for the receiver.

equivalent isotropic radiated power: equivalent power radiated from an isotropic directivity device producing the same field intensity at a point of observation as the field intensity radiated in the direction of the same point of observation by the discussed device.

NOTE: Isotropic directivity is equal in all directions (i.e. 0 dBi).

equivalent isotropic sensitivity: sensitivity for an isotropic directivity device equivalent to the sensitivity of the discussed device exposed to an incoming wave from a defined AoA.

NOTE 1: The sensitivity is the minimum received power level at which specific requirement is met.

NOTE 2: Isotropic directivity is equal in all directions (i.e. 0 dBi).

feeder link: Wireless link between satellite-gateway and satellite.

Geostationary Earth Orbit: Circular orbit at 35,786 km above the Earth's equator and following the direction of the Earth's rotation. An object in such an orbit has an orbital period equal to the Earth's rotational period and thus appears motionless, at a fixed position in the sky, to ground observers.

Low Earth Orbit: Orbit around the Earth with an altitude between 300 km, and 1500 km.

Highest Carrier: The carrier with the highest carrier frequency transmitted/received in a specified frequency band.

Lowest Carrier: The carrier with the lowest carrier frequency transmitted/received in a specified frequency band.

maximum carrier output power: mean power level measured per carrier at the indicated interface, during the *transmitter ON period* in a specified reference condition.

maximum carrier TRP output power: mean power level measured per RIB during the *transmitter ON period* for a specific carrier in a specified reference condition and corresponding to the declared *rated carrier TRP output power* ($P_{\text{rated,c,TRP}}$).

maximum total output power: mean power level measured within the *operating band* at the indicated interface, during the *transmitter ON period* in a specified reference condition.

maximum total TRP output power: mean power level measured per RIB during the *transmitter ON period* in a specified reference condition and corresponding to the declared *rated total TRP output power* ($P_{\text{rated,t,TRP}}$).

measurement bandwidth: RF bandwidth in which an emission level is specified.

minSENS: the lowest declared EIS value for the OSDD's declared for OTA sensitivity requirement.

minSENS RoAoA: The *reference RoAoA* associated with the OSDD with the lowest declared EIS.

minimum elevation angle: Minimum angle under which the satellite can be seen by a UE.

necessary bandwidth: The width of the frequency band which is just sufficient to ensure the transmission of information at the rate and with the quality required under specified conditions.

non-terrestrial networks: Networks, or segments of networks, using an airborne or space-borne vehicle to embark a transmission equipment relay node or SAN.

operating band: frequency range in which NR operates (paired or unpaired), that is defined with a specific set of technical requirements.

NOTE: The *operating band(s)* for a SAN is declared by the manufacturer according to the designations in tables 5.2-1 and 5.2-2.

OTA coverage range: a common range of directions within which TX OTA requirements that are neither specified in the *OTA peak directions sets* nor as *TRP requirement* are intended to be met.

OTA peak directions set: set(s) of *beam peak directions* within which certain TX OTA requirements are intended to be met, where all *OTA peak directions set(s)* are subsets of the *OTA coverage range*.

NOTE: The *beam peak directions* are related to a corresponding contiguous range or discrete list of *beam centre directions* by the *beam direction pairs* included in the set.

OTA REFSENS RoAoA: the RoAoA determined by the contour defined by the points at which the achieved EIS is 3dB higher than the achieved EIS in the reference direction assuming that for any AoA, the receiver gain is optimized for that AoA.

NOTE: This contour will be related to the average element/sub-array radiation pattern 3dB beamwidth.

OTA sensitivity directions declaration: set of manufacturer declarations comprising at least one set of declared minimum EIS values (with *SAN channel bandwidth*), and related directions over which the EIS applies.

NOTE: All the directions apply to all the EIS values in an OSDD.

polarization match: condition that exists when a plane wave, incident upon an antenna from a given direction, has a polarization that is the same as the receiving polarization of the antenna in that direction.

radiated interface boundary: *operating band* specific radiated requirements reference where the radiated requirements apply.

NOTE: For requirements based on EIRP/EIS, the *radiated interface boundary* is associated to the far-field region.

Radio Bandwidth: frequency difference between the upper edge of the highest used carrier and the lower edge of the lowest used carrier.

rated beam EIRP: For a declared beam and *beam direction pair*, the *rated beam EIRP* level is the maximum power that the SAN is declared to radiate at the associated *beam peak direction* during the *transmitter ON period*.

rated carrier output power: mean power level associated with a particular carrier the manufacturer has declared to be available at the indicated interface, during the *transmitter ON period* in a specified reference condition.

rated carrier TRP output power: mean power level declared by the manufacturer per carrier, for SAN operating in single carrier, multi-carrier, or carrier aggregation configurations that the manufacturer has declared to be available at the RIB during the *transmitter ON period*.

rated total output power: mean power level associated with a particular *operating band* the manufacturer has declared to be available at the indicated interface, during the *transmitter ON period* in a specified reference condition.

rated total TRP output power: mean power level declared by the manufacturer, that the manufacturer has declared to be available at the RIB during the *transmitter ON period*.

reference beam direction pair: declared *beam direction pair*, including reference *beam centre direction* and reference *beam peak direction* where the reference *beam peak direction* is the direction for the intended maximum EIRP within the *OTA peak directions set*.

receiver target: AoA in which reception is performed by *SAN types I-H* or *SAN type I-O*.

receiver target redirection range: union of all the *sensitivity RoAoA* achievable through redirecting the *receiver target* related to particular OSDD.

receiver target reference direction: direction inside the *OTA sensitivity directions declaration* declared by the manufacturer for conformance testing. For an OSDD without *receiver target redirection range*, this is a direction inside the *sensitivity RoAoA*.

reference RoAoA: the *sensitivity RoAoA* associated with the *receiver target reference direction* for each OSDD.

requirement set: one of the NR SAN requirement's set as defined for *SAN type 1-H*, *SAN type 1-O*.

SAN channel bandwidth: RF bandwidth supporting a single NR RF carrier with the *transmission bandwidth* configured in the uplink or downlink.

NOTE 1: The *SAN channel bandwidth* is measured in MHz and is used as a reference for transmitter and receiver RF requirements.

NOTE 2: It is possible for the SAN to transmit to and/or receive from one or more satellite UE bandwidth parts that are smaller than or equal to the *SAN transmission bandwidth configuration*, in any part of the *SAN transmission bandwidth configuration*.

SAN RF Bandwidth: RF bandwidth in which a SAN transmits and/or receives single or multiple carrier(s) within a supported *operating band*.

NOTE: In single carrier operation, the *SAN RF Bandwidth* is equal to the *SAN channel bandwidth*.

SAN RF Bandwidth edge: frequency of one of the edges of the *SAN RF Bandwidth*.

SAN transmission bandwidth configuration: set of resource blocks located within the *SAN channel bandwidth* which may be used for transmitting or receiving by the SAN.

SAN type 1-H: Satellite Access Node operating at FR1-NTN with a requirement set consisting of conducted requirements defined at individual *TAB connectors* and OTA requirements defined at RIB.

SAN type 1-O: Satellite Access Node operating at FR1-NTN with a requirement set consisting only of OTA requirements defined at the RIB.

SAN total assigned bandwidth: Bandwidth of the total assigned band (frequencies range) as defined in SM.1541-6 [9].

SAN transponder bandwidth: Total bandwidth of the carrier(s) in operation by one SAN transponder.

NOTE: When the SAN transponder operates one carrier only, the SAN transponder bandwidth is equal to the SAN channel bandwidth of this carrier.

SAN transponder: part of the SAN permitting to receive, channelize and transmit signals within an allocated bandwidth.

satellite: A space-borne vehicle embarking a transparent payload, or a regenerative payload telecommunication transmitter, placed into Low-Earth Orbit (LEO) or Geostationary Earth Orbit (GEO).

Satellite Access Node: node providing NR user plane and control plane protocol terminations towards NTN satellite capable UE, and connected via the NG interface to the 5GC. It encompasses a transparent payload on board a NTN platform, with satellite-gateway and gNB functions.

satellite-gateway: An earth station or gateway is located at the surface of Earth, and providing sufficient RF power and RF sensitivity for accessing to the satellite.

sensitivity RoAoA: RoAoA within the *OTA sensitivity directions declaration*, within which the declared EIS(s) of an OSDD is intended to be achieved at any instance of time for a specific SAN direction setting.

TAB connector: *transceiver array boundary* connector.

total radiated power: is the total power radiated by the antenna.

NOTE: The *total radiated power* is the power radiating in all direction for two orthogonal polarizations. *Total radiated power* is defined in both the near-field region and the far-field region.

transceiver array boundary: conducted interface between the transceiver unit array and the composite antenna.

transmission bandwidth: RF Bandwidth of an instantaneous transmission from a satellite UE or SAN, measured in resource block units.

3.2 Symbols

For the purposes of the present document, the following symbols apply:

| | |
|-------------------------|--|
| β | Percentage of the mean transmitted power emitted outside the occupied bandwidth on the assigned channel. |
| $BeW_{\theta,REFSENS}$ | Beamwidth equivalent to the <i>OTA REFSENS RoAoA</i> in the θ -axis in degrees. Applicable for FR1-NTN only. |
| $BeW_{\varphi,REFSENS}$ | Beamwidth equivalent to the <i>OTA REFSENS RoAoA</i> in the φ -axis in degrees. Applicable for FR1-NTN only. |
| $BW_{Channel}$ | <i>SAN channel bandwidth.</i> |
| BW_{Config} | <i>Transmission bandwidth configuration</i> , where $BW_{Config} = N_{RB} \times SCS \times 12$. |
| $BW_{GB,low}$ | The minimum guard band defined in clause 5.3.3 for lowest assigned component carrier. |
| $BW_{GB,high}$ | The minimum guard band defined in clause 5.3.3 for highest assigned component carrier. |
| BW_{SAN} | The <i>SAN transponder bandwidth</i> |
| Δf | Separation between the <i>channel edge</i> frequency and the nominal -3 dB point of the measuring filter closest to the carrier frequency. |
| ΔF_{Global} | Global frequency raster granularity. |
| Δf_{max} | $f_{offset,max}$ minus half of the bandwidth of the measuring filter. |
| Δf_{OOB} | Maximum offset of the out-of-band boundary from the uplink <i>operating band</i> edge. |
| $\Delta_{minSENS}$ | Difference between conducted reference sensitivity and <i>minSENS</i> . |
| $\Delta_{OTA,REFSENS}$ | Difference between conducted reference sensitivity and <i>OTA REFSENS</i> . |
| ΔF_{Raster} | Channel raster granularity. |
| $EIS_{minSENS}$ | The EIS declared for the <i>minSENS RoAoA</i> . |
| $EIS_{REFSENS}$ | <i>OTA REFSENS</i> EIS value. |
| F_C | <i>RF reference frequency</i> on the channel raster, given in table 5.4.2.2-1. |
| $F_{C,low}$ | The F_C of the <i>lowest carrier</i> , expressed in MHz. |
| $F_{C,high}$ | The F_C of the <i>highest carrier</i> , expressed in MHz. |
| $F_{DL,low}$ | The lowest frequency of the downlink <i>operating band</i> . |
| $F_{DL,high}$ | The highest frequency of the downlink <i>operating band</i> . |
| F_{filter} | Filter centre frequency. |
| $F_{offset,high}$ | Frequency offset from $F_{C,high}$ to the upper <i>SAN RF Bandwidth edge</i> . |
| $F_{offset,low}$ | Frequency offset from $F_{C,low}$ to the lower <i>SAN RF Bandwidth edge</i> . |
| f_{offset} | Separation between the <i>channel edge</i> frequency and the centre of the measuring. |
| $f_{offset,max}$ | The offset to the frequency Δf_{OOBUE} outside the downlink <i>operating band</i> . |
| F_{REF} | RF reference frequency. |
| $F_{REF-Offs}$ | Offset used for calculating F_{REF} . |
| $F_{UL,low}$ | The lowest frequency of the uplink <i>operating band</i> . |
| $F_{UL,high}$ | The highest frequency of the uplink <i>operating band</i> . |
| n_{PRB} | Physical resource block number. |
| N_{RB} | <i>Transmission bandwidth configuration</i> , expressed in resource blocks. |
| N_{REF} | NR Absolute Radio Frequency Channel Number (NR-ARFCN). |
| $N_{REF-Offs}$ | Offset used for calculating N_{REF} scaling per cell, as calculated in clause 6.1. |
| $P_{EIRP,N}$ | EIRP level for channel N. |
| $P_{max,c,TABC}$ | The <i>maximum carrier output power per TAB connector</i> . |
| $P_{max,c,TRP}$ | <i>Maximum carrier TRP output power</i> measured at the RIB(s), and corresponding to the declared <i>rated carrier TRP output power</i> ($P_{rated,c,TRP}$). |
| $P_{max,c,EIRP}$ | The maximum carrier EIRP when the SAN is configured at the maximum rated carrier output TRP ($P_{rated,c,TRP}$). |
| $P_{rated,c,sys}$ | $P_{rated,c,sys,GEO}$ for SAN GEO class or $P_{rated,c,sys,LEO}$ for SAN LEO class. |
| $P_{rated,c,sys,GEO}$ | The sum of $P_{rated,c,TABC}$ for all <i>TAB connectors</i> for a single carrier of the SAN GEO class. |
| $P_{rated,c,sys,LEO}$ | The sum of $P_{rated,c,TABC}$ for all <i>TAB connectors</i> for a single carrier of the SAN LEO class. |
| $P_{rated,c,TABC}$ | $P_{rated,c,TABC,GEO}$ for SAN GEO class or $P_{rated,c,TABC,LEO}$ for SAN LEO class. |
| $P_{rated,c,TABC,GEO}$ | The <i>rated carrier output power per TAB connector</i> of the SAN GEO class. |
| $P_{rated,c,TABC,LEO}$ | The <i>rated carrier output power per TAB connector</i> of the SAN LEO class. |
| $P_{rated,c,TRP}$ | <i>Rated carrier TRP output power</i> declared per RIB. |

| | |
|---------------------------|--|
| $P_{\text{rated,t,TABC}}$ | The <i>rated total output power</i> declared at <i>TAB connector</i> . |
| $P_{\text{rated,t,TRP}}$ | <i>Rated total TRP output power</i> declared per RIB. |
| $P_{\text{rated,t,sys}}$ | The sum of $P_{\text{rated,t,TABC}}$ for all <i>TAB connectors</i> . |
| P_{REFSENS} | Conducted Reference Sensitivity power level. |
| SS_{REF} | SS block reference frequency position. |

3.3 Abbreviations

For the purposes of the present document, the abbreviations given in 3GPP TR 21.905 [1] and the following apply. An abbreviation defined in the present document takes precedence over the definition of the same abbreviation, if any, in 3GPP TR 21.905 [1].

| | |
|------------|--|
| AA | Antenna Array |
| ACLR | Adjacent Channel Leakage Ratio |
| ACS | Adjacent Channel Selectivity |
| AoA | Angle of Arrival |
| AWGN | Additive White Gaussian Noise |
| BW | Bandwidth |
| CA | Carrier Aggregation |
| CP-OFDM | Cyclic Prefix-OFDM |
| CW | Continuous Wave |
| DFT-s-OFDM | Discrete Fourier Transform-spread-OFDM |
| DM-RS | Demodulation Reference Signal |
| EIRP | Equivalent Isotropic Radiated Power |
| EIS | Equivalent Isotropic Sensitivity |
| EVM | Error Vector Magnitude |
| FR | Frequency Range |
| FRC | Fixed Reference Channel |
| GEO | Geostationary Earth Orbiting |
| GSCN | Global Synchronization Channel Number |
| ICS | In-Channel Selectivity |
| LEO | Low Earth Orbiting |
| MCS | Modulation and Coding Scheme |
| NR | New Radio |
| NR-ARFCN | NR Absolute Radio Frequency Channel Number |
| NTN | Non-Terrestrial Network |
| OOB | Out-of-band |
| OOBE | Out-of-band Emissions |
| OSDD | OTA Sensitivity Directions Declaration |
| OTA | Over-The-Air |
| PRB | Physical Resource Block |
| PT-RS | Phase Tracking Reference Signal |
| QAM | Quadrature Amplitude Modulation |
| RB | Resource Block |
| RDN | Radio Distribution Network |
| RE | Resource Element |
| REFSENS | Reference Sensitivity |
| RF | Radio Frequency |
| RIB | Radiated Interface Boundary |
| RMS | Root Mean Square (value) |
| RoAoA | Range of Angles of Arrival |
| RX | Receiver |
| SAN | Satellite Access Node |
| SCS | Sub-Carrier Spacing |
| SSB | Synchronization Signal Block |
| TAB | Transceiver Array Boundary |
| TRP | Total Radiated Power |
| TX | Transmitter |

4 General

4.1 Relationship with other core specifications

The present document is a single-RAT specification for a SAN, covering RF characteristics and minimum performance requirements. Conducted and radiated core requirements are defined for the SAN architectures and SAN types defined in clause 4.3.

The applicability of each requirement is described in clause 4.6.

4.2 Relationship between minimum requirements and test requirements

Conformance to the present specification is demonstrated by fulfilling the test requirements specified in the conformance specification TS 38.181 [3].

The minimum requirements given in this specification make no allowance for measurement uncertainty. The test specifications TS 38.181 [3] define test tolerances. These test tolerances are individually calculated for each test. The test tolerances are used to relax the minimum requirements in this specification to create test requirements. For some requirements, including regulatory requirements, the test tolerance is set to zero.

The measurement results returned by the test system are compared - without any modification - against the test requirements as defined by the shared risk principle.

The shared risk principle is defined in recommendation ITU-R M.1545 [4].

4.3 Requirement reference points

4.3.1 SAN type 1-H

For *SAN type 1-H*, the requirements are defined for two points of reference, signified by radiated requirements and conducted requirements.

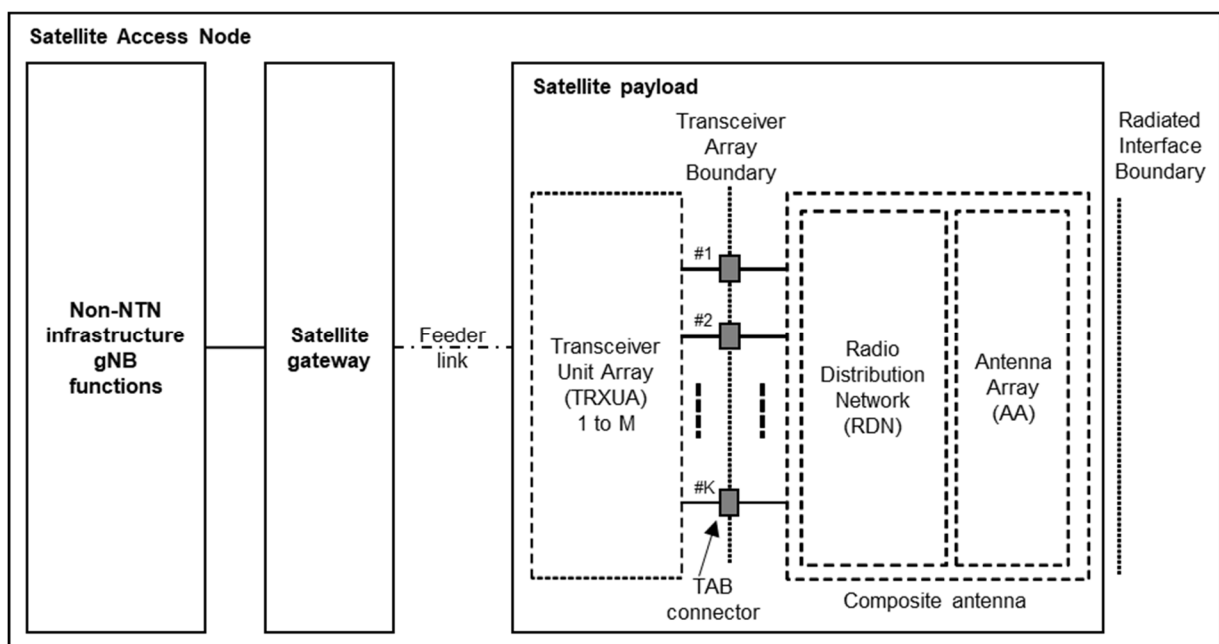

Figure 4.3.1-1: Radiated and conducted reference points for *SAN type 1-H*

Radiated characteristics are defined over the air (OTA), where the radiated interface is referred to as the *Radiated Interface Boundary* (RIB). Radiated requirements are also referred to as OTA requirements. The (spatial) characteristics in which the OTA requirements apply are detailed for each requirement.

Conducted characteristics are defined at individual or groups of *TAB connectors* at the *transceiver array boundary*, which is the conducted interface between the transceiver unit array and the composite antenna.

The transceiver unit array is part of the composite transceiver functionality receiving and transmitting modulated signal to ensure radio links with users.

The satellite payload is composed by a transceiver unit array and a composite antenna array. The transceiver unit array contains an implementation specific number of transmitter units and an implementation specific number of receiver units.

The composite antenna contains a radio distribution network (RDN) and an antenna array. The RDN is a linear passive network which distributes the RF power generated by the transceiver unit array to the antenna array, and/or distributes the radio signals collected by the antenna array to the transceiver unit array, in an implementation specific way.

How a conducted requirement is applied to the *transceiver array boundary* is detailed in the respective requirement clause.

4.3.2 SAN type 1-O

For *SAN type 1-O*, the radiated characteristics are defined over the air (OTA), where the *operating band* specific radiated interface is referred to as the *Radiated Interface Boundary* (RIB). Radiated requirements are also referred to as OTA requirements. The (spatial) characteristics in which the OTA requirements apply are detailed for each requirement.

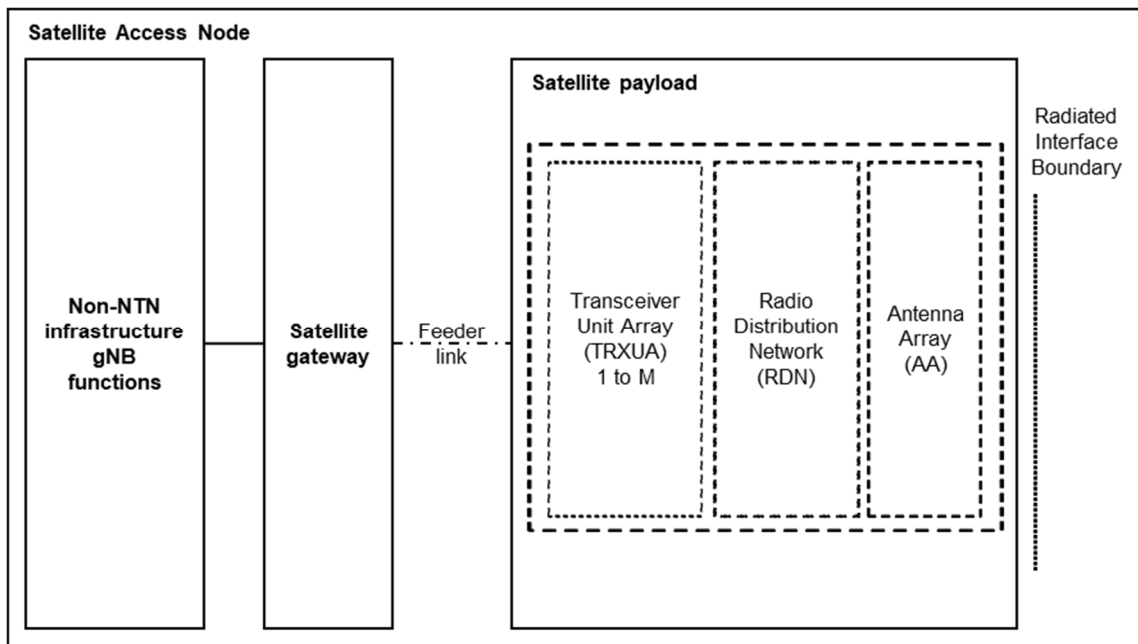

Figure 4.3.2-1: Radiated reference points for SAN type 1-O

4.4 Satellite Access Node classes

The requirements in this specification apply to Satellite Access Node unless otherwise stated. The associated deployment scenarios are exactly the same for SAN with and without connectors.

For *SAN type 1-O* and *SAN type 1-H*, two SAN classes (LEO and GEO) are defined in Table 4.4-1.

Table 4.4-1 SAN classes

| SAN Class | Satellite constellation |
|-----------|---|
| GEO | GEO satellite |
| LEO | LEO 600 km satellite LEO 1200 km satellite |

4.5 Regional requirements

Some requirements in the present document may only apply in certain regions either as optional requirements, or as mandatory requirements set by local and regional regulation. It is normally not stated in the 3GPP specifications under what exact circumstances the regional requirements apply, since this is defined by local or regional regulation.

Table 4.5-1 lists all requirements in the present specification that may be applied differently in different regions.

Table 4.5-1: List of regional requirements

| Clause number | Requirement | Comments |
|---------------|--|---|
| 5.2 | <i>Operating bands</i> | Satellite <i>operating bands</i> may be applied regionally. |
| 6.6.4, 9.7 | Out-of-band emission, OTA unwanted emissions | For n255 operation in US, Limits in FCC Title 47 apply. |
| 6.6.5 | Tx spurious emissions, OTA Tx spurious emissions | For n255 operation in US, Limits in FCC Title 47 apply. |

4.6 Applicability of minimum requirements

In table 4.6-1, the requirement applicability for each *requirement set* is defined. For each requirement, the applicable requirement clause in the specification is identified. Requirements not included in a *requirement set* is marked not applicable (NA).

Table 4.6-1: Requirement set applicability

| Requirement | Requirement set | | |
|---|-----------------|--------------|--------|
| | SAN type 1-H | SAN type 1-O | |
| Satellite Access Network output power | 6.2 | NA | |
| Output power dynamics | 6.3 | | |
| Transmit ON/OFF power | NA | | |
| Frequency error | 6.5.1 | | |
| Modulation quality | 6.5.2 | | |
| Time alignment error | NA | | |
| Occupied bandwidth | 6.6.2 | | |
| ACLR | 6.6.3 | | |
| Out-of-band emissions | 6.6.4 | | |
| Transmitter spurious emissions | 6.6.5 | | |
| Transmitter intermodulation | NA | | |
| Reference sensitivity level | 7.2 | | |
| Dynamic range | 7.3 | | |
| ACS | 7.4.1 | | |
| In-band blocking | NA | | |
| Out-of-band blocking | 7.5 | | |
| Receiver spurious emissions | NA | | |
| Receiver intermodulation | NA | | |
| In-channel selectivity | 7.8 | | |
| Performance requirements | 8 | | |
| Radiated transmit power | 9.2 | 9.2 | |
| OTA Satellite Access Network output power | NA | 9.3 | |
| OTA output power dynamics | | 9.4 | |
| OTA transmit ON/OFF power | | NA | |
| OTA frequency error | | 9.6.1 | |
| OTA modulation quality | | 9.6.2 | |
| OTA time alignment error | | NA | |
| OTA occupied bandwidth | | 9.7.2 | |
| OTA ACLR | | 9.7.3 | |
| OTA out-of-band emission | | 9.7.4 | |
| OTA transmitter spurious emission | | 9.7.5 | |
| OTA transmitter intermodulation | | NA | |
| OTA sensitivity | | 10.2 | 10.2 |
| OTA reference sensitivity level | | NA | 10.3 |
| OTA dynamic range | | | 10.4 |
| OTA ACS | | | 10.5.1 |
| OTA in-band blocking | | | NA |
| OTA out-of-band blocking | | | 10.6 |
| OTA receiver spurious emission | NA | | |
| OTA receiver intermodulation | NA | | |
| OTA in-channel selectivity | 10.9 | | |
| Radiated performance requirements | | 11 | |

NOTE: Co-location requirements are not applicable to SAN.

5 Operating bands and channel arrangement

5.1 General

The channel arrangements presented in this clause are based on the *operating bands* and *SAN channel bandwidths* defined in the present release of specifications.

NOTE: Other *operating bands* and *SAN channel bandwidths* may be considered in future releases.

Requirements throughout the RF specifications are in many cases defined separately for different frequency ranges (FR). The frequency ranges in which satellite can operate according to the present version of the specification are identified as described in table 5.1-1.

Table 5.1-1: Definition of NTN frequency ranges

| Frequency range designation | Corresponding frequency range (MHz) |
|---|-------------------------------------|
| FR1-NTN (NOTE) | 410 – 7125 |
| NOTE: NTN bands within this frequency range are regarded as a FR1 band when references from other specifications. | |

5.2 Operating bands

Satellite is designed to operate in the *operating bands* defined in table 5.2-1.

Table 5.2-1: Satellite *operating bands* in FR1-NTN

| Satellite operating band | Uplink (UL) operating band SAN receive / UE transmit $F_{UL,low} - F_{UL,high}$ | Downlink (DL) operating band SAN transmit / UE receive $F_{DL,low} - F_{DL,high}$ | Duplex mode |
|---|---|---|-------------|
| n256 | 1980 MHz – 2010 MHz | 2170 MHz – 2200 MHz | FDD |
| n255 | 1626.5 MHz – 1660.5 MHz | 1525 MHz – 1559 MHz | FDD |
| NOTE: Satellite bands are numbered in descending order from n256. | | | |

5.3 Satellite Access Node channel bandwidth

5.3.1 General

The *SAN channel bandwidth* supports a single RF carrier in the uplink or downlink at the SAN. Different UE channel bandwidths may be supported within the same spectrum for transmitting to and receiving from UEs connected to the SAN. The placement of the UE channel bandwidth is flexible but can only be completely within the *SAN channel bandwidth*. The SAN shall be able to transmit to and/or receive from one or more UE bandwidth parts that are smaller than or equal to the number of carrier resource blocks on the RF carrier, in any part of the carrier resource blocks.

The relationship between the channel bandwidth, the guard band and the *transmission bandwidth configuration* is shown in figure 5.3.1-1.

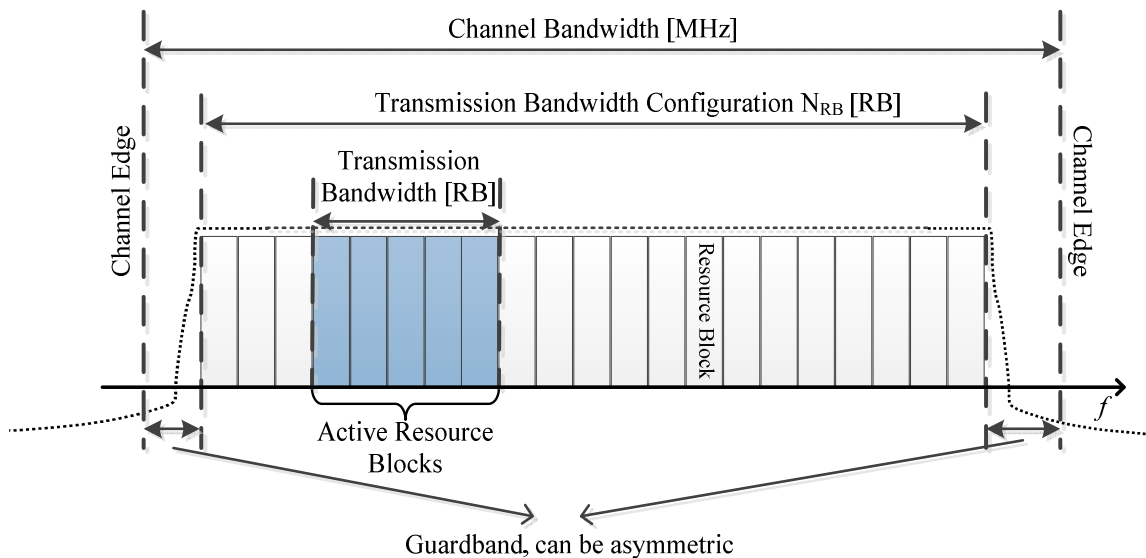

Figure 5.3.1-1: Definition of channel bandwidth and *transmission bandwidth configuration* for one channel

5.3.2 Transmission bandwidth configuration

The *transmission bandwidth configuration* N_{RB} for each *SAN channel bandwidth* and subcarrier spacing is specified in table 5.3.2.-1 for FR1-NTN.

Table 5.3.2-1: Transmission bandwidth configuration N_{RB} for FR1-NTN

| SCS (kHz) | 5 MHz | 10 MHz | 15 MHz | 20 MHz |
|-----------|----------|----------|----------|----------|
| | N_{RB} | N_{RB} | N_{RB} | N_{RB} |
| 15 | 25 | 52 | 79 | 106 |
| 30 | 11 | 24 | 38 | 51 |
| 60 | N/A | 11 | 18 | 24 |

NOTE: All Tx and Rx requirements are defined based on *transmission bandwidth configuration* specified in table 5.3.2-1 for FR1-NTN.

5.3.3 Minimum guardband and transmission bandwidth configuration

The minimum guard band for each *SAN channel bandwidth* and SCS is specified in table 5.3.3-1 for FR1-NTN.

Table 5.3.3-1: Minimum guard band (kHz) (FR1-NTN)

| SCS (kHz) | 5 MHz | 10 MHz | 15 MHz | 20 MHz |
|-----------|-------|--------|--------|--------|
| 15 | 242.5 | 312.5 | 382.5 | 452.5 |
| 30 | 505 | 665 | 645 | 805 |
| 60 | N/A | 1010 | 990 | 1330 |

The number of RBs configured in any *SAN channel bandwidth* shall ensure that the minimum guard band specified in this clause is met.

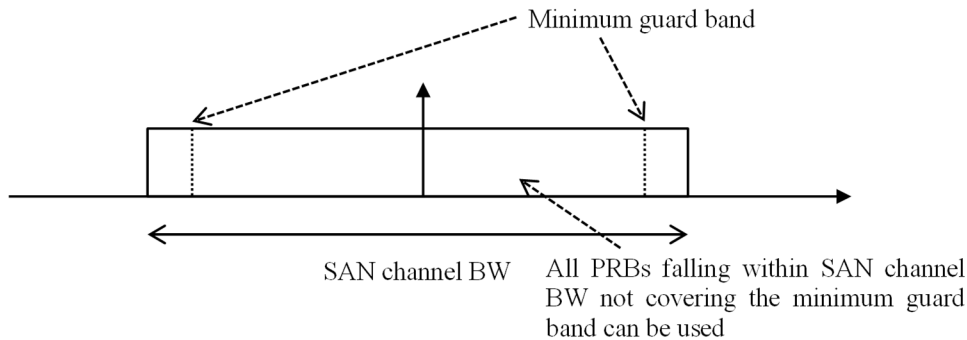

Figure 5.3.3-1: SAN PRB utilization

In the case that multiple numerologies are multiplexed in the same symbol, the minimum guard band on each side of the carrier is the guard band applied at the configured *SAN channel bandwidth* for the numerology that is transmitted/received immediately adjacent to the guard band.

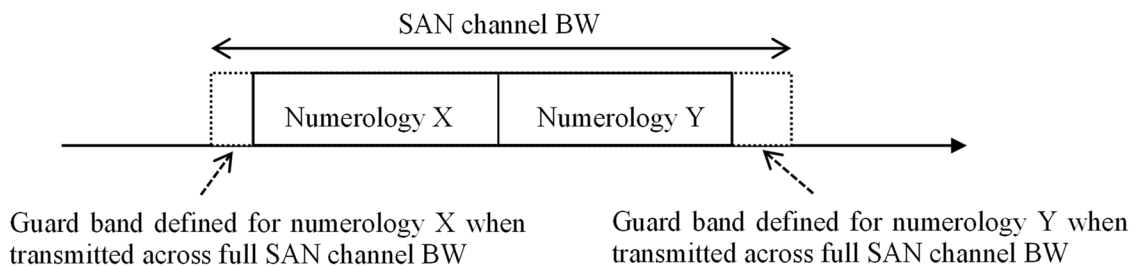

Figure 5.3.3-2: Guard band definition when transmitting multiple numerologies

NOTE: Figure 5.3.3-2 is not intended to imply the size of any guard between the two numerologies. Inter-numerology guard band within the carrier is implementation dependent.

5.3.4 RB alignment

For each *SAN channel bandwidth* and each numerology, *SAN transmission bandwidth configuration* must fulfil the minimum guard band requirement specified in clause 5.3.3.

For each numerology, its common resource blocks are specified in clause 4.4.4.3 in TS 38.211 [5], and the starting point of its *transmission bandwidth configuration* on the common resource block grid for a given channel bandwidth is indicated by an offset to “Reference point A” in the unit of the numerology.

For each numerology, all *UE transmission bandwidth configurations* indicated to UEs served by the SAN by higher layer parameter *carrierBandwidth* defined in TS 38.331 [6] shall fall within the *SAN transmission bandwidth configuration*.

5.3.5 SAN channel bandwidth per operating band

The requirements in this specification apply to the combination of *SAN channel bandwidths*, SCS and *operating bands* shown in table 5.3.5-1 for FR1-NTN. The *transmission bandwidth configuration* in table 5.3.2-1 shall be supported for each of the *SAN channel bandwidths* within the SAN capability. The *SAN channel bandwidths* are specified for both the Tx and Rx path.

Table 5.3.5-1: SAN channel bandwidths and SCS per operating band in FR1-NTN

| SAN Operating Band | SCS (kHz) | SAN channel bandwidth (MHz) | | | |
|--------------------|-----------|-----------------------------|----|----|----|
| | | 5 | 10 | 15 | 20 |
| n256 | 15 | 5 | 10 | 15 | 20 |
| | 30 | | 10 | 15 | 20 |
| | 60 | | 10 | 15 | 20 |
| n255 | 15 | 5 | 10 | 15 | 20 |
| | 30 | | 10 | 15 | 20 |
| | 60 | | 10 | 15 | 20 |

5.4 Channel arrangement

5.4.1 Channel spacing

5.4.1.1 Channel spacing for adjacent carriers

The spacing between carriers will depend on the deployment scenario, the size of the frequency block available and the SAN channel bandwidths. The nominal channel spacing between two adjacent SAN carriers is defined as following:

- For SAN FR1-NTN operating bands with 100 kHz channel raster,

$$\text{Nominal Channel spacing} = (\text{BW}_{\text{Channel}(1)} + \text{BW}_{\text{Channel}(2)})/2$$

where $\text{BW}_{\text{Channel}(1)}$ and $\text{BW}_{\text{Channel}(2)}$ are the SAN channel bandwidths of the two respective SAN carriers. The channel spacing can be adjusted depending on the channel raster to optimize performance in a particular deployment scenario.

5.4.2 Channel raster

5.4.2.1 NR-ARFCN and channel raster

The global frequency raster defines a set of RF reference frequencies F_{REF} . The RF reference frequency is used in signalling to identify the position of RF channels, SS blocks and other elements. The global frequency raster is defined for all frequencies from 0 to 100 GHz. The granularity of the global frequency raster is ΔF_{Global} .

RF reference frequencies are designated by an NR Absolute Radio Frequency Channel Number (NR-ARFCN) in the range [0...3279165] on the global frequency raster. The relation between the NR-ARFCN and the RF reference frequency F_{REF} in MHz is given by the following equation, where $F_{\text{REF-Offs}}$ and $N_{\text{REF-Offs}}$ are given in table 5.4.2.1-1 and N_{REF} is the NR-ARFCN.

$$F_{\text{REF}} = F_{\text{REF-Offs}} + \Delta F_{\text{Global}} (N_{\text{REF}} - N_{\text{REF-Offs}})$$

Table 5.4.2.1-1: NR-ARFCN parameters for the global frequency raster

| Range of frequencies (MHz) | ΔF_{Global} (kHz) | $F_{\text{REF-Offs}}$ (MHz) | $N_{\text{REF-Offs}}$ | Range of N_{REF} |
|----------------------------|----------------------------------|-----------------------------|-----------------------|---------------------------|
| 0 – 3000 | 5 | 0 | 0 | 0 – 599999 |

The channel raster defines a subset of RF reference frequencies that can be used to identify the RF channel position in the uplink and downlink. The RF reference frequency for an RF channel maps to a resource element on the carrier. For each operating band, a subset of frequencies from the global frequency raster are applicable for that band and forms a channel raster with a granularity ΔF_{Raster} , which may be equal to or larger than ΔF_{Global} .

For the uplink of FDD FR1 NTN bands defined in Table 5.2-1

$$F_{\text{REF, shift}} = F_{\text{REF}} + \Delta_{\text{shift}}, \Delta_{\text{shift}} = 0 \text{ kHz or } 7.5 \text{ kHz.}$$

where Δ_{shift} is signalled by the network in higher layer parameter *frequencyShift7p5khz* [7].

The mapping between the *channel raster* and corresponding resource element is given in clause 5.4.2.2. The applicable entries for each *operating band* are defined in clause 5.4.2.3.

5.4.2.2 Channel raster to resource element mapping

The mapping between the *RF reference frequency* on the channel raster and the corresponding resource element is given in table 5.4.2.2-1 and can be used to identify the RF channel position. The mapping depends on the total number of RBs that are allocated in the channel and applies to both UL and DL. The mapping must apply to at least one numerology supported by the SAN.

Table 5.4.2.2-1: Channel Raster to Resource Element Mapping

| | | |
|---|---|---|
| | $N_{RB} \bmod 2 = 0$ | $N_{RB} \bmod 2 = 1$ |
| Resource element index k | 0 | 6 |
| Physical resource block index n_{PRB} | $n_{PRB} = \left\lfloor \frac{N_{RB}}{2} \right\rfloor$ | $n_{PRB} = \left\lfloor \frac{N_{RB}}{2} \right\rfloor$ |

N_{RB} is the transmission bandwidth configuration specified in sub-clause 5.3.2, n_{PRB} is the PRB index within the N_{RB} , and k is the resource element index within this PRB.

5.4.2.3 Channel raster entries for each *operating band*

The RF channel positions on the channel raster in each SAN *operating band* are given through the applicable NR-ARFCN in table 5.4.2.3-1 for FR1-NTN, using the channel raster to resource element mapping in clause 5.4.2.2.

For SAN *operating bands* with 100 kHz channel raster, $\Delta F_{\text{Raster}} = 20 \times \Delta F_{\text{Global}}$. In this case, every 20th NR-ARFCN within the *operating band* are applicable for the channel raster within the *operating band* and the step size for the channel raster in table 5.4.2.3-1 is given as <20>.

Table 5.4.2.3-1: Applicable NR-ARFCN per *operating band* in FR1-NTN

| SAN operating band | ΔF_{Raster} (kHz) | Uplink range of N_{REF} (First – <Step size> – Last) | Downlink range of N_{REF} (First – <Step size> – Last) |
|--------------------|----------------------------------|---|---|
| n256 | 100 | 396000 – <20> – 402000 | 434000 – <20> – 440000 |
| n255 | 100 | 325300 – <20> – 332100 | 305000 – <20> – 311800 |

5.4.3 Synchronization raster

5.4.3.1 Synchronization raster and numbering

The synchronization raster indicates the frequency positions of the synchronization block that can be used by the UE for system acquisition when explicit signalling of the synchronization block position is not present.

A global synchronization raster is defined for all frequencies. The frequency position of the SS block is defined as SS_{REF} with corresponding number GSCN. The parameters defining the SS_{REF} and GSCN for all the frequency ranges are in table 5.4.3.1-1.

The resource element corresponding to the SS block reference frequency SS_{REF} is given in clause 5.4.3.2. The synchronization raster and the subcarrier spacing of the synchronization block are defined separately for each band.

Table 5.4.3.1-1: GSCN parameters for the global frequency raster

| Range of frequencies (MHz) | SS block frequency position SS_{REF} | GSCN | Range of GSCN |
|---|--|----------------|---------------|
| 0 – 3000 | $N * 1200 \text{ kHz} + M * 50 \text{ kHz}$, $N = 1:2499$, $M \in \{1,3,5\}$ (Note) | $3N + (M-3)/2$ | 2 – 7498 |
| NOTE: The default value for <i>operating bands</i> which only support SCS spaced channel raster(s) is $M=3$. | | | |

5.4.3.2 Synchronization raster to synchronization block resource element mapping

The mapping between the synchronization raster and the corresponding resource element of the SS block is given in table 5.4.3.2-1.

Table 5.4.3.2-1: Synchronization Raster to SS block Resource Element Mapping

| | |
|----------------------------|-----|
| Resource element index k | 120 |
|----------------------------|-----|

k is the subcarrier number of SS/PBCH block defined in TS 38.211 clause 7.4.3.1 [5].

5.4.3.3 Synchronization raster entries for each operating band

The synchronization raster for each band is given in table 5.4.3.3-1. The distance between applicable GSCN entries is given by the <Step size> indicated in table 5.4.3.3-1 for FR1-NTN.

Table 5.4.3.3-1: Applicable SS raster entries per operating band (FR1-NTN)

| SAN operating band | SS Block SCS | SS Block pattern (NOTE) | Range of GSCN (First – <Step size> – Last) |
|---|--------------|-------------------------|--|
| n256 | 15 kHz | Case A | 5429 – <1> – 5494 |
| n255 | 15 kHz | Case A | 3818 – <1> – 3892 |
| | 30 kHz | Case B | 3824 – <1> – 3886 |
| NOTE: SS Block pattern is defined in clause 4.1 in TS 38.213 [7]. | | | |

6 Conducted transmitter characteristics

6.1 General

Unless otherwise stated, the conducted transmitter characteristics are specified at the *TAB connector* for *SAN type 1-H*, with a full complement of transceiver units for the configuration in normal operating conditions.

6.2 Satellite Access Node output power

6.2.1 General

The SAN conducted output power requirement applies at *TAB connector* for *SAN type 1-H*.

The *rated carrier output power* of the *SAN type 1-H* shall be as specified in table 6.2.1-2.

Table 6.2.1-2: SAN type 1-H rated output power limits for SAN classes

| SAN class | $P_{\text{rated,c,sys}}$ (NOTE) | $P_{\text{rated,c,TABC}}$ (NOTE) |
|---|---------------------------------|----------------------------------|
| SAN GEO class | $P_{\text{rated,c,sys,GEO}}$ | $P_{\text{rated,c,TABC,GEO}}$ |
| SAN LEO class | $P_{\text{rated,c,sys,LEO}}$ | $P_{\text{rated,c,TABC,LEO}}$ |
| NOTE: $P_{\text{rated,c,sys}}$ or $P_{\text{rated,c,TABC}}$ of SAN shall be based on manufacturer declaration and comply with regulation requirement. | | |

6.2.2 Minimum requirement for SAN type 1-H

In normal conditions, $P_{\text{max,c,TABC}}$ shall remain within +2 dB and -2 dB of the *rated carrier output power* $P_{\text{rated,c,TABC}}$ for each *TAB connector* as declared by the manufacturer.

6.3 Output power dynamics

6.3.1 General

Transmitted signal quality (as specified in clause 6.5) shall be maintained for the output power dynamics requirements of this clause.

Power control is used to limit the interference level.

6.3.2 RE power control dynamic range

6.3.2.1 General

The RE power control dynamic range is the difference between the power of an RE and the average RE power for a SAN at maximum output power ($P_{\text{max,c,TABC}}$) for a specified reference condition.

For *SAN type 1-H* this requirement shall apply at each *TAB connector* supporting transmission in the *operating band*.

6.3.2.2 Minimum requirement for SAN type 1-H

RE power control dynamic range requirement is specified in table 6.3.2.2-1.

Table 6.3.2.2-1: RE power control dynamic range

| Modulation scheme used on the RE | RE power control dynamic range (dB) | |
|--|-------------------------------------|------|
| | (down) | (up) |
| QPSK (PDCCH) | -6 | +4 |
| QPSK (PDSCH) | -6 | +3 |
| 16QAM (PDSCH) | -3 | +3 |
| 64QAM (PDSCH) (NOTE 2) | 0 | 0 |
| NOTE 1: The output power per carrier shall always be less or equal to the maximum output power of the satellite access node. | | |
| NOTE 2: This requirement is optional, subject to manufacturer declaration. | | |

6.3.3 Total power dynamic range

6.3.3.1 General

The SAN total power dynamic range is the difference between the maximum and the minimum transmit power of an OFDM symbol for a specified reference condition.

For *SAN type 1-H* this requirement shall apply at each *TAB connector* supporting transmission in the *operating band*.

NOTE 1: The upper limit of the dynamic range is the OFDM symbol power for a SAN when transmitting on all RBs at maximum output power. The lower limit of the total power dynamic range is the average power for single RB transmission. The OFDM symbol shall carry PDSCH and not contain RS or SSB.

6.3.3.2 Minimum requirement for *SAN type 1-H*

The downlink (DL) total power dynamic range for each SAN carrier shall be larger than or equal to the level in table 6.3.3.2-1.

Table 6.3.3.2-1: Total power dynamic range

| SAN channel bandwidth (MHz) | Total power dynamic range (dB) | | |
|-----------------------------|--------------------------------|------------|------------|
| | 15 kHz SCS | 30 kHz SCS | 60 kHz SCS |
| 5 | 13.9 | 10.4 | N/A |
| 10 | 17.1 | 13.8 | 10.4 |
| 15 | 18.9 | 15.7 | 12.5 |
| 20 | 20.2 | 17 | 13.8 |

6.4 Transmit ON/OFF power

The requirement is not applicable in this version of the specification.

6.5 Transmitted signal quality

6.5.1 Frequency error

6.5.1.1 General

Frequency error is the measure of the difference between the actual SAN transmit frequency and the assigned frequency. The same source shall be used for RF frequency and data clock generation.

For *SAN type 1-H* this requirement shall be applied at each *TAB connector* supporting transmission in the *operating band*.

6.5.1.2 Minimum requirement for *SAN type 1-H*

The modulated carrier frequency of each carrier configured by the SAN shall be accurate to within 0.05 ppm observed over 1 ms.

6.5.2 Modulation quality

6.5.2.1 General

Modulation quality is defined by the difference between the measured carrier signal and an ideal signal. Modulation quality can e.g. be expressed as Error Vector Magnitude (EVM). The Error Vector Magnitude is a measure of the difference between the ideal symbols and the measured symbols after the equalization. This difference is called the error vector. Details about how the EVM is determined are specified in Annex B.

For *SAN type 1-H* this requirement shall be applied at each *TAB connector* supporting transmission in the *operating band*.

6.5.2.2 Minimum Requirement for *SAN type 1-H*

The EVM levels of each carrier for different modulation schemes on PDSCH outlined in table 6.5.2.2-1 shall be met using the frame structure described in clause 6.5.2.3.

Table 6.5.2.2-1: EVM requirements for SAN type 1-H carrier

| Modulation scheme for PDSCH | Required EVM |
|---|--------------|
| QPSK | 17.5 % |
| 16QAM | 12.5 % |
| 64QAM (NOTE) | 8 % |
| NOTE: EVM requirement for 64QAM is optional, subject to manufacturer declaration. | |

6.5.2.3 EVM frame structure for measurement

EVM shall be evaluated for each carrier over all allocated resource blocks and downlink subframes. Different modulation schemes listed in table 6.5.2.2-1 shall be considered for rank 1.

For all bandwidths, the EVM measurement shall be performed for each carrier over all allocated resource blocks and downlink subframes within 10 ms measurement periods. The boundaries of the EVM measurement periods need not be aligned with radio frame boundaries.

6.5.3 Time alignment error

The requirement is not applicable in this version of the specification.

6.6 Unwanted emissions

6.6.1 General

Unwanted emissions consist of out-of-band emissions and spurious emissions according to ITU definitions [2]. In ITU terminology, out of band emissions are unwanted emissions immediately outside the *SAN channel bandwidth* resulting from the modulation process and non-linearity in the transmitter but excluding spurious emissions. Spurious emissions are emissions which are caused by unwanted transmitter effects such as harmonics emission, parasitic emission, intermodulation products and frequency conversion products, but exclude out of band emissions.

The out-of-band emissions requirement for the SAN transmitter is specified both in terms of Adjacent Channel Leakage power Ratio (ACLR) and out-of-band emissions (OOBE). There is in addition a requirement for occupied bandwidth.

Table 6.6.1-1: void

For *SAN type 1-H* the unwanted emission requirements are applied to sum of power over all *TAB connectors* for all the configurations supported by the SAN, except for occupied bandwidth in subclause 6.6.2.

6.6.2 Occupied bandwidth

6.6.2.1 General

The occupied bandwidth is the width of a frequency band such that, below the lower and above the upper frequency limits, the mean powers emitted are each equal to a specified percentage $\beta/2$ of the total mean transmitted power. See also Recommendation ITU-R SM.328 [8].

The value of $\beta/2$ shall be taken as 0.5%.

The minimum requirement below may be applied regionally. There may also be regional requirements to declare the occupied bandwidth according to the definition in the present clause.

For *SAN type 1-H* this requirement shall be applied at each *TAB connector* supporting transmission in the *operating band*.

6.6.2.2 Minimum requirement for SAN type 1-H

The occupied bandwidth for each carrier shall be less than the *SAN channel bandwidth*.

6.6.3 Adjacent Channel Leakage Power Ratio

6.6.3.1 General

Adjacent Channel Leakage power Ratio (ACLR) is the ratio of the filtered mean power centred on the assigned channel frequency to the filtered mean power centred on an adjacent channel frequency.

The requirements shall apply outside the *SAN RF Bandwidth* or *Radio Bandwidth* whatever the type of transmitter considered (single carrier or multi-carrier) and for all transmission modes foreseen by the manufacturer's specification.

6.6.3.2 Minimum requirement for SAN type 1-H

The ACLR is defined with a square filter of bandwidth equal to the transmission bandwidth configuration of the transmitted signal (BW_{Config}) centred on the assigned channel frequency and a filter centred on the adjacent channel frequency according to the tables below.

The ACLR shall be higher than the value specified in Table 6.6.3.2-1/2.

Table 6.6.3.2-1: SAN ACLR limit for GEO class

| SAN channel bandwidth of lowest/highest carrier transmitted BW_{Channel} (MHz) | SAN adjacent channel centre frequency offset below the lowest or above the highest carrier centre frequency transmitted | Assumed adjacent channel carrier (informative) | Filter on the adjacent channel frequency and corresponding filter bandwidth | ACLR limit (dB) |
|---|---|--|---|-----------------|
| 5, 10, 15, 20 | BW_{Channel} | NR of same BW (NOTE 2) | Square (BW_{Config}) (NOTE 1) | 14 |
| | $2 \times BW_{\text{Channel}}$ | NR of same BW (NOTE 2) | Square (BW_{Config}) (NOTE 1) | 14 |
| NOTE 1: BW_{Channel} and BW_{Config} are the <i>SAN channel bandwidth</i> and <i>transmission bandwidth configuration</i> of the <i>lowest/highest carrier</i> transmitted on the assigned channel frequency. | | | | |
| NOTE 2: With SCS that provides largest transmission bandwidth configuration (BW_{Config}). | | | | |

Table 6.6.3.2-2: SAN ACLR limit for LEO class

| SAN channel bandwidth of lowest/highest carrier transmitted BW_{Channel} (MHz) | SAN adjacent channel centre frequency offset below the lowest or above the highest carrier centre frequency transmitted | Assumed adjacent channel carrier (informative) | Filter on the adjacent channel frequency and corresponding filter bandwidth | ACLR limit (dB) |
|---|---|--|---|-----------------|
| 5, 10, 15, 20 | BW_{Channel} | NR of same BW (NOTE 2) | Square (BW_{Config}) (NOTE 1) | 24 |
| | $2 \times BW_{\text{Channel}}$ | NR of same BW (NOTE 2) | Square (BW_{Config}) (NOTE 1) | 24 |
| NOTE 1: BW_{Channel} and BW_{Config} are the <i>SAN channel bandwidth</i> and <i>transmission bandwidth configuration</i> of the <i>lowest/highest carrier</i> transmitted on the assigned channel frequency. | | | | |
| NOTE 2: With SCS that provides largest transmission bandwidth configuration (BW_{Config}). | | | | |

6.6.4 Out-of-band emissions

6.6.4.1 General

Unless otherwise stated, the out-of-band emission (OOBE) limits for SAN in FRI-NTN are defined from BW_{SAN} channel edge up to frequencies separated from the BW_{SAN} channel edge by 200% of the *necessary bandwidth*, where the *necessary bandwidth* is BW_{SAN} .

The requirements shall apply whatever the type of transmitter considered and for all transmission modes foreseen by the manufacturer's specification.

Basic limits are specified in the tables below, where:

- Δf is the separation between the BW_{SAN} *channel edge* frequency and the nominal -3dB point of the measuring filter closest to the carrier frequency.
- f_{offset} is the separation between the *channel edge* frequency and the centre of the measuring filter.
- Δ_{sat_class} [dB] is the *SAN class parameter* in dB identified to characterize different SAN classes.

6.6.4.2 Basic limits

For SAN operating in Bands n256, n255, the requirements are specified in table 6.6.4.2-1 for GEO and LEO class respectively, in line with Annex 5 of ITU recommendation SM.1541-6 [9].

The SAN out-of-band emissions(OOBE) requirements for GEO and LEO classes are therefore defined as described in Table 6.6.4.2-1 below.

Table 6.6.4.2-1: SAN LEO and GEO Classes OOBE basic limits

| Frequency offset of measurement filter -3dB point, Δf | Frequency offset of measurement filter centre frequency, f_{offset} | Basic limits (dBm) | Measurement bandwidth |
|--|---|---|-----------------------|
| $0 \text{ MHz} \leq \Delta f < 2 \times BW_{SAN}$ | $0.002 \text{ MHz} \leq f_{offset} < 2 \times BW_{SAN} + 0.002 \text{ MHz}$ | $\max \left(SE \text{ limit, } P_{rat ed, sys} - 10 \log_{10}(BW_{SAN}) - 24 - \Delta_{sat_class} [dB] - 40 \right. \\ \left. \times \log_{10} \left(\frac{f_{offset} - 0.002}{BW_{SAN}} \times 2 + 1 \right) \right) \text{ dBm}$ | 4 kHz |
| NOTE 1: BW_{SAN} is in the unit of MHz. NOTE 2: SE limit is spurious emission limit specified in spurious emission clause 6.6.5. NOTE 3: PSD attenuation as in ITU-R SM.1541-6 [9], Annex 5 OoB domain emission limits for space services. NOTE 4: Δ_{sat_class} [dB]=0 dB for GEO class and Δ_{sat_class} [dB]=3 dB for LEO class. | | | |

6.6.4.3 Minimum requirements for SAN type 1-H

The out-of-band emissions minimum requirements for *SAN type 1-H* are that the power summation emissions at the *TAB connectors* shall not exceed the *basic limit* in clause 6.6.4.2.

6.6.5 Transmitter spurious emissions

6.6.5.1 General

The transmitter spurious emission limits shall apply from 30 MHz to the fifth harmonic of the upper frequency edge of the DL operating band, excluding the *SAN transponder bandwidth* BW_{SAN} and the frequency range where the out-of-band emissions apply. For some *operating bands*, the upper limit is higher than 12.75 GHz in order to comply with the 5th harmonic limit of the downlink *operating band*, as specified in ITU-R recommendation SM.329 [2].

The requirements shall apply whatever the type of transmitter considered (single carrier or multi-carrier). It applies for all transmission modes foreseen by the manufacturer's specification.

Unless otherwise stated, all requirements are measured as mean power (RMS).

6.6.5.2 Basic limits

6.6.5.2.1 General transmitter spurious emissions requirements

The requirements in table 6.6.5.2.1-1 shall apply. The application of those limits shall be the same as for out-of-band emissions in clause 6.6.4.

Table 6.6.5.2.1-1: General SAN transmitter spurious emission basic limits in FR1-NTN

| Spurious frequency range | $P_{\text{rated,t,sys}}$ (dBm) | Basic limit (dBm) | Measurement bandwidth (kHz) | Notes |
|---|--------------------------------|--|-----------------------------|------------------------|
| 30 MHz – 5 th harmonic of the upper frequency edge of the DL operating band | ≤ 47 | -13 | 4 | NOTE 1, NOTE 2, NOTE 3 |
| | > 47 | $P_{\text{rated,t,sys}} - 60\text{dB}$ | | |
| NOTE 1: <i>Measurement bandwidths</i> as in ITU-R SM.329 [2], s4.1. | | | | |
| NOTE 2: Upper frequency as in ITU-R SM.329 [2], s2.5 table 1. | | | | |
| NOTE 3: The lower frequency limit is replaced by 0.7 times the waveguide cut-off frequency, according to ITU-R SM.329 [2], for systems having an integral antenna incorporating a waveguide section, or with an antenna connection in such form, and of unperturbed length equal to at least twice the cut-off. | | | | |

6.6.5.2.2 Protection of the own Satellite Access Node receiver

This requirement shall be applied for NR FDD operation in order to prevent the receivers of the SAN being desensitized by emissions from its own SAN transmitter. It is measured at the *TAB connector* for *SAN type 1-H* for any type of SAN which has common or separate Tx/Rx *TAB connectors*.

The spurious emission *basic limits* are provided in table 6.6.5.2.2-1.

Table 6.6.5.2.2-1: SAN spurious emissions *basic limits* for protection of the SAN receiver

| Frequency range | Basic limits | Measurement bandwidth |
|--|--------------|-----------------------|
| $F_{\text{UL,low}} - F_{\text{UL,high}}$ | -96 dBm | 100 kHz |

6.6.5.2.3 Additional spurious emissions requirements

The additional spurious emissions requirement is not applicable for SAN.

6.6.5.2.4 Co-location with other Satellite Access Nodes

The co-location requirement is not applicable for SAN.

6.6.5.3 Minimum requirements for *SAN type 1-H*

The transmitter spurious emissions minimum requirements for *SAN type 1-H* are that that the power summation emissions at the *TAB connectors* shall not exceed the *basic limit* in clause 6.6.5.2.

6.7 Transmitter intermodulation

The requirement is not applicable in this version of the specification.

7 Conducted receiver characteristics

7.1 General

Conducted receiver characteristics are specified at the *TAB connector* for *SAN type 1-H*, with full complement of transceivers for the configuration in normal operating condition.

Unless otherwise stated, the following arrangements apply for conducted receiver characteristics requirements in clause 7:

- Requirements shall be met for any transmitter setting.
- The requirements shall be met with the transmitter unit(s) ON.
- Throughput requirements do not assume HARQ retransmissions.
- When SAN is configured to receive multiple carriers, all the throughput requirements are applicable for each received carrier.
- For ACS and blocking characteristics, the negative offsets of the interfering signal apply relative to the lower *SAN RF Bandwidth* edge or *sub-block* edge inside a *sub-block gap*, and the positive offsets of the interfering signal apply relative to the upper *SAN RF Bandwidth* edge or *sub-block* edge inside a *sub-block gap*.

NOTE: In normal operating condition the SAN is configured to transmit and receive at the same time.

7.2 Reference sensitivity level

7.2.1 General

The reference sensitivity power level P_{REFSENS} is the minimum mean power received at the *TAB connector* for *SAN type 1-H* at which a throughput requirement shall be met for a specified reference measurement channel.

7.2.2 Minimum requirements for *SAN type 1-H*

The throughput shall be $\geq 95\%$ of the maximum throughput of the reference measurement channel as specified in annex A.1 with parameters specified in table 7.2.2-1 and 7.2.2-2 for *SAN type 1-H* in all operating band in FR1-NTN.

Table 7.2.2-1: SAN GEO class reference sensitivity levels

| SAN channel bandwidth (MHz) | Sub-carrier spacing (kHz) | Reference measurement channel (NOTE) | Reference sensitivity power level, P_{REFSENS} (dBm) |
|---|---------------------------|--------------------------------------|---|
| 5, 10, 15 | 15 | G-FR1-A1-1 | -99.3 |
| 10, 15 | 30 | G-FR1-A1-2 | -99.4 |
| 10, 15 | 60 | G-FR1-A1-3 | -96.5 |
| 20 | 15 | G-FR1-A1-4 | -92.9 |
| 20 | 30 | G-FR1-A1-5 | -93.2 |
| 20 | 60 | G-FR1-A1-6 | -93.3 |
| NOTE: P_{REFSENS} is the power level of a single instance of the reference measurement channel. This requirement shall be met for each consecutive application of a single instance of the reference measurement channel mapped to disjoint frequency ranges with a width corresponding to the number of resource blocks of the reference measurement channel each, except for one instance that might overlap one other instance to cover the full SAN channel bandwidth. | | | |

Table 7.2.2-2: SAN LEO class reference sensitivity levels

| SAN channel bandwidth (MHz) | Sub-carrier spacing (kHz) | Reference measurement channel (NOTE) | Reference sensitivity power level, P_{REFSENS} (dBm) |
|---|---------------------------|--------------------------------------|---|
| 5, 10, 15 | 15 | G-FR1-A1-1 | -102.4 |
| 10, 15 | 30 | G-FR1-A1-2 | -102.5 |
| 10, 15 | 60 | G-FR1-A1-3 | -99.6 |
| 20 | 15 | G-FR1-A1-4 | -96.0 |
| 20 | 30 | G-FR1-A1-5 | -96.3 |
| 20 | 60 | G-FR1-A1-6 | -96.4 |
| NOTE: P_{REFSENS} is the power level of a single instance of the reference measurement channel. This requirement shall be met for each consecutive application of a single instance of the reference measurement channel mapped to disjoint frequency ranges with a width corresponding to the number of resource blocks of the reference measurement channel each, except for one instance that might overlap one other instance to cover the full SAN channel bandwidth. | | | |

7.3 Dynamic range

7.3.1 General

The dynamic range is specified as a measure of the capability of the receiver to receive a wanted signal in the presence of an interfering signal at the *TAB connector* for SAN type 1-H inside the received SAN channel bandwidth. In this condition, a throughput requirement shall be met for a specified reference measurement channel. The interfering signal for the dynamic range requirement is an AWGN signal.

7.3.2 Minimum requirements for SAN type 1-H

The throughput shall be $\geq 95\%$ of the maximum throughput of the reference measurement channel as specified in annex A.2 with parameters specified in table 7.3.2-1 for LEO.

Table 7.3.2-1: SAN LEO class dynamic range

| SAN channel bandwidth (MHz) | Subcarrier spacing (kHz) | Reference measurement channel | Wanted signal mean power (dBm) | Interfering signal mean power (dBm) / BW _{Config} | Type of interfering signal |
|-----------------------------|--------------------------|-------------------------------|--------------------------------|--|----------------------------|
| 5 | 15 | G-FR1-A2-1 | -76.4 | -88.2 | AWGN |
| | 30 | G-FR1-A2-2 | -77.1 | | |
| 10 | 15 | G-FR1-A2-1 | -76.4 | -85.0 | AWGN |
| | 30 | G-FR1-A2-2 | -77.1 | | |
| | 60 | G-FR1-A2-3 | -74.1 | | |
| 15 | 15 | G-FR1-A2-1 | -76.4 | -83.2 | AWGN |
| | 30 | G-FR1-A2-2 | -77.1 | | |
| | 60 | G-FR1-A2-3 | -74.1 | | |
| 20 | 15 | G-FR1-A2-4 | -70.2 | -81.9 | AWGN |
| | 30 | G-FR1-A2-5 | -70.2 | | |
| | 60 | G-FR1-A2-6 | -70.5 | | |

NOTE: The wanted signal mean power is the power level of a single instance of the corresponding reference measurement channel. This requirement shall be met for each consecutive application of a single instance of the reference measurement channel mapped to disjoint frequency ranges with a width corresponding to the number of resource blocks of the reference measurement channel each, except for one instance that might overlap one other instance to cover the full SAN channel bandwidth.

7.4 In-band selectivity and blocking

7.4.1 Adjacent Channel Selectivity (ACS)

7.4.1.1 General

Adjacent channel selectivity (ACS) is a measure of the receiver's ability to receive a wanted signal at its assigned channel frequency at *TAB connector* for *SAN type 1-H* in the presence of an adjacent channel signal with a specified center frequency offset of the interfering signal to the band edge of a victim system.

7.4.1.2 Minimum requirements for SAN type 1-H

The throughput shall be $\geq 95\%$ of the maximum throughput of the reference measurement channel.

For SAN, the wanted and the interfering signal coupled to the *SAN type 1-H TAB connector* are specified in table 7.4.1.2-1 and the frequency offset between the wanted and interfering signal in table 7.4.1.2-2 for ACS. The reference measurement channel for the wanted signal is identified in table 7.2.2-1 and 7.2.2-2 for each *SAN channel bandwidth* in any operating band and further specified in annex A.1. The characteristics of the interfering signal is further specified in annex C.

The ACS requirement is applicable outside the *SAN RF Bandwidth* or *Radio Bandwidth*. The interfering signal offset is defined relative to the *SAN RF Bandwidth* edges or *Radio Bandwidth* edges.

Minimum conducted requirement is defined at the *TAB connector* for *SAN type 1-H*.

Table 7.4.1.2-1: Satellite Access Node ACS requirement

| SAN channel bandwidth of the lowest/highest carrier received (MHz) | Wanted signal mean power (dBm) | Interfering signal mean power (dBm) |
|---|---|--|
| 5, 10, 15, 20 (NOTE 1) | $P_{\text{REFSENS}} + 6$ dB (NOTE 2) | SAN GEO class: -57 SAN LEO class: -60 |
| NOTE 1: The SCS for the lowest/highest carrier received is the lowest SCS supported by the SAN for that bandwidth. NOTE 2: P_{REFSENS} depends on the <i>SAN channel bandwidth</i> as specified in table 7.2.2-1 and 7.2.2-2. | | |

Table 7.4.1.2-2: Satellite Access Node ACS interferer frequency offset values

| SAN channel bandwidth of the lowest/highest carrier received (MHz) | Interfering signal center frequency offset from the lower/upper SAN RF Bandwidth edge (MHz) | Type of interfering signal |
|--|---|---|
| 5 | ± 2.5025 | 5 MHz CP-OFDM NR signal 15 kHz SCS, 25 RBs |
| 10 | ± 2.5075 | |
| 15 | ± 2.5125 | |
| 20 | ± 2.5025 | |

7.4.2 In-band blocking

The requirement is not applicable in this version of the specification.

7.5 Out-of-band blocking

7.5.1 General

The out-of-band blocking characteristics is a measure of the receiver ability to receive a wanted signal at its assigned channel at the *TAB connector* for *SAN type 1-H* in the presence of an unwanted interferer out of the *operating band*, which is a CW signal for out-of-band blocking.

7.5.2 Minimum requirements for *SAN type 1-H*

The throughput shall be $\geq 95\%$ of the maximum throughput of the reference measurement channel, with a wanted and an interfering signal coupled to *SAN type 1-H TAB connector* using the parameters in table 7.5.2-1.

The reference measurement channel for the wanted signal is identified in clause 7.2.2 for each *SAN channel bandwidth* and further specified in annex A.1.

The out-of-band blocking requirement apply from 1 MHz to $F_{UL,low} - \Delta f_{OOB}$ and from $F_{UL,high} + \Delta f_{OOB}$ up to 12750 MHz, including the downlink frequency range of the FDD *operating band* for SAN. The Δf_{OOB} for *SAN type 1-H* is defined in table 7.5.2-2.

Minimum conducted requirement is defined at the *TAB connector* for *SAN type 1-H*.

Table 7.5.2-1: Out-of-band blocking requirement for NR

| Wanted signal mean power (dBm) | Interfering signal mean power (dBm) | Type of interfering signal |
|---|-------------------------------------|----------------------------|
| $P_{REFSENS} + 6$ dB (NOTE) | -44 | CW carrier |
| NOTE: $P_{REFSENS}$ depends on the <i>SAN channel bandwidth</i> . | | |

Table 7.5.2-2: Δf_{OOB} offset for NR operating bands

| SAN type | Operating band characteristics | Δf_{OOB} (MHz) |
|---------------------|--------------------------------------|------------------------|
| <i>SAN type 1-H</i> | $F_{UL,high} - F_{UL,low} < 100$ MHz | 20 |

7.6 Receiver spurious emissions

The requirement is not applicable in this version of the specification.

7.6.1 Void

7.6.2 Void

7.7 Receiver intermodulation

The requirement is not applicable in this version of the specification.

7.8 In-channel selectivity

7.8.1 General

In-channel selectivity (ICS) is a measure of the receiver ability to receive a wanted signal at its assigned resource block locations at *TAB connector* for *SAN type 1-H* in the presence of an interfering signal received at a larger power spectral density. In this condition a throughput requirement shall be met for a specified reference measurement channel. The interfering signal shall be an NR signal which is time aligned with the wanted signal.

7.8.2 Minimum requirements for *SAN type 1-H*

For *SAN type 1-H*, the throughput shall be $\geq 95\%$ of the maximum throughput of the reference measurement channel as specified in annex A.1 with parameters specified in table 7.8.2-1 for GEO SAN, in table 7.8.2-2 for LEO SAN. The characteristics of the interfering signal is further specified in annex C.

Table 7.8.2-1: SAN GEO class ICS requirement

| <i>SAN channel bandwidth</i> (MHz) | Subcarrier spacing (kHz) | Reference measurement channel | Wanted signal mean power (dBm) | Interfering signal mean power (dBm) | Type of interfering signal |
|------------------------------------|--|-------------------------------|--------------------------------|-------------------------------------|--|
| 5 | 15 | G-FR1-A1-7 | -98.2 | -92.0 | DFT-s-OFDM NR signal, 15 kHz SCS, 10 RBs |
| 10,15,20 | 15 | G-FR1-A1-1 | -96.3 | -88.1 | DFT-s-OFDM NR signal, 15 kHz SCS, 25 RBs |
| 5 | 30 | G-FR1-A1-8 | -98.9 | -92.0 | DFT-s-OFDM NR signal, 30 kHz SCS, 5 RBs |
| 10,15,20 | 30 | G-FR1-A1-2 | -96.4 | -89.0 | DFT-s-OFDM NR signal, 30 kHz SCS, 10 RBs |
| 10,15,20 | 60 | G-FR1-A1-9 | -95.8 | -89.0 | DFT-s-OFDM NR signal, 60 kHz SCS, 5 RBs |
| NOTE: | Wanted and interfering signal are placed adjacently around F_c , where the F_c is defined for <i>SAN channel bandwidth</i> of the wanted signal according to the table 5.4.2.2-1. The aggregated wanted and interferer signal shall be centred in the <i>SAN channel bandwidth</i> of the wanted signal. | | | | |

Table 7.8.2-2: SAN LEO class ICS requirement

| SAN channel bandwidth (MHz) | Subcarrier spacing (kHz) | Reference measurement channel | Wanted signal mean power (dBm) | Interfering signal mean power (dBm) | Type of interfering signal |
|-----------------------------|--|-------------------------------|--------------------------------|-------------------------------------|--|
| 5 | 15 | G-FR1-A1-7 | -101.3 | -83.1 | DFT-s-OFDM NR signal, 15 kHz SCS, 10 RBs |
| 10,15,20 | 15 | G-FR1-A1-1 | -99.4 | -79.2 | DFT-s-OFDM NR signal, 15 kHz SCS, 25 RBs |
| 5 | 30 | G-FR1-A1-8 | -102.0 | -83.1 | DFT-s-OFDM NR signal, 30 kHz SCS, 5 RBs |
| 10,15,20 | 30 | G-FR1-A1-2 | -99.5 | -80.1 | DFT-s-OFDM NR signal, 30 kHz SCS, 10 RBs |
| 10,15,20 | 60 | G-FR1-A1-9 | -98.9 | -80.1 | DFT-s-OFDM NR signal, 60 kHz SCS, 5 RBs |
| NOTE: | Wanted and interfering signal are placed adjacently around F_c , where the F_c is defined for SAN channel bandwidth of the wanted signal according to the table 5.4.2.2-1. The aggregated wanted and interferer signal shall be centred in the SAN channel bandwidth of the wanted signal. | | | | |

8 Conducted performance requirements

8.1 General

Conducted performance requirements specify the ability of the SAN type 1-H to correctly transmit and receive signals in various conditions and configurations. Conducted performance requirements are specified at the TAB connector(s) (for SAN type 1-H).

Conducted performance requirements for the SAN are specified for the fixed reference channels defined in annex A and for the propagation conditions defined in Recommendation ITU-R P.618 (*Propagation data and prediction methods required for the design of Earth-space telecommunication systems*).

Unless stated otherwise, performance requirements apply for a single carrier only. Performance requirements for a SAN supporting carrier aggregation are defined in terms of single carrier requirements.

For FDD operation the requirements in clause 8 shall be met with the transmitter units associated with TAB connectors (for SAN type 1-H) in the operating band turned ON.

NOTE: In normal operating conditions, TAB connectors (for SAN type 1-H) in FDD operation are configured to transmit and receive at the same time. The associated transmitter unit(s) may be OFF for some of the tests as specified in TS 38.181 [3].

The SNR used in this clause is specified based on a single carrier and defined as:

$$\text{SNR} = S / N$$

Where:

S is the total signal power in the slot on a single on a single TAB connector (for SAN type 1-H).

N is the noise density integrated in a bandwidth corresponding to the transmission bandwidth over the same duration where signal energy exists on a single TAB connector (for SAN type 1-H).

8.2 Performance requirements for PUSCH

8.2.1 Requirements for PUSCH with transform precoding disabled

8.2.1.1 General

The performance requirement of PUSCH is determined by a minimum required throughput for a given SNR. The required throughput is expressed as a fraction of maximum throughput for the FRCs listed in annex A. The performance requirements assume HARQ retransmissions.

Table: 8.2.1.1-1 Test parameters for testing PUSCH

| Parameter | | Value |
|---|---|--------------------------------|
| Transform precoding | | Disabled |
| HARQ | Maximum number of HARQ transmissions | 4 |
| | RV sequence | 0, 2, 3, 1 |
| DM-RS | DM-RS configuration type | 1 |
| | DM-RS duration | single-symbol DM-RS |
| | Additional DM-RS position | pos1 |
| | Number of DM-RS CDM group(s) without data | 2 |
| | Ratio of PUSCH EPRE to DM-RS EPRE | -3 dB |
| | DM-RS port | {0} |
| DM-RS sequence generation | | $N_{ID}^0=0, n_{SCID}=0$ |
| Time domain resource assignment | PUSCH mapping type | A, B |
| | Start symbol | 0 |
| | Allocation length | 14 |
| Frequency domain resource assignment | RB assignment | Full applicable test bandwidth |
| | Frequency hopping | Disabled |
| Code block group based PUSCH transmission | | Disabled |

8.2.1.2 Minimum requirements

The throughput shall be equal to or larger than the fraction of maximum throughput for the FRCs stated in tables 8.2.1.2-1 to 8.2.1.2-4 at the given SNR. FRCs are defined in annex A.

Table 8.2.1.2-1: Minimum requirements for PUSCH with 70% of maximum throughput, Type A, 5 MHz channel bandwidth, 15 kHz SCS

| Number of TX antennas | Number of RX antennas | Cyclic prefix | Propagation conditions and correlation matrix (Annex G) | Fraction of maximum throughput | FRC (annex A) | Additional DM-RS position | SNR (dB) |
|-----------------------|-----------------------|---------------|---|--------------------------------|---------------|---------------------------|----------|
| 1 | 1 | Normal | NTN-TDLA100-200 Low | 70 % | G-FR1-A3-1 | pos1 | 3.2 |
| | | Normal | NTN-TDLC5-200 Low | 70 % | G-FR1-A3-1 | pos1 | 1.6 |
| | 2 | Normal | NTN-TDLA100-200 Low | 70 % | G-FR1-A3-1 | pos1 | -0.7 |
| | | Normal | NTN-TDLC5-200 Low | 70% | G-FR1-A3-1 | pos1 | -1.2 |

Table 8.2.1.2-2: Minimum requirements for PUSCH with 70% of maximum throughput, Type A, 10 MHz channel bandwidth, 30 kHz SCS

| Number of TX antennas | Number of RX antennas | Cyclic prefix | Propagation conditions and correlation matrix (Annex G) | Fraction of maximum throughput | FRC (annex A) | Additional DM-RS position | SNR (dB) |
|-----------------------|-----------------------|---------------|---|--------------------------------|---------------|---------------------------|----------|
| 1 | 1 | Normal | NTN-TDLA100-200 Low | 70 % | G-FR1-A3-3 | pos1 | 2.9 |
| | | Normal | NTN-TDLC5-200 Low | 70 % | G-FR1-A3-3 | pos1 | 1.4 |
| | 2 | Normal | NTN-TDLA100-200 Low | 70 % | G-FR1-A3-3 | pos1 | -1.0 |
| | | Normal | NTN-TDLC5-200 Low | 70% | G-FR1-A3-3 | pos1 | -1.4 |

Table 8.2.1.2-3: Minimum requirements for PUSCH with 70% of maximum throughput, Type B, 5 MHz channel bandwidth, 15 kHz SCS

| Number of TX antennas | Number of RX antennas | Cyclic prefix | Propagation conditions and correlation matrix (Annex G) | Fraction of maximum throughput | FRC (annex A) | Additional DM-RS position | SNR (dB) |
|-----------------------|-----------------------|---------------|---|--------------------------------|---------------|---------------------------|----------|
| 1 | 1 | Normal | NTN-TDLA100-200 Low | 70 % | G-FR1-A3-1 | pos1 | 3.3 |
| | | Normal | NTN-TDLC5-200 Low | 70 % | G-FR1-A3-1 | pos1 | 1.6 |
| | 2 | Normal | NTN-TDLA100-200 Low | 70 % | G-FR1-A3-1 | pos1 | -0.6 |
| | | Normal | NTN-TDLC5-200 Low | 70% | G-FR1-A3-1 | pos1 | -1.2 |

Table 8.2.1.2-4: Minimum requirements for PUSCH with 70% of maximum throughput, Type B, 10 MHz channel bandwidth, 30 kHz SCS

| Number of TX antennas | Number of RX antennas | Cyclic prefix | Propagation conditions and correlation matrix (Annex G) | Fraction of maximum throughput | FRC (annex A) | Additional DM-RS position | SNR (dB) |
|-----------------------|-----------------------|---------------|---|--------------------------------|---------------|---------------------------|----------|
| 1 | 1 | Normal | NTN-TDLA100-200 Low | 70 % | G-FR1-A3-3 | pos1 | 2.9 |
| | | Normal | NTN-TDLC5-200 Low | 70 % | G-FR1-A3-3 | pos1 | 1.3 |
| | 2 | Normal | NTN-TDLA100-200 Low | 70 % | G-FR1-A3-3 | pos1 | -1.0 |
| | | Normal | NTN-TDLC5-200 Low | 70% | G-FR1-A3-3 | pos1 | -1.4 |

8.2.2 Requirements for PUSCH with transform precoding enabled

8.2.2.1 General

The performance requirement of PUSCH is determined by a minimum required throughput for a given SNR. The required throughput is expressed as a fraction of maximum throughput for the FRCs listed in annex A. The performance requirements assume HARQ retransmissions.

Table 8.2.2.1-1: Test parameters for testing PUSCH

| Parameter | | Value |
|---|---|--|
| Transform precoding | | Enabled |
| HARQ | Maximum number of HARQ transmissions | 4 |
| | RV sequence | 0, 2, 3, 1 |
| DM-RS | DM-RS configuration type | 1 |
| | DM-RS duration | single-symbol DM-RS |
| | Additional DM-RS position | pos1 |
| | Number of DM-RS CDM group(s) without data | 2 |
| | Ratio of PUSCH EPRE to DM-RS EPRE | -3 dB |
| | DM-RS port | {0} |
| | DM-RS sequence generation | $N_{ID}^0=0$, group hopping and sequence hopping are disabled |
| Time domain resource assignment | PUSCH mapping type | A, B |
| | Start symbol | 0 |
| | Allocation length | 14 |
| Frequency domain resource assignment | RB assignment | Full applicable test bandwidth |
| | Frequency hopping | Disabled |
| Code block group based PUSCH transmission | | Disabled |

8.2.2.2 Minimum requirements

The throughput shall be equal to or larger than the fraction of maximum throughput for the FRCs stated in tables 8.2.2.2-1 to 8.2.2.2-4 at the given SNR. FRCs are defined in annex A.

Table 8.2.2.2-1: Minimum requirements for PUSCH with 70% of maximum throughput, PUSCH mapping Type A, 5 MHz channel bandwidth, 15 kHz SCS

| Number of TX antennas | Number of RX antennas | Cyclic prefix | Propagation conditions and correlation matrix (Annex G) | Fraction of maximum throughput | FRC (annex A) | Additional DM-RS position | SNR (dB) |
|-----------------------|-----------------------|---------------|---|--------------------------------|---------------|---------------------------|----------|
| 1 | 1 | Normal | NTN-TDLA100-200 Low | 70 % | G-FR1-A3-5 | pos1 | 3.7 |
| | | Normal | NTN-TDLC5-200 Low | 70 % | G-FR1-A3-5 | pos1 | 1.6 |
| | 2 | Normal | NTN-TDLA100-200 Low | 70 % | G-FR1-A3-5 | pos1 | -0.5 |
| | | Normal | NTN-TDLC5-200 Low | 70% | G-FR1-A3-5 | pos1 | -1.2 |

Table 8.2.2.2-2: Minimum requirements for PUSCH with 70% of maximum throughput, PUSCH mapping Type A, 10 MHz channel bandwidth, 30 kHz SCS

| Number of TX antennas | Number of RX antennas | Cyclic prefix | Propagation conditions and correlation matrix (Annex G) | Fraction of maximum throughput | FRC (annex A) | Additional DM-RS position | SNR (dB) |
|-----------------------|-----------------------|---------------|---|--------------------------------|---------------|---------------------------|----------|
| 1 | 1 | Normal | NTN-TDLA100-200 Low | 70 % | G-FR1-A3-6 | pos1 | 3.5 |
| | | Normal | NTN-TDLC5-200 Low | 70 % | G-FR1-A3-6 | pos1 | 1.3 |
| | 2 | Normal | NTN-TDLA100-200 Low | 70 % | G-FR1-A3-6 | pos1 | -0.7 |
| | | Normal | NTN-TDLC5-200 Low | 70% | G-FR1-A3-6 | pos1 | -1.4 |

Table 8.2.2.2-3: Minimum requirements for PUSCH with 70% of maximum throughput, PUSCH mapping Type B, 5 MHz channel bandwidth, 15 kHz SCS

| Number of TX antennas | Number of RX antennas | Cyclic prefix | Propagation conditions and correlation matrix (Annex G) | Fraction of maximum throughput | FRC (annex A) | Additional DM-RS position | SNR (dB) |
|-----------------------|-----------------------|---------------|---|--------------------------------|---------------|---------------------------|----------|
| 1 | 1 | Normal | NTN-TDLA100-200 Low | 70 % | G-FR1-A3-5 | pos1 | 3.7 |
| | | Normal | NTN-TDLC5-200 Low | 70 % | G-FR1-A3-5 | pos1 | 1.6 |
| | 2 | Normal | NTN-TDLA100-200 Low | 70 % | G-FR1-A3-5 | pos1 | -0.5 |
| | | Normal | NTN-TDLC5-200 Low | 70% | G-FR1-A3-5 | pos1 | -1.2 |

Table 8.2.2.2-4: Minimum requirements for PUSCH with 70% of maximum throughput, PUSCH mapping Type B, 10 MHz channel bandwidth, 30 kHz SCS

| Number of TX antennas | Number of RX antennas | Cyclic prefix | Propagation conditions and correlation matrix (Annex G) | Fraction of maximum throughput | FRC (annex A) | Additional DM-RS position | SNR (dB) |
|-----------------------|-----------------------|---------------|---|--------------------------------|---------------|---------------------------|----------|
| 1 | 1 | Normal | NTN-TDLA100-200 Low | 70 % | G-FR1-A3-6 | pos1 | 3.5 |
| | | Normal | NTN-TDLC5-200 Low | 70 % | G-FR1-A3-6 | pos1 | 1.3 |
| | 2 | Normal | NTN-TDLA100-200 Low | 70 % | G-FR1-A3-6 | pos1 | -0.7 |
| | | Normal | NTN-TDLC5-200 Low | 70% | G-FR1-A3-6 | pos1 | -1.4 |

8.2.3 Requirements for UL timing adjustment

The performance requirement of UL timing adjustment is determined by a minimum required throughput for the moving UE at given SNR. The performance requirements assume HARQ retransmissions.

In the tests for UL timing adjustment, two signals are configured, one being transmitted by a moving UE and the other being transmitted by a stationary UE. The transmission of SRS from UE is optional. FRC parameters in Table A.3-1 are applied for both UEs. The received power for both UEs is the same. The resource blocks allocated for both UEs are consecutive.

Table 8.2.3-1 Test parameters for testing UL timing adjustment

| Parameter | | Value |
|--|--|--|
| Transform precoding | | Disabled |
| HARQ | Maximum number of HARQ transmissions | 4 |
| | RV sequence | 0, 2, 3, 1 |
| DM-RS | DM-RS configuration type | 1 |
| | DM-RS duration | single-symbol DM-RS |
| | Additional DM-RS position | pos1 |
| | Number of DM-RS CDM group(s) without data | 2 |
| | Ratio of PUSCH EPRE to DM-RS EPRE | -3 dB |
| | DM-RS port | {0} |
| | DM-RS sequence generation | $N_{ID}^0=0, n_{SCID}=0$ for moving UE $N_{ID}^0=1, n_{SCID}=1$ for stationary UE |
| Time domain resource assignment | PUSCH mapping type | A, B |
| | Start symbol | 0 |
| | Allocation length | 14 |
| Frequency domain resource assignment | RB assignment | 12 RB for each UE |
| | Starting PRB index | Moving UE: 0 Stationary UE: 12 |
| | Frequency hopping | Disabled |
| SRS resource allocation | Slots in which sounding RS is transmitted (Note 1) | slot #1 in radio frames |
| | SRS resource allocation | $C_{SRS}=5, B_{SRS}=0$, for 20 RB |
| Code block group based PUSCH transmission | | Disabled |
| NOTE 1: The transmission of SRS is optional. The transmission comb is configured as $K_{TC}=2$. The SRS periodic is configured as $T_{SRS}=10$ for 15kHz SCS and 20 for 30kHz SCS respectively. | | |

8.2.3.2 Minimum requirements

The throughput shall be $\geq 70\%$ of the maximum throughput of the reference measurement channel as specified in Annex A for the moving UE at the SNR given in table 8.2.3.2-1 to table 8.2.3.2-4.

Table 8.2.3.2-1: Minimum requirements for UL timing adjustment with 70% of maximum throughput, PUSCH mapping Type A, 5 MHz channel bandwidth, 15 kHz SCS

| Number of TX antennas | Number of RX antennas | Cyclic prefix | Propagation conditions and correlation matrix (Annex G) | Fraction of maximum throughput | FRC (annex A) | Additional DM-RS position | SNR (dB) |
|-----------------------|-----------------------|---------------|---|--------------------------------|---------------|---------------------------|----------|
| 1 | 1 | Normal | Scenario X | 70 % | G-FR1-A3-2 | pos1 | 4.1 |
| | 2 | Normal | Scenario X | 70 % | G-FR1-A3-2 | pos1 | -0.3 |

Table 8.2.3.2-2: Minimum requirements for UL timing adjustment with 70% of maximum throughput, PUSCH mapping Type A, 10 MHz channel bandwidth, 30 kHz SCS

| Number of TX antennas | Number of RX antennas | Cyclic prefix | Propagation conditions and correlation matrix (Annex G) | Fraction of maximum throughput | FRC (annex A) | Additional DM-RS position | SNR (dB) |
|-----------------------|-----------------------|---------------|---|--------------------------------|---------------|---------------------------|----------|
| 1 | 1 | Normal | Scenario X | 70 % | G-FR1-A3-4 | pos1 | 3.6 |
| | 2 | Normal | Scenario X | 70 % | G-FR1-A3-4 | pos1 | -0.5 |

Table 8.2.3.2-3: Minimum requirements for UL timing adjustment with 70% of maximum throughput, PUSCH mapping Type B, 5 MHz channel bandwidth, 15 kHz SCS

| Number of TX antennas | Number of RX antennas | Cyclic prefix | Propagation conditions and correlation matrix (Annex G) | Fraction of maximum throughput | FRC (annex A) | Additional DM-RS position | SNR (dB) |
|-----------------------|-----------------------|---------------|---|--------------------------------|---------------|---------------------------|----------|
| 1 | 1 | Normal | Scenario X | 70 % | G-FR1-A3-2 | pos1 | 4.2 |
| | 2 | Normal | Scenario X | 70 % | G-FR1-A3-2 | pos1 | -0.3 |

Table 8.2.3.2-4: Minimum requirements for UL timing adjustment with 70% of maximum throughput, PUSCH mapping Type B, 10 MHz channel bandwidth, 30 kHz SCS

| Number of TX antennas | Number of RX antennas | Cyclic prefix | Propagation conditions and correlation matrix (Annex G) | Fraction of maximum throughput | FRC (annex A) | Additional DM-RS position | SNR (dB) |
|-----------------------|-----------------------|---------------|---|--------------------------------|---------------|---------------------------|----------|
| 1 | 1 | Normal | Scenario X | 70 % | G-FR1-A3-4 | pos1 | 3.6 |
| | 2 | Normal | Scenario X | 70 % | G-FR1-A3-4 | pos1 | -0.4 |

8.2.4 Requirements for PUSCH repetition Type A

8.2.4.1 General

The performance requirement of PUSCH is determined by a maximum block error probability (BLER) for a given SNR. The BLER is defined as the probability of incorrectly decoding the PUSCH information when the PUSCH information is sent. The performance requirements assume HARQ re-transmissions.

Table: 8.2.4.1-1 Test parameters for testing PUSCH repetition Type A

| Parameter | | Value |
|--|---|-------------------------------------|
| Transform precoding | | Disabled |
| Channel bandwidth | | 15kHz SCS: 5MHz 30kHz SCS: 10MHz |
| HARQ | Maximum number of HARQ transmissions | 4 |
| | RV sequence | 0, 3, 0, 3 [Note 1] |
| DM-RS | DM-RS configuration type | 1 |
| | DM-RS duration | single-symbol DM-RS |
| | Additional DM-RS position | pos1 |
| | Number of DM-RS CDM group(s) without data | 2 |
| | Ratio of PUSCH EPRE to DM-RS EPRE | -3 dB |
| | DM-RS port | {0} |
| DM-RS sequence generation | | $N_{ID}^0=0$, $n_{SCID}=0$ |
| Time domain resource assignment | PUSCH mapping type | A, B |
| | Start symbol | 0 |
| | Allocation length | 14 |
| | PUSCH aggregation factor | n_2 |
| Frequency domain resource assignment | RB assignment | Full applicable test bandwidth |
| | Frequency hopping | Disabled |
| Code block group based PUSCH transmission | | Disabled |
| Note 1: The effective RV sequence is {0, 2, 3, 1} with slot aggregation. | | |

8.2.4.2 Minimum requirements

The BLER shall be equal to or smaller than the required target BLER for the FRCs stated in tables 8.2.4.2-1 to 8.2.4.2-4 at the given SNR. FRCs are defined in annex A.

Table 8.2.4.2-1: Minimum requirements for PUSCH repetition TypeA, PUSCH mapping Type A, 5 MHz channel bandwidth, 15 kHz SCS

| Number of TX antennas | Number of RX antennas | Cyclic prefix | Propagation conditions and correlation matrix (Annex G) | Target BLER | FRC (Annex A) | Additional DM-RS position | SNR (dB) |
|---|-----------------------|---------------|---|-------------|---------------|---------------------------|----------|
| 1 | 1 | Normal | NTN-TDLA100-200 Low | 1% (Note 1) | G-FR1-A3A-1 | pos1 | -5.1 |
| | 2 | Normal | NTN-TDLA100-200 Low | 1% (Note 1) | G-FR1-A3A-1 | pos1 | -8.5 |
| Note 1: BLER is defined as residual BLER; i.e. ratio of incorrectly received transport blocks / sent transport blocks, independently of the number HARQ transmission(s) for each transport block. | | | | | | | |

Table 8.2.4.2-2: Minimum requirements for PUSCH, PUSCH mapping Type A, 10 MHz channel bandwidth, 30 kHz SCS

| Number of TX antennas | Number of RX antennas | Cyclic prefix | Propagation conditions and correlation matrix (Annex G) | Target BLER | FRC (Annex A) | Additional DM-RS position | SNR (dB) |
|---|-----------------------|---------------|---|-------------|---------------|---------------------------|----------|
| 1 | 1 | Normal | NTN-TDLA100-200 Low | 1% (Note 1) | G-FR1-A3A-2] | pos1 | -5.1 |
| | 2 | Normal | NTN-TDLA100-200 Low | 1% (Note 1) | G-FR1-A3A-2 | pos1 | -8.5 |
| Note 1: BLER is defined as residual BLER; i.e. ratio of incorrectly received transport blocks / sent transport blocks, independently of the number HARQ transmission(s) for each transport block. | | | | | | | |

Table 8.2.4.2-3: Minimum requirements for PUSCH, PUSCH mapping Type B, 5 MHz channel bandwidth, 15 kHz SCS

| Number of TX antennas | Number of RX antennas | Cyclic prefix | Propagation conditions and correlation matrix (Annex G) | Target BLER | FRC (Annex A) | Additional DM-RS position | SNR (dB) |
|---|-----------------------|---------------|---|-------------|---------------|---------------------------|----------|
| 1 | 1 | Normal | NTN-TDLA100-200 Low | 1% (Note 1) | G-FR1-A3A-1 | pos1 | -5.1 |
| | 2 | Normal | NTN-TDLA100-200 Low | 1% (Note 1) | G-FR1-A3A-1 | pos1 | -8.5 |
| Note 1: BLER is defined as residual BLER; i.e. ratio of incorrectly received transport blocks / sent transport blocks, independently of the number HARQ transmission(s) for each transport block. | | | | | | | |

Table 8.2.4.2-4: Minimum requirements for PUSCH, PUSCH mapping Type B, 10 MHz channel bandwidth, 30 kHz SCS

| Number of TX antennas | Number of RX antennas | Cyclic prefix | Propagation conditions and correlation matrix (Annex G) | Target BLER | FRC (Annex A) | Additional DM-RS position | SNR (dB) |
|---|-----------------------|---------------|---|-------------|---------------|---------------------------|----------|
| 1 | 1 | Normal | NTN-TDLA100-200 Low | 1% (Note 1) | G-FR1-A3A-2 | pos1 | -5.1 |
| | 2 | Normal | NTN-TDLA100-200 Low | 1% (Note 1) | G-FR1-A3A-2 | pos1 | -8.5 |
| Note 1: BLER is defined as residual BLER; i.e. ratio of incorrectly received transport blocks / sent transport blocks, independently of the number HARQ transmission(s) for each transport block. | | | | | | | |

8.3 Performance requirements for PUCCH

8.3.1 DTX to ACK probability

8.3.1.1 General

The DTX to ACK probability, i.e. the probability that ACK is detected when nothing was sent:

$$\text{Prob}(\text{PUCCH DTX} \rightarrow \text{Ack bits}) = \frac{\#(\text{false ACK bits})}{\#(\text{PUCCH DTX}) * \#(\text{ACK/NACK bits})}$$

where:

- #(false ACK bits) denotes the number of detected ACK bits.
- #(ACK/NACK bits) denotes the number of encoded bits per slot
- #(PUCCH DTX) denotes the number of DTX occasions

8.3.1.2 Minimum requirement

The DTX to ACK probability shall not exceed 1% for all PUCCH formats carrying ACK/NACK bits:

$$\text{Prob}(\text{PUCCH DTX} \rightarrow \text{Ack bits}) \leq 10^{-2}$$

8.3.2 Performance requirements for PUCCH format 0

8.3.2.1 General

The ACK missed detection probability is the probability of not detecting an ACK when an ACK was sent.

Table 8.3.2.1-1: Test Parameters

| Parameter | Test |
|--------------------------------------|--|
| Number of UCI information bits | 1 |
| Number of PRBs | 1 |
| First PRB prior to frequency hopping | 0 |
| Intra-slot frequency hopping | Enabled |
| First PRB after frequency hopping | the largest PRB index – (nrofPRBs – 1) |
| Group and sequence hopping | neither |
| Hopping ID | 0 |
| Initial cyclic shift | 0 |
| First symbol | 12 for 2 symbols |

The transient period as specified in TS 38.101-5 [11] clause 6.3.3 is not taken into account for performance requirement testing, where the RB hopping is symmetric to the CC centre, i.e. intra-slot frequency hopping is enabled.

8.3.2.2 Minimum requirements

The ACK missed detection probability shall not exceed 1% at the SNR given in table 8.3.2.2-1 and in table 8.3.2.2-2.

Table 8.3.2.2-1: Minimum requirements for PUCCH format 0, 15 kHz SCS and 5MHz channel bandwidth

| Number of TX antennas | Number of RX antennas | Propagation conditions and correlation matrix (Annex X) | SNR (dB) |
|-----------------------|-----------------------|---|----------|
| 1 | 1 | NTN-TDLA100-200 Low | 8.9 |
| | 2 | NTN-TDLA100-200 Low | 3.3 |

Table 8.3.2.2-2: Minimum requirements for PUCCH format 0, 30 kHz SCS and 10MHz channel bandwidth

| Number of TX antennas | Number of RX antennas | Propagation conditions and correlation matrix (Annex X) | SNR (dB) |
|-----------------------|-----------------------|---|----------|
| 1 | 1 | NTN-TDLA100-200 Low | 11.1 |
| | 2 | NTN-TDLA100-200 Low | 4.8 |

8.3.3 Performance requirements for PUCCH format 1

8.3.3.1 NACK to ACK requirements

8.3.3.1.1 General

The NACK to ACK detection probability is the probability that an ACK bit is falsely detected when an NACK bit was sent on the particular bit position, where the NACK to ACK detection probability is defined as follows:

$$\text{Prob}(\text{PUCCH NACK} \rightarrow \text{ACK bits}) = \frac{\#(\text{NACK bits decoded as ACK bits})}{\#(\text{Total NACK bits})},$$

where:

- $\#(\text{Total NACK bits})$ denotes the total number of NACK bits transmitted
- $\#(\text{NACK bits decoded as ACK bits})$ denotes the number of NACK bits decoded as ACK bits at the receiver, i.e. the number of received ACK bits
- NACK bits in the definition do not contain the NACK bits which are mapped from DTX, i.e. NACK bits received when DTX is sent should not be considered.

Random codeword selection is assumed.

Table 8.3.3.1.1-1: Test Parameters

| Parameter | Test |
|--|---|
| Number of information bits | 2 |
| Number of PRBs | 1 |
| Number of symbols | 14 |
| First PRB prior to frequency hopping | 0 |
| Intra-slot frequency hopping | enabled |
| First PRB after frequency hopping | The largest PRB index – (nrofPRBs – 1) |
| Group and sequence hopping | neither |
| Hopping ID | 0 |
| Initial cyclic shift | 0 |
| First symbol | 0 |
| Index of orthogonal cover code (<i>timeDomainOCC</i>) | 0 |

The transient period as specified in TS 38.101-5 [11] clause 6.3.3 is not taken into account for performance requirement testing, where the RB hopping is symmetric to the CC centre, i.e. intra-slot frequency hopping is enabled.

8.3.3.1.2 Minimum requirements

The NACK to ACK probability shall not exceed 0.1% at the SNR given in table 8.3.3.1.2-1 and table 8.3.3.1.2-2.

Table 8.3.3.1.2-1: Minimum requirements for PUCCH format 1, 15 kHz SCS and 5MHz channel bandwidth

| Number of TX antennas | Number of RX antennas | Cyclis Prefix | Propagation conditions and correlation matrix (Annex X) | SNR (dB) |
|-----------------------|-----------------------|---------------|---|----------|
| 1 | 1 | Normal | NTN-TDLA100-200 Low | 2.2 |
| | 2 | Normal | NTN-TDLA100-200 Low | -4.1 |

Table 8.3.3.1.2-2: Minimum requirements for PUCCH format 1, 30 kHz SCS and 10MHz channel bandwidth

| Number of TX antennas | Number of RX antennas | Cyclis Prefix | Propagation conditions and correlation matrix (Annex X) | SNR (dB) |
|-----------------------|-----------------------|---------------|---|----------|
| 1 | 1 | Normal | NTN-TDLA100-200 Low | 3.0 |
| | 2 | Normal | NTN-TDLA100-200 Low | -3.5 |

8.3.3.2 ACK missed detection requirements

8.3.3.2.1 General

The ACK missed detection probability is the probability of not detecting an ACK when an ACK was sent. The test parameters in table 8.3.3.1.1-1 are configured.

The transient period as specified in TS 38.101-5 [11] clause 6.3.3 is not taken into account for performance requirement testing, where the RB hopping is symmetric to the centre, i.e. intra-slot frequency hopping is enabled.

8.3.3.2.2 Minimum requirements

The ACK missed detection probability shall not exceed 1% at the SNR given in table 8.3.3.2.2-1 and in table 8.3.3.2.2-2.

Table 8.3.3.2.2-1: Minimum requirements for PUCCH format 1, 15 kHz SCS and 5MHz channel bandwidth

| Number of TX antennas | Number of RX antennas | Cyclis Prefix | Propagation conditions and correlation matrix (Annex X) | SNR (dB) |
|-----------------------|-----------------------|---------------|---|----------|
| 1 | 1 | Normal | NTN-TDLA100-200 Low | 1.5 |
| | 2 | Normal | NTN-TDLA100-200 Low | -4.6 |

Table 8.3.3.2.2-2: Minimum requirements for PUCCH format 1, 30 kHz SCS and 10MHz channel bandwidth

| Number of TX antennas | Number of RX antennas | Cyclis Prefix | Propagation conditions and correlation matrix (Annex X) | SNR (dB) |
|-----------------------|-----------------------|---------------|---|----------|
| 1 | 1 | Normal | NTN-TDLA100-200 Low | 3.1 |
| | 2 | Normal | NTN-TDLA100-200 Low | -3.4 |

8.3.4 Performance requirements for PUCCH format 2

8.3.4.1 ACK missed detection requirements

8.3.4.1.1 General

The ACK missed detection probability is the probability of not detecting an ACK when an ACK was sent.

The ACK missed detection requirement only applies to the PUCCH format 2 with 4 UCI bits.

Table 8.3.4.1.1-1: Test Parameters

| Parameter | Value |
|--------------------------------------|--------------|
| Modulation order | QSPK |
| First PRB prior to frequency hopping | 0 |
| Intra-slot frequency hopping | N/A |
| First PRB after frequency hopping | N/A |
| Number of PRBs | 4 |
| Number of symbols | 1 |
| The number of UCI information bits | 4 |
| First symbol | 13 |
| DM-RS sequence generation | $N_{ID}^0=0$ |

The transient period as specified in TS 38.101-5 [11] clause 6.3.3 is not taken into account for performance requirement testing, where the RB hopping is symmetric to the CC center, i.e. intra-slot frequency hopping is enabled.

8.3.4.1.2 Minimum requirements

The ACK missed detection probability shall not exceed 1% at the SNR given in table 8.3.4.1.2-1 and table 8.3.4.1.2-2 for 4 UCI bits.

Table 8.3.4.1.2-1: Minimum requirements for PUCCH format 2, 15 kHz SCS and 5MHz channel bandwidth

| Number of TX antennas | Number of RX antennas | Cyclis Prefix | Propagation conditions and correlation matrix (Annex X) | SNR (dB) |
|-----------------------|-----------------------|---------------|---|----------|
| 1 | 1 | Normal | NTN-TDLA100-200 Low | 14.6 |
| | 2 | Normal | NTN-TDLA100-200 Low | 4.7 |

Table 8.3.4.1.2-2: Minimum requirements for PUCCH format 2, 30 kHz SCS and 10MHz channel bandwidth

| Number of TX antennas | Number of RX antennas | Cyclis Prefix | Propagation conditions and correlation matrix (Annex X) | SNR (dB) |
|-----------------------|-----------------------|---------------|---|----------|
| 1 | 1 | Normal | NTN-TDLA100-200 Low | 12.0 |
| | 2 | Normal | NTN-TDLA100-200 Low | 4.4 |

8.3.4.2 UCI BLER performance requirements

8.3.4.2.1 General

The UCI block error probability (BLER) is defined as the probability of incorrectly decoding the UCI information when the UCI information is sent. The UCI information does not contain CSI part 2.

The transient period as specified in TS 38.101-5 [11] clause 6.3.3 is not taken into account for performance requirement testing, where the RB hopping is symmetric to the CC centre, i.e. intra-slot frequency hopping is enabled.

The UCI block error probability performance requirement only applies to the PUCCH format 2 with 22 UCI bits.

Table 8.3.4.2.1-1: Test Parameters

| Parameter | Value |
|--------------------------------------|--|
| Modulation order | QSPK |
| First PRB prior to frequency hopping | 0 |
| Intra-slot frequency hopping | enabled |
| Frist PRB after frequency hopping | The largest PRB index – (Number of PRBs – 1) |
| Number of PRBs | 9 |
| Number of symbols | 2 |
| The number of UCI information bits | 22 |
| First symbol | 12 |
| DM-RS sequence generation | $N_{ID}^0=0$ |

8.3.4.2.2 Minimum requirements

The UCI block error probability shall not exceed 1% at the SNR given in table 8.3.4.2.2-1 and table 8.3.4.2.2-2 for 22 UCI bits.

Table 8.3.4.2.2-1: Minimum requirements for PUCCH format 2, 15 kHz SCS and 5MHz channel bandwidth

| Number of TX antennas | Number of RX antennas | Cyclis Prefix | Propagation conditions and correlation matrix (Annex X) | SNR (dB) |
|-----------------------|-----------------------|---------------|---|----------|
| 1 | 1 | Normal | NTN-TDLA100-200 Low | 6.3 |
| | 2 | Normal | NTN-TDLA100-200 Low | 0.8 |

Table 8.3.4.2.2-2: Minimum requirements for PUCCH format 2, 30 kHz SCS and 10MHz channel bandwidth

| Number of TX antennas | Number of RX antennas | Cyclis Prefix | Propagation conditions and correlation matrix (Annex X) | SNR (dB) |
|-----------------------|-----------------------|---------------|---|----------|
| 1 | 1 | Normal | NTN-TDLA100-200 Low | 6.4 |
| | 2 | Normal | NTN-TDLA100-200 Low | 0.5 |

8.3.5 Performance requirements for PUCCH format 3

8.3.5.1 General

The performance is measured by the required SNR at UCI block error probability not exceeding 1%.

The UCI block error probability is defined as the conditional probability of incorrectly decoding the UCI information when the UCI information is sent. The UCI information does not contain CSI part 2.

The transient period as specified in TS 38.101-5 [11] clause 6.3.3 is not taken into account for performance requirement testing, where the RB hopping is symmetric to the centre, i.e. intra-slot frequency hopping is enabled.

Table 8.3.5.1-1: Test Parameters

| Parameter | Test |
|--------------------------------------|--|
| Modulation order | QPSK |
| First PRB prior to frequency hopping | 0 |
| Intra-slot frequency hopping | enabled |
| First PRB after frequency hopping | The largest PRB index – (Number of PRBs – 1) |
| Group and sequence hopping | neither |
| Hopping ID | 0 |
| Number of PRBs | 1 |
| Number of symbols | 14 |
| The number of UCI information bits | 16 |
| First symbol | 0 |

8.3.5.2 Minimum requirements

The UCI block error probability shall not exceed 1% at the SNR given in Table 8.3.5.2-1 and Table 8.3.5.2-2.

Table 8.3.5.2-1: Minimum requirements for PUCCH format 3, 15 kHz SCS and 5MHz channel bandwidth

| Number of TX antennas | Number of RX antennas | Cyclis Prefix | Propagation conditions and correlation matrix (Annex X) | Additioan DM-RS configuration | SNR (dB) |
|-----------------------|-----------------------|---------------|---|-------------------------------|----------|
| 1 | 1 | Normal | NTN-TDLA100-200 Low | No additional DM-RS | 6.6 |
| | | | | Additional DM-RS | 6.4 |
| | 2 | Normal | NTN-TDLA100-200 Low | No additional DM-RS | 0.3 |
| | | | | Additional DM-RS | 0.0 |

Table 8.3.5.2-2: Minimum requirements for PUCCH format 3, 30 kHz SCS and 10MHz channel bandwidth

| Number of TX antennas | Number of RX antennas | Cyclis Prefix | Propagation conditions and correlation matrix (Annex X) | Additioan DM-RS configuration | SNR (dB) |
|-----------------------|-----------------------|---------------|---|-------------------------------|----------|
| 1 | 1 | Normal | NTN-TDLA100-200 Low | No additional DM-RS | 9.2 |
| | | | | Additional DM-RS | 8.6 |
| | 2 | Normal | NTN-TDLA100-200 Low | No additional DM-RS | 1.6 |
| | | | | Additional DM-RS | 1.5 |

8.3.6 Performance requirements for PUCCH format 4

8.3.6.1 General

The performance is measured by the required SNR at UCI block error probability not exceeding 1%.

The UCI block error probability is defined as the conditional probability of incorrectly decoding the UCI information when the UCI information is sent. The UCI information does not contain CSI part 2.

The transient period as specified in TS 38.101-5 [11] clause 6.3.3 is not taken into account for performance requirement testing, where the RB hopping is symmetric to the centre, i.e. intra-slot frequency hopping is enabled.

Table 8.3.6.1-1: Test parameters

| Parameter | Value |
|--------------------------------------|--|
| Modulation order | QPSK |
| First PRB prior to frequency hopping | 0 |
| Number of PRBs | 1 |
| Intra-slot frequency hopping | enabled |
| First PRB after frequency hopping | The largest PRB index – (Number of PRBs – 1) |
| Group and sequence hopping | neither |
| Hopping ID | 0 |
| Number of symbols | 14 |
| The number of UCI information bits | 22 |
| First symbol | 0 |
| Length of the orthogonal cover code | n2 |
| Index of the orthogonal cover code | n0 |

8.3.6.2 Minimum requirement

The UCI block error probability shall not exceed 1% at the SNR given in Table 8.3.6.2-1 and Table 8.3.6.2-2.

Table 8.3.6.2-1: Minimum requirements for PUCCH format 4, 15 kHz SCS and 5MHz channel bandwidth

| Number of TX antennas | Number of RX antennas | Cyclis Prefix | Propagation conditions and correlation matrix (Annex X) | Additioan DM-RS configuration | SNR (dB) |
|-----------------------|-----------------------|---------------|---|-------------------------------|----------|
| 1 | 1 | Normal | NTN-TDLA100-200 Low | No additional DM-RS | 8.9 |
| | | | | Additional DM-RS | 8.6 |
| | 2 | Normal | NTN-TDLA100-200 Low | No additional DM-RS | 2.5 |
| | | | | Additional DM-RS | 2.2 |

Table 8.3.6.2-2: Minimum requirements for PUCCH format 4, 30 kHz SCS and 10MHz channel bandwidth

| Number of TX antennas | Number of RX antennas | Cyclis Prefix | Propagation conditions and correlation matrix (Annex X) | Additioan DM-RS configuration | SNR (dB) |
|-----------------------|-----------------------|---------------|---|-------------------------------|----------|
| 1 | 1 | Normal | NTN-TDLA100-200 Low | No additional DM-RS | 10.5 |
| | | | | Additional DM-RS | 10.5 |
| | 2 | Normal | NTN-TDLA100-200 Low | No additional DM-RS | 3.5 |
| | | | | Additional DM-RS | 3.3 |

8.3.7 Performance requirements for multi-slot PUCCH

8.3.7.1 General

8.3.7.2 Performance requirements for multi-slot PUCCH format 1

8.3.7.2.1 NACK to ACK requirements

8.3.7.2.1.1 General

The NACK to ACK detection probability is the probability that an ACK bit is falsely detected when a NACK bit was sent on the particular bit position, where the NACK to ACK detection probability is defined as follows:

$$\text{Prob}(\text{PUCCH NACK} \rightarrow \text{ACK bits}) = \frac{\#(\text{NACK bits decoded as ACK bits})}{\#(\text{Total NACK bits})},$$

where:

- $\#(\text{Total NACK bits})$ denotes the total number of NACK bits transmitted
- $\#(\text{NACK bits decoded as ACK bits})$ denotes the number of NACK bits decoded as ACK bits at the receiver, i.e., the number of received ACK bits
- NACK bits in the definition do not contain the NACK bits which are mapped from DTX, i.e., NACK bits received when DTX is sent should not be considered.

Random codeword selection is assumed.

Table 8.3.7.2.1.1-1: Test Parameters for multi-slot PUCCH format 1

| Parameter | Test |
|--|---|
| Number of information bits | 2 |
| Number of PRBs | 1 |
| Number of symbols | 14 |
| First PRB prior to frequency hopping | 0 |
| Intra-slot frequency hopping | disabled |
| Inter-slot frequency hopping | enabled |
| First PRB after frequency hopping | The largest PRB index – (nrofPRBs – 1) |
| Group and sequence hopping | neither |
| Hopping ID | 0 |
| Initial cyclic shift | 0 |
| First symbol | 0 |
| Index of orthogonal cover code (<i>timeDomainOCC</i>) | 0 |
| Number of slots for PUCCH repetition | 2 |

8.3.7.2.1.2 Minimum requirements

The multi-slot NACK to ACK probability shall not exceed 0.1% at the SNR given in table 8.3.7.2.1.2-1 and 8.3.7.2.1.2-2.

Table 8.3.7.2.1.2-1: Minimum requirements for multi-slot PUCCH format 1 with 15kHz SCS 5MHz channel bandwidth

| Number of TX antennas | Number of RX antennas | Cyclic Prefix | Propagation conditions and correlation matrix (Annex G) | SNR (dB) |
|-----------------------|-----------------------|---------------|---|----------|
| 1 | 1 | Normal | NTN-TDLA100-200 Low | 0.6 |
| | 2 | Normal | NTN-TDLA100-200 Low | -6.6 |

Table 8.3.7.2.1.2-2: Minimum requirements for multi-slot PUCCH format 1 with 30kHz SCS 10MHz channel bandwidth

| Number of TX antennas | Number of RX antennas | Cyclic Prefix | Propagation conditions and correlation matrix (Annex G) | SNR (dB) |
|-----------------------|-----------------------|---------------|---|----------|
| 1 | 1 | Normal | NTN-TDLA100-200 Low | 1.2 |
| | 2 | Normal | NTN-TDLA100-200 Low | -5.6 |

8.3.7.2.2 ACK missed detection requirements

8.3.7.2.2.1 General

The ACK missed detection probability is the probability of not detecting an ACK when an ACK was sent. The test parameters in table 8.3.7.2.1.1-1 are configured.

8.3.7.2.2.2 Minimum requirements

The multi-slot ACK missed detection probability shall not exceed 1% at the SNR given in table 8.3.7.2.2.2-1 and 8.3.7.2.2.2-2.

Table 8.3.7.2.2.2-1: Minimum requirements for multi-slot PUCCH format 1 with 15kHz SCS 5MHz channel bandwidth

| Number of TX antennas | Number of RX antennas | Cyclic Prefix | Propagation conditions and correlation matrix (Annex G) | SNR (dB) |
|-----------------------|-----------------------|---------------|---|----------|
| 1 | 1 | Normal | NTN-TDLA100-200 Low | -1.9 |
| | 2 | Normal | NTN-TDLA100-200 Low | -8.0 |

Table 8.3.7.2.2.2-2: Minimum requirements for multi-slot PUCCH format 1 with 30kHz SCS 10MHz channel bandwidth

| Number of TX antennas | Number of RX antennas | Cyclic Prefix | Propagation conditions and correlation matrix (Annex G) | SNR (dB) |
|-----------------------|-----------------------|---------------|---|----------|
| 1 | 1 | Normal | NTN-TDLA100-200 Low | -1.2 |
| | 2 | Normal | NTN-TDLA100-200 Low | -7.6 |

8.4 Performance requirements for PRACH

8.4.1 PRACH False alarm probability

8.4.1.1 General

The false alarm requirement is valid for any number of receive antennas, for any channel bandwidth.

The false alarm probability is the conditional total probability of erroneous detection of the preamble (i.e. erroneous detection from any detector) when input is only noise.

8.4.1.2 Minimum requirement

The false alarm probability shall be less than or equal to 0.1%.

8.4.2 PRACH detection requirements

8.4.2.1 General

The probability of detection is the conditional probability of correct detection of the preamble when the signal is present. There are several error cases – detecting different preamble than the one that was sent, not detecting a preamble at all or correct preamble detection but with the wrong timing estimation. For AWGN, NTN-TDLA100, a timing estimation error occurs if the estimation error of the timing of the strongest path is larger than the time error tolerance given in Table 8.4.2.1-1.

Table 8.4.2.1-1: Time error tolerance for AWGN, NTN-TDLA100-200

| PRACH preamble | PRACH SCS (kHz) | Time error tolerance | |
|----------------|-----------------|----------------------|-------------|
| | | AWGN | NTN-TDLA100 |
| 0 | 1.25 | 1.04 us | 1.324 us |
| 2 | 1.25 | 1.04 us | 1.324 us |
| B4, C2 | 15 | 0.52 us | 0.804 us |
| | 30 | 0.26 us | 0.544 us |

The test preambles are listed in table A.4 and the test parameter *msg1-FrequencyStart* is set to 0.

8.4.2.2 Minimum requirements

The probability of detection shall be equal to or exceed 99% for the SNR levels listed in Tables 8.4.2.2-1 to 8.4.2.2-3.

Table 8.4.2.2-1: PRACH missed detection test requirements, 1.25 kHz SCS

| Number of TX antennas | Number of demodulation branches | Propagation conditions and correlation matrix (annex J) | Frequency offset | SNR (dB) | |
|-----------------------|---------------------------------|---|------------------|----------------|----------------|
| | | | | Burst format 0 | Burst format 2 |
| 1 | 1 | AWGN | 0 | -12.0 | -17.4 |
| | | NTN-TDLA100-200 Low | 200 Hz | 0.7 | -9.7 |
| | 2 | AWGN | 0 | -14.5 | -19.8 |
| | | NTN-TDLA100-200 Low | 200 Hz | -6.8 | -14.9 |

Table 8.4.2.2-2: PRACH missed detection test requirements, 15 kHz SCS

| Number of TX antennas | Number of demodulation branches | Propagation conditions and correlation matrix (annex J) | Frequency offset | SNR (dB) | |
|-----------------------|---------------------------------|---|------------------|-----------------|-----------------|
| | | | | Burst format B4 | Burst format C2 |
| 1 | 1 | AWGN | 0 | -14.6 | -9.2 |
| | | NTN-TDLA100-200 Low | 200 Hz | -2.7 | 1.9 |
| | 2 | AWGN | 0 | -16.8 | -12.5 |
| | | NTN-TDLA100-200 Low | 200 Hz | -4.8 | -4.8 |

Table 8.4.2.2-3: PRACH missed detection test requirements, 30 kHz SCS

| Number of TX antennas | Number of demodulation branches | Propagation conditions and correlation matrix (annex J) | Frequency offset | SNR (dB) | |
|-----------------------|---------------------------------|---|------------------|-----------------|-----------------|
| | | | | Burst format B4 | Burst format C2 |
| 1 | 1 | AWGN | 0 | -14.4 | -9.2 |
| | | NTN-TDLA100-200 Low | 200 Hz | -4.3 | 0.1 |
| | 2 | AWGN | 0 | -16.5 | -11.9 |
| | | NTN-TDLA100-200 Low | 200 Hz | -10.0 | -5.8 |

9 Radiated transmitter characteristics

9.1 General

Radiated transmitter characteristics requirements apply on the *SAN type 1-H* or *SAN type 1-O* including all its functional components active and for all foreseen modes of operation of the SAN unless otherwise stated.

9.2 Radiated transmit power

9.2.1 General

SAN type 1-H and *SAN type 1-O* are declared to support one or more beams, as per manufacturer's declarations specified in TS 38.181 [3]. Radiated transmit power is defined as the EIRP level for a declared beam at a specific *beam peak direction*.

For each beam, the requirement is based on declaration of a beam identity, *reference beam direction pair*, beamwidth, *rated beam EIRP*, *OTA peak directions set*, the *beam direction pairs* at the maximum steering directions and their associated *rated beam EIRP* and beamwidth(s).

For a declared beam and *beam direction pair*, the *rated beam EIRP* level is the maximum power that the SAN is declared to radiate at the associated *beam peak direction* during the *transmitter ON period*.

For each *beam peak direction* associated with a *beam direction pair* within the *OTA peak directions set*, a specific *rated beam EIRP* level may be claimed. Any claimed value shall be met within the accuracy requirement as described below. *Rated beam EIRP* is only required to be declared for the *beam direction pairs* subject to conformance testing as detailed in TS 38.181 [3].

NOTE 1: *OTA peak directions set* is set of *beam peak directions* for which the EIRP accuracy requirement is intended to be met. The *beam peak directions* are related to a corresponding contiguous range or discrete list of *beam centre directions* by the *beam direction pairs* included in the set.

NOTE 2: A *beam direction pair* is data set consisting of the *beam centre direction* and the related *beam peak direction*.

NOTE 3: A declared EIRP value is a value provided by the manufacturer for verification according to the conformance specification declaration requirements, whereas a claimed EIRP value is provided by the manufacturer to the equipment user for normal operation of the equipment and is not subject to formal conformance testing.

9.2.2 Minimum requirement for *SAN type 1-H* and *SAN type 1-O*

For each declared beam, in normal conditions, for any specific *beam peak direction* associated with a *beam direction pair* within the *OTA peak directions set*, a manufacturer claimed EIRP level in the corresponding *beam peak direction* shall be achievable to within ± 2.2 dB of the claimed value.

Normal conditions are defined in TS 38.181, annex B [3].

In certain regions, the minimum requirement for normal conditions may apply also for some conditions outside the range of conditions defined as normal.

9.3 OTA Satellite Access Node output power

9.3.1 General

OTA SAN output power is declared as the TRP radiated requirement, with the output power accuracy requirement defined at the RIB. TRP does not change with beamforming settings as long as the *beam peak direction* is within the *OTA peak directions set*. Thus the TRP accuracy requirement must be met for any beamforming setting for which the *beam peak direction* is within the *OTA peak directions set*.

The SAN *rated carrier TRP output power* for *SAN type 1-O* shall be based on manufacturer declaration.

Despite the general requirements for the SAN output power described in clause 9.3.2, additional regional requirements might be applicable.

9.3.2 Minimum requirement for *SAN type 1-O*

In normal conditions, the *SAN type 1-O maximum carrier TRP output power*, $P_{\max,c,TRP}$ measured at the RIB shall remain within ± 2 dB of the *rated carrier TRP output power* $P_{\text{rated},c,TRP}$, as declared by the manufacturer.

Normal conditions are defined in TS 38.181 [3], annex B.

9.4 OTA output power dynamics

9.4.1 General

Transmit signal quality (as specified in clause 9.6) shall be maintained for the output power dynamics requirements.

The OTA output power requirements are *directional requirements* and apply to the *beam peak directions* over the *OTA peak directions set*.

9.4.2 OTA RE power control dynamic range

9.4.2.1 General

The OTA RE power control dynamic range is the difference between the power of an RE and the average RE power for a SAN at maximum output power ($P_{\max,c,EIRP}$) for a specified reference condition.

This requirement shall apply at each RIB supporting transmission in the *operating band*.

9.4.2.2 Minimum requirement for SAN type 1-O

The OTA RE power control dynamic range is specified the same as the conducted RE power control dynamic range requirement for *SAN type 1-H* in table 6.3.2.2-1.

9.4.3 OTA total power dynamic range

9.4.3.1 General

The OTA total power dynamic range is the difference between the maximum and the minimum transmit power of an OFDM symbol for a specified reference condition.

This requirement shall apply at each RIB supporting transmission in the *operating band*.

NOTE 1: The upper limit of the OTA total power dynamic range is the SAN maximum carrier EIRP ($P_{\max,c,EIRP}$) when transmitting on all RBs. The lower limit of the OTA total power dynamic range is the average EIRP for single RB transmission in the same direction using the same beam. The OFDM symbol carries PDSCH and not contain RS or SSB.

9.4.3.2 Minimum requirement for SAN type 1-O

OTA total power dynamic range minimum requirement for SAN type 1-O is specified such as for each NR carrier it shall be larger than or equal to the levels specified for the conducted requirement for SAN type 1-H in table 6.3.3.2-1.

9.5 OTA transmit ON/OFF power

The requirement is not applicable in this version of the specification.

9.6 OTA transmitted signal quality

9.6.1 OTA frequency error

9.6.1.1 General

OTA frequency error is the measure of the difference between the actual SAN transmit frequency and the assigned frequency. The same source shall be used for RF frequency and data clock generation.

OTA frequency error requirement is defined as a *directional requirement* at the RIB and shall be met within the *OTA coverage range*.

9.6.1.2 Minimum requirement for SAN type 1-0

The modulated carrier frequency of each carrier configured by the SAN shall be accurate to within 0.05 ppm observed over 1 ms.

9.6.2 OTA modulation quality

9.6.2.1 General

Modulation quality is defined by the difference between the measured carrier signal and an ideal signal. Modulation quality can e.g. be expressed as Error Vector Magnitude (EVM). Details about how the EVM is determined are specified in annex B for FR1.

OTA modulation quality requirement is defined as a *directional requirement* at the RIB and shall be met within the *OTA coverage range*.

9.6.2.2 Minimum requirement for SAN type 1-0

For SAN type 1-0, the EVM levels of each carrier for different modulation schemes on PDSCH outlined in table 6.5.2.2-1 shall be met. Requirements shall be the same as clause 6.5.2.2 and follow EVM frame structure from clause 6.5.2.3.

9.6.3 OTA time alignment error

The requirement is not applicable in this version of the specification.

9.7 OTA unwanted emissions

9.7.1 General

Unwanted emissions consist of so-called out-of-band emissions and spurious emissions according to ITU definitions ITU-R SM.329 [2]. In ITU terminology, out of band emissions are unwanted emissions immediately outside the *SAN channel bandwidth* resulting from the modulation process and non-linearity in the transmitter but excluding spurious emissions. Spurious emissions are emissions which are caused by unwanted transmitter effects such as harmonics emission, parasitic emission, intermodulation products and frequency conversion products, but exclude out of band emissions.

The OTA out-of-band emissions requirement for the *SAN type 1-0* is specified both in terms of Adjacent Channel Leakage power Ratio (ACLR) and out-of-band emissions.(OOBE). The unwanted emission requirements are applied per cell for all the configurations. Requirements for OTA unwanted emissions are captured as TRP requirements or *directional requirements*, as described per requirement.

There is in addition a requirement for occupied bandwidth.

9.7.2 OTA occupied bandwidth

9.7.2.1 General

The OTA occupied bandwidth is the width of a frequency band such that, below the lower and above the upper frequency limits, the mean powers emitted are each equal to a specified percentage $\beta/2$ of the total mean transmitted power. See also recommendation ITU-R SM.328 [8].

The value of $\beta/2$ shall be taken as 0.5%.

The minimum requirement below may be applied regionally. There may also be regional requirements to declare the OTA occupied bandwidth according to the definition in the present clause.

The OTA occupied bandwidth is defined as a *directional requirement* and shall be met in the manufacturer's declared *OTA coverage range* at the RIB.

9.7.2.2 Minimum requirement for SAN type 1-O

The OTA occupied bandwidth for each carrier shall be less than the *SAN channel bandwidth*.

9.7.3 OTA Adjacent Channel Leakage Power Ratio (ACLR)

9.7.3.1 General

OTA Adjacent Channel Leakage power Ratio (ACLR) is the ratio of the filtered mean power centred on the assigned channel frequency to the filtered mean power centred on an adjacent channel frequency. The measured power is TRP.

The requirement shall be applied per RIB.

9.7.3.2 Minimum requirement for SAN type 1-O

The ACLR limit specified in tables 6.6.3.2-1 for SAN GEO class and 6.6.3.2-2 for SAN LEO class shall apply.

For a RIB operating in multi-carrier, the ACLR requirements in clause 6.6.3.2 shall apply to SAN channel bandwidths of the outermost carrier for the frequency ranges defined in tables 6.6.3.2-1 and 6.6.3.2-2.

9.7.4 OTA out-of-band emissions

9.7.4.1 General

The OTA limits for out-of-band emissions are specified as TRP per RIB unless otherwise stated.

9.7.4.2 Minimum requirement for SAN type 1-O

Out-of-band emissions in FR1 are limited by OTA out-of-band emission limits. Unless otherwise stated, the out-of-band emission limits in FR1 are defined from channel edge up to frequencies separated from the channel edge by 200% of the necessary bandwidth. The requirements shall apply whatever the type of transmitter considered and for all transmission modes foreseen by the manufacturer's specification. For a RIB operating in multi-carrier, the requirements apply to SAN channel bandwidths of the outermost carrier for the frequency ranges defined in clause 6.6.4.1.

The OTA out-of-band emissions requirement for SAN type 1-O shall not exceed each applicable limit in clause 6.6.4.2.

9.7.5 OTA transmitter spurious emissions

9.7.5.1 General

Unless otherwise stated, all requirements are measured as mean power.

The OTA spurious emissions limits are specified as TRP per RIB unless otherwise stated.

9.7.5.2 Minimum requirement for SAN type 1-0

9.7.5.2.1 General

The OTA transmitter spurious emission limits for FR1 shall apply from 30 MHz to the 5th harmonic of the upper frequency edge of the DL operating band, excluding the *SAN transponder bandwidth* BW_{SAN} and the frequency range where the out-of-band emissions apply.

The requirements shall apply whatever the type of transmitter considered (single carrier or multi-carrier). It applies for all transmission modes foreseen by the manufacturer's specification.

9.7.5.2.2 General OTA transmitter spurious emissions requirements

The *basic limits* of table 9.7.5.2.2-1 shall apply. The application of those limits shall be the same as for out-of-band emissions in clause 6.6.4.

Table 9.7.5.2.2-1: General SAN transmitter spurious emission basic limits in FR1

| Spurious frequency range | $P_{rated,t,TRP}$ (dBm) | Basic limit (dBm) | Measurement bandwidth (kHz) | Notes |
|---|-------------------------|---------------------------------|-----------------------------|------------------------|
| 30 MHz – 5 th harmonic of the upper frequency edge of the DL operating band | ≤ 47 | -13 | 4 | NOTE 1, NOTE 2, NOTE 3 |
| | > 47 | $P_{rated,t,TRP} - 60\text{dB}$ | | |
| NOTE 1: <i>Measurement bandwidths</i> as in ITU-R SM.329 [2], s4.1. | | | | |
| NOTE 2: Upper frequency as in ITU-R SM.329 [2], s2.5 table 1. | | | | |
| NOTE 3: The lower frequency limit is replaced by 0.7 times the waveguide cut-off frequency, according to ITU-R SM.329 [2], for systems having an integral antenna incorporating a waveguide section, or with an antenna connection in such form, and of unperturbed length equal to at least twice the cut-off. | | | | |

The transmitter spurious emissions minimum requirements for *SAN type 1-0* are that the power summation emissions at the *TAB connectors* shall not exceed the *basic limit* in table 9.7.5.2.2-1.

9.7.5.2.3 Protection of the SAN receiver

The co-location requirement is not applicable for SAN in this version of the specification.

9.7.5.2.4 Additional spurious emissions requirements

The additional spurious emissions requirement is not applicable for SAN.

9.8 OTA transmitter intermodulation

The requirement is not applicable in this version of the specification.

10 Radiated receiver characteristics

10.1 General

Radiated receiver characteristics are specified at RIB for *SAN type 1-H* or *SAN type 1-O*, with full complement of transceivers for the configuration in normal operating condition.

Unless otherwise stated, the following arrangements apply for the radiated receiver characteristics requirements in clause 10:

- Requirements shall be met for any transmitter setting.
- The requirements shall be met with the transmitter unit(s) ON.
- Throughput requirements defined for the radiated receiver characteristics do not assume HARQ retransmissions.
- When SAN is configured to receive multiple carriers, all the throughput requirements are applicable for each received carrier.
- For ACS and blocking characteristics, the negative offsets of the interfering signal apply relative to the lower *SAN RF Bandwidth* edge, and the positive offsets of the interfering signal apply relative to the upper *SAN RF Bandwidth* edge.
- Each requirement shall be met over the RoAoA specified.

NOTE 1: In normal operating condition the SAN in FDD operation is configured to transmit and receive at the same time.

For FR1 requirements which are to be met over the *OTA REFSENS RoAoA* absolute requirement values are offset by the following term:

$$\Delta_{\text{OTAREFSENS}} = 44.1 - 10 \cdot \log_{10}(\text{Be}W_{\theta, \text{REFSENS}} \cdot \text{Be}W_{\phi, \text{REFSENS}}) \text{ dB for the reference direction}$$

and

$$\Delta_{\text{OTAREFSENS}} = 41.1 - 10 \cdot \log_{10}(\text{Be}W_{\theta, \text{REFSENS}} \cdot \text{Be}W_{\phi, \text{REFSENS}}) \text{ dB for all other directions}$$

For requirements which are to be met over the *minSENS RoAoA* absolute requirement values are offset by the following term:

$$\Delta_{\text{minSENS}} = P_{\text{REFSENS}} - \text{EIS}_{\text{minSENS}} \text{ (dB)}$$

10.2 OTA sensitivity

10.2.1 General

The OTA sensitivity requirement is a *directional requirement* based upon the declaration of one or more *OTA sensitivity direction declarations* (OSDD), related to a *SAN type 1-H* and *SAN type 1-O* receiver.

The *SAN type 1-H* and *SAN type 1-O* may optionally be capable of redirecting/changing the *receiver target* by means of adjusting SAN settings resulting in multiple *sensitivity RoAoA*. The *sensitivity RoAoA* resulting from the current SAN settings is the active *sensitivity RoAoA*.

If the SAN is capable of redirecting the *receiver target* related to the OSDD then the OSDD shall include:

- *SAN channel bandwidth* and declared minimum EIS level applicable to any active *sensitivity RoAoA* inside the *receiver target redirection range* in the OSDD.
- A declared *receiver target redirection range*, describing all the angles of arrival that can be addressed for the OSDD through alternative settings in the SAN.

- Five declared *sensitivity RoAoA* comprising the conformance testing directions as detailed in TS 38.181 [3].
- The *receiver target reference direction*.

NOTE 1: Some of the declared *sensitivity RoAoA* may coincide depending on the redirection capability.

NOTE 2: In addition to the declared *sensitivity RoAoA*, several *sensitivity RoAoA* may be implicitly defined by the *receiver target redirection range* without being explicitly declared in the OSDD.

If the SAN is not capable of redirecting the *receiver target* related to the OSDD, then the OSDD includes only:

- The set(s) of RAT, *SAN channel bandwidth* and declared minimum EIS level applicable to the *sensitivity RoAoA* in the OSDD.
- One declared active *sensitivity RoAoA*.
- The *receiver target reference direction*.

NOTE 3: For SAN without target redirection capability, the declared (fixed) *sensitivity RoAoA* is always the active *sensitivity RoAoA*.

The OTA sensitivity EIS level declaration shall apply to each supported polarization, under the assumption of *polarization match*.

10.2.2 Minimum requirement for *SAN type 1-0*

For a received signal whose AoA of the incident wave is within the active *sensitivity RoAoA* of an OSDD, the error rate criterion as described in clause 7.2 shall be met when the level of the arriving signal is equal to the minimum EIS level in the respective declared set of EIS level and *SAN channel bandwidth*.

10.3 OTA reference sensitivity level

10.3.1 General

The OTA REFSENS requirement is a *directional requirement* and is intended to ensure the minimum OTA reference sensitivity level for a declared *OTA REFSENS RoAoA*. The OTA reference sensitivity power level $EIS_{REFSENS}$ is the minimum mean power received at the RIB at which a reference performance requirement shall be met for a specified reference measurement channel.

The OTA REFSENS requirement shall apply to each supported polarization, under the assumption of *polarization match*.

10.3.2 Minimum requirement for *SAN type 1-0*

The throughput shall be $\geq 95\%$ of the maximum throughput of the reference measurement channel as specified in the corresponding table and annex A.1 when the OTA test signal is at the corresponding $EIS_{REFSENS}$ level and arrives from any direction within the *OTA REFSENS RoAoA*.

Table 10.3.2-1: SAN GEO class reference sensitivity levels

| SAN channel bandwidth (MHz) | Sub-carrier spacing (kHz) | Reference measurement channel | OTA reference sensitivity level, $EIS_{REFSENS}$ (dBm) |
|--|---------------------------|-------------------------------|--|
| 5, 10, 15 | 15 | G-FR1-A1-1 | -99.3 - $\Delta_{OTAREFSENS}$ |
| 10, 15 | 30 | G-FR1-A1-2 | -99.4 - $\Delta_{OTAREFSENS}$ |
| 10, 15 | 60 | G-FR1-A1-3 | -96.5 - $\Delta_{OTAREFSENS}$ |
| 20 | 15 | G-FR1-A1-4 | -92.9 - $\Delta_{OTAREFSENS}$ |
| 20 | 30 | G-FR1-A1-5 | -93.2 - $\Delta_{OTAREFSENS}$ |
| 20 | 60 | G-FR1-A1-6 | -93.3 - $\Delta_{OTAREFSENS}$ |
| NOTE: $EIS_{REFSENS}$ is the power level of a single instance of the reference measurement channel. This requirement shall be met for each consecutive application of a single instance of the reference measurement channel mapped to disjoint frequency ranges with a width corresponding to the number of resource blocks of the reference measurement channel each, except for one instance that might overlap one other instance to cover the full SAN channel bandwidth. | | | |

Table 10.3.2-2: SAN LEO class reference sensitivity levels

| SAN channel bandwidth (MHz) | Sub-carrier spacing (kHz) | Reference measurement channel | OTA reference sensitivity level, $EIS_{REFSENS}$ (dBm) |
|--|---------------------------|-------------------------------|--|
| 5, 10, 15 | 15 | G-FR1-A1-1 | -102.4 - $\Delta_{OTAREFSENS}$ |
| 10, 15 | 30 | G-FR1-A1-2 | -102.5 - $\Delta_{OTAREFSENS}$ |
| 10, 15 | 60 | G-FR1-A1-3 | -99.6 - $\Delta_{OTAREFSENS}$ |
| 20 | 15 | G-FR1-A1-4 | -96.0 - $\Delta_{OTAREFSENS}$ |
| 20 | 30 | G-FR1-A1-5 | -96.3 - $\Delta_{OTAREFSENS}$ |
| 20 | 60 | G-FR1-A1-6 | -96.4 - $\Delta_{OTAREFSENS}$ |
| NOTE: $EIS_{REFSENS}$ is the power level of a single instance of the reference measurement channel. This requirement shall be met for each consecutive application of a single instance of the reference measurement channel mapped to disjoint frequency ranges with a width corresponding to the number of resource blocks of the reference measurement channel each, except for one instance that might overlap one other instance to cover the full SAN channel bandwidth. | | | |

10.4 OTA dynamic range

10.4.1 General

The OTA dynamic range is a measure of the capability of the receiver unit to receive a wanted signal in the presence of an interfering signal inside the received SAN channel bandwidth.

The requirement shall apply at the RIB when the AoA of the incident wave of a received signal and the interfering signal are from the same direction and are within the *OTA REFSENS RoAoA*.

The wanted and interfering signals apply to each supported polarization, under the assumption of *polarization match*.

10.4.2 Minimum requirement for SAN type 1-O

The throughput shall be $\geq 95\%$ of the maximum throughput of the reference measurement channel as specified in annex A.2 with parameters specified in table 10.4.2-1 for LEO SAN.

Table 10.4.2-1: SAN LEO class dynamic range

| SAN channel bandwidth (MHz) | Subcarrier spacing (kHz) | Reference measurement channel | Wanted signal mean power (dBm) | Interfering signal mean power (dBm) / BW_{Config} | Type of interfering signal |
|---|--------------------------|-------------------------------|--------------------------------|---|----------------------------|
| 5 | 15 | G-FR1-A2-1 | -76.4 - $\Delta_{OTAREFSENS}$ | -88.2 - $\Delta_{OTAREFSENS}$ | AWGN |
| | 30 | G-FR1-A2-2 | -77.1 - $\Delta_{OTAREFSENS}$ | | |
| 10 | 15 | G-FR1-A2-1 | -76.4 - $\Delta_{OTAREFSENS}$ | -85.0 - $\Delta_{OTAREFSENS}$ | AWGN |
| | 30 | G-FR1-A2-2 | -77.1 - $\Delta_{OTAREFSENS}$ | | |
| | 60 | G-FR1-A2-3 | -74.1 - $\Delta_{OTAREFSENS}$ | | |
| 15 | 15 | G-FR1-A2-1 | -76.4 - $\Delta_{OTAREFSENS}$ | -83.2 - $\Delta_{OTAREFSENS}$ | AWGN |
| | 30 | G-FR1-A2-2 | -77.1 - $\Delta_{OTAREFSENS}$ | | |
| | 60 | G-FR1-A2-3 | -74.1 - $\Delta_{OTAREFSENS}$ | | |
| 20 | 15 | G-FR1-A2-4 | -70.2 - $\Delta_{OTAREFSENS}$ | -81.9 - $\Delta_{OTAREFSENS}$ | AWGN |
| | 30 | G-FR1-A2-5 | -70.2 - $\Delta_{OTAREFSENS}$ | | |
| | 60 | G-FR1-A2-6 | -70.5 - $\Delta_{OTAREFSENS}$ | | |
| <p>NOTE: The wanted signal mean power is the power level of a single instance of the corresponding reference measurement channel. This requirement shall be met for each consecutive application of a single instance of the reference measurement channel mapped to disjoint frequency ranges with a width corresponding to the number of resource blocks of the reference measurement channel each, except for one instance that might overlap one other instance to cover the full <i>SAN channel bandwidth</i>.</p> | | | | | |

10.5 OTA in-band selectivity and blocking

10.5.1 OTA adjacent channel selectivity

10.5.1.1 General

OTA Adjacent channel selectivity (ACS) is a measure of the receiver's ability to receive an OTA wanted signal at its assigned channel frequency in the presence of an OTA adjacent channel signal with a specified centre frequency offset of the interfering signal to the band edge of a victim system.

10.5.1.2 Minimum requirement for *SAN type 1-0*

The requirement shall apply at the RIB when the AoA of the incident wave of a received signal and the interfering signal are from the same direction and are within the *minSENS RoAoA*.

The wanted and interfering signals apply to each supported polarization, under the assumption of *polarization match*.

The throughput shall be $\geq 95\%$ of the maximum throughput of the reference measurement channel.

For FR1, the OTA wanted signal and the interfering signal are specified in table 10.5.1.2-1 and table 10.5.1.2-2 for OTA ACS. The reference measurement channel for the OTA wanted signal is further specified in annex A.1. The characteristic of the interfering signal is further specified in annex C.

The OTA ACS requirement is applicable outside the *SAN RF Bandwidth* or *Radio Bandwidth*. The OTA interfering signal offset is defined relative to the *SAN RF Bandwidth edges* or *Radio Bandwidth edges*.

Table 10.5.1.2-1: OTA ACS requirement for *SAN type 1-O*

| SAN channel bandwidth of the lowest/highest carrier received (MHz) | Wanted signal mean power (dBm) (NOTE 2) | Interfering signal mean power (dBm) |
|--|---|--|
| 5, 10, 15, 20 (NOTE 1) | $EIS_{\min\text{SENS}} + 6 \text{ dB}$ | SAN LEO class: $-60 - \Delta_{\min\text{SENS}}$ SAN GEO class: $-57 - \Delta_{\min\text{SENS}}$ |
| NOTE 1: The SCS for the <i>lowest/highest carrier</i> received is the lowest SCS supported by the SAN for that bandwidth | | |
| NOTE 2: $EIS_{\min\text{SENS}}$ depends on the <i>SAN channel bandwidth</i> | | |

Table 10.5.1.2-2: OTA ACS interferer frequency offset for *SAN type 1-O*

| SAN channel bandwidth of the lowest/highest carrier received (MHz) | Interfering signal centre frequency offset from the lower/upper SAN RF Bandwidth edge or sub-block edge inside a sub-block gap (MHz) | Type of interfering signal |
|--|--|--|
| 5 | ± 2.5025 | 5 MHz CP-OFDM NR signal, 15 kHz SCS, 25 RBs |
| 10 | ± 2.5075 | |
| 15 | ± 2.5125 | |
| 20 | ± 2.5025 | |

10.5.2 OTA in-band blocking

The requirement is not applicable in this version of the specification.

10.6 OTA out-of-band blocking

10.6.1 General

The OTA out-of-band blocking characteristics are a measure of the receiver unit ability to receive a wanted signal at the *RIB* at its assigned channel in the presence of an unwanted interferer.

10.6.2 Minimum requirement for *SAN type 1-O*

10.6.2.1 General minimum requirement

The requirement shall apply at the *RIB* when the *AoA* of the incident wave of the received signal and the interfering signal are from the same direction and are within the *minSENS RoAoA*.

The wanted signal applies to each supported polarization, under the assumption of *polarization match*. The interferer shall be *polarization matched* in-band and the polarization maintained for out-of-band frequencies.

For OTA wanted and OTA interfering signals provided at the *RIB* using the parameters in table 10.6.2.1-1, the following requirements shall be met:

- The throughput shall be $\geq 95\%$ of the maximum throughput of the reference measurement channel. The reference measurement channel for the OTA wanted signal is identified in clause 10.3.2 for each *SAN channel bandwidth* and further specified in annex A.1.

For *SAN type 1-O* the OTA out-of-band blocking requirement apply from 30 MHz to $F_{\text{UL,low}} - \Delta f_{\text{OOB}}$ and from $F_{\text{UL,high}} + \Delta f_{\text{OOB}}$ up to 12750 MHz, including the downlink frequency range of the *SAN operating band*. The Δf_{OOB} for *SAN type 1-O* is defined in table 10.6.2.1-2.

Table 10.6.2.1-1: OTA out-of-band blocking performance requirement

| Wanted signal mean power (dBm) | Interfering signal RMS field-strength (V/m) | Type of interfering Signal |
|---|---|----------------------------|
| EIS _{minSENS} + 6 dB (NOTE 1) | 0.0029 (NOTE 2) | CW carrier |
| NOTE 1: EIS _{minSENS} depends on the <i>channel bandwidth</i> as specified in clause 10.2. NOTE 2: The RMS field-strength level in V/m is related to the interferer EIRP level at a distance described as $E = \frac{\sqrt{30EIRP}}{r}$, where EIRP is in W and r is in m. | | |

Table 10.6.2.1-2: Δf_{OOB} offset for satellite *operating bands*

| SAN type | Operating band characteristics | Δf_{OOB} (MHz) |
|--------------|--|-------------------------------|
| SAN type 1-O | $F_{\text{UL,high}} - F_{\text{UL,low}} < 100$ MHz | 20 |

10.7 OTA receiver spurious emissions

The requirement is not applicable in this version of the specification.

10.7.1 Void

10.7.2 Void

10.8 OTA receiver intermodulation

The requirement is not applicable in this version of the specification.

10.9 OTA in-channel selectivity

10.9.1 General

In-channel selectivity (ICS) is a measure of the receiver ability to receive a wanted signal at its assigned resource block locations in the presence of an interfering signal received at a larger power spectral density. In this condition a throughput requirement shall be met for a specified reference measurement channel. The interfering signal shall be an NR signal as specified in annex A.1 and shall be time aligned with the wanted signal.

10.9.2 Minimum requirement for *SAN type 1-O*

The requirement shall apply at the RIB when the AoA of the incident wave of the received signal and the interfering signal are the same direction and are within the *minSENS RoAoA*.

The wanted and interfering signals applies to each supported polarization, under the assumption of *polarization match*.

For a wanted and an interfering signal coupled to the RIB, the following requirements shall be met:

- For *SAN type 1-O*, the throughput shall be $\geq 95\%$ of the maximum throughput of the reference measurement channel as specified in annex A.1 with parameters specified in table 10.9.2-1 for GEO SAN, in table 10.9.2-2 for LEO SAN. The characteristics of the interfering signal is further specified in annex C.

Table 10.9.2-1: SAN GEO classICS requirement

| SAN channel bandwidth (MHz) | Subcarrier spacing (kHz) | Reference measurement channel | Wanted signal mean power (dBm) | Interfering signal mean power (dBm) | Type of interfering signal |
|--|--------------------------|-------------------------------|------------------------------------|-------------------------------------|--|
| 5 | 15 | G-FR1-A1-7 | -98.2 - $\Delta_{\min\text{SENS}}$ | -92.0 - $\Delta_{\min\text{SENS}}$ | DFT-s-OFDM NR signal, 15 kHz SCS, 10 RBs |
| 10,15,20 | 15 | G-FR1-A1-1 | -96.3 - $\Delta_{\min\text{SENS}}$ | -88.1 - $\Delta_{\min\text{SENS}}$ | DFT-s-OFDM NR signal, 15 kHz SCS, 25 RBs |
| 5 | 30 | G-FR1-A1-8 | -98.9 - $\Delta_{\min\text{SENS}}$ | -92.0 - $\Delta_{\min\text{SENS}}$ | DFT-s-OFDM NR signal, 30 kHz SCS, 5 RBs |
| 10,15,20 | 30 | G-FR1-A1-2 | -96.4 - $\Delta_{\min\text{SENS}}$ | -89.0 - $\Delta_{\min\text{SENS}}$ | DFT-s-OFDM NR signal, 30 kHz SCS, 10 RBs |
| 10,15,20 | 60 | G-FR1-A1-9 | -95.8 - $\Delta_{\min\text{SENS}}$ | -89.0 - $\Delta_{\min\text{SENS}}$ | DFT-s-OFDM NR signal, 60 kHz SCS, 5 RBs |
| NOTE: Wanted and interfering signal are placed adjacently around F_c , where the F_c is defined for SAN channel bandwidth of the wanted signal according to the table 5.4.2.2-1. The aggregated wanted and interferer signal shall be centred in the SAN channel bandwidth of the wanted signal. | | | | | |

Table 10.9.2-2: SAN LEO class ICS requirement

| SAN channel bandwidth (MHz) | Subcarrier spacing (kHz) | Reference measurement channel | Wanted signal mean power (dBm) | Interfering signal mean power (dBm) | Type of interfering signal |
|--|--------------------------|-------------------------------|-------------------------------------|-------------------------------------|--|
| 5 | 15 | G-FR1-A1-7 | -101.3 - $\Delta_{\min\text{SENS}}$ | -83.1 - $\Delta_{\min\text{SENS}}$ | DFT-s-OFDM NR signal, 15 kHz SCS, 10 RBs |
| 10,15,20 | 15 | G-FR1-A1-1 | -99.4 - $\Delta_{\min\text{SENS}}$ | -79.2 - $\Delta_{\min\text{SENS}}$ | DFT-s-OFDM NR signal, 15 kHz SCS, 25 RBs |
| 5 | 30 | G-FR1-A1-8 | -102.0 - $\Delta_{\min\text{SENS}}$ | -83.1 - $\Delta_{\min\text{SENS}}$ | DFT-s-OFDM NR signal, 30 kHz SCS, 5 RBs |
| 10,15,20 | 30 | G-FR1-A1-2 | -99.5 - $\Delta_{\min\text{SENS}}$ | -80.1 - $\Delta_{\min\text{SENS}}$ | DFT-s-OFDM NR signal, 30 kHz SCS, 10 RBs |
| 10,15,20 | 60 | G-FR1-A1-9 | -98.9 - $\Delta_{\min\text{SENS}}$ | -80.1 - $\Delta_{\min\text{SENS}}$ | DFT-s-OFDM NR signal, 60 kHz SCS, 5 RBs |
| NOTE: Wanted and interfering signal are placed adjacently around F_c , where the F_c is defined for SAN channel bandwidth of the wanted signal according to the table 5.4.2.2-1. The aggregated wanted and interferer signal shall be centred in the SAN channel bandwidth of the wanted signal. | | | | | |

11 Radiated performance requirements

11.1 General

11.1.1 Scope and definitions

Radiated performance requirements specify the ability of the SAN type 1-O to correctly transmit and receive radiated signals in various conditions and configurations. Radiated performance requirements are specified at the RIB.

Radiated performance requirements for the SAN are specified for the fixed reference channels defined in annex A and for the propagation conditions defined in Recommendation ITU-R P.618 (*Propagation data and prediction methods required for the design of Earth-space telecommunication systems*). The requirements only apply to those FRCs that are supported by the SAN.

The radiated performance requirements for *SAN type I-O* are limited to two OTA *demodulation branches* as described in clause 11.1.2. Conformance requirements can only be tested for 1 or 2 *demodulation branches* depending on the number of polarizations supported by the SAN, with the required SNR applied separately per polarization.

Unless stated otherwise, radiated performance requirements apply for a single carrier only. Radiated performance requirements for a SAN supporting carrier aggregation are defined in terms of single carrier requirements.

For *SAN type I-O* in FDD operation the requirements in clause 8 shall be met with the transmitter units associated with the RIB in the *operating band* turned ON.

NOTE 1: *SAN type I-O* in normal operating conditions in FDD operation is configured to transmit and receive at the same time. The transmitter unit(s) associated with the RIB may be OFF for some of the tests as specified in TS 38.181[3].

In tests performed with signal generators a synchronization signal may be provided from the SAN to the signal generator, to enable correct timing of the wanted signal.

Whenever the "RX antennas" term is used for the radiated performance requirements description, it shall refer to the *demodulation branches* (i.e. not physical antennas of the antenna array).

The SNR used in this clause is specified based on a single carrier and defined as:

$$\text{SNR} = S / N$$

Where:

S is the total signal power in a slot on a RIB.

N is the noise density integrated in a bandwidth corresponding to the *transmission bandwidth* over the duration where signal energy exists on a RIB.

11.1.2 OTA demodulation branches

Radiated performance requirements are only specified for up to 2 *demodulation branches*.

If the *SAN type I-O* uses polarization diversity and has the ability to maintain isolation between the signals for each of the *demodulation branches*, then radiated performance requirements can be tested for up to two *demodulation branches* (i.e. 1RX or 2RX test setups). When tested for two *demodulation branches*, each demodulation branch maps to one polarization.

If the *SAN type I-O* does not use polarization diversity then radiated performance requirements can only be tested for a single *demodulation branch* (i.e. 1RX test setup).

11.2 Performance requirements for PUSCH

11.2.1 Requirements for PUSCH with transform precoding disabled

Apply the requirements defined in clause 8.2.1.

11.2.2 Requirements for PUSCH with transform precoding enabled

Apply the requirements defined in clause 8.2.2.

11.2.3 Requirements for UL timing adjustment

Apply the requirements defined in clause 8.2.3.

11.2.4 Requirements for PUSCH repetition Type A

Apply the requirements defined in clause 8.2.4.

11.3 Performance requirements for PUCCH

11.3.1 Requirements for *SAN type 1-O*

11.3.1.1 DTX to ACK probability

Apply the requirements defined in clause 8.3.1.

11.3.1.2 Performance requirements for PUCCH format 0

Apply the requirements defined in clause 8.3.2 for 1Rx and 2Rx.

11.3.1.3 Performance requirements for PUCCH format 1

Apply the requirements defined in sub-clause 8.3.3 for 1Rx and 2Rx.

11.3.1.4 Performance requirements for PUCCH format 2

Apply the requirements defined in clause 8.3.4 for 1Rx and 2Rx.

11.3.1.5 Performance requirements for PUCCH format 3

Apply the requirements defined in clause 8.3.5 for 1Rx and 2Rx.

11.3.1.6 Performance requirements for PUCCH format 4

Apply the requirements defined in clause 8.3.6 for 1Rx and 2Rx.

11.3.1.7 Performance requirements for multi-slot PUCCH

Apply the requirements defined in clause 8.3.7 for 1Rx and 2Rx.

11.4 Performance requirements for PRACH

11.4.1 PRACH False alarm probability

Apply the requirements defined in clause 8.4.1.

11.4.2 PRACH detection requirements

Apply the requirements defined in clause 8.4.2.

Annex A (normative): Reference measurement channels

A.1 Fixed Reference Channels for RF Rx requirements in FR1 (QPSK, R=1/3)

The parameters for the reference measurement channels are specified in table A.1-1 for FR1 reference sensitivity level, ACS, out-of-band blocking, in-channel selectivity, OTA sensitivity, OTA reference sensitivity level, OTA ACS, OTA out-of-band blocking and OTA in-channel selectivity.

The reference measurement channels for the dynamic range requirement are captured in annex A.2.

Table A.1-1: Fixed Reference Channels for SAN Rx requirements, FR1

| Reference channel | G-FR1-A1-1 | G-FR1-A1-2 | G-FR1-A1-3 | G-FR1-A1-4 | G-FR1-A1-5 | G-FR1-A1-6 | G-FR1-A1-7 | G-FR1-A1-8 | G-FR1-A1-9 |
|---|------------|------------|------------|------------|------------|------------|------------|------------|------------|
| Subcarrier spacing (kHz) | 15 | 30 | 60 | 15 | 30 | 60 | 15 | 30 | 60 |
| Allocated resource blocks | 25 | 11 | 11 | 106 | 51 | 24 | 15 | 6 | 6 |
| CP-OFDM Symbols per slot (Note 1) | 12 | 12 | 12 | 12 | 12 | 12 | 12 | 12 | 12 |
| Modulation | QPSK | QPSK | QPSK | QPSK | QPSK | QPSK | QPSK | QPSK | QPSK |
| Code rate (Note 2) | 1/3 | 1/3 | 1/3 | 1/3 | 1/3 | 1/3 | 1/3 | 1/3 | 1/3 |
| Payload size (bits) | 2152 | 984 | 984 | 9224 | 4352 | 2088 | 1320 | 528 | 528 |
| Transport block CRC (bits) | 16 | 16 | 16 | 24 | 24 | 16 | 16 | 16 | 16 |
| Code block CRC size (bits) | - | - | - | 24 | - | - | - | - | - |
| Number of code blocks - C | 1 | 1 | 1 | 2 | 1 | 1 | 1 | 1 | 1 |
| Code block size including CRC (bits) (Note 3) | 2168 | 1000 | 1000 | 4648 | 4376 | 2104 | 1336 | 544 | 544 |
| Total number of bits per slot | 7200 | 3168 | 3168 | 30528 | 14688 | 6912 | 4320 | 1728 | 1728 |
| Total symbols per slot | 3600 | 1584 | 1584 | 15264 | 7344 | 3456 | 2160 | 864 | 864 |
| NOTE 1: $UL-DMRS-config-type = 1$ with $UL-DMRS-max-len = 1$, $UL-DMRS-add-pos = 1$ with $l_0 = 2$, $l = 11$ as per table 6.4.1.1.3-3 of TS 38.211 [5]. | | | | | | | | | |
| NOTE 2: MCS index 4 and target coding rate = 308/1024 are adopted to calculate payload size for receiver sensitivity and in-channel selectivity. | | | | | | | | | |
| NOTE 3: Code block size including CRC (bits) equals to K' in clause 5.2.2 of TS 38.212 [10]. | | | | | | | | | |

A.2 Fixed Reference Channels for dynamic range (16QAM, R=2/3)

The parameters for the reference measurement channels are specified in table A.2-1 for FR1 dynamic range and OTA dynamic range.

Table A.2-1: Fixed Reference Channels for dynamic range and OTA dynamic range, FR1

| Reference channel | G-FR1-A2-1 | G-FR1-A2-2 | G-FR1-A2-3 | G-FR1-A2-4 | G-FR1-A2-5 | G-FR1-A2-6 |
|---|------------|------------|------------|------------|------------|------------|
| Subcarrier spacing (kHz) | 15 | 30 | 60 | 15 | 30 | 60 |
| Allocated resource blocks | 25 | 11 | 11 | 106 | 51 | 24 |
| CP-OFDM Symbols per slot (Note 1) | 12 | 12 | 12 | 12 | 12 | 12 |
| Modulation | 16QAM | 16QAM | 16QAM | 16QAM | 16QAM | 16QAM |
| Code rate (Note 2) | 2/3 | 2/3 | 2/3 | 2/3 | 2/3 | 2/3 |
| Payload size (bits) | 9224 | 4032 | 4032 | 38936 | 18960 | 8968 |
| Transport block CRC (bits) | 24 | 24 | 24 | 24 | 24 | 24 |
| Code block CRC size (bits) | 24 | - | - | 24 | 24 | 24 |
| Number of code blocks – C | 2 | 1 | 1 | 5 | 3 | 2 |
| Code block size including CRC (bits) (Note 3) | 4648 | 4056 | 4056 | 7816 | 6352 | 4520 |
| Total number of bits per slot | 14400 | 6336 | 6336 | 61056 | 29376 | 13824 |
| Total symbols per slot | 3600 | 1584 | 1584 | 15264 | 7344 | 3456 |
| NOTE 1: DM-RS configuration type = 1 with DM-RS duration = single-symbol DM-RS, additional DM-RS position = pos1 with $l_0=2$, $l=11$ as per table 6.4.1.1.3-3 of TS 38.211 [5]. | | | | | | |
| NOTE 2: MCS index 16 and target coding rate = 658/1024 are adopted to calculate payload size. | | | | | | |
| NOTE 3: Code block size including CRC (bits) equals to K' in clause 5.2.2 of TS 38.212 [10]. | | | | | | |

A.3 Fixed Reference Channels for performance requirements (QPSK, R=308/1024)

The parameters for the reference measurement channel are specified in table A.3-1 for FR1 PUSCH performance requirements:

- FRC parameters are specified in table A.3-1 for FR1 PUSCH with transform precoding disabled, additional DM-RS position = pos0 and 1 transmission layer.
- FRC parameters are specified in table A.3-2 for FR1 PUSCH with transform precoding enabled, additional DM-RS position = pos0 and 1 transmission layer.

Table A.3-1: FRC parameters for FR1 PUSCH performance requirements, transform precoding disabled, additional DM-RS position = pos1 and 1 transmission layer (QPSK, R=308/1024)

| Reference channel | G-FR1-A3-1 | G-FR1-A3-2 | G-FR1-A3-3 | G-FR1-A3-4 |
|--|------------|------------|------------|------------|
| Subcarrier spacing (kHz) | 15 | 15 | 30 | 30 |
| Allocated resource blocks | 25 | 12 | 24 | 12 |
| Data bearing CP-OFDM Symbols per slot (Note 1) | 12 | 12 | 12 | 12 |
| Modulation | QPSK | QPSK | QPSK | QPSK |
| Code rate (Note 2) | 308/1024 | 308/1024 | 308/1024 | 308/1024 |
| Payload size (bits) | 2152 | 1032 | 2024 | 1032 |
| Transport block CRC (bits) | 16 | 16 | 16 | 16 |
| Code block CRC size (bits) | - | - | - | - |
| Number of code blocks - C | 1 | 1 | 1 | 1 |
| Code block size including CRC (bits) (Note 2) | 2168 | 1048 | 2040 | 1048 |
| Total number of bits per slot | 7200 | 3456 | 6912 | 3456 |
| Total resource elements per slot | 3600 | 1728 | 3456 | 1728 |
| NOTE 1: DM-RS configuration type = 1 with DM-RS duration = single-symbol DM-RS and the number of DM-RS CDM groups without data is 2, additional DM-RS position = pos1, $l_0=2$ and $l=11$ for PUSCH mapping type A, $l_0=0$ and $l=10$ for PUSCH mapping type B as per table 6.4.1.1.3-3 of TS 38.211 [5]. | | | | |
| NOTE 2: Code block size including CRC (bits) equals to K' in clause 5.2.2 of TS 38.212 [10]. | | | | |

Table A.3-2: FRC parameters for FR1 PUSCH performance requirements, transform precoding enabled, additional DM-RS position = pos1 and 1 transmission layer (QPSK, R=308/1024)

| Reference channel | G-FR1-A3-5 | G-FR1-A3-6 |
|--|------------|------------|
| Subcarrier spacing (kHz) | 15 | 30 |
| Allocated resource blocks | 25 | 24 |
| Data bearing CP-OFDM Symbols per slot (Note 1) | 12 | 12 |
| Modulation | QPSK | QPSK |
| Code rate (Note 2) | 308/1024 | 308/1024 |
| Payload size (bits) | 2152 | 2088 |
| Transport block CRC (bits) | 16 | 16 |
| Code block CRC size (bits) | - | - |
| Number of code blocks - C | 1 | 1 |
| Code block size including CRC (bits) (Note 2) | 2168 | 2104 |
| Total number of bits per slot | 7200 | 6912 |
| Total resource elements per slot | 3600 | 3456 |
| NOTE 1: DM-RS configuration type = 1 with DM-RS duration = single-symbol DM-RS and the number of DM-RS CDM groups without data is 2, additional DM-RS position = pos1, $l_0=2$ and $l=11$ for PUSCH mapping type A, $l_0=0$ and $l=10$ for PUSCH mapping type B as per table 6.4.1.1.3-3 of TS 38.211 [5]. | | |
| NOTE 2: Code block size including CRC (bits) equals to K' in clause 5.2.2 of TS 38.212 [10]. | | |

A.3A Fixed Reference Channels for performance requirements (QPSK, R=99/1024)

The parameters for the reference measurement channel are specified in table A.3A-1 for FR1 PUSCH performance requirements:

- FRC parameters are specified in table A.3A-1 for FR1 PUSCH with transform precoding disabled, additional DM-RS position = pos1 and 1 transmission layer.

Table A.3A-1: FRC parameters for FR1 PUSCH performance requirements, transform precoding disabled, additional DM-RS position = pos1 and 1 transmission layer (QPSK, R=99/1024)

| Reference channel | G-FR1-A3A-1 | G-FR1-A3A-2 |
|--|-------------|-------------|
| Subcarrier spacing (kHz) | 15 | 30 |
| Allocated resource blocks | 25 | 24 |
| Data bearing CP-OFDM Symbols per slot (Note 1) | 12 | 12 |
| Modulation | QPSK | QPSK |
| Code rate (Note 2) | 99/1024 | 99/1024 |
| Payload size (bits) | 704 | 672 |
| Transport block CRC (bits) | 16 | 16 |
| Code block CRC size (bits) | - | - |
| Number of code blocks - C | 1 | 1 |
| Code block size including CRC (bits) (Note 2) | 720 | 688 |
| Total number of bits per slot | 7200 | 6912 |
| Total resource elements per slot | 3600 | 3456 |
| NOTE 1: DM-RS configuration type = 1 with DM-RS duration = single-symbol DM-RS and the number of DM-RS CDM groups without data is 2, additional DM-RS position = pos1, $l_0 = 2$ and $l = 11$ for PUSCH mapping type A, $l_0 = 0$ and $l = 10$ for PUSCH mapping type B as per table 6.4.1.1.3-3 of TS 38.211 [5]. NOTE 2: Code block size including CRC (bits) equals to K' in clause 5.2.2 of TS 38.212 [10]. | | |

A.4 PRACH test preambles

Table A.4-1 Test preambles in FR1

| Burst format | SCS (kHz) | Ncs | Logical sequence index | v |
|--------------|-----------|-----|------------------------|----|
| 0 | 1.25 | 13 | 22 | 32 |
| 2 | 1.25 | 13 | 22 | 32 |
| B4, C2 | 15 | 23 | 0 | 0 |
| | 30 | 46 | 0 | 0 |

Annex B (normative): Error Vector Magnitude (FR1)

B.1 Reference point for measurement

The EVM shall be measured at the point after the FFT and a zero-forcing (ZF) equalizer in the receiver, as depicted in figure B.1-1 below.

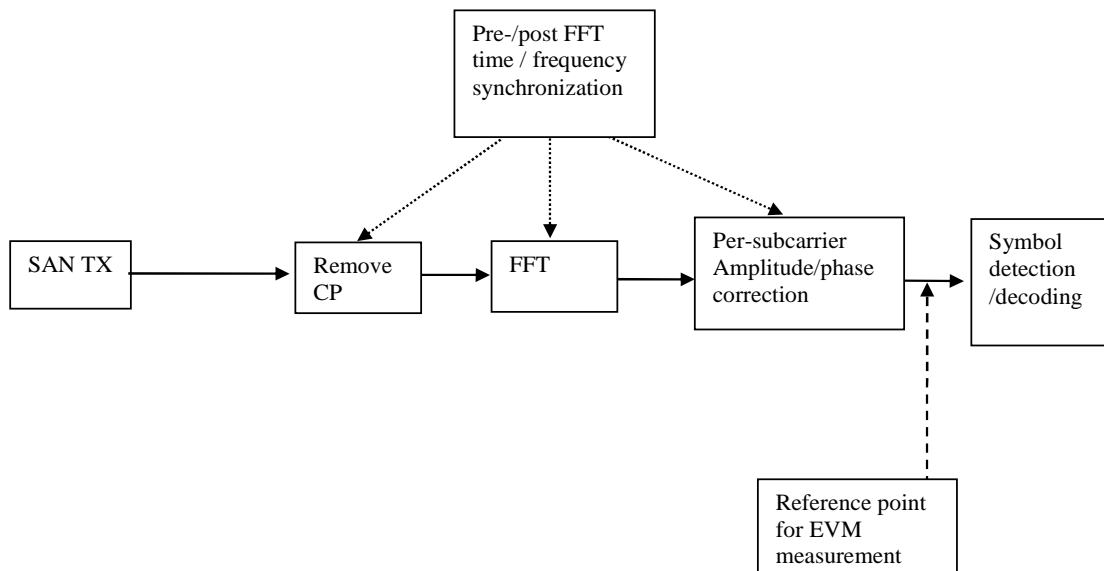

Figure B.1-1: Reference point for EVM measurement

B.2 Basic unit of measurement

The basic unit of EVM measurement is defined over one slot in the time domain and N_{BW}^{RB} subcarriers in the frequency domain:

$$EVM = \sqrt{\frac{\sum_{t \in T} \sum_{f \in F(t)} |Z'(t, f) - I(t, f)|^2}{\sum_{t \in T} \sum_{f \in F(t)} |I(t, f)|^2}}$$

where

T is the set of symbols with the considered modulation scheme being active within the slot,

$F(t)$ is the set of subcarriers within the N_{BW}^{RB} subcarriers with the considered modulation scheme being active in symbol t ,

$I(t, f)$ is the ideal signal reconstructed by the measurement equipment in accordance with relevant Tx models,

$Z'(t, f)$ is the modified signal under test defined in annex B.3.

NOTE: Although the basic unit of measurement is one slot, the equalizer is calculated over 10 ms measurement interval to reduce the impact of noise in the reference signals. The boundaries of the 10 ms measurement intervals need not be aligned with radio frame boundaries.

B.3 Modified signal under test

Implicit in the definition of EVM is an assumption that the receiver is able to compensate a number of transmitter impairments. The signal under test is equalized and decoded according to:

$$Z'(t, f) = \frac{FFT \left\{ z(v - \Delta\tilde{t}) \cdot e^{-j2\pi\Delta\tilde{f}v} \right\} e^{j2\pi f\Delta\tilde{t}}}{\tilde{a}(f) \cdot e^{j\tilde{\varphi}(f)}}$$

where

$z(v)$ is the time domain samples of the signal under test.

$\Delta\tilde{t}$ is the sample timing difference between the FFT processing window in relation to nominal timing of the ideal signal. Note that two timing offsets are determined, the corresponding EVM is measured and the maximum used as described in annex B.7.

$\Delta\tilde{f}$ is the RF frequency offset.

$\tilde{\varphi}(f)$ is the phase response of the TX chain.

$\tilde{a}(f)$ is the amplitude response of the TX chain.

B.4 Estimation of frequency offset

The observation period for determining the frequency offset $\Delta\tilde{f}$ shall be 1 slot.

B.5 Estimation of time offset

B.5.1 General

The observation period for determining the sample timing difference $\Delta\tilde{t}$ shall be 1 slot.

In the following $\Delta\tilde{c}$ represents the middle sample of the EVM window of length W (defined in annex B.5.2) or the last sample of the first window half if W is even.

$\Delta\tilde{c}$ is estimated so that the EVM window of length W is centred on the measured cyclic prefix of the considered OFDM symbol. To minimize the estimation error the timing shall be based on demodulation reference signals. To limit time distortion of any transmit filter the reference signals in the 1 outer RBs are not taken into account in the timing estimation

Two values for $\Delta\tilde{t}$ are determined:

$$\Delta\tilde{t}_l = \Delta\tilde{c} + \alpha - \left\lfloor \frac{W}{2} \right\rfloor \text{ and}$$

$$\Delta\tilde{t}_h = \Delta\tilde{c} + \left\lceil \frac{W}{2} \right\rceil \text{ where } \alpha = 0 \text{ if } W \text{ is odd and } \alpha = 1 \text{ if } W \text{ is even.}$$

When the cyclic prefix length varies from symbol to symbol then T shall be further restricted to the subset of symbols with the considered modulation scheme being active and with the considered cyclic prefix length type.

B.5.2 Window length

Table B.5.2-1, B.5.2-2, B.5.2-3 specify the EVM window length (W) for normal CP.

Table B.5.2-1: EVM window length for normal CP, FR1, 15 kHz SCS

| Channel bandwidth (MHz) | FFT size | CP length for symbols 1-6 and 8-13 in FFT samples | EVM window length W | Ratio of W to total CP length for symbols 1-6 and 8-13 (Note) (%) |
|-------------------------|----------|---|-----------------------|---|
| 5 | 512 | 36 | 14 | 40 |
| 10 | 1024 | 72 | 28 | 40 |
| 15 | 1536 | 108 | 44 | 40 |
| 20 | 2048 | 144 | 58 | 40 |

NOTE: These percentages are informative and apply to a slot's symbols 1 to 6 and 8 to 13. Symbols 0 and 7 have a longer CP and therefore a lower percentage.

Table B.5.2-2: EVM window length for normal CP, FR1, 30 kHz SCS

| Channel bandwidth (MHz) | FFT size | CP length for symbols 1-13 in FFT samples | EVM window length W | Ratio of W to total CP length for symbols 1-13 (Note) (%) |
|-------------------------|----------|---|-----------------------|---|
| 5 | 256 | 18 | 8 | 40 |
| 10 | 512 | 36 | 14 | 40 |
| 15 | 768 | 54 | 22 | 40 |
| 20 | 1024 | 72 | 28 | 40 |

NOTE: These percentages are informative and apply to a slot's symbols 1 through 13. Symbol 0 has a longer CP and therefore a lower percentage.

Table B.5.2-3: EVM window length for normal CP, FR1, 60 kHz SCS

| Channel bandwidth (MHz) | FFT size | CP length in FFT samples | EVM window length W | Ratio of W to total CP length (Note) (%) |
|-------------------------|----------|--------------------------|-----------------------|--|
| 10 | 256 | 18 | 8 | 40 |
| 15 | 384 | 27 | 11 | 40 |
| 20 | 512 | 36 | 14 | 40 |

NOTE: These percentages are informative and apply to all OFDM symbols within subframe except for symbol 0 of slot 0 and slot 2. Symbol 0 of slot 0 and slot 2 may have a longer CP and therefore a lower percentage.

Table B.5.2-4 below specifies the EVM window length (W) for extended CP. The number of CP samples excluded from the EVM window is the same as for normal CP length.

Table B.5.2-4: EVM window length for extended CP, FR1, 60 kHz SCS

| Channel bandwidth (MHz) | FFT size | CP length in FFT samples | EVM window length W | Ratio of W to total CP length (Note) (%) |
|-------------------------|----------|--------------------------|-----------------------|--|
| 10 | 256 | 64 | 54 | 84 |
| 15 | 384 | 96 | 80 | 83 |
| 20 | 512 | 128 | 106 | 83 |

NOTE: These percentages are informative.

B.6 Estimation of TX chain amplitude and frequency response parameters

The equalizer coefficients $\tilde{a}(f)$ and $\tilde{\varphi}(f)$ are determined as follows:

1. Calculate the complex ratios (amplitude and phase) of the post-FFT acquired signal $Z'(t, f)$ and the post-FFT ideal signal $I_2(t, f)$, for each reference signal, over 10ms measurement interval. This process creates a set of complex ratios:

$$a(t, f).e^{j\varphi(t, f)} = \frac{Z'(t, f)}{I_2(t, f)}$$

Where the post-FFT ideal signal $I_2(t, f)$ is constructed by the measuring equipment according to the relevant TX specifications, using the following parameters: i.e. nominal demodulation reference signals, (all other modulation symbols are set to 0 V), nominal carrier frequency, nominal amplitude and phase for each applicable subcarrier, nominal timing.

2. Perform time averaging at each reference signal subcarrier of the complex ratios, the time-averaging length is 10ms measurement interval. Prior to the averaging of the phases $\varphi(t_i, f)$ an unwrap operation must be performed according to the following definition: The unwrap operation corrects the radian phase angles of $\varphi(t_i, f)$ by adding multiples of 2π when absolute phase jumps between consecutive time instances t_i are greater than or equal to the jump tolerance of π radians. This process creates an average amplitude and phase for each reference signal subcarrier (i.e. every second subcarrier).

$$a(f) = \frac{\sum_{i=1}^N a(t_i, f)}{N}$$

$$\varphi(f) = \frac{\sum_{i=1}^N \varphi(t_i, f)}{N}$$

Where N is the number of reference signal; time-domain locations t_i from $Z'(t, f)$ for each reference signal subcarrier f .

3. The equalizer coefficients for amplitude and phase $\hat{a}(f)$ and $\hat{\varphi}(f)$ at the reference signal subcarriers are obtained by computing the moving average in the frequency domain of the time-averaged reference signal subcarriers, i.e. every second subcarrier. The moving average window size is 19 and averaging is over the DM-RS subcarriers in the allocated RBs. For DM-RS subcarriers at or near the edge of the channel, or when the number of available DM-RS subcarriers within a set of contiguously allocated RBs is smaller than the moving average window size, the window size is reduced accordingly as per figure B.6-1.
4. Perform linear interpolation from the equalizer coefficients $\hat{a}(f)$ and $\hat{\varphi}(f)$ to compute coefficients $\tilde{a}(f)$, $\tilde{\varphi}(f)$ for each subcarrier.

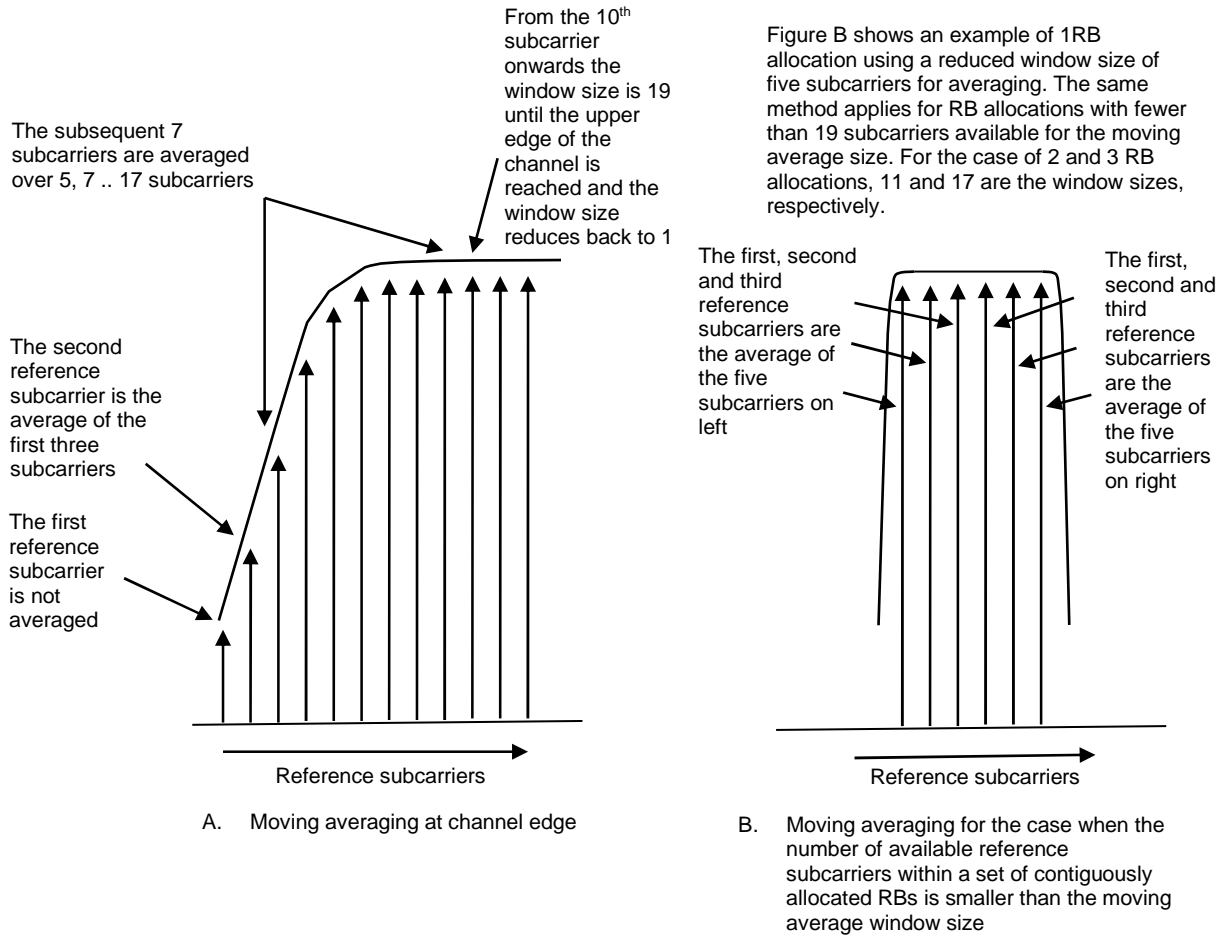

Figure B.6-1: Reference subcarrier smoothing in the frequency domain

B.7 Averaged EVM

EVM is averaged over all allocated downlink resource blocks with the considered modulation scheme in the frequency domain, and a minimum of N_{dl} slots where N_{dl} is the number of slots in a 10 ms measurement interval.

For FDD the averaging in the time domain equals the N_{dl} slot duration of the 10 ms measurement interval from the equalizer estimation step.

$$\overline{EVM}_{frame} = \sqrt{\frac{1}{\sum_{i=1}^{N_{dl}} Ni} \sum_{i=1}^{N_{dl}} \sum_{j=1}^{Ni} EVM_{i,j}^2}$$

- Where Ni is the number of resource blocks with the considered modulation scheme in slot i .
- The EVM requirements shall be tested against the maximum of the RMS average at the window W extremities of the EVM measurements:
- Thus $\overline{EVM}_{frame,l}$ is calculated using $\Delta\tilde{t} = \Delta\tilde{t}_l$ in the expressions above and $\overline{EVM}_{frame,h}$ is calculated using $\Delta\tilde{t} = \Delta\tilde{t}_h$ in the \overline{EVM}_{frame} calculation.
- Thus we get:

$$\overline{EVM} = \max(\overline{EVM}_{frame,l}, \overline{EVM}_{frame,h})$$

Annex C (normative): Characteristics of the interfering signals

The interfering signal shall be a PUSCH or PDSCH containing data and DM-RS symbols. Normal cyclic prefix is used. The data content shall be uncorrelated to the wanted signal and modulated according to clause 6 of TS 38.211 [9]. Mapping of PUSCH or PDSCH modulation to receiver requirement are specified in table C-1.

Table C-1: Modulation of the interfering signal

| Receiver requirement | Modulation | Interfering signal | Clauses |
|------------------------------|-------------------|---------------------------|-----------------|
| In-channel selectivity | 16QAM | PUSCH | 7.8 10.9 |
| Adjacent channel selectivity | QPSK | PDSCH | 7.4.1 10.5.1 |

Annex D (Normative): Propagation conditions

D.1 Static propagation condition

The propagation for the static performance measurement is an Additive White Gaussian Noise (AWGN) environment. No fading or multi-paths exist for this propagation model.

D.2 Multi-path fading propagation conditions

The multipath propagation conditions consist of several parts:

- A delay profile in the form of a "tapped delay-line", characterized by a number of taps at fixed positions on a sampling grid. The profile can be further characterized by the r.m.s. delay spread and the maximum delay spanned by the taps.
- A combination of channel model parameters that include the Delay profile and the Doppler spectrum that is characterized by a classical spectrum shape and a maximum Doppler frequency.

D.2.1 Delay profiles

The delay profiles are simplified from the TR 38.811 [13] TDL models. The simplification steps are shown below for information. These steps are only used when new delay profiles are created. Otherwise, the delay profiles specified in G.2.1.1 can be used as such.

- Step 1: Use the original TDL model from TR 38.811 [13].
- Step 2: Re-order the taps in ascending delays
- Step 3: Perform delay scaling according to the procedure described in clause 7.7.2 in TR 38.901 [12].
- Step 4: Apply the quantization to the delay resolution 5 ns. This is done simply by rounding the tap delays to the nearest multiple of the delay resolution.
- Step 5: If multiple Rayleigh taps are rounded to the same delay bin, merge them by calculating their linear power sum.
- Step 6: If there is a LOS path in the model, the power for all paths could be slightly adjusted to keep the RMS delay spread is close to target delay spread and mean power is 0dB.
- Step 7: Round the amplitudes of taps to one decimal (e.g. -8.78 dB → -8.8 dB)
- Step 8: If the delay spread has slightly changed due to the tap merge, adjust the final delay spread by increasing or decreasing the power of the last tap so that the delay spread is corrected.
- Step 9: Re-normalize the highest Rayleigh tap to 0 dB when there is no LOS path in the model.

Note 1: Some values of the delay profile created by the simplification steps may differ from the values in tables G.2.1.1-2 and G.2.1.1-3 for the corresponding model.

Note 2: For Step 5 and Step 6, the power values are expressed in the linear domain using 6 digits of precision. The operations are in the linear domain.

D.2.1.1 Delay profiles for FR1

The delay profiles for FR1 are selected to be representative of low, medium and high delay spread environment. The resulting model parameters are specified in table D.2.1.1-1 and the tapped delay line models are specified in tables D.2.1.1-2 ~ D.2.1.1-4.

Table D.2.1.1-1: Delay profiles for NR channel models

| Model | Number of channel taps | Delay spread (r.m.s.) | Maximum excess tap delay (span) | Delay resolution |
|-------------|------------------------|-----------------------|---------------------------------|------------------|
| NTN-TDLA100 | 3 | 100 ns | 285 | 5ns |
| NTN-TDLC5 | 2 | 5 ns | 60 | 5ns |

Table D.2.1.1-2: NTN-TDLA100 (DS = 100 ns)

| Tap # | Delay (ns) | Power (dB) | Fading distribution |
|-------|------------|------------|---------------------|
| 1 | 0 | 0 | Rayleigh |
| 2 | 110 | -4.7 | Rayleigh |
| 3 | 285 | -6.5 | Rayleigh |

Table D.2.1.1-3: NTN-TDLC5 (DS = 5 ns)

| Tap # | Delay (ns) | Power (dB) | Fading distribution |
|-------|------------|------------|---------------------|
| 1 | 0 | -0.6 | LOS path |
| | 0 | -8.9 | Rayleigh |
| 2 | 60 | -21.5 | Rayleigh |

D.2.2 Combinations of channel model parameters

The propagation conditions used for the performance measurements in multi-path fading environment are indicated as a combination of a channel model name and a maximum Doppler frequency, i.e., NTN-TDLA<DS>-<Doppler> or NTN-TDLC<DS>-<Doppler> where '<DS>' indicates the desired delay spread and '<Doppler>' indicates the maximum Doppler frequency (Hz).

Table D.2.2-1 show the propagation conditions that are used for the performance measurements in multi-path fading environment.

Table D.2.2-1: Channel model parameters for FR1

| Combination name | Tapped delay line model | Maximum Doppler frequency |
|------------------|-------------------------|---------------------------|
| NTN-TDLA100-200 | NTN-TDLA100 | 200 Hz |
| NTN-TDLC5-200 | NTN-TDLC5 | 200 Hz |

D.2.3 MIMO channel correlation matrices

The MIMO channel correlation matrices defined in annex D.2.3 apply for the antenna configuration using uniform linear arrays at both SAN and UE and for the antenna configuration using cross polarized antennas.

D.2.3.1 MIMO correlation matrices using Uniform Linear Array

The MIMO channel correlation matrices defined in annex D.2.3.1 apply for the antenna configuration using uniform linear array (ULA) at both SAN and UE.

D.2.3.1.1 Definition of MIMO correlation matrices

Table D.2.3.1.1-1 defines the correlation matrix for the SAN.

Table D.2.3.1.1-1: SAN correlation matrix

| | gNB correlation |
|--------------|--|
| One antenna | $R_{gNB} = 1$ |
| Two antennas | $R_{gNB} = \begin{pmatrix} 1 & \alpha \\ \alpha^* & 1 \end{pmatrix}$ |

Table D.2.3.1.1-2 defines the correlation matrix for the UE:

Table D.2.3.1.1-2: UE correlation matrix

| | One antenna |
|----------------|--------------------|
| UE correlation | $R_{UE} = 1$ |

Table D.2.3.1.1-3 defines the channel spatial correlation matrix R_{spat} . The parameters, α and β in table D.2.3.1.1-3 defines the spatial correlation between the antennas at the SAN and UE respectively.

Table D.2.3.1.1-3: R_{spat} correlation matrices

| | |
|----------|---|
| 1x1 case | $R_{spat} = R_{SAN} = 1$ |
| 1x2 case | $R_{spat} = R_{SAN} = \begin{bmatrix} 1 & \alpha \\ \alpha^* & 1 \end{bmatrix}$ |

For cases with more antennas at either SAN or UE or both, the channel spatial correlation matrix can still be expressed as the Kronecker product of R_{UE} and R_{SAN} according to $R_{spat} = R_{UE} \otimes R_{SAN}$.

D.2.3.1.2 MIMO correlation matrices at high, medium and low level

The α and β for different correlation types are given in table D.2.3.1.2-1.

Table D.2.3.1.2-1: Correlation for high, medium and low level

| Low correlation | | Medium correlation | | High correlation | |
|------------------------|---------|---------------------------|---------|-------------------------|---------|
| α | β | α | β | α | β |
| 0 | 0 | 0.9 | 0.3 | 0.9 | 0.9 |

The correlation matrices for high, medium and low correlation are defined in table D.2.3.1.2-2, D.2.3.1.2-3 and D.2.3.1.2-4 as below.

Table D.2.3.1.2-2: MIMO correlation matrices for high correlation

| | |
|----------|---|
| 1x1 case | $R_{high} = I_1$ |
| 1x2 case | $R_{high} = \begin{pmatrix} 1 & 0.9 \\ 0.9 & 1 \end{pmatrix}$ |

Table D.2.3.1.2-3: MIMO correlation matrices for medium correlation

| | |
|----------|-----|
| 1x1 case | N/A |
| 1x2 case | N/A |

Table D.2.3.1.2-4: MIMO correlation matrices for low correlation

| | |
|----------|--------------------------|
| 1x1 case | $R_{low} = \mathbf{I}_1$ |
| 1x2 case | $R_{low} = \mathbf{I}_2$ |

In table D.2.3.1.2-4, \mathbf{I}_d is a $d \times d$ identity matrix.

NOTE: For completeness, the correlation matrices were defined for high, medium and low correlation but performance requirements exist only for low correlation.

D.3 Moving propagation conditions

Figure D.3-1 illustrates the moving propagation conditions for the test of the UL timing adjustment performance. The time difference between the reference timing and the first tap is according Equation (D.3-1). The timing difference between moving UE and stationary UE is equal to $\Delta\tau - (T_A - 31) \times 16 \times 64 T_c$ for 15kHz SCS, $\Delta\tau - (T_A - 31) \times 16 \times 32 T_c$ for 30kHz SCS and $\Delta\tau - (T_A - 31) \times 16 \times 8 T_c$ for 120kHz SCS. The relative timing among all taps is fixed. The parameters for the moving propagation conditions are shown in Table D.3-1.

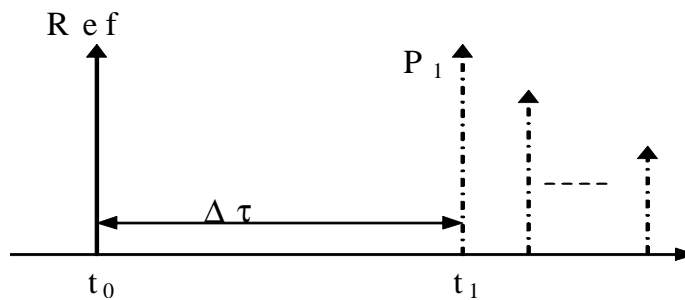

Figure D.3-1: Moving propagation conditions

$$\Delta\tau = \frac{A}{2} \cdot \sin(\Delta\omega \cdot t) \tag{D.3-1}$$

Table D.3-1: Parameters for UL timing adjustment

| Parameter | Scenario X |
|----------------|--|
| Channel model | Stationary UE: AWGN Moving UE: NTN-TDLA100-200 Low |
| UE speed | 120 km/h |
| CP length | Normal |
| A | 15 kHz: 10 us 30 kHz: 5 us |
| $\Delta\omega$ | 15 kHz: 0.04 s ⁻¹ 30 kHz: 0.08 s ⁻¹ |

Annex E (informative): Change history

| Change history | | | | | | | |
|----------------|----------------|------------|----|-----|-----|---|-------------|
| Date | Meeting | TDoc | CR | Rev | Cat | Subject/Comment | New version |
| 2022-01 | RAN4#101-bis-e | R4-2201830 | | | | Initial Skeleton Revised in R4-2203087 | 0.0.1 |
| 2022-01 | RAN4#101-bis-e | R4-2203087 | | | | Initial Skeleton | 0.0.1 |
| 2022-03 | RAN4#102-e | R4-2203955 | | | | TP for 38.108: clause 7.1&7.2 on Rx refsens sensitivity | 0.1.0 |
| 2022-03 | RAN4#102-e | R4-2205057 | | | | pCR to TS 38.108 -Radiated Tx general and transmit power | 0.1.0 |
| 2022-03 | RAN4#102-e | R4-2207331 | | | | TP for 38.108: clause 5.3&5.4 on system parameters | 0.1.0 |
| 2022-03 | RAN4#102-e | R4-2207335 | | | | TP for TS 38.108: General (5.1) and Operating Band (5.2) | 0.1.0 |
| 2022-03 | RAN4#102-e | R4-2207336 | | | | Draft text proposal for Clause 4.4 Satellite Access Node classes - TS 38.108 | 0.1.0 |
| 2022-03 | RAN4#102-e | R4-2207337 | | | | TP for 38.108: clause 4.3 requirement reference point | 0.1.0 |
| 2022-03 | RAN4#102-e | R4-2207340 | | | | TP to TR 38.108 on 4.5 Regional Requirement | 0.1.0 |
| 2022-03 | RAN4#102-e | R4-2207354 | | | | pCR to TS 38.108 - Scope and general | 0.1.0 |
| 2022-03 | RAN4#102-e | R4-2207355 | | | | TP to TS 38.108: section 4 | 0.1.0 |
| 2022-03 | RAN4#102-e | R4-2207356 | | | | TP to TS 38.108: section 3 | 0.1.0 |
| 2022-03 | RAN4#102-e | R4-2207357 | | | | TP for 38.108: clause 9.7 OTA unwanted emissions | 0.1.0 |
| 2022-03 | RAN4#102-e | R4-2207359 | | | | TP for TS 38.108 OTA output power dynamics(9.4) | 0.1.0 |
| 2022-03 | RAN4#102-e | R4-2207361 | | | | TP to TS 38.108: 9.5 (OTA Tx ON/OFF), 9.6 (OTA TX signal quality) and 9.8 (OTA Tx IMD) | 0.1.0 |
| 2022-03 | RAN4#102-e | R4-2207362 | | | | TP for 38.108: clause 9.3 OTA Satellite Access Node output power | 0.1.0 |
| 2022-03 | RAN4#102-e | R4-2207363 | | | | TP for TS 38.108 Annex B | 0.1.0 |
| 2022-03 | RAN4#102-e | R4-2207364 | | | | TP for 38.108: clause 10.5 OTA in-band selectivity and blocking | 0.1.0 |
| 2022-03 | RAN4#102-e | R4-2207365 | | | | pCR to TS 38.108 - Radiated Rx general and sensitivity | 0.1.0 |
| 2022-03 | RAN4#102-e | R4-2207366 | | | | TP for TS 38.108 OTA Rx requirements(10.3, 10.4,10.6 and 10.9) | 0.1.0 |
| 2022-03 | RAN4#102-e | R4-2207368 | | | | TP to TS 38.108: section 10.7 (OTA Rx spur) and 10.8 (OTA Rx IMD) | 0.1.0 |
| 2022-03 | RAN4#102-e | R4-2207371 | | | | TP to TS 38.108: section 10.7 (OTA Rx spur) and 10.8 (OTA Rx IMD) | 0.1.0 |
| 2022-03 | RAN4#102-e | R4-2207372 | | | | Draft text proposal for Clause 6.1 and 6.2 Satellite Access Node output power - TS 38.108 | 0.1.0 |
| 2022-03 | RAN4#102-e | R4-2207373 | | | | TP to TS 38.108: section 6.4 (Tx ON/OFF) and 6.5 (TX signal quality) | 0.1.0 |
| 2022-03 | RAN4#102-e | R4-2207374 | | | | TP to TS 38.108: section 6.7 (Tx IMD) | 0.1.0 |
| 2022-03 | RAN4#102-e | R4-2207377 | | | | pCR to TS 38.108 - In-band selectivity and blocking | 0.1.0 |
| 2022-03 | RAN4#102-e | R4-2207378 | | | | TP for TS 38.108 Dynamic range(7.3) and In channel selectivity(7.8) | 0.1.0 |
| 2022-03 | RAN4#102-e | R4-2207380 | | | | Draft text proposal for Clause 7.5 Out-of-band blocking - TS 38.108 | 0.1.0 |
| 2022-03 | RAN4#102-e | R4-2207382 | | | | TP to TS 38.108: section 7.6 (Rx spur) and section 7.7 (Rx IMD) | 0.1.0 |
| 2022-03 | RAN4#102-e | R4-2207383 | | | | TP to TS 38.108: annex A (FRC) | 0.1.0 |
| 2022-05 | RAN4#103-e | R4-2208663 | | | | TP to TS 38.108 on Conducted receiver characteristics | 0.2.0 |
| 2022-05 | RAN4#103-e | R4-2210849 | | | | pCR for Clause 4.3 Requirement reference points - TS 38.108 | 0.2.0 |
| 2022-05 | RAN4#103-e | R4-2210850 | | | | pCR for Annex D - TS 38.108 | 0.2.0 |
| 2022-05 | RAN4#103-e | R4-2210854 | | | | TP for 38.108: clause 7.3.2 Conducted transmission characteristics | 0.2.0 |
| 2022-05 | RAN4#103-e | R4-2210855 | | | | pCR to TS 38.108 – Transmitter spurious | 0.2.0 |
| 2022-05 | RAN4#103-e | R4-2210856 | | | | pCR to TS 38.108 – cleanup - alignment | 0.2.0 |
| 2022-05 | RAN4#103-e | R4-2210857 | | | | TP to TS 38.108 on 6.0 Conducted transmitter characteristics | 0.2.0 |
| 2022-05 | RAN4#103-e | R4-2210861 | | | | pCR for Clause 7.4 In-band selectivity and blocking - TS 38.108 | 0.2.0 |
| 2022-05 | RAN4#103-e | R4-2210862 | | | | pCR for Clause 7.5 Out-of-band blocking - TS 38.108 | 0.2.0 |
| 2022-05 | RAN4#103-e | R4-2210863 | | | | pCR for Clause 7.6 Receiver spurious emissions - TS 38.108 | 0.2.0 |
| 2022-05 | RAN4#103-e | R4-2210864 | | | | pCR for Clause 10.6.2 Minimum requirement for SAN type 1-O - TS 38.108 | 0.2.0 |
| 2022-05 | RAN4#103-e | R4-2210873 | | | | TP for TS 38.108, 6.6.4 Operating band unwanted emissions | 0.2.0 |
| 2022-05 | RAN4#103-e | R4-2211135 | | | | TP to TS 38.108: TS corrections; RF requirements | 0.2.0 |
| 2022-05 | RAN4#103-e | R4-2211202 | | | | TP to TS 38.108: removal of extreme conditions requirements | 0.2.0 |
| 2022-06 | RAN#96 | RP-221342 | | | | For RAN 1-step approval | 1.0.0 |

| Change history | | | | | | | |
|----------------|----------|-----------|------|-----|-----|---|-------------|
| Date | Meeting | TDoc | CR | Rev | Cat | Subject/Comment | New version |
| 2022-06 | RAN#96 | | | | | Approved by plenary – Rel-17 spec under change control | 17.0.0 |
| 2022-09 | RAN#97 | RP-222035 | 0001 | 1 | F | CR to TS 38.108 - conducted Tx requirements issues fixes | 17.1.0 |
| 2022-09 | RAN#97 | RP-222035 | 0002 | 1 | F | CR to TS 38.108 - conducted Rx requirements issues fixes | 17.1.0 |
| 2022-09 | RAN#97 | RP-222035 | 0003 | 1 | F | CR to TS 38.108 - OTA Tx requirements issues fixes | 17.1.0 |
| 2022-09 | RAN#97 | RP-222035 | 0004 | 1 | F | CR to TS 38.108 - OTA Rx requirements issues fixes | 17.1.0 |
| 2022-09 | RAN#97 | RP-222035 | 0006 | 1 | D | Correction of OTA ACLR absolute basic limit | 17.1.0 |
| 2022-09 | RAN#97 | RP-222035 | 0008 | 1 | F | Correction of OTA receiver spurious emission requirement | 17.1.0 |
| 2022-09 | RAN#97 | RP-222035 | 0010 | 1 | F | Correction of conducted receiver spurious emission requirement | 17.1.0 |
| 2022-09 | RAN#97 | RP-222035 | 0011 | | F | CR to TS 38.108: removal of NTN SAN output power accuracy requirements for the extreme test conditions, Rel-17 | 17.1.0 |
| 2022-12 | RAN#98-e | RP-223306 | 0012 | 1 | F | Corrections to SAN TS 38.108 | 17.2.0 |
| 2022-12 | RAN#98-e | RP-223306 | 0013 | | F | CR for TS 38.108, Correct definiton order in sub-clause 3.1 | 17.2.0 |
| 2022-12 | RAN#98-e | RP-223311 | 0022 | 1 | B | Description of general performance part sections for SAN TS 38.108 | 17.2.0 |
| 2022-12 | RAN#98-e | RP-223303 | 0024 | | B | Big CR on NTN SAN performance requirements (TS38.108, Rel-17) | 17.2.0 |
| 2022-12 | RAN#98-e | RP-223311 | 0025 | | F | CR to TS 38.108: removal of colocation requirements | 17.2.0 |
| 2023-03 | RAN#99 | RP-230516 | 0028 | 1 | F | CR to TS 38.108: OBUE and open issues clarifications | 17.3.0 |
| 2023-03 | RAN#99 | RP-230516 | 0027 | 1 | F | CR for TS 38.108, Correct unwanted emission requirements applicability for SAN type 1-H | 17.3.0 |
| 2023-03 | RAN#99 | RP-230516 | 0030 | 1 | F | CR to TS 38.108: corrections | 17.3.0 |
| 2023-06 | RAN#100 | RP-231344 | 0036 | | F | CR on NTN SAN performance requirements (TS38.108, Rel-17) | 17.4.0 |
| 2023-06 | RAN#100 | RP-231344 | 0037 | 1 | F | Corrections to SAN TS 38.108 | 17.4.0 |
| 2023-09 | RAN#101 | RP-232494 | 0038 | | F | CR for TS 38.108, Correction on antenna connector | 17.5.0 |
| 2023-09 | RAN#101 | RP-232494 | 0040 | 1 | F | CR to 38.108: Application of unwanted emissions requirements | 17.5.0 |
| 2023-09 | RAN#101 | RP-232494 | 0042 | | F | [NR_NTN_solutions-Perf] CR for channel model description in SAN PRACH demodulation requirement | 17.5.0 |
| 2023-12 | RAN#102 | RP-233349 | 0044 | 1 | F | CR for TS 38.108, Correction on out-of-band emissions | 17.6.0 |
| 2024-03 | RAN#103 | RP-240569 | 0050 | | F | (NR_NTN_solutions-Core) CR for TS 38.108, Correction on general SAN transmitter spurious emission limits in FR1 | 17.7.0 |
| 2024-03 | RAN#103 | RP-240570 | 0052 | 1 | F | (NR_NTN_solutions-Core) CR for TS 38.108 to update NTN frequency range (R17) | 17.7.0 |
| 2024-06 | RAN#104 | RP-241386 | 0057 | | F | Clarification for applicability of DSS for NTN FR1 bands | 17.8.0 |
| 2024-06 | RAN#104 | RP-241386 | 0063 | 1 | F | CR to 38.108: Minimum requirements for unwanted emissions for SAN (rel-17) | 17.8.0 |
| 2024-06 | RAN#104 | RP-241387 | 0065 | | F | CR for 38.108 on FR1 PUCCH demodulation requirements | 17.8.0 |
| 2024-06 | RAN#104 | RP-241386 | 0068 | | F | (NR_NTN_solutions-Core) CR to TS 38.108: Channel raster to resource element mapping | 17.8.0 |
| 2024-06 | RAN#104 | RP-241387 | 0070 | | F | (NR_NTN_solutions-Perf) CR to 38.108: Correction on FR1s in demod requirement | 17.8.0 |
| 2024-06 | RAN#104 | RP-241386 | 0073 | 1 | F | CR to TS 38.108: Corrections for non-regenerative payload and gateway | 17.8.0 |
| 2024-06 | RAN#104 | RP-241386 | 0077 | | F | CR to TS 38.108: Correction of the FR1-NTN frequency range | 17.8.0 |

History

| Document history | | |
|-------------------------|--------------|-------------|
| V17.0.0 | July 2022 | Publication |
| V17.1.0 | October 2022 | Publication |
| V17.2.0 | January 2023 | Publication |
| V17.3.0 | May 2023 | Publication |
| V17.4.0 | July 2023 | Publication |
| V17.5.0 | October 2023 | Publication |
| V17.6.0 | January 2024 | Publication |
| V17.7.0 | May 2024 | Publication |
| V17.8.0 | August 2024 | Publication |